

**ELECTROMAGNETIC EMISSIONS COMPLIANCE REPORT
INTENTIONAL RADIATOR CERTIFICATION TO
FCC PART 15 SUBPART C REQUIREMENT AND CANADIAN RSS 210
ISSUE 8 REQUIREMENTS**

OF

Tablet

MODEL No.: DMTAB-NV08B

FCC ID: ZYQ-DMTAB-NV08B

IC: 10558B-DMTABNV08B

Trademark: dreamtab

REPORT NO.: ES140304032E4

ISSUE DATE: March 14, 2014

Prepared for

KEEN HIGH HOLDING (HK) LIMITED

Unit 13, 7/F Technology Park, 18 On Lai street Shatin New Territories HK

Prepared by

SHENZHEN EMTEK CO., LTD.

Bldg 69, Majialong Industry Zone, Nanshan District, Shenzhen,

Guangdong, China

TEL: 86-755-26954280

FAX: 86-755-26954282

VERIFICATION OF COMPLIANCE

Applicant:	KEEN HIGH HOLDING (HK) LIMITED Unit 13, 7/F Technology Park, 18 On Lai street Shatin New Territories HK
Product Description:	Tablet
Model Number:	DMTAB-NV08B
File Number:	ES140304032E4
Date of Test:	March 4, 2014 to March 19, 2014

We hereby certify that:

The above equipment was tested by SHENZHEN EMTEK CO., LTD. The test data, data evaluation, test procedures, and equipment configurations shown in this report were made in accordance with the procedures given in ANSI C63.4 (2009) and the energy emitted by the sample EUT tested as described in this report is in compliance with conducted and radiated emission limits of FCC Rules Part 15.247 and Canadian RSS 210 Issue 8 Requirements..

The test results of this report relate only to the tested sample identified in this report.

Date of Test : March 4, 2014 to March 19, 2014

Prepared by : 
June Xie/Editor

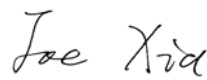
Reviewer : 
Joe Xia /Supervisor

Approve & Authorized Signer : 
Lisa Wang/Manager

Table of Contents

1. General Information	5
1.1 Product Description.....	5
1.2 Related Submittal(s) / Grant(s)	6
1.3 Test Methodology.....	6
1.4 Special Accessories	6
1.5 Equipment Modifications.....	6
1.6 Test Facility.....	6
2. System Test Configuration	7
2.1 EUT Configuration.....	7
2.2 EUT Exercise	7
2.3 Test Procedure.....	7
2.4 Configuration of Tested System.....	7
3. Description of Test Modes	9
4. Summary of Test Results	10
5. Conducted Emissions Test	11
5.1 Measurement Procedure.....	11
5.2 Test SET-UP (Block Diagram of Configuration)	11
5.3 Measurement Equipment Used	11
5.4 Conducted Emission Limit.....	11
5.5 Measurement Result.....	12
6. Radiated Emission Test.....	14
6.1 Measurement Procedure.....	14
6.2 Test SET-UP (Block Diagram of Configuration)	14
6.3 Measurement Equipment Used	15
6.4 Radiated Emission Limit.....	15
6.5 Measurement Result.....	17
7. 6dB Bandwidth Test	23
7.1 Measurement Procedure.....	23
7.2 Test SET-UP (Block Diagram of Configuration)	23
7.3 Measurement Equipment Used	23
7.4 Measurement Results	23
8. Maximum Peak Output Power Test	26
8.1 Measurement Procedure.....	26
8.2 Test SET-UP (Block Diagram of Configuration)	26
8.3 Measurement Equipment Used	26
8.4 Peak Power output limit.....	26
8.5 Measurement Results	26
9. Band Edge Test	27
9.1 Measurement Procedure.....	27
9.2 Test SET-UP (Block Diagram of Configuration)	27

9.3	Measurement Equipment Used	27
9.4	Measurement Results	27
10.	Power Density.....	28
10.1	Test Equipment.....	28
10.2	Measuring Instruments and Setting.....	28
10.3	Test Procedures	28
10.4	Block Diagram of Test Setup	28
10.5	Limit.....	28
10.6	Test Result.....	29
11	Antenna Port Emission.....	31
11.1	Test Equipment.....	31
11.2	Measuring Instruments and Setting.....	31
11.3	Test Procedures	31
11.4	Block Diagram of Test setup.....	31
11.5	Test Result.....	31
12.	Antenna Application.....	35
12.1	Antenna Requirement	35
12.2	Result	35

1. General Information

1.1 Product Description

A major technical descriptions of EUT is described as following:

A). Operation Frequency:

2.4G 802.11b/g/n(HT20):2412MHz-2462MHz; 802.11n(HT40): 2422MHz-2452MHz

5G 802.11a/n(HT20):5180-5240 MHz; 5745-5805 MHz;

802.11n(HT40): 5190-5230 MHz; 5755-5795 MHz;

Bluetooth 4.0: 2402-2480MHz

RFID: 13.56MHz

B). Modulation:

GFSK, 1/4 Π -DQPSK, 8DPSK for Bluetooth DSS+EDR;

GFSK for Bluetooth DTS(BLE)

OFDM with BPSK/QPSK/16QAM/64QAM for 802.11a/g/n,

DSSS with DBPSK/DQPSK/CCK for 802.11b; ASK for RFID;

C). Number of Channel: 2.4G 802.11b/g/n(HT20): 11channels; 802.11n(HT40): 7channels

5G 802.11a/n(HT20): 8channels; 802.11n(HT40): 4 channels; RFID: 1channel;

Bluetooth 4.0 DSS: 79 channels; Bluetooth 4.0 DTS: 40 channels;

D). Max Peak Conducted Power: 2.4G wifi 15.11dBm, 5G wifi 7.91dBm, Bluetooth 4.0

DSS: -1.86dBm; Bluetooth 4.0 DTS:0.139dBm

E) Antenna Gain: 1.4dBi for 2.4G WIFI&BT; 2.3dBi for 5G WIFI;

F). Antenna Type: Ceramics antenna

G). Power Supply: DC 3.7V from Li-ion Battery and DC 5V from AC adapter

H). Adapter : Model: W12-010N3A

Input: AC 100-240V, 50/60Hz, 0.3A

Output: DC 5.0V, 2A

Channel	Frequency (MHz)	Channel	Frequency (MHz)	Channel	Frequency (MHz)
1	2402	15	2430	29	2458
2	2404	16	2432	30	2460
3	2406	17	2434	31	2462
4	2408	18	2436	32	2464
5	2410	19	2438	33	2466
6	2412	20	2440	34	2468
7	2414	21	2442	35	2470
8	2416	22	2444	36	2472
9	2418	23	2446	37	2474
10	2420	24	2448	38	2476
11	2422	25	2450	39	2478
12	2424	26	2452	40	2480
13	2426	27	2454		
14	2428	28	2456		

Note:

1. This device is included BT4.0 BLE transceiver function.
2. Test of channel was included the lowest middle and highest frequency in lowest data rate and to perform the test, then record on this report.

1.2 Related Submittal(s) / Grant(s)

This submittal(s) (test report) is intended for FCC ID: ZYQ-DMTAB-NV08B filing to comply with Section 15.247 of the FCC Part 15, Subpart C Rules and also intended for IC ID: 10558B-DMTABNV08B filing to comply with Canadian RSS 210 Issue 8.0.
The composite system is compliance with Subpart B is authorized under a DOC procedure.

1.3 Test Methodology

All the test program has follow FCC new test procedure KDB558074 D01 v03r01, Both conducted and radiated testing was performed according to the procedures in ANSI C63.10 (2009). Radiated testing was performed at an antenna to EUT distance 3 meters.

1.4 Special Accessories

Not available for this EUT intended for grant.

1.5 Equipment Modifications

Not available for this EUT intended for grant.

1.6 Test Facility

Site Description
EMC Lab.

: Accredited by CNAS, 2013.10.29
The certificate is valid until 2016.10.28
The Laboratory has been assessed and proved to be in compliance with CNAS/CL01: 2006(identical to ISO/IEC17025: 2005)
The Certificate Registration Number is L2291

Accredited by TUV Rheinland Shenzhen 2010.5.25
The Laboratory has been assessed according to the requirements ISO/IEC 17025

Accredited by FCC, October 28, 2010
The Certificate Registration Number is 406365.

Accredited by Industry Canada, March 05, 2010
The Certificate Registration Number is 46405-4480.

Name of Firm : SHENZHEN EMTEK CO., LTD.
Site Location : Bldg 69, Majialong Industry Zone,
Nanshan District, Shenzhen, Guangdong, China

2. System Test Configuration

2.1 EUT Configuration

The EUT configuration for testing is installed on RF field strength measurement to meet the Commissions requirement and operating in a manner which intends to maximize its emission characteristics in a continuous normal application.

2.2 EUT Exercise

The Transmitter was operated in the normal operating mode. The TX frequency was fixed which was for the purpose of the measurements.

2.3 Test Procedure

2.3.1 Conducted Emissions

The EUT is a placed on as turn table which is 0.8 m above ground plane. According to the requirements of ANSI C63.4-2009 Conducted emissions from the EUT measured in the frequency range between 0.15 MHz and 30 MHz using CISPR Quasi-Peak and average detector mode.

2.3.2 Radiated Emissions

The EUT is a placed on as turn table which is 0.8 m above ground plane. The turn table shall rotate 360 degrees to determine the position of maximum emission level. EUT is set 3m away from the receiving antenna which varied from 1m to 4m to find out the highest emission. And also, each emission was to be maximized by changing the polarization of receiving antenna both horizontal and vertical. In order to find out the max. Emission, the relative positions of this hand-held transmitter (EUT) was rotated through three orthogonal axes according to the requirements in Section 13.1.4.1 of ANSI C63.4-2009.

2.4 Configuration of Tested System

Fig. 2-1 Configuration of Tested System

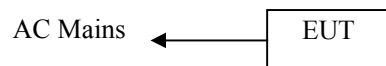

Table 2-1 Equipment Used in Tested System

Item	Equipment	Mfr/Brand	Model/Type No.	FCC ID	IC ID	Series No.	Note
1.	Tablet	dreamtab	DMTAB-N V08B	ZYQ-DMTAB- NV08B	10558B-DMTABN V08B	N/A	EUT

Note:

- (1) Unless otherwise denoted as EUT in 『Remark』 column, device(s) used in tested system is a support equipment.

3. Description of Test Modes

The Transmitter of EUT is an Internet Tablet and powered by host equipment; these is Digital Transmission system (DTS) and with modulation GFSK.

The mode is used: **Transmitting mode**

1. For lowest channel : 2402MHz (Channel 01)
2. For middle channel : 2440MHz (Channel 20)
3. For highest channel: 2480MHz (Channel 40)

4. Summary of Test Results

FCC Rules	IC Rules	Description Of Test	Result
§15.247(a)(2)	RSS-210, A8.2(a)	6dB bandwidth	Pass
§15.247(b)(3)	RSS-210, A8.4(2)	Max Peak output Power test	Pass
§15.247(e)	RSS-210, A8.2(b)	Power density	Pass
§15.247(d)	RSS-210, A2.9, A8.5	Band edge test	Pass
§15.207	RSS-GEN, Section 7.2.2	AC Power Conducted Emission	Pass
§15.247(d), §15.209	RSS-210, A2.9, A8.5	Radiated Emission	Pass
§15.247(d)	RSS-210, A8.5 RSS-GEN, Section 7.2.3	Antenna Port Emission	Pass
§15.247(b)&§15.203	N/A	Antenna Application	Pass

5. Conducted Emissions Test

5.1 Measurement Procedure

1. The EUT was placed on a table which is 0.8m above ground plane.
2. Maximum procedure was performed on the six highest emissions to ensure EUT compliance.
3. Repeat above procedures until all frequency measured were complete.

5.2 Test SET-UP (Block Diagram of Configuration)

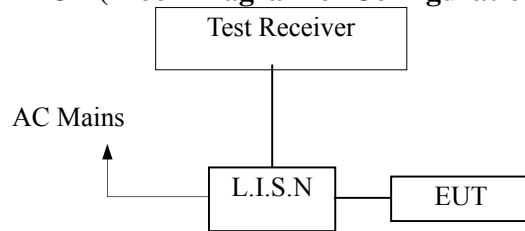

5.3 Measurement Equipment Used

Conducted Emission Test Site					
EQUIPMENT TYPE	MFR	MODEL NUMBER	SERIAL NUMBER	LAST CAL.	CAL DUE.
Test Receiver	Rohde & Schwarz	ESCS30	828985/018	05/29/2013	05/28/2014
L.I.S.N.	Schwarzbeck	NNLK8129	8129203	05/29/2013	05/28/2014
50Ω Coaxial Switch	Anritsu	MP59B	M20531	N/A	N/A
Pulse Limiter	Rohde & Schwarz	ESH3-Z2	100006	05/29/2013	05/28/2014
Voltage Probe	Rohde & Schwarz	TK9416	N/A	05/29/2013	05/28/2014
I.S.N	Rohde & Schwarz	ENY22	1109.9508.02	05/29/2013	05/28/2014

5.4 Conducted Emission Limit

Conducted Emission

Frequency(MHz)	Quasi-peak	Average
0.15-0.5	66-56	56-46
0.5-5.0	56	46
5.0-30.0	60	50

- Note:** 1. The lower limit shall apply at the transition frequencies
 2. The limit decreases in line with the logarithm of the frequency in the range of 0.15 to 0.50MHz.

5.5 Measurement Result

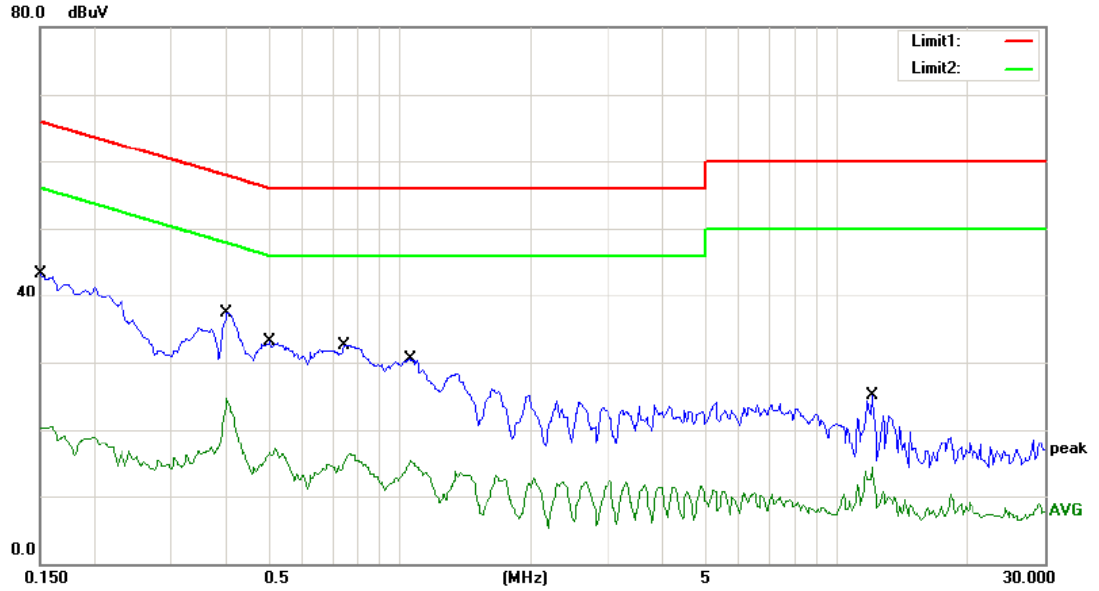

Site Conduction #1 Phase: **N** Temperature: 24
 Limit: (CE)FCC PART 15 class B QP Power: AC 120V/60Hz Humidity: 53 %
 Mode: ON
 Note:

No.	Mk.	Freq.	Reading Level	Correct Factor	Measurement	Limit	Over	Detector	Comment
		MHz	dBuV	dB	dBuV	dBuV	dB		
1		0.1500	43.27	0.00	43.27	66.00	-22.73	QP	
2		0.1500	20.57	0.00	20.57	56.00	-35.43	AVG	
3	*	0.4000	37.30	0.00	37.30	57.85	-20.55	QP	
4		0.4000	24.70	0.00	24.70	47.85	-23.15	AVG	
5		0.5050	33.14	0.00	33.14	56.00	-22.86	QP	
6		0.5050	17.07	0.00	17.07	46.00	-28.93	AVG	
7		0.7450	32.58	0.00	32.58	56.00	-23.42	QP	
8		0.7450	16.23	0.00	16.23	46.00	-29.77	AVG	
9		1.0550	30.42	0.00	30.42	56.00	-25.58	QP	
10		1.0550	15.27	0.00	15.27	46.00	-30.73	AVG	
11		12.0750	25.18	0.00	25.18	60.00	-34.82	QP	
12		12.0750	14.37	0.00	14.37	50.00	-35.63	AVG	

*:Maximum data x:Over limit l:over margin Comment: Factor build in receiver. Operator: KK

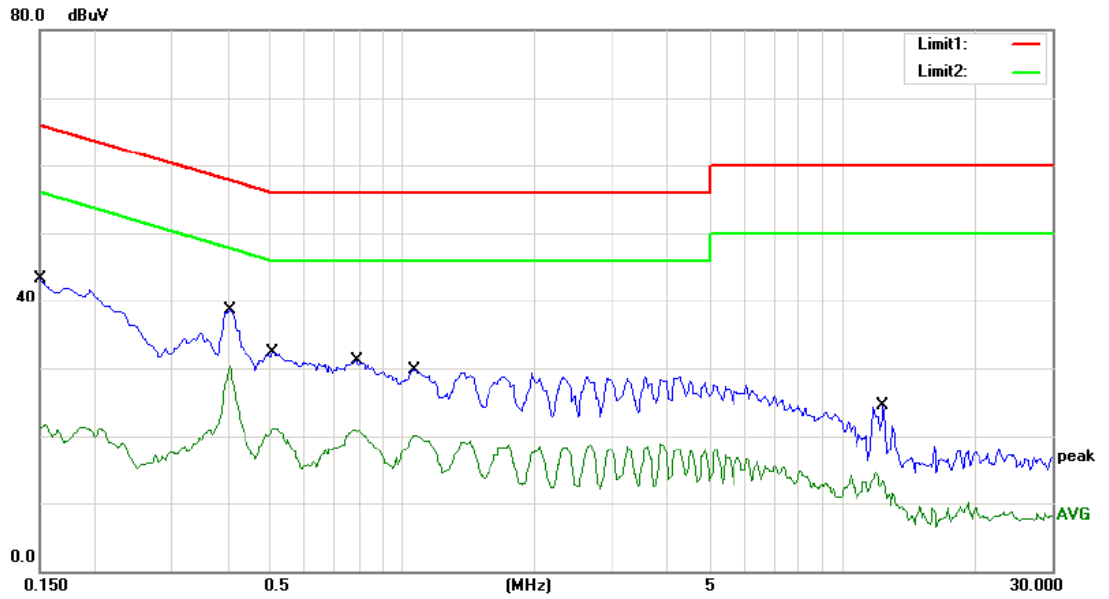

Site Conduction #1 Phase: **L1** Temperature: 24
 Limit: (CE)FCC PART 15 class B_QP Power: AC 120V/60Hz Humidity: 53 %
 Mode: ON
 Note:

No.	Mk.	Freq. MHz	Reading Level dBuV	Correct Factor dB	Measure- ment dBuV	Limit dBuV	Over dB	Detector	Comment
1		0.1500	43.31	0.00	43.31	66.00	-22.69	QP	
2		0.1500	21.73	0.00	21.73	56.00	-34.27	AVG	
3		0.4050	38.48	0.00	38.48	57.75	-19.27	QP	
4	*	0.4050	30.33	0.00	30.33	47.75	-17.42	AVG	
5		0.5100	32.23	0.00	32.23	56.00	-23.77	QP	
6		0.5100	21.14	0.00	21.14	46.00	-24.86	AVG	
7		0.7850	31.08	0.00	31.08	56.00	-24.92	QP	
8		0.7850	21.00	0.00	21.00	46.00	-25.00	AVG	
9		1.0700	29.73	0.00	29.73	56.00	-26.27	QP	
10		1.0700	20.19	0.00	20.19	46.00	-25.81	AVG	
11		12.4250	24.51	0.00	24.51	60.00	-35.49	QP	
12		12.4250	14.47	0.00	14.47	50.00	-35.53	AVG	

*:Maximum data x:Over limit !:over margin Comment: Factor build in receiver. Operator: KK

6. Radiated Emission Test

6.1 Measurement Procedure

1. The EUT was placed on a turn table which is 0.8m above ground plane.
2. Maximum procedure was performed on the six highest emissions to ensure EUT compliance.
3. And also, each emission was to be maximized by changing the polarization of receiving antenna both horizontal and vertical.
4. Repeat above procedures until all frequency measured was complete.

For emissions measurement set the bandwidth of the Spectrum's RBW at 1MHz above 1GHz and RBW 100 KHz below 1GHz.

6.2 Test SET-UP (Block Diagram of Configuration)

(A) Radiated Emission Test Set-Up, Frequency Below 30MHz

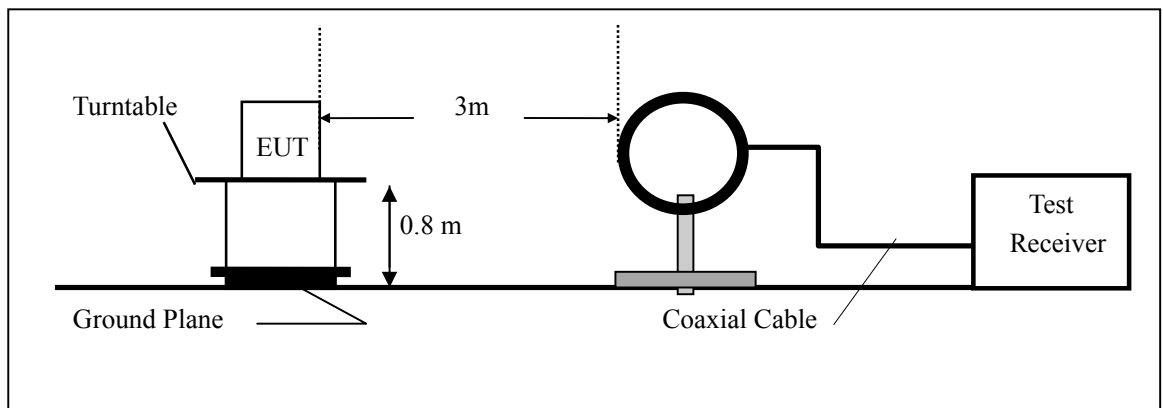

(B) Radiated Emission Test Set-Up, Frequency Below 1000MHz

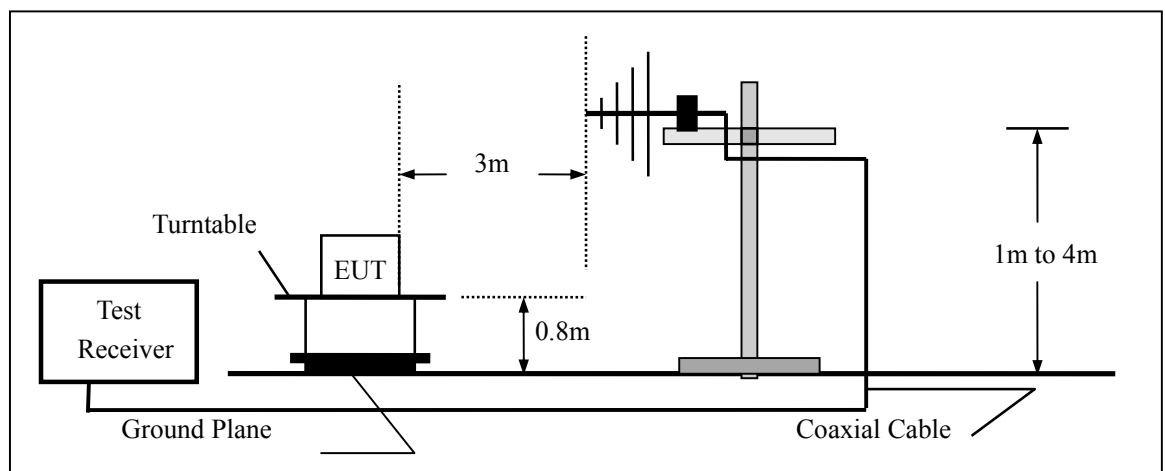

(C) Radiated Emission Test Set-Up, Frequency above 1000MHz

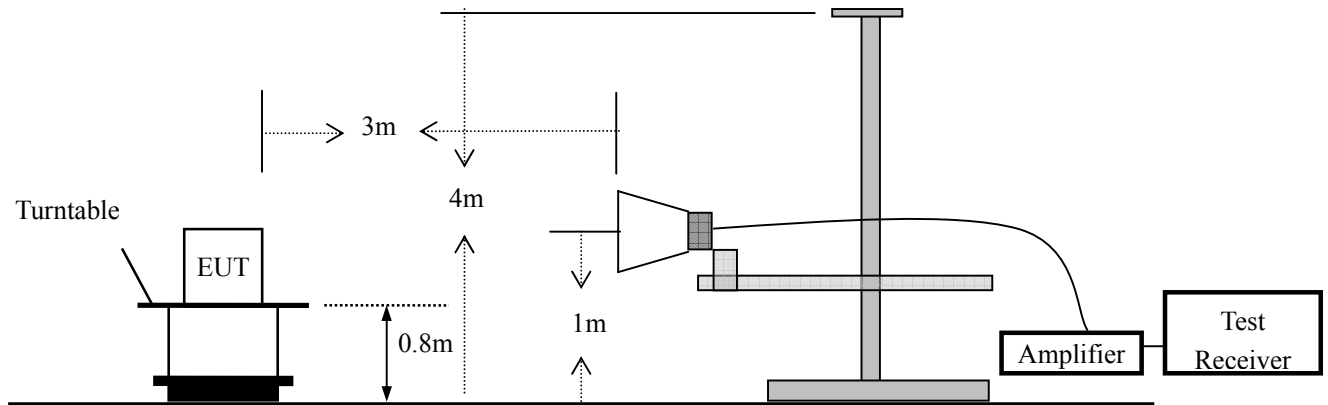

6.3 Measurement Equipment Used

EQUIPMENT TYPE	MFR	MODEL NUMBER	SERIAL NUMBER	LAST CAL.	CAL DUE.
EMI Test Receiver	Rohde & Schwarz	ESU	1302.6005.26	05/29/2013	05/28/2014
Pre-Amplifier	HP	8447D	2944A07999	05/29/2013	05/28/2014
Bilog Antenna	Schwarzbeck	VULB9163	142	05/14/2013	05/13/2014
Loop Antenna	ARA	PLA-1030/B	1029	05/14/2013	05/13/2014
Horn Antenna	Schwarzbeck	BBHA 9170	BBHA9170399	05/14/2013	05/13/2014
Horn Antenna	Schwarzbeck	BBHA 9120	D143	05/14/2013	05/13/2014
Cable	Schwarzbeck	AK9513	ACRX1	05/29/2013	05/28/2014
Cable	Rosenberger	N/A	FP2RX2	05/29/2013	05/28/2014
Cable	Schwarzbeck	AK9513	CRPX1	05/29/2013	05/28/2014
Cable	Schwarzbeck	AK9513	CRRX2	05/29/2013	05/28/2014

6.4 Radiated Emission Limit

The emissions from an intentional radiator shall not exceed the field strength levels specified in the following table 15.209(a):

Frequencies (MHz)	Field Strength (micровolts/meter)	Measurement Distance (meters)
0.009~0.490	2400/F(KHz)	300
0.490~1.705	24000/F(KHz)	30
1.705~30.0	30	30
30~88	100	3
88~216	150	3
216~960	200	3
Above 960	500	3

15.205 Restricted bands of operation

MHz	MHz	MHz	GHz
0.090 - 0.110	16.42 - 16.423	399.9 - 410	4.5 - 5.15
¹ 0.495 - 0.505	16.69475 - 16.69525	608 - 614	5.35 - 5.46
2.1735 - 2.1905	16.80425 - 16.80475	960 - 1240	7.25 - 7.75
4.125 - 4.128	25.5 - 25.67	1300 - 1427	8.025 - 8.5
4.17725 - 4.17775	37.5 - 38.25	1435 - 1626.5	9.0 - 9.2
4.20725 - 4.20775	73 - 74.6	1645.5 - 1646.5	9.3 - 9.5
6.215 - 6.218	74.8 - 75.2	1660 - 1710	10.6 - 12.7
6.26775 - 6.26825	108 - 121.94	1718.8 - 1722.2	13.25 - 13.4
6.31175 - 6.31225	123 - 138	2200 - 2300	14.47 - 14.5
8.291 - 8.294	149.9 - 150.05	2310 - 2390	15.35 - 16.2
8.362 - 8.366	156.52475 - 156.52525	2483.5 - 2500	17.7 - 21.4
8.37625 - 8.38675	156.7 - 156.9	2690 - 2900	22.01 - 23.12
8.41425 - 8.41475	162.0125 - 167.17	3260 - 3267	23.6 - 24.0
12.29 - 12.293	167.72 - 173.2	3332 - 3339	31.2 - 31.8
12.51975 - 12.52025	240 - 285	3345.8 - 3358	36.43 - 36.5
12.57675 - 12.57725	322 - 335.4	3600 - 4400	(²)

- Remark: 1. Emission level in dBuV/m=20 log (uV/m)
 2. Measurement was performed at an antenna to the closed point of EUT distance of meters.
 3. Only spurious frequency is permitted to locate within the Restricted Bands specified in provision of § 15.205, and the emissions located in restricted bands also comply with 15.209 limit.

6.5 Measurement Result

Operation Mode: TX Mode Test Date : March 4, 2014
 Frequency Range: 30~1000MHz Temperature : 26°C
 Test Result: PASS Humidity : 60 %
 Measured Distance: 3m Test By: WOLF

Freq. (MHz)	Ant.Pol. H/V	Emission Level (dBuV/m)	Limit 3m (dBuV/m)	Over (dB)
--	--	--	--	--

Note: the amplitude of spurious emission that is attenuated by more than 20dB below the permissible limit has no need to be reported.

Distance extrapolation factor =40log(Specific distance/ test distance)(dB);

Limit line=Specific limits(dBuV) + distance extrapolation factor.

Operation Mode: TX Channel 01 Test Date : March 4, 2014
 Frequency Range: 30~1000MHz Temperature : 26°C
 Test Result: PASS Humidity : 60 %
 Measured Distance: 3m Test By: WOLF

Freq. (MHz)	Ant.Pol. H/V	Emission Level (dBuV/m)	Limit 3m (dBuV/m)	Over (dB)	Note
31.55	V	28.61	40.00	-11.39	PK
40.88	V	32.68	40.00	-7.32	PK
47.10	V	30.32	40.00	-9.68	PK
87.52	V	29.18	40.00	-10.82	PK
127.93	V	29.77	43.50	-13.73	PK
162.13	V	28.14	43.50	-15.36	PK
87.52	H	23.05	40.00	-16.95	PK
168.35	H	29.17	43.50	-14.33	PK
188.56	H	29.41	43.50	-14.09	PK
267.84	H	30.36	46.00	-15.64	PK
333.13	H	28.39	46.00	-17.61	PK
463.70	H	27.98	46.00	-18.02	PK

- Note:**
- (1) All Readings are Peak Value.
 - (2) Emission Level= Reading Level+Probe Factor +Cable Loss.
 - (3) The average measurement was not performed when the peak measured data under the limit of average detection.
 - (4) EUT stood on the table position is the worst case result in the report.

Operation Mode: TX Channel 20 Test Date : March 4, 2014
 Frequency Range: 30~1000MHz Temperature : 26°C
 Test Result: PASS Humidity : 60 %
 Measured Distance: 3m Test By: WOLF

Freq. (MHz)	Ant.Pol. H/V	Emission Level (dBuV/m)	Limit 3m (dBuV/m)	Over (dB)	Note
33.10	V	29.36	40.00	-10.64	PK
40.40	V	32.33	40.00	-7.67	PK
47.77	V	30.53	40.00	-9.47	PK
89.57	V	27.95	40.00	-12.05	PK
126.88	V	29.32	43.50	-14.18	PK
160.96	V	28.41	43.50	-15.09	PK
88.88	H	20.49	40.00	-19.51	PK
166.27	H	28.39	43.50	-15.11	PK
189.58	H	29.91	43.50	-13.59	PK
269.05	H	30.87	46.00	-15.13	PK
334.11	H	28.60	46.00	-17.40	PK
464.54	H	28.43	46.00	-17.57	PK

- Note:**
- (1) All Readings are Peak Value.
 - (2) Emission Level= Reading Level+Probe Factor +Cable Loss.
 - (3) The average measurement was not performed when the peak measured data under the limit of average detection.
 - (4) EUT stood on the table position is the worst case result in the report.

Operation Mode: TX Channel 40 Test Date : March 4, 2014
 Frequency Range: 30~1000MHz Temperature : 26°C
 Test Result: PASS Humidity : 60 %
 Measured Distance: 3m Test By: WOLF

Freq. (MHz)	Ant.Pol. H/V	Emission Level (dBuV/m)	Limit 3m (dBuV/m)	Over (dB)	Note
39.33	V	33.06	40.00	-6.94	PK
45.55	V	30.34	40.00	-9.66	PK
87.52	V	31.10	40.00	-8.90	PK
126.38	V	27.09	43.50	-16.41	PK
183.89	V	27.61	43.50	-15.89	PK
199.44	V	26.46	43.50	-17.04	PK
87.52	H	23.54	40.00	-16.46	PK
168.35	H	27.74	43.50	-15.76	PK
190.11	H	29.32	43.50	-14.18	PK
266.28	H	30.87	46.00	-15.13	PK
333.13	H	29.05	46.00	-16.95	PK
570.96	H	29.85	46.00	-16.15	PK

- Note:**
- (1) All Readings are Peak Value.
 - (2) Emission Level= Reading Level+Probe Factor +Cable Loss.
 - (3) The average measurement was not performed when the peak measured data under the limit of average detection.
 - (4) EUT stood on the table position is the worst case result in the report.

Operation Mode: TX Channel 01 Test Date : March 4, 2014
 Frequency Range: 1GHz~25GHz Temperature : 26°C
 Test Result: PASS Humidity : 60 %
 Measured Distance: 3m Test By: WOLF

Freq. (MHz)	Ant.Pol. H/V	Emission Level(dBuV/m)		Limit 3m(dBuV/m)		Over(dB)	
		PK	AV	PK	AV	PK	AV
4805.31	V	49.26	32.17	74.00	54.00	-24.74	-21.83
7221.49	V	47.33	30.24	74.00	54.00	-26.67	-23.76
9635.08	V	48.45	31.07	74.00	54.00	-25.55	-22.93
--	--	--	--	--	--	--	--
--	--	--	--	--	--	--	--
--	--	--	--	--	--	--	--
4805.32	H	49.23	32.28	74.00	54.00	-24.77	-21.72
7223.59	H	48.17	31.15	74.00	54.00	-25.83	-22.85
9635.08	H	47.25	30.09	74.00	54.00	-26.75	-23.91

All emissions not reported were more than 20dB below the specified limit or in the noise floor.

- Note:**
- (1) All Readings are Peak Value and AV.
 - (2) Emission Level= Reading Level+Probe Factor +Cable Loss.
 - (3) Data of measurement within this frequency range shown “ -- ” in the table above means the reading of emissions are attenuated more than 20dB below the permissible limits or the field strength is too small to be measured.

Operation Mode:	TX Channel 20	Test Date :	March 4, 2014
Frequency Range:	1GHz~25GHz	Temperature :	26°C
Test Result:	PASS	Humidity :	60 %
Measured Distance:	3m	Test By:	WOLF

Freq. (MHz)	Ant.Pol. H/V	Emission Level(dBuV/m)		Limit 3m(dBuV/m)		Over(dB)	
		PK	AV	PK	AV	PK	AV
4893.33	V	48.77	33.38	74	54	-25.23	-20.62
7349.90	V	47.05	30.10	74	54	-26.95	-23.90
9798.96	V	47.45	32.48	74	54	-26.55	-21.52
--	--	--	--	--	--	--	--
--	--	--	--	--	--	--	--
--	--	--	--	--	--	--	--
4893.43	H	48.78	32.59	74	54	-25.22	-21.41
7352.12	H	48.92	30.74	74	54	-25.08	-23.26
9799.49	H	46.66	30.87	74	54	-27.34	-23.13

All emissions not reported were more than 20dB below the specified limit or in the noise floor.

- Note:**
- (1) All Readings are Peak Value and AV.
 - (2) Emission Level= Reading Level+Probe Factor +Cable Loss.
 - (3) Data of measurement within this frequency range shown “ -- ” in the table above means the reading of emissions are attenuated more than 20dB below the permissible limits or the field strength is too small to be measured.

Operation Mode: TX Channel 40 Test Date : March 4, 2014
 Frequency Range: 1GHz~25GHz Temperature : 26°C
 Test Result: PASS Humidity : 60 %
 Measured Distance: 3m Test By: WOLF

Freq. (MHz)	Ant.Pol. H/V	Emission Level(dBuV/m)		Limit 3m(dBuV/m)		Over(dB)	
		PK	AV	PK	AV	PK	AV
4966.42	V	47.78	32.81	74.00	54.00	-26.22	-21.19
7466.92	V	46.22	30.31	74.00	54.00	-27.78	-23.69
9937.53	V	47.47	32.33	74.00	54.00	-26.53	-21.67
--	--	--	--	--	--	--	--
--	--	--	--	--	--	--	--
--	--	--	--	--	--	--	--
4968.65	H	47.90	33.24	74.00	54.00	-26.10	-20.76
7467.70	H	48.01	31.46	74.00	54.00	-25.99	-22.54
9937.60	H	47.11	30.56	74.00	54.00	-26.89	-23.44

All emissions not reported were more than 20dB below the specified limit or in the noise floor.

- Note:**
- (1) All Readings are Peak Value and AV.
 - (2) Emission Level= Reading Level+Probe Factor +Cable Loss.
 - (3) Data of measurement within this frequency range shown “ -- ” in the table above means the reading of emissions are attenuated more than 20dB below the permissible limits or the field strength is too small to be measured.

7. 6dB Bandwidth Test

7.1 Measurement Procedure

The EUT was operating in BLE mode or could be controlled its channel. Printed out the test result from the spectrum by hard copy function.

1. Set resolution bandwidth (RBW) = 100 kHz.
2. Set the video bandwidth (VBW) $\geq 3 \times$ RBW.
3. Detector = Peak.
4. Trace mode = max hold.
5. Sweep = auto couple.
6. Allow the trace to stabilize.
7. Measure the maximum width of the emission that is constrained by the frequencies associated with the two outermost amplitude points (upper and lower frequency) that are attenuated by 6 dB relative to the maximum level measured in the fundamental emission.

7.2 Test SET-UP (Block Diagram of Configuration)

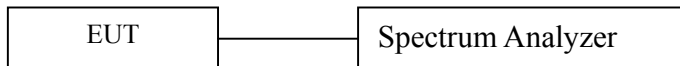

7.3 Measurement Equipment Used

EQUIPMENT TYPE	MFR	MODEL NUMBER	SERIAL NUMBER	LAST CAL.	CAL DUE.
Spectrum Analyzer	Agilent	E4407B	88156318	05/29/2013	05/28/2014

7.4 Measurement Results

6 Bandwidth Test Data Chart:
 Refer to attached data chart.

Spectrum Detector: PK Test Date : March 13, 2014
 Test By: Jack Temperature : 26°C
 Test Result: PASS Humidity : 60 %

Channel number	Channel frequency (MHz)	Measurement level (KHz)	Required Limit (kHz)
01	2402	538.556	>500
20	2440	536.082	>500
40	2480	537.316	>500

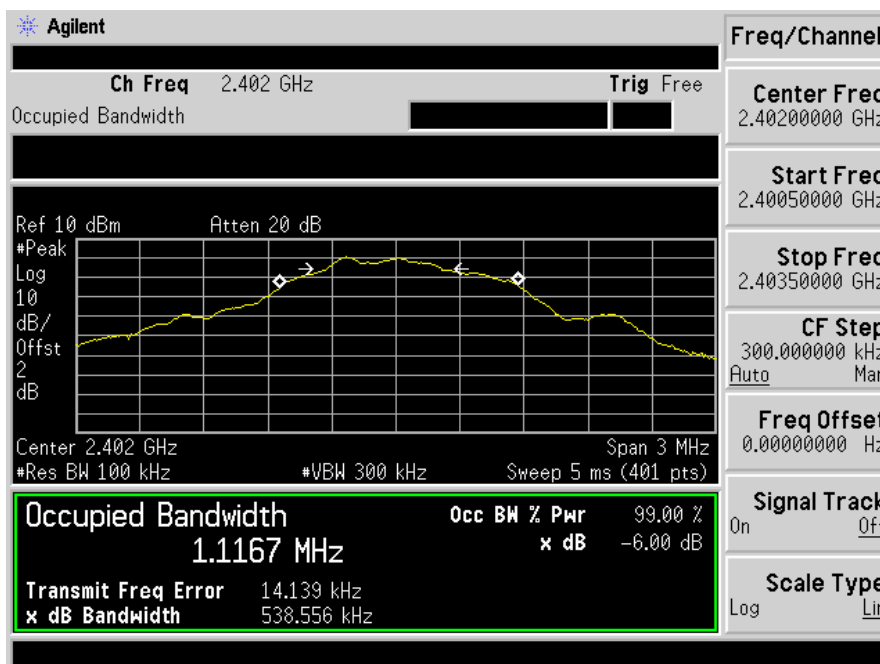

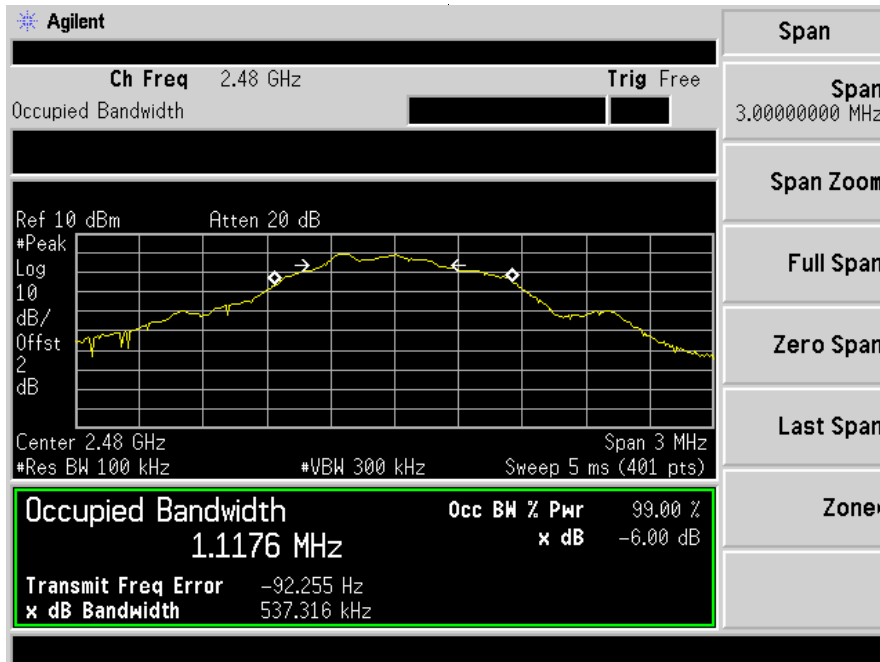
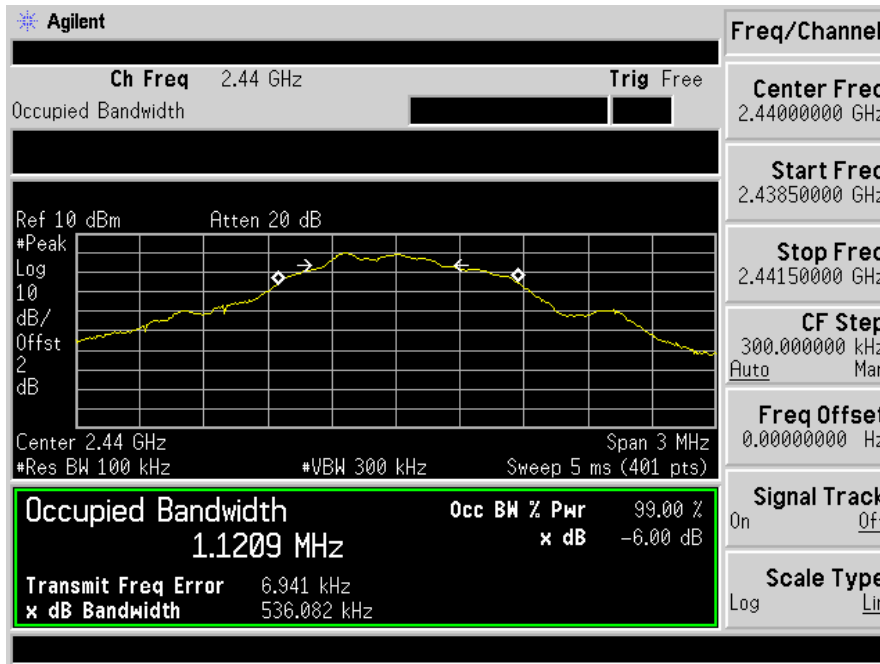

8. Maximum Peak Output Power Test

8.1 Measurement Procedure

The maximum peak conducted output power can be measured using a broadband peak RF power meter. The power meter must have a video bandwidth that is greater than or equal to the DTS bandwidth and shall utilize a fast, average-responding diode type sensor.

- a. The Transmitter output (antenna port) was connected to the power meter.
- b. Turn on the EUT and power meter and then record the peak power value.
- c. Repeat above procedures on all channels needed to be tested.

8.2 Test SET-UP (Block Diagram of Configuration)



8.3 Measurement Equipment Used

EQUIPMENT TYPE	MODEL NUMBER	SERIAL NUMBER	LAST CAL.	CAL DUE.
Power meter	ML2495A	0824006	05/29/2013	05/28/2014
Power sensor	MA2411B	0738172	05/29/2013	05/28/2014

8.4 Peak Power output limit

The maximum peak power shall be less 1Watt.

8.5 Measurement Results

Spectrum Detector:	PK	Test Date :	March 13, 2014
Test By:	Joe	Temperature :	26°C
Test Result:	PASS	Humidity :	60 %

Channel number	Channel Frequency(MHz)	Peak Power output(dBm)	Peak Power Limit(W)	Pass/Fail
01	2402	0.039	1W(30dBm)	PASS
20	2440	0.139	1W(30dBm)	PASS
40	2480	-0.192	1W(30dBm)	PASS

9. Band Edge Test

9.1 Measurement Procedure

1. The EUT was Operating in hopping mode or could be controlled its channel. Printed out test result from the spectrum by hard copy function.
2. The EUT was placed on a turn table which is 0.8m above ground plane.
3. Maximum procedure was performed on the six highest emissions to ensure EUT compliance.
4. And also, each emission was to be maximized by changing the polarization of receiving antenna both horizontal and vertical.
5. Repeat above procedures until all frequency measured were complete.

9.2 Test SET-UP (Block Diagram of Configuration)

As 6.2 Test set up (B) and (C)

9.3 Measurement Equipment Used

Same as 6.3 Radiated Emission Measurement.

9.4 Measurement Results

Spectrum Detector:	PK/AV	Test Date :	March 13, 2014
Test By:	Joe	Temperature :	26°C
Test channel:	01	Humidity :	60 %

Frequency (MHz)	Polarity	Level (dBuV/m)		Limited (dBuV/m)	
		PK	AV	PK	AV
2390	H	45.31	26.73	74	54
2390	V	46.42	28.59	74	54

Spectrum Detector:	PK/AV	Test Date :	March 13, 2014
Test By:	Joe	Temperature :	26°C
Test channel:	40	Humidity :	60 %

Frequency (MHz)	Polarity	Level (dBuV/m)		Limited (dBuV/m)	
		PK	AV	PK	AV
2483.5	H	45.21	26.72	74	54
2483.5	V	46.13	26.87	74	54

10. Power Density

10.1 Test Equipment

EQUIPMENT TYPE	MFR	MODEL NUMBER	SERIAL NUMBER	LAST CAL.	CAL DUE.
Spectrum Analyzer	Agilent	E4407B	88156318	05/29/2013	05/28/2014

10.2 Measuring Instruments and Setting

The following table is the setting of spectrum analyzer.

Spectrum analyzer	Setting
Attenuation	Auto
Span Frequency	Set the span to 1.5 times the DTS bandwidth.
RB	3kHz \leq RBW \leq 100KHz
VB	3 x RBW
Detector	Peak
Trace	Max hold
Sweep Time	Automatic

10.3 Test Procedures

- a. The transmitter output (antenna port) was connected to the spectrum analyzer.
- b. Set analyzer center frequency to DTS channel center frequency.
- c. Set the analyzer span to a minimum of 1.5 times the DTS bandwidth.
- d. Set the RBW \geq 3 kHz. Set the VBW \geq 3 x RBW.
- e. Detector = peak.
- f. Sweep time = auto couple.
- g. Trace mode = max hold.
- h. Allow trace to fully stabilize.
- i. Use the peak marker function to determine the maximum amplitude level.

10.4 Block Diagram of Test Setup

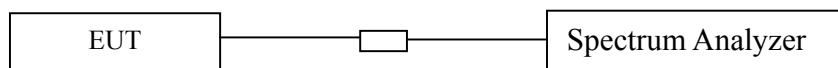

10.5 Limit

The transmitted power density averaged over any 1 second interval shall not be greater +8dBm in any 3 kHz bandwidth.

10.6 Test Result

Spectrum Detector: PK Test Date : March 19, 2014
 Test By: Joe Temperature : 26°C
 Test Result: PASS Humidity : 60 %

Channel	Measurement Level (dBm)	Required Limit (dBm)	Result
01	-15.57	<8dBm	PASS
20	-16.19	<8dBm	PASS
40	-16.46	<8dBm	PASS

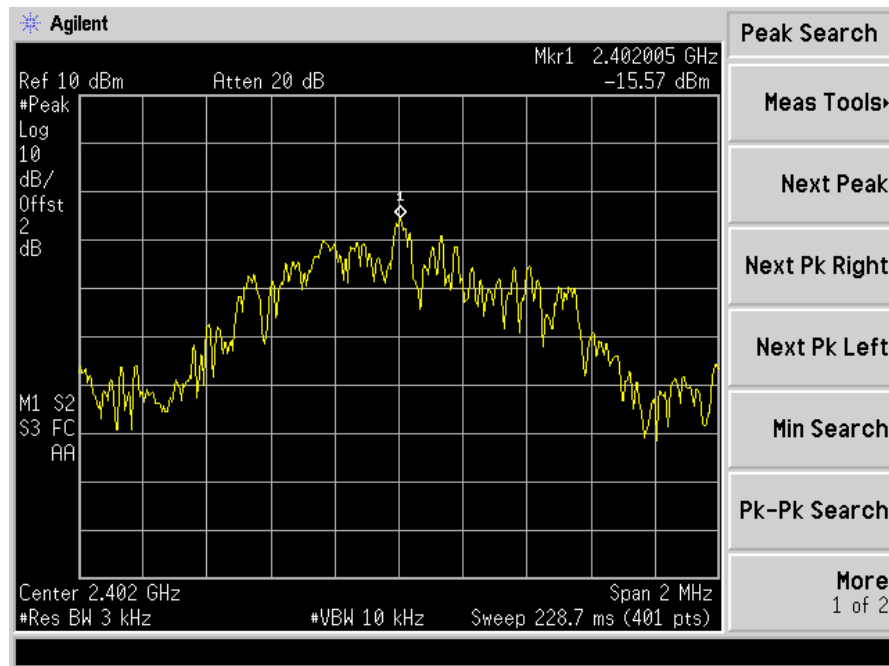

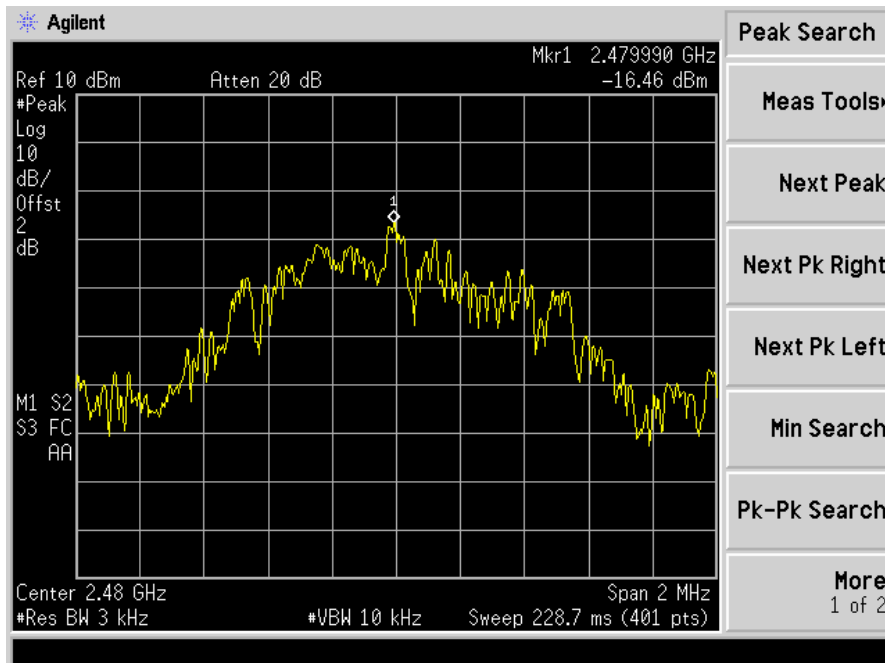
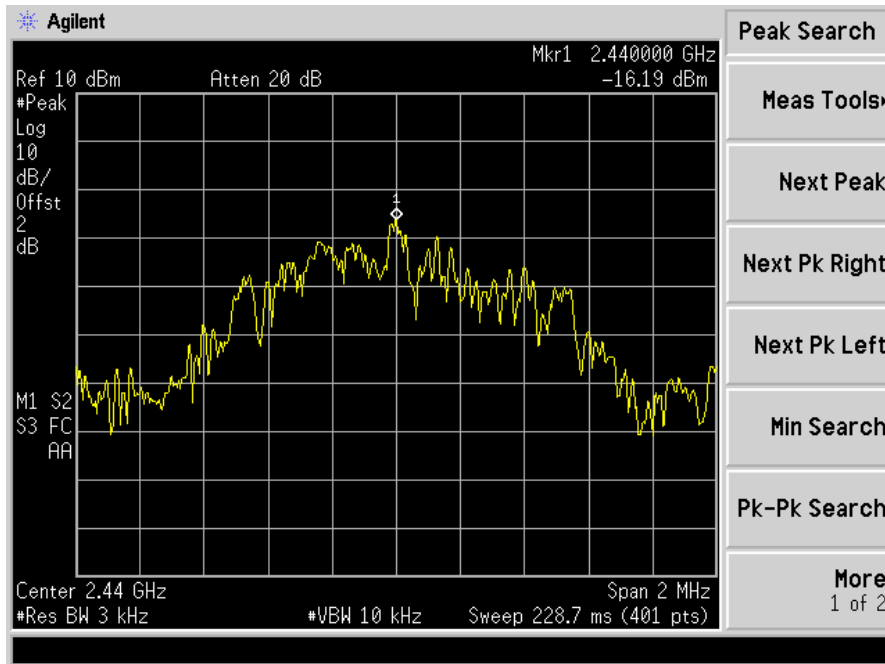

11 Antenna Port Emission

11.1 Test Equipment

EQUIPMENT TYPE	MFR	MODEL NUMBER	SERIAL NUMBER	LAST CAL.	CAL DUE.
Spectrum Analyzer	Agilent	E4407B	88156318	05/29/2013	05/28/2014

11.2 Measuring Instruments and Setting

The following table is the setting of spectrum analyzer.

Spectrum analyzer	Setting
Attenuation	Auto
RB	100kHz for Below 1GHz, 1MHz for above 1GHz
VB	300kHz for Below 1GHz, 3MHz for above 1GHz
Detector	Peak
Trace	Max hold

11.3 Test Procedures

The conducted spurious emissions were measured conducted using a spectrum analyzer at low, Middle, and high channels, the limit was determined by attenuation 20dB of the RF peak power output.

11.4 Block Diagram of Test setup

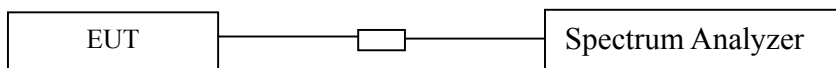

11.5 Test Result

PASS.

Low Channel 01

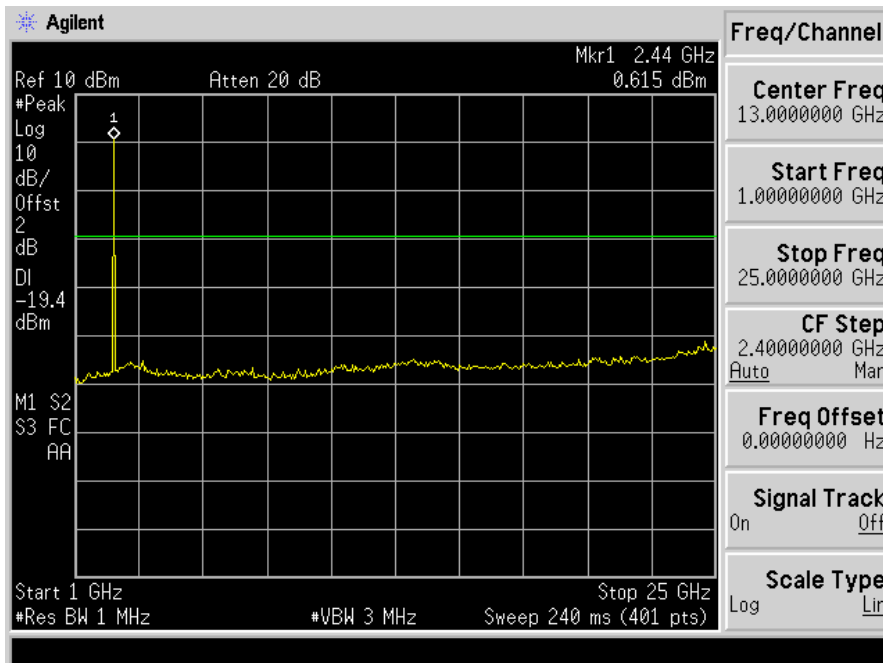
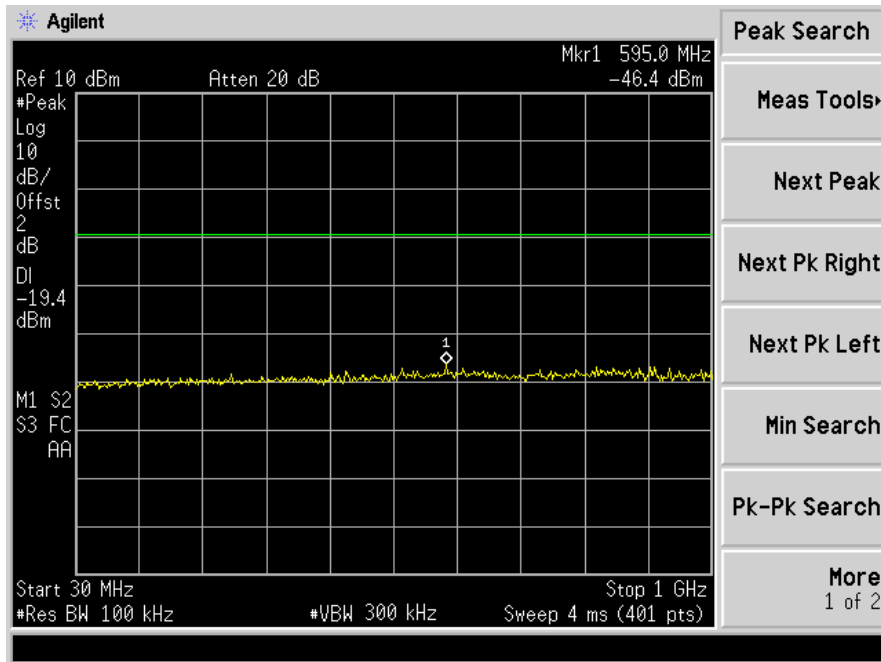

Mid Channel 20

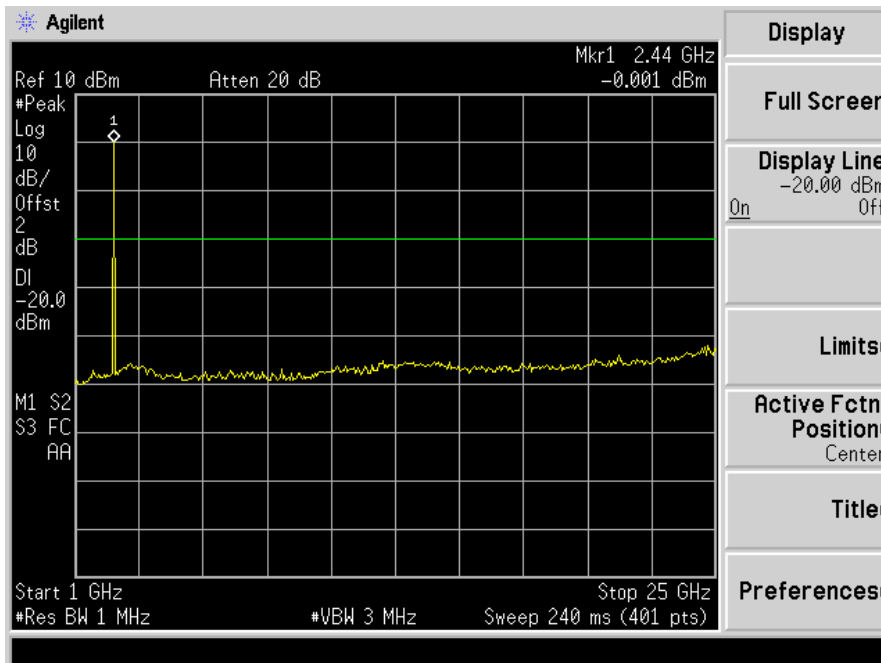
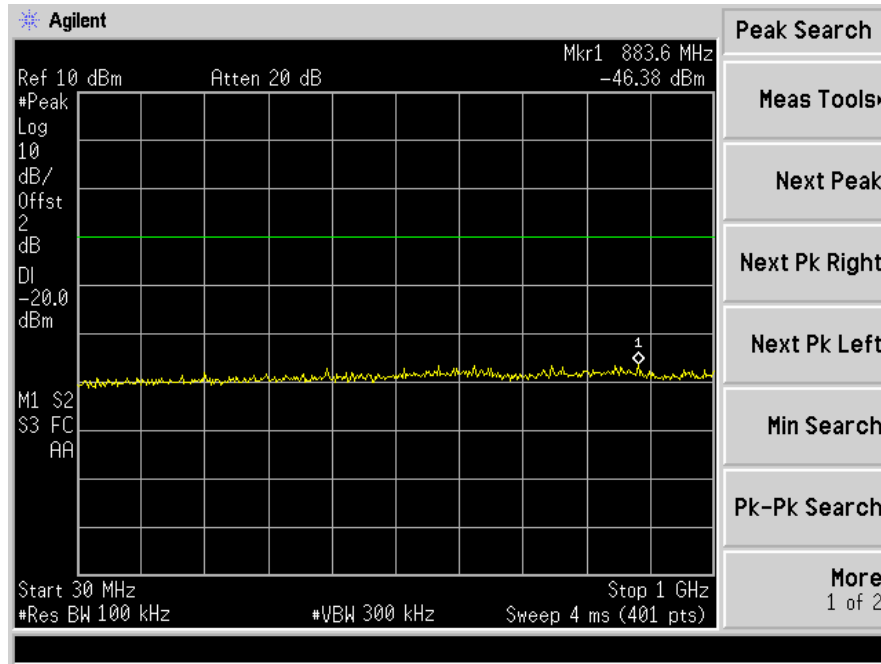

High Channel 40

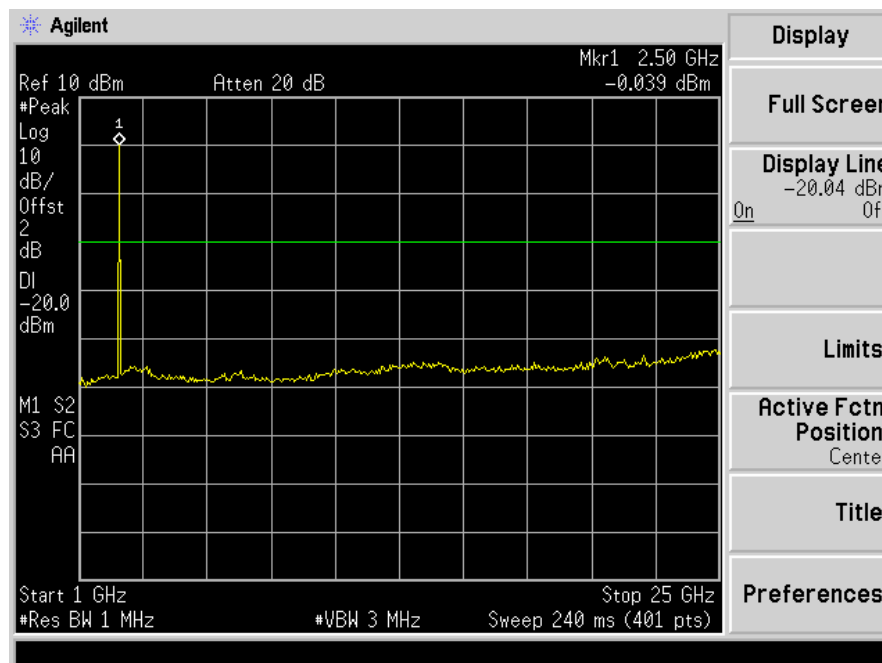
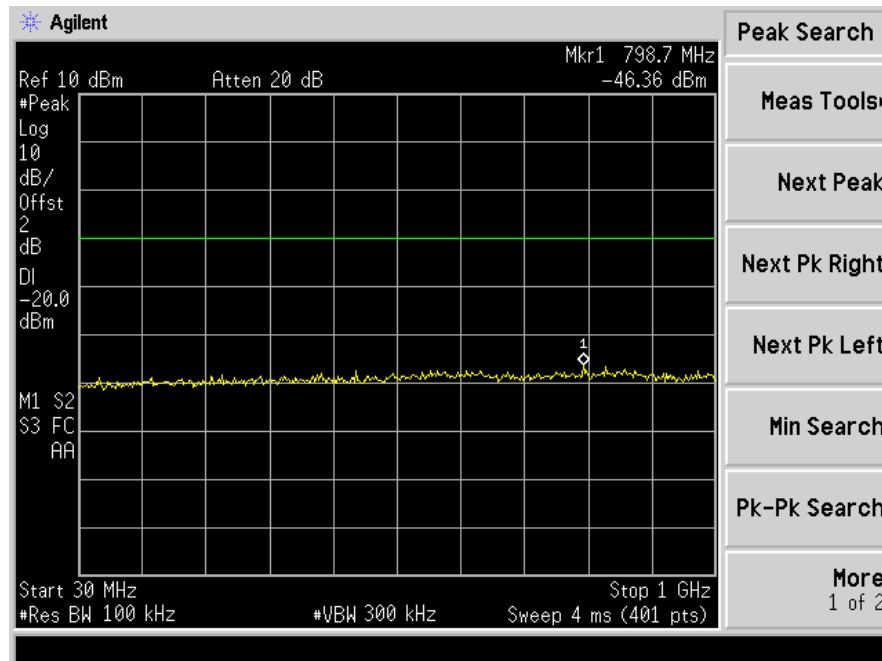

12. Antenna Application

12.1 Antenna Requirement

For intentional device, according to FCC 47 CFR Section 15.203, an intentional radiator shall be designed to ensure that no antenna other than that furnished by the responsible party shall be used with the device. And according to FCC 47 CFR Section 15.247 (b), if transmitting antennas of directional gain greater than 6dBi are used, the power shall be reduced by the amount in dB that the directional gain of the antenna exceeds 6dBi.

12.2 Result

The EUT'S antenna is PCB Antenna. The antenna's gain is 1.4dBi and meets the requirement.