

TEST REPORT

Report Number: 100529802MPK-004

Project Number: G100529802

Report Date: November 28, 2011

Testing performed on the

Clarity Monitors

Model Numbers: SPM80V12A, SPM80V12A-S, SPM125V8A and SPM125V8A-S

FCC ID: ZRV-SPM

IC ID: 9977A-SPM

to

FCC Part 15.247 and RSS-210 Issue 8

for

Solar Power Technologies

Test Performed by:

Intertek

1365 Adams Court

Menlo Park, CA 94025 USA

Test Authorized by:

Solar Power Technologies

3006 Bee Caves Road, Suite A330

Austin, TX 78746, USA

Prepared by:

Krishna K Vemuri

Date: November 28, 2011

Reviewed by:

Ollie Moyrong

Date: November 28, 2011

This report is for the exclusive use of Intertek's Client and is provided pursuant to the agreement between Intertek and its Client. Intertek's responsibility and liability are limited to the terms and conditions of the agreement. Intertek assumes no liability to any party, other than to the Client in accordance with the agreement, for any loss, expense or damage occasioned by the use of this report. Only the Client is authorized to copy or distribute this report and then only in its entirety. Any use of the Intertek name or one of its marks for the sale or advertisement of the tested material, product or service must first be approved in writing by Intertek. The observations and test results in this report are relevant only to the sample tested. This report by itself does not imply that the material, product, or service is or has ever been under an Intertek certification program. This report must not be used to claim product endorsement by A2LA, NIST nor any other agency of the U.S. Government.

Report No. 100529802MPK-004

Equipment Under Test:	Clarity Monitors
Trade Name:	Solar Power Technologies
Model Nos.:	SPM80V12A, SPM80V12A-S, SPM125V8A and SPM125V8A-S
FCC ID:	ZRV-SPM
IC ID:	9977A-SPM
Applicant:	Solar Power Technologies
Contact:	Mr. Ray Burgess
Address:	3006 Bee Caves Road, Suite A330 Austin, TX 78746
Country	USA
Tel. Number:	(512) 560-5460
Email	Rburgess@spowertech.com
Applicable Regulation:	FCC Part 15, Subpart C and RSS-210 Issue 8
Test Site Location:	ITS – Site 1 1365 Adams Drive Menlo Park, CA 94025
Date of Test:	October 20 to November 22, 2011

We attest to the accuracy of this report:



Krishna K Vemuri
EMC Senior Staff Engineer



Ollie Moyrong
Engineering Manager

TABLE OF CONTENTS

1.0	Introduction.....	4
1.1	Summary of Tests.....	5
2.0	General Description	6
2.1	Product Description.....	6
2.2	Related Submittal(s) Grants	6
2.3	Test Methodology	7
2.4	Test Facility.....	7
3.0	System Test Configuration.....	8
3.1	Support Equipment	8
3.2	Block Diagram of Test Setup	9
3.3	Justification	10
3.4	Software Exercise Program	10
3.5	Mode of Operation During Test	10
3.6	Modifications Required for Compliance	10
4.0	Measurement Results.....	11
4.1	Conducted Output Power at Antenna Terminals.....	11
4.2	6-dB Bandwidth	15
4.3	Out-of-Band Conducted Emissions.....	19
4.4	Power Spectral Density	20
4.5	Transmitter Radiated Emissions.....	24
4.6	Radiated Emissions from Digital Parts and Receiver.....	46
4.7	AC Line Conducted Emission.....	62
5.0	RF Exposure Evaluation	67
6.0	List of Test Equipment	68
7.0	Document History	69

1.0 Introduction

The Equipment Under Test (EUT) is a Clarity Monitor which is attached to each panel in a PV array. The Clarity Monitor units continually measure real-time panel performance, providing insight into large-scale arrays with an unprecedented level of precision and detail. These units organize themselves into a dynamic wireless mesh network, forwarding real-time array performance data through the SPG-1 Wireless Gateway to the Clarity Intelligent Array site management system. After capturing panel performance data, the site management system then analyses and detects panel-level, string and/or area impairments that are adversely impacting energy production, and then recommends actions to maintain the array at peak performance.

There are 4 versions of the Clarity Monitor:

- SPM80V12A: typically used with crystalline PV panels ($V_{oc} < 80V$)
- SPM80V12A-S: same as above, equipped with Disable Switch option
- SPM125V8A: typically used with thin-film PV panels ($V_{oc} < 125V$)
- SPM125V8A-S: same as above, equipped with Disable Switch option

The Equipment Under Test (EUT) is a device with a DTS (Digital Transmission System) transceiver operating in the 2.4GHz frequency band.

This report is designed to show compliance of the 2.4 GHz transceiver with FCC Part 15.247 and RSS-210 requirements.

1.1 Summary of Tests

TEST	REFERENCE FCC 17.247	REFERENCE RSS-210	RESULTS
Output Power	15.247(b)(3)	A8.4(4)	Complies
6-dB Bandwidth	15.247(a)(2)	A8.2(a)	Complies
Power Spectral Density	15.247(e)	A8.2(b)	Complies
Out-of-Band Antenna Conducted Emission	15.247(d)	A8.5	The EUT has a permanently attached internal antenna. It does not contain an antenna port connector. Instead of Antenna Conducted measurements, Radiated measurements were performed.
Out-of-Band Radiated Emission (except emissions in Restricted Bands)	15.247(d)	A8.5	Complies
Radiated Emission in Restricted Bands	15.247(d), 15.205	2.2	Complies
RF Exposure	15.247(i)	RSS-102	Complies
AC Conducted Emission	15.207	RSS-GEN	Complies ¹
Radiated Emission from Digital Parts and Receiver	15.109	ICES-003	Complies

¹ EUT does not contain any AC power ports. EUT is DC powered. In an actual installation the EUT input (DC) is connected to Solar Panel and output (DC) is connected to storage network. Conducted emissions test was performed on the EUT output which is connected to the load simulating the storage network.

2.0 General Description

2.1 Product Description

Overview of the EUT

Applicant	Solar Power Technologies 3006 Bee Caves Road, Suite A330 Austin, TX 78746, USA
Manufacturer Name & Address	Solar Power Technologies 3006 Bee Caves Road, Suite A330 Austin, TX 78746, USA
Model Number	SPM80V12A, SPM80V12A-S, SPM125V8A and SPM125V8A-S
FCC Identifier	ZRV-SPM
IC ID Number	9977A-SPM
Rated RF Output (EIRP)	-18.2 dBm, 0.015 mW
Frequency Range	2405 - 2475 MHz
Number of Channel(s)	15
Modulation Type	OQPSK, ZigBee (IEEE 802.15.4)
Antenna Type and Gain	Internal PCB Antenna, Gain = 2dBi

Production versions of the samples were received on October 20, 2011 in good condition. As declared by the Applicant, they are identical to production units.

Test start date October 20, 2011

Test end date: November 22, 2011

2.2 Related Submittal(s) Grants

None.

2.3 Test Methodology

Radiated and AC Line conducted emissions measurements were performed according to the procedures in ANSI C63.4. Radiated tests were performed at an antenna to EUT distance of 3 meters, unless stated otherwise in the "**Data Sheet**" of this Application. All other measurements were made in accordance with the procedures described in the FCC guidance document, *Measurement of Digital Transmission Systems Operating under Section 15.247*.

2.4 Test Facility

The radiated emission test site and conducted measurement facility used to collect the data is 10m semi-anechoic chamber located in Menlo Park, California. This test facility and site measurement data have been fully placed on file with the FCC and Industry Canada (Site # 2042L-1).

3.0 System Test Configuration

3.1 Support Equipment

Item #	Description	Model No.	Serial No.
1	EXTECH DC Power Supply	EP-3003	D30030012
2	OHMITE 100 Ohm Resistor	D225K100	Not Labeled
3	Solar Power Technologies, Clarity Disable Switch	SPG1	MPK1110201601-005
4	AXIOMTEK Industrial Computer	rBOX104-FL1.33G	E1186M1041000002-0D
5	Staples Keyboard	17542	170E0201
6	Dell Monitor	1704FPTt	CN-0Y4299-71618-5AB-AC4F
7	Altech Corp. Power Adapter	MDR-40-48	RB08207545

3.2 Block Diagram of Test Setup

The diagram shown below details the interconnection of the EUT and support equipment. For specific layout, refer to the test configuration photograph in the relevant section of this report.

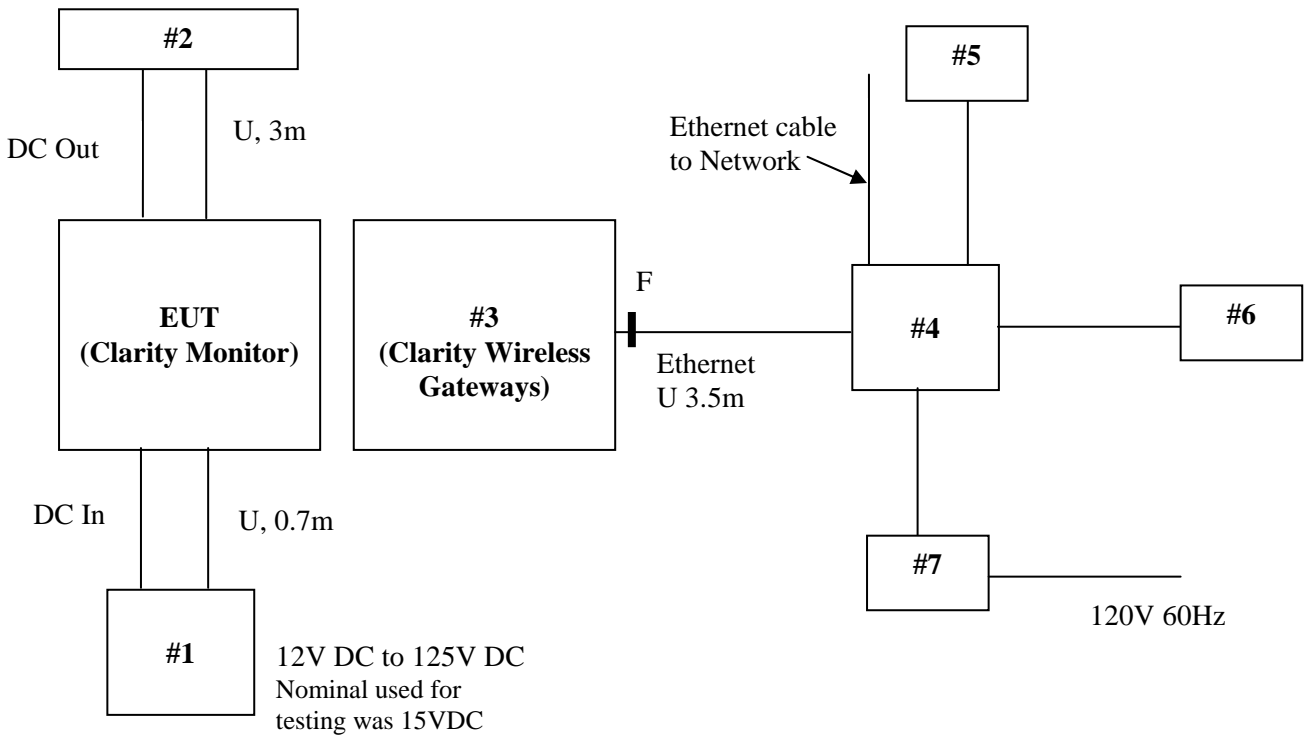

S = Shielded	F = With Ferrite
U = Unshielded	m = Length in Meters

3.3 Justification

For radiated emission measurements the EUT was placed on a non-conductive table. The EUT was configured to transmit full power.

The Clarity Monitors, models: SPM80V12A, SPM80V12A-S, SPM125V8A and SPM125V8A-S, have the identical radio sections. The only difference between the models is a minor change in non-radio sections. All radio tests were performed on the model: SPM125V8A-S only; however, the test results are applicable to SPM80V12A, SPM80V12A-S and SPM125V8A models. Radiated Emissions from Digital Parts and Receiver were performed on the all models.

3.4 Software Exercise Program

Solar Power Technologies proprietary test software.

3.5 Mode of Operation During Test

The EUT was setup in the software controlled test mode to continuously transmit a modulated signal at lowest (2405 MHz), middle (2445 MHz) and highest (2475 MHz) channels (frequencies).

3.6 Modifications Required for Compliance

No modifications were installed by Intertek Testing Services during compliance testing in order to bring the product into compliance.

4.0 Measurement Results

4.1 Conducted Output Power at Antenna Terminals FCC 15.247(b)(3)

Requirements

For systems operating in the 2400-2483.5 MHz band using digital modulation, the maximum peak output power is 1 watt (30 dBm), the conducted power limit is based on the use of antenna with directional gain that do not exceed 6dBi. If the transmitting antenna of directional gain greater than 6dBi are used, the conducted output power from the intentional radiator shall be reduced below the stated value as in FCC 15.247(b)(4)(i).

Procedure

The EUT has a permanently attached internal antenna. It does not contain an antenna port connector. Instead of Antenna Conducted measurements, Radiated measurements were performed.

The maximum field strength of the fundamental was measured.

The transmitter's peak power was calculated using the following equation:

Where: E = the measured maximum field strength in V/m.

Set the RBW > 6dB bandwidth of the emission or use a peak power meter.

$P = (E \times d)^2 / (30 \times G)$.

G = the numeric gain of the transmitting antenna over an isotropic radiator.

d = the distance in meters from which the field strength was measured.

P = the power in watts for which you are solving.

Test Results

Frequency (MHz)	Output in dBm	Output in mW	Plot number
2405	-18.2	0.015	1.1
2445	-18.8	0.013	1.2
2475	-18.9	0.013	1.3

Note: The EUT's antenna has less than 6 dBi gain.

Plot 1.1

Uncorrected Receiver Reading

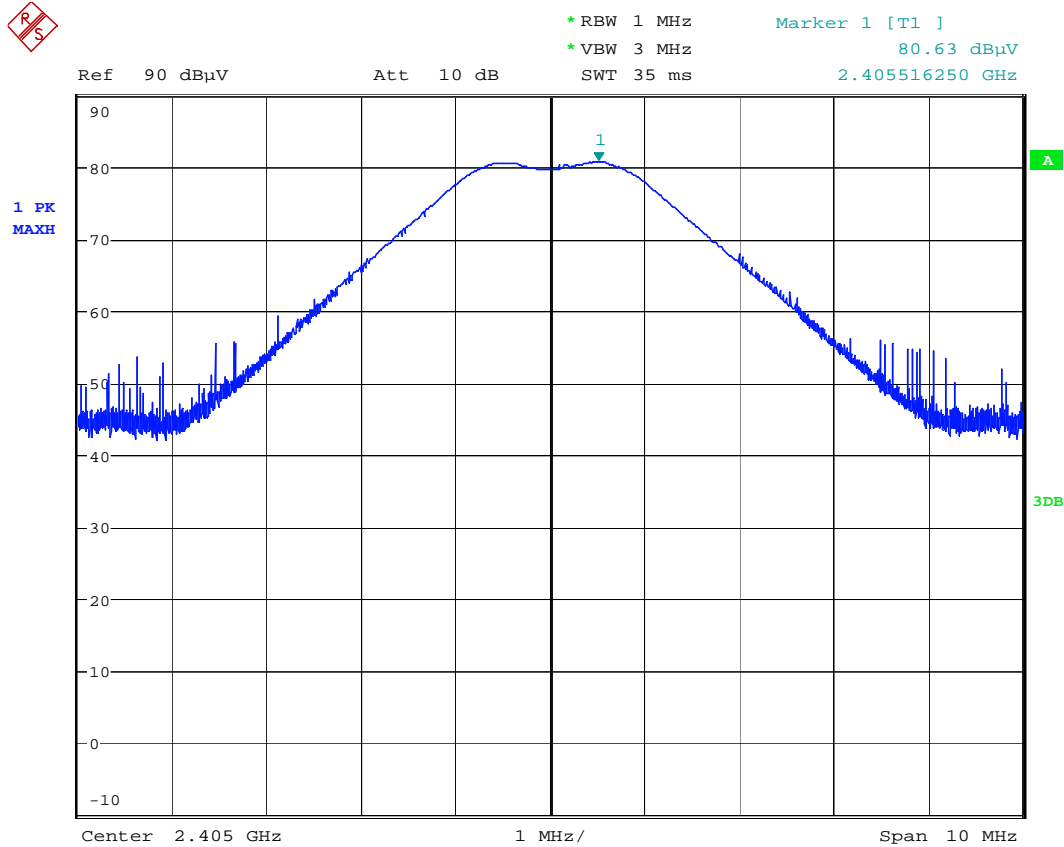

Output Power

Date: 14.NOV.2011 15:07:51

Final Corrected Reading

Frequency	RA	AG	CF	AF	Final Field Strength	EIRP	EIRP
MHz	dB(uV)	dB	dB	dB(1/m)	dB(uV/m)	dBm	mW
2405.0	80.6	35.6	4.4	27.7	77.1	-18.2	0.015

RA = Receiver Amplitude

AG = Amplifier Gain

CF = Cable Factor

AF = Antenna Factor

Plot 1.2

Uncorrected Receiver Reading

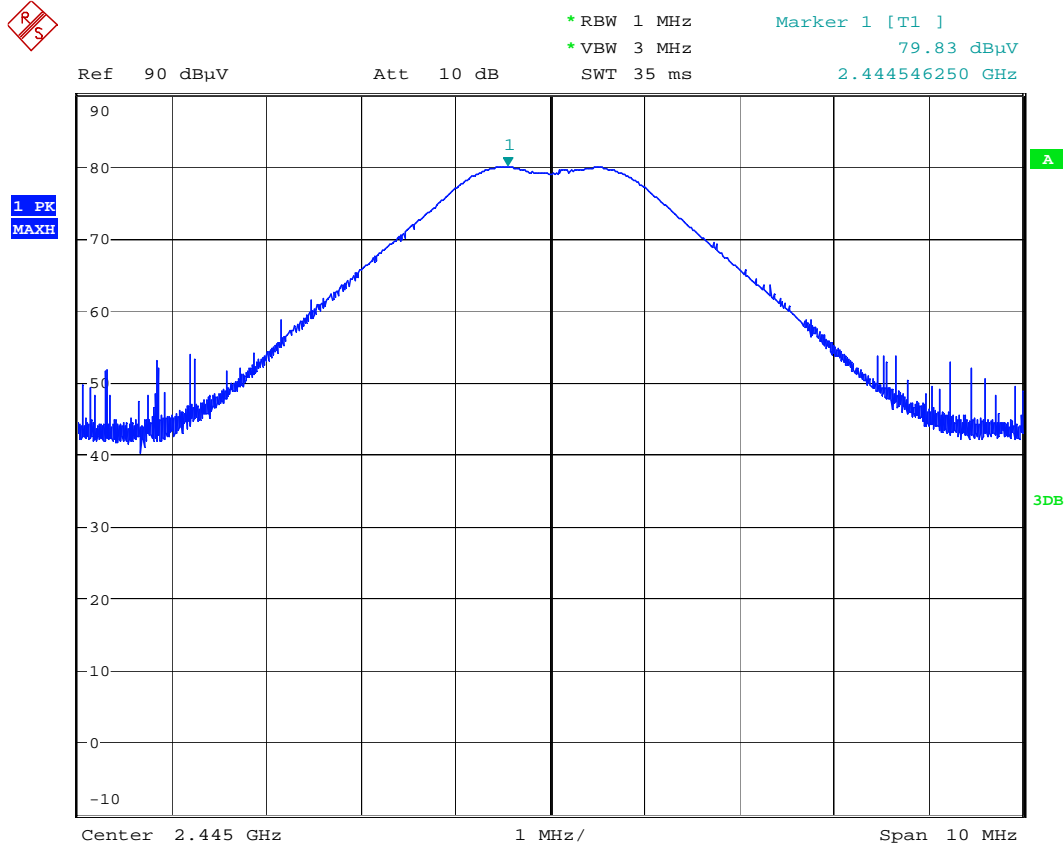

Output Power

Date: 14.NOV.2011 14:52:55

Final Corrected Reading

Frequency	RA	AG	CF	AF	Final Field Strength	EIRP	EIRP
MHz	dB(uV)	dB	dB	dB(1/m)	dB(uV/m)	dBm	mW
2445.0	79.8	35.6	4.5	27.8	76.5	-18.8	0.013

RA = Receiver Amplitude
 AG = Amplifier Gain
 CF = Cable Factor
 AF = Antenna Factor

Plot 1.3

Uncorrected Receiver Reading

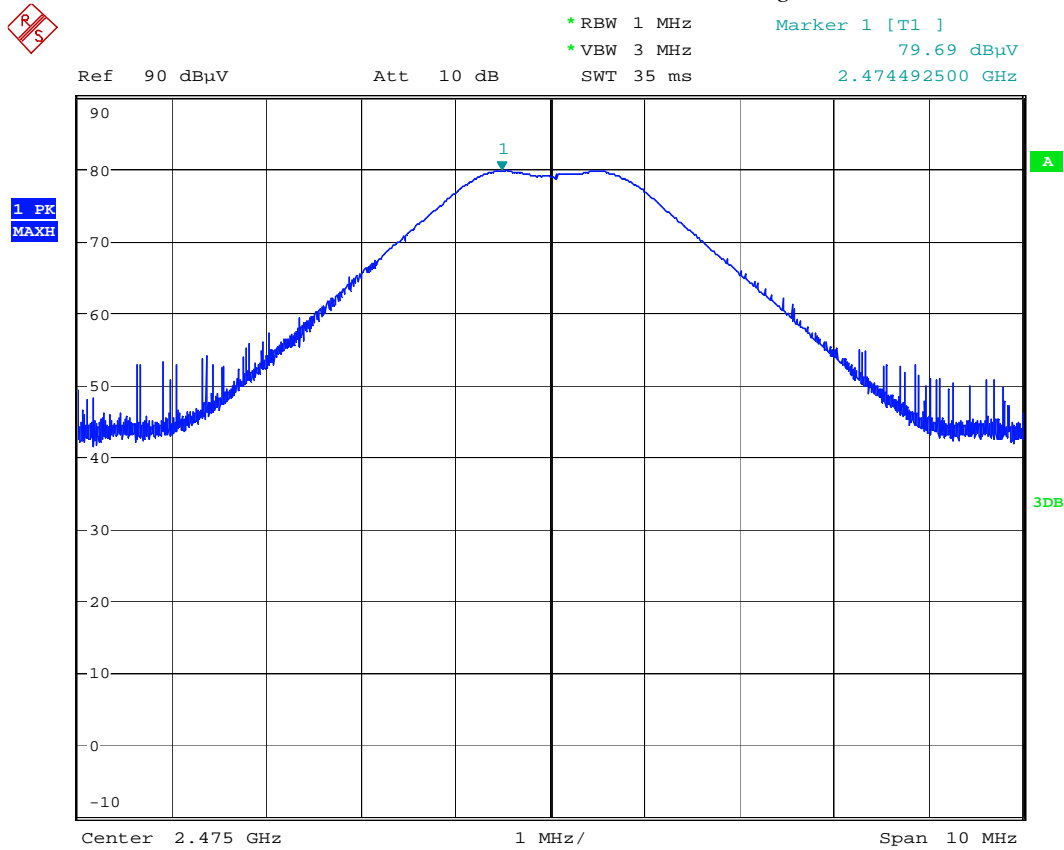

Output Power

Date: 14.NOV.2011 16:44:25

Final Corrected Reading

Frequency	RA	AG	CF	AF	Final Field Strength	EIRP	EIRP
MHz	dB(uV)	dB	dB	dB(1/m)	dB(uV/m)	dBm	mW
2475.0	79.7	35.7	4.5	27.9	76.4	-18.9	0.013

RA = Receiver Amplitude

AG = Amplifier Gain

CF = Cable Factor

AF = Antenna Factor

4.2 6-dB Bandwidth
FCC 15.247(a)(2)

Requirements

For systems operating in the 2400-2483.5 MHz band using digital modulation, the minimum 6-dB Bandwidth shall be at least 500kHz.

Procedure

A measuring antenna was placed in close proximity to the EUT. The spectrum analyzer resolution bandwidth was set to approximately 1% of the total emission bandwidth, $VBW > RBW$. The 6-dB Bandwidth was measured by using the DELTA MARKER function of the analyzer.

In addition, the Occupied Bandwidth (99%) was measured.

Test Results

Frequency (MHz)	6-dB Channel Bandwidth (MHz)	Plot
2405	1.192	2.1
2445	1.189	2.2
2475	1.192	2.3

Frequency (MHz)	99% Occupied Bandwidth (MHz)	Plot
2405	2.486	2.1
2445	2.470	2.2
2475	2.492	2.3



Plot 2.1

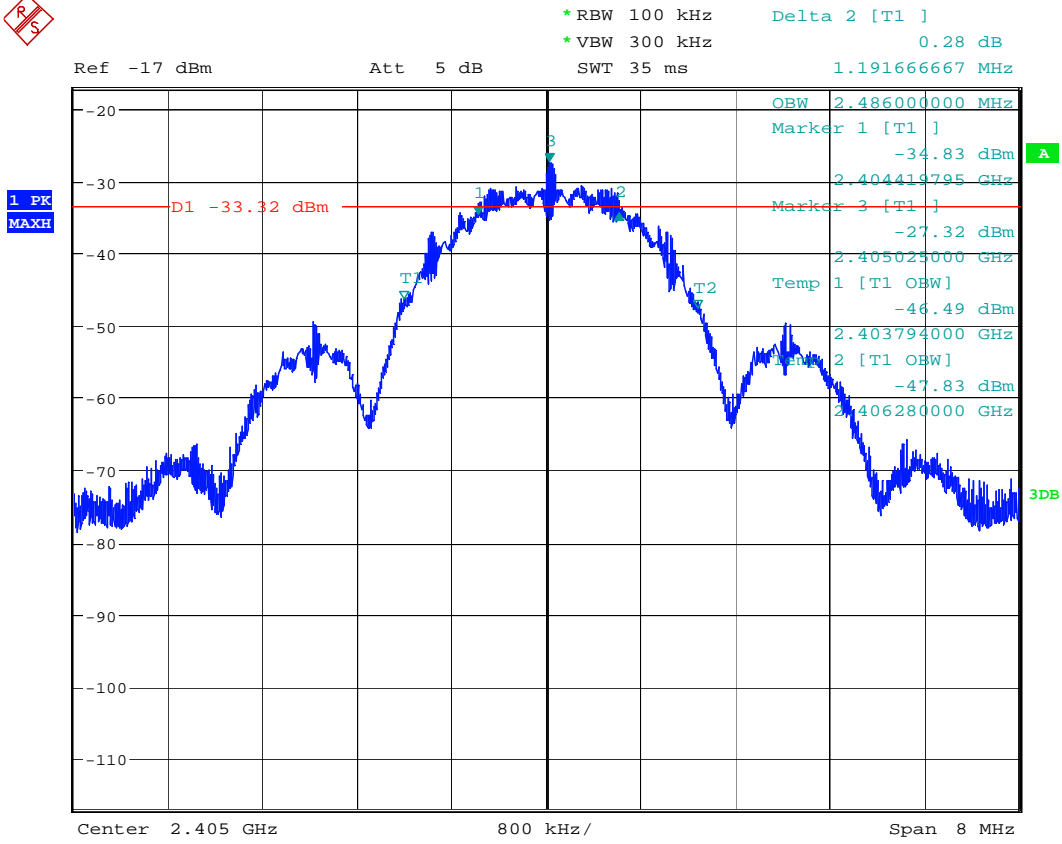

6-dB bandwidth and Occupied bandwidth

Date: 14.NOV.2011 15:37:58

Plot 2.2



*RBW 100 kHz Delta 2 [T1]
 *VBW 300 kHz 0.52 dB
 SWT 35 ms 1.188846154 MHz

Ref -17 dBm

Att 5 dB

1 PK
MAXH

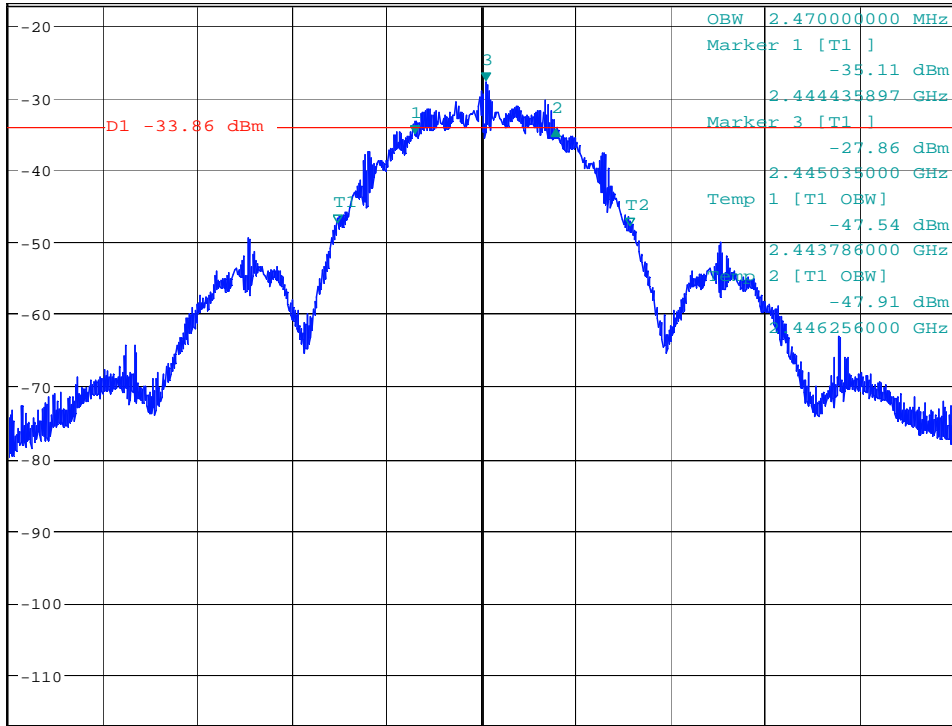

Center 2.445 GHz 800 kHz/ Span 8 MHz

6-dB bandwidth and Occupied bandwidth

Date: 14.NOV.2011 15:47:06

Plot 2.3



*RBW 100 kHz Delta 2 [T1] 1.23 dB
 *VBW 300 kHz 1.192307692 MHz

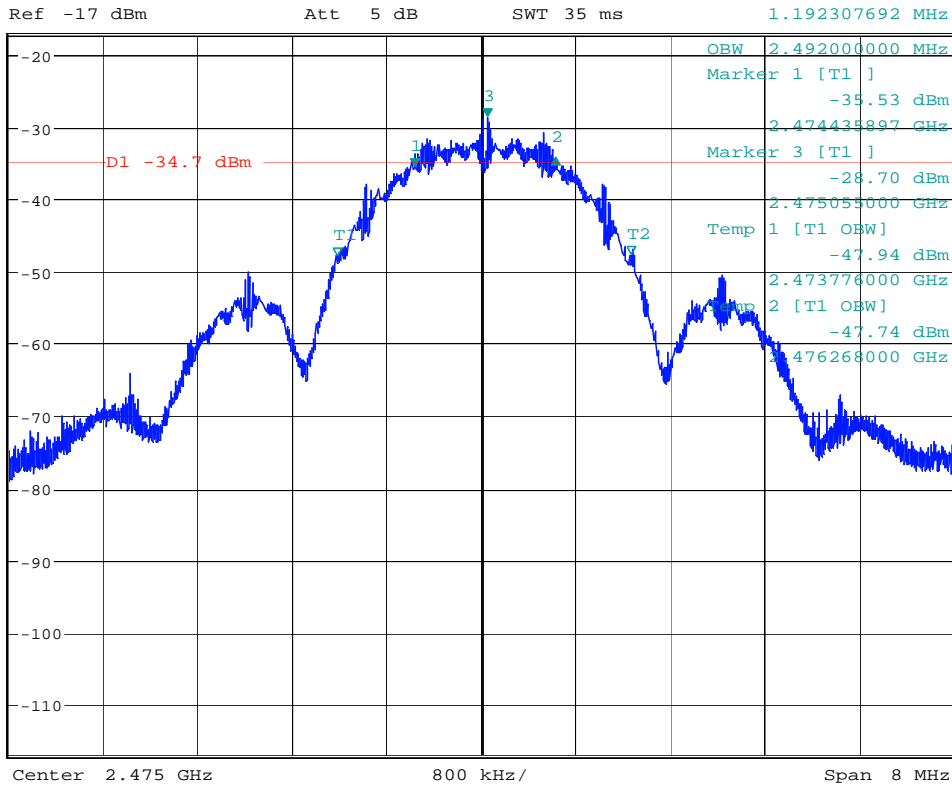

6-dB bandwidth and Occupied bandwidth

Date: 14.NOV.2011 15:59:09

4.3 Out-of-Band Conducted Emissions FCC 15.247(d)

Requirement

In any 100 kHz bandwidth outside the EUT pass-band, the RF power shall be at least 20 dB below that of the maximum in-band 100 kHz emission.

Procedure

The EUT has a permanently attached internal antenna. It does not contain an antenna port connector. Instead of Antenna Conducted measurements, Radiated measurements were performed. The out-of-band emissions were measured from 30 MHz to 25 GHz.

Test Result

Refer to the radiated emissions test data located in report section 4.5.

The attenuation of emissions outside the EUT pass-band is more than 20 dB.

4.4 Power Spectral Density FCC 15.247 (e)

Requirement

For digitally modulated systems, the power spectral density conducted from the intentional radiator to the antenna should not be greater than 8dBm in any 3 kHz band during any time interval of continuous transmission.

Procedure

The EUT has a permanently attached internal antenna. It does not contain an antenna port connector. Instead of Antenna Conducted measurements, Radiated measurements were performed.

(A) Tune the analyzer to the highest point of the maximized fundamental emission.
Reset the analyzer to a RBW = 3 kHz, VBW > RBW, span = 300 kHz, sweep = 100 sec.

(B) From the peak level obtained in (A), derive the field strength, E, by applying the appropriate antenna factor, cable loss, pre-amp gain, etc.

The transmitter's peak power was calculated using the following equation:

Where: E = the measured maximum field strength in V/m.

Set the RBW > 6dB bandwidth of the emission or use a peak power meter.

$$P = (E \times d)^2 / (30 \times G)$$

G = the numeric gain of the transmitting antenna over an isotropic radiator.

d = the distance in meters from which the field strength was measured.

P = the power in watts for which you are solving.

Test Result

Refer to the following plots for the test result:

Frequency (MHz)	Power Spectral Density (dBm)	Plot
2405	-29.0	4.1
2445	-29.3	4.2
2475	-29.5	4.3

Plot 4.1

Uncorrected Receiver Reading

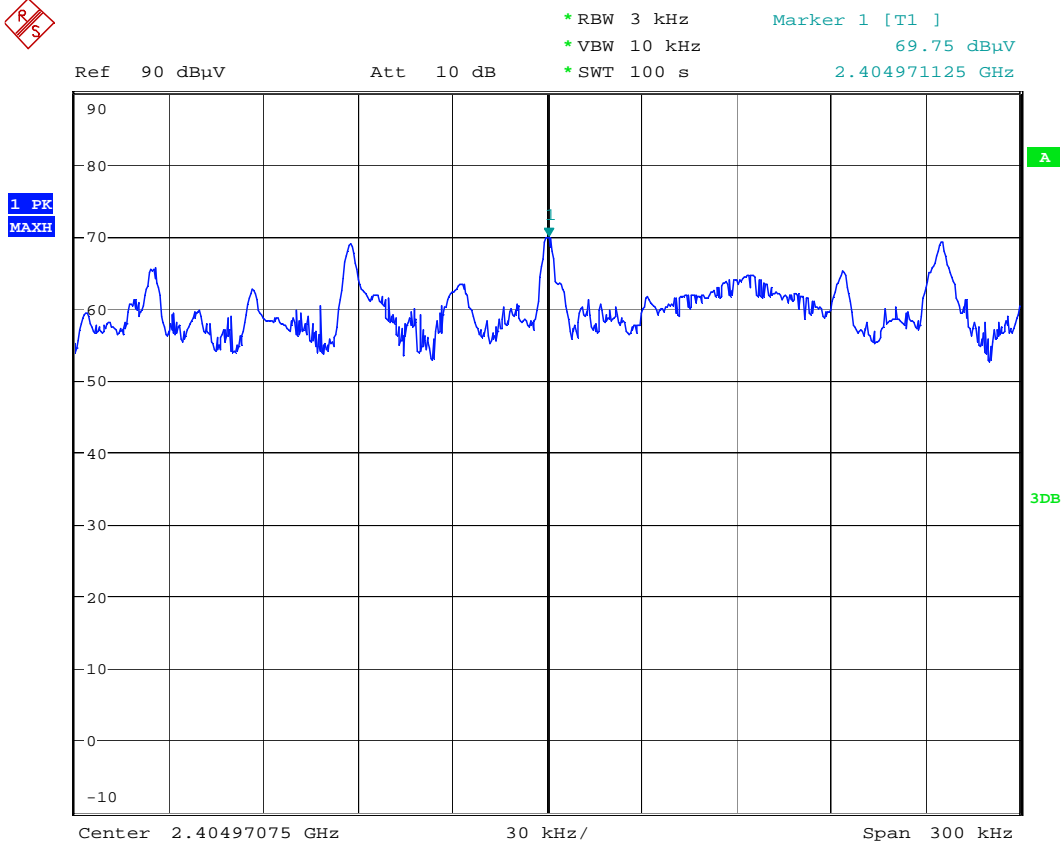

Power Spectral Density

Date: 14.NOV.2011 16:36:48

Final Corrected Reading

Frequency	RA	AG	CF	AF	Final Field Strength	EIRP	EIRP
MHz	dB(uV)	dB	dB	dB(1/m)	dB(uV/m)	dBm	mW
2405.0	69.8	35.6	4.4	27.7	66.3	-29.0	0.0013

RA = Receiver Amplitude

AG = Amplifier Gain

CF = Cable Factor

AF = Antenna Factor

Plot 4.2

Uncorrected Receiver Reading

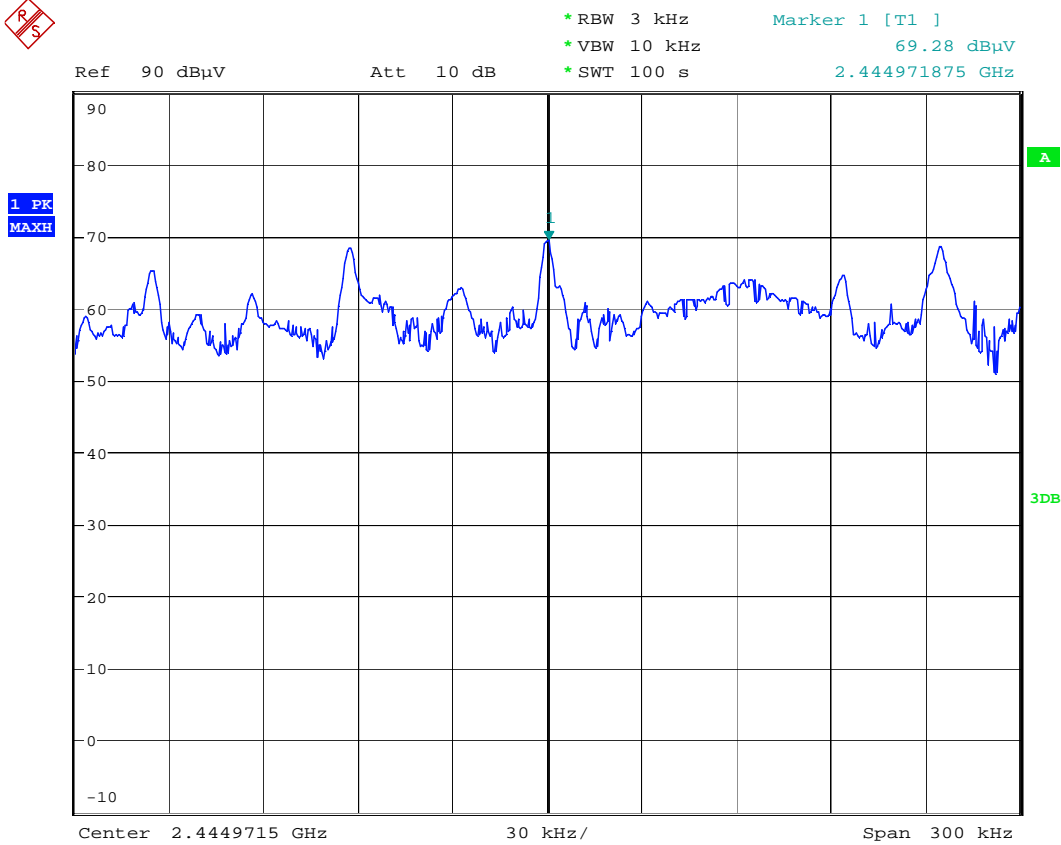

Power Spectral Density

Date: 14.NOV.2011 16:27:50

Final Corrected Reading

Frequency	RA	AG	CF	AF	Final Field Strength	EIRP	EIRP
MHz	dB(uV)	dB	dB	dB(1/m)	dB(uV/m)	dBm	mW
2445.0	69.3	35.6	4.5	27.8	66.0	-29.3	0.0012

RA = Receiver Amplitude

AG = Amplifier Gain

CF = Cable Factor

AF = Antenna Factor

Plot 4.3

Uncorrected Receiver Reading

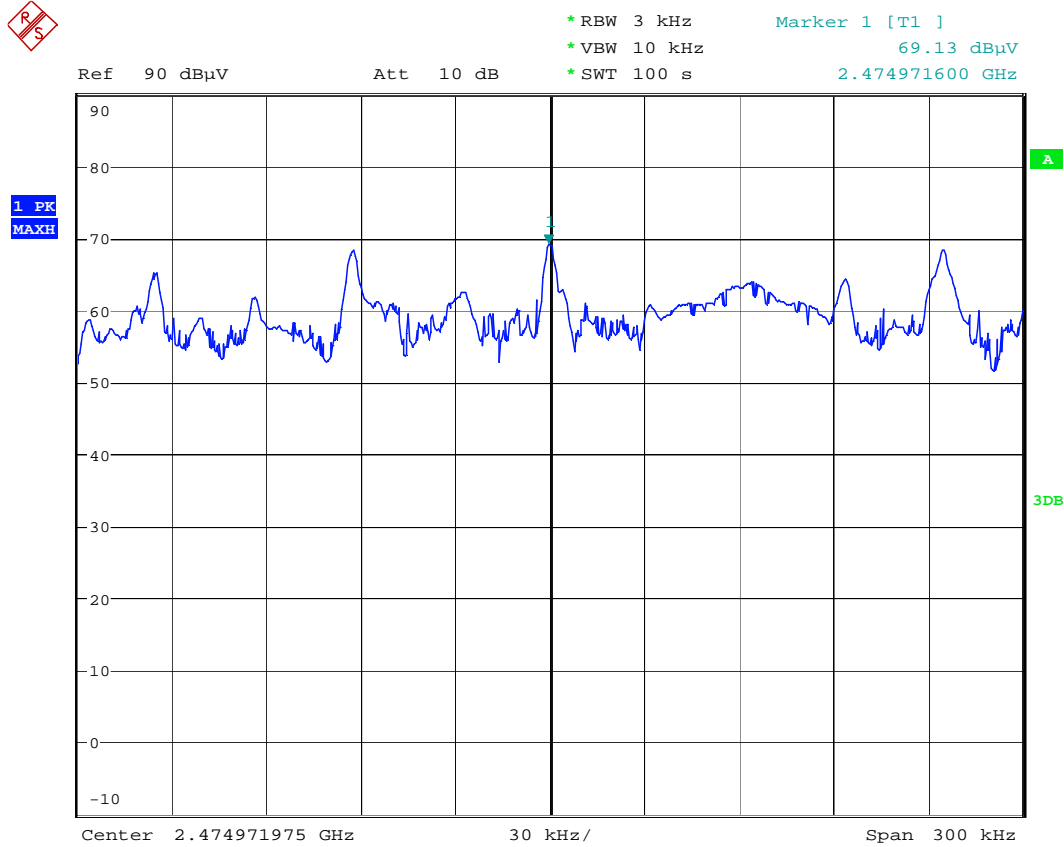

Power Spectral Density
 Date: 14.NOV.2011 16:18:21

Final Corrected Reading

Frequency	RA	AG	CF	AF	Final Field Strength	EIRP	EIRP
MHz	dB(uV)	dB	dB	dB(1/m)	dB(uV/m)	dBm	mW
2475.0	69.1	35.7	4.5	27.9	65.8	-29.5	0.0011

RA = Receiver Amplitude
 AG = Amplifier Gain
 CF = Cable Factor
 AF = Antenna Factor

4.5 Transmitter Radiated Emissions FCC 15.247 (d), 15.205, 15.209

Procedure

Radiated emission measurements were performed from 30 MHz to 25,000 MHz. Spectrum Analyzer Resolution Bandwidth is 100 kHz or greater for frequencies 30 MHz to 1000 MHz, 1 MHz - for frequencies above 1000 MHz.

The EUT is placed on a non-conductive table. If the EUT attaches to peripherals, they are connected and operational (as typical as possible). During testing, all cables were manipulated to produce worst case emissions. The signal is maximized through rotation. The antenna height and polarization are varied during the search for maximum signal level. The antenna height is varied from 1 to 4 meters.

Radiated emissions are taken at three meters unless the signal level is too low for measurement at that distance. If necessary, a pre-amplifier is used and/or the test is conducted at a closer distance. All readings are extrapolated back to the equivalent three-meter reading using inverse scaling with distance.

Data is included of the worst case configuration (the configuration which resulted in the highest emission levels). A sample calculation, configuration photographs and data tables of the emissions are included.

Field Strength Calculation

For measurements made at 10 meters distance

The field strength is calculated by adding the Antenna Factor and Cable Factor to from the measured reading, followed by subtracting the Amplifier Gain (if any) and Distance Correction Factor (if any). The basic equation with a sample calculation is as follows:

The field strength is calculated by adding the Antenna Factor and Cable Factor and the Distance Correction Factor; and subtracting the Amplifier Gain from the measured reading. The basic equation with a sample calculation is as follows:

$$FS = RA + AF + CF - AG + DCF$$

Where FS = Field Strength in dB(μ V/m)

RA = Receiver Amplitude (including preamplifier) in dB(μ V)

AF = Antenna Factor in dB(1/m)

CF = Cable Attenuation Factor in dB

AG = Amplifier Gain in dB

DCF = Distance Correction Factor in dB for measurements made at 10 meters distance

Assume a receiver reading of 52.5 dB(μ V) is obtained. The antennas factor of 7.4 dB(1/m) and cable factor of 1.6 dB is added. The amplifier gain of 29 dB and Distance Correction Factor (for measurements made at 10 meters distance) of 10.5 dB is added, giving field strength of 43 dB(μ V/m). This value in dB(μ V/m) was converted to its corresponding level in μ V/m.

$$RA = 52.5 \text{ dB}(\mu\text{V})$$

$$AF = 7.4 \text{ dB}(1/\text{m})$$

$$CF = 1.6 \text{ dB}$$

$$AG = 29.0 \text{ dB}$$

$$DCF = 10.5 \text{ dB}$$

$$FS = 52.5 + 7.4 + 1.6 - 29.0 + 10.5 = 43 \text{ dB}(\mu\text{V}/\text{m}).$$

$$\text{Level in } \mu\text{V}/\text{m} = \text{Common Antilogarithm } [(43 \text{ dB}\mu\text{V}/\text{m})/20] = 141.3 \mu\text{V}/\text{m}.$$

For measurements made at 3 meters distance

The field strength is calculated by following the example above for measurements made at 10 meters distance except the Distance Correction Factor in dB is not applied.

Result

The data on the following pages list the significant emission frequencies, the limit and the margin of compliance. The radiated emissions in the restricted bands are presented on the following Plots 5.1 – 5.30. The EUT passed by 1.0 dB.

Plot 5.1

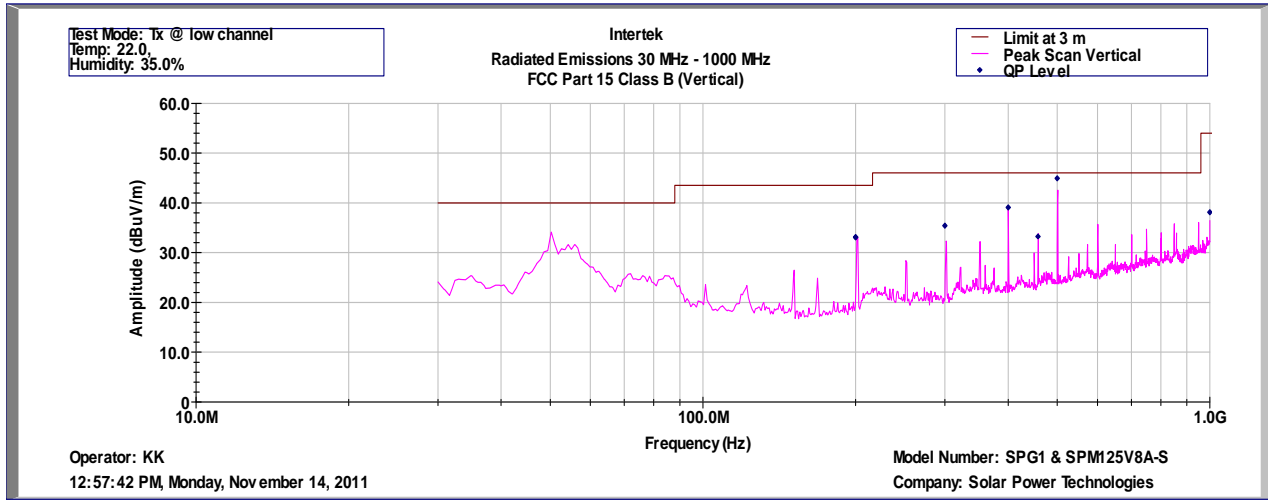

Intertek

Radiated Emissions 30 MHz - 1000 MHz
FCC Part 15 Class B (QP-Vertical)

Operator: KK
14-Nov-11

Model Number: SPG1 & SPM125V8A-S
Company: Solar Power Technologies

Frequency Hz	Quasi Pk FS dB(uV/m)	Limit@3m dB(uV/m)	Margin dB	RA dB(uV)	Cable dB	AG dB	DCF dB	AF dB(1/m)
2.00E+08	33.1	43.5	-10.4	43.1	1.6	32.0	10.5	9.8
3.00E+08	35.4	46.0	-10.6	41.8	2.0	32.0	10.5	13.1
4.00E+08	39.1	46.0	-6.9	43.3	2.3	32.1	10.5	15.0
4.58E+08	33.3	46.0	-12.7	36.2	2.5	32.1	10.5	16.1
5.00E+08	44.9	46.0	-1.1	47.3	2.6	32.2	10.5	16.7
1.00E+09	38.1	54.0	-15.9	31.3	3.8	30.7	10.5	23.3

Test Mode: Tx @ low channel
Temp: 22.0C
Humidity: 35.0%

Notes: Measurements made at 10 meters distance.

SPG1 & SPM125V8A-S were placed on the test table and measured at the same time.

Plot 5. 2

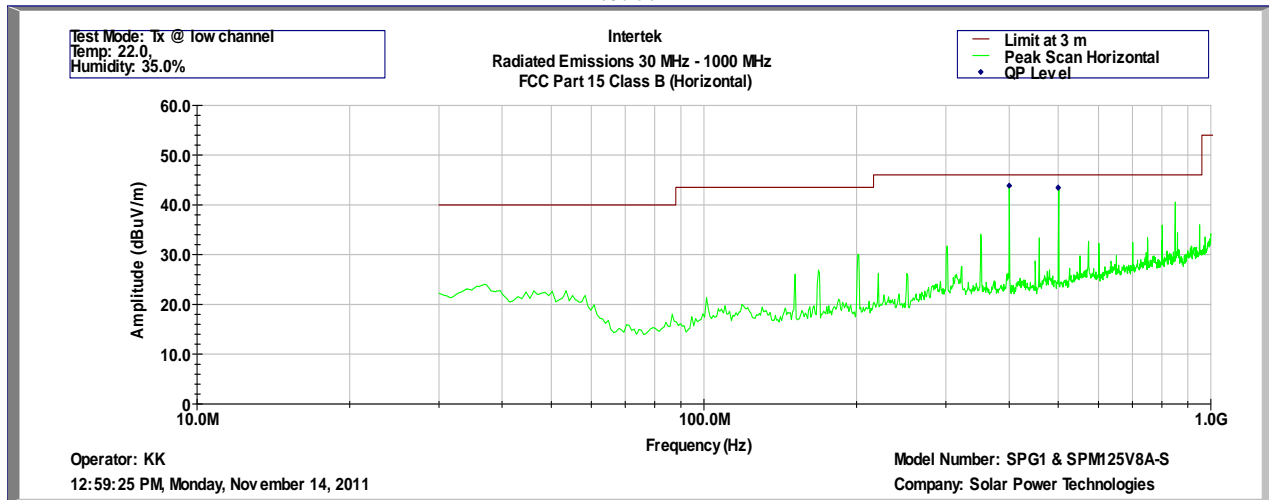

Intertek
Radiated Emissions 30 MHz - 1000 MHz
FCC Part 15 Class B (QP-Horizontal)

Operator: KK
14-Nov-11

Model Number: SPG1 & SPM125V8A-S
Company: Solar Power Technologies

Frequency Hz	Quasi Pk FS dB(uV/m)	Limit@3m dB(uV/m)	Margin dB	RA dB(uV)	CF dB	AG dB	DCF dB	AF dB(1/m)
4.00E+08	43.9	46.0	-2.1	48.1	2.3	32.1	10.5	15.0
5.00E+08	43.4	46.0	-2.6	45.8	2.6	32.2	10.5	16.7

Test Mode: Tx @ low channel
Temp: 22.0C
Humidity: 35.0%

Notes: Measurements made at 10 meters distance.

SPG1 & SPM125V8A-S were placed on the test table and measured at the same time.

Plot 5.3

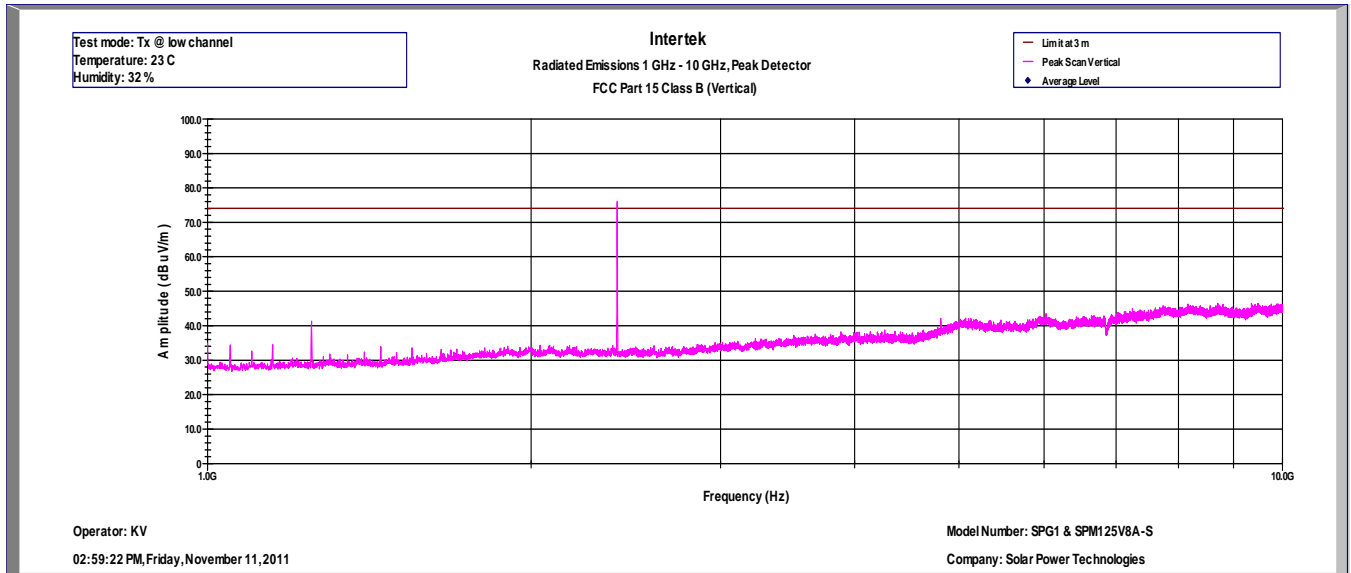

Plot 5.4

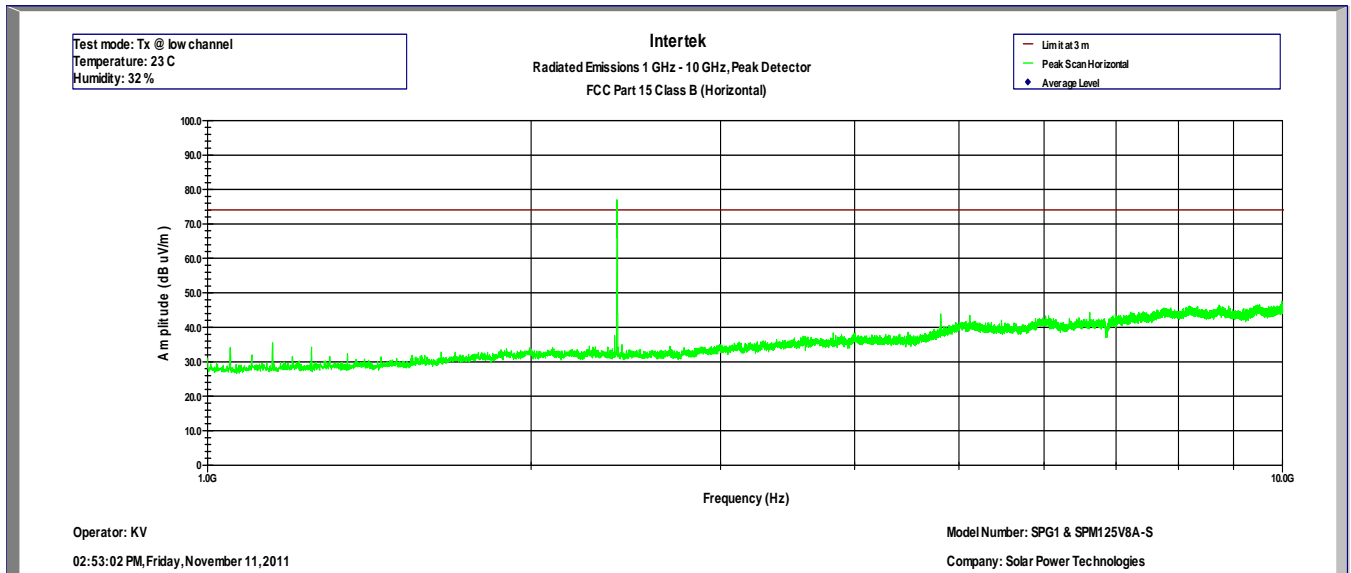

Measurement at the Bandedge

Frequency (Hz)	Pk Level (dBuV/m)	Limit@3m (dBuV/m)	Margin (dB)	Raw (dBuV)	Cable (dB)	Preamp (dB)	AF dB(1/m)
2.3900+09	33.1	74.0	-40.9	36.5	4.4	35.6	27.8

Notes: Measurements made at 3 meters distance.

SPG1 & SPM125V8A-S were placed on the test table and measured at the same time.

Plot 5.5

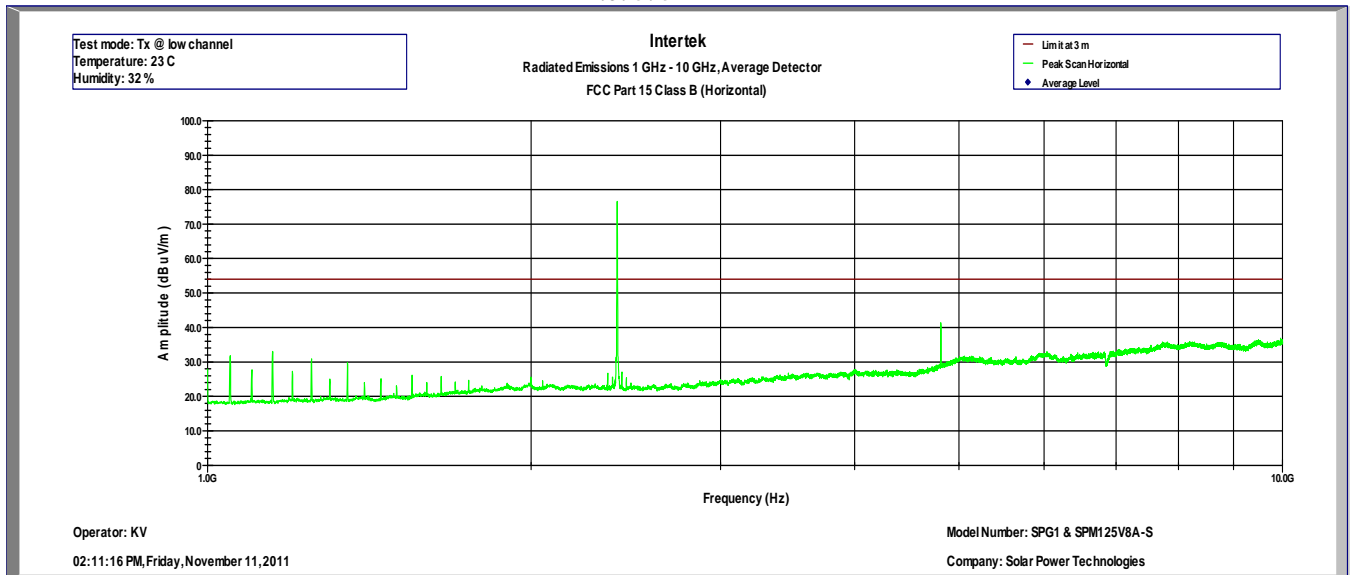

Plot 5.6

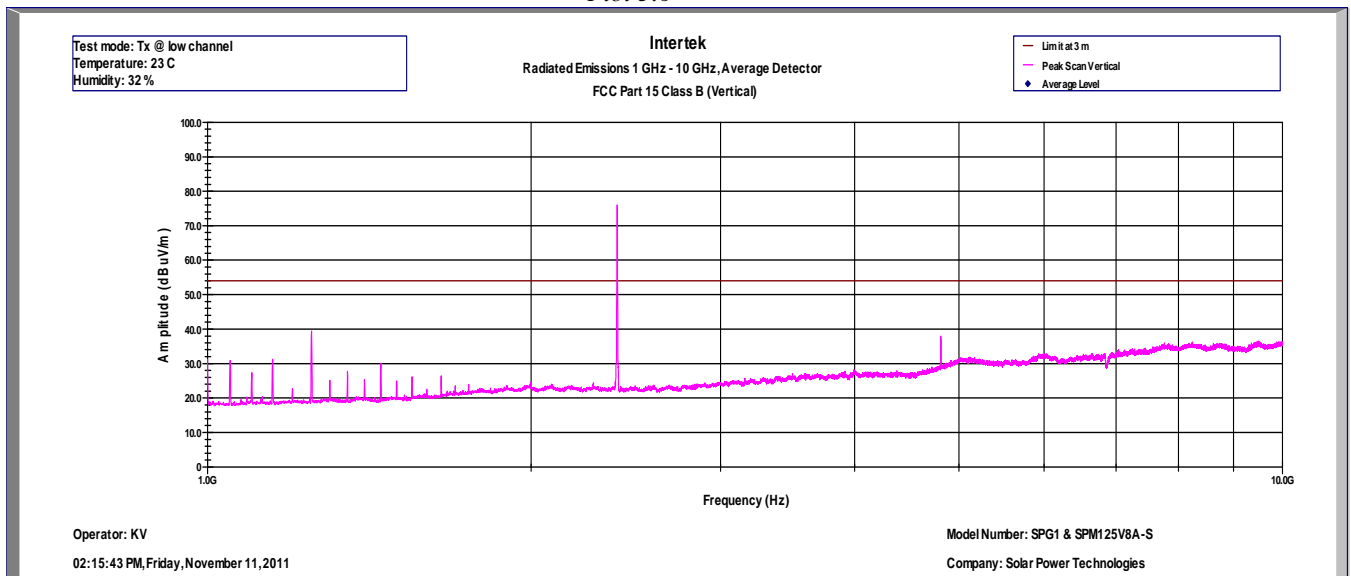

Measurement at the Bandedge

Frequency (Hz)	Av Level (dBuV/m)	Limit@3m (dBuV/m)	Margin (dB)	Raw (dBuV)	Cable (dB)	Preamp (dB)	AF dB(1/m)
2.3900+09	23.9	54.0	-30.1	27.3	4.4	35.6	27.8

Notes: Measurements made at 3 meters distance.

SPG1 & SPM125V8A-S were placed on the test table and measured at the same time.

Plot 5.7

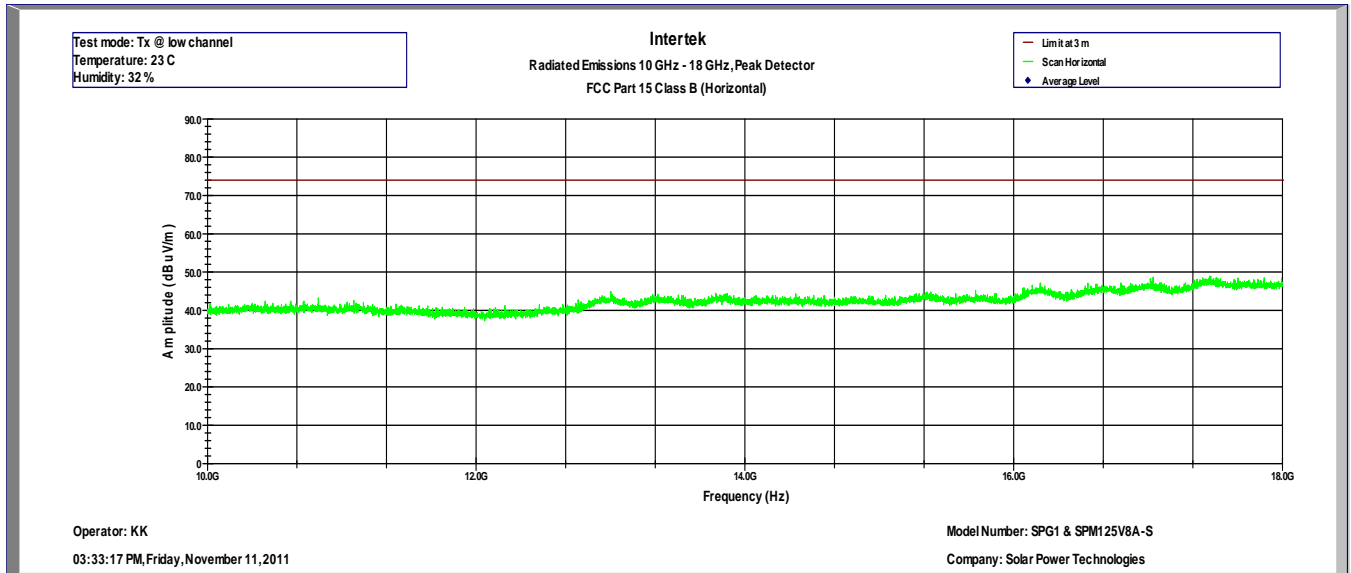

Plot 5.8

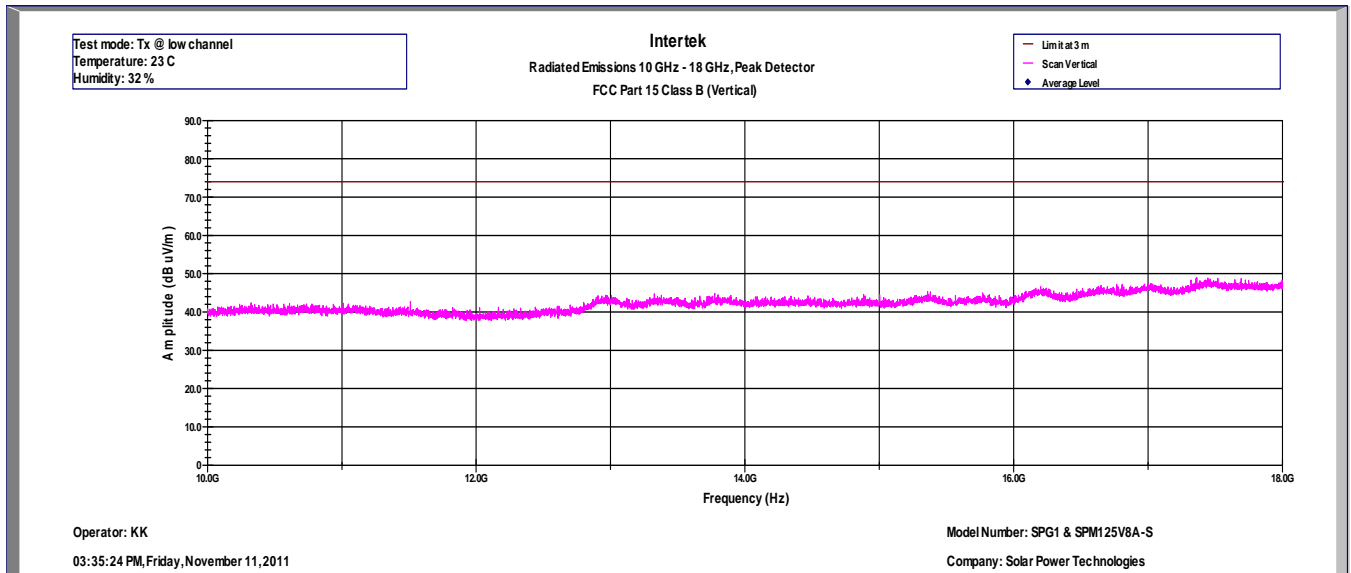

Notes: Measurements made at 3 meters distance.

SPG1 & SPM125V8A-S were placed on the test table and measured at the same time.

No emissions were detected above the noise floor which was at least 10 dB below the limit in the range of 18GHz – 25GHz.

Plot 5.9

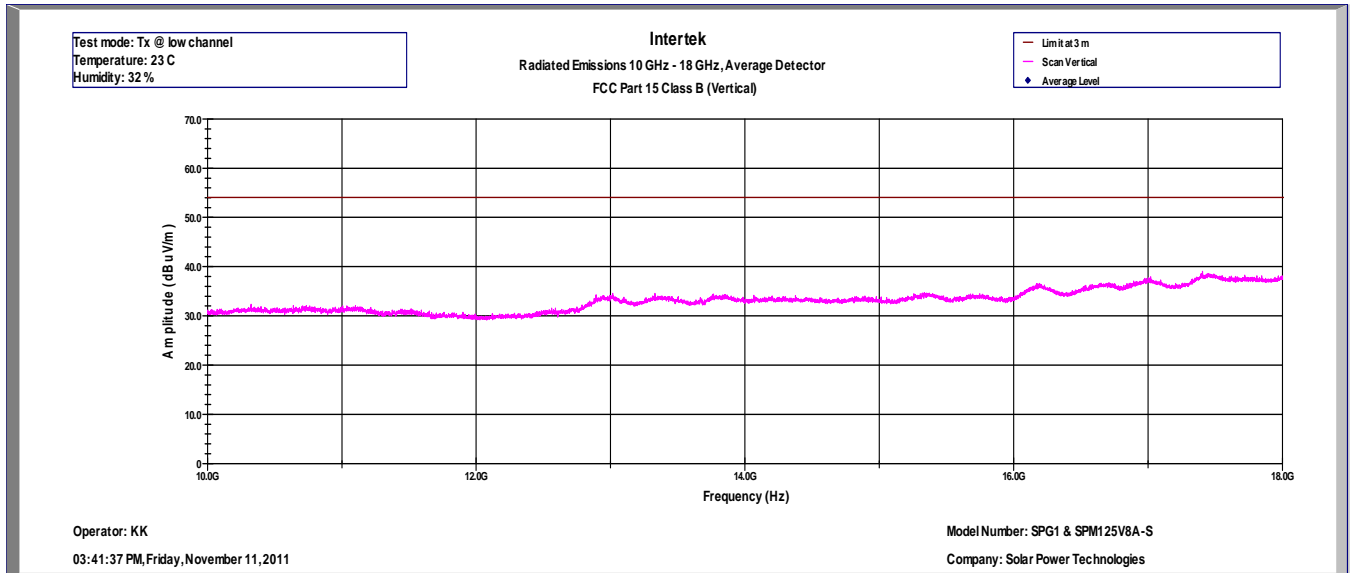

Plot 5.10

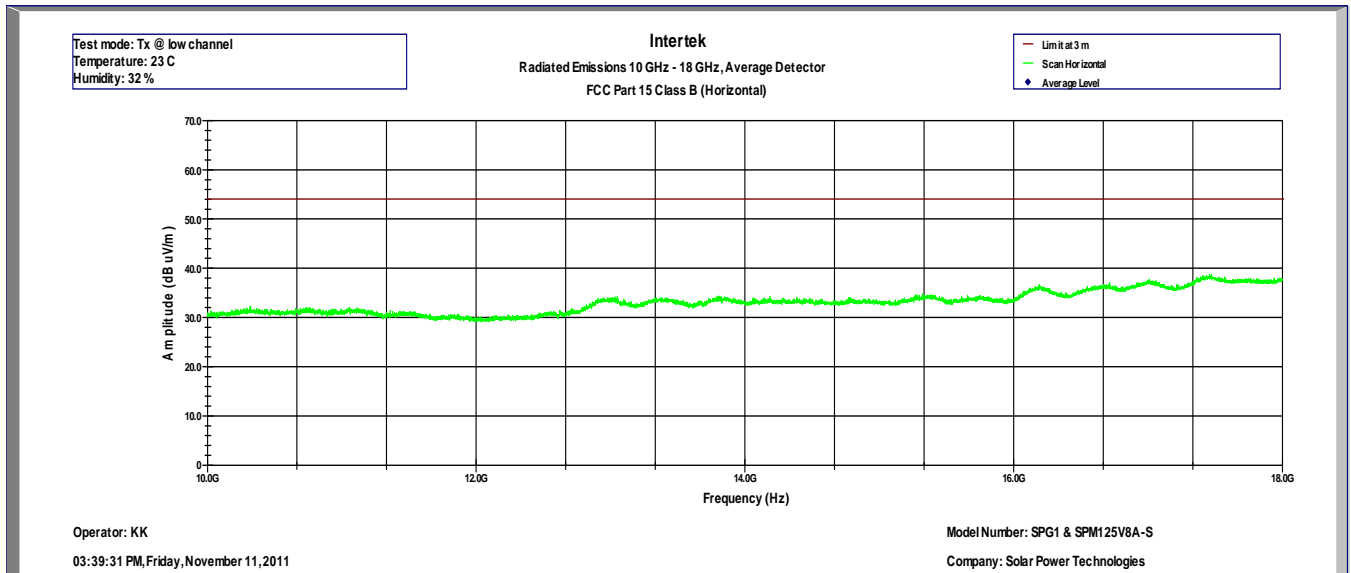

Notes: Measurements made at 3 meters distance.

SPG1 & SPM125V8A-S were placed on the test table and measured at the same time.

No emissions were detected above the noise floor which was at least 10 dB below the limit in the range of 18GHz – 25GHz.

Plot 5.11

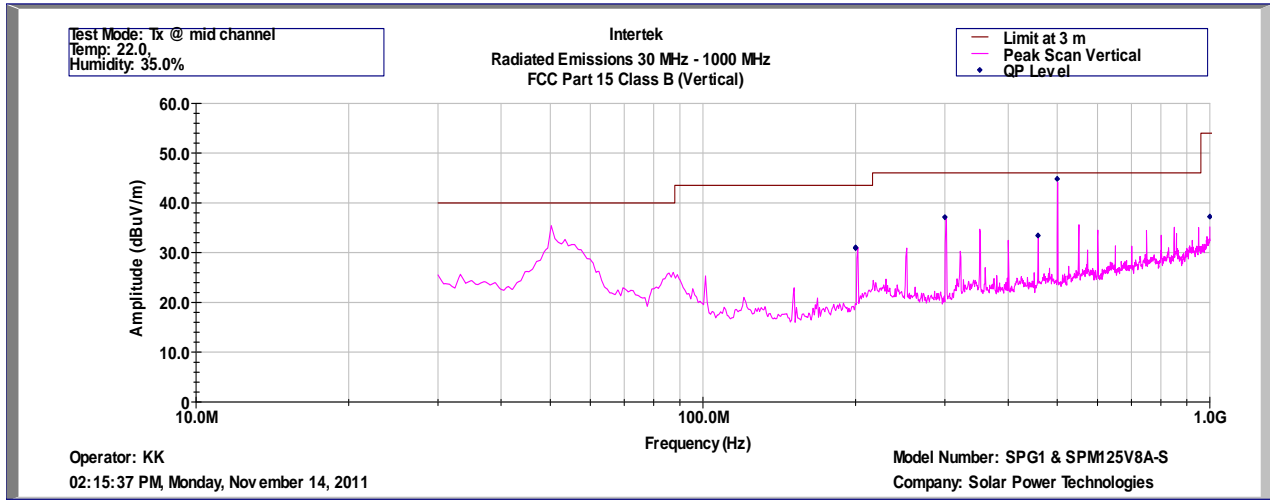

Intertek
Radiated Emissions 30 MHz - 1000 MHz
FCC Part 15 Class B (QP-Vertical)

Operator: KK Model Number: SPG1 & SPM125V8A-S
14-Nov-11 Company: Solar Power Technologies

Frequency Hz	Quasi Pk FS dB(uV/m)	Limit@3m dB(uV/m)	Margin dB	RA dB(uV)	Cable dB	AG dB	DCF dB	AF dB(1/m)
2.00E+08	31.0	43.5	-12.5	41.0	1.6	32.0	10.5	9.8
3.00E+08	37.1	46.0	-8.9	43.5	2.0	32.0	10.5	13.1
4.58E+08	33.5	46.0	-12.5	36.4	2.5	32.1	10.5	16.1
5.00E+08	44.8	46.0	-1.2	47.2	2.6	32.2	10.5	16.7
1.00E+09	37.2	54.0	-16.8	30.4	3.8	30.7	10.5	23.3

Test Mode: Tx @ mid channel
Temp: 22.0C
Humidity: 35.0%

Notes: Measurements made at 10 meters distance.

SPG1 & SPM125V8A-S were placed on the test table and measured at the same time.

Plot 5.12

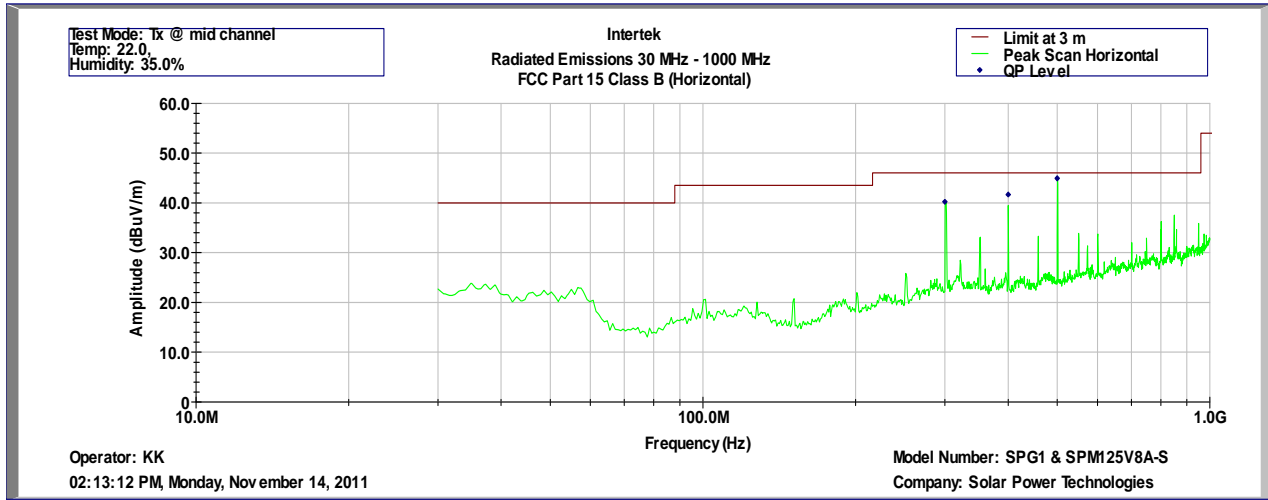

Intertek
Radiated Emissions 30 MHz - 1000 MHz
FCC Part 15 Class B (QP-Horizontal)

Operator: KK
14-Nov-11

Model Number: SPG1 & SPM125V8A-S
Company: Solar Power Technologies

Frequency Hz	Quasi Pk FS dB(uV/m)	Limit@3m dB(uV/m)	Margin dB	RA dB(uV)	CF dB	AG dB	DCF dB	AF dB(1/m)
3.00E+08	40.2	46.0	-5.8	46.6	2.0	32.0	10.5	13.1
4.00E+08	41.7	46.0	-4.3	45.9	2.3	32.1	10.5	15.0
5.00E+08	44.9	46.0	-1.1	47.3	2.6	32.2	10.5	16.7

Test Mode: Tx @ mid channel
Temp: 22.0C
Humidity: 35.0%

Notes: Measurements made at 10 meters distance.

SPG1 & SPM125V8A-S were placed on the test table and measured at the same time.

Plot 5.13

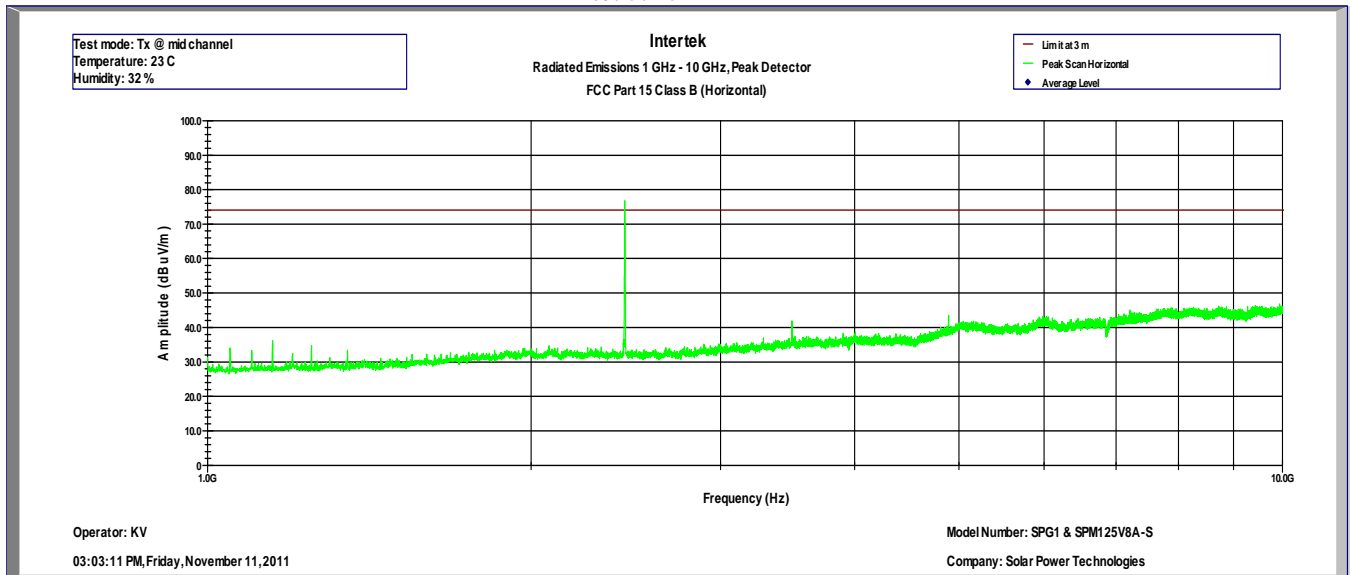

Plot 5.14

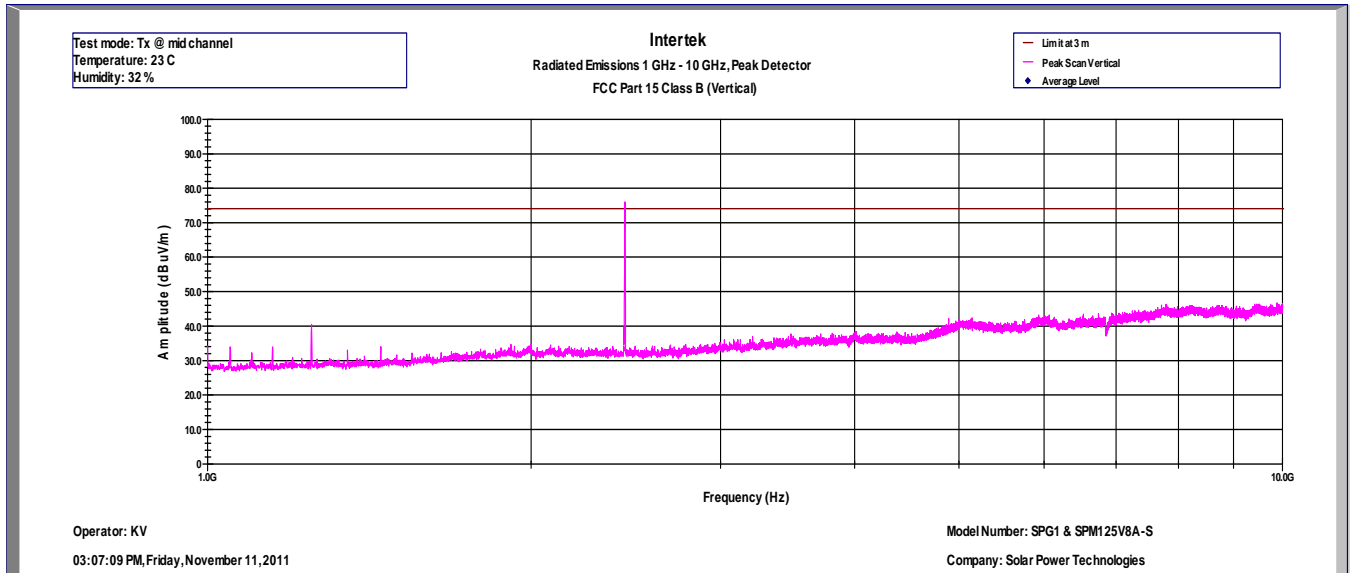

Notes: Measurements made at 3 meters distance.
 SPG1 & SPM125V8A-S were placed on the test table and measured at the same time.

Plot 5.15

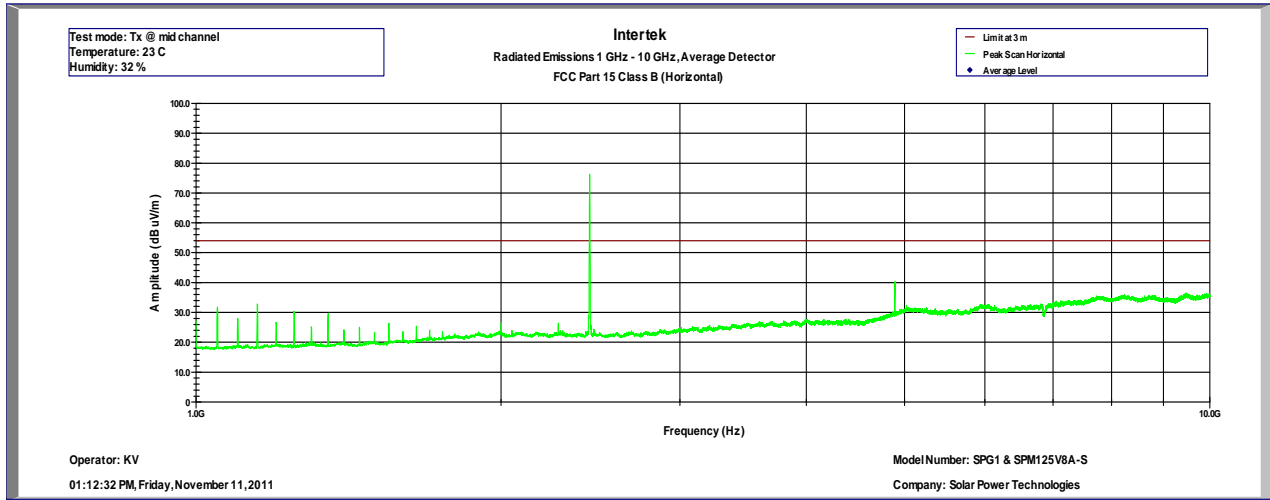

Plot 5.16

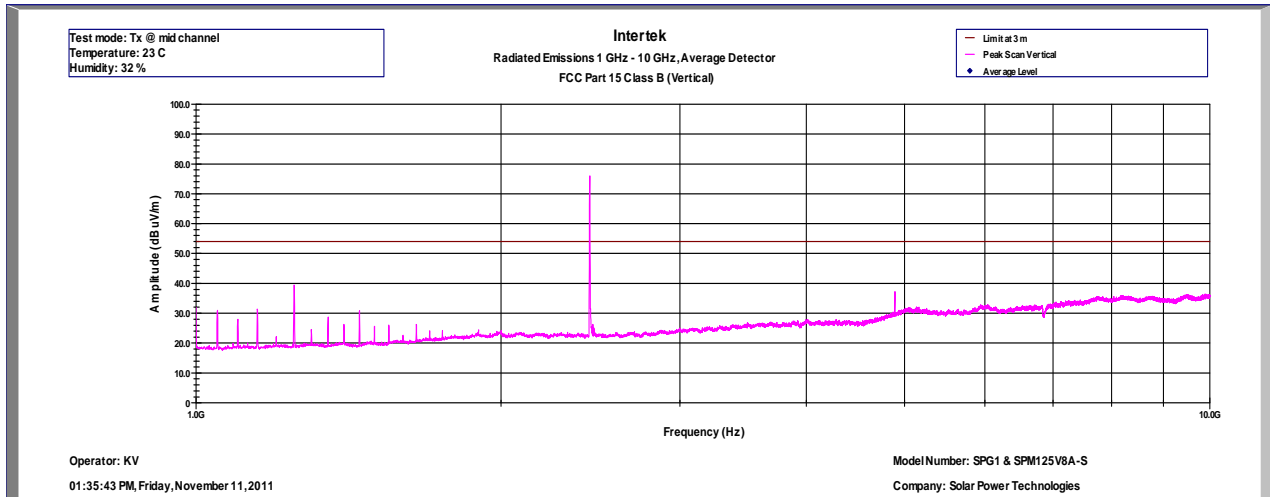

Notes: Measurements made at 3 meters distance.
 SPG1 & SPM125V8A-S were placed on the test table and measured at the same time.

Plot 5.17

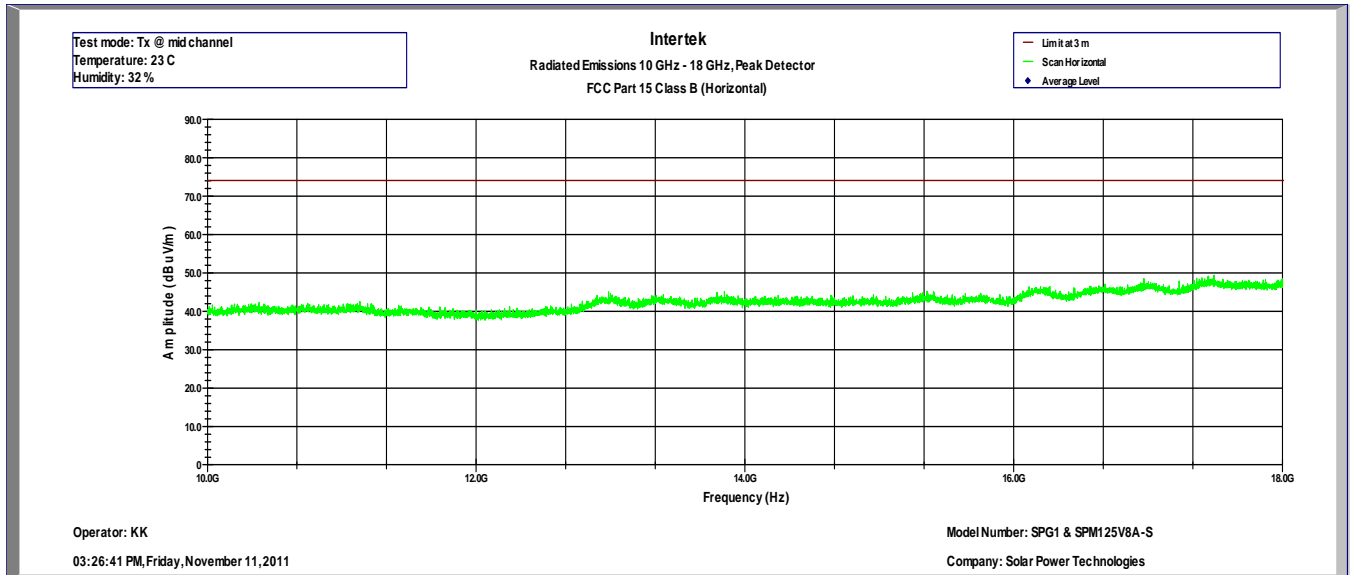

Plot 5.18

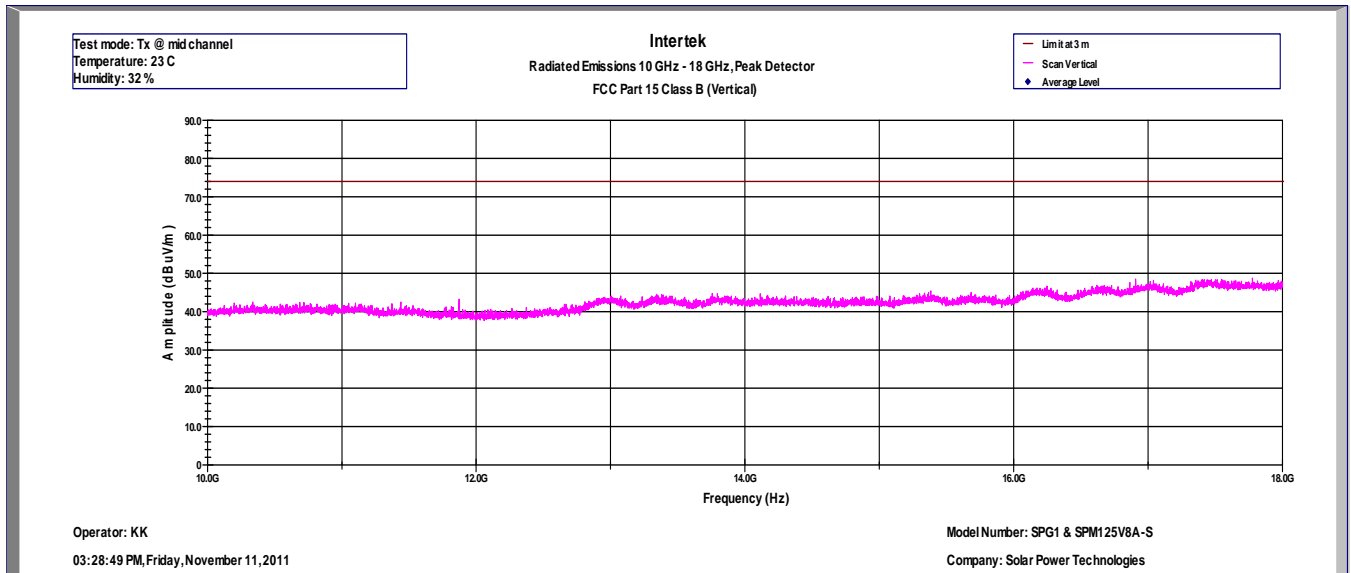

Notes: Measurements made at 3 meters distance.

SPG1 & SPM125V8A-S were placed on the test table and measured at the same time.

No emissions were detected above the noise floor which was at least 10 dB below the limit in the range of 18GHz – 25GHz.

Plot 5.19

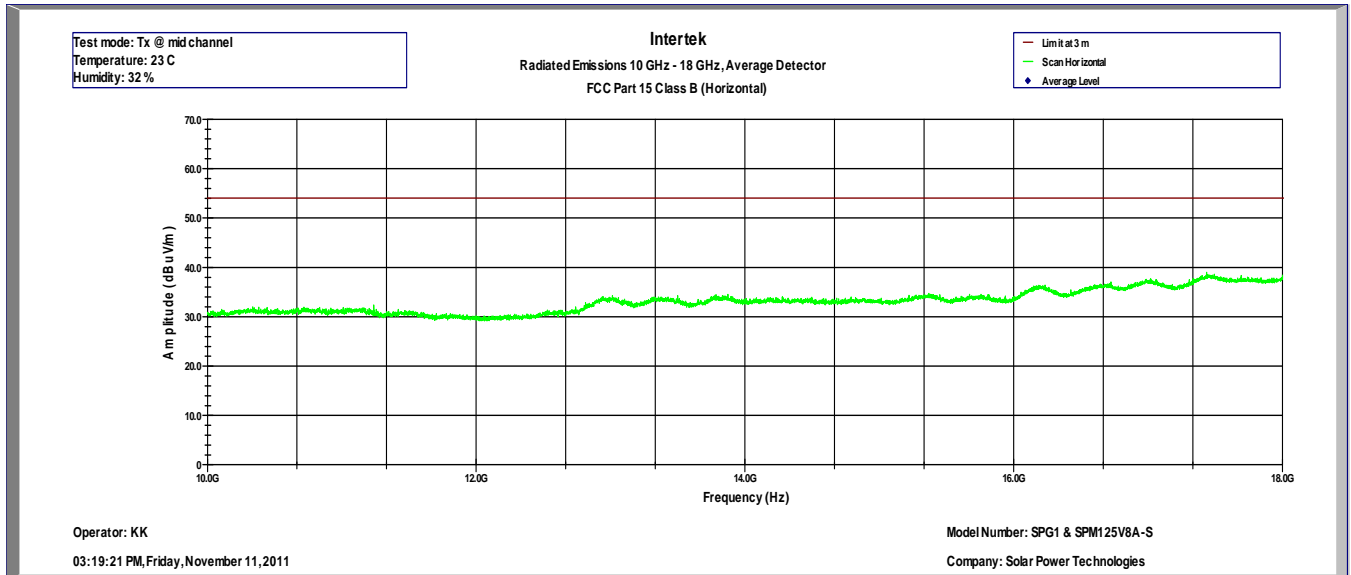

Plot 5.20

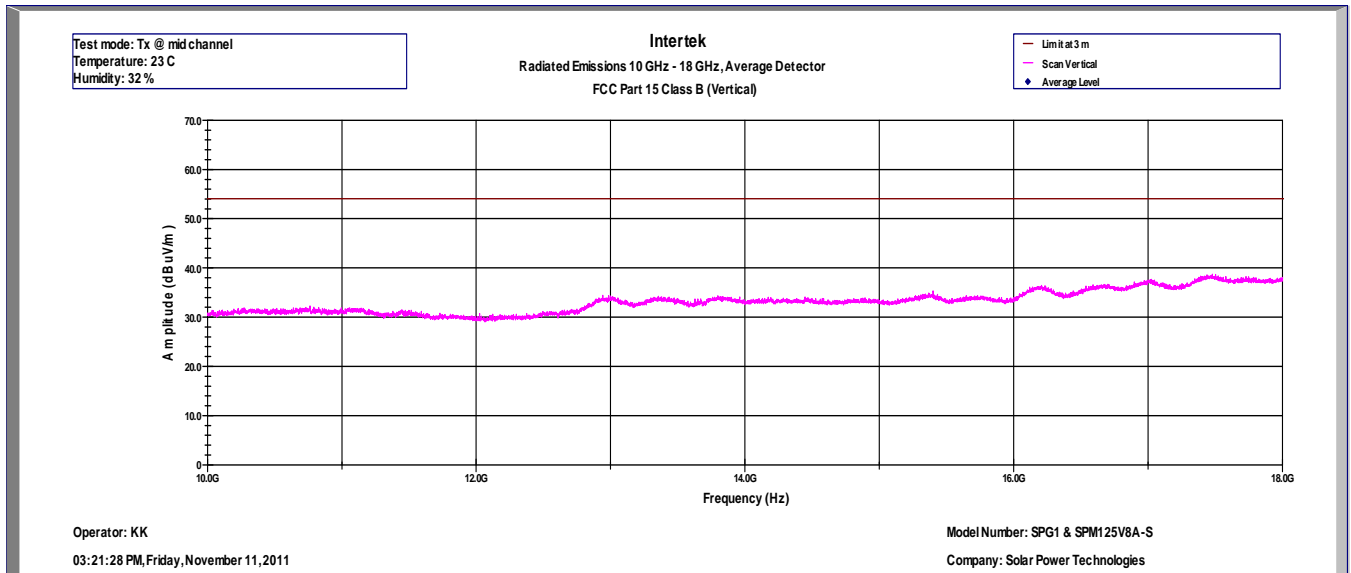

Notes: Measurements made at 3 meters distance.

SPG1 & SPM125V8A-S were placed on the test table and measured at the same time.

No emissions were detected above the noise floor which was at least 10 dB below the limit in the range of 18GHz – 25GHz.

Plot 5. 21

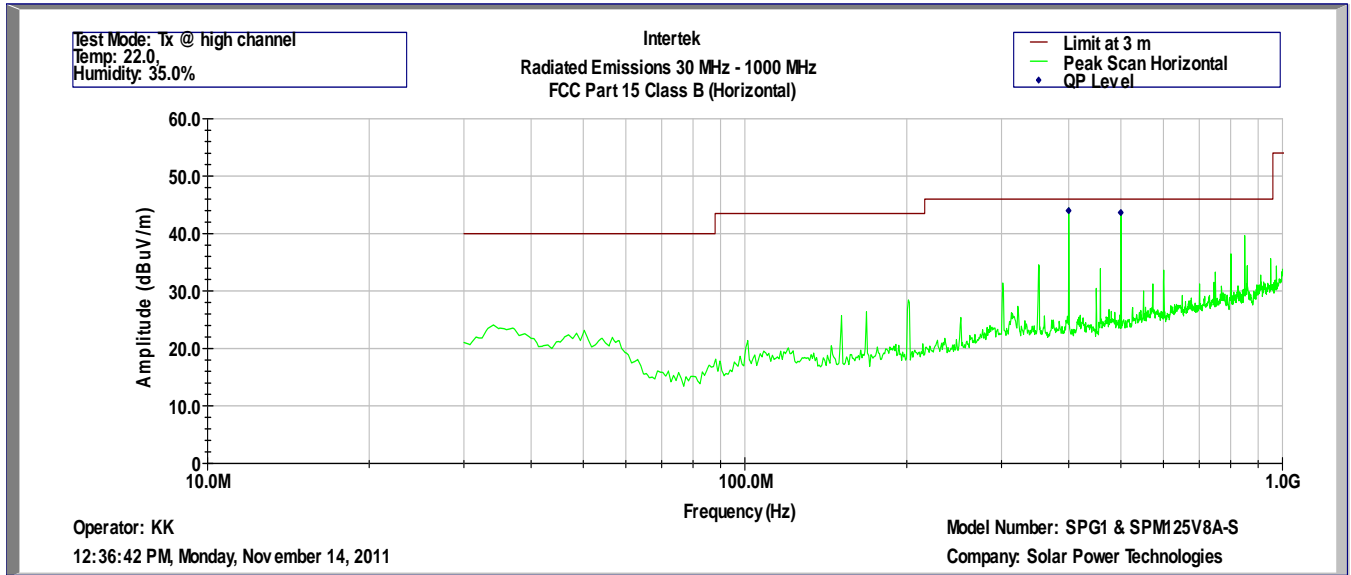

Intertek
Radiated Emissions 30 MHz - 1000 MHz
FCC Part 15 Class B (QP-Horizontal)

Operator: KK
14-Nov-11

Model Number: SPG1 & SPM125V8A-S
Company: Solar Power Technologies

Frequency	Quasi Pk FS	Limit@3m	Margin	RA	CF	AG	DCF	AF
Hz	dB(uV/m)	dB(uV/m)	dB	dB(uV)	dB	dB	dB	dB(1/m)
4.00E+08	44.0	46.0	-2.0	48.2	2.3	32.1	10.5	15.0
5.00E+08	43.6	46.0	-2.4	46.0	2.6	32.2	10.5	16.7

Test Mode: Tx @ high channel
Temp: 22.0C
Humidity: 35.0%

Notes: Measurements made at 10 meters distance.

SPG1 & SPM125V8A-S were placed on the test table and measured at the same time.

Plot 5. 22

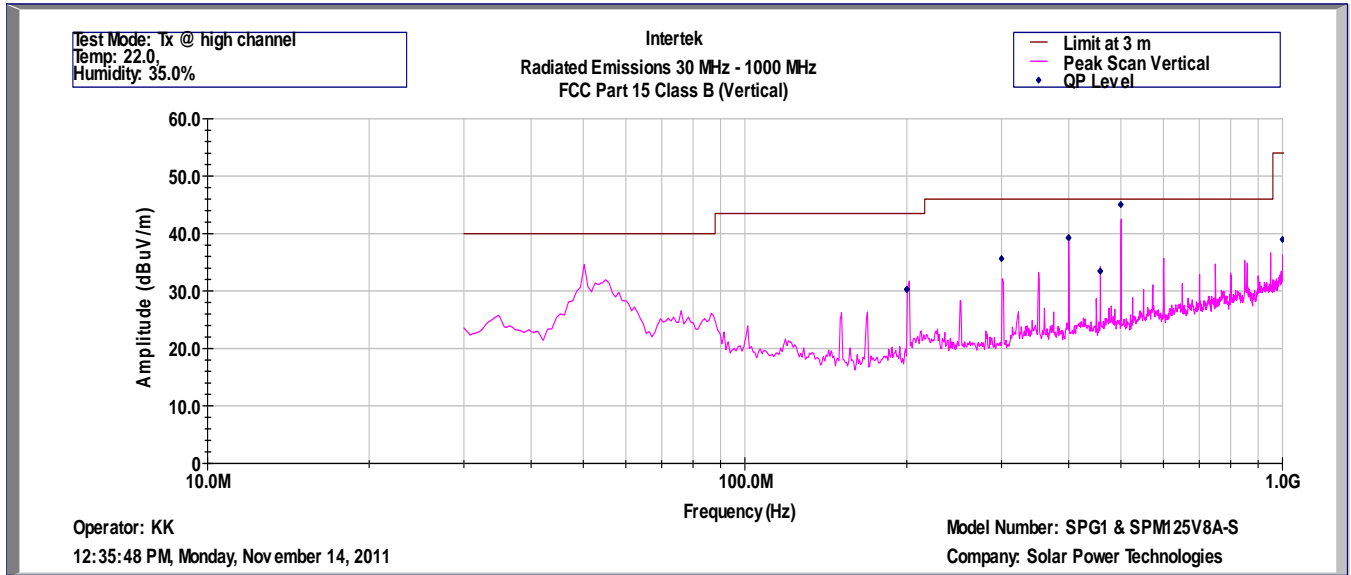

Intertek
Radiated Emissions 30 MHz - 1000 MHz
FCC Part 15 Class B (QP-Vertical)

Operator: KK
14-Nov-11

Model Number: SPG1 & SPM125V8A-S
Company: Solar Power Technologies

Frequency Hz	Quasi Pk FS dB(uV/m)	Limit@3m dB(uV/m)	Margin dB	RA dB(uV)	Cable dB	AG dB	DCF dB	AF dB(1/m)
2.00E+08	30.3	43.5	-13.2	40.3	1.6	32.0	10.5	9.8
3.00E+08	35.6	46.0	-10.4	42.0	2.0	32.0	10.5	13.1
4.00E+08	39.3	46.0	-6.7	43.5	2.3	32.1	10.5	15.0
4.58E+08	33.5	46.0	-12.5	36.4	2.5	32.1	10.5	16.1
5.00E+08	45.0	46.0	-1.0	47.4	2.6	32.2	10.5	16.7
1.00E+09	38.9	54.0	-15.1	32.1	3.8	30.7	10.5	23.3

Test Mode: Tx @ high channel
Temp: 22.0C
Humidity: 35.0%

Notes: Measurements made at 10 meters distance.

SPG1 & SPM125V8A-S were placed on the test table and measured at the same time.

Plot 5.23

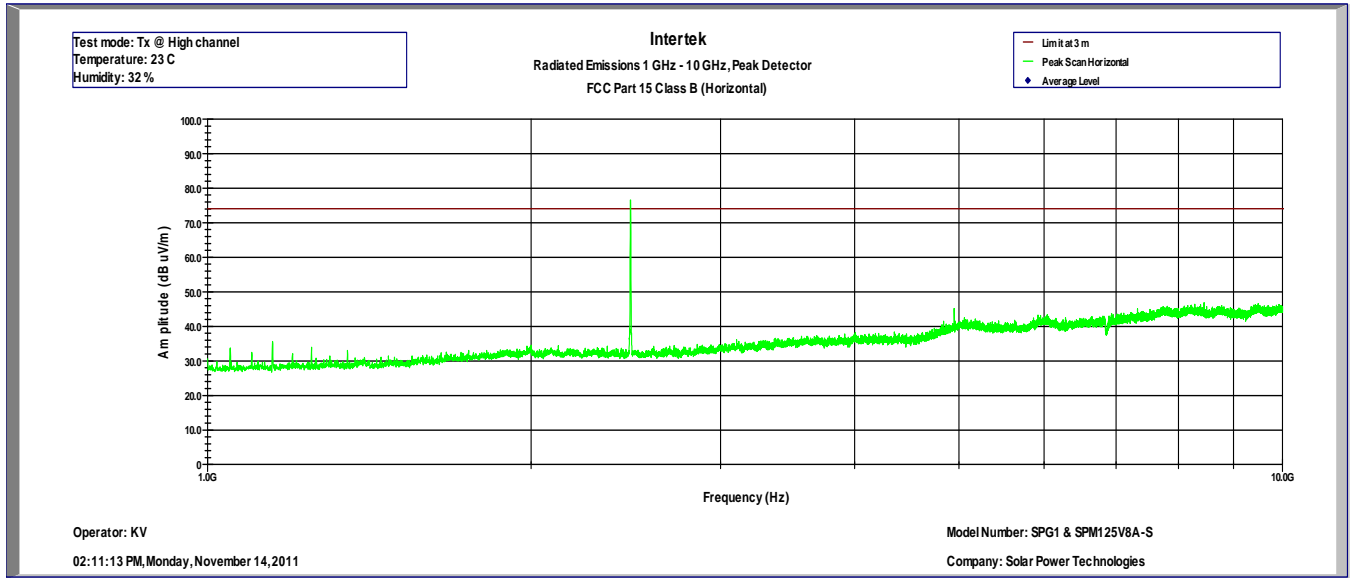

Plot 5.24

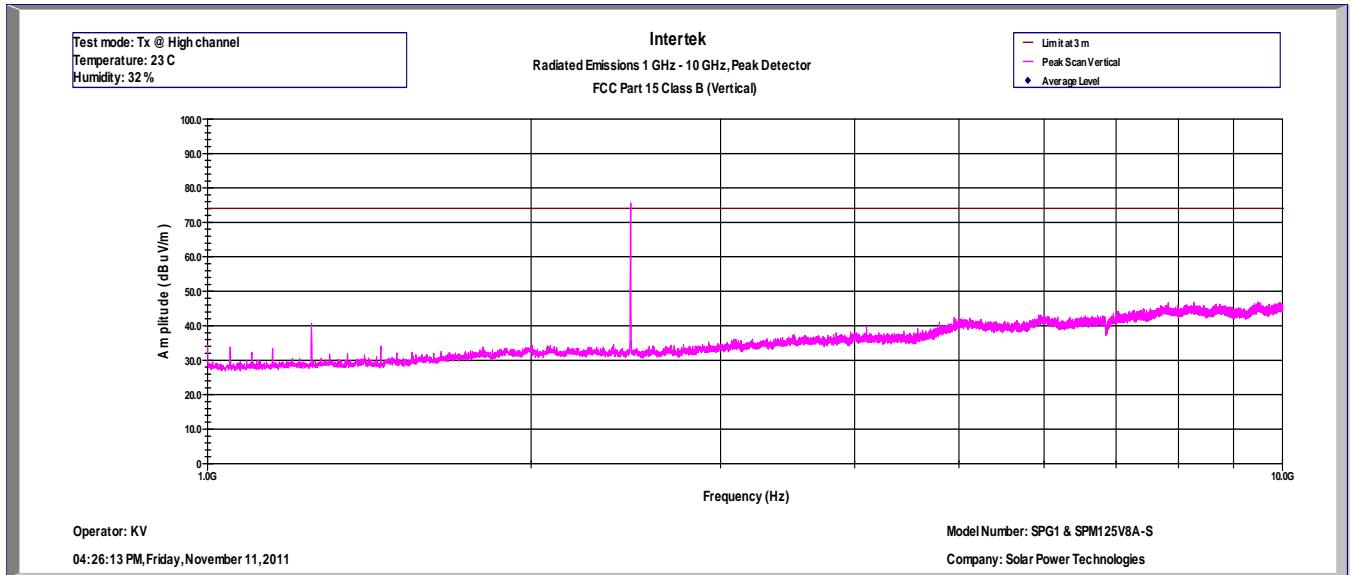

Measurement at the Bandedge

Frequency (Hz)	Pk Level (dBuV/m)	Limit@3m (dBuV/m)	Margin (dB)	Raw (dBuV)	Cable (dB)	Preamp (dB)	AF dB(1/m)
2.4835+09	33.9	74.0	-40.8	37.0	4.5	35.7	28.1

Notes: Measurements made at 3 meters distance.

SPG1 & SPM125V8A-S were placed on the test table and measured at the same time.

Plot 5. 25

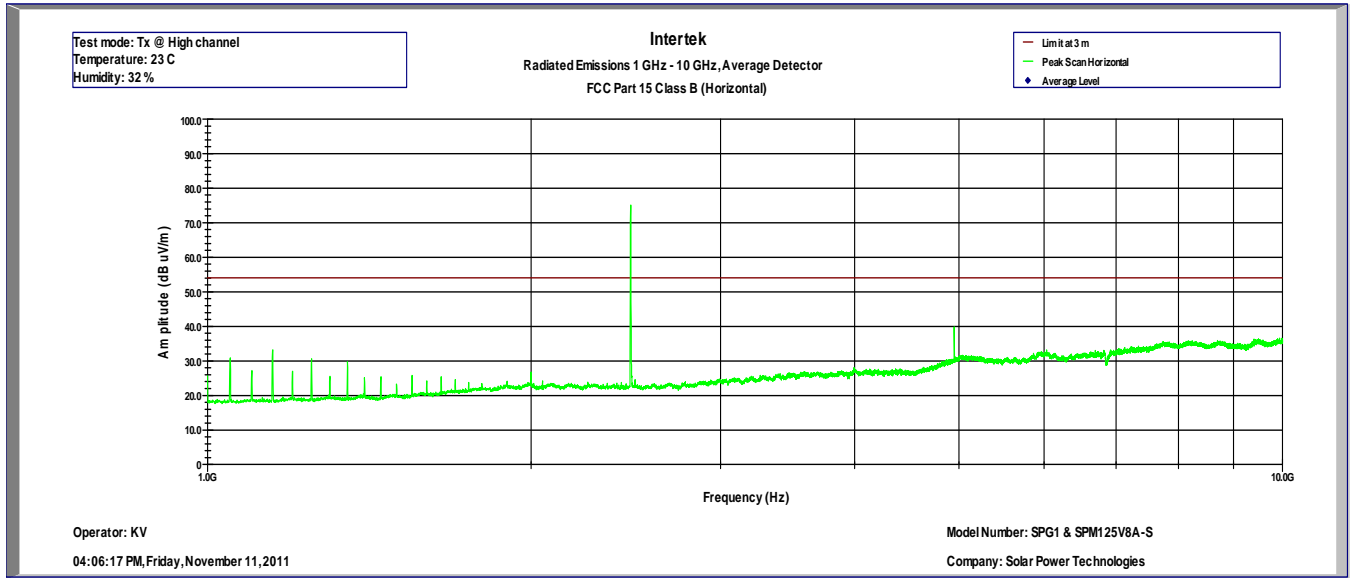

Plot 5. 26

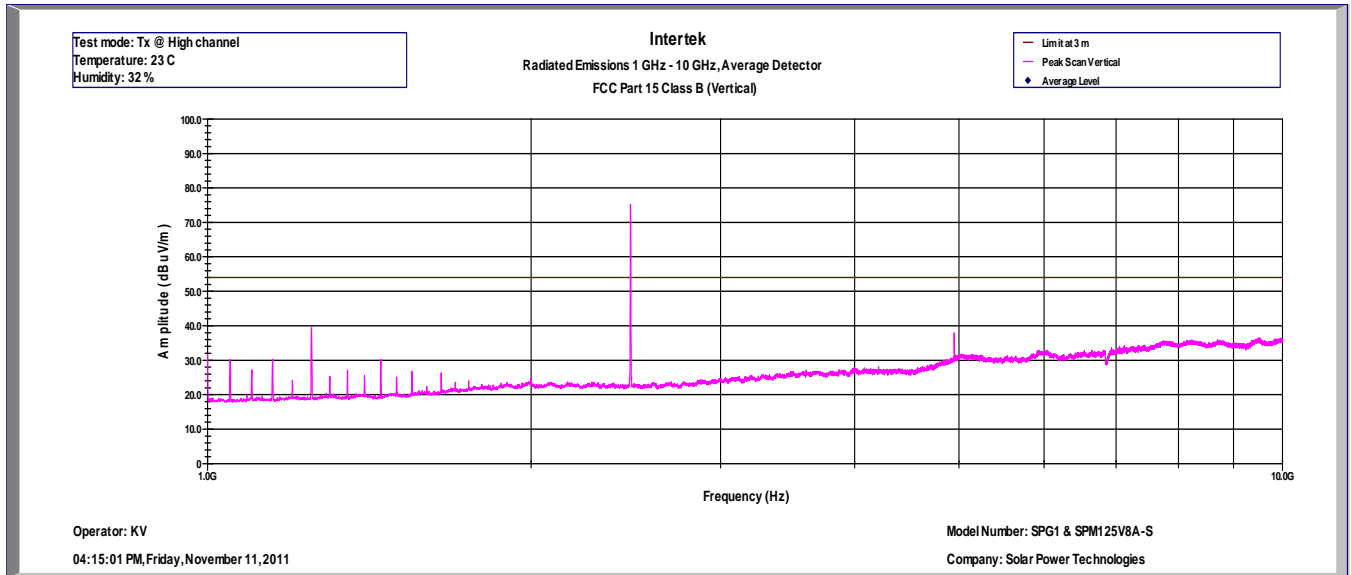

Measurement at the Bandedge

Frequency (Hz)	Av Level (dBuV/m)	Limit@3m (dBuV/m)	Margin (dB)	Raw (dBuV)	Cable (dB)	Preamp (dB)	AF (dB(1/m))
2.4835+09	22.9	54.0	-30.8	26.0	4.5	35.7	28.1

Notes: Measurements made at 3 meters distance.

SPG1 & SPM125V8A-S were placed on the test table and measured at the same time.

Plot 5.27

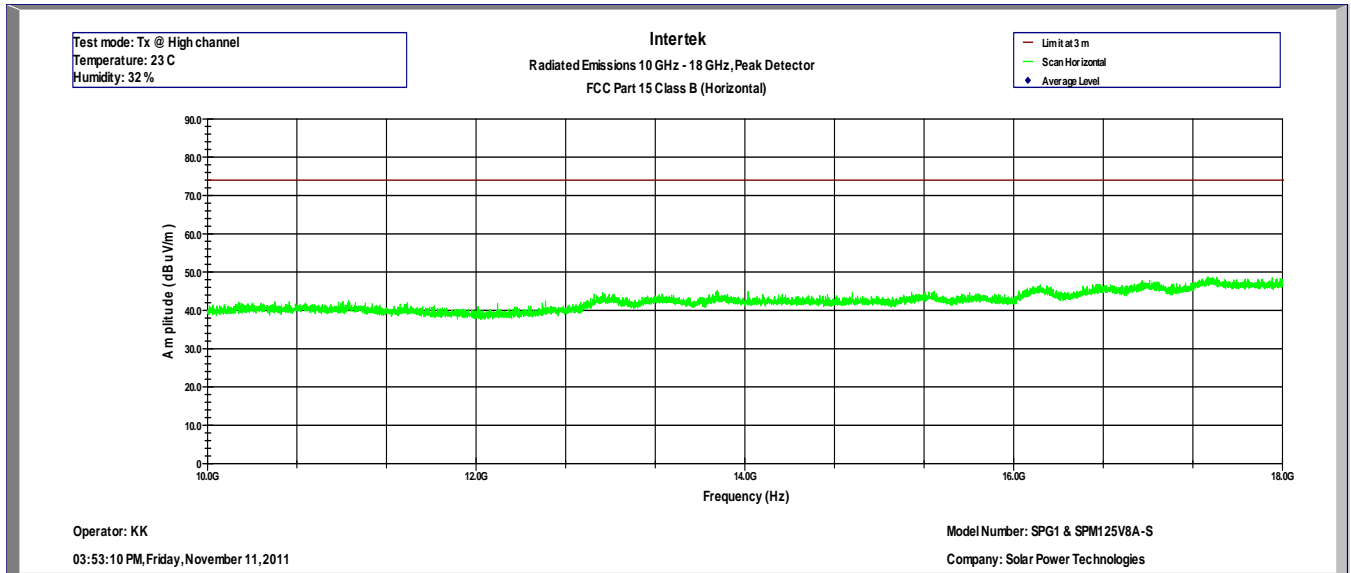

Plot 5.28

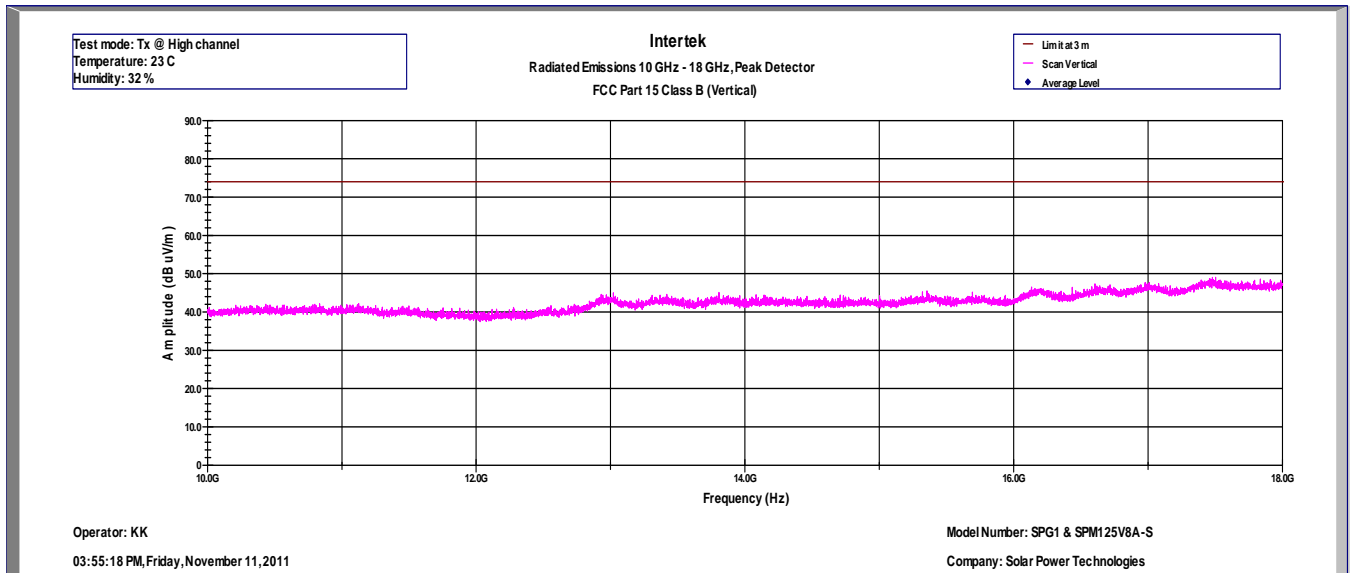

Notes: Measurements made at 3 meters distance.

SPG1 & SPM125V8A-S were placed on the test table and measured at the same time.

No emissions were detected above the noise floor which was at least 10 dB below the limit in the range of 18GHz – 25GHz.

Plot 5. 29

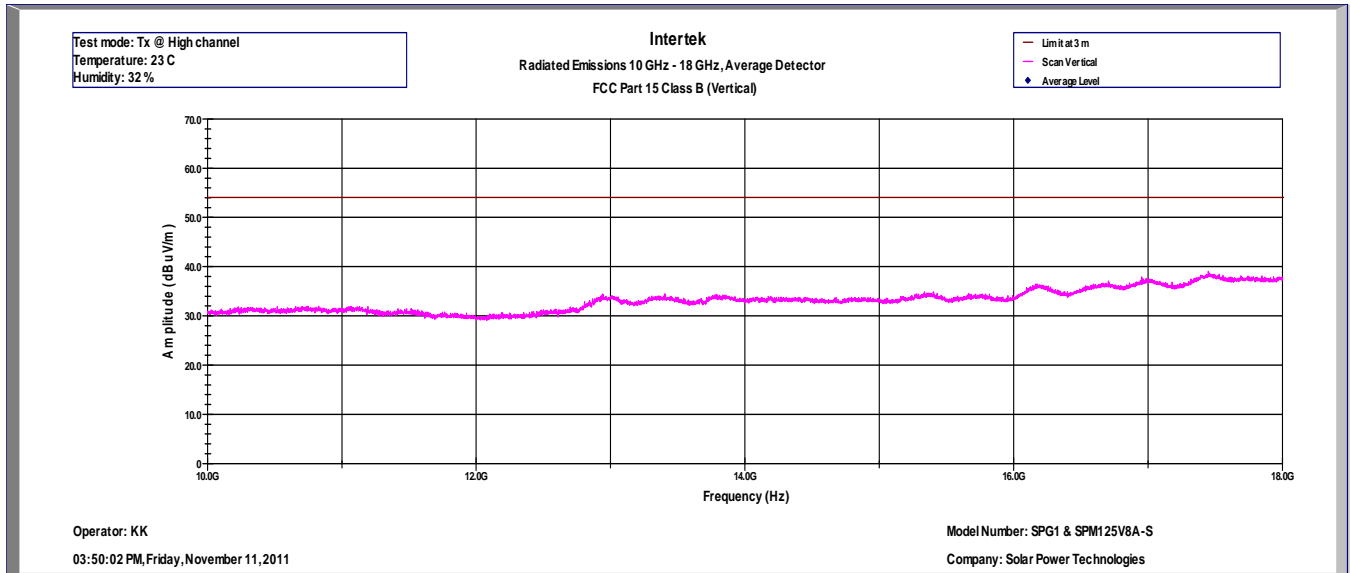

Plot 5. 30

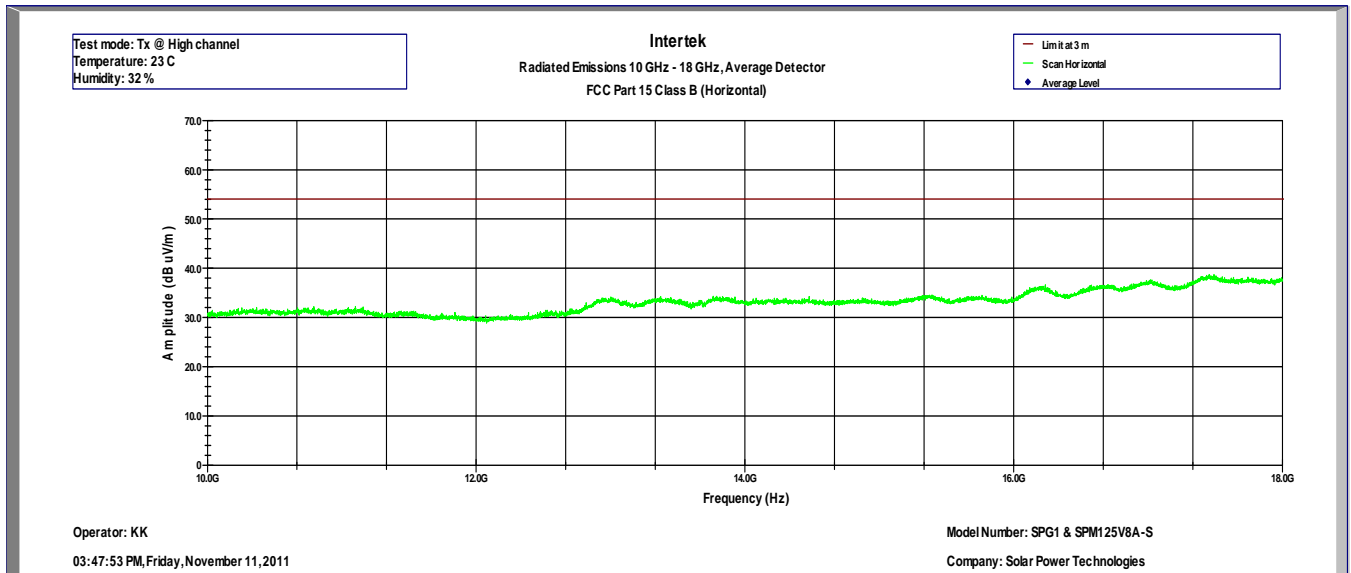

Notes: Measurements made at 3 meters distance.

SPG1 & SPM125V8A-S were placed on the test table and measured at the same time.

No emissions were detected above the noise floor which was at least 10 dB below the limit in the range of 18GHz – 25GHz.

Test Configuration Photographs

The following photographs show the testing configurations used.

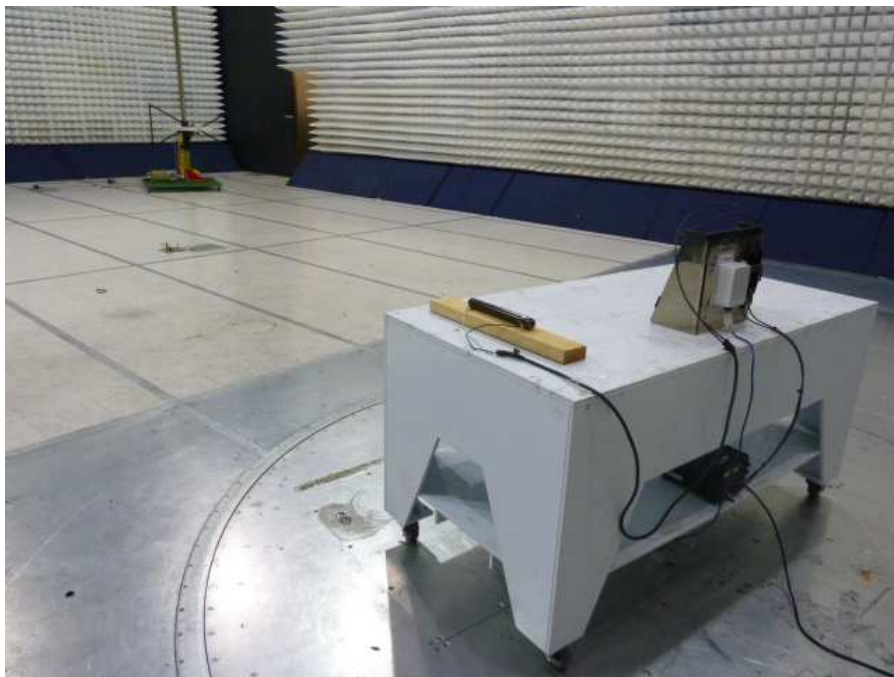

Test Configuration Photographs

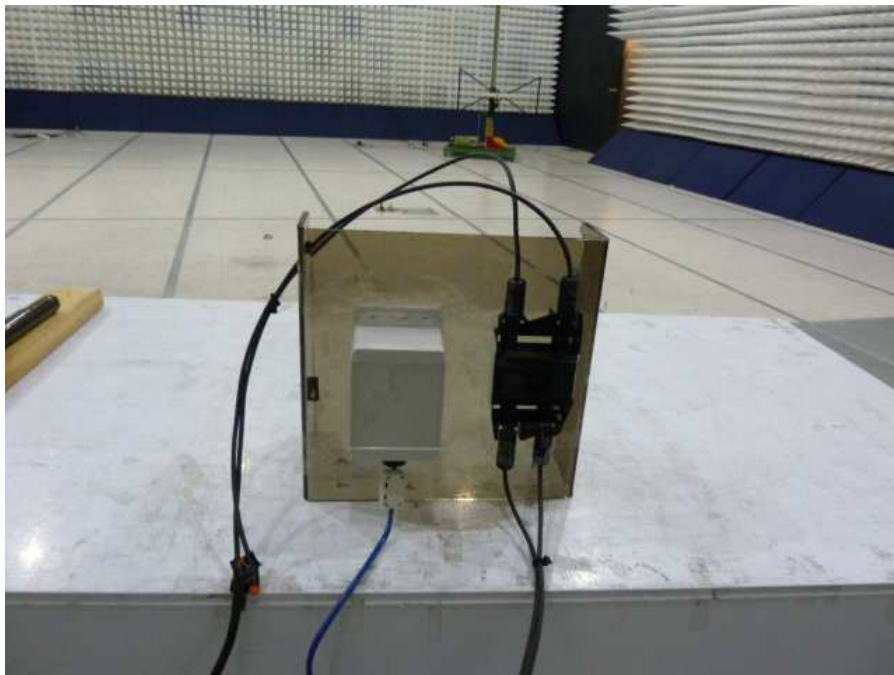

4.6 Radiated Emissions from Digital Parts and Receiver
FCC Ref: 15.109

Test Limit

*Limits for Electromagnetic Radiated Emissions, FCC Section 15.109(b) and ICES 003**

Frequency (MHz)	Class A at 10m dB(μ V/m)	Class B at 3m dB(μ V/m)
30-88	39	40.0
88-216	43.5	43.5
216-960	46.4	46.0
Above 960	49.5	54.0

* According to FCC Part 15.109(g) an alternative to the radiated emission limits shown above, digital devices may be shown to comply with the limit of CISPR Pub. 22

Test Results

Radiated emission measurements were performed from 30 MHz to 1000 MHz. The data on the following pages list the significant emission frequencies, the limit and the margin of compliance. The results are presented on the following Plots 6.1 – 6.16.

The EUT passed by 2.3 dB.

Plot 6.1

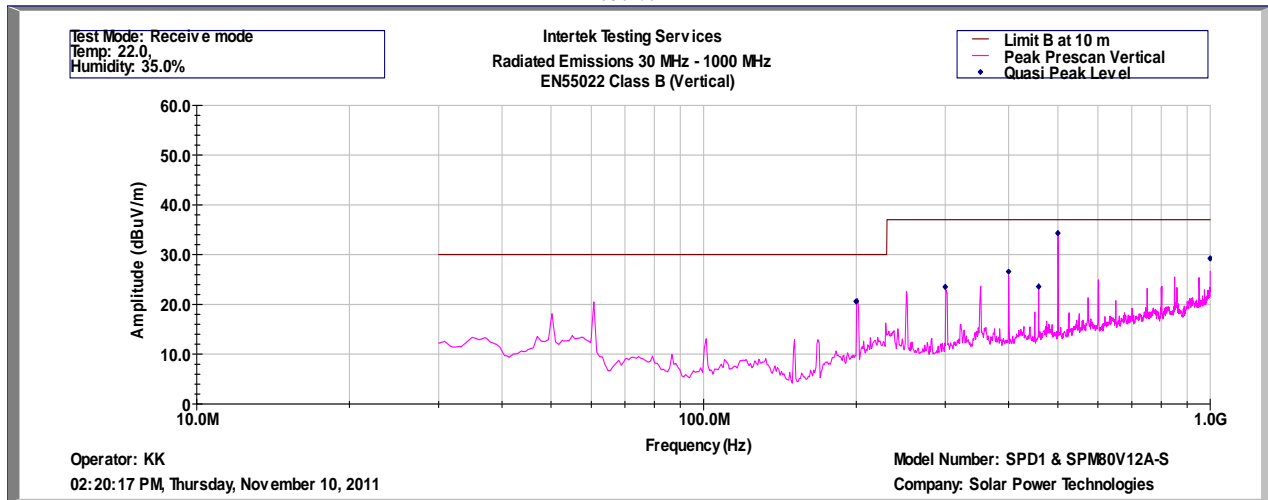

Intertek Testing Services
Radiated Emissions 30 MHz - 1000 MHz
EN55022 Class B (QP-Vertical)

Operator: KK
10-Nov-11

Model Number: SPD1 & SPM80V12A-S
Company: Solar Power Technologies

Frequency Hz	Quasi Pk FS dB(uV/m)	Limit@10m dB(uV/m)	Margin dB	RA dB(uV)	AG dB	AF dB(1/m)	CF dB
2.00E+08	20.6	30.0	-9.4	41.1	32.0	9.8	1.6
2.00E+08	20.6	30.0	-9.4	41.1	32.0	9.8	1.6
3.00E+08	23.5	37.0	-13.5	40.4	32.0	13.1	2.0
4.00E+08	26.6	37.0	-10.4	41.3	32.1	15.0	2.3
4.58E+08	23.6	37.0	-13.4	37.0	32.1	16.1	2.5
5.00E+08	34.3	37.0	-2.7	47.2	32.2	16.7	2.6
1.00E+09	29.2	37.0	-7.8	32.9	30.7	23.3	3.8

Test Mode: Receive mode
Temp: 22.0C
Humidity: 35.0%

Notes: Measurements made at 10 meters distance.

SPD1 & SPM80V12A-S were placed on the test table and measured at the same time.



Plot 6.2

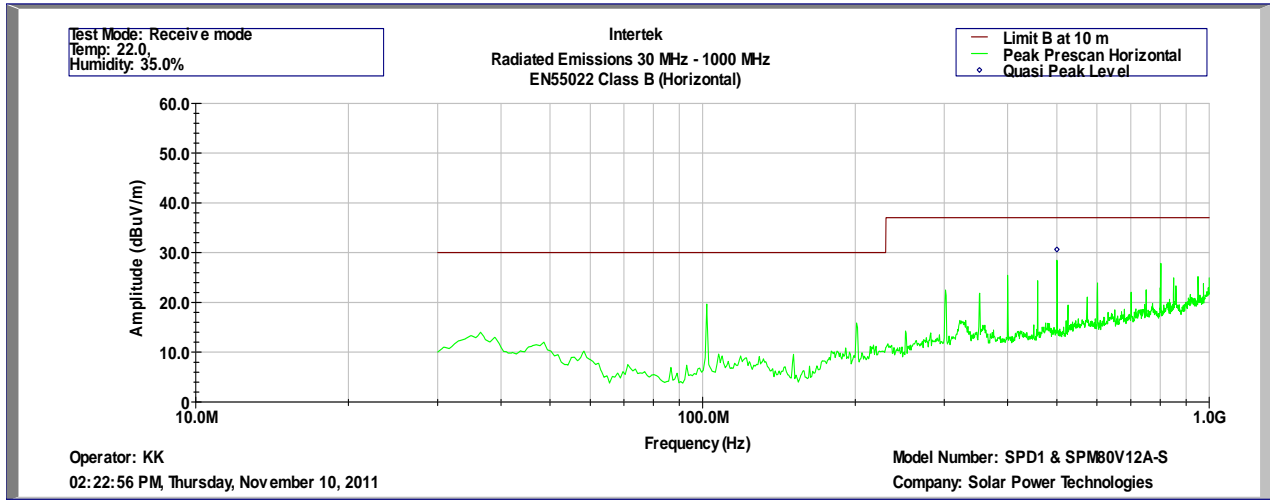

Intertek
Radiated Emissions 30 MHz - 1000 MHz
EN55022 Class B (QP-Horizontal)

Operator: KK
10-Nov-11

Model Number: SPD1 & SPM80V12A-S
Company: Solar Power Technologies

Frequency	Quasi Pk FS	Limit@10m	Margin	RA	AG	AF	CF
Hz	dB(uV/m)	dB(uV/m)	dB	dB(uV)	dB	dB(1/m)	dB
5.00E+08	30.6	37.0	-6.4	43.5	32.2	16.7	2.6

Test Mode: Receive mode

Temp: 22.0C

Humidity: 35.0%

Notes: Measurements made at 10 meters distance.

SPD1 & SPM80V12A-S were placed on the test table and measured at the same time.

Plot 6.3

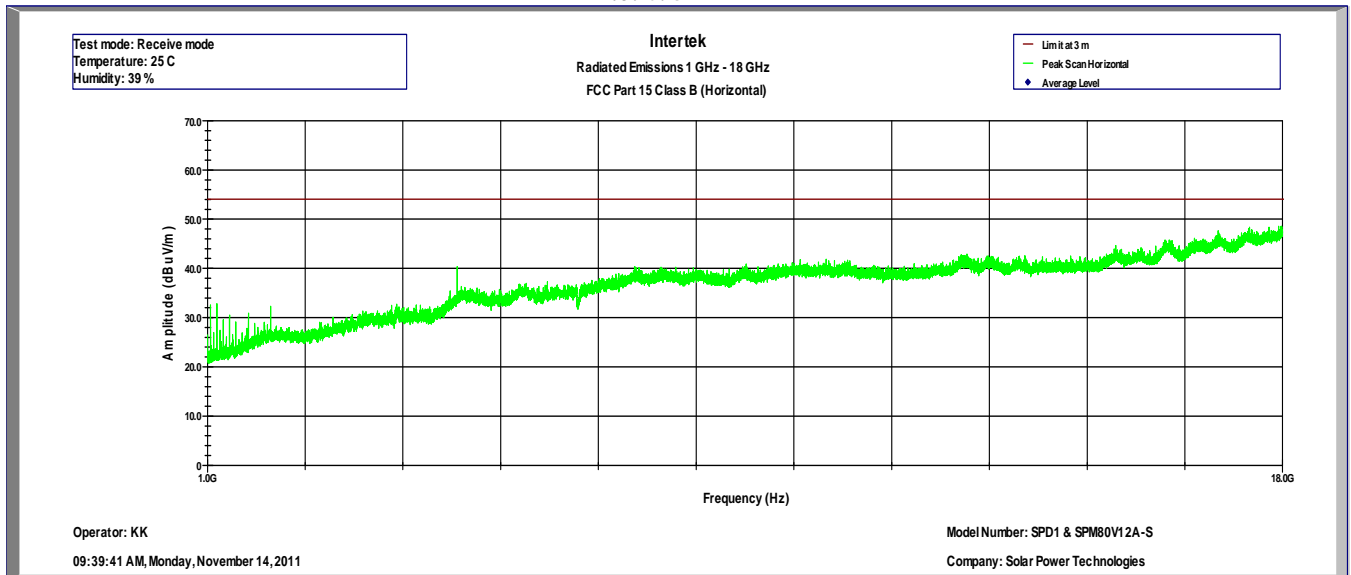

Plot 6.4

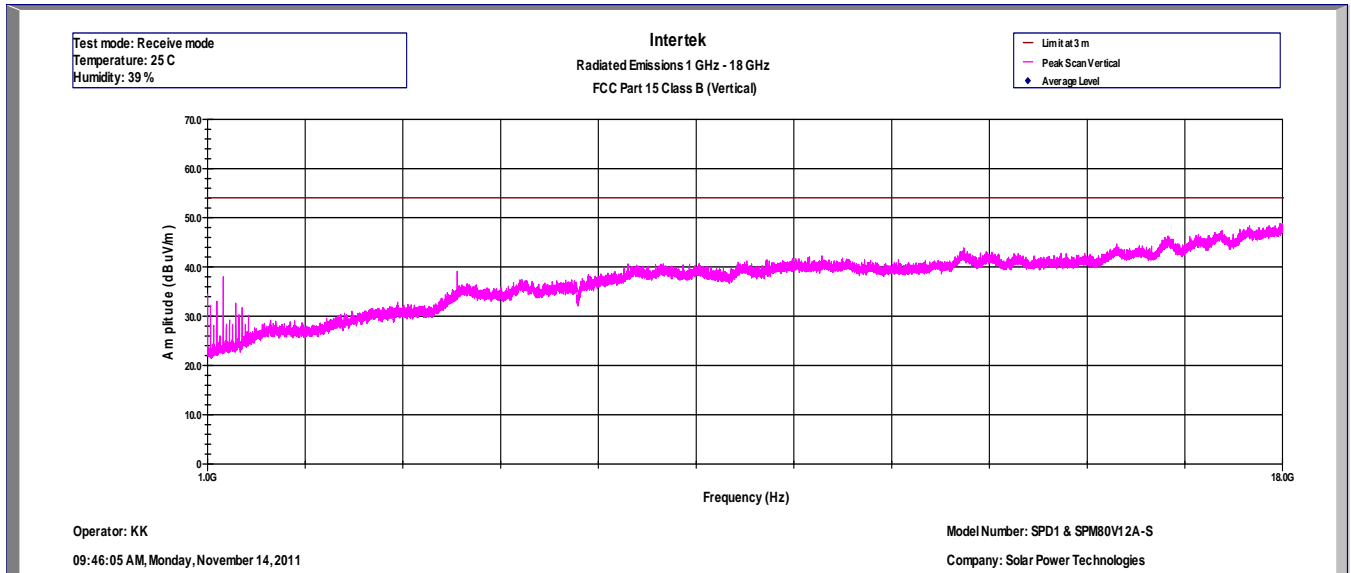

Notes: Measurements made at 3 meters distance.

SPD1 & SPM80V12A-S were placed on the test table and measured at the same time.

Plot 6. 5

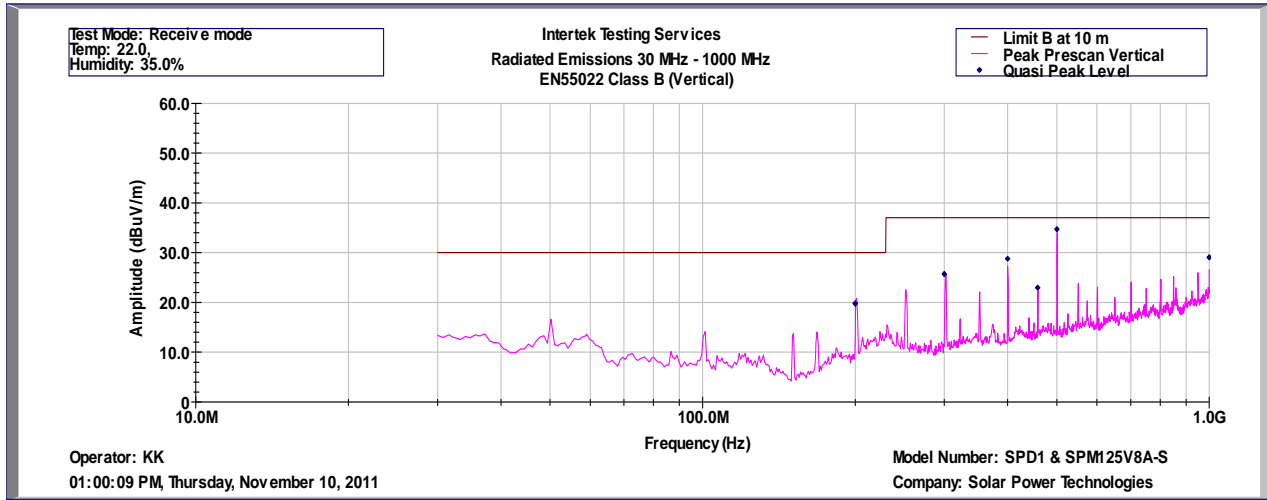

Intertek Testing Services
 Radiated Emissions 30 MHz - 1000 MHz
 EN55022 Class B (QP-Vertical)

Operator: KK
 10-Nov-11

Model Number: SPD1 & SPM125V8A-S
 Company: Solar Power Technologies

Frequency Hz	Quasi Pk FS dB(uV/m)	Limit@10m dB(uV/m)	Margin dB	RA dB(uV)	AG dB	AF dB(1/m)	CF dB
2.00E+08	19.8	30.0	-10.2	40.3	32.0	9.8	1.6
2.00E+08	19.8	30.0	-10.2	40.3	32.0	9.8	1.6
3.00E+08	25.7	37.0	-11.3	42.6	32.0	13.1	2.0
4.00E+08	28.8	37.0	-8.2	43.5	32.1	15.0	2.3
4.58E+08	23.0	37.0	-14.0	36.4	32.1	16.1	2.5
5.00E+08	34.7	37.0	-2.3	47.6	32.2	16.7	2.6
1.00E+09	29.0	37.0	-8.0	32.7	30.7	23.3	3.8

Test Mode: Receive mode
 Temp: 22.0,
 Humidity: 35.0%

Notes: Measurements made at 10 meters distance.

SPD1 & SPM125V8A-S were placed on the test table and measured at the same time.

Plot 6. 6

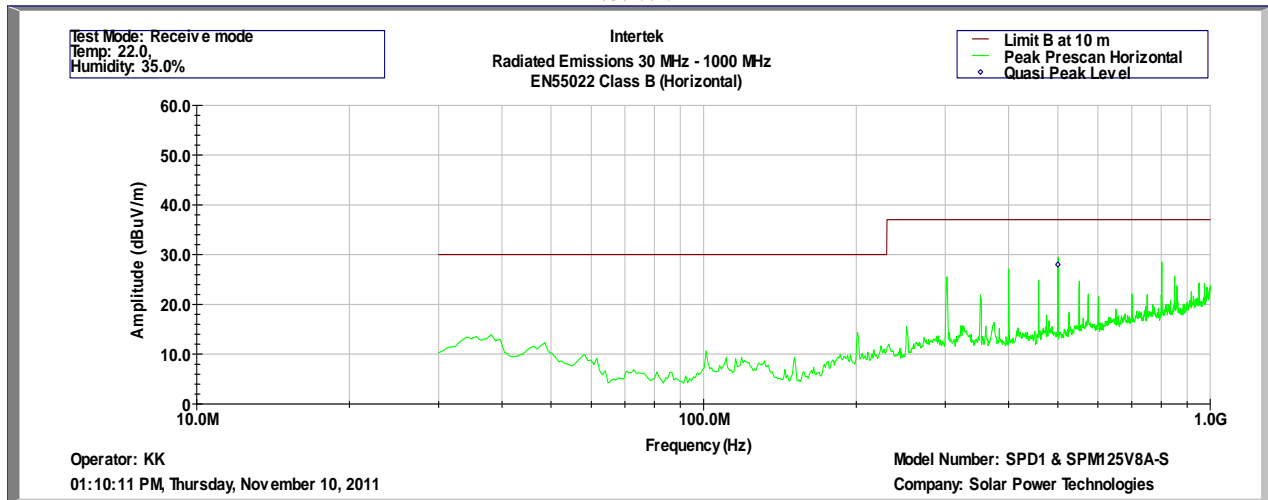

Intertek
Radiated Emissions 30 MHz - 1000 MHz
EN55022 Class B (QP-Horizontal)

Operator: KK
10-Nov-11

Model Number: SPD1 & SPM125V8A-S
Company: Solar Power Technologies

Frequency	Quasi Pk FS	Limit@10m	Margin	RA	AG	AF	CF
Hz	dB(uV/m)	dB(uV/m)	dB	dB(uV)	dB	dB(1/m)	dB
5.00E+08	28.0	37.0	-9.0	40.9	32.2	16.7	2.6

Test Mode: Receive mode
Temp: 22.0C
Humidity: 35.0%

Notes: Measurements made at 10 meters distance.

SPD1 & SPM125V8A-S were placed on the test table and measured at the same time.

Plot 6.7

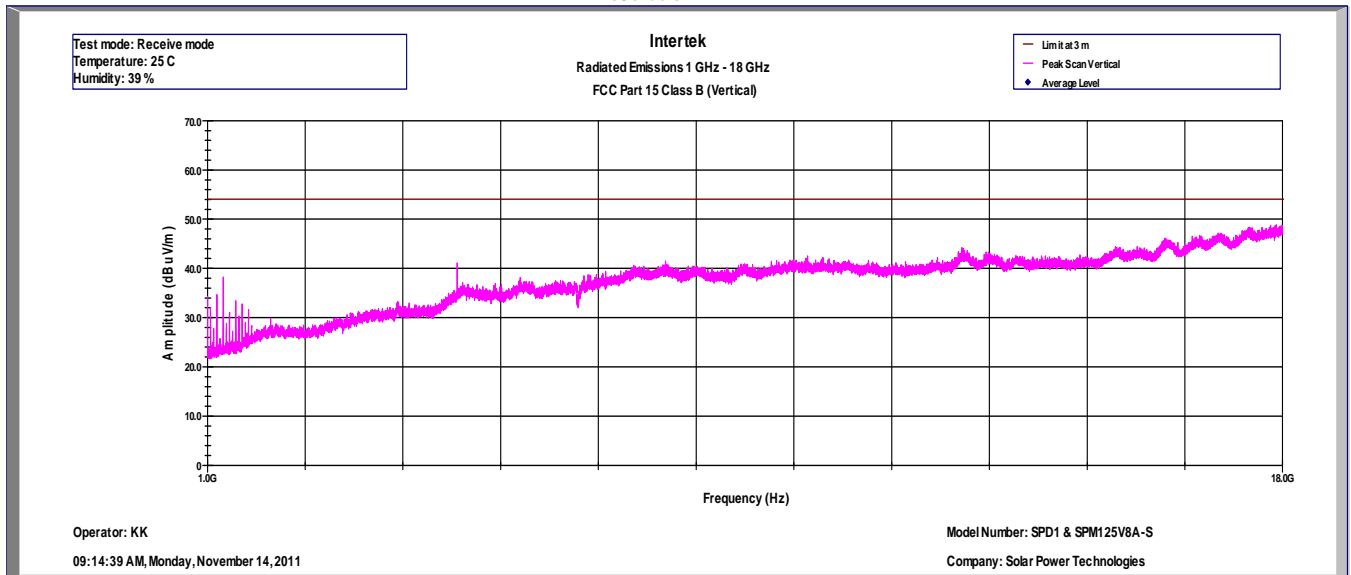

Plot 6.8

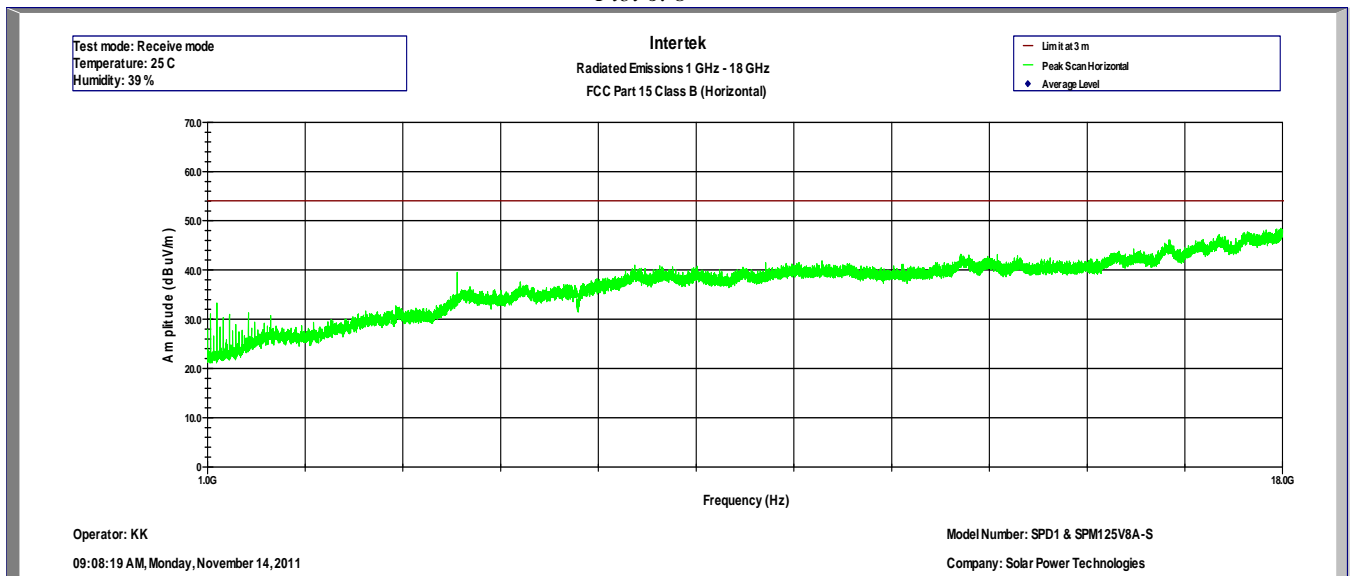

Notes: Measurements made at 3 meters distance.

SPD1 & SPM125V8A-S were placed on the test table and measured at the same time.

Plot 6.9

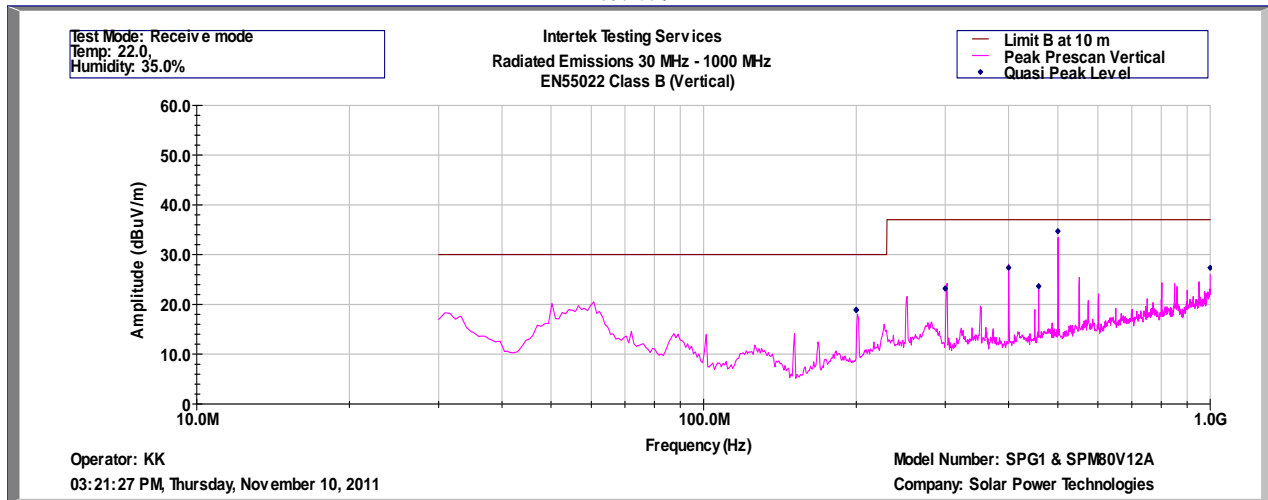

Intertek Testing Services
 Radiated Emissions 30 MHz - 1000 MHz
 EN55022 Class B (QP-Vertical)

Operator: KK
 10-Nov-11

Model Number: SPG1 & SPM80V12A
 Company: Solar Power Technologies

Frequency Hz	Quasi Pk FS dB(uV/m)	Limit@10m dB(uV/m)	Margin dB	RA dB(uV)	AG dB	AF dB(1/m)	CF dB
2.00E+08	18.9	30.0	-11.1	39.4	32.0	9.8	1.6
2.00E+08	18.9	30.0	-11.1	39.4	32.0	9.8	1.6
3.00E+08	23.2	37.0	-13.8	40.1	32.0	13.1	2.0
4.00E+08	27.4	37.0	-9.6	42.1	32.1	15.0	2.3
4.58E+08	23.7	37.0	-13.3	37.1	32.1	16.1	2.5
5.00E+08	34.7	37.0	-2.3	47.6	32.2	16.7	2.6
1.00E+09	27.3	37.0	-9.7	31.0	30.7	23.3	3.8

Test Mode: Receive mode
 Temp: 22.0C
 Humidity: 35.0%

Notes: Measurements made at 10 meters distance.

SPG1 & SPM80V12A were placed on the test table and measured at the same time.

Plot 6. 10

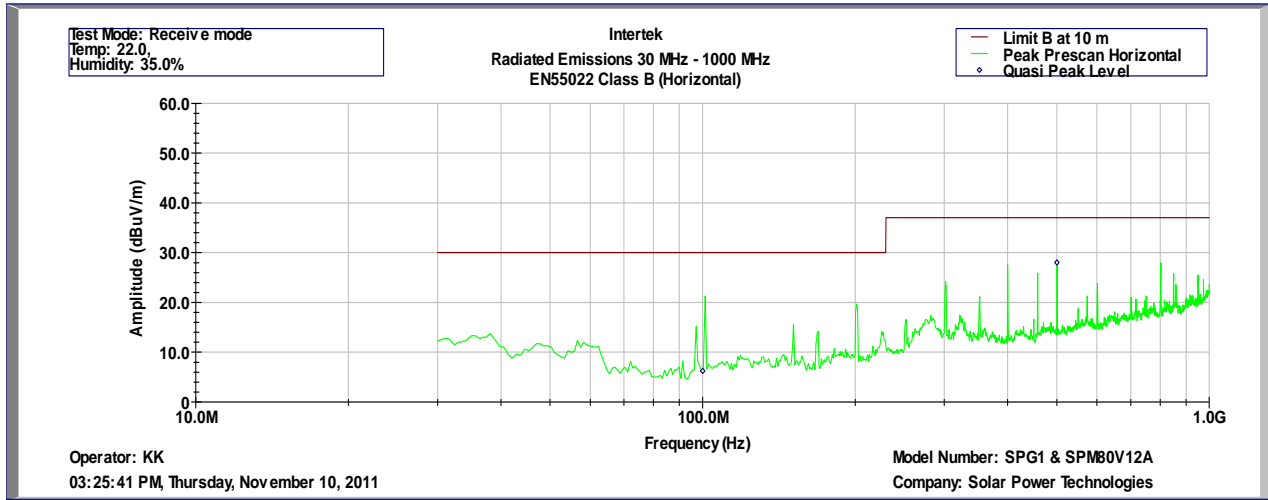

Intertek
Radiated Emissions 30 MHz - 1000 MHz
EN55022 Class B (QP-Horizontal)

Operator: KK
10-Nov-11

Model Number: SPG1 & SPM80V12A
Company: Solar Power Technologies

Frequency Hz	Quasi Pk FS dB(uV/m)	Limit@10m dB(uV/m)	Margin dB	RA dB(uV)	AG dB	AF dB(1/m)	CF dB
1.00E+08	6.2	30.0	-23.8	27.0	32.0	10.1	1.2
5.00E+08	28.0	37.0	-9.0	40.9	32.2	16.7	2.6

Test Mode: Receive mode
Temp: 22.0C
Humidity: 35.0%

Notes: Measurements made at 10 meters distance.

SPG1 & SPM80V12A were placed on the test table and measured at the same time.

Plot 6. 11

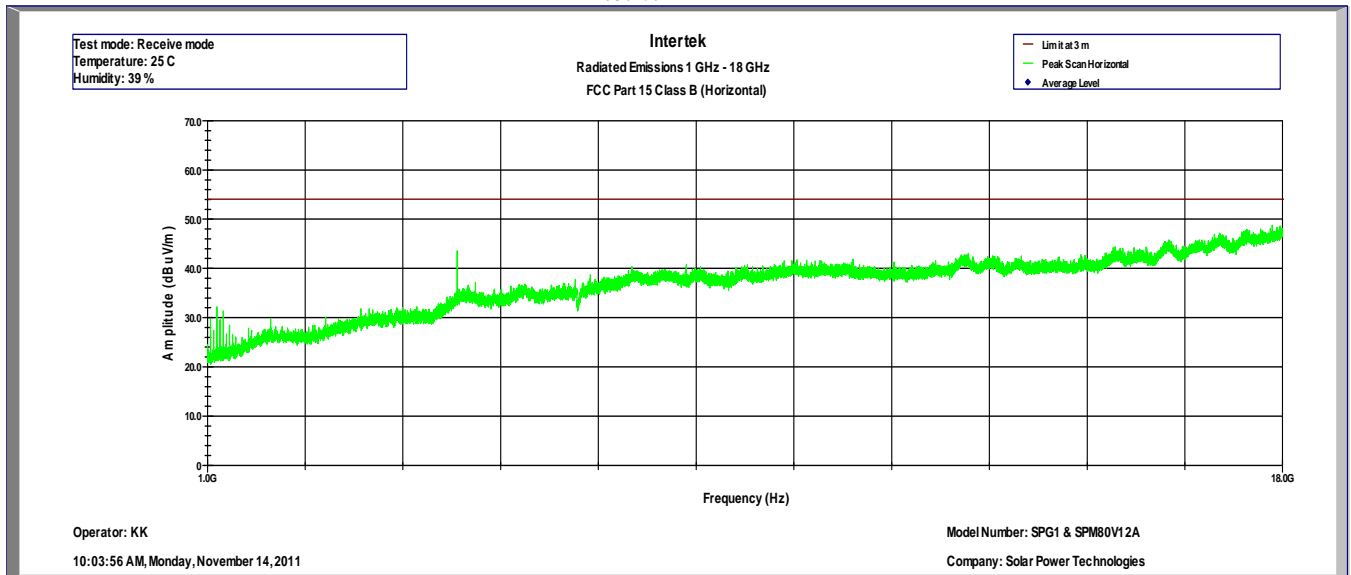

Plot 6. 12

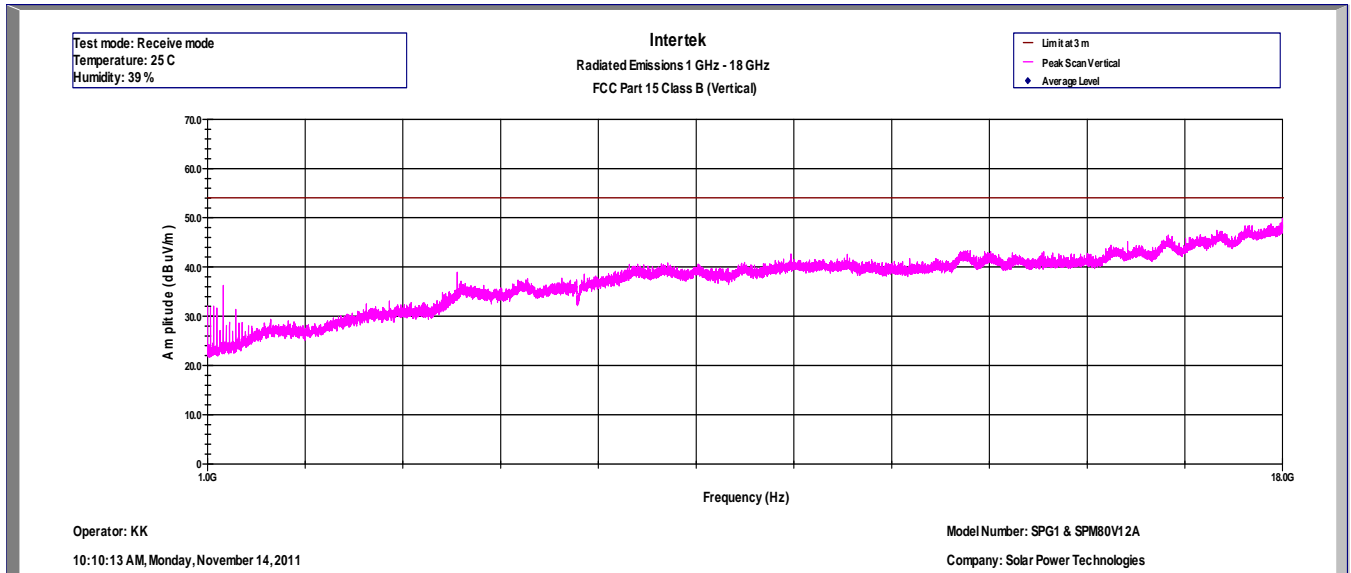

Notes: Measurements made at 3 meters distance.

SPG1 & SPM80V12A were placed on the test table and measured at the same time.

Plot 6.13

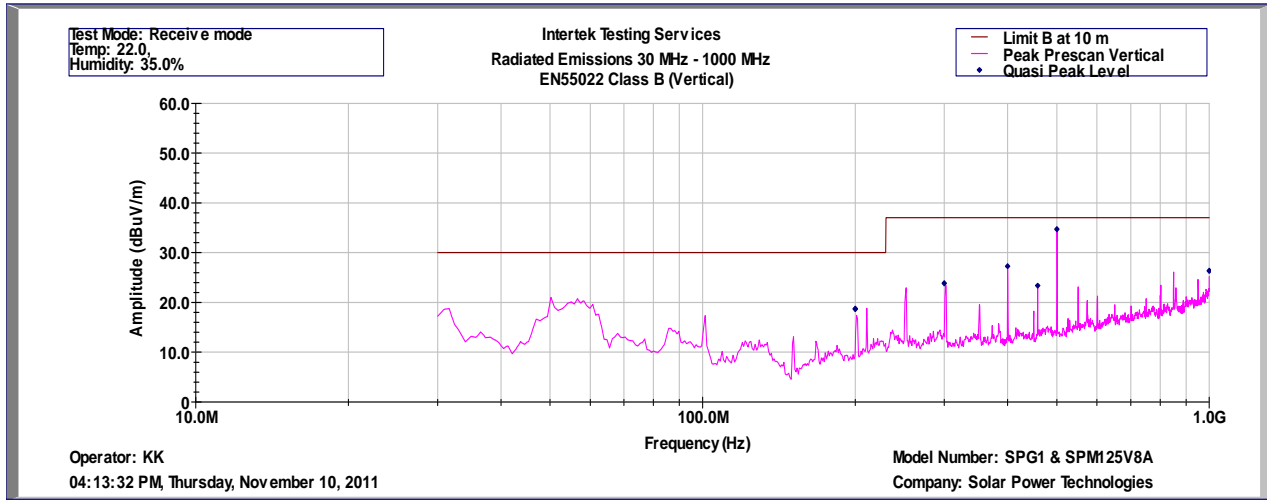

Intertek Testing Services
Radiated Emissions 30 MHz - 1000 MHz
EN55022 Class B (QP-Vertical)

Operator: KK
10-Nov-11

Model Number: SPG1 & SPM125V8A
Company: Solar Power Technologies

Frequency Hz	Quasi Pk FS dB(uV/m)	Limit@10m dB(uV/m)	Margin dB	RA dB(uV)	AG dB	AF dB(1/m)	CF dB
2.00E+08	18.7	30.0	-11.3	39.2	32.0	9.8	1.6
2.00E+08	18.7	30.0	-11.3	39.2	32.0	9.8	1.6
3.00E+08	23.8	37.0	-13.2	40.7	32.0	13.1	2.0
4.00E+08	27.3	37.0	-9.7	42.0	32.1	15.0	2.3
4.58E+08	23.4	37.0	-13.6	36.8	32.1	16.1	2.5
5.00E+08	34.7	37.0	-2.3	47.6	32.2	16.7	2.6
1.00E+09	26.3	37.0	-10.7	30.0	30.7	23.3	3.8

Test Mode: Receive mode
Temp: 22.0C
Humidity: 35.0%

Notes: Measurements made at 10 meters distance.

SPG1 & SPM125V8A were placed on the test table and measured at the same time.

Plot 6.14

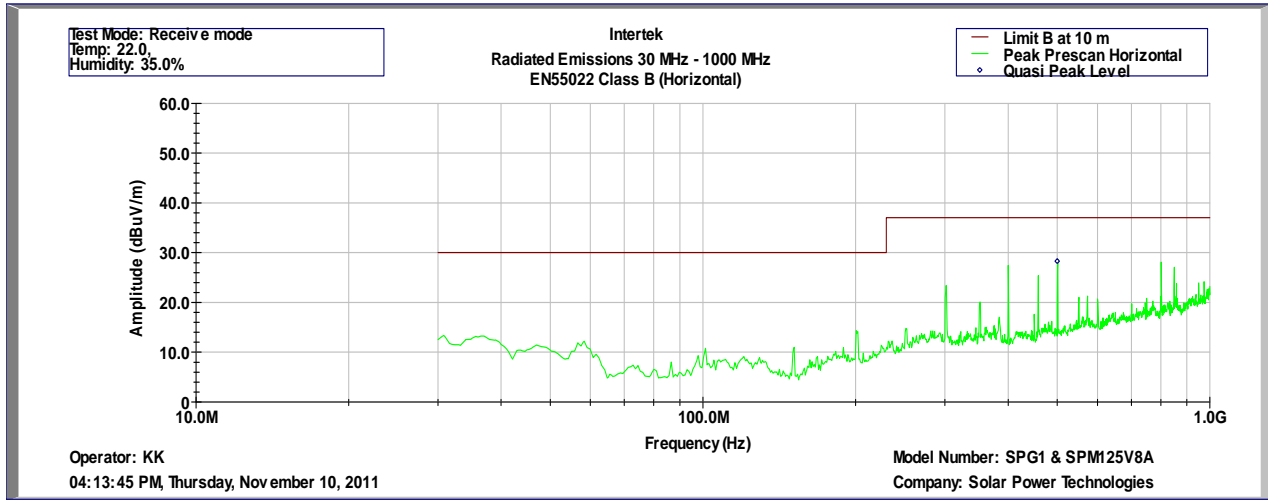

Intertek
Radiated Emissions 30 MHz - 1000 MHz
EN55022 Class B (QP-Horizontal)

Operator: KK
10-Nov-11

Model Number: SPG1 & SPM125V8A
Company: Solar Power Technologies

Frequency	Quasi Pk FS	Limit@10m	Margin	RA	AG	AF	CF
Hz	dB(uV/m)	dB(uV/m)	dB	dB(uV)	dB	dB(1/m)	dB
5.00E+08	28.3	37.0	-8.7	41.2	32.2	16.7	2.6

Test Mode: Receive mode
Temp: 22.0C
Humidity: 35.0%

Notes: Measurements made at 10 meters distance.

SPG1 & SPM125V8A were placed on the test table and measured at the same time.

Plot 6. 15

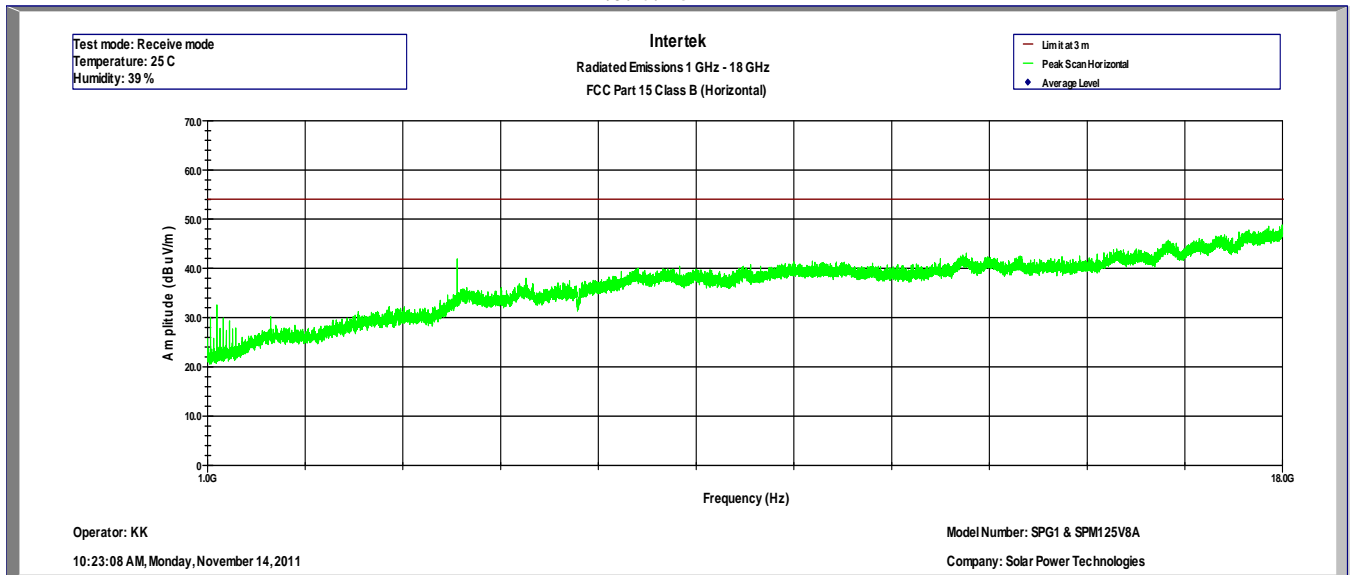

Plot 6. 16

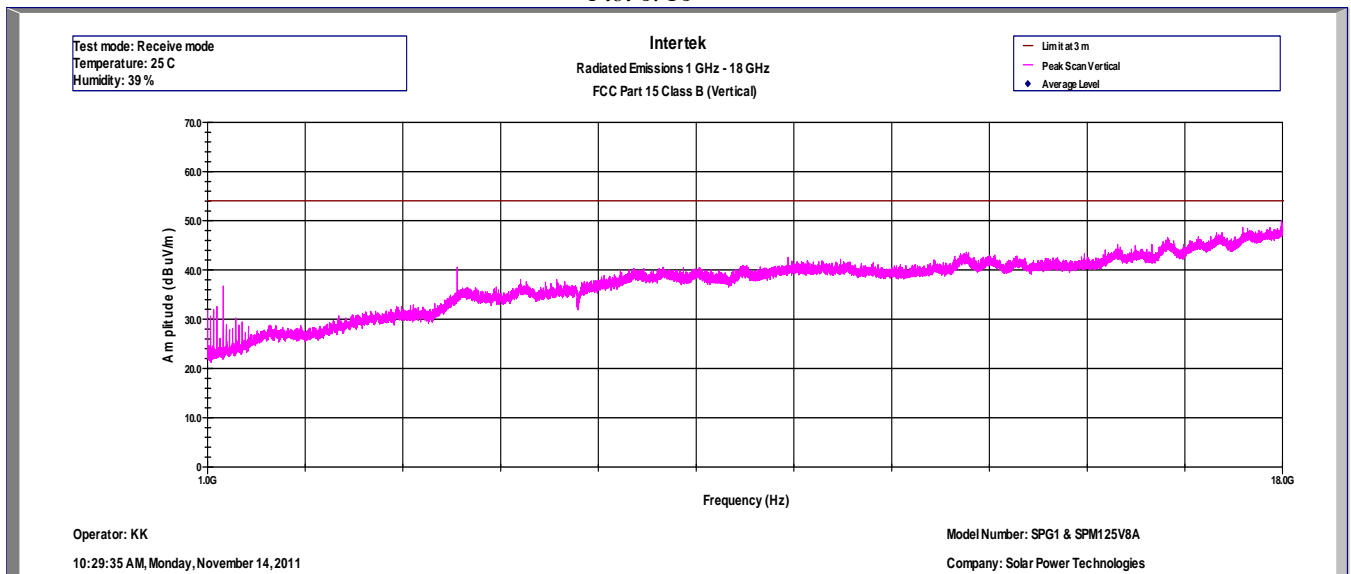

Notes: Measurements made at 3 meters distance.

SPG1 & SPM125V8A were placed on the test table and measured at the same time.

Test Configuration Photographs

The following photographs show the testing configurations used.



Test Configuration Photographs

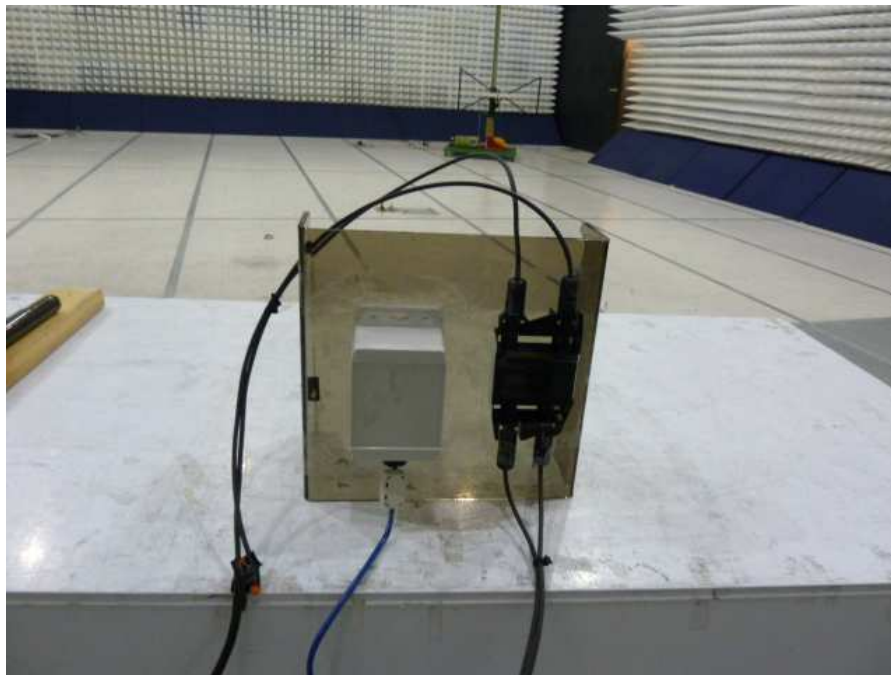

Test Configuration Photographs

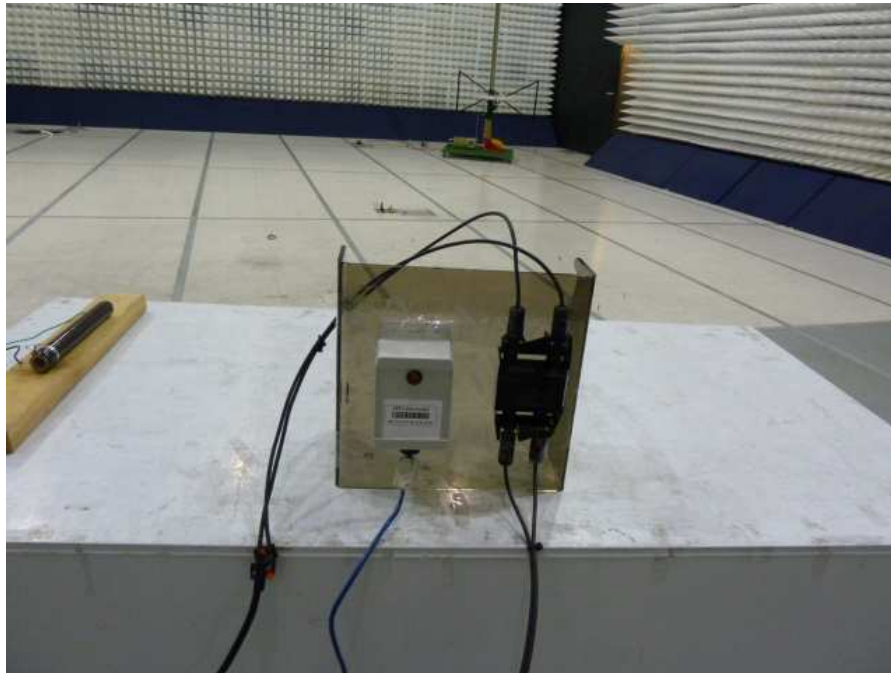

Test Limit

Frequency Band MHz	Class B Limit dB (μ V)	
	Quasi-Peak	Average
0.15-0.50	66 to 56 Decreases linearly with the logarithm of the frequency	56 to 46 Decreases linearly with the logarithm of the frequency
0.50-5.00	56	46
5.00-30.00	60	50

Note: At the transition frequency the lower limit applies.

Test Procedure

Measurements are carried out using quasi-peak and average detector receivers in accordance with CISPR 16. An AMN is required to provide a defined impedance at high frequencies across the power feed at the point of measurement of terminal voltage and also to provide isolation of the circuit under test from the ambient noise on the power lines. An AMN as defined in CISPR 16 shall be used.

The EUT is located so that the distance between the boundary of the EUT and the closest surface of the AMN is 0.8m.

Where a flexible mains cord is provided by the manufacturer, this shall be 1m long or if in excess of 1m, the excess cable is folded back and forth as far as possible so as to form a bundle not exceeding 0.4m in length.

The EUT is arranged and connected with cables terminated in accordance with the product specification.

Conducted disturbance is measured between the phase lead and the reference ground, and between the neutral lead and the reference ground. Both measured values are reported.

The EUT, where intended for tabletop use, is placed on a table whose top is 0.8m above the ground plane. A vertical, metal reference plane is placed 0.4m from the EUT. The vertical metal reference-plane is at least 2m by 2m. The EUT shall be kept at least 0.8m from any other metal surface or other ground plane not being part of the EUT. The table is constructed of non-conductive materials. Its dimensions are 1m by 1.5m, but may be extended for larger EUT.

Floor standing EUT are placed on a horizontal metal ground plane and isolated from the ground plane by resting on an insulating material. The metal ground plane extends at least 0.5m beyond the boundaries of the EUT and has minimum dimensions of 2m by 2m.

Equipment setup for conducted disturbance tests followed the guidelines of ANSI C63.4.

Test Results

EN 55022 Conducted Disturbance at DC Mains

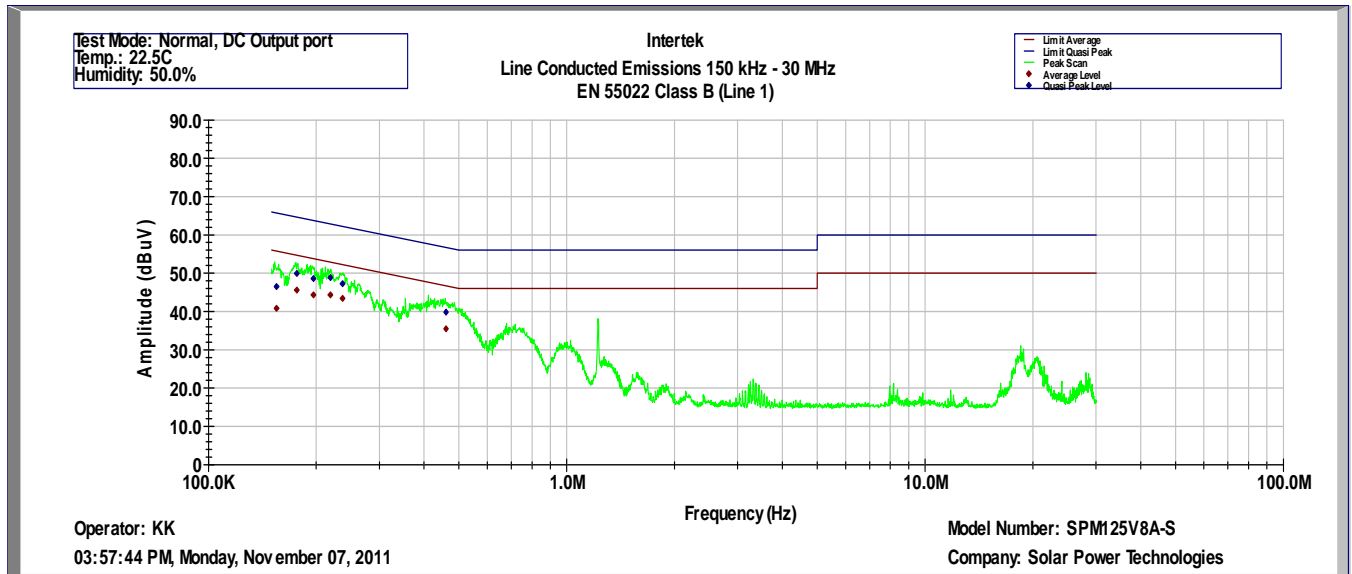

Intertek Testing Services
Line Conducted Emissions 150 kHz - 30 MHz
EN 55022 Class B (Line 1)

Operator: KK
03:45:58 PM, Monday, November 07, 2011

Model Number: SPM125V8A-S
Company: Solar Power Technologies

Frequency	Av Level	QP Level	Av Limit	QP Limit	Av Margin	QP Margin
Hz	dBuV	dBuV	dBuV	dBuV	dB	dB
154855	40.8	46.5	55.9	65.9	-15.1	-19.3
176503	45.5	49.9	55.2	65.2	-9.7	-15.3
196451	44.3	48.6	54.7	64.7	-10.4	-16.1
219048	44.3	48.9	54.0	64.0	-9.7	-15.2
236686	43.4	47.3	53.5	63.5	-10.2	-16.2
460200	35.5	39.8	47.1	57.1	-11.7	-17.3

Test Mode: Normal, DC Output port
Temp.: 22.5C
Humidity: 50.0%

EN 55022 Conducted Disturbance at DC Mains

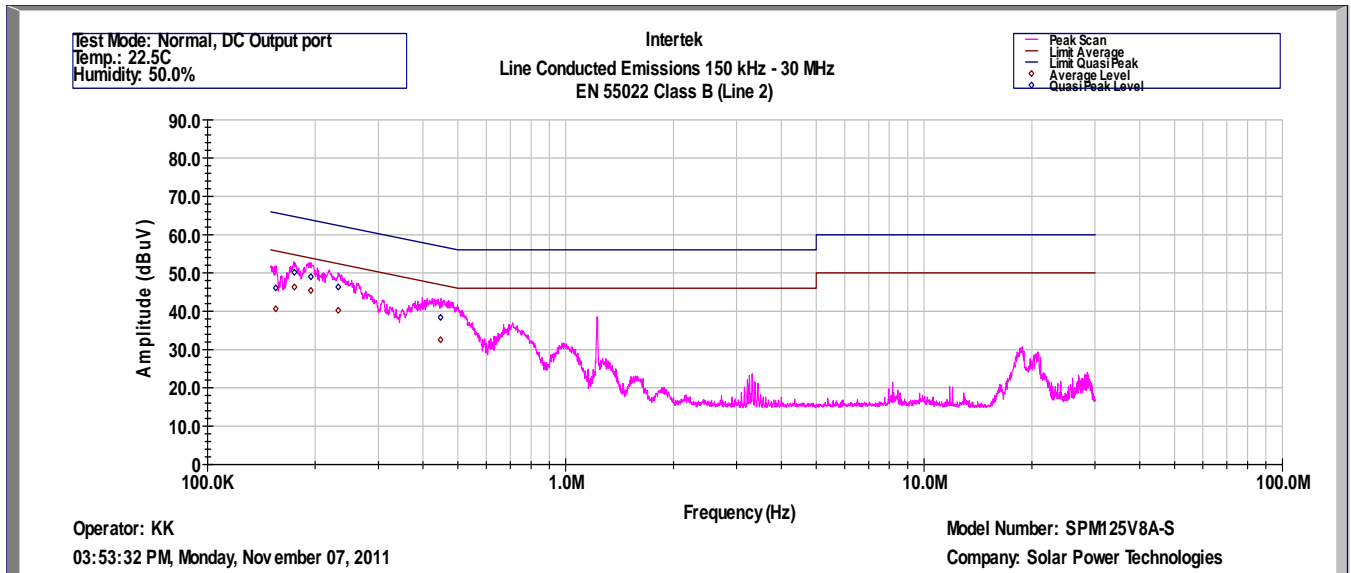

Intertek Testing Services
Line Conducted Emissions 150 kHz - 30 MHz
EN 55022 Class B (Line 2)

Operator: KK
03:45:58 PM, Monday, November 07, 2011

Model Number: SPM125V8A-S
Company: Solar Power Technologies

Frequency Hz	Av Level dBuV	QP Level dBuV	Av Limit dBuV	QP Limit dBuV	Av Margin dB	QP Margin dB
155159	40.6	46.1	55.9	65.9	-15.2	-19.7
174932	46.3	50.2	55.3	65.3	-9.0	-15.1
194404	45.4	49.0	54.7	64.7	-9.3	-15.7
231814	40.3	46.3	53.7	63.7	-13.4	-17.4
447472	32.6	38.4	47.5	57.5	-14.9	-19.1

Test Mode: Normal, DC Output port
Temp.: 22.5C
Humidity: 50.0%

Results:	Complies by 7.5dB
-----------------	--------------------------

Note: Investigation was performed on the DC Output port up to 125V. The worst case data was reported.

Test Configuration Photographs

The following photographs show the testing configurations used.

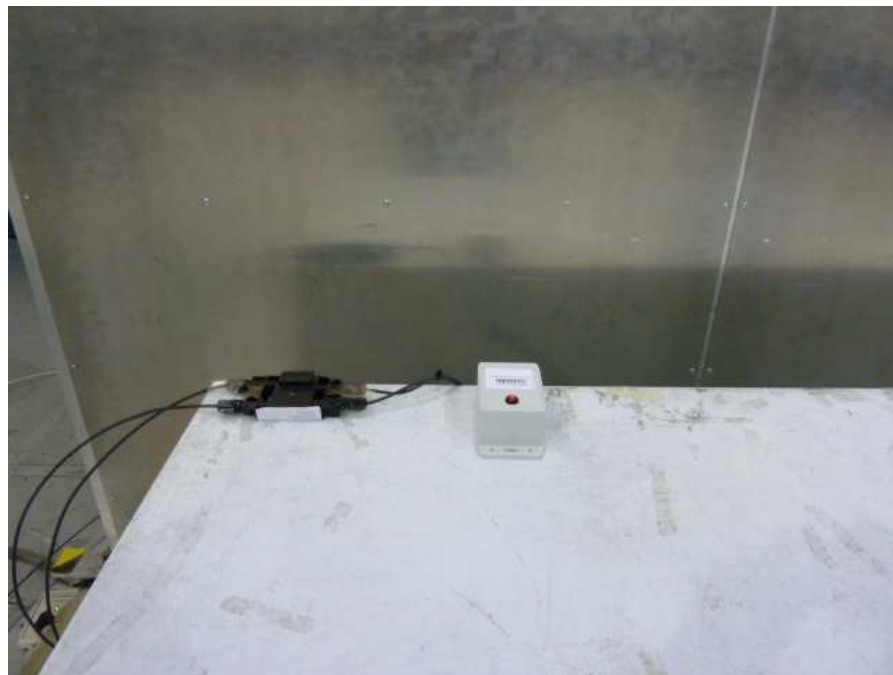

5.2.4 Test Configuration Photographs (continued)

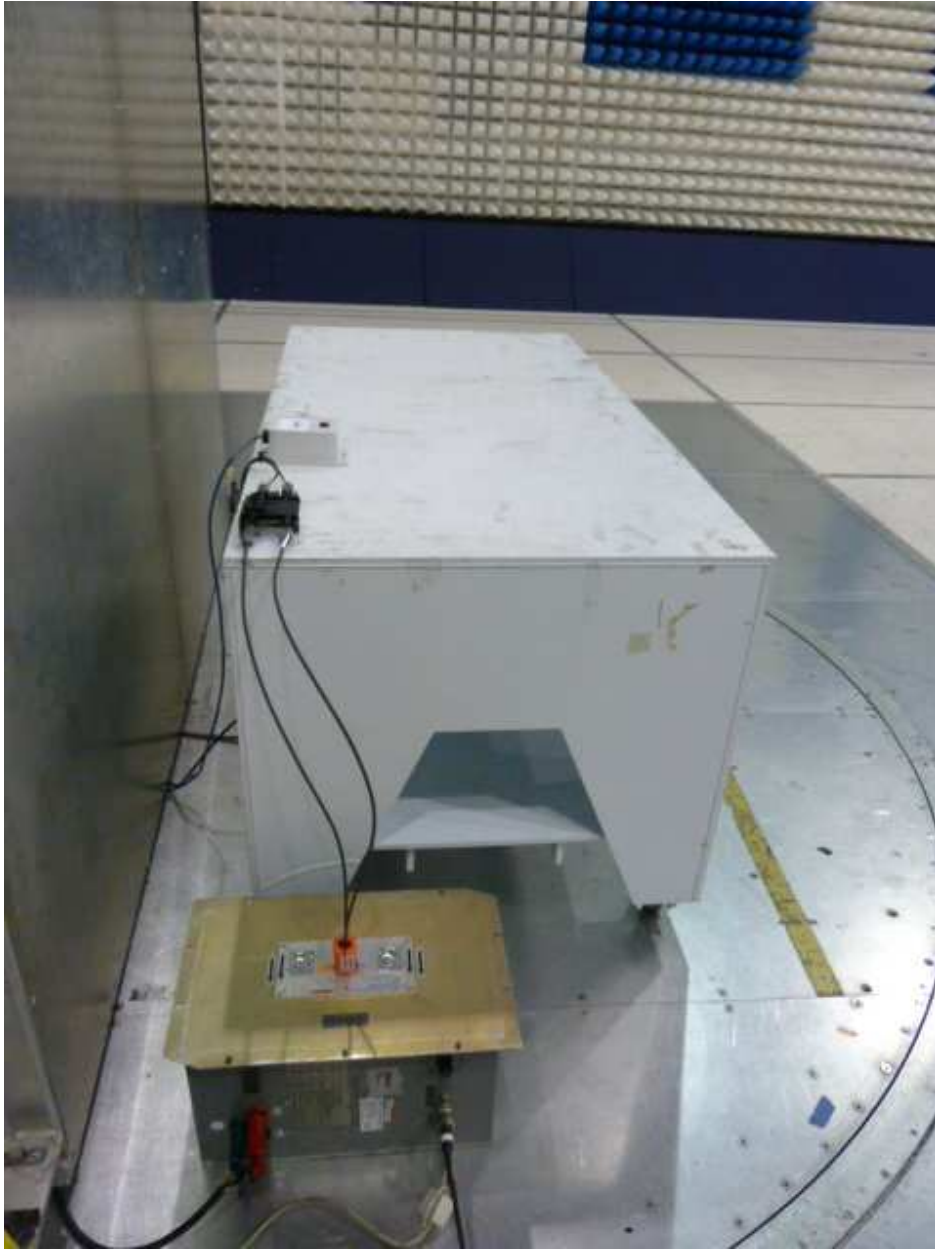

5.0 RF Exposure Evaluation

MPE Evaluation

The EUT is a wireless device used in a mobile application, at least 20 cm from any body part of the user or nearby persons.

The maximum Peak EIRP calculated is -18.2 dBm or 0.015 mW; therefore, to comply with RF Exposure Requirement, the MPE is calculated.

The Power Density can be calculated using the formula

$$S = \text{EIRP} / 4\pi D^2$$

Where: S is Power Density in W/m^2
D is the distance from the antenna.

It is considered that 20 cm is the minimum distance that user can go closest to the EUT.

At 20 cm, $S = 0.00003 \text{ W}/\text{m}^2$, which is below the MPE Limit of $10 \text{ W}/\text{m}^2$

6.0 List of Test Equipment

Measurement equipment used for emission compliance testing utilized the equipment on the following list:

Equipment	Manufacturer	Model/Type	Serial #	Cal Int	Cal Due
RF Filter Section	Hewlett Packard	85460A	3448A00267	12	12/08/11
EMI Receiver	Hewlett Packard	8546A	3710A00373	12	12/08/11
Spectrum Analyzer	Rohde&Schwarz	FSP40	036612004	12	11/09/12
BI-Log Antenna	ARA	LPB-2513/A	1154	12	07/06/12
Pre-Amplifier	Sonoma	310N	185634	12	12/01/11
Pre-Amplifier	Miteq	AMF-4D-001180-24-10P	799159	12	09/01/12
Spectrum Analyzer	Rohde&Schwarz	FSU	200482	12	03/23/12
Horn Antenna	EMCO	3115	00126795	12	11/03/12
Signal Generator	Hewlett Packard	SMR40	100445	12	09/01/12
LISN	FCC	FCC-LISN-50-50-M-H	2012	12	06/28/12



7.0 Document History

Revision/ Job Number	Writer Initials	Date	Change
1.0 / G100529802	KK	November 28, 2011	Original document