



Neutron Engineering Inc.

FCC/IC Radio Test Report

FCC ID: ZQO-DWPCIE83

IC: 2581A-DWPCIE83

This report concerns (check one) : Original Grant Class I Change

Issued Date : Aug. 02, 2011
Project No. : 1107C138
Equipment : Half-size mini-PCle digital wireless audio module
Model Name : DWPCle83

Applicant : STANDARD MICROSYSTEMS CORPORATION
Address : 3930,EAST RAY ROAD SUITE 200,PHOENIX,
Arizona,85044-7176,United States

Tested by:
Neutron Engineering Inc. EMC Laboratory
Date of Receipt: Jul. 15, 2011
Date of Test:
Jul. 15, 2011 ~ Aug. 01, 2011

Testing Engineer :

(Ivan Cao)

Technical Manager :

(Leo Hung)

Authorized Signatory :

(Steven Lu)

Neutron Engineering Inc.

**No.3,Jinshagang 1st Road, ShiXia, Dalang
Town, Dong Guan, China.
TEL : (0769) 8318-3000 FAX : (0769) 8319-6000**



Declaration

Neutron represents to the client that testing is done in accordance with standard procedures as applicable and that test instruments used has been calibrated with the standards traceable to National Measurement Laboratory (**NML**) of **R.O.C.**, or National Institute of Standards and Technology (**NIST**) of **U.S.A.**

Neutron's reports apply only to the specific samples tested under conditions. It is manufacture's responsibility to ensure that additional production units of this model are manufactured with the identical electrical and mechanical components. **Neutron** shall have no liability for any declarations, inferences or generalizations drawn by the client or others from **Neutron** issued reports.

Neutron's reports must not be used by the client to claim product endorsement by the authorities or any agency of the Government.

This report is the confidential property of the client. As a mutual protection to the clients, the public and **Neutron-self**, extracts from the test report shall not be reproduced except in full with **Neutron's** authorized written approval.

Neutron's laboratory quality assurance procedures are in compliance with the **ISO Guide 17025** requirements, and accredited by the conformity assessment authorities listed in this test report.

Limitation

For the use of the authority's logo is limited unless the Test Standard(s)/Scope(s)/Item(s) mentioned in this test report is (are) included in the conformity assessment authorities acceptance respective.



Table of Contents	Page
1 . CERTIFICATION	6
2 . SUMMARY OF TEST RESULTS	7
2.1 TEST FACILITY	8
2.2 MEASUREMENT UNCERTAINTY	8
3 . GENERAL INFORMATION	9
3.1 GENERAL DESCRIPTION OF EUT	9
3.2 DESCRIPTION OF TEST MODES	11
3.3 TABLE OF PARAMETERS OF TEXT SOFTWARE SETTING	11
3.4 BLOCK DIAGRAM SHOWING THE CONFIGURATION OF SYSTEM TESTED	12
3.5 DESCRIPTION OF SUPPORT UNITS	13
4 . EMC EMISSION TEST	14
4.1 CONDUCTED EMISSION MEASUREMENT	14
4.1.1 POWER LINE CONDUCTED EMISSION	14
4.1.2 MEASUREMENT INSTRUMENTS LIST	14
4.1.3 TEST PROCEDURE	15
4.1.4 DEVIATION FROM TEST STANDARD	15
4.1.5 TEST SETUP	15
4.1.6 EUT OPERATING CONDITIONS	15
4.1.7 TEST RESULTS	16
4.2 RADIATED EMISSION MEASUREMENT	18
4.2.1 RADIATED EMISSION LIMITS	18
4.2.2 MEASUREMENT INSTRUMENTS LIST	19
4.2.3 TEST PROCEDURE	19
4.2.4 DEVIATION FROM TEST STANDARD	20
4.2.5 TEST SETUP	20
4.2.6 EUT OPERATING CONDITIONS	20
4.2.7 TEST RESULTS-BETWEEN 30MHZ - 1000MHZ	21
4.2.8 TEST RESULTS - ABOVE 1000MHZ	29
5 . 26dB Spectrum Bandwidth	65
5.1 APPLIED PROCEDURES / LIMIT	65
5.1.1 MEASUREMENT INSTRUMENTS LIST	65
5.1.2 TEST PROCEDURE	65
5.1.3 DEVIATION FROM STANDARD	65
5.1.4 TEST SETUP	65
5.1.5 EUT OPERATION CONDITIONS	65
5.1.6 TEST RESULTS	66



Table of Contents	Page
6 . Maximum Conducted Output Power	70
6.1 APPLIED PROCEDURES / LIMIT	70
6.1.1 MEASUREMENT INSTRUMENTS LIST	70
6.1.2 TEST PROCEDURE	70
6.1.3 DEVIATION FROM STANDARD	71
6.1.4 TEST SETUP	71
6.1.5 EUT OPERATION CONDITIONS	71
6.1.6 TEST RESULTS	72
7 . ANTENNA CONDUCTED SPURIOUS EMISSION	80
7.1 APPLIED PROCEDURES / LIMIT	80
7.1.1 MEASUREMENT INSTRUMENTS LIST	80
7.1.2 TEST PROCEDURE	80
7.1.3 DEVIATION FROM STANDARD	80
7.1.4 TEST SETUP	80
7.1.5 EUT OPERATION CONDITIONS	80
7.1.6 TEST RESULTS	81
8 . POWER SPECTRAL DENSITY TEST	91
8.1 APPLIED PROCEDURES / LIMIT	91
8.1.1 MEASUREMENT INSTRUMENTS LIST	91
8.1.2 TEST PROCEDURE	91
8.1.3 DEVIATION FROM STANDARD	91
8.1.4 TEST SETUP	91
8.1.5 EUT OPERATION CONDITIONS	91
9 . Peak Excursion Measurement	96
9.1 APPLIED PROCEDURES / LIMIT	96
9.1.1 MEASUREMENT INSTRUMENTS LIST	96
9.1.2 TEST PROCEDURE	96
9.1.3 DEVIATION FROM STANDARD	96
9.1.4 TEST SETUP	97
9.1.5 EUT OPERATION CONDITIONS	97
9.1.6 TEST RESULTS	98
10 . Frequency Stability Measurement	102
10.1 APPLIED PROCEDURES / LIMIT	102
10.1.1 MEASUREMENT INSTRUMENTS LIST	102
10.1.2 TEST PROCEDURE	102
10.1.3 DEVIATION FROM STANDARD	102
10.1.4 TEST SETUP	103
10.1.5 EUT OPERATION CONDITIONS	103
10.1.6 TEST RESULTS	104



	Table of Contents	Page
11 . EUT TEST PHOTO		105



1. CERTIFICATION

Equipment : Half-size mini-PCle digital wireless audio module
Brand Name : SMSC
Model Name : DWPCle83
Applicant : STANDARD MICROSYSTEMS CORPORATION
Date of Test : Jul. 15, 2011 ~ Aug. 01, 2011
Standards : FCC Part15, Subpart E(15.407) / ANSI C63.4 : 2003; Canada RSS-210:2010

The above equipment has been tested and found compliance with the requirement of the relative standards by Neutron Engineering Inc. EMC Laboratory.

The test data, data evaluation, and equipment configuration contained in our test report (Ref No. NEI-FICP-3-1107C138) were obtained utilizing the test procedures, test instruments, test sites that has been accredited by the Authority of NVLAP and TAF according to the ISO-17025 quality assessment standard and technical standard(s).

Test result included in this report is only for the 5.2G Mode part of the product.



2. SUMMARY OF TEST RESULTS

Test procedures according to the technical standards:

FCC Part15, Subpart E / RSS-210: 2010				
Standard Section		Test Item	Judgment	Remark
RSS-GEN 7.2.2	15.207	AC Power Line Conducted Emissions	PASS	
RSS-210 A9.2(1)	15.407(a)	26dB Spectrum Bandwidth	PASS	
RSS-210 A9.2(1)	15.407(a)	Maximum Conducted Output Power	PASS	
RSS-210 A9.2(1)	15.407(a)	Power Spectral Density	PASS	
	15.407(a)	Peak Excursion	PASS	
RSS-210 Annex 8 (A8.5)	15.407(a)	Radiated Emissions	PASS	
RSS-210 A9.2(1)	15.407(b)	Band Edge Emissions	PASS	
RSS-210 A1.1.4	15.407(b)	Frequency Stability	PASS	
	15.407(g) 15.203	Antenna Requirements	PASS	
	1.1307 1.1310 2.1091 2.1093	RF Exposure Compliance	PASS	

NOTE:

(1) "N/A" denotes test is not applicable in this Test Report



2.1 TEST FACILITY

The test facilities used to collect the test data in this report is **DG-C02/DG-CB03** at the location of No.3,Jinshagang 1st Road, ShiXia, Dalang Town, Dong Guan, China.523792
 Neutron's test firm number for FCC 319330
 Neutron's test firm number for IC 4428B-1

2.2 MEASUREMENT UNCERTAINTY

The reported uncertainty of measurement $y \pm U$, where expanded uncertainty **U** is based on a standard uncertainty multiplied by a coverage factor of **k=2**, providing a level of confidence of approximately **95%**.

A. Conducted Measurement :

Test Site	Method	Measurement Frequency Range	U , (dB)	NOTE
DG-C02	CISPR	150 KHz ~ 30MHz	1.94	

B. Radiated Measurement :

Test Site	Method	Measurement Frequency Range	Ant. H / V	U , (dB)	NOTE
DG-CB03	CISPR	30MHz ~ 200MHz	V	3.82	
		30MHz ~ 200MHz	H	3.60	
		200MHz ~ 1,000MHz	V	3.86	
		200MHz ~ 1,000MHz	H	3.94	



3. GENERAL INFORMATION

3.1 GENERAL DESCRIPTION OF EUT

Equipment	Half-size mini-PCle digital wireless audio module
Brand Name	SMSC
Model Name	DWPCle83
OEM Brand/Model Name	N/A
Model Difference	N/A
Product Description	The EUT is a Half-size mini-PCle digital wireless audio module.
	Operation Frequency: 5.2G:5180MHz~5240MHz
	Modulation Type: QPSK (digital modulation)
	Bit Rate of Transmitter: 22 Mbps
	Number Of Channel: 3CH
	Antenna Designation: Please see Note 3.
	Antenna Gain(Peak): Please see Note 3.
	Peak OutputPower: 13.17 dBm -ANT A 12.57 dBm -ANT B
	Average OutputPower: 9.94 dBm -ANT A 10.13 dBm -ANT B
	Based on the application, features, or specification exhibited in User's Manual, the EUT is considered as an ITE/Computing Device. More details of EUT technical specification, please refer to the User's Manual.
Channel List	Please refer to the Note 3.
Power Source	#1: DC Voltage supplied from Notebook USB Port. #2: DC Voltage supplied from the test fixture modular
Power Rating	#1: I/P AC 230V/50Hz O/P DC 5V #2: DC 3.3V
Connecting I/O Port(s)	Please refer to the User's Manual

Note:

1. For a more detailed features description, please refer to the manufacturer's specifications or the User's Manual.
- 2.

Frequency Band	Channel No.	Frequency
5180~5240MHz	01	5180 MHz
	02	5210 MHz
	03	5240 MHz



3. Antenna Specification:

Ant.	Brand	Model Name/Part No.	Antenna Type	Connector	Gain (dBi)
1	WNC	WNC_ANT_WIMAX_3D-2_2300-5850MHz	PIFA	U. FL	2.4GHz – +3.65dBi peak 5.2GHz – +4.80dBi peak 5.8GHz – +5.21dBi peak
2	WNC	Main Antenna: 81.EDG15.GCP	PIFA	U. FL	2.4GHz – -0.21dBi peak 5.2GHz – +0.14dBi peak 5.8GHz – -1.07dBi peak
	WNC	Aux Antenna: 81.EDG15.GCN	PIFA	U. FL	2.4GHz – -1.36dBi peak 5.2GHz – -2.98dBi peak 5.8GHz – -1.89dBi peak
3	WNC	Main Antenna: 81.EDG15.GCU	PIFA	U. FL	2.4GHz – -2.67dBi peak 5.2GHz – -2.80dBi peak 5.8GHz – -0.90dBi peak
	WNC	Aux Antenna: 81.EDG15.GCT	PIFA	U. FL	2.4GHz – -1.21dBi peak 5.2GHz – -2.02dBi peak 5.8GHz – -0.94dBi peak
4	YAGEO	Main CAN43131LMVT05631	PIFA	U. FL	2.4GHz – -2.91dBi peak 5.2GHz – -5.28dBi peak 5.8GHz – -2.97dBi peak
	YAGEO	Aux CAN43131LMVT05632	PIFA	U. FL	2.4GHz – -2.71dBi peak 5.2GHz – -2.34dBi peak 5.8GHz – -3.03dBi peak
5	YAGEO	Main CAN43131WLVT05643	PIFA	U. FL	2.4GHz – -2.66dBi peak 5.2GHz – -1.37dBi peak 5.8GHz – -2.51dBi peak
	YAGEO	Aux CAN43131WLVT05644	PIFA	U. FL	2.4GHz – -1.79dBi peak 5.2GHz – -4.38dBi peak 5.8GHz – -2.76dBi peak



3.2 DESCRIPTION OF TEST MODES

To investigate the maximum EMI emission characteristics generates from EUT, the test system was pre-scanning tested base on the consideration of following EUT operation mode or test configuration mode which possible have effect on EMI emission level. Each of these EUT operation mode(s) or test configuration mode(s) mentioned above was evaluated respectively.

Pretest Test Mode	Description
Mode 1	5.2G/CH01, CH02, CH03
Mode 2	Normal Link

The EUT system operated these modes were found to be the worst case during the pre-scanning test as Following: **(Worst case for ANT1)**

For Conducted Test	
Final Test Mode	Description
Mode 2	Normal Link

For Radiated Test	
Final Test Mode	Description
Mode 1	5.2G/CH01, CH02, CH03

3.3 TABLE OF PARAMETERS OF TEXT SOFTWARE SETTING

During testing channel & power controlling software provided by the customer was used to control the operating channel as well as the output power level. The RF output power selection is for the setting of RF output power expected by the customer and is going to be fixed on the firmware of the final end product

Test software Version	Test Program:WxMainGuiCustomer_05		
Frequency	5180 MHz	5210 MHz	5240 MHz
	DEF	DEF	DEF



3.4 BLOCK DIAGRAM SHOWING THE CONFIGURATION OF SYSTEM TESTED

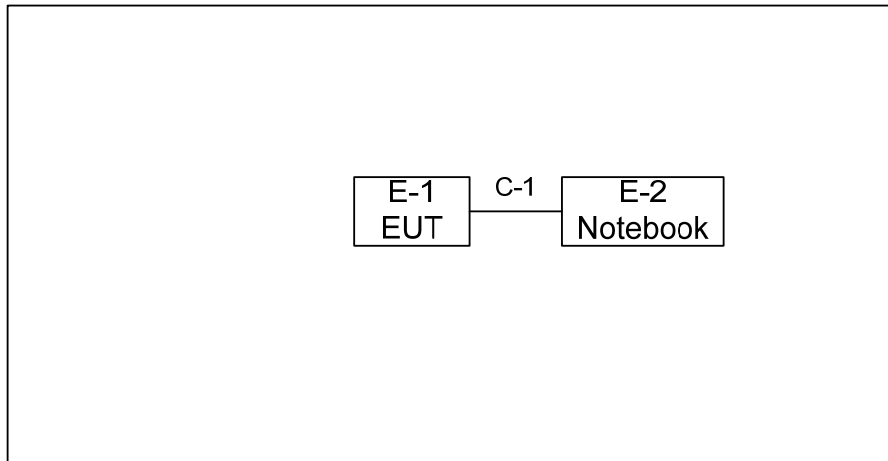

C-1:USB Cable

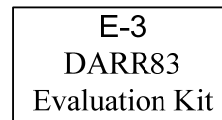



3.5 DESCRIPTION OF SUPPORT UNITS

The EUT has been tested as an independent unit together with other necessary accessories or support units. The following support units or accessories were used to form a representative test configuration during the tests.

Item	Equipment	Mfr/Brand	Model/Type No.	FCC ID	Series No.	Note
E-1	Half-size mini-PCIe digital wireless audio module	SMSC	DWPCle83	QO-DWPCIE83/ 2581A-DWPCIE83	N/A	EUT
E-2	NOTEBOOK	HP	Probook	DOC	CNUO2203XG	
E-3	DARR83 Evaluation Kit	SMSC	DARR83 Evaluation Kit	N/A	N/A	E-3

Item	Shielded Type	Ferrite Core	Length	Note
C-1	YES	NO	0.7M	

Note:

- (1) The support equipment was authorized by Declaration of Confirmation.
- (2) For detachable type I/O cable should be specified the length in cm in 『Length』 column.



4. EMC EMISSION TEST

4.1 CONDUCTED EMISSION MEASUREMENT

4.1.1 POWER LINE CONDUCTED EMISSION (Frequency Range 150KHz-30MHz)

FREQUENCY (MHz)	Class A (dBuV)		Class B (dBuV)	
	Quasi-peak	Average	Quasi-peak	Average
0.15 -0.5	79.00	66.00	66 - 56 *	56 - 46 *
0.50 -5.0	73.00	60.00	56.00	46.00
5.0 -30.0	73.00	60.00	60.00	50.00

Note:

- (1) The tighter limit applies at the band edges.
- (2) The limit of " * " marked band means the limitation decreases linearly with the logarithm of the frequency in the range.

4.1.2 MEASUREMENT INSTRUMENTS LIST

Item	Kind of Equipment	Manufacturer	Type No.	Serial No.	Calibrated until
1	LISN	EMCO	3816/2SH	00052766	May.25.2012
2	LISN	R&S	ENV216	100526	May.25.2012
3	Test Cable	N/A	C_19	N/A	Apr.25.2012
4	EMI TEST RECEIVER	R&S	ESCI	100895	May.26.2012
5	50Ω Terminator	SHX	TF2-3G-A	08122901	May.26.2012

Remark: " N/A" denotes No Model Name , Serial No. or No Calibration specified.

4.1.3 TEST PROCEDURE

- The EUT was placed 0.8 meters from the horizontal ground plane with EUT being connected to the power mains through a line impedance stabilization network (LISN). All other support equipments powered from additional LISN(s). The LISN provide 50 Ohm/ 50uH of coupling impedance for the measuring instrument.
- Interconnecting cables that hang closer than 40 cm to the ground plane shall be folded back and forth in the center forming a bundle 30 to 40 cm long.
- I/O cables that are not connected to a peripheral shall be bundled in the center. The end of the cable may be terminated, if required, using the correct terminating impedance. The overall length shall not exceed 1 m.
- LISN at least 80 cm from nearest part of EUT chassis.
- For the actual test configuration, please refer to the related Item –EUT Test Photos.

4.1.4 DEVIATION FROM TEST STANDARD

No deviation

4.1.5 TEST SETUP

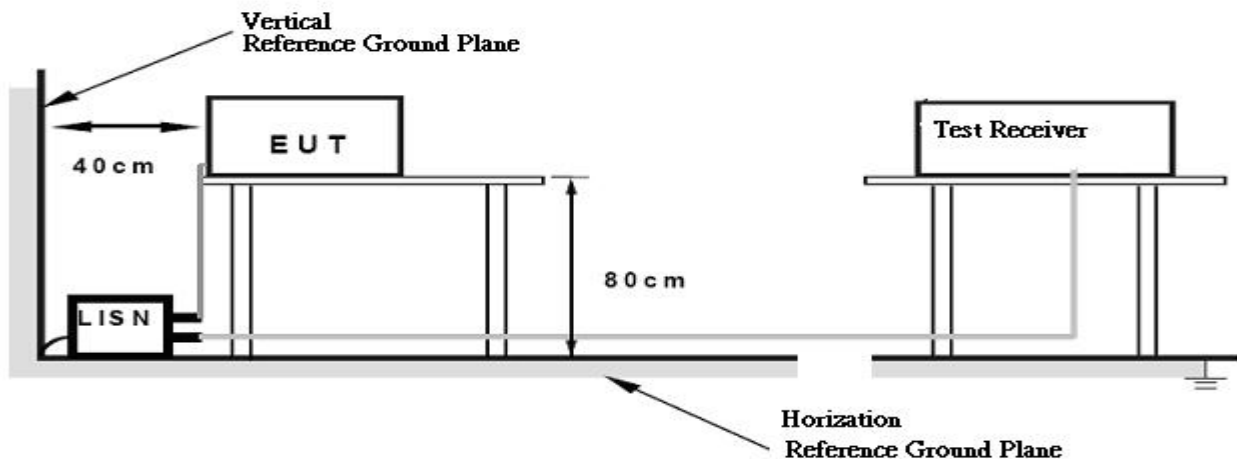

4.1.6 EUT OPERATING CONDITIONS

The EUT was configured for testing in a typical fashion (as a customer would normally use it). The EUT has been programmed to continuously transmit during test. This operating condition was tested and used to collect the included data.

The EUT was programmed to be in continuously transmitting mode.



4.1.7 TEST RESULTS

EUT :	Half-size mini-PCle digital wireless audio module	Model Name :	DWPCle83
Temperature :	25 °C	Relative Humidity :	58 %
Test Voltage :	AC 120V/60Hz		
Test Mode :	Normal Link		

Freq. (MHz)	Terminal L/N	Measured(dBuV)		Limits(dBuV)		Margin (dB)	Note
		QP-Mode	AV-Mode	QP-Mode	AV-Mode		
0.16	Line	51.27	*	65.58	55.58	-14.31	(QP)
0.29	Line	40.11	*	60.40	50.40	-20.29	(QP)
0.47	Line	39.30	*	56.44	46.44	-17.14	(QP)
0.91	Line	36.03	*	56.00	46.00	-19.97	(QP)
10.14	Line	36.77	*	60.00	50.00	-23.23	(QP)
12.32	Line	42.36	*	60.00	50.00	-17.64	(QP)

Remark

- (1) Reading in which marked as QP means measurements by using are Quasi-Peak Mode with Detector BW=9KHz; SPA setting in RBW=10KHz,VBW =10KHz, Swp. Time = 0.2 sec./MHz ◦ Reading in which marked as AV means measurements by using are Average Mode with instrument setting in RBW=10KHz,VBW=10KHz, Swp. Time =0.2 sec./MHz ◦
- (2) All readings are QP Mode value unless otherwise stated AVG in column of 'Note'. If the QP Mode Measured value compliance with the QP Limits and lower than AVG Limits, the EUT shall be deemed to meet both QP & AVG Limits and then only QP Mode was measured, but AVG Mode didn't perform ◦ In this case, a “ * ” marked in AVG Mode column of Interference Voltage Measured ◦
- (3) Measuring frequency range from 150KHz to 30MHz ◦

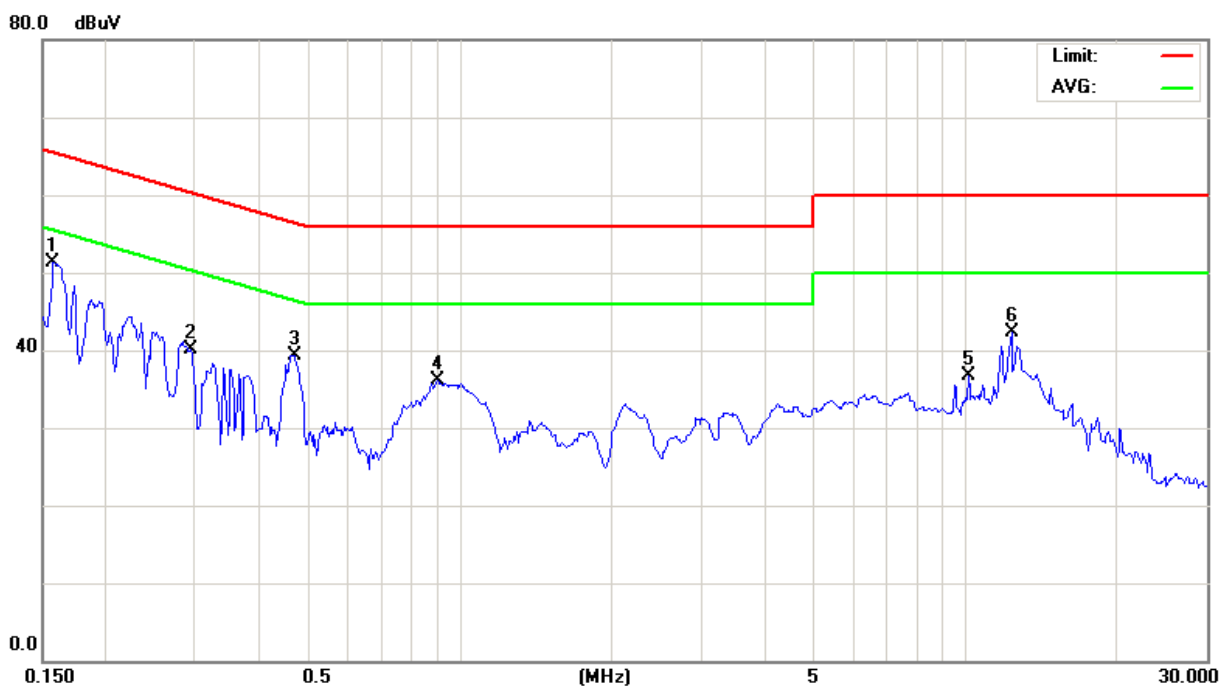



EUT :	Half-size mini-PCle digital wireless audio module	Model Name :	DWPCle83
Temperature :	25 °C	Relative Humidity :	58 %
Test Voltage :	AC 120V/60Hz		
Test Mode :	Normal Link		

Freq. (MHz)	Terminal L/N	Measured(dBuV)		Limits(dBuV)		Margin (dB)	Note
		QP-Mode	AV-Mode	QP-Mode	AV-Mode		
0.16	Neutral	50.24	*	65.48	55.48	-15.24	(QP)
0.19	Neutral	46.13	*	63.91	53.91	-17.78	(QP)
0.47	Neutral	38.97	*	56.58	46.58	-17.61	(QP)
1.58	Neutral	34.17	*	56.00	46.00	-21.83	(QP)
9.95	Neutral	41.05	*	60.00	50.00	-18.95	(QP)
12.52	Neutral	42.28	*	60.00	50.00	-17.72	(QP)

Remark

- (1) Reading in which marked as QP means measurements by using are Quasi-Peak Mode with Detector BW=9KHz; SPA setting in RBW=10KHz,VBW =10KHz, Swp. Time = 0.2 sec./MHz ◦ Reading in which marked as AV means measurements by using are Average Mode with instrument setting in RBW=10KHz,VBW=10KHz, Swp. Time =0.2 sec./MHz ◦
- (2) All readings are QP Mode value unless otherwise stated AVG in column of 'Note'. If the QP Mode Measured value compliance with the QP Limits and lower than AVG Limits, the EUT shall be deemed to meet both QP & AVG Limits and then only QP Mode was measured, but AVG Mode didn't perform ◦ In this case, a " * " marked in AVG Mode column of Interference Voltage Measured ◦
- (3) Measuring frequency range from 150KHz to 30MHz ◦

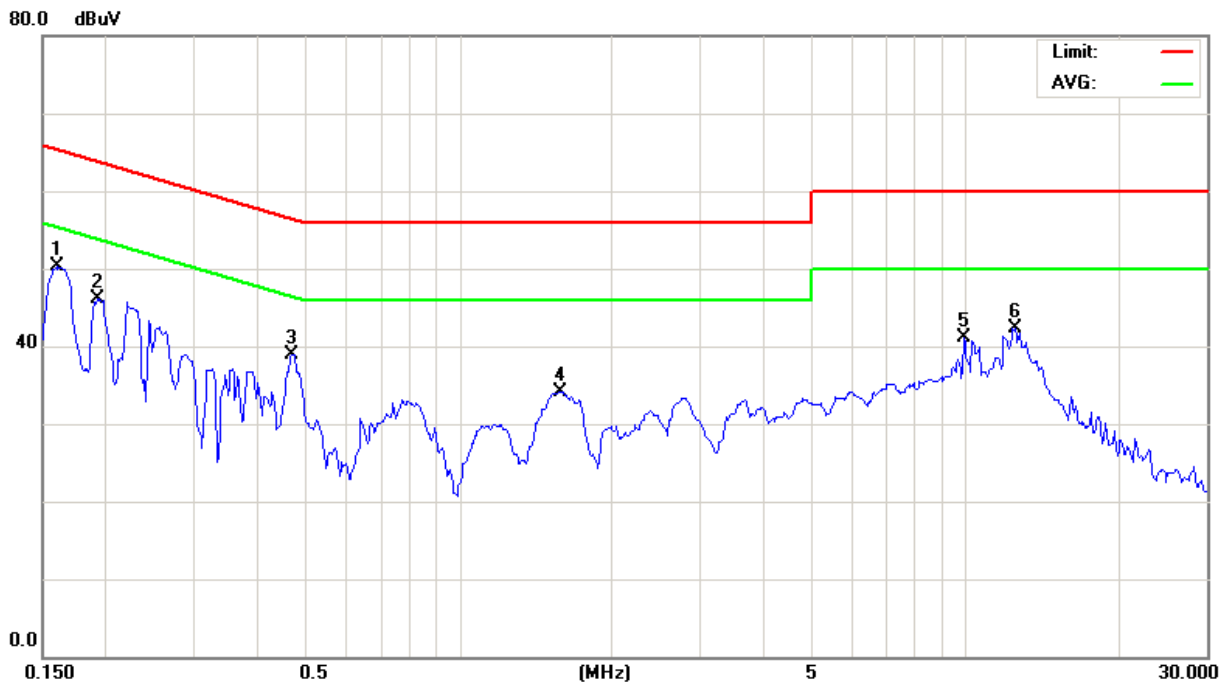



4.2 RADIATED EMISSION MEASUREMENT

4.2.1 RADIATED EMISSION LIMITS (Frequency Range 9kHz-1000MHz)

20dBc in any 100 kHz bandwidth outside the operating frequency band. In case the emission fall within the restricted band specified on 15.205(a), then the 15.209(a) limit in the table below has to be followed.

Frequencies (MHz)	Field Strength (micorvolts/meter)	Measurement Distance (meters)
0.009~0.490	2400/F(KHz)	300
0.490~1.705	24000/F(KHz)	30
1.705~30.0	30	30
30~88	100	3
88~216	150	3
216~960	200	3
Above 960	500	3

LIMITS OF RADIATED EMISSION MEASUREMENT (Above 1000MHz)

FREQUENCY (MHz)	(dBuV/m) (at 1.5m)	
	PEAK	AVERAGE
Above 1000	80	60

Notes:

- (1) The limit for radiated test was performed according to FCC PART 15C.
- (2) The tighter limit applies at the band edges.
- (3) Emission level (dBuV/m)=20log Emission level (uV/m).
 The limits above 5GHz shall be extrapolated to the specified distance using an extrapolation factor of 20dB/decade form 3m to 1.5m
 Distance extrapolation factor = 20 log (3m/1.5m) dB ;
 Limit line = specific limits (dBuV) + 6 dB



4.2.2 MEASUREMENT INSTRUMENTS LIST

Item	Kind of Equipment	Manufacturer	Type No.	Serial No.	Calibrated until
1	Triple Loop Antenna	R&S	HFH2-Z2	830749/020	May.26.2012
2	Bi-log Antenna	Schwarzbeck	VULB9160	9160-3232	May.25.2012
3	Horn Antenna	ETS	3115	00075789	May.11.2012
4	Broad-Band Horn Antenna	Schwarzbeck	BBHA 9170	9170340	Dec.14.2011
5	Amplifier	HP	8447D	2944A09673	May.25.2012
6	Amplifier	Agilent	8449B	3008A02274	May.25.2012
7	Amplifier	EMC	EMC265404 5	980039	Aug.12.2011
8	Test Receiver	R&S	ESCI	100895	May.25.2012
9	Spectrum Analyzer	R&S	FSP 40	100185	Nov.26.2011
10	Test Cable	N/A	C-01_CB03	N/A	Jul.04.2012
11	Test Cable	HUBER+SUHNER	SUCOFLEX_ 8m	313794/4	Apr.11.2012
12	Controller	CT	SC100	N/A	N/A
13	Broad-Band Horn Antenna	Schwarzbeck	BBHA 9170	9170319	Aug.16.2011
14	26.5G-40G Amplifier	EMC Instruments	EMC265404 5	980039	Jun .04.2012

Remark: " N/A" denotes No Model Name / Serial No. and No Calibration specified.

4.2.3 TEST PROCEDURE

- a. The measuring distance of at 10 m shall be used for measurements at frequency up to 1GHz. For frequencies above 1GHz, any suitable measuring distance may be used.
- b. The EUT was placed on the top of a rotating table 0.8 meters above the ground at a 3m or 10 meter open area test site. The table was rotated 360 degrees to determine the position of the highest radiation.
- c. The height of the equipment or of the substitution antenna shall be 0.8 m; the height of the test antenna shall vary between 1 m to 4 m. Both horizontal and vertical polarizations of the antenna are set to make the measurement.
- d. The initial step in collecting conducted emission data is a spectrum analyzer peak detector mode pre-scanning the measurement frequency range. Significant peaks are then marked and then Quasi Peak detector mode re-measured.
- e. If the Peak Mode measured value compliance with and lower than Quasi Peak Mode Limit, the EUT shall be deemed to meet QP Limits and then no additional QP Mode measurement performed.
- f. For the actual test configuration, please refer to the related Item –EUT Test Photos.

4.2.4 DEVIATION FROM TEST STANDARD

No deviation

4.2.5 TEST SETUP

Radiated Emission Test Set-Up Frequency 30 - 1000MHz

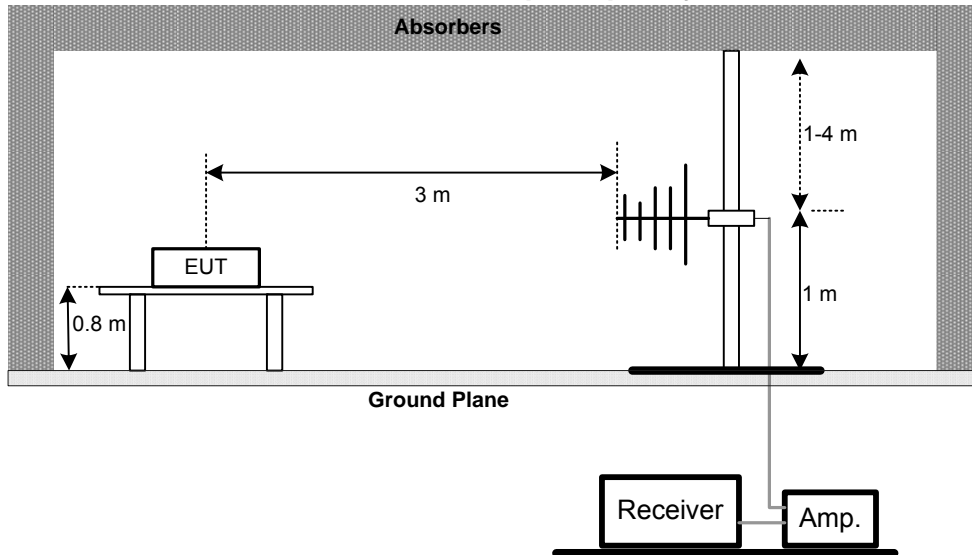

Radiated Emission Test Set-Up Frequency Above 1 GHz

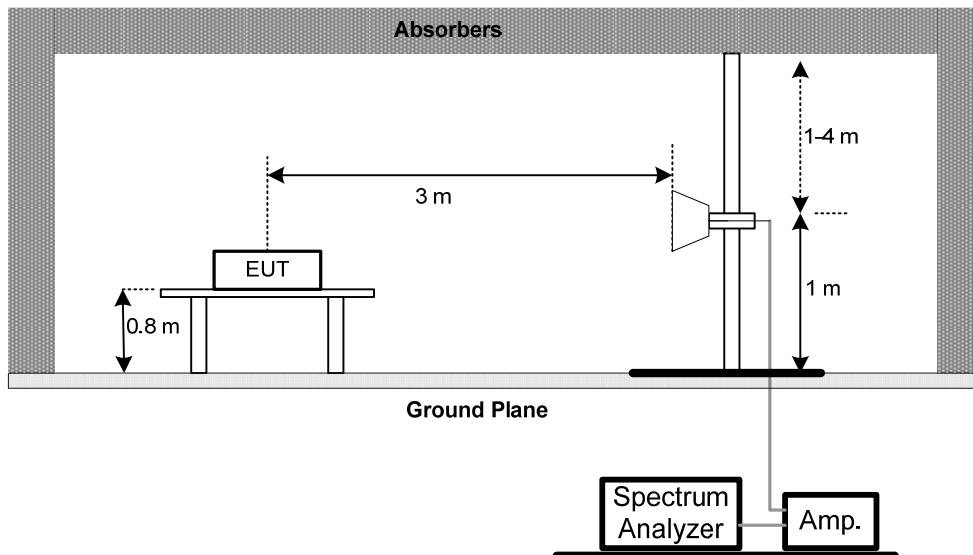

4.2.6 EUT OPERATING CONDITIONS

The EUT tested system was configured as the statements of 4.1.6 Unless otherwise a special operating condition is specified in the follows during the testing.



4.2.7 TEST RESULTS-BETWEEN 30MHZ - 1000MHZ

EUT :	Half-size mini-PCIe digital wireless audio module	Model Name :	DWPCIe83
Temperature :	25 ° C	Relative Humidity :	58%
Test Voltage :	DC 3.3V		
Test Mode :	5.2G/ TX Mode 5180MHz (Antenna A)		

Freq. (MHz)	Ant. H/V	Reading(RA) (dBuV)	Corr.Factor(CF) (dB)	Measured(FS) (dBuV/m)	Limits(QP) (dBuV/m)	Margin (dB)	Note
39.70	V	42.81	-16.83	25.98	40.00	- 14.02	
119.73	V	47.40	-18.28	29.12	43.50	- 14.38	
177.93	V	38.89	-16.97	21.92	43.50	- 21.58	
202.18	V	41.17	-16.51	24.66	43.50	- 18.84	
240.98	V	42.63	-15.10	27.53	46.00	- 18.47	
301.60	V	34.65	-12.03	22.62	46.00	- 23.38	

Remark :

- (1) Spectrum Setting : 30MHz – 1000MHz , RBW= 100KHz, VBW=100KHz, Sweep time = 200 ms. 1GHz- 40GHz, RBW= 1MHz, VBW= 1MHz, Sweep time = Auto
- (2) All readings are Peak unless otherwise stated QP in column of 『Note』 . Peak denotes that the Peak reading compliance with the QP Limits and then QP Mode measurement didn't perform ◦
- (3) Measuring frequency range from 30MHz to 1000MHz or the 10th harmonic of highest fundamental frequency ◦ “F” denotes fundamental frequency; “ H” denotes spurious frequency. “E” denotes band edge frequency.
- (4) Radiated emissions measured in frequency range from 30 MHz to 1000 MHz were made with an instrument using Peak detector mode or QP detector mode of the emission ◦
- (5) Data of measurement within this frequency range shown “ - ” in the table above means the reading of emissions are attenuated more than 20dB below the permissible limits or the field strength is too small to be measured.

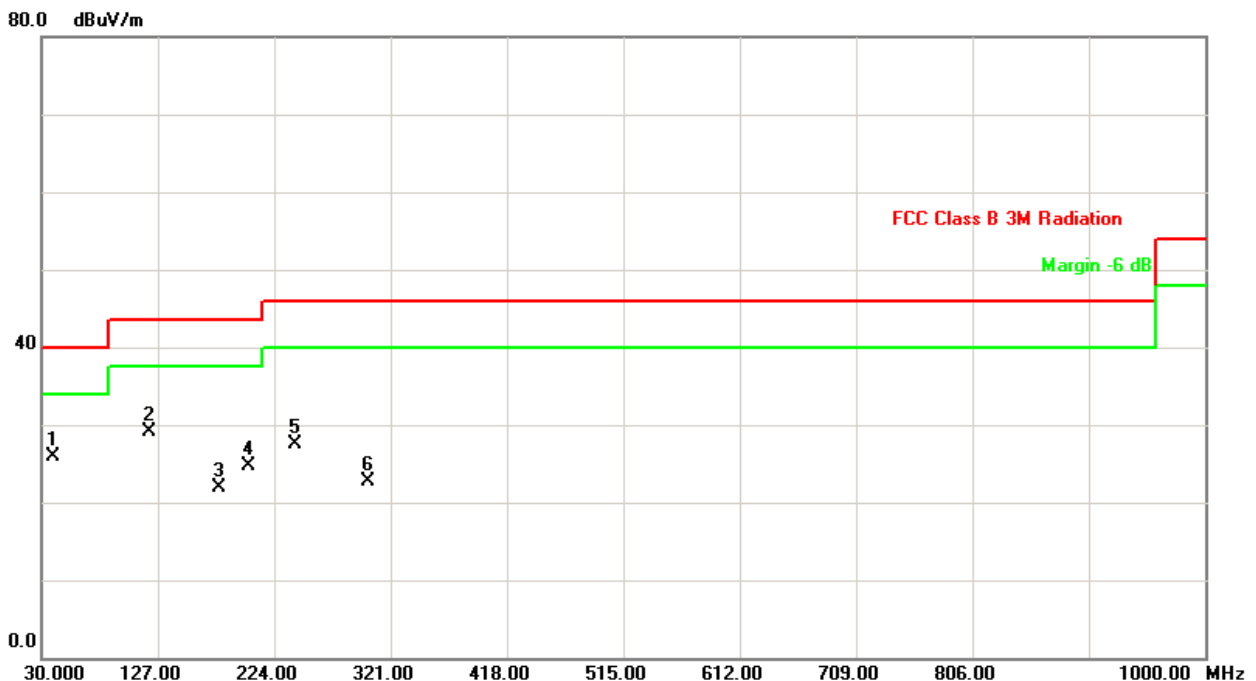



EUT :	Half-size mini-PCIe digital wireless audio module	Model Name :	DWPCIe83
Temperature :	25 °C	Relative Humidity :	58%
Test Voltage :	DC 3.3V		
Test Mode :	5.2G/ TX Mode 5180MHz (Antenna A)		

Freq. (MHz)	Ant. H/V	Reading(RA) (dBuV)	Corr.Factor(CF) (dB)	Measured(FS) (dBuV/m)	Limits(QP) (dBuV/m)	Margin (dB)	Note
119.73	H	45.91	-18.28	27.63	43.50	- 15.87	
194.90	H	45.36	-16.66	28.70	43.50	- 14.80	
238.55	H	50.14	-15.23	34.91	46.00	- 11.09	
262.80	H	43.44	-13.69	29.75	46.00	- 16.25	
364.65	H	35.86	-10.31	25.55	46.00	- 20.45	
500.45	H	32.95	-7.34	25.61	46.00	- 20.39	

Remark :

- (1) Spectrum Setting : 30MHz – 1000MHz , RBW= 100KHz, VBW=100KHz, Sweep time = 200 ms. 1GHz- 25GHz, RBW= 1MHz, VBW= 1MHz, Sweep time = Auto
- (2) All readings are Peak unless otherwise stated QP in column of 『Note』 . Peak denotes that the Peak reading compliance with the QP Limits and then QP Mode measurement didn't perform ◦
- (3) Measuring frequency range from 30MHz to 1000MHz or the 10th harmonic of highest fundamental frequency ◦ “F” denotes fundamental frequency; “ H” denotes spurious frequency. “E” denotes band edge frequency.
- (4) Radiated emissions measured in frequency range from 30 MHz to 1000 MHz were made with an instrument using Peak detector mode or QP detector mode of the emission ◦
- (5) Data of measurement within this frequency range shown “ - ” in the table above means the reading of emissions are attenuated more than 20dB below the permissible limits or the field strength is too small to be measured.

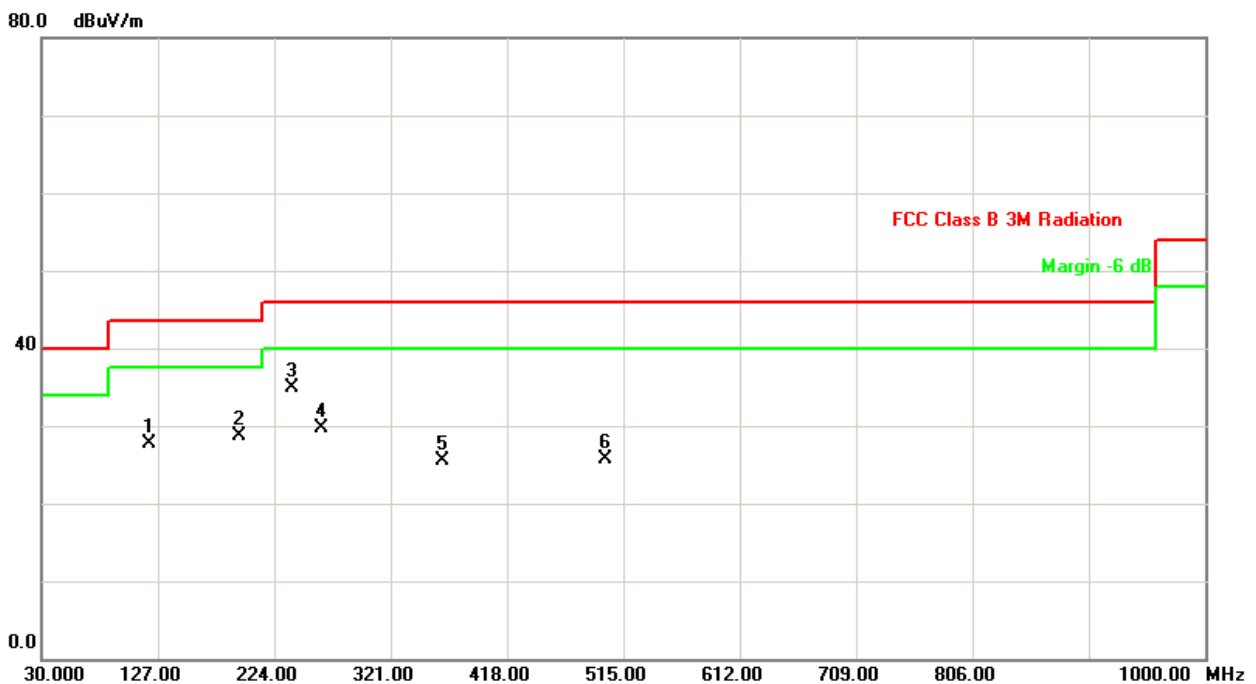



EUT :	Half-size mini-PCIe digital wireless audio module	Model Name :	DWPCIe83
Temperature :	25° C	Relative Humidity :	58%
Test Voltage :	DC 3.3V		
Test Mode :	5.2G/ TX Mode 5180MHz (Antenna B)		

Freq. (MHz)	Ant. H/V	Reading(RA) (dBuV)	Corr.Factor(CF) (dB)	Measured(FS) (dBuV/m)	Limits(QP) (dBuV/m)	Margin (dB)	Note
39.70	V	41.81	-16.83	24.98	40.00	- 15.02	
119.73	V	46.90	-18.28	28.62	43.50	- 14.88	
202.18	V	38.67	-16.51	22.16	43.50	- 21.34	
240.98	V	42.13	-15.10	27.03	46.00	- 18.97	
270.08	V	38.73	-13.28	25.45	46.00	- 20.55	
548.95	V	33.34	-5.53	27.81	46.00	- 18.19	

Remark :

- (1) Spectrum Setting : 30MHz – 1000MHz , RBW= 100KHz, VBW=100KHz, Sweep time = 200 ms. 1GHz- 40GHz, RBW= 1MHz, VBW= 1MHz, Sweep time = Auto
- (2) All readings are Peak unless otherwise stated QP in column of 『Note』 . Peak denotes that the Peak reading compliance with the QP Limits and then QP Mode measurement didn't perform ◦
- (3) Measuring frequency range from 30MHz to 1000MHz or the 10th harmonic of highest fundamental frequency ◦ “F” denotes fundamental frequency; “ H” denotes spurious frequency. “E” denotes band edge frequency.
- (4) Radiated emissions measured in frequency range from 30 MHz to 1000 MHz were made with an instrument using Peak detector mode or QP detector mode of the emission ◦
- (5) Data of measurement within this frequency range shown “ - ” in the table above means the reading of emissions are attenuated more than 20dB below the permissible limits or the field strength is too small to be measured.

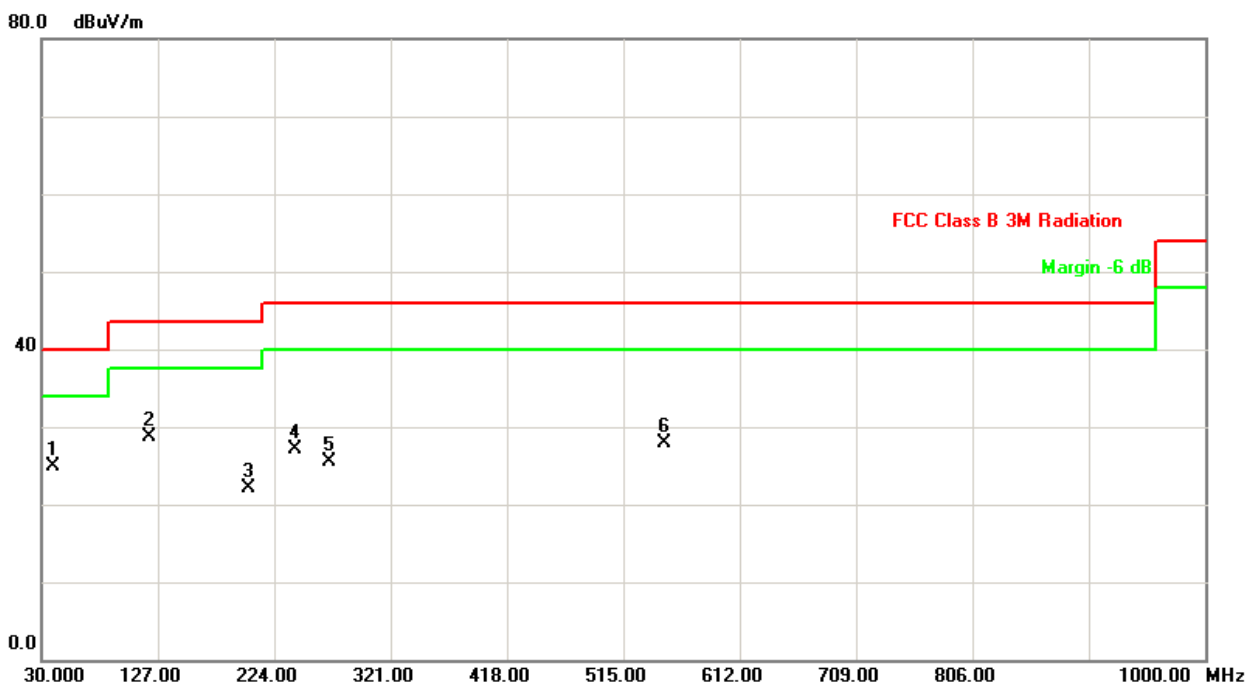



EUT :	Half-size mini-PCIe digital wireless audio module	Model Name :	DWPCIe83
Temperature :	25 °C	Relative Humidity :	58%
Test Voltage :	DC 3.3V		
Test Mode :	5.2G/ TX Mode 5180MHz (Antenna B)		

Freq. (MHz)	Ant. H/V	Reading(RA) (dBuV)	Corr.Factor(CF) (dB)	Measured(FS) (dBuV/m)	Limits(QP) (dBuV/m)	Margin (dB)	Note
119.73	H	44.91	-18.28	26.63	43.50	- 16.87	
194.90	H	45.36	-16.66	28.70	43.50	- 14.80	
238.55	H	49.64	-15.23	34.41	46.00	- 11.59	
262.80	H	42.94	-13.69	29.25	46.00	- 16.75	
337.98	H	36.52	-11.14	25.38	46.00	- 20.62	
679.90	H	29.84	-3.24	26.60	46.00	- 19.40	

Remark :

- (1) Spectrum Setting : 30MHz – 1000MHz , RBW= 100KHz, VBW=100KHz, Sweep time = 200 ms. 1GHz- 25GHz, RBW= 1MHz, VBW= 1MHz, Sweep time = Auto
- (2) All readings are Peak unless otherwise stated QP in column of 『Note』 . Peak denotes that the Peak reading compliance with the QP Limits and then QP Mode measurement didn't perform ◦
- (3) Measuring frequency range from 30MHz to 1000MHz or the 10th harmonic of highest fundamental frequency ◦ “F” denotes fundamental frequency; “ H” denotes spurious frequency. “E” denotes band edge frequency.
- (4) Radiated emissions measured in frequency range from 30 MHz to 1000 MHz were made with an instrument using Peak detector mode or QP detector mode of the emission ◦
- (5) Data of measurement within this frequency range shown “ - ” in the table above means the reading of emissions are attenuated more than 20dB below the permissible limits or the field strength is too small to be measured.

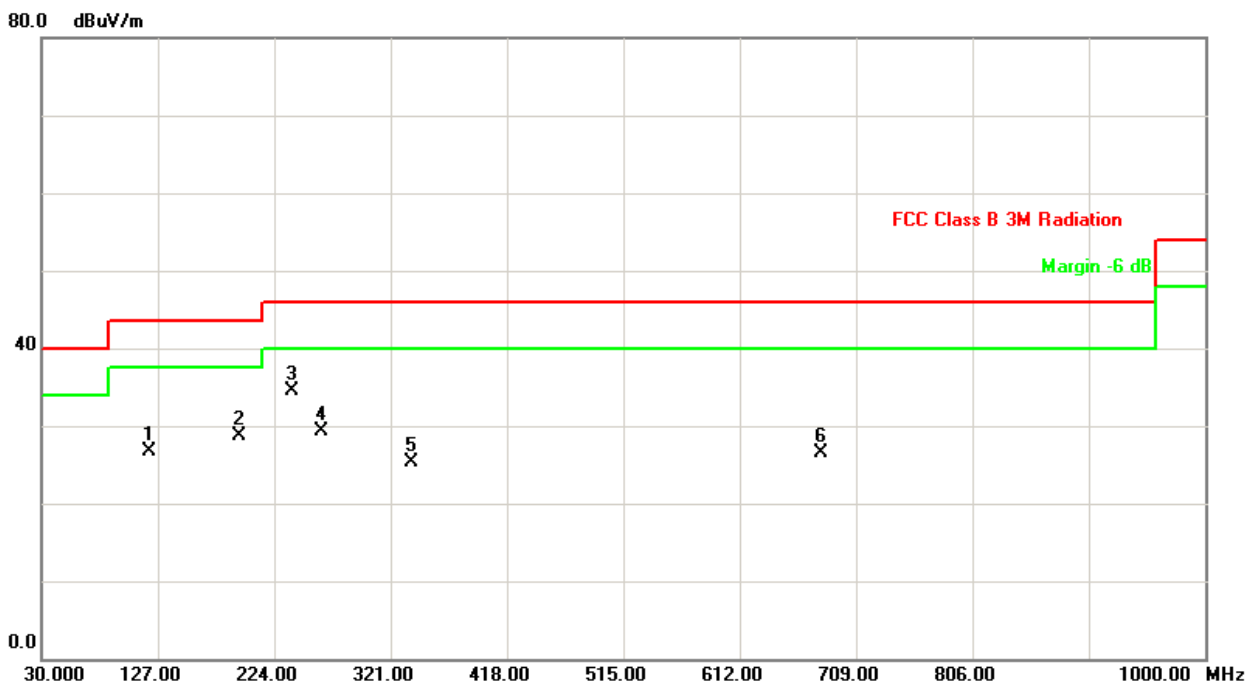



EUT :	Half-size mini-PCIe digital wireless audio module	Model Name :	DWPCIe83
Temperature :	25 ° C	Relative Humidity :	58%
Test Voltage :	DC 3.3V		
Test Mode :	5.2G/ RX Mode 5180MHz (Antenna A)		

Freq. (MHz)	Ant. H/V	Reading(RA) (dBuV)	Corr.Factor(CF) (dB)	Measured(FS) (dBuV/m)	Limits(QP) (dBuV/m)	Margin (dB)	Note
39.70	V	45.81	-16.83	28.98	40.00	- 11.02	
119.73	V	48.90	-18.28	30.62	43.50	- 12.88	
143.98	V	41.44	-17.66	23.78	43.50	- 19.72	
202.18	V	42.67	-16.51	26.16	43.50	- 17.34	
240.98	V	43.13	-15.10	28.03	46.00	- 17.97	
262.80	V	38.86	-13.69	25.17	46.00	- 20.83	

Remark :

- (1) Spectrum Setting : 30MHz – 1000MHz , RBW= 100KHz, VBW=100KHz, Sweep time = 200 ms. 1GHz- 40GHz, RBW= 1MHz, VBW= 1MHz, Sweep time = Auto
- (2) All readings are Peak unless otherwise stated QP in column of 『Note』 . Peak denotes that the Peak reading compliance with the QP Limits and then QP Mode measurement didn't perform ◦
- (3) Measuring frequency range from 30MHz to 1000MHz or the 10th harmonic of highest fundamental frequency ◦ “F” denotes fundamental frequency; “ H” denotes spurious frequency. “E” denotes band edge frequency.
- (4) Radiated emissions measured in frequency range from 30 MHz to 1000 MHz were made with an instrument using Peak detector mode or QP detector mode of the emission ◦
- (5) Data of measurement within this frequency range shown “ - ” in the table above means the reading of emissions are attenuated more than 20dB below the permissible limits or the field strength is too small to be measured.

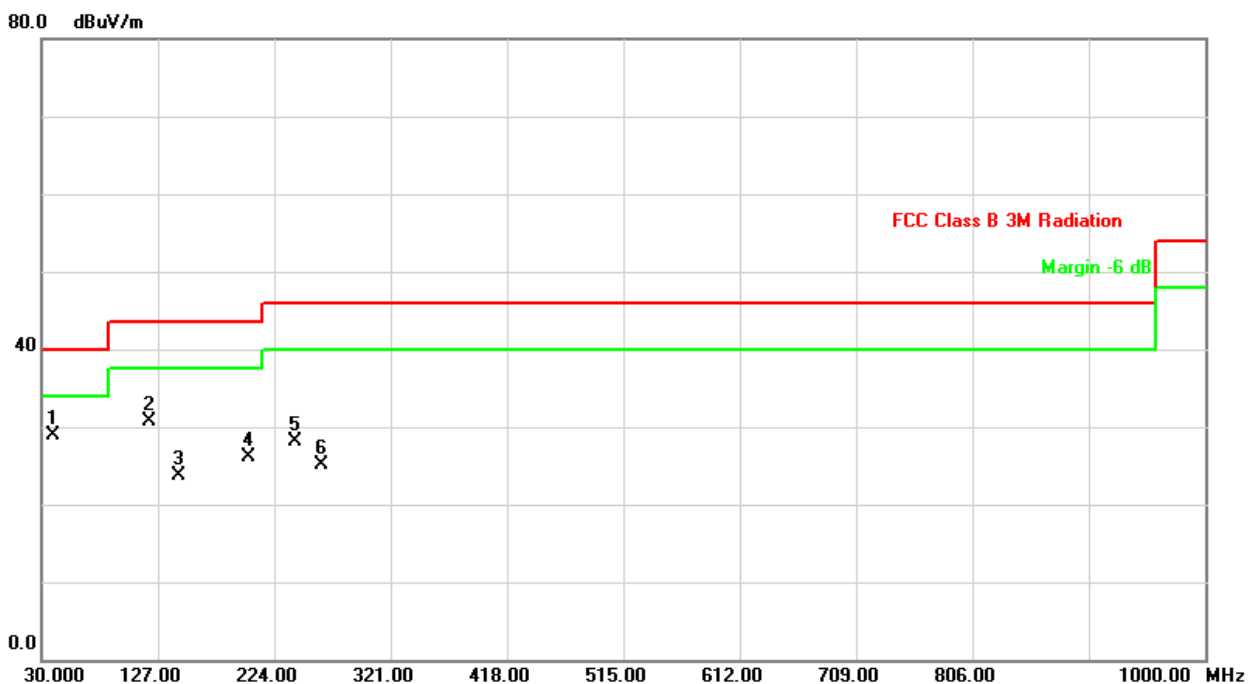



EUT :	Half-size mini-PCIe digital wireless audio module	Model Name :	DWPCIe83
Temperature :	25 °C	Relative Humidity :	58%
Test Voltage :	DC 3.3V		
Test Mode :	5.2G/ RX Mode 5180MHz (Antenna A)		

Freq. (MHz)	Ant. H/V	Reading(RA) (dBuV)	Corr.Factor(CF) (dB)	Measured(FS) (dBuV/m)	Limits(QP) (dBuV/m)	Margin (dB)	Note
119.73	H	44.91	-18.28	26.63	43.50	- 16.87	
194.90	H	46.86	-16.66	30.20	43.50	- 13.30	
238.55	H	49.64	-15.23	34.41	46.00	- 11.59	
262.80	H	44.94	-13.69	31.25	46.00	- 14.75	
337.98	H	37.52	-11.14	26.38	46.00	- 19.62	
500.45	H	32.45	-7.34	25.11	46.00	- 20.89	

Remark :

- (1) Spectrum Setting : 30MHz – 1000MHz , RBW= 100KHz, VBW=100KHz, Sweep time = 200 ms. 1GHz- 25GHz, RBW= 1MHz, VBW= 1MHz, Sweep time = Auto
- (2) All readings are Peak unless otherwise stated QP in column of 『Note』 . Peak denotes that the Peak reading compliance with the QP Limits and then QP Mode measurement didn't perform ◦
- (3) Measuring frequency range from 30MHz to 1000MHz or the 10th harmonic of highest fundamental frequency ◦ “F” denotes fundamental frequency; “ H” denotes spurious frequency. “E” denotes band edge frequency.
- (4) Radiated emissions measured in frequency range from 30 MHz to 1000 MHz were made with an instrument using Peak detector mode or QP detector mode of the emission ◦
- (5) Data of measurement within this frequency range shown “ - ” in the table above means the reading of emissions are attenuated more than 20dB below the permissible limits or the field strength is too small to be measured.

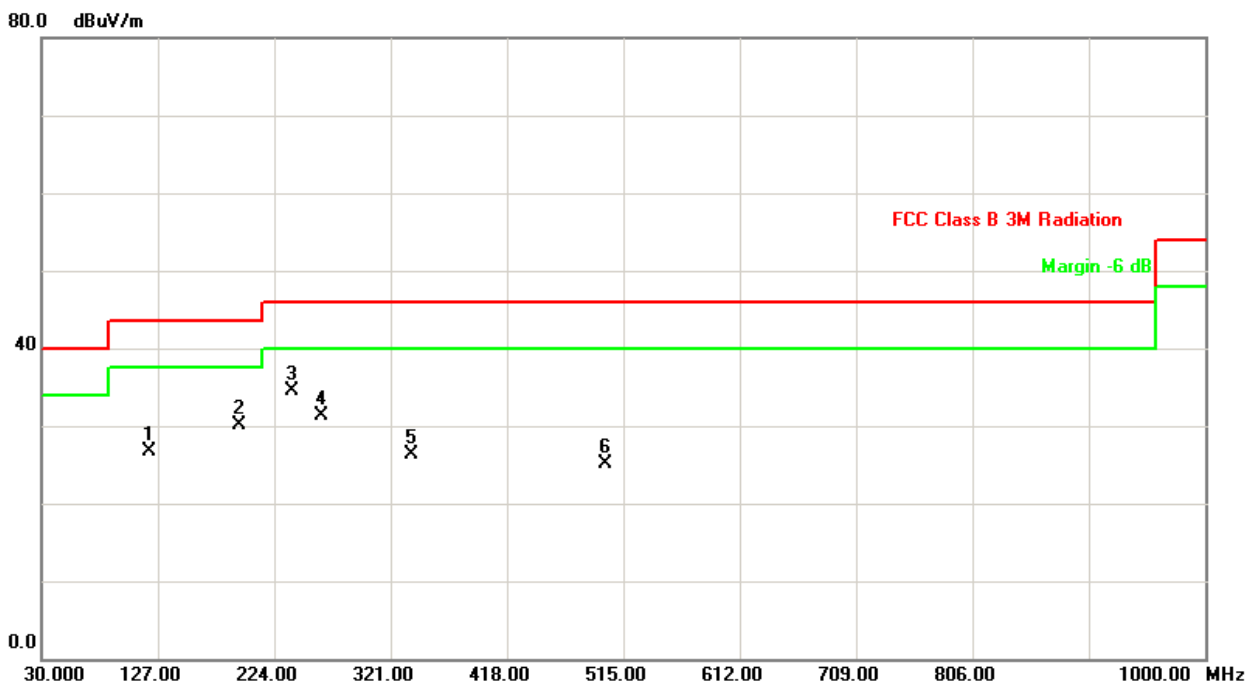



EUT :	Half-size mini-PCIe digital wireless audio module	Model Name :	DWPCIe83
Temperature :	25° C	Relative Humidity :	58%
Test Voltage :	DC 3.3V		
Test Mode :	5.2G/ RX Mode 5180MHz (Antenna B)		

Freq. (MHz)	Ant. H/V	Reading(RA) (dBuV)	Corr.Factor(CF) (dB)	Measured(FS) (dBuV/m)	Limits(QP) (dBuV/m)	Margin (dB)	Note
39.70	V	44.81	-16.83	27.98	40.00	- 12.02	
76.08	V	39.92	-18.86	21.06	40.00	- 18.94	
182.78	V	39.59	-16.84	22.75	43.50	- 20.75	
202.18	V	41.67	-16.51	25.16	43.50	- 18.34	
240.98	V	42.13	-15.10	27.03	46.00	- 18.97	
500.45	V	34.16	-7.34	26.82	46.00	- 19.18	

Remark :

- (1) Spectrum Setting : 30MHz – 1000MHz , RBW= 100KHz, VBW=100KHz, Sweep time = 200 ms. 1GHz- 40GHz, RBW= 1MHz, VBW= 1MHz, Sweep time = Auto
- (2) All readings are Peak unless otherwise stated QP in column of 『Note』 . Peak denotes that the Peak reading compliance with the QP Limits and then QP Mode measurement didn't perform ◦
- (3) Measuring frequency range from 30MHz to 1000MHz or the 10th harmonic of highest fundamental frequency ◦ “F” denotes fundamental frequency; “ H” denotes spurious frequency. “E” denotes band edge frequency.
- (4) Radiated emissions measured in frequency range from 30 MHz to 1000 MHz were made with an instrument using Peak detector mode or QP detector mode of the emission ◦
- (5) Data of measurement within this frequency range shown “ - ” in the table above means the reading of emissions are attenuated more than 20dB below the permissible limits or the field strength is too small to be measured.

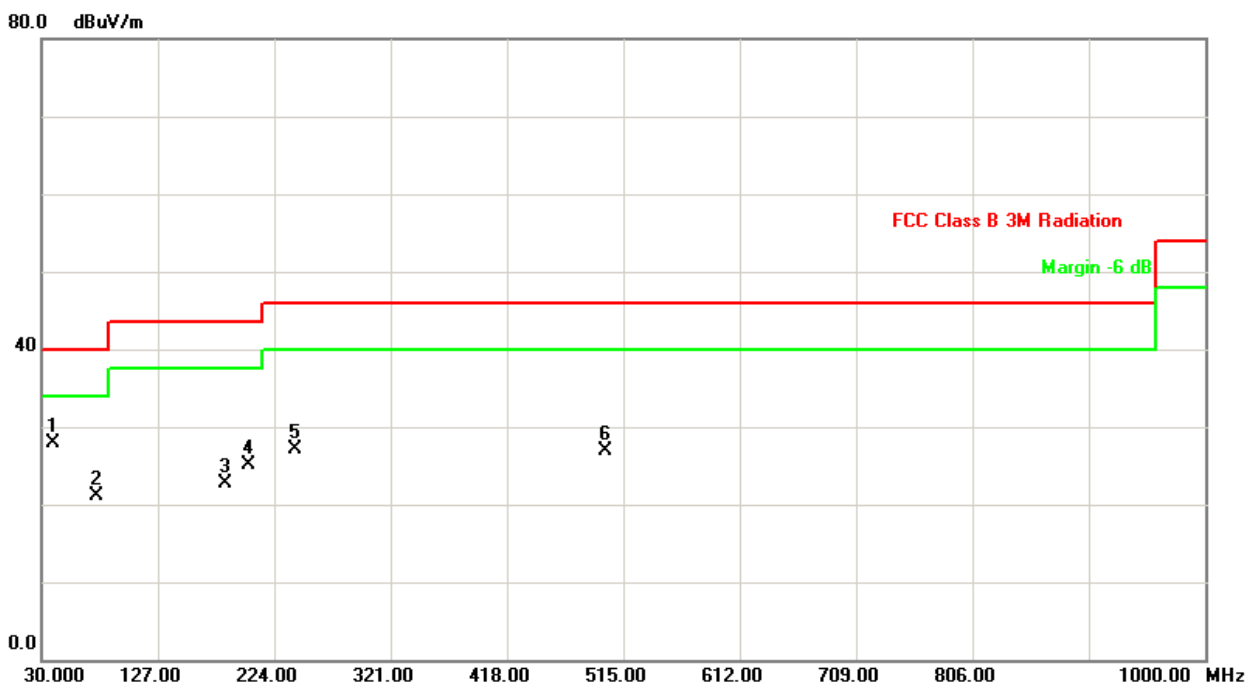



EUT :	Half-size mini-PCle digital wireless audio module	Model Name :	DWPCle83
Temperature :	25 °C	Relative Humidity :	58%
Test Voltage :	DC 3.3V		
Test Mode :	5.2G/ RX Mode 5180MHz (Antenna B)		

Freq. (MHz)	Ant. H/V	Reading(RA) (dBuV)	Corr.Factor(CF) (dB)	Measured(FS) (dBuV/m)	Limits(QP) (dBuV/m)	Margin (dB)	Note
119.73	H	44.91	-18.28	26.63	43.50	- 16.87	
204.60	H	46.41	-16.44	29.97	43.50	- 13.53	
238.55	H	49.14	-15.23	33.91	46.00	- 12.09	
262.80	H	44.44	-13.69	30.75	46.00	- 15.25	
337.98	H	37.52	-11.14	26.38	46.00	- 19.62	
500.45	H	31.45	-7.34	24.11	46.00	- 21.89	

Remark :

- (1) Spectrum Setting : 30MHz – 1000MHz , RBW= 100KHz, VBW=100KHz, Sweep time = 200 ms. 1GHz- 25GHz, RBW= 1MHz, VBW= 1MHz, Sweep time = Auto
- (2) All readings are Peak unless otherwise stated QP in column of 『Note』 . Peak denotes that the Peak reading compliance with the QP Limits and then QP Mode measurement didn't perform ◦
- (3) Measuring frequency range from 30MHz to 1000MHz or the 10th harmonic of highest fundamental frequency ◦ “F” denotes fundamental frequency; “ H” denotes spurious frequency. “E” denotes band edge frequency.
- (4) Radiated emissions measured in frequency range from 30 MHz to 1000 MHz were made with an instrument using Peak detector mode or QP detector mode of the emission ◦
- (5) Data of measurement within this frequency range shown “ - ” in the table above means the reading of emissions are attenuated more than 20dB below the permissible limits or the field strength is too small to be measured.

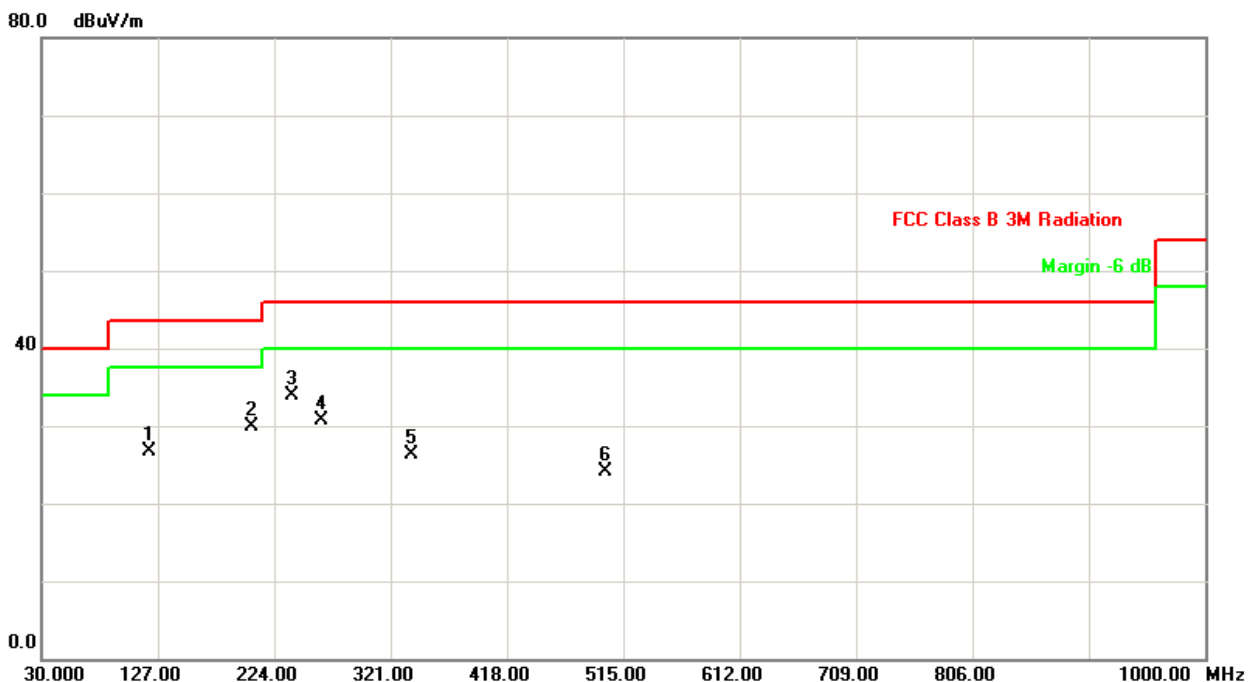



4.2.8 TEST RESULTS - ABOVE 1000MHZ

EUT :	Half-size mini-PCIe digital wireless audio module	Model Name :	DWPCIe83
Temperature :	25 °C	Relative Humidity :	58 %
Test Voltage :	DC 3.3V		
Test Mode :	5.2G/ TX Mode 5180MHz (Antenna A)		

Freq. (MHz)	Ant.Pol. H/V	Reading		Ant./CF CF(dB)	Act.		Limit		Note
		Peak (dBuV)	AV (dBuV)		Peak (dBuV/m)	AV (dBuV/m)	Peak (dBuV/m)	AV (dBuV/m)	
5150.00	V	26.07	15.21	39.11	65.18	54.32	74.30	60.00	X/E
5176.20	V	67.46	64.17	39.18	106.64	103.35			X/F
3453.34	V	48.87	44.48	1.67	50.54	46.15	74.30	60.00	X/H
10359.98	V	45.65	33.76	12.63	58.28	46.39	74.30	60.00	X/H

Remark :

- (1) Spectrum Setting : 30MHz – 1000MHz , RBW= 100KHz, VBW=100KHz, Sweep time = 200 ms. 1GHz- 40GHz, RBW= 1MHz, VBW= 1MHz, Sweep time = Auto
- (2) All readings are Peak unless otherwise stated AV in column of 『Note』 . Peak denotes that the Peak reading compliance with the AV Limits and then AV Mode measurement didn't perform.
- (3) Measuring frequency range from 30MHz to 1000MHz or the 10th harmonic of highest fundamental frequency. "F" denotes fundamental frequency; "H" denotes spurious frequency. "E" denotes band edge frequency. (This judgment method includes the Band Edge Requirement.)
- (4) Radiated emissions measured in frequency range above 1000MHz were made with an instrument using Peak detector mode and AV detector mode of the emission .
- (5) Data of measurement within this frequency range shown " * " in the table above means the reading of emissions are attenuated more than 20dB below the permissible limits or the field strength is too small to be measured.
- (6) A preamp and high pass filter were used for this test in order to provide sufficient measurement sensitivity.
- (7) EUT Orthogonal Axes :
 "X" - denotes Laid on Table ; "Y" - denotes Vertical Stand ; "Z" - denotes Side Stand
- (8) During the measurements above 1GHz it is taken care of that the EUT is always within the 3dB cone of radiation BW of the used antenna.
- (9) The limits above 5GHz shall be extrapolated to the specified distance using an extrapolation factor of 20dB/decade form 3m to 1.5m
 Distance extrapolation factor = 20 log (3m/1.5m) dB ;
 Limit line = specific limits (dBuV) + 6 dB



Orthogonal Axis : X
5.2G/CH01(Above 1000 MHz, Vertical)

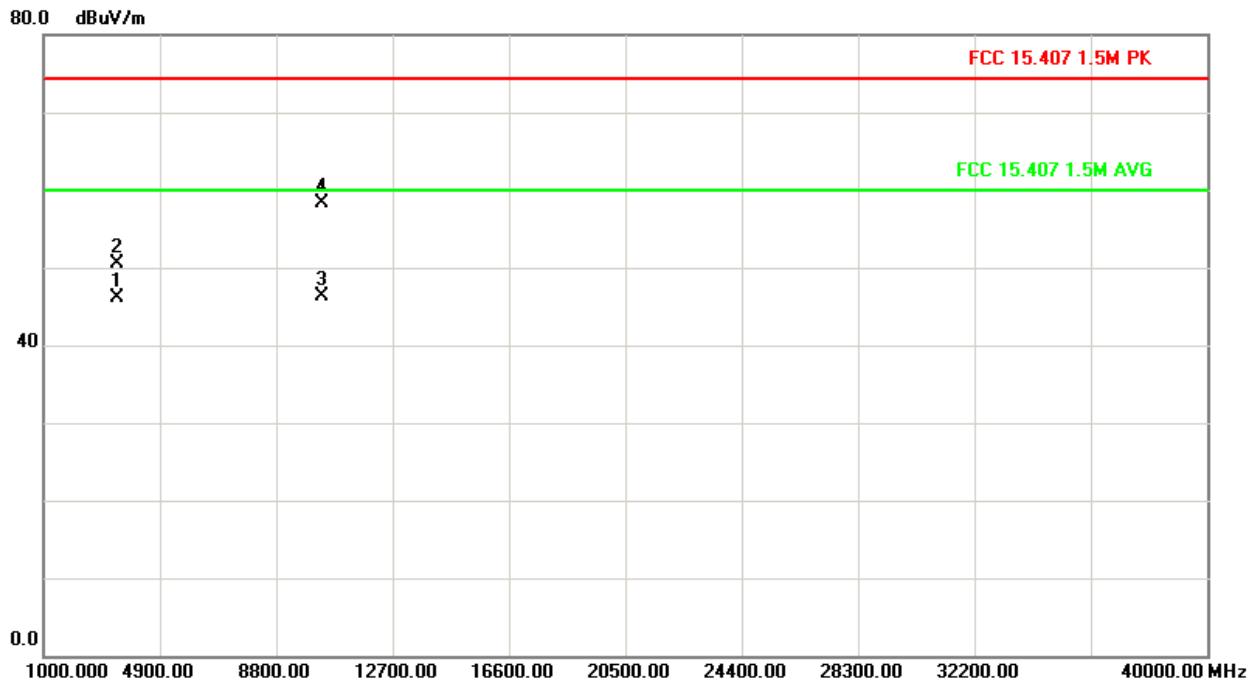
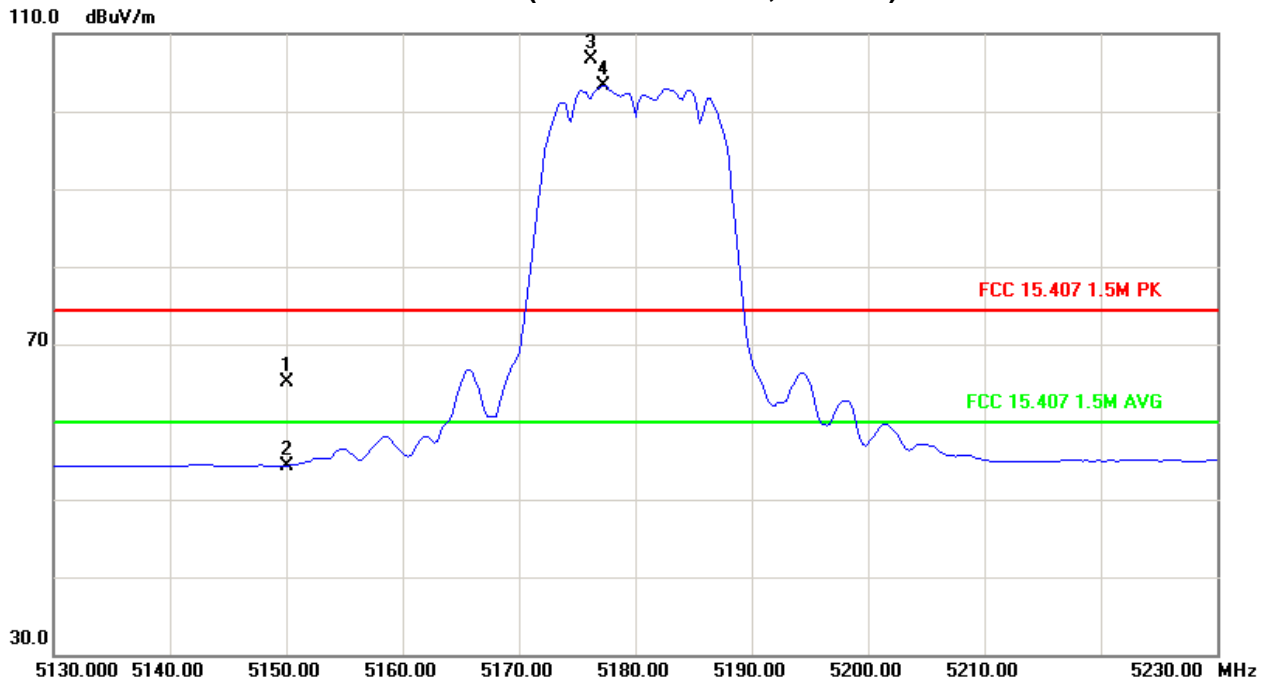



EUT :	Half-size mini-PCle digital wireless audio module	Model Name :	DWPCle83
Temperature :	25 °C	Relative Humidity :	58 %
Test Voltage :	DC 3.3V		
Test Mode :	5.2G/ TX Mode 5180MHz (Antenna A)		

Freq. (MHz)	Ant.Pol. H/V	Reading		Ant./CF CF(dB)	Act.		Limit		Note
		Peak (dBuV)	AV (dBuV)		Peak (dBuV/m)	AV (dBuV/m)	Peak (dBuV/m)	AV (dBuV/m)	
5150.00	H	25.23	15.12	39.11	64.34	54.23	74.30	60.00	X/E
5176.00	H	64.74	61.59	39.18	103.92	100.77			X/F
3453.34	H	48.21	45.95	1.61	49.82	47.56	74.30	60.00	X/H
10359.99	H	44.76	32.18	12.63	57.39	44.81	74.30	60.00	X/H

Remark :

- (1) Spectrum Setting : 30MHz – 1000MHz , RBW= 100KHz, VBW=100KHz, Sweep time = 200 ms. 1GHz- 40GHz, RBW= 1MHz, VBW= 1MHz, Sweep time = Auto
- (2) All readings are Peak unless otherwise stated AV in column of 『Note』 . Peak denotes that the Peak reading compliance with the AV Limits and then AV Mode measurement didn't perform.
- (3) Measuring frequency range from 30MHz to 1000MHz or the 10th harmonic of highest fundamental frequency. "F" denotes fundamental frequency; "H" denotes spurious frequency. "E" denotes band edge frequency. (This judgment method includes the Band Edge Requirement.)
- (4) Radiated emissions measured in frequency range above 1000MHz were made with an instrument using Peak detector mode and AV detector mode of the emission .
- (5) Data of measurement within this frequency range shown " * " in the table above means the reading of emissions are attenuated more than 20dB below the permissible limits or the field strength is too small to be measured.
- (6) A preamp and high pass filter were used for this test in order to provide sufficient measurement sensitivity.
- (7) EUT Orthogonal Axes :
"X" - denotes Laid on Table ; "Y" - denotes Vertical Stand ; "Z" - denotes Side Stand
- (8) During the measurements above 1GHz it is taken care of that the EUT is always within the 3dB cone of radiation BW of the used antenna.
- (9) The limits above 5GHz shall be extrapolated to the specified distance using an extrapolation factor of 20dB/decade form 3m to 1.5m
Distance extrapolation factor = 20 log (3m/1.5m) dB ;
Limit line = specific limits (dBuV) + 6 dB



Orthogonal Axis : X
5.2G/CH01(Above 1000 MHz, Horizontal)

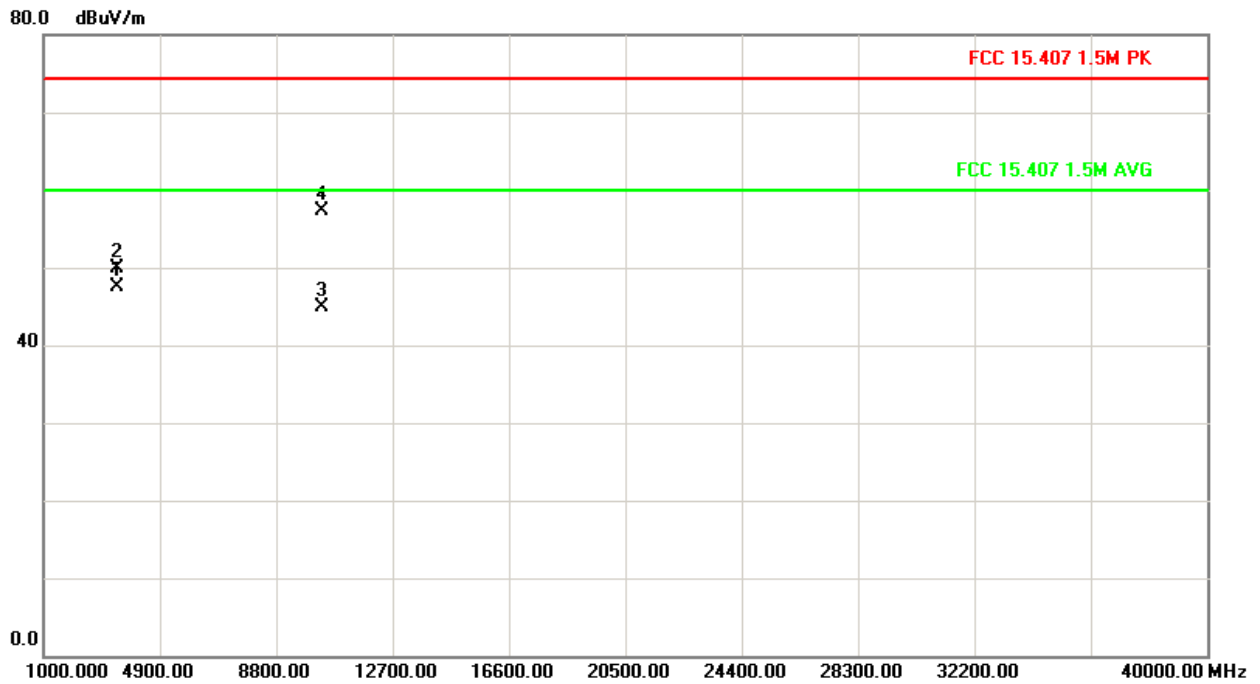
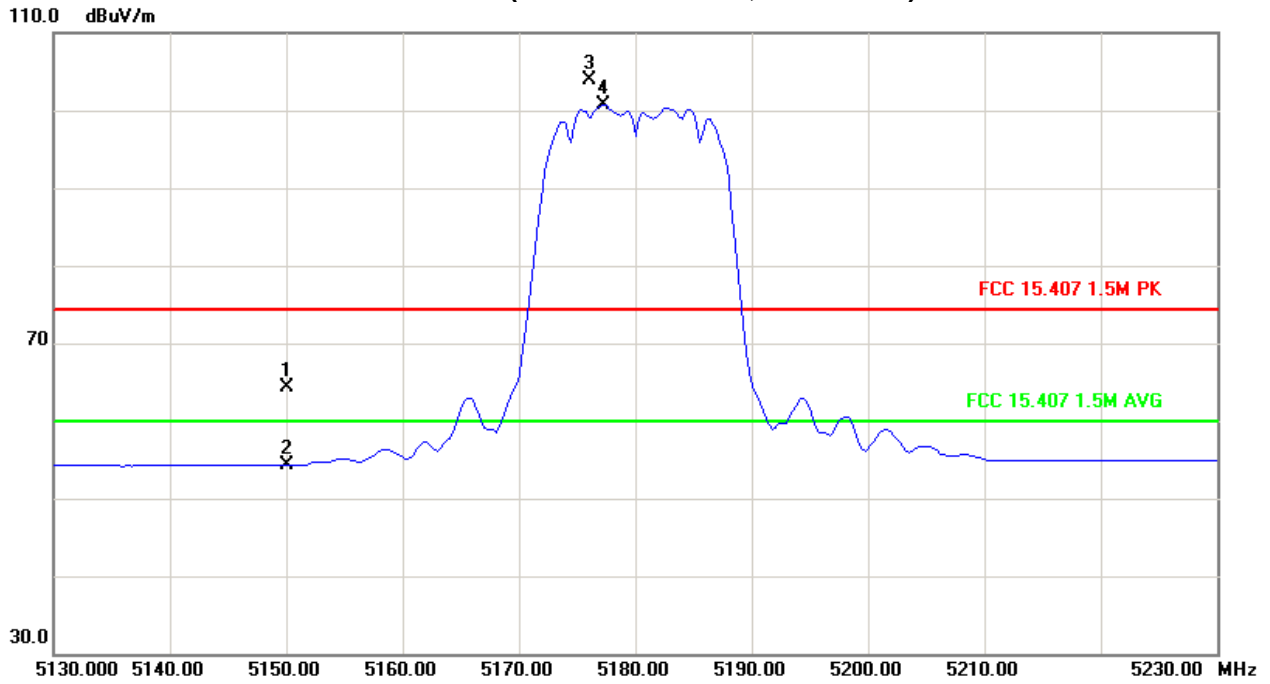



EUT :	Half-size mini-PCIe digital wireless audio module	Model Name :	DWPCIe83
Temperature :	25 °C	Relative Humidity :	58 %
Test Voltage :	DC 3.3V		
Test Mode :	5.2G/ TX Mode 5210MHz (Antenna A)		

Freq. (MHz)	Ant.Pol. H/V	Reading		Ant./CF CF(dB)	Act.		Limit		Note
		Peak (dBuV)	AV (dBuV)		Peak (dBuV/m)	AV (dBuV/m)	Peak (dBuV/m)	AV (dBuV/m)	
5211.00	V	67.98	64.88	39.27	107.25	104.15			X/F
3473.33	V	49.74	45.49	1.67	51.41	47.16	74.30	60.00	X/H
10420.01	V	45.13	33.32	12.65	57.78	45.97	74.30	60.00	X/H

Remark :

- (1) Spectrum Setting : 30MHz – 1000MHz , RBW= 100KHz, VBW=100KHz, Sweep time = 200 ms. 1GHz- 40GHz, RBW= 1MHz, VBW= 1MHz, Sweep time = Auto
- (2) All readings are Peak unless otherwise stated AV in column of 『Note』 . Peak denotes that the Peak reading compliance with the AV Limits and then AV Mode measurement didn't perform.
- (3) Measuring frequency range from 30MHz to 1000MHz or the 10th harmonic of highest fundamental frequency “F” denotes fundamental frequency; “H” denotes spurious frequency. “E” denotes band edge frequency. (This judgment method includes the Band Edge Requirement.)
- (4) Radiated emissions measured in frequency range above 1000MHz were made with an instrument using Peak detector mode and AV detector mode of the emission ◦
- (5) Data of measurement within this frequency range shown “ * ” in the table above means the reading of emissions are attenuated more than 20dB below the permissible limits or the field strength is too small to be measured.
- (6) A preamp and high pass filter were used for this test in order to provide sufficient measurement sensitivity.
- (7) EUT Orthogonal Axes :
“X” - denotes Laid on Table ; ”Y” - denotes Vertical Stand ; ”Z” - denotes Side Stand
- (8) During the measurements above 1GHz it is taken care of that the EUT is always within the 3dB cone of radiation BW of the used antenna.
- (9) The limits above 5GHz shall be extrapolated to the specified distance using an extrapolation factor of 20dB/decade form 3m to 1.5m
Distance extrapolation factor = 20 log (3m/1.5m) dB ;
Limit line = specific limits (dBuV) + 6 dB



Orthogonal Axis : X
5.2G/CH02(Above 1000 MHz, Vertical)

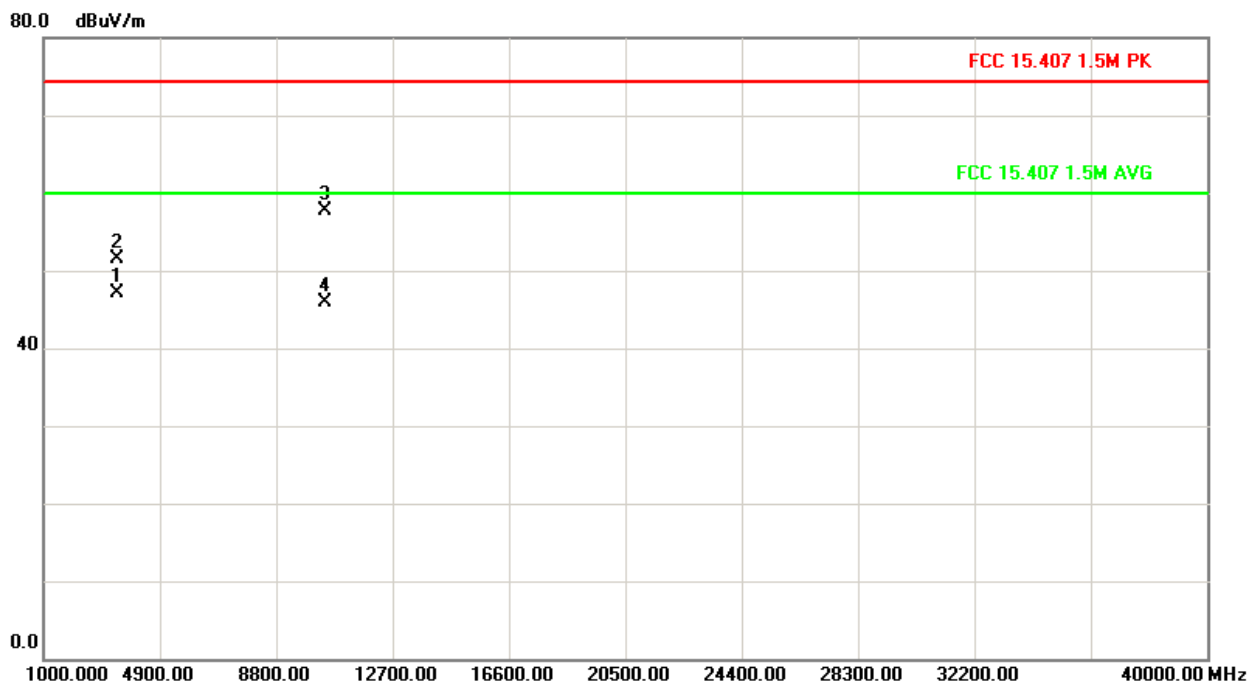
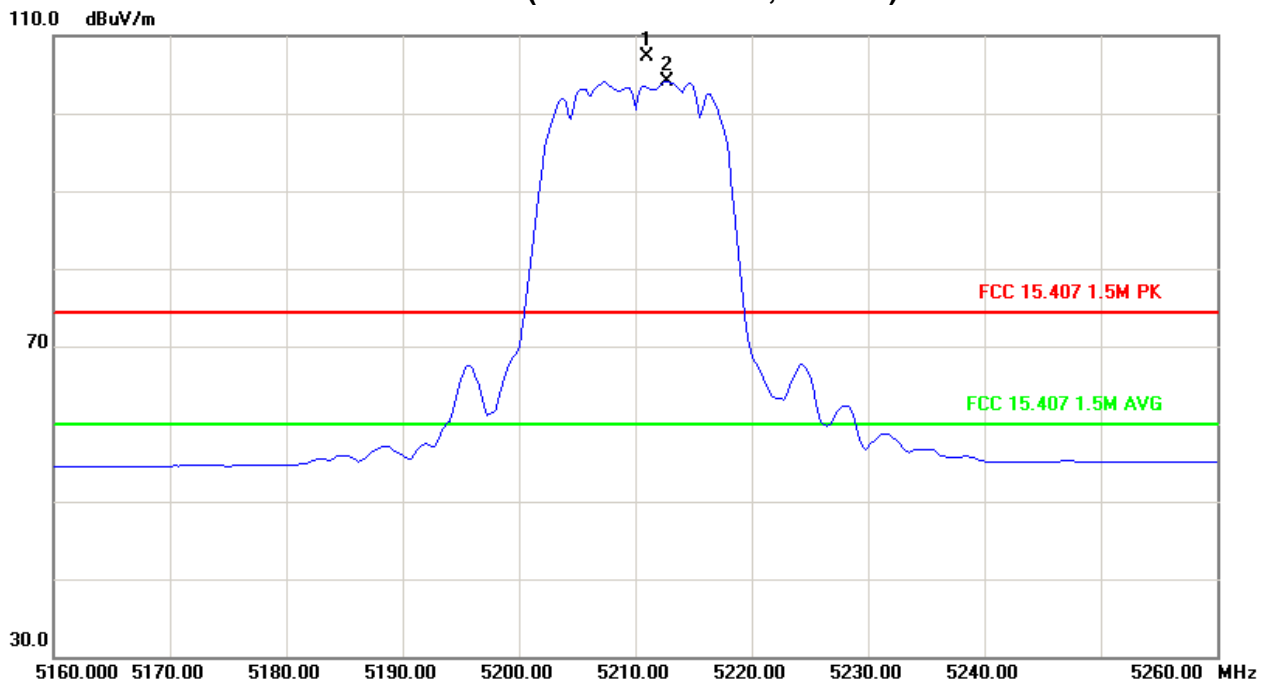



EUT :	Half-size mini-PCIe digital wireless audio module	Model Name :	DWPCIe83
Temperature :	25 °C	Relative Humidity :	58 %
Test Voltage :	DC 3.3V		
Test Mode :	5.2G/ TX Mode 5210MHz (Antenna A)		

Freq. (MHz)	Ant.Pol. H/V	Reading		Ant./CF CF(dB)	Act.		Limit		Note
		Peak (dBuV)	AV (dBuV)		Peak (dBuV/m)	AV (dBuV/m)	Peak (dBuV/m)	AV (dBuV/m)	
5211.00	H	65.14	62.00	39.27	104.41	101.27			X/F
3473.33	H	48.44	45.95	1.67	50.11	47.62	74.30	60.00	X/H
10420.01	H	44.18	31.57	12.65	56.83	44.22	74.30	60.00	X/H

Remark :

- (1) Spectrum Setting : 30MHz – 1000MHz , RBW= 100KHz, VBW=100KHz, Sweep time = 200 ms. 1GHz- 40GHz, RBW= 1MHz, VBW= 1MHz, Sweep time = Auto
- (2) All readings are Peak unless otherwise stated AV in column of 『Note』 . Peak denotes that the Peak reading compliance with the AV Limits and then AV Mode measurement didn't perform.
- (3) Measuring frequency range from 30MHz to 1000MHz or the 10th harmonic of highest fundamental frequency. "F" denotes fundamental frequency; "H" denotes spurious frequency. "E" denotes band edge frequency. (This judgment method includes the Band Edge Requirement.)
- (4) Radiated emissions measured in frequency range above 1000MHz were made with an instrument using Peak detector mode and AV detector mode of the emission .
- (5) Data of measurement within this frequency range shown " * " in the table above means the reading of emissions are attenuated more than 20dB below the permissible limits or the field strength is too small to be measured.
- (6) A preamp and high pass filter were used for this test in order to provide sufficient measurement sensitivity.
- (7) EUT Orthogonal Axes :
 "X" - denotes Laid on Table ; "Y" - denotes Vertical Stand ; "Z" - denotes Side Stand
- (8) During the measurements above 1GHz it is taken care of that the EUT is always within the 3dB cone of radiation BW of the used antenna.
- (9) The limits above 5GHz shall be extrapolated to the specified distance using an extrapolation factor of 20dB/decade form 3m to 1.5m
 Distance extrapolation factor = 20 log (3m/1.5m) dB ;
 Limit line = specific limits (dBuV) + 6 dB



Orthogonal Axis : X
5.2G/CH02(Above 1000 MHz, Horizontal)

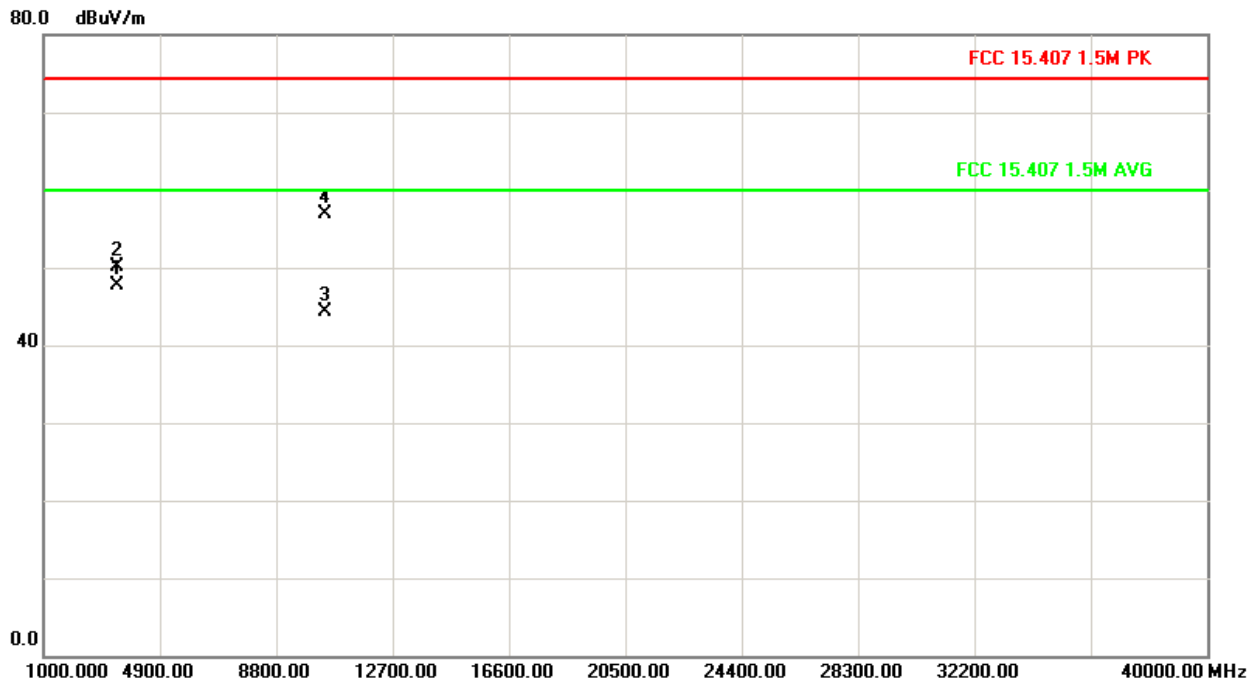
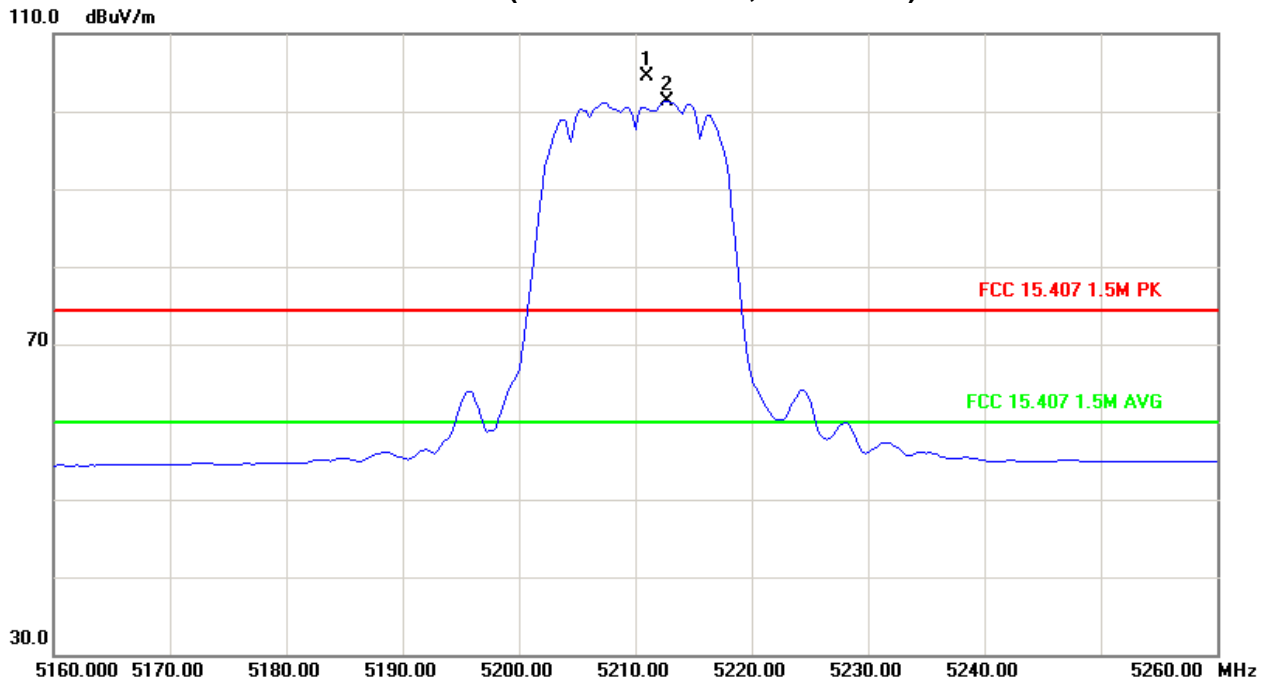



EUT :	Half-size mini-PCIe digital wireless audio module	Model Name :	DWPCIe83
Temperature :	25 °C	Relative Humidity :	52 %
Test Voltage :	DC 3.3V		
Test Mode :	5.2G/ TX Mode 5240MHz (Antenna A)		

Freq. (MHz)	Ant.Pol. H/V	Reading		Ant./CF CF(dB)	Act.		Limit		Note
		Peak (dBuV)	AV (dBuV)		Peak (dBuV/m)	AV (dBuV/m)	Peak (dBuV/m)	AV (dBuV/m)	
5236.00	V	68.82	65.70	39.33	108.15	105.03			X/F
3493.30	V	51.05	46.90	1.73	52.78	48.63	74.30	60.00	X/H
10480.07	V	42.59	33.40	12.68	55.27	46.08	74.30	60.00	X/H

Remark :

- (1) Spectrum Setting : 30MHz – 1000MHz , RBW= 100KHz, VBW=100KHz, Sweep time = 200 ms. 1GHz- 40GHz, RBW= 1MHz, VBW= 1MHz, Sweep time = Auto
- (2) All readings are Peak unless otherwise stated AV in column of 『Note』 . Peak denotes that the Peak reading compliance with the AV Limits and then AV Mode measurement didn't perform.
- (3) Measuring frequency range from 30MHz to 1000MHz or the 10th harmonic of highest fundamental frequency “F” denotes fundamental frequency; “H” denotes spurious frequency. “E” denotes band edge frequency. (This judgment method includes the Band Edge Requirement.)
- (4) Radiated emissions measured in frequency range above 1000MHz were made with an instrument using Peak detector mode and AV detector mode of the emission ◦
- (5) Data of measurement within this frequency range shown “ * ” in the table above means the reading of emissions are attenuated more than 20dB below the permissible limits or the field strength is too small to be measured.
- (6) A preamp and high pass filter were used for this test in order to provide sufficient measurement sensitivity.
- (7) EUT Orthogonal Axes :
 “X” - denotes Laid on Table ; ”Y” - denotes Vertical Stand ; ”Z” - denotes Side Stand
- (8) During the measurements above 1GHz it is taken care of that the EUT is always within the 3dB cone of radiation BW of the used antenna.
- (9) The limits above 5GHz shall be extrapolated to the specified distance using an extrapolation factor of 20dB/decade form 3m to 1.5m
 Distance extrapolation factor = 20 log (3m/1.5m) dB ;
 Limit line = specific limits (dBuV) + 6 dB



Orthogonal Axis : X
5.2G/CH03(Above 1000 MHz, Vertical)

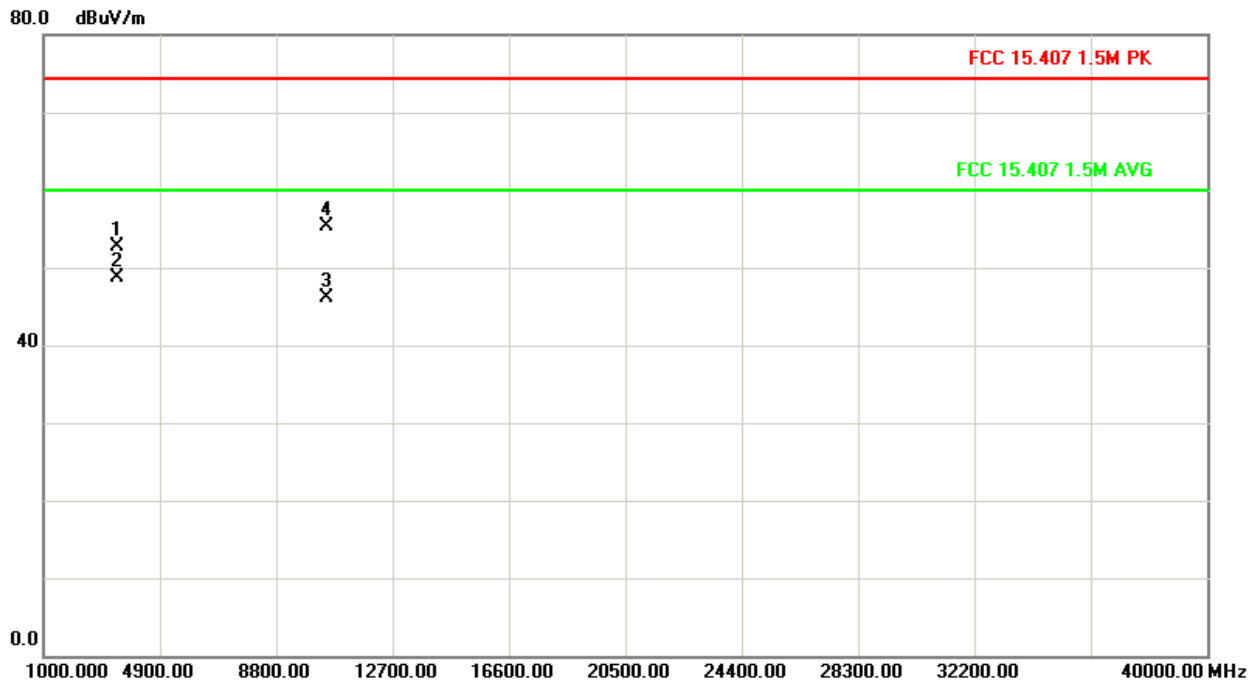
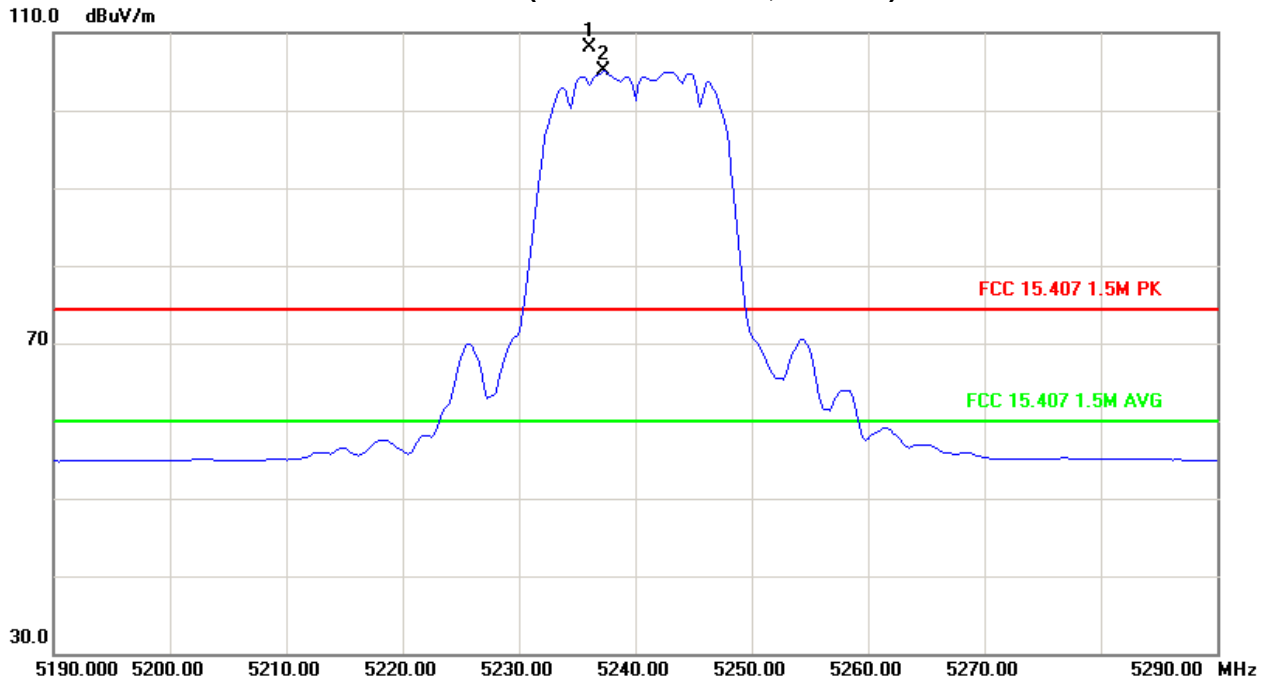



EUT :	Half-size mini-PCIe digital wireless audio module	Model Name :	DWPCIe83
Temperature :	25 °C	Relative Humidity :	52 %
Test Voltage :	DC 3.3V		
Test Mode :	5.2G/ TX Mode 5240MHz (Antenna A)		

Freq. (MHz)	Ant.Pol. H/V	Reading		Ant./CF CF(dB)	Act.		Limit		Note
		Peak (dBuV)	AV (dBuV)		Peak (dBuV/m)	AV (dBuV/m)	Peak (dBuV/m)	AV (dBuV/m)	
5236.00	H	66.06	62.85	39.33	105.39	102.18			X/F
3493.41	H	49.84	46.41	1.73	51.57	48.14	74.30	60.00	X/H
10480.04	H	45.05	32.27	12.68	57.73	44.95	74.30	60.00	X/H

Remark :

- (1) Spectrum Setting : 30MHz – 1000MHz , RBW= 100KHz, VBW=100KHz, Sweep time = 200 ms. 1GHz- 40GHz, RBW= 1MHz, VBW= 1MHz, Sweep time = Auto
- (2) All readings are Peak unless otherwise stated AV in column of 『Note』 . Peak denotes that the Peak reading compliance with the AV Limits and then AV Mode measurement didn't perform.
- (3) Measuring frequency range from 30MHz to 1000MHz or the 10th harmonic of highest fundamental frequency. "F" denotes fundamental frequency; "H" denotes spurious frequency. "E" denotes band edge frequency. (This judgment method includes the Band Edge Requirement.)
- (4) Radiated emissions measured in frequency range above 1000MHz were made with an instrument using Peak detector mode and AV detector mode of the emission .
- (5) Data of measurement within this frequency range shown " * " in the table above means the reading of emissions are attenuated more than 20dB below the permissible limits or the field strength is too small to be measured.
- (6) A preamp and high pass filter were used for this test in order to provide sufficient measurement sensitivity.
- (7) EUT Orthogonal Axes :
 "X" - denotes Laid on Table ; "Y" - denotes Vertical Stand ; "Z" - denotes Side Stand
- (8) During the measurements above 1GHz it is taken care of that the EUT is always within the 3dB cone of radiation BW of the used antenna.
- (9) The limits above 5GHz shall be extrapolated to the specified distance using an extrapolation factor of 20dB/decade form 3m to 1.5m
 Distance extrapolation factor = 20 log (3m/1.5m) dB ;
 Limit line = specific limits (dBuV) + 6 dB



Orthogonal Axis : X
5.2G/CH03(Above 1000 MHz, Horizontal)

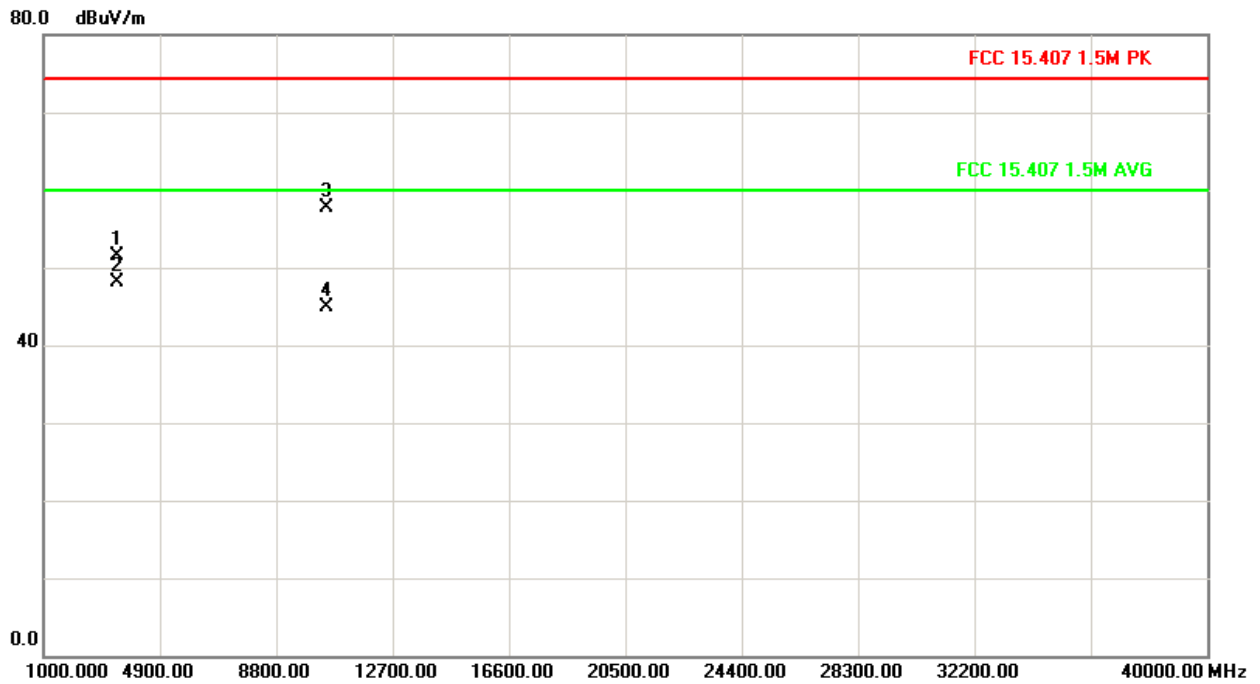
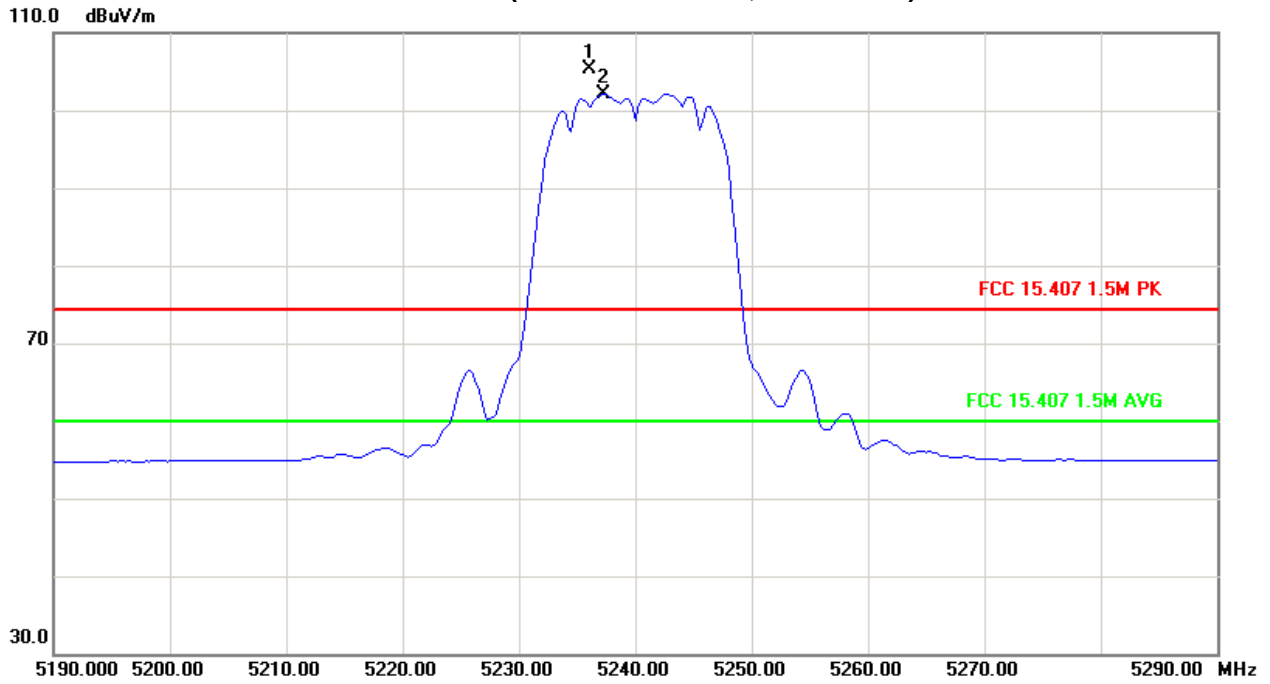



EUT :	Half-size mini-PCIe digital wireless audio module	Model Name :	DWPCIe83
Temperature :	25 °C	Relative Humidity :	58 %
Test Voltage :	DC 3.3V		
Test Mode :	5.2G/ TX Mode 5180MHz (Antenna B)		

Freq. (MHz)	Ant.Pol. H/V	Reading		Ant./CF CF(dB)	Act.		Limit		Note
		Peak (dBuV)	AV (dBuV)		Peak (dBuV/m)	AV (dBuV/m)	Peak (dBuV/m)	AV (dBuV/m)	
5150.00	V	25.16	15.00	39.11	64.27	54.11	74.30	60.00	X/E
5176.96	V	67.25	63.96	39.18	106.43	103.14			X/F
3453.33	V	48.84	44.44	1.67	50.51	46.11	74.30	60.00	X/H
10359.91	V	46.08	33.41	12.63	58.71	46.04	74.30	60.00	X/H

Remark :

- (1) Spectrum Setting : 30MHz – 1000MHz , RBW= 100KHz, VBW=100KHz, Sweep time = 200 ms. 1GHz- 40GHz, RBW= 1MHz, VBW= 1MHz, Sweep time = Auto
- (2) All readings are Peak unless otherwise stated AV in column of 『Note』 . Peak denotes that the Peak reading compliance with the AV Limits and then AV Mode measurement didn't perform.
- (3) Measuring frequency range from 30MHz to 1000MHz or the 10th harmonic of highest fundamental frequency. "F" denotes fundamental frequency; "H" denotes spurious frequency. "E" denotes band edge frequency. (This judgment method includes the Band Edge Requirement.)
- (4) Radiated emissions measured in frequency range above 1000MHz were made with an instrument using Peak detector mode and AV detector mode of the emission .
- (5) Data of measurement within this frequency range shown " * " in the table above means the reading of emissions are attenuated more than 20dB below the permissible limits or the field strength is too small to be measured.
- (6) A preamp and high pass filter were used for this test in order to provide sufficient measurement sensitivity.
- (7) EUT Orthogonal Axes :
 "X" - denotes Laid on Table ; "Y" - denotes Vertical Stand ; "Z" - denotes Side Stand
- (8) During the measurements above 1GHz it is taken care of that the EUT is always within the 3dB cone of radiation BW of the used antenna.
- (9) The limits above 5GHz shall be extrapolated to the specified distance using an extrapolation factor of 20dB/decade form 3m to 1.5m
 Distance extrapolation factor = $20 \log (3m/1.5m)$ dB ;
 Limit line = specific limits (dBuV) + 6 dB



Orthogonal Axis : X
5.2G/CH01(Above 1000 MHz, Vertical)

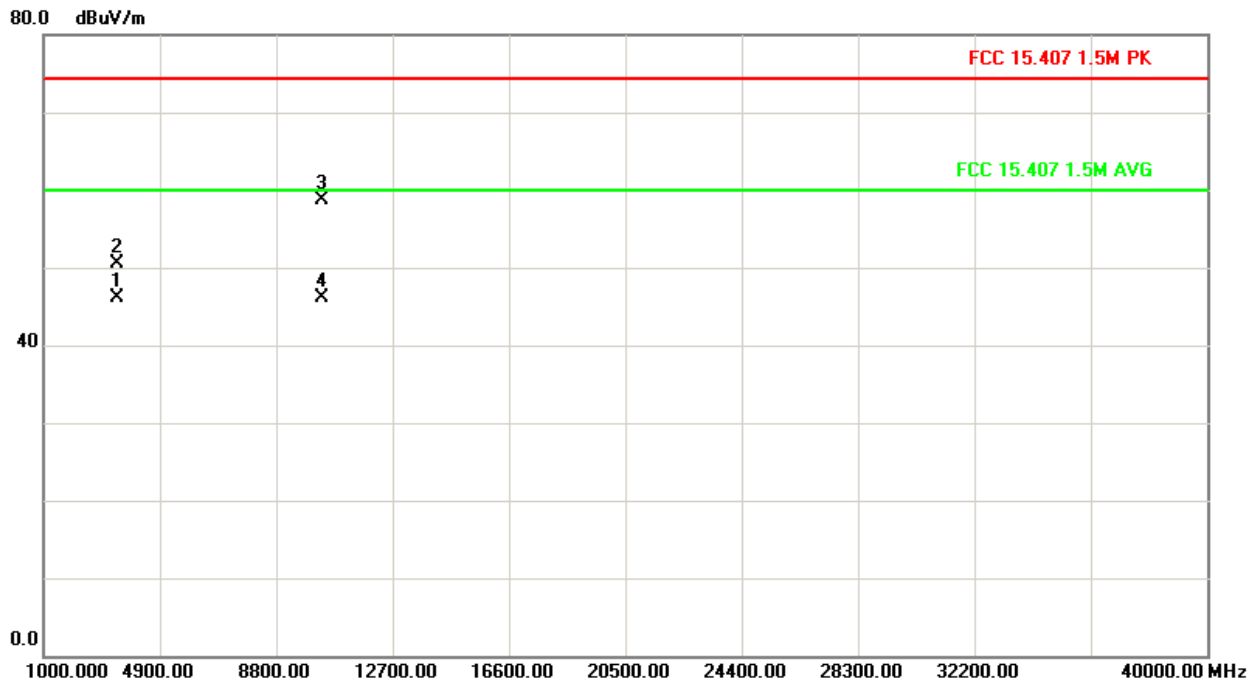
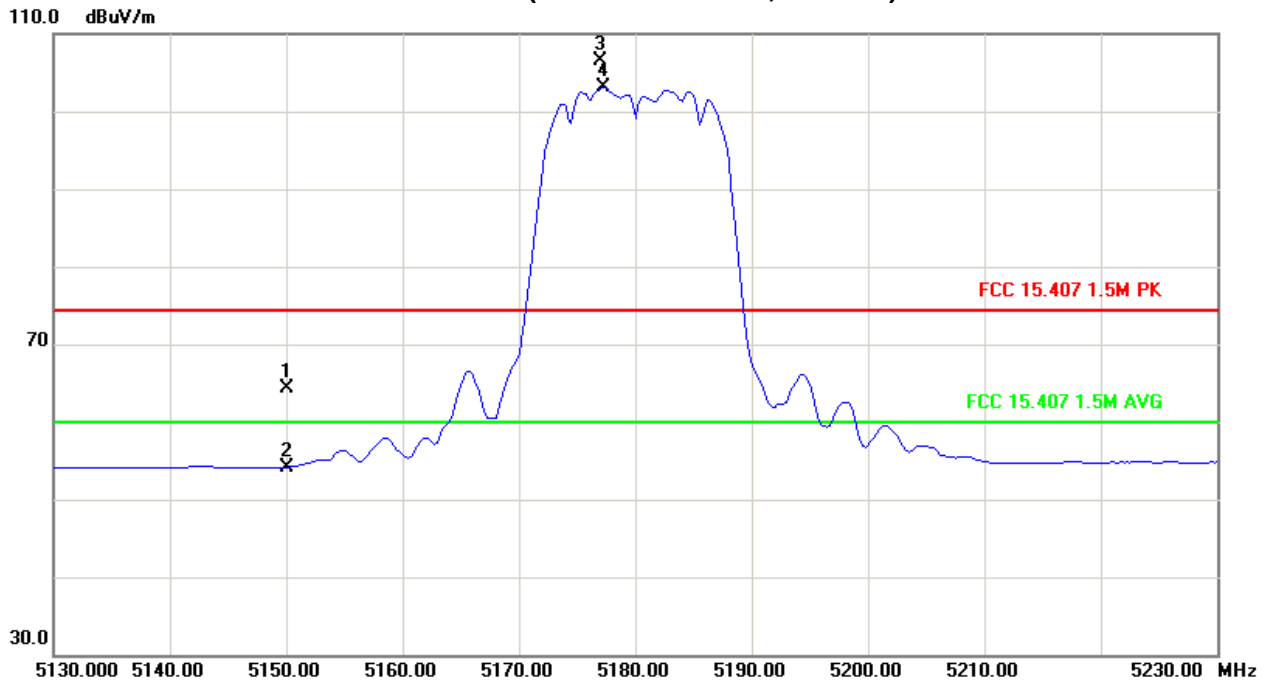



EUT :	Half-size mini-PCle digital wireless audio module	Model Name :	DWPCle83
Temperature :	25 °C	Relative Humidity :	58 %
Test Voltage :	DC 3.3V		
Test Mode :	5.2G/ TX Mode 5180MHz (Antenna B)		

Freq. (MHz)	Ant.Pol. H/V	Reading		Ant./CF CF(dB)	Act.		Limit		Note
		Peak (dBuV)	AV (dBuV)		Peak (dBuV/m)	AV (dBuV/m)	Peak (dBuV/m)	AV (dBuV/m)	
5150.00	H	25.10	14.99	39.11	64.21	54.10	74.30	60.00	X/E
5179.12	H	64.60	61.46	39.18	103.78	100.64			X/F
3453.32	H	48.52	45.31	1.61	50.13	46.92	74.30	60.00	X/H
10359.97	H	44.98	31.88	12.63	57.61	44.51	74.30	60.00	X/H

Remark :

- (1) Spectrum Setting : 30MHz – 1000MHz , RBW= 100KHz, VBW=100KHz, Sweep time = 200 ms. 1GHz- 40GHz, RBW= 1MHz, VBW= 1MHz, Sweep time = Auto
- (2) All readings are Peak unless otherwise stated AV in column of 『Note』 . Peak denotes that the Peak reading compliance with the AV Limits and then AV Mode measurement didn't perform.
- (3) Measuring frequency range from 30MHz to 1000MHz or the 10th harmonic of highest fundamental frequency. "F" denotes fundamental frequency; "H" denotes spurious frequency. "E" denotes band edge frequency. (This judgment method includes the Band Edge Requirement.)
- (4) Radiated emissions measured in frequency range above 1000MHz were made with an instrument using Peak detector mode and AV detector mode of the emission .
- (5) Data of measurement within this frequency range shown " * " in the table above means the reading of emissions are attenuated more than 20dB below the permissible limits or the field strength is too small to be measured.
- (6) A preamp and high pass filter were used for this test in order to provide sufficient measurement sensitivity.
- (7) EUT Orthogonal Axes :
 "X" - denotes Laid on Table ; "Y" - denotes Vertical Stand ; "Z" - denotes Side Stand
- (8) During the measurements above 1GHz it is taken care of that the EUT is always within the 3dB cone of radiation BW of the used antenna.
- (9) The limits above 5GHz shall be extrapolated to the specified distance using an extrapolation factor of 20dB/decade form 3m to 1.5m
 Distance extrapolation factor = 20 log (3m/1.5m) dB ;
 Limit line = specific limits (dBuV) + 6 dB



Orthogonal Axis : X
5.2G/CH01(Above 1000 MHz, Horizontal)

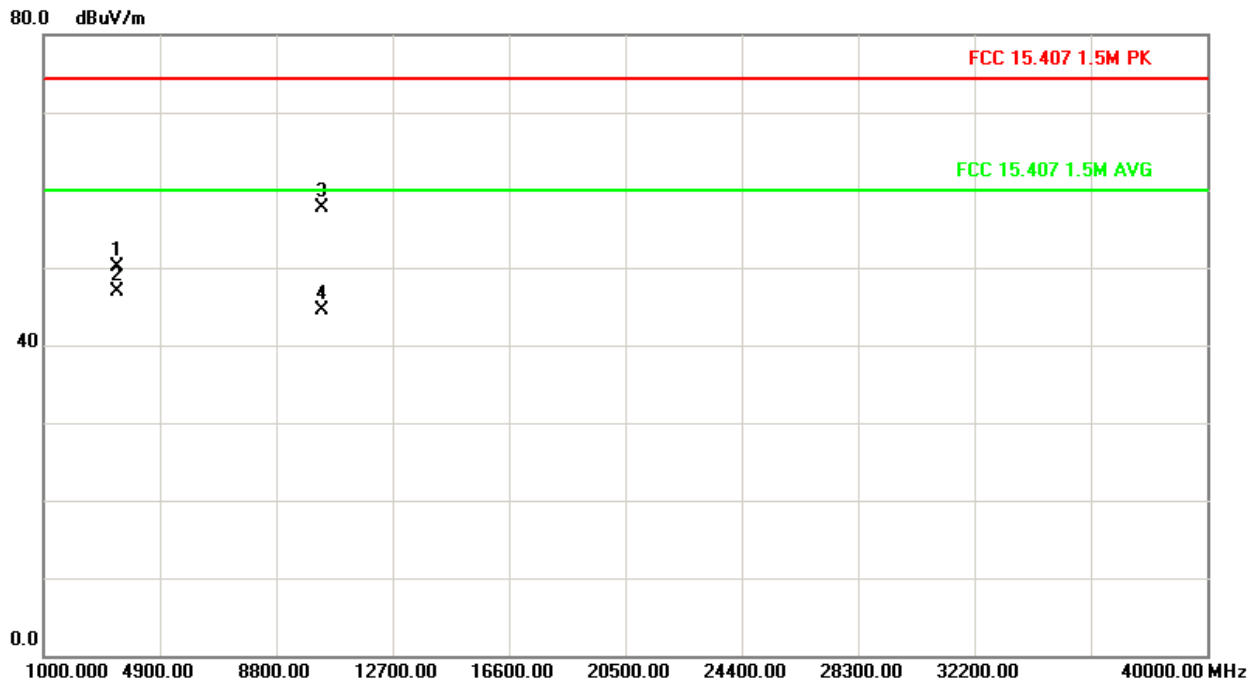
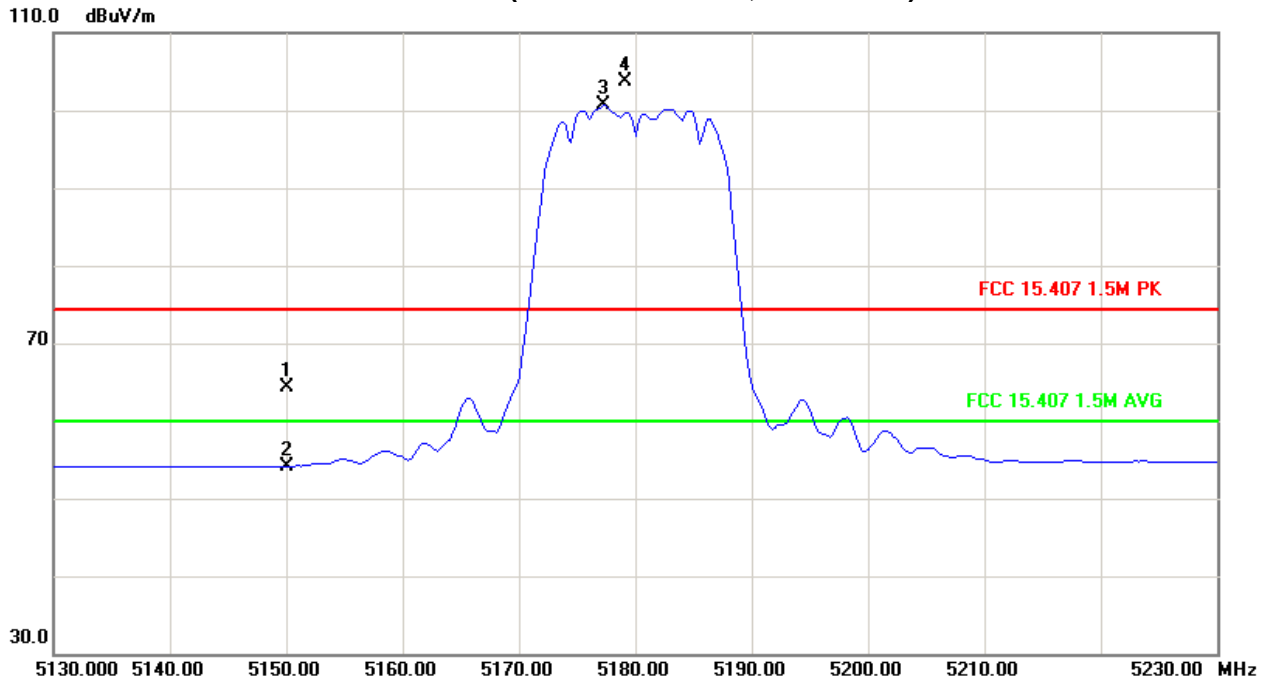



EUT :	Half-size mini-PCIe digital wireless audio module	Model Name :	DWPCIe83
Temperature :	25 °C	Relative Humidity :	58 %
Test Voltage :	DC 3.3V		
Test Mode :	5.2G/ TX Mode 5210MHz (Antenna B)		

Freq. (MHz)	Ant.Pol. H/V	Reading		Ant./CF CF(dB)	Act.		Limit		Note
		Peak (dBuV)	AV (dBuV)		Peak (dBuV/m)	AV (dBuV/m)	Peak (dBuV/m)	AV (dBuV/m)	
5211.12	V	67.09	64.88	39.27	106.36	104.15			X/F
3473.32	V	49.75	45.48	1.67	51.42	47.15	74.30	60.00	X/H
10420.01	V	44.73	33.11	12.65	57.38	45.76	74.30	60.00	X/H

Remark :

- (1) Spectrum Setting : 30MHz – 1000MHz , RBW= 100KHz, VBW=100KHz, Sweep time = 200 ms. 1GHz- 40GHz, RBW= 1MHz, VBW= 1MHz, Sweep time = Auto
- (2) All readings are Peak unless otherwise stated AV in column of 『Note』 . Peak denotes that the Peak reading compliance with the AV Limits and then AV Mode measurement didn't perform.
- (3) Measuring frequency range from 30MHz to 1000MHz or the 10th harmonic of highest fundamental frequency “F” denotes fundamental frequency; “H” denotes spurious frequency. “E” denotes band edge frequency. (This judgment method includes the Band Edge Requirement.)
- (4) Radiated emissions measured in frequency range above 1000MHz were made with an instrument using Peak detector mode and AV detector mode of the emission ◦
- (5) Data of measurement within this frequency range shown “ * ” in the table above means the reading of emissions are attenuated more than 20dB below the permissible limits or the field strength is too small to be measured.
- (6) A preamp and high pass filter were used for this test in order to provide sufficient measurement sensitivity.
- (7) EUT Orthogonal Axes :
 “X” - denotes Laid on Table ; ”Y” - denotes Vertical Stand ; ”Z” - denotes Side Stand
- (8) During the measurements above 1GHz it is taken care of that the EUT is always within the 3dB cone of radiation BW of the used antenna.
- (9) The limits above 5GHz shall be extrapolated to the specified distance using an extrapolation factor of 20dB/decade form 3m to 1.5m
 Distance extrapolation factor = 20 log (3m/1.5m) dB ;
 Limit line = specific limits (dBuV) + 6 dB



Orthogonal Axis : X
5.2G/CH02(Above 1000 MHz, Vertical)

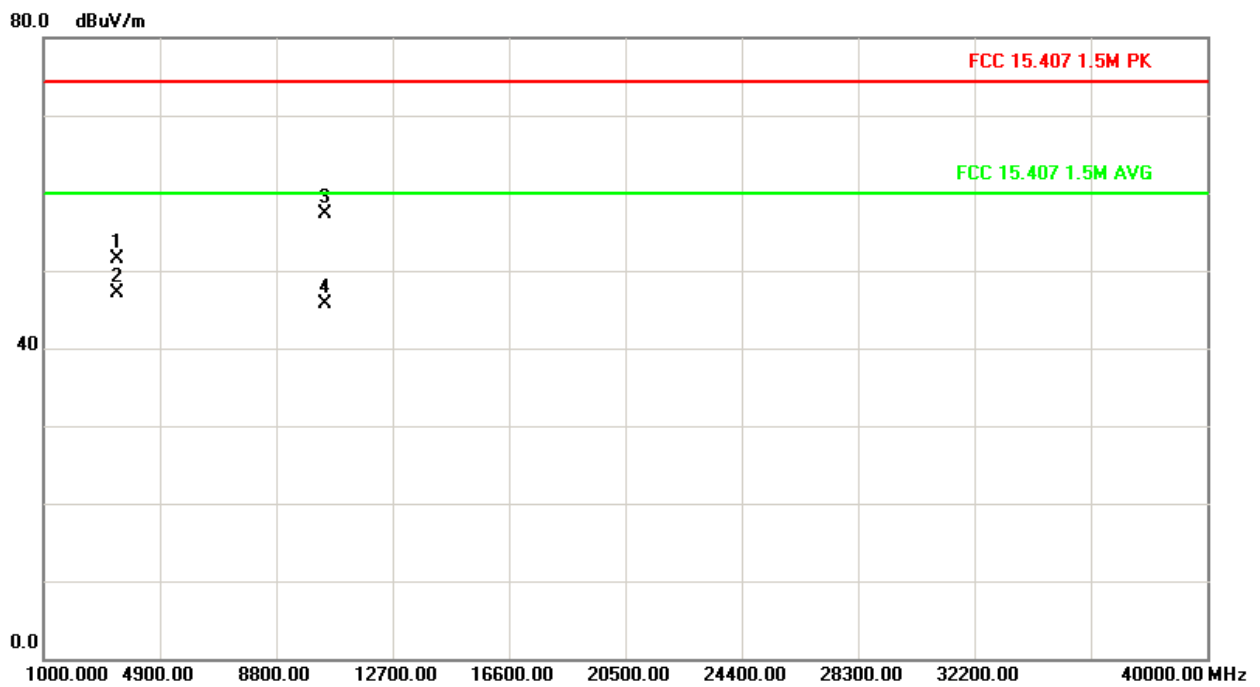
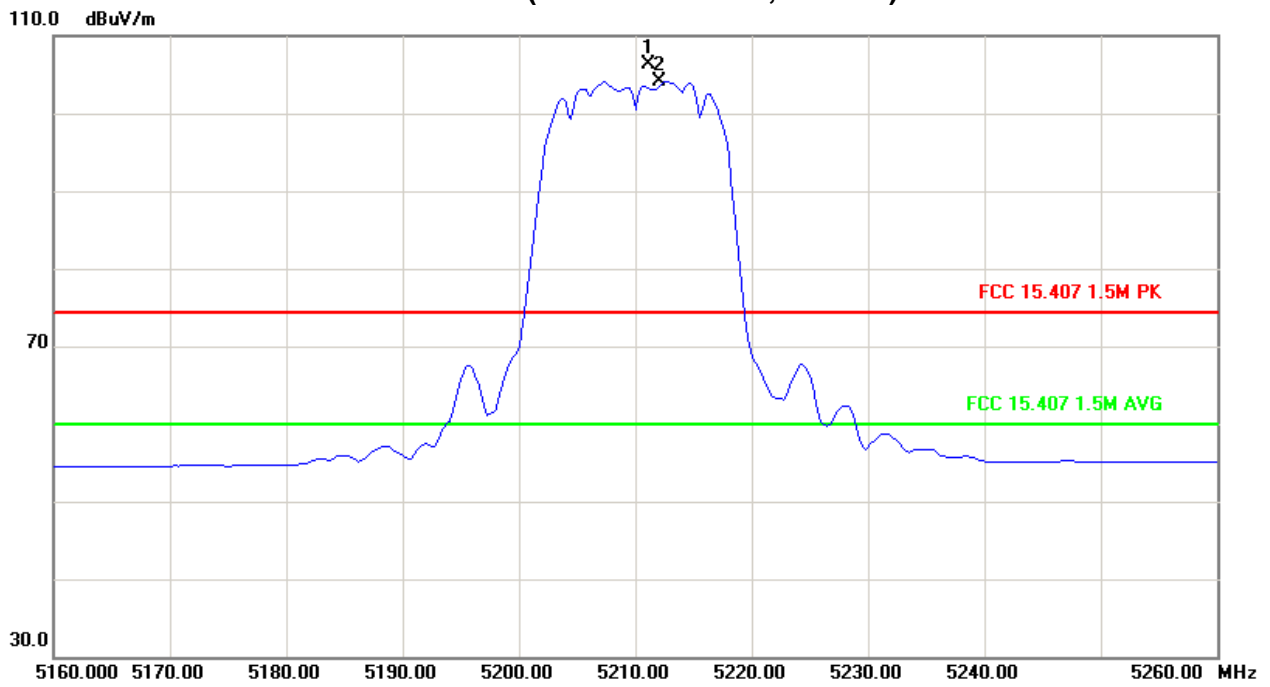



EUT :	Half-size mini-PCIe digital wireless audio module	Model Name :	DWPCIe83
Temperature :	25 °C	Relative Humidity :	58 %
Test Voltage :	DC 3.3V		
Test Mode :	5.2G/ TX Mode 5210MHz (Antenna B)		

Freq. (MHz)	Ant.Pol. H/V	Reading		Ant./CF CF(dB)	Act.		Limit		Note
		Peak (dBuV)	AV (dBuV)		Peak (dBuV/m)	AV (dBuV/m)	Peak (dBuV/m)	AV (dBuV/m)	
5211.00	H	66.06	61.83	39.27	105.33	101.10			X/F
3473.32	H	48.54	46.00	1.67	50.21	47.67	74.30	60.00	X/H
10420.01	H	43.88	31.55	12.65	56.53	44.20	74.30	60.00	X/H

Remark :

- (1) Spectrum Setting : 30MHz – 1000MHz , RBW= 100KHz, VBW=100KHz, Sweep time = 200 ms. 1GHz- 40GHz, RBW= 1MHz, VBW= 1MHz, Sweep time = Auto
- (2) All readings are Peak unless otherwise stated AV in column of 『Note』 . Peak denotes that the Peak reading compliance with the AV Limits and then AV Mode measurement didn't perform.
- (3) Measuring frequency range from 30MHz to 1000MHz or the 10th harmonic of highest fundamental frequency. "F" denotes fundamental frequency; "H" denotes spurious frequency. "E" denotes band edge frequency. (This judgment method includes the Band Edge Requirement.)
- (4) Radiated emissions measured in frequency range above 1000MHz were made with an instrument using Peak detector mode and AV detector mode of the emission .
- (5) Data of measurement within this frequency range shown " * " in the table above means the reading of emissions are attenuated more than 20dB below the permissible limits or the field strength is too small to be measured.
- (6) A preamp and high pass filter were used for this test in order to provide sufficient measurement sensitivity.
- (7) EUT Orthogonal Axes :
 "X" - denotes Laid on Table ; "Y" - denotes Vertical Stand ; "Z" - denotes Side Stand
- (8) During the measurements above 1GHz it is taken care of that the EUT is always within the 3dB cone of radiation BW of the used antenna.
- (9) The limits above 5GHz shall be extrapolated to the specified distance using an extrapolation factor of 20dB/decade form 3m to 1.5m
 Distance extrapolation factor = 20 log (3m/1.5m) dB ;
 Limit line = specific limits (dBuV) + 6 dB



Orthogonal Axis : X
5.2G/CH02(Above 1000 MHz, Horizontal)

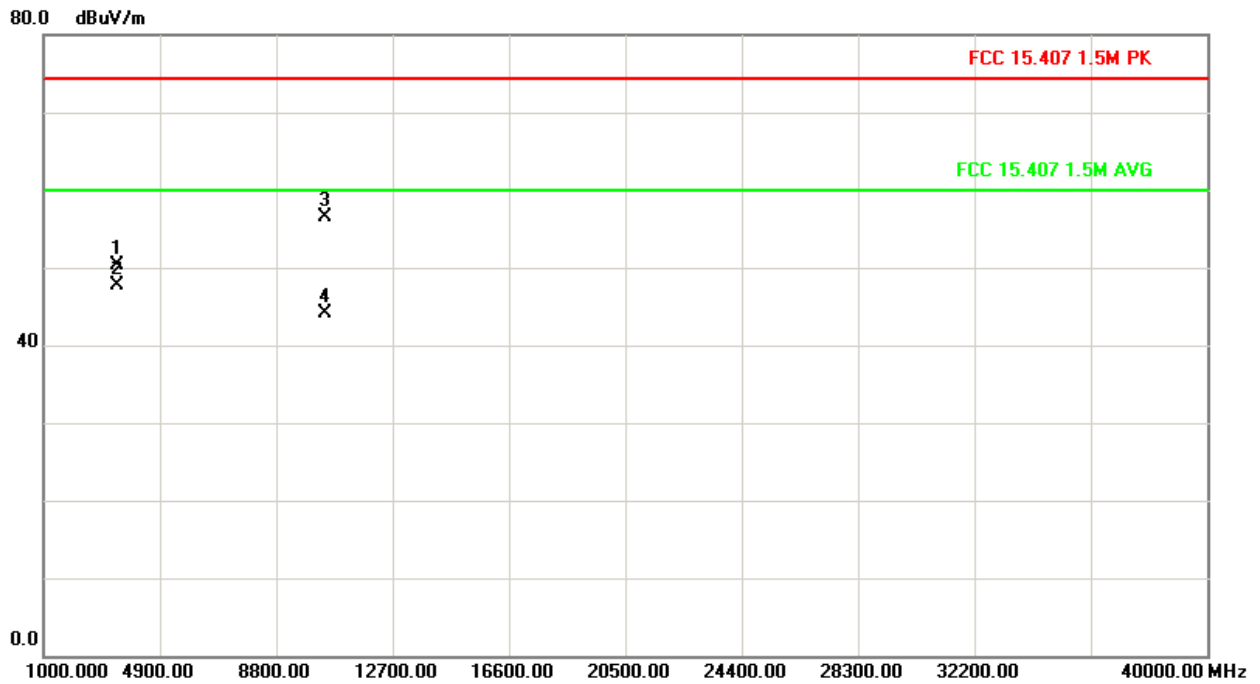
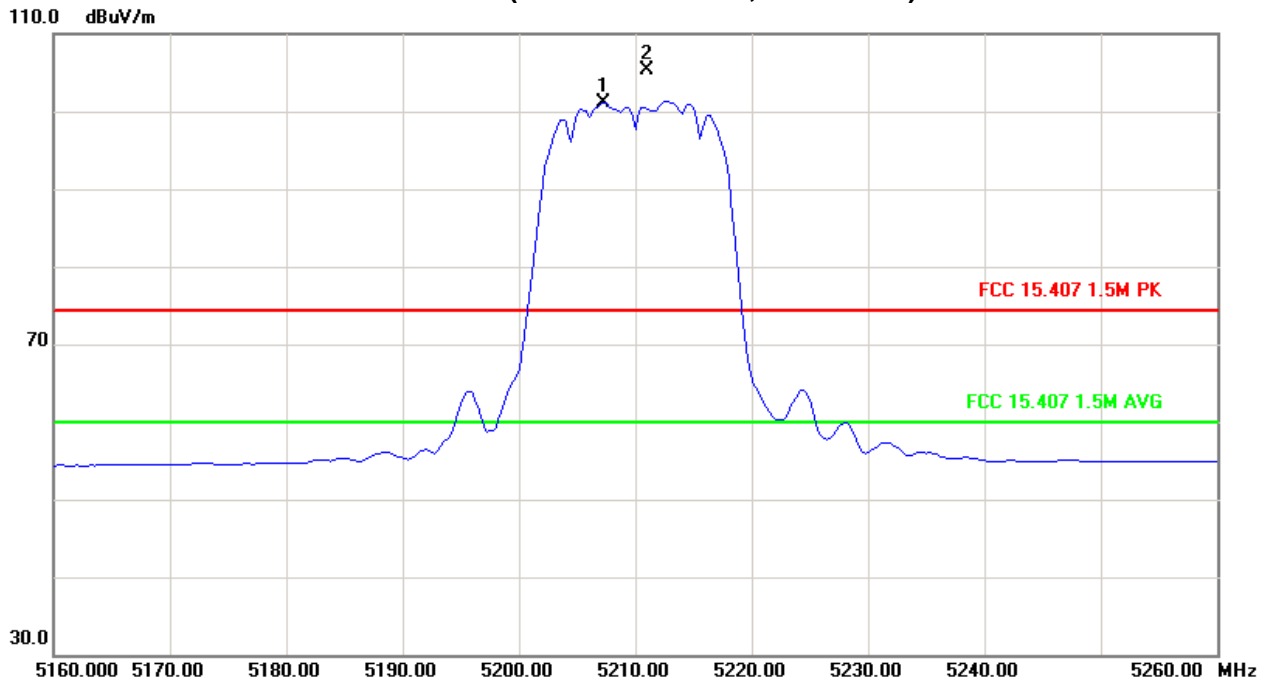



EUT :	Half-size mini-PCIe digital wireless audio module	Model Name :	DWPCIe83
Temperature :	25 °C	Relative Humidity :	52 %
Test Voltage :	DC 3.3V		
Test Mode :	5.2G/ TX Mode 5240MHz (Antenna B)		

Freq. (MHz)	Ant.Pol. H/V	Reading		Ant./CF CF(dB)	Act.		Limit		Note
		Peak (dBuV)	AV (dBuV)		Peak (dBuV/m)	AV (dBuV/m)	Peak (dBuV/m)	AV (dBuV/m)	
5236.46	V	68.57	65.70	39.34	107.91	105.04			X/F
3493.25	V	51.03	46.88	1.73	52.76	48.61	74.30	60.00	X/H
10480.07	V	43.89	32.70	12.68	56.57	45.38	74.30	60.00	X/H

Remark :

- (1) Spectrum Setting : 30MHz – 1000MHz , RBW= 100KHz, VBW=100KHz, Sweep time = 200 ms. 1GHz- 40GHz, RBW= 1MHz, VBW= 1MHz, Sweep time = Auto
- (2) All readings are Peak unless otherwise stated AV in column of 『Note』 . Peak denotes that the Peak reading compliance with the AV Limits and then AV Mode measurement didn't perform.
- (3) Measuring frequency range from 30MHz to 1000MHz or the 10th harmonic of highest fundamental frequency “F” denotes fundamental frequency; “H” denotes spurious frequency. “E” denotes band edge frequency. (This judgment method includes the Band Edge Requirement.)
- (4) Radiated emissions measured in frequency range above 1000MHz were made with an instrument using Peak detector mode and AV detector mode of the emission ◦
- (5) Data of measurement within this frequency range shown “ * ” in the table above means the reading of emissions are attenuated more than 20dB below the permissible limits or the field strength is too small to be measured.
- (6) A preamp and high pass filter were used for this test in order to provide sufficient measurement sensitivity.
- (7) EUT Orthogonal Axes :
“X” - denotes Laid on Table ; ”Y” - denotes Vertical Stand ; ”Z” - denotes Side Stand
- (8) During the measurements above 1GHz it is taken care of that the EUT is always within the 3dB cone of radiation BW of the used antenna.
- (9) The limits above 5GHz shall be extrapolated to the specified distance using an extrapolation factor of 20dB/decade form 3m to 1.5m
Distance extrapolation factor = 20 log (3m/1.5m) dB ;
Limit line = specific limits (dBuV) + 6 dB



Orthogonal Axis : X
5.2G/CH03(Above 1000 MHz, Vertical)

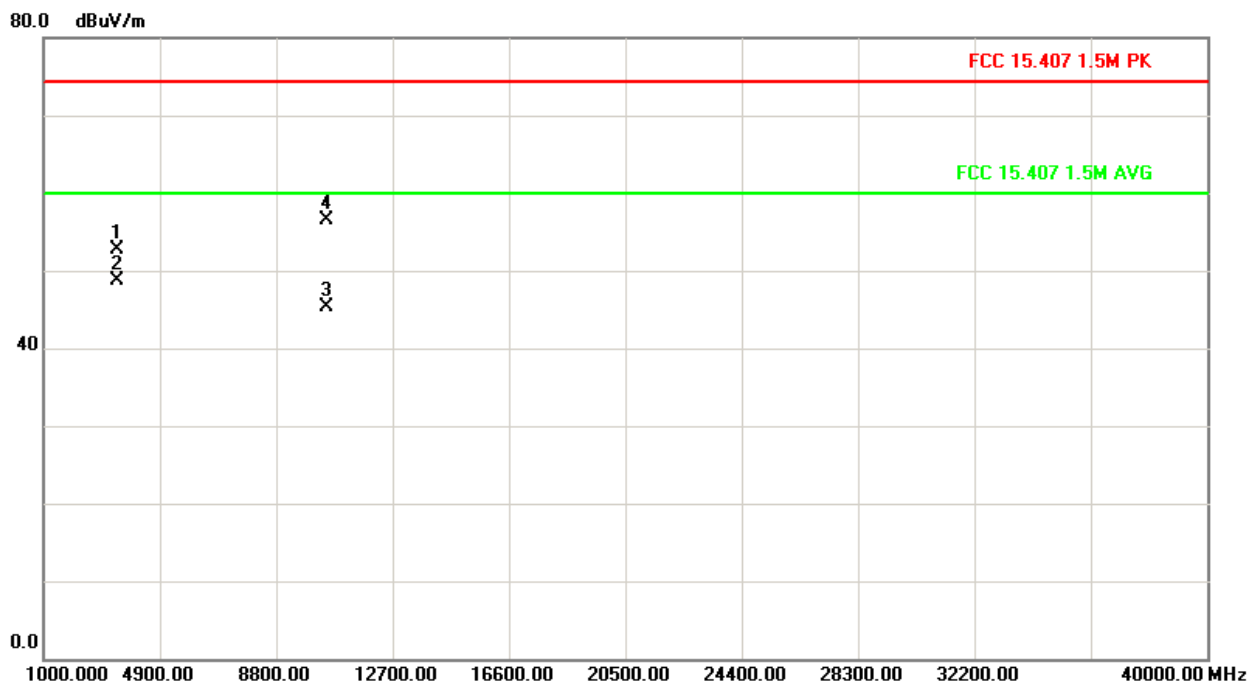
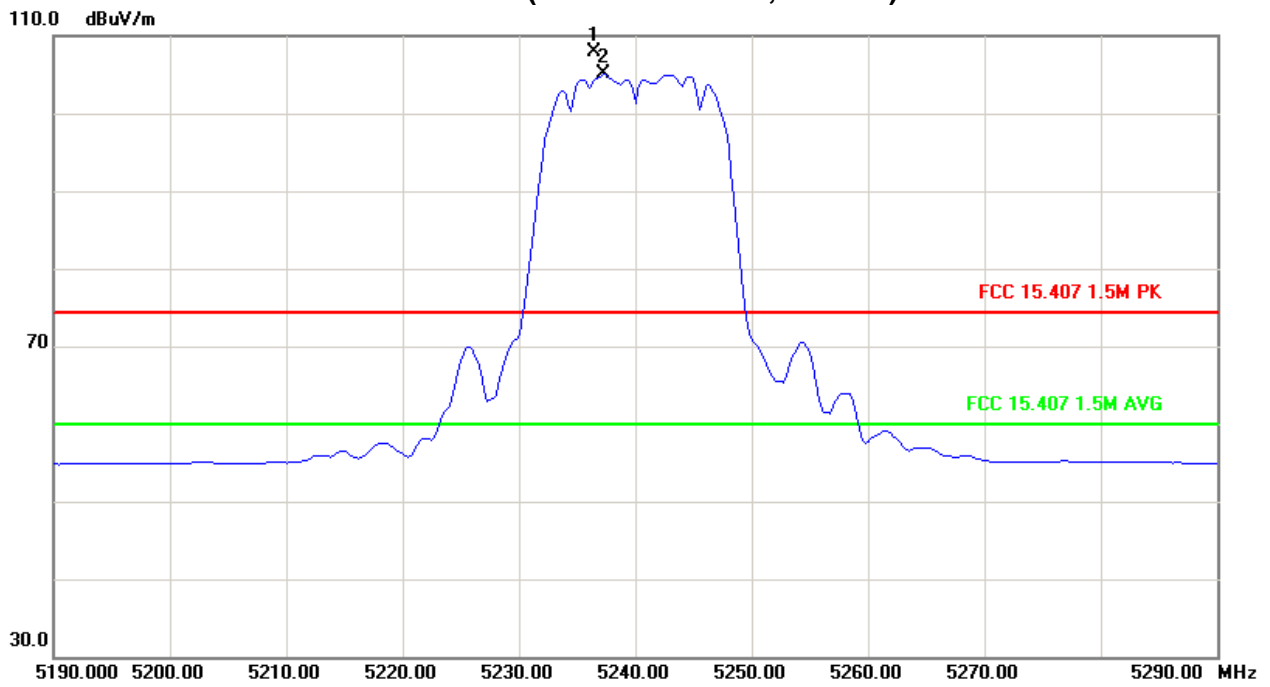



EUT :	Half-size mini-PCIe digital wireless audio module	Model Name :	DWPCIe83
Temperature :	25 °C	Relative Humidity :	52 %
Test Voltage :	DC 3.3V		
Test Mode :	5.2G/ TX Mode 5240MHz (Antenna B)		

Freq. (MHz)	Ant.Pol. H/V	Reading		Ant./CF CF(dB)	Act.		Limit		Note
		Peak (dBuV)	AV (dBuV)		Peak (dBuV/m)	AV (dBuV/m)	Peak (dBuV/m)	AV (dBuV/m)	
5236.51	H	66.05	62.92	39.34	105.39	102.26			X/F
3493.40	H	50.68	47.49	1.73	52.41	49.22	74.30	60.00	X/H
10480.12	H	44.55	31.76	12.68	57.23	44.44	74.30	60.00	X/H

Remark :

- (1) Spectrum Setting : 30MHz – 1000MHz , RBW= 100KHz, VBW=100KHz, Sweep time = 200 ms. 1GHz- 40GHz, RBW= 1MHz, VBW= 1MHz, Sweep time = Auto
- (2) All readings are Peak unless otherwise stated AV in column of 『Note』 . Peak denotes that the Peak reading compliance with the AV Limits and then AV Mode measurement didn't perform.
- (3) Measuring frequency range from 30MHz to 1000MHz or the 10th harmonic of highest fundamental frequency. "F" denotes fundamental frequency; "H" denotes spurious frequency. "E" denotes band edge frequency. (This judgment method includes the Band Edge Requirement.)
- (4) Radiated emissions measured in frequency range above 1000MHz were made with an instrument using Peak detector mode and AV detector mode of the emission .
- (5) Data of measurement within this frequency range shown " * " in the table above means the reading of emissions are attenuated more than 20dB below the permissible limits or the field strength is too small to be measured.
- (6) A preamp and high pass filter were used for this test in order to provide sufficient measurement sensitivity.
- (7) EUT Orthogonal Axes :
 "X" - denotes Laid on Table ; "Y" - denotes Vertical Stand ; "Z" - denotes Side Stand
- (8) During the measurements above 1GHz it is taken care of that the EUT is always within the 3dB cone of radiation BW of the used antenna.
- (9) The limits above 5GHz shall be extrapolated to the specified distance using an extrapolation factor of 20dB/decade form 3m to 1.5m
 Distance extrapolation factor = 20 log (3m/1.5m) dB ;
 Limit line = specific limits (dBuV) + 6 dB



Orthogonal Axis : X
5.2G/CH03(Above 1000 MHz, Horizontal)

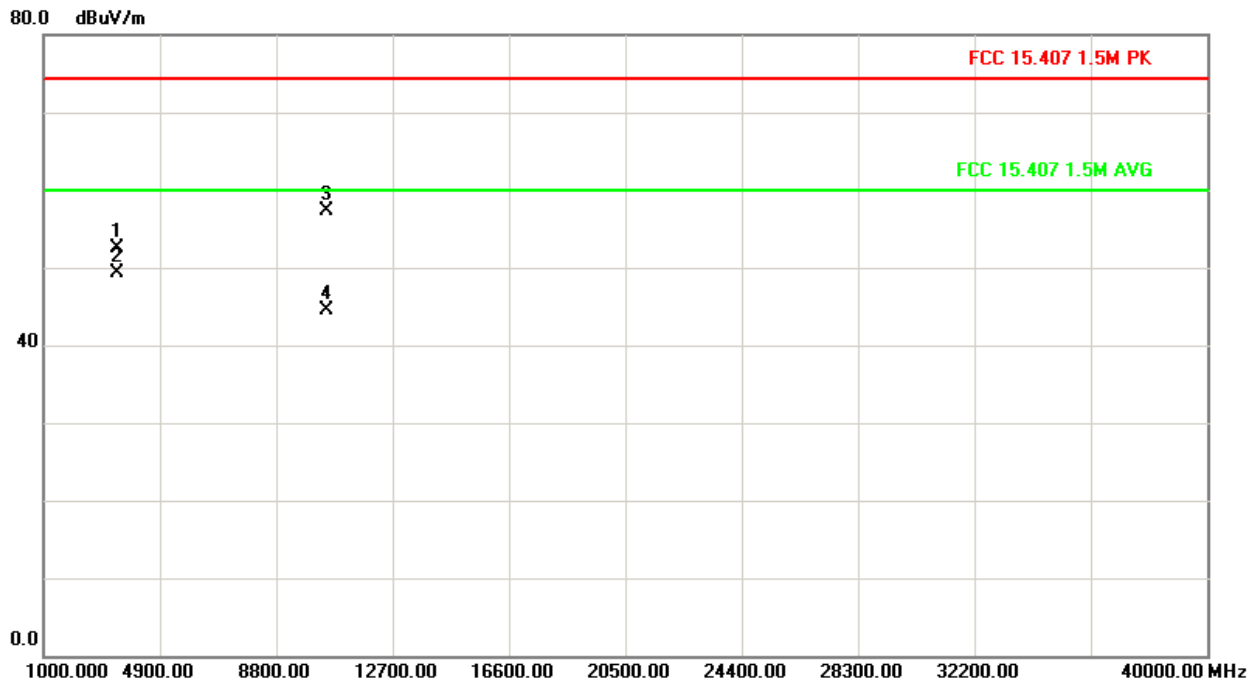
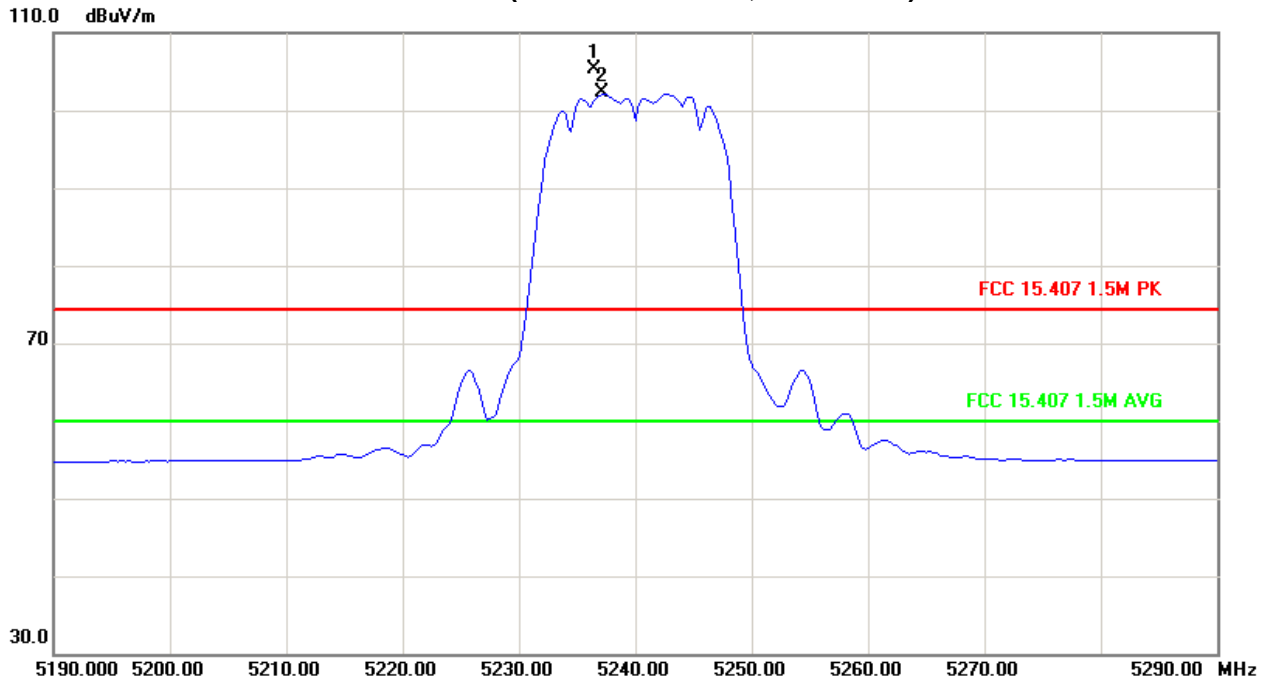



EUT :	Half-size mini-PCle digital wireless audio module	Model Name :	DWPCle83
Temperature :	25 °C	Relative Humidity :	58 %
Pressure :	1006hPa	Test Voltage :	DC 3.3V
Test Mode :	RX Mode 5180MHz (Antenna A)		

Freq. (MHz)	Ant.Pol. H/V	Reading		Ant./CF CF(dB)	Act.		Limit		Note
		Peak (dBuV)	AV (dBuV)		Peak (dBuV/m)	AV (dBuV/m)	Peak (dBuV/m)	AV (dBuV/m)	
3453.36	V	44.96	37.71	1.61	46.57	39.32	80.00	60.00	X/H

Remark :

- (1) All readings are Peak unless otherwise stated QP in column of 『Note』 . Peak denotes that the Peak reading compliance with the QP Limits and then QP Mode measurement didn't perform ◦
- (2) Measuring frequency range from 1000MHz to 6000MHz or the 10th harmonic of highest fundamental frequency ◦“F” denotes fundamental frequency; “H” denotes spurious frequency. “E” denotes band edge frequency. (This judgment method includes the Band Edge Requirement.)
- (3) Radiated emissions measured in frequency range above 1000MHz were made with an instrument using Peak detector mode and AV detector mode of the emission ◦
- (4) Data of measurement within this frequency range shown “ * ” in the table above means the reading of emissions are attenuated more than 20dB below the permissible limits or the field strength is too small to be measured.
- (5) A preamp and high pass filter were used for this test in order to provide sufficient measurement sensitivity.
- (6) EUT Orthogonal Axis :
 “X” - denotes Laid on Table ; “Y” - denotes Vertical Stand ; “Z” - denotes Side Stand

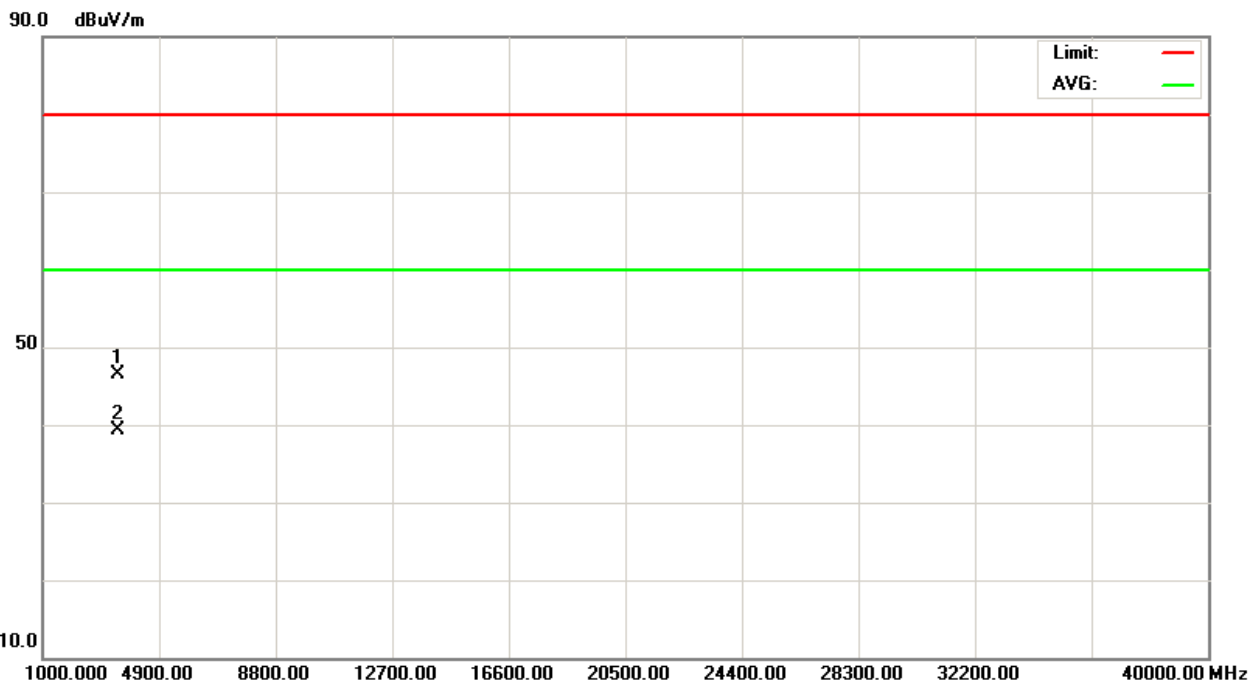



EUT :	Half-size mini-PCle digital wireless audio module	Model Name :	DWPCle83
Temperature :	25 °C	Relative Humidity :	58 %
Pressure :	1006hPa	Test Voltage :	DC 3.3V
Test Mode :	RX Mode 5180MHz (Antenna A)		

Freq. (MHz)	Ant.Pol. H/V	Reading		Ant./CF CF(dB)	Act.		Limit		Note
		Peak (dBuV)	AV (dBuV)		Peak (dBuV/m)	AV (dBuV/m)	Peak (dBuV/m)	AV (dBuV/m)	
3453.36	H	45.20	38.14	1.61	46.81	39.75	80.00	60.00	X/H

Remark :

- (1) All readings are Peak unless otherwise stated QP in column of 『Note』 . Peak denotes that the Peak reading compliance with the QP Limits and then QP Mode measurement didn't perform ◦
- (2) Measuring frequency range from 1000MHz to 6000MHz or the 10th harmonic of highest fundamental frequency ◦ "F" denotes fundamental frequency; "H" denotes spurious frequency. "E" denotes band edge frequency. (This judgment method includes the Band Edge Requirement.)
- (3) Radiated emissions measured in frequency range above 1000MHz were made with an instrument using Peak detector mode and AV detector mode of the emission ◦
- (4) Data of measurement within this frequency range shown " * " in the table above means the reading of emissions are attenuated more than 20dB below the permissible limits or the field strength is too small to be measured.
- (5) A preamp and high pass filter were used for this test in order to provide sufficient measurement sensitivity.
- (6) EUT Orthogonal Axis :
 "X" - denotes Laid on Table ; "Y" - denotes Vertical Stand ; "Z" - denotes Side Stand

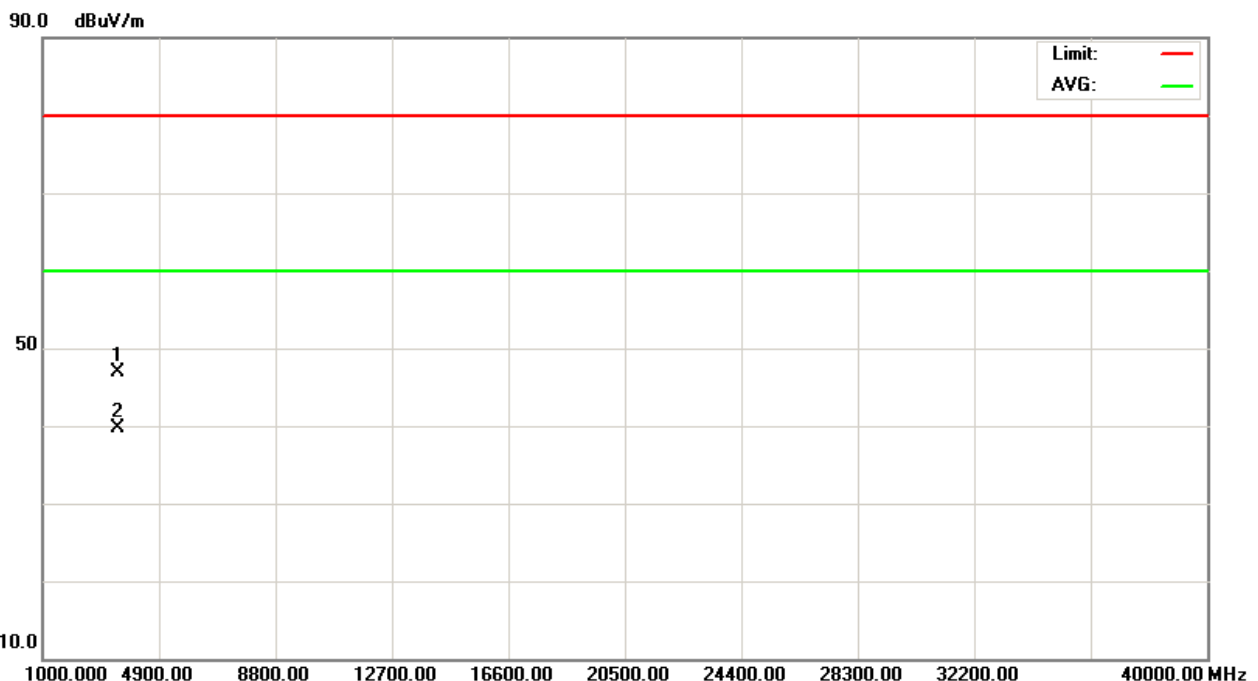



EUT :	Half-size mini-PCle digital wireless audio module	Model Name :	DWPCle83
Temperature :	25 °C	Relative Humidity :	58 %
Pressure :	1006hPa	Test Voltage :	DC 3.3V
Test Mode :	RX Mode 5210MHz (Antenna A)		

Freq. (MHz)	Ant.Pol. H/V	Reading		Ant./CF CF(dB)	Act.		Limit		Note
		Peak (dBuV)	AV (dBuV)		Peak (dBuV/m)	AV (dBuV/m)	Peak (dBuV/m)	AV (dBuV/m)	
3473.32	V	45.16	38.02	1.67	46.83	39.69	80.00	60.00	X/H

Remark :

- (1) All readings are Peak unless otherwise stated QP in column of 『Note』 . Peak denotes that the Peak reading compliance with the QP Limits and then QP Mode measurement didn't perform ◦
- (2) Measuring frequency range from 1000MHz to 6000MHz or the 10th harmonic of highest fundamental frequency ◦“F” denotes fundamental frequency; “H” denotes spurious frequency. “E” denotes band edge frequency. (This judgment method includes the Band Edge Requirement.)
- (3) Radiated emissions measured in frequency range above 1000MHz were made with an instrument using Peak detector mode and AV detector mode of the emission ◦
- (4) Data of measurement within this frequency range shown “ * ” in the table above means the reading of emissions are attenuated more than 20dB below the permissible limits or the field strength is too small to be measured.
- (5) A preamp and high pass filter were used for this test in order to provide sufficient measurement sensitivity.
- (6) EUT Orthogonal Axis :
 “X” - denotes Laid on Table ; “Y” - denotes Vertical Stand ; “Z” - denotes Side Stand

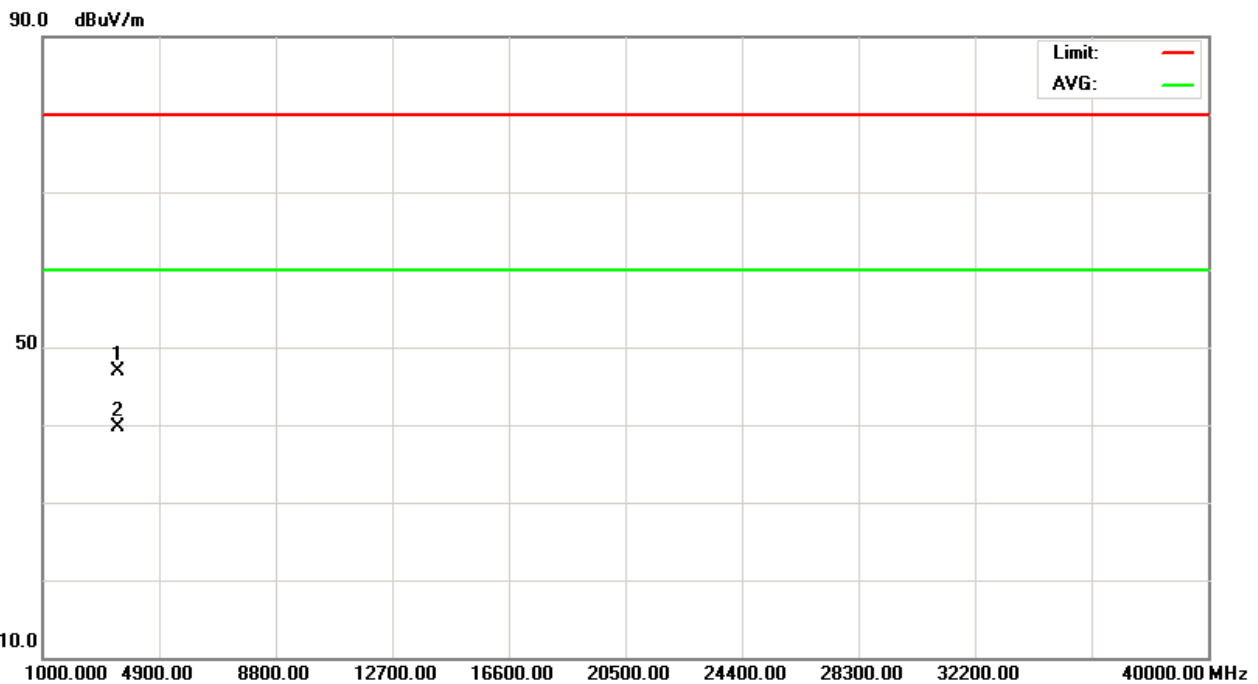



EUT :	Half-size mini-PCle digital wireless audio module	Model Name :	DWPCle83
Temperature :	25 °C	Relative Humidity :	58 %
Pressure :	1006hPa	Test Voltage :	DC 3.3V
Test Mode :	RX Mode 5210MHz (Antenna A)		

Freq. (MHz)	Ant.Pol. H/V	Reading		Ant./CF CF(dB)	Act.		Limit		Note
		Peak (dBuV)	AV (dBuV)		Peak (dBuV/m)	AV (dBuV/m)	Peak (dBuV/m)	AV (dBuV/m)	
3473.32	H	45.30	38.73	1.67	46.97	40.40	80.00	60.00	X/H

Remark :

- (1) All readings are Peak unless otherwise stated QP in column of 『Note』 . Peak denotes that the Peak reading compliance with the QP Limits and then QP Mode measurement didn't perform ◦
- (2) Measuring frequency range from 1000MHz to 6000MHz or the 10th harmonic of highest fundamental frequency ◦ "F" denotes fundamental frequency; "H" denotes spurious frequency. "E" denotes band edge frequency. (This judgment method includes the Band Edge Requirement.)
- (3) Radiated emissions measured in frequency range above 1000MHz were made with an instrument using Peak detector mode and AV detector mode of the emission ◦
- (4) Data of measurement within this frequency range shown " * " in the table above means the reading of emissions are attenuated more than 20dB below the permissible limits or the field strength is too small to be measured.
- (5) A preamp and high pass filter were used for this test in order to provide sufficient measurement sensitivity.
- (6) EUT Orthogonal Axis :
 "X" - denotes Laid on Table ; "Y" - denotes Vertical Stand ; "Z" - denotes Side Stand

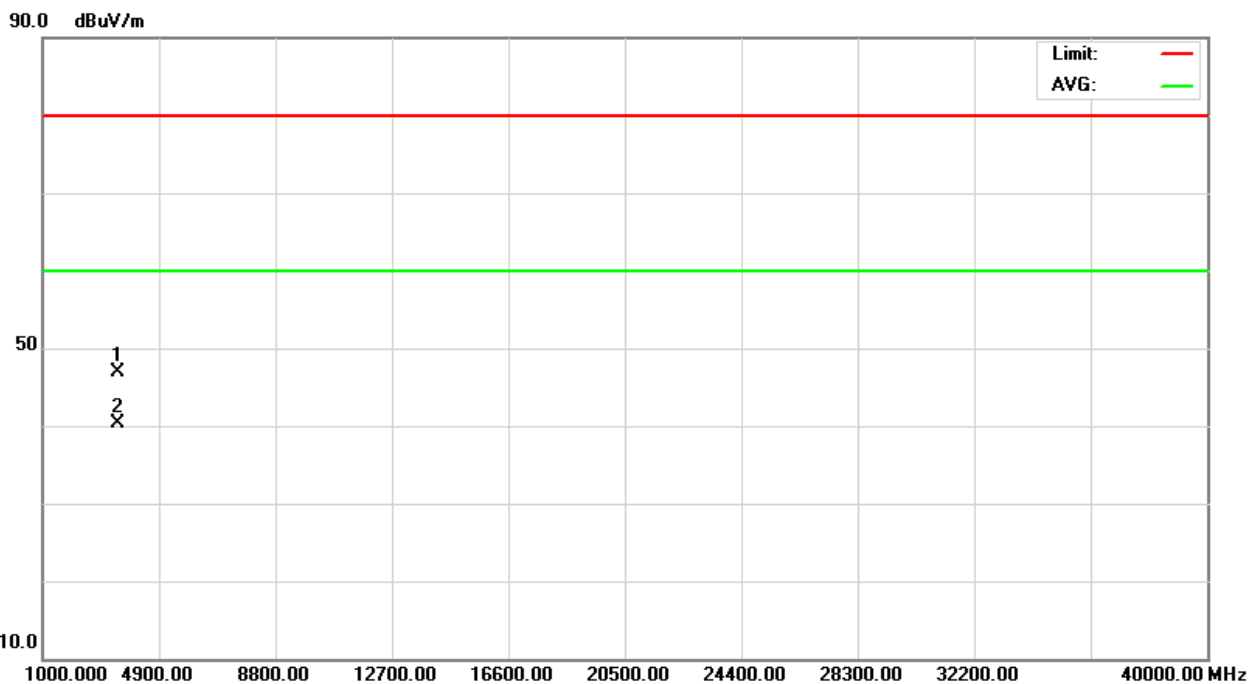



EUT :	Half-size mini-PCIe digital wireless audio module	Model Name :	DWPCIe83
Temperature :	25 °C	Relative Humidity :	58 %
Pressure :	1006hPa	Test Voltage :	DC 3.3V
Test Mode :	RX Mode 5240MHz (Antenna A)		

Freq. (MHz)	Ant.Pol. H/V	Reading		Ant./CF CF(dB)	Act.		Limit		Note
		Peak (dBuV)	AV (dBuV)		Peak (dBuV/m)	AV (dBuV/m)	Peak (dBuV/m)	AV (dBuV/m)	
3493.45	V	46.18	38.76	1.73	47.91	40.49	80.00	60.00	X/H

Remark :

- (1) All readings are Peak unless otherwise stated QP in column of 『Note』 . Peak denotes that the Peak reading compliance with the QP Limits and then QP Mode measurement didn't perform ◦
- (2) Measuring frequency range from 1000MHz to 6000MHz or the 10th harmonic of highest fundamental frequency ◦“F” denotes fundamental frequency; “H” denotes spurious frequency. “E” denotes band edge frequency. (This judgment method includes the Band Edge Requirement.)
- (3) Radiated emissions measured in frequency range above 1000MHz were made with an instrument using Peak detector mode and AV detector mode of the emission ◦
- (4) Data of measurement within this frequency range shown “ * ” in the table above means the reading of emissions are attenuated more than 20dB below the permissible limits or the field strength is too small to be measured.
- (5) A preamp and high pass filter were used for this test in order to provide sufficient measurement sensitivity.
- (6) EUT Orthogonal Axis :
 “X” - denotes Laid on Table ; “Y” - denotes Vertical Stand ; “Z” - denotes Side Stand

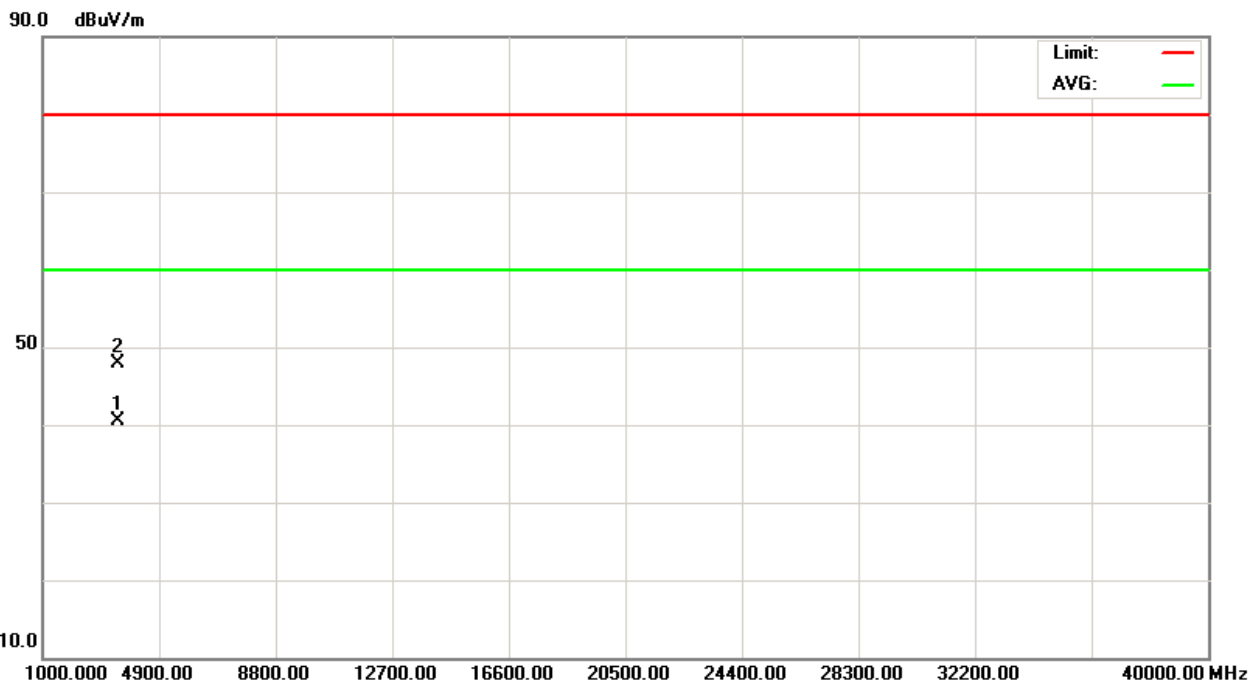



EUT :	Half-size mini-PCle digital wireless audio module	Model Name :	DWPCle83
Temperature :	25 °C	Relative Humidity :	58 %
Pressure :	1006hPa	Test Voltage :	DC 3.3V
Test Mode :	RX Mode 5240MHz (Antenna A)		

Freq. (MHz)	Ant.Pol. H/V	Reading		Ant./CF CF(dB)	Act.		Limit		Note
		Peak (dBuV)	AV (dBuV)		Peak (dBuV/m)	AV (dBuV/m)	Peak (dBuV/m)	AV (dBuV/m)	
3493.24	H	46.34	39.58	1.73	48.07	41.31	80.00	60.00	X/H

Remark :

- (1) All readings are Peak unless otherwise stated QP in column of 『Note』 . Peak denotes that the Peak reading compliance with the QP Limits and then QP Mode measurement didn't perform ◦
- (2) Measuring frequency range from 1000MHz to 6000MHz or the 10th harmonic of highest fundamental frequency ◦ "F" denotes fundamental frequency; "H" denotes spurious frequency. "E" denotes band edge frequency. (This judgment method includes the Band Edge Requirement.)
- (3) Radiated emissions measured in frequency range above 1000MHz were made with an instrument using Peak detector mode and AV detector mode of the emission ◦
- (4) Data of measurement within this frequency range shown " * " in the table above means the reading of emissions are attenuated more than 20dB below the permissible limits or the field strength is too small to be measured.
- (5) A preamp and high pass filter were used for this test in order to provide sufficient measurement sensitivity.
- (6) EUT Orthogonal Axis :
 "X" - denotes Laid on Table ; "Y" - denotes Vertical Stand ; "Z" - denotes Side Stand

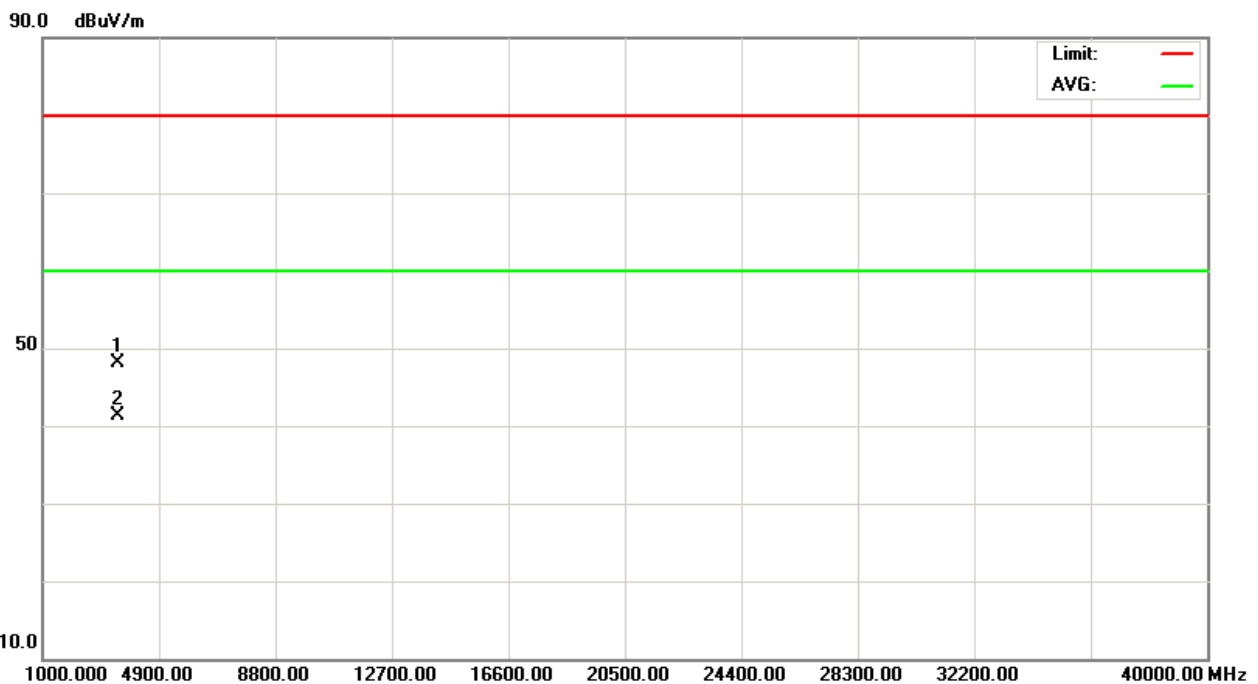



EUT :	Half-size mini-PCle digital wireless audio module	Model Name :	DWPCle83
Temperature :	25 °C	Relative Humidity :	58 %
Pressure :	1006hPa	Test Voltage :	DC 3.3V
Test Mode :	RX Mode 5180MHz (Antenna B)		

Freq. (MHz)	Ant.Pol. H/V	Reading		Ant./CF CF(dB)	Act.		Limit		Note
		Peak (dBuV)	AV (dBuV)		Peak (dBuV/m)	AV (dBuV/m)	Peak (dBuV/m)	AV (dBuV/m)	
3453.35	V	44.51	37.86	1.61	46.12	39.47	80.00	60.00	X/H

Remark :

- (1) All readings are Peak unless otherwise stated QP in column of 『Note』 . Peak denotes that the Peak reading compliance with the QP Limits and then QP Mode measurement didn't perform ◦
- (2) Measuring frequency range from 1000MHz to 6000MHz or the 10th harmonic of highest fundamental frequency ◦“F” denotes fundamental frequency; “H” denotes spurious frequency. “E” denotes band edge frequency. (This judgment method includes the Band Edge Requirement.)
- (3) Radiated emissions measured in frequency range above 1000MHz were made with an instrument using Peak detector mode and AV detector mode of the emission ◦
- (4) Data of measurement within this frequency range shown “ * ” in the table above means the reading of emissions are attenuated more than 20dB below the permissible limits or the field strength is too small to be measured.
- (5) A preamp and high pass filter were used for this test in order to provide sufficient measurement sensitivity.
- (6) EUT Orthogonal Axis :
 “X” - denotes Laid on Table ; “Y” - denotes Vertical Stand ; “Z” - denotes Side Stand

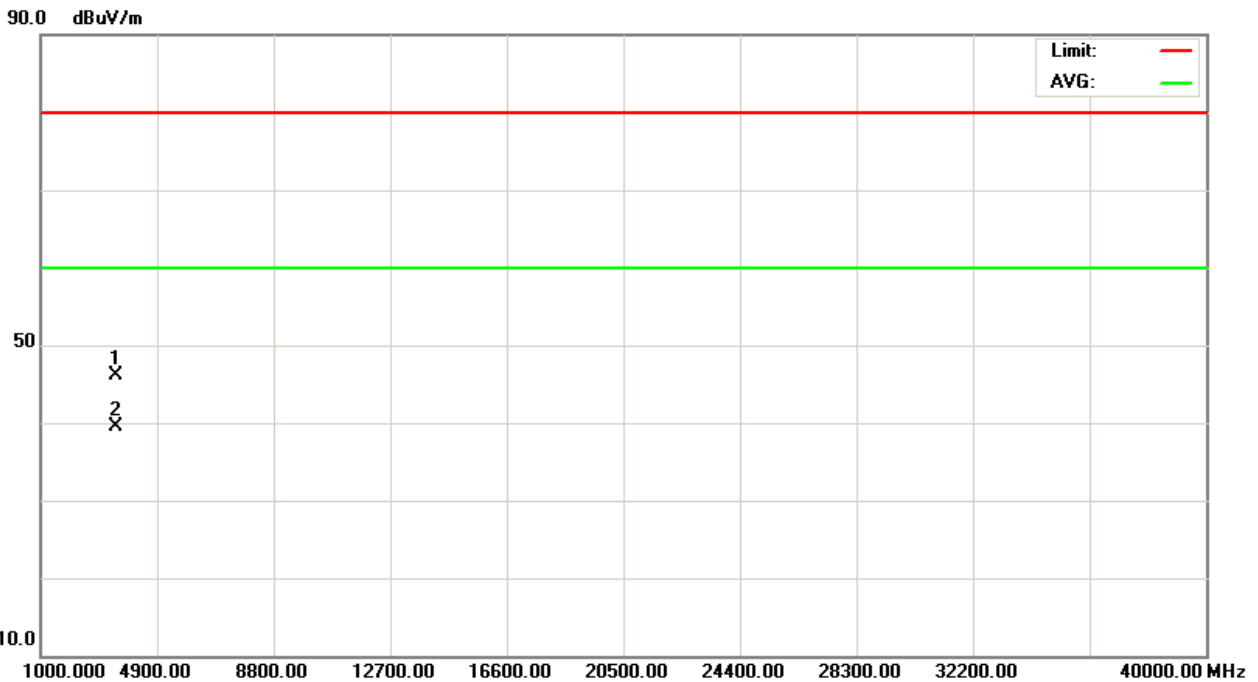



EUT :	Half-size mini-PCle digital wireless audio module	Model Name :	DWPCle83
Temperature :	25 °C	Relative Humidity :	58 %
Pressure :	1006hPa	Test Voltage :	DC 3.3V
Test Mode :	RX Mode 5180MHz (Antenna B)		

Freq. (MHz)	Ant.Pol. H/V	Reading		Ant./CF CF(dB)	Act.		Limit		Note
		Peak (dBuV)	AV (dBuV)		Peak (dBuV/m)	AV (dBuV/m)	Peak (dBuV/m)	AV (dBuV/m)	
3453.37	H	44.20	37.54	1.61	45.81	39.15	80.00	60.00	X/H

Remark :

- (1) All readings are Peak unless otherwise stated QP in column of 『Note』 . Peak denotes that the Peak reading compliance with the QP Limits and then QP Mode measurement didn't perform ◦
- (2) Measuring frequency range from 1000MHz to 6000MHz or the 10th harmonic of highest fundamental frequency ◦ "F" denotes fundamental frequency; "H" denotes spurious frequency. "E" denotes band edge frequency. (This judgment method includes the Band Edge Requirement.)
- (3) Radiated emissions measured in frequency range above 1000MHz were made with an instrument using Peak detector mode and AV detector mode of the emission ◦
- (4) Data of measurement within this frequency range shown " * " in the table above means the reading of emissions are attenuated more than 20dB below the permissible limits or the field strength is too small to be measured.
- (5) A preamp and high pass filter were used for this test in order to provide sufficient measurement sensitivity.
- (6) EUT Orthogonal Axis :
 "X" - denotes Laid on Table ; "Y" - denotes Vertical Stand ; "Z" - denotes Side Stand

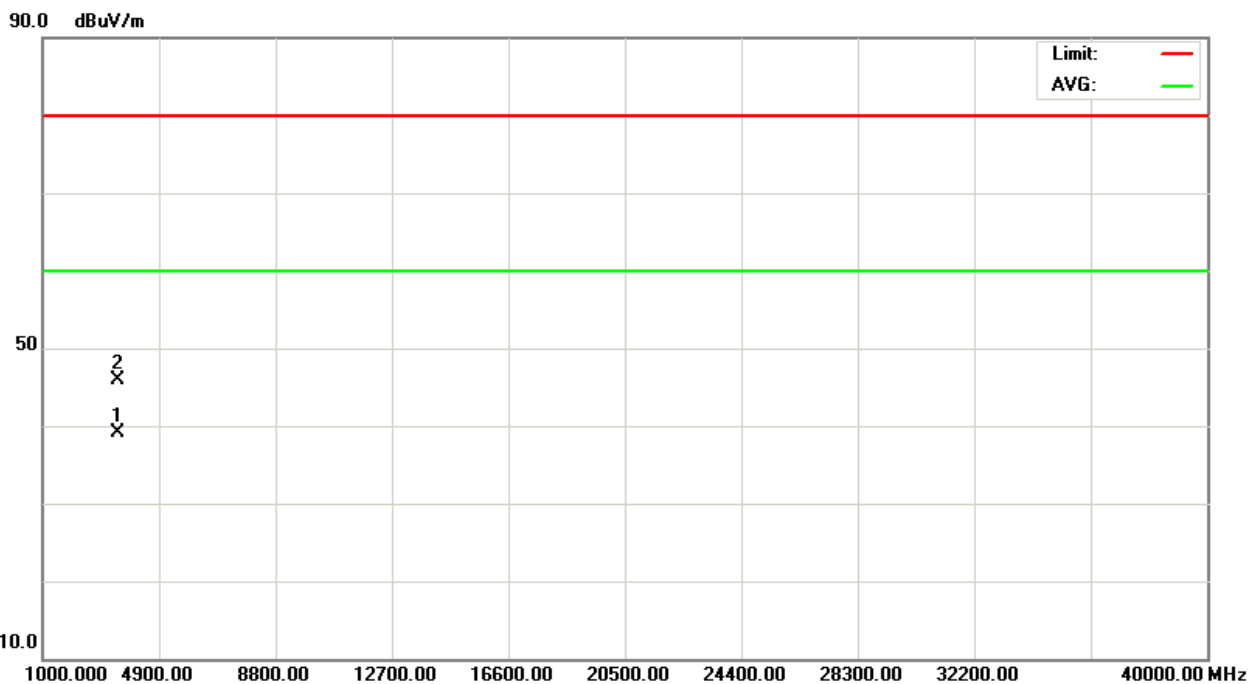



EUT :	Half-size mini-PCle digital wireless audio module	Model Name :	DWPCle83
Temperature :	25 °C	Relative Humidity :	58 %
Pressure :	1006hPa	Test Voltage :	DC 3.3V
Test Mode :	RX Mode 5210MHz (Antenna B)		

Freq. (MHz)	Ant.Pol. H/V	Reading		Ant./CF CF(dB)	Act.		Limit		Note
		Peak (dBuV)	AV (dBuV)		Peak (dBuV/m)	AV (dBuV/m)	Peak (dBuV/m)	AV (dBuV/m)	
3473.36	V	45.15	38.04	1.67	46.82	39.71	80.00	60.00	X/H

Remark :

- (1) All readings are Peak unless otherwise stated QP in column of 『Note』 . Peak denotes that the Peak reading compliance with the QP Limits and then QP Mode measurement didn't perform ◦
- (2) Measuring frequency range from 1000MHz to 6000MHz or the 10th harmonic of highest fundamental frequency ◦“F” denotes fundamental frequency; “H” denotes spurious frequency. “E” denotes band edge frequency. (This judgment method includes the Band Edge Requirement.)
- (3) Radiated emissions measured in frequency range above 1000MHz were made with an instrument using Peak detector mode and AV detector mode of the emission ◦
- (4) Data of measurement within this frequency range shown “ * ” in the table above means the reading of emissions are attenuated more than 20dB below the permissible limits or the field strength is too small to be measured.
- (5) A preamp and high pass filter were used for this test in order to provide sufficient measurement sensitivity.
- (6) EUT Orthogonal Axis :
 “X” - denotes Laid on Table ; “Y” - denotes Vertical Stand ; “Z” - denotes Side Stand

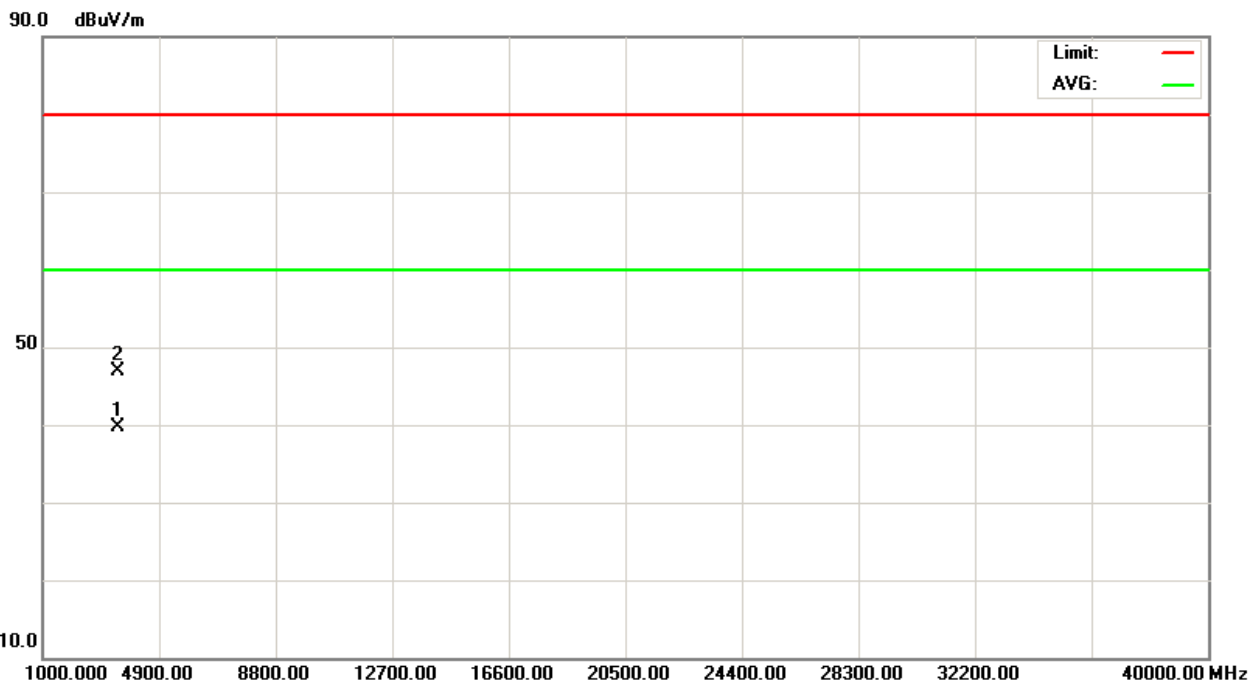



EUT :	Half-size mini-PCle digital wireless audio module	Model Name :	DWPCle83
Temperature :	25 °C	Relative Humidity :	58 %
Pressure :	1006hPa	Test Voltage :	DC 3.3V
Test Mode :	RX Mode 5210MHz (Antenna B)		

Freq. (MHz)	Ant.Pol. H/V	Reading		Ant./CF CF(dB)	Act.		Limit		Note
		Peak (dBuV)	AV (dBuV)		Peak (dBuV/m)	AV (dBuV/m)	Peak (dBuV/m)	AV (dBuV/m)	
3473.35	H	44.49	38.37	1.67	46.16	40.04	80.00	60.00	X/H

Remark :

- (1) All readings are Peak unless otherwise stated QP in column of 『Note』 . Peak denotes that the Peak reading compliance with the QP Limits and then QP Mode measurement didn't perform ◦
- (2) Measuring frequency range from 1000MHz to 6000MHz or the 10th harmonic of highest fundamental frequency ◦ "F" denotes fundamental frequency; "H" denotes spurious frequency. "E" denotes band edge frequency. (This judgment method includes the Band Edge Requirement.)
- (3) Radiated emissions measured in frequency range above 1000MHz were made with an instrument using Peak detector mode and AV detector mode of the emission ◦
- (4) Data of measurement within this frequency range shown " * " in the table above means the reading of emissions are attenuated more than 20dB below the permissible limits or the field strength is too small to be measured.
- (5) A preamp and high pass filter were used for this test in order to provide sufficient measurement sensitivity.
- (6) EUT Orthogonal Axis :
 "X" - denotes Laid on Table ; "Y" - denotes Vertical Stand ; "Z" - denotes Side Stand

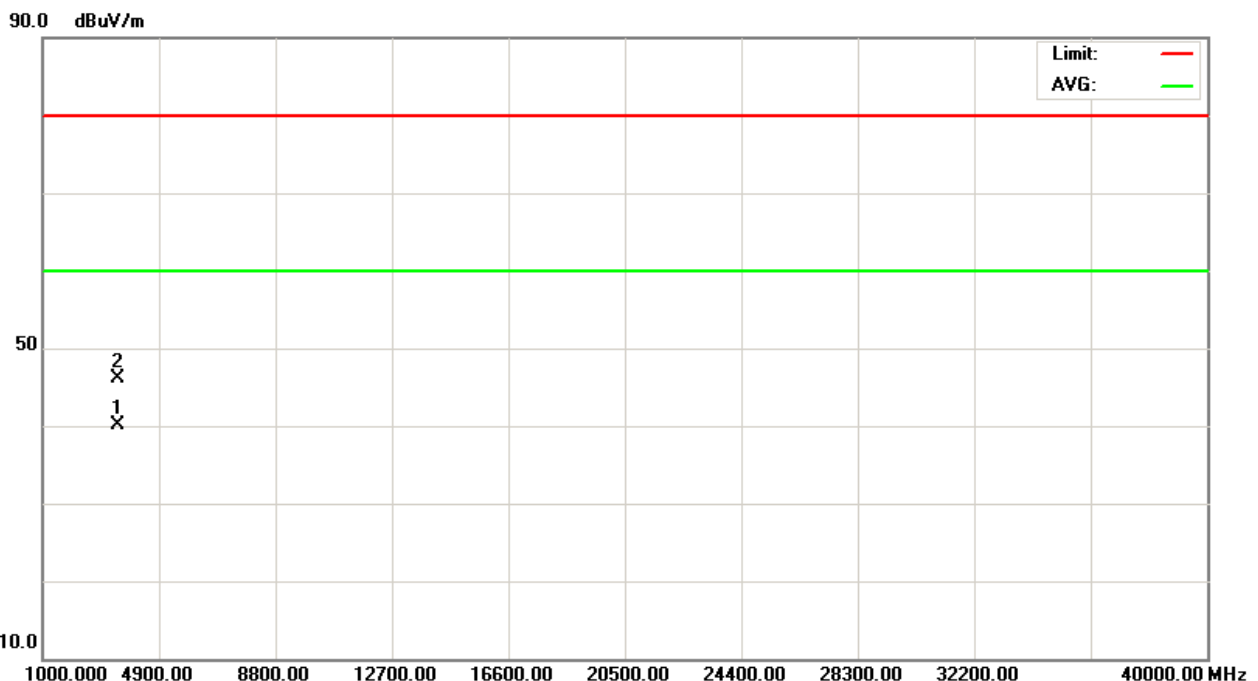



EUT :	Half-size mini-PCle digital wireless audio module	Model Name :	DWPCle83
Temperature :	25 °C	Relative Humidity :	58 %
Pressure :	1006hPa	Test Voltage :	DC 3.3V
Test Mode :	RX Mode 5240MHz (Antenna B)		

Freq. (MHz)	Ant.Pol. H/V	Reading		Ant./CF CF(dB)	Act.		Limit		Note
		Peak (dBuV)	AV (dBuV)		Peak (dBuV/m)	AV (dBuV/m)	Peak (dBuV/m)	AV (dBuV/m)	
3493.42	V	45.44	38.78	1.73	47.17	40.51	80.00	60.00	X/H

Remark :

- (1) All readings are Peak unless otherwise stated QP in column of 『Note』 . Peak denotes that the Peak reading compliance with the QP Limits and then QP Mode measurement didn't perform ◦
- (2) Measuring frequency range from 1000MHz to 6000MHz or the 10th harmonic of highest fundamental frequency ◦“F” denotes fundamental frequency; “H” denotes spurious frequency. “E” denotes band edge frequency. (This judgment method includes the Band Edge Requirement.)
- (3) Radiated emissions measured in frequency range above 1000MHz were made with an instrument using Peak detector mode and AV detector mode of the emission ◦
- (4) Data of measurement within this frequency range shown “ * ” in the table above means the reading of emissions are attenuated more than 20dB below the permissible limits or the field strength is too small to be measured.
- (5) A preamp and high pass filter were used for this test in order to provide sufficient measurement sensitivity.
- (6) EUT Orthogonal Axis :
 “X” - denotes Laid on Table ; ”Y” - denotes Vertical Stand ; ”Z” - denotes Side Stand

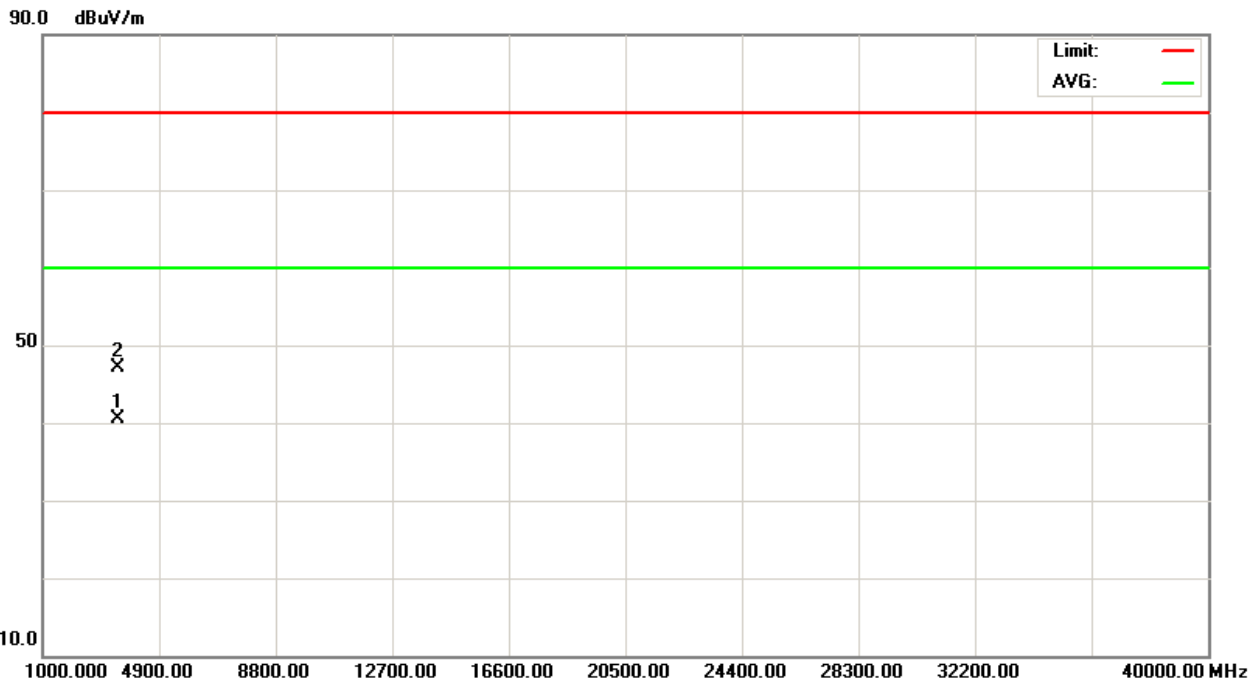



EUT :	Half-size mini-PCle digital wireless audio module	Model Name :	DWPCle83
Temperature :	25 °C	Relative Humidity :	58 %
Pressure :	1006hPa	Test Voltage :	DC 3.3V
Test Mode :	RX Mode 5240MHz (Antenna B)		

Freq. (MHz)	Ant.Pol. H/V	Reading		Ant./CF CF(dB)	Act.		Limit		Note
		Peak (dBuV)	AV (dBuV)		Peak (dBuV/m)	AV (dBuV/m)	Peak (dBuV/m)	AV (dBuV/m)	
3493.23	H	46.68	39.30	1.73	48.41	41.03	80.00	60.00	X/H

Remark :

- (1) All readings are Peak unless otherwise stated QP in column of 『Note』 . Peak denotes that the Peak reading compliance with the QP Limits and then QP Mode measurement didn't perform ◦
- (2) Measuring frequency range from 1000MHz to 6000MHz or the 10th harmonic of highest fundamental frequency ◦ "F" denotes fundamental frequency; "H" denotes spurious frequency. "E" denotes band edge frequency. (This judgment method includes the Band Edge Requirement.)
- (3) Radiated emissions measured in frequency range above 1000MHz were made with an instrument using Peak detector mode and AV detector mode of the emission ◦
- (4) Data of measurement within this frequency range shown " * " in the table above means the reading of emissions are attenuated more than 20dB below the permissible limits or the field strength is too small to be measured.
- (5) A preamp and high pass filter were used for this test in order to provide sufficient measurement sensitivity.
- (6) EUT Orthogonal Axis :
 "X" - denotes Laid on Table ; "Y" - denotes Vertical Stand ; "Z" - denotes Side Stand

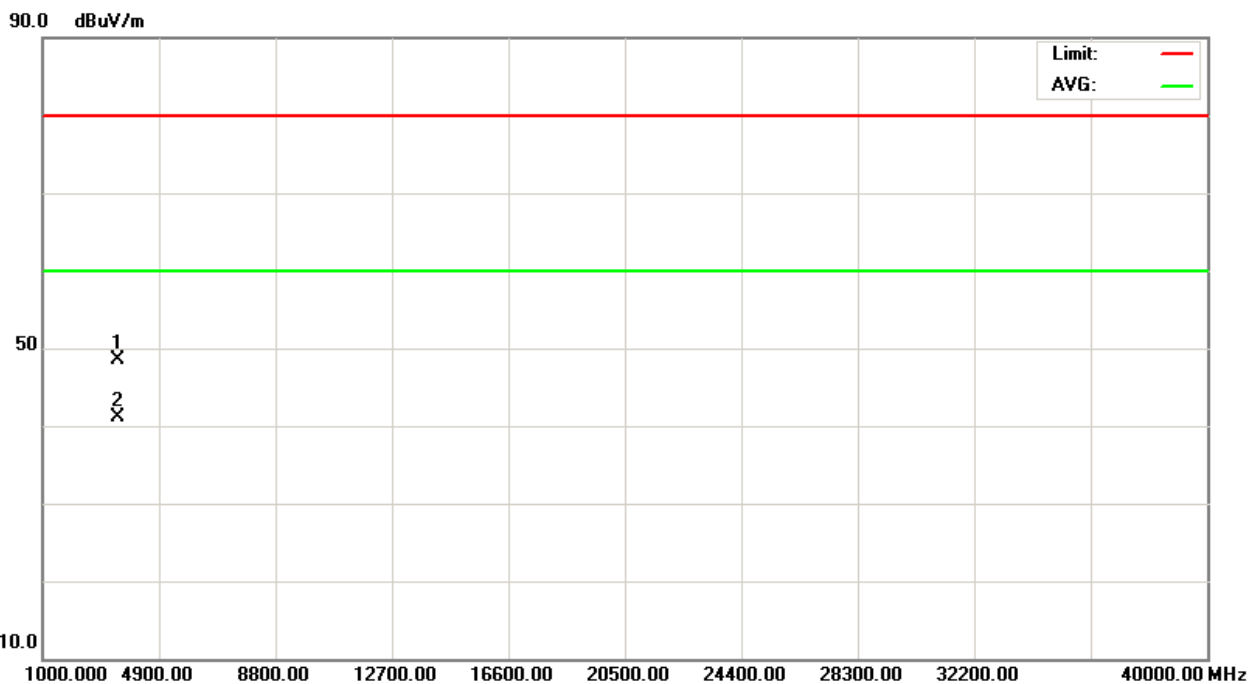



5. 26dB Spectrum Bandwidth

5.1 APPLIED PROCEDURES / LIMIT

FCC Part15, Subpart E			
Test Item	Limit	Frequency Range (MHz)	Result
26 dB Bandwidth	-----	5150 - 5250 5250 - 5350 5470 - 5725 5725 - 5825	PASS

5.1.1 MEASUREMENT INSTRUMENTS LIST

Item	Kind of Equipment	Manufacturer	Type No.	Serial No.	Calibrated until
1	Spectrum Analyzer	R&S	FSP_40	100129	Jan. 04, 2012

Remark: " N/A" denotes No Model Name , Serial No. or No Calibration specified.

5.1.2 TEST PROCEDURE

a. The EUT was directly connected to the spectrum analyzer and antenna output port as show in the block diagram below,

b.

Spectrum Parameters	Setting
Attenuation	Auto
Span Frequency	> 26dB Bandwidth
RB	300 kHz
VB	1000 kHz
Detector	Peak
Trace	Max Hold
Sweep Time	Auto

c. Measured the spectrum width with power higher than 26dB below carrier

5.1.3 DEVIATION FROM STANDARD

No deviation.

5.1.4 TEST SETUP



5.1.5 EUT OPERATION CONDITIONS

The EUT tested system was configured as the statements of 4.1.6 Unless otherwise a special operating condition is specified in the follows during the testing.



5.1.6 TEST RESULTS

EUT :	Half-size mini-PCIe digital wireless audio module	Model Name :	DWPCIe83
Temperature :	25 °C	Relative Humidity :	58 %
Test Voltage :	DC 3.3V		
Test Mode :	5.2G/CH01, CH02, CH03 (Antenna A)		

Channel	Frequency (MHz)	26dB Bandwidth (MHz)	99% Occupied Bandwidth (MHz)
CH01	5180	16.40	15.00
CH02	5210	16.40	15.00
CH03	5240	16.30	15.00

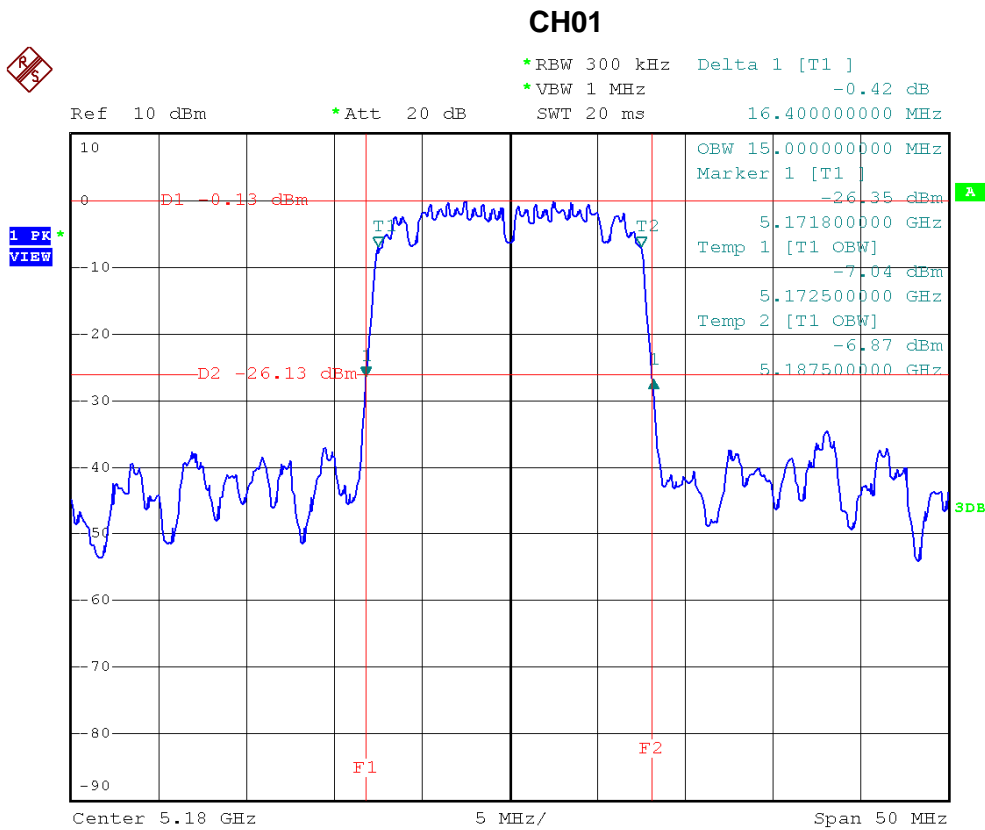

Date: 27.JUL.2011 15:41:01



CH02

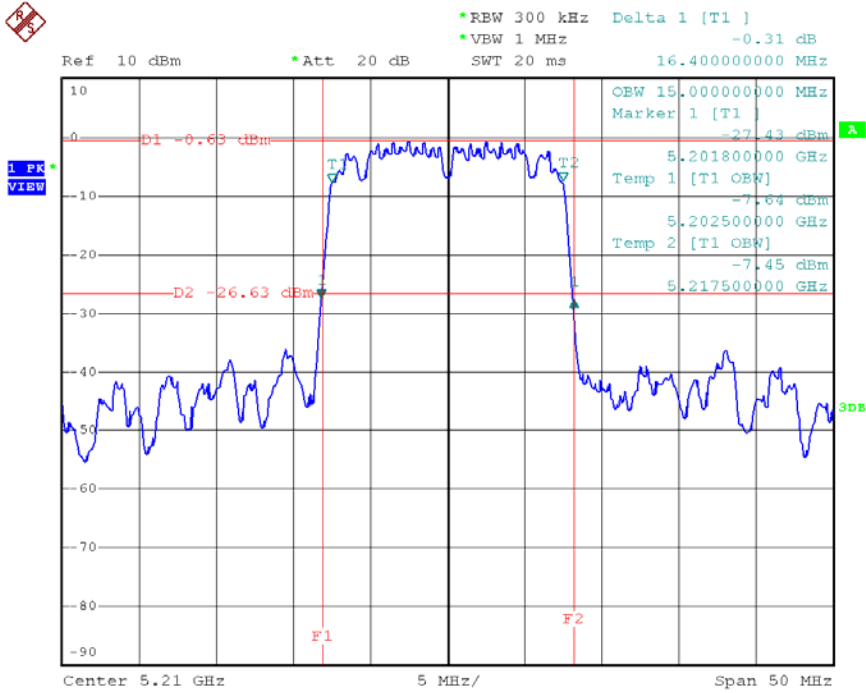

Date: 27.JUL.2011 15:42:33

CH03

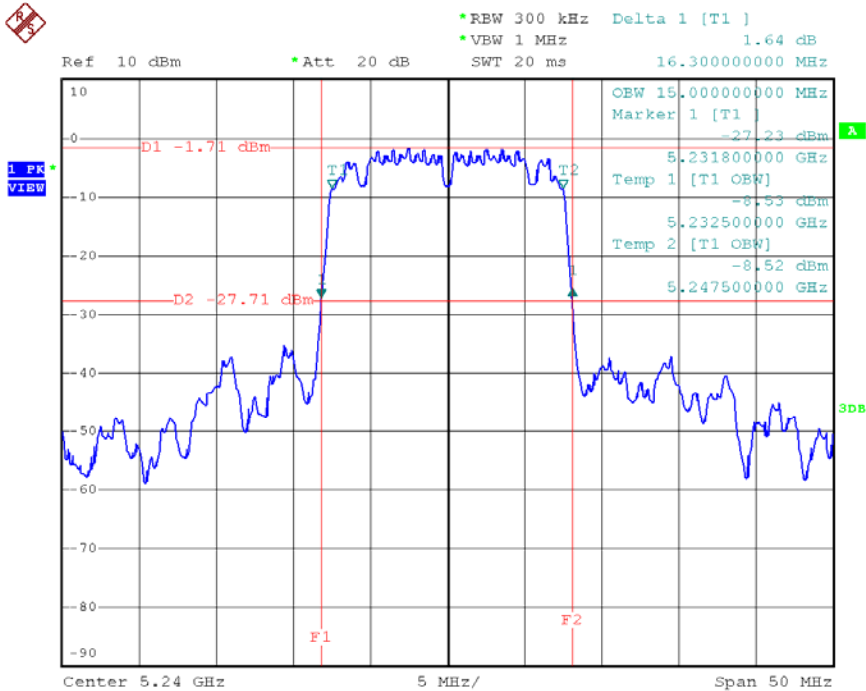

Date: 27.JUL.2011 15:45:05



EUT :	Half-size mini-PCIe digital wireless audio module	Model Name :	DWPCIe83
Temperature :	25 °C	Relative Humidity :	58 %
Test Voltage :	DC 3.3V		
Test Mode :	5.2G/CH01, CH02, CH03 (Antenna B)		

Channel	Frequency (MHz)	26dB Bandwidth (MHz)	99% Occupied Bandwidth (MHz)
CH01	5180	16.40	15.00
CH02	5210	16.40	15.00
CH03	5240	16.40	15.00

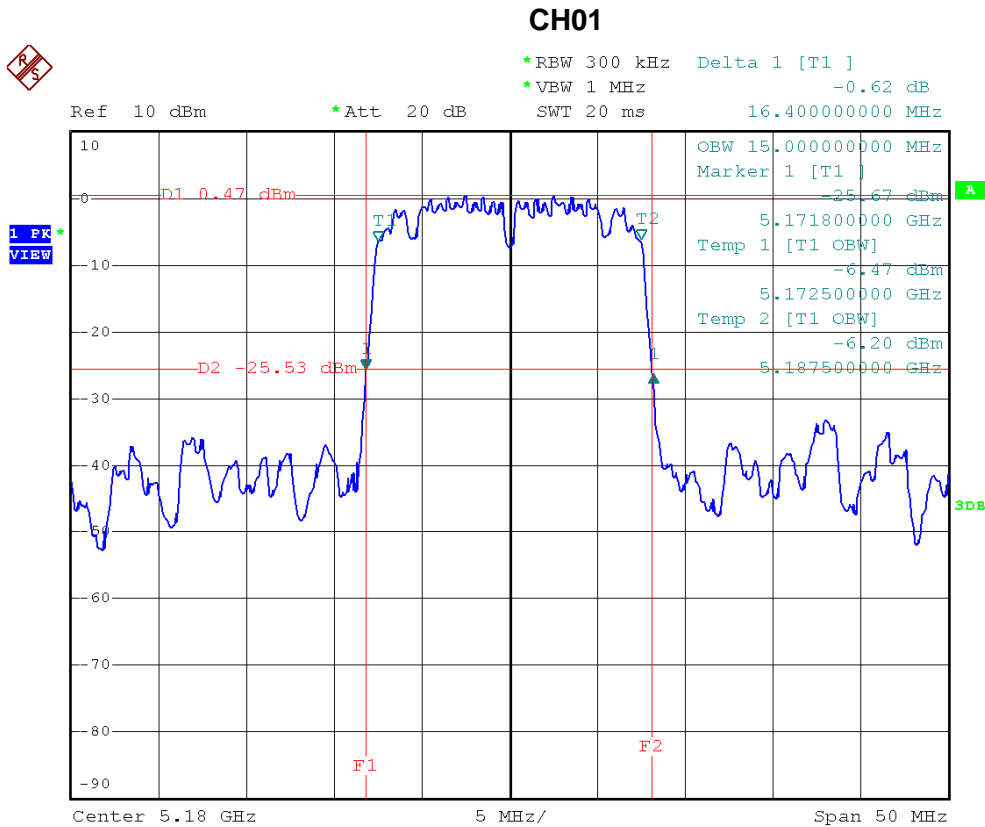

Date: 27.JUL.2011 15:15:39



CH02

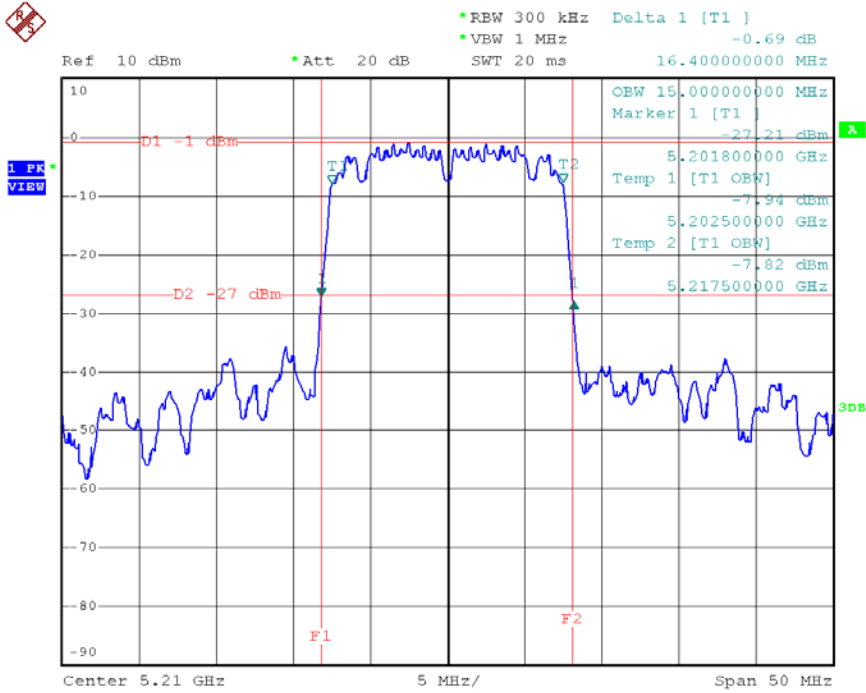

Date: 27.JUL.2011 15:46:48

CH03

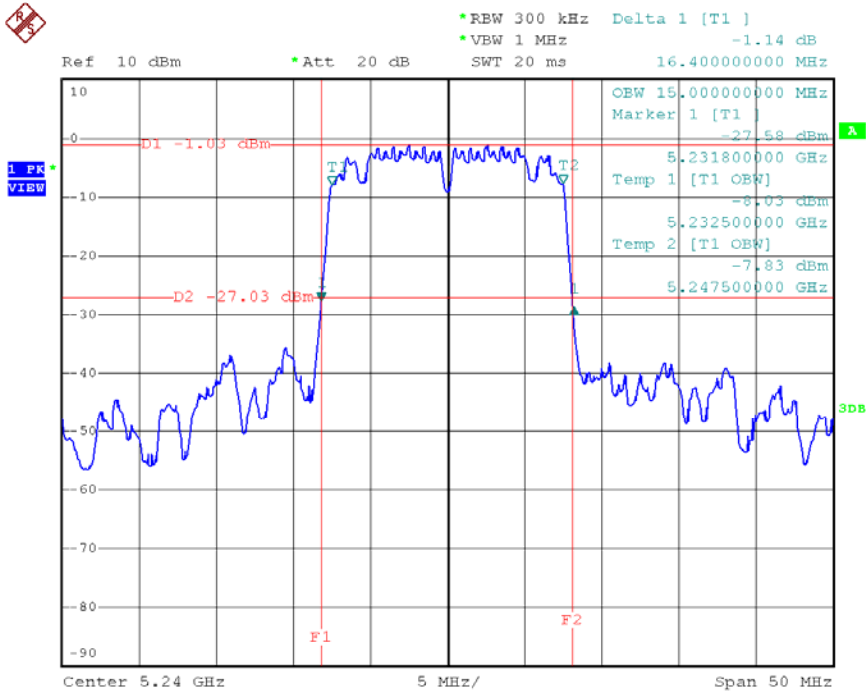

Date: 27.JUL.2011 15:11:18



6. Maximum Conducted Output Power

6.1 APPLIED PROCEDURES / LIMIT

FCC Part15, Subpart E			
Test Item	Frequency Range (MHz)	Limit	Result
Peak Output Power	5150 - 5250	not exceed the lesser of 50 mW (17dBm) or 4 dBm + 10log B,	PASS
	5250 - 5350	not exceed the lesser of 250 mW (24dBm) or 11 dBm + 10log B	N/A
	5470 - 5725	not exceed the lesser of 250 mW (24dBm) or 11 dBm + 10log B	N/A
	5725 - 5825	not exceed the lesser of 1 W (30dBm) or 17 dBm + 10log B.	N/A

Note: where “B” is the 26 dB emissions bandwidth in MHz.

6.1.1 MEASUREMENT INSTRUMENTS LIST

Item	Kind of Equipment	Manufacturer	Type No.	Serial No.	Calibrated until
1	Spectrum Analyzer	R&S	FSP_40	100129	Jan. 04, 2012

Remark: ” N/A” denotes No Model Name , Serial No. or No Calibration specified.

6.1.2 TEST PROCEDURE

a. The EUT was directly connected to the spectrum analyzer and antenna output port as show in the block diagram below,

b.

Spectrum Parameter	Setting
Attenuation	Auto
Span Frequency	Encompass the entire emissions bandwidth (EBW) of the signal
RB	1000 kHz
VB	3000 kHz (>/1/T) T: Transmission Pluse
Detector	Sample
Trace	Max Hold
Sweep Time	60s

b. Test was performed in accordance with method #3 of FCC Public Notice DA-02-2138.



6.1.3 DEVIATION FROM STANDARD

No deviation.

6.1.4 TEST SETUP

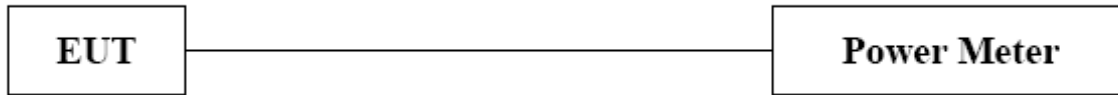

6.1.5 EUT OPERATION CONDITIONS

The EUT tested system was configured as the statements of 4.1.6 Unless otherwise a special operating condition is specified in the follows during the testing.



6.1.6 TEST RESULTS

EUT :	Half-size mini-PCIe digital wireless audio module	Model Name :	DWPCIe83
Temperature :	25 °C	Relative Humidity :	58 %
Test Voltage :	DC 3.3V		
Test Mode :	5.2G/CH01, CH02, CH03 (Antenna A)		

Peak Output Power

Test Channel	Frequency (MHz)	Peak Output Power (dBm)	LIMIT (dBm)	LIMIT (W)
CH01	5180	13.17	17.00	0.0501
CH02	5210	12.17	17.00	0.0501
CH03	5240	11.70	17.00	0.0501

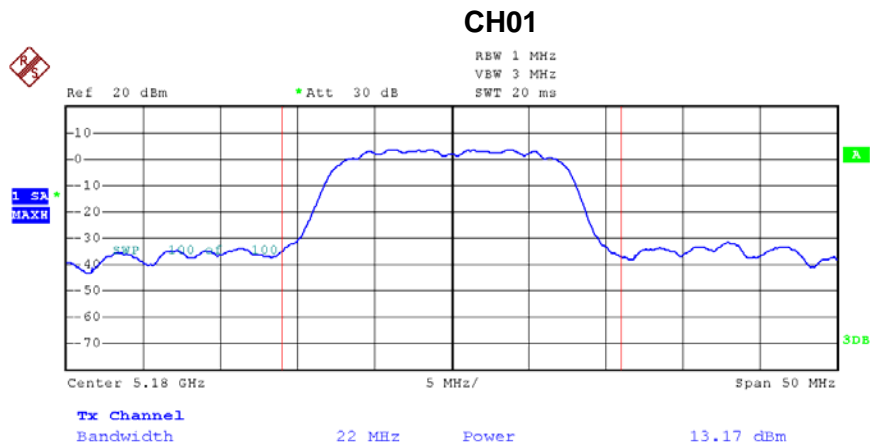

Date: 27.JUL.2011 14:39:56



CH02

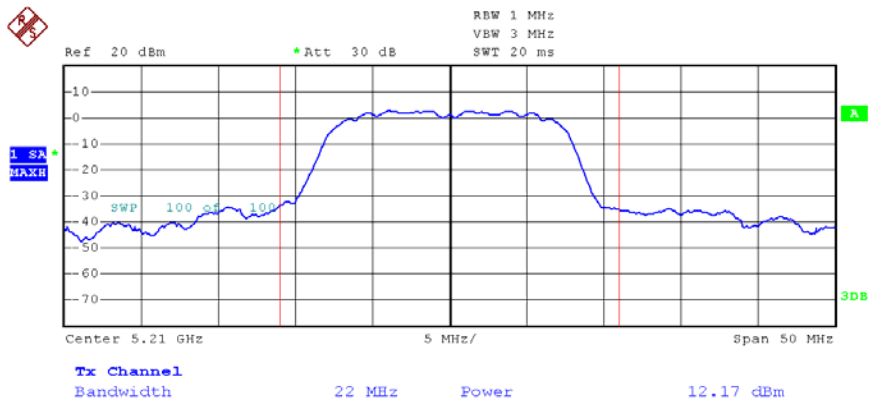

Date: 27.JUL.2011 14:40:30

CH03

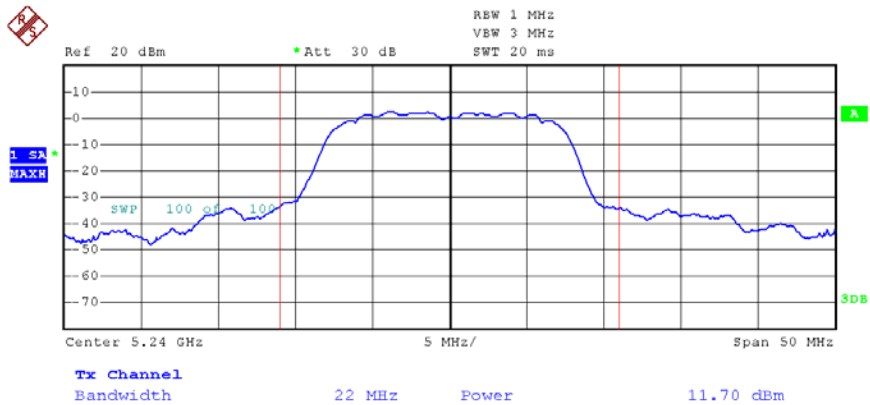

Date: 27.JUL.2011 14:41:27



Average Output Power limit: None ; for reporting purposes only

Test Channel	Frequency (MHz)	AV Output Power (dBm)	LIMIT (dBm)	LIMIT (W)
CH01	5180	9.53	17.00	0.0501
CH02	5210	9.39	17.00	0.0501
CH03	5240	9.94	17.00	0.0501

CH01

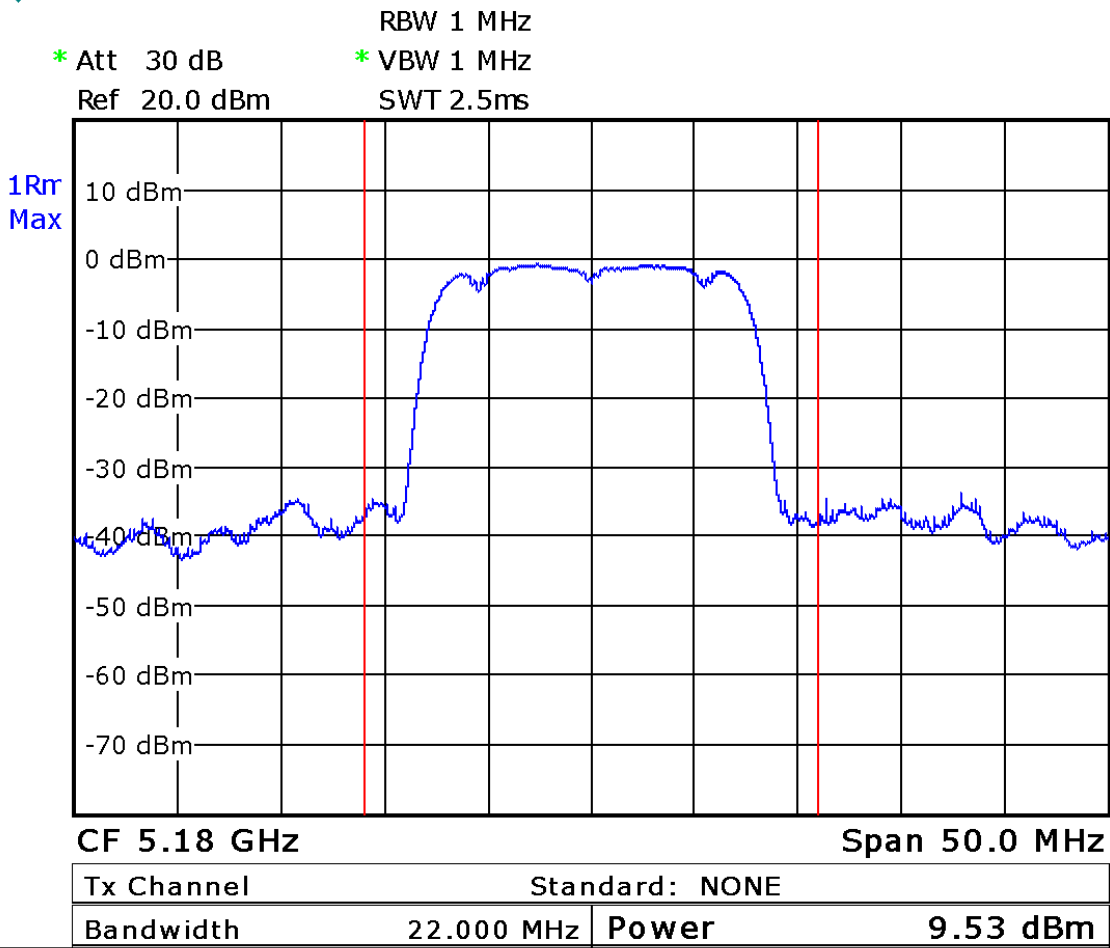

Date: 21.JUL.2011 19:29:16



CH02

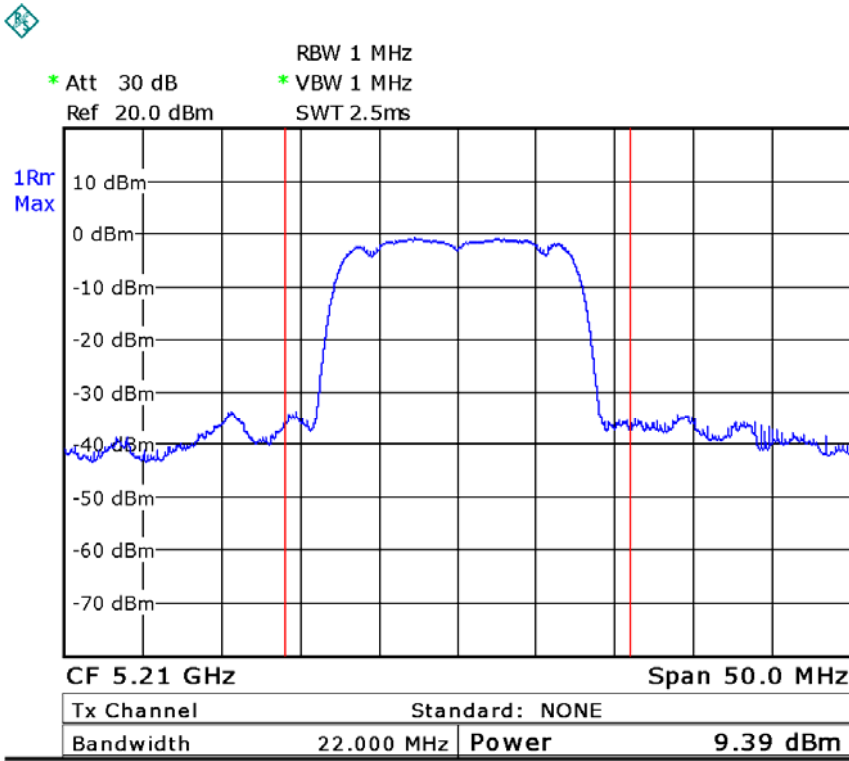

Date: 21.JUL.2011 19:29:05

CH03

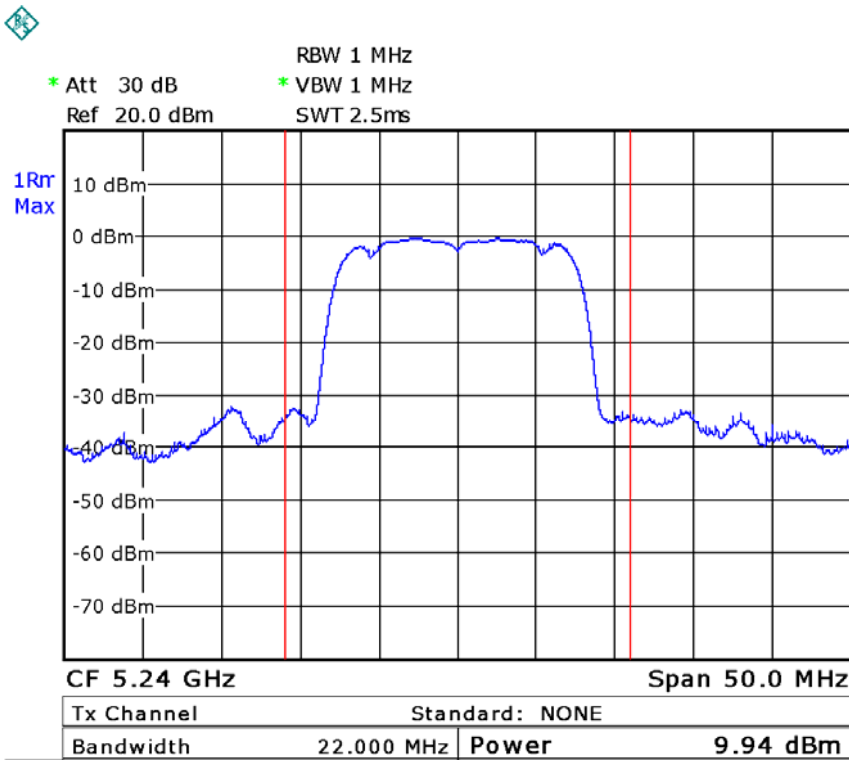

Date: 21.JUL.2011 19:28:42



Peak Output Power

EUT :	Half-size mini-PCle digital wireless audio module	Model Name :	DWPCle83
Temperature :	25 °C	Relative Humidity :	58 %
Test Voltage :	DC 3.3V		
Test Mode :	5.2G/CH01, CH02, CH03 (Antenna B)		

Test Channel	Frequency (MHz)	Peak Output Power (dBm)	LIMIT (dBm)	LIMIT (W)
CH01	5180	12.57	17.00	0.0501
CH02	5210	12.24	17.00	0.0501
CH03	5240	11.24	17.00	0.0501

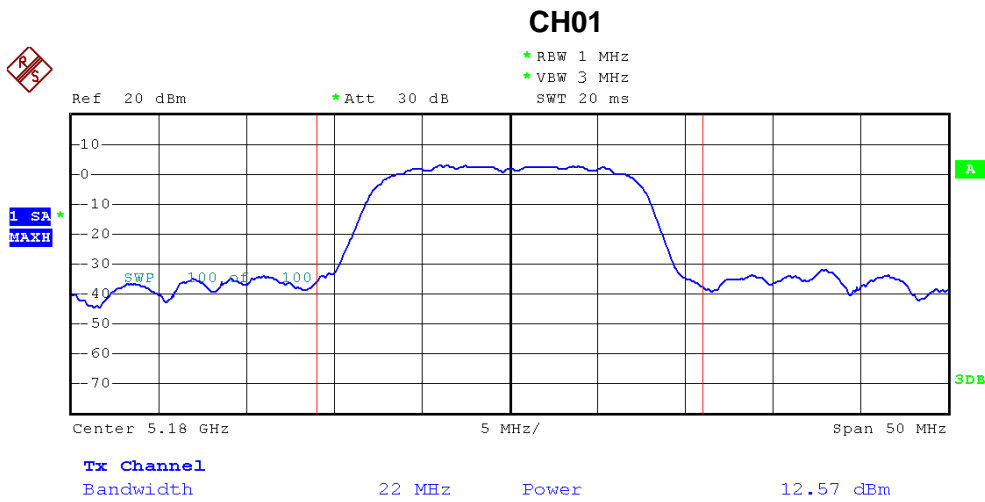

Date: 27.JUL.2011 14:56:35



CH02

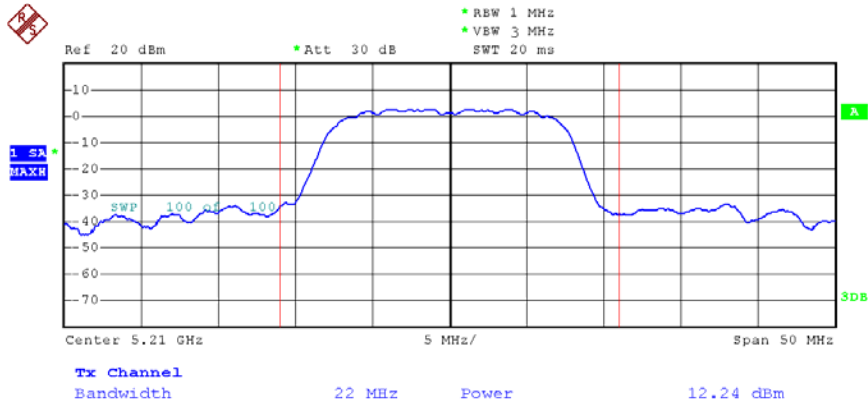

Date: 27.JUL.2011 14:55:37

CH03

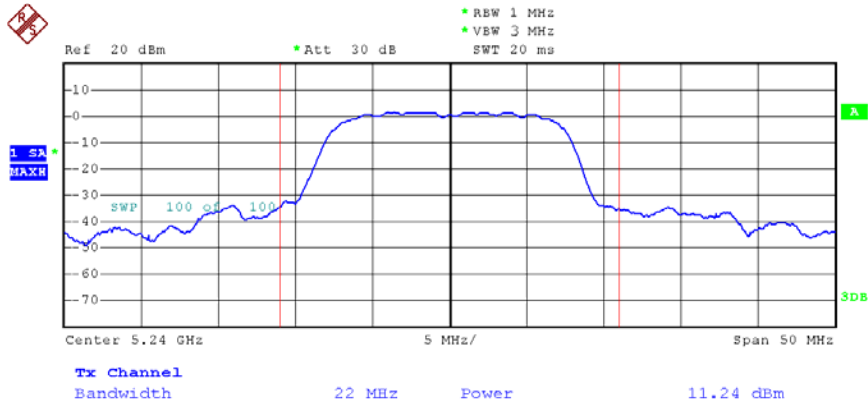

Date: 27.JUL.2011 14:54:11



Average Output Power limit: None ; for reporting purposes only

Test Channel	Frequency (MHz)	AV Output Power (dBm)	LIMIT (dBm)	LIMIT (W)
CH01	5180	10.13	17.00	0.0501
CH02	5210	10.01	17.00	0.0501
CH03	5240	10.02	17.00	0.0501

CH01

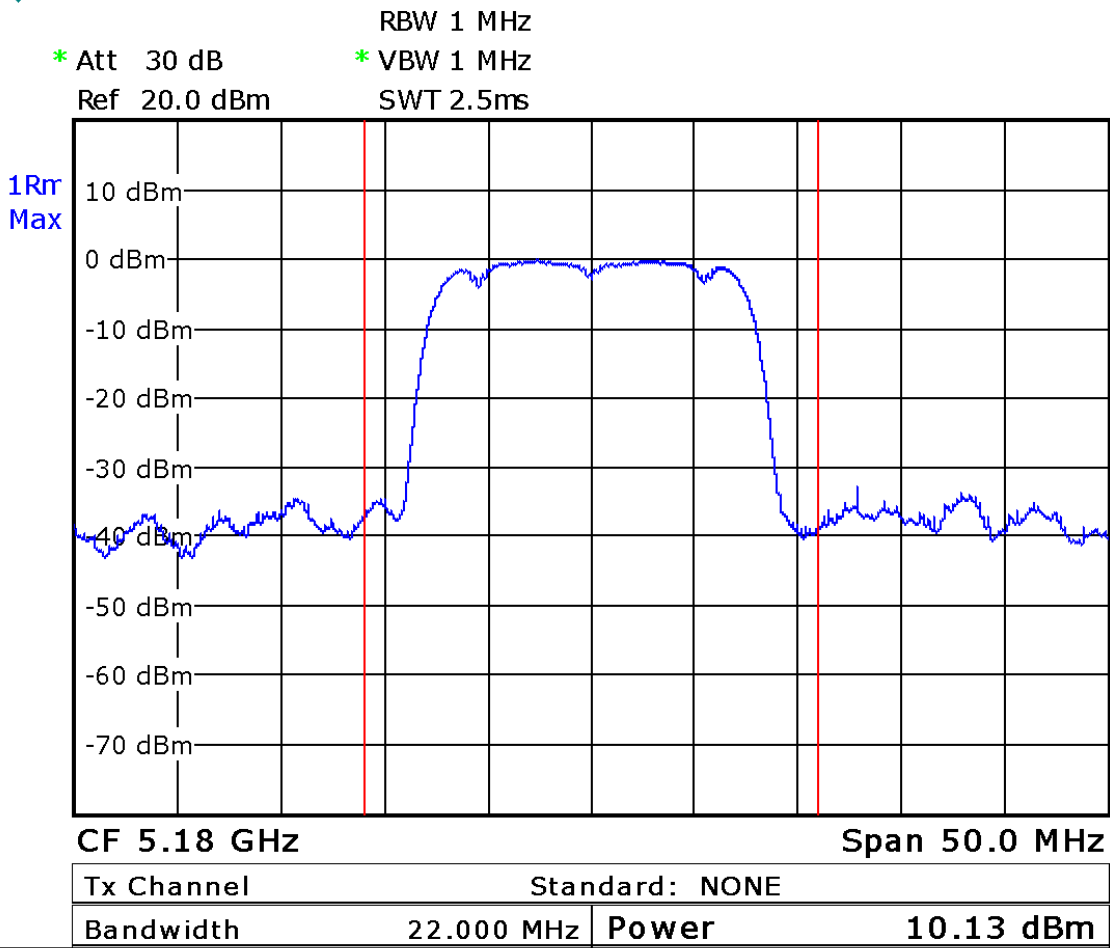

Date: 21.JUL.2011 19:37:42



CH02

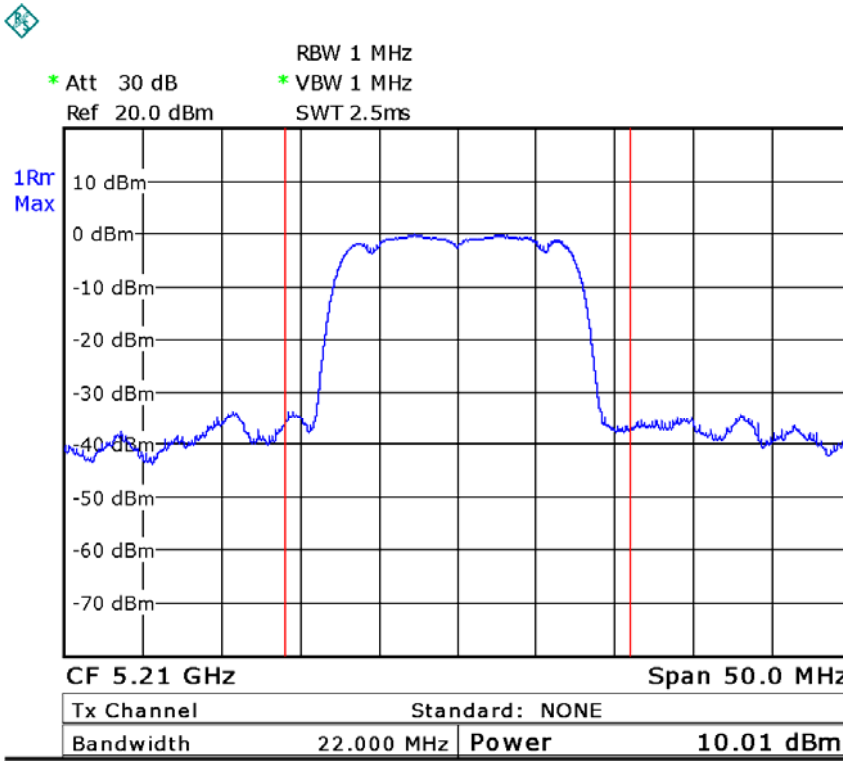

Date: 21.JUL.2011 19:38:07

CH03

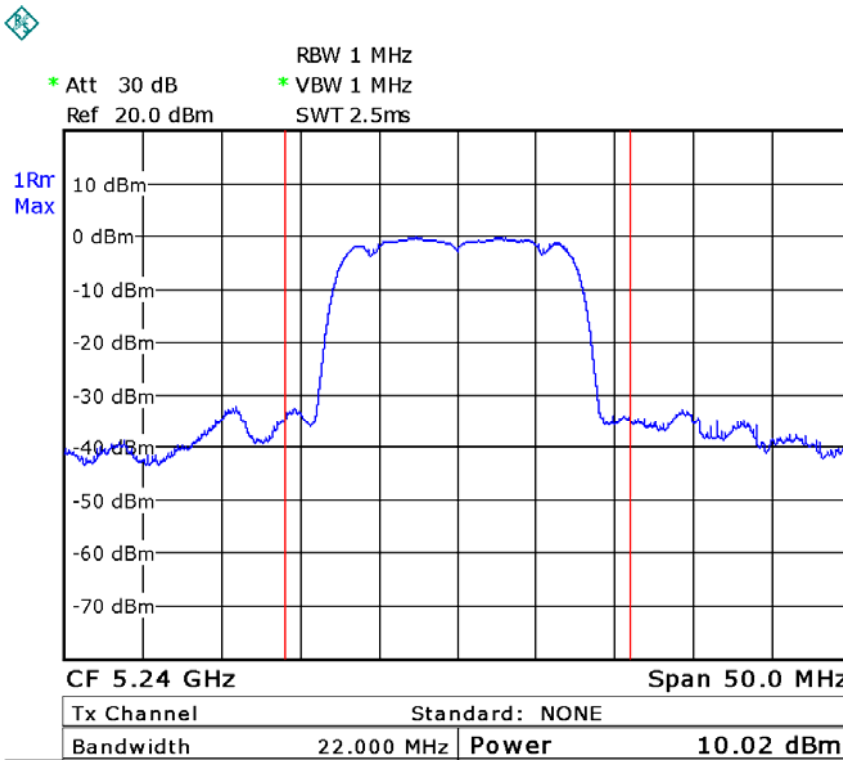

Date: 21.JUL.2011 19:38:28



7. ANTENNA CONDUCTED SPURIOUS EMISSION

7.1 APPLIED PROCEDURES / LIMIT

FCC Part15, Subpart E			
Test Item	Limit	Frequency Range (MHz)	Result
Antenna conducted Spurious Emission	-27 dBm/1MHz	5150 - 5250	PASS

7.1.1 MEASUREMENT INSTRUMENTS LIST

Item	Kind of Equipment	Manufacturer	Type No.	Serial No.	Calibrated until
1	Spectrum Analyzer	R&S	FSP_40	100129	Jan. 04, 2012

Remark: " N/A" denotes No Model Name , Serial No. or No Calibration specified.

7.1.2 TEST PROCEDURE

a. The EUT was directly connected to the spectrum analyzer and antenna output port as show in the block diagram below,

b.

Spectrum Parameter	Setting
Attenuation	Auto
RB	1000 kHz
VB	1000 kHz
Trace	Max Hold
Sweep Time	Auto

7.1.3 DEVIATION FROM STANDARD

No deviation.

7.1.4 TEST SETUP



7.1.5 EUT OPERATION CONDITIONS

The EUT tested system was configured as the statements of 4.1.6 Unless otherwise a special operating condition is specified in the follows during the testing.



7.1.6 TEST RESULTS

EUT :	Half-size mini-PCle digital wireless audio module	Model Name :	DWPCle83
Temperature :	25 °C	Relative Humidity :	58 %
Test Voltage :	DC 3.3V		
Test Mode :	5.2G/CH01, CH02 , CH03 (Antenna A)		

Channel of Worst Data: CH01			
The max. radio frequency power in any 1000kHz bandwidth outside the frequency band		The max. radio frequency power in any 1000kHz bandwidth within the frequency band.	
FREQUENCY(MHz)	POWER(dBm)	FREQUENCY(MHz)	POWER(dBm)
5131.20 MHz	-46.40	5368.40MHz	-45.57
Limit: -27 dBm/1MHz		Result:PASS	
Measurement method: S.A Read value+Ant gain+cable loss			



TX mode CH01

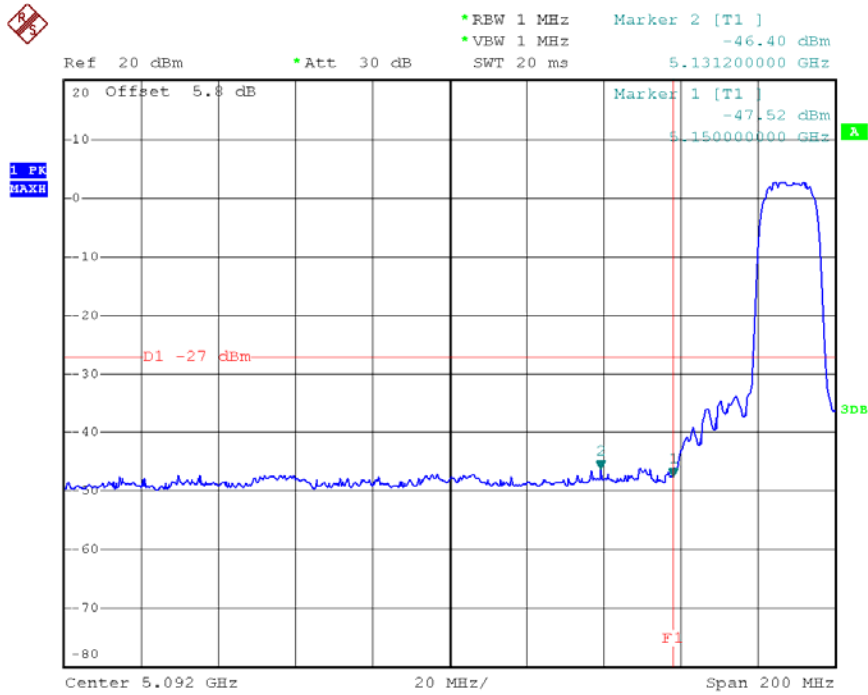

Date: 27.JUL.2011 15:51:42

TX mode CH03

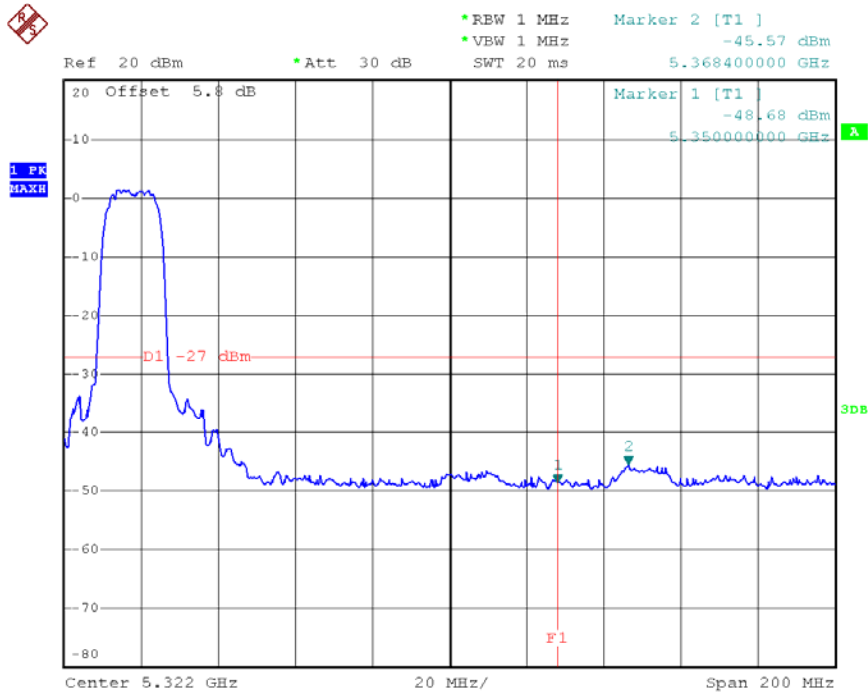

Date: 27.JUL.2011 15:53:41

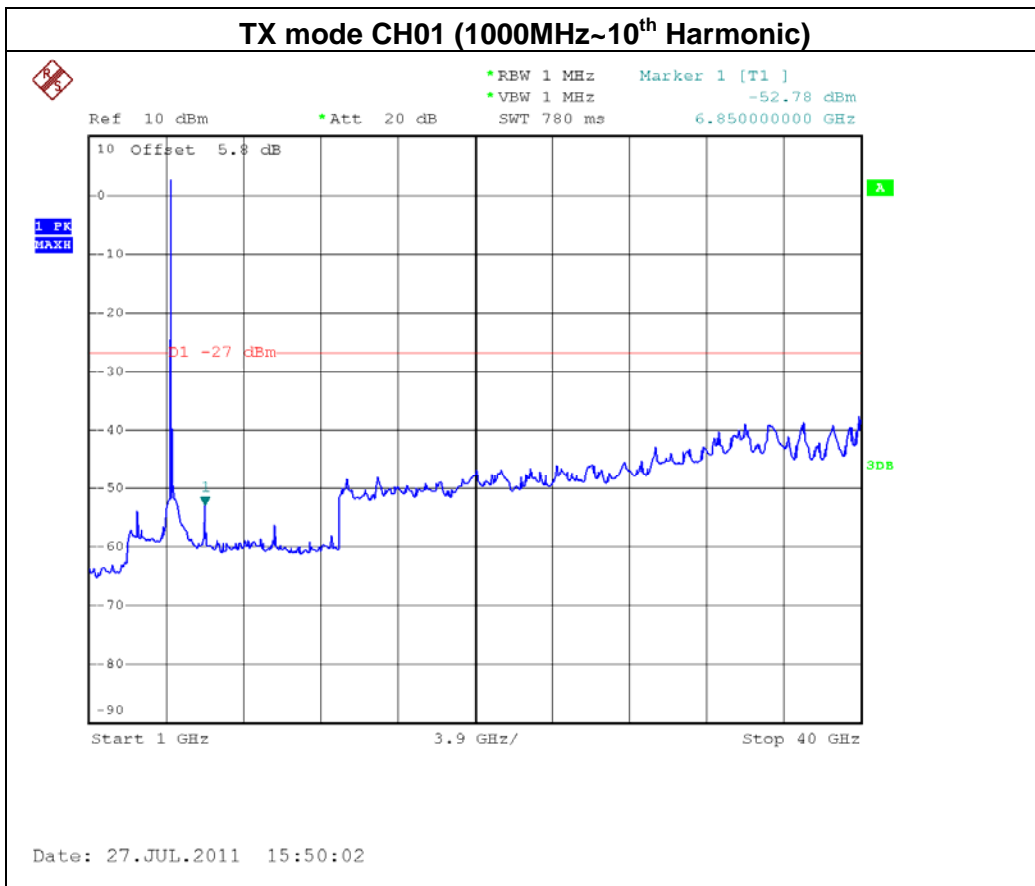
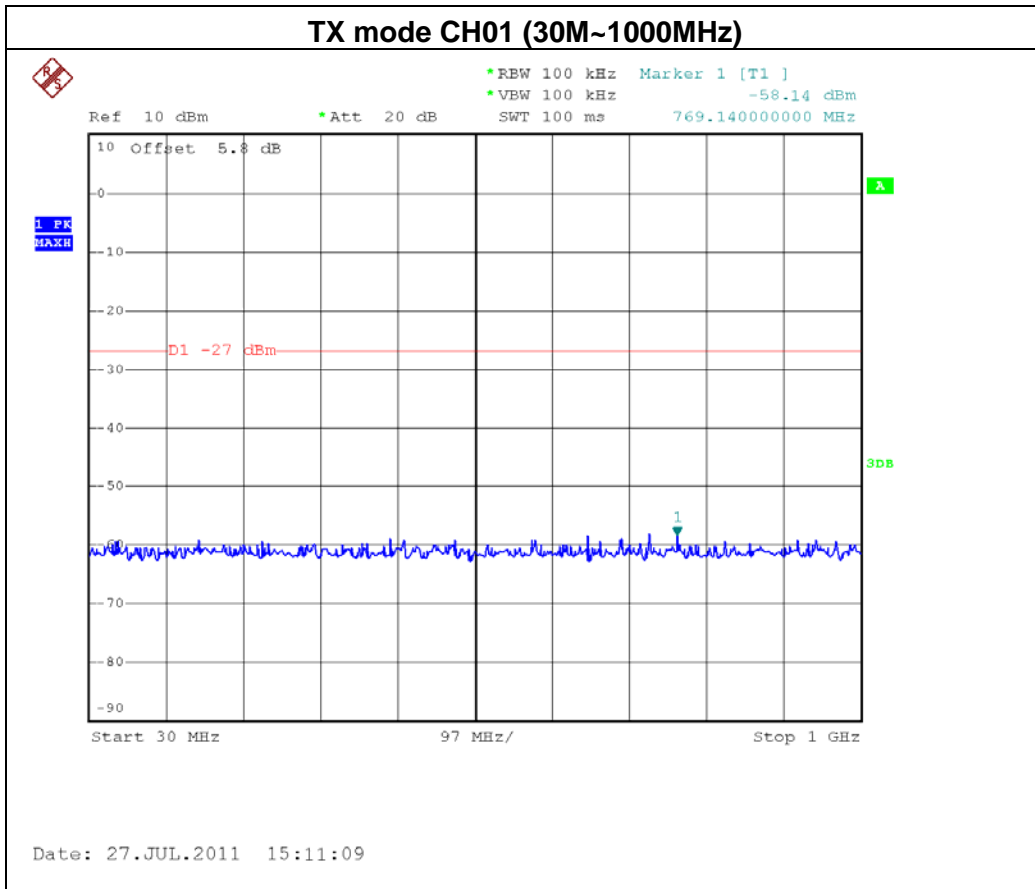

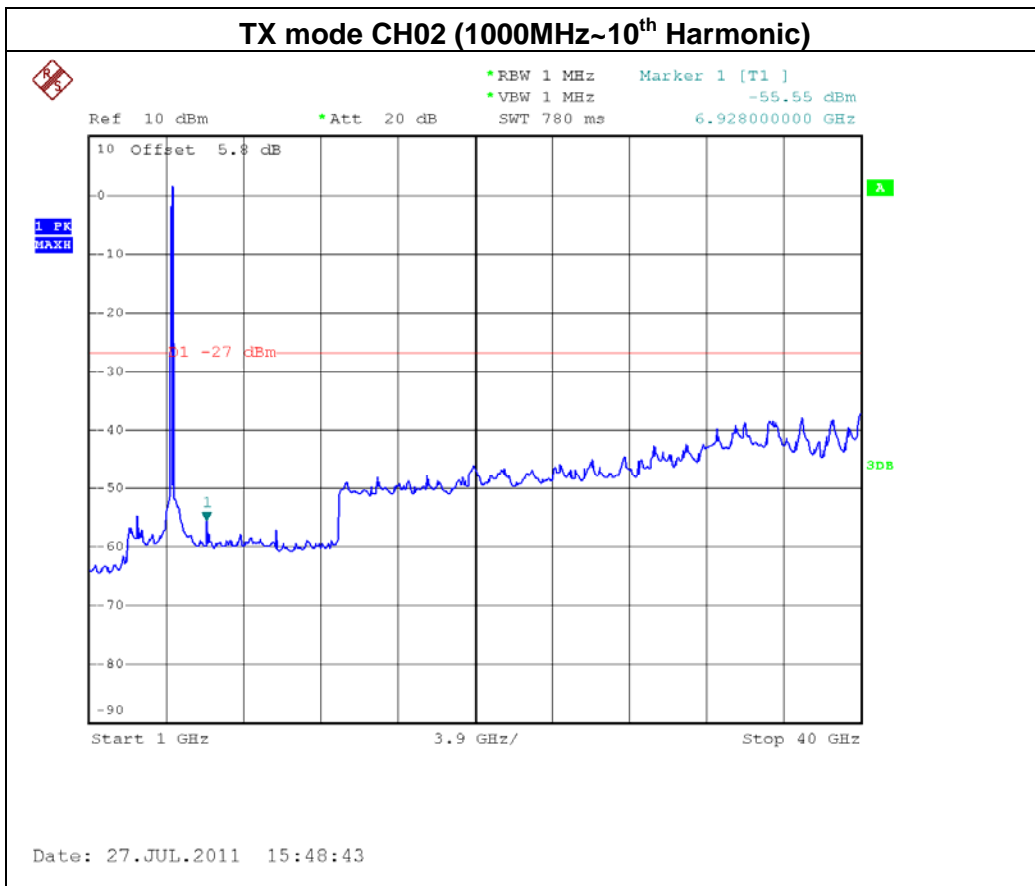
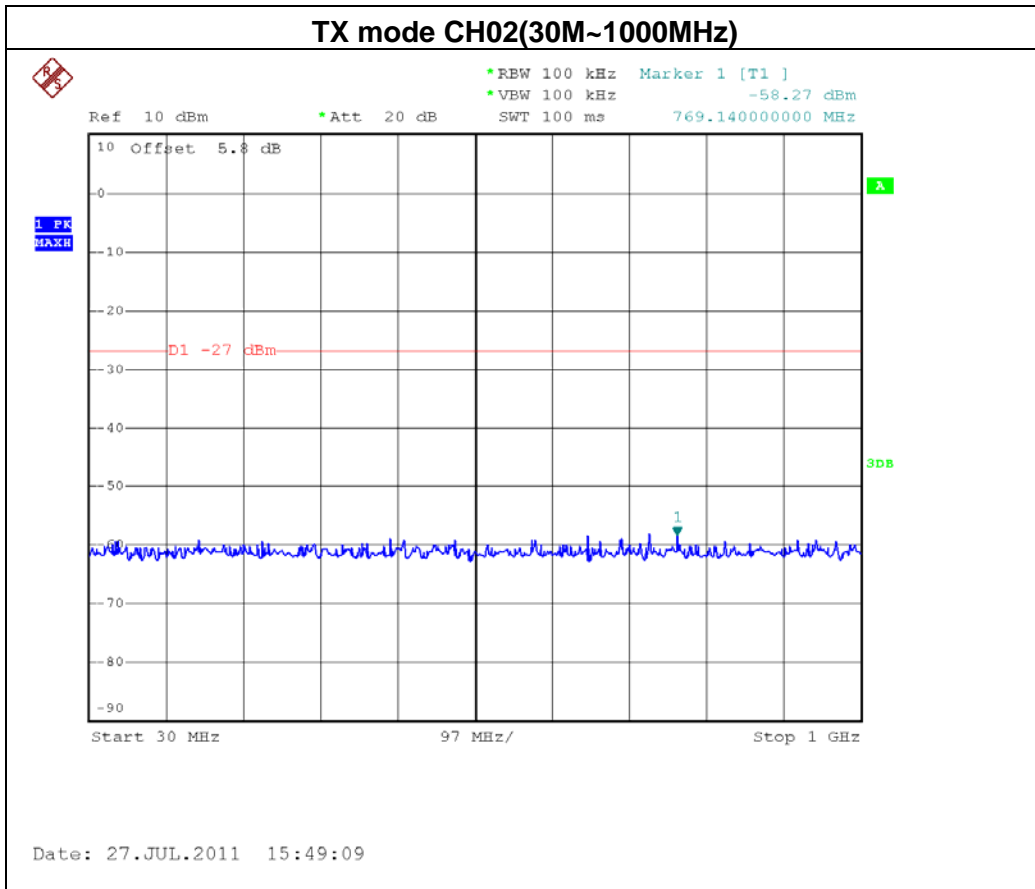



TX mode CH03(30M~1000MHz)

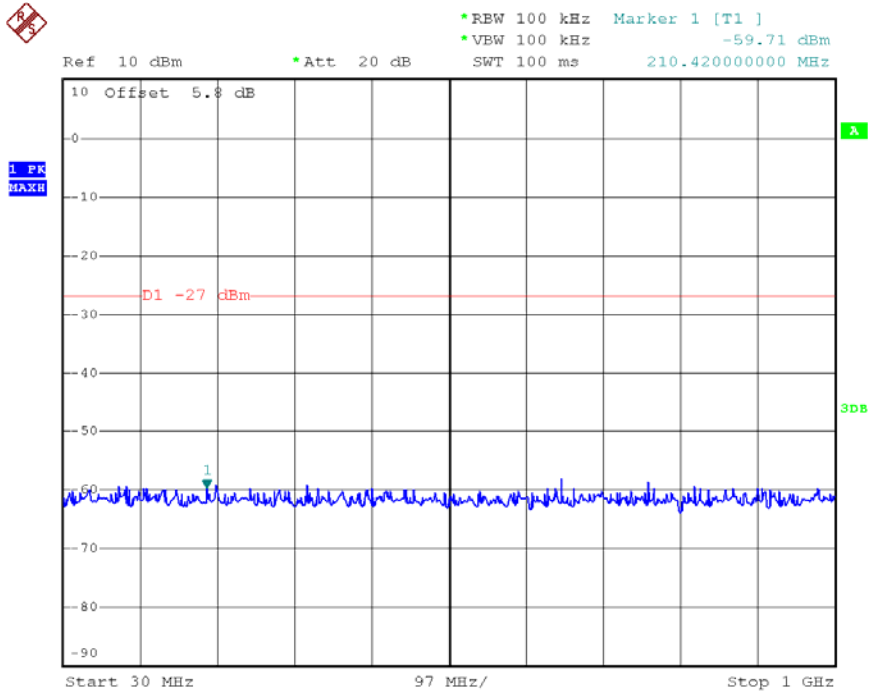

Date: 27.JUL.2011 15:54:56

TX mode CH03 (1000MHz~10th Harmonic)

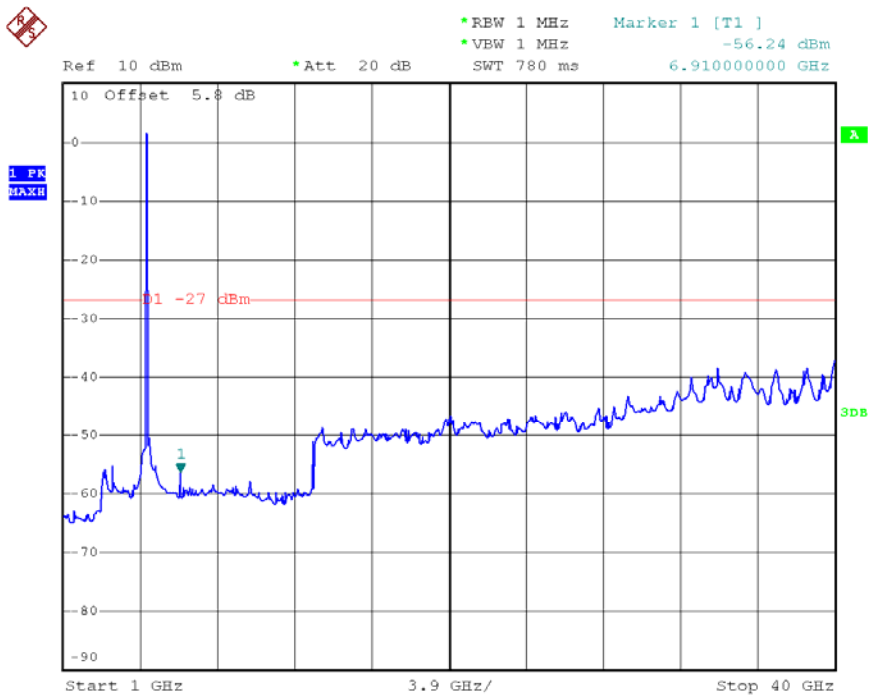

Date: 27.JUL.2011 15:54:35



EUT :	Half-size mini-PCIe digital wireless audio module	Model Name :	DWPCIe83
Temperature :	25 °C	Relative Humidity :	58 %
Test Voltage :	DC 3.3V		
Test Mode :	5.2G/CH01, CH02 , CH03 (Antenna B)		

Channel of Worst Data: CH01			
The max. radio frequency power in any 1000kHz bandwidth outside the frequency band		The max. radio frequency power in any 1000kHz bandwidth within the frequency band.	
FREQUENCY(MHz)	POWER(dBm)	FREQUENCY(MHz)	POWER(dBm)
5097.60 MHz	-46.10	5368.00MHz	-45.78
Limit: -27 dBm/1MHz		Result:PASS	
Measurement method: S.A Read value+Ant gain+cable loss			



TX mode CH01

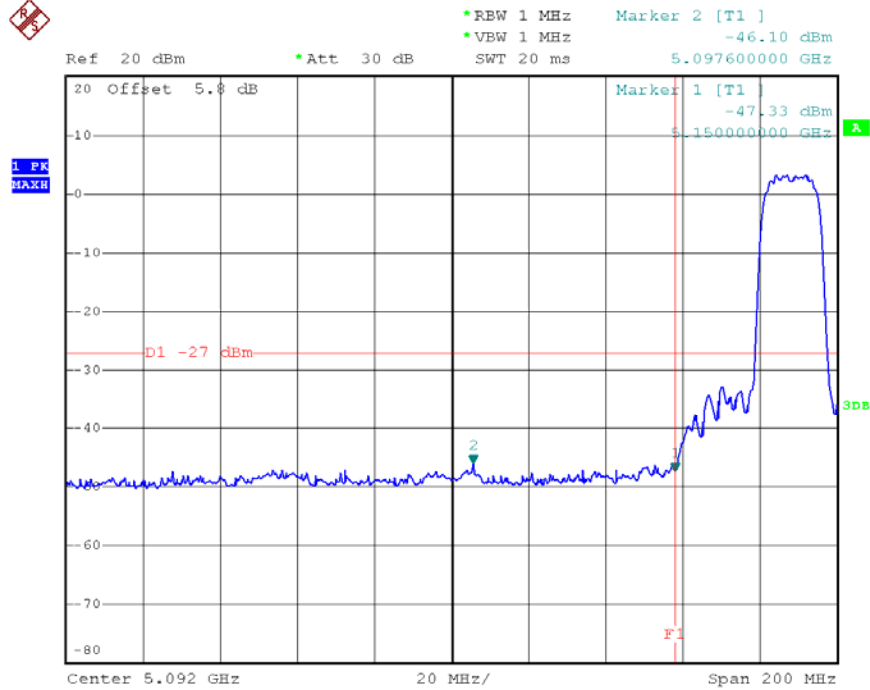

Date: 27.JUL.2011 15:02:56

TX mode CH03

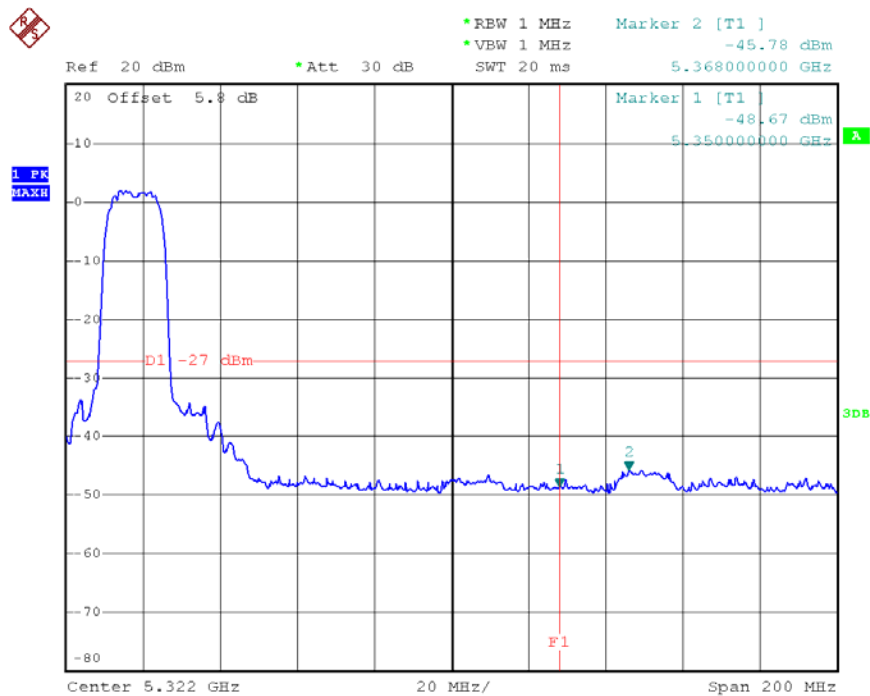

Date: 27.JUL.2011 15:07:17

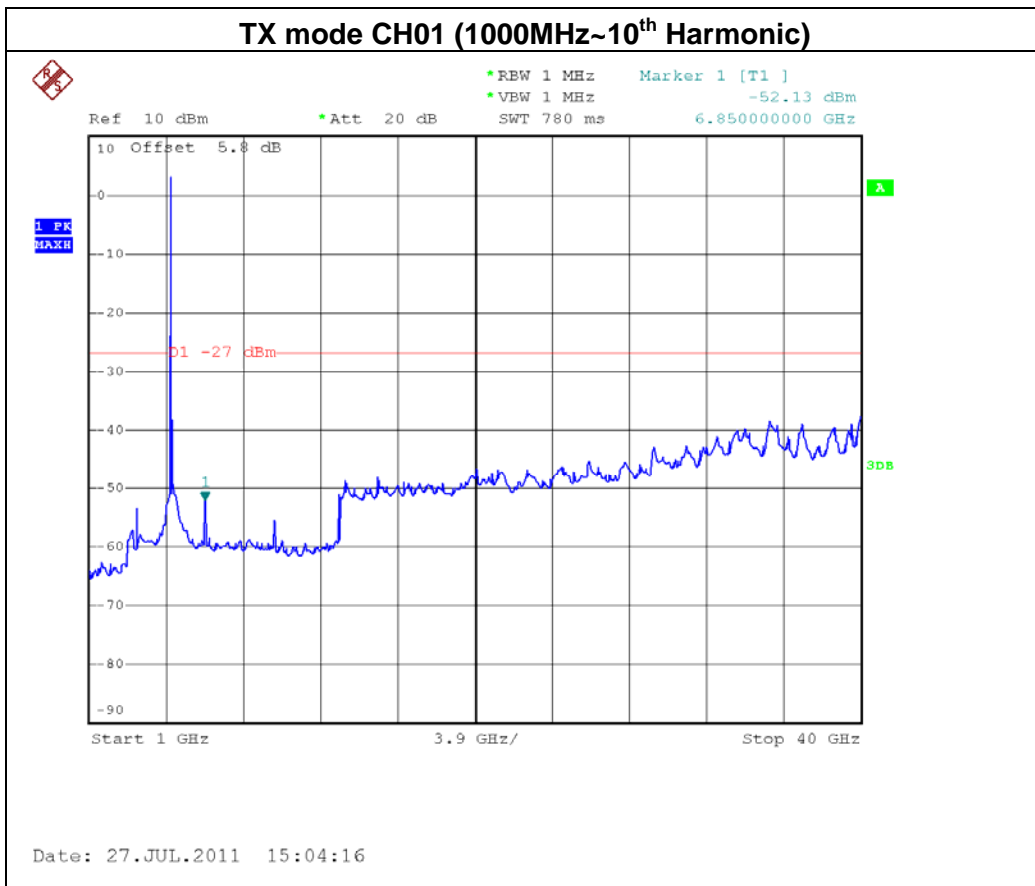
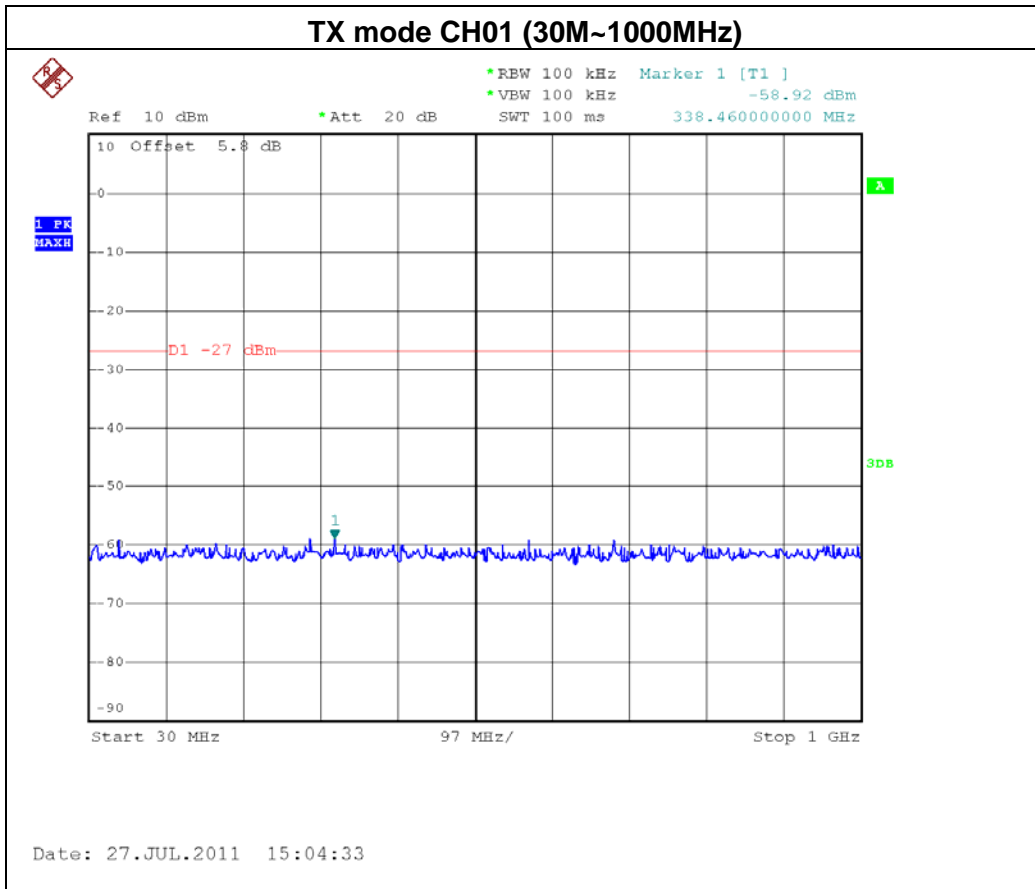

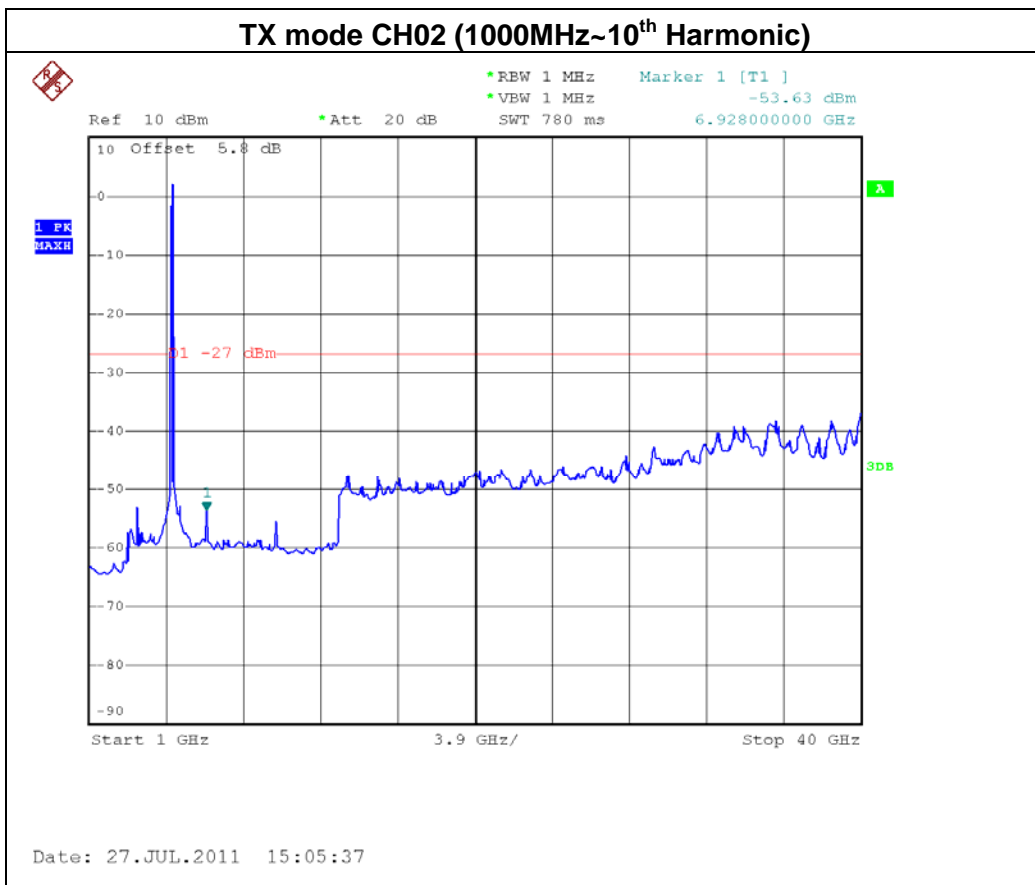
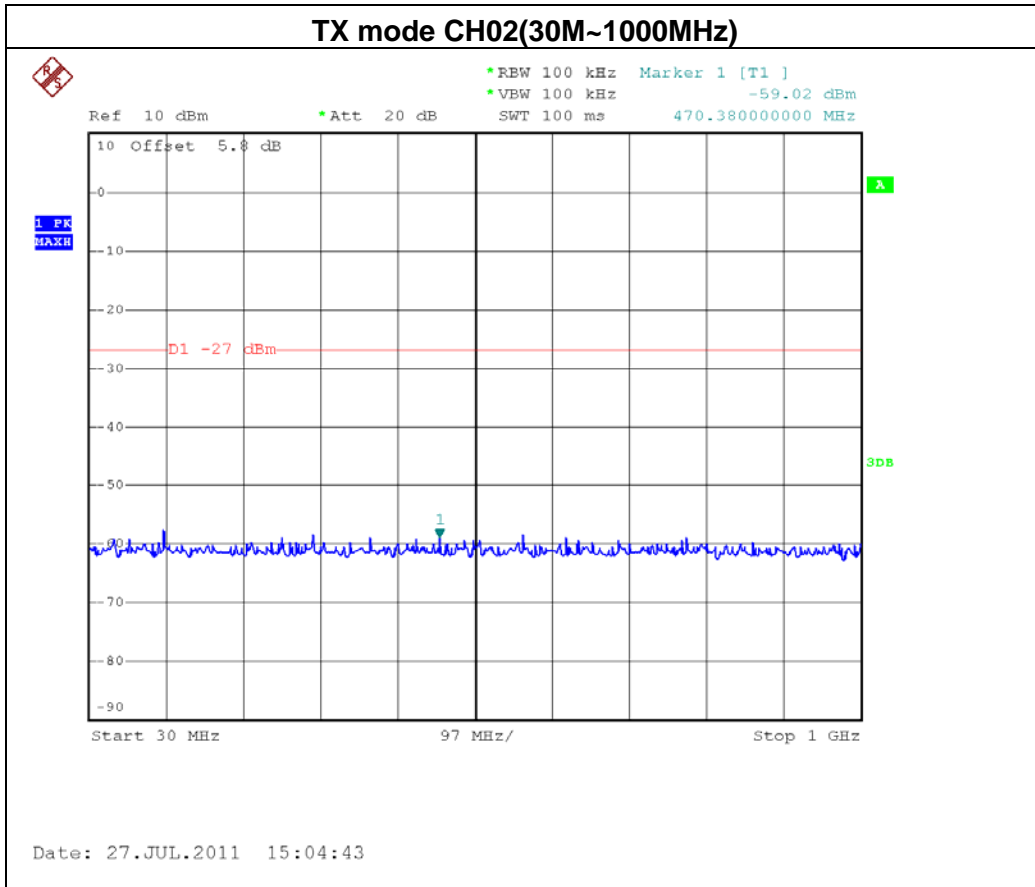

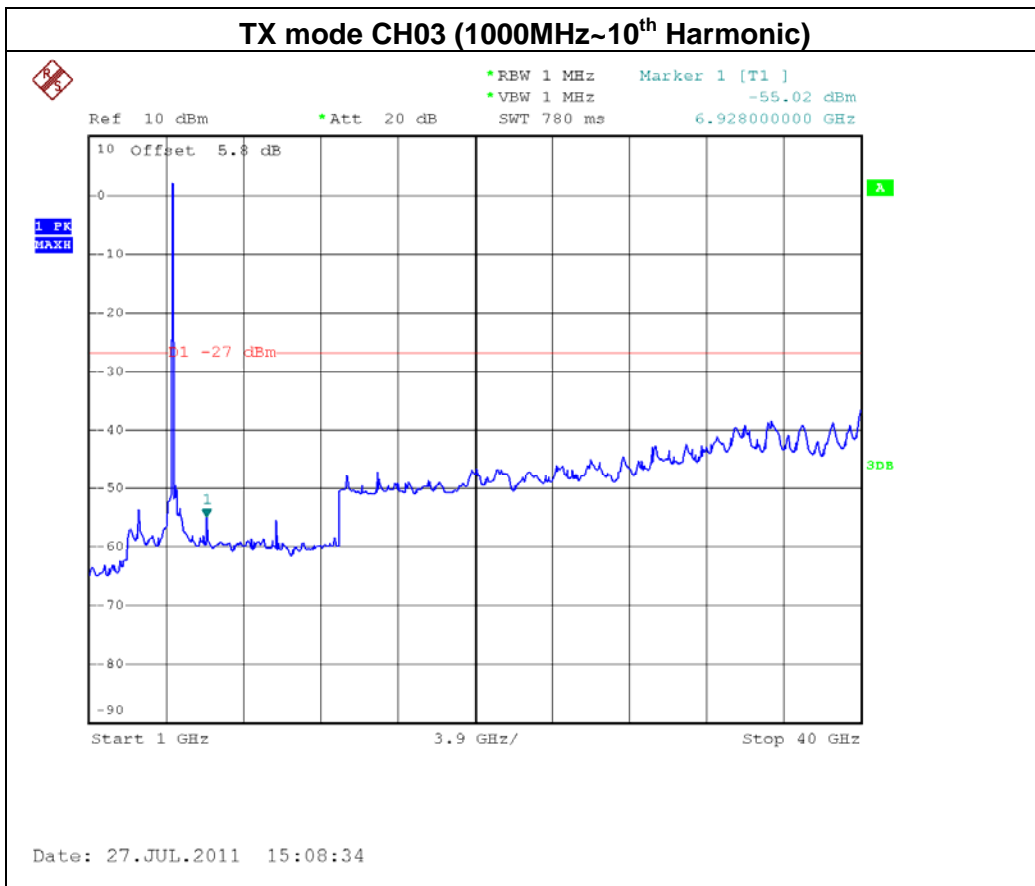
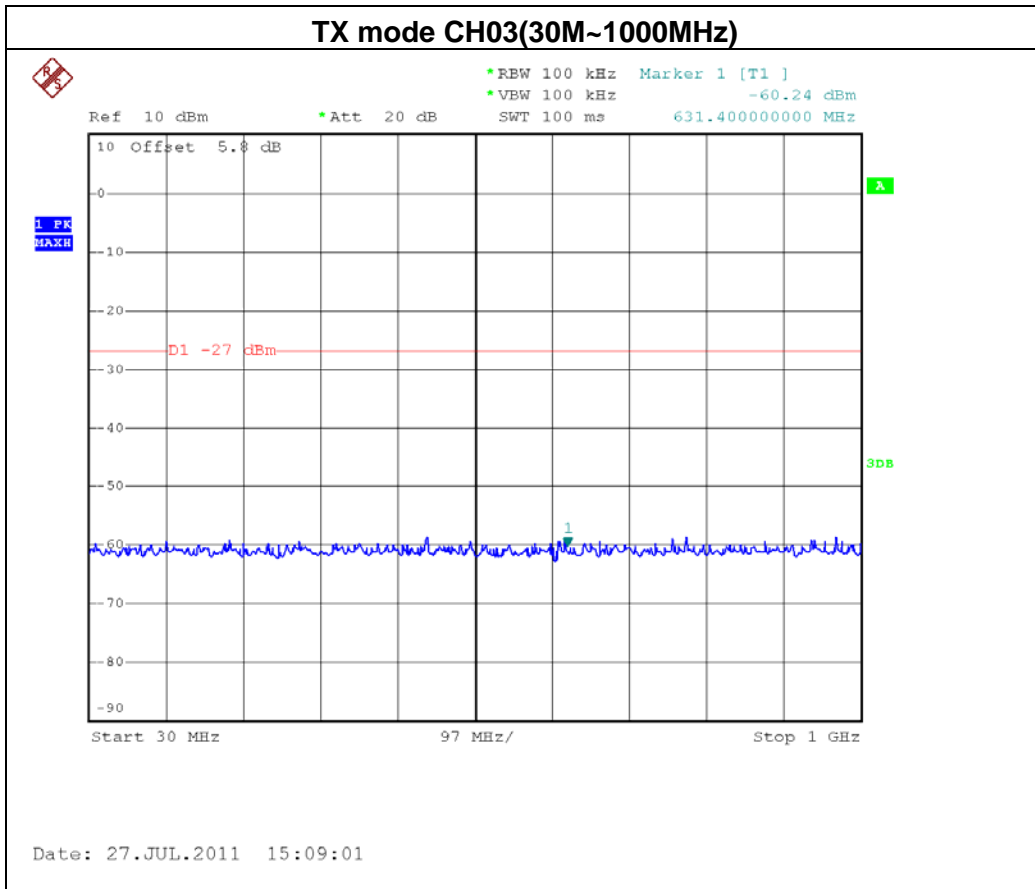



8. POWER SPECTRAL DENSITY TEST

8.1 APPLIED PROCEDURES / LIMIT

FCC Part15, Subpart E			
Test Item	Limit	Frequency Range (MHz)	Result
Power Spectral Density	4 dBm	5150 - 5250	PASS
	11 dBm	5250 - 5350	N/A
	11 dBm	5470 - 5725	N/A
	17 dBm	5725 - 5825	N/A

8.1.1 MEASUREMENT INSTRUMENTS LIST

Item	Kind of Equipment	Manufacturer	Type No.	Serial No.	Calibrated until
1	Spectrum Analyzer	R&S	FSP_40	100129	Jan. 04, 2012

Remark: " N/A" denotes No Model Name, Serial No. or No Calibration specified.

8.1.2 TEST PROCEDURE

a. The EUT was directly connected to the spectrum analyzer and antenna output port as show in the block diagram below,

b.

Spectrum Parameter	Setting
Attenuation	Auto
Span Frequency	Encompass the entire emissions bandwidth (EBW) of the signal
RB	1000 kHz
VB	1000 kHz
Detector	Peak
Trace	Max Hold
Sweep Time	Auto

8.1.3 DEVIATION FROM STANDARD

No deviation.

8.1.4 TEST SETUP

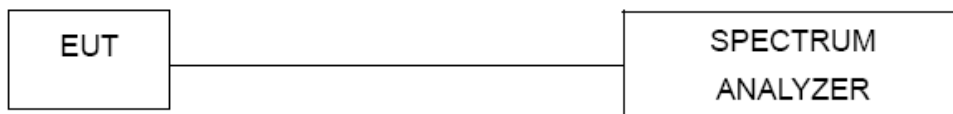

8.1.5 EUT OPERATION CONDITIONS

The EUT tested system was configured as the statements of 4.1.6 Unless otherwise a special operating condition is specified in the follows during the testing.



8.1.6 TEST RESULTS

EUT :	Half-size mini-PCle digital wireless audio module	Model Name :	DWPCle83
Temperature :	25 °C	Relative Humidity :	58 %
Test Voltage :	DC 3.3V		
Test Mode :	5.2G/CH01, CH02, CH03 (Antenna A)		

Test Channel	Frequency (MHz)	Power Density (dBm)	LIMIT (dBm)
CH01	5180	2.26	4.00
CH02	5210	1.50	4.00
CH03	5240	1.00	4.00

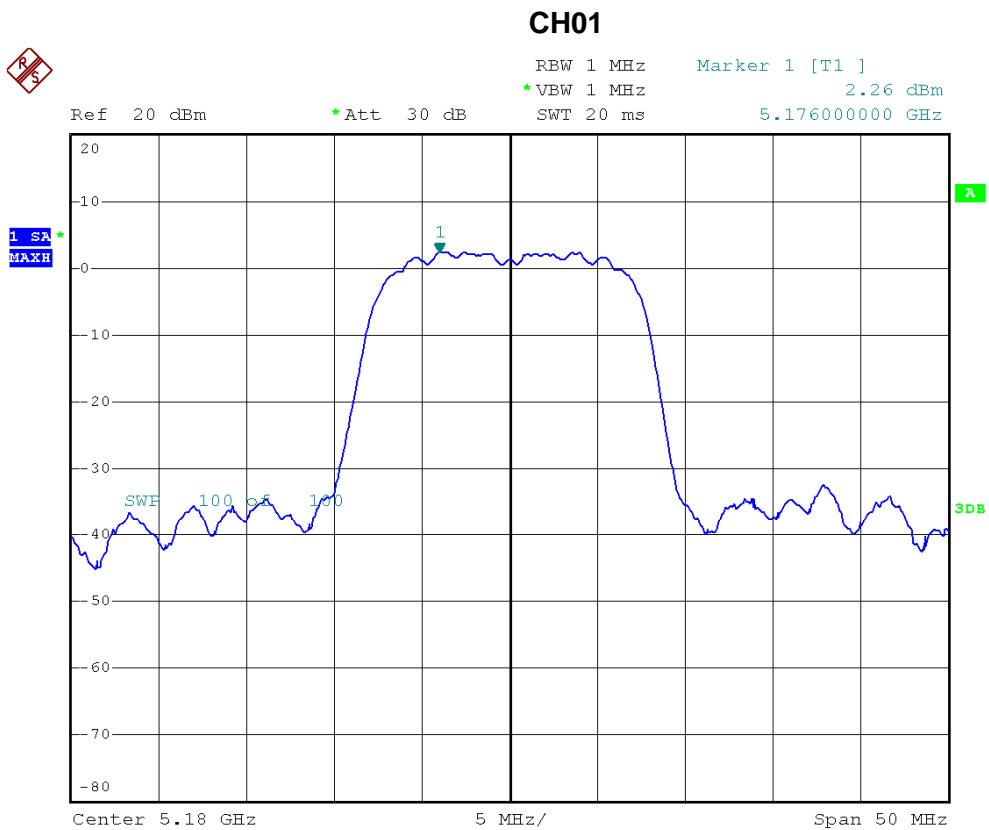

Date: 27.JUL.2011 14:46:55



CH02

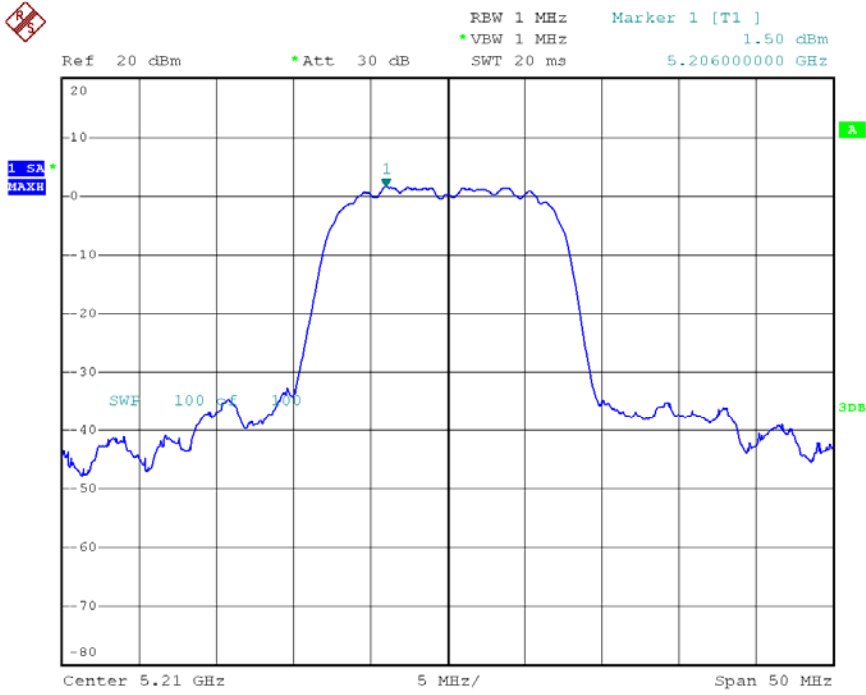

Date: 27.JUL.2011 14:47:24

CH03

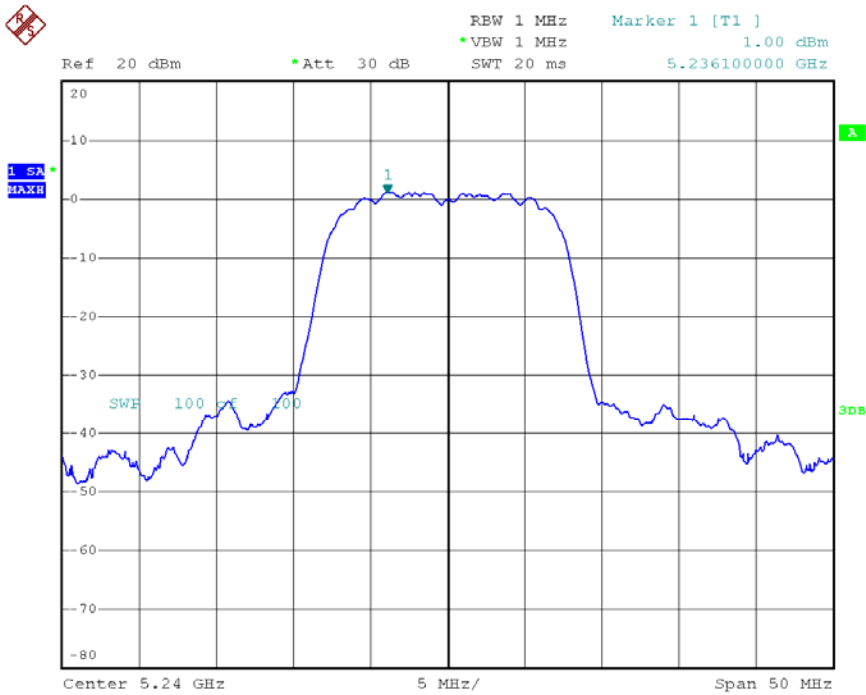

Date: 27.JUL.2011 14:48:13



EUT :	Half-size mini-PCle digital wireless audio module	Model Name :	DWPCle83
Temperature :	25 °C	Relative Humidity :	58 %
Test Voltage :	DC 3.3V		
Test Mode :	5.2G/CH01, CH02, CH03 (Antenna B)		

Test Channel	Frequency (MHz)	Power Density (dBm)	LIMIT (dBm)
CH01	5180	2.84	4.00
CH02	5210	2.42	4.00
CH03	5240	1.47	4.00

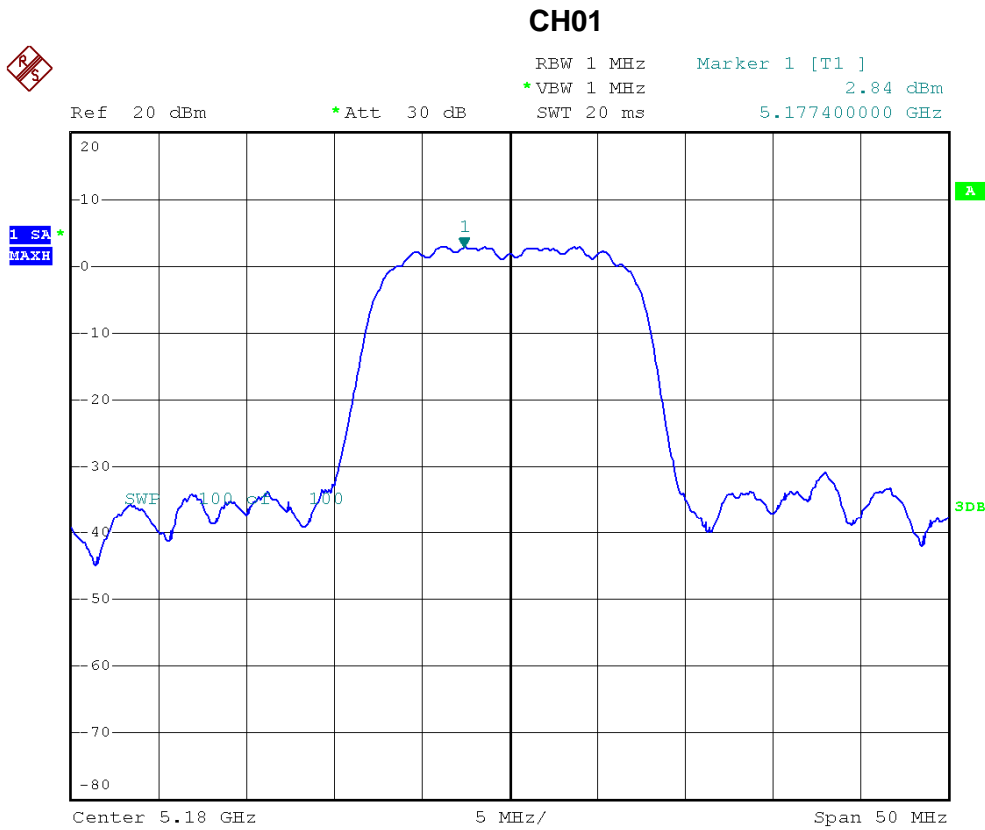

Date: 27.JUL.2011 14:51:23



CH02

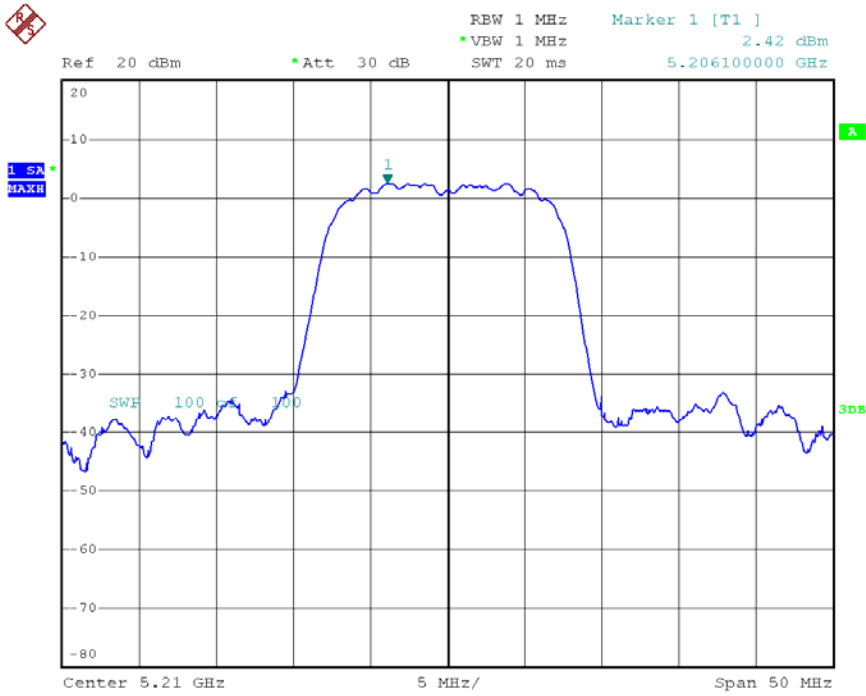

Date: 27.JUL.2011 14:51:41

CH03

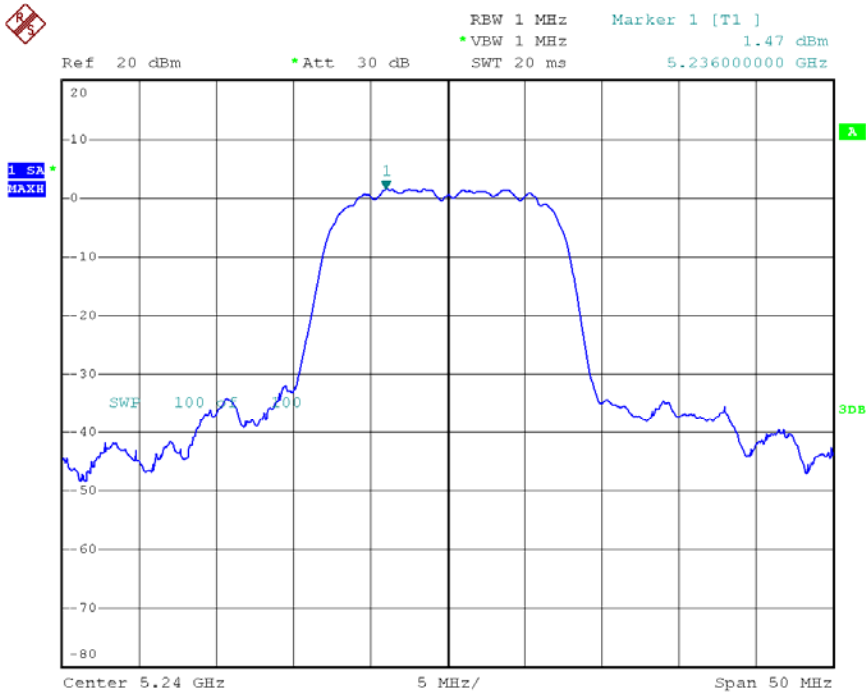

Date: 27.JUL.2011 14:52:22



9. Peak Excursion Measurement

9.1 APPLIED PROCEDURES / LIMIT

FCC Part15, Subpart E			
Test Item	Limit	Frequency Range (MHz)	Result
Peak Excursion Measurement	13 dB	5150 - 5250	PASS
		5250 - 5350	N/A
		5470 - 5725	N/A
		5725 - 5825	N/A

9.1.1 MEASUREMENT INSTRUMENTS LIST

Item	Kind of Equipment	Manufacturer	Type No.	Serial No.	Calibrated until
1	Spectrum Analyzer	R&S	FSP_40	100129	Jan. 04, 2012

Remark: " N/A" denotes No Model Name, Serial No. or No Calibration specified.

9.1.2 TEST PROCEDURE

a. The EUT was directly connected to the spectrum analyzer and antenna output port as show in the block diagram below,

b.

Spectrum Parameter	Setting
Attenuation	Auto
Span Frequency	Encompass the entire emissions bandwidth (EBW) of the signal
RB	1000 kHz (Peak Trace) / 1000 kHz (Average Trace)
VB	3000 kHz (Peak Trace) / 300 kHz (Average Trace)
Detector	Peak (Peak Trace) / Sample (Average Trace)
Trace	Max Hold
Sweep Time	60s

c. Peak Trace: Set RBW = 1 MHz, VBW ≥ 3 MHz with peak detector and maxhold settings.

d. Average Trace: Method #3—video averaging with max hold--and sum power across the band. Set span to encompass the entire emissions bandwidth (EBW) of the signal. Set sweep trigger to "free run". Set RBW = 1 MHz. Set VBW ≥ 1/T (IEEE 5.2GVBW = 300kHz ≥ 1/4μs). Use sample detector mode if bin width (i.e., span/number of points in spectrum) < 0.5 RBW. Otherwise use peak detector mode. Set max hold. Allow max hold to run for 60 seconds.

9.1.3 DEVIATION FROM STANDARD

No deviation.



9.1.4 TEST SETUP



9.1.5 EUT OPERATION CONDITIONS

The EUT tested system was configured as the statements of 4.1.6 Unless otherwise a special operating condition is specified in the follows during the testing.



9.1.6 TEST RESULTS

EUT :	Half-size mini-PCle digital wireless audio module	Model Name :	DWPCle83
Temperature :	25 °C	Relative Humidity :	58 %
Test Voltage :	DC 3.3V		
Test Mode :	5.2G/CH01, CH02, CH03 (Antenna A)		

Test Channel	Frequency (MHz)	Peak Excursion (dB)	LIMIT (dB)
CH01	5180	5.18	13
CH02	5210	5.21	13
CH03	5240	5.24	13

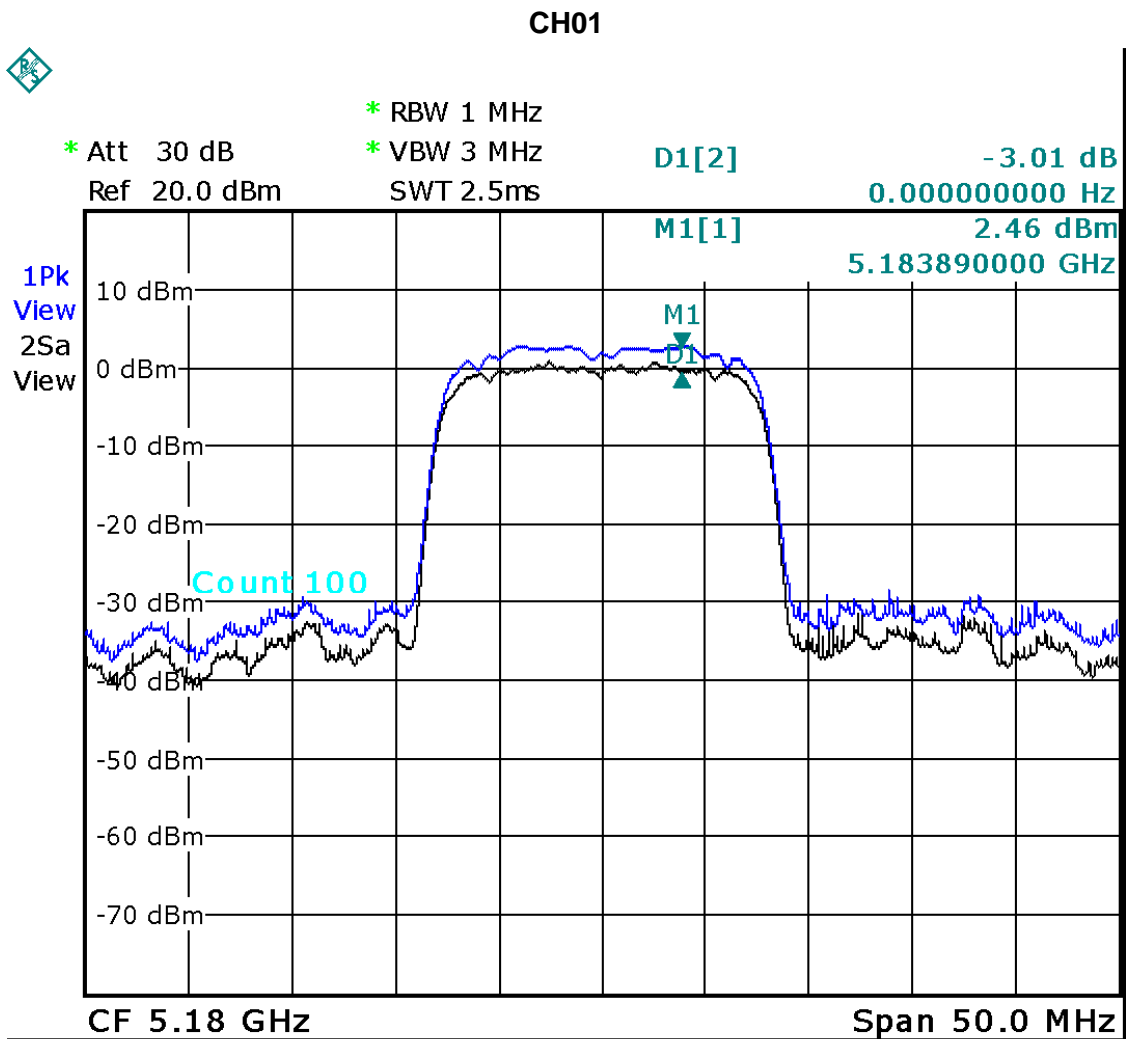

Date: 27.JUL.2011 17:26:19



CH02

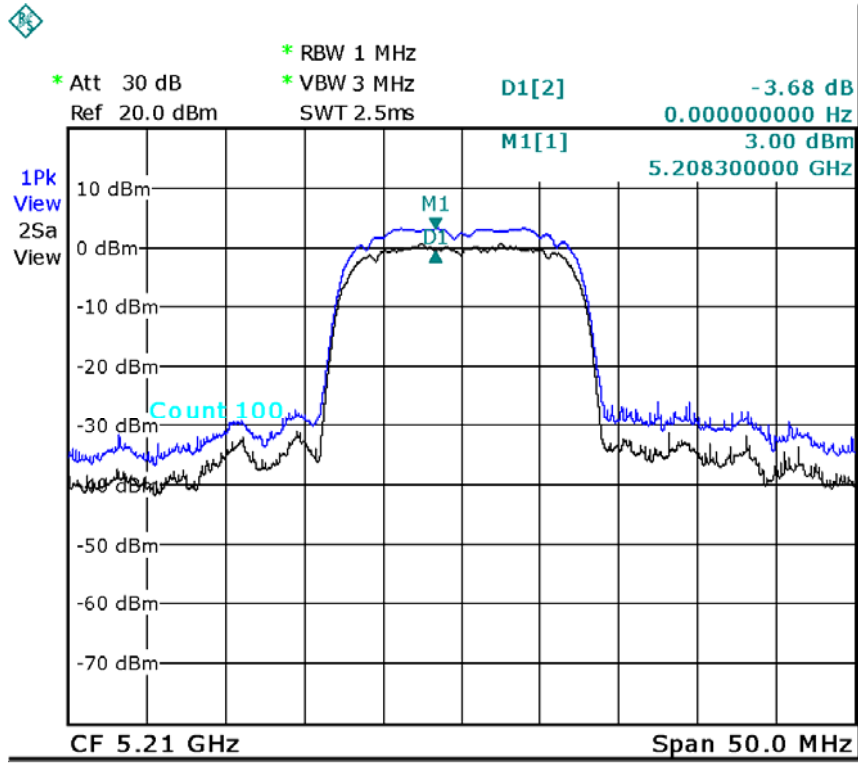

Date: 27.JUL.2011 17:36:19

CH03

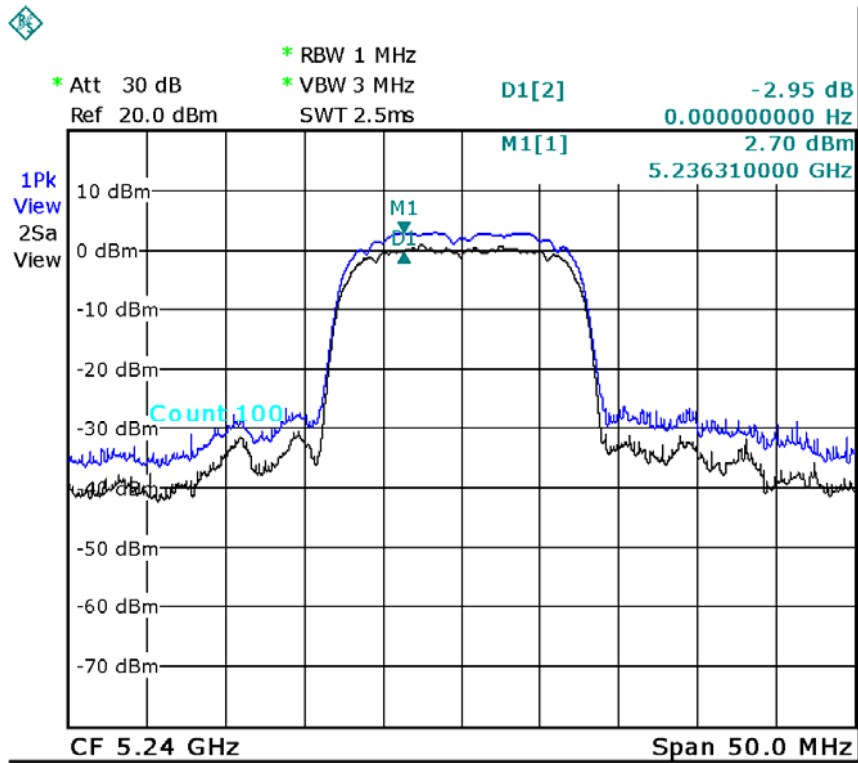

Date: 27.JUL.2011 17:39:16



EUT :	Half-size mini-PCIe digital wireless audio module	Model Name :	DWPCle83
Temperature :	25 °C	Relative Humidity :	58 %
Test Voltage :	DC 3.3V		
Test Mode :	5.2G/CH01, CH02, CH03 (Antenna B)		

Test Channel	Frequency (MHz)	Peak Excursion (dB)	LIMIT (dB)
CH01	5180	5.18	13
CH02	5210	5.24	13
CH03	5240	5.21	13

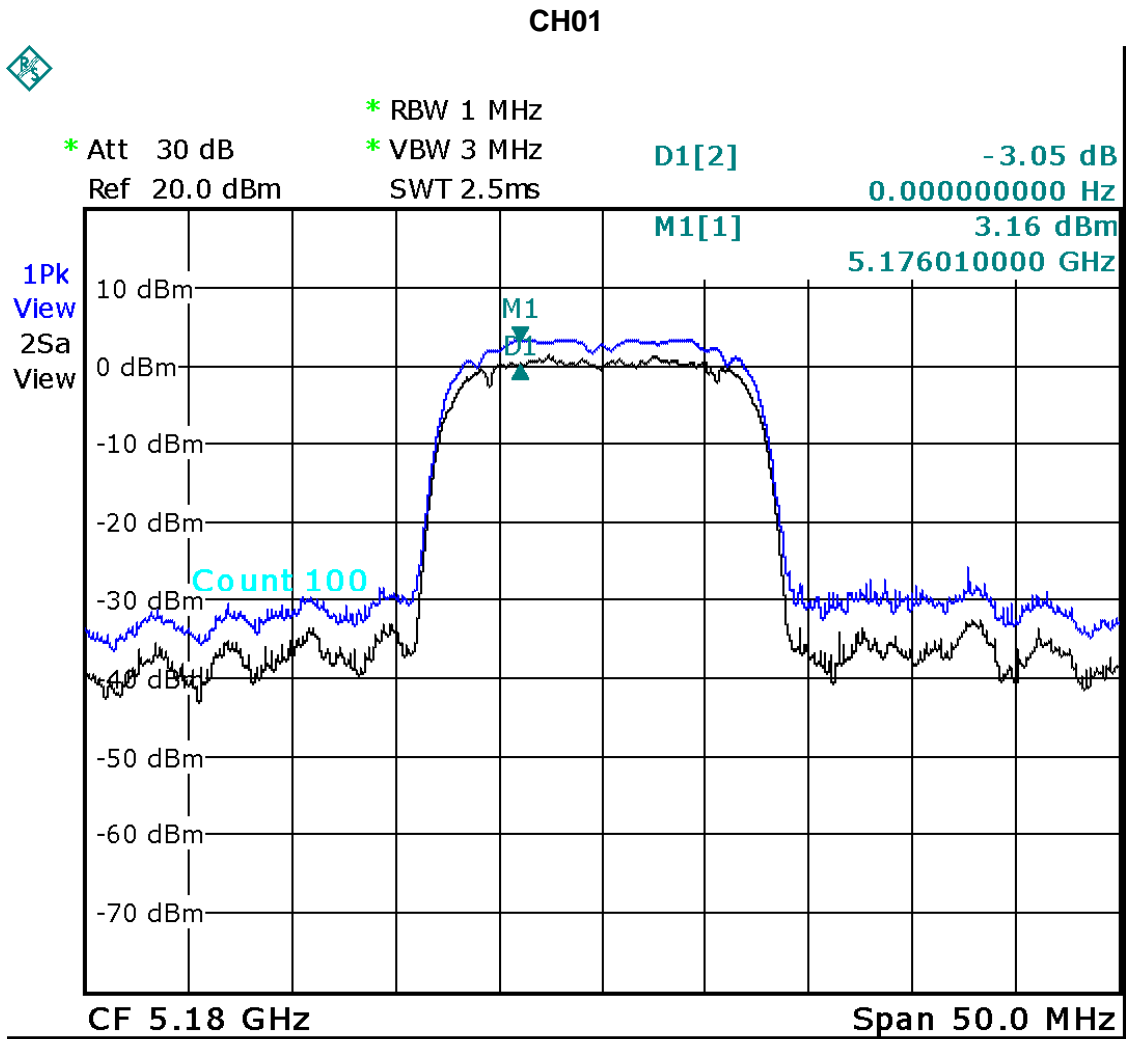

Date: 27.JUL.2011 17:48:38



CH02

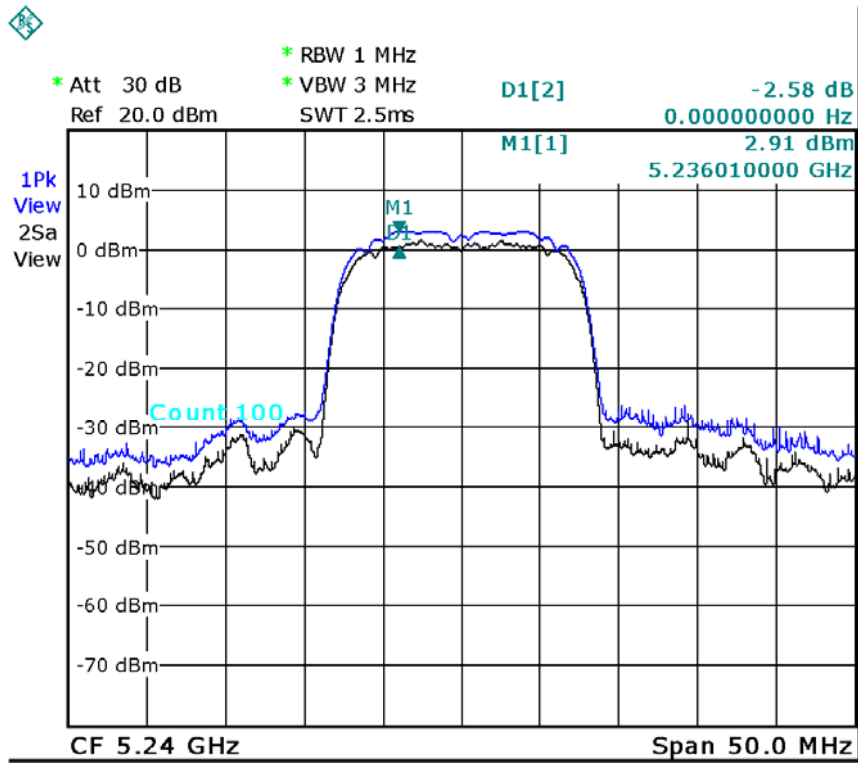

Date: 27.JUL.2011 17:43:58

CH03

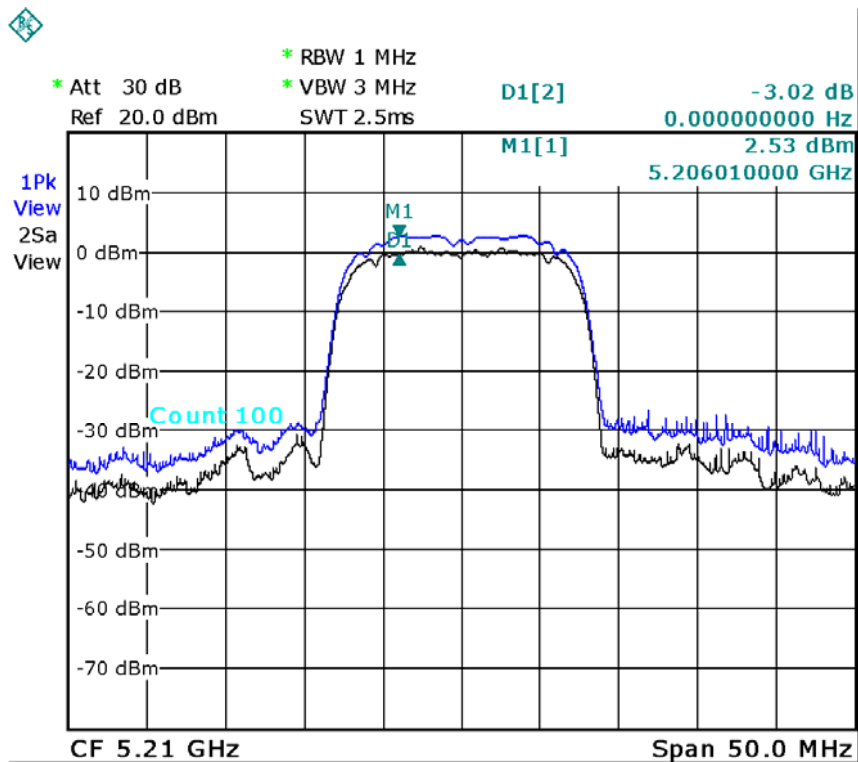

Date: 27.JUL.2011 17:46:36



10. Frequency Stability Measurement

10.1 APPLIED PROCEDURES / LIMIT

FCC Part15, Subpart E 15.407(g)			
Test Item	Limit	Frequency Range (MHz)	Result
Frequency Stability	specified in the user's manual	5150 - 5250	PASS
		5250 - 5350	N/A
		5470 - 5725	N/A
		5725 - 5825	N/A

10.1.1 MEASUREMENT INSTRUMENTS LIST

Item	Kind of Equipment	Manufacturer	Type No.	Serial No.	Calibrated until
1	Spectrum Analyzer	R&S	FSP_40	100129	Jan. 04, 2012
2	Precision Oven Tester	HOLINK	H-T-1F-D	BA03101701	May. 12, 2012

Remark: " N/A" denotes No Model Name, Serial No. or No Calibration specified.

10.1.2 TEST PROCEDURE

a. The EUT was directly connected to the spectrum analyzer and antenna output port as show in the block diagram below,

b.

Spectrum Parameter	Setting
Attenuation	Auto
Span Frequency	Entire absence of modulation emissions bandwidth
RB	10 kHz
VB	10 kHz
Sweep Time	Auto

c. The test extreme voltage is to change the primary supply voltage from 85 to 115 percent of the nominal value.

d. user manual temperature is 0°C~60°C.

10.1.3 DEVIATION FROM STANDARD

No deviation.



10.1.4 TEST SETUP

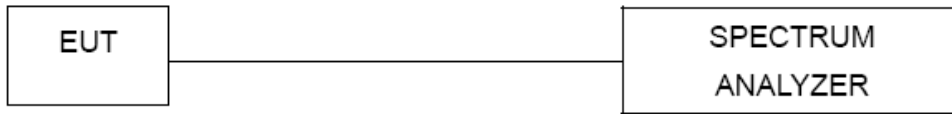

10.1.5 EUT OPERATION CONDITIONS

The EUT tested system was configured as the statements of 4.1.6 Unless otherwise a special operating condition is specified in the follows during the testing.



10.1.6 TEST RESULTS

EUT :	Half-size mini-PCle digital wireless audio module	Model Name :	DWPCle83
Temperature :	25 °C	Relative Humidity :	58 %
Test Voltage :	DC 3.3V		
Test Mode :	5.2G/CH01, CH02, CH03		

Voltage vs. Frequency Stability

Voltage	Measurement Frequency (MHz)	
(V)	5210	-
138.00	5210.004123	
120.00	5210.004214	
102.00	5210.004167	
Max. Deviation (MHz)	0.004214	
Max. Deviation (ppm)	0.81	

Temperature vs. Frequency Stability

Temperature	Measurement Frequency (MHz)	
(°C)	5210	-
0	5210.050400	
10	5210.025800	
20	5210.004140	
30	5199.982200	
40	5199.967600	
50	5199.961440	
60	5210.064460	
Max. Deviation (MHz)	0.074740	
Max. Deviation (ppm)	14.37	



11. EUT TEST PHOTO

Conducted Measurement Photos

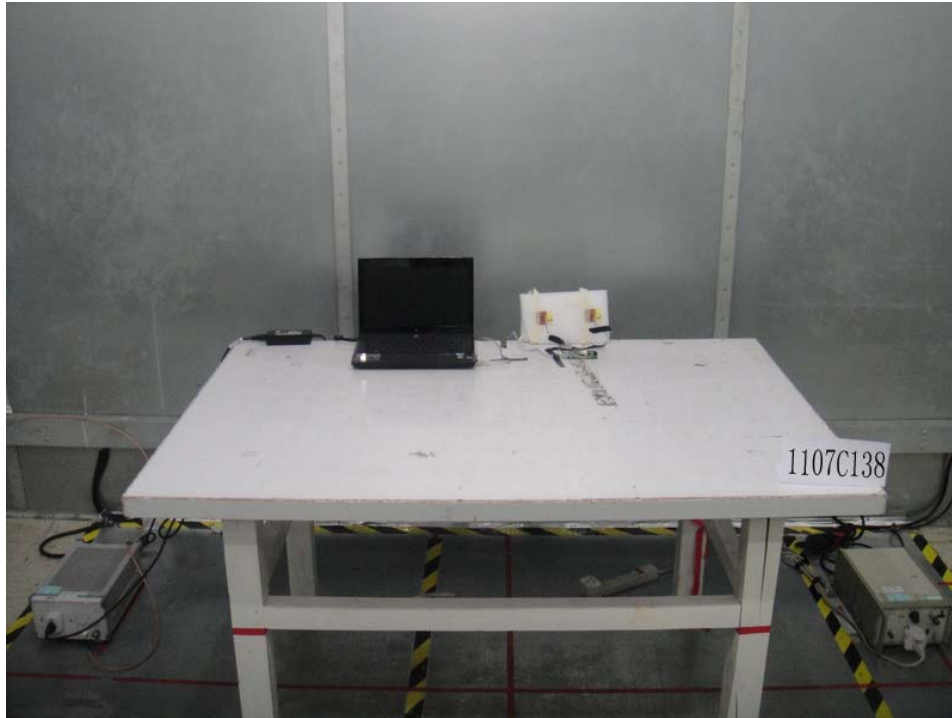



Radiated Measurement Photos

