



SAR EVALUATION REPORT

Applicant Name:
 LG Electronics MobileComm U.S.A., Inc.
 1000 Sylvan Avenue
 Englewood Cliffs, NJ 07632
 United States

Date of Testing:
 04/13/15 - 04/23/15
Test Site/Location:
 PCTEST Lab, Columbia, MD, USA
Document Serial No.:
 OY1504150740.ZNF

FCC ID: ZNFVN210

APPLICANT: LG ELECTRONICS MOBILECOMM U.S.A., INC.

DUT Type: Portable Handset
Application Type: Certification
FCC Rule Part(s): CFR §2.1093
Model(s): LG-VN210, LGVN210, VN210, LG-VN210PP, LGVN210PP, VN210PP

Equipment Class	Band & Mode	Tx Frequency	SAR	
			1 gm Head (W/kg)	1 gm Body-Worn (W/kg)
PCE	GSM/GPRS/EDGE 850	824.20 - 848.80 MHz	0.26	0.43
PCE	GSM/GPRS/EDGE 1900	1850.20 - 1909.80 MHz	0.57	0.50
PCE	Cell. CDMA	824.70 - 848.31 MHz	0.36	0.57
PCE	PCS CDMA	1851.25 - 1908.75 MHz	0.78	0.66
DSS	Bluetooth	2402 - 2480 MHz	N/A	
Simultaneous SAR per KDB 690783 D01v01r03:			N/A	0.76



This wireless portable device has been shown to be capable of compliance for localized specific absorption rate (SAR) for uncontrolled environment/general population exposure limits specified in ANSI/IEEE C95.1-1992 and has been tested in accordance with the measurement procedures specified in Section 1.7 of this report; for North American frequency bands only.

I attest to the accuracy of data. All measurements reported herein were performed by me or were made under my supervision and are correct to the best of my knowledge and belief. I assume full responsibility for the completeness of these measurements and vouch for the qualifications of all persons taking them. Test results reported herein relate only to the item(s) tested.

 Randy Ortanez
 President





The SAR Tick is an initiative of the Mobile Manufacturers Forum (MMF). While a product may be considered eligible, use of the SAR Tick logo requires an agreement with the MMF. Further details can be obtained by emailing: sartick@mmfai.info.

FCC ID: ZNFVN210	 PCTEST ENGINEERING LABORATORY, INC.	SAR EVALUATION REPORT	 LG	Reviewed by: Quality Manager
Document S/N: OY1504150740.ZNF	Test Dates: 04/13/15 - 04/23/15	DUT Type: Portable Handset	Page 1 of 29	

T A B L E O F C O N T E N T S

1	DEVICE UNDER TEST	3
2	INTRODUCTION	6
3	DOSIMETRIC ASSESSMENT	7
4	DEFINITION OF REFERENCE POINTS	8
5	TEST CONFIGURATION POSITIONS FOR HANDSETS	9
6	RF EXPOSURE LIMITS	12
7	FCC MEASUREMENT PROCEDURES.....	13
8	RF CONDUCTED POWERS.....	15
9	SYSTEM VERIFICATION.....	17
10	SAR DATA SUMMARY	19
11	FCC MULTI-TX AND ANTENNA SAR CONSIDERATIONS.....	22
12	SAR MEASUREMENT VARIABILITY	24
13	EQUIPMENT LIST.....	25
14	MEASUREMENT UNCERTAINTIES	26
15	CONCLUSION.....	27
16	REFERENCES	28
APPENDIX A: SAR TEST PLOTS		
APPENDIX B: SAR DIPOLE VERIFICATION PLOTS		
APPENDIX C: PROBE AND DIPOLE CALIBRATION CERTIFICATES		
APPENDIX D: SAR TISSUE SPECIFICATIONS		
APPENDIX E: SAR SYSTEM VALIDATION		
APPENDIX F: DUT ANTENNA DIAGRAM & SAR TEST SETUP PHOTOGRAPHS		

FCC ID: ZNFVN210	 PCTEST <small>ENGINEERING LABORATORY, INC.</small>	SAR EVALUATION REPORT		Reviewed by: Quality Manager
Document S/N: 0Y1504150740.ZNF	Test Dates: 04/13/15 - 04/23/15	DUT Type: Portable Handset	Page 2 of 29	

1 DEVICE UNDER TEST

1.1 Device Overview

Band & Mode	Operating Modes	Tx Frequency
GSM/GPRS/EDGE 850	Voice/Data	824.20 - 848.80 MHz
GSM/GPRS/EDGE 1900	Voice/Data	1850.20 - 1909.80 MHz
Cell. CDMA	Voice/Data	824.70 - 848.31 MHz
PCS CDMA	Voice/Data	1851.25 - 1908.75 MHz
Bluetooth	Data	2402 - 2480 MHz



1.2 Nominal and Maximum Output Power Specifications

This device operates using the following maximum and nominal output power specifications. SAR values were scaled to the maximum allowed power to determine compliance per KDB Publication 447498 D01v05.

Mode / Band		Voice (dBm)	Burst Average GMSK (dBm)		Burst Average 8-PSK (dBm)	
		1 TX Slot	1 TX Slots	2 TX Slots	1 TX Slots	2 TX Slots
GSM/GPRS/EDGE 850	Maximum	32.7	32.7	31.7	26.7	25.7
	Nominal	32.2	32.2	31.2	26.2	25.2
GSM/GPRS/EDGE 1900	Maximum	29.7	29.7	28.7	25.7	24.7
	Nominal	29.2	29.2	28.2	25.2	24.2

Mode / Band		Modulated Average (dBm)
Cell. CDMA	Maximum	25.0
	Nominal	24.5
PCS CDMA	Maximum	25.0
	Nominal	24.5

Mode / Band		Modulated Average (dBm)
Bluetooth	Maximum	8.5
	Nominal	7.5

FCC ID: ZNFVN210	 PCTEST ENGINEERING LABORATORY, INC.	SAR EVALUATION REPORT		Reviewed by: Quality Manager
Document S/N: OY1504150740.ZNF	Test Dates: 04/13/15 - 04/23/15	DUT Type: Portable Handset		Page 3 of 29

1.3 DUT Antenna Locations

The overall dimensions of this device are > 9 x 5 cm. The overall diagonal dimension of the device is <160 mm and the diagonal display is <150 mm. A diagram showing the location of the device antennas can be found in Appendix F.

1.4 Simultaneous Transmission Capabilities

According to FCC KDB Publication 447498 D05v01, transmitters are considered to be transmitting simultaneously when there is overlapping transmission, with the exception of transmissions during network hand-offs with maximum hand-off duration less than 30 seconds.

This device contains multiple transmitters that may operate simultaneously, and therefore requires a simultaneous transmission analysis according to FCC KDB Publication 447498 D01v05 3) procedures.

**Table 1-1
Simultaneous Transmission Scenarios**

No.	Capable Transmit Configuration	Head	Body-Worn Accessory	Notes
1	1x CDMA voice + 2.4 GHz Bluetooth	N/A	Yes	
2	GSM voice + 2.4 GHz Bluetooth	N/A	Yes	
3	GPRS/EDGE + 2.4 GHz Bluetooth	N/A	Yes*	*-Pre-installed VOIP applications are considered.

Note: All licensed modes share the same antenna path and cannot transmit simultaneously.

1.5 Miscellaneous SAR Test Considerations

(A) WIFI/BT

Per FCC KDB 447498 D01v05, the 1g SAR exclusion threshold for distances <50mm is defined by the following equation:

$$\frac{\text{Max Power of Channel (mW)}}{\text{Test Separation Dist (mm)}} * \sqrt{\text{Frequency(GHz)}} \leq 3.0$$

Based on the maximum conducted power of Bluetooth (rounded to the nearest mW) and the antenna to user separation distance, body-worn Bluetooth SAR was not required; $[(7/15)^* \sqrt{2.480}] = 0.7 < 3.0$. Per KDB Publication 447498 D01v05, the maximum power of the channel was rounded to the nearest mW before calculation.

(B) Licensed Transmitter(s)



GSM/GPRS/EDGE DTM is not supported for US bands. Therefore, the GSM Voice modes in this report do not transmit simultaneously with GPRS/EDGE Data.

1.6 Power Reduction for SAR

There is no power reduction used for any band/mode implemented in this device for SAR purposes.

1.7 Guidance Applied

- IEEE 1528-2003



FCC ID: ZNFVN210	 PCTEST ENGINEERING LABORATORY, INC.	SAR EVALUATION REPORT		Reviewed by: Quality Manager
Document S/N: OY1504150740.ZNF	Test Dates: 04/13/15 - 04/23/15	DUT Type: Portable Handset	Page 4 of 29	

- FCC KDB Publication 941225 D01v03, D06v02 (2G/3G)
- FCC KDB Publication 447498 D01v05r02 (General SAR Guidance)
- FCC KDB Publication 865664 D01v01r03, D02v01r01 (SAR Measurements up to 6 GHz)
- October 2013 TCB Workshop Notes (GPRS Testing Considerations)

1.8 Device Serial Numbers

Several samples with identical hardware were used to support SAR testing. The manufacturer has confirmed that the device(s) tested have the same physical, mechanical and thermal characteristics and are within operational tolerances expected for production units.

	Head Serial Number	Body-Worn Serial Number
GSM/GPRS/EDGE 850	AE066E	1WRM1
GSM/GPRS/EDGE 1900	1WRM1	1WRM1
Cell. CDMA	AE066E	1WRM1
PCS CDMA	59C36	1WRM1

FCC ID: ZNFVN210	 PCTEST ENGINEERING LABORATORY, INC.	SAR EVALUATION REPORT	 LG	Reviewed by: Quality Manager
Document S/N: 0Y1504150740.ZNF	Test Dates: 04/13/15 - 04/23/15	DUT Type: Portable Handset		Page 5 of 29

2 INTRODUCTION

The FCC and Industry Canada have adopted the guidelines for evaluating the environmental effects of radio frequency (RF) radiation in ET Docket 93-62 on Aug. 6, 1996 and Health Canada Safety Code 6 to protect the public and workers from the potential hazards of RF emissions due to FCC-regulated portable devices. [1]

The safety limits used for the environmental evaluation measurements are based on the criteria published by the American National Standards Institute (ANSI) for localized specific absorption rate (SAR) in IEEE/ANSI C95.1-1992 Standard for Safety Levels with Respect to Human Exposure to Radio Frequency Electromagnetic Fields, 3 kHz to 300 GHz [3] and Health Canada RF Exposure Guidelines Safety Code 6 [22]. The measurement procedure described in IEEE/ANSI C95.3-2002 Recommended Practice for the Measurement of Potentially Hazardous Electromagnetic Fields - RF and Microwave [4] is used for guidance in measuring the Specific Absorption Rate (SAR) due to the RF radiation exposure from the Equipment Under Test (EUT). These criteria for SAR evaluation are similar to those recommended by the International Committee for Non-Ionizing Radiation Protection (ICNIRP) in Biological Effects and Exposure Criteria for Radiofrequency Electromagnetic Fields,” Report No. Vol 74. SAR is a measure of the rate of energy absorption due to exposure to an RF transmitting source. SAR values have been related to threshold levels for potential biological hazards.

2.1 SAR Definition

Specific Absorption Rate is defined as the time derivative (rate) of the incremental energy (dU) absorbed by (dissipated in) an incremental mass (dm) contained in a volume element (dV) of a given density (ρ). It is also defined as the rate of RF energy absorption per unit mass at a point in an absorbing body (see Equation 2-1).

Equation 2-1
SAR Mathematical Equation

$$SAR = \frac{d}{dt} \left(\frac{dU}{dm} \right) = \frac{d}{dt} \left(\frac{dU}{\rho dv} \right)$$



SAR is expressed in units of Watts per Kilogram (W/kg).

$$SAR = \frac{\sigma \cdot E^2}{\rho}$$

where:

- σ = conductivity of the tissue-simulating material (S/m)
- ρ = mass density of the tissue-simulating material (kg/m³)
- E = Total RMS electric field strength (V/m)

NOTE: The primary factors that control rate of energy absorption were found to be the wavelength of the incident field in relation to the dimensions and geometry of the irradiated organism, the orientation of the organism in relation to the polarity of field vectors, the presence of reflecting surfaces, and whether conductive contact is made by the organism with a ground plane.[6]

FCC ID: ZNFVN210	 SAR EVALUATION REPORT 		Reviewed by: Quality Manager
Document S/N: 0Y1504150740.ZNF	Test Dates: 04/13/15 - 04/23/15	DUT Type: Portable Handset	Page 6 of 29

3 DOSIMETRIC ASSESSMENT

3.1 Measurement Procedure

The evaluation was performed using the following procedure compliant to FCC KDB Publication 865664 D01v01 and IEEE 1528-2013:

1. The SAR distribution at the exposed side of the head or body was measured at a distance no greater than 5.0 mm from the inner surface of the shell. The area covered the entire dimension of the device-head and body interface and the horizontal grid resolution was determined per FCC KDB Publication 865664 D01v01 (See Table 3-1) and IEEE 1528-2013.
2. The point SAR measurement was taken at the maximum SAR region determined from Step 1 to enable the monitoring of SAR fluctuations/drifts during the 1g/10g cube evaluation. SAR at this fixed point was measured and used as a reference value.
3. Based on the area scan data, the peak of the region with maximum SAR was determined by spline interpolation. Around this point, a volume was assessed according to the measurement resolution and volume size requirements of FCC KDB Publication 865664 D01v01 (See Table 3-1) and IEEE 1528-2013. On the basis of this data set, the spatial peak SAR value was evaluated with the following procedure (see references or the DASy manual online for more details):
 - a. SAR values at the inner surface of the phantom are extrapolated from the measured values along the line away from the surface with spacing no greater than that in Table 3-1. The extrapolation was based on a least-squares algorithm. A polynomial of the fourth order was calculated through the points in the z-axis (normal to the phantom shell).
 - b. After the maximum interpolated values were calculated between the points in the cube, the SAR was averaged over the spatial volume (1g or 10g) using a 3D-Spline interpolation algorithm. The 3D-spline is composed of three one-dimensional splines with the “Not a knot” condition (in x, y, and z directions). The volume was then integrated with the trapezoidal algorithm. One thousand points (10 x 10 x 10) were obtained through interpolation, in order to calculate the averaged SAR.
 - c. All neighboring volumes were evaluated until no neighboring volume with a higher average value was found.
4. The SAR reference value, at the same location as step 2, was re-measured after the zoom scan was complete to calculate the SAR drift. If the drift deviated by more than 5%, the SAR test and drift measurements were repeated.

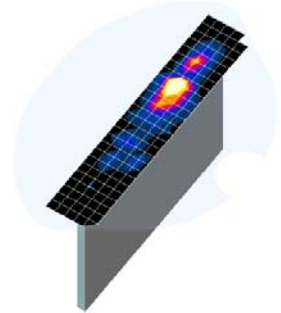

**Figure 3-1
Sample SAR Area
Scan**

**Table 3-1
Area and Zoom Scan Resolutions per FCC KDB Publication 865664 D01v01***

Frequency	Maximum Area Scan Resolution (mm) ($\Delta x_{area}, \Delta y_{area}$)	Maximum Zoom Scan Resolution (mm) ($\Delta x_{zoom}, \Delta y_{zoom}$)	Maximum Zoom Scan Spatial Resolution (mm)			Minimum Zoom Scan Volume (mm) (x,y,z)
			Uniform Grid	Graded Grid		
			$\Delta z_{zoom}(n)$	$\Delta z_{zoom}(1)^*$	$\Delta z_{zoom}(n>1)^*$	
≤ 2 GHz	≤ 15	≤ 8	≤ 5	≤ 4	≤ 1.5* $\Delta z_{zoom}(n-1)$	≥ 30
2-3 GHz	≤ 12	≤ 5	≤ 5	≤ 4	≤ 1.5* $\Delta z_{zoom}(n-1)$	≥ 30
3-4 GHz	≤ 12	≤ 5	≤ 4	≤ 3	≤ 1.5* $\Delta z_{zoom}(n-1)$	≥ 28
4-5 GHz	≤ 10	≤ 4	≤ 3	≤ 2.5	≤ 1.5* $\Delta z_{zoom}(n-1)$	≥ 25
5-6 GHz	≤ 10	≤ 4	≤ 2	≤ 2	≤ 1.5* $\Delta z_{zoom}(n-1)$	≥ 22

*Also compliant to IEEE 1528-2013 Table 6

FCC ID: ZNFVN210	PCTEST <small>ENGINEERING LABORATORY, INC.</small>		SAR EVALUATION REPORT		Reviewed by: Quality Manager
Document S/N: OY1504150740.ZNF	Test Dates: 04/13/15 - 04/23/15	DUT Type: Portable Handset			Page 7 of 29

4 DEFINITION OF REFERENCE POINTS

4.1 EAR REFERENCE POINT

Figure 4-2 shows the front, back and side views of the SAM Twin Phantom. The point “M” is the reference point for the center of the mouth, “LE” is the left ear reference point (ERP), and “RE” is the right ERP. The ERP is 15mm posterior to the entrance to the ear canal (EEC) along the B-M line (Back-Mouth), as shown in Figure 4-1. The plane passing through the two ear canals and M is defined as the Reference Plane. The line N-F (Neck-Front), also called the Reference Pivoting Line, is not perpendicular to the reference plane (see Figure 4-1). Line B-M is perpendicular to the N-F line. Both N-F and B-M lines are marked on the external phantom shell to facilitate handset positioning [5].

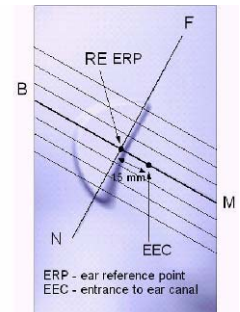

Figure 4-1
Close-Up Side view of ERP

4.2 HANDSET REFERENCE POINTS

Two imaginary lines on the handset were established: the vertical centerline and the horizontal line. The test device was placed in a normal operating position with the acoustic output located along the “vertical centerline” on the front of the device aligned to the “ear reference point” (See Figure 4-3). The acoustic output was then located at the same level as the center of the ear reference point. The test device was positioned so that the “vertical centerline” was bisecting the front surface of the handset at its top and bottom edges, positioning the “ear reference point” on the outer surface of the both the left and right head phantoms on the ear reference point.



Figure 4-2
Front, back and side view of SAM Twin Phantom

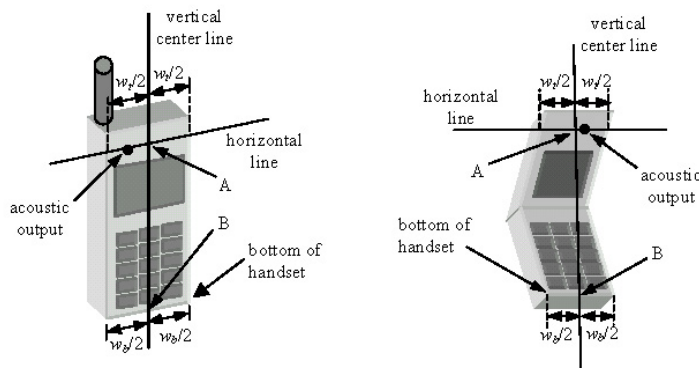



Figure 4-3
Handset Vertical Center & Horizontal Line Reference Points

FCC ID: ZNFVN210	 PCTEST ENGINEERING LABORATORY, INC.	SAR EVALUATION REPORT	 LG	Reviewed by: Quality Manager
Document S/N: OY1504150740.ZNF	Test Dates: 04/13/15 - 04/23/15	DUT Type: Portable Handset		Page 8 of 29

5 TEST CONFIGURATION POSITIONS FOR HANDSETS

5.1 Device Holder

The device holder is made out of low-loss POM material having the following dielectric parameters: relative permittivity $\epsilon = 3$ and loss tangent $\delta = 0.02$.

5.2 Positioning for Cheek

1. The test device was positioned with the device close to the surface of the phantom such that point A is on the (virtual) extension of the line passing through points RE and LE on the phantom (see Figure 5-1), such that the plane defined by the vertical center line and the horizontal line of the phone is approximately parallel to the sagittal plane of the phantom.

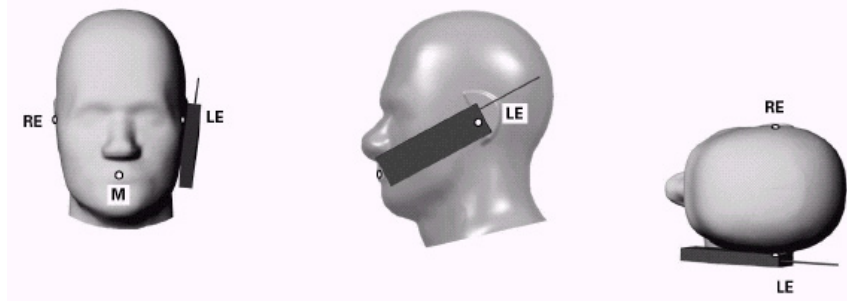



Figure 5-1 Front, Side and Top View of Cheek Position

2. The handset was translated towards the phantom along the line passing through RE & LE until the handset touches the pinna.
3. While maintaining the handset in this plane, the handset was rotated around the LE-RE line until the vertical centerline was in the reference plane.
4. The phone was then rotated around the vertical centerline until the phone (horizontal line) was symmetrical with respect to the line NF.
5. While maintaining the vertical centerline in the reference plane, keeping point A on the line passing through RE and LE, and maintaining the device contact with the ear, the device was rotated about the NF line until any point on the handset made contact with a phantom point below the ear (cheek) (See Figure 5-2).

5.3 Positioning for Ear / 15° Tilt

With the test device aligned in the “Cheek Position”:

1. While maintaining the orientation of the phone, the phone was retracted parallel to the reference plane far enough to enable a rotation of the phone by 15 degrees.
2. The phone was then rotated around the horizontal line by 15 degrees.
3. While maintaining the orientation of the phone, the phone was moved parallel to the reference plane until any part of the handset touched the head. (In this position, point A was located on the line RE-LE). The tilted position is obtained when the contact is on the pinna. If the contact was at any location other than the pinna, the angle of the phone would then be reduced. In this situation, the tilted position was obtained when any part of the phone was in contact of the ear as well as a second part of the phone was in contact with the head (see Figure 5-2).

FCC ID: ZNFVN210	 PCTEST ENGINEERING LABORATORY, INC.	SAR EVALUATION REPORT	 LG	Reviewed by: Quality Manager
Document S/N: OY1504150740.ZNF	Test Dates: 04/13/15 - 04/23/15	DUT Type: Portable Handset		Page 9 of 29

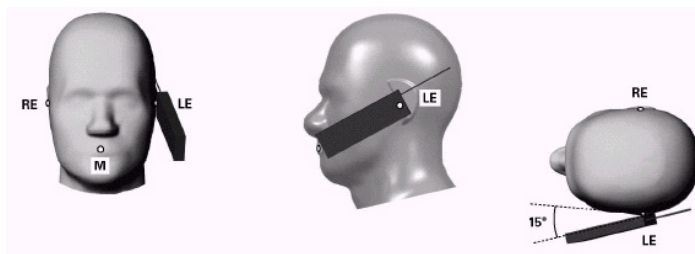

Figure 5-2 Front, Side and Top View of Ear/15° Tilt Position

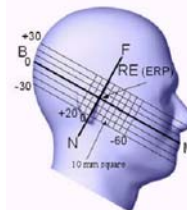

Figure 5-3 Side view w/ relevant markings

5.4 SAR Evaluations near the Mouth/Jaw Regions of the SAM Phantom

Antennas located near the bottom of a phone may require SAR measurements around the mouth and jaw regions of the SAM head phantom. This typically applies to clam-shell style phones that are generally longer in the unfolded normal use positions or to certain older style long rectangular phones. Per IEEE 1528-2013, a rotated SAM phantom is necessary to allow probe access to such regions. Both SAM heads of the TwinSAM-Chin20 are rotated 20 degrees around the NF line. Each head can be removed from the table for emptying and cleaning.

Under these circumstances, the following procedures apply, adopted from the FCC guidance on SAR handsets document FCC KDB Publication 648474 D04_v01. The SAR required in these regions of SAM should be measured using a flat phantom. The phone should be positioned with a separation distance of 4 mm between the ear reference point (ERP) and the outer surface of the flat phantom shell. While maintaining this distance at the ERP location, the low (bottom) edge of the phone should be lowered from the phantom to establish the same separation distance between the peak SAR location identified by the truncated partial SAR distribution measured with the SAM phantom. The distance from the peak SAR location to the phone is determined by the straight line passing perpendicularly through the phantom surface. When it is not feasible to maintain 4 mm separation at the ERP while also establishing the required separation at the peak SAR location, the top edge of the phone will be allowed to touch the phantom with a separation < 4 mm at the ERP. The phone should not be tilted to the left or right while placed in this inclined position to the flat phantom.

5.5 Body-Worn Accessory Configurations

Body-worn operating configurations are tested with the belt-clips and holsters attached to the device and positioned against a flat phantom in a normal use configuration (see Figure 5-4). Per FCC KDB Publication 648474 D04v01, Body-worn accessory exposure is typically related to voice mode operations when handsets are carried in body-worn accessories. The body-worn accessory procedures in FCC KDB Publication 447498 D01v05 should be used to test for body-worn accessory SAR compliance, without a headset connected to it. This enables the test results for such configuration to be compatible with that required for hotspot mode when the body-worn accessory test separation distance is greater than or equal to that required for hotspot mode, when applicable. When the reported SAR for a body-worn accessory, measured without a headset connected to the handset, is > 1.2 W/kg, the highest reported SAR configuration for that wireless mode and frequency band should be repeated for that body-worn accessory with a headset attached to the handset.

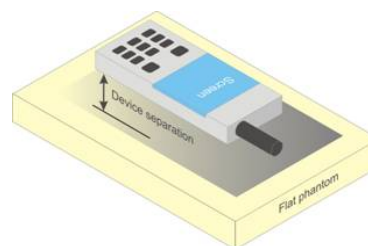



Figure 5-4 Sample Body-Worn Diagram

FCC ID: ZNFVN210	 PCTEST <small>ENGINEERING LABORATORY, INC.</small>		SAR EVALUATION REPORT		Reviewed by: Quality Manager
Document S/N: OY1504150740.ZNF	Test Dates: 04/13/15 - 04/23/15	DUT Type: Portable Handset		Page 10 of 29	



Accessories for Body-worn operation configurations are divided into two categories: those that do not contain metallic components and those that do contain metallic components. When multiple accessories that do not contain metallic components are supplied with the device, the device is tested with only the accessory that dictates the closest spacing to the body. Then multiple accessories that contain metallic components are tested with the device with each accessory. If multiple accessories share an identical metallic component (i.e. the same metallic belt-clip used with different holsters with no other metallic components) only the accessory that dictates the closest spacing to the body is tested.

Body-worn accessories may not always be supplied or available as options for some devices intended to be authorized for body-worn use. In this case, a test configuration with a separation distance between the back of the device and the flat phantom is used. Test position spacing was documented. Transmitters that are designed to operate in front of a person's face, as in push-to-talk configurations, are tested for SAR compliance with the front of the device positioned to face the flat phantom in head fluid. For devices that are carried next to the body such as a shoulder, waist or chest-worn transmitters, SAR compliance is tested with the accessories, including headsets and microphones, attached to the device and positioned against a flat phantom in a normal use configuration.

5.6 Extremity Exposure Configurations

Devices that are designed or intended for use on extremities or mainly operated in extremity only exposure conditions; i.e., hands, wrists, feet and ankles, may require extremity SAR evaluation. When the device also operates in close proximity to the user's body, SAR compliance for the body is also required. The 1-g body and 10-g extremity SAR Exclusion Thresholds found in KDB Publication 44798 D01v05 should be applied to determine SAR test requirements.

Per KDB Publication 447498 D01v05, Cell phones (handsets) are not normally designed to be used on extremities or operated in extremity only exposure conditions. The maximum output power levels of handsets generally do not require extremity SAR testing to show compliance. Therefore, extremity SAR was not evaluated for this device.

FCC ID: ZNFVN210	 SAR EVALUATION REPORT 		Reviewed by: Quality Manager
Document S/N: 0Y1504150740.ZNF	Test Dates: 04/13/15 - 04/23/15	DUT Type: Portable Handset	Page 11 of 29

6 RF EXPOSURE LIMITS

6.1 Uncontrolled Environment

UNCONTROLLED ENVIRONMENTS are defined as locations where there is the exposure of individuals who have no knowledge or control of their exposure. The general population/uncontrolled exposure limits are applicable to situations in which the general public may be exposed or in which persons who are exposed as a consequence of their employment may not be made fully aware of the potential for exposure or cannot exercise control over their exposure. Members of the general public would come under this category when exposure is not employment-related; for example, in the case of a wireless transmitter that exposes persons in its vicinity.



6.2 Controlled Environment

CONTROLLED ENVIRONMENTS are defined as locations where there is exposure that may be incurred by persons who are aware of the potential for exposure, (i.e. as a result of employment or occupation). In general, occupational/controlled exposure limits are applicable to situations in which persons are exposed as a consequence of their employment, who have been made fully aware of the potential for exposure and can exercise control over their exposure. This exposure category is also applicable when the exposure is of a transient nature due to incidental passage through a location where the exposure levels may be higher than the general population/uncontrolled limits, but the exposed person is fully aware of the potential for exposure and can exercise control over his or her exposure by leaving the area or by some other appropriate means.

Table 6-1
SAR Human Exposure Specified in ANSI/IEEE C95.1-1992 and Health Canada Safety Code 6

HUMAN EXPOSURE LIMITS		
	UNCONTROLLED ENVIRONMENT <i>General Population</i> (W/kg) or (mW/g)	CONTROLLED ENVIRONMENT <i>Occupational</i> (W/kg) or (mW/g)
Peak Spatial Average SAR Head	1.6	8.0
Whole Body SAR	0.08	0.4
Peak Spatial Average SAR Hands, Feet, Ankle, Wrists, etc.	4.0	20

1. The Spatial Peak value of the SAR averaged over any 1 gram of tissue (defined as a tissue volume in the shape of a cube) and over the appropriate averaging time.
2. The Spatial Average value of the SAR averaged over the whole body.
3. The Spatial Peak value of the SAR averaged over any 10 grams of tissue (defined as a tissue volume in the shape of a cube) and over the appropriate averaging time.

FCC ID: ZNFVN210	 SAR EVALUATION REPORT 		Reviewed by: Quality Manager
Document S/N: OY1504150740.ZNF	Test Dates: 04/13/15 - 04/23/15	DUT Type: Portable Handset	Page 12 of 29

7 FCC MEASUREMENT PROCEDURES

Power measurements for licensed transmitters are performed using a base station simulator under digital average power.

7.1 Measured and Reported SAR

Per FCC KDB Publication 447498 D01v05, when SAR is not measured at the maximum power level allowed for production units, the results must be scaled to the maximum tune-up tolerance limit according to the power applied to the individual channels tested to determine compliance. For simultaneous transmission, the measured aggregate SAR must be scaled according to the sum of the differences between the maximum tune-up tolerance and actual power used to test each transmitter. When SAR is measured at or scaled to the maximum tune-up tolerance limit, the results are referred to as *reported* SAR. The highest *reported* SAR results are identified on the grant of equipment authorization according to procedures in KDB 690783 D01v01r02.

7.2 3G SAR Test Reduction Procedure

In FCC KDB Publication 941225 D01v03, certain transmission modes within a frequency band and wireless mode evaluated for SAR are defined as primary modes. The equivalent modes considered for SAR test reduction are denoted as secondary modes. When the maximum output power including tune-up tolerance specified for production units in a secondary mode is ≤ 0.25 dB higher than the primary mode or when the highest reported SAR of the primary mode, scaled by the ratio of specified maximum output power and tune-up tolerance of secondary to primary mode, is ≤ 1.2 W/kg, SAR measurements are not required for the secondary mode. These criteria are referred to as the 3G SAR test reduction procedure. When the 3G SAR test reduction procedure is not satisfied, SAR measurements are additionally required for the secondary mode.

7.3 Procedures Used to Establish RF Signal for SAR

The following procedures are according to FCC KDB Publication 941225 D01v03 “3G SAR Measurement Procedures.”



The device is placed into a simulated call using a base station simulator in a RF shielded chamber. Establishing connections in this manner ensure a consistent means for testing SAR and are recommended for evaluating SAR [4]. Devices under test are evaluated prior to testing, with a fully charged battery and were configured to operate at maximum output power. In order to verify that the device is tested throughout the SAR test at maximum output power, the SAR measurement system measures a “point SAR” at an arbitrary reference point at the start and end of the 1 gram SAR evaluation, to assess for any power drifts during the evaluation. If the power drift deviates by more than 5%, the SAR test and drift measurements are repeated.

7.4 SAR Measurement Conditions for CDMA2000

The following procedures were performed according to FCC KDB Publication 941225 D01v03 “3G SAR Measurement Procedures.”

7.4.1 Output Power Verification

See 3GPP2 C.S0011/TIA-98-E as recommended by FCC KDB Publication 941225 D01v03 “3G SAR Measurement Procedures.” Maximum output power is verified on the High, Middle and Low

FCC ID: ZNFVN210	 PCTEST ENGINEERING LABORATORY, INC.	SAR EVALUATION REPORT	 LG	Reviewed by: Quality Manager
Document S/N: 0Y1504150740.ZNF	Test Dates: 04/13/15 - 04/23/15	DUT Type: Portable Handset		Page 13 of 29

channels according to procedures in section 4.4.5.2 of 3GPP2 C.S0011/TIA-98-E. SO55 tests were measured with power control bits in the “All Up” condition.

1. If the mobile station (MS) supports Reverse TCH RC 1 and Forward TCH RC 1, set up a call using Fundamental Channel Test Mode 1 (RC=1/1) with 9600 bps data rate only.
2. Under RC1, C.S0011 Table 4.4.5.2-1, Table 7-1 parameters were applied.
3. If the MS supports the RC 3 Reverse FCH, RC3 Reverse SCH₀ and demodulation of RC 3,4, or 5, set up a call using Supplemental Channel Test Mode 3 (RC 3/3) with 9600 bps Fundamental Channel and 9600 bps SCH₀ data rate.
4. Under RC3, C.S0011 Table 4.4.5.2-2, Table 7-2 was applied.

Table 7-1
Parameters for Max. Power for RC1

Parameter	Units	Value
$\frac{I_{or}}{I_{or}}$	dBm/1.23 MHz	-104
$\frac{Pilot E_c}{I_{or}}$	dB	-7
$\frac{Traffic E_c}{I_{or}}$	dB	-7.4

Table 7-2
Parameters for Max. Power for RC3

Parameter	Units	Value
$\frac{I_{or}}{I_{or}}$	dBm/1.23 MHz	-86
$\frac{Pilot E_c}{I_{or}}$	dB	-7
$\frac{Traffic E_c}{I_{or}}$	dB	-7.4

5. FCHs were configured at full rate for maximum SAR with “All Up” power control bits.



7.4.2 Head SAR Measurements

SAR for next to the ear head exposure is measured in RC3 with the handset configured to transmit at fullrate in SO55. The 3G SAR test reduction procedure is applied to RC1 with RC3 as the primary mode; otherwise, SAR is required for the channel with maximum measured output in RC1 using the head exposure configuration that results in the highest reported SAR in RC3.

7.4.3 Body-worn SAR Measurements

SAR for body-worn exposure configurations is measured in RC3 with the DUT configured to transmit at full rate on FCH with all other code channels disabled using TDSO / SO32. The 3G SAR test reduction procedure is applied to the multiple code channel configuration (FCH+SCH_n), with FCH only as the primary mode. Otherwise, SAR is required for multiple code channel configuration (FCH + SCH_n), with FCH at full rate and SCH₀ enabled at 9600 bps, using the highest reported SAR configuration for FCH only. When multiple code channels are enabled, the transmitter output can shift by more than 0.5 dB and may lead to higher SAR drifts and SCH dropouts.

The 3G SAR test reduction procedure is applied to body-worn accessory SAR in RC1 with RC3 as the primary mode. Otherwise, SAR is required for RC1, with SO55 and full rate, using the highest reported SAR configuration for body-worn accessory exposure in RC3.

FCC ID: ZNFVN210	 PCTEST ENGINEERING LABORATORY, INC.	SAR EVALUATION REPORT		Reviewed by: Quality Manager
Document S/N: OY1504150740.ZNF	Test Dates: 04/13/15 - 04/23/15	DUT Type: Portable Handset	Page 14 of 29	

8 RF CONDUCTED POWERS



8.1 CDMA Conducted Powers

Band	Channel	Frequency	SO55 [dBm]	SO55 [dBm]	TDSO S032 [dBm]	TDSO S032 [dBm]
	F-RC	MHz	RC1	RC3	FCH+SCH	FCH
Cellular	1013	824.7	24.96	25.00	24.99	25.00
	384	836.52	24.92	24.96	24.98	24.99
	777	848.31	24.97	24.99	25.00	25.00
PCS	25	1851.25	24.92	24.96	24.99	24.98
	600	1880	25.00	24.98	25.00	25.00
	1175	1908.75	24.88	24.93	24.97	24.99

Note: RC1 is only applicable for IS-95 compatibility.



Figure 8-1
Power Measurement Setup

FCC ID: ZNFVN210	 SAR EVALUATION REPORT 		Reviewed by: Quality Manager
Document S/N: 0Y1504150740.ZNF	Test Dates: 04/13/15 - 04/23/15	DUT Type: Portable Handset	Page 15 of 29

8.2 GSM Conducted Powers

		Maximum Burst-Averaged Output Power				
		Voice	GPRS/EDGE Data (GMSK)		EDGE Data (8-PSK)	
Band	Channel	GSM [dBm] CS (1 Slot)	GPRS [dBm] 1 Tx Slot	GPRS [dBm] 2 Tx Slot	EDGE [dBm] 1 Tx Slot	EDGE [dBm] 2 Tx Slot
GSM 850	128	32.69	32.26	31.42	26.70	25.70
	190	32.41	32.36	31.70	26.68	25.69
	251	32.50	32.46	31.39	26.63	25.65
GSM 1900	512	29.36	29.51	28.22	25.70	24.51
	661	29.26	29.37	28.13	25.51	24.34
	810	29.19	29.33	28.16	25.58	24.29

		Calculated Maximum Frame-Averaged Output Power				
		Voice	GPRS/EDGE Data (GMSK)		EDGE Data (8-PSK)	
Band	Channel	GSM [dBm] CS (1 Slot)	GPRS [dBm] 1 Tx Slot	GPRS [dBm] 2 Tx Slot	EDGE [dBm] 1 Tx Slot	EDGE [dBm] 2 Tx Slot
GSM 850	128	23.66	23.23	25.40	17.67	19.68
	190	23.38	23.33	25.68	17.65	19.67
	251	23.47	23.43	25.37	17.60	19.63
GSM 1900	512	20.33	20.48	22.20	16.67	18.49
	661	20.23	20.34	22.11	16.48	18.32
	810	20.16	20.30	22.14	16.55	18.27

GSM 850	Frame	23.17	23.17	25.18	17.17	19.18
GSM 1900	Avg. Targets:	20.17	20.17	22.18	16.17	18.18



Notes:

- Both burst-averaged and calculated frame-averaged powers are included. Frame-averaged power was calculated from the measured burst-averaged power by converting the slot powers into linear units and calculating the energy over 8 timeslots.
- The source-based frame-averaged output power was evaluated for all GPRS/EDGE slot configurations. The configuration with the highest target frame averaged output power was evaluated for VoIP SAR. When the maximum frame-averaged powers are equivalent across two or more slots (within 0.25 dB), the configuration with the most number of time slots was tested.
- GPRS/EDGE (GMSK) output powers were measured with coding scheme setting of 1 (CS1) on the base station simulator. CS1 was configured to measure GPRS output power measurements and SAR to ensure GMSK modulation in the signal. Our Investigation has shown that CS1 - CS4 settings do not have any impact on the output levels or modulation in the GPRS modes.
- EDGE (8-PSK) output powers were measured with MCS7 on the base station simulator. MCS7 coding scheme was used to measure the output powers for EDGE since investigation has shown that choosing MCS7 coding scheme will ensure 8-PSK modulation. It has been shown that MCS levels that produce 8PSK modulation do not have an impact on output power.

GSM Class: B
GPRS Multislot class: 10 (Max 2 Tx uplink slots)
EDGE Multislot class: 10 (Max 2 Tx uplink slots)
DTM Multislot Class: N/A



Figure 8-2
Power Measurement Setup

FCC ID: ZNFVN210	 SAR EVALUATION REPORT 		Reviewed by: Quality Manager
Document S/N: OY1504150740.ZNF	Test Dates: 04/13/15 - 04/23/15	DUT Type: Portable Handset	Page 16 of 29



9 SYSTEM VERIFICATION

9.1 Tissue Verification

**Table 9-1
Measured Tissue Properties**

Calibrated for Tests Performed on:	Tissue Type	Tissue Temp During Calibration (C°)	Measured Frequency (MHz)	Measured Conductivity, σ (S/m)	Measured Dielectric Constant, ϵ	TARGET Conductivity, σ (S/m)	TARGET Dielectric Constant, ϵ	% dev σ	% dev ϵ
04/22/2015	835H	21.8	820	0.874	41.096	0.899	41.578	-2.78%	-1.16%
			835	0.888	40.883	0.900	41.500	-1.33%	-1.49%
			850	0.904	40.713	0.916	41.500	-1.31%	-1.90%
04/13/2015	1900H	21.8	1850	1.375	39.012	1.400	40.000	-1.79%	-2.47%
			1880	1.406	38.879	1.400	40.000	0.43%	-2.80%
			1910	1.437	38.731	1.400	40.000	2.64%	-3.17%
04/22/2015	1900H	22.9	1850	1.348	39.515	1.400	40.000	-3.71%	-1.21%
			1880	1.373	39.490	1.400	40.000	-1.93%	-1.28%
			1910	1.409	39.334	1.400	40.000	0.64%	-1.66%
04/22/2015	835B	21.7	820	0.990	54.599	0.969	55.258	2.17%	-1.19%
			835	1.003	54.467	0.970	55.200	3.40%	-1.33%
			850	1.016	54.308	0.988	55.154	2.83%	-1.53%
04/16/2015	1900B	21.7	1850	1.478	52.963	1.520	53.300	-2.76%	-0.63%
			1880	1.510	52.856	1.520	53.300	-0.66%	-0.83%
			1910	1.548	52.755	1.520	53.300	1.84%	-1.02%
04/23/2015	1900B	21.0	1850	1.480	52.210	1.520	53.300	-2.63%	-2.05%
			1880	1.512	52.094	1.520	53.300	-0.53%	-2.26%
			1910	1.547	51.934	1.520	53.300	1.78%	-2.56%

The above measured tissue parameters were used in the DASY software. The DASY software was used to perform interpolation to determine the dielectric parameters at the SAR test device frequencies (per KDB Publication 865664 and IEEE 1528-2013 6.6.1.2). The tissue parameters listed in the SAR test plots may slightly differ from the table above due to significant digit rounding in the software.

FCC ID: ZNFVN210	 SAR EVALUATION REPORT 		Reviewed by: Quality Manager
Document S/N: OY1504150740.ZNF	Test Dates: 04/13/15 - 04/23/15	DUT Type: Portable Handset	Page 17 of 29

9.2 Test System Verification

Prior to SAR assessment, the system is verified to $\pm 10\%$ of the SAR measurement on the reference dipole at the time of calibration by the calibration facility. Full system validation status and result summary can be found in Appendix E.

**Table 9-2
System Verification Results**

System Verification TARGET & MEASURED												
SAR System #	Tissue Frequency (MHz)	Tissue Type	Date:	Amb. Temp (°C)	Liquid Temp (°C)	Input Power (W)	Dipole SN	Probe SN	Measured SAR _{1g} (W/kg)	1 W Target SAR _{1g} (W/kg)	1 W Normalized SAR _{1g} (W/kg)	Deviation _{1g} (%)
J	835	HEAD	04/22/2015	21.3	21.8	0.100	4d133	3022	0.880	9.200	8.800	-4.35%
J	1900	HEAD	04/13/2015	21.9	21.8	0.100	5d149	3022	4.300	40.200	43.000	6.97%
G	1900	HEAD	04/22/2015	23.2	22.3	0.100	5d149	3318	3.960	40.200	39.600	-1.49%
C	835	BODY	04/22/2015	21.8	21.7	0.100	4d132	3333	0.941	9.140	9.410	2.95%
K	1900	BODY	04/16/2015	22.9	21.7	0.100	5d149	3288	4.010	40.400	40.100	-0.74%
K	1900	BODY	04/23/2015	22.1	21.0	0.100	5d149	3288	4.200	40.400	42.000	3.96%

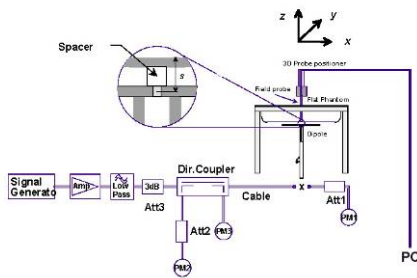

**Figure 9-1
System Verification Setup Diagram**



**Figure 9-2
System Verification Setup Photo**

FCC ID: ZNFVN210	PCTEST ENGINEERING LABORATORY, INC.	SAR EVALUATION REPORT	LG	Reviewed by: Quality Manager
Document S/N: OY1504150740.ZNF	Test Dates: 04/13/15 - 04/23/15	DUT Type: Portable Handset	Page 18 of 29	

10 SAR DATA SUMMARY



10.1 Standalone Head SAR Data

**Table 10-1
GSM 850 Head SAR**

MEASUREMENT RESULTS															
FREQUENCY		Mode/Band	Service	Maximum Allowed Power [dBm]	Conducted Power [dBm]	Power Drift [dB]	Side	Test Position	Device Serial Number	# of Time Slots	Duty Cycle	SAR (1g)	Scaling Factor	Scaled SAR (1g)	Plot #
MHz	Ch.											(W/kg)		(W/kg)	
836.60	190	GSM 850	GSM	32.7	32.41	-0.18	Right	Cheek	AE066E	1	1:8.3	0.128	1.069	0.137	
836.60	190	GSM 850	GSM	32.7	32.41	-0.04	Right	Tilt	AE066E	1	1:8.3	0.096	1.069	0.103	
836.60	190	GSM 850	GSM	32.7	32.41	-0.12	Left	Cheek	AE066E	1	1:8.3	0.174	1.069	0.186	
836.60	190	GSM 850	GSM	32.7	32.41	0.05	Left	Tilt	AE066E	1	1:8.3	0.100	1.069	0.107	
836.60	190	GSM 850	GPRS	31.7	31.70	-0.09	Right	Cheek	AE066E	2	1:4.15	0.251	1.000	0.251	
836.60	190	GSM 850	GPRS	31.7	31.70	-0.02	Right	Tilt	AE066E	2	1:4.15	0.156	1.000	0.156	
836.60	190	GSM 850	GPRS	31.7	31.70	-0.07	Left	Cheek	AE066E	2	1:4.15	0.260	1.000	0.260	A1
836.60	190	GSM 850	GPRS	31.7	31.70	-0.05	Left	Tilt	AE066E	2	1:4.15	0.151	1.000	0.151	
ANSI / IEEE C95.1 1992 - SAFETY LIMIT Spatial Peak Uncontrolled Exposure/General Population							Head 1.6 W/kg (mW/g) averaged over 1 gram								

**Table 10-2
GSM 1900 Head SAR**

MEASUREMENT RESULTS															
FREQUENCY		Mode/Band	Service	Maximum Allowed Power [dBm]	Conducted Power [dBm]	Power Drift [dB]	Side	Test Position	Device Serial Number	# of Time Slots	Duty Cycle	SAR (1g)	Scaling Factor	Scaled SAR (1g)	Plot #
MHz	Ch.											(W/kg)		(W/kg)	
1880.00	661	GSM 1900	GSM	29.7	29.26	0.03	Right	Cheek	1WRM1	1	1:8.3	0.344	1.107	0.381	
1880.00	661	GSM 1900	GSM	29.7	29.26	0.09	Right	Tilt	1WRM1	1	1:8.3	0.063	1.107	0.070	
1880.00	661	GSM 1900	GSM	29.7	29.26	0.10	Left	Cheek	1WRM1	1	1:8.3	0.453	1.107	0.501	
1880.00	661	GSM 1900	GSM	29.7	29.26	-0.03	Left	Tilt	1WRM1	1	1:8.3	0.070	1.107	0.077	
1880.00	661	GSM 1900	GPRS	28.7	28.13	0.07	Right	Cheek	1WRM1	2	1:4.15	0.388	1.140	0.442	
1880.00	661	GSM 1900	GPRS	28.7	28.13	0.04	Right	Tilt	1WRM1	2	1:4.15	0.076	1.140	0.087	
1880.00	661	GSM 1900	GPRS	28.7	28.13	-0.05	Left	Cheek	1WRM1	2	1:4.15	0.501	1.140	0.571	A2
1880.00	661	GSM 1900	GPRS	28.7	28.13	-0.18	Left	Tilt	1WRM1	2	1:4.15	0.035	1.140	0.040	
ANSI / IEEE C95.1 1992 - SAFETY LIMIT Spatial Peak Uncontrolled Exposure/General Population							Head 1.6 W/kg (mW/g) averaged over 1 gram								

FCC ID: ZNFVN210	 PCTEST ENGINEERING LABORATORY, INC.	SAR EVALUATION REPORT	 LG	Reviewed by: Quality Manager
Document S/N: OY1504150740.ZNF	Test Dates: 04/13/15 - 04/23/15	DUT Type: Portable Handset		Page 19 of 29

**Table 10-3
Cell. CDMA Head SAR**

MEASUREMENT RESULTS														
FREQUENCY		Mode/Band	Service	Maximum Allowed Power [dBm]	Conducted Power [dBm]	Power Drift [dB]	Side	Test Position	Device Serial Number	Duty Cycle	SAR (1g)	Scaling Factor	Scaled SAR (1g)	Plot #
MHz	Ch.										(W/kg)		(W/kg)	
836.52	384	Cell. CDMA	RC3 / SO55	25.0	24.96	-0.15	Right	Cheek	AE066E	1:1	0.327	1.009	0.330	
836.52	384	Cell. CDMA	RC3 / SO55	25.0	24.96	0.06	Right	Tilt	AE066E	1:1	0.216	1.009	0.218	
836.52	384	Cell. CDMA	RC3 / SO55	25.0	24.96	-0.13	Left	Cheek	AE066E	1:1	0.360	1.009	0.363	A3
836.52	384	Cell. CDMA	RC3 / SO55	25.0	24.96	0.00	Left	Tilt	AE066E	1:1	0.204	1.009	0.206	
ANSI / IEEE C95.1 1992 - SAFETY LIMIT Spatial Peak Uncontrolled Exposure/General Population							Head 1.6 W/kg (mW/g) averaged over 1 gram							



**Table 10-4
PCS CDMA Head SAR**

MEASUREMENT RESULTS														
FREQUENCY		Mode/Band	Service	Maximum Allowed Power [dBm]	Conducted Power [dBm]	Power Drift [dB]	Side	Test Position	Device Serial Number	Duty Cycle	SAR (1g)	Scaling Factor	Scaled SAR (1g)	Plot #
MHz	Ch.										(W/kg)		(W/kg)	
1880.00	600	PCS CDMA	RC3 / SO55	25.0	24.98	-0.15	Right	Cheek	59C36	1:1	0.780	1.005	0.784	A4
1880.00	600	PCS CDMA	RC3 / SO55	25.0	24.98	-0.03	Right	Tilt	59C36	1:1	0.138	1.005	0.139	
1880.00	600	PCS CDMA	RC3 / SO55	25.0	24.98	-0.03	Left	Mouth-Jaw	59C36	1:1	0.718	1.005	0.722	
1880.00	600	PCS CDMA	RC3 / SO55	25.0	24.98	0.02	Left	Tilt	59C36	1:1	0.190	1.005	0.191	
ANSI / IEEE C95.1 1992 - SAFETY LIMIT Spatial Peak Uncontrolled Exposure/General Population							Head 1.6 W/kg (mW/g) averaged over 1 gram							

10.2 Standalone Body-Worn SAR Data

**Table 10-5
GSM/CDMA Body-Worn SAR Data**

MEASUREMENT RESULTS															
FREQUENCY		Mode	Service	Maximum Allowed Power [dBm]	Conducted Power [dBm]	Power Drift [dB]	Spacing	Device Serial Number	# of Time Slots	Duty Cycle	Side	SAR (1g)	Scaling Factor	Scaled SAR (1g)	Plot #
MHz	Ch.											(W/kg)		(W/kg)	
836.60	190	GSM 850	GSM	32.7	32.41	0.00	15 mm	1WRM1	1	1:8.3	back	0.371	1.069	0.397	
836.60	190	GSM 850	GPRS	31.7	31.70	0.03	15 mm	1WRM1	2	1:4.15	back	0.433	1.000	0.433	A5
1880.00	661	GSM 1900	GSM	29.7	29.26	-0.13	15 mm	1WRM1	1	1:8.3	back	0.302	1.107	0.334	
1880.00	661	GSM 1900	GPRS	28.7	28.13	-0.14	15 mm	1WRM1	2	1:4.15	back	0.438	1.140	0.499	A6
836.52	384	Cell. CDMA	TDSO / SO32	25.0	24.99	0.01	15 mm	1WRM1	N/A	1:1	back	0.565	1.002	0.566	A7
1880.00	600	PCS CDMA	TDSO / SO32	25.0	25.00	-0.01	15 mm	1WRM1	N/A	1:1	back	0.661	1.000	0.661	A8
ANSI / IEEE C95.1 1992 - SAFETY LIMIT Spatial Peak Uncontrolled Exposure/General Population							Body 1.6 W/kg (mW/g) averaged over 1 gram								

FCC ID: ZNFVN210		SAR EVALUATION REPORT		Reviewed by: Quality Manager
Document S/N: OY1504150740.ZNF	Test Dates: 04/13/15 - 04/23/15	DUT Type: Portable Handset		Page 20 of 29

10.3 SAR Test Notes

General Notes:



1. The test data reported are the worst-case SAR values according to test procedures specified in IEEE 1528-2003, and FCC KDB Publication 447498 D01v05.
2. Batteries are fully charged at the beginning of the SAR measurements.
3. Liquid tissue depth was at least 15.0 cm for all frequencies.
4. The manufacturer has confirmed that the device(s) tested have the same physical, mechanical and thermal characteristics and are within operational tolerances expected for production units.
5. SAR results were scaled to the maximum allowed power to demonstrate compliance per FCC KDB Publication 447498 D01v05.
6. Device was tested using a fixed spacing for body-worn accessory testing. A separation distance of 15 mm was considered because the manufacturer has determined that there will be body-worn accessories available in the marketplace for users to support this separation distance.
7. Per FCC KDB Publication 648474 D04v01, body-worn SAR was evaluated without a headset connected to the device. Since the standalone reported body-worn SAR was ≤ 1.2 W/kg, no additional body-worn SAR evaluations using a headset cable were required.
8. Per FCC KDB 865664 D01 v01, variability SAR tests were not performed since the measured SAR results for all frequency bands was less than 0.8 W/kg. Please see Section 12 for more information.

GSM Test Notes:

1. Body-Worn accessory testing is typically associated with voice operations. Therefore, GSM voice was evaluated for body-worn SAR.
2. Justification for reduced test configurations per KDB Publication 941225 D01v01 and October 2013 TCB Workshop Notes: The source-based frame-averaged output power was evaluated for all GPRS/EDGE slot configurations. The configuration with the highest target frame averaged output power was evaluated for hotspot SAR. When the maximum frame-averaged powers are equivalent across two or more slots (within 0.25 dB), the configuration with the most number of time slots was tested.
3. Per FCC KDB Publication 447498 D01v05, if the reported (scaled) SAR measured at the middle channel or highest output power channel for each test configuration is ≤ 0.8 W/kg then testing at the other channels is not required for such test configuration(s). When the maximum output power variation across the required test channels is $> \frac{1}{2}$ dB, instead of the middle channel, the highest output power channel was used.
4. GPRS Mode was additionally tested for VoIP.

CDMA Notes:

1. Head SAR for CDMA2000 mode was tested under RC3/SO55 per FCC KDB Publication 941225 D01v03.
2. Body-Worn SAR was tested with 1x RTT with TDSO / SO32 FCH Only. TDSO / SO32 FCH+SCH SAR tests were not required since the maximum output target power was not more than 0.25 dB higher than the TDSO / SO32 FCH only powers and SAR is less than 1.2 W/kg, per FCC KDB Publication 941225 D01.
3. Per FCC KDB Publication 447498 D01v05, if the reported (scaled) SAR measured at the middle channel or highest output power channel for each test configuration is ≤ 0.8 W/kg then testing at the other channels is not required for such test configuration(s). When the maximum output power variation across the required test channels is $> \frac{1}{2}$ dB, instead of the middle channel, the highest output power channel was used.

FCC ID: ZNFVN210	 SAR EVALUATION REPORT 		Reviewed by: Quality Manager
Document S/N: OY1504150740.ZNF	Test Dates: 04/13/15 - 04/23/15	DUT Type: Portable Handset	Page 21 of 29

11 FCC MULTI-TX AND ANTENNA SAR CONSIDERATIONS

11.1 Introduction

The following procedures adopted from FCC KDB Publication 447498 D01v05r02 are applicable to devices with built-in unlicensed transmitters such as 802.11 and Bluetooth devices which may simultaneously transmit with the licensed transmitter.

11.2 Simultaneous Transmission Procedures

This device contains transmitters that may operate simultaneously. Therefore simultaneous transmission analysis is required. Per FCC KDB 447498 D01v05 IV.C.1.iii and IEEE 1528-2013 Section 6.3.4.1.2, simultaneous transmission SAR test exclusion may be applied when the sum of the 1-g SAR for all the simultaneous transmitting antennas in a specific physical test configuration is ≤ 1.6 W/kg. The different test positions in an exposure condition may be considered collectively to determine SAR test exclusion according to the sum of 1-g or 10-g SAR.



When standalone SAR is not required to be measured, per FCC KDB 447498 D01v05 4.3.2 2), the following equation must be used to estimate the standalone 1g SAR for simultaneous transmission assessment involving that transmitter.

$$\text{Estimated SAR} = \frac{\sqrt{f(\text{GHz})}}{7.5} * \frac{(\text{Max Power of channel, mW})}{\text{Min. Separation Distance, mm}}$$

**Table 11-1
Estimated SAR**

Mode	Frequency	Maximum Allowed Power	Separation Distance (Body)	Estimated SAR (Body)
	[MHz]	[dBm]	[mm]	[W/kg]
Bluetooth	2480	8.50	15	0.098

Note: Held-to ear configurations are not applicable to Bluetooth operations and therefore were not considered for simultaneous transmission. Per KDB Publication 447498 D01v05, the maximum power of the channel was rounded to the nearest mW before calculation.

FCC ID: ZNFVN210	 SAR EVALUATION REPORT 		Reviewed by: Quality Manager
Document S/N: 0Y1504150740.ZNF	Test Dates: 04/13/15 - 04/23/15	DUT Type: Portable Handset	Page 22 of 29

11.3 Body-Worn Simultaneous Transmission Analysis



Table 11-2
Simultaneous Transmission Scenario with Bluetooth (Body-Worn at 1.5 cm)

Configuration	Mode	2G/3G SAR (W/kg)	Bluetooth SAR (W/kg)	Σ SAR (W/kg)
Back Side	GSM 850	0.397	0.098	0.495
Back Side	GPRS 850	0.433	0.098	0.531
Back Side	GSM 1900	0.334	0.098	0.432
Back Side	GPRS 1900	0.499	0.098	0.597
Back Side	Cell. CDMA	0.566	0.098	0.664
Back Side	PCS CDMA	0.661	0.098	0.759

Note: Bluetooth SAR was not required to be measured per FCC KDB 447498. Estimated SAR results were used in the above table to determine simultaneous transmission SAR test exclusion.

11.4 Simultaneous Transmission Conclusion

The above numerical summed SAR results for all the worst-case simultaneous transmission conditions were below the SAR limit. Therefore, the above analysis is sufficient to determine that simultaneous transmission cases will not exceed the SAR limit and therefore no measured volumetric simultaneous SAR summation is required per FCC KDB Publication 447498 D01v05 and IEEE 1528-2013 Section 6.3.4.1.2.

FCC ID: ZNFVN210	 SAR EVALUATION REPORT 		Reviewed by: Quality Manager
Document S/N: 0Y1504150740.ZNF	Test Dates: 04/13/15 - 04/23/15	DUT Type: Portable Handset	Page 23 of 29



12 SAR MEASUREMENT VARIABILITY

12.1 Measurement Variability

Per FCC KDB Publication 865664 D01v01, SAR measurement variability was not assessed for each frequency band since all measured SAR values are < 0.80 W/kg.

12.2 Measurement Uncertainty



The measured SAR was < 1.5 W/kg for all frequency bands. Therefore, per KDB Publication 865664 D01v01, the extended measurement uncertainty analysis per IEEE 1528-2003 was not required.

FCC ID: ZNFVN210	 PCTEST ENGINEERING LABORATORY, INC.	SAR EVALUATION REPORT	 LG	Reviewed by: Quality Manager
Document S/N: 0Y1504150740.ZNF	Test Dates: 04/13/15 - 04/23/15	DUT Type: Portable Handset		Page 24 of 29

13 EQUIPMENT LIST

Manufacturer	Model	Description	Cal Date	Cal Interval	Cal Due	Serial Number
Agilent	8594A	(9kHz-2.9GHz) Spectrum Analyzer	N/A	N/A	N/A	3051A00187
Agilent	8648D	(9kHz-4GHz) Signal Generator	3/15/2015	Annual	3/15/2016	3629U00687
Agilent	8753E	(30kHz-6GHz) Network Analyzer	12/30/2014	Annual	12/30/2015	JP38020182
Agilent	8753ES	S-Parameter Network Analyzer	3/12/2015	Annual	3/12/2016	MY40000670
Agilent	8753ES	Network Analyzer	3/20/2015	Annual	3/20/2016	MY40001472
Agilent	8753ES	S-Parameter Network Analyzer	5/22/2014	Annual	5/22/2015	US39170118
Agilent	E4438C	ESG Vector Signal Generator	3/13/2015	Annual	3/13/2016	MY42082385
Agilent	E4438C	ESG Vector Signal Generator	3/12/2015	Annual	3/12/2016	MY45090700
Agilent	E5515C	Wireless Communications Test Set	11/5/2013	Biennial	11/5/2015	GB46310798
Agilent	E8257D	(250kHz-20GHz) Signal Generator	3/15/2015	Annual	3/15/2016	MY45470194
Agilent	N5182A	MXG Vector Signal Generator	10/27/2014	Annual	10/27/2015	MY47420603
Agilent	N5182A	MXG Vector Signal Generator	3/16/2015	Annual	3/16/2016	MY47420651
Amplifier Research	1551G6	Amplifier	CBT	N/A	CBT	433971
Amplifier Research	1551G6	Amplifier	CBT	N/A	CBT	433972
Anritsu	MA24106A	USB Power Sensor	5/14/2014	Annual	5/14/2015	1231535
Anritsu	MA24106A	USB Power Sensor	5/14/2014	Annual	5/14/2015	1231538
Anritsu	MA2411B	Pulse Power Sensor	11/17/2014	Annual	11/17/2015	1126066
Anritsu	MA2411B	Pulse Power Sensor	11/17/2014	Annual	11/17/2015	1207364
Anritsu	MA2411B	Pulse Power Sensor	11/13/2014	Annual	11/13/2015	1339018
COMTECH	AR85729-5	Solid State Amplifier	CBT	N/A	CBT	M155A00-009
COMTECH	AR85729-5/5759B	Solid State Amplifier	CBT	N/A	CBT	M3W1A00-1002
Control Company	4040	Digital Thermometer	3/18/2015	Biennial	3/18/2017	150194895
Control Company	4040	Digital Thermometer	3/18/2015	Biennial	3/18/2017	150194896
Control Company	4040	Digital Thermometer	3/15/2015	Biennial	3/15/2017	150194897
Control Company	4040	Digital Thermometer	3/15/2015	Biennial	3/15/2017	150194898
Control Company	4052	Long Stem Thermometer	9/27/2013	Biennial	9/27/2015	130567447
Control Company	4353	Long Stem Thermometer	1/22/2015	Biennial	1/22/2017	150053169
Control Company	4353	Long Stem Thermometer	3/5/2015	Biennial	3/5/2017	150149534
Control Company	4353	Long Stem Thermometer	3/5/2015	Biennial	3/5/2017	150149565
Gigatronics	80701A	(0.05-18GHz) Power Sensor	10/30/2014	Annual	10/30/2015	1833460
Gigatronics	8651A	Universal Power Meter	10/30/2014	Annual	10/30/2015	8650319
MCL	BW-N6W5+	6dB Attenuator	CBT	N/A	CBT	1139
MiniCircuits	SLP-2400+	Low Pass Filter	CBT	N/A	CBT	R8979500903
Mini-Circuits	BW-N20W5	Power Attenuator	CBT	N/A	CBT	1226
Mini-Circuits	BW-N20W5+	DC to 18 GHz Precision Fixed 20 dB Attenuator	CBT	N/A	CBT	N/A
Mini-Circuits	NLP-1200+	Low Pass Filter DC to 1000 MHz	CBT	N/A	CBT	N/A
Mini-Circuits	NLP-2950+	Low Pass Filter DC to 2700 MHz	CBT	N/A	CBT	N/A
Mitutoyo	CD-6°CSX	Digital Caliper	5/8/2014	Biennial	5/8/2016	13264162
Narda	4772-3	Attenuator (3dB)	CBT	N/A	CBT	9406
Narda	BW-53W2	Attenuator (3dB)	CBT	N/A	CBT	120
Pasternack	PE2208-6	Bidirectional Coupler	CBT	N/A	CBT	N/A
Pasternack	PE2209-10	Bidirectional Coupler	CBT	N/A	CBT	N/A
Rohde & Schwarz	CMW500	Radio Communication Tester	3/18/2015	Annual	3/18/2016	128633
Rohde & Schwarz	CMW500	Radio Communication Tester	4/8/2015	Annual	4/8/2016	140148
Seekonk	NC-100	Torque Wrench	3/18/2014	Biennial	3/18/2016	22313
Seekonk	NC-100	Torque Wrench	3/18/2014	Biennial	3/18/2016	N/A
Seekonk	NC-100	Torque Wrench	3/18/2014	Biennial	3/18/2016	N/A
SPEAG	D1900V2	1900 MHz SAR Dipole	7/23/2014	Annual	7/23/2015	5d149
SPEAG	D835V2	835 MHz SAR Dipole	1/16/2015	Annual	1/16/2016	4d132
SPEAG	D835V2	835 MHz SAR Dipole	7/24/2014	Annual	7/24/2015	4d133
SPEAG	DAE4	Dasy Data Acquisition Electronics	1/14/2015	Annual	1/14/2016	1272
SPEAG	DAE4	Dasy Data Acquisition Electronics	8/12/2014	Annual	8/12/2015	1322
SPEAG	DAE4	Dasy Data Acquisition Electronics	9/18/2014	Annual	9/18/2015	1364
SPEAG	DAE4	Dasy Data Acquisition Electronics	10/23/2014	Annual	10/23/2015	1408
SPEAG	DAK-3.5	Dielectric Assessment Kit	5/6/2014	Annual	5/6/2015	1070
SPEAG	DAKS-3.5	Portable Dielectric Assessment Kit	8/12/2014	Annual	8/12/2015	1041
SPEAG	ES3DV2	SAR Probe	8/19/2014	Annual	8/19/2015	3022
SPEAG	ES3DV3	SAR Probe	9/24/2014	Annual	9/24/2015	3288
SPEAG	ES3DV3	SAR Probe	1/23/2015	Annual	1/23/2016	3318
SPEAG	ES3DV3	SAR Probe	10/24/2014	Annual	10/24/2015	3333
VWR	36934-158	Wall-Mounted Thermometer	4/29/2014	Biennial	4/29/2016	111859323
VWR	36934-158	Wall-Mounted Thermometer	8/8/2013	Biennial	8/8/2015	130477877



Note: CBT (Calibrated Before Testing). Prior to testing, the measurement paths containing a cable, amplifier, attenuator, coupler or filter were connected to a calibrated source (i.e. a signal generator) to determine the losses of the measurement path. The power meter offset was then adjusted to compensate for the measurement system losses. This level offset is stored within the power meter before measurements are made. This calibration verification procedure applies to the system verification and output power measurements. The calibrated reading is then taken directly from the power meter after compensation of the losses for all final power measurements.

FCC ID: ZNFVN210	 PCTEST ENGINEERING LABORATORY, INC.	SAR EVALUATION REPORT		Reviewed by: Quality Manager
Document S/N: OY1504150740.ZNF	Test Dates: 04/13/15 - 04/23/15	DUT Type: Portable Handset	Page 25 of 29	

14 MEASUREMENT UNCERTAINTIES

a	b	c	d	e= f(d,k)	f	g	h = c x f/e	i = c x g/e	k
Uncertainty Component	IEEE 1528 Sec.	Tol. (± %)	Prob. Dist.	Div.	c _i 1gm	c _i 10 gms	1gm u _i (± %)	10gms u _i (± %)	v _i
Measurement System									
Probe Calibration	E.2.1	6.0	N	1	1.0	1.0	6.0	6.0	∞
Axial Isotropy	E.2.2	0.25	N	1	0.7	0.7	0.2	0.2	∞
Hemishperical Isotropy	E.2.2	1.3	N	1	1.0	1.0	1.3	1.3	∞
Boundary Effect	E.2.3	0.4	N	1	1.0	1.0	0.4	0.4	∞
Linearity	E.2.4	0.3	N	1	1.0	1.0	0.3	0.3	∞
System Detection Limits	E.2.5	5.1	N	1	1.0	1.0	5.1	5.1	∞
Readout Electronics	E.2.6	1.0	N	1	1.0	1.0	1.0	1.0	∞
Response Time	E.2.7	0.8	R	1.73	1.0	1.0	0.5	0.5	∞
Integration Time	E.2.8	2.6	R	1.73	1.0	1.0	1.5	1.5	∞
RF Ambient Conditions	E.6.1	3.0	R	1.73	1.0	1.0	1.7	1.7	∞
Probe Positioner Mechanical Tolerance	E.6.2	0.4	R	1.73	1.0	1.0	0.2	0.2	∞
Probe Positioning w/ respect to Phantom	E.6.3	2.9	R	1.73	1.0	1.0	1.7	1.7	∞
Extrapolation, Interpolation & Integration algorithms for Max. SAR Evaluation	E.5	1.0	R	1.73	1.0	1.0	0.6	0.6	∞
Test Sample Related									
Test Sample Positioning	E.4.2	6.0	N	1	1.0	1.0	6.0	6.0	287
Device Holder Uncertainty	E.4.1	3.32	R	1.73	1.0	1.0	1.9	1.9	∞
Output Power Variation - SAR drift measurement	6.6.2	5.0	R	1.73	1.0	1.0	2.9	2.9	∞
Phantom & Tissue Parameters									
Phantom Uncertainty (Shape & Thickness tolerances)	E.3.1	4.0	R	1.73	1.0	1.0	2.3	2.3	∞
Liquid Conductivity - deviation from target values	E.3.2	5.0	R	1.73	0.64	0.43	1.8	1.2	∞
Liquid Conductivity - measurement uncertainty	E.3.3	3.8	N	1	0.64	0.43	2.4	1.6	6
Liquid Permittivity - deviation from target values	E.3.2	5.0	R	1.73	0.60	0.49	1.7	1.4	∞
Liquid Permittivity - measurement uncertainty	E.3.3	4.5	N	1	0.60	0.49	2.7	2.2	6
Combined Standard Uncertainty (k=1)	RSS						12.1	11.7	299
Expanded Uncertainty (95% CONFIDENCE LEVEL)	k=2						24.2	23.5	

The above measurement uncertainties are according to IEEE Std. 1528-2003



FCC ID: ZNFVN210	 PCTEST ENGINEERING LABORATORY, INC.	SAR EVALUATION REPORT		Reviewed by: Quality Manager
Document S/N: OY1504150740.ZNF	Test Dates: 04/13/15 - 04/23/15	DUT Type: Portable Handset		Page 26 of 29

15 CONCLUSION

15.1 Measurement Conclusion



The SAR evaluation indicates that the EUT complies with the RF radiation exposure limits of the FCC and Industry Canada, with respect to all parameters subject to this test. These measurements were taken to simulate the RF effects of RF exposure under worst-case conditions. Precise laboratory measures were taken to assure repeatability of the tests. The results and statements relate only to the item(s) tested.

Please note that the absorption and distribution of electromagnetic energy in the body are very complex phenomena that depend on the mass, shape, and size of the body, the orientation of the body with respect to the field vectors, and the electrical properties of both the body and the environment. Other variables that may play a substantial role in possible biological effects are those that characterize the environment (e.g. ambient temperature, air velocity, relative humidity, and body insulation) and those that characterize the individual (e.g. age, gender, activity level, debilitation, or disease). Because various factors may interact with one another to vary the specific biological outcome of an exposure to electromagnetic fields, any protection guide should consider maximal amplification of biological effects as a result of field-body interactions, environmental conditions, and physiological variables. [3]



FCC ID: ZNFVN210	 PCTEST ENGINEERING LABORATORY, INC.	SAR EVALUATION REPORT	 LG	Reviewed by: Quality Manager
Document S/N: 0Y1504150740.ZNF	Test Dates: 04/13/15 - 04/23/15	DUT Type: Portable Handset		Page 27 of 29

16 REFERENCES

- [1] Federal Communications Commission, ET Docket 93-62, Guidelines for Evaluating the Environmental Effects of Radiofrequency Radiation, Aug. 1996.
- [2] ANSI/IEEE C95.1-2005, American National Standard safety levels with respect to human exposure to radio frequency electromagnetic fields, 3kHz to 300GHz, New York: IEEE, 2006.
- [3] ANSI/IEEE C95.1-1992, American National Standard safety levels with respect to human exposure to radio frequency electromagnetic fields, 3kHz to 300GHz, New York: IEEE, Sept. 1992.
- [4] ANSI/IEEE C95.3-2002, IEEE Recommended Practice for the Measurement of Potentially Hazardous Electromagnetic Fields - RF and Microwave, New York: IEEE, December 2002.
- [5] IEEE Standards Coordinating Committee 39 –Standards Coordinating Committee 34 – IEEE Std. 1528-2003, Recommended Practice for Determining the Peak Spatial-Average Specific Absorption Rate (SAR) in the Human Head Due to Wireless Communications Devices: Measurement Techniques.
- [6] NCRP, National Council on Radiation Protection and Measurements, Biological Effects and Exposure Criteria for RadioFrequency Electromagnetic Fields, NCRP Report No. 86, 1986. Reprinted Feb. 1995.
- [7] T. Schmid, O. Egger, N. Kuster, Automated E-field scanning system for dosimetric assessments, IEEE Transaction on Microwave Theory and Techniques, vol. 44, Jan. 1996, pp. 105-113.
- [8] K. Pokovic, T. Schmid, N. Kuster, Robust setup for precise calibration of E-field probes in tissue simulating liquids at mobile communications frequencies, ICECOM97, Oct. 1997, pp. 1-124.
- [9] K. Pokovic, T. Schmid, and N. Kuster, E-field Probe with improved isotropy in brain simulating liquids, Proceedings of the ELMAR, Zadar, Croatia, June 23-25, 1996, pp. 172-175.
- [10] Schmid & Partner Engineering AG, Application Note: Data Storage and Evaluation, June 1998, p2.
- [11] V. Hombach, K. Meier, M. Burkhardt, E. Kuhn, N. Kuster, The Dependence of EM Energy Absorption upon Human Modeling at 900 MHz, IEEE Transaction on Microwave Theory and Techniques, vol. 44 no. 10, Oct. 1996, pp. 1865-1873.
- [12] N. Kuster and Q. Balzano, Energy absorption mechanism by biological bodies in the near field of dipole antennas above 300MHz, IEEE Transaction on Vehicular Technology, vol. 41, no. 1, Feb. 1992, pp. 17-23.
- [13] G. Hartsgrove, A. Kraszewski, A. Surowiec, Simulated Biological Materials for Electromagnetic Radiation Absorption Studies, University of Ottawa, Bioelectromagnetics, Canada: 1987, pp. 29-36.
- [14] Q. Balzano, O. Garay, T. Manning Jr., Electromagnetic Energy Exposure of Simulated Users of Portable Cellular Telephones, IEEE Transactions on Vehicular Technology, vol. 44, no.3, Aug. 1995.
- [15] W. Gander, Computermathematick, Birkhaeuser, Basel, 1992.
- [16] W.H. Press, S.A. Teukolsky, W.T. Vetterling, and B.P. Flannery, Numerical Recipes in C, The Art of Scientific Computing, Second edition, Cambridge University Press, 1992.
- [17] N. Kuster, R. Kastle, T. Schmid, Dosimetric evaluation of mobile communications equipment with known precision, IEEE Transaction on Communications, vol. E80-B, no. 5, May 1997, pp. 645-652.

FCC ID: ZNFVN210	 SAR EVALUATION REPORT 		Reviewed by: Quality Manager
Document S/N: OY1504150740.ZNF	Test Dates: 04/13/15 - 04/23/15	DUT Type: Portable Handset	Page 28 of 29

- [18] CENELEC CLC/SC111B, European Prestandard (prENV 50166-2), Human Exposure to Electromagnetic Fields High-frequency: 10kHz-300GHz, Jan. 1995.
- [19] Prof. Dr. Niels Kuster, ETH, Eidgenössische Technische Hochschule Zürich, Dosimetric Evaluation of the Cellular Phone.
- [20] IEC 62209-1, Human exposure to radio frequency fields from hand-held and body-mounted wireless communication devices - Human models, instrumentation, and procedures - Part 1: Procedure to determine the specific absorption rate (SAR) for hand-held devices used in close proximity to the ear (frequency range of 300 MHz to 3 GHz), Feb. 2005.
- [21] Industry Canada RSS-102 Radio Frequency Exposure Compliance of Radiocommunication Apparatus (All Frequency Bands) Issue 4, March 2010.
- [22] Health Canada Safety Code 6 Limits of Human Exposure to Radio Frequency Electromagnetic Fields in the Frequency Range from 3 kHz – 300 GHz, 2009
- [23] FCC SAR Test Procedures for 2G-3G Devices, Mobile Hotspot and UMPC Devices KDB Publications 941225, D01-D07
- [24] SAR Measurement Guidance for IEEE 802.11 Transmitters, KDB Publication 248227 D01 DR02-41929
- [25] FCC SAR Considerations for Handsets with Multiple Transmitters and Antennas, KDB Publications 648474 D03-D04
- [26] FCC SAR Evaluation Considerations for Laptop, Notebook, Netbook and Tablet Computers, FCC KDB Publication 616217 D04
- [27] FCC SAR Measurement and Reporting Requirements for 100MHz – 6 GHz, KDB Publications 865664 D01-D02
- [28] FCC General RF Exposure Guidance and SAR Procedures for Dongles, KDB Publication 447498, D01-D02
- [29] Anexo à Resolução No. 533, de 10 de Setembro de 2009.
- [30] IEC 62209-2, Human exposure to radio frequency fields from hand-held and body-mounted wireless communication devices - Human models, instrumentation, and procedures - Part 2: Procedure to determine the specific absorption rate (SAR) for wireless communication devices used in close proximity to the human body (frequency range of 30 MHz to 6 GHz), Mar. 2010.

FCC ID: ZNFVN210	 SAR EVALUATION REPORT 		Reviewed by: Quality Manager
Document S/N: 0Y1504150740.ZNF	Test Dates: 04/13/15 - 04/23/15	DUT Type: Portable Handset	Page 29 of 29

APPENDIX A: SAR TEST DATA

PCTEST ENGINEERING LABORATORY, INC.

DUT: ZNFVN210; Type: Portable Handset; Serial: AE066E

Communication System: UID 0, GSM GPRS; 2 Tx slots; Frequency: 836.6 MHz; Duty Cycle: 1:4.15

Medium: 835 Head Medium parameters used (interpolated):

$f = 836.6 \text{ MHz}$; $\sigma = 0.89 \text{ S/m}$; $\epsilon_r = 40.865$; $\rho = 1000 \text{ kg/m}^3$

Phantom section: Left Section

Test Date: 04-22-2015; Ambient Temp: 21.3°C; Tissue Temp: 21.8°C

Probe: ES3DV2 - SN3022; ConvF(6.18, 6.18, 6.18); Calibrated: 8/19/2014;

Sensor-Surface: 3mm (Mechanical Surface Detection)

Electronics: DAE4 Sn1322; Calibrated: 8/12/2014

Phantom: SAM with CRP v4.0; Type: QD000P40CD; Serial: TP:1800

Measurement SW: DASY52, Version 52.8 (8); SEMCAD X Version 14.6.10 (7331)

Mode: GPRS 850, Left Head, Cheek, Mid.ch, 2 Tx slots

Area Scan (9x15x1): Measurement grid: dx=15mm, dy=15mm

Zoom Scan (5x5x7)/Cube 0: Measurement grid: dx=8mm, dy=8mm, dz=5mm

Reference Value = 17.03 V/m; Power Drift = -0.07 dB

Peak SAR (extrapolated) = 0.323 W/kg

SAR(1 g) = 0.260 W/kg

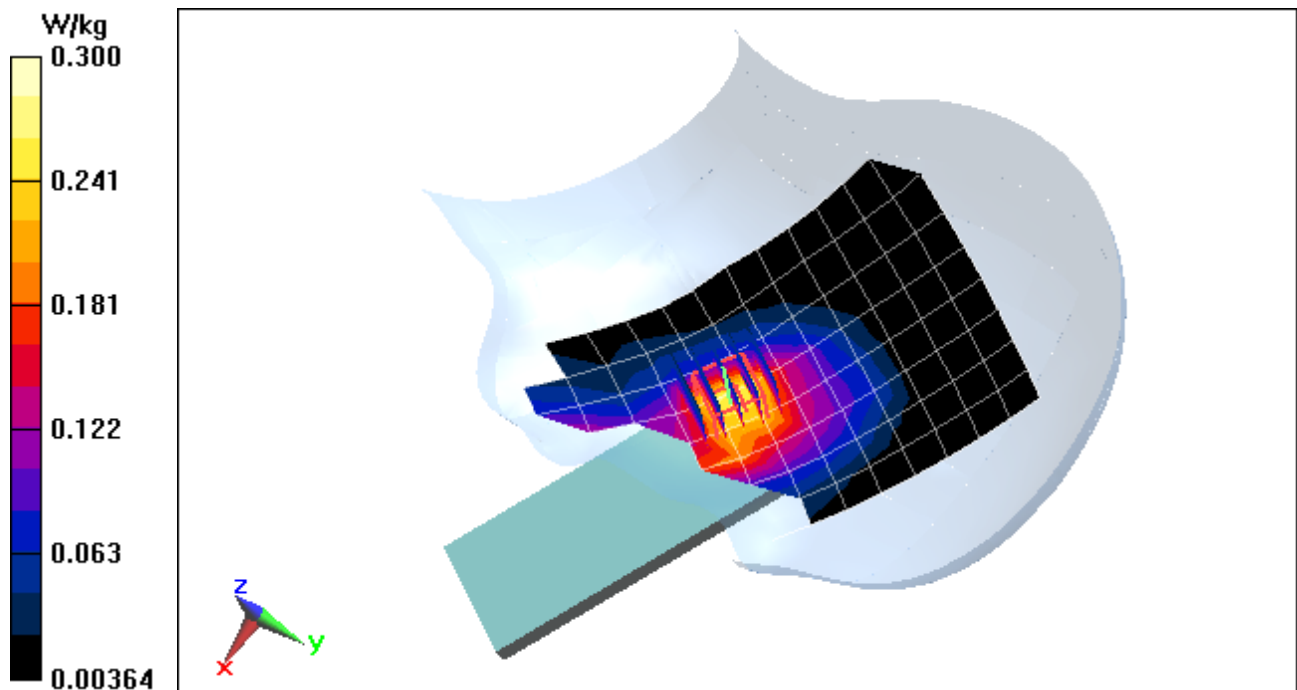

PCTEST ENGINEERING LABORATORY, INC.

DUT: ZNFVN210; Type: Portable Handset; Serial: 1WRM1

Communication System: UID 0, GSM GPRS; 2 Tx slots (0); Frequency: 1880 MHz; Duty Cycle: 1:4.15

Medium: 1900 Head Medium parameters used:

$f = 1880 \text{ MHz}$; $\sigma = 1.373 \text{ S/m}$; $\epsilon_r = 39.49$; $\rho = 1000 \text{ kg/m}^3$

Phantom section: Left Section

Test Date: 04-22-2015; Ambient Temp: 23.2°C; Tissue Temp: 22.3°C

Probe: ES3DV3 - SN3318; ConvF(5.05, 5.05, 5.05); Calibrated: 1/23/2015;

Sensor-Surface: 3mm (Mechanical Surface Detection)

Electronics: DAE4 Sn1272; Calibrated: 1/14/2015

Phantom: SAM Front; Type: SAM; Serial: 1686

Measurement SW: DASY52, Version 52.8 (8); SEMCAD X Version 14.6.10 (7331)

Mode: GPRS 1900, Left Head, Cheek, Mid.ch, 2 Tx slots

Area Scan (8x14x1): Measurement grid: dx=15mm, dy=15mm

Zoom Scan (6x6x7)/Cube 0: Measurement grid: dx=8mm, dy=8mm, dz=5mm

Reference Value = 20.12 V/m; Power Drift = -0.05 dB

Peak SAR (extrapolated) = 0.936 W/kg

SAR(1 g) = 0.501 W/kg

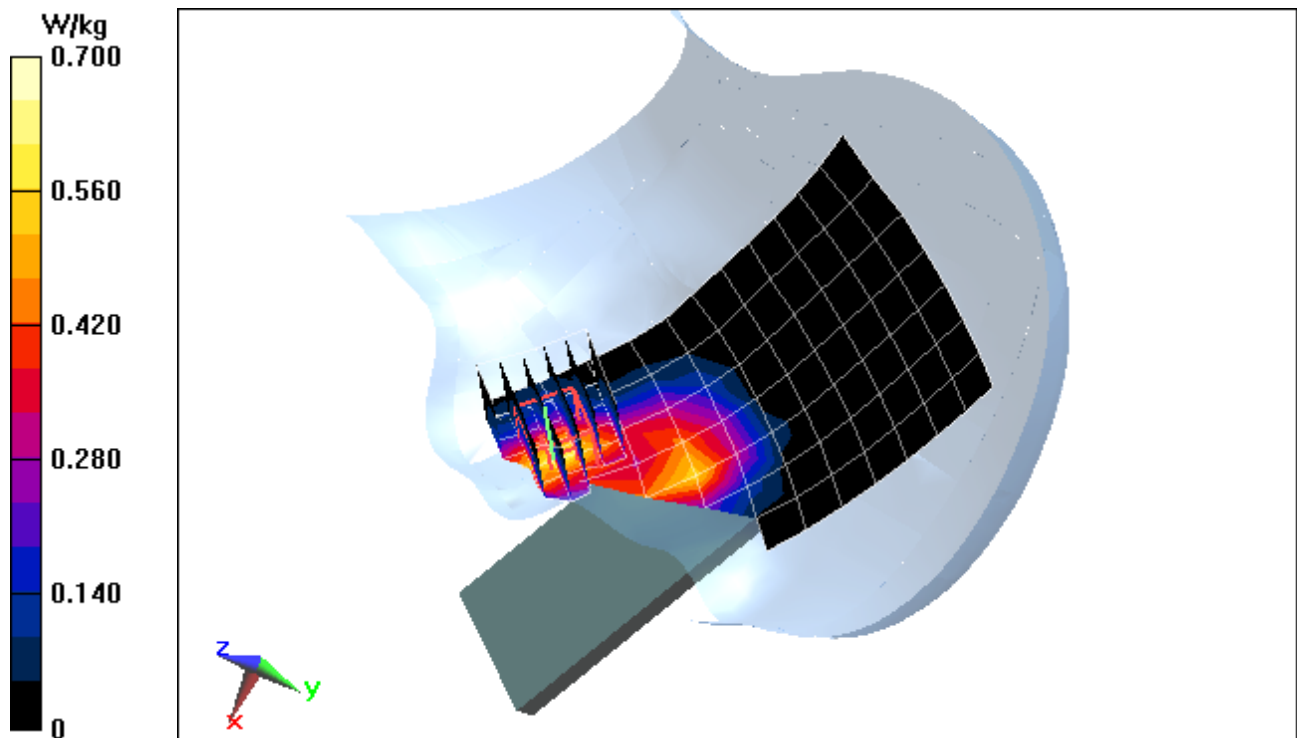

PCTEST ENGINEERING LABORATORY, INC.

DUT: ZNFVN210; Type: Portable Handset; Serial: AE066E

Communication System: UID 0, Cellular CDMA ; Frequency: 836.52 MHz; Duty Cycle: 1:1

Medium: 835 Head Medium parameters used (interpolated):

$f = 836.52 \text{ MHz}$; $\sigma = 0.89 \text{ S/m}$; $\epsilon_r = 40.866$; $\rho = 1000 \text{ kg/m}^3$

Phantom section: Left Section

Test Date: 04-22-2015; Ambient Temp: 21.3°C; Tissue Temp: 21.8°C

Probe: ES3DV2 - SN3022; ConvF(6.18, 6.18, 6.18); Calibrated: 8/19/2014;

Sensor-Surface: 3mm (Mechanical Surface Detection)

Electronics: DAE4 Sn1322; Calibrated: 8/12/2014

Phantom: SAM with CRP v4.0; Type: QD000P40CD; Serial: TP:1800

Measurement SW: DASY52, Version 52.8 (8); SEMCAD X Version 14.6.10 (7331)

Mode: Cell. CDMA, Left Head, Cheek, Mid.ch

Area Scan (9x15x1): Measurement grid: dx=15mm, dy=15mm

Zoom Scan (5x5x7)/Cube 0: Measurement grid: dx=8mm, dy=8mm, dz=5mm

Reference Value = 20.20 V/m; Power Drift = -0.13 dB

Peak SAR (extrapolated) = 0.555 W/kg

SAR(1 g) = 0.360 W/kg

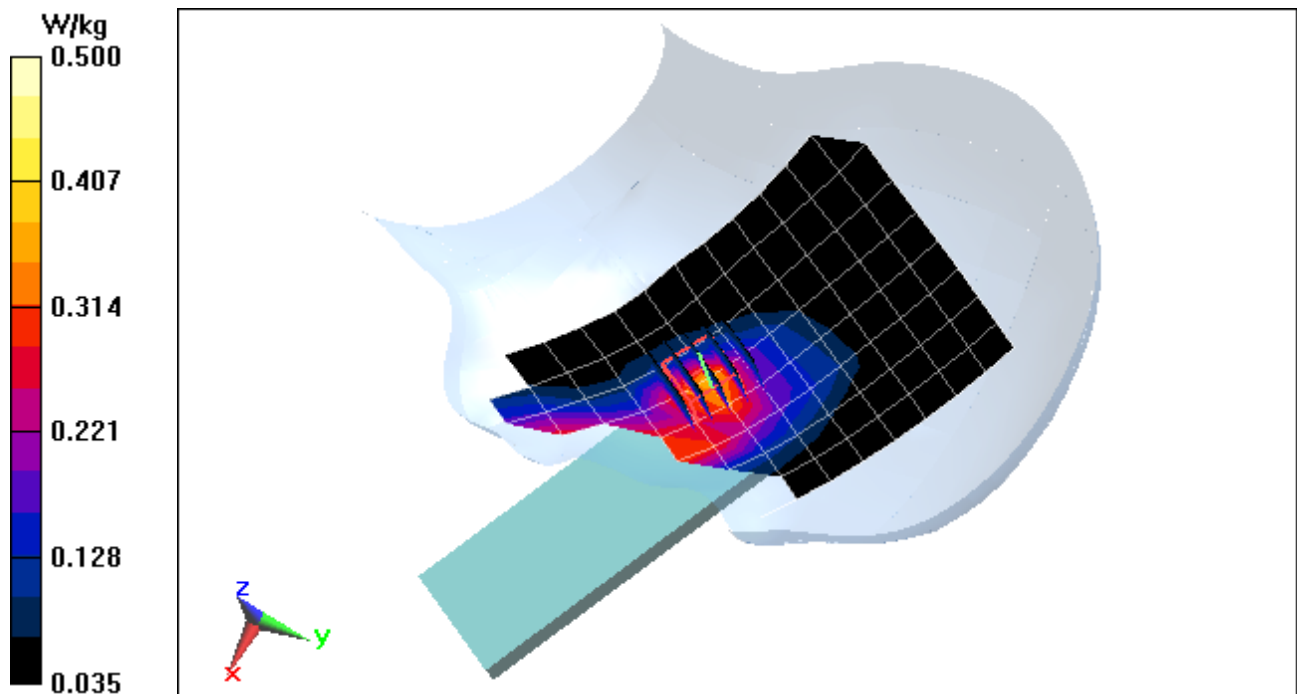

PCTEST ENGINEERING LABORATORY, INC.

DUT: ZNFVN210; Type: Portable Handset; Serial: 59C36

Communication System: UID 0, CDMA; Frequency: 1880 MHz; Duty Cycle: 1:1

Medium: 1900 Head Medium parameters used:

$f = 1880 \text{ MHz}$; $\sigma = 1.406 \text{ S/m}$; $\epsilon_r = 38.879$; $\rho = 1000 \text{ kg/m}^3$

Phantom section: Right Section

Test Date: 04-13-2015; Ambient Temp: 21.9°C; Tissue Temp: 21.8°C

Probe: ES3DV2 - SN3022; ConvF(4.85, 4.85, 4.85); Calibrated: 8/19/2014;

Sensor-Surface: 3mm (Mechanical Surface Detection)

Electronics: DAE4 Sn1322; Calibrated: 8/12/2014

Phantom: SAM with CRP v4.0; Type: QD000P40CD; Serial: TP:1800

Measurement SW: DASY52, Version 52.8 (8); SEMCAD X Version 14.6.10 (7331)

Mode: PCS CDMA, Right Head, Cheek, Mid.ch

Area Scan (9x15x1): Measurement grid: dx=15mm, dy=15mm

Zoom Scan (6x6x7)/Cube 0: Measurement grid: dx=8mm, dy=8mm, dz=5mm

Reference Value = 23.69 V/m; Power Drift = -0.15 dB

Peak SAR (extrapolated) = 1.20 W/kg

SAR(1 g) = 0.780 W/kg

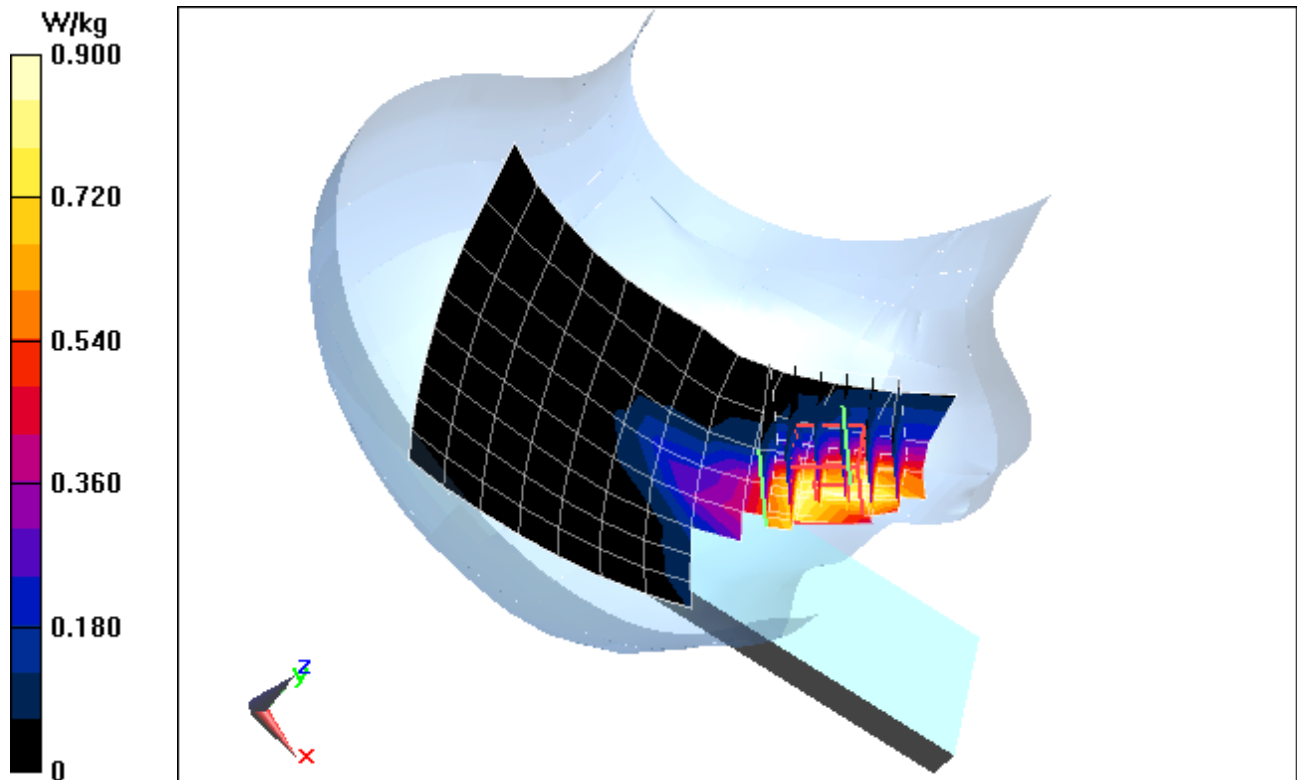

PCTEST ENGINEERING LABORATORY, INC.

DUT: ZNFVN210; Type: Portable Handset; Serial: 1WRM1

Communication System: UID 0, GSM GPRS; 2 Tx slots; Frequency: 836.6 MHz; Duty Cycle: 1:4.15

Medium: 835 Body Medium parameters used (interpolated):

$f = 836.6 \text{ MHz}$; $\sigma = 1.004 \text{ S/m}$; $\epsilon_r = 54.45$; $\rho = 1000 \text{ kg/m}^3$

Phantom section: Flat Section; Space: 1.5 cm

Test Date: 04-22-2015; Ambient Temp: 21.8°C; Tissue Temp: 21.7°C

Probe: ES3DV3 - SN3333; ConvF(6.12, 6.12, 6.12); Calibrated: 10/24/2014;

Sensor-Surface: 3mm (Mechanical Surface Detection)

Electronics: DAE4 Sn1408; Calibrated: 10/23/2014

Phantom: Main TWIN SAM; Type: QD000P40CC; Serial: TP-1406

Measurement SW: DASY52, Version 52.8 (8); SEMCAD X Version 14.6.10 (7331)

Mode: GPRS 850, Body SAR, Back side, Mid.ch, 2 Tx Slots

Area Scan (9x15x1): Measurement grid: dx=15mm, dy=15mm

Zoom Scan (5x6x7)/Cube 0: Measurement grid: dx=8mm, dy=8mm, dz=5mm

Reference Value = 20.87 V/m; Power Drift = 0.03 dB

Peak SAR (extrapolated) = 0.593 W/kg

SAR(1 g) = 0.433 W/kg

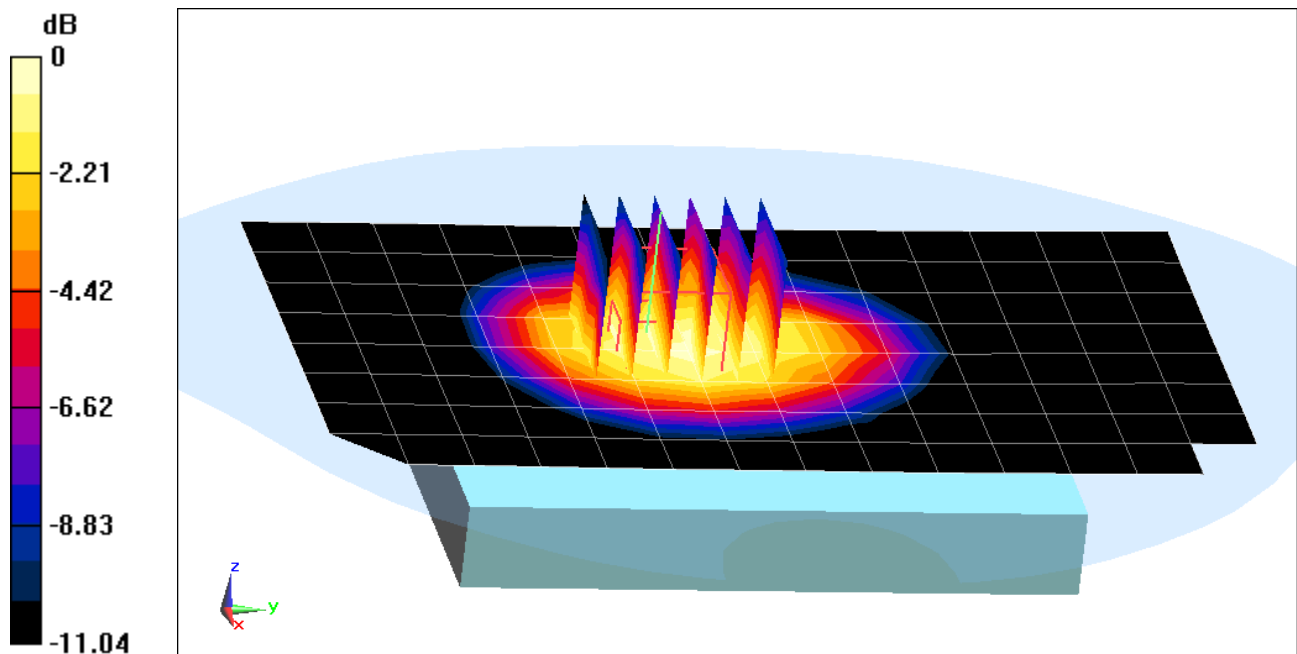

0 dB = 0.483 W/kg = -3.16 dBW/kg

PCTEST ENGINEERING LABORATORY, INC.

DUT: ZNFVN210; Type: Portable Handset; Serial: 1WRM1

Communication System: UID 0, GSM GPRS; 2 Tx slots; Frequency: 1880 MHz; Duty Cycle: 1:4.15

Medium: 1900 Body Medium parameters used:

$f = 1880 \text{ MHz}$; $\sigma = 1.512 \text{ S/m}$; $\epsilon_r = 52.094$; $\rho = 1000 \text{ kg/m}^3$

Phantom section: Flat Section; Space: 1.5 cm

Test Date: 04-23-2015; Ambient Temp: 22.1°C; Tissue Temp: 21.0°C

Probe: ES3DV3 - SN3288; ConvF(4.82, 4.82, 4.82); Calibrated: 9/24/2014;

Sensor-Surface: 3mm (Mechanical Surface Detection)

Electronics: DAE4 Sn1364; Calibrated: 9/18/2014

Phantom: ELI v5.0; Type: QDOVA001BB; Serial: 1229

Measurement SW: DASY52, Version 52.8 (8); SEMCAD X Version 14.6.10 (7331)

Mode: GPRS 1900, Body SAR, Back side, Mid.ch, 2 Tx Slots

Area Scan (9x15x1): Measurement grid: dx=15mm, dy=15mm

Zoom Scan (5x5x7)/Cube 0: Measurement grid: dx=8mm, dy=8mm, dz=5mm

Reference Value = 17.55 V/m; Power Drift = -0.14 dB

Peak SAR (extrapolated) = 0.690 W/kg

SAR(1 g) = 0.438 W/kg

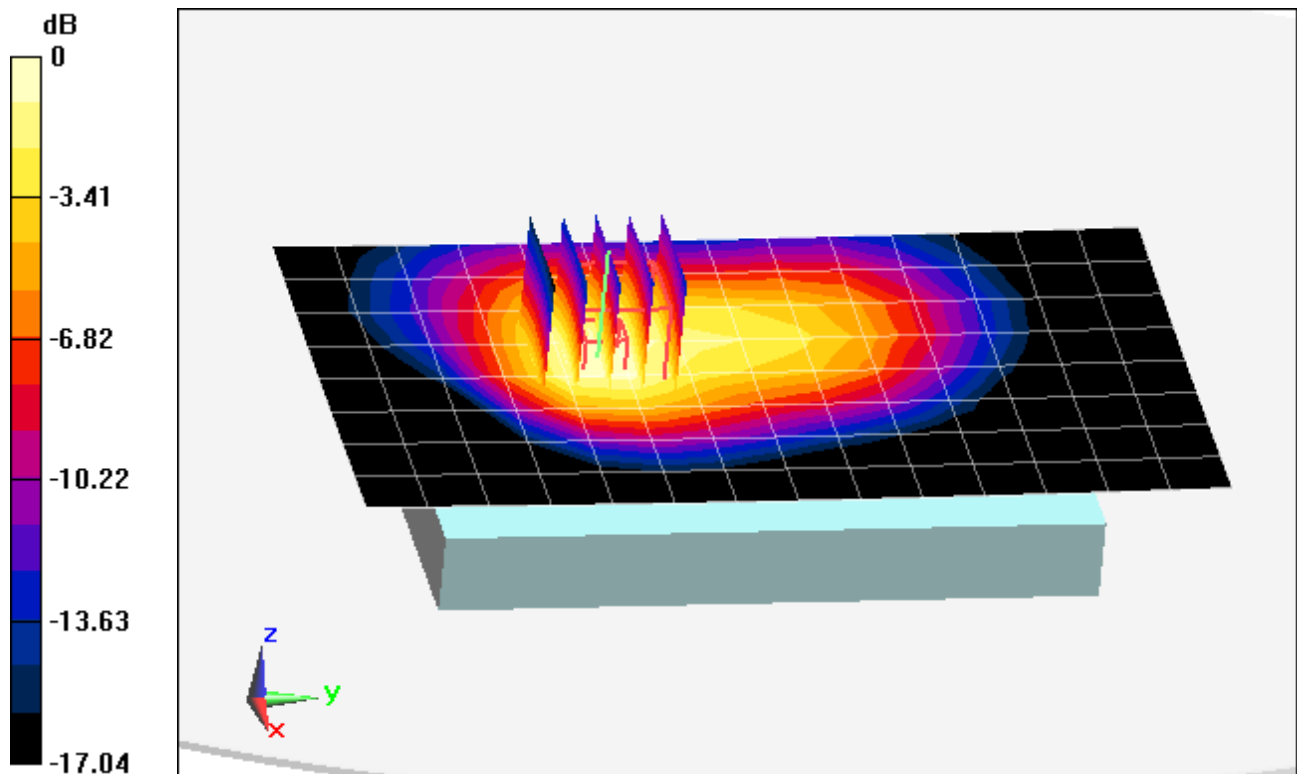

0 dB = 0.520 W/kg = -2.84 dBW/kg

PCTEST ENGINEERING LABORATORY, INC.

DUT: ZNFVN210; Type: Portable Handset; Serial: 1WRM1

Communication System: UID 0, CDMA; Frequency: 836.52 MHz; Duty Cycle: 1:1
Medium: 835 Body Medium parameters used (interpolated):
 $f = 836.52 \text{ MHz}$; $\sigma = 1.004 \text{ S/m}$; $\epsilon_r = 54.451$; $\rho = 1000 \text{ kg/m}^3$
Phantom section: Flat Section; Space: 1.5 cm

Test Date: 04-22-2015; Ambient Temp: 21.8°C; Tissue Temp: 21.7°C

Probe: ES3DV3 - SN3333; ConvF(6.12, 6.12, 6.12); Calibrated: 10/24/2014;
Sensor-Surface: 3mm (Mechanical Surface Detection)
Electronics: DAE4 Sn1408; Calibrated: 10/23/2014
Phantom: Main TWIN SAM; Type: QD000P40CC; Serial: TP-1406
Measurement SW: DASY52, Version 52.8 (8); SEMCAD X Version 14.6.10 (7331)

Mode: Cell. CDMA, Body SAR, Back side, Mid.ch

Area Scan (9x15x1): Measurement grid: dx=15mm, dy=15mm

Zoom Scan (5x5x7)/Cube 0: Measurement grid: dx=8mm, dy=8mm, dz=5mm

Reference Value = 24.73 V/m; Power Drift = 0.01 dB

Peak SAR (extrapolated) = 0.771 W/kg

SAR(1 g) = 0.565 W/kg

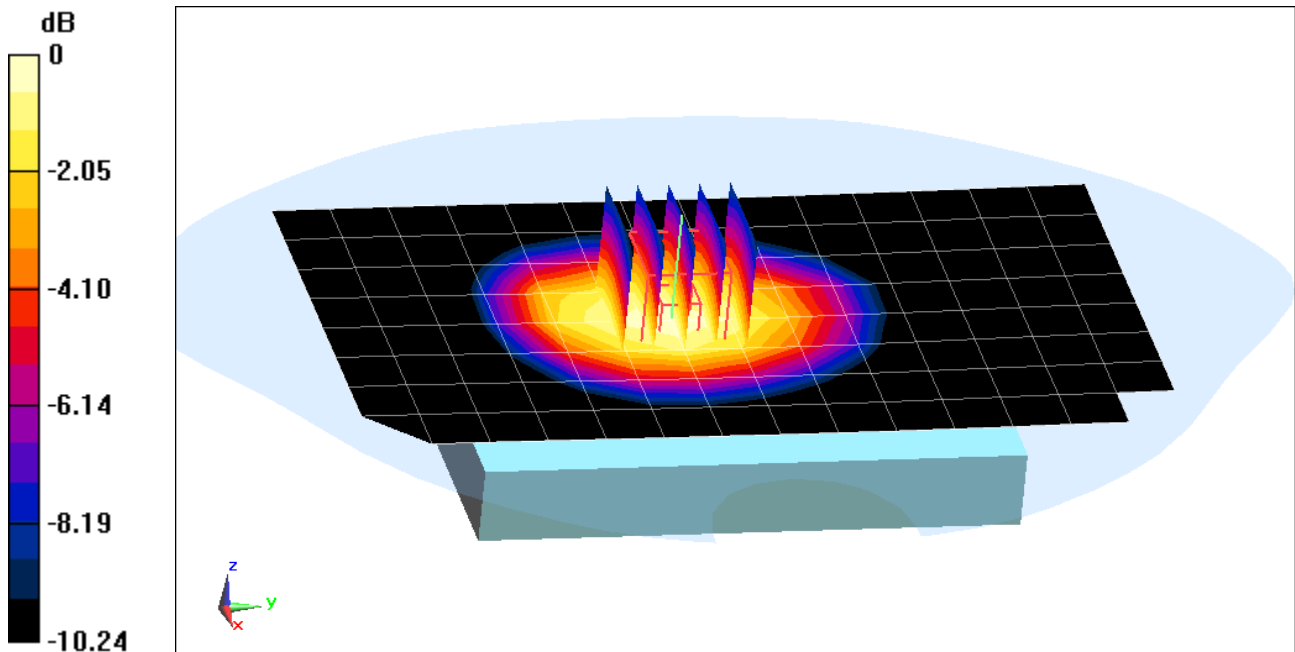

0 dB = 0.641 W/kg = -1.93 dBW/kg

PCTEST ENGINEERING LABORATORY, INC.

DUT: ZNFVN210; Type: Portable Handset; Serial: 1WRM1

Communication System: UID 0, CDMA; Frequency: 1880 MHz; Duty Cycle: 1:1

Medium: 1900 Body Medium parameters used:

$f = 1880 \text{ MHz}$; $\sigma = 1.51 \text{ S/m}$; $\epsilon_r = 52.856$; $\rho = 1000 \text{ kg/m}^3$

Phantom section: Flat Section; Space: 1.5 cm

Test Date: 04-16-2015; Ambient Temp: 22.9°C; Tissue Temp: 21.7°C

Probe: ES3DV3 - SN3288; ConvF(4.82, 4.82, 4.82); Calibrated: 9/24/2014;

Sensor-Surface: 3mm (Mechanical Surface Detection)

Electronics: DAE4 Sn1364; Calibrated: 9/18/2014

Phantom: ELI v5.0; Type: QDOVA001BB; Serial: 1229

Measurement SW: DASY52, Version 52.8 (8); SEMCAD X Version 14.6.10 (7331)

Mode: PCS CDMA, Body SAR, Back side, Mid.ch

Area Scan (9x15x1): Measurement grid: dx=15mm, dy=15mm

Zoom Scan (5x5x7)/Cube 0: Measurement grid: dx=8mm, dy=8mm, dz=5mm

Reference Value = 21.17 V/m; Power Drift = -0.01 dB

Peak SAR (extrapolated) = 1.06 W/kg

SAR(1 g) = 0.661 W/kg

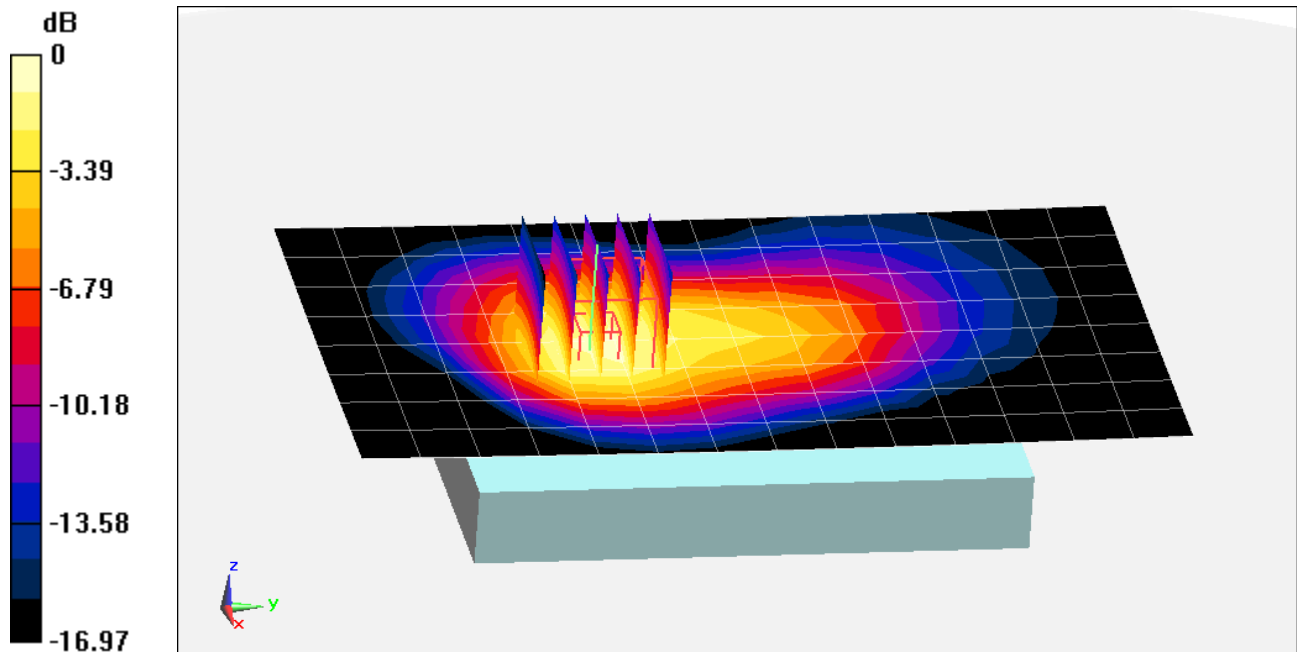

0 dB = 0.796 W/kg = -0.99 dBW/kg

APPENDIX B: SYSTEM VERIFICATION

PCTEST ENGINEERING LABORATORY, INC.

DUT: Dipole 835 MHz; Type: D835V2; Serial: 4d133

Communication System: UID 0, CW; Frequency: 835 MHz; Duty Cycle: 1:1

Medium: 835 Head Medium parameters used:

$f = 835 \text{ MHz}$; $\sigma = 0.888 \text{ S/m}$; $\epsilon_r = 40.883$; $\rho = 1000 \text{ kg/m}^3$

Phantom section: Flat Section; Space: 1.5 cm

Test Date: 04-22-2015; Ambient Temp: 21.3°C; Tissue Temp: 21.8°C

Probe: ES3DV2 - SN3022; ConvF(6.18, 6.18, 6.18); Calibrated: 8/19/2014;

Sensor-Surface: 3mm (Mechanical Surface Detection)

Electronics: DAE4 Sn1322; Calibrated: 8/12/2014

Phantom: SAM with CRP v4.0; Type: QD000P40CD; Serial: TP:1800

Measurement SW: DASY52, Version 52.8 (8); SEMCAD X Version 14.6.10 (7331)

835 MHz System Verification

Area Scan (7x14x1): Measurement grid: dx=15mm, dy=15mm

Zoom Scan (5x5x7)/Cube 0: Measurement grid: dx=8mm, dy=8mm, dz=5mm

Input Power = 20 dBm (100 mW)

Peak SAR (extrapolated) = 1.30 W/kg

SAR(1 g) = 0.880 W/kg

Deviation = -4.35 %

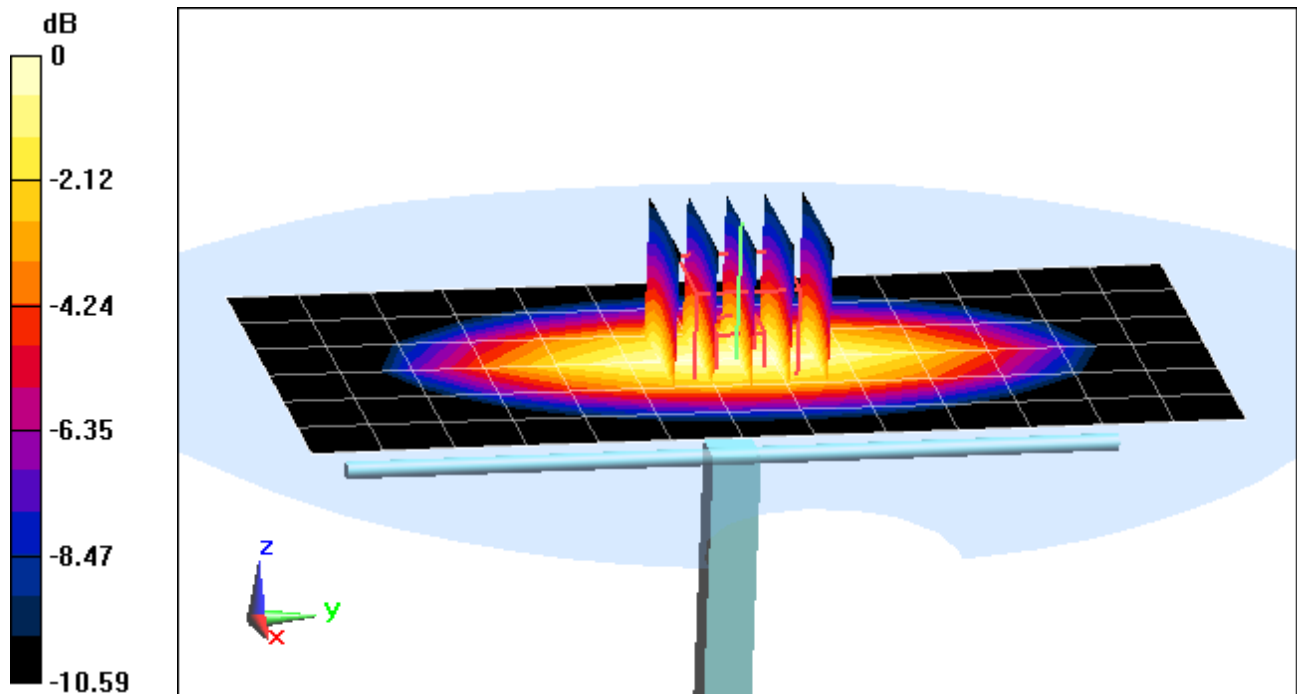

0 dB = 1.03 W/kg = 0.13 dBW/kg

PCTEST ENGINEERING LABORATORY, INC.

DUT: Dipole 1900 MHz; Type: D1900V2; Serial: 5d149

Communication System: UID 0, CW; Frequency: 1900 MHz; Duty Cycle: 1:1

Medium: 1900 Head Medium parameters used (interpolated):

$f = 1900 \text{ MHz}$; $\sigma = 1.427 \text{ S/m}$; $\epsilon_r = 38.78$; $\rho = 1000 \text{ kg/m}^3$

Phantom section: Flat Section; Space: 1.0 cm

Test Date: 04-13-2015; Ambient Temp: 21.9°C; Tissue Temp: 21.8°C

Probe: ES3DV2 - SN3022; ConvF(4.85, 4.85, 4.85); Calibrated: 8/19/2014;

Sensor-Surface: 3mm (Mechanical Surface Detection)

Electronics: DAE4 Sn1322; Calibrated: 8/12/2014

Phantom: SAM with CRP v4.0; Type: QD000P40CD; Serial: TP:1800

Measurement SW: DASY52, Version 52.8 (8); SEMCAD X Version 14.6.10 (7331)

1900 MHz System Verification

Area Scan (7x10x1): Measurement grid: dx=15mm, dy=15mm

Zoom Scan (5x5x7)/Cube 0: Measurement grid: dx=8mm, dy=8mm, dz=5mm

Input Power = 20 dBm (100 mW)

Peak SAR (extrapolated) = 7.78 W/kg

SAR(1 g) = 4.3 W/kg

Deviation = 6.97 %

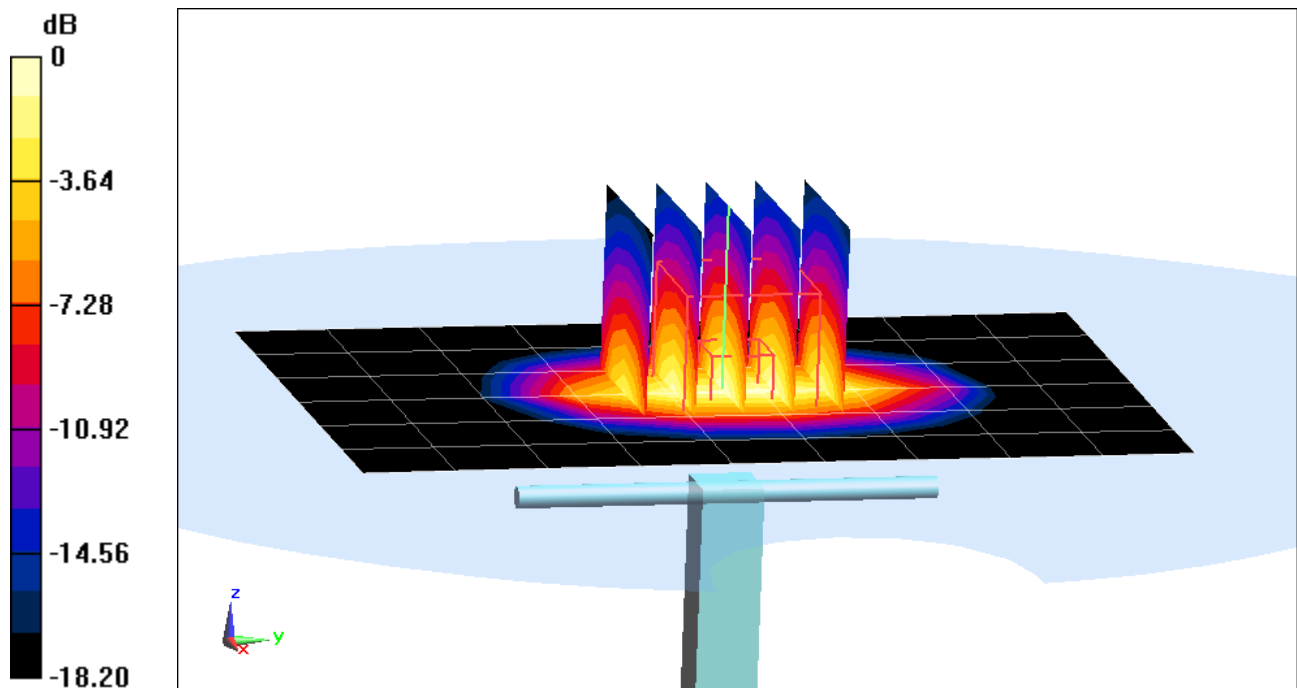

0 dB = 5.39 W/kg = 7.32 dBW/kg

PCTEST ENGINEERING LABORATORY, INC.

DUT: Dipole 1900 MHz; Type: D1900V2; Serial: 5d149

Communication System: UID 0, CW; Frequency: 1900 MHz; Duty Cycle: 1:1

Medium: 1900 Head Medium parameters used (interpolated):

$f = 1900 \text{ MHz}$; $\sigma = 1.397 \text{ S/m}$; $\epsilon_r = 39.386$; $\rho = 1000 \text{ kg/m}^3$

Phantom section: Flat Section; Space: 1.0 cm

Test Date: 04-22-2015; Ambient Temp: 23.2°C; Tissue Temp: 22.3°C

Probe: ES3DV3 - SN3318; ConvF(5.05, 5.05, 5.05); Calibrated: 1/23/2015;

Sensor-Surface: 3mm (Mechanical Surface Detection)

Electronics: DAE4 Sn1272; Calibrated: 1/14/2015

Phantom: SAM Front; Type: SAM; Serial: 1686

Measurement SW: DASY52, Version 52.8 (8); SEMCAD X Version 14.6.10 (7331)

1900 MHz System Verification

Area Scan (7x10x1): Measurement grid: dx=15mm, dy=15mm

Zoom Scan (5x5x7)/Cube 0: Measurement grid: dx=8mm, dy=8mm, dz=5mm

Input Power = 20 dBm (100 mW)

Peak SAR (extrapolated) = 7.26 W/kg

SAR(1 g) = 3.96 W/kg

Deviation = -1.49 %

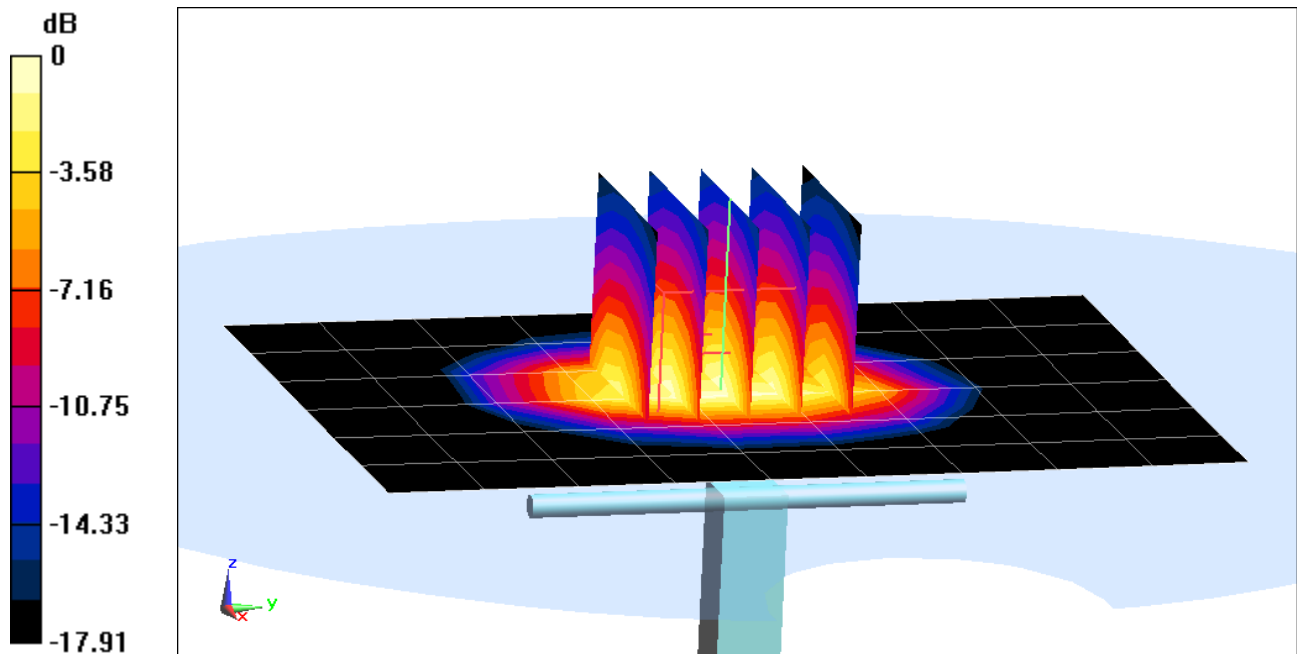

0 dB = 5.03 W/kg = 7.02 dBW/kg

PCTEST ENGINEERING LABORATORY, INC.

DUT: Dipole 835 MHz; Type: D835V2; Serial: 4d132

Communication System: UID 0, CW; Frequency: 835 MHz; Duty Cycle: 1:1

Medium: 835 Body Medium parameters used:

$f = 835 \text{ MHz}$; $\sigma = 1.003 \text{ S/m}$; $\epsilon_r = 54.467$; $\rho = 1000 \text{ kg/m}^3$

Phantom section: Flat Section; Space: 1.5 cm

Test Date: 04-22-2015; Ambient Temp: 21.8°C; Tissue Temp: 21.7°C

Probe: ES3DV3 - SN3333; ConvF(6.12, 6.12, 6.12); Calibrated: 10/24/2014;

Sensor-Surface: 3mm (Mechanical Surface Detection)

Electronics: DAE4 Sn1408; Calibrated: 10/23/2014

Phantom: Main TWIN SAM; Type: QD000P40CC; Serial: TP-1406

Measurement SW: DASY52, Version 52.8 (8); SEMCAD X Version 14.6.10 (7331)

835 MHz System Verification

Area Scan (7x14x1): Measurement grid: dx=15mm, dy=15mm

Zoom Scan (5x5x7)/Cube 0: Measurement grid: dx=8mm, dy=8mm, dz=5mm

Input Power = 20 dBm (100 mW)

Peak SAR (extrapolated) = 1.38 W/kg

SAR(1 g) = 0.941 W/kg

Deviation = 2.95 %

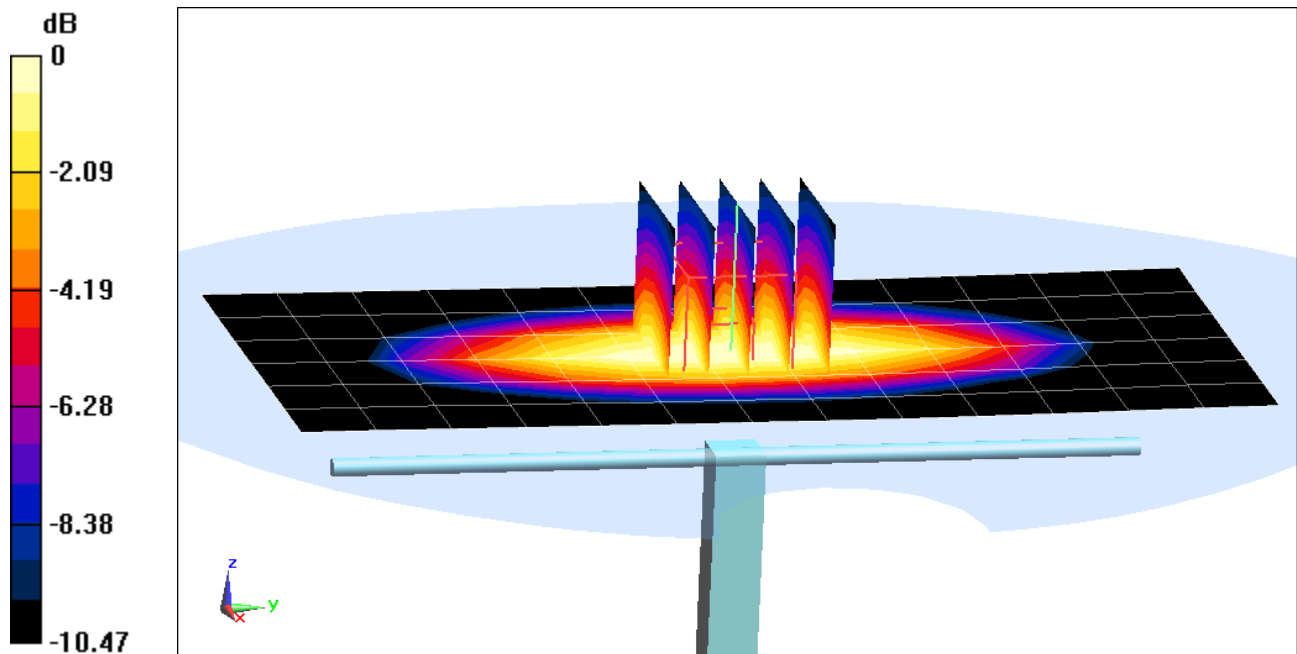

0 dB = 1.10 W/kg = 0.41 dBW/kg

PCTEST ENGINEERING LABORATORY, INC.

DUT: Dipole 1900 MHz; Type: D1900V2; Serial: 5d149

Communication System: UID 0, CW; Frequency: 1900 MHz; Duty Cycle: 1:1

Medium: 1900 Body Medium parameters used (interpolated):

$f = 1900 \text{ MHz}$; $\sigma = 1.535 \text{ S/m}$; $\epsilon_r = 51.987$; $\rho = 1000 \text{ kg/m}^3$

Phantom section: Flat Section; Space: 1.0 cm

Test Date: 04-23-2015; Ambient Temp: 22.1°C; Tissue Temp: 21.0°C

Probe: ES3DV3 - SN3288; ConvF(4.82, 4.82, 4.82); Calibrated: 9/24/2014;

Sensor-Surface: 3mm (Mechanical Surface Detection)

Electronics: DAE4 Sn1364; Calibrated: 9/18/2014

Phantom: ELI v5.0; Type: QDOVA001BB; Serial: 1229

Measurement SW: DASY52, Version 52.8 (8); SEMCAD X Version 14.6.10 (7331)

1900 MHz System Verification

Area Scan (7x10x1): Measurement grid: dx=15mm, dy=15mm

Zoom Scan (5x5x7)/Cube 0: Measurement grid: dx=8mm, dy=8mm, dz=5mm

Input Power = 20 dBm (100 mW)

Peak SAR (extrapolated) = 7.54 W/kg

SAR(1 g) = 4.2 W/kg

Deviation = 3.96 %

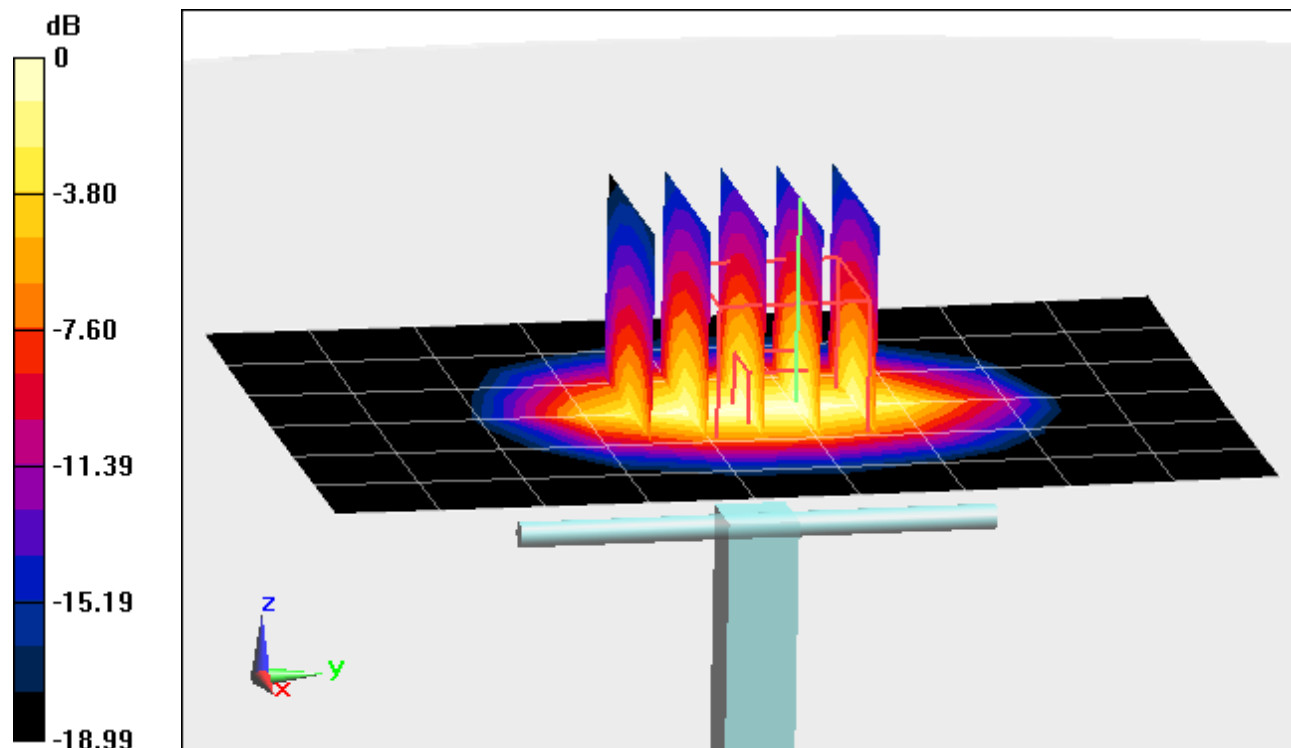

0 dB = 4.95 W/kg = 6.95 dBW/kg

APPENDIX C: PROBE CALIBRATION

**Calibration Laboratory of
Schmid & Partner
Engineering AG**
Zeughausstrasse 43, 8004 Zurich, Switzerland



S Schweizerischer Kalibrierdienst
C Service suisse d'étalonnage
S Servizio svizzero di taratura
Swiss Calibration Service

Accredited by the Swiss Accreditation Service (SAS)
The Swiss Accreditation Service is one of the signatories to the EA
Multilateral Agreement for the recognition of calibration certificates

Accreditation No.: **SCS 108**

Client **PC Test**

Certificate No: **ES3-3022_Aug14/2**

CALIBRATION CERTIFICATE (Replacement of No: ES3-3022_Aug14)

Object: **ES3DV2 - SN:3022**

Calibration procedure(s): **QA CAL-01.v9, QA CAL-12.v9, QA CAL-23.v5, QA CAL-25.v6**
Calibration procedure for dosimetric E-field probes CC
D/12/14

Calibration date: **August 19, 2014**

This calibration certificate documents the traceability to national standards, which realize the physical units of measurements (SI).
The measurements and the uncertainties with confidence probability are given on the following pages and are part of the certificate.

All calibrations have been conducted in the closed laboratory facility: environment temperature (22 ± 3)°C and humidity < 70%.

Calibration Equipment used (M&TE critical for calibration)

Primary Standards	ID	Cal Date (Certificate No.)	Scheduled Calibration
Power meter E4419B	GB41293874	03-Apr-14 (No. 217-01911)	Apr-15
Power sensor E4412A	MY41498087	03-Apr-14 (No. 217-01911)	Apr-15
Reference 3 dB Attenuator	SN: S5054 (3c)	03-Apr-14 (No. 217-01915)	Apr-15
Reference 20 dB Attenuator	SN: S5277 (20x)	03-Apr-14 (No. 217-01919)	Apr-15
Reference 30 dB Attenuator	SN: S5129 (30b)	03-Apr-14 (No. 217-01920)	Apr-15
Reference Probe ES3DV2	SN: 3013	30-Dec-13 (No. ES3-3013_Dec13)	Dec-14
DAE4	SN: 660	13-Dec-13 (No. DAE4-660_Dec13)	Dec-14
Secondary Standards	ID	Check Date (in house)	Scheduled Check
RF generator HP 8648C	US3642U01700	4-Aug-99 (in house check Apr-13)	In house check: Apr-16
Network Analyzer HP 8753E	US37390585	18-Oct-01 (in house check Oct-13)	In house check: Oct-14

Calibrated by:	Name Jeton Kastrali	Function Laboratory Technician	Signature
Approved by:	Name Katja Pokovic	Function Technical Manager	

Issued: November 3, 2014

This calibration certificate shall not be reproduced except in full without written approval of the laboratory.



Accredited by the Swiss Accreditation Service (SAS)
The Swiss Accreditation Service is one of the signatories to the EA
Multilateral Agreement for the recognition of calibration certificates

Accreditation No.: **SCS 108**

Glossary:

TSL	tissue simulating liquid
NORM _{x,y,z}	sensitivity in free space
ConvF	sensitivity in TSL / NORM _{x,y,z}
DCP	diode compression point
CF	crest factor (1/duty_cycle) of the RF signal
A, B, C, D	modulation dependent linearization parameters
Polarization φ	φ rotation around probe axis
Polarization ϑ	ϑ rotation around an axis that is in the plane normal to probe axis (at measurement center), i.e., $\vartheta = 0$ is normal to probe axis
Connector Angle	information used in DASY system to align probe sensor X to the robot coordinate system

Calibration is Performed According to the Following Standards:

- IEEE Std 1528-2013, "IEEE Recommended Practice for Determining the Peak Spatial-Averaged Specific Absorption Rate (SAR) in the Human Head from Wireless Communications Devices: Measurement Techniques", June 2013
- IEC 62209-1, "Procedure to measure the Specific Absorption Rate (SAR) for hand-held devices used in close proximity to the ear (frequency range of 300 MHz to 3 GHz)", February 2005

Methods Applied and Interpretation of Parameters:

- NORM_{x,y,z}**: Assessed for E-field polarization $\vartheta = 0$ ($f \leq 900$ MHz in TEM-cell; $f > 1800$ MHz: R22 waveguide). NORM_{x,y,z} are only intermediate values, i.e., the uncertainties of NORM_{x,y,z} does not affect the E²-field uncertainty inside TSL (see below ConvF).
- NORM(f)_{x,y,z}** = NORM_{x,y,z} * *frequency_response* (see Frequency Response Chart). This linearization is implemented in DASY4 software versions later than 4.2. The uncertainty of the frequency response is included in the stated uncertainty of ConvF.
- DCP_{x,y,z}**: DCP are numerical linearization parameters assessed based on the data of power sweep with CW signal (no uncertainty required). DCP does not depend on frequency nor media.
- PAR**: PAR is the Peak to Average Ratio that is not calibrated but determined based on the signal characteristics
- A_{x,y,z}; B_{x,y,z}; C_{x,y,z}; D_{x,y,z}; VR_{x,y,z}; A, B, C, D** are numerical linearization parameters assessed based on the data of power sweep for specific modulation signal. The parameters do not depend on frequency nor media. VR is the maximum calibration range expressed in RMS voltage across the diode.
- ConvF and Boundary Effect Parameters**: Assessed in flat phantom using E-field (or Temperature Transfer Standard for $f \leq 800$ MHz) and inside waveguide using analytical field distributions based on power measurements for $f > 800$ MHz. The same setups are used for assessment of the parameters applied for boundary compensation (alpha, depth) of which typical uncertainty values are given. These parameters are used in DASY4 software to improve probe accuracy close to the boundary. The sensitivity in TSL corresponds to NORM_{x,y,z} * ConvF whereby the uncertainty corresponds to that given for ConvF. A frequency dependent ConvF is used in DASY version 4.4 and higher which allows extending the validity from ± 50 MHz to ± 100 MHz.
- Spherical isotropy (3D deviation from isotropy)**: in a field of low gradients realized using a flat phantom exposed by a patch antenna.
- Sensor Offset**: The sensor offset corresponds to the offset of virtual measurement center from the probe tip (on probe axis). No tolerance required.
- Connector Angle**: The angle is assessed using the information gained by determining the NORM_x (no uncertainty required).

Probe ES3DV2

SN:3022

Manufactured: April 15, 2003
Calibrated: August 19, 2014

Calibrated for DASY/EASY Systems
(Note: non-compatible with DASY2 system!)

DASY/EASY - Parameters of Probe: ES3DV2 - SN:3022

Basic Calibration Parameters

	Sensor X	Sensor Y	Sensor Z	Unc (k=2)
Norm ($\mu V/(V/m)^2$) ^A	1.00	1.04	0.96	$\pm 10.1\%$
DCP (mV) ^B	103.0	96.3	101.6	

Modulation Calibration Parameters

UID	Communication System Name		A dB	B dB $\sqrt{\mu V}$	C	D dB	VR mV	Unc ^E (k=2)
0	CW	X	0.0	0.0	1.0	0.00	181.8	$\pm 2.7\%$
		Y	0.0	0.0	1.0		183.0	
		Z	0.0	0.0	1.0		192.3	
10010- CAA	SAR Validation (Square, 100ms, 10ms)	X	2.51	63.1	12.7	10.00	42.6	$\pm 1.9\%$
		Y	2.62	63.1	12.9		42.7	
		Z	3.12	65.7	13.6		40.4	
10011- CAB	UMTS-FDD (WCDMA)	X	3.33	67.8	19.2	2.91	145.9	$\pm 0.9\%$
		Y	3.13	64.9	16.9		147.4	
		Z	3.20	66.4	18.2		139.6	
10012- CAA	IEEE 802.11b WIFI 2.4 GHz (DSSS, 1 Mbps)	X	3.05	70.1	19.8	1.87	147.2	$\pm 0.9\%$
		Y	2.62	65.1	16.2		147.4	
		Z	2.85	68.2	18.4		141.7	
10013- CAA	IEEE 802.11g WIFI 2.4 GHz (DSSS-OFDM, 6 Mbps)	X	11.10	70.9	23.6	9.46	143.9	$\pm 3.0\%$
		Y	11.04	70.2	22.9		144.2	
		Z	10.77	70.2	23.1		134.7	
10021- DAB	GSM-FDD (TDMA, GMSK)	X	19.66	99.7	28.6	9.39	126.0	$\pm 1.9\%$
		Y	11.04	89.6	25.5		138.9	
		Z	10.45	88.8	24.9		137.5	
10023- DAB	GPRS-FDD (TDMA, GMSK, TN 0)	X	20.19	99.6	28.5	9.57	142.0	$\pm 2.5\%$
		Y	10.53	88.4	25.0		145.5	
		Z	15.52	96.5	27.8		147.6	
10024- DAB	GPRS-FDD (TDMA, GMSK, TN 0-1)	X	31.93	99.6	25.2	6.56	149.5	$\pm 1.9\%$
		Y	12.70	87.9	22.2		148.0	
		Z	27.00	99.8	25.7		135.3	
10027- DAB	GPRS-FDD (TDMA, GMSK, TN 0-1-2)	X	38.32	99.8	23.8	4.80	148.1	$\pm 2.2\%$
		Y	9.80	83.2	19.3		138.8	
		Z	31.96	99.9	24.2		128.9	
10028- DAB	GPRS-FDD (TDMA, GMSK, TN 0-1-2-3)	X	40.03	99.5	22.8	3.55	130.5	$\pm 2.2\%$
		Y	40.27	99.6	23.0		148.1	
		Z	43.09	99.7	22.5		140.1	
10032- CAA	IEEE 802.15.1 Bluetooth (GFSK, DH5)	X	38.93	99.4	20.4	1.16	146.7	$\pm 1.9\%$
		Y	32.83	92.5	17.9		139.2	
		Z	31.94	99.5	20.8		133.1	
10039- CAB	CDMA2000 (1xRTT, RC1)	X	4.66	66.8	19.3	4.57	144.5	$\pm 1.2\%$
		Y	4.56	65.3	17.9		137.2	
		Z	4.52	66.1	18.7		131.7	

10081-CAB	CDMA2000 (1xRTT, RC3)	X	3.82	66.0	18.7	3.97	140.3	±0.9 %
		Y	3.77	64.5	17.3		133.6	
		Z	3.79	65.7	18.4		128.2	
10098-CAB	UMTS-FDD (HSUPA, Subtest 2)	X	4.40	66.2	18.5	3.98	130.9	±1.2 %
		Y	4.39	65.0	17.4		131.1	
		Z	4.47	66.3	18.4		140.0	
10100-CAB	LTE-FDD (SC-FDMA, 100% RB, 20 MHz, QPSK)	X	6.30	67.3	19.8	5.67	137.4	±1.7 %
		Y	6.25	66.3	18.9		135.9	
		Z	6.36	67.4	19.7		147.5	
10108-CAB	LTE-FDD (SC-FDMA, 100% RB, 10 MHz, QPSK)	X	6.14	66.8	19.6	5.80	134.6	±1.7 %
		Y	6.17	66.1	18.9		133.9	
		Z	6.24	67.0	19.7		144.5	
10110-CAB	LTE-FDD (SC-FDMA, 100% RB, 5 MHz, QPSK)	X	5.82	66.3	19.4	5.75	131.2	±1.7 %
		Y	5.82	65.4	18.6		130.3	
		Z	5.91	66.5	19.4		140.4	
10114-CAA	IEEE 802.11n (HT Greenfield, 13.5 Mbps, BPSK)	X	10.00	68.5	21.2	8.10	124.3	±2.5 %
		Y	9.89	67.9	20.6		124.0	
		Z	10.05	68.6	21.2		133.2	
10117-CAA	IEEE 802.11n (HT Mixed, 13.5 Mbps, BPSK)	X	10.01	68.6	21.2	8.07	125.8	±2.5 %
		Y	9.91	67.9	20.7		125.8	
		Z	10.09	68.8	21.3		134.7	
10151-CAB	LTE-TDD (SC-FDMA, 50% RB, 20 MHz, QPSK)	X	9.69	75.5	26.4	9.28	144.7	±3.3 %
		Y	9.09	72.7	24.6		143.2	
		Z	8.54	72.0	24.5		124.8	
10154-CAB	LTE-FDD (SC-FDMA, 50% RB, 10 MHz, QPSK)	X	5.82	66.2	19.4	5.75	131.3	±1.9 %
		Y	6.06	66.3	19.1		149.2	
		Z	5.91	66.5	19.4		140.7	
10160-CAB	LTE-FDD (SC-FDMA, 50% RB, 15 MHz, QPSK)	X	6.27	66.9	19.7	5.82	136.5	±1.4 %
		Y	6.19	65.8	18.7		128.4	
		Z	6.33	67.0	19.6		145.4	
10169-CAB	LTE-FDD (SC-FDMA, 1 RB, 20 MHz, QPSK)	X	4.81	66.4	19.7	5.73	134.8	±1.7 %
		Y	4.92	66.1	19.1		149.9	
		Z	4.78	66.4	19.6		141.2	
10172-CAB	LTE-TDD (SC-FDMA, 1 RB, 20 MHz, QPSK)	X	7.83	76.6	27.2	9.21	131.4	±3.5 %
		Y	7.54	74.5	25.8		147.8	
		Z	7.71	76.7	27.4		145.3	
10175-CAB	LTE-FDD (SC-FDMA, 1 RB, 10 MHz, QPSK)	X	4.90	66.9	20.0	5.72	147.6	±1.4 %
		Y	4.90	66.0	19.1		148.0	
		Z	4.78	66.4	19.6		141.6	
10181-CAB	LTE-FDD (SC-FDMA, 1 RB, 15 MHz, QPSK)	X	4.90	66.9	20.0	5.72	148.1	±1.4 %
		Y	4.89	65.9	19.0		146.9	
		Z	4.80	66.5	19.7		142.1	
10193-CAA	IEEE 802.11n (HT Greenfield, 6.5 Mbps, BPSK)	X	9.80	68.7	21.4	8.09	135.1	±2.7 %
		Y	9.78	68.2	20.9		135.5	
		Z	9.70	68.5	21.2		130.2	

10196-CAA	IEEE 802.11n (HT Mixed, 6.5 Mbps, BPSK)	X	9.79	68.7	21.4	8.10	136.4	±2.7 %
		Y	9.81	68.3	20.9		138.0	
		Z	9.72	68.6	21.3		132.8	
10219-CAA	IEEE 802.11n (HT Mixed, 7.2 Mbps, BPSK)	X	9.68	68.6	21.3	8.03	136.0	±2.7 %
		Y	9.74	68.3	21.0		137.4	
		Z	9.62	68.5	21.2		132.6	
10222-CAA	IEEE 802.11n (HT Mixed, 15 Mbps, BPSK)	X	10.20	69.1	21.5	8.06	143.4	±2.5 %
		Y	9.91	68.0	20.7		125.8	
		Z	10.27	69.4	21.6		148.4	
10225-CAB	UMTS-FDD (HSPA+)	X	6.87	66.9	19.6	5.97	139.5	±1.9 %
		Y	7.04	66.9	19.3		149.3	
		Z	6.89	67.0	19.5		143.5	
10237-CAB	LTE-TDD (SC-FDMA, 1 RB, 10 MHz, QPSK)	X	7.66	75.9	26.9	9.21	126.1	±3.0 %
		Y	7.17	73.1	25.1		132.1	
		Z	7.18	74.6	26.3		128.0	
10252-CAB	LTE-TDD (SC-FDMA, 50% RB, 10 MHz, QPSK)	X	8.58	73.1	25.3	9.24	127.6	±3.3 %
		Y	8.22	71.0	23.7		126.9	
		Z	8.83	74.3	26.0		149.8	
10267-CAB	LTE-TDD (SC-FDMA, 100% RB, 10 MHz, QPSK)	X	9.69	75.5	26.5	9.30	143.8	±3.3 %
		Y	8.88	72.0	24.2		135.2	
		Z	8.83	72.9	25.1		131.3	
10274-CAB	UMTS-FDD (HSUPA, Subtest 5, 3GPP Rel8.10)	X	5.87	67.0	19.2	4.87	141.2	±1.4 %
		Y	5.77	65.8	18.1		136.0	
		Z	5.71	66.3	18.6		132.7	
10275-CAB	UMTS-FDD (HSUPA, Subtest 5, 3GPP Rel8.4)	X	4.44	67.2	19.2	3.96	147.3	±0.9 %
		Y	4.29	65.3	17.6		139.2	
		Z	4.31	66.3	18.5		139.6	
10291-AAB	CDMA2000, RC3, SO55, Full Rate	X	3.60	67.1	19.1	3.46	137.8	±0.7 %
		Y	3.44	64.8	17.2		129.6	
		Z	3.48	66.2	18.4		130.5	
10292-AAB	CDMA2000, RC3, SO32, Full Rate	X	3.50	66.9	18.9	3.39	139.5	±0.7 %
		Y	3.38	64.8	17.2		132.0	
		Z	3.48	66.5	18.5		133.1	
10297-AAA	LTE-FDD (SC-FDMA, 50% RB, 20 MHz, QPSK)	X	6.12	66.7	19.6	5.81	133.3	±1.9 %
		Y	6.35	66.7	19.3		149.3	
		Z	6.17	66.8	19.5		132.7	
10311-AAA	LTE-FDD (SC-FDMA, 100% RB, 15 MHz, QPSK)	X	6.72	67.4	20.0	6.06	138.7	±1.7 %
		Y	6.63	66.3	19.1		131.4	
		Z	6.72	67.3	19.9		138.7	
10315-AAA	IEEE 802.11b WiFi 2.4 GHz (DSSS, 1 Mbps, 96pc duty cycle)	X	2.90	69.9	19.8	1.71	146.4	±0.5 %
		Y	2.54	65.2	16.5		139.3	
		Z	2.75	68.1	18.5		146.4	
10316-AAA	IEEE 802.11g WiFi 2.4 GHz (ERP-OFDM, 6 Mbps, 96pc duty cycle)	X	10.12	69.3	21.9	8.36	142.9	±3.0 %
		Y	10.01	68.5	21.3		135.2	
		Z	10.11	69.3	21.9		141.7	

10403-AAB	CDMA2000 (1xEV-DO, Rev. 0)	X	4.59	68.2	19.0	3.76	126.7	±0.7 %
		Y	4.59	67.2	18.0		142.4	
		Z	4.64	68.5	19.0		143.0	
10404-AAB	CDMA2000 (1xEV-DO, Rev. A)	X	4.64	68.8	19.3	3.77	147.1	±0.9 %
		Y	4.47	67.1	17.9		139.6	
		Z	4.54	68.4	18.9		147.2	
10415-AAA	IEEE 802.11b WiFi 2.4 GHz (DSSS, 1 Mbps, 99pc duty cycle)	X	2.66	69.0	19.4	1.54	145.8	±0.5 %
		Y	2.40	64.8	16.2		140.0	
		Z	2.62	67.8	18.4		147.2	
10416-AAA	IEEE 802.11g WiFi 2.4 GHz (ERP-OFDM, 6 Mbps, 99pc duty cycle)	X	9.97	69.1	21.7	8.23	142.0	±3.0 %
		Y	10.08	68.9	21.4		145.8	
		Z	10.01	69.2	21.8		143.3	

The reported uncertainty of measurement is stated as the standard uncertainty of measurement multiplied by the coverage factor $k=2$, which for a normal distribution corresponds to a coverage probability of approximately 95%.

[^] The uncertainties of Norm X, Y, Z do not affect the E^2 -field uncertainty inside TSL (see Pages 8 and 9).

[^] Numerical linearization parameter: uncertainty not required.

[^] Uncertainty is determined using the max. deviation from linear response applying rectangular distribution and is expressed for the square of the field value.

DASY/EASY - Parameters of Probe: ES3DV2 - SN:3022

Calibration Parameter Determined in Head Tissue Simulating Media

f (MHz) ^c	Relative Permittivity ^F	Conductivity (S/m) ^F	ConvF X	ConvF Y	ConvF Z	Alpha ^G	Depth ^G (mm)	Unct. (k=2)
750	41.9	0.89	6.39	6.39	6.39	0.20	2.24	± 12.0 %
835	41.5	0.90	6.18	6.18	6.18	0.23	1.98	± 12.0 %
1750	40.1	1.37	5.04	5.04	5.04	0.51	1.35	± 12.0 %
1900	40.0	1.40	4.85	4.85	4.85	0.38	1.66	± 12.0 %
2450	39.2	1.80	4.31	4.31	4.31	0.66	1.28	± 12.0 %
2600	39.0	1.96	4.13	4.13	4.13	0.76	1.28	± 12.0 %

^c Frequency validity above 300 MHz of ± 100 MHz only applies for DASY v4.4 and higher (see Page 2), else it is restricted to ± 50 MHz. The uncertainty is the RSS of the ConvF uncertainty at calibration frequency and the uncertainty for the indicated frequency band. Frequency validity below 300 MHz is ± 10, 25, 40, 50 and 70 MHz for ConvF assessments at 30, 64, 128, 150 and 220 MHz respectively. Above 5 GHz frequency validity can be extended to ± 110 MHz.

^F At frequencies below 3 GHz, the validity of tissue parameters (ϵ and σ) can be relaxed to ± 10% if liquid compensation formula is applied to measured SAR values. At frequencies above 3 GHz, the validity of tissue parameters (ϵ and σ) is restricted to ± 5%. The uncertainty is the RSS of the ConvF uncertainty for indicated target tissue parameters.

^G Alpha/Depth are determined during calibration. SPEAG warrants that the remaining deviation due to the boundary effect after compensation is always less than ± 1% for frequencies below 3 GHz and below ± 2% for frequencies between 3-6 GHz at any distance larger than half the probe tip diameter from the boundary.

DASY/EASY - Parameters of Probe: ES3DV2 - SN:3022

Calibration Parameter Determined in Body Tissue Simulating Media

f (MHz) ^C	Relative Permittivity ^F	Conductivity (S/m) ^F	ConvF X	ConvF Y	ConvF Z	Alpha ^G	Depth ^G (mm)	Unct. (k=2)
450	56.7	0.94	6.78	6.78	6.78	0.12	1.30	± 13.3 %
600	56.1	0.95	6.72	6.72	6.72	0.05	1.20	± 13.3 %
750	55.5	0.96	6.02	6.02	6.02	0.23	2.05	± 12.0 %
835	55.2	0.97	5.98	5.98	5.98	0.29	1.85	± 12.0 %
1750	53.4	1.49	4.70	4.70	4.70	0.66	1.25	± 12.0 %
1900	53.3	1.52	4.49	4.49	4.49	0.33	2.02	± 12.0 %
2450	52.7	1.95	4.05	4.05	4.05	0.80	1.01	± 12.0 %
2600	52.5	2.16	3.94	3.94	3.94	0.68	1.03	± 12.0 %

^C Frequency validity above 300 MHz of ± 100 MHz only applies for DASY v4.4 and higher (see Page 2), else it is restricted to ± 50 MHz. The uncertainty is the RSS of the ConvF uncertainty at calibration frequency and the uncertainty for the indicated frequency band. Frequency validity below 300 MHz is ± 10, 25, 40, 50 and 70 MHz for ConvF assessments at 30, 64, 128, 150 and 220 MHz respectively. Above 5 GHz frequency validity can be extended to ± 110 MHz.

^F At frequencies below 3 GHz, the validity of tissue parameters (ϵ and σ) can be relaxed to ± 10% if liquid compensation formula is applied to measured SAR values. At frequencies above 3 GHz, the validity of tissue parameters (ϵ and σ) is restricted to ± 5%. The uncertainty is the RSS of the ConvF uncertainty for indicated target tissue parameters.

^G Alpha/Depth are determined during calibration. SPEAG warrants that the remaining deviation due to the boundary effect after compensation is always less than ± 1% for frequencies below 3 GHz and below ± 2% for frequencies between 3-6 GHz at any distance larger than half the probe tip diameter from the boundary.

Frequency Response of E-Field (TEM-Cell:ifi110 EXX, Waveguide: R22)

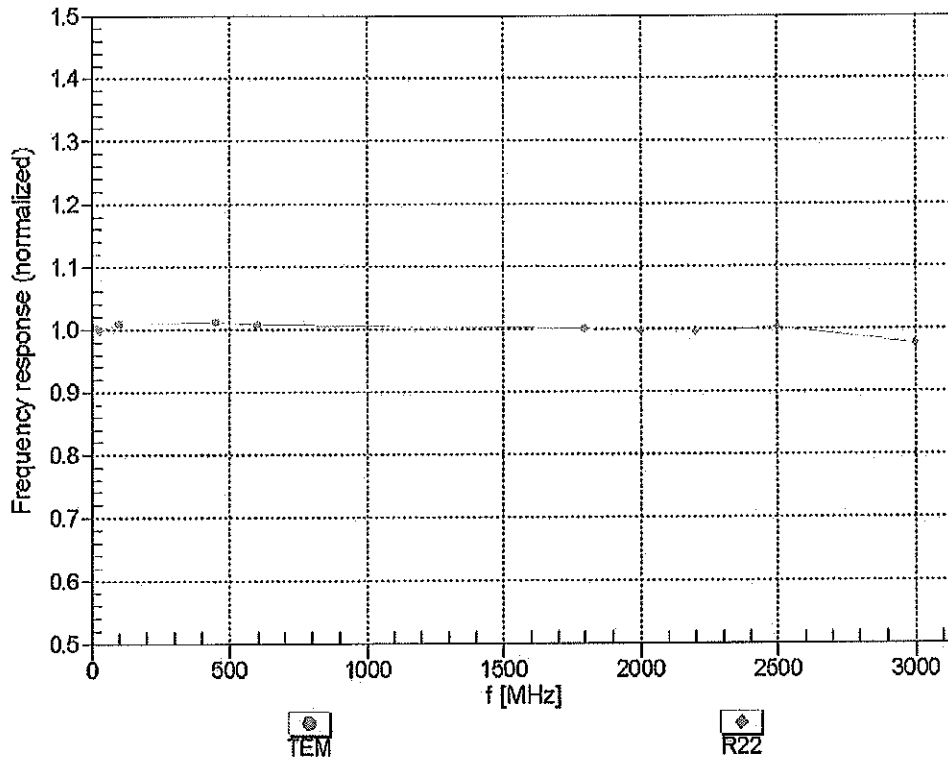

Uncertainty of Frequency Response of E-field: $\pm 6.3\%$ ($k=2$)

Receiving Pattern (ϕ), $\theta = 0^\circ$

f=600 MHz,TEM

f=1800 MHz,R22

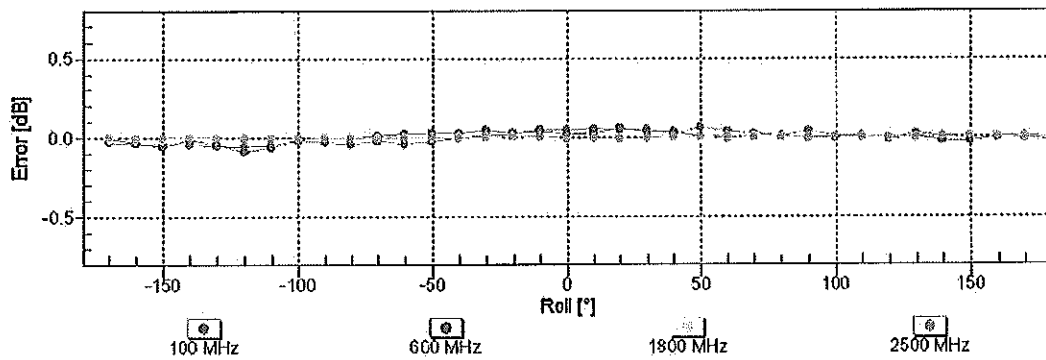
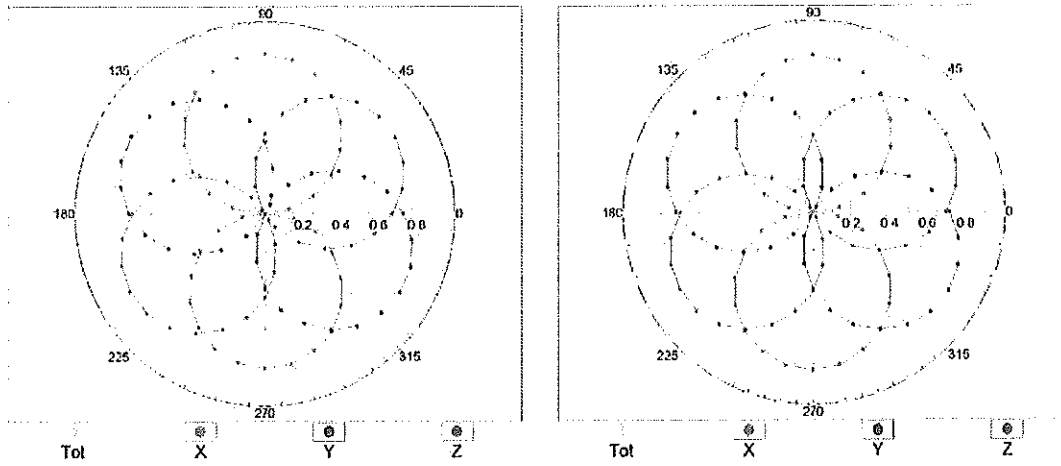

Uncertainty of Axial Isotropy Assessment: $\pm 0.5\%$ (k=2)

Dynamic Range $f(SAR_{head})$ (TEM cell, $f_{eval} = 1900$ MHz)

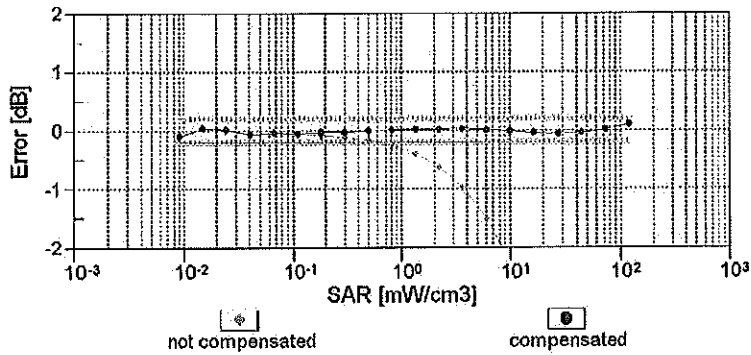
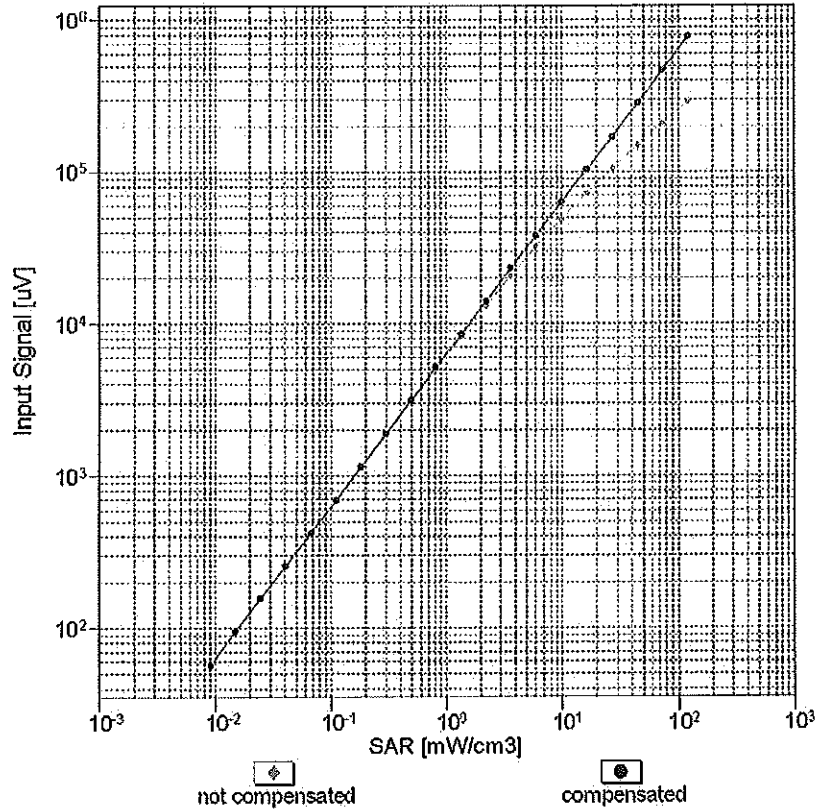

Uncertainty of Linearity Assessment: $\pm 0.6\%$ ($k=2$)

Conversion Factor Assessment

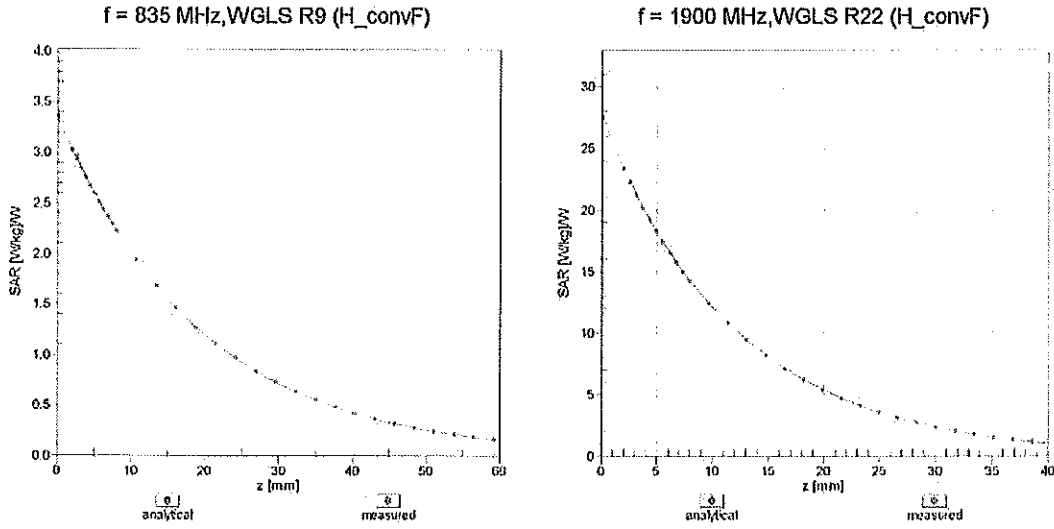

Deviation from Isotropy in Liquid Error (ϕ, θ), f = 900 MHz

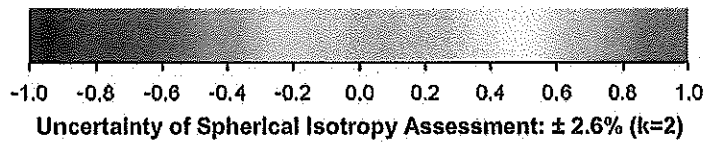
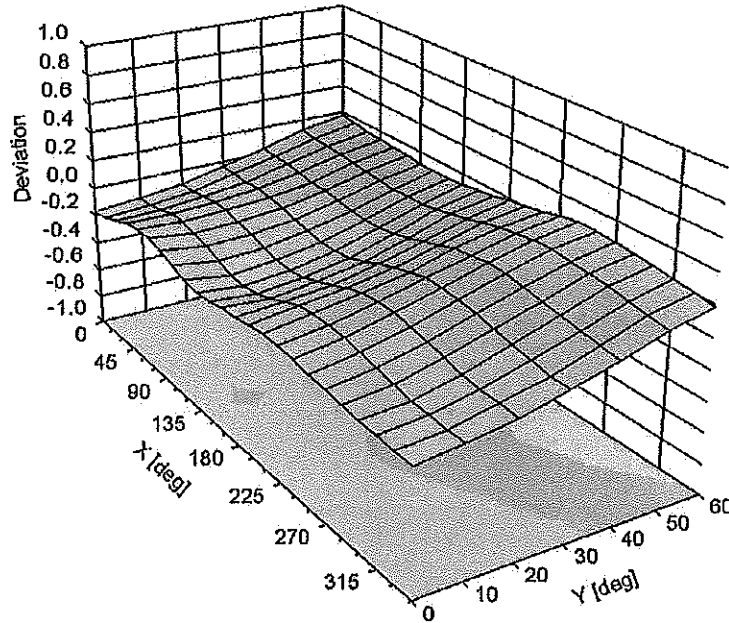

DASY/EASY - Parameters of Probe: ES3DV2 - SN:3022**Other Probe Parameters**

Sensor Arrangement	Triangular
Connector Angle (°)	-80.3
Mechanical Surface Detection Mode	enabled
Optical Surface Detection Mode	disabled
Probe Overall Length	337 mm
Probe Body Diameter	10 mm
Tip Length	10 mm
Tip Diameter	4 mm
Probe Tip to Sensor X Calibration Point	2 mm
Probe Tip to Sensor Y Calibration Point	2 mm
Probe Tip to Sensor Z Calibration Point	2 mm
Recommended Measurement Distance from Surface	3 mm



Accredited by the Swiss Accreditation Service (SAS)
The Swiss Accreditation Service is one of the signatories to the EA
Multilateral Agreement for the recognition of calibration certificates

Accreditation No.: **SCS 0108**

Client **PC Test**

Certificate No: **ES3-3318_Jan15**

CALIBRATION CERTIFICATE

Object **ES3DV3 - SN:3318**

Calibration procedure(s) **QA CAL-01.v9, QA CAL-23.v5, QA CAL-25.v6
Calibration procedure for dosimetric E-field probes**

CC
1/30/15

Calibration date: **January 23, 2015**

This calibration certificate documents the traceability to national standards, which realize the physical units of measurements (SI).
The measurements and the uncertainties with confidence probability are given on the following pages and are part of the certificate.

All calibrations have been conducted in the closed laboratory facility: environment temperature $(22 \pm 3)^\circ\text{C}$ and humidity $< 70\%$.

Calibration Equipment used (M&TE critical for calibration)

Primary Standards	ID	Cal Date (Certificate No.)	Scheduled Calibration
Power meter E4419B	GB41293874	03-Apr-14 (No. 217-01911)	Apr-15
Power sensor E4412A	MY41498087	03-Apr-14 (No. 217-01911)	Apr-15
Reference 3 dB Attenuator	SN: S5054 (3c)	03-Apr-14 (No. 217-01915)	Apr-15
Reference 20 dB Attenuator	SN: S5277 (20x)	03-Apr-14 (No. 217-01919)	Apr-15
Reference 30 dB Attenuator	SN: S5129 (30b)	03-Apr-14 (No. 217-01920)	Apr-15
Reference Probe ES3DV2	SN: 3013	30-Dec-14 (No. ES3-3013_Dec14)	Dec-15
DAE4	SN: 660	14-Jan-15 (No. DAE4-660_Jan15)	Jan-16
Secondary Standards	ID	Check Date (in house)	Scheduled Check
RF generator HP 8648C	US3642U01700	4-Aug-99 (in house check Apr-13)	In house check: Apr-16
Network Analyzer HP 8753E	US37390585	18-Oct-01 (in house check Oct-14)	In house check: Oct-15

Calibrated by:	Name Israe Elnaouq	Function Laboratory Technician	Signature
Approved by:	Katja Pokovic	Technical Manager	

Issued: January 26, 2015

This calibration certificate shall not be reproduced except in full without written approval of the laboratory.



Accredited by the Swiss Accreditation Service (SAS)

Accreditation No.: **SCS 0108**

The Swiss Accreditation Service is one of the signatories to the EA
Multilateral Agreement for the recognition of calibration certificates

Glossary:

TSL	tissue simulating liquid
NORM _{x,y,z}	sensitivity in free space
ConvF	sensitivity in TSL / NORM _{x,y,z}
DCP	diode compression point
CF	crest factor (1/duty_cycle) of the RF signal
A, B, C, D	modulation dependent linearization parameters
Polarization φ	φ rotation around probe axis
Polarization θ	θ rotation around an axis that is in the plane normal to probe axis (at measurement center), i.e., θ = 0 is normal to probe axis
Connector Angle	information used in DASY system to align probe sensor X to the robot coordinate system

Calibration is Performed According to the Following Standards:

- a) IEEE Std 1528-2013, "IEEE Recommended Practice for Determining the Peak Spatial-Averaged Specific Absorption Rate (SAR) in the Human Head from Wireless Communications Devices: Measurement Techniques", June 2013
- b) IEC 62209-1, "Procedure to measure the Specific Absorption Rate (SAR) for hand-held devices used in close proximity to the ear (frequency range of 300 MHz to 3 GHz)", February 2005

Methods Applied and Interpretation of Parameters:

- *NORM_{x,y,z}*: Assessed for E-field polarization θ = 0 (f ≤ 900 MHz in TEM-cell; f > 1800 MHz: R22 waveguide). *NORM_{x,y,z}* are only intermediate values, i.e., the uncertainties of *NORM_{x,y,z}* does not affect the E²-field uncertainty inside TSL (see below *ConvF*).
- *NORM(f)_{x,y,z}* = *NORM_{x,y,z}* * *frequency_response* (see Frequency Response Chart). This linearization is implemented in DASY4 software versions later than 4.2. The uncertainty of the frequency response is included in the stated uncertainty of *ConvF*.
- *DCP_{x,y,z}*: DCP are numerical linearization parameters assessed based on the data of power sweep with CW signal (no uncertainty required). DCP does not depend on frequency nor media.
- *PAR*: PAR is the Peak to Average Ratio that is not calibrated but determined based on the signal characteristics
- *A_{x,y,z}*; *B_{x,y,z}*; *C_{x,y,z}*; *D_{x,y,z}*; *VR_{x,y,z}*; *A, B, C, D* are numerical linearization parameters assessed based on the data of power sweep for specific modulation signal. The parameters do not depend on frequency nor media. *VR* is the maximum calibration range expressed in RMS voltage across the diode.
- *ConvF and Boundary Effect Parameters*: Assessed in flat phantom using E-field (or Temperature Transfer Standard for f ≤ 800 MHz) and inside waveguide using analytical field distributions based on power measurements for f > 800 MHz. The same setups are used for assessment of the parameters applied for boundary compensation (alpha, depth) of which typical uncertainty values are given. These parameters are used in DASY4 software to improve probe accuracy close to the boundary. The sensitivity in TSL corresponds to *NORM_{x,y,z}* * *ConvF* whereby the uncertainty corresponds to that given for *ConvF*. A frequency dependent *ConvF* is used in DASY version 4.4 and higher which allows extending the validity from ± 50 MHz to ± 100 MHz.
- *Spherical isotropy (3D deviation from isotropy)*: in a field of low gradients realized using a flat phantom exposed by a patch antenna.
- *Sensor Offset*: The sensor offset corresponds to the offset of virtual measurement center from the probe tip (on probe axis). No tolerance required.
- *Connector Angle*: The angle is assessed using the information gained by determining the *NORM_x* (no uncertainty required).

Probe ES3DV3

SN:3318

Manufactured: January 10, 2012
Calibrated: January 23, 2015

Calibrated for DASY/EASY Systems
(Note: non-compatible with DASY2 system!)

DASY/EASY - Parameters of Probe: ES3DV3 - SN:3318

Basic Calibration Parameters

	Sensor X	Sensor Y	Sensor Z	Unc (k=2)
Norm ($\mu V/(V/m)^2$) ^A	1.15	0.92	1.28	± 10.1 %
DCP (mV) ^B	106.4	109.2	103.4	

Modulation Calibration Parameters

UID	Communication System Name		A dB	B dB√μV	C	D dB	VR mV	Unc ^E (k=2)
0	CW	X	0.0	0.0	1.0	0.00	200.6	±3.5 %
		Y	0.0	0.0	1.0		185.3	
		Z	0.0	0.0	1.0		207.7	
10010- CAA	SAR Validation (Square, 100ms, 10ms)	X	3.26	66.4	14.0	10.00	41.4	±1.2 %
		Y	1.76	59.6	9.8		36.1	
		Z	1.82	57.7	9.6		43.6	
10011- CAB	UMTS-FDD (WCDMA)	X	3.48	68.9	19.9	2.91	120.2	±0.5 %
		Y	3.76	70.1	19.9		146.0	
		Z	3.11	66.0	17.9		124.4	
10012- CAB	IEEE 802.11b WiFi 2.4 GHz (DSSS, 1 Mbps)	X	3.71	74.2	21.7	1.87	121.7	±0.7 %
		Y	3.65	73.3	20.7		147.5	
		Z	2.77	67.4	17.8		126.6	
10013- CAB	IEEE 802.11g WiFi 2.4 GHz (DSSS-OFDM, 6 Mbps)	X	10.68	69.5	22.7	9.46	114.7	±2.5 %
		Y	10.82	70.4	23.0		139.8	
		Z	11.22	71.1	23.7		122.2	
10021- DAB	GSM-FDD (TDMA, GMSK)	X	16.13	95.0	26.6	9.39	122.7	±2.2 %
		Y	4.61	73.1	17.2		130.8	
		Z	15.10	92.0	25.4		135.9	
10023- DAB	GPRS-FDD (TDMA, GMSK, TN 0)	X	17.03	96.8	27.5	9.57	113.0	±1.9 %
		Y	4.15	71.7	16.8		119.9	
		Z	21.50	98.0	27.5		130.9	
10024- DAB	GPRS-FDD (TDMA, GMSK, TN 0-1)	X	35.51	99.5	24.5	6.56	147.6	±2.7 %
		Y	6.12	77.2	17.1		118.1	
		Z	38.50	99.7	24.7		114.0	
10027- DAB	GPRS-FDD (TDMA, GMSK, TN 0-1-2)	X	45.57	99.9	23.2	4.80	113.3	±1.7 %
		Y	2.73	68.4	12.6		133.3	
		Z	54.59	99.9	22.9		131.0	
10028- DAB	GPRS-FDD (TDMA, GMSK, TN 0-1-2-3)	X	53.68	99.5	21.9	3.55	123.0	±3.0 %
		Y	60.05	99.8	21.1		144.9	
		Z	66.60	99.6	21.6		140.7	
10032- CAA	IEEE 802.15.1 Bluetooth (GFSK, DH5)	X	20.92	99.4	21.8	1.16	136.6	±2.2 %
		Y	95.40	88.3	13.8		117.6	
		Z	100.00	99.5	18.7		110.1	
10100- CAB	LTE-FDD (SC-FDMA, 100% RB, 20 MHz, QPSK)	X	6.50	68.1	20.2	5.67	130.5	±1.2 %
		Y	6.11	66.7	19.2		107.2	
		Z	6.55	68.2	20.1		142.7	

10103-CAB	LTE-TDD (SC-FDMA, 100% RB, 20 MHz, QPSK)	X	9.76	74.8	25.9	9.29	116.0	±2.5 %
		Y	8.85	72.2	24.1		134.9	
		Z	10.83	77.4	27.2		131.5	
10108-CAC	LTE-FDD (SC-FDMA, 100% RB, 10 MHz, QPSK)	X	6.36	67.7	20.1	5.80	128.7	±1.2 %
		Y	5.92	66.1	19.0		106.6	
		Z	6.42	67.7	20.0		140.4	
10117-CAB	IEEE 802.11n (HT Mixed, 13.5 Mbps, BPSK)	X	10.20	69.1	21.6	8.07	118.1	±2.5 %
		Y	10.27	69.3	21.4		143.9	
		Z	10.43	69.7	21.8		131.0	
10151-CAB	LTE-TDD (SC-FDMA, 50% RB, 20 MHz, QPSK)	X	9.09	73.7	25.5	9.28	112.0	±2.7 %
		Y	8.35	71.5	23.9		131.1	
		Z	9.58	74.4	25.6		126.8	
10154-CAC	LTE-FDD (SC-FDMA, 50% RB, 10 MHz, QPSK)	X	6.01	67.0	19.8	5.75	126.4	±1.2 %
		Y	6.17	67.7	19.9		148.9	
		Z	6.07	67.1	19.7		137.2	
10160-CAB	LTE-FDD (SC-FDMA, 50% RB, 15 MHz, QPSK)	X	6.41	67.4	19.9	5.82	130.9	±0.9 %
		Y	6.06	66.2	19.0		109.1	
		Z	6.54	67.7	20.0		142.6	
10169-CAB	LTE-FDD (SC-FDMA, 1 RB, 20 MHz, QPSK)	X	4.79	66.5	19.8	5.73	109.4	±0.9 %
		Y	4.82	67.1	19.8		128.8	
		Z	4.85	66.4	19.5		119.0	
10172-CAB	LTE-TDD (SC-FDMA, 1 RB, 20 MHz, QPSK)	X	8.44	79.3	28.7	9.21	125.1	±2.5 %
		Y	7.15	75.0	26.0		144.0	
		Z	10.13	83.8	30.8		141.9	
10175-CAC	LTE-FDD (SC-FDMA, 1 RB, 10 MHz, QPSK)	X	5.13	68.2	20.8	5.72	146.5	±0.9 %
		Y	4.77	66.8	19.6		125.2	
		Z	4.81	66.2	19.4		118.5	
10181-CAB	LTE-FDD (SC-FDMA, 1 RB, 15 MHz, QPSK)	X	5.11	68.1	20.7	5.72	146.4	±0.9 %
		Y	4.79	67.0	19.7		126.0	
		Z	4.88	66.6	19.7		118.9	
10196-CAB	IEEE 802.11n (HT Mixed, 6.5 Mbps, BPSK)	X	9.63	68.3	21.2	8.10	108.2	±2.5 %
		Y	9.84	68.9	21.3		135.5	
		Z	9.99	69.2	21.7		124.0	
10225-CAB	UMTS-FDD (HSPA+)	X	6.99	67.3	19.7	5.97	134.8	±0.9 %
		Y	6.73	66.8	19.2		115.9	
		Z	6.71	66.2	19.0		106.3	
10237-CAB	LTE-TDD (SC-FDMA, 1 RB, 10 MHz, QPSK)	X	7.79	76.4	27.0	9.21	126.4	±2.5 %
		Y	7.19	75.1	26.1		144.7	
		Z	10.12	83.9	30.9		142.0	
10252-CAB	LTE-TDD (SC-FDMA, 50% RB, 10 MHz, QPSK)	X	8.19	71.9	24.7	9.24	103.3	±2.2 %
		Y	7.76	70.8	23.6		122.0	
		Z	9.31	75.2	26.4		119.1	
10267-CAB	LTE-TDD (SC-FDMA, 100% RB, 10 MHz, QPSK)	X	8.90	73.0	25.1	9.30	108.7	±2.2 %
		Y	8.38	71.6	24.0		129.7	
		Z	10.15	76.5	26.9		126.1	

10275-CAB	UMTS-FDD (HSUPA, Subtest 5, 3GPP Rel8.4)	X	4.42	67.2	19.2	3.96	119.1	±0.7 %
		Y	4.71	68.5	19.5		143.8	
		Z	4.39	66.7	18.6		131.7	
10291-AAB	CDMA2000, RC3, SO55, Full Rate	X	3.65	67.5	19.3	3.46	111.3	±0.5 %
		Y	3.89	69.0	19.6		130.9	
		Z	3.49	66.1	18.2		122.4	
10292-AAB	CDMA2000, RC3, SO32, Full Rate	X	3.60	67.6	19.3	3.39	114.4	±0.5 %
		Y	3.85	69.1	19.7		133.4	
		Z	3.45	66.2	18.2		123.7	
10297-AAA	LTE-FDD (SC-FDMA, 50% RB, 20 MHz, QPSK)	X	6.36	67.6	20.1	5.81	128.7	±1.2 %
		Y	5.95	66.1	19.0		106.5	
		Z	6.39	67.6	19.9		140.7	
10311-AAA	LTE-FDD (SC-FDMA, 100% RB, 15 MHz, QPSK)	X	6.98	68.4	20.6	6.06	134.9	±1.2 %
		Y	6.52	66.7	19.3		111.3	
		Z	7.06	68.6	20.5		146.2	
10403-AAB	CDMA2000 (1xEV-DO, Rev. 0)	X	4.97	69.7	19.7	3.76	122.2	±0.5 %
		Y	5.31	71.6	20.2		143.6	
		Z	4.54	67.3	18.2		133.0	
10404-AAB	CDMA2000 (1xEV-DO, Rev. A)	X	4.77	69.4	19.6	3.77	120.8	±0.5 %
		Y	5.40	72.4	20.6		141.3	
		Z	4.71	68.5	18.9		131.5	
10415-AAA	IEEE 802.11b WiFi 2.4 GHz (DSSS, 1 Mbps, 99pc duty cycle)	X	3.07	71.7	20.7	1.54	120.5	±0.7 %
		Y	3.52	73.8	21.0		142.0	
		Z	2.38	66.1	17.4		129.6	
10416-AAA	IEEE 802.11g WiFi 2.4 GHz (ERP-OFDM, 6 Mbps, 99pc duty cycle)	X	9.73	68.3	21.2	8.23	114.7	±2.5 %
		Y	9.99	69.2	21.5		138.0	
		Z	10.10	69.4	21.9		125.3	

The reported uncertainty of measurement is stated as the standard uncertainty of measurement multiplied by the coverage factor $k=2$, which for a normal distribution corresponds to a coverage probability of approximately 95%.

^A The uncertainties of NormX,Y,Z do not affect the E^2 -field uncertainty inside TSL (see Pages 7 and 8).

^B Numerical linearization parameter: uncertainty not required.

^E Uncertainty is determined using the max. deviation from linear response applying rectangular distribution and is expressed for the square of the field value.

DASY/EASY - Parameters of Probe: ES3DV3 - SN:3318

Calibration Parameter Determined in Head Tissue Simulating Media

f (MHz) ^C	Relative Permittivity ^F	Conductivity (S/m) ^F	ConvF X	ConvF Y	ConvF Z	Alpha ^G	Depth ^G (mm)	Unct. (k=2)
750	41.9	0.89	6.58	6.58	6.58	0.36	1.73	± 12.0 %
835	41.5	0.90	6.39	6.39	6.39	0.80	1.14	± 12.0 %
1750	40.1	1.37	5.27	5.27	5.27	0.76	1.19	± 12.0 %
1900	40.0	1.40	5.05	5.05	5.05	0.44	1.55	± 12.0 %
2300	39.5	1.67	4.78	4.78	4.78	0.80	1.23	± 12.0 %
2450	39.2	1.80	4.50	4.50	4.50	0.55	1.49	± 12.0 %
2600	39.0	1.96	4.34	4.34	4.34	0.76	1.32	± 12.0 %

^C Frequency validity above 300 MHz of ± 100 MHz only applies for DASY v4.4 and higher (see Page 2), else it is restricted to ± 50 MHz. The uncertainty is the RSS of the ConvF uncertainty at calibration frequency and the uncertainty for the indicated frequency band. Frequency validity below 300 MHz is ± 10, 25, 40, 50 and 70 MHz for ConvF assessments at 30, 64, 128, 150 and 220 MHz respectively. Above 5 GHz frequency validity can be extended to ± 110 MHz.

^F At frequencies below 3 GHz, the validity of tissue parameters (ϵ and σ) can be relaxed to ± 10% if liquid compensation formula is applied to measured SAR values. At frequencies above 3 GHz, the validity of tissue parameters (ϵ and σ) is restricted to ± 5%. The uncertainty is the RSS of the ConvF uncertainty for indicated target tissue parameters.

^G Alpha/Depth are determined during calibration. SPEAG warrants that the remaining deviation due to the boundary effect after compensation is always less than ± 1% for frequencies below 3 GHz and below ± 2% for frequencies between 3-6 GHz at any distance larger than half the probe tip diameter from the boundary.

DASY/EASY - Parameters of Probe: ES3DV3 - SN:3318

Calibration Parameter Determined in Body Tissue Simulating Media

f (MHz) ^C	Relative Permittivity ^F	Conductivity (S/m) ^F	ConvF X	ConvF Y	ConvF Z	Alpha ^G	Depth (mm) ^G	Unct. (k=2)
750	55.5	0.96	6.22	6.22	6.22	0.67	1.28	± 12.0 %
835	55.2	0.97	6.23	6.23	6.23	0.80	1.19	± 12.0 %
1750	53.4	1.49	4.95	4.95	4.95	0.40	1.77	± 12.0 %
1900	53.3	1.52	4.76	4.76	4.76	0.60	1.48	± 12.0 %
2300	52.9	1.81	4.52	4.52	4.52	0.80	1.19	± 12.0 %
2450	52.7	1.95	4.37	4.37	4.37	0.72	1.23	± 12.0 %
2600	52.5	2.16	4.17	4.17	4.17	0.80	1.00	± 12.0 %

^C Frequency validity above 300 MHz of ± 100 MHz only applies for DASY v4.4 and higher (see Page 2), else it is restricted to ± 50 MHz. The uncertainty is the RSS of the ConvF uncertainty at calibration frequency and the uncertainty for the indicated frequency band. Frequency validity below 300 MHz is ± 10, 25, 40, 50 and 70 MHz for ConvF assessments at 30, 64, 128, 150 and 220 MHz respectively. Above 5 GHz frequency validity can be extended to ± 110 MHz.

^F At frequencies below 3 GHz, the validity of tissue parameters (ϵ and σ) can be relaxed to ± 10% if liquid compensation formula is applied to measured SAR values. At frequencies above 3 GHz, the validity of tissue parameters (ϵ and σ) is restricted to ± 5%. The uncertainty is the RSS of the ConvF uncertainty for indicated target tissue parameters.

^G Alpha/Depth are determined during calibration. SPEAG warrants that the remaining deviation due to the boundary effect after compensation is always less than ± 1% for frequencies below 3 GHz and below ± 2% for frequencies between 3-6 GHz at any distance larger than half the probe tip diameter from the boundary.

Frequency Response of E-Field (TEM-Cell: ifi110 EXX, Waveguide: R22)

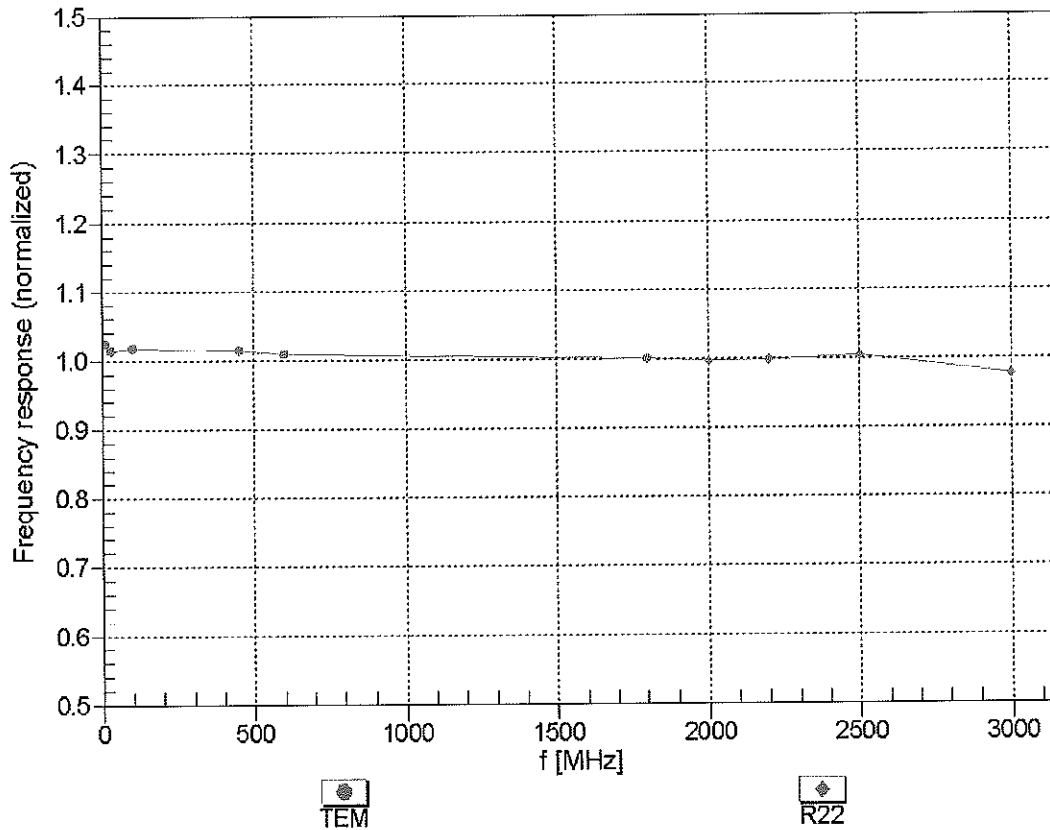

Uncertainty of Frequency Response of E-field: $\pm 6.3\%$ (k=2)

Receiving Pattern (ϕ), $\theta = 0^\circ$

f=600 MHz,TEM

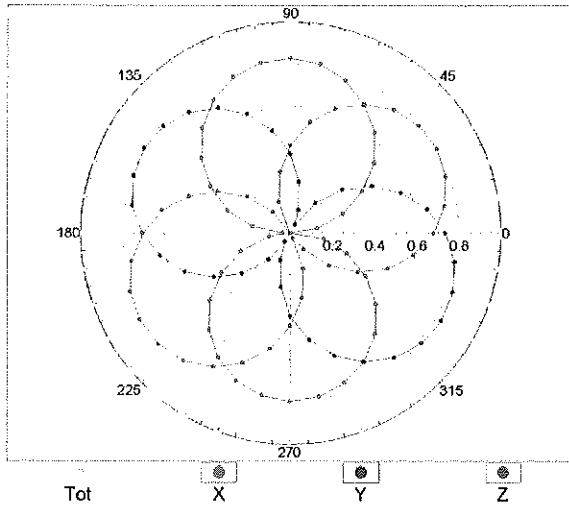

f=1800 MHz,R22

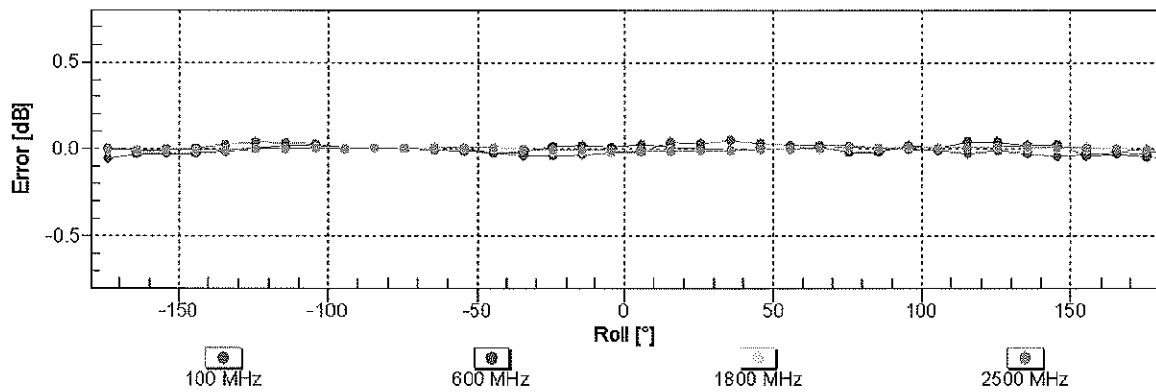
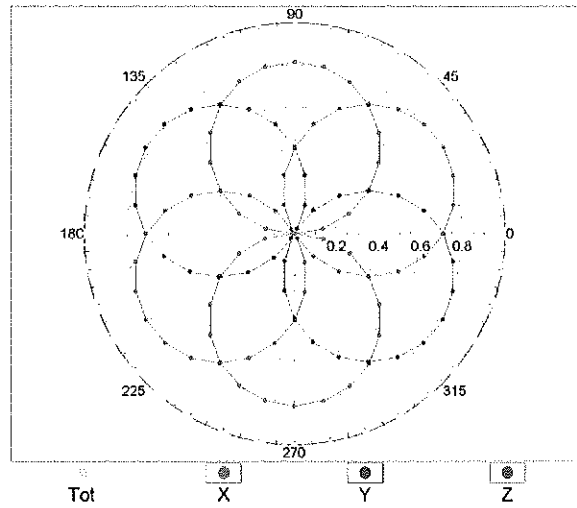

Uncertainty of Axial Isotropy Assessment: $\pm 0.5\%$ (k=2)

Dynamic Range f(SAR_{head}) (TEM cell , f_{eval}= 1900 MHz)

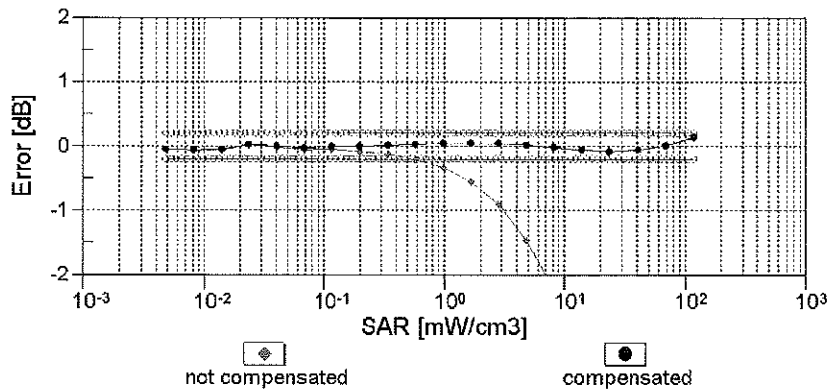
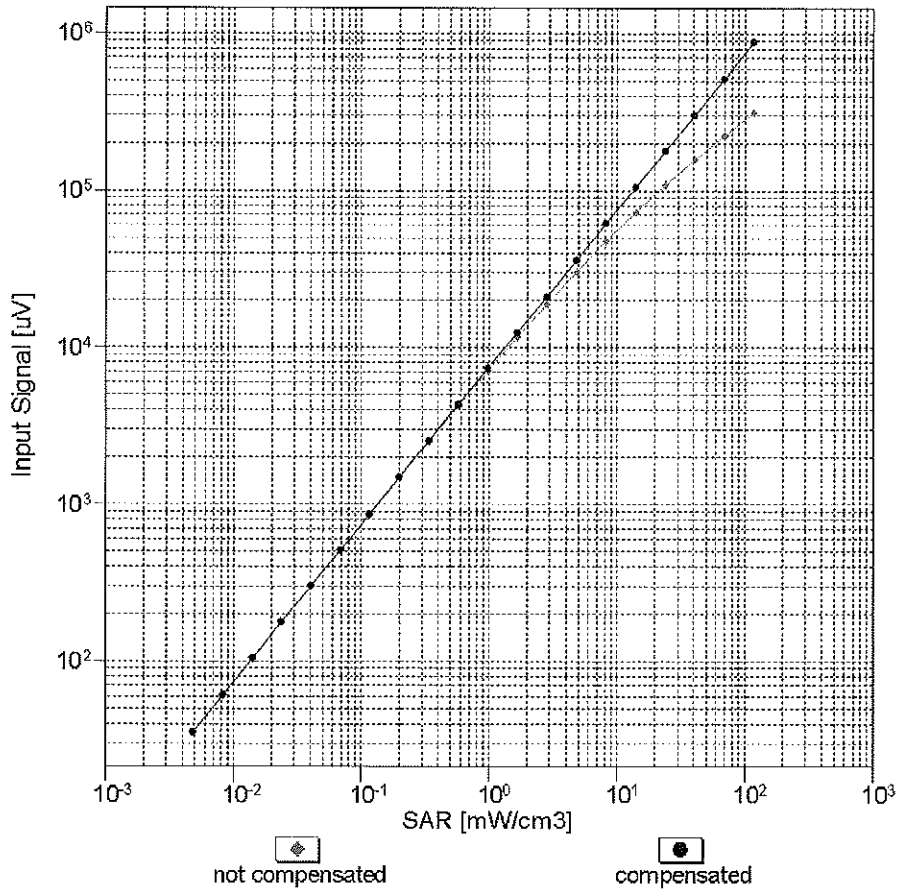

Uncertainty of Linearity Assessment: ± 0.6% (k=2)

Conversion Factor Assessment

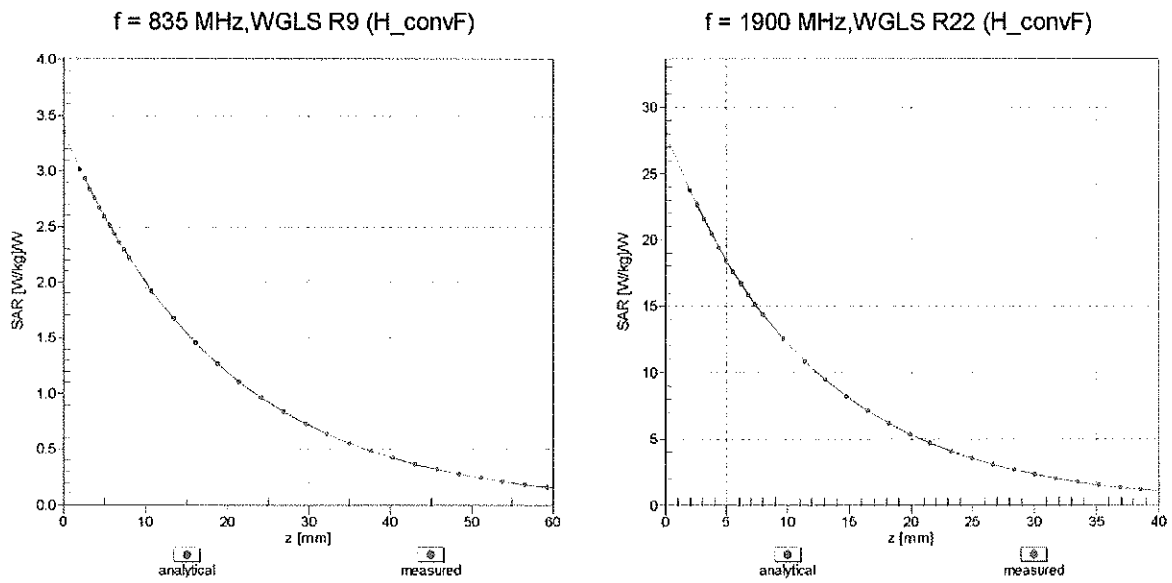

Deviation from Isotropy in Liquid Error (ϕ, θ), f = 900 MHz

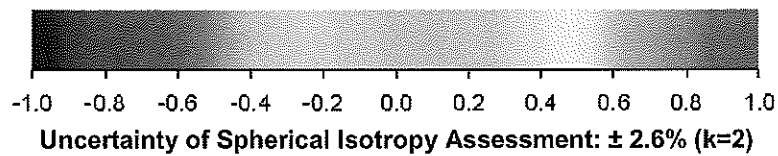
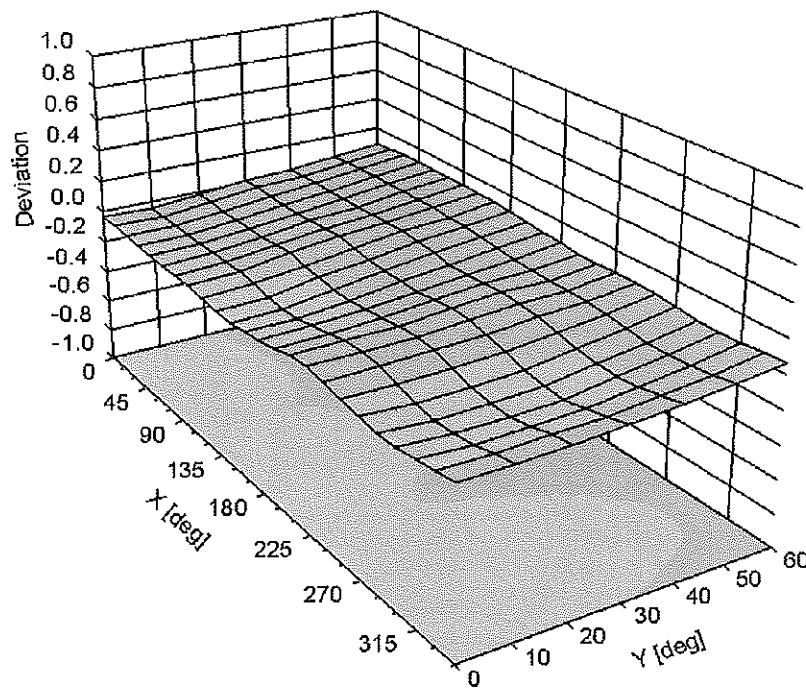

DASY/EASY - Parameters of Probe: ES3DV3 - SN:3318**Other Probe Parameters**

Sensor Arrangement	Triangular
Connector Angle (°)	-104.4
Mechanical Surface Detection Mode	enabled
Optical Surface Detection Mode	disabled
Probe Overall Length	337 mm
Probe Body Diameter	10 mm
Tip Length	10 mm
Tip Diameter	4 mm
Probe Tip to Sensor X Calibration Point	2 mm
Probe Tip to Sensor Y Calibration Point	2 mm
Probe Tip to Sensor Z Calibration Point	2 mm
Recommended Measurement Distance from Surface	3 mm

**Calibration Laboratory of
Schmid & Partner
Engineering AG**
Zeughausstrasse 43, 8004 Zurich, Switzerland



S Schweizerischer Kalibrierdienst
C Service suisse d'étalonnage
S Servizio svizzero di taratura
Swiss Calibration Service

Accredited by the Swiss Accreditation Service (SAS)
The Swiss Accreditation Service is one of the signatories to the EA
Multilateral Agreement for the recognition of calibration certificates

Accreditation No.: **SCS 108**

Client **PC Test**

Certificate No: **ES3-3333_Oct14**

CALIBRATION CERTIFICATE

Object **ES3DV3 - SN:3333**

Calibration procedure(s) **QA CAL-01.v9, QA CAL-23.v5, QA CAL-25.v6
Calibration procedure for dosimetric E-field probes**

CC
10/31/14

Calibration date: **October 24, 2014**

This calibration certificate documents the traceability to national standards, which realize the physical units of measurements (SI).
The measurements and the uncertainties with confidence probability are given on the following pages and are part of the certificate.

All calibrations have been conducted in the closed laboratory facility: environment temperature (22 ± 3)°C and humidity < 70%.

Calibration Equipment used (M&TE critical for calibration)

Primary Standards	ID	Cal Date (Certificate No.)	Scheduled Calibration
Power meter E4419B	GB41293874	03-Apr-14 (No. 217-01911)	Apr-15
Power sensor E4412A	MY41498087	03-Apr-14 (No. 217-01911)	Apr-15
Reference 3 dB Attenuator	SN: S5054 (3c)	03-Apr-14 (No. 217-01915)	Apr-15
Reference 20 dB Attenuator	SN: S5277 (20x)	03-Apr-14 (No. 217-01919)	Apr-15
Reference 30 dB Attenuator	SN: S5129 (30b)	03-Apr-14 (No. 217-01920)	Apr-15
Reference Probe ES3DV2	SN: 3013	30-Dec-13 (No. ES3-3013_Dec13)	Dec-14
DAE4	SN: 660	13-Dec-13 (No. DAE4-660_Dec13)	Dec-14
Secondary Standards	ID	Check Date (in house)	Scheduled Check
RF generator HP 8648C	US3642U01700	4-Aug-99 (in house check Apr-13)	In house check: Apr-16
Network Analyzer HP 8753E	US37390585	18-Oct-01 (in house check Oct-14)	In house check: Oct-15

	Name	Function	Signature
Calibrated by:	Leif Klysner	Laboratory Technician	
Approved by:	Kalja Pokovic	Technical Manager	
			Issued: October 24, 2014

This calibration certificate shall not be reproduced except in full without written approval of the laboratory.



Accredited by the Swiss Accreditation Service (SAS)
The Swiss Accreditation Service is one of the signatories to the EA
Multilateral Agreement for the recognition of calibration certificates

Accreditation No.: **SCS 108**

Glossary:

TSL	tissue simulating liquid
NORM _{x,y,z}	sensitivity in free space
ConvF	sensitivity in TSL / NORM _{x,y,z}
DCP	diode compression point
CF	crest factor (1/duty_cycle) of the RF signal
A, B, C, D	modulation dependent linearization parameters
Polarization ϕ	ϕ rotation around probe axis
Polarization ϑ	ϑ rotation around an axis that is in the plane normal to probe axis (at measurement center), i.e., $\vartheta = 0$ is normal to probe axis
Connector Angle	information used in DASY system to align probe sensor X to the robot coordinate system

Calibration is Performed According to the Following Standards:

- a) IEEE Std 1528-2013, "IEEE Recommended Practice for Determining the Peak Spatial-Averaged Specific Absorption Rate (SAR) in the Human Head from Wireless Communications Devices: Measurement Techniques", June 2013
- b) IEC 62209-1, "Procedure to measure the Specific Absorption Rate (SAR) for hand-held devices used in close proximity to the ear (frequency range of 300 MHz to 3 GHz)", February 2005

Methods Applied and Interpretation of Parameters:

- **NORM_{x,y,z}:** Assessed for E-field polarization $\vartheta = 0$ ($f \leq 900$ MHz in TEM-cell; $f > 1800$ MHz: R22 waveguide). NORM_{x,y,z} are only intermediate values, i.e., the uncertainties of NORM_{x,y,z} does not affect the E²-field uncertainty inside TSL (see below ConvF).
- **NORM(f)_{x,y,z} = NORM_{x,y,z} * frequency_response** (see Frequency Response Chart). This linearization is implemented in DASY4 software versions later than 4.2. The uncertainty of the frequency response is included in the stated uncertainty of ConvF.
- **DCP_{x,y,z}:** DCP are numerical linearization parameters assessed based on the data of power sweep with CW signal (no uncertainty required). DCP does not depend on frequency nor media.
- **PAR:** PAR is the Peak to Average Ratio that is not calibrated but determined based on the signal characteristics
- **A_{x,y,z}; B_{x,y,z}; C_{x,y,z}; D_{x,y,z}; VR_{x,y,z}:** A, B, C, D are numerical linearization parameters assessed based on the data of power sweep for specific modulation signal. The parameters do not depend on frequency nor media. VR is the maximum calibration range expressed in RMS voltage across the diode.
- **ConvF and Boundary Effect Parameters:** Assessed in flat phantom using E-field (or Temperature Transfer Standard for $f \leq 800$ MHz) and inside waveguide using analytical field distributions based on power measurements for $f > 800$ MHz. The same setups are used for assessment of the parameters applied for boundary compensation (alpha, depth) of which typical uncertainty values are given. These parameters are used in DASY4 software to improve probe accuracy close to the boundary. The sensitivity in TSL corresponds to NORM_{x,y,z} * ConvF whereby the uncertainty corresponds to that given for ConvF. A frequency dependent ConvF is used in DASY version 4.4 and higher which allows extending the validity from ± 50 MHz to ± 100 MHz.
- **Spherical Isotropy (3D deviation from isotropy):** in a field of low gradients realized using a flat phantom exposed by a patch antenna.
- **Sensor Offset:** The sensor offset corresponds to the offset of virtual measurement center from the probe tip (on probe axis). No tolerance required.
- **Connector Angle:** The angle is assessed using the information gained by determining the NORM_x (no uncertainty required).

Probe ES3DV3

SN:3333

Manufactured: January 24, 2012
Calibrated: October 24, 2014

Calibrated for DASY/EASY Systems
(Note: non-compatible with DASY2 system!)

DASY/EASY - Parameters of Probe: ES3DV3 - SN:3333

Basic Calibration Parameters

	Sensor X	Sensor Y	Sensor Z	Unc (k=2)
Norm ($\mu\text{V}/(\text{V}/\text{m})^2$) ^A	1.08	0.90	0.88	$\pm 10.1 \%$
DCP (mV) ^B	102.7	107.7	106.3	

Modulation Calibration Parameters

UID	Communication System Name		A dB	B dB $\sqrt{\mu\text{V}}$	C	D dB	VR mV	Unc ^E (k=2)
0	CW	X	0.0	0.0	1.0	0.00	190.7	$\pm 2.5 \%$
		Y	0.0	0.0	1.0		183.3	
		Z	0.0	0.0	1.0		197.9	
10010- CAA	SAR Validation (Square, 100ms, 10ms)	X	3.17	61.7	12.2	10.00	42.4	$\pm 1.9 \%$
		Y	3.16	63.7	12.4		38.0	
		Z	1.84	59.2	10.5		39.9	
10011- CAB	UMTS-FDD (WCDMA)	X	3.22	65.9	17.6	2.91	128.5	$\pm 0.5 \%$
		Y	3.60	69.3	19.8		146.7	
		Z	3.51	68.1	18.8		133.7	
10012- CAA	IEEE 802.11b WIFI 2.4 GHz (DSSS, 1 Mbps)	X	3.14	68.6	18.2	1.87	132.6	$\pm 0.7 \%$
		Y	3.64	73.3	21.1		127.5	
		Z	3.50	71.4	19.6		136.4	
10013- CAA	IEEE 802.11g WIFI 2.4 GHz (DSSS-OFDM, 6 Mbps)	X	11.56	70.8	23.0	9.46	135.8	$\pm 3.5 \%$
		Y	10.93	70.2	23.0		122.3	
		Z	10.93	70.0	22.6		132.8	
10021- DAB	GSM-FDD (TDMA, GMSK)	X	24.60	96.9	27.6	9.39	147.6	$\pm 1.9 \%$
		Y	19.44	94.3	26.1		148.6	
		Z	9.58	82.7	21.9		138.2	
10023- DAB	GPRS-FDD (TDMA, GMSK, TN 0)	X	20.09	93.0	26.4	9.57	141.7	$\pm 2.7 \%$
		Y	24.86	99.0	27.9		143.5	
		Z	11.74	86.4	23.4		134.4	
10024- DAB	GPRS-FDD (TDMA, GMSK, TN 0-1)	X	23.76	91.2	23.1	6.56	147.8	$\pm 2.5 \%$
		Y	37.10	99.8	25.3		149.9	
		Z	16.01	88.1	21.6		128.0	
10027- DAB	GPRS-FDD (TDMA, GMSK, TN 0-1-2)	X	36.24	94.5	22.6	4.80	128.6	$\pm 2.5 \%$
		Y	47.57	99.9	23.7		133.5	
		Z	44.37	99.7	23.6		140.1	
10028- DAB	GPRS-FDD (TDMA, GMSK, TN 0-1-2-3)	X	65.86	99.7	22.7	3.55	133.1	$\pm 2.7 \%$
		Y	55.92	100.0	22.6		142.0	
		Z	59.41	100.0	22.2		125.1	
10032- CAA	IEEE 802.15.1 Bluetooth (GFSK, DH5)	X	85.87	100.0	20.1	1.16	138.3	$\pm 2.2 \%$
		Y	14.41	99.2	23.3		130.5	
		Z	85.82	99.8	19.3		135.9	
10100- CAB	LTE-FDD (SC-FDMA, 100% RB, 20 MHz, QPSK)	X	6.49	67.4	19.4	5.67	144.6	$\pm 1.7 \%$
		Y	6.49	68.0	20.1		139.9	
		Z	6.54	67.9	19.7		147.3	

10103-CAB	LTE-TDD (SC-FDMA, 100% RB, 20 MHz, QPSK)	X	10.81	74.7	24.9	9.29	122.0	±3.0 %
		Y	10.50	75.9	26.1		131.6	
		Z	9.76	73.5	24.5		138.6	
10108-CAB	LTE-FDD (SC-FDMA, 100% RB, 10 MHz, QPSK)	X	6.43	67.2	19.4	5.80	143.3	±1.7 %
		Y	6.37	67.7	20.0		138.0	
		Z	6.43	67.5	19.7		146.7	
10117-CAA	IEEE 802.11n (HT Mixed, 13.5 Mbps, BPSK)	X	10.19	68.6	20.9	8.07	136.2	±2.5 %
		Y	10.15	68.9	21.4		128.3	
		Z	10.12	68.7	21.0		137.9	
10151-CAB	LTE-TDD (SC-FDMA, 50% RB, 20 MHz, QPSK)	X	11.48	77.0	26.1	9.28	147.5	±3.3 %
		Y	9.81	74.9	25.8		125.7	
		Z	9.22	72.8	24.3		133.2	
10154-CAB	LTE-FDD (SC-FDMA, 50% RB, 10 MHz, QPSK)	X	6.10	66.5	19.1	5.75	140.0	±1.7 %
		Y	6.04	67.1	19.8		134.8	
		Z	6.12	67.1	19.5		143.2	
10160-CAB	LTE-FDD (SC-FDMA, 50% RB, 15 MHz, QPSK)	X	6.57	67.2	19.4	5.82	146.3	±1.7 %
		Y	6.47	67.6	20.0		139.6	
		Z	6.56	67.6	19.7		148.5	
10169-CAB	LTE-FDD (SC-FDMA, 1 RB, 20 MHz, QPSK)	X	5.16	66.7	19.4	5.73	145.8	±1.4 %
		Y	5.02	67.5	20.2		137.5	
		Z	5.07	67.2	19.7		147.1	
10172-CAB	LTE-TDD (SC-FDMA, 1 RB, 20 MHz, QPSK)	X	10.07	79.2	27.3	9.21	136.5	±3.0 %
		Y	9.70	81.5	29.3		142.5	
		Z	7.63	74.3	25.3		125.0	
10175-CAB	LTE-FDD (SC-FDMA, 1 RB, 10 MHz, QPSK)	X	5.13	66.6	19.3	5.72	145.9	±1.4 %
		Y	5.01	67.4	20.1		137.5	
		Z	5.04	67.1	19.7		146.3	
10181-CAB	LTE-FDD (SC-FDMA, 1 RB, 15 MHz, QPSK)	X	5.14	66.6	19.3	5.72	145.7	±1.4 %
		Y	5.03	67.5	20.3		137.4	
		Z	5.06	67.2	19.7		146.6	
10196-CAA	IEEE 802.11n (HT Mixed, 6.5 Mbps, BPSK)	X	9.88	68.3	20.8	8.10	130.9	±2.5 %
		Y	10.13	69.6	21.8		149.0	
		Z	9.77	68.4	20.9		131.6	
10225-CAB	UMTS-FDD (HSPA+)	X	6.98	66.5	19.0	5.97	132.9	±1.7 %
		Y	7.14	67.8	20.0		149.7	
		Z	7.02	67.2	19.4		134.3	
10237-CAB	LTE-TDD (SC-FDMA, 1 RB, 10 MHz, QPSK)	X	10.13	79.4	27.4	9.21	137.5	±3.0 %
		Y	9.73	81.6	29.3		143.3	
		Z	7.59	74.1	25.1		125.6	
10252-CAB	LTE-TDD (SC-FDMA, 50% RB, 10 MHz, QPSK)	X	10.80	76.4	25.9	9.24	140.0	±3.3 %
		Y	10.19	77.2	27.1		147.2	
		Z	8.55	71.8	23.9		124.9	
10267-CAB	LTE-TDD (SC-FDMA, 100% RB, 10 MHz, QPSK)	X	11.59	77.3	26.3	9.30	148.4	±3.5 %
		Y	9.87	75.1	25.9		126.0	
		Z	9.21	72.7	24.2		133.6	

10275-CAB	UMTS-FDD (HSUPA, Subtest 5, 3GPP Rel8.4)	X	4.40	66.1	18.1	3.96	134.1	±0.7 %
		Y	4.48	67.4	19.2		129.7	
		Z	4.54	67.2	18.7		137.4	
10291-AAB	CDMA2000, RC3, SO55, Full Rate	X	3.59	65.7	17.7	3.46	127.5	±0.7 %
		Y	3.85	68.4	19.7		143.4	
		Z	3.78	67.6	18.8		129.7	
10292-AAB	CDMA2000, RC3, SO32, Full Rate	X	3.56	65.9	17.8	3.39	127.9	±0.7 %
		Y	3.81	68.6	19.8		144.2	
		Z	3.71	67.5	18.8		130.7	
10297-AAA	LTE-FDD (SC-FDMA, 50% RB, 20 MHz, QPSK)	X	6.44	67.1	19.4	5.81	143.0	±1.7 %
		Y	6.37	67.6	20.0		137.9	
		Z	6.43	67.5	19.7		146.5	
10311-AAA	LTE-FDD (SC-FDMA, 100% RB, 15 MHz, QPSK)	X	7.02	67.8	19.8	6.06	148.7	±1.9 %
		Y	6.96	68.2	20.4		143.6	
		Z	6.72	67.1	19.5		126.9	
10403-AAB	CDMA2000 (1xEV-DO, Rev. 0)	X	4.73	67.0	17.9	3.76	140.2	±0.7 %
		Y	4.96	69.4	19.5		130.7	
		Z	5.05	69.3	19.1		140.9	
10404-AAB	CDMA2000 (1xEV-DO, Rev. A)	X	4.70	67.2	18.1	3.77	138.1	±0.7 %
		Y	4.85	69.5	19.6		129.6	
		Z	5.14	70.1	19.5		139.3	
10415-AAA	IEEE 802.11b WiFi 2.4 GHz (DSSS, 1 Mbps, 99pc duty cycle)	X	2.47	66.1	17.1	1.54	133.2	±0.7 %
		Y	3.15	72.2	20.9		127.9	
		Z	3.32	72.0	20.1		137.2	
10416-AAA	IEEE 802.11g WiFi 2.4 GHz (ERP-OFDM, 6 Mbps, 99pc duty cycle)	X	9.99	68.4	21.0	8.23	131.6	±2.5 %
		Y	9.84	68.6	21.4		123.3	
		Z	9.89	68.6	21.1		133.4	

The reported uncertainty of measurement is stated as the standard uncertainty of measurement multiplied by the coverage factor $k=2$, which for a normal distribution corresponds to a coverage probability of approximately 95%.

^A The uncertainties of NormX,Y,Z do not affect the E^2 -field uncertainty inside TSL (see Pages 7 and 8).

^B Numerical linearization parameter: uncertainty not required.

^E Uncertainty is determined using the max. deviation from linear response applying rectangular distribution and is expressed for the square of the field value.

DASY/EASY - Parameters of Probe: ES3DV3 - SN:3333

Calibration Parameter Determined in Head Tissue Simulating Media

f (MHz) ^C	Relative Permittivity ^F	Conductivity (S/m) ^F	ConvF X	ConvF Y	ConvF Z	Alpha ^G	Depth ^G (mm)	Unct. (k=2)
750	41.9	0.89	6.55	6.55	6.55	0.34	1.74	± 12.0 %
835	41.5	0.90	6.33	6.33	6.33	0.44	1.48	± 12.0 %
1750	40.1	1.37	5.26	5.26	5.26	0.73	1.21	± 12.0 %
1900	40.0	1.40	5.11	5.11	5.11	0.66	1.32	± 12.0 %
2450	39.2	1.80	4.53	4.53	4.53	0.62	1.40	± 12.0 %
2600	39.0	1.96	4.40	4.40	4.40	0.68	1.38	± 12.0 %

^C Frequency validity above 300 MHz of ± 100 MHz only applies for DASY v4.4 and higher (see Page 2), else it is restricted to ± 50 MHz. The uncertainty is the RSS of the ConvF uncertainty at calibration frequency and the uncertainty for the indicated frequency band. Frequency validity below 300 MHz is ± 10, 25, 40, 50 and 70 MHz for ConvF assessments at 30, 64, 128, 150 and 220 MHz respectively. Above 5 GHz frequency validity can be extended to ± 110 MHz.

^F At frequencies below 3 GHz, the validity of tissue parameters (ϵ and σ) can be relaxed to ± 10% if liquid compensation formula is applied to measured SAR values. At frequencies above 3 GHz, the validity of tissue parameters (ϵ and σ) is restricted to ± 5%. The uncertainty is the RSS of the ConvF uncertainty for indicated target tissue parameters.

^G Alpha/Depth are determined during calibration. SPEAG warrants that the remaining deviation due to the boundary effect after compensation is always less than ± 1% for frequencies below 3 GHz and below ± 2% for frequencies between 3-6 GHz at any distance larger than half the probe tip diameter from the boundary.

DASY/EASY - Parameters of Probe: ES3DV3 - SN:3333

Calibration Parameter Determined In Body Tissue Simulating Media

f (MHz) ^C	Relative Permittivity ^F	Conductivity (S/m) ^F	ConvF X	ConvF Y	ConvF Z	Alpha ^G	Depth (mm)	Uct. (k=2)
750	55.5	0.96	6.14	6.14	6.14	0.35	1.76	± 12.0 %
835	55.2	0.97	6.12	6.12	6.12	0.57	1.37	± 12.0 %
1750	53.4	1.49	4.89	4.89	4.89	0.80	1.24	± 12.0 %
1900	53.3	1.52	4.67	4.67	4.67	0.75	1.29	± 12.0 %
2450	52.7	1.95	4.26	4.26	4.26	0.80	1.01	± 12.0 %
2600	52.5	2.16	4.13	4.13	4.13	0.80	0.99	± 12.0 %

^C Frequency validity above 300 MHz of ± 100 MHz only applies for DASY v4.4 and higher (see Page 2), else it is restricted to ± 50 MHz. The uncertainty is the RSS of the ConvF uncertainty at calibration frequency and the uncertainty for the indicated frequency band. Frequency validity below 300 MHz is $\pm 10, 25, 40, 50$ and 70 MHz for ConvF assessments at 30, 64, 128, 150 and 220 MHz respectively. Above 5 GHz frequency validity can be extended to ± 110 MHz.

^F At frequencies below 3 GHz, the validity of tissue parameters (ϵ and σ) can be relaxed to $\pm 10\%$ if liquid compensation formula is applied to measured SAR values. At frequencies above 3 GHz, the validity of tissue parameters (ϵ and σ) is restricted to $\pm 5\%$. The uncertainty is the RSS of the ConvF uncertainty for indicated target tissue parameters.

^G Alpha/Depth are determined during calibration. SPEAG warrants that the remaining deviation due to the boundary effect after compensation is always less than $\pm 1\%$ for frequencies below 3 GHz and below $\pm 2\%$ for frequencies between 3-6 GHz at any distance larger than half the probe tip diameter from the boundary.

Frequency Response of E-Field (TEM-Cell: ifi110 EXX, Waveguide: R22)

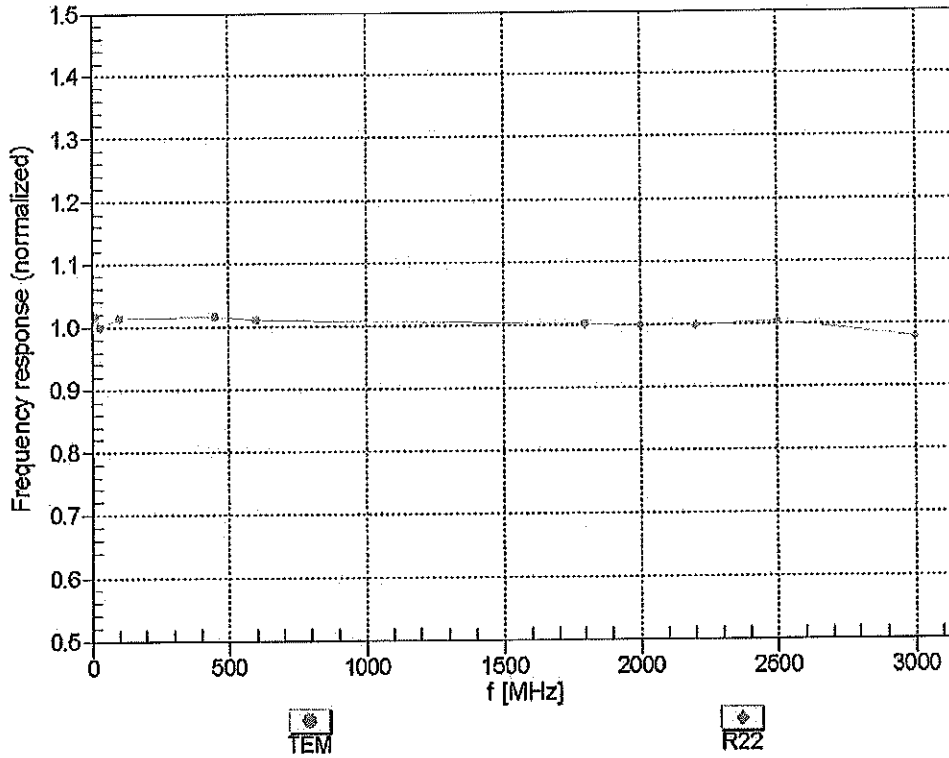

Uncertainty of Frequency Response of E-field: $\pm 6.3\%$ (k=2)

Receiving Pattern (ϕ), $\theta = 0^\circ$

f=600 MHz,TEM

f=1800 MHz,R22

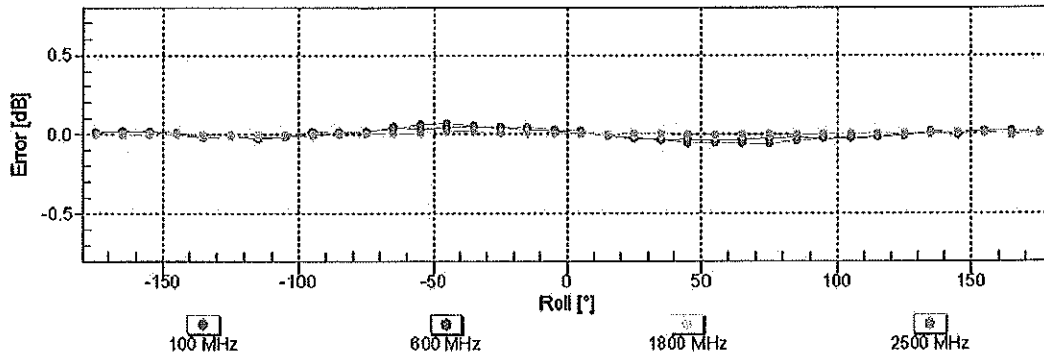
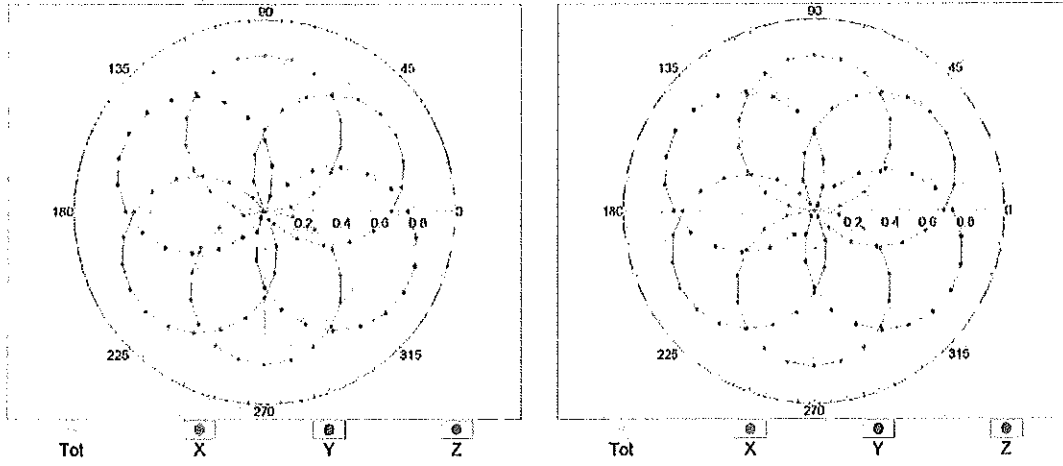

Uncertainty of Axial Isotropy Assessment: $\pm 0.5\%$ (k=2)

Dynamic Range $f(SAR_{head})$ (TEM cell , $f_{eval}= 1900$ MHz)

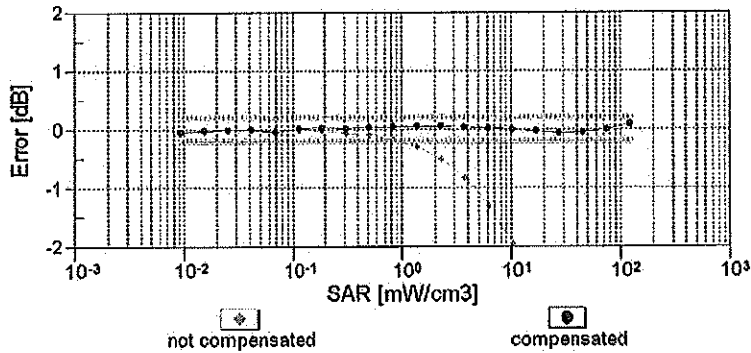
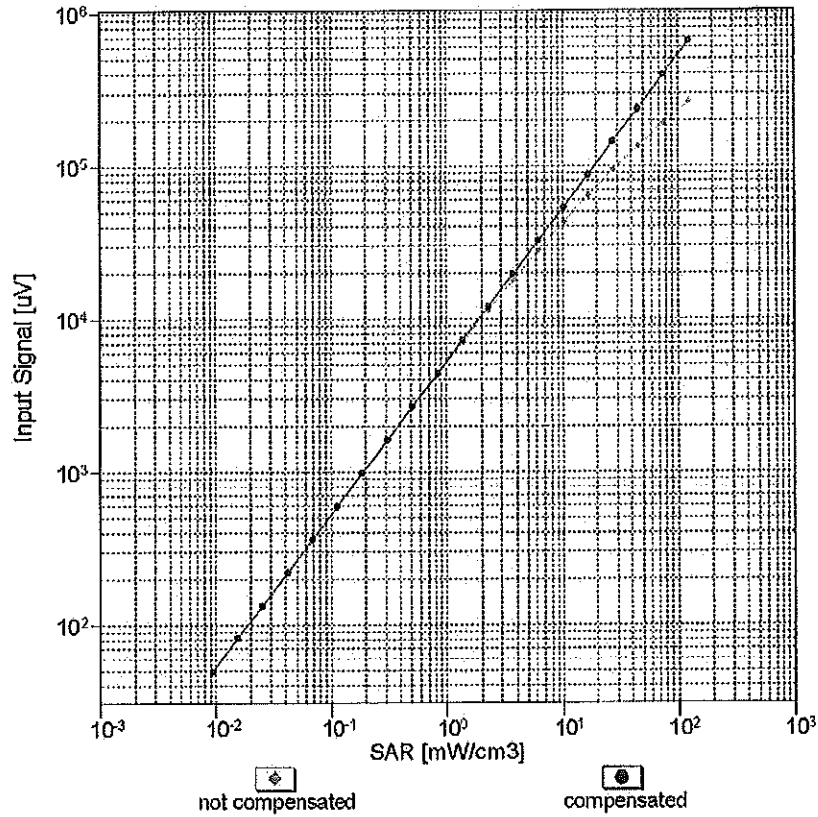

Uncertainty of Linearity Assessment: $\pm 0.6\%$ ($k=2$)

Conversion Factor Assessment

f = 835 MHz, WGLS R9 (H_convF)

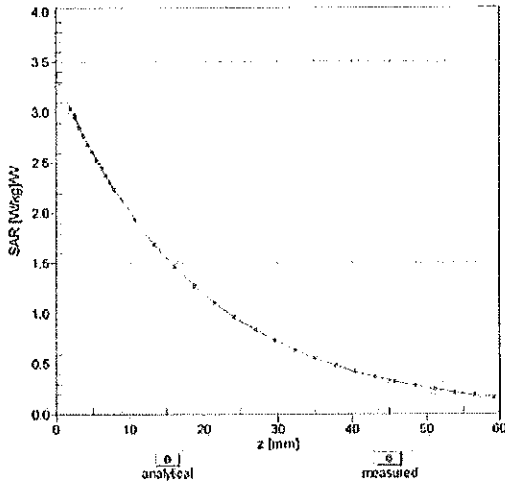

f = 1900 MHz, WGLS R22 (H_convF)

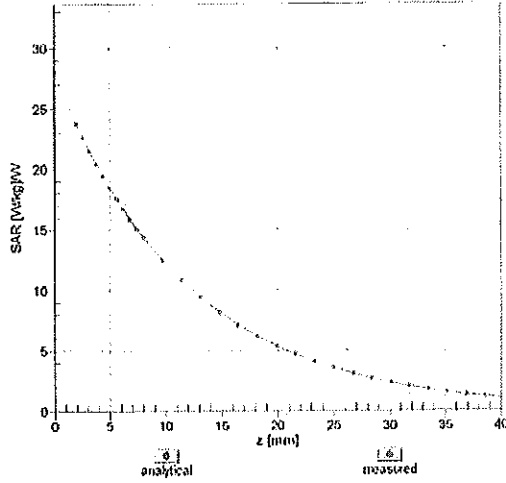

Deviation from Isotropy in Liquid

Error (ϕ, θ), f = 900 MHz

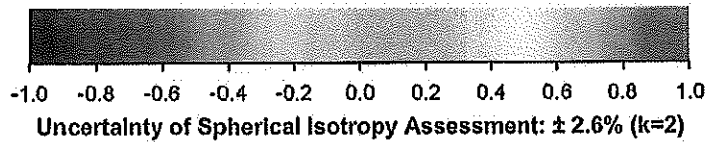
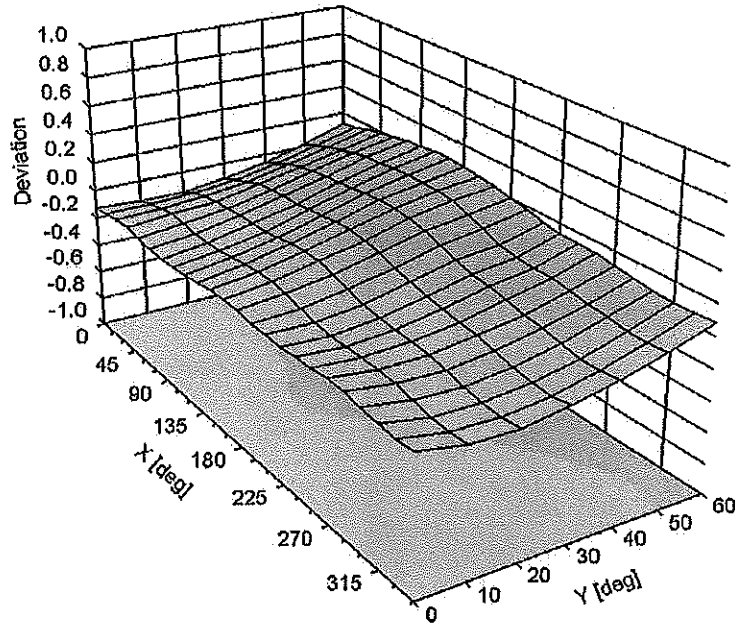

DASY/EASY - Parameters of Probe: ES3DV3 - SN:3333**Other Probe Parameters**

Sensor Arrangement	Triangular
Connector Angle (°)	-34.9
Mechanical Surface Detection Mode	enabled
Optical Surface Detection Mode	disabled
Probe Overall Length	337 mm
Probe Body Diameter	10 mm
Tip Length	10 mm
Tip Diameter	4 mm
Probe Tip to Sensor X Calibration Point	2 mm
Probe Tip to Sensor Y Calibration Point	2 mm
Probe Tip to Sensor Z Calibration Point	2 mm
Recommended Measurement Distance from Surface	3 mm

**Calibration Laboratory of
Schmid & Partner
Engineering AG**
Zeughausstrasse 43, 8004 Zurich, Switzerland



S Schweizerischer Kalibrierdienst
S Service suisse d'étalonnage
C Servizio svizzero di taratura
S Swiss Calibration Service

Accreditation No.: **SCS 108**

Accredited by the Swiss Accreditation Service (SAS)
The Swiss Accreditation Service is one of the signatories to the EA
Multilateral Agreement for the recognition of calibration certificates

Client **PC Test**

Certificate No: **ES3-3288_Sep14/2**

CALIBRATION CERTIFICATE (Replacement of No:ES3-3288_Sep14)

Object **ES3DV3 - SN:3288**

Calibration procedure(s) **QA CAL-01.v9, QA CAL-23.v5, QA CAL-25.v6
Calibration procedure for dosimetric E-field probes**

CC
11/12/14

Calibration date: **September 24, 2014**

This calibration certificate documents the traceability to national standards, which realize the physical units of measurements (SI).
The measurements and the uncertainties with confidence probability are given on the following pages and are part of the certificate.

All calibrations have been conducted in the closed laboratory facility: environment temperature (22 ± 3)°C and humidity < 70%.

Calibration Equipment used (M&TE critical for calibration)

Primary Standards	ID	Cal Date (Certificate No.)	Scheduled Calibration
Power meter E4419B	GB41293874	03-Apr-14 (No. 217-01911)	Apr-15
Power sensor E4412A	MY41498087	03-Apr-14 (No. 217-01911)	Apr-15
Reference 3 dB Attenuator	SN: S5054 (3c)	03-Apr-14 (No. 217-01915)	Apr-15
Reference 20 dB Attenuator	SN: S5277 (20x)	03-Apr-14 (No. 217-01919)	Apr-15
Reference 30 dB Attenuator	SN: S5129 (30b)	03-Apr-14 (No. 217-01920)	Apr-15
Reference Probe ES3DV2	SN: 3013	30-Dec-13 (No. ES3-3013_Dec13)	Dec-14
DAE4	SN: 660	13-Dec-13 (No. DAE4-660_Dec13)	Dec-14
Secondary Standards	ID	Check Date (in house)	Scheduled Check
RF generator HP 8648C	US3642U01700	4-Aug-99 (in house check Apr-13)	In house check: Apr-16
Network Analyzer HP 8753E	US37390585	18-Oct-01 (in house check Oct-13)	In house check: Oct-14

	Name	Function	Signature
Calibrated by:	Leif Klysner	Laboratory Technician	
Approved by:	Katja Pokovic	Technical Manager	

Issued: November 3, 2014

This calibration certificate shall not be reproduced except in full without written approval of the laboratory.



Accredited by the Swiss Accreditation Service (SAS)
The Swiss Accreditation Service is one of the signatories to the EA
Multilateral Agreement for the recognition of calibration certificates

Accreditation No.: **SCS 108**

Glossary:

TSL	tissue simulating liquid
NORM _{x,y,z}	sensitivity in free space
ConvF	sensitivity in TSL / NORM _{x,y,z}
DCP	diode compression point
CF	crest factor (1/duty_cycle) of the RF signal
A, B, C, D	modulation dependent linearization parameters
Polarization φ	φ rotation around probe axis
Polarization ϑ	ϑ rotation around an axis that is in the plane normal to probe axis (at measurement center), i.e., ϑ = 0 is normal to probe axis
Connector Angle	information used in DASY system to align probe sensor X to the robot coordinate system

Calibration is Performed According to the Following Standards:

- a) IEEE Std 1528-2013, "IEEE Recommended Practice for Determining the Peak Spatial-Averaged Specific Absorption Rate (SAR) in the Human Head from Wireless Communications Devices: Measurement Techniques", June 2013
- b) IEC 62209-1, "Procedure to measure the Specific Absorption Rate (SAR) for hand-held devices used in close proximity to the ear (frequency range of 300 MHz to 3 GHz)", February 2005

Methods Applied and Interpretation of Parameters:

- *NORM_{x,y,z}*: Assessed for E-field polarization ϑ = 0 (f ≤ 900 MHz in TEM-cell; f > 1800 MHz: R22 waveguide). *NORM_{x,y,z}* are only intermediate values, i.e., the uncertainties of *NORM_{x,y,z}* does not affect the E²-field uncertainty inside TSL (see below *ConvF*).
- *NORM(f)_{x,y,z}* = *NORM_{x,y,z}* * *frequency_response* (see Frequency Response Chart). This linearization is implemented in DASY4 software versions later than 4.2. The uncertainty of the frequency response is included in the stated uncertainty of *ConvF*.
- *DCP_{x,y,z}*: DCP are numerical linearization parameters assessed based on the data of power sweep with CW signal (no uncertainty required). DCP does not depend on frequency nor media.
- *PAR*: PAR is the Peak to Average Ratio that is not calibrated but determined based on the signal characteristics
- *A_{x,y,z}*; *B_{x,y,z}*; *C_{x,y,z}*; *D_{x,y,z}*; *VR_{x,y,z}*: *A, B, C, D* are numerical linearization parameters assessed based on the data of power sweep for specific modulation signal. The parameters do not depend on frequency nor media. *VR* is the maximum calibration range expressed in RMS voltage across the diode.
- *ConvF and Boundary Effect Parameters*: Assessed in flat phantom using E-field (or Temperature Transfer Standard for f ≤ 800 MHz) and inside waveguide using analytical field distributions based on power measurements for f > 800 MHz. The same setups are used for assessment of the parameters applied for boundary compensation (alpha, depth) of which typical uncertainty values are given. These parameters are used in DASY4 software to improve probe accuracy close to the boundary. The sensitivity in TSL corresponds to *NORM_{x,y,z}* * *ConvF* whereby the uncertainty corresponds to that given for *ConvF*. A frequency dependent *ConvF* is used in DASY version 4.4 and higher which allows extending the validity from ± 50 MHz to ± 100 MHz.
- *Spherical isotropy (3D deviation from isotropy)*: in a field of low gradients realized using a flat phantom exposed by a patch antenna.
- *Sensor Offset*: The sensor offset corresponds to the offset of virtual measurement center from the probe tip (on probe axis). No tolerance required.
- *Connector Angle*: The angle is assessed using the information gained by determining the *NORM_x* (no uncertainty required).

Probe ES3DV3

SN:3288

Manufactured:	July 6, 2010
Repaired:	September 18, 2014
Calibrated:	September 24, 2014

Calibrated for DASY/EASY Systems

(Note: non-compatible with DASY2 system!)

DASY/EASY - Parameters of Probe: ES3DV3 - SN:3288

Basic Calibration Parameters

	Sensor X	Sensor Y	Sensor Z	Unc (k=2)
Norm ($\mu\text{V}/(\text{V}/\text{m})^2$) ^A	1.05	1.16	0.92	$\pm 10.1 \%$
DCP (mV) ^B	105.1	104.6	106.7	

Modulation Calibration Parameters

UID	Communication System Name		A dB	B dB $\sqrt{\mu\text{V}}$	C	D dB	VR mV	Unc ^E (k=2)
0	CW	X	0.0	0.0	1.0	0.00	195.8	$\pm 3.5 \%$
		Y	0.0	0.0	1.0		175.9	
		Z	0.0	0.0	1.0		177.1	
10010- CAA	SAR Validation (Square, 100ms, 10ms)	X	2.71	61.9	11.4	10.00	40.3	$\pm 2.2 \%$
		Y	2.37	60.2	11.2		42.6	
		Z	1.54	56.6	8.9		41.2	
10011- CAB	UMTS-FDD (WCDMA)	X	3.29	67.1	18.4	2.91	133.8	$\pm 0.5 \%$
		Y	3.43	67.9	18.9		139.5	
		Z	3.45	68.1	18.9		141.3	
10012- CAA	IEEE 802.11b WiFi 2.4 GHz (DSSS, 1 Mbps)	X	2.99	68.9	18.6	1.87	135.1	$\pm 0.7 \%$
		Y	3.59	72.4	20.4		140.7	
		Z	3.54	72.4	20.3		143.0	
10013- CAA	IEEE 802.11g WiFi 2.4 GHz (DSSS-OFDM, 6 Mbps)	X	11.15	70.8	23.3	9.46	132.3	$\pm 3.5 \%$
		Y	11.29	70.8	23.2		141.1	
		Z	11.07	70.7	23.2		139.2	
10021- DAB	GSM-FDD (TDMA, GMSK)	X	14.71	90.5	24.5	9.39	149.0	$\pm 1.9 \%$
		Y	16.40	92.8	26.0		131.3	
		Z	11.34	87.2	23.6		126.1	
10023- DAB	GPRS-FDD (TDMA, GMSK, TN 0)	X	15.91	92.2	25.3	9.57	138.9	$\pm 2.5 \%$
		Y	21.25	96.9	27.2		142.0	
		Z	11.68	87.2	23.5		145.9	
10024- DAB	GPRS-FDD (TDMA, GMSK, TN 0-1)	X	38.62	99.8	24.7	6.56	123.8	$\pm 2.2 \%$
		Y	36.71	99.7	25.2		128.1	
		Z	36.56	99.4	24.5		129.5	
10027- DAB	GPRS-FDD (TDMA, GMSK, TN 0-1-2)	X	56.60	99.6	22.6	4.80	138.8	$\pm 1.9 \%$
		Y	46.94	99.9	23.7		149.9	
		Z	51.17	99.8	22.9		144.9	
10028- DAB	GPRS-FDD (TDMA, GMSK, TN 0-1-2-3)	X	70.88	100.0	21.6	3.55	147.5	$\pm 1.9 \%$
		Y	52.58	99.8	22.6		129.4	
		Z	76.98	99.8	21.2		128.7	
10032- CAA	IEEE 802.15.1 Bluetooth (GFSK, DH5)	X	98.89	99.5	18.9	1.16	135.8	$\pm 1.4 \%$
		Y	78.39	99.6	19.5		141.7	
		Z	95.21	95.5	17.1		143.4	
10039- CAB	CDMA2000 (1xRTT, RC1)	X	4.72	66.7	18.9	4.57	133.7	$\pm 0.9 \%$
		Y	4.85	67.1	19.1		137.7	
		Z	4.81	67.4	19.2		141.9	

10081-CAB	CDMA2000 (1xRTT, RC3)	X	3.91	66.3	18.6	3.97	129.5	±0.7 %
		Y	4.00	66.6	18.7		133.7	
		Z	3.99	66.8	18.8		137.5	
10098-CAB	UMTS-FDD (HSUPA, Subtest 2)	X	4.63	66.9	18.7	3.98	141.4	±0.7 %
		Y	4.78	67.5	19.0		147.7	
		Z	4.57	66.8	18.6		127.8	
10100-CAB	LTE-FDD (SC-FDMA, 100% RB, 20 MHz, QPSK)	X	6.59	68.2	20.1	5.67	149.2	±1.4 %
		Y	6.36	67.3	19.6		130.7	
		Z	6.36	67.5	19.6		133.6	
10108-CAB	LTE-FDD (SC-FDMA, 100% RB, 10 MHz, QPSK)	X	6.44	67.8	20.0	5.80	146.6	±1.4 %
		Y	6.23	66.8	19.4		128.8	
		Z	6.24	67.1	19.6		131.4	
10110-CAB	LTE-FDD (SC-FDMA, 100% RB, 5 MHz, QPSK)	X	6.08	67.1	19.6	5.75	143.2	±1.4 %
		Y	6.20	67.4	19.8		148.0	
		Z	5.92	66.6	19.3		128.5	
10114-CAA	IEEE 802.11n (HT Greenfield, 13.5 Mbps, BPSK)	X	10.32	69.3	21.5	8.10	137.0	±2.2 %
		Y	10.31	69.1	21.4		143.5	
		Z	10.37	69.5	21.6		146.1	
10117-CAA	IEEE 802.11n (HT Mixed, 13.5 Mbps, BPSK)	X	10.35	69.4	21.6	8.07	138.3	±2.2 %
		Y	10.36	69.3	21.4		146.4	
		Z	10.42	69.6	21.6		149.0	
10151-CAB	LTE-TDD (SC-FDMA, 50% RB, 20 MHz, QPSK)	X	9.95	75.7	26.2	9.28	134.9	±3.3 %
		Y	10.37	76.0	26.1		146.6	
		Z	9.77	75.4	26.0		142.5	
10154-CAB	LTE-FDD (SC-FDMA, 50% RB, 10 MHz, QPSK)	X	6.12	67.2	19.7	5.75	144.9	±1.4 %
		Y	6.21	67.4	19.8		148.8	
		Z	5.91	66.5	19.3		128.7	
10160-CAB	LTE-FDD (SC-FDMA, 50% RB, 15 MHz, QPSK)	X	6.28	66.7	19.4	5.82	125.5	±1.2 %
		Y	6.37	66.8	19.4		129.7	
		Z	6.36	67.1	19.6		132.9	
10169-CAB	LTE-FDD (SC-FDMA, 1 RB, 20 MHz, QPSK)	X	5.08	67.6	20.2	5.73	147.0	±1.2 %
		Y	4.95	66.6	19.6		128.6	
		Z	4.91	66.9	19.8		131.2	
10172-CAB	LTE-TDD (SC-FDMA, 1 RB, 20 MHz, QPSK)	X	8.18	77.2	27.2	9.21	123.4	±2.7 %
		Y	8.37	76.6	26.6		129.5	
		Z	7.97	76.7	26.9		128.7	
10175-CAB	LTE-FDD (SC-FDMA, 1 RB, 10 MHz, QPSK)	X	5.05	67.4	20.1	5.72	146.2	±1.4 %
		Y	5.10	67.3	20.0		142.8	
		Z	4.87	66.7	19.6		129.6	
10181-CAB	LTE-FDD (SC-FDMA, 1 RB, 15 MHz, QPSK)	X	5.04	67.4	20.0	5.72	145.5	±1.2 %
		Y	5.12	67.4	20.0		143.4	
		Z	4.87	66.7	19.6		129.9	
10193-CAA	IEEE 802.11n (HT Greenfield, 6.5 Mbps, BPSK)	X	9.92	68.9	21.4	8.09	131.0	±2.2 %
		Y	9.84	68.5	21.1		130.0	
		Z	9.94	69.0	21.4		138.6	

10196-CAA	IEEE 802.11n (HT Mixed, 6.5 Mbps, BPSK)	X	9.90	68.9	21.4	8.10	130.8	±2.2 %
		Y	9.81	68.4	21.0		131.4	
		Z	9.95	69.1	21.5		140.5	
10219-CAA	IEEE 802.11n (HT Mixed, 7.2 Mbps, BPSK)	X	9.81	68.8	21.3	8.03	130.0	±2.2 %
		Y	9.89	68.9	21.3		138.1	
		Z	9.89	69.1	21.5		140.5	
10222-CAA	IEEE 802.11n (HT Mixed, 15 Mbps, BPSK)	X	10.25	69.2	21.4	8.06	137.1	±2.2 %
		Y	10.30	69.2	21.4		144.4	
		Z	10.38	69.6	21.6		148.4	
10225-CAB	UMTS-FDD (HSPA+)	X	6.90	66.8	19.3	5.97	132.8	±1.4 %
		Y	7.09	67.3	19.6		142.0	
		Z	7.04	67.4	19.6		143.5	
10237-CAB	LTE-TDD (SC-FDMA, 1 RB, 10 MHz, QPSK)	X	9.61	81.9	29.6	9.21	149.3	±2.7 %
		Y	8.66	77.6	27.1		133.7	
		Z	8.20	77.5	27.3		132.2	
10252-CAB	LTE-TDD (SC-FDMA, 50% RB, 10 MHz, QPSK)	X	9.16	74.5	25.8	9.24	126.3	±3.0 %
		Y	9.62	75.0	25.8		137.4	
		Z	9.16	74.8	25.9		135.2	
10267-CAB	LTE-TDD (SC-FDMA, 100% RB, 10 MHz, QPSK)	X	9.97	75.7	26.3	9.30	133.7	±3.3 %
		Y	10.38	75.9	26.1		146.1	
		Z	9.91	75.7	26.3		143.8	
10274-CAB	UMTS-FDD (HSUPA, Subtest 5, 3GPP Rel8.10)	X	5.86	66.6	18.7	4.87	129.9	±0.9 %
		Y	6.01	67.1	19.0		135.7	
		Z	5.95	67.1	19.0		139.4	
10275-CAB	UMTS-FDD (HSUPA, Subtest 5, 3GPP Rel8.4)	X	4.40	66.7	18.6	3.96	136.4	±0.7 %
		Y	4.55	67.3	19.0		138.3	
		Z	4.56	67.6	19.1		144.3	
10291-AAB	CDMA2000, RC3, SO55, Full Rate	X	3.64	66.9	18.7	3.46	127.4	±0.5 %
		Y	3.77	67.6	19.1		130.2	
		Z	3.72	67.5	19.0		134.4	
10292-AAB	CDMA2000, RC3, SO32, Full Rate	X	3.58	67.0	18.7	3.39	128.4	±0.5 %
		Y	3.73	67.7	19.1		132.7	
		Z	3.69	67.8	19.1		136.1	
10297-AAA	LTE-FDD (SC-FDMA, 50% RB, 20 MHz, QPSK)	X	6.43	67.7	19.9	5.81	145.5	±1.4 %
		Y	6.49	67.7	19.9		149.5	
		Z	6.23	67.0	19.6		129.5	
10311-AAA	LTE-FDD (SC-FDMA, 100% RB, 15 MHz, QPSK)	X	6.74	67.3	19.8	6.06	126.7	±1.4 %
		Y	6.83	67.5	19.8		132.9	
		Z	6.81	67.6	19.9		135.8	
10315-AAA	IEEE 802.11b WiFi 2.4 GHz (DSSS, 1 Mbps, 96pc duty cycle)	X	3.00	69.9	19.4	1.71	133.9	±0.5 %
		Y	3.30	71.5	20.1		141.0	
		Z	3.22	71.4	20.0		142.9	
10316-AAA	IEEE 802.11g WiFi 2.4 GHz (ERP-OFDM, 6 Mbps, 96pc duty cycle)	X	10.17	69.2	21.8	8.36	130.5	±2.5 %
		Y	10.20	69.1	21.6		138.4	
		Z	10.20	69.4	21.8		140.7	

10403-AAB	CDMA2000 (1xEV-DO, Rev. 0)	X	4.75	68.3	18.8	3.76	138.5	±0.7 %
		Y	5.00	69.1	19.2		146.7	
		Z	4.92	69.2	19.1		148.5	
10404-AAB	CDMA2000 (1xEV-DO, Rev. A)	X	4.73	68.6	18.9	3.77	136.3	±0.7 %
		Y	4.97	69.4	19.4		143.7	
		Z	4.91	69.6	19.3		146.0	
10415-AAA	IEEE 802.11b WiFi 2.4 GHz (DSSS, 1 Mbps, 99pc duty cycle)	X	2.65	68.1	18.5	1.54	135.2	±0.5 %
		Y	3.05	70.8	19.9		140.7	
		Z	2.87	69.8	19.3		144.8	
10416-AAA	IEEE 802.11g WiFi 2.4 GHz (ERP-OFDM, 6 Mbps, 99pc duty cycle)	X	10.00	69.0	21.5	8.23	130.8	±2.2 %
		Y	10.06	68.9	21.4		138.6	
		Z	10.08	69.3	21.7		141.6	

The reported uncertainty of measurement is stated as the standard uncertainty of measurement multiplied by the coverage factor $k=2$, which for a normal distribution corresponds to a coverage probability of approximately 95%.

^A The uncertainties of NormX,Y,Z do not affect the E²-field uncertainty inside TSL (see Pages 8 and 9).

^B Numerical linearization parameter: uncertainty not required.

^E Uncertainty is determined using the max. deviation from linear response applying rectangular distribution and is expressed for the square of the field value.

DASY/EASY - Parameters of Probe: ES3DV3 - SN:3288

Calibration Parameter Determined in Head Tissue Simulating Media

f (MHz) ^C	Relative Permittivity ^F	Conductivity (S/m) ^F	ConvF X	ConvF Y	ConvF Z	Alpha ^G	Depth ^G (mm)	Unct. (k=2)
750	41.9	0.89	6.81	6.81	6.81	0.37	1.70	± 12.0 %
835	41.5	0.90	6.51	6.51	6.51	0.45	1.52	± 12.0 %
1750	40.1	1.37	5.38	5.38	5.38	0.44	1.58	± 12.0 %
1900	40.0	1.40	5.17	5.17	5.17	0.80	1.18	± 12.0 %
2450	39.2	1.80	4.56	4.56	4.56	0.80	1.21	± 12.0 %
2600	39.0	1.96	4.44	4.44	4.44	0.80	1.22	± 12.0 %

^C Frequency validity above 300 MHz of ± 100 MHz only applies for DASY v4.4 and higher (see Page 2), else it is restricted to ± 50 MHz. The uncertainty is the RSS of the ConvF uncertainty at calibration frequency and the uncertainty for the indicated frequency band. Frequency validity below 300 MHz is ± 10, 25, 40, 50 and 70 MHz for ConvF assessments at 30, 64, 128, 150 and 220 MHz respectively. Above 5 GHz frequency validity can be extended to ± 110 MHz.

^F At frequencies below 3 GHz, the validity of tissue parameters (ϵ and σ) can be relaxed to ± 10% if liquid compensation formula is applied to measured SAR values. At frequencies above 3 GHz, the validity of tissue parameters (ϵ and σ) is restricted to ± 5%. The uncertainty is the RSS of the ConvF uncertainty for indicated target tissue parameters.

^G Alpha/Depth are determined during calibration. SPEAG warrants that the remaining deviation due to the boundary effect after compensation is always less than ± 1% for frequencies below 3 GHz and below ± 2% for frequencies between 3-6 GHz at any distance larger than half the probe tip diameter from the boundary.

DASY/EASY - Parameters of Probe: ES3DV3 - SN:3288

Calibration Parameter Determined in Body Tissue Simulating Media

f (MHz) ^C	Relative Permittivity ^F	Conductivity (S/m) ^F	ConvF X	ConvF Y	ConvF Z	Alpha ^G	Depth ^G (mm)	Unct. (k=2)
750	55.5	0.96	6.38	6.38	6.38	0.31	1.89	± 12.0 %
835	55.2	0.97	6.32	6.32	6.32	0.55	1.39	± 12.0 %
1750	53.4	1.49	5.03	5.03	5.03	0.57	1.44	± 12.0 %
1900	53.3	1.52	4.82	4.82	4.82	0.51	1.54	± 12.0 %
2450	52.7	1.95	4.36	4.36	4.36	0.71	1.07	± 12.0 %
2600	52.5	2.16	4.22	4.22	4.22	0.80	1.07	± 12.0 %

^C Frequency validity above 300 MHz of ± 100 MHz only applies for DASY v4.4 and higher (see Page 2), else it is restricted to ± 50 MHz. The uncertainty is the RSS of the ConvF uncertainty at calibration frequency and the uncertainty for the indicated frequency band. Frequency validity below 300 MHz is ± 10, 25, 40, 50 and 70 MHz for ConvF assessments at 30, 64, 128, 150 and 220 MHz respectively. Above 5 GHz frequency validity can be extended to ± 110 MHz.

^F At frequencies below 3 GHz, the validity of tissue parameters (ϵ and σ) can be relaxed to ± 10% if liquid compensation formula is applied to measured SAR values. At frequencies above 3 GHz, the validity of tissue parameters (ϵ and σ) is restricted to ± 5%. The uncertainty is the RSS of the ConvF uncertainty for indicated target tissue parameters.

^G Alpha/Depth are determined during calibration. SPEAG warrants that the remaining deviation due to the boundary effect after compensation is always less than ± 1% for frequencies below 3 GHz and below ± 2% for frequencies between 3-6 GHz at any distance larger than half the probe tip diameter from the boundary.

Frequency Response of E-Field

(TEM-Cell:ifi1110 EXX, Waveguide: R22)

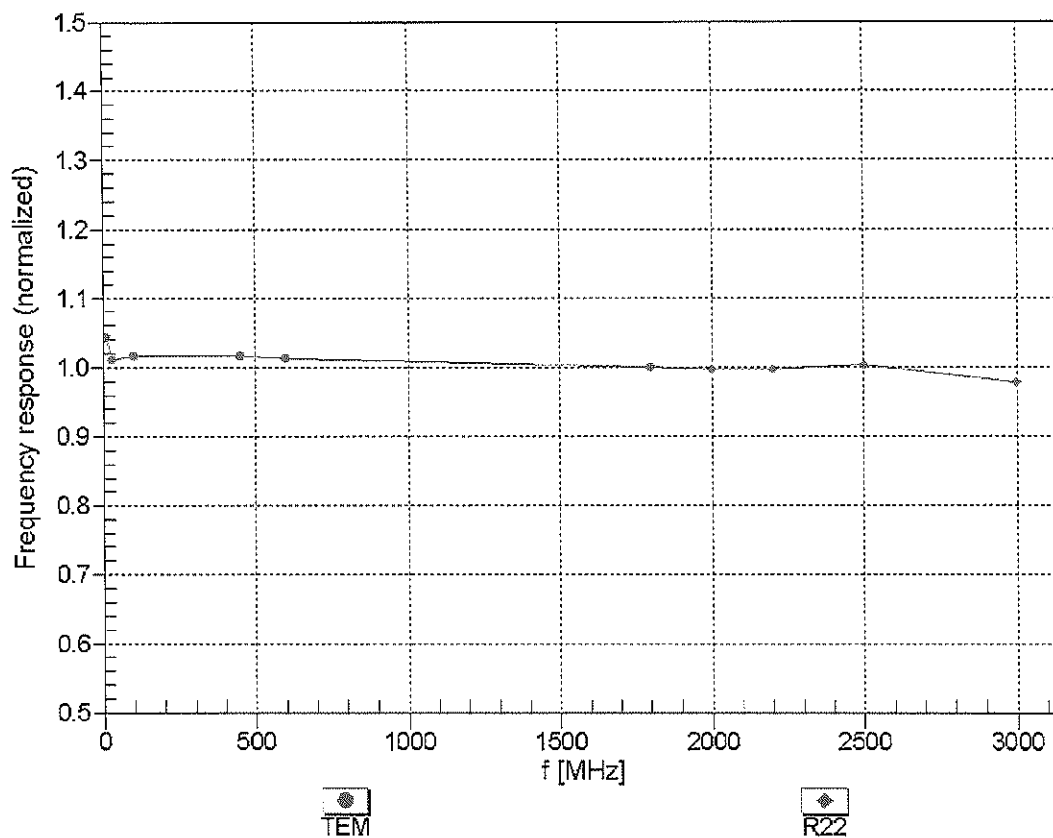

Uncertainty of Frequency Response of E-field: $\pm 6.3\%$ (k=2)

Receiving Pattern (ϕ), $\theta = 0^\circ$

f=600 MHz,TEM

f=1800 MHz,R22

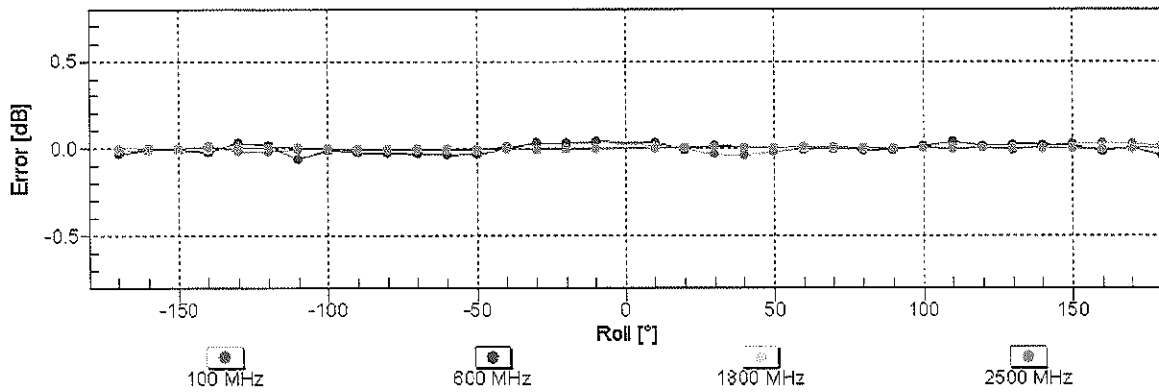
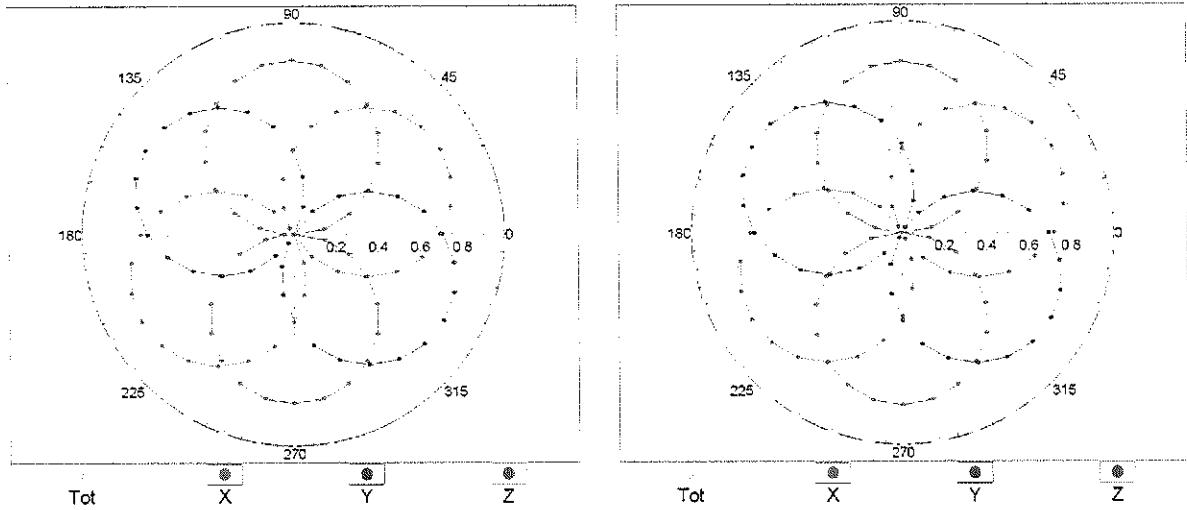

Uncertainty of Axial Isotropy Assessment: $\pm 0.5\%$ ($k=2$)

Dynamic Range $f(\text{SAR}_{\text{head}})$ (TEM cell , $f_{\text{eval}} = 1900 \text{ MHz}$)

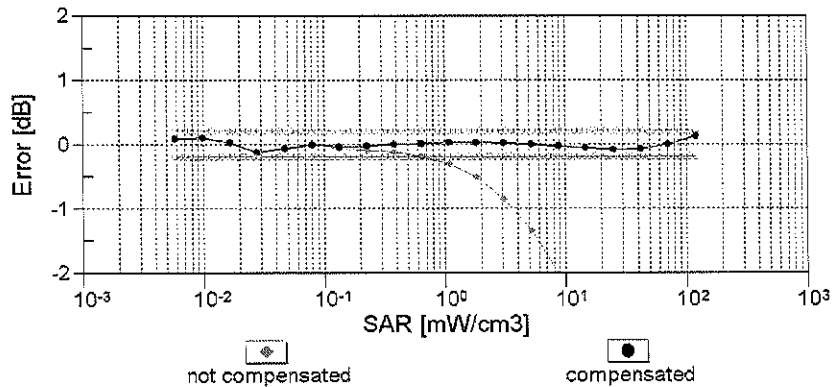
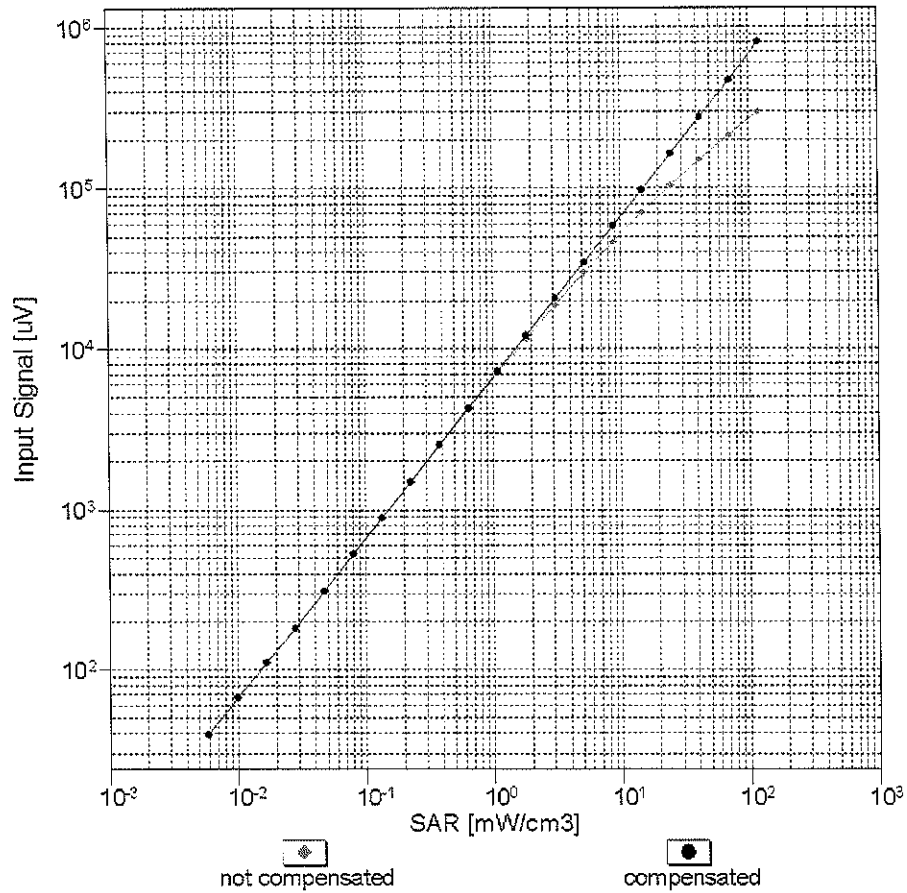

Uncertainty of Linearity Assessment: $\pm 0.6\%$ ($k=2$)

Conversion Factor Assessment

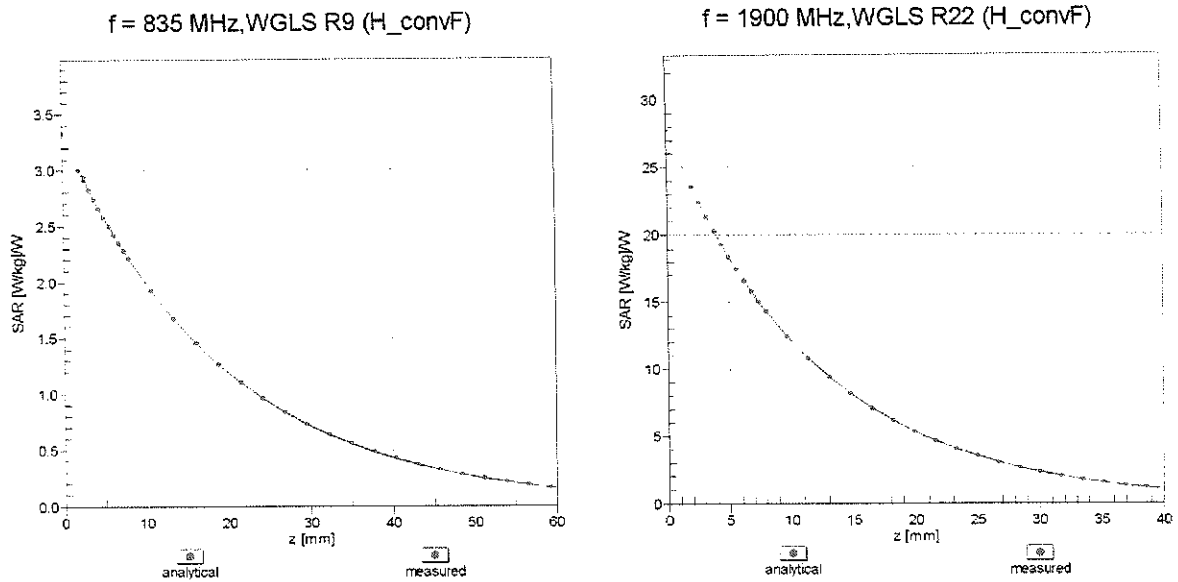

Deviation from Isotropy in Liquid

Error (ϕ, θ), f = 900 MHz

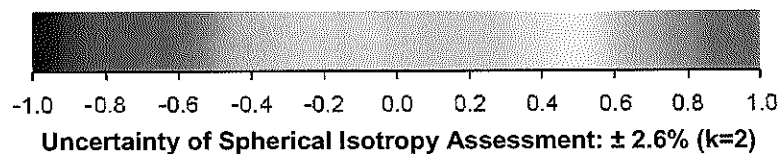
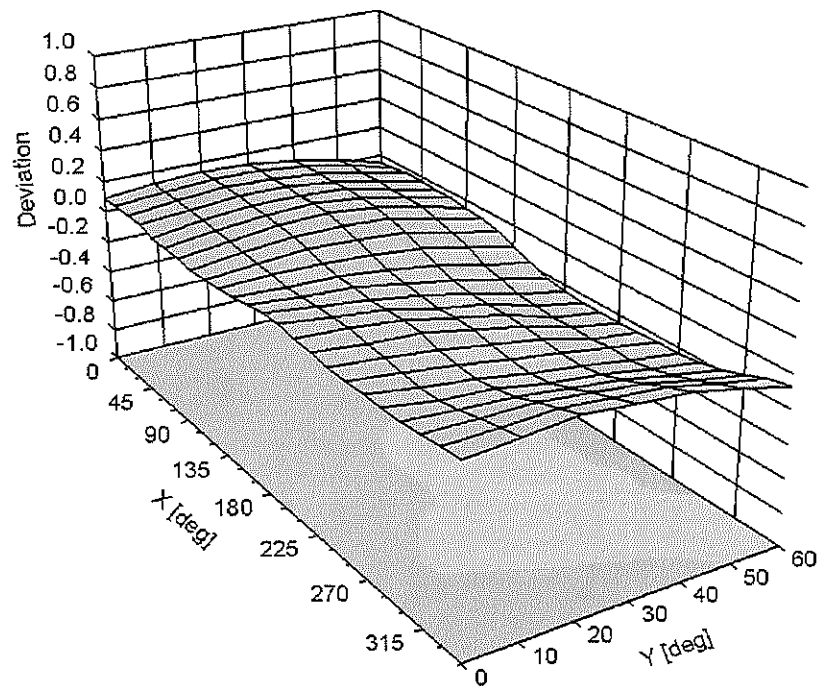

DASY/EASY - Parameters of Probe: ES3DV3 - SN:3288

Other Probe Parameters

Sensor Arrangement	Triangular
Connector Angle (°)	-110
Mechanical Surface Detection Mode	enabled
Optical Surface Detection Mode	disabled
Probe Overall Length	337 mm
Probe Body Diameter	10 mm
Tip Length	10 mm
Tip Diameter	4 mm
Probe Tip to Sensor X Calibration Point	2 mm
Probe Tip to Sensor Y Calibration Point	2 mm
Probe Tip to Sensor Z Calibration Point	2 mm
Recommended Measurement Distance from Surface	3 mm