

**Calibration Laboratory of  
 Schmid & Partner  
 Engineering AG**  
 Zeughausstrasse 43, 8004 Zurich, Switzerland



**S** Schweizerischer Kalibrierdienst  
**C** Service suisse d'étalonnage  
**S** Servizio svizzero di taratura  
**S** Swiss Calibration Service

Accredited by the Swiss Accreditation Service (SAS)  
 The Swiss Accreditation Service is one of the signatories to the EA  
 Multilateral Agreement for the recognition of calibration certificates

Accreditation No.: **SCS 0108**

Client **DT&C (Dymstec)**

Certificate No: **D5GHzV2-1212\_Feb18**

## CALIBRATION CERTIFICATE



Object: **D5GHzV2 - SN:1212**  
 Calibration procedure(s): **QA CAL-22.v2  
 Calibration procedure for dipole validation kits between 3-6 GHz**  
 Calibration date: **February 15, 2018**

This calibration certificate documents the traceability to national standards, which realize the physical units of measurements (SI).  
 The measurements and the uncertainties with confidence probability are given on the following pages and are part of the certificate.

All calibrations have been conducted in the closed laboratory facility: environment temperature (22 ± 3)°C and humidity < 70%.

Calibration Equipment used (M&TE critical for calibration)

Primary Standards	ID #	Cal Date (Certificate No.)	Scheduled Calibration
Power meter NRP	SN: 104778	04-Apr-17 (No. 217-02521/02522)	Apr-18
Power sensor NRP-Z91	SN: 103244	04-Apr-17 (No. 217-02521)	Apr-18
Power sensor NRP-Z91	SN: 103245	04-Apr-17 (No. 217-02522)	Apr-18
Reference 20 dB Attenuator	SN: 5058 (20k)	07-Apr-17 (No. 217-02528)	Apr-18
Type-N mismatch combination	SN: 5047.2 / 06327	07-Apr-17 (No. 217-02529)	Apr-18
Reference Probe EX3DV4	SN: 3503	30-Dec-17 (No. EX3-3503_Dec17)	Dec-18
DAE4	SN: 601	26-Oct-17 (No. DAE4-601_Oct17)	Oct-18
Secondary Standards	ID #	Check Date (in house)	Scheduled Check
Power meter EPM-442A	SN: GB37480704	07-Oct-15 (in house check Oct-16)	In house check: Oct-18
Power sensor HP 8481A	SN: US37292783	07-Oct-15 (in house check Oct-16)	In house check: Oct-18
Power sensor HP 8481A	SN: MY41092317	07-Oct-15 (in house check Oct-16)	In house check: Oct-18
RF generator R&S SMT-06	SN: 100972	15-Jun-15 (in house check Oct-16)	In house check: Oct-18
Network Analyzer HP 8753E	SN: US37390585	18-Oct-01 (in house check Oct-17)	In house check: Oct-18

	Name	Function	Signature
Calibrated by:	Jeton Kastrati	Laboratory Technician	
Approved by:	Katja Pokovic	Technical Manager	

Issued: March 21, 2018

This calibration certificate shall not be reproduced except in full without written approval of the laboratory.

**Calibration Laboratory of  
Schmid & Partner  
Engineering AG**  
Zeughausstrasse 43, 8004 Zurich, Switzerland



**S** Schweizerischer Kalibrierdienst  
**S** Service suisse d'étalonnage  
**C** Servizio svizzero di taratura  
**S** Swiss Calibration Service

Accredited by the Swiss Accreditation Service (SAS)  
The Swiss Accreditation Service is one of the signatories to the EA  
Multilateral Agreement for the recognition of calibration certificates

Accreditation No.: **SCS 0108**

#### Glossary:

TSL	tissue simulating liquid
ConvF	sensitivity in TSL / NORM x,y,z
N/A	not applicable or not measured

#### Calibration is Performed According to the Following Standards:

- IEEE Std 1528-2013, "IEEE Recommended Practice for Determining the Peak Spatial-Averaged Specific Absorption Rate (SAR) in the Human Head from Wireless Communications Devices: Measurement Techniques", June 2013
- IEC 62209-1, "Measurement procedure for the assessment of Specific Absorption Rate (SAR) from hand-held and body-mounted devices used next to the ear (frequency range of 300 MHz to 6 GHz)", July 2016
- IEC 62209-2, "Procedure to determine the Specific Absorption Rate (SAR) for wireless communication devices used in close proximity to the human body (frequency range of 30 MHz to 6 GHz)", March 2010
- KDB 865664, "SAR Measurement Requirements for 100 MHz to 6 GHz"

#### Additional Documentation:

- DASY4/5 System Handbook

#### Methods Applied and Interpretation of Parameters:

- Measurement Conditions:** Further details are available from the Validation Report at the end of the certificate. All figures stated in the certificate are valid at the frequency indicated.
- Antenna Parameters with TSL:** The dipole is mounted with the spacer to position its feed point exactly below the center marking of the flat phantom section, with the arms oriented parallel to the body axis.
- Feed Point Impedance and Return Loss:** These parameters are measured with the dipole positioned under the liquid filled phantom. The impedance stated is transformed from the measurement at the SMA connector to the feed point. The Return Loss ensures low reflected power. No uncertainty required.
- Electrical Delay:** One-way delay between the SMA connector and the antenna feed point. No uncertainty required.
- SAR measured:** SAR measured at the stated antenna input power.
- SAR normalized:** SAR as measured, normalized to an input power of 1 W at the antenna connector.
- SAR for nominal TSL parameters:** The measured TSL parameters are used to calculate the nominal SAR result.

The reported uncertainty of measurement is stated as the standard uncertainty of measurement multiplied by the coverage factor  $k=2$ , which for a normal distribution corresponds to a coverage probability of approximately 95%.

### Measurement Conditions

DASY system configuration, as far as not given on page 1.

DASY Version	DASY5	V52.10.0
Extrapolation	Advanced Extrapolation	
Phantom	Modular Flat Phantom V5.0	
Distance Dipole Center - TSL	10 mm	with Spacer
Zoom Scan Resolution	dx, dy = 4.0 mm, dz = 1.4 mm	Graded Ratio = 1.4 (Z direction)
Frequency	5200 MHz ± 1 MHz 5300 MHz ± 1 MHz 5500 MHz ± 1 MHz 5600 MHz ± 1 MHz 5800 MHz ± 1 MHz	

### Head TSL parameters at 5200 MHz

The following parameters and calculations were applied.

	Temperature	Permittivity	Conductivity
Nominal Head TSL parameters	22.0 °C	36.0	4.66 mho/m
Measured Head TSL parameters	(22.0 ± 0.2) °C	36.4 ± 6 %	4.53 mho/m ± 6 %
Head TSL temperature change during test	< 0.5 °C	----	----

### SAR result with Head TSL at 5200 MHz

SAR averaged over 1 cm <sup>3</sup> (1 g) of Head TSL	Condition	
SAR measured	100 mW input power	7.95 W/kg
SAR for nominal Head TSL parameters	normalized to 1W	<b>79.6 W/kg ± 19.9 % (k=2)</b>

SAR averaged over 10 cm <sup>3</sup> (10 g) of Head TSL	condition	
SAR measured	100 mW input power	2.26 W/kg
SAR for nominal Head TSL parameters	normalized to 1W	<b>22.6 W/kg ± 19.5 % (k=2)</b>

### Head TSL parameters at 5300 MHz

The following parameters and calculations were applied.

	Temperature	Permittivity	Conductivity
Nominal Head TSL parameters	22.0 °C	35.9	4.76 mho/m
Measured Head TSL parameters	(22.0 ± 0.2) °C	36.3 ± 6 %	4.64 mho/m ± 6 %
Head TSL temperature change during test	< 0.5 °C	----	----

### SAR result with Head TSL at 5300 MHz

SAR averaged over 1 cm <sup>3</sup> (1 g) of Head TSL	Condition	
SAR measured	100 mW input power	8.10 W/kg
SAR for nominal Head TSL parameters	normalized to 1W	81.1 W / kg ± 19.9 % (k=2)

SAR averaged over 10 cm <sup>3</sup> (10 g) of Head TSL	condition	
SAR measured	100 mW input power	2.31 W/kg
SAR for nominal Head TSL parameters	normalized to 1W	23.1 W/kg ± 19.5 % (k=2)

### Head TSL parameters at 5500 MHz

The following parameters and calculations were applied.

	Temperature	Permittivity	Conductivity
Nominal Head TSL parameters	22.0 °C	35.6	4.96 mho/m
Measured Head TSL parameters	(22.0 ± 0.2) °C	36.0 ± 6 %	4.84 mho/m ± 6 %
Head TSL temperature change during test	< 0.5 °C	----	----

### SAR result with Head TSL at 5500 MHz

SAR averaged over 1 cm <sup>3</sup> (1 g) of Head TSL	Condition	
SAR measured	100 mW input power	8.53 W/kg
SAR for nominal Head TSL parameters	normalized to 1W	85.4 W/kg ± 19.9 % (k=2)

SAR averaged over 10 cm <sup>3</sup> (10 g) of Head TSL	condition	
SAR measured	100 mW input power	2.40 W/kg
SAR for nominal Head TSL parameters	normalized to 1W	24.0 W/kg ± 19.5 % (k=2)

### Head TSL parameters at 5600 MHz

The following parameters and calculations were applied.

	Temperature	Permittivity	Conductivity
Nominal Head TSL parameters	22.0 °C	35.5	5.07 mho/m
Measured Head TSL parameters	(22.0 ± 0.2) °C	35.8 ± 6 %	4.95 mho/m ± 6 %
Head TSL temperature change during test	< 0.5 °C	----	----

### SAR result with Head TSL at 5600 MHz

SAR averaged over 1 cm <sup>3</sup> (1 g) of Head TSL	Condition	
SAR measured	100 mW input power	8.36 W/kg
SAR for nominal Head TSL parameters	normalized to 1W	<b>83.6 W/kg ± 19.9 % (k=2)</b>

SAR averaged over 10 cm <sup>3</sup> (10 g) of Head TSL	condition	
SAR measured	100 mW input power	2.38 W/kg
SAR for nominal Head TSL parameters	normalized to 1W	<b>23.8 W/kg ± 19.5 % (k=2)</b>

### Head TSL parameters at 5800 MHz

The following parameters and calculations were applied.

	Temperature	Permittivity	Conductivity
Nominal Head TSL parameters	22.0 °C	35.3	5.27 mho/m
Measured Head TSL parameters	(22.0 ± 0.2) °C	35.5 ± 6 %	5.16 mho/m ± 6 %
Head TSL temperature change during test	< 0.5 °C	----	----

### SAR result with Head TSL at 5800 MHz

SAR averaged over 1 cm <sup>3</sup> (1 g) of Head TSL	Condition	
SAR measured	100 mW input power	7.95 W/kg
SAR for nominal Head TSL parameters	normalized to 1W	<b>79.5 W/kg ± 19.9 % (k=2)</b>

SAR averaged over 10 cm <sup>3</sup> (10 g) of Head TSL	condition	
SAR measured	100 mW input power	2.24 W/kg
SAR for nominal Head TSL parameters	normalized to 1W	<b>22.4 W/kg ± 19.5 % (k=2)</b>

### Body TSL parameters at 5200 MHz

The following parameters and calculations were applied.

	Temperature	Permittivity	Conductivity
Nominal Body TSL parameters	22.0 °C	49.0	5.30 mho/m
Measured Body TSL parameters	(22.0 ± 0.2) °C	47.5 ± 6 %	5.41 mho/m ± 6 %
Body TSL temperature change during test	< 0.5 °C	----	----

### SAR result with Body TSL at 5200 MHz

SAR averaged over 1 cm <sup>3</sup> (1 g) of Body TSL	Condition	
SAR measured	100 mW input power	7.31 W/kg
SAR for nominal Body TSL parameters	normalized to 1W	72.7 W/kg ± 19.9 % (k=2)

SAR averaged over 10 cm <sup>3</sup> (10 g) of Body TSL	condition	
SAR measured	100 mW input power	2.03 W/kg
SAR for nominal Body TSL parameters	normalized to 1W	20.2 W/kg ± 19.5 % (k=2)

### Body TSL parameters at 5300 MHz

The following parameters and calculations were applied.

	Temperature	Permittivity	Conductivity
Nominal Body TSL parameters	22.0 °C	48.9	5.42 mho/m
Measured Body TSL parameters	(22.0 ± 0.2) °C	47.3 ± 6 %	5.54 mho/m ± 6 %
Body TSL temperature change during test	< 0.5 °C	----	----

### SAR result with Body TSL at 5300 MHz

SAR averaged over 1 cm <sup>3</sup> (1 g) of Body TSL	Condition	
SAR measured	100 mW input power	7.57 W/kg
SAR for nominal Body TSL parameters	normalized to 1W	75.2 W/kg ± 19.9 % (k=2)

SAR averaged over 10 cm <sup>3</sup> (10 g) of Body TSL	condition	
SAR measured	100 mW input power	2.11 W/kg
SAR for nominal Body TSL parameters	normalized to 1W	20.9 W/kg ± 19.5 % (k=2)

**Body TSL parameters at 5500 MHz**

The following parameters and calculations were applied.

	Temperature	Permittivity	Conductivity
Nominal Body TSL parameters	22.0 °C	48.6	5.65 mho/m
Measured Body TSL parameters	(22.0 ± 0.2) °C	47.0 ± 6 %	5.80 mho/m ± 6 %
Body TSL temperature change during test	< 0.5 °C	----	----

**SAR result with Body TSL at 5500 MHz**

SAR averaged over 1 cm <sup>3</sup> (1 g) of Body TSL	Condition	
SAR measured	100 mW input power	8.04 W/kg
SAR for nominal Body TSL parameters	normalized to 1W	79.9 W/kg ± 19.9 % (k=2)

SAR averaged over 10 cm <sup>3</sup> (10 g) of Body TSL	condition	
SAR measured	100 mW input power	2.22 W/kg
SAR for nominal Body TSL parameters	normalized to 1W	22.0 W/kg ± 19.5 % (k=2)

**Body TSL parameters at 5600 MHz**

The following parameters and calculations were applied.

	Temperature	Permittivity	Conductivity
Nominal Body TSL parameters	22.0 °C	48.5	5.77 mho/m
Measured Body TSL parameters	(22.0 ± 0.2) °C	46.8 ± 6 %	5.95 mho/m ± 6 %
Body TSL temperature change during test	< 0.5 °C	----	----

**SAR result with Body TSL at 5600 MHz**

SAR averaged over 1 cm <sup>3</sup> (1 g) of Body TSL	Condition	
SAR measured	100 mW input power	7.94 W/kg
SAR for nominal Body TSL parameters	normalized to 1W	78.9 W/kg ± 19.9 % (k=2)

SAR averaged over 10 cm <sup>3</sup> (10 g) of Body TSL	condition	
SAR measured	100 mW input power	2.20 W/kg
SAR for nominal Body TSL parameters	normalized to 1W	21.8 W/kg ± 19.5 % (k=2)

**Body TSL parameters at 5800 MHz**

The following parameters and calculations were applied.

	Temperature	Permittivity	Conductivity
Nominal Body TSL parameters	22.0 °C	48.2	6.00 mho/m
Measured Body TSL parameters	(22.0 ± 0.2) °C	46.4 ± 6 %	6.23 mho/m ± 6 %
Body TSL temperature change during test	< 0.5 °C	----	----

**SAR result with Body TSL at 5800 MHz**

SAR averaged over 1 cm <sup>3</sup> (1 g) of Body TSL	Condition	
SAR measured	100 mW input power	7.62 W/kg
SAR for nominal Body TSL parameters	normalized to 1W	<b>75.7 W/kg ± 19.9 % (k=2)</b>

SAR averaged over 10 cm <sup>3</sup> (10 g) of Body TSL	condition	
SAR measured	100 mW input power	2.10 W/kg
SAR for nominal Body TSL parameters	normalized to 1W	<b>20.8 W/kg ± 19.5 % (k=2)</b>



**Appendix (Additional assessments outside the scope of SCS 0108)**
**Antenna Parameters with Head TSL at 5200 MHz**

Impedance, transformed to feed point	48.3 $\Omega$ - 3.7 j $\Omega$
Return Loss	- 27.8 dB

**Antenna Parameters with Head TSL at 5300 MHz**

Impedance, transformed to feed point	47.8 $\Omega$ - 0.1 j $\Omega$
Return Loss	- 33.0 dB

**Antenna Parameters with Head TSL at 5500 MHz**

Impedance, transformed to feed point	46.8 $\Omega$ + 1.4 j $\Omega$
Return Loss	- 28.8 dB

**Antenna Parameters with Head TSL at 5600 MHz**

Impedance, transformed to feed point	50.4 $\Omega$ + 3.1 j $\Omega$
Return Loss	- 30.2 dB

**Antenna Parameters with Head TSL at 5800 MHz**

Impedance, transformed to feed point	52.3 $\Omega$ + 3.2 j $\Omega$
Return Loss	- 28.2 dB

**Antenna Parameters with Body TSL at 5200 MHz**

Impedance, transformed to feed point	47.9 $\Omega$ - 3.7 j $\Omega$
Return Loss	- 27.3 dB

**Antenna Parameters with Body TSL at 5300 MHz**

Impedance, transformed to feed point	48.6 $\Omega$ + 2.0 j $\Omega$
Return Loss	- 32.0 dB

**Antenna Parameters with Body TSL at 5500 MHz**

Impedance, transformed to feed point	47.4 $\Omega$ + 3.1 j $\Omega$
Return Loss	- 27.5 dB

### Antenna Parameters with Body TSL at 5600 MHz

Impedance, transformed to feed point	50.5 $\Omega$ + 4.0 j $\Omega$
Return Loss	- 28.0 dB

### Antenna Parameters with Body TSL at 5800 MHz

Impedance, transformed to feed point	52.5 $\Omega$ + 4.4 j $\Omega$
Return Loss	- 26.2 dB

### General Antenna Parameters and Design

Electrical Delay (one direction)	1.191 ns
----------------------------------	----------

After long term use with 100W radiated power, only a slight warming of the dipole near the feedpoint can be measured.

The dipole is made of standard semirigid coaxial cable. The center conductor of the feeding line is directly connected to the second arm of the dipole. The antenna is therefore short-circuited for DC-signals. On some of the dipoles, small end caps are added to the dipole arms in order to improve matching when loaded according to the position as explained in the "Measurement Conditions" paragraph. The SAR data are not affected by this change. The overall dipole length is still according to the Standard.

No excessive force must be applied to the dipole arms, because they might bend or the soldered connections near the feedpoint may be damaged.

### Additional EUT Data

Manufactured by	SPEAG
Manufactured on	November 14, 2014

**DASY5 Validation Report for Head TSL**

Date: 14.02.2018

Test Laboratory: SPEAG, Zurich, Switzerland

**DUT: Dipole D5GHzV2; Type: D5GHzV2; Serial: D5GHzV2 - SN:1212**Communication System: UID 0 - CW; Frequency: 5200 MHz, Frequency: 5300 MHz,  
Frequency: 5500 MHz, Frequency: 5600 MHz, Frequency: 5800 MHzMedium parameters used:  $f = 5200$  MHz;  $\sigma = 4.53$  S/m;  $\epsilon_r = 36.4$ ;  $\rho = 1000$  kg/m<sup>3</sup>,Medium parameters used:  $f = 5300$  MHz;  $\sigma = 4.64$  S/m;  $\epsilon_r = 36.3$ ;  $\rho = 1000$  kg/m<sup>3</sup>,Medium parameters used:  $f = 5500$  MHz;  $\sigma = 4.84$  S/m;  $\epsilon_r = 36$ ;  $\rho = 1000$  kg/m<sup>3</sup>,Medium parameters used:  $f = 5600$  MHz;  $\sigma = 4.95$  S/m;  $\epsilon_r = 35.8$ ;  $\rho = 1000$  kg/m<sup>3</sup>,Medium parameters used:  $f = 5800$  MHz;  $\sigma = 5.16$  S/m;  $\epsilon_r = 35.5$ ;  $\rho = 1000$  kg/m<sup>3</sup>

Phantom section: Flat Section

Measurement Standard: DASY5 (IEEE/IEC/ANSI C63.19-2011)

## DASY52 Configuration:

- Probe: EX3DV4 - SN3503; ConvF(5.75, 5.75, 5.75); Calibrated: 30.12.2017, ConvF(5.5, 5.5, 5.5);  
Calibrated: 30.12.2017, ConvF(5.2, 5.2, 5.2); Calibrated: 30.12.2017, ConvF(5.05, 5.05, 5.05);  
Calibrated: 30.12.2017, ConvF(4.96, 4.96, 4.96); Calibrated: 30.12.2017;
- Sensor-Surface: 1.4mm (Mechanical Surface Detection)
- Electronics: DAE4 Sn601; Calibrated: 26.10.2017
- Phantom: Flat Phantom 5.0 (front); Type: QD 000 P50 AA; Serial: 1001
- DASY52 52.10.0(1446); SEMCAD X 14.6.10(7417)

**Dipole Calibration for Head Tissue/Pin=100mW, dist=10mm, f=5200 MHz/Zoom Scan, dist=1.4mm (8x8x7)/Cube 0:**

Measurement grid: dx=4mm, dy=4mm, dz=1.4mm

Reference Value = 71.98 V/m; Power Drift = -0.08 dB

Peak SAR (extrapolated) = 28.5 W/kg

**SAR(1 g) = 7.95 W/kg; SAR(10 g) = 2.26 W/kg**

Maximum value of SAR (measured) = 18.0 W/kg

**Dipole Calibration for Head Tissue/Pin=100mW, dist=10mm, f=5300 MHz/Zoom Scan, dist=1.4mm (8x8x7)/Cube 0:**

Measurement grid: dx=4mm, dy=4mm, dz=1.4mm

Reference Value = 72.21 V/m; Power Drift = -0.08 dB

Peak SAR (extrapolated) = 29.9 W/kg

**SAR(1 g) = 8.1 W/kg; SAR(10 g) = 2.31 W/kg**

Maximum value of SAR (measured) = 18.8 W/kg

**Dipole Calibration for Head Tissue/Pin=100mW, dist=10mm, f=5500 MHz/Zoom Scan, dist=1.4mm (8x8x7)/Cube 0:**

Measurement grid: dx=4mm, dy=4mm, dz=1.4mm

Reference Value = 73.15 V/m; Power Drift = -0.08 dB

Peak SAR (extrapolated) = 33.3 W/kg

**SAR(1 g) = 8.53 W/kg; SAR(10 g) = 2.4 W/kg**

Maximum value of SAR (measured) = 20.1 W/kg

**Dipole Calibration for Head Tissue/Pin=100mW, dist=10mm, f=5600 MHz/Zoom Scan, dist=1.4mm (8x8x7)/Cube 0:** Measurement grid: dx=4mm, dy=4mm, dz=1.4mm  
 Reference Value = 72.01 V/m; Power Drift = -0.05 dB  
 Peak SAR (extrapolated) = 32.2 W/kg  
**SAR(1 g) = 8.36 W/kg; SAR(10 g) = 2.38 W/kg**  
 Maximum value of SAR (measured) = 20.0 W/kg

**Dipole Calibration for Head Tissue/Pin=100mW, dist=10mm, f=5800 MHz/Zoom Scan, dist=1.4mm (8x8x7)/Cube 0:** Measurement grid: dx=4mm, dy=4mm, dz=1.4mm  
 Reference Value = 70.08 V/m; Power Drift = -0.03 dB  
 Peak SAR (extrapolated) = 31.9 W/kg  
**SAR(1 g) = 7.95 W/kg; SAR(10 g) = 2.24 W/kg**  
 Maximum value of SAR (measured) = 19.4 W/kg

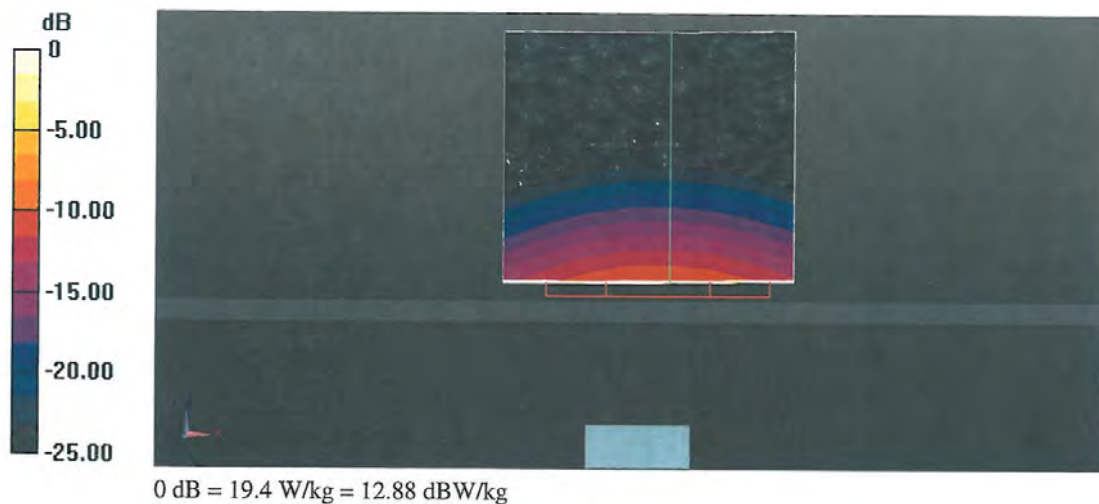

Impedance Measurement Plot for Head TSL

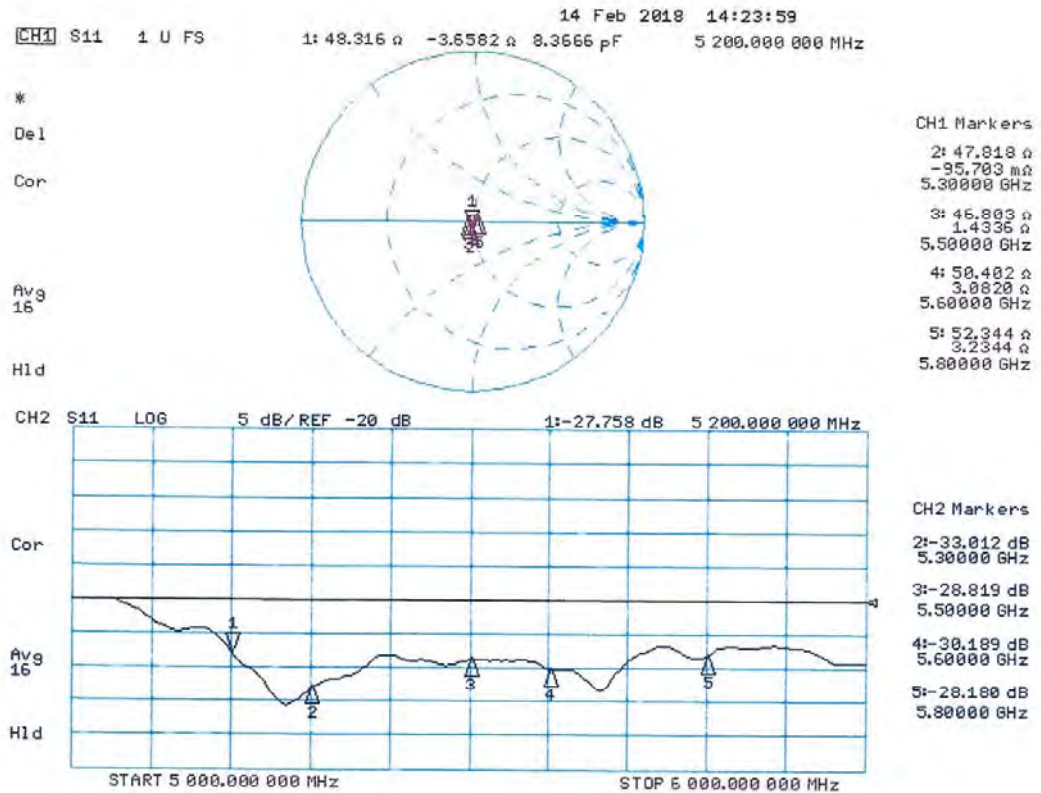

**DASY5 Validation Report for Body TSL**

Date: 15.02.2018

Test Laboratory: SPEAG, Zurich, Switzerland

**DUT: Dipole D5GHzV2; Type: D5GHzV2; Serial: D5GHzV2 - SN:1212**

Communication System: UID 0 - CW; Frequency: 5200 MHz, Frequency: 5300 MHz,  
Frequency: 5500 MHz, Frequency: 5600 MHz, Frequency: 5800 MHz

Medium parameters used:  $f = 5200$  MHz;  $\sigma = 5.41$  S/m;  $\epsilon_r = 47.5$ ;  $\rho = 1000$  kg/m<sup>3</sup>,

Medium parameters used:  $f = 5300$  MHz;  $\sigma = 5.54$  S/m;  $\epsilon_r = 47.3$ ;  $\rho = 1000$  kg/m<sup>3</sup>,

Medium parameters used:  $f = 5500$  MHz;  $\sigma = 5.8$  S/m;  $\epsilon_r = 47$ ;  $\rho = 1000$  kg/m<sup>3</sup>,

Medium parameters used:  $f = 5600$  MHz;  $\sigma = 5.95$  S/m;  $\epsilon_r = 46.8$ ;  $\rho = 1000$  kg/m<sup>3</sup>,

Medium parameters used:  $f = 5800$  MHz;  $\sigma = 6.23$  S/m;  $\epsilon_r = 46.4$ ;  $\rho = 1000$  kg/m<sup>3</sup>

Phantom section: Flat Section

Measurement Standard: DASY5 (IEEE/IEC/ANSI C63.19-2011)

## DASY52 Configuration:

- Probe: EX3DV4 - SN3503; ConvF(5.35, 5.35, 5.35); Calibrated: 30.12.2017, ConvF(5.15, 5.15, 5.15);  
Calibrated: 30.12.2017, ConvF(4.7, 4.7, 4.7); Calibrated: 30.12.2017, ConvF(4.65, 4.65, 4.65);  
Calibrated: 30.12.2017, ConvF(4.53, 4.53, 4.53); Calibrated: 30.12.2017;
- Sensor-Surface: 1.4mm (Mechanical Surface Detection)
- Electronics: DAE4 Sn601; Calibrated: 26.10.2017
- Phantom: Flat Phantom 5.0 (back); Type: QD 000 P50 AA; Serial: 1002
- DASY52 52.10.0(1446); SEMCAD X 14.6.10(7417)

**Dipole Calibration for Body Tissue/Pin=100mW, dist=10mm, f=5200 MHz/Zoom Scan, dist=1.4mm (8x8x7)/Cube 0:**

Measurement grid: dx=4mm, dy=4mm, dz=1.4mm

Reference Value = 64.59 V/m; Power Drift = -0.02 dB

Peak SAR (extrapolated) = 27.2 W/kg

**SAR(1 g) = 7.31 W/kg; SAR(10 g) = 2.03 W/kg**

Maximum value of SAR (measured) = 16.9 W/kg

**Dipole Calibration for Body Tissue/Pin=100mW, dist=10mm, f=5300 MHz/Zoom Scan, dist=1.4mm (8x8x7)/Cube 0:**

Measurement grid: dx=4mm, dy=4mm, dz=1.4mm

Reference Value = 64.99 V/m; Power Drift = -0.01 dB

Peak SAR (extrapolated) = 29.6 W/kg

**SAR(1 g) = 7.57 W/kg; SAR(10 g) = 2.11 W/kg**

Maximum value of SAR (measured) = 17.7 W/kg

**Dipole Calibration for Body Tissue/Pin=100mW, dist=10mm, f=5500 MHz/Zoom Scan, dist=1.4mm (8x8x7)/Cube 0:**

Measurement grid: dx=4mm, dy=4mm, dz=1.4mm

Reference Value = 65.88 V/m; Power Drift = -0.07 dB

Peak SAR (extrapolated) = 33.3 W/kg

**SAR(1 g) = 8.04 W/kg; SAR(10 g) = 2.22 W/kg**

Maximum value of SAR (measured) = 19.3 W/kg

**Dipole Calibration for Body Tissue/Pin=100mW, dist=10mm, f=5600 MHz/Zoom Scan, dist=1.4mm (8x8x7)/Cube 0:** Measurement grid: dx=4mm, dy=4mm, dz=1.4mm  
 Reference Value = 64.59 V/m; Power Drift = -0.02 dB  
 Peak SAR (extrapolated) = 33.4 W/kg  
**SAR(1 g) = 7.94 W/kg; SAR(10 g) = 2.2 W/kg**  
 Maximum value of SAR (measured) = 19.0 W/kg

**Dipole Calibration for Body Tissue/Pin=100mW, dist=10mm, f=5800 MHz/Zoom Scan, dist=1.4mm (8x8x7)/Cube 0:** Measurement grid: dx=4mm, dy=4mm, dz=1.4mm  
 Reference Value = 63.42 V/m; Power Drift = -0.02 dB  
 Peak SAR (extrapolated) = 33.2 W/kg  
**SAR(1 g) = 7.62 W/kg; SAR(10 g) = 2.1 W/kg**  
 Maximum value of SAR (measured) = 18.7 W/kg

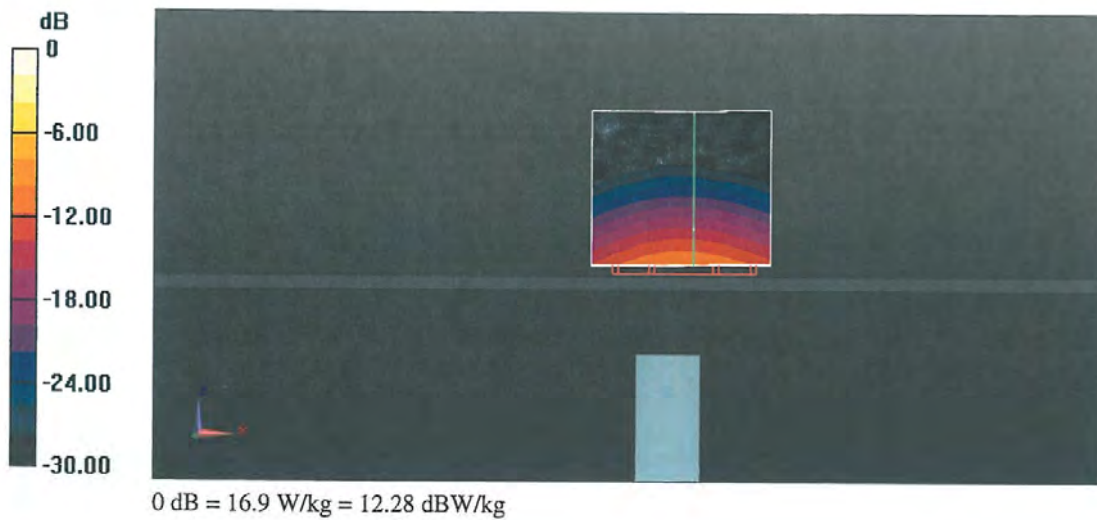

Impedance Measurement Plot for Body TSL

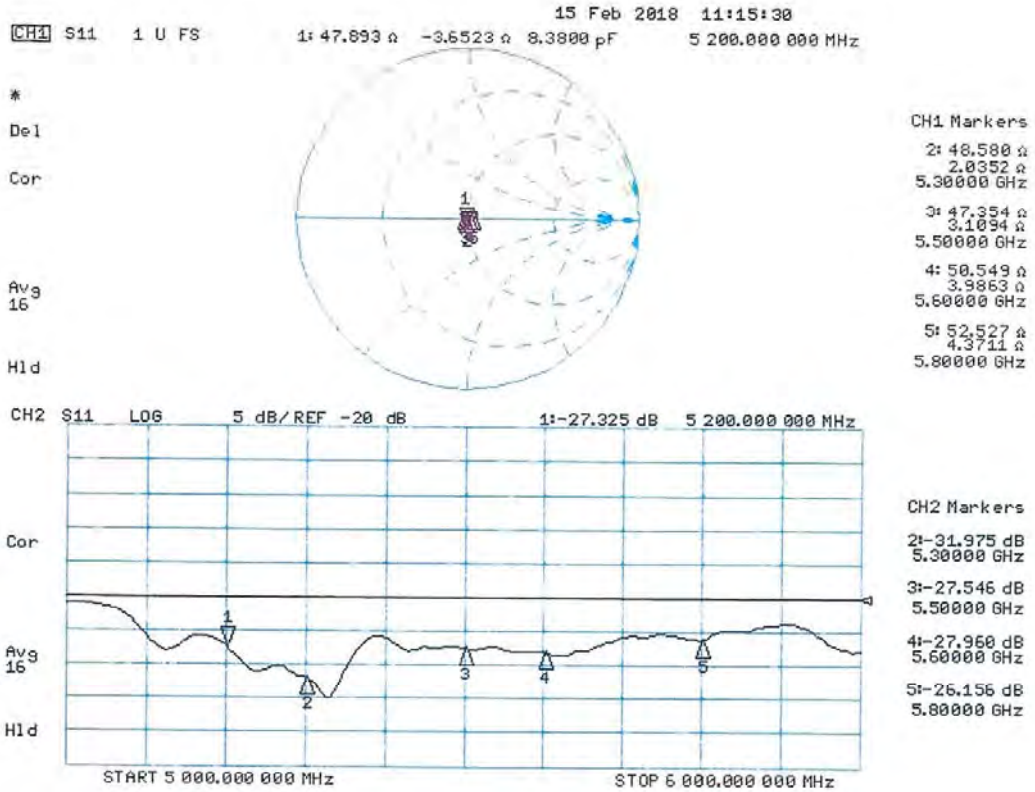



## APPENDIX C. – SAR Tissue Specifications

The brain and muscle mixtures consist of a viscous gel using hydrox-ethylcellulose (HEC) gelling agent and saline solution (see Table 3.1). Preservation with a bactericide is added and visual inspection is made to make sure air bubbles are not trapped during the mixing process. The mixture is calibrated to obtain proper dielectric constant (permittivity) and conductivity of the desired tissue. The mixture characterizations used for the brain and muscle tissue simulating liquids are according to the data by C. Gabriel and G. Harts grove.



**Figure 3.9 Simulated Tissue**

**Table C.1 Composition of the Tissue Equivalent Matter**

Ingredients (% by weight)	Frequency (MHz)							
	835		1900		2450		5200 ~ 5800	
Tissue Type	Head	Body	Head	Body	Head	Body	Head	Body
Water	40.19	50.75	55.24	70.23	71.88	73.40	65.52	80.00
Salt (NaCl)	1.480	0.940	0.310	0.290	0.160	0.060	-	-
Sugar	57.90	48.21	-	-	-	-	-	-
HEC	0.250	-	-	-	-	-	-	-
Bactericide	0.180	0.100	-	-	-	-	-	-
Triton X-100	-	-	-	-	19.97	-	17.24	-
DGBE	-	-	44.45	29.48	7.990	26.54	-	-
Diethylene glycol hexyl ether	-	-	-	-	-	-	17.24	-
Polysorbate (Tween) 80	-	-	-	-	-	-	-	20.00
Target for Dielectric Constant	41.5	55.2	40.0	53.3	39.2	52.7	-	-
Target for Conductivity (S/m)	0.90	0.97	1.40	1.52	1.80	1.95	-	-

- Salt: 99 % Pure Sodium Chloride                      Sugar: 98 % Pure Sucrose
- Water: De-ionized, 16M resistivity                      HEC: Hydroxyethyl Cellulose
- DGBE: 99 % Di(ethylene glycol) butyl ether,[2-(2-butoxyethoxy) ethanol]
- Triton X-100(ultra pure): Polyethylene glycol mono[4-(1,1,3,3-tetramethylbutyl)phenyl] ether

**Table C.2 HSL/MSL750 (Head and Body liquids for 700 – 800 MHz)**

Item	Head Tissue Simulation Liquids HSL750
	Muscle (body) Tissue Simulation Liquids MSL750
Type No	SL AAH 075, SL AAM 075
Manufacturer	SPEAG
The item is composed of the following ingredients:	
H <sup>2</sup> O	Water, 35 – 58%
Sucrose	Sucrose, 40 – 60%
NaCl	Sodium Chloride, 0 – 6%
Hydroxyethyl-cellulose	Medium Viscosity (CAS# 9004-62-0), < 0.3%
Preventol-D7	Preservative: aqueous preparation, (CAS# 55965-84-9), containing 5-chloro-2-methyl-3(2H)-isothiazolone and 2-methyl-3(2H)-isothiazolone, 0.1 – 0.6%

**Table C.3 HSL/MSL1750 (Head and Body liquids for 1700 – 1800 MHz)**

Item	Head Tissue Simulation Liquids HSL1750
	Muscle (body) Tissue Simulation Liquids MSL1750
Type No	SL AAH 175, SL AAM 175
Manufacturer	SPEAG
The item is composed of the following ingredients:	
H <sup>2</sup> O	Water, 52 – 75%
C <sub>8</sub> H <sub>18</sub> O <sub>3</sub>	Diethylene glycol monobutyl ether (DGBE), 25 – 48%
NaCl	Sodium Chloride, < 1.0%

## **APPENDIX D. – SAR SYSTEM VALIDATION**

## SAR System Validation

Per FCC KDB 865664 D02v01r02, SAR system validation status should be documented to confirm measurement accuracy. The SAR systems (including SAR probes, system components and software versions) used for this device were validated against its performance specifications prior to the SAR measurements. Reference dipoles were used with the required tissue- equivalent media for system validation, according to the procedures outlined in FCC KDB 865664 D01v01r04 and IEEE 1528-2013. Since SAR probe calibrations are frequency dependent, each probe calibration point was validated at a frequency within the valid frequency range of the probe calibration point, using the system that normally operates with the probe for routine SAR measurements and according to the required tissue-equivalent media.

A tabulated summary of the system validation status including the validation date(s), measurement frequencies, SAR probes and tissue dielectric parameters has been included.

**Table D.1 SAR System Validation Summary**

SAR System	Freq. [MHz]	Date	Probe SN	Probe Type	Probe CAL. Point		PERM.	COND.	CW Validation			MOD. Validation		
							( $\epsilon_r$ )	( $\sigma$ )	Sensitivity	Probe Linearity	Probe Isortropy	MOD. Type	Duty Factor	PAR
D	750	2018.10.15	3933	EX3DV4	750	Head	42.212	0.887	PASS	PASS	PASS	N/A	N/A	N/A
D	835	2018.10.16	3933	EX3DV4	835	Head	40.978	0.919	PASS	PASS	PASS	GMSK	PASS	N/A
D	1800	2018.10.17	3933	EX3DV4	1800	Head	39.954	1.397	PASS	PASS	PASS	N/A	N/A	N/A
D	1900	2018.10.18	3933	EX3DV4	1900	Head	39.547	1.369	PASS	PASS	PASS	GMSK	PASS	N/A
E	2450	2018.08.13	3930	EX3DV4	2450	Head	38.885	1.854	PASS	PASS	PASS	OFDM/TDD	PASS	PASS
D	2600	2018.10.22	3933	EX3DV4	2600	Head	38.458	1.977	PASS	PASS	PASS	TDD	PASS	N/A
C	5200	2018.05.14	3916	EX3DV4	5200	Head	34.856	4.725	PASS	PASS	PASS	OFDM	N/A	PASS
C	5300	2018.05.15	3916	EX3DV4	5300	Head	34.854	4.856	PASS	PASS	PASS	OFDM	N/A	PASS
C	5500	2018.05.16	3916	EX3DV4	5500	Head	34.625	5.113	PASS	PASS	PASS	OFDM	N/A	PASS
C	5600	2018.05.17	3916	EX3DV4	5600	Head	34.265	5.221	PASS	PASS	PASS	OFDM	N/A	PASS
C	5800	2018.05.18	3916	EX3DV4	5800	Head	34.113	5.414	PASS	PASS	PASS	OFDM	N/A	PASS
D	750	2018.10.15	3933	EX3DV4	750	Body	54.650	0.965	PASS	PASS	PASS	N/A	N/A	N/A
D	835	2018.10.16	3933	EX3DV4	835	Body	54.597	0.975	PASS	PASS	PASS	GMSK	PASS	N/A
D	1800	2018.10.17	3933	EX3DV4	1800	Body	52.381	1.553	PASS	PASS	PASS	N/A	N/A	N/A
D	1900	2018.10.18	3933	EX3DV4	1900	Body	52.289	1.571	PASS	PASS	PASS	GMSK	PASS	N/A
E	2450	2018.08.13	3930	EX3DV4	2450	Body	51.854	2.005	PASS	PASS	PASS	OFDM/TDD	PASS	PASS
D	2600	2018.10.22	3933	EX3DV4	2600	Body	51.142	2.221	PASS	PASS	PASS	TDD	PASS	N/A
C	5200	2018.05.14	3916	EX3DV4	5200	Body	48.156	5.467	PASS	PASS	PASS	OFDM	N/A	PASS
C	5300	2018.05.15	3916	EX3DV4	5300	Body	48.111	5.488	PASS	PASS	PASS	OFDM	N/A	PASS
C	5500	2018.05.16	3916	EX3DV4	5500	Body	47.774	5.822	PASS	PASS	PASS	OFDM	N/A	PASS
C	5600	2018.05.17	3916	EX3DV4	5600	Body	47.116	5.911	PASS	PASS	PASS	OFDM	N/A	PASS
C	5800	2018.05.18	3916	EX3DV4	5800	Body	46.774	6.223	PASS	PASS	PASS	OFDM	N/A	PASS

NOTE: While the probes have been calibrated for both a CW and modulated signals, all measurements were performed using communication systems calibrated for CW signals only. Modulations in the table above represent test configurations for which the measurement system has been validated per FCC KDB Publication 865664 D01v01r04 for scenarios when CW probe calibrations are used with other signal types. SAR systems were validated for modulated signals with a periodic duty cycle, such as GMSK, or with a high peak to average ratio (>5 dB), such as OFDM according to KDB 865664.

## **APPENDIX E. – Downlink LTE CA RF Conducted Powers**



## E.2 LTE Downlink Only Carrier Aggregation Test Selection and Setup

SAR test exclusion for LTE downlink Carrier Aggregation is determined by power measurements according to the number of component carriers (CCs) supported by the product implementation. For those configurations required by April 2018 TCBC Workshop Notes, conducted power measurements with LTE Carrier Aggregation (CA) (downlink only) active are made in accordance to KDB Publication 941225 D05Av01r02. The RRC connection is only handled by one cell, the primary component carrier (PCC) for downlink and uplink communications. After making a data connection to the PCC, the UE device adds secondary component carrier(s) (SCC) on the downlink only. All uplink communications and acknowledgements remain identical to specifications when downlink carrier aggregation is inactive on the PCC. Additional conducted output powers are measured with the downlink carrier aggregation active for the configuration with highest measured maximum conducted power with downlink carrier aggregation inactive measured among the channel bandwidth, modulation and RB combinations in each frequency band.

Per FCC KDB Publication 941225 D05Av01r02, no SAR measurements are required for carrier aggregation configurations when the average output power with downlink only carrier aggregation active is not more than 0.25 dB higher than the average output power with downlink only carrier aggregation inactive.

General PCC and SCC configuration selection procedure

PCC uplink channel, channel bandwidth, modulation and RB configurations were selected based on section C)3)b)ii) of KDB 941225 D05v01r02. The downlink PCC channel was paired with the selected PCC uplink channel according to normal configurations without carrier aggregation.

To maximize aggregation bandwidth, highest channel bandwidth available for that CA combination was selected for SCC. For inter-band CA, the SCC downlink channels were selected near the middle of their transmission bands. For contiguous intra-band CA, the downlink channel spacing between the component carriers was set to multiple of 300 kHz less than the nominal channel spacing defined in section 5.4.1A of 3GPP TS 36.521. For non-contiguous intra-band CA, the downlink channel spacing between the component carriers was set to be larger than the nominal channel spacing and provided maximum separation between the component carriers.

All selected PCC and SCC(s) remained fully within the uplink/downlink transmission band of the respective component carrier.

When a device supports LTE capabilities with overlapping transmission frequency ranges, the standalone powers from the band with a larger transmission frequency range can be used to select measurement configurations for the band with the fully covered transmission frequency range.



### E.3 LTE DL Carrier Aggregation Conducted Powers

- Below downlink CA configurations were determined based on Manufacturer's information.

Table E.3.1 CA BW Class

Class	ATBC		Maximum number of CC
	N <sub>RB,agg</sub>	MHz	
A	$N \leq 100$	20	1
B	$25 < N \leq 100$	20	2
C	$100 < N \leq 200$	40	2
D	$200 < N \leq 300$	60	3
E	$300 < N \leq 400$	80	4
F	$400 < N \leq 500$	100	5
I	$700 < N \leq 800$	160	8

Table E.3.2 Exclusion Table for LTE DL CA (2CC)

Index	2CC	Supported Channel Bandwidth [MHz]		Restriction	Completely Covered by Measurement Superset
		CC1	CC2		
2CC #1	CA 4A-5A (0)	5, 10	5, 10		No
2CC #2	CA 4A-5A (1)	5, 10, 15, 20	5, 10		No
2CC #3	CA 4A-12A(0)	1, 4, 3, 5, 10	5, 10		No
2CC #4	CA 4A-12A(1)	1, 4, 3, 5, 10, 15, 20	5, 10		No
2CC #5	CA 4A-12A(2)	5, 10, 15, 20	3, 5, 10		No
2CC #6	CA 4A-12A(3)	5, 10	5, 10		No
2CC #7	CA 4A-12A(4)	5, 10, 15, 20	5, 10		No
2CC #8	CA 4A-12A(5)	5, 10, 15	5		No
2CC #9	CA 4A-17A (0)	5, 10	5, 10		No
2CC #10	CA 41C (0)	10, 15, 20	10, 15, 20		No
2CC #11	CA 41C (1)	5, 10, 15, 20	5, 10, 15, 20		No
2CC #12	CA 41C (2)	10, 15, 20	10, 15, 20		No
2CC #13	CA 41C (3)	10, 20	20		No

Note: Only yellow highlighted cells need power measurement.

Table E.3.3 Exclusion Table for LTE DL CA (3CC)

Index	3CC	Supported Channel Bandwidth [MHz]			Restriction	Completely Covered by Measurement Superset
		CC1	CC2	CC3		
3CC #1	CA 41D (0)	10, 15, 20	10, 15, 20	10, 15, 20		No

Note: Only yellow highlighted cells need power measurement.

Table E.3.4 Exclusion Table for LTE DL CA (4CC)

Index	3CC	Supported Channel Bandwidth [MHz]				Restriction	Completely Covered by Measurement Superset
		CC1	CC2	CC3	CC4		
4CC #1	CA 41E (0)	15, 20	15, 20	15, 20	20		No

Note: Only yellow highlighted cells need power measurement.

Table E.3.5 LTE Band 4 as PCC

Combination	PCC									SCC				Power	
	PCC Band	PCC BW (MHz)	PCC (UL) CH.	PCC (UL) Freq. (MHz)	Mod.	PCC UL# RB	PCC UL RB Offset	PCC (DL) CH.	PCC (DL) Freq. (MHz)	SCC Band	SCC BW (MHz)	SCC (DL) CH.	SCC (DL) Freq. (MHz)	LTE Tx. Power with DL CA Enabled (dBm)	LTE Single Carrier Tx. Power (dBm)
CA 4A-5A (0)	LTE B4	10	20350	1750.0	QPSK	1	0	2350	2150.0	LTE B5	10	2525	881.5	22.25	22.28
CA 4A-5A (1)	LTE B4	20	20175	1732.5	QPSK	1	0	2175	2132.5	LTE B5	10	2525	881.5	22.39	22.41
CA 4A-12A (0)	LTE B4	10	20350	1750.0	QPSK	1	0	2350	2150.0	LTE B12	10	5095	737.5	22.27	22.28
CA 4A-12A (1)	LTE B4	20	20175	1732.5	QPSK	1	0	2175	2132.5	LTE B12	10	5095	737.5	22.38	22.41
CA 4A-12A (2)	LTE B4	20	20175	1732.5	QPSK	1	0	2175	2132.5	LTE B12	10	5095	737.5	22.38	22.41
CA 4A-12A (3)	LTE B4	10	20350	1750.0	QPSK	1	0	2350	2150.0	LTE B12	10	5095	737.5	22.27	22.28
CA 4A-12A (4)	LTE B4	20	20175	1732.5	QPSK	1	0	2175	2132.5	LTE B12	10	5095	737.5	22.38	22.41
CA 4A-12A (5)	LTE B4	15	20325	1747.5	QPSK	1	0	2325	2147.5	LTE B12	5	5095	737.5	22.36	22.37
CA 4A-17A (0)	LTE B4	10	20350	1750.0	QPSK	1	0	2350	2150.0	LTE B17	10	5790	740.0	22.26	22.28

Table E.3.6 LTE Band 5 as PCC

Combination	PCC									SCC				Power	
	PCC Band	PCC BW (MHz)	PCC (UL) CH.	PCC (UL) Freq. (MHz)	Mod.	PCC UL# RB	PCC UL RB Offset	PCC (DL) CH.	PCC (DL) Freq. (MHz)	SCC Band	SCC BW (MHz)	SCC (DL) CH.	SCC (DL) Freq. (MHz)	LTE Tx. Power with DL CA Enabled (dBm)	LTE Single Carrier Tx. Power (dBm)
CA 4A-5A (0)	LTE B5	10	20525	836.5	QPSK	1	0	2525	881.5	LTE B4	10	2175	2132.5	25.27	25.29
CA 4A-5A (1)	LTE B5	10	20525	836.5	QPSK	1	0	2525	881.5	LTE B4	20	2175	2132.5	25.25	25.29

Table E.3.7 LTE Band 12 as PCC

Combination	PCC									SCC				SCC				Power	
	PCC Band	PCC BW (MHz)	PCC (UL) CH.	PCC (UL) Freq. (MHz)	Mod.	PCC UL# RB	PCC UL RB Offset	PCC (DL) CH.	PCC (DL) Freq. (MHz)	SCC Band	SCC BW (MHz)	SCC (DL) CH.	SCC (DL) Freq. (MHz)	SCC Band	SCC BW (MHz)	SCC (DL) CH.	SCC (DL) Freq. (MHz)	LTE Tx. Power with DL CA Enabled (dBm)	LTE Single Carrier Tx. Power (dBm)
CA 4A-12A (0)	LTE B12	10	23095	707.5	QPSK	1	25	5095	737.5	LTE B4	10	2175	2132.5	-	-	-	-	25.35	25.37
CA 4A-12A (1)	LTE B12	10	23095	707.5	QPSK	1	25	5095	737.5	LTE B4	20	2175	2132.5	-	-	-	-	25.33	25.37
CA 4A-12A (2)	LTE B12	10	23095	707.5	QPSK	1	25	5095	737.5	LTE B4	20	2175	2132.5	-	-	-	-	25.33	25.37
CA 4A-12A (3)	LTE B12	10	23095	707.5	QPSK	1	25	5095	737.5	LTE B4	10	2175	2132.5	-	-	-	-	25.35	25.37
CA 4A-12A (4)	LTE B12	10	23095	707.5	QPSK	1	25	5095	737.5	LTE B4	20	2175	2132.5	-	-	-	-	25.33	25.37
CA 4A-12A (5)	LTE B12	5	23095	707.5	QPSK	1	12	5095	737.5	LTE B4	15	2175	2132.5	-	-	-	-	25.31	25.34

Table E.3.8 LTE Band 17 as PCC

Combination	PCC									SCC				Power	
	PCC Band	PCC BW (MHz)	PCC (UL) CH.	PCC (UL) Freq. (MHz)	Mod.	PCC UL# RB	PCC UL RB Offset	PCC (DL) CH.	PCC (DL) Freq. (MHz)	SCC Band	SCC BW (MHz)	SCC (DL) CH.	SCC (DL) Freq. (MHz)	LTE Tx. Power with DL CA Enabled (dBm)	LTE Single Carrier Tx. Power (dBm)
CA 4A-17A (0)	LTE B17	10	23790	710.0	QPSK	1	25	5790	740.0	LTE B4	10	2175	2132.5	25.34	25.35

Table E.3.9 LTE Band 41 as PCC

Combination	PCC									SCC				SCC				Power	
	PCC Band	PCC BW (MHz)	PCC (UL) CH.	PCC (UL) Freq. (MHz)	Mod.	PCC UL# RB	PCC UL RB Offset	PCC (DL) CH.	PCC (DL) Freq. (MHz)	SCC Band	SCC BW (MHz)	SCC (DL) CH.	SCC (DL) Freq. (MHz)	SCC Band	SCC BW (MHz)	SCC (DL) CH.	SCC (DL) Freq. (MHz)	LTE Tx. Power with DL CA Enabled (dBm)	LTE Single Carrier Tx. Power (dBm)
CA 41C (0)	LTE B41	20	39750	2506.0	QPSK	1	0	39750	2506.0	LTE B41	20	39948	2525.8	-	-	-	-	23.71	23.74
CA 41C (1)	LTE B41	20	39750	2506.0	QPSK	1	0	39750	2506.0	LTE B41	20	39948	2525.8	-	-	-	-	23.71	23.74
CA 41C (2)	LTE B41	20	39750	2506.0	QPSK	1	0	39750	2506.0	LTE B41	20	39948	2525.8	-	-	-	-	23.71	23.74
CA 41C (3)	LTE B41	20	39750	2506.0	QPSK	1	0	39750	2506.0	LTE B41	20	39948	2525.8	-	-	-	-	23.71	23.74
CA 41D (0)	LTE B41	20	39750	2506.0	QPSK	1	0	39750	2506.0	LTE B41	20	39948	2525.8	LTE B41	20	40148	2545.8	23.76	23.74
CA 41E (0)	LTE B41	20	39750	2506.0	QPSK	1	0	39750	2506.0	LTE B41	20	39948	2525.8	LTE B41	20	40148	2545.8	23.69	23.74

- Note(s):
- The device only supports downlink Carrier Aggregation. Uplink Carrier Aggregation is not supported. The DL carrier aggregation powers were measured according to the April 2018 TCB Workshop Notes (LTE Carrier Aggregation). Per Fall 2017 TCB Workshop Notes (LTE Carrier Aggregation) and FCC KDB Publication 941225 D05Av01r02, no further power measurements and SAR measurements are required for DL carrier aggregation configurations when the average output power with downlink only carrier aggregation active is not more than 0.25 dB higher than the average output power with downlink only carrier aggregation inactive.
  - For downlink carrier aggregation combinations, PCC uplink channel was selected based on section C.3)b)ii) of KDB 941225 D05Av01r02.

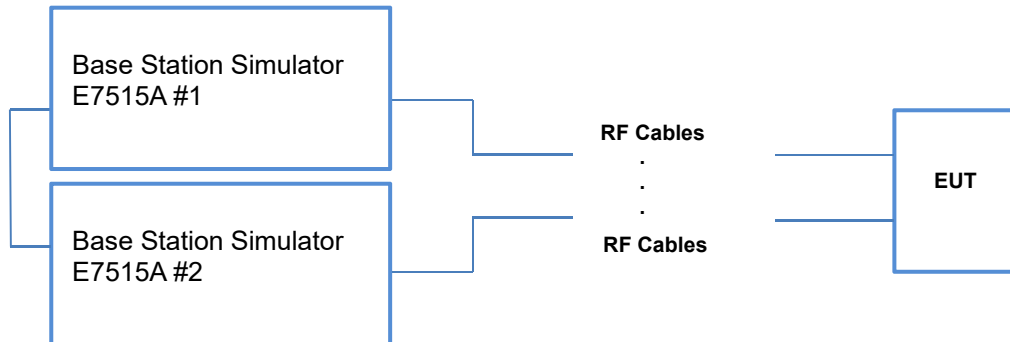

Figure E.3.1 DL 4CA Power Measurement Setup

### E.4 64QAM uplink : Applying KDB inquiry # 331653

According to the Response to Inquiry to FCC (KDB Inquiry Tracking Number: 331653), the SAR Power Measurement Plan is as follows.

- Per KDB 941225 D05 V02r05, we'll measure conducted powers per Section 5.1 for all uplink modulations (QPSK, 16QAM, 64QAM) and include in the test report.
- From these power measurements, we will apply the procedures in Section 5.2.4 ("Higher Order Modulations") to determine SAR test reduction for 16QAM and 64QAM test cases.

## **APPENDIX F. – Description of Test Equipment**

## F.1 SAR Measurement Setup

Measurements are performed using the DASY5 automated dosimetric assessment system. The DASY5 is made by Schmid & Partner Engineering AG (SPEAG) in Zurich, Switzerland and consists of high precision robotics system (Staubli), robot controller, desktop computer, near-field probe, probe alignment sensor, and the generic twin phantom containing the brain equivalent material. The robot is a six-axis industrial robot performing precise movements to position the probe to the location (points) of maximum electromagnetic field (EMF) (see Fig. G.1.1).

A cell controller system contains the power supply, robot controller each pendant (Joystick), and a remote control used to drive the robot motors. The PC consists of the Intel Core i7-3770 3.40 GHz desktop computer with Windows 7 system and SAR Measurement Software DASY5, A/D interface card, monitor, mouse, and keyboard. The Staubli Robotis connected to the cell controller to allow software manipulation of the robot. A data acquisition electronic (DAE) circuit that performs the signal amplification, signal multiplexing, AD-conversion, offset measurements, mechanical surface detection, collision detection, etc. is connected to the Electro-optical coupler (EOC). The EOC performs the conversion from the optical into digital electric signal of the DAE and transfers data to the PC plug-in card.

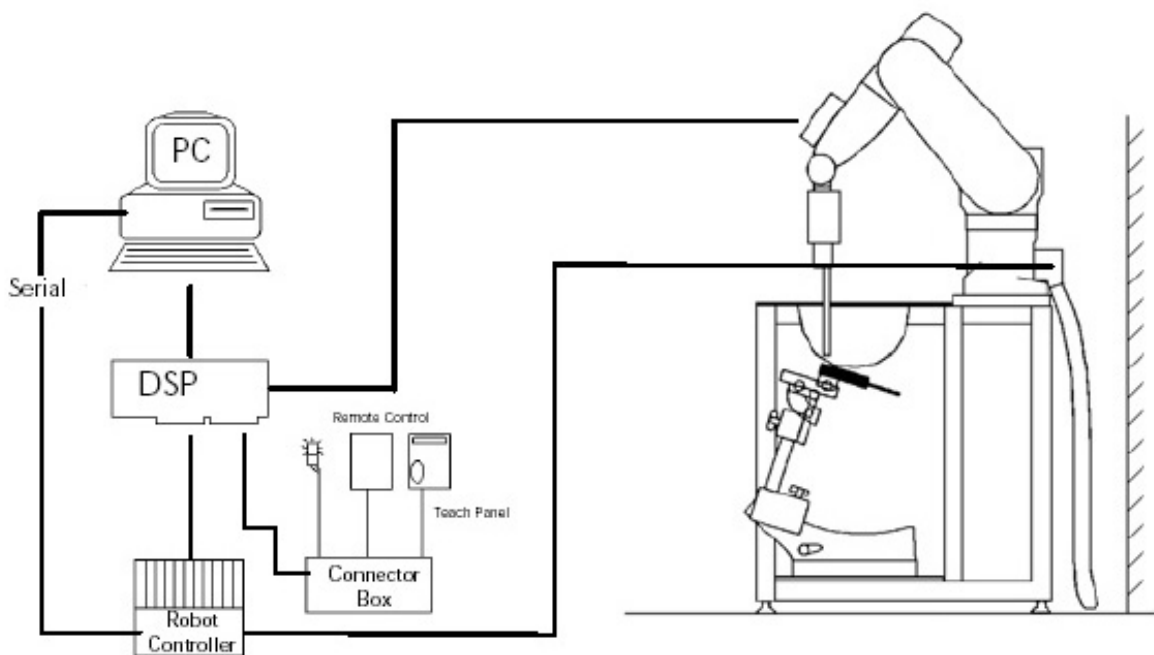
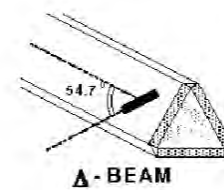

Figure F.1.1 SAR Measurement System Setup

The DAE4 consists of a highly sensitive electrometer-grade preamplifier with auto-zeroing, a channel and gain-switching multiplexer, a fast 16 bit AD-converter and a command decoder and control logic unit. Transmission to the PC-card is accomplished through an optical downlink for data and status information and an optical uplink for commands and clock lines. The mechanical probe mounting device includes two different sensor systems for frontal and sidewise probe contacts. They are also used for mechanical surface detection and probe collision detection. The robot uses its own controller with a built in VME-bus computer. The system is described in detail.

**F.2 Probe Specification**

<b>Calibration</b>	In air from 10 MHz to 6 GHz In brain and muscle simulating tissue at Frequencies of 750 MHz, 835 MHz, 900 MHz, 1750 MHz, 1900 MHz, 2300 MHz, 2450 MHz, 2600 MHz, 3500 MHz, 3700 MHz, 5200 MHz, 5300 MHz, 5500 MHz, 5600 MHz, 5800 MHz / 2450 MHz, 2600 MHz, 5200 MHz, 5300 MHz, 5500 MHz, 5600 MHz, 5800 MHz / 2450 MHz, 2600 MHz, 3500 MHz, 3700 MHz, 5200 MHz, 5300 MHz, 5500 MHz, 5600 MHz, 5800 MHz
<b>Frequency</b>	10 MHz to 6 GHz
<b>Linearity</b>	± 0.2 dB(30 MHz to 6 GHz)
<b>Dynamic</b>	10 µW/g to > 100 mW/g
<b>Range</b>	Linearity : ±0.2dB
<b>Dimensions</b>	Overall length : 337 mm
<b>Tip length</b>	20 mm
<b>Body diameter</b>	12 mm
<b>Tip diameter</b>	2.5 mm
<b>Distance from probe tip to sensor center</b>	1.0 mm
<b>Application</b>	SAR Dosimetry Testing Compliance tests of mobile phones



**Figure F.2.1 Triangular Probe Configurations**



**Figure F.2.2 Probe Thick-Film Technique**



**DAE System**

The SAR measurements were conducted with the dosimetric probe EX3DV4 designed in the classical triangular configuration(see F.2.1) and optimized for dosimetric evaluation. The probe is constructed using the thick film technique; with printed resistive lines on ceramic substrates. The probe is equipped with an optical multitier line ending at the front of the probe tip. It is connected to the EOC box on the robot arm and provides an automatic detection of the phantom surface. Half of the fibers are connected to a pulsed infrared transmitter, the other half to a synchronized receiver. As the probe approaches the surface, the reflection from the surface produces a coupling from the transmitting to the receiving fibers. This reflection increases first during the approach, reaches maximum and then decreases. If the probe is flatly touching the surface, the coupling is zero. The distance of the coupling maximum to the surface is independent of the surface reflectivity and largely independent of the surface to probe angle. The DASY5 software reads the reflection during a software approach and looks for the maximum using a 2nd order fitting. The approach is stopped at reaching the maximum.

### F.3 E-Probe Calibration Process

#### Dosimetric Assessment Procedure

Each probe is calibrated according to a dosimetric assessment procedure with accuracy better than +/- 10%. The spherical isotropy was evaluated with the procedure and found to be better than +/-0.25dB. The sensitivity parameters (Norm X, Norm Y, Norm Z), the diode compression parameter (DCP) and the conversion factor (Conv F) of the probe is tested.

#### Free Space Assessment

The free space E-field from amplified probe outputs is determined in a test chamber. This is performed in a TEM cell for frequencies below 1 GHz, and in a waveguide above 1GHz for free space. For the free space calibration, the probe is placed in the volumetric center of the cavity at the proper orientation with the field. The probe is then rotated 360 degrees.

#### Temperature Assessment \*

E-field temperature correlation calibration is performed in a flat phantom filled with the appropriate simulated brain tissue. The measured free space E-field in the medium, correlates to temperature rise in a dielectric medium. For temperature correlation calibration a RF transparent the remits or based temperature probe is used in conjunction with the E-field probe.

$$SAR = C \frac{\Delta T}{\Delta t}$$

where:

$\Delta t$  = exposure time (30 seconds),

C = heat capacity of tissue (brain or muscle),

$\Delta T$  = temperature increase due to RF exposure.

$$SAR = \frac{|E|^2 \cdot \sigma}{\rho}$$

where:

$\sigma$  = simulated tissue conductivity,

$\rho$  = Tissue density (1.25 g/cm<sup>3</sup> for brain tissue)

SAR is proportional to  $\Delta T / \Delta t$ , the initial rate of tissue heating, before thermal diffusion takes place. Now it's possible to quantify the electric field in the simulated tissue by equating the thermally derived SAR to the E- field;

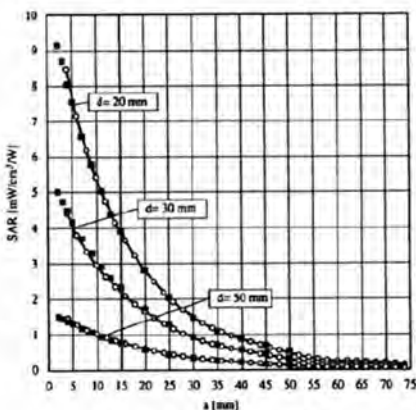

Figure F.3.1 E-Field and Temperature Measurements at 900MHz

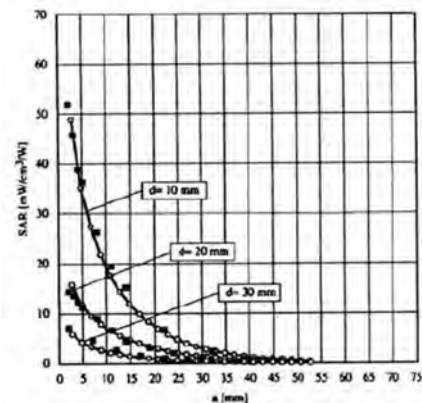

Figure F.3.2 E-Field and Temperature Measurements at 1800MHz

## F.4 Data Extrapolation

The DASY5 software automatically executes the following procedures to calculate the field units from the microvolt readings at the probe connector. The first step of the evaluation is a linearization of the filtered input signal to account for the compression characteristics of the detector diode. The compensation depends on the input signal, the diode type and the DC-transmission factor from the diode to the evaluation electronics. If the exciting field is pulsed, the crest factor of the signal must be known to correctly compensate for peak power. The formula for each channel can be given like below;

$$V_i = U_i + U_i^2 \cdot \frac{cf}{dcp_i}$$

with  $V_i$  = compensated signal of channel i (i=x,y,z)  
 $U_i$  = input signal of channel i (i=x,y,z)  
 $cf$  = crest factor of exciting field (DASY parameter)  
 $dcp_i$  = diode compression point (DASY parameter)

From the compensated input signals the primary field data for each channel can be evaluated:

E-field probes:

$$E_i = \sqrt{\frac{V_i}{Norm_i \cdot ConvF}}$$

with  $V_i$  = compensated signal of channel i (i = x,y,z)  
 $Norm_i$  = sensor sensitivity of channel i (i = x,y,z)  
 $\mu V/(V/m)^2$  for E-field probes  
 $ConvF$  = sensitivity of enhancement in solution  
 $E_i$  = electric field strength of channel i in V/m

The RSS value of the field components gives the total field strength (Hermetian magnitude):

$$E_{tot} = \sqrt{E_x^2 + E_y^2 + E_z^2}$$

The primary field data are used to calculate the derived field units.

$$SAR = E_{tot}^2 \cdot \frac{\sigma}{\rho \cdot 1000}$$

with  $SAR$  = local specific absorption rate in W/g  
 $E_{tot}$  = total field strength in V/m  
 $\sigma$  = conductivity in [mho/m] or [Siemens/m]  
 $\rho$  = equivalent tissue density in g/cm<sup>3</sup>

The power flow density is calculated assuming the excitation field to be a free space field.

$$P_{pwr} = \frac{E_{tot}^2}{3770}$$

with  $P_{pwr}$  = equivalent power density of a plane wave in W/cm<sup>2</sup>  
 $E_{tot}$  = total electric field strength in V/m

## F.5 SAM Twin Phantom

The SAM Twin Phantom V5.0 is constructed of a fiberglass shell integrated in a wooden table. The shape of the shell is based on data from an anatomical study designed to determine the maximum exposure in at least 90% of all users. It enables the dosimetric evaluation of left and right hand phone usage as well as body mounted usage at the flat phantom region. A cover prevents the evaporation of the liquid.

Reference markings on the Phantom allow the complete setup of all predefined phantom positions and measurement grids by manually teaching three points in the robot. (see Fig. F.5.1)



**Figure F.5.1 SAM Twin Phantom**

### SAM Twin Phantom Specification:

<b>Construction</b>	The shell corresponds to the specifications of the Specific Anthropomorphic Mannequin (SAM) phantom defined in IEEE 1528 and IEC 62209-1. It enables the dosimetric evaluation of left and right hand phone usage as well as body mounted usage at the flat phantom region. A cover prevents evaporation of the liquid. Reference markings on the phantom allow the complete setup of all predefined phantom positions and measurement grids by teaching three points with the robot. Twin SAM V5.0 has the same shell geometry and is manufactured from the same material as Twin SAM V4.0, but has reinforced top structure.
<b>Shell Thickness</b>	$2 \pm 0.2$ mm
<b>Filling Volume</b>	Approx. 25 liters
<b>Dimensions</b>	Length: 1000 mm Width: 500 mm Height: adjustable feet

### Specific Anthropomorphic Mannequin (SAM) Specifications:

The phantom for handset SAR assessment testing is a low-loss dielectric shell, with shape and dimensions derived from the anthropometric data of the 90th percentile adult male head dimensions as tabulated by the US Army. The SAM Twin Phantom shell is bisected along the mid-sagittal plane into right and left halves (see Fig. F.5.2). The perimeter sidewalls of each phantom halves are extended to allow filling with liquid to a depth that is sufficient to minimized reflections from the upper surface. The liquid depth is maintained at a minimum depth of 15cm to minimize reflections from the upper surface.

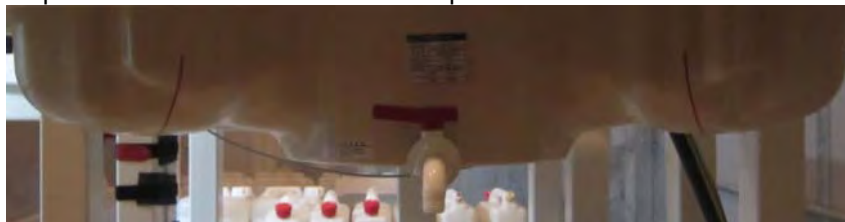

**Figure F.5.2 Sam Twin Phantom shell**



## F.6 Device Holder for Transmitters

In combination with the Twin SAM Phantom V4.0/V4.0c, V5.0 or ELI4, the Mounting Device enables the rotation of the mounted transmitter device in spherical coordinates. Rotation point is the ear opening point. Transmitter devices can be easily and accurately positioned according to IEC, IEEE, FCC or other specifications. The device holder can be locked for positioning at different phantom sections (left head, right head, flat).

Note: A simulating human hand is not used due to the complex anatomical and geometrical structure of the hand that may produce infinite number of configurations. To produce the worst-case condition (the hand absorbs antenna output power), the hand is omitted during the tests.



Figure F.6.1 Mounting Device

## F.7 Automated Test System Specifications

### Positioner

<b>Robot</b>	Stäubli Unimation Corp. Robot Model: TX90XL/ TX60L
<b>Repeatability</b>	0.02 mm
<b>No. of axis</b>	6

### Data Acquisition Electronic (DAE) System

#### Cell Controller

<b>Processor</b>	Intel Core i7-3770/Intel Core i7-4770
<b>Clock Speed</b>	3.40 GHz
<b>Operating System</b>	Windows 7 Professional
<b>Data Card</b>	DASY5 PC-Board

#### Data Converter

<b>Features</b>	Signal, multiplexer, A/D converter. & control logic
<b>Software</b>	DASY5
<b>Connecting Lines</b>	Optical downlink for data and status info Optical uplink for commands and clock

#### PC Interface Card

<b>Function</b>	24 bit (64 MHz) DSP for real time processing Link to DAE 4 16 bit A/D converter for surface detection system serial link to robot direct emergency stop output for robot
-----------------	--

#### E-Field Probes

<b>Model</b>	EX3DV4 S/N: 3916/ EX3DV4 S/N: 3933/ EX3DV4 S/N: 3930
<b>Construction</b>	Triangular core fiber optic detection system
<b>Frequency</b>	10 MHz to 6 GHz
<b>Linearity</b>	$\pm 0.2$ dB (30 MHz to 6 GHz)

#### Phantom

<b>Phantom</b>	SAM Twin Phantom (V5.0)
<b>Shell Material</b>	Composite
<b>Thickness</b>	$2.0 \pm 0.2$ mm



Figure F.7.1 DASY5 Test System