



# TEST REPORT



**DT&C Co., Ltd.**

42, Yurim-ro, 154Beon-gil, Cheoin-gu, Yongin-si, Gyeonggi-do, Korea, 17042  
Tel : 031-321-2664, Fax : 031-321-1664

1. Report No : DRTFCC1808-0196
2. Customer
  - Name : LG Electronics USA, Inc.
  - Address : 1000 Sylvan Ave. Englewood Cliffs, New Jersey, United States 07632
3. Use of Report : FCC Original Grant
4. Product Name / Model Name : Mobile Phone / SS1805  
FCC ID : ZNFSS1805
5. Test Method Used : KDB971168 D01v03, ANSI/TIA-603-E-2016, ANSI C63.26-2015  
Test Specification : §2, §24(E)
6. Date of Test : 2018.07.09 ~ 2018.07.27
7. Testing Environment : Refer to appended test report.
8. Test Result : Refer to the attached test result.

Affirmation	Tested by	Reviewed by
	Name : SunGeun Lee  (Signature)	Name : Geunki Son  (Signature)

The test results presented in this test report are limited only to the sample supplied by applicant and the use of this test report is inhibited other than its purpose. This test report shall not be reproduced except in full, without the written approval of DT&C Co., Ltd.

2018 . 08 . 08 .

**DT&C Co., Ltd.**

If this report is required to confirmation of authenticity, please contact to [report@dtnc.net](mailto:report@dtnc.net)

## Test Report Version

Test Report No.	Date	Description
DRTFCC1808-0196	Aug. 08, 2018	Initial issue

# Table of Contents

- 1. GENERAL INFORMATION ..... 4**
- 2. INTRODUCTION ..... 5**
  - 2.1 EUT DESCRIPTION ..... 5
  - 2.2. EUT CAPABILITIES..... 5
  - 2.3. TESTING ENVIRONMENT..... 5
  - 2.4 MEASURING INSTRUMENT CALIBRATION..... 5
  - 2.5. MEASUREMENT UNCERTAINTY ..... 5
  - 2.6. TEST FACILITY..... 5
- 3. DESCRIPTION OF TESTS..... 6**
  - 3.1 ERP & EIRP (Effective Radiated Power & Equivalent Isotropic Radiated Power) ..... 6
  - 3.2 PEAK TO AVERAGE RATIO ..... 8
  - 3.3 OCCUPIED BANDWIDTH..... 9
  - 3.4 BAND EDGE EMISSIONS AT ANTENNA TERMINAL ..... 10
  - 3.5 SPURIOUS AND HARMONIC EMISSIONS AT ANTENNA TERMINAL ..... 11
  - 3.6 UNDESIRABLE EMISSIONS..... 12
  - 3.7 FREQUENCY STABILITY ..... 13
- 4. LIST OF TEST EQUIPMENT..... 14**
- 5. SUMMARY OF TEST RESULTS ..... 15**
- 6. SAMPLE CALCULATION ..... 16**
- 7. TEST DATA ..... 18**
  - 7.1 OCCUPIED BANDWIDTH..... 18
  - 7.2 PEAK TO AVERAGE RATIO ..... 18
  - 7.3 BAND EDEG EMISSIONS (Conducted)..... 18
  - 7.4 SPURIOUS AND HARMONICS EMISSIONS (Conducted)..... 18
  - 7.5 EIRP ..... 19
    - 7.5.1 LTE Band 2..... 19
  - 7.6 UNDESIRABLE EMISSIONS (Radiated) ..... 20
    - 7.6.1 LTE Band 2..... 20
  - 7.7 FREQUENCY STABILITY ..... 23
    - 7.7.1 LTE Band 2..... 23
- 8. TEST PLOTS..... 24**
  - 8.1 OCCUPIED BANDWIDTH..... 24
    - 8.1.1 LTE Band 2..... 24
  - 8.2 PEAK TO AVERAGE RATIO ..... 30
    - 8.2.1 LTE Band 2..... 30
  - 8.3 BAND EDGE EMISSIONS(Conducted)..... 36
    - 8.3.1 LTE Band 2..... 36
  - 8.4 SPURIOUS AND HARMONICS EMISSIONS(Conducted)..... 48
    - 8.4.1 LTE Band 2..... 48

## 1. GENERAL INFORMATION

**Applicant Name** : LG Electronics USA, Inc.  
**Address** : 1000 Sylvan Ave. Englewood Cliffs, New Jersey, United States 07632  
**FCC ID** : ZNFSS1805  
**FCC Classification** : PCS Licensed Transmitter held to ear (PCE)  
**EUT Type** : Mobile Phone  
**Model Name** : SS1805  
**Add Model Name** : NA  
**Supplying power** : DC 3.85 V  
**Antenna Information** : PIFA Antenna

Mode	TX Frequency (MHz)	Emission Designator	Modulation	EIRP	
				Max power(dBm)	Max power(W)
LTE Band 2	1860 ~ 1900	17M9G7D	QPSK	20.56	0.114
LTE Band 2	1860 ~ 1900	17M9W7D	16QAM	20.39	0.109
LTE Band 2	1857.5 ~ 1902.5	13M4G7D	QPSK	20.49	0.112
LTE Band 2	1857.5 ~ 1902.5	13M4W7D	16QAM	19.96	0.099
LTE Band 2	1855 ~ 1905	8M96G7D	QPSK	20.43	0.110
LTE Band 2	1855 ~ 1905	8M94W7D	16QAM	19.66	0.092
LTE Band 2	1852.5 ~ 1907.5	4M49G7D	QPSK	20.07	0.102
LTE Band 2	1852.5 ~ 1907.5	4M48W7D	16QAM	19.73	0.094
LTE Band 2	1851.5 ~ 1908.5	2M69G7D	QPSK	19.82	0.096
LTE Band 2	1851.5 ~ 1908.5	2M69W7D	16QAM	19.34	0.086
LTE Band 2	1850.7 ~ 1909.3	1M09G7D	QPSK	19.72	0.094
LTE Band 2	1850.7 ~ 1909.3	1M10W7D	16QAM	19.04	0.080

## 2. INTRODUCTION

### 2.1 EUT DESCRIPTION

The Equipment Under Test (EUT) supports GSM/WCDMA/LTE Phone with Bluetooth, WLAN.

### 2.2. EUT CAPABILITIES

This EUT contains the following capabilities:

850/1900 GSM, 1700/1900 WCDMA/HSUPA, LTE Band 2, 802.11b/g/n WLAN(2.4GHz)  
802.11a/n/ac WLAN(5GHz), Bluetooth(BDR, EDR, LE).

### 2.3. TESTING ENVIRONMENT

Ambient Condition	
▪ Temperature	+20 °C ~ +28 °C
▪ Relative Humidity	40 % ~ 48 %

### 2.4 MEASURING INSTRUMENT CALIBRATION

The measuring equipment, which was utilized in performing the tests documented herein, has been calibrated in accordance with the manufacturer's recommendations for utilizing calibration equipment, which is traceable to recognized national standards.

### 2.5. MEASUREMENT UNCERTAINTY

The measurement uncertainties shown below were calculated in accordance with requirements of ANSI C63.4-2014. All measurement uncertainty values are shown with a coverage factor of  $k = 2$  to indicate a 95 % level of confidence.

Parameter	Measurement uncertainty
Radiated Disturbance (Below 1 GHz)	5.1 dB (The confidence level is about 95 %, $k = 2$ )
Radiated Disturbance (1 GHz ~ 18 GHz)	5.4 dB (The confidence level is about 95 %, $k = 2$ )
Radiated Disturbance (Above 18 GHz)	5.3 dB (The confidence level is about 95 %, $k = 2$ )

### 2.6. TEST FACILITY

<b>DT&amp;C Co., Ltd.</b>		
The 3 m test site and conducted measurement facility used to collect the radiated data are located at the 42, Yurim-ro, 154beon-gil, Cheoin-gu, Yongin-si, Gyeonggi-do, Korea 17042. The test site complies with the requirements of § 2.948 according to ANSI C63.4-2014.		
<b>- FCC MRA Accredited Test Firm No. : KR0034</b>		
<a href="http://www.dtnet.net">www.dtnet.net</a>		
Telephone	:	+ 82-31-321-2664
FAX	:	+ 82-31-321-1664

### 3. DESCRIPTION OF TESTS

#### 3.1 ERP & EIRP (Effective Radiated Power & Equivalent Isotropic Radiated Power)

##### Test Set-up

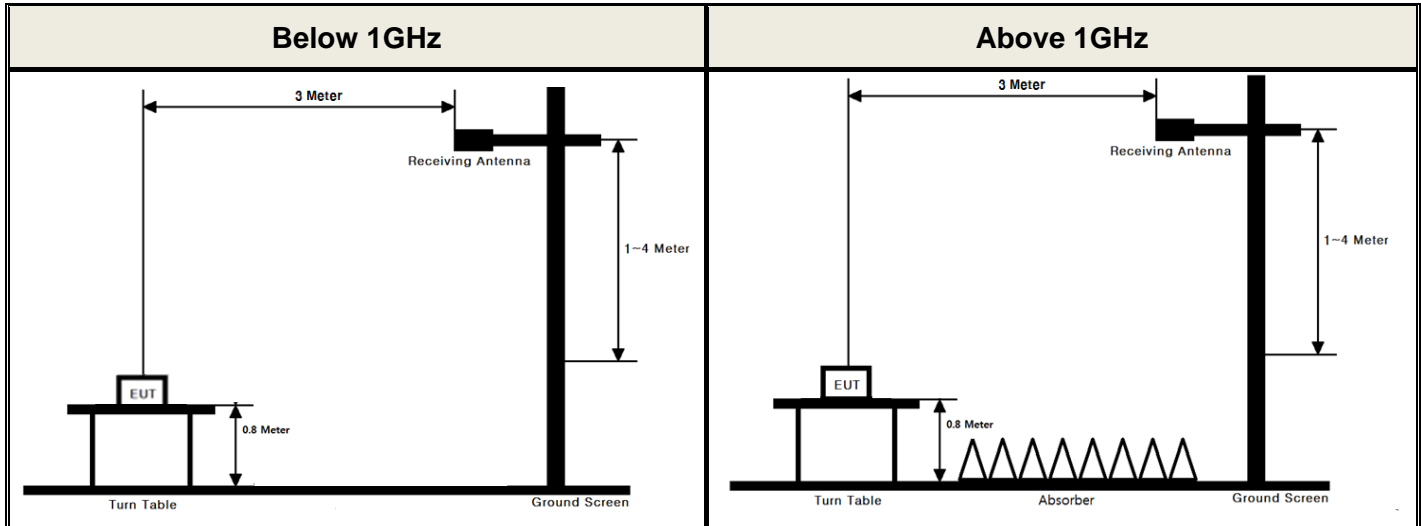

These measurements were performed at 3 m test site. The equipment under test is placed on a non-conductive table 0.8-meters above a turntable which is flush with the ground plane and 3 meters from the receive antenna. For measurements above 1GHz absorbers are placed on the floor between the turn table and the antenna mast in such a way so as to maximize the reduction of reflections. For measurements below 1 GHz, the absorbers are removed.

##### Test Procedure

- ANSI/TIA-603-E-2016 - Section 2.2.17
- KDB971168 D01v03 - Section 5.2.2
- ANSI C63.26-2015 – Section 5.2.4.4.1

##### Test setting

1. Set span to 2 x to 3 x the OBW.
2. Set RBW = 1% to 5% of the OBW.
3. Set VBW  $\geq$  3 x RBW.
4. Set number of points in sweep  $\geq$  2 x span / RBW.
5. Sweep time:
  - 1) Set = auto-couple, or
  - 2) Set  $\geq$  [10 x (number of points in sweep) x (transmission period)] for single sweep (automation-compatible) measurement. Transmission period is the on and off time of the transmitter.
6. Detector = power averaging (rms).
7. If the EUT can be configured to transmit continuously, then set the trigger to free run.
8. If the EUT cannot be configured to transmit continuously, then use a sweep trigger with the level set to enable triggering only on full power bursts and configure the EUT to transmit at full power for the entire duration of each sweep. Verify that the sweep time is less than or equal to the transmission burst duration. Time gating can also be used under similar constraints (i.e., configured such that measurement data is collected only during active full-power transmissions).
9. Trace average at least 100 traces in power averaging (rms) mode if sweep is set to auto-couple. To accurately determine the average power over multiple symbols, it can be necessary to increase the number of traces to be averaged above 100 or, if using a manually configured sweep time, increase the sweep time.

10. Compute the power by integrating the spectrum across the OBW of the signal using the instrument's band or channel power measurement function, with the band/channel limits set equal to the OBW band edges. If the instrument does not have a band or channel power function, then sum the spectrum levels (in linear power units) at intervals equal to the RBW extending across the entire OBW of the spectrum.

The receiver antenna height and turntable rotations were adjusted for the highest reading on the receive spectrum analyzer.

A half-wave dipole was substituted in place of the EUT. This dipole antenna was driven by a signal generator and the level of the signal generator was adjusted to obtain the same receive spectrum analyzer reading. The conducted power at the terminal of the substitute antenna is measured.

The ERP/EIRP is calculated using the following formula:

**ERP/EIRP = The conducted power at the substitute antenna's terminal [dBm] + Substitute Antenna gain [dBd for ERP, dBi for EIRP]**

For readings above 1 GHz, the above procedure is repeated using horn antennas and the difference between the gain of the horn antenna and an isotropic antenna are taken into consideration.

This measurement was performed with the EUT oriented in 3 orthogonal axis.

## 3.2 PEAK TO AVERAGE RATIO

### Test set-up

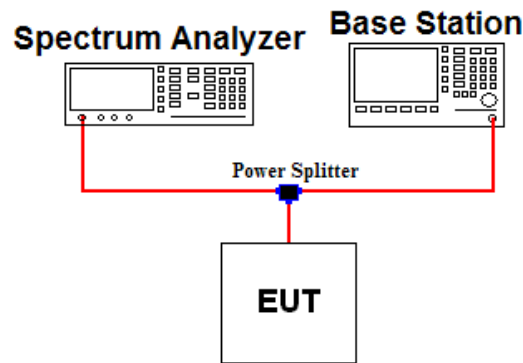

### Test Procedure

- KDB971168 D01v03 - Section 5.7.2
- ANSI C63.26-2015 – Section 5.2.3.4

A peak to average ratio measurement is performed at the conducted port of the EUT.

The spectrum analyzers Complementary Cumulative Distribution Function (CCDF) measurement profile is used to determine the largest deviation between the average and the peak power of the EUT in a given bandwidth. The CCDF curve shows how much time the peak waveform spends at or above a given average power level. The present of time the signal spends at or above the level defines the probability for that particular power level.

### Test setting

The spectrum Analyzer's CCDF measurement function is enabled.

1. Set resolution/measurement bandwidth  $\geq$  OBW or specified reference bandwidth.
2. Set the number of counts to a value that stabilizes the measured CCDF curve.
3. Set the measurement interval as follows:
  - 1) For continuous transmissions, set to the greater of  $[10 \times (\text{number of points in sweep}) \times (\text{transmission symbol period})]$  or 1 ms.
  - 2) For burst transmissions, employ an external trigger that is synchronized with the EUT burst timing sequence, or use the internal burst trigger with a trigger level that allows the burst to stabilize. Set the measurement interval to a time that is less than or equal to the burst duration.
  - 3) If there are several carriers in a single antenna port, the peak power shall be determined for each individual carrier (by disabling the other carriers while measuring the required carrier) and the total peak power calculated from the sum of the individual carrier peak powers.
4. Record the maximum PAPR level associated with a probability of 0.1%.
5. The peak power level is calculated from the sum of the PAPR value from step d) to the measured average power.



### 3.3 OCCUPIED BANDWIDTH.

#### Test set-up

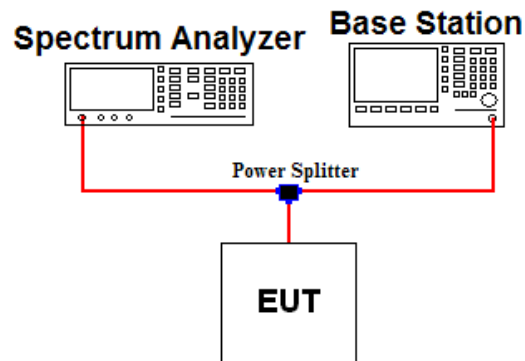

#### Test Procedure

- KDB971168 D01v03 - Section 4.3
- ANSI C63.26-2015 – Section 5.4.4

The occupied bandwidth, that is the frequency bandwidth such that, below its lower and above its upper frequency limits, the mean powers radiated are each equal to 0.5 percent of the total mean power of a given emission.

#### Test setting

1. The signal analyzer's automatic bandwidth measurement capability was used to perform the 99 % occupied bandwidth and the 26 dB bandwidth. The bandwidth measurement was not influenced by any intermediate power nulls in the fundamental emission.
2.  $RBW = 1 \sim 5 \%$  of the expected OBW &  $VBW \geq 3 \times RBW$
3. Detector = Peak
4. Trance mode = Max hold
5. Sweep = Auto couple
6. The trace was allowed to stabilize
7. If necessary, step 2 ~ 6 were repeated after changing the RBW such that it would be within 1 ~ 5 % of the 99 % occupied bandwidth observed in step 6.

### 3.4 BAND EDGE EMISSIONS AT ANTENNA TERMINAL

#### Test set-up

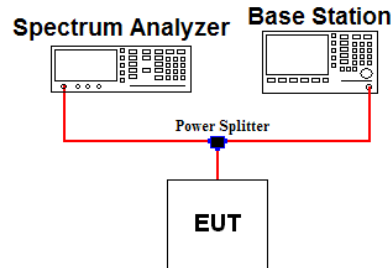

#### Test Procedure

- KDB971168 D01v03 - Section 6
- ANSI C63.26-2015 – Section 5.7

All out of band emissions are measured by means of a calibrated spectrum analyzer. The EUT was setup to maximum output power at its lowest and highest channel with all bandwidths, modulations and RB configurations.

The power of any spurious emission shall be attenuated below the transmitter power (P) by at least  $43 + 10 \log(P)$  dB.

#### Test setting

1. Start and stop frequency were set such that the band edge would be placed in the center of the plot
2. Span was set large enough so as to capture all out of band emissions near the band edge
3. RBW  $\geq 1\%$  of the emission bandwidth
4. VBW  $\geq 3 \times$  RBW
5. Detector = RMS & Trace mode = Max hold
6. Sweep time = Auto couple or 1 s for band edge
7. Number of sweep point  $\geq 2 \times$  span / RBW
8. The trace was allowed to stabilize

Note 1: Per Part 22.917(b)(1) / 24.238(b) / 27.53(h) in the 1 MHz bands immediately outside and adjacent to the frequency block a resolution bandwidth of at least one percent of the emission bandwidth of the fundamental emission of the transmitter may be employed to demonstrate compliance with the out-of-band emissions limit. The emission bandwidth is defined as the width of the signal between two points, one below the carrier center frequency and one above the carrier center frequency, outside of which all emission are attenuated at least 26 dB below the transmitter power.

### 3.5 SPURIOUS AND HARMONIC EMISSIONS AT ANTENNA TERMINAL

#### Test set-up

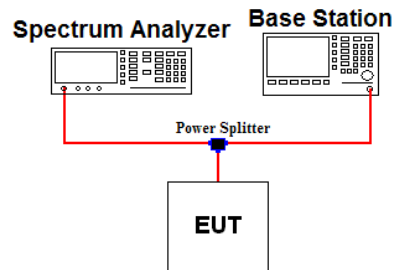

#### Test Procedure

- KDB971168 D01v03 - Section 6
- ANSI C63.26-2015 – Section 5.7

The level of the carrier and the various conducted spurious and harmonic frequencies is measured by means of a calibrated spectrum analyzer. The EUT was setup to maximum output power at its low, middle, high channel with all bandwidths, modulations and RB configurations. The spectrum is scanned from 9 kHz up to a frequency including its 10<sup>th</sup> harmonic.

The power of any spurious emission shall be attenuated below the transmitter power (P) by at least  $43 + 10 \log(P)$  dB.

#### Test setting

1. RBW = 100 kHz (Below 1 GHz) or 1 MHz (Above 1 GHz) & VBW  $\geq 3 \times$  RBW ( Refer to Note 1)
2. Detector = RMS & Trace mode = Max hold
3. Sweep time = Auto couple
4. Number of sweep point  $\geq 2 \times$  span / RBW
5. The trace was allowed to stabilize

Note 1: Compliance with these provisions is based on the use of measurement instrumentation employing a resolution bandwidth of 100 kHz or greater for frequencies less than 1GHz and 1MHz or greater for frequencies greater than 1GHz.

### 3.6 UNDESIRABLE EMISSIONS

#### Test Set-up

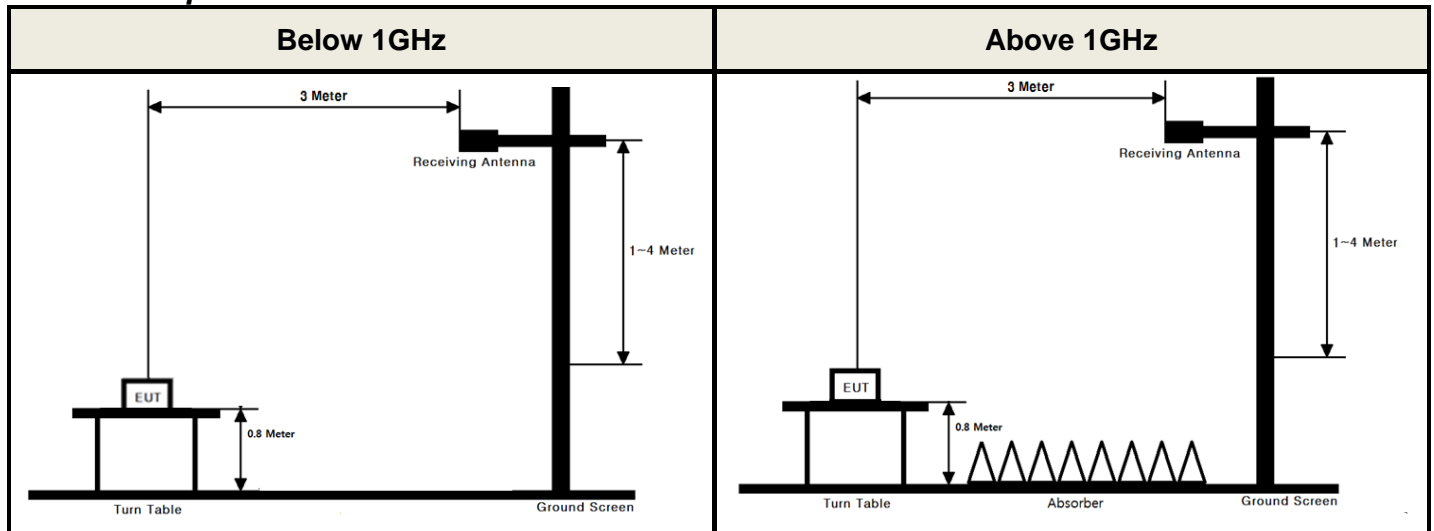

These measurements were performed at 3 test site. The equipment under test is placed on a non-conductive table 0.8-meters above a turntable which is flush with the ground plane and 3 meters from the receive antenna. For measurements above 1GHz absorbers are placed on the floor between the turn table and the antenna mast in such a way so as to maximize the reduction of reflections. For measurements below 1 GHz, the absorbers are removed.

#### Test Procedure

- ANSI/TIA-603-E-2016 - Section 2.2.12
- KDB971168 D01v03 - Section 5.8
- ANSI C63.26-2015 – Section 5.5

#### Test setting

1. RBW = 100 kHz for below 1 GHz and 1 MHz for above 1 GHz / VBW  $\geq 3 \times$  RBW
2. Detector = RMS & Trace mode = Max hold
3. Sweep time = Auto couple
4. Number of sweep point  $\geq 2 \times$  span / RBW
5. The trace was allowed to stabilize

The receive antenna height and turntable rotations were adjusted for the highest reading on the receive spectrum analyzer.

For radiated power measurements below 1 GHz, a half-wave dipole was substituted in place of the EUT. This dipole antenna was driven by a signal generator and the level of the signal generator was adjusted to obtain the same spectrum analyzer reading.

For radiated power measurements above 1 GHz, a Horn antenna was substituted in place of the EUT. This Horn antenna was driven by a signal generator and the level of the signal generator was adjusted to obtain the same spectrum analyzer reading. The difference between the gain of the horn and an isotropic antenna are taken into consideration.

This measurement was performed with the EUT oriented in 3 orthogonal axis.

### 3.7 FREQUENCY STABILITY

#### Test Set-up

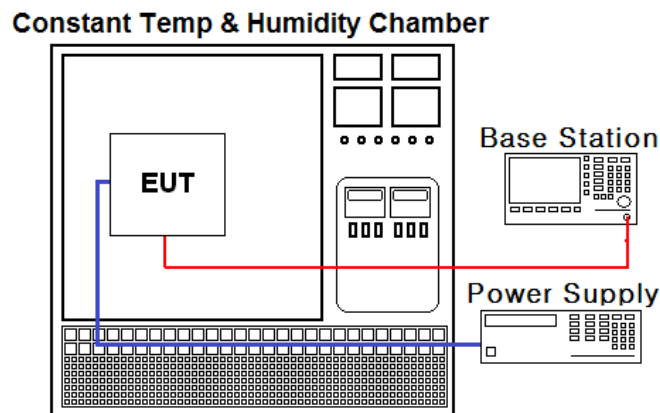

#### Test Procedure

- ANSI/TIA-603-E-2016
- KDB971168 D01v03 - Section 9

The frequency stability of the transmitter is measured by:

a.) **Temperature:**

The temperature is varied from - 30 °C to + 50 °C using an environmental chamber.

b.) **Primary Supply Voltage:**

The primary supply voltage is varied from 85 % to 115 % of the nominal value for non hand-carried battery and AC powered equipment. For hand-carried, battery-powered equipment, primary supply voltage is reduced to the battery operating end point which shall be specified by the manufacturer.

#### Specification:

The frequency stability shall be sufficient to ensure that the fundamental emission stays within the authorized frequency block for Part 24, 27. The frequency stability of the transmitter shall be maintained within  $\pm 0.00025\%$  ( $\pm 2.5$  ppm) of the center frequency for Part 22.

#### Time Period and Procedure:

1. The carrier frequency of the transmitter is measured at room temperature.  
(20 °C to provide a reference)
2. The equipment is turned on in a "standby" condition for one minute before applying power to the transmitter. Measurement of the carrier frequency of the transmitter is made within one minute after applying power to the transmitter.
3. Frequency measurements are made at 10 °C intervals ranging from -30 °C to +50 °C.  
A period of at least one half-hour is provided to allow stabilization of the equipment at each temperature level.

#### 4. LIST OF TEST EQUIPMENT

Type	Manufacturer	Model	Cal.Date (yy/mm/dd)	Next.Cal. Date (yy/mm/dd)	S/N
Spectrum Analyzer	Agilent Technologies	N9020A	18/07/09	19/07/09	MY48011075
Spectrum Analyzer	Agilent Technologies	N9020A	18/07/09	19/07/09	MY46471251
DC power supply	Agilent Technologies	66332A	18/07/02	19/07/02	US37473422
Multimeter	FLUKE	17B	17/12/26	18/12/26	26030065WS
Power Splitter	Anritsu	K241B	17/12/27	18/12/27	1301183
Temp & Humi Test Chamber	SJ Science	SJ-TH-S50	18/07/06	19/07/06	U5542113
Radio Communication Analyzer	Anritsu	MT8820C	17/09/07	18/09/07	6201127429
Thermohygrometer	BODYCOM	BJ5478	18/01/03	19/01/03	120612-2
Thermohygrometer	BODYCOM	BJ5478	18/01/03	19/01/03	120612-1
Signal Generator	Rohde Schwarz	SMBV100A	17/12/27	18/12/27	255571
Signal Generator	ANRITSU	MG3695C	18/02/12	19/02/12	173501
Loop Antenna	Schwarzbeck	FMZB1513	18/01/30	20/01/30	1513-128
Biglog Antenna	Schwarzbeck	VULB 9160	18/07/13	20/07/13	3359
HORN ANT	ETS	3117	18/05/10	20/05/10	00140394
HORN ANT	ETS	3117	18/03/26	20/03/26	00152145
HORN ANT	A.H.Systems	SAS-574	17/04/25	19/04/25	154
HORN ANT	A.H.Systems	SAS-574	17/07/31	19/07/31	155
Amplifier	EMPOWER	BBS3Q7ELU	17/09/06	18/09/06	1020
PreAmplifier	tsj	MLA-10K01-B01-27	18/01/11	19/01/11	2005354
PreAmplifier	Agilent	8449B	18/07/05	19/07/05	3008A02108
High-pass filter	Wainwright	WHKX12-2580-3000- 18000-80SS	18/07/05	19/07/05	3
High-pass filter	Wainwright	WHNX8.0/26.5-6SS	18/07/03	19/07/03	3
High-pass filter	Wainwright	WHNX8.5/26.5G- 6SS	18/07/03	19/07/03	1
Cable	DTNC	Cable	18/02/28	19/02/28	C-016-4
Cable	DTNC	Cable	18/02/28	19/02/28	RF-81
Cable	Radiall	TESTPRO3	18/02/28	19/02/28	RF-74
Cable	DTNC	Cable	18/02/28	19/02/28	RF-76
Cable	DTNC	Cable	18/02/28	19/02/28	RF-54
Cable	DTNC	Cable	18/02/28	19/02/28	RF-32

Note1: The measurement antennas were calibrated in accordance to the requirements of ANSI C63.5-2017.

Note2: The cable is not a regular calibration item, so it has been calibrated by DT & C itself.

## 5. SUMMARY OF TEST RESULTS

FCC Part Section(s)	Test Description	Test Limit	Test Condition	Status Note 1
2.1046	Conducted Output Power	N/A	Conducted	<b>C</b> Note2
2.1049	Occupied Bandwidth	N/A		<b>C</b>
24.232(d)	Peak to Average Ratio	< 13 dB		<b>C</b>
2.1051 24.238(a)	Band Edge / Conducted Spurious Emissions	> 43 + 10log <sub>10</sub> (P) dB at Band edge and for all out-of-band emissions		<b>C</b>
2.1055 24.235	Frequency Stability	Fundamental emissions must stay within Authorized frequency block		<b>C</b>
24.232(c)	Radiated Output Power (B2)	< 2 Watts max. EIRP	Radiated Note2	<b>C</b>
2.1053 24.238(a)	Undesirable Emissions	> 43 + 10log <sub>10</sub> (P) dB for all out-of-band emissions		<b>C</b>

Note 1: **C**=Comply    **NC**=Not Comply    **NT**=Not Tested    **NA**=Not Applicable  
 Note 2: Refer to RF exposure report.

## 6. SAMPLE CALCULATION

### A. Emission Designator

#### LTE Band 2(QPSK)

Emission Designator = **17M9G7D**

LTE OBW = 17.876 MHz

G = Phase Modulation

7 = Quantized/Digital Info

D = Data Transmission

#### LTE Band 2(16QAM)

Emission Designator = **17M9W7D**

LTE OBW = 17.919 MHz

W = Amplitude/Angle Modulated

7 = Quantized/Digital Info

D = Data Transmission



## B. For substitution method

Channel Bandwidth (MHz)	Test Frequency (MHz)	Test Mode	RB Size/ Offset	Spectrum Reading Value(dBm)	Ant Pol (H/V)	Level(dBm) @ Ant Terminal	TX Ant Gain (dBi)	EIRP (dBm)	EIRP (W)
20	1720	QPSK	1/0	-26.44	H	15.76	4.80	20.56	0.114

### ERP or EIRP = Level @ Ant Terminal LEVEL(dBm) + Tx Ant. Gain

- 1) The EUT mounted on a non-conductive turntable is 0.8 meter above test site ground level.
- 2) During the test, the turn table is rotated until the maximum signal is found.
- 3) Record the field strength meter's level.
- 4) Replace the EUT with dipole/Horn antenna that is connected to a calibrated signal generator.
- 5) Increase the signal generator output till the field strength meter's level is equal to the item (3).
- 6) The signal generator output level with substituted antenna gain is the rating of ERP, EIRP or Radiated spurious emission.

## 7. TEST DATA

### 7.1 OCCUPIED BANDWIDTH

- Plots of the EUT's Occupied Bandwidth are shown in Clause 8.1

### 7.2 PEAK TO AVERAGE RATIO

- Plots of the EUT's Peak- to- Average Ratio are shown in Clause 8.2

### 7.3 BAND EDGE EMISSIONS (Conducted)

- Plots of the EUT's Band Edge Emissions are shown in Clause 8.3

### 7.4 SPURIOUS AND HARMONICS EMISSIONS (Conducted)

- Plots of the EUT's Spurious Emissions are shown in Clause 8.4

## 7.5 EIRP

### 7.5.1 LTE Band 2

Channel Bandwidth (MHz)	Test Frequency (MHz)	Test Mode	RB Size/ Offset	Ant Pol (H/V)	Level(dBm) @ Ant Terminal	TX Ant Gain (dBi)	EIRP (dBm)	EIRP (W)
20	1860	QPSK	1/50	H	14.23	4.91	19.14	0.082
		16QAM	1/50	H	13.81	4.91	18.72	0.074
	1880	QPSK	1/50	H	15.76	4.80	20.56	0.114
		16QAM	1/50	H	15.59	4.80	20.39	0.109
	1900	QPSK	1/50	H	14.06	4.69	18.75	0.075
		16QAM	1/50	H	13.50	4.69	18.19	0.066
15	1857.5	QPSK	1/0	H	15.49	4.92	20.41	0.110
		16QAM	1/0	H	14.74	4.92	19.66	0.092
	1880	QPSK	1/0	H	15.69	4.80	20.49	0.112
		16QAM	1/0	H	15.16	4.80	19.96	0.099
	1902.5	QPSK	1/0	H	13.96	4.68	18.64	0.073
		16QAM	1/0	H	13.58	4.68	18.26	0.067
10	1855	QPSK	1/25	H	14.54	4.94	19.48	0.089
		16QAM	1/25	H	14.09	4.94	19.03	0.080
	1880	QPSK	1/25	H	15.63	4.80	20.43	0.110
		16QAM	1/25	H	14.86	4.80	19.66	0.092
	1905	QPSK	1/25	H	13.88	4.67	18.55	0.072
		16QAM	1/25	H	13.50	4.67	18.17	0.066
5	1852.5	QPSK	1/12	H	14.40	4.95	19.35	0.086
		16QAM	1/12	H	14.03	4.95	18.98	0.079
	1880	QPSK	1/12	H	15.27	4.80	20.07	0.102
		16QAM	1/12	H	14.93	4.80	19.73	0.094
	1907.5	QPSK	1/12	H	14.10	4.65	18.75	0.075
		16QAM	1/12	H	13.73	4.65	18.38	0.069
3	1851.5	QPSK	1/0	H	14.78	4.95	19.73	0.094
		16QAM	1/0	H	14.16	4.95	19.11	0.081
	1880	QPSK	1/0	H	15.02	4.80	19.82	0.096
		16QAM	1/0	H	14.54	4.80	19.34	0.086
	1908.5	QPSK	1/0	H	14.17	4.65	18.82	0.076
		16QAM	1/0	H	13.69	4.65	18.34	0.068
1.4	1850.7	QPSK	1/2	H	14.72	4.96	19.68	0.093
		16QAM	1/2	H	14.01	4.96	18.97	0.079
	1880	QPSK	1/2	H	14.92	4.80	19.72	0.094
		16QAM	1/2	H	14.23	4.80	19.03	0.080
	1909.3	QPSK	1/2	H	14.92	4.64	19.56	0.090
		16QAM	1/2	H	14.40	4.64	19.04	0.080

Note: This device was tested under all bandwidths, modulations and RB configurations and the worst case data are reported in the table above.

## 7.6 UNDESIRABLE EMISSIONS (Radiated)

### 7.6.1 LTE Band 2

B.W (MHz)	Test Freq. (MHz)	RB Size/Offset	Test Mode	Freq.(MHz)	Ant Pol (H/V)	Level(dBm) @ Ant Terminal	TX Ant Gain(dBi)	Result		Limit (dBc)
								(dBm)	(dBc)	
20	1860	1/50	QPSK	3719.87	V	-53.36	8.39	-44.97	64.11	32.14
				5580.40	V	-50.84	10.51	-40.33	59.47	
				7440.41	V	-49.84	11.75	-38.09	57.23	
			16QAM	3719.65	V	-53.62	8.39	-45.23	63.95	31.72
				5580.37	V	-50.73	10.51	-40.22	58.94	
				7440.94	V	-49.83	11.75	-38.08	56.80	
	1880	1/50	QPSK	3760.09	V	-53.86	8.36	-45.50	66.06	33.56
				5640.34	V	-49.28	10.64	-38.64	59.20	
				7520.12	V	-48.69	11.94	-36.75	57.31	
			16QAM	3759.86	V	-53.93	8.36	-45.57	65.96	33.39
				5640.39	V	-49.66	10.64	-39.02	59.41	
				7520.34	V	-48.74	11.94	-36.80	57.19	
	1900	1/50	QPSK	3800.16	V	-54.40	8.22	-46.18	64.93	31.75
				5700.35	V	-49.90	10.74	-39.16	57.91	
				7600.77	V	-50.25	12.14	-38.11	56.86	
16QAM			3799.65	V	-53.09	8.22	-44.87	63.06	31.19	
			5700.20	V	-49.90	10.74	-39.16	57.35		
			7600.35	V	-49.74	12.14	-37.60	55.79		
15	1857.5	1/0	QPSK	3702.26	V	-53.78	8.38	-45.40	65.81	33.41
				5552.46	V	-50.99	10.42	-40.57	60.98	
				7403.32	V	-48.70	11.70	-37.00	57.41	
			16QAM	3702.56	V	-53.68	8.38	-45.30	64.96	32.66
				5552.18	V	-51.18	10.42	-40.76	60.42	
				7403.68	V	-48.69	11.70	-36.99	56.65	
	1880	1/0	QPSK	3746.50	V	-54.13	8.40	-45.73	66.22	33.49
				5619.78	V	-49.70	10.61	-39.09	59.58	
				7493.24	V	-48.30	11.90	-36.40	56.89	
			16QAM	3746.55	V	-54.32	8.40	-45.92	65.88	32.96
				5619.24	V	-49.55	10.61	-38.94	58.90	
				7493.05	V	-48.28	11.90	-36.38	56.34	
	1902.5	1/0	QPSK	3791.14	V	-54.26	8.25	-46.01	64.65	31.64
				5687.77	V	-48.81	10.72	-38.09	56.73	
				7583.33	V	-44.88	12.09	-32.79	51.43	
16QAM			3791.65	V	-54.39	8.25	-46.14	64.40	31.26	
			5687.92	V	-48.88	10.72	-38.16	56.42		
			7583.19	V	-44.97	12.09	-32.88	51.14		

Note 1: Limit Calculation =  $43 + 10\log_{10}(P[\text{Watts}])$

Note 2: This device was tested under all bandwidths, modulations and RB configurations and the worst case data are reported in the table above.

Note 3: The frequency spectrum is examined from 9 kHz to the 10th harmonic of the fundamental frequency of the transmitter. No other spurious and harmonic emissions were reported greater than listed emissions above table.

B.W (MHz)	Test Freq. (MHz)	RB Size/ Offset	Test Mode	Freq.(MHz)	Ant Pol (H/V)	Level(dBm) @ Ant Terminal	TX Ant Gain(dBi)	Result		Limit (dBc)
								(dBm)	(dBc)	
10	1855	1/25	QPSK	3710.43	V	-54.03	8.38	-45.65	65.13	32.48
				5565.13	V	-51.62	10.46	-41.16	60.64	
				7420.21	V	-49.07	11.72	-37.35	56.83	
			16QAM	3711.05	V	-53.95	8.38	-45.57	64.60	32.03
				5565.38	V	-51.57	10.46	-41.11	60.14	
				7420.47	V	-49.34	11.72	-37.62	56.65	
	1880	1/25	QPSK	3760.32	V	-53.21	8.36	-44.85	65.28	33.43
				5640.50	V	-49.75	10.64	-39.11	59.54	
				7520.28	V	-49.40	11.94	-37.46	57.89	
			16QAM	3760.95	V	-53.29	8.36	-44.93	64.59	32.66
				5640.18	V	-49.61	10.64	-38.97	58.63	
				7520.54	V	-49.57	11.94	-37.63	57.29	
	1905	1/25	QPSK	3810.32	V	-54.39	8.22	-46.17	64.72	31.55
				5715.38	V	-49.50	10.73	-38.77	57.32	
				7620.55	V	-44.10	12.16	-31.94	50.49	
16QAM			3810.64	V	-54.40	8.22	-46.18	64.35	31.17	
			5715.25	V	-49.58	10.73	-38.85	57.02		
			7620.76	V	-44.12	12.16	-31.96	50.13		
5	1852.5	1/12	QPSK	3704.98	V	-54.16	8.38	-45.78	65.13	32.35
				5557.49	V	-51.29	10.44	-40.85	60.20	
				7410.09	V	-49.58	11.71	-37.87	57.22	
			16QAM	3705.11	V	-54.19	8.38	-45.81	64.79	31.98
				5557.36	V	-51.18	10.44	-40.74	59.72	
				7410.65	V	-49.90	11.71	-38.19	57.17	
	1880	1/12	QPSK	3760.22	V	-53.93	8.36	-45.57	65.64	33.07
				5639.96	V	-49.38	10.64	-38.74	58.81	
				7519.76	V	-48.34	11.94	-36.40	56.47	
			16QAM	3760.35	V	-54.12	8.36	-45.76	65.49	32.73
				5639.42	V	-49.47	10.64	-38.83	58.56	
				7519.49	V	-48.25	11.94	-36.31	56.04	
	1907.5	1/12	QPSK	3814.95	V	-54.14	8.22	-45.92	64.67	31.75
				5722.61	V	-49.20	10.73	-38.47	57.22	
				7629.80	V	-44.38	12.17	-32.21	50.96	
16QAM			3814.72	V	-54.03	8.22	-45.81	64.19	31.38	
			5722.48	V	-49.26	10.73	-38.53	56.91		
			7629.45	V	-44.43	12.17	-32.26	50.64		

Note 1: Limit Calculation =  $43 + 10\log_{10}(P[\text{Watts}])$

Note 2: This device was tested under all bandwidths, modulations and RB configurations and the worst case data are reported in the table above.

Note 3: The frequency spectrum is examined from 9 kHz to the 10th harmonic of the fundamental frequency of the transmitter. No other spurious and harmonic emissions were reported greater than listed emissions above table.

B.W (MHz)	Test Freq. (MHz)	RB Size/ Offset	Test Mode	Freq.(MHz)	Ant Pol (H/V)	Level(dBm) @ Ant Terminal	TX Ant Gain(dBi)	Result		Limit (dBc)
								(dBm)	(dBc)	
3	1851.5	1/0	QPSK	3700.44	V	-53.68	8.38	-45.30	65.03	32.73
				5550.81	V	-51.80	10.41	-41.39	61.12	
				7400.81	V	-48.84	11.70	-37.14	56.87	
			16QAM	3700.69	V	-53.91	8.38	-45.53	64.64	32.11
				5550.45	V	-51.74	10.41	-41.33	60.44	
				7400.46	V	-48.96	11.70	-37.26	56.37	
	1880	1/0	QPSK	3757.96	V	-53.50	8.37	-45.13	64.95	32.82
				5636.28	V	-50.22	10.64	-39.58	59.40	
				7514.89	V	-48.84	11.94	-36.90	56.72	
			16QAM	3757.75	V	-53.66	8.37	-45.29	64.63	32.34
				5636.20	V	-50.16	10.64	-39.52	58.86	
				7514.62	V	-48.72	11.94	-36.78	56.12	
	1908.5	1/0	QPSK	3814.92	V	-54.49	8.22	-46.27	65.09	31.82
				5721.85	V	-49.66	10.73	-38.93	57.75	
				7629.04	V	-43.55	12.17	-31.38	50.20	
16QAM			3814.94	V	-54.54	8.22	-46.32	64.66	31.34	
			5721.15	V	-49.96	10.73	-39.23	57.57		
			7629.39	V	-43.46	12.17	-31.29	49.63		
1.4	1850.7	1/2	QPSK	3701.22	V	-54.48	8.38	-46.10	65.78	32.68
				5551.64	V	-50.67	10.42	-40.25	59.93	
				7402.42	V	-49.43	11.70	-37.73	57.41	
			16QAM	3701.34	V	-54.41	8.38	-46.03	65.00	31.97
				5551.43	V	-50.77	10.41	-40.36	59.33	
				7402.63	V	-49.48	11.70	-37.78	56.75	
	1880	1/2	QPSK	3759.27	V	-53.09	8.37	-44.72	64.44	32.72
				5640.05	V	-49.87	10.64	-39.23	58.95	
				7519.79	V	-49.38	11.94	-37.44	57.16	
			16QAM	3759.33	V	-53.07	8.37	-44.70	63.73	32.03
				5640.19	V	-49.93	10.64	-39.29	58.32	
				7519.45	V	-49.25	11.94	-37.31	56.34	
	1909.3	1/2	QPSK	3818.18	V	-54.34	8.22	-46.12	65.68	32.56
				5727.85	V	-50.10	10.72	-39.38	58.94	
				7636.83	V	-43.94	12.18	-31.76	51.32	
16QAM			3818.36	V	-54.53	8.22	-46.31	65.35	32.04	
			5727.42	V	-49.91	10.72	-39.19	58.23		
			7636.44	V	-44.02	12.18	-31.84	50.88		

Note 1: Limit Calculation =  $43 + 10\log_{10}(P[\text{Watts}])$

Note 2: This device was tested under all bandwidths, modulations and RB configurations and the worst case data are reported in the table above.

Note 3: The frequency spectrum is examined from 9 kHz to the 10th harmonic of the fundamental frequency of the transmitter. No other spurious and harmonic emissions were reported greater than listed emissions above table.

## 7.7 FREQUENCY STABILITY

### 7.7.1 LTE Band 2

OPERATING FREQUENCY : 1880 MHz  
 REFERENCE VOLTAGE : 3.85 VDC  
 LIMIT : The frequency stability shall be sufficient to ensure that the fundamental emission stays within the authorized frequency block.

VOLTAGE (%)	POWER (V DC)	TEMP (°C)	FREQUENCY (Hz)	FREQ.Dev (Hz)	Deviation	
					(ppm)	(%)
100%	3.85	+20(Ref)	1,879,999,995	-5	-0.0027	-0.000000266
100%		-30	1,879,999,999	-1	-0.0005	-0.000000053
100%		-20	1,880,000,008	8	0.0043	0.000000426
100%		-10	1,880,000,006	6	0.0032	0.000000319
100%		0	1,879,999,997	-3	-0.0016	-0.000000160
100%		+10	1,880,000,004	4	0.0021	0.000000213
100%		+20	1,879,999,995	-5	-0.0027	-0.000000266
100%		+30	1,880,000,007	7	0.0037	0.000000372
100%		+40	1,879,999,994	-6	-0.0032	-0.000000319
100%		+50	1,879,999,995	-5	-0.0027	-0.000000266
115%		4.43	+20	1,879,999,991	-9	-0.0048
BATT.ENDPOINT	3.60	+20	1,880,000,004	4	0.0021	0.000000213

**Note.** Based on the results of the frequency stability test at the center channel the frequency deviation results measured are very small. as such it is determined that the channels at the band edge would remain inband when the maximum measured frequency deviation noted during the frequency stability tests is applied. therefore the device is determined to remain operating in band over the temperature and voltage range as tested.

## 8. TEST PLOTS

Note: All bandwidths, RB configurations, and modulations were investigated.  
The worst case test results are reported.

### 8.1 OCCUPIED BANDWIDTH

#### 8.1.1 LTE Band 2

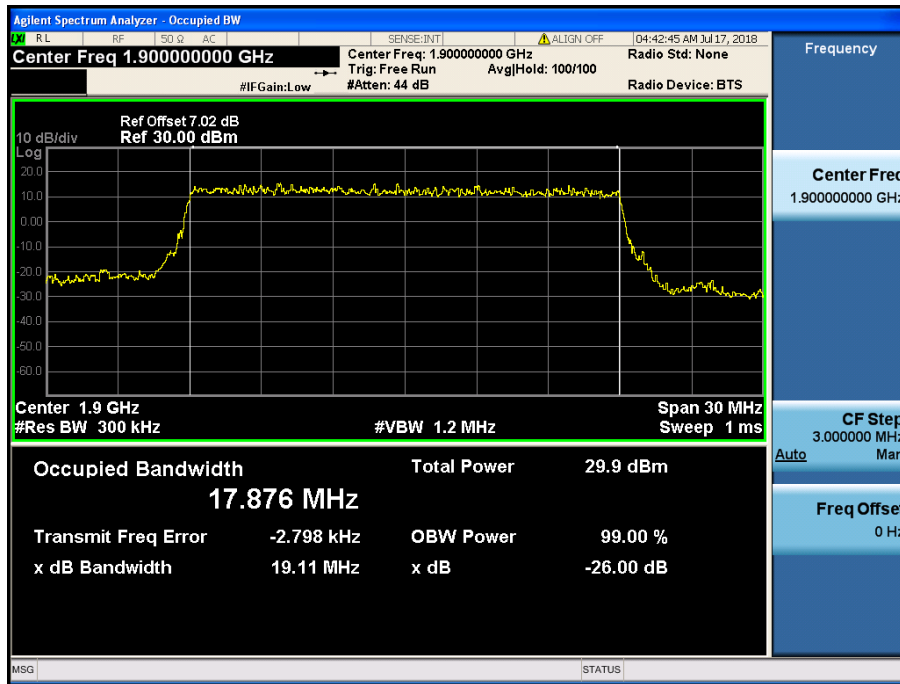

LTE Band 2 / 20 MHz / QPSK - RB Size 100

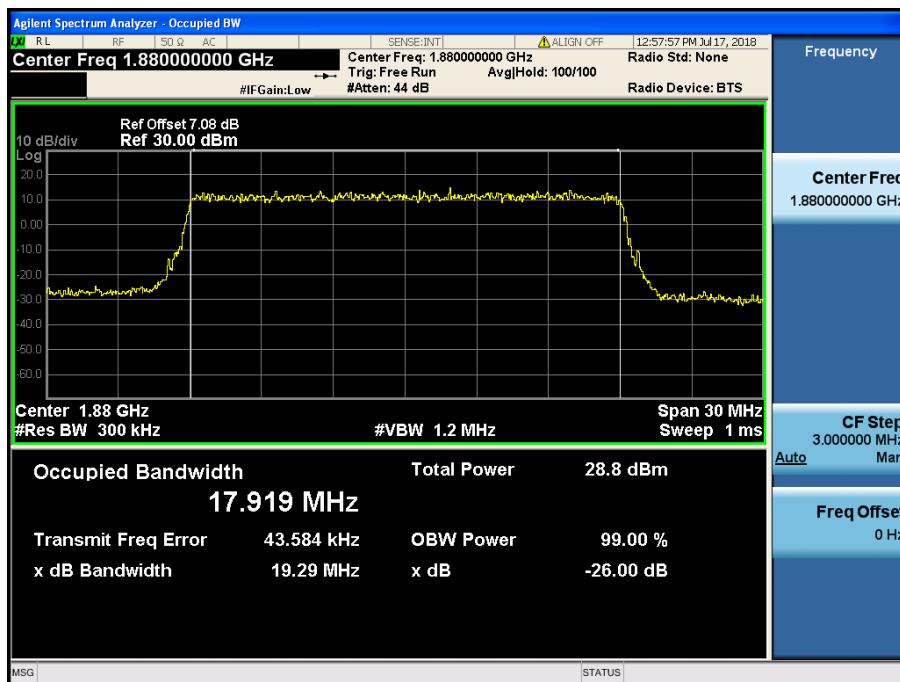

LTE Band 2 / 20 MHz / 16QAM - RB Size 100



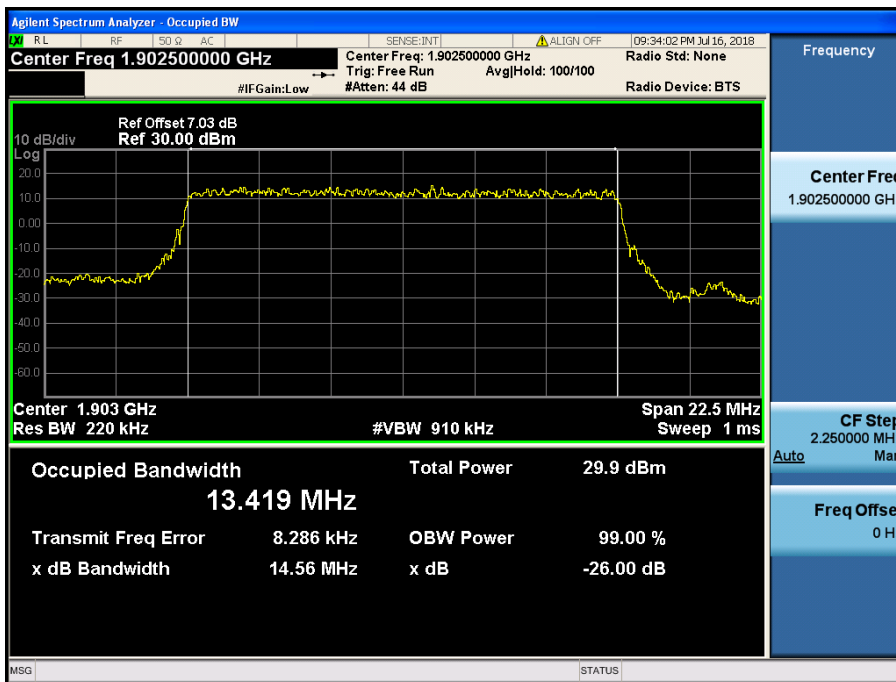

LTE Band 2 / 15 MHz / QPSK - RB Size 75

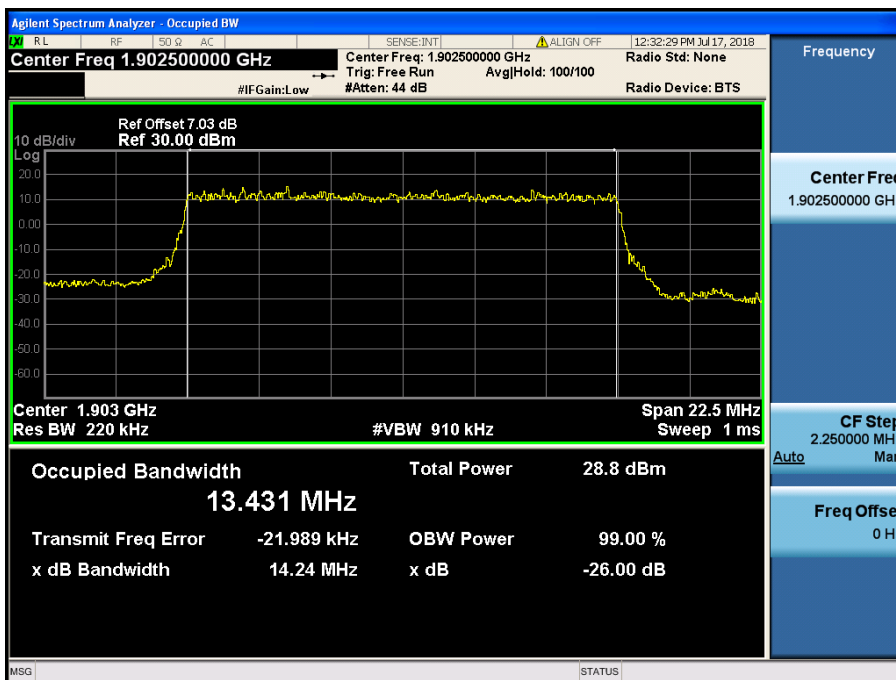

LTE Band 2 / 15 MHz / 16QAM - RB Size 75

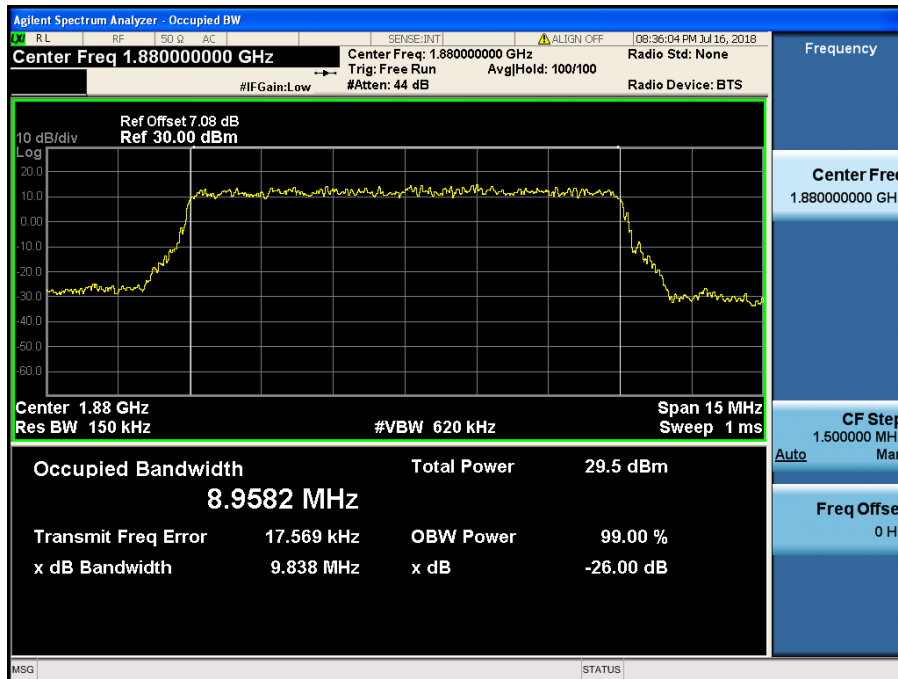

LTE Band 2 / 10 MHz / QPSK - RB Size 50

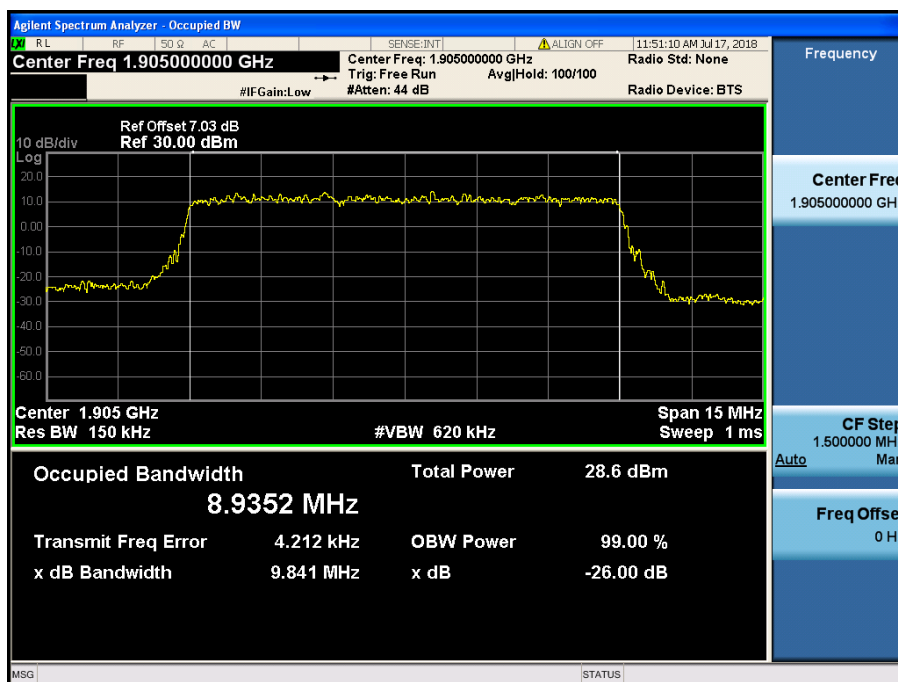

LTE Band 2 / 10 MHz / 16QAM - RB Size 50

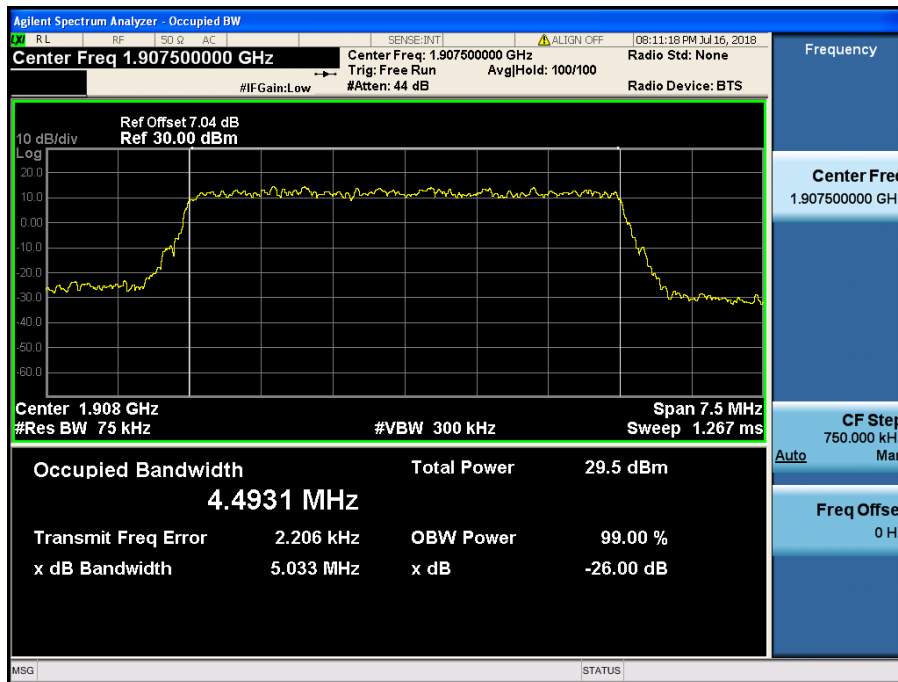

LTE Band 2 / 5 MHz / QPSK - RB Size 25

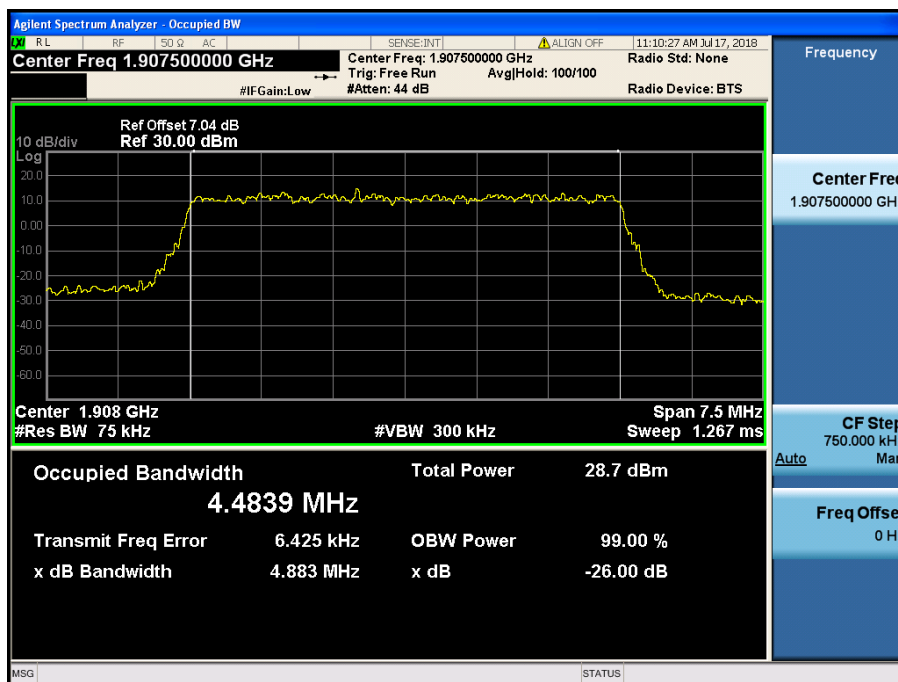

LTE Band 2 / 5 MHz / 16QAM - RB Size 25

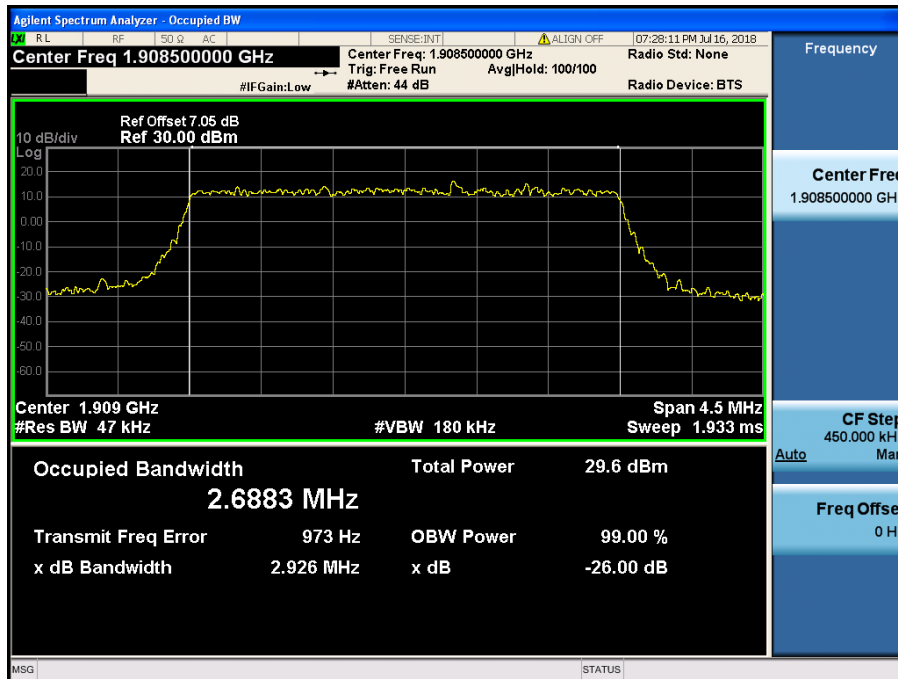

LTE Band 2 / 3 MHz / QPSK - RB Size 15

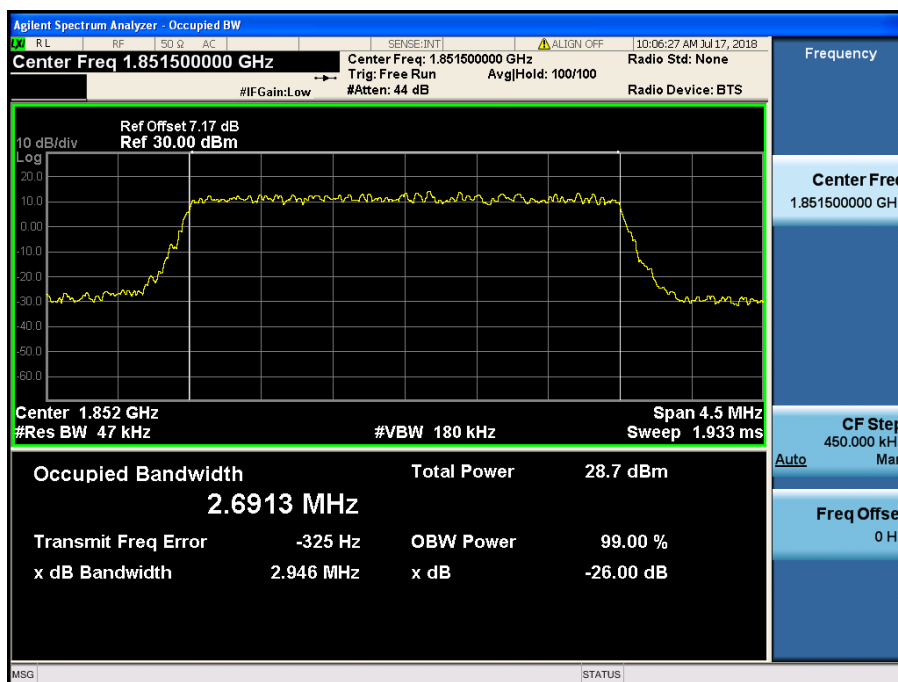

LTE Band 2 / 3 MHz / 16QAM - RB Size 15

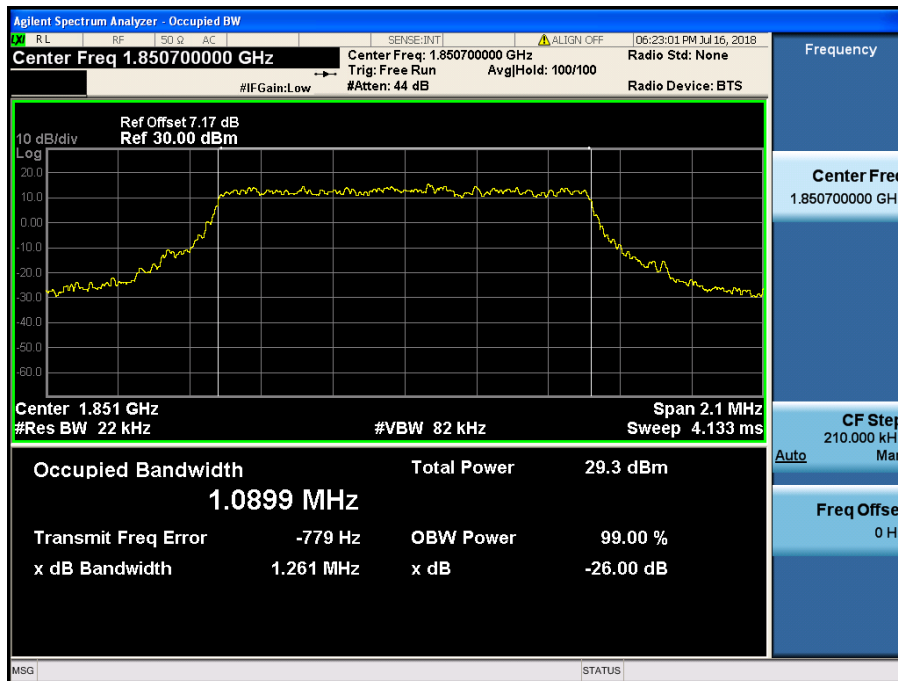

LTE Band 2 / 1.4 MHz / QPSK - RB Size 6

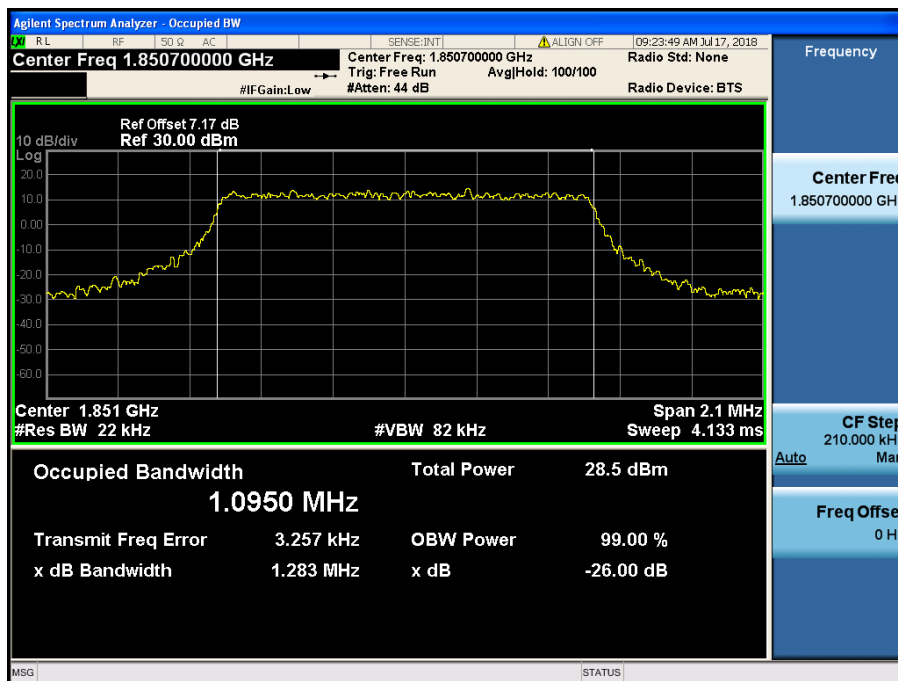

LTE Band 2 / 1.4 MHz / 16QAM - RB Size 6

## 8.2 PEAK TO AVERAGE RATIO

### 8.2.1 LTE Band 2

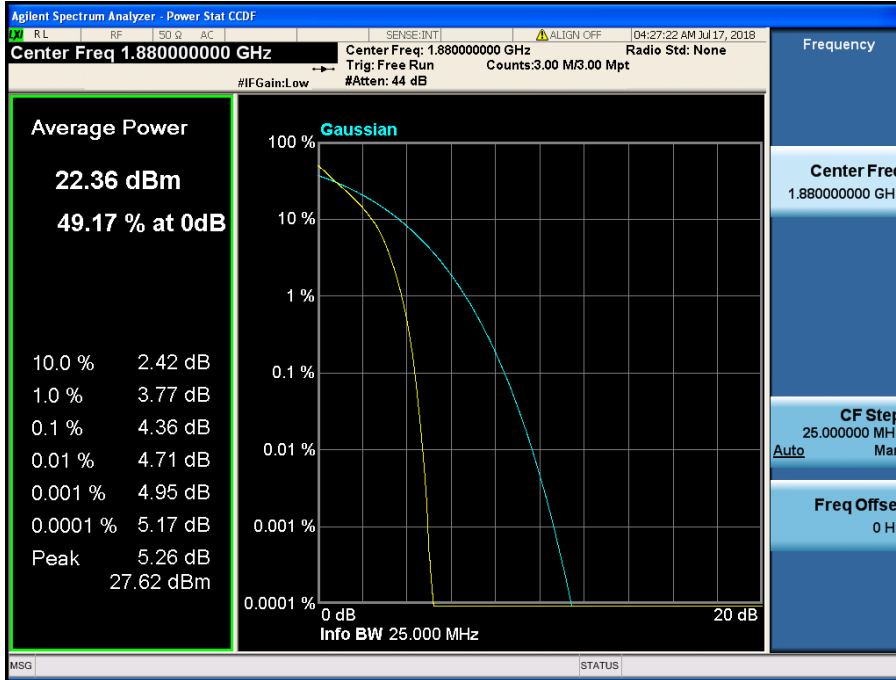

LTE Band 2 / 20 MHz / QPSK - RB Size 100

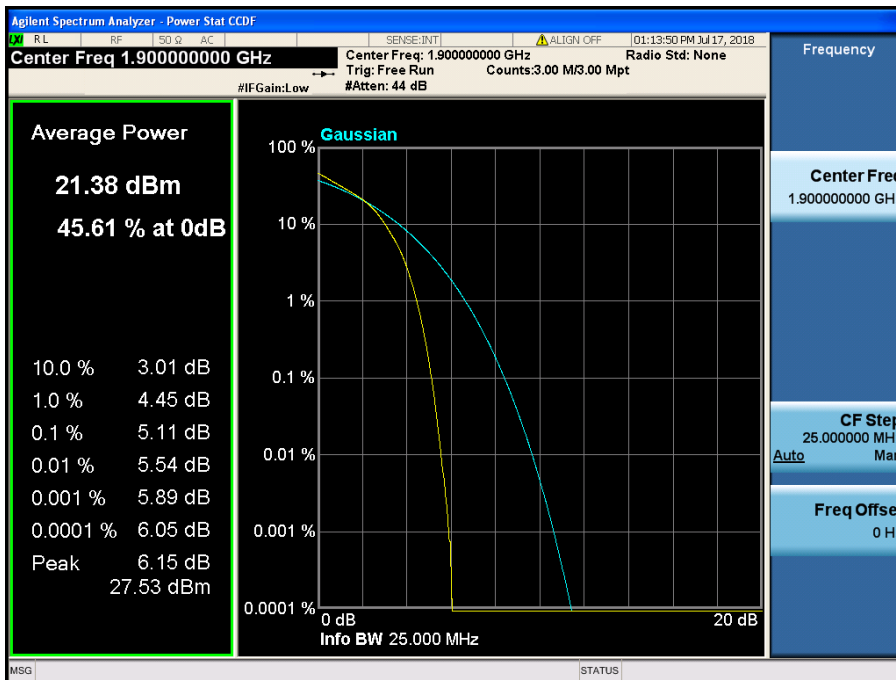

LTE Band 2 / 20 MHz / 16QAM - RB Size 100

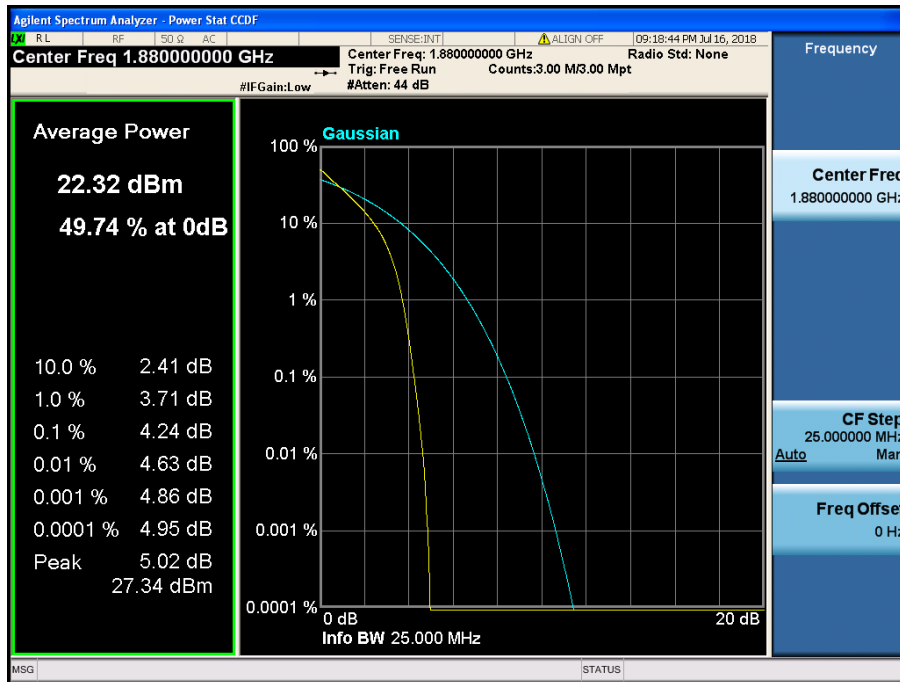

LTE Band 2 / 15 MHz / QPSK - RB Size 75

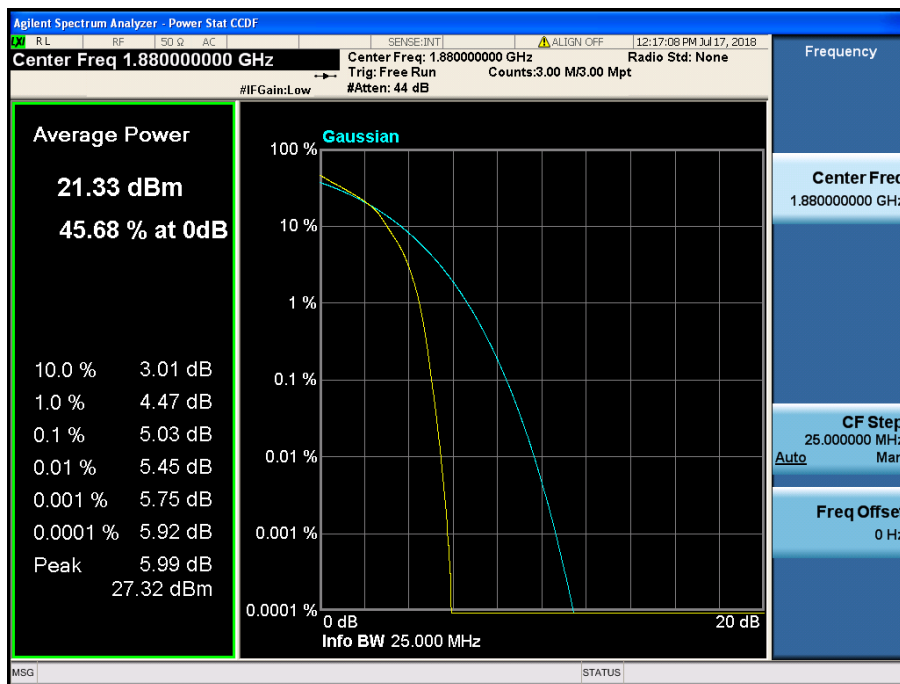

LTE Band 2 / 15 MHz / 16QAM - RB Size 75

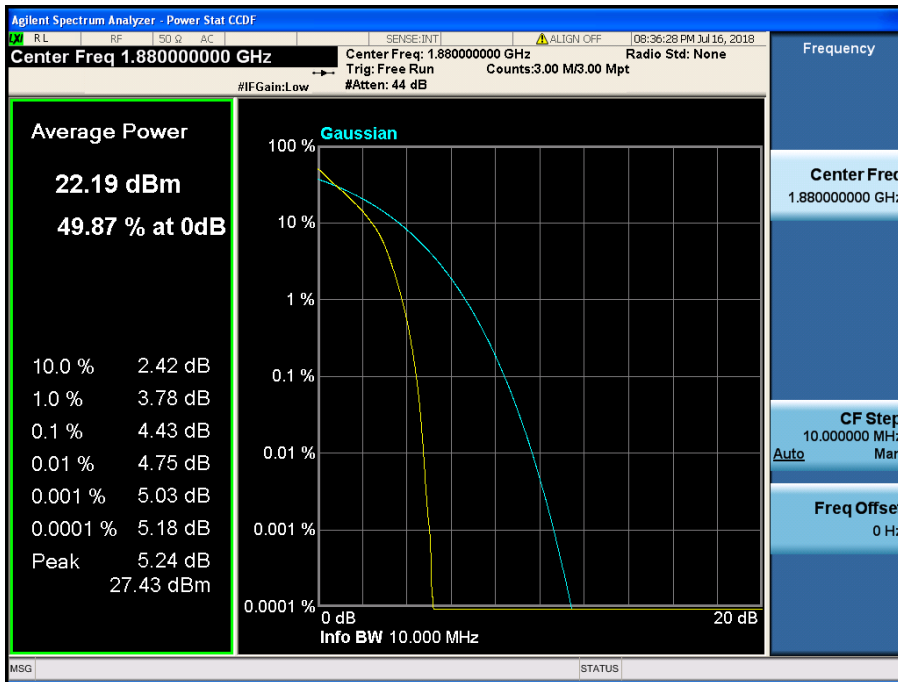

LTE Band 2 / 10 MHz / QPSK - RB Size 50

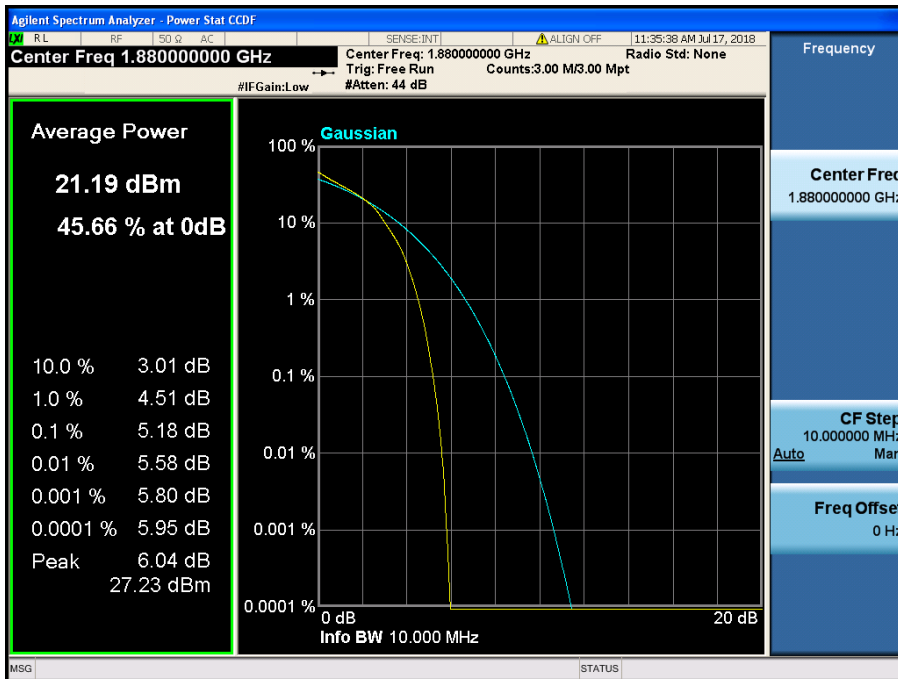

LTE Band 2 / 10 MHz / 16QAM - RB Size 50





LTE Band 2 / 5 MHz / QPSK - RB Size 25

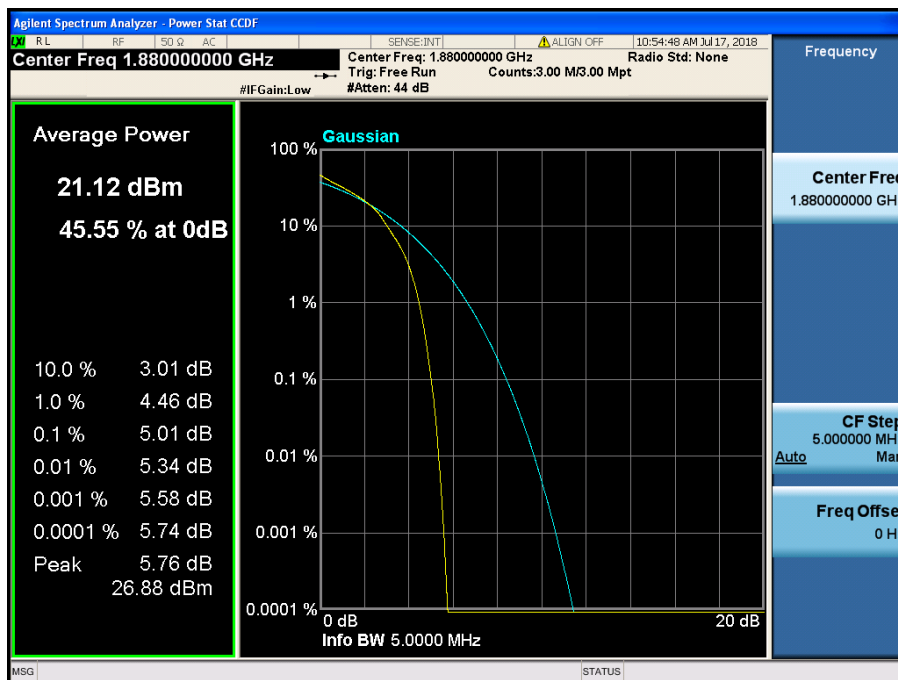

LTE Band 2 / 5 MHz / 16QAM - RB Size 25

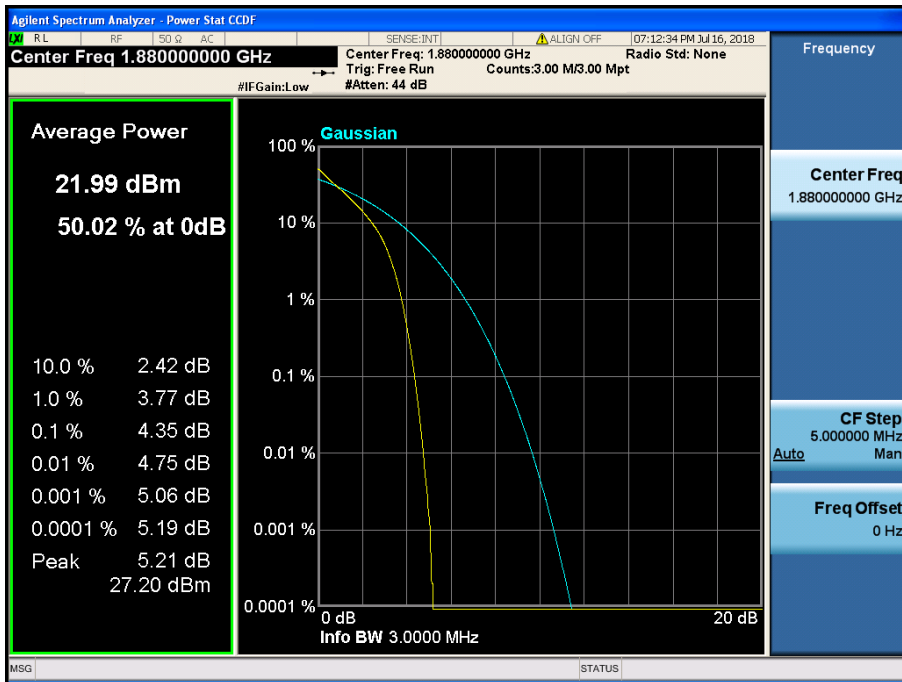

LTE Band 2 / 3 MHz / QPSK - RB Size 15

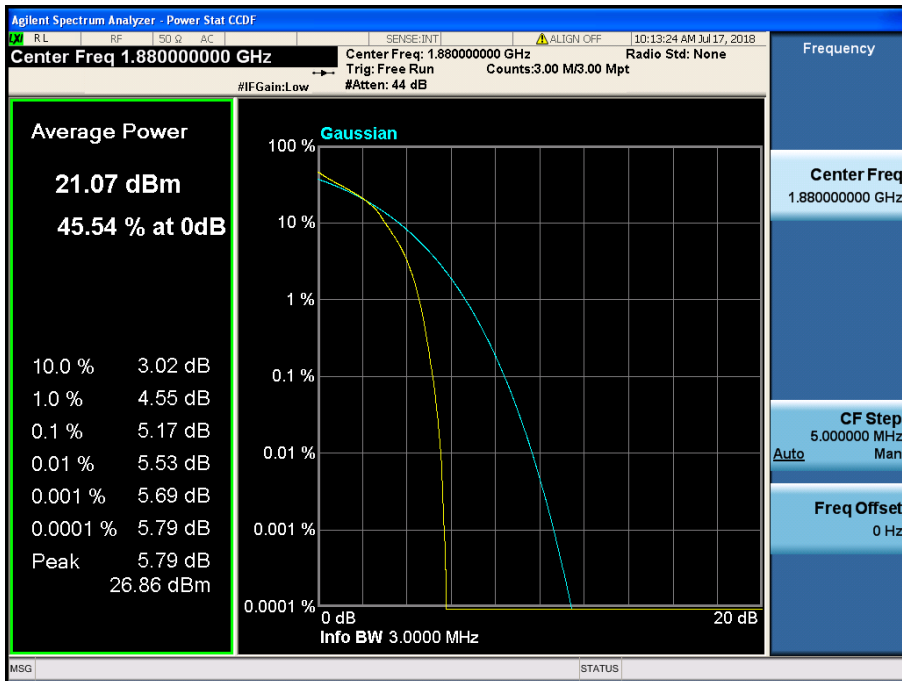

LTE Band 2 / 3 MHz / 16QAM - RB Size 15

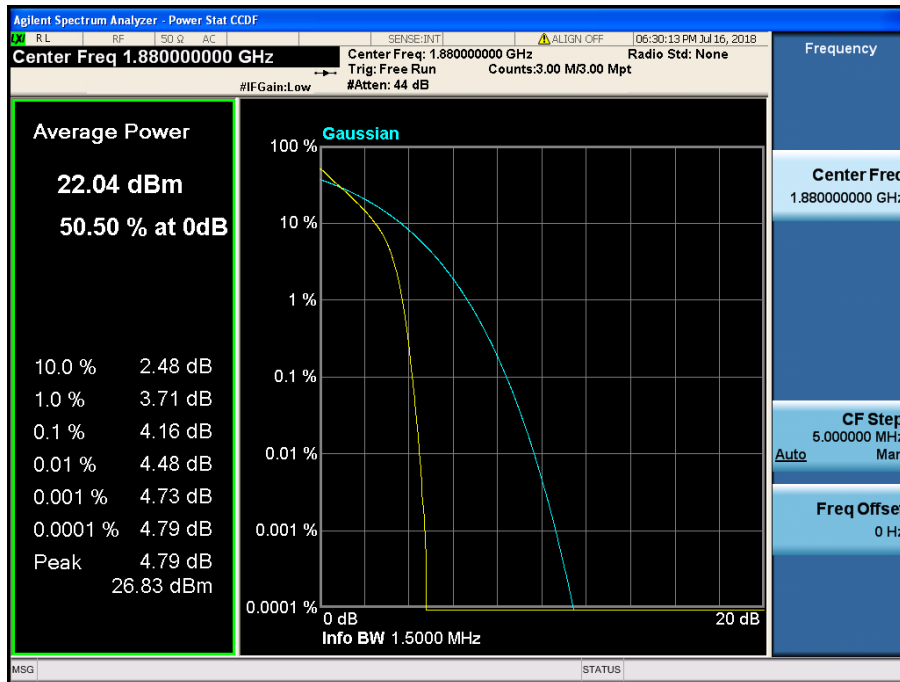

LTE Band 2 / 1.4 MHz / QPSK - RB Size 6

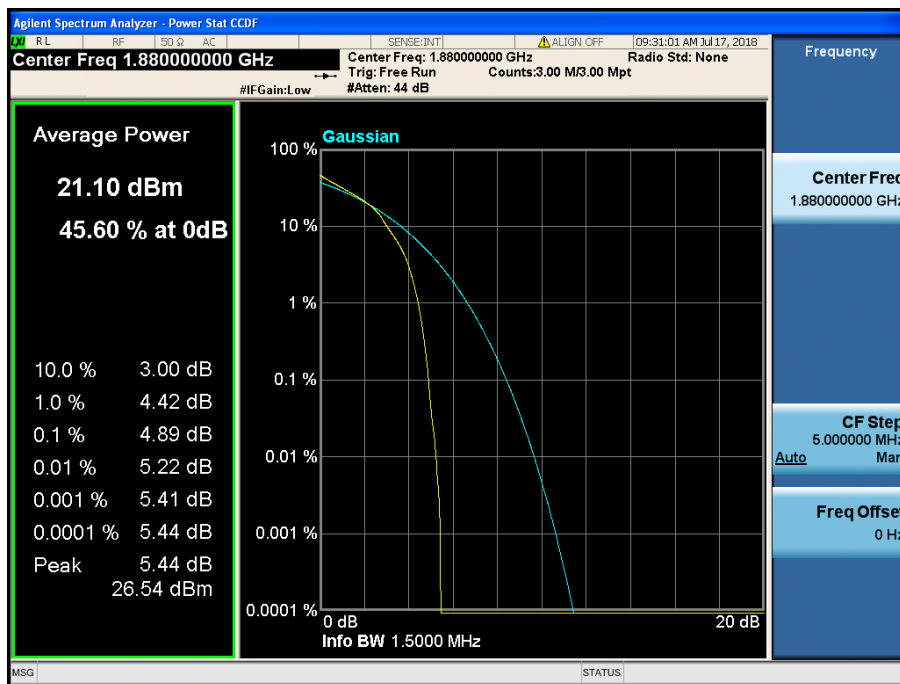

LTE Band 2 / 1.4 MHz / 16QAM - RB Size 6

### 8.3 BAND EDGE EMISSIONS(Conducted)

#### 8.3.1 LTE Band 2

- Lower Band Edge



LTE Band 2 / 20MHz / QPSK - RB Size/Offset (50/0)

- Lower Extended Band Edge

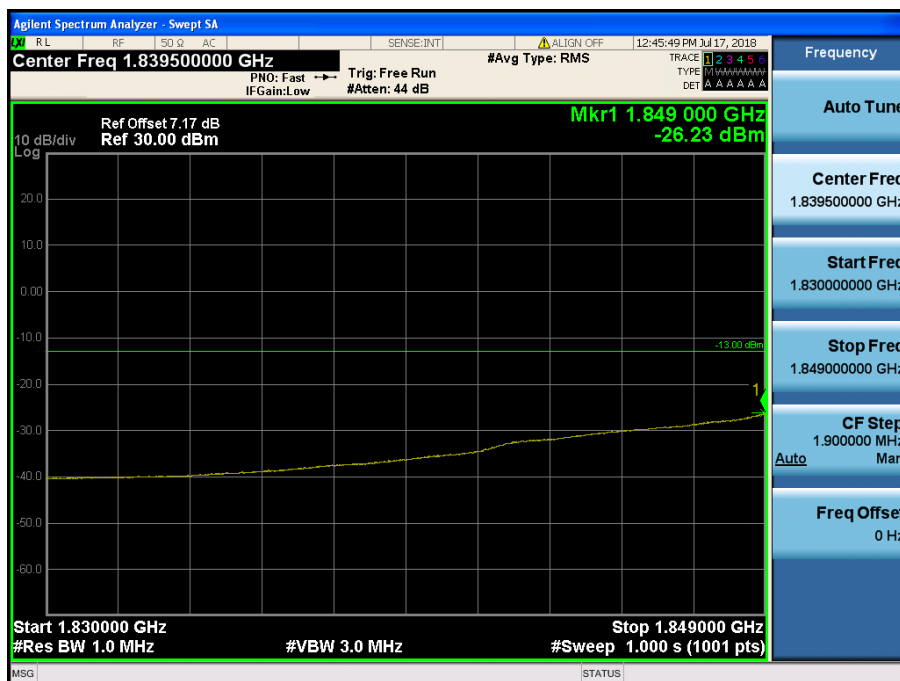

LTE Band 2 / 20MHz / 16QAM - RB Size/Offset (50/0)

- Upper Band Edge



LTE Band 2 / 20MHz / QPSK - RB Size/Offset (50/50)

- Upper Extended Band Edge



LTE Band 2 / 20MHz / QPSK - RB Size/Offset (50/50)

- Lower Band Edge



LTE Band 2 / 15MHz / QPSK - RB Size/Offset (36/0)

- Lower Extended Band Edge

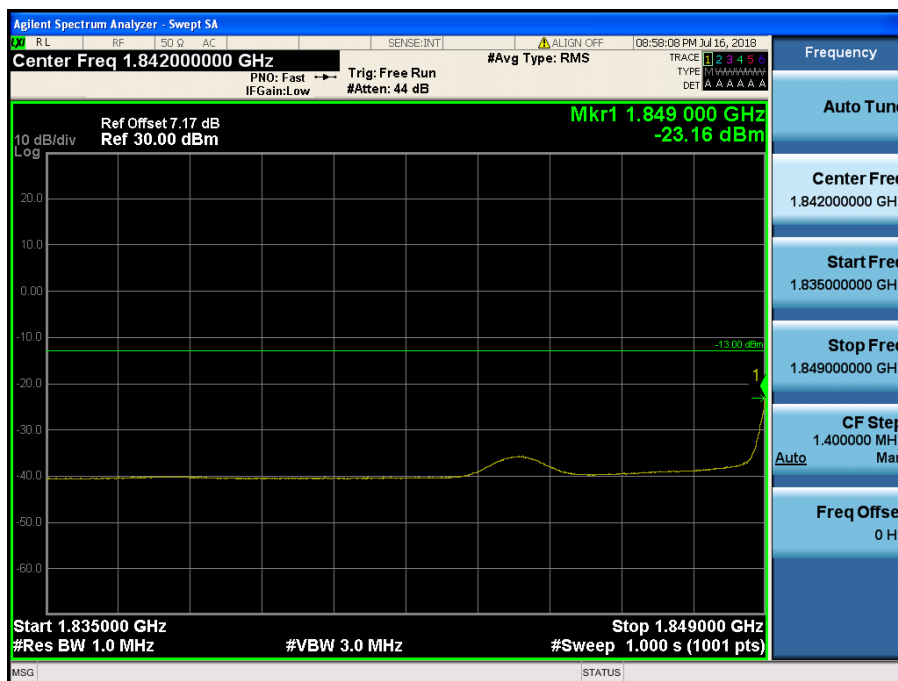

LTE Band 2 / 15MHz / QPSK - RB Size/Offset (1/0)

- Upper Band Edge



LTE Band 2 / 15MHz / QPSK - RB Size/Offset (36/39)

- Upper Extended Band Edge

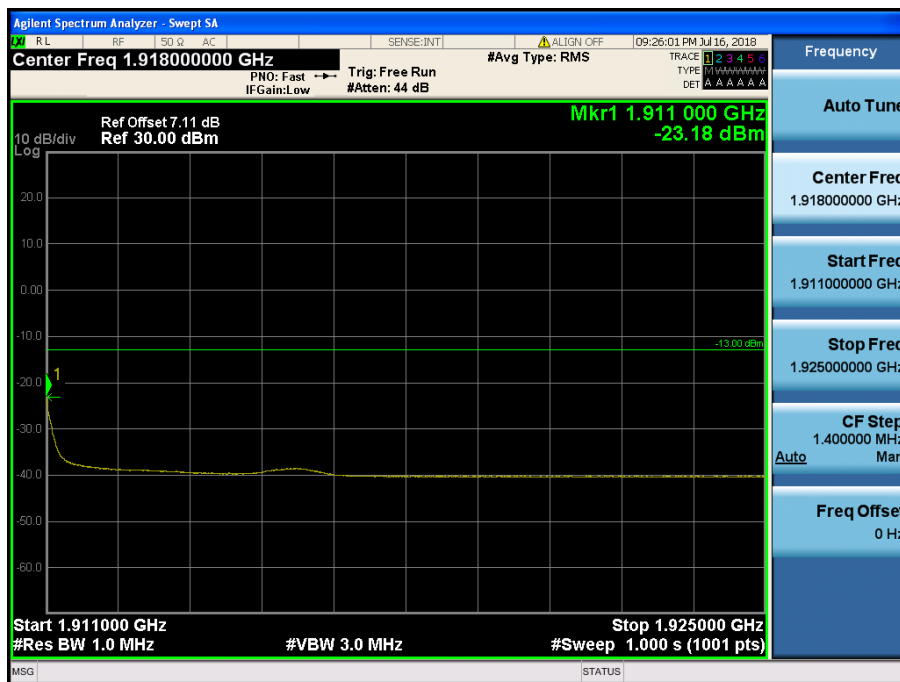

LTE Band 2 / 15MHz / QPSK - RB Size/Offset (1/74)

- Lower Band Edge



LTE Band 2 / 10MHz / QPSK - RB Size/Offset (25/0)

- Lower Extended Band Edge



LTE Band 2 / 10MHz / QPSK - RB Size/Offset (25/0)



- Upper Band Edge



LTE Band 2 / 10MHz / QPSK - RB Size/Offset (25/25)

- Upper Extended Band Edge

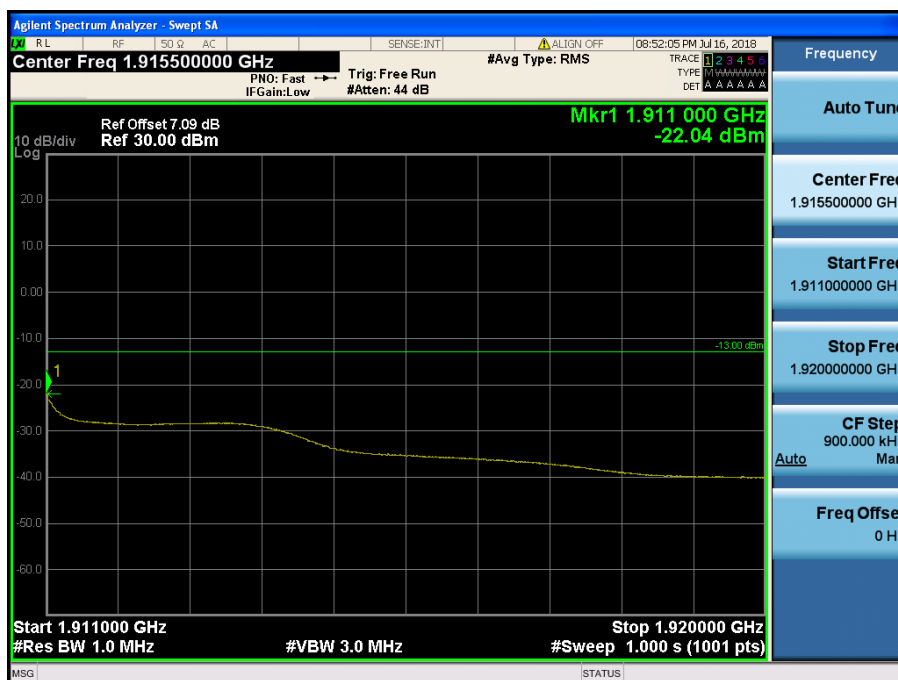

LTE Band 2 / 10MHz / QPSK - RB Size/Offset (25/25)

- Lower Band Edge

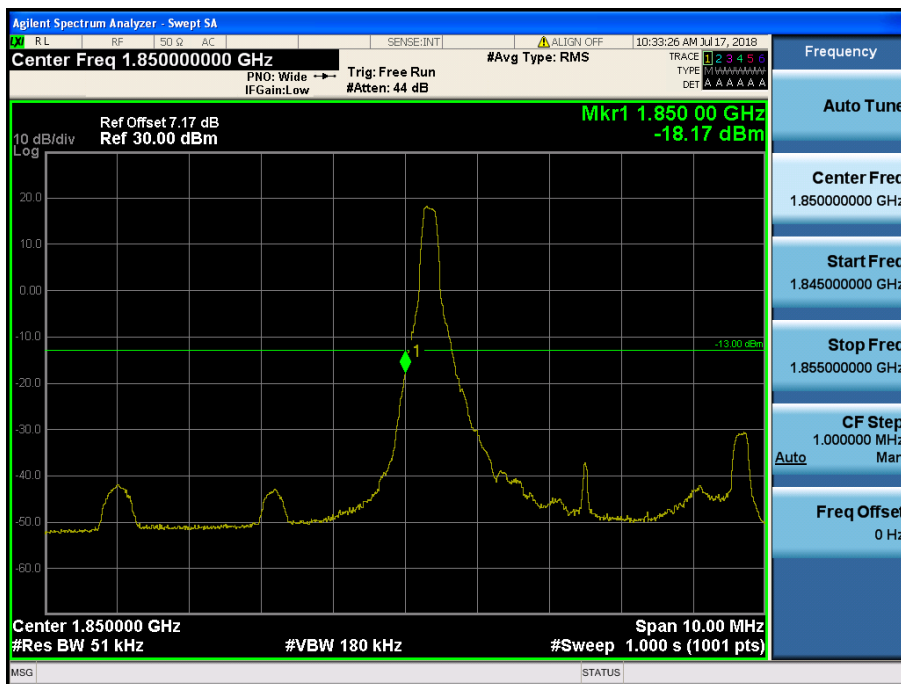

LTE Band 2 / 5MHz / 16QAM RB Size/Offset (1/0)

- Lower Extended Band Edge

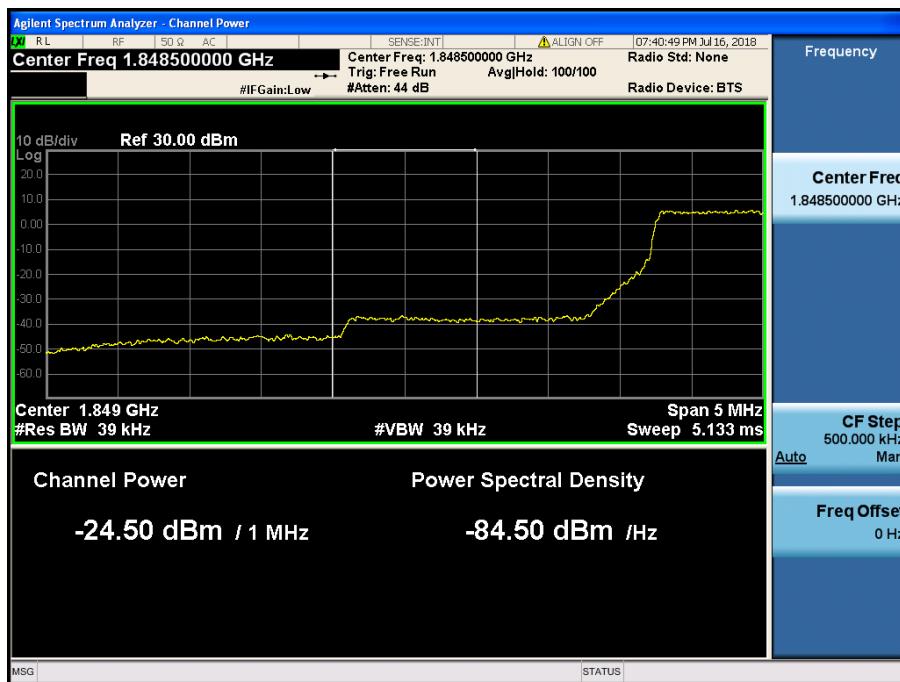

LTE Band 2 / 5MHz / QPSK RB Size/Offset (12/0)

- Upper Band Edge

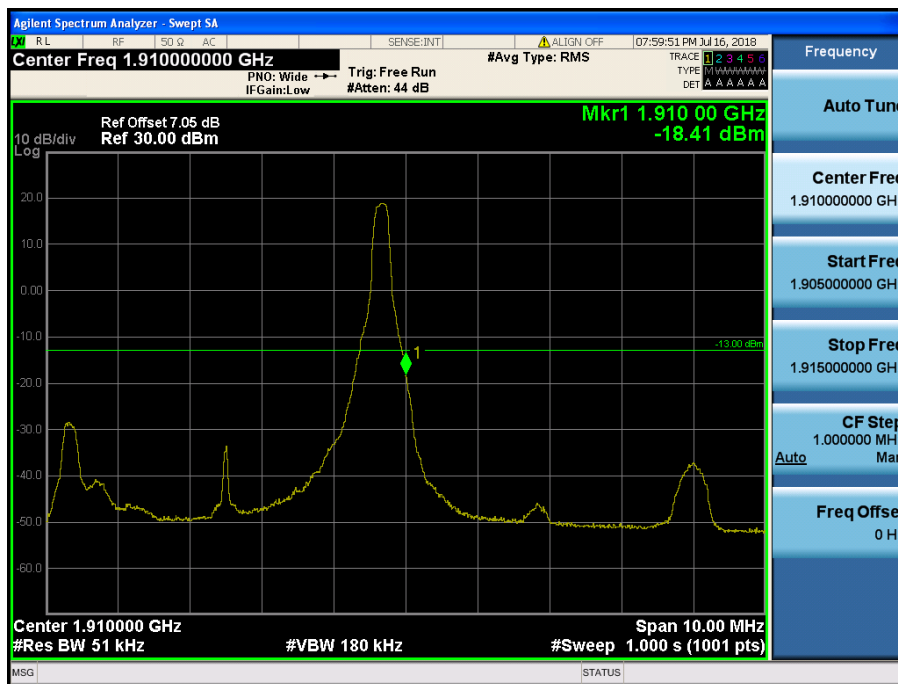

LTE Band 2 / 5MHz / QPSK - RB Size/Offset (1/24)

- Upper Extended Band Edge

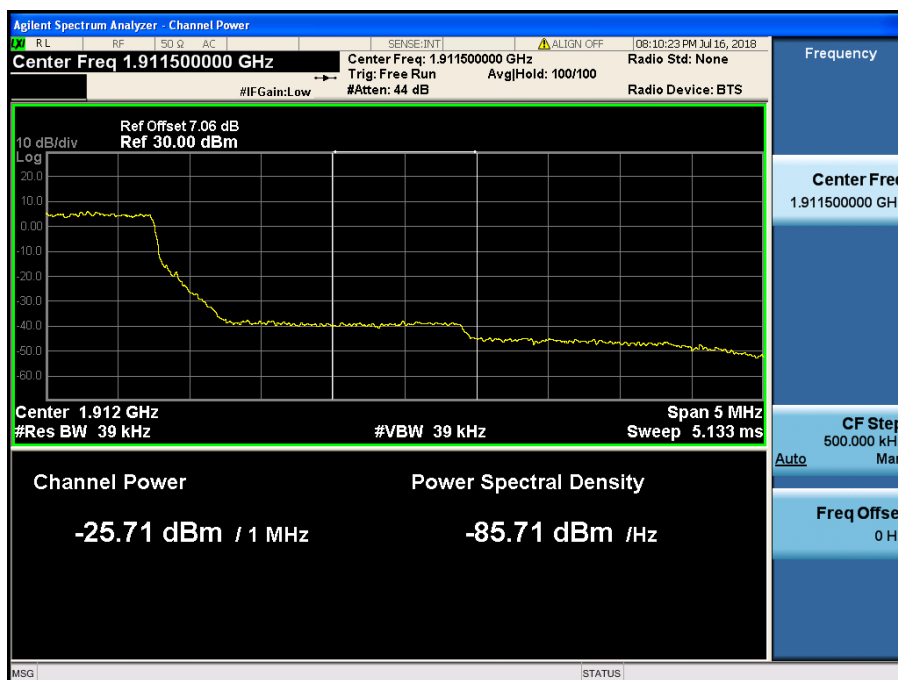

LTE Band 2 / 5MHz / QPSK - RB Size/Offset (12/13)

- Lower Band Edge

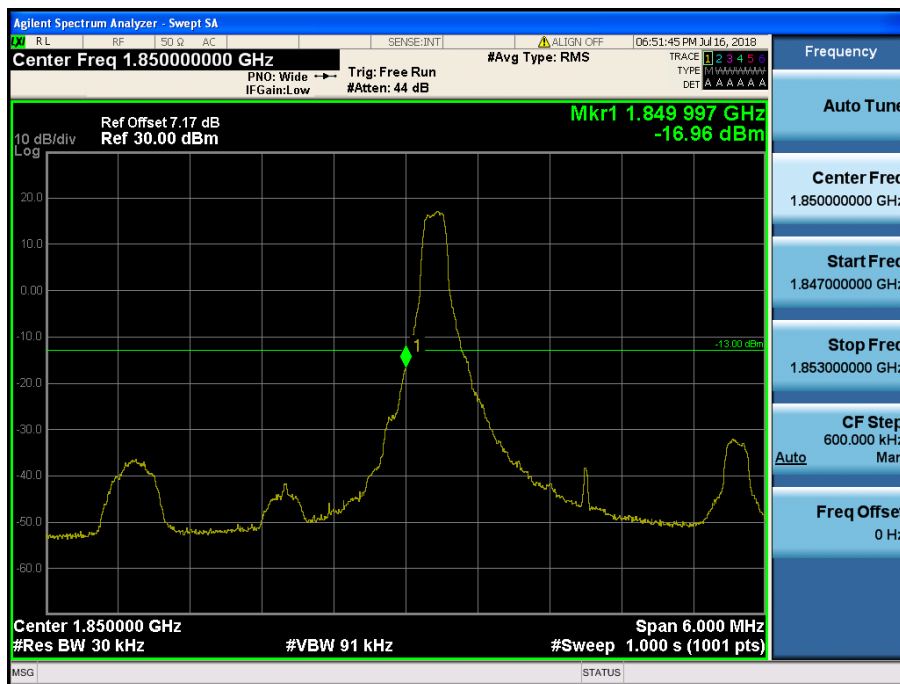

LTE Band 2 / 3MHz / QPSK - RB Size/Offset (1/0)

- Lower Extended Band Edge

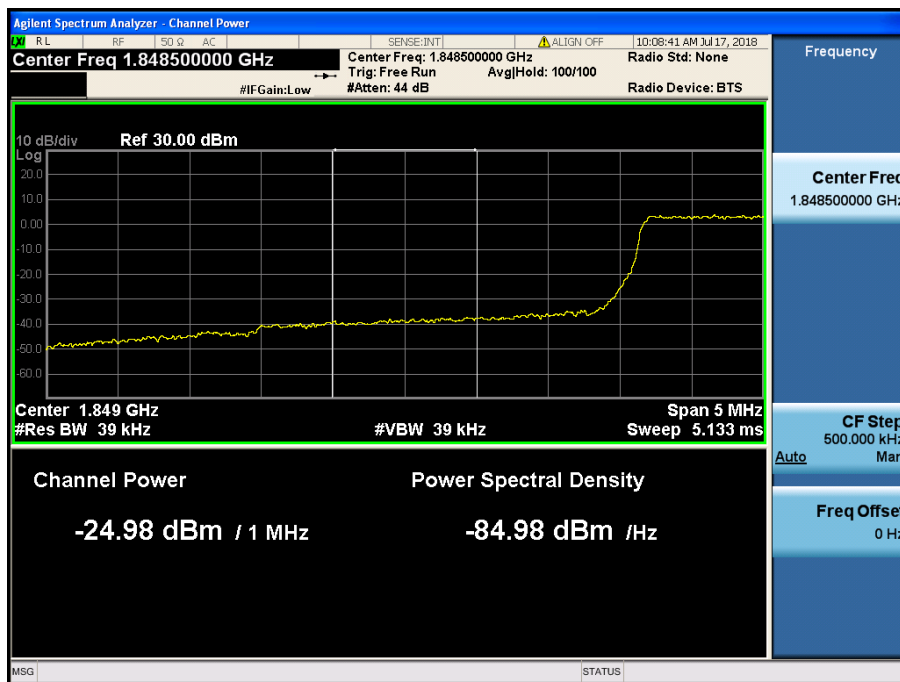

LTE Band 2 / 3MHz / 16QAM - RB Size/Offset (15/0)

- Upper Band Edge

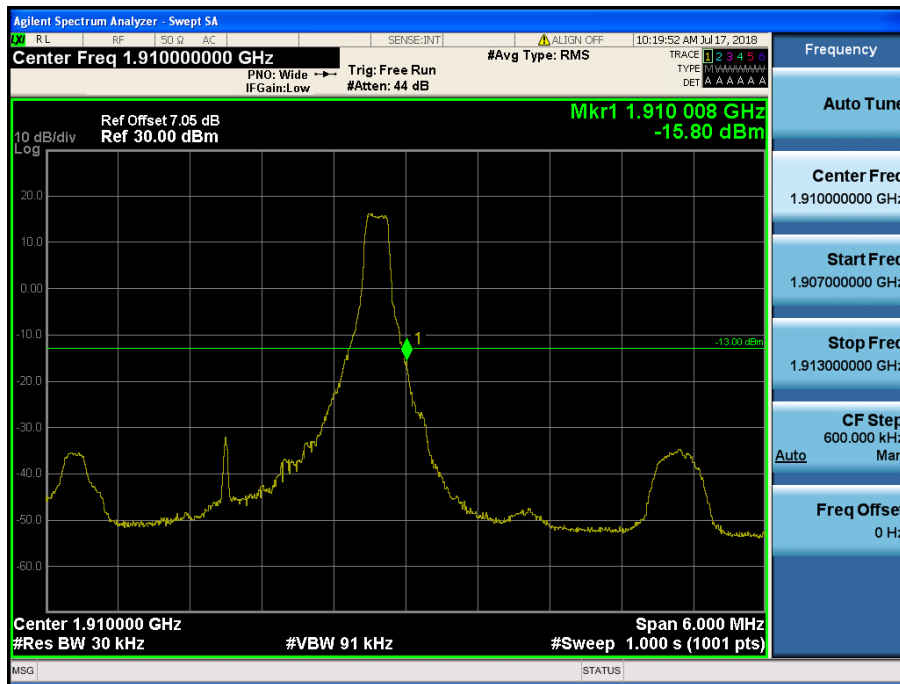

LTE Band 2 / 3MHz / 16QAM - RB Size/Offset (1/14)

- Upper Extended Band Edge



LTE Band 2 / 3MHz / QPSK - RB Size/Offset (8/4)

- Lower Band Edge

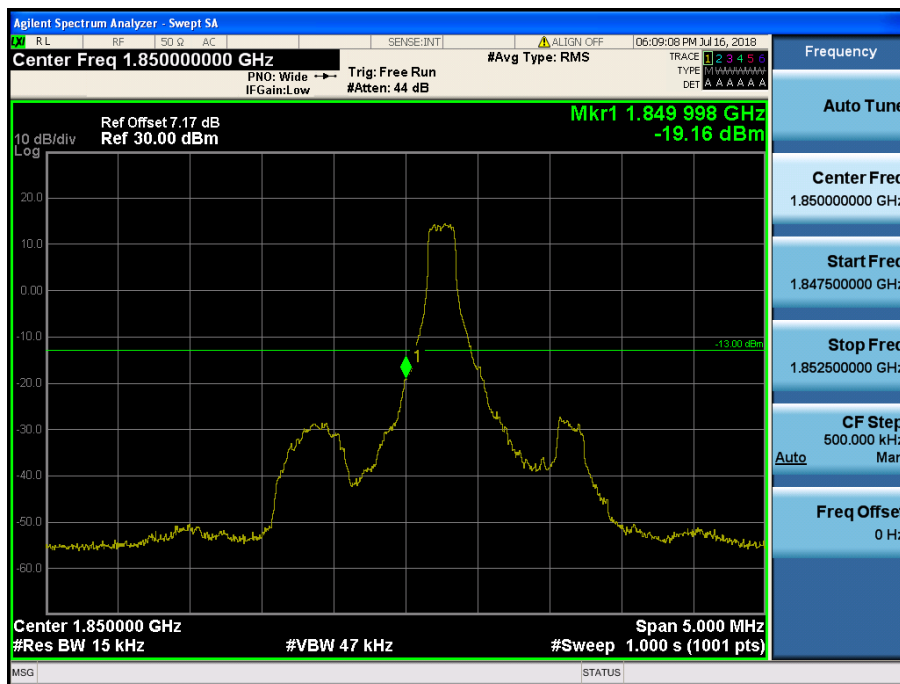

LTE Band 2 / 1.4MHz / QPSK - RB Size/Offset (1/0)

- Lower Extended Band Edge



LTE Band 2 / 1.4MHz / QPSK - RB Size/Offset (3/2)

- Upper Band Edge



LTE Band 2 / 1.4MHz / QPSK - RB Size/Offset (3/3)

- Upper Extended Band Edge

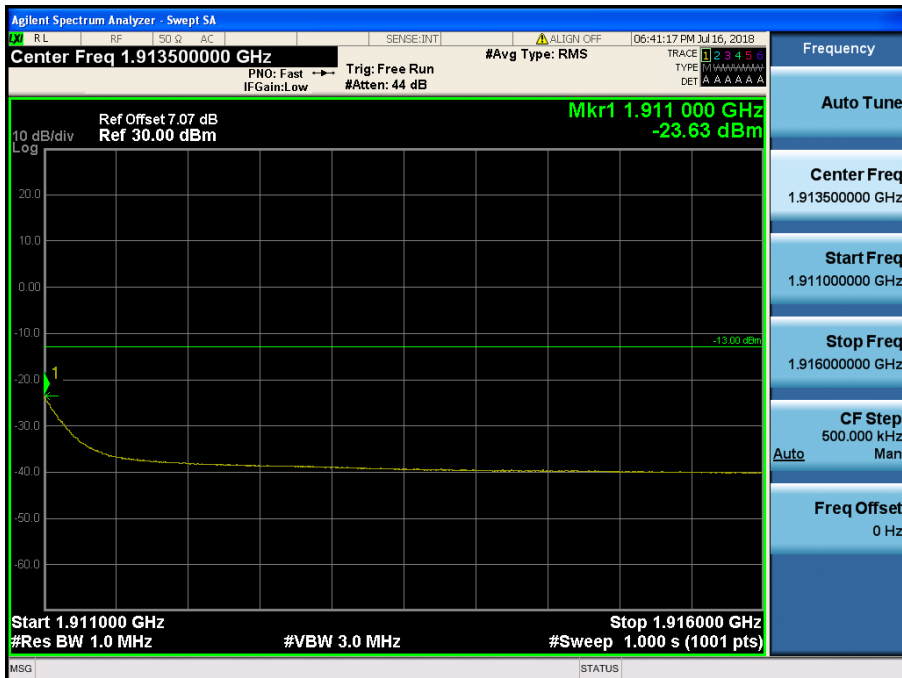

LTE Band 2 / 1.4MHz / QPSK - RB Size/Offset (3/0)

### 8.4 SPURIOUS AND HARMONICS EMISSIONS(Conducted)

#### 8.4.1 LTE Band 2

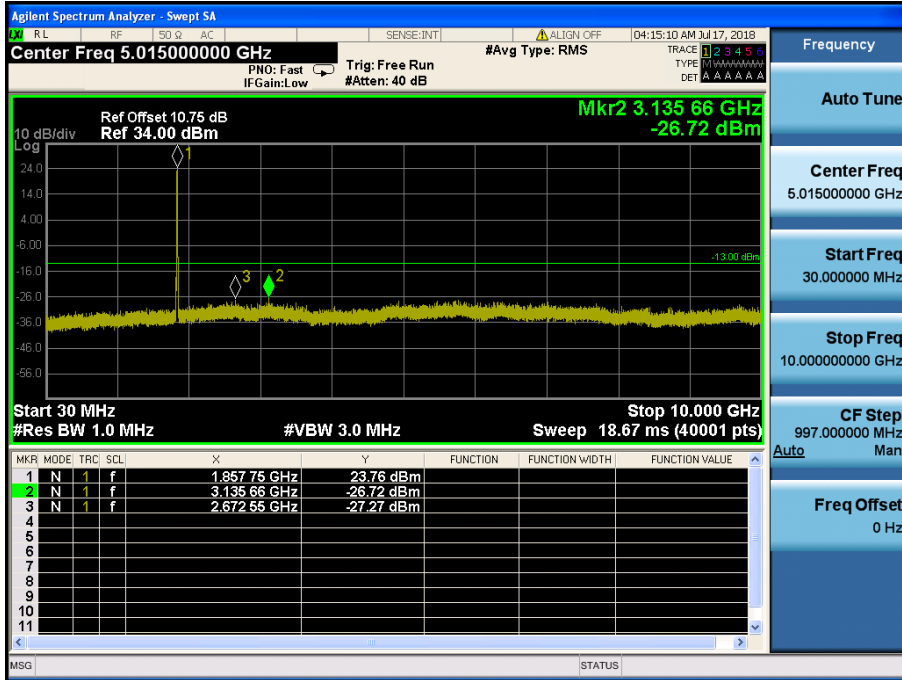

LTE Band 2 / 20MHz / QPSK - RB Size/Offset (50/0) –Low Channel

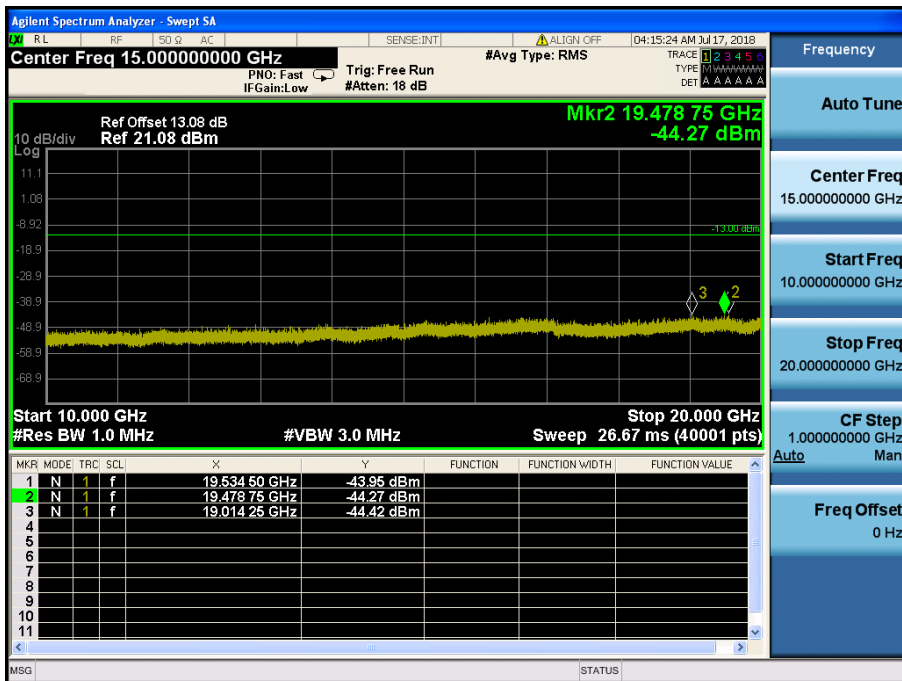

LTE Band 2 / 20MHz / QPSK - RB Size/Offset (50/0) –Low Channel



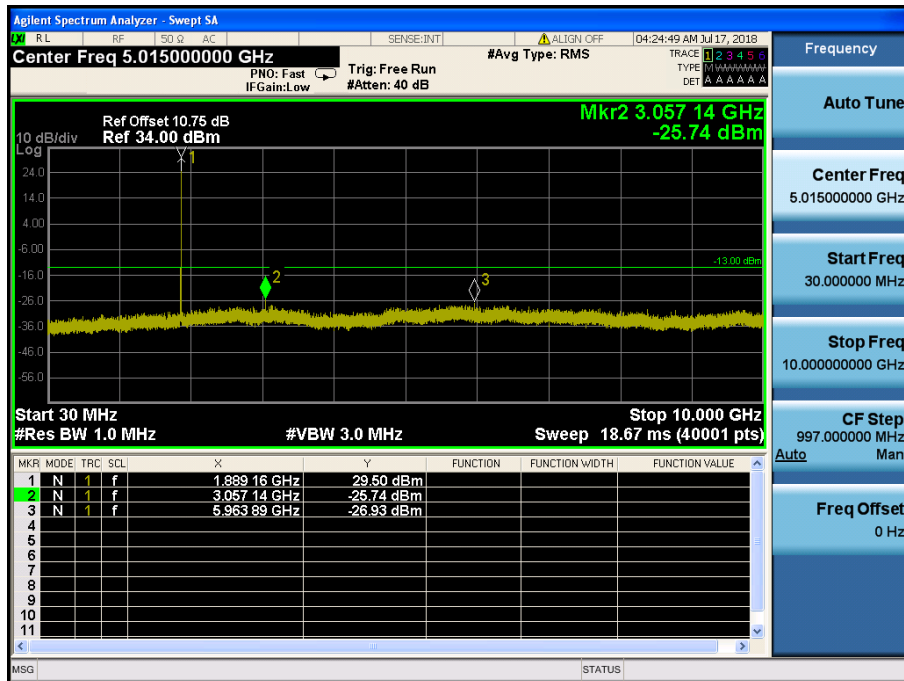

LTE Band 2 / 20MHz / QPSK - RB Size/Offset (1/99)–Mid Channel

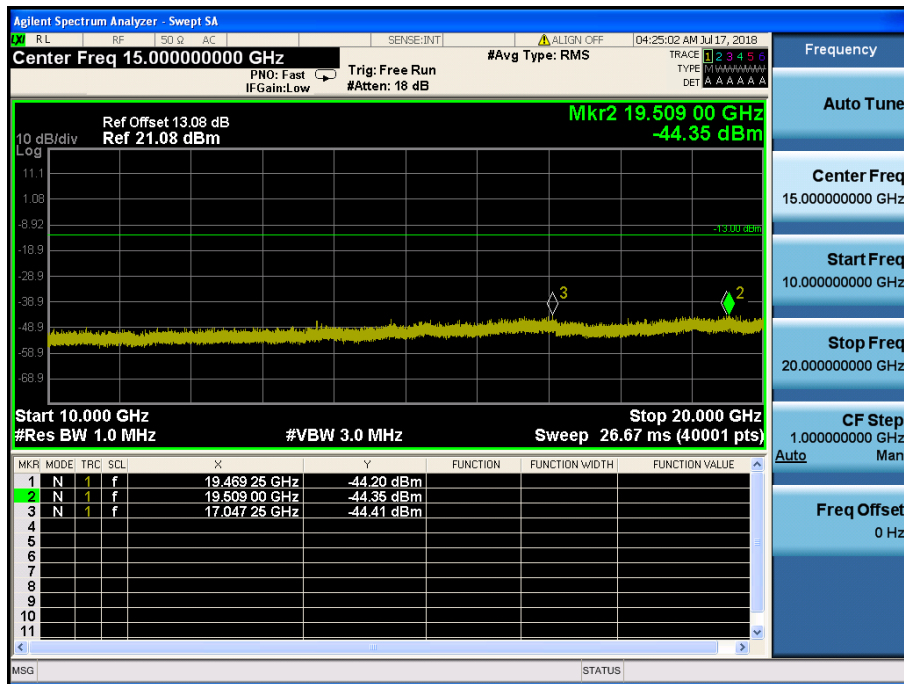

LTE Band 2 / 20MHz / QPSK - RB Size/Offset (1/99)–Mid Channel

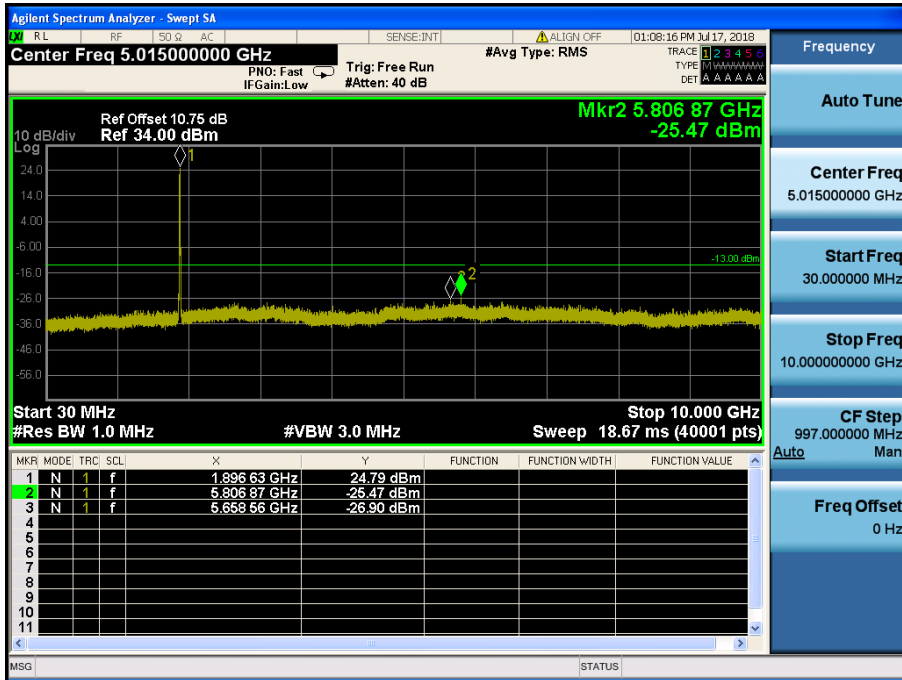

LTE Band 2 / 20MHz / 16QAM - RB Size/Offset (50/0) – High Channel

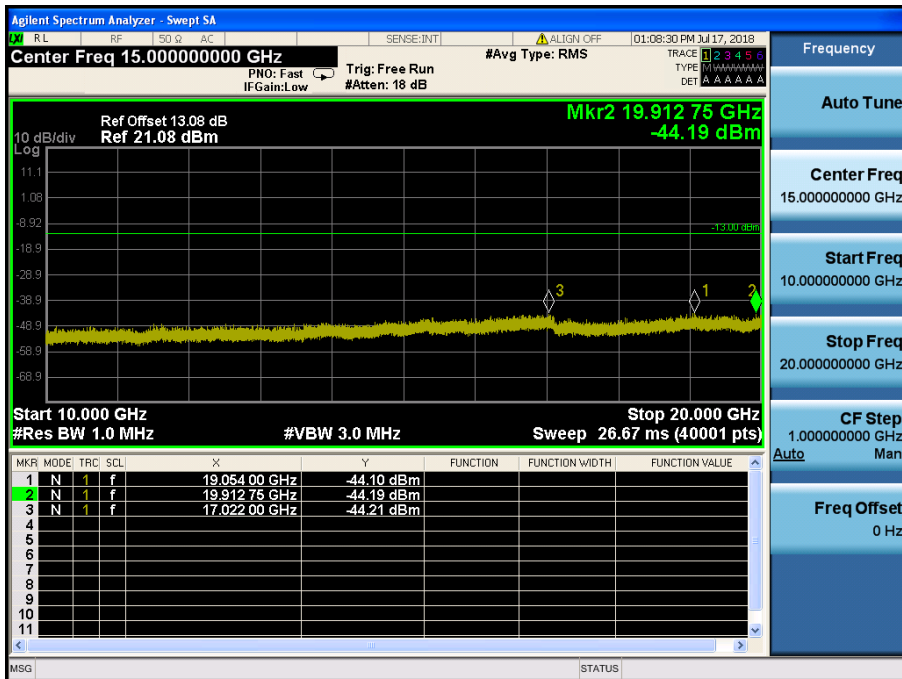

LTE Band 2 / 20MHz / 16QAM - RB Size/Offset (50/0) – High Channel

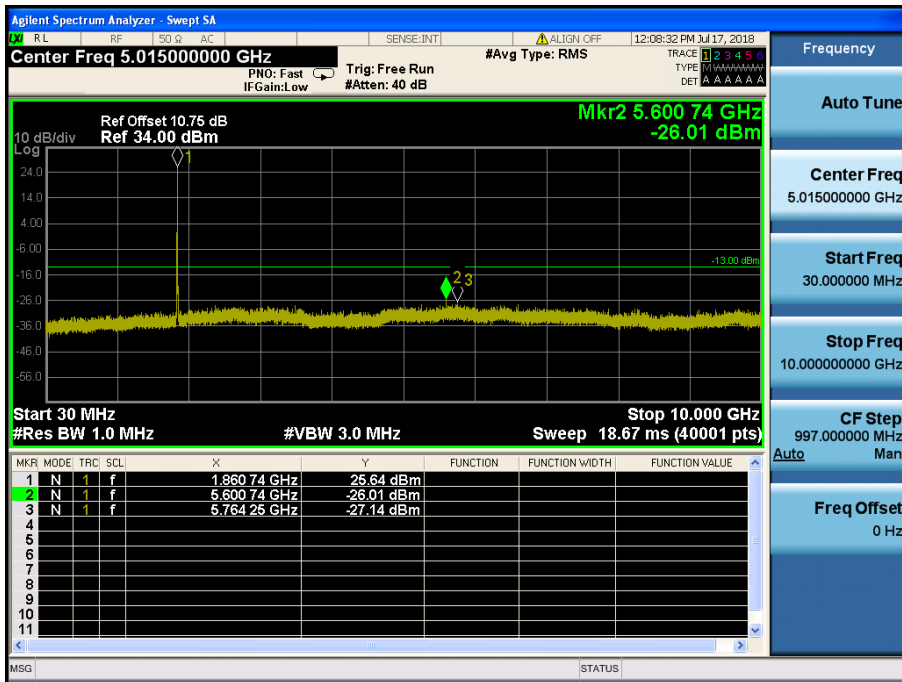

LTE Band 2 / 15MHz / 16QAM - RB Size/Offset (36/39)-Low Channel

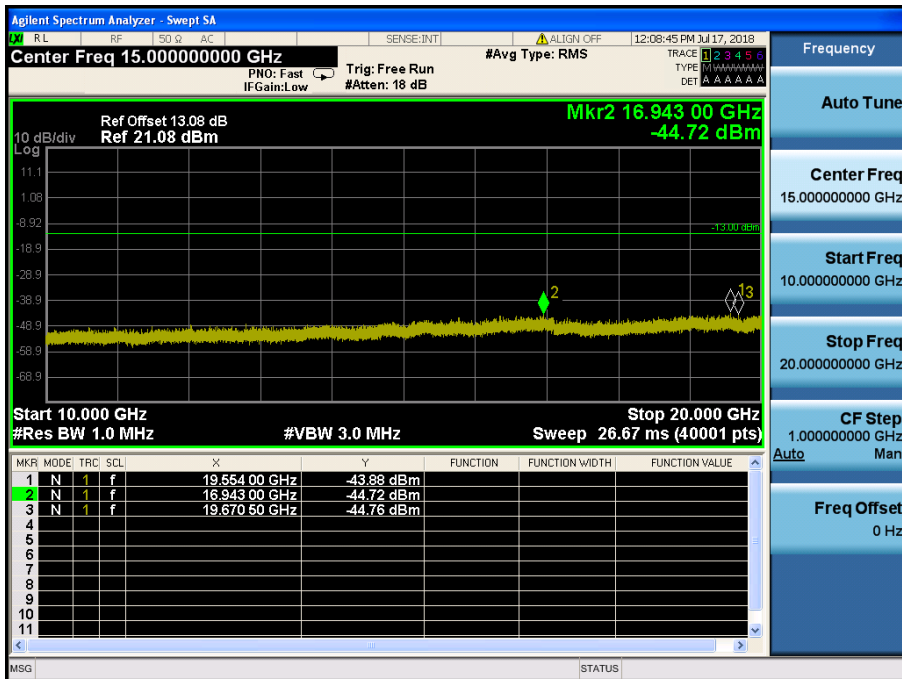

LTE Band 2 / 15MHz / 16QAM - RB Size/Offset (36/39)-Low Channel

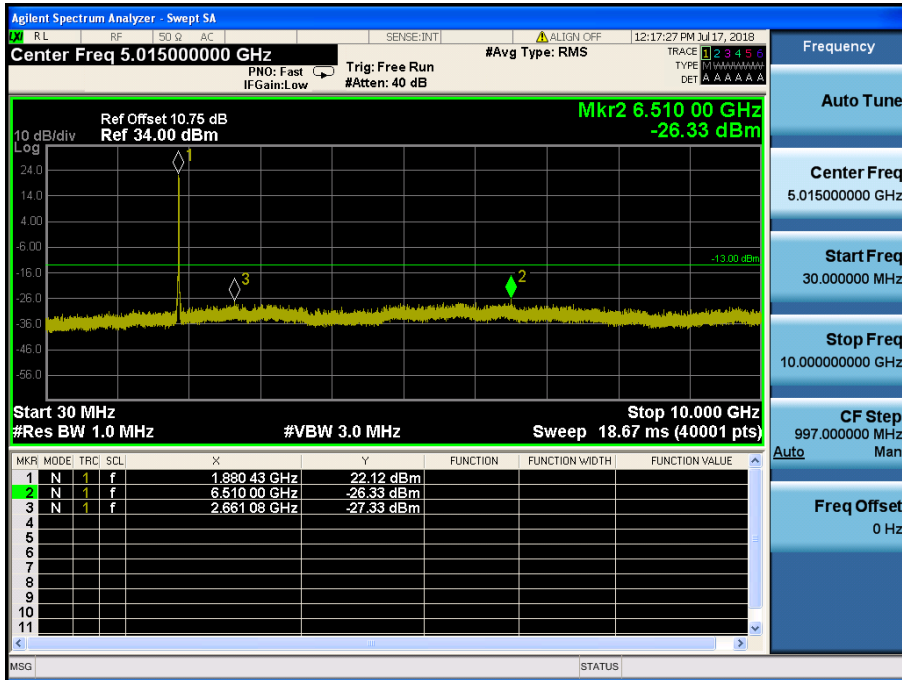

LTE Band 2 / 15MHz / 16QAM - RB Size/Offset (75/0) – Mid Channel

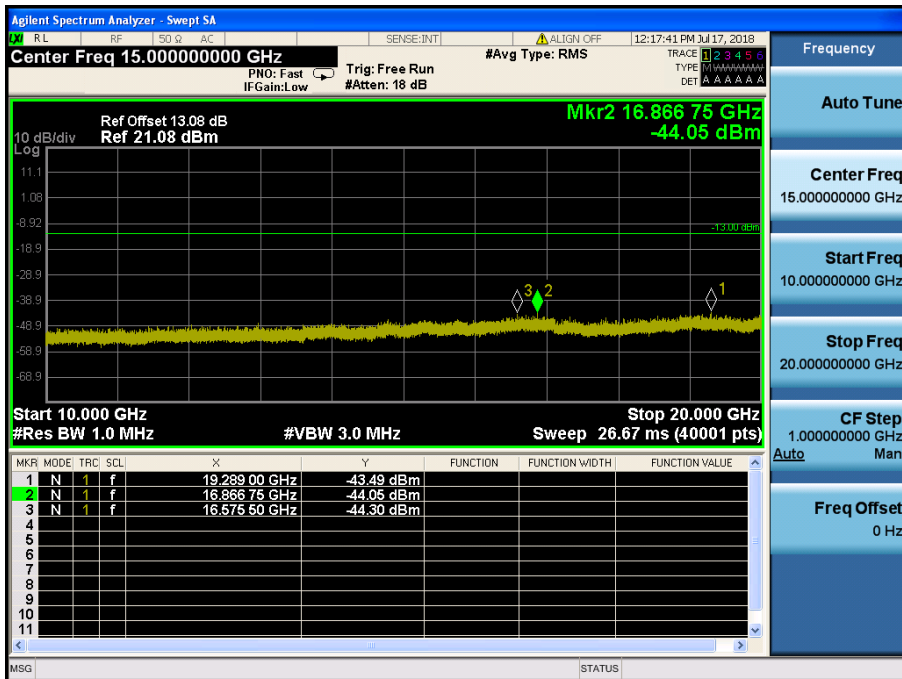

LTE Band 2 / 15MHz / 16QAM - RB Size/Offset (75/0) – Mid Channel

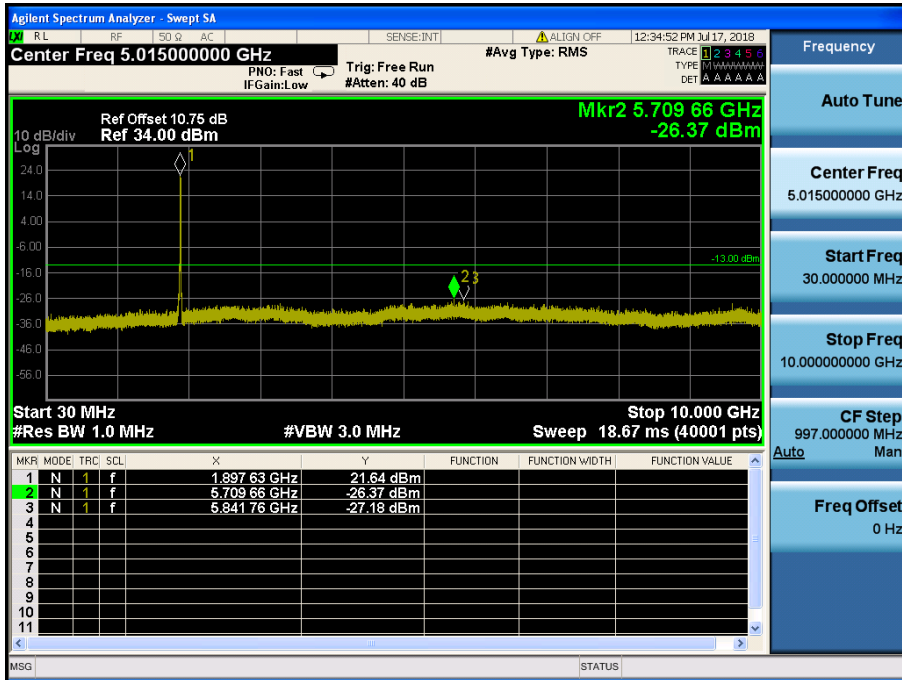

LTE Band 2 / 15MHz / 16QAM - RB Size/Offset (75/0) – High Channel

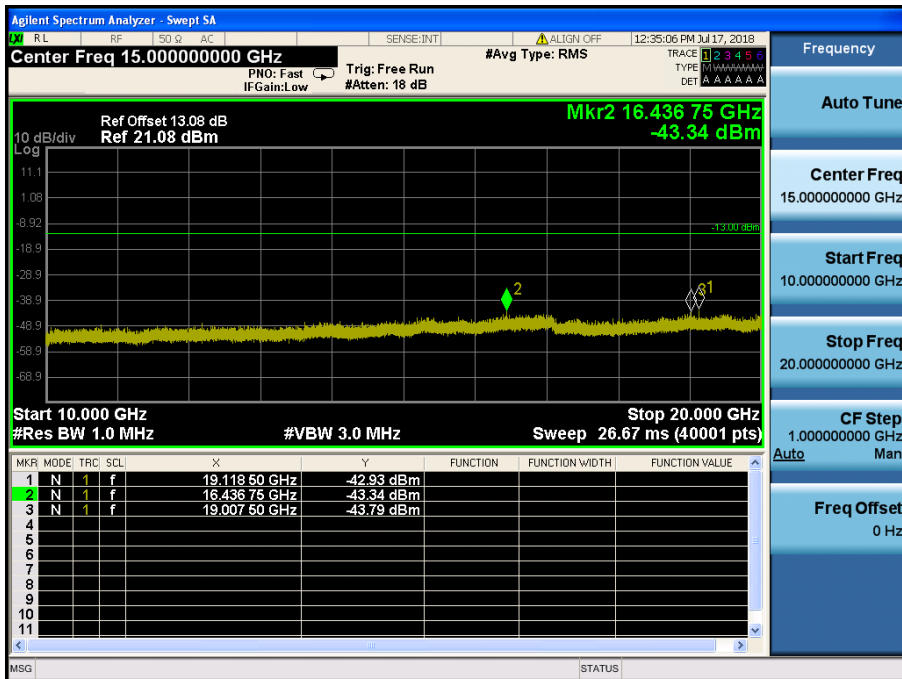

LTE Band 2 / 15MHz / 16QAM - RB Size/Offset (75/0) – High Channel

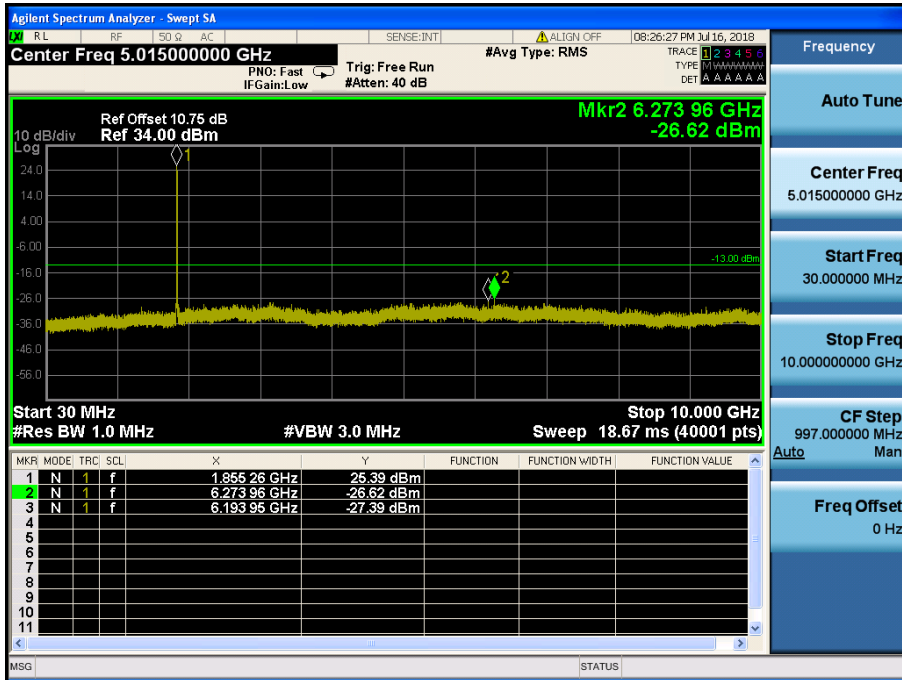

LTE Band 2 / 10MHz / QPSK - RB Size/Offset (25/12) – Low Channel

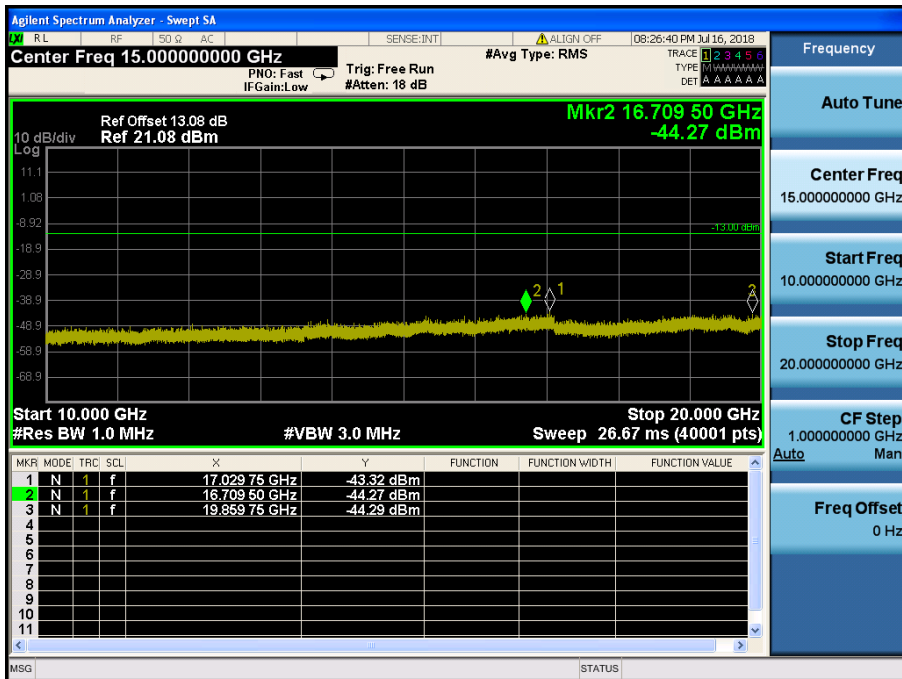

LTE Band 2 / 10MHz / QPSK - RB Size/Offset (25/12) – Low Channel

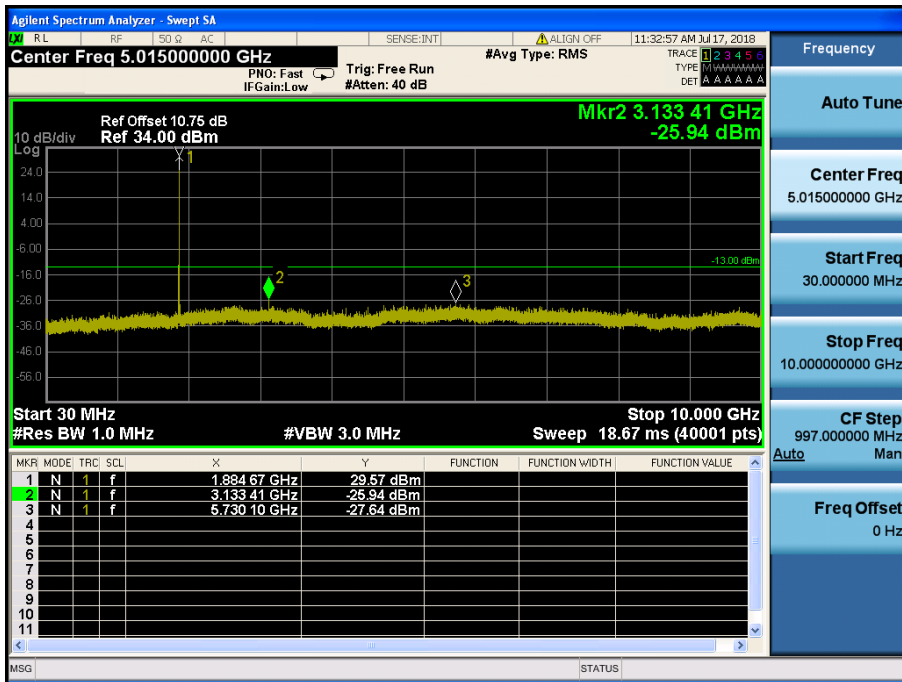

LTE Band 2 / 10MHz / 16QAM - RB Size/Offset (1/49) – Mid Channel

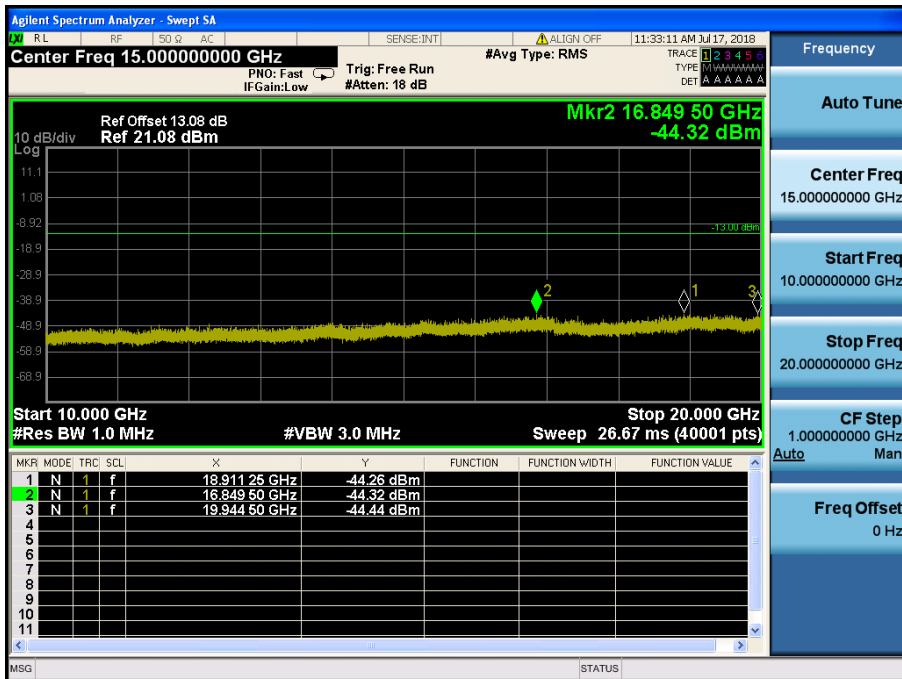

LTE Band 2 / 10MHz / 16QAM - RB Size/Offset (1/49) – Mid Channel

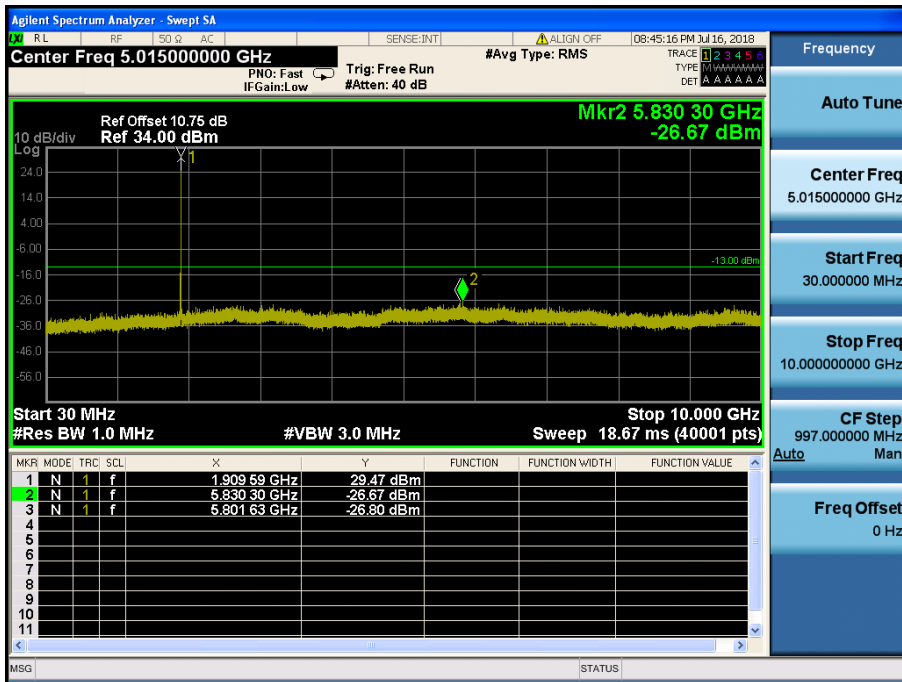

LTE Band 2 / 10MHz / QPSK - RB Size/Offset (1/49) – High Channel

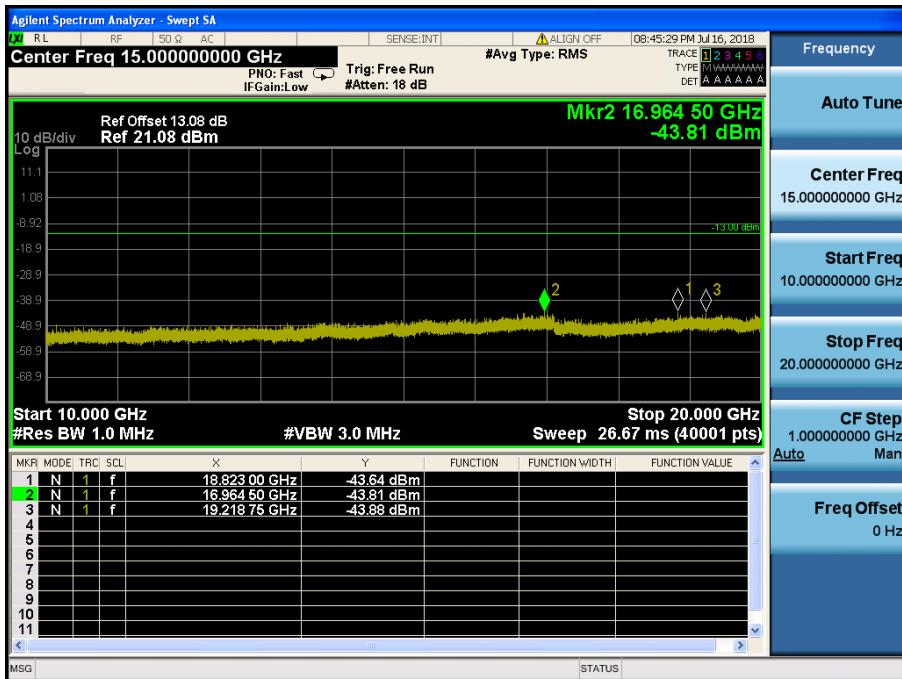

LTE Band 2 / 10MHz / QPSK - RB Size/Offset (1/49) – High Channel



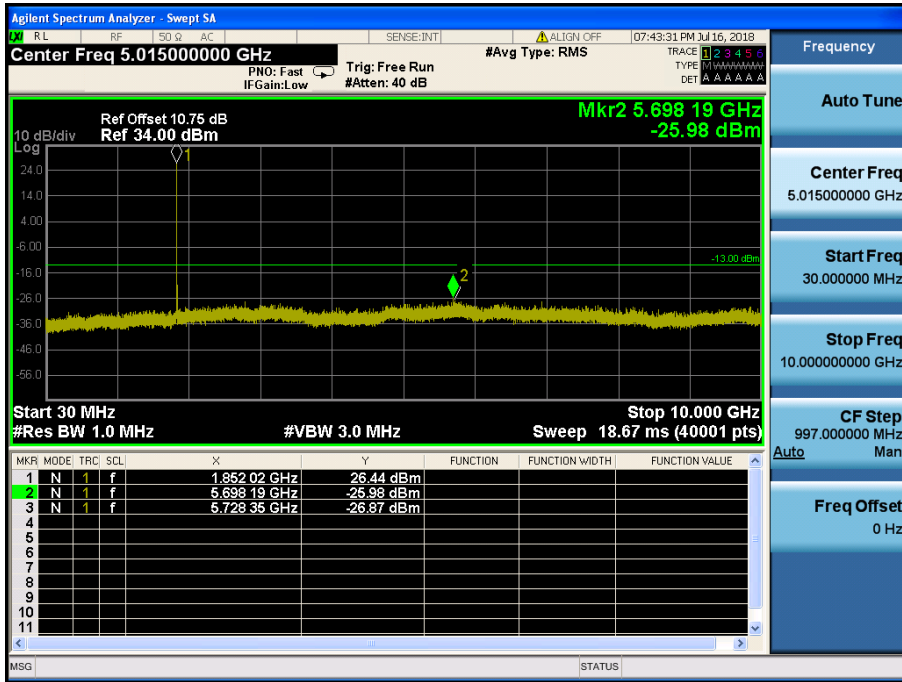

LTE Band 2 / 5MHz / QPSK - RB Size/Offset (12/6) – Low Channel

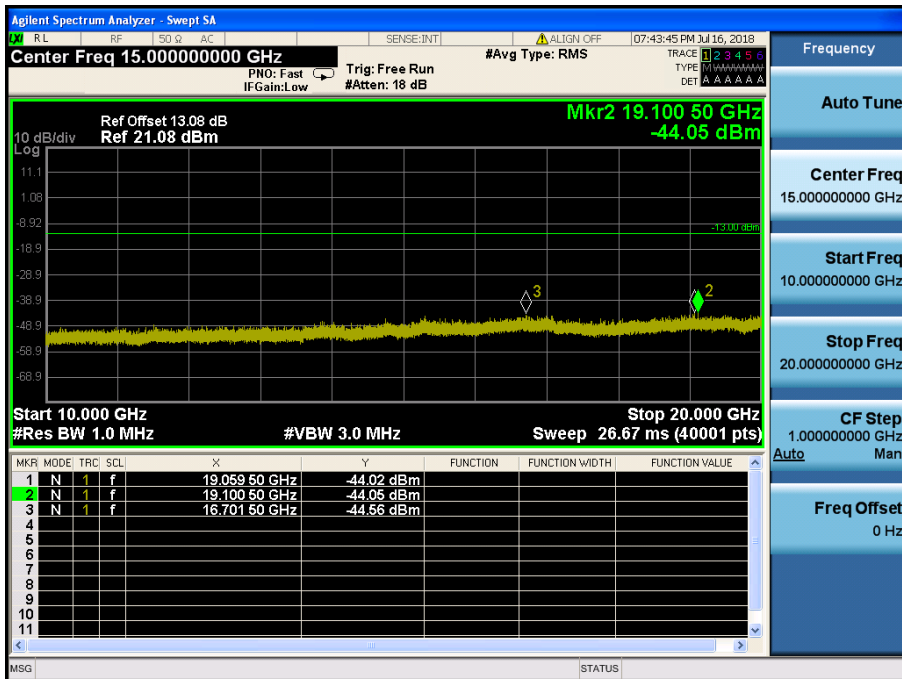

LTE Band 2 / 5MHz / QPSK - RB Size/Offset (12/6) – Low Channel

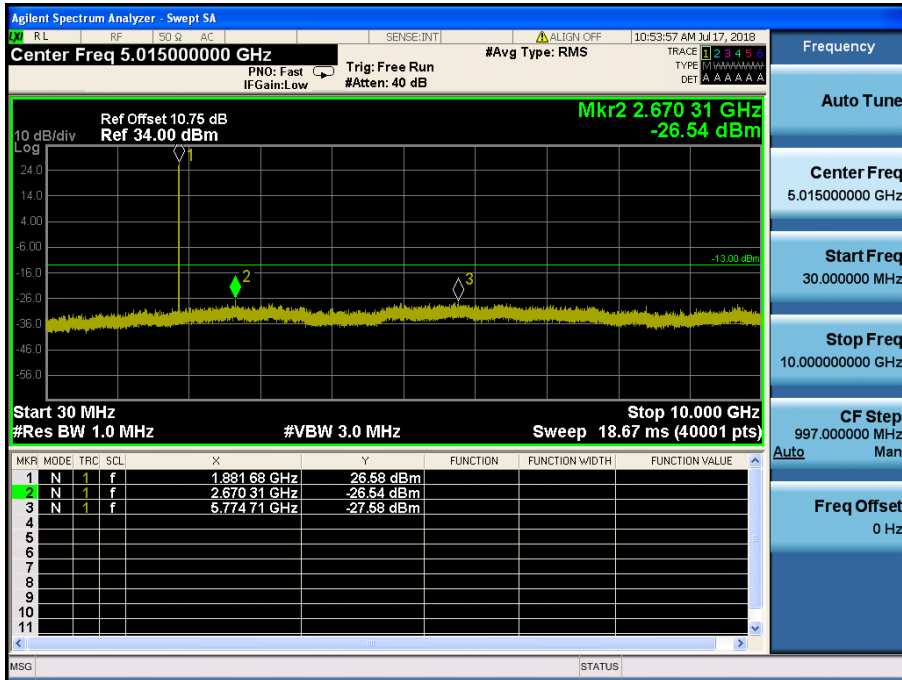

LTE Band 2 / 5MHz / 16QAM - RB Size/Offset (12/13) – Mid Channel

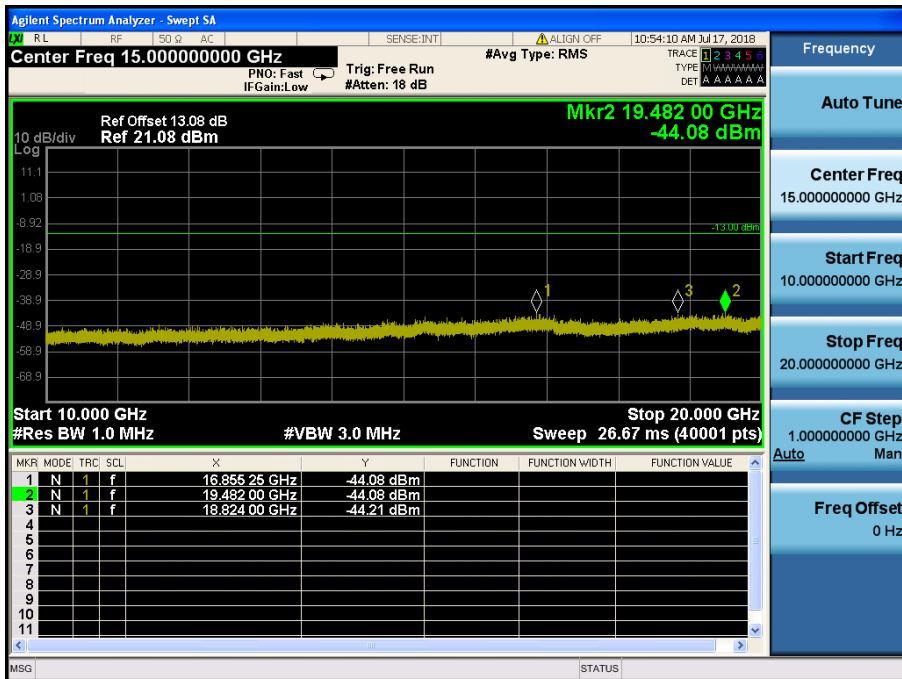

LTE Band 2 / 5MHz / 16QAM - RB Size/Offset (12/13) – Mid Channel

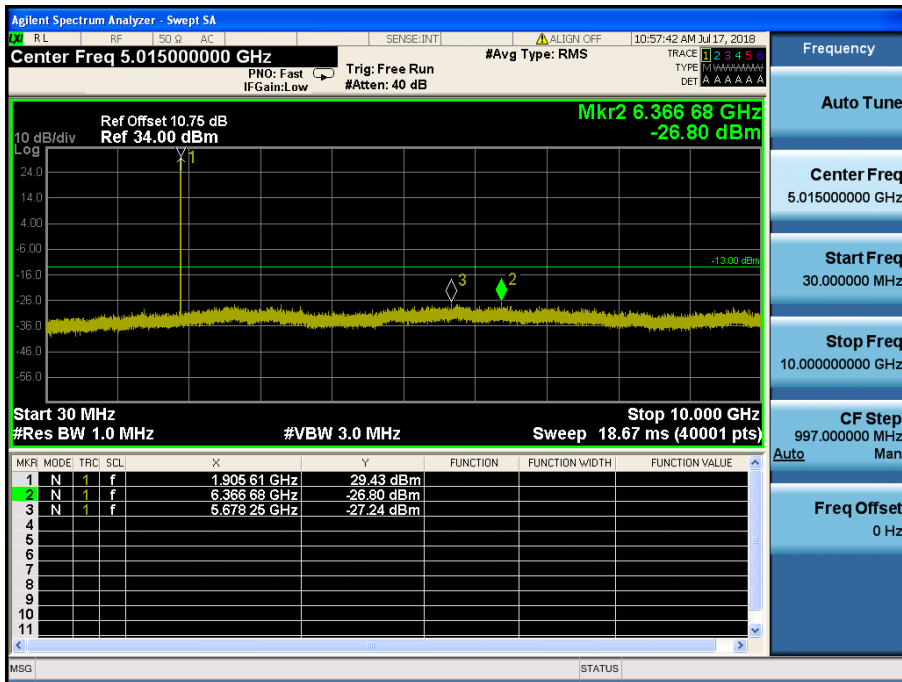

LTE Band 2 / 5MHz / 16QAM - RB Size/Offset (1/0) – High Channel

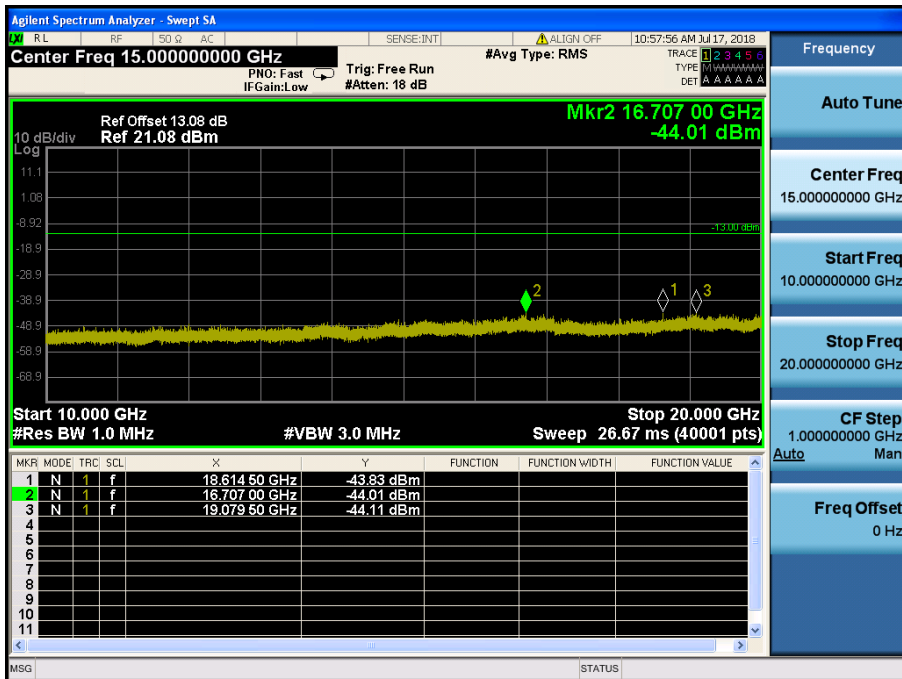

LTE Band 2 / 5MHz / 16QAM - RB Size/Offset (1/0) – High Channel

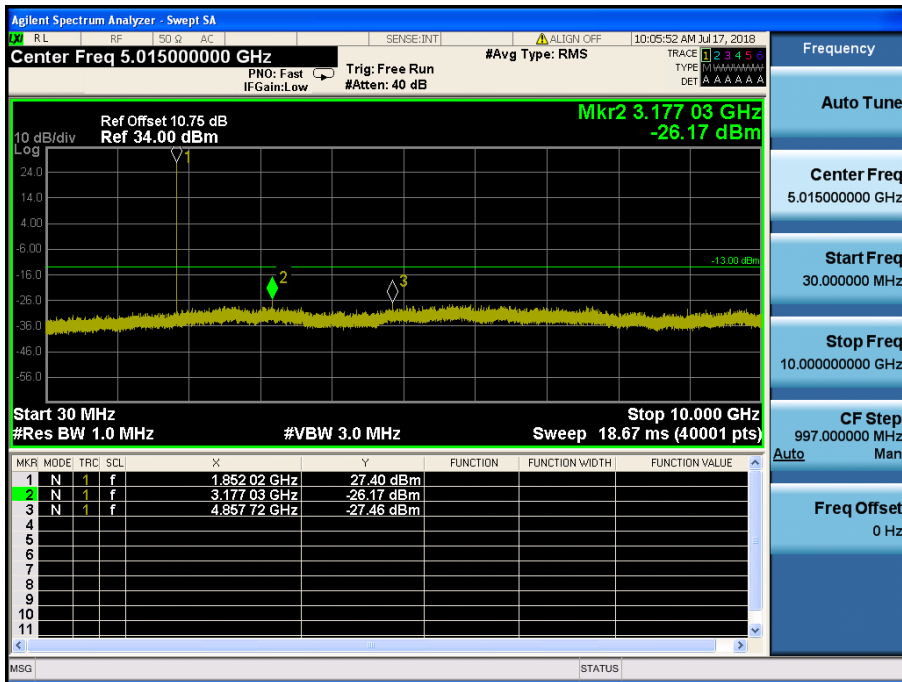

LTE Band 2 / 3MHz / 16QAM - RB Size/Offset (8/7) – Low Channel

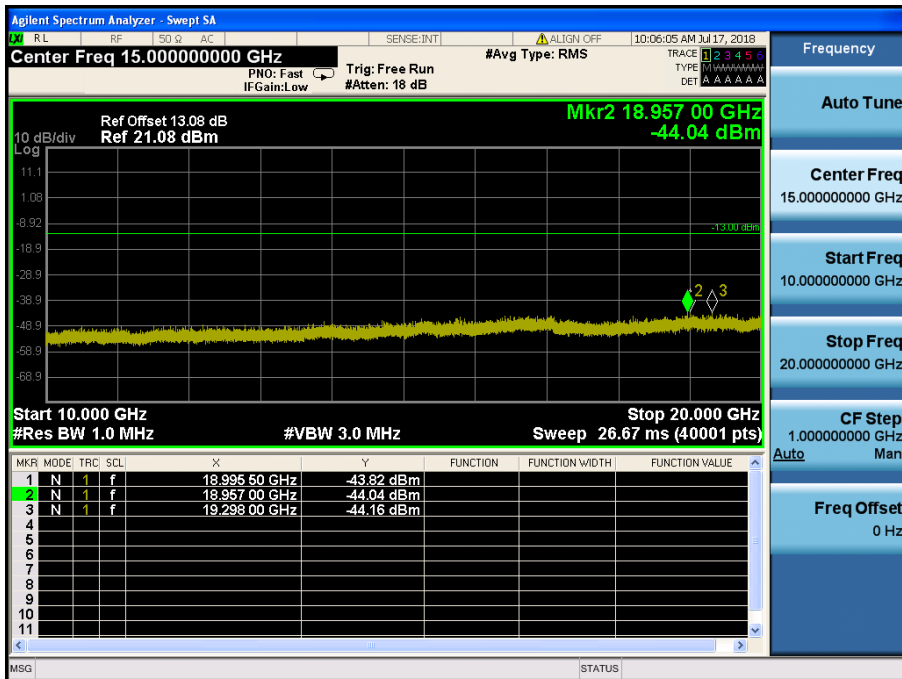

LTE Band 2 / 3MHz / 16QAM - RB Size/Offset (8/7) – Low Channel

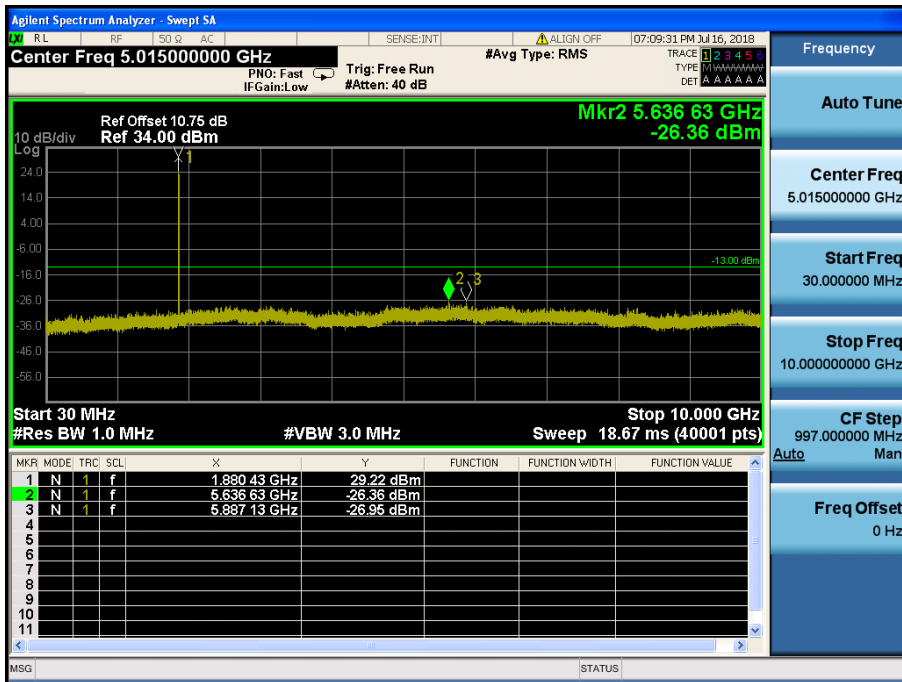

LTE Band 2 / 3MHz / QPSK - RB Size/Offset (1/7) – Mid Channel

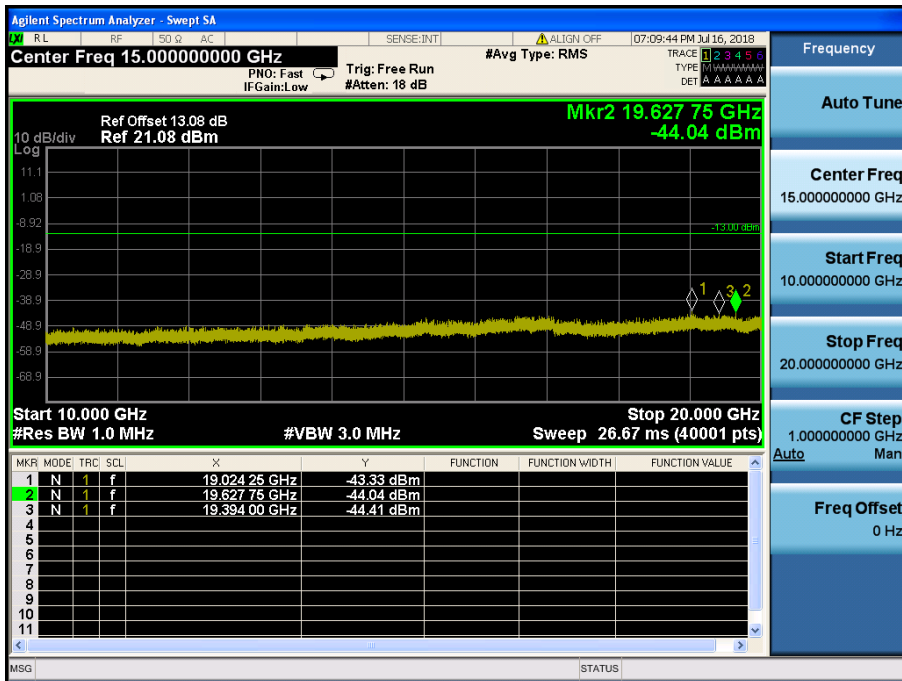

LTE Band 2 / 3MHz / QPSK - RB Size/Offset (1/7) – Mid Channel

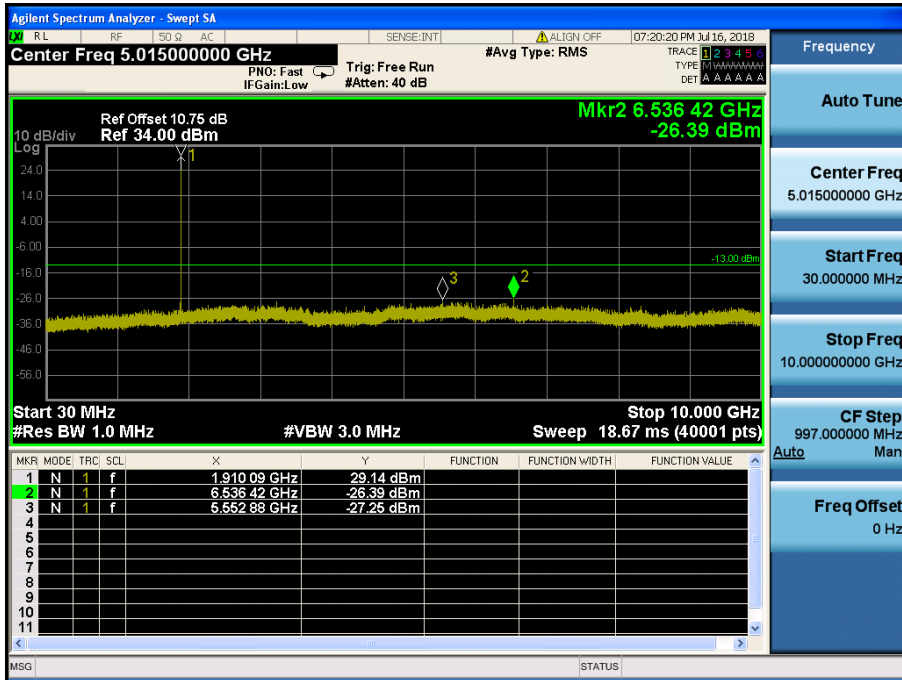

LTE Band 2 / 3MHz / QPSK - RB Size/Offset (1/14) – High Channel

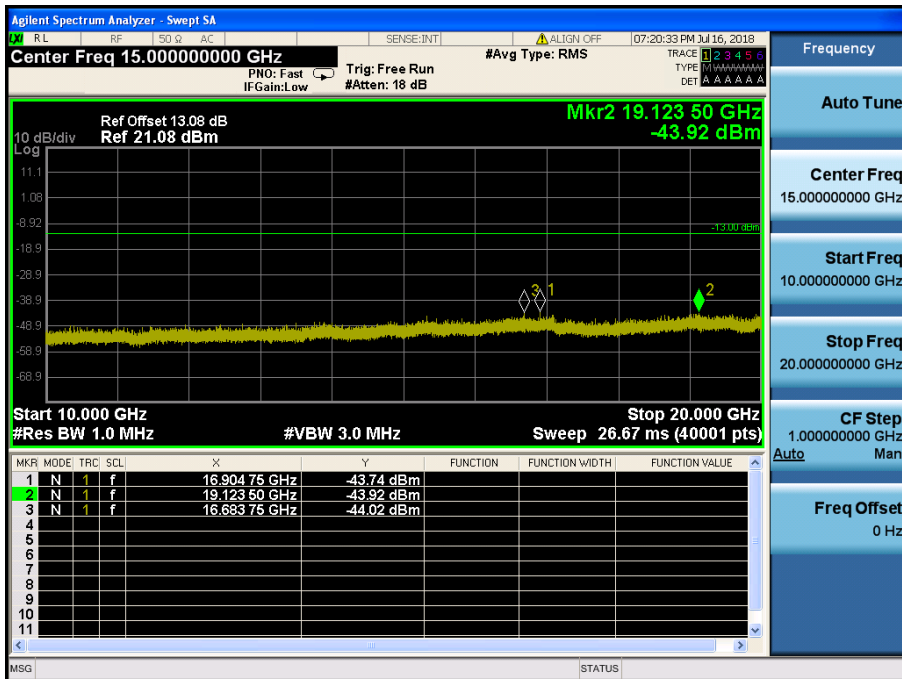

LTE Band 2 / 3MHz / QPSK - RB Size/Offset (1/14) – High Channel

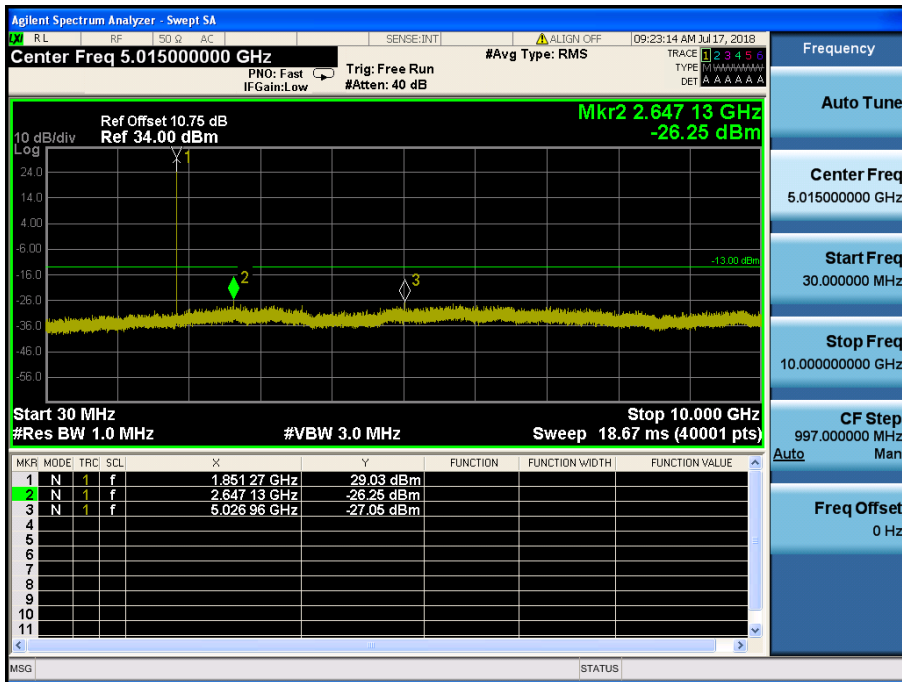

LTE Band 2 / 1.4MHz / 16QAM - RB Size/Offset (3/3) – Low Channel

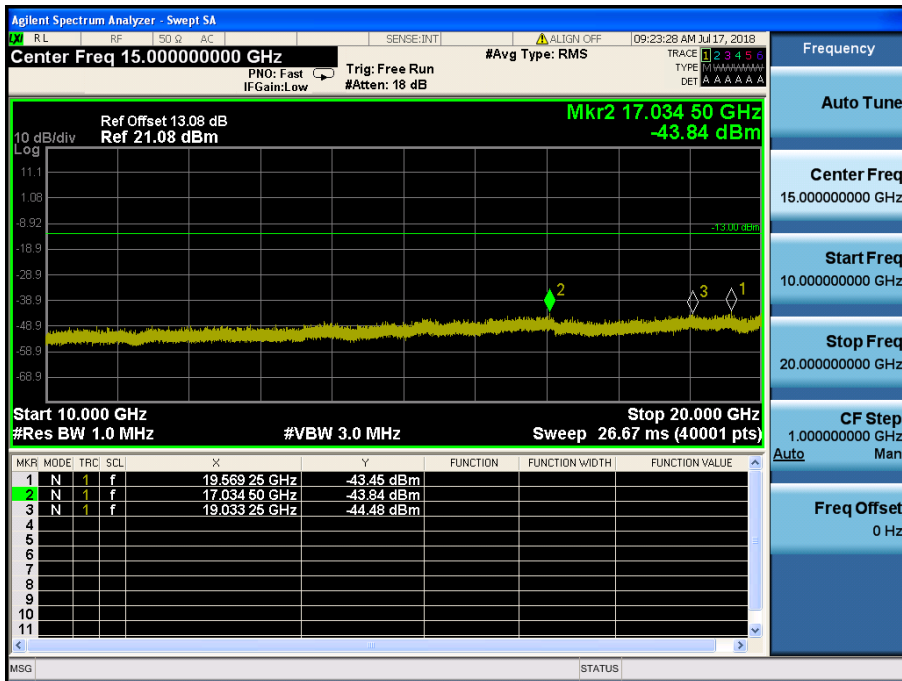

LTE Band 2 / 1.4MHz / 16QAM - RB Size/Offset (3/3) – Low Channel

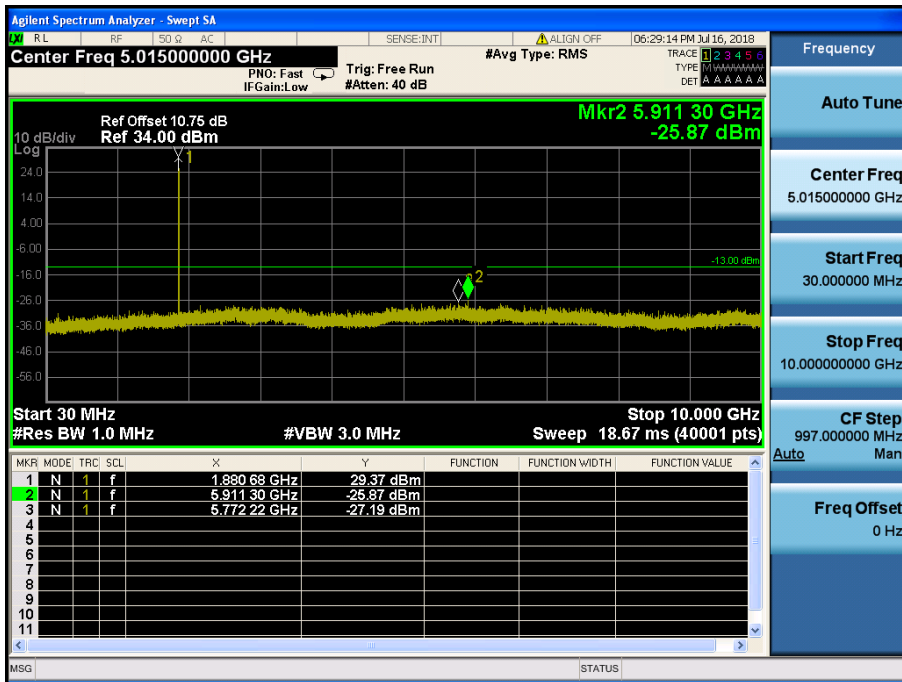

LTE Band 2 / 1.4MHz / QPSK - RB Size/Offset (3/3) – Mid Channel

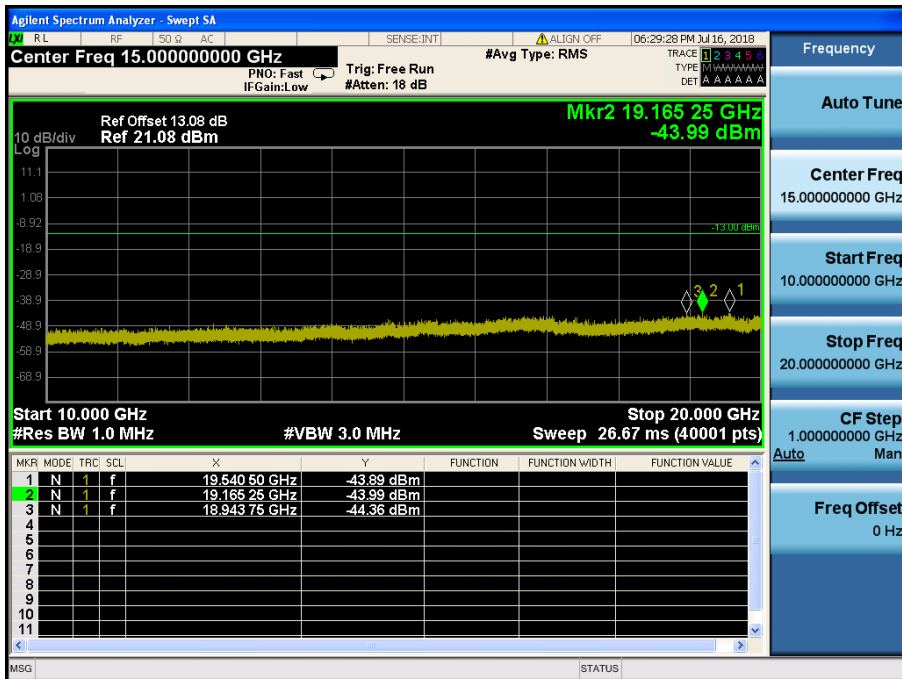

LTE Band 2 / 1.4MHz / QPSK - RB Size/Offset (3/3) – Mid Channel



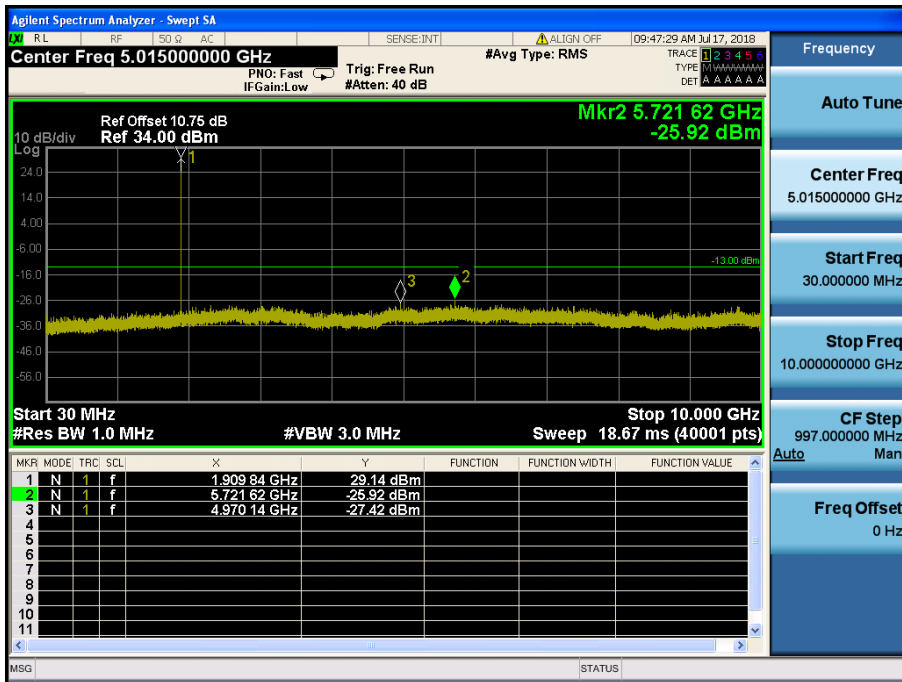

LTE Band 2 / 1.4MHz / 16QAM - RB Size/Offset (3/3) – High Channel

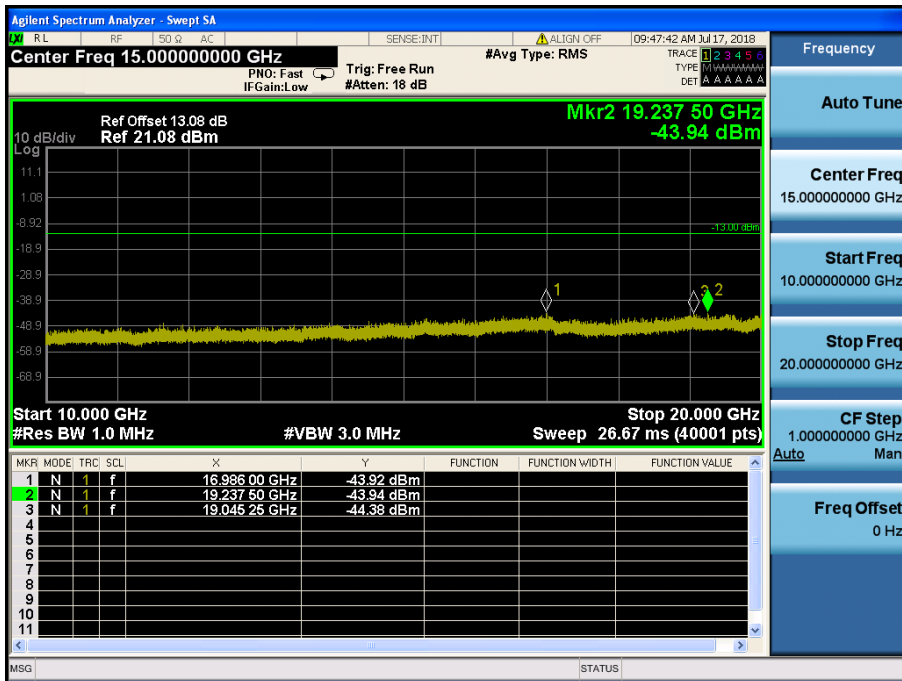

LTE Band 2 / 1.4MHz / 16QAM - RB Size/Offset (3/3) – High Channel