

TEST REPORT



DT&C Co., Ltd.

42, Yurim-ro, 154Beon-gil, Cheoin-gu, Yongin-si, Gyeonggi-do, Korea, 17042
Tel : 031-321-2664, Fax : 031-321-1664

1. Report No : DRTFCC1709-0210(1)
2. Customer
 - Name : LG Electronics MobileComm USA, Inc.
 - Address : 1000 Sylvan Ave., Englewood Cliffs, New Jersey, United States, 07632
3. Use of Report : FCC Original Grant
4. Product Name / Model Name : Mobile Phone / QVR
FCC ID : ZNFQVR
5. Test Method Used : KDB971168 D01v02r02, ANSI/TIA-603-E-2016
Test Specification : §2, §22(H), §27
6. Date of Test : 2017.09.01 ~ 2017.09.20, 2017.10.09
7. Testing Environment : Refer to appended test report.
8. Test Result : Refer to the attached test result.

Affirmation	Tested by	Technical Manager
	Name : Jaejin Lee  (Signature)	Name : Geunki Son  (Signature)

The test results presented in this test report are limited only to the sample supplied by applicant and the use of this test report is inhibited other than its purpose. This test report shall not be reproduced except in full, without the written approval of DT&C Co., Ltd.

2017 . 10 . 09 .

DT&C Co., Ltd.

If this report is required to confirmation of authenticity, please contact to report@dtnc.net

Test Report Version

Test Report No.	Date	Description
DRTFCC1709-0210	Sep. 27, 2017	Initial issue
DRTFCC1709-0210(1)	Oct. 09, 2017	Retest of the OBW and Band edge

Table of Contents

1. GENERAL INFORMATION	5
2. INTRODUCTION	6
2.1 EUT DESCRIPTION	6
2.2. EUT CAPABILITIES	6
2.3. TESTING ENVIRONMENT	6
2.4 MEASURING INSTRUMENT CALIBRATION.....	6
2.5. MEASUREMENT UNCERTAINTY	6
2.6. TEST FACILITY.....	6
3. DESCRIPTION OF TESTS.....	7
3.1 ERP & EIRP (Effective Radiated Power & Equivalent Isotropic Radiated Power)	7
3.2 PEAK TO AVERAGE RATIO	9
3.3 OCCUPIED BANDWIDTH.....	10
3.4 BAND EDGE EMISSIONS AT ANTENNA TERMINAL	11
3.5 SPURIOUS AND HARMONIC EMISSIONS AT ANTENNA TERMINAL	12
3.6 UNDESIRABLE EMISSIONS	13
3.7 FREQUENCY STABILITY	14
4. LIST OF TEST EQUIPMENT	15
5. SUMMARY OF TEST RESULTS	16
6. SAMPLE CALCULATION	17
7. TEST DATA.....	19
7.1 OCCUPIED BANDWIDTH.....	19
7.2 PEAK TO AVERAGE RATIO	19
7.3 BAND EDEG EMISSIONS (Conducted).....	19
7.4 SPURIOUS AND HARMONICS EMISSIONS (Conducted)	19
7.5 ERP & EIRP	20
7.5.1 LTE Band 17.....	20
7.5.2 LTE Band 13.....	21
7.5.3 LTE Band 5.....	22
7.6 UNDESIRABLE EMISSIONS (Radiated).....	24
7.6.1 LTE Band 17.....	24
7.6.2 LTE Band 13.....	26
7.6.3 LTE Band 5.....	29
7.7 FREQUENCY STABILITY	32
7.7.1 LTE Band 17.....	32
7.7.2 LTE Band 13.....	33
7.7.3 LTE Band 5.....	34
8. TEST PLOTS	35
8.1 OCCUPIED BANDWIDTH.....	35
8.1.1 LTE Band 17.....	35

8.1.2 LTE Band 13.....	39
8.1.3 LTE Band 5.....	43
8.2 PEAK TO AVERAGE RATIO	51
8.2.1 LTE Band 17.....	51
8.2.2 LTE Band 13.....	55
8.2.3 LTE Band 5.....	59
8.3 BAND EDGE EMISSIONS(Conducted).....	67
8.3.1 LTE Band 17.....	67
8.3.2 LTE Band 13.....	73
8.3.3 LTE Band 5.....	81
8.4 SPURIOUS AND HARMONICS EMISSIONS(Conducted)	89
8.4.1 LTE Band 17.....	89
8.4.2 LTE Band 13.....	92
8.4.3 LTE Band 5.....	94

1. GENERAL INFORMATION

Applicant Name : LG Electronics MobileComm USA, Inc.
Address : 1000 Sylvan Ave., Englewood Cliffs, New Jersey, United States, 07632
FCC ID : ZNFQVR
FCC Classification : Licensed Portable Transmitter Held to Ear (PCE)
EUT Type : Mobile Phone
Model Name : QVR
Add Model Name : NA
Supplying power : DC 3.85 V
Antenna Information : Built-in type

Mode	TX Frequency (MHz)	Emission Designator	Modulation	ERP	
				Max power (dBm)	Max power (W)
LTE Band 17	709 ~ 711	8M96G7D	QPSK	17.56	0.057
LTE Band 17	709 ~ 711	8M96W7D	16QAM	16.49	0.045
LTE Band 17	709 ~ 711	8M94W7D	64QAM	15.91	0.039
LTE Band 17	706.5 ~ 713.5	4M48G7D	QPSK	17.78	0.060
LTE Band 17	706.5 ~ 713.5	4M49W7D	16QAM	16.74	0.047
LTE Band 17	706.5 ~ 713.5	4M49W7D	64QAM	15.61	0.036
LTE Band 13	782 ~ 782	8M92G7D	QPSK	15.35	0.034
LTE Band 13	782 ~ 782	8M93W7D	16QAM	13.50	0.022
LTE Band 13	782 ~ 782	8M94W7D	64QAM	12.67	0.018
LTE Band 13	779.5 ~ 784.5	4M47G7D	QPSK	15.55	0.036
LTE Band 13	779.5 ~ 784.5	4M48W7D	16QAM	14.00	0.025
LTE Band 13	779.5 ~ 784.5	4M49W7D	64QAM	13.05	0.020
LTE Band 5	829 ~ 844	8M97G7D	QPSK	20.10	0.102
LTE Band 5	829 ~ 844	8M94W7D	16QAM	19.14	0.082
LTE Band 5	829 ~ 844	8M95W7D	64QAM	18.45	0.070
LTE Band 5	826.5 ~ 846.5	4M49G7D	QPSK	19.91	0.098
LTE Band 5	826.5 ~ 846.5	4M48W7D	16QAM	19.35	0.086
LTE Band 5	826.5 ~ 846.5	4M48W7D	64QAM	17.94	0.062
LTE Band 5	825.5 ~ 847.5	2M69G7D	QPSK	19.74	0.094
LTE Band 5	825.5 ~ 847.5	2M70W7D	16QAM	18.93	0.078
LTE Band 5	825.5 ~ 847.5	2M70W7D	64QAM	17.96	0.063
LTE Band 5	824.7 ~ 848.3	1M9G7D	QPSK	19.65	0.092
LTE Band 5	824.7 ~ 848.3	1M9W7D	16QAM	18.82	0.076
LTE Band 5	824.7 ~ 848.3	1M9W7D	64QAM	17.77	0.060

2. INTRODUCTION

2.1 EUT DESCRIPTION

The Equipment under Test (EUT) supports GSM, WCDMA, LTE, WLAN, Bluetooth and NFC.

2.2. EUT CAPABILITIES

This ETU contains the following capabilities:

850/1900 GSM/GPRS/EDGE, 850/1700/1900 WCDMA/HSUPA, Multi-band LTE, 802.11b/g/n/ac WLAN(2.4GHz), 802.11a/n/ac WLAN(5GHz), Bluetooth(BDR, EDR, LE), NFC

2.3. TESTING ENVIRONMENT

Ambient Condition	
▪ Temperature	+20 °C ~ +24 °C
▪ Relative Humidity	40 % ~ 46 %

2.4 MEASURING INSTRUMENT CALIBRATION

The measuring equipment, which was utilized in performing the tests documented herein, has been calibrated in accordance with the manufacturer's recommendations for utilizing calibration equipment, which is traceable to recognized national standards.

2.5. MEASUREMENT UNCERTAINTY

The measurement uncertainties shown below were calculated in accordance with requirements of ANSI C 63.4-2014. All measurement uncertainty values are shown with a coverage factor of $k = 2$ to indicate a 95 % level of confidence.

Parameter	Measurement uncertainty
Radiated Disturbance (Below 1 GHz)	± 5.1 dB (The confidence level is about 95 %, $k = 2$)
Radiated Disturbance (1 GHz ~ 18 GHz)	± 5.4 dB (The confidence level is about 95 %, $k = 2$)
Radiated Disturbance (Above 18 GHz)	± 5.3 dB (The confidence level is about 95 %, $k = 2$)

2.6. TEST FACILITY

DT&C Co., Ltd.		
The 3 m test site and conducted measurement facility used to collect the radiated data are located at the 42, Yurim-ro, 154beon-gil, Cheoin-gu, Yongin-si, Gyeonggi-do, Korea 17042. The site is constructed in conformance with the requirements.		
- FCC MRA Accredited Test Firm No. : KR0034		
www.dtnc.net		
Telephone	:	+ 82-31-321-2664
FAX	:	+ 82-31-321-1664

3. DESCRIPTION OF TESTS

3.1 ERP & EIRP (Effective Radiated Power & Equivalent Isotropic Radiated Power)

Test Set-up

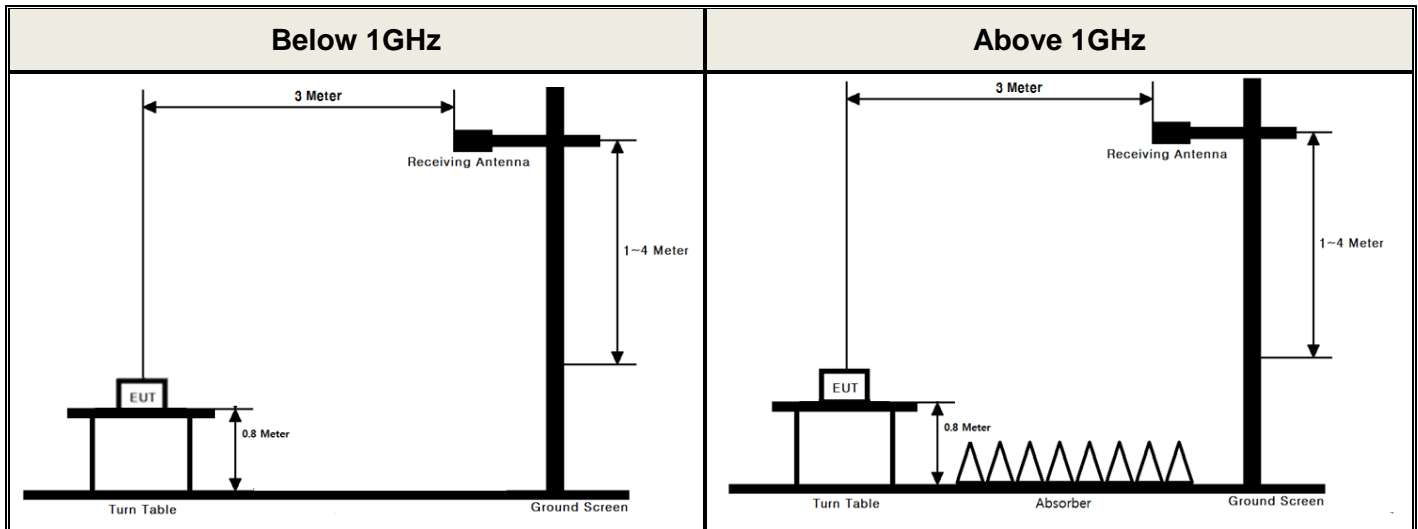

These measurements were performed at 3 m test site. The equipment under test is placed on a non-conductive table 0.8-meters above a turntable which is flush with the ground plane and 3 meters from the receive antenna. For measurements above 1GHz absorbers are placed on the floor between the turn table and the antenna mast in such a way so as to maximize the reduction of reflections. For measurements below 1 GHz, the absorbers are removed.

Test Procedure

- ANSI/TIA-603-E-2016 - Section 2.2.17
- KDB971168 D01v02r02 - Section 5.2.1

Test setting

1. Set span to at least 1.5 times the OBW.
2. Set RBW = 1-5 % of the OBW, not to exceed 1 MHz.
3. Set VBW $\geq 3 \times$ RBW.
4. Set number of points in sweep $\geq 2 \times$ span / RBW.
5. Sweep time = auto couple.
6. Detector = RMS (power averaging).
7. If the EUT can be configured to transmit continuously (i.e., burst duty cycle ≥ 98 %), then set the trigger to free run.
8. If the EUT cannot be configured to transmit continuously (i.e., burst duty cycle < 98 %), then use a sweep trigger with the level set to enable triggering only on full power bursts and configure the EUT to transmit at full power for the entire duration of each sweep.
Ensure that the sweep time is less than or equal to the transmission burst duration.
9. Trace average at least 100 traces in power averaging (i.e., RMS) mode.
10. Compute the power by integrating the spectrum across the OBW of the signal using the instrument's band power measurement function, with the band limits set equal to the OBW band edges. If the instrument does not have a band power function, then sum the spectrum levels (in linear power units) at intervals equal to the RBW extending across the entire OBW of the spectrum.

The receiver antenna height and turntable rotations were adjusted for the highest reading on the receive spectrum analyzer.

A half-wave dipole was substituted in place of the EUT. This dipole antenna was driven by a signal generator and the level of the signal generator was adjusted to obtain the same receive spectrum analyzer reading. The conducted power at the terminal of the substitute antenna is measured.

The ERP/EIRP is calculated using the following formula:

ERP/EIRP = The conducted power at the substitute antenna`s terminal [dBm] + Substitute Antenna gain [dBd for ERP , dBi for EIRP]

For readings above 1 GHz, the above procedure is repeated using horn antennas and the difference between the gain of the horn antenna and an isotropic antenna are taken into consideration.

3.2 PEAK TO AVERAGE RATIO

Test set-up

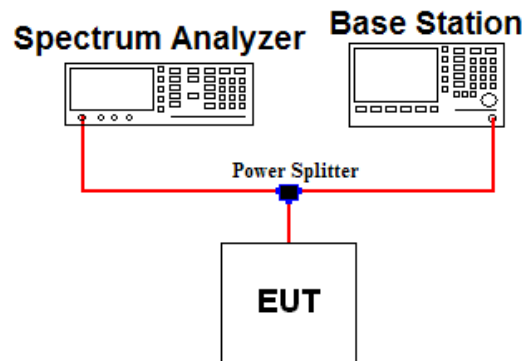

Test Procedure

- KDB971168 D01v02r02 - Section 5.7.1

A peak to average ratio measurement is performed at the conducted port of the EUT. The spectrum analyzers Complementary Cumulative Distribution Function (CCDF) measurement profile is used to determine the largest deviation between the average and the peak power of the EUT in a given bandwidth. The CCDF curve shows how much time the peak waveform spends at or above a given average power level. The present of time the signal spends at or above the level defines the probability for that particular power level.

Test setting

The spectrum Analyzer's CCDF measurement function is enabled.

1. Set resolution/measurement bandwidth \geq signal's occupied bandwidth.
2. Set the number of counts to a value that stabilizes the measured CCDF curve
3. Set the measurement interval as follows:
 - 1) For continuous transmissions, set to 1 ms.
 - 2) For burst transmissions, employ an external trigger that is synchronized with the EUT burst timing sequence, or use the internal burst trigger with a trigger level that allows the burst to stabilize and set the measurement interval to a time that is less than or equal to the burst duration.
4. Record the maximum PAPR level associated with a probability of 0.1 %

3.3 OCCUPIED BANDWIDTH.

Test set-up

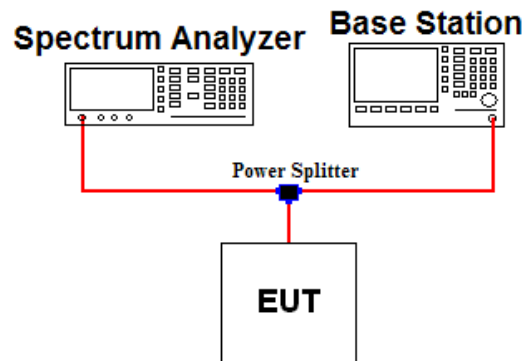

Test Procedure

- KDB971168 D01v02r02 - Section 4.2

The occupied bandwidth, that is the frequency bandwidth such that, below its lower and above its upper frequency limits, the mean powers radiated are each equal to 0.5 percent of the total mean power of a given emission.

Test setting

1. The signal analyzer's automatic bandwidth measurement capability was used to perform the 99 % occupied bandwidth and the 26 dB bandwidth. The bandwidth measurement was not influenced by any intermediate power nulls in the fundamental emission.
2. $RBW = 1 \sim 5 \%$ of the expected OBW & $VBW \geq 3 \times RBW$
3. Detector = Peak
4. Trance mode = Max hold
5. Sweep = Auto couple
6. The trace was allowed to stabilize
7. If necessary, step 2 ~ 6 were repeated after changing the RBW such that it would be within 1 ~ 5 % of the 99 % occupied bandwidth observed in step 6.

3.4 BAND EDGE EMISSIONS AT ANTENNA TERMINAL

Test set-up

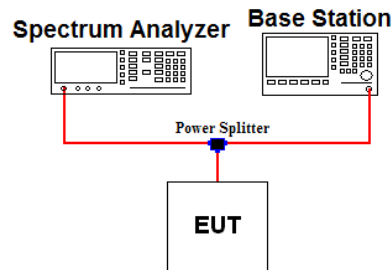

Test Procedure

- KDB971168 D01v02r02 - Section 6

All out of band emissions are measured by means of a calibrated spectrum analyzer. The EUT was setup to maximum output power at its lowest and highest channel with all bandwidths, modulations and RB configurations.

The power of any spurious emission shall be attenuated below the transmitter power (P) by at least $43 + 10 \log(P)$ dB.

Test setting

1. Start and stop frequency were set such that the band edge would be placed in the center of the plot
2. Span was set large enough so as to capture all out of band emissions near the band edge
3. RBW ≥ 1 % of the emission bandwidth
4. VBW $\geq 3 \times$ RBW
5. Detector = RMS & Trace mode = Max hold
6. Sweep time = Auto couple or 1 s for band edge
7. Number of sweep point $\geq 2 \times$ span / RBW
8. The trace was allowed to stabilize

Note 1: Per Part 22.917(b)(1) in the 1 MHz bands immediately outside and adjacent to the frequency block a resolution bandwidth of at least one percent of the emission bandwidth of the fundamental emission of the transmitter may be employed to demonstrate compliance with the out-of-band emissions limit.

The emission bandwidth is defined as the width of the signal between two points, one below the carrier center frequency and one above the carrier center frequency, outside of which all emission are attenuated at least 26 dB below the transmitter power.

Note 2: Per Part 27(g) for operations in the 600 MHz band and the 698-746 MHz band, compliance with this provision is based on the use of measurement instrumentation employing a resolution bandwidth of 100 kilohertz or greater. However, in the 100 kilohertz bands immediately outside and adjacent to a licensee's frequency block, a resolution bandwidth of at least 30 kHz may be employed.

Note 3: Per Part 27.53(c.5) for operations in the 776-788 MHz band, compliance with this provision is based on the use of measurement instrumentation employing a resolution bandwidth of 100 kilohertz or greater. However, in the 100 kilohertz bands immediately outside and adjacent to a licensee's frequency block, a resolution bandwidth of at least 30 kHz may be employed.

Note 4: Per Part 27.53(c.4) for all frequencies between 763-775 MHz and 793-805 MHz, the FCC limit is $65 + 10 \log_{10}(P[\text{Watts}]) - 35 \text{ dBm}$ in a 6.25kHz bandwidth.

3.5 SPURIOUS AND HARMONIC EMISSIONS AT ANTENNA TERMINAL

Test set-up

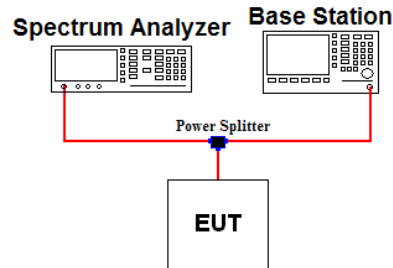

Test Procedure

- KDB971168 D01v02r02 - Section 6

The level of the carrier and the various conducted spurious and harmonic frequencies is measured by means of a calibrated spectrum analyzer. The EUT was setup to maximum output power at its low, middle, high channel with all bandwidths, modulations and RB configurations. The spectrum is scanned from 9 kHz up to a frequency including its 10th harmonic.

The power of any spurious emission shall be attenuated below the transmitter power (P) by at least $43 + 10 \log(P)$ dB.

Test setting

1. RBW = 100 kHz(Below 1 GHz) or 1 MHz(Above 1 GHz) & VBW $\geq 3 \times$ RBW (Refer to Note 1)
2. Detector = RMS & Trace mode = Max hold
3. Sweep time = Auto couple
4. Number of sweep point $\geq 2 \times$ span / RBW
5. The trace was allowed to stabilize

Note 1: Compliance with these provisions is based on the use of measurement instrumentation employing a resolution bandwidth of 100 kHz or greater for frequencies less than 1GHz and 1MHz or greater for frequencies greater than 1GHz.

3.6 UNDESIRABLE EMISSIONS

Test Set-up

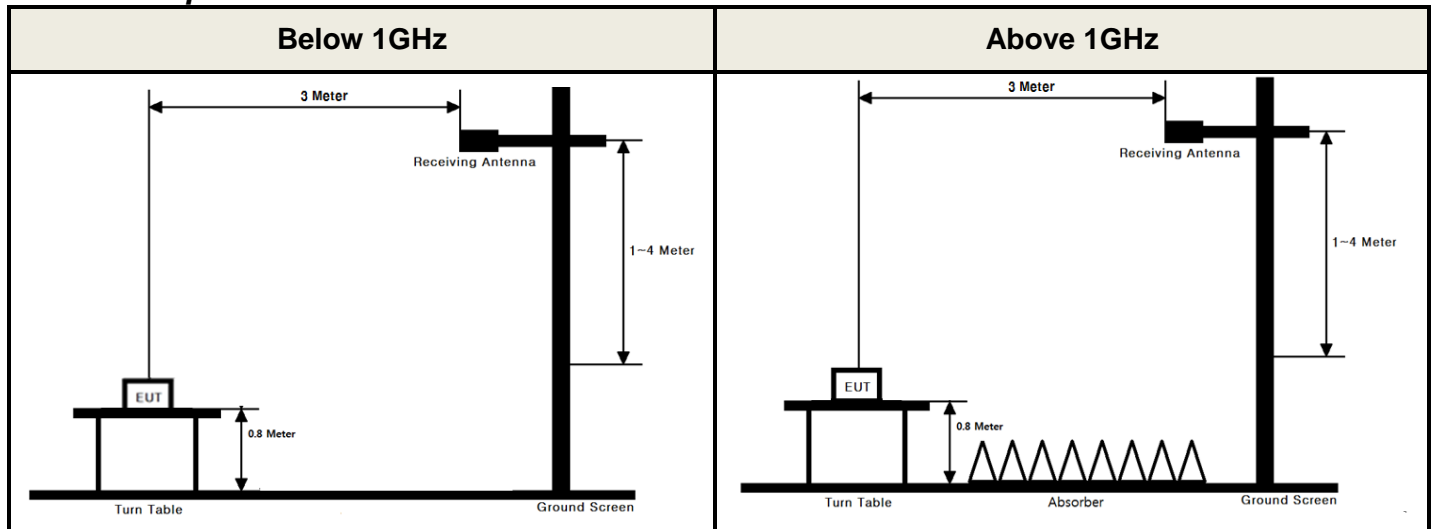

These measurements were performed at 3 test site. The equipment under test is placed on a non-conductive table 0.8-meters above a turntable which is flush with the ground plane and 3 meters from the receive antenna. For measurements above 1GHz absorbers are placed on the floor between the turn table and the antenna mast in such a way so as to maximize the reduction of reflections. For measurements below 1 GHz, the absorbers are removed.

Test Procedure

- ANSI/TIA-603-E-2016 - Section 2.2.12
- KDB971168 D01v02r02 - Section 5.8

Test setting

1. RBW = 100 kHz for below 1 GHz and 1 MHz for above 1 GHz / VBW \geq 3 X RBW
2. Detector = RMS & Trace mode = Max hold
3. Sweep time = Auto couple
4. Number of sweep point \geq 2 X span / RBW
5. The trace was allowed to stabilize

The receive antenna height and turntable rotations were adjusted for the highest reading on the receive spectrum analyzer.

For radiated power measurements below 1 GHz, a half-wave dipole was substituted in place of the EUT. This dipole antenna was driven by a signal generator and the level of the signal generator was adjusted to obtain the same spectrum analyzer reading.

For radiated power measurements above 1 GHz, a Horn antenna was substituted in place of the EUT. This Horn antenna was driven by a signal generator and the level of the signal generator was adjusted to obtain the same spectrum analyzer reading. The difference between the gain of the horn and an isotropic antenna are taken into consideration.

This measurement was performed with the EUT oriented in 3 orthogonal axis.

3.7 FREQUENCY STABILITY

Test Set-up

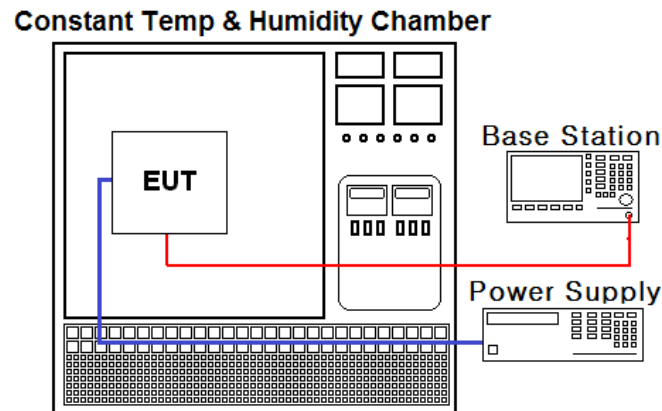

Test Procedure

- ANSI/TIA-603-E-2016
- KDB971168 D01v02r02 - Section 9

The frequency stability of the transmitter is measured by:

a.) **Temperature:**

The temperature is varied from - 30 °C to + 50 °C using an environmental chamber.

b.) **Primary Supply Voltage:**

The primary supply voltage is varied from 85 % to 115 % of the nominal value for non hand-carried battery and AC powered equipment. For hand-carried, battery-powered equipment, primary supply voltage is reduced to the battery operating end point which shall be specified by the manufacturer.

Specification:

The frequency stability shall be sufficient to ensure that the fundamental emission stays within the authorized frequency block for Part 24, 27. The frequency stability of the transmitter shall be maintained within $\pm 0.00025\%$ (± 2.5 ppm) of the center frequency for Part 22.

Time Period and Procedure:

1. The carrier frequency of the transmitter is measured at room temperature.
(20 °C to provide a reference)
2. The equipment is turned on in a "standby" condition for one minute before applying power to the transmitter. Measurement of the carrier frequency of the transmitter is made within one minute after applying power to the transmitter.
3. Frequency measurements are made at 10 °C intervals ranging from -30 °C to +50 °C.
A period of at least one half-hour is provided to allow stabilization of the equipment at each temperature level.

4. LIST OF TEST EQUIPMENT

Type	Manufacturer	Model	Cal.Date (yy/mm/dd)	Next.Cal. Date (yy/mm/dd)	S/N
Spectrum Analyzer	Agilent Technologies	N9020A	16/10/11	17/10/11	MY46471251
			17/09/05	18/09/05	
Spectrum Analyzer	Agilent Technologies	N9020A	16/10/19	17/10/19	MY48011075
			17/09/06	18/09/06	
Radio Communication Analyzer	Anritsu	MT8820C	17/01/03	18/01/03	6201274516
DC Power Supply	Agilent Technologies	66332A	16/10/17	17/10/17	MY43000394
			17/09/05	18/09/05	
Multimeter	FLUKE	17B	17/04/12	18/04/12	26030065WS
Power Splitter	Anritsu	K241B	17/01/11	18/01/11	016681
Temp & Humi Test Chamber	SJ Science	SJ-TH-S50	17/01/25	18/01/25	SJ-TH-S50-140205
Thermohygrometer	BODYCOM	BJ5478	17/04/11	18/04/11	120612-1
Signal Generator	R&S	SMBV100A	17/01/04	18/01/04	255571
Signal Generator	R&S	SMF100A	17/04/21	18/04/21	102341
Loop Antenna	Schwarzbeck	FMZB1513	16/04/22	18/04/22	1513-128
Bilog Antenna	Schwarzbeck	VULB9160	16/11/11	18/11/11	3151
Dipole Antenna	Schwarzbeck	VHA9103	17/03/14	19/03/14	2116
Dipole Antenna	Schwarzbeck	VHA9103	16/04/15	18/04/15	2117
Dipole Antenna	Schwarzbeck	UHA9105	17/03/14	19/03/14	2261
Dipole Antenna	Schwarzbeck	UHA9105	16/04/15	18/04/15	2262
HORN ANT	ETS-LINDGREN	3117	16/02/26	18/02/26	00152145
HORN ANT	ETS-LINDGREN	3117	16/05/03	18/05/03	00140394
Amplifier	RF Bay Inc	MPA-40-40	17/04/12	18/04/12	21151801
Amplifier	EMPOWER	BBS3Q7ELU	16/09/08	17/09/08	1020
			17/09/06	18/09/06	
PreAmplifier	tsj	MLA-010K01-B01-27	17/03/06	18/03/06	1844539
Amplifier	Agilent	8449B	16/10/19	17/10/19	3008A02108
			17/09/05	18/09/05	
High-pass filter	Wainwright	WHKX12-935-1000-15000-40SS	16/09/09	17/09/09	7
			17/09/05	18/09/05	

5. SUMMARY OF TEST RESULTS

FCC Part Section(s)	Test Description	Test Limit	Test Condition	Status Note 1
2.1046	Conducted Output Power	N/A	Conducted	C Note2
2.1049	Occupied Bandwidth	N/A		C
27.50(d.5)	Peak to Average Ratio	< 13 dB		C
2.1051 22.917(a) 27.53(g) 27.53(c)	Band Edge / Conducted Spurious Emissions	> 43 + 10log ₁₀ (P) dB at Band edge and for all out-of-band emissions		C
27.53(c.4)	Undesirable Emissions in 763 ~ 775MHz & 793 ~ 805MHz	< 65 + 10 log ₁₀ (P) dB		C
2.1055 22.355 27.54	Frequency Stability	< 2.5 ppm (Part 22) Fundamental emissions must stay within Authorized frequency block (Part 27)		C
27.50(b.10) 27.50(c.10)	Radiated Output Power (B13, 17)	< 3 Watts max. ERP	Radiated ^{Note3}	C
22.913(a.2)	Radiated Output Power (B5)	< 7 Watts max. ERP		C
2.1053 22.917(a) 27.53(g) 27.53(c)	Undesirable Emissions	> 43 + 10log ₁₀ (P) dB for all out-of-band emissions		C
27.53(f)	Undesirable Emissions in 1559 ~ 1610MHz	< -70 dBW/MHz (for wideband signals) < -80 dBW (for discrete emissions of less than 700 Hz bandwidth)		C

Note 1: **C**=Comply **NC**=Not Comply **NT**=Not Tested **NA**=Not Applicable

Note 2: Refer to RF Exposure Report (Test Report SAR)

Note 3: This device supports wireless charging capability.

So per KDB648474 D03v01r04, the radiated test items were performed both normal and charging conditions. For wireless charging condition, the handset is placed on the representative charging pad under normal conditions and in a simulated call configuration.

And the worst case data was reported.

6. SAMPLE CALCULATION

A. Emission Designator

LTE Band 17(QPSK)

Emission Designator = **8M96G7D**
LTE OBW = 8.963 MHz
G = Phase Modulation
7 = Quantized/Digital Info
D = Data Transmission

LTE Band 17(64QAM)

Emission Designator = **8M94W7D**
LTE OBW = 8.941 MHz
W = Amplitude/Angle Modulated
7 = Quantized/Digital Info
D = Data Transmission

LTE Band 13(QPSK)

Emission Designator = **8M92G7D**
LTE OBW = 8.925 MHz
G = Phase Modulation
7 = Quantized/Digital Info
D = Data Transmission

LTE Band 17(64QAM)

Emission Designator = **8M94W7D**
LTE OBW = 8.937 MHz
W = Amplitude/Angle Modulated
7 = Quantized/Digital Info
D = Data Transmission

LTE Band 5(QPSK)

Emission Designator = **8M97G7D**
LTE OBW = 8.972 MHz
G = Phase Modulation
7 = Quantized/Digital Info
D = Data Transmission

LTE Band 5(64QAM)

Emission Designator = **8M95W7D**
LTE OBW = 8.947 MHz
W = Amplitude/Angle Modulated
7 = Quantized/Digital Info
D = Data Transmission

LTE Band 17(16QAM)

Emission Designator = **8M96W7D**
LTE OBW = 8.964 MHz
W = Amplitude/Angle Modulated
7 = Quantized/Digital Info
D = Data Transmission

LTE Band 13(16QAM)

Emission Designator = **8M93W7D**
LTE OBW = 8.933 MHz
W = Amplitude/Angle Modulated
7 = Quantized/Digital Info
D = Data Transmission

LTE Band 5(16QAM)

Emission Designator = **8M94W7D**
LTE OBW = 8.943 MHz
W = Amplitude/Angle Modulated
7 = Quantized/Digital Info
D = Data Transmission

B. For substitution method

Channel Bandwidth (MHz)	Test Frequency (MHz)	Test Mode	RB Size/ Offset	Spectrum Reading Value(dBm)	EUT Axis	Ant Pol (H/V)	Level(dBm) @ Ant Terminal	TX Ant Gain (dBd)	ERP (dBm)	ERP (W)
10	829	QPSK	1/0	-16.51	X	H	18.87	1.23	20.10	0.102

ERP or EIRP = Level @ Ant Terminal LEVEL(dBm) + Tx Ant. Gain

- 1) The EUT mounted on a non-conductive turntable is 0.8 meter above test site ground level.
- 2) During the test, the turn table is rotated until the maximum signal is found.
- 3) Record the field strength meter's level.
- 4) Replace the EUT with dipole/Horn antenna that is connected to a calibrated signal generator.
- 5) Increase the signal generator output till the field strength meter's level is equal to the item (3).
- 6) The signal generator output level with substituted antenna gain is the rating of ERP, EIRP or Radiated spurious emission.

7. TEST DATA

7.1 OCCUPIED BANDWIDTH

- Plots of the EUT's Occupied Bandwidth are shown in Clause 8.1

7.2 PEAK TO AVERAGE RATIO

- Plots of the EUT's Peak- to- Average Ratio are shown in Clause 8.2

7.3 BAND EDGE EMISSIONS (Conducted)

- Plots of the EUT's Band Edge Emissions are shown in Clause 8.3

7.4 SPURIOUS AND HARMONICS EMISSIONS (Conducted)

- Plots of the EUT's Spurious Emissions are shown in Clause 8.4

7.5 ERP & EIRP

7.5.1 LTE Band 17

- Measurement data: Without wireless charging pad

Channel Bandwidth (MHz)	Test Frequency (MHz)	Test Mode	RB Size/ Offset	Ant Pol (H/V)	Level(dBm) @ Ant Terminal	TX Ant Gain (dBd)	ERP (dBm)	ERP (W)
10	709	QPSK	1/0	H	16.28	1.28	17.56	0.057
		16QAM	1/0	H	15.21	1.28	16.49	0.045
		64QAM	1/0	H	14.63	1.28	15.91	0.039
	711	QPSK	1/0	H	15.85	1.28	17.13	0.052
		16QAM	1/0	H	15.08	1.28	16.36	0.043
		64QAM	1/0	H	14.28	1.28	15.56	0.036
5	706.5	QPSK	1/0	H	16.50	1.28	17.78	0.060
		16QAM	1/0	H	15.46	1.28	16.74	0.047
		64QAM	1/0	H	14.33	1.28	15.61	0.036
	710	QPSK	1/0	H	15.93	1.28	17.21	0.053
		16QAM	1/0	H	14.91	1.28	16.19	0.042
		64QAM	1/0	H	13.97	1.28	15.25	0.033
	713.5	QPSK	1/0	H	14.98	1.28	16.26	0.042
		16QAM	1/0	H	14.31	1.28	15.59	0.036
		64QAM	1/0	H	13.29	1.28	14.57	0.029

Note: This device was tested under all bandwidths, modulations and RB configurations and the worst case data are reported in the table above.

- Measurement data: With wireless charging pad

Channel Bandwidth (MHz)	Test Frequency (MHz)	Test Mode	RB Size/ Offset	Ant Pol (H/V)	Level(dBm) @ Ant Terminal	TX Ant Gain (dBd)	ERP (dBm)	ERP (W)
10	709	QPSK	1/0	H	15.96	1.28	17.24	0.053
5	706.5	QPSK	1/0	H	16.31	1.28	17.59	0.057

Note: This device was tested under all bandwidths, modulations and RB configurations and the worst case data are reported in the table above.

7.5.2 LTE Band 13

- Measurement data: Without wireless charging pad

Channel Bandwidth (MHz)	Test Frequency (MHz)	Test Mode	RB Size/ Offset	Ant Pol (H/V)	Level(dBm) @ Ant Terminal	TX Ant Gain (dBd)	ERP (dBm)	ERP (W)
10	782	QPSK	1/0	H	14.09	1.26	15.35	0.034
		16QAM	1/0	H	12.24	1.26	13.50	0.022
		64QAM	1/0	H	11.41	1.26	12.67	0.018
5	779.5	QPSK	1/12	H	13.36	1.26	14.62	0.029
		16QAM	1/12	H	11.91	1.26	13.17	0.021
		64QAM	1/12	H	10.89	1.26	12.15	0.016
	782	QPSK	1/12	H	13.81	1.26	15.07	0.032
		16QAM	1/12	H	12.28	1.26	13.54	0.023
		64QAM	1/12	H	11.35	1.26	12.61	0.018
	784.5	QPSK	1/0	H	14.30	1.25	15.55	0.036
		16QAM	1/0	H	12.75	1.25	14.00	0.025
		64QAM	1/0	H	11.80	1.25	13.05	0.020

Note: This device was tested under all bandwidths, modulations and RB configurations and the worst case data are reported in the table above.

- Measurement data: With wireless charging pad

Channel Bandwidth (MHz)	Test Frequency (MHz)	Test Mode	RB Size/ Offset	Ant Pol (H/V)	Level(dBm) @ Ant Terminal	TX Ant Gain (dBd)	ERP (dBm)	ERP (W)
10	782	QPSK	1/0	H	13.84	1.26	15.10	0.032
5	784.5	QPSK	1/0	H	14.27	1.25	15.52	0.036

Note: This device was tested under all bandwidths, modulations and RB configurations and the worst case data are reported in the table above.

7.5.3 LTE Band 5

- Measurement data: Without wireless charging pad

Channel Bandwidth (MHz)	Test Frequency (MHz)	Test Mode	RB Size/ Offset	Ant Pol (H/V)	Level(dBm) @ Ant Terminal	TX Ant Gain (dBd)	ERP (dBm)	ERP (W)
10	829	QPSK	1/0	H	18.87	1.23	20.10	0.102
		16QAM	1/0	H	17.91	1.23	19.14	0.082
		64QAM	1/0	H	17.22	1.23	18.45	0.070
	836.5	QPSK	1/25	H	18.34	1.22	19.56	0.090
		16QAM	1/25	H	17.81	1.22	19.03	0.080
		64QAM	1/25	H	16.40	1.22	17.62	0.058
	844	QPSK	1/0	H	17.73	1.21	18.94	0.078
		16QAM	1/0	H	17.35	1.21	18.56	0.072
		64QAM	1/0	H	16.35	1.21	17.56	0.057
5	826.5	QPSK	1/0	H	18.68	1.23	19.91	0.098
		16QAM	1/0	H	18.12	1.23	19.35	0.086
		64QAM	1/0	H	16.71	1.23	17.94	0.062
	836.5	QPSK	1/12	H	17.86	1.22	19.08	0.081
		16QAM	1/12	H	17.18	1.22	18.40	0.069
		64QAM	1/12	H	16.19	1.22	17.41	0.055
	846.5	QPSK	1/24	H	17.51	1.21	18.72	0.074
		16QAM	1/24	H	16.75	1.21	17.96	0.063
		64QAM	1/24	H	15.50	1.21	16.71	0.047
3	825.5	QPSK	1/7	H	18.51	1.23	19.74	0.094
		16QAM	1/7	H	17.70	1.23	18.93	0.078
		64QAM	1/7	H	16.73	1.23	17.96	0.063
	836.5	QPSK	1/7	H	18.18	1.22	19.40	0.087
		16QAM	1/7	H	17.32	1.22	18.54	0.071
		64QAM	1/7	H	16.34	1.22	17.56	0.057
	847.5	QPSK	1/14	H	17.39	1.21	18.60	0.072
		16QAM	1/14	H	16.70	1.21	17.91	0.062
		64QAM	1/14	H	15.69	1.21	16.90	0.049
1.4	824.7	QPSK	1/2	H	18.42	1.23	19.65	0.092
		16QAM	1/2	H	17.59	1.23	18.82	0.076
		64QAM	1/2	H	16.54	1.23	17.77	0.060
	836.5	QPSK	1/2	H	18.17	1.22	19.39	0.087
		16QAM	1/2	H	17.41	1.22	18.63	0.073
		64QAM	1/2	H	16.16	1.22	17.38	0.055
	848.3	QPSK	1/5	H	17.77	1.21	18.98	0.079
		16QAM	1/5	H	16.97	1.21	18.18	0.066
		64QAM	1/5	H	16.01	1.21	17.22	0.053

Note: This device was tested under all bandwidths, modulations and RB configurations and the worst case data are reported in the table above.

- Measurement data: With wireless charging pad

Channel Bandwidth (MHz)	Test Frequency (MHz)	Test Mode	RB Size/ Offset	Ant Pol (H/V)	Level(dBm) @ Ant Terminal	TX Ant Gain (dBd)	ERP (dBm)	ERP (W)
10	829	QPSK	1/0	H	18.80	1.23	20.03	0.101
5	826.5	QPSK	1/0	H	18.31	1.23	19.54	0.090
3	825.5	QPSK	1/7	H	18.10	1.23	19.33	0.086
1.4	824.7	QPSK	1/2	H	18.10	1.23	19.33	0.086

Note: This device was tested under all bandwidths, modulations and RB configurations and the worst case data are reported in the table above.

7.6 UNDESIRABLE EMISSIONS (Radiated)

7.6.1 LTE Band 17

- Measurement data: Without wireless charging pad

B.W (MHz)	Test Freq. (MHz)	RB Size/Offset	Test Mode	Freq.(MHz)	Ant Pol (H/V)	Level(dBm) @ Ant Terminal	TX Ant Gain(dBd)	Result		Limit (dBc)
								(dBm)	(dBc)	
10	709	1/0	QPSK	1407.92	V	-60.20	2.95	-57.25	74.81	30.56
		1/0	16QAM	1410.72	V	-60.03	2.96	-57.07	73.56	29.49
		1/0	64QAM	1411.67	V	-60.64	2.97	-57.67	74.16	28.91
	711	1/0	QPSK	1413.65	V	-59.45	2.98	-56.47	73.60	30.13
		1/0	16QAM	1411.31	V	-59.77	2.97	-56.80	73.16	29.36
		1/0	64QAM	1412.97	V	-59.85	2.98	-56.87	73.23	28.56
5	706.5	1/24	QPSK	1409.38	V	-59.41	2.96	-56.45	74.23	30.78
		1/24	16QAM	1409.75	V	-60.05	2.96	-57.09	73.83	29.74
		1/24	64QAM	1410.51	V	-59.28	2.96	-56.32	73.06	28.61
	710	1/12	QPSK	1416.17	V	-59.84	3.00	-56.84	74.05	30.21
		1/12	16QAM	1413.41	V	-59.88	2.98	-56.90	73.09	29.19
		1/12	64QAM	1416.77	V	-59.29	3.00	-56.29	72.48	28.25
	713.5	1/0	QPSK	1421.64	V	-59.60	3.03	-56.57	72.83	29.26
		1/0	16QAM	1423.23	V	-59.94	3.04	-56.90	72.49	28.59
		1/0	64QAM	1422.92	V	-59.57	3.04	-56.53	72.12	27.57

Note 1: Limit Calculation = $43 + 10\log_{10}(P[\text{Watts}])$

Note 2: This device was tested under all bandwidths, modulations and RB configurations and the worst case data are reported in the table above.

Note 3: The frequency spectrum is examined from 9 kHz to the 10th harmonic of the fundamental frequency of the transmitter. No other spurious and harmonic emissions were reported greater than listed emissions above table.

- Measurement data: With wireless charging pad

B.W (MHz)	Test Freq. (MHz)	RB Size/ Offset	Test Mode	Freq.(MHz)	Ant Pol (H/V)	Level(dBm) @ Ant Terminal	TX Ant Gain(dBd)	Result		Limit (dBc)
								(dBm)	(dBc)	
10	709	1/0	QPSK	1410.35	H	-60.46	2.96	-57.50	57.50	30.24
5	706.5	1/0	QPSK	1411.11	H	-60.54	2.97	-57.57	57.57	30.59

Note 1: Limit Calculation = $43 + 10\log_{10}(P[\text{Watts}])$

Note 2: This device was tested under all bandwidths, modulations and RB configurations and the worst case data are reported in the table above.

Note 3: The frequency spectrum is examined from 9 kHz to the 10th harmonic of the fundamental frequency of the transmitter. No other spurious and harmonic emissions were reported greater than listed emissions above table.

7.6.2 LTE Band 13

- Measurement data: Without wireless charging pad

B.W (MHz)	Test Freq. (MHz)	RB Size/ Offset	Test Mode	Freq.(MHz)	Ant Pol (H/V)	Level(dBm) @ Ant Terminal	TX Ant Gain(dBd)	Result		Limit (dBc)
								(dBm)	(dBc)	
10	782	1/0	QPSK	1555.12	H	-60.03	3.64	-56.39	71.74	28.35
				2332.54	H	-55.92	3.97	-51.95	67.30	
		1/0	16QAM	1555.26	H	-60.38	3.64	-56.74	70.24	26.50
				2332.48	H	-55.94	3.97	-51.97	65.47	
		1/0	64QAM	1556.07	H	-60.66	3.65	-57.01	70.51	25.67
				2331.95	H	-56.92	3.96	-52.96	66.46	
5	706.5	1/12	QPSK	2337.97	H	-55.92	3.97	-51.95	66.57	27.62
		1/12	16QAM	2337.84	H	-55.90	3.97	-51.93	65.10	26.17
		1/12	64QAM	2337.86	H	-57.09	3.97	-53.12	66.29	25.15
	779.5	1/12	QPSK	2346.38	H	-56.30	3.99	-52.31	67.38	28.07
		1/12	16QAM	2346.21	H	-56.33	3.99	-52.34	65.88	26.54
		1/12	64QAM	2346.75	H	-56.64	3.99	-52.65	66.19	25.61
	784.5	1/0	QPSK	2346.86	H	-56.68	3.99	-52.69	68.24	28.55
		1/0	16QAM	2346.77	H	-56.81	3.99	-52.82	66.82	27.00
		1/0	64QAM	2347.16	H	-57.20	3.99	-53.21	67.21	26.05

Note 1: Limit Calculation = $43 + 10\log_{10}(P[\text{Watts}])$

Note 2: This device was tested under all bandwidths, modulations and RB configurations and the worst case data are reported in the table above.

Note 3: The frequency spectrum is examined from 9 kHz to the 10th harmonic of the fundamental frequency of the transmitter. No other spurious and harmonic emissions were reported greater than listed emissions above table.

- Measurement data: With wireless charging pad

B.W (MHz)	Test Freq. (MHz)	RB Size/ Offset	Test Mode	Freq.(MHz)	Ant Pol (H/V)	Level(dBm) @ Ant Terminal	TX Ant Gain(dBd)	Result		Limit (dBc)
								(dBm)	(dBc)	
10	782	1/0	QPSK	1554.23	H	-60.61	3.64	-56.97	56.97	28.10
				2332.36	H	-55.94	3.97	-51.97	51.97	
5	784.5	1/0	QPSK	2347.25	H	-56.94	3.99	-52.95	52.95	28.51

Note 1: Limit Calculation = $43 + 10\log_{10}(P[\text{Watts}])$

Note 2: This device was tested under all bandwidths, modulations and RB configurations and the worst case data are reported in the table above.

Note 3: The frequency spectrum is examined from 9 kHz to the 10th harmonic of the fundamental frequency of the transmitter. No other spurious and harmonic emissions were reported greater than listed emissions above table.

UNDESIRABLE EMISSIONS IN 1559~1610MHz (LTE Band 13)
- Measurement data: Without wireless charging pad

B.W (MHz)	Test Freq. (MHz)	RB Size/ Offset	Test Mode	Freq.(MHz)	Ant Pol (H/V)	Level(dBm) @ Ant Terminal	TX Ant Gain(dBi)	Result		Limit (dBm/MHz)
								(dBm)	(dBc)	
10	782	1/25	QPSK	1561.82	H	-60.57	6.37	-54.20	14.20	-40.00
		1/25	16QAM	1561.78	H	-60.60	6.37	-54.23	14.23	
		1/25	64QAM	1561.85	H	-60.82	6.37	-54.45	14.45	
5	779.5	1/12	QPSK	1560.16	H	-60.63	6.37	-54.26	14.26	
		1/12	16QAM	1560.92	H	-60.82	6.37	-54.45	14.45	
		1/12	64QAM	1559.41	H	-60.71	6.38	-54.33	14.33	
	782	1/0	QPSK	1565.96	H	-60.63	6.35	-54.28	14.28	
		1/0	16QAM	1562.74	H	-60.86	6.36	-54.50	14.50	
		1/0	64QAM	1564.62	H	-60.67	6.35	-54.32	14.32	
	784.5	1/12	QPSK	1564.61	H	-60.42	6.35	-54.07	14.07	
		1/12	16QAM	1566.61	H	-60.79	6.34	-54.45	14.45	
		1/12	64QAM	1566.78	H	-60.58	6.34	-54.24	14.24	

- Measurement data: With wireless charging pad

B.W (MHz)	Test Freq. (MHz)	RB Size/ Offset	Test Mode	Freq.(MHz)	Ant Pol (H/V)	Level(dBm) @ Ant Terminal	TX Ant Gain(dBi)	Result		Limit (dBm/MHz)
								(dBm)	(dBc)	
10	782	1/25	QPSK	1561.75	H	-60.57	6.37	-54.20	14.20	-40.00
5	784.5	1/0	QPSK	1565.27	H	-59.64	6.35	-53.29	13.29	

Note 1: Limit Calculation = -70 dBW/MHz (equivalent isotropically radiated power for wideband signals)

Note 2: This device was tested under all bandwidths, modulations and RB configurations and the worst case data are reported in the table above.

Note 3: The frequency spectrum is examined from 9 kHz to the 10th harmonic of the fundamental frequency of the transmitter. No other spurious and harmonic emissions were reported greater than listed emissions above table.

7.6.3 LTE Band 5
- Measurement data: Without wireless charging pad

B.W (MHz)	Test Freq. (MHz)	RB Size/ Offset	Test Mode	Freq.(MHz)	Ant Pol (H/V)	Level(dBm) @ Ant Terminal	TX Ant Gain(dBd)	Result		Limit (dBc)
								(dBm)	(dBc)	
10	829	1/0	QPSK	1649.16	H	-56.97	3.77	-53.20	73.30	33.10
				2473.47	H	-56.20	4.05	-52.15	72.25	
		1/0	16QAM	1649.26	H	-58.50	3.77	-54.73	73.87	32.14
				2473.15	H	-56.55	4.05	-52.50	71.64	
		1/0	64QAM	1649.09	H	-58.88	3.77	-55.11	74.25	31.45
				2473.56	H	-56.83	4.05	-52.78	71.92	
	836.5	1/25	QPSK	1673.33	H	-56.43	3.78	-52.65	72.21	32.56
				2509.55	H	-56.49	4.04	-52.45	72.01	
		1/25	16QAM	1672.82	H	-58.05	3.78	-54.27	73.30	32.03
				2510.85	H	-55.88	4.04	-51.84	70.87	
		1/25	64QAM	1673.18	H	-58.38	3.78	-54.60	73.63	30.62
				2508.99	H	-56.56	4.04	-52.52	71.55	
	844	1/0	QPSK	1679.55	H	-56.82	3.78	-53.04	71.98	31.94
				2515.69	H	-56.51	4.05	-52.46	71.40	
		1/0	16QAM	1679.22	H	-56.63	3.78	-52.85	71.41	31.56
				2515.96	H	-56.70	4.05	-52.65	71.21	
		1/0	64QAM	1679.12	H	-57.52	3.78	-53.74	72.30	30.56
				2515.04	H	-56.71	4.05	-52.66	71.22	
5	826.5	1/0	QPSK	1648.78	H	-58.15	3.77	-54.38	74.29	32.91
				2472.84	H	-56.75	4.05	-52.70	72.61	
		1/0	16QAM	1648.67	H	-58.77	3.77	-55.00	74.35	32.35
				2472.74	H	-56.84	4.05	-52.79	72.14	
		1/0	64QAM	1648.80	H	-57.78	3.77	-54.01	73.36	30.94
				2472.72	H	-56.89	4.05	-52.84	72.19	
	836.5	1/12	QPSK	1672.66	H	-57.32	3.78	-53.54	72.62	32.08
				2509.37	H	-56.49	4.04	-52.45	71.53	
		1/12	16QAM	1672.91	H	-58.33	3.78	-54.55	72.95	31.40
				2510.37	H	-56.44	4.04	-52.40	70.80	
		1/12	64QAM	1672.94	H	-57.74	3.78	-53.96	72.36	30.41
				2509.55	H	-56.08	4.04	-52.04	70.44	
	846.5	1/24	QPSK	1697.25	H	-56.65	3.79	-52.86	71.58	31.72
				2545.05	H	-56.42	4.06	-52.36	71.08	
		1/24	16QAM	1697.33	H	-57.44	3.79	-53.65	71.61	30.96
				2545.95	H	-55.19	4.06	-51.13	69.09	
		1/24	64QAM	1697.27	H	-55.75	3.79	-51.96	69.92	29.71
				2547.20	H	-55.78	4.06	-51.72	69.68	

- Measurement data: Without wireless charging pad

B.W (MHz)	Test Freq. (MHz)	RB Size/ Offset	Test Mode	Freq.(MHz)	Ant Pol (H/V)	Level(dBm) @ Ant Terminal	TX Ant Gain(dBd)	Result		Limit (dBc)
								(dBm)	(dBc)	
3	825.5	1/7	QPSK	1651.30	H	-57.41	3.78	-53.63	73.37	32.74
				2476.03	H	-55.84	4.05	-51.79	71.53	
		1/7	16QAM	1651.36	H	-56.74	3.78	-52.96	71.89	31.93
				2474.11	H	-56.78	4.05	-52.73	71.66	
		1/7	64QAM	1650.94	H	-57.20	3.78	-53.42	72.35	30.96
				2476.52	H	-56.43	4.05	-52.38	71.31	
	836.5	1/7	QPSK	1673.13	H	-55.98	3.78	-52.20	71.60	32.40
				2509.66	H	-56.34	4.04	-52.30	71.70	
		1/7	16QAM	1673.22	H	-55.80	3.78	-52.02	70.56	31.54
				2509.85	H	-55.57	4.04	-51.53	70.07	
		1/7	64QAM	1673.15	H	-57.67	3.78	-53.89	72.43	30.56
				2509.88	H	-55.42	4.04	-51.38	69.92	
	847.5	1/14	QPSK	1697.43	H	-56.18	3.79	-52.39	70.99	31.60
				2545.64	H	-56.03	4.06	-51.97	70.57	
		1/14	16QAM	1697.76	H	-56.57	3.79	-52.78	70.69	30.91
				2545.64	H	-56.05	4.06	-51.99	69.90	
		1/14	64QAM	1697.75	H	-55.67	3.79	-51.88	69.79	29.90
				2546.30	H	-55.58	4.06	-51.52	69.43	
1.4	824.7	1/2	QPSK	1649.10	H	-56.84	3.77	-53.07	72.72	32.65
				2473.70	H	-56.67	4.05	-52.62	72.27	
		1/2	16QAM	1649.20	H	-58.55	3.77	-54.78	73.60	31.82
				2473.31	H	-56.71	4.05	-52.66	71.48	
		1/2	64QAM	1649.23	H	-55.97	3.77	-52.20	71.02	30.77
				2472.98	H	-56.39	4.05	-52.34	71.16	
	836.5	1/2	QPSK	1673.22	H	-57.11	3.78	-53.33	72.72	32.39
				2509.49	H	-56.13	4.04	-52.09	71.48	
		1/2	16QAM	1672.53	H	-56.90	3.78	-53.12	71.75	31.63
				2507.41	H	-56.20	4.04	-52.16	70.79	
		1/2	64QAM	1672.79	H	-57.06	3.78	-53.28	71.91	30.38
				2507.47	H	-55.82	4.04	-51.78	70.41	
	848.3	1/5	QPSK	1697.36	H	-55.67	3.79	-51.88	70.86	31.98
				2546.24	H	-55.48	4.06	-51.42	70.40	
		1/5	16QAM	1697.88	H	-56.70	3.79	-52.91	71.09	31.18
				2547.70	H	-56.03	4.06	-51.97	70.15	
		1/5	64QAM	1697.49	H	-56.71	3.79	-52.92	71.10	30.22
				2546.59	H	-56.00	4.06	-51.94	70.12	

Note 1: Limit Calculation = $43 + 10\log_{10}(P[\text{Watts}])$

Note 2: This device was tested under all bandwidths, modulations and RB configurations and the worst case data are reported in the table above.

Note 3: The frequency spectrum is examined from 9 kHz to the 10th harmonic of the fundamental frequency of the transmitter. No other spurious and harmonic emissions were reported greater than listed emissions above table.

- Measurement data: With wireless charging pad

B.W (MHz)	Test Freq. (MHz)	RB Size/ Offset	Test Mode	Freq.(MHz)	Ant Pol (H/V)	Level(dBm) @ Ant Terminal	TX Ant Gain(dBd)	Result		Limit (dBc)
								(dBm)	(dBc)	
10	829	1/0	QPSK	1648.63	H	-58.58	3.77	-54.81	54.81	33.03
				2473.28	H	-56.24	4.05	-52.19	52.19	
5	826.5	1/0	QPSK	1648.62	H	-57.57	3.77	-53.80	53.80	32.54
				2472.67	H	-56.84	4.05	-52.79	52.79	
3	825.5	1/7	QPSK	1650.83	H	-56.88	3.78	-53.10	53.10	32.33
				2476.02	H	-56.44	4.05	-52.39	52.39	
1.4	824.7	1/2	QPSK	1649.14	H	-58.88	3.77	-55.11	55.11	32.33
				2474.11	H	-56.60	4.05	-52.55	52.55	

Note 1: Limit Calculation = $43 + 10\log_{10}(P[\text{Watts}])$

Note 2: This device was tested under all bandwidths, modulations and RB configurations and the worst case data are reported in the table above.

Note 3: The frequency spectrum is examined from 9 kHz to the 10th harmonic of the fundamental frequency of the transmitter. No other spurious and harmonic emissions were reported greater than listed emissions above table.

7.7 FREQUENCY STABILITY

7.7.1 LTE Band 17

OPERATING FREQUENCY : 710 MHz
 REFERENCE VOLTAGE : 3.85 VDC
 LIMIT : The frequency stability shall be sufficient to ensure that the fundamental emission stays within the authorized frequency block.

VOLTAGE (%)	POWER (V DC)	TEMP (°C)	FREQUENCY (Hz)	FREQ.Dev (Hz)	Deviation	
					(ppm)	(%)
100%	3.85	+20(Ref)	709,999,996	-4	-0.0056	-0.000000563
100%		-30	710,000,008	8	0.0113	0.000001127
100%		-20	710,000,002	2	0.0028	0.000000282
100%		-10	710,000,006	6	0.0085	0.000000845
100%		0	709,999,995	-5	-0.0070	-0.000000704
100%		+10	709,999,997	-3	-0.0042	-0.000000423
100%		+20	709,999,996	-4	-0.0056	-0.000000563
100%		+30	710,000,004	4	0.0056	0.000000563
100%		+40	710,000,003	3	0.0042	0.000000423
100%		+50	710,000,008	8	0.0113	0.000001127
115%	4.43	+20	709,999,996	-4	-0.0056	-0.000000563
BATT.ENDPOINT	3.20	+20	709,999,993	-7	-0.0099	-0.000000986

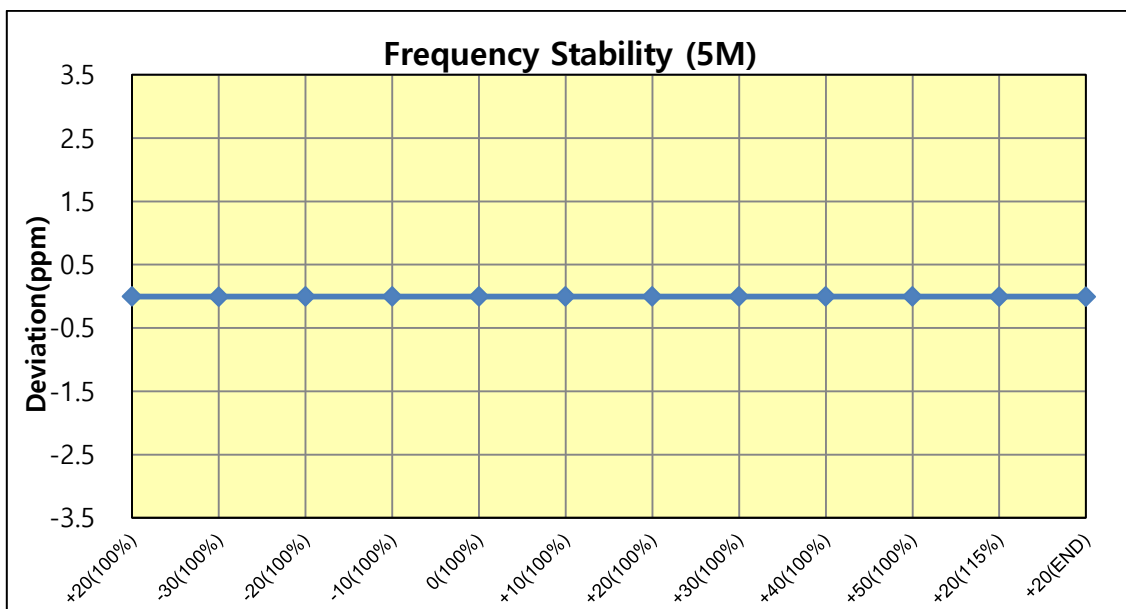

Note. Based on the results of the frequency stability test at the center channel the frequency deviation results measured are very small, as such it is determined that the channels at the band edge would remain inband when the maximum measured frequency deviation noted during the frequency stability tests is applied. therefore the device is determined to remain operating in band over the temperature and voltage range as tested.

7.7.2 LTE Band 13

OPERATING FREQUENCY : 782 MHz
 REFERENCE VOLTAGE : 3.85 VDC
 LIMIT : The frequency stability shall be sufficient to ensure that the fundamental emission stays within the authorized frequency block.

VOLTAGE (%)	POWER (V DC)	TEMP (°C)	FREQUENCY (Hz)	FREQ.Dev (Hz)	Deviation	
					(ppm)	(%)
100%	3.85	+20(Ref)	781,999,998	-2	-0.0026	-0.000000256
100%		-30	782,000,011	11	0.0141	0.000001407
100%		-20	782,000,008	8	0.0102	0.000001023
100%		-10	781,999,996	-4	-0.0051	-0.000000512
100%		0	781,999,993	-7	-0.0090	-0.000000895
100%		+10	781,999,994	-6	-0.0077	-0.000000767
100%		+20	781,999,998	-2	-0.0026	-0.000000256
100%		+30	782,000,005	5	0.0064	0.000000639
100%		+40	781,999,997	-3	-0.0038	-0.000000384
100%		+50	782,000,009	9	0.0115	0.000001151
115%		4.43	+20	781,999,994	-6	-0.0077
BATT.ENDPOINT	3.20	+20	782,000,008	8	0.0102	0.000001023

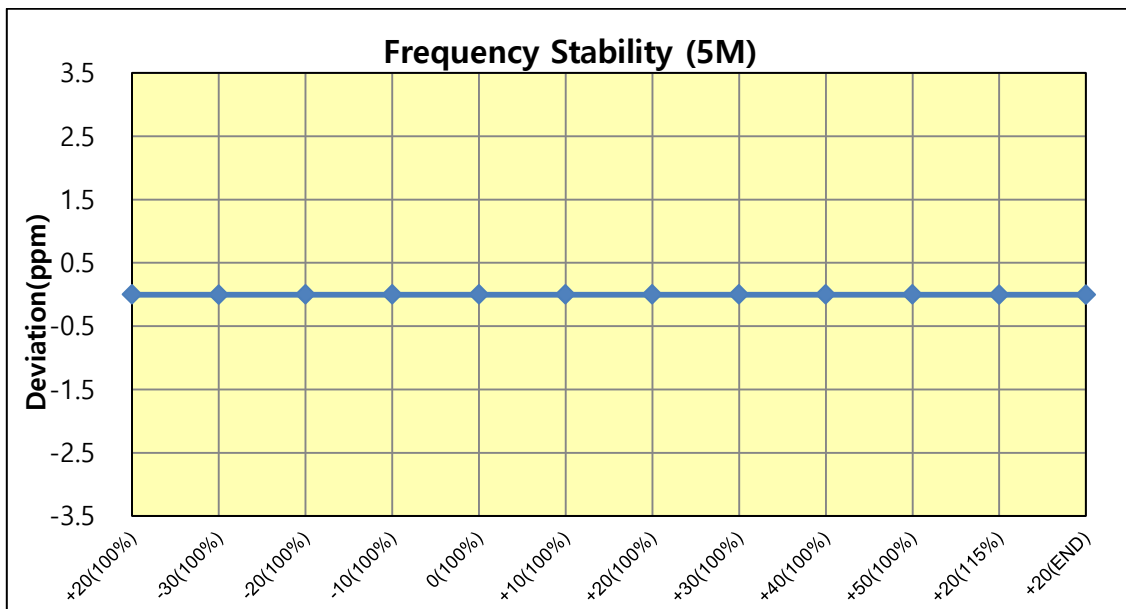

Note. Based on the results of the frequency stability test at the center channel the frequency deviation results measured are very small. as such it is determined that the channels at the band edge would remain inband when the maximum measured frequency deviation noted during the frequency stability tests is applied. therefore the device is determined to remain operating in band over the temperature and voltage range as tested.

7.7.3 LTE Band 5

OPERATING FREQUENCY : 836.5 MHz
 REFERENCE VOLTAGE : 3.85 VDC
 DEVIATION LIMIT : $\pm 0.00025\%$ or 2.5 ppm

VOLTAGE (%)	POWER (V DC)	TEMP (°C)	FREQUENCY (Hz)	FREQ.Dev (Hz)	Deviation	
					(ppm)	(%)
100%	3.85	+20(Ref)	836,500,006	6	0.0072	0.000000717
100%		-30	836,500,004	4	0.0048	0.000000478
100%		-20	836,499,997	-3	-0.0036	-0.000000359
100%		-10	836,499,993	-7	-0.0084	-0.000000837
100%		0	836,500,002	2	0.0024	0.000000239
100%		+10	836,499,992	-8	-0.0096	-0.000000956
100%		+20	836,500,006	6	0.0072	0.000000717
100%		+30	836,499,996	-4	-0.0048	-0.000000478
100%		+40	836,500,005	5	0.0060	0.000000598
100%		+50	836,500,005	5	0.0060	0.000000598
115%		4.43	+20	836,500,007	7	0.0084
BATT.ENDPOINT	3.20	+20	836,499,997	-3	-0.0036	-0.000000359

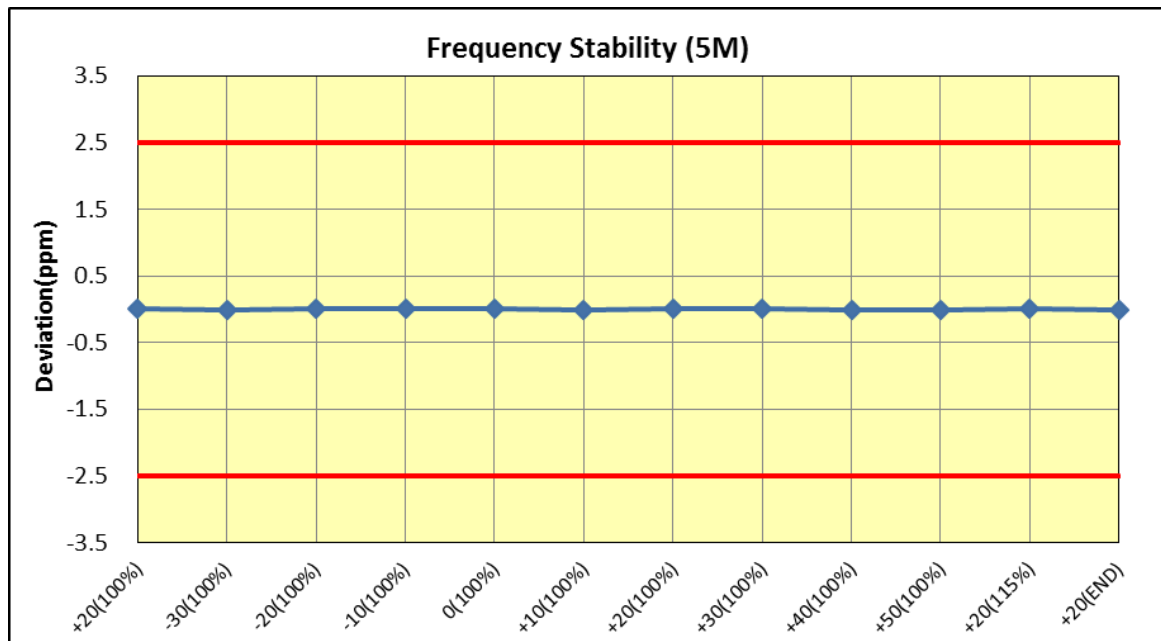

8. TEST PLOTS

Note: All bandwidths, RB configurations, and modulations were investigated. The worst case test results are reported.

8.1 OCCUPIED BANDWIDTH

8.1.1 LTE Band 17

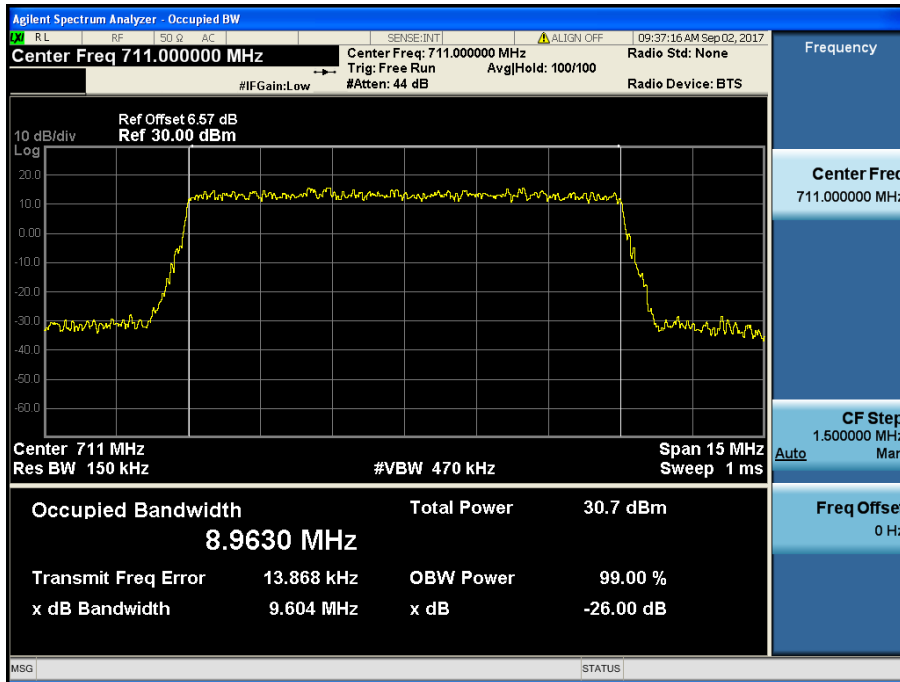

LTE Band 17 / 10 MHz / QPSK - RB Size 50

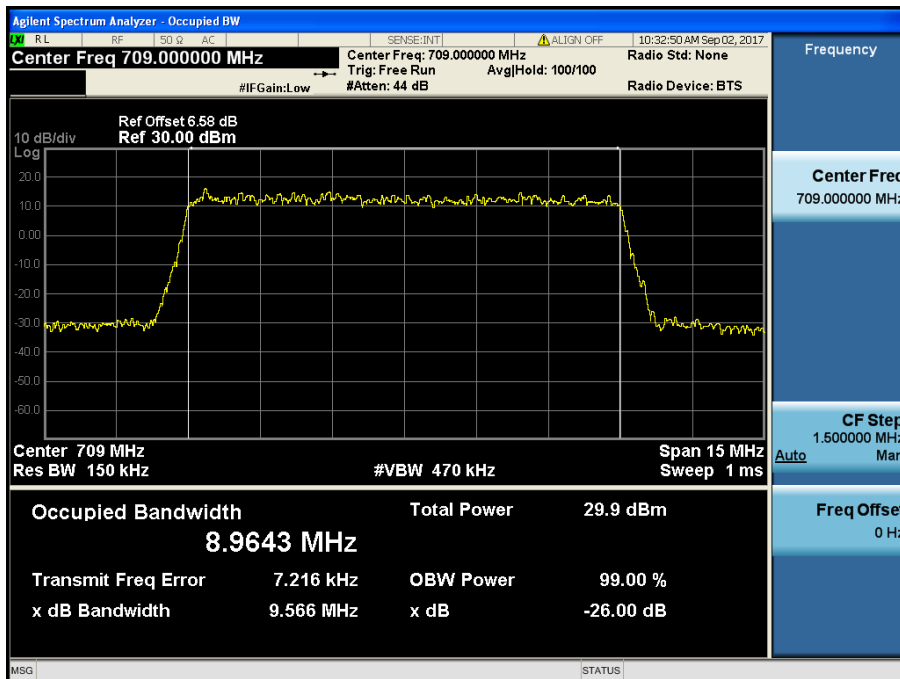

LTE Band 17 / 10 MHz / 16QAM - RB Size 50

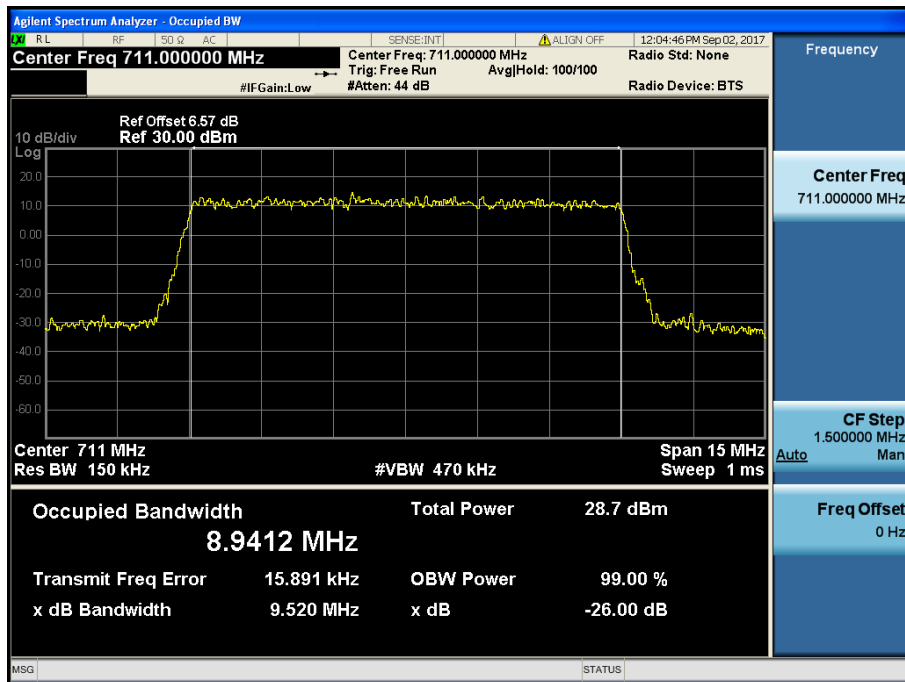

LTE Band 17 / 10 MHz / 64QAM - RB Size 50

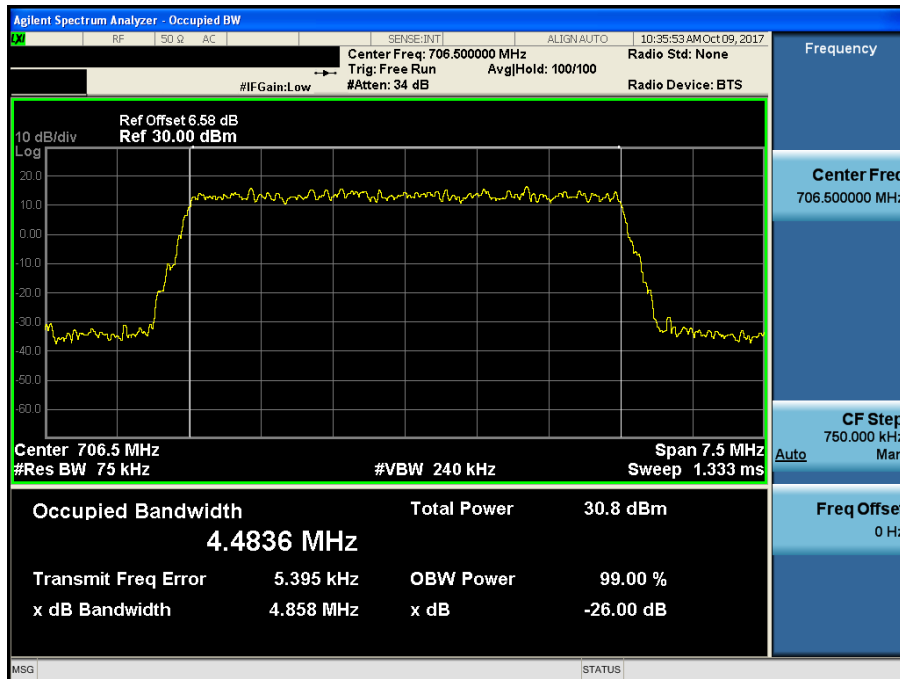

LTE Band 17 / 5 MHz / QPSK - RB Size 25

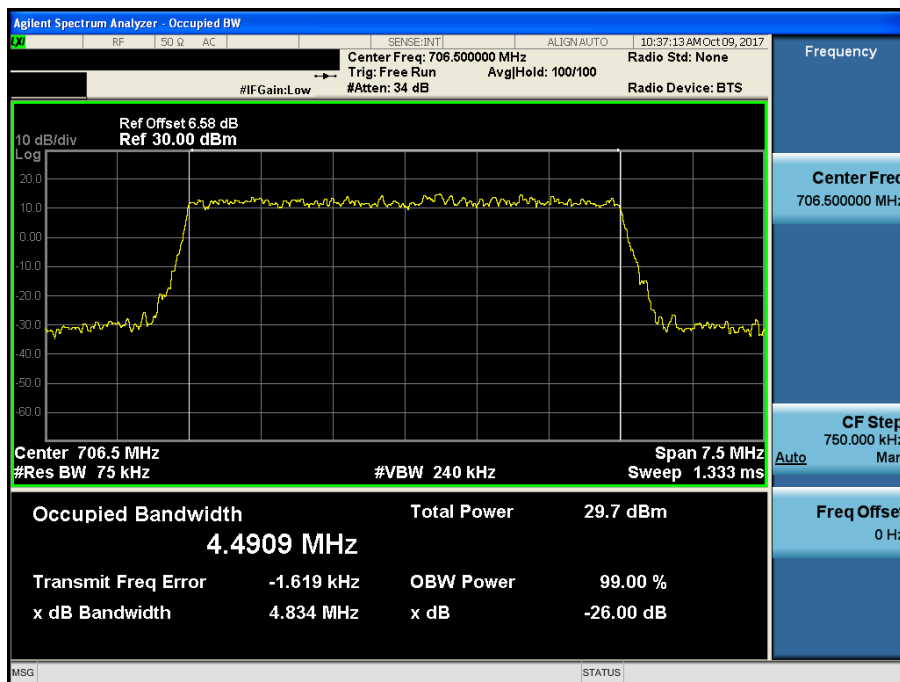

LTE Band 17 / 5 MHz / 16QAM - RB Size 25

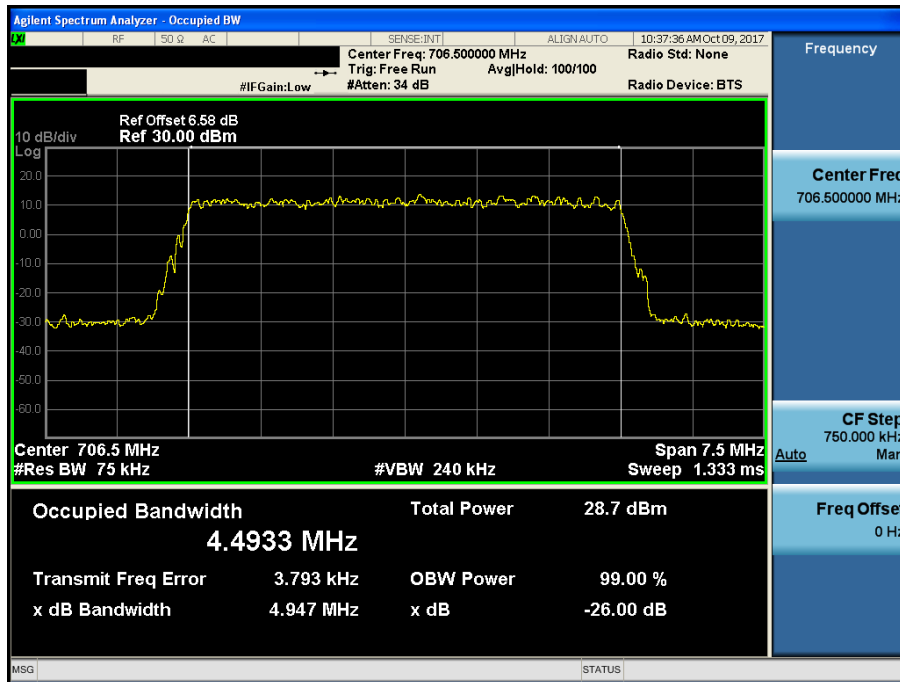

LTE Band 17 / 5 MHz / 64QAM - RB Size 25

8.1.2 LTE Band 13

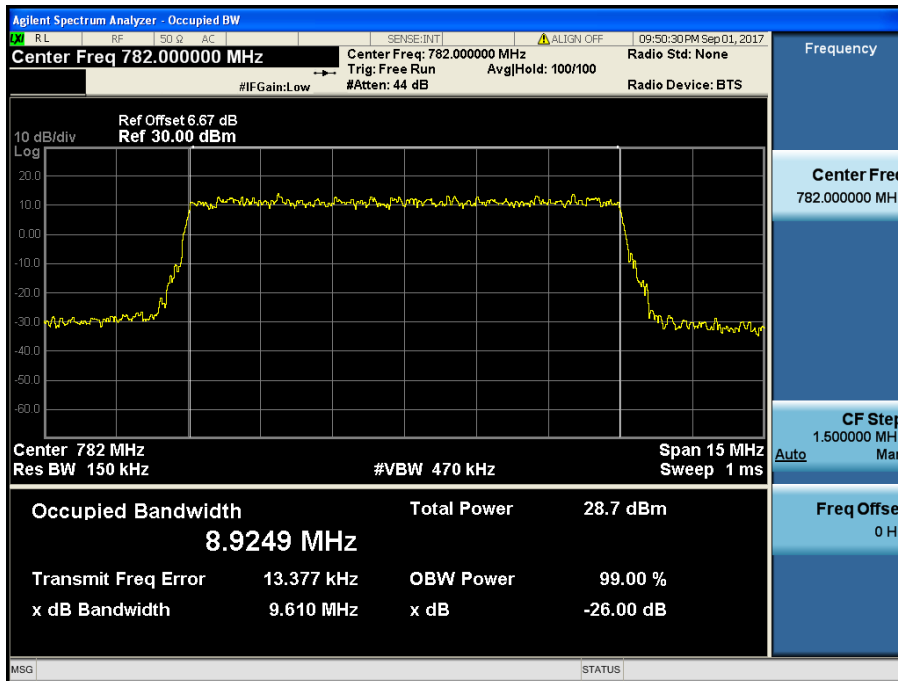

LTE Band 13 / 10 MHz / QPSK - RB Size 50

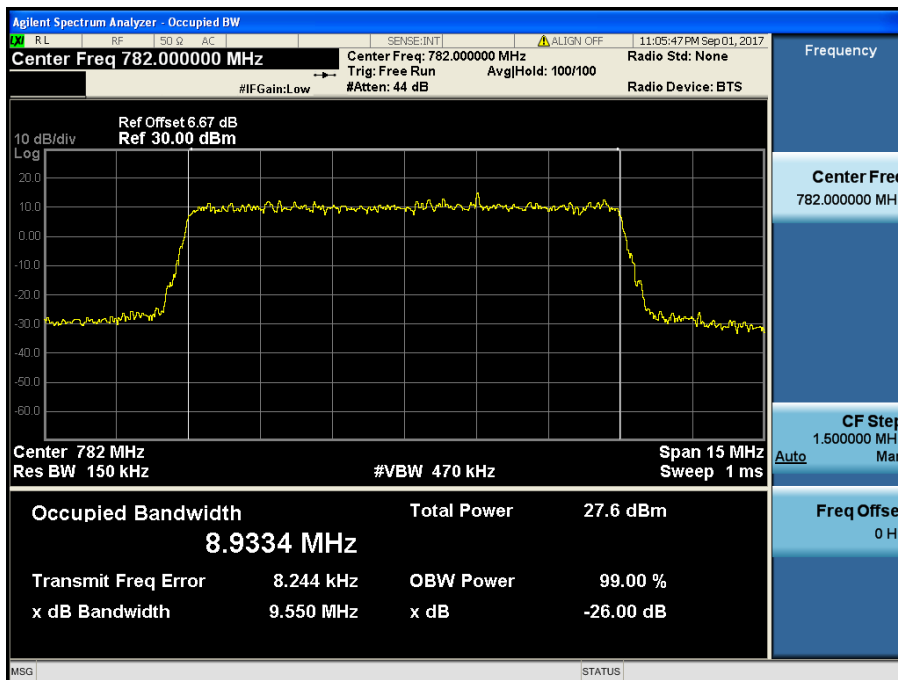

LTE Band 13 / 10 MHz / 16QAM - RB Size 50

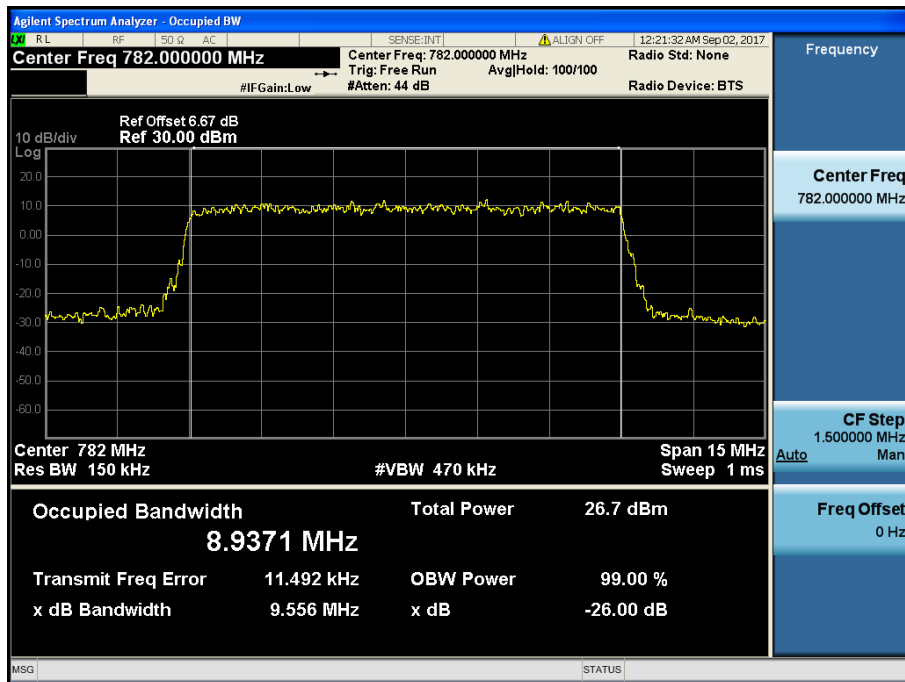

LTE Band 13 / 10 MHz / 64QAM - RB Size 50

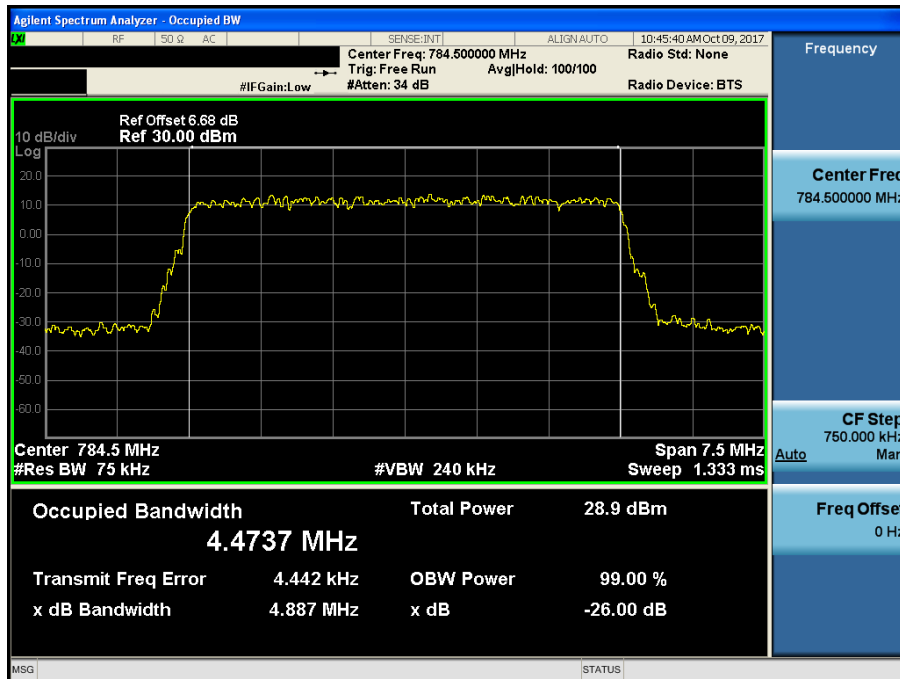

LTE Band 13 / 5 MHz / QPSK - RB Size 25

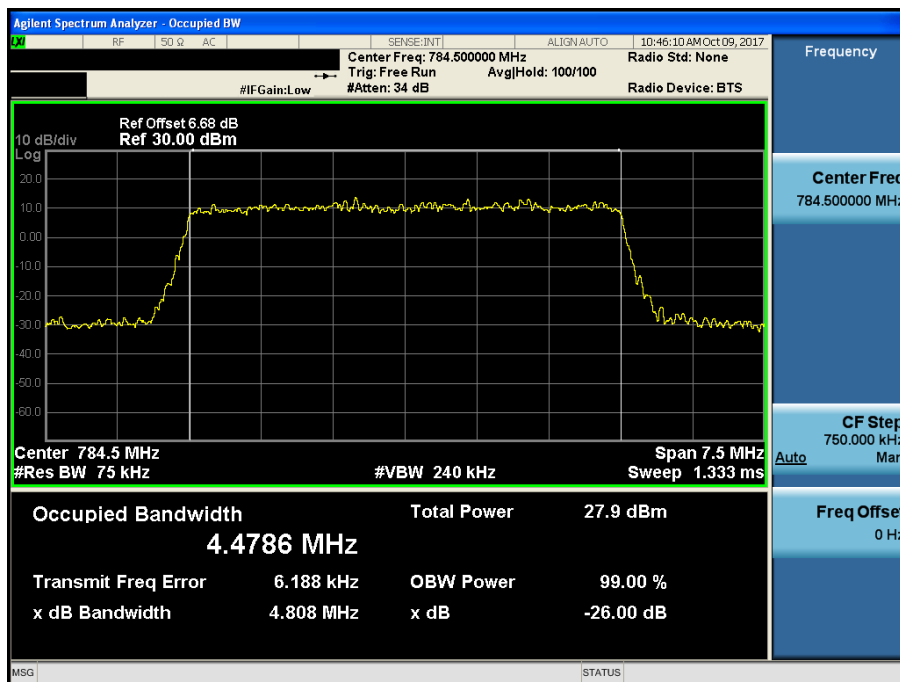

LTE Band 13 / 5 MHz / 16QAM - RB Size 25

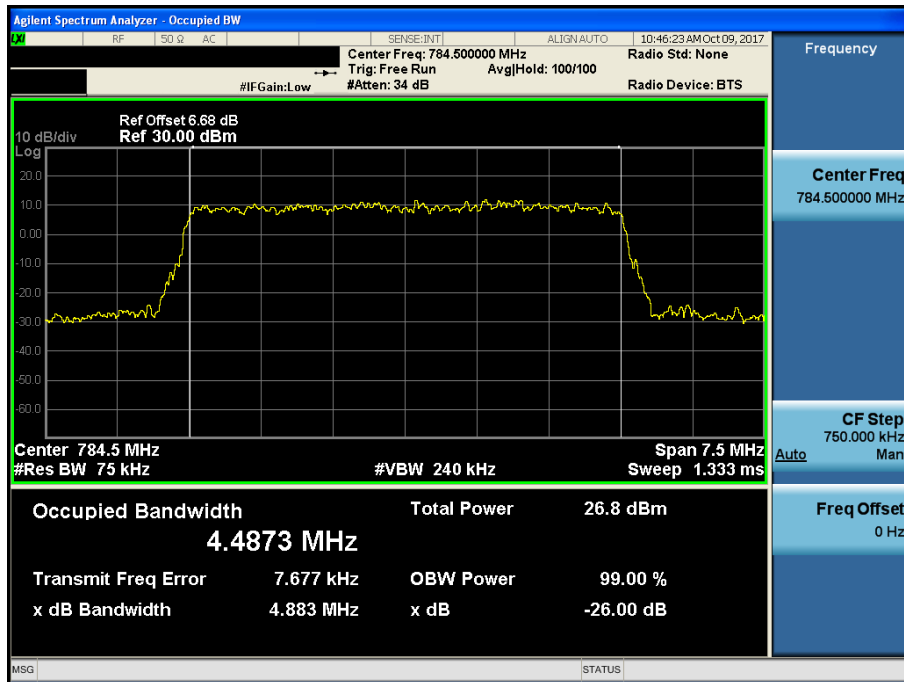

LTE Band 13 / 5 MHz / 64QAM - RB Size 25

8.1.3 LTE Band 5

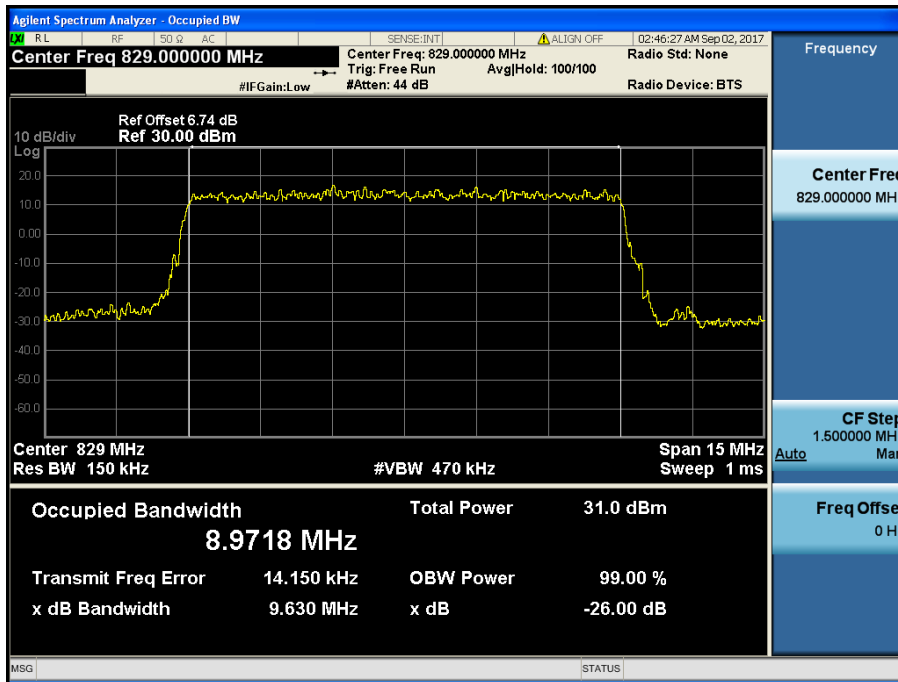

LTE Band 5 / 10 MHz / QPSK - RB Size 50

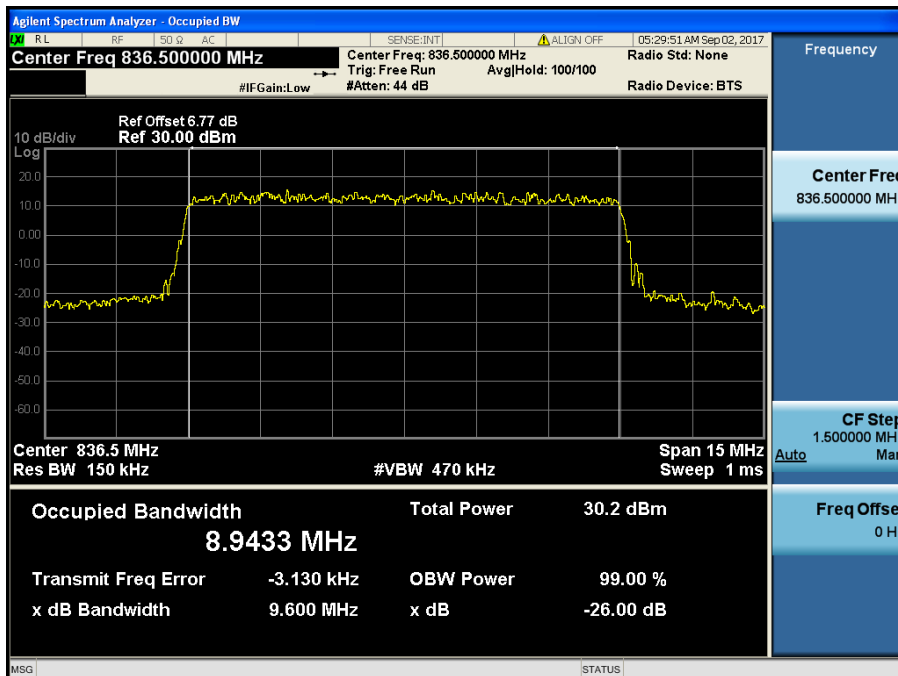

LTE Band 5 / 10 MHz / 16QAM - RB Size 50

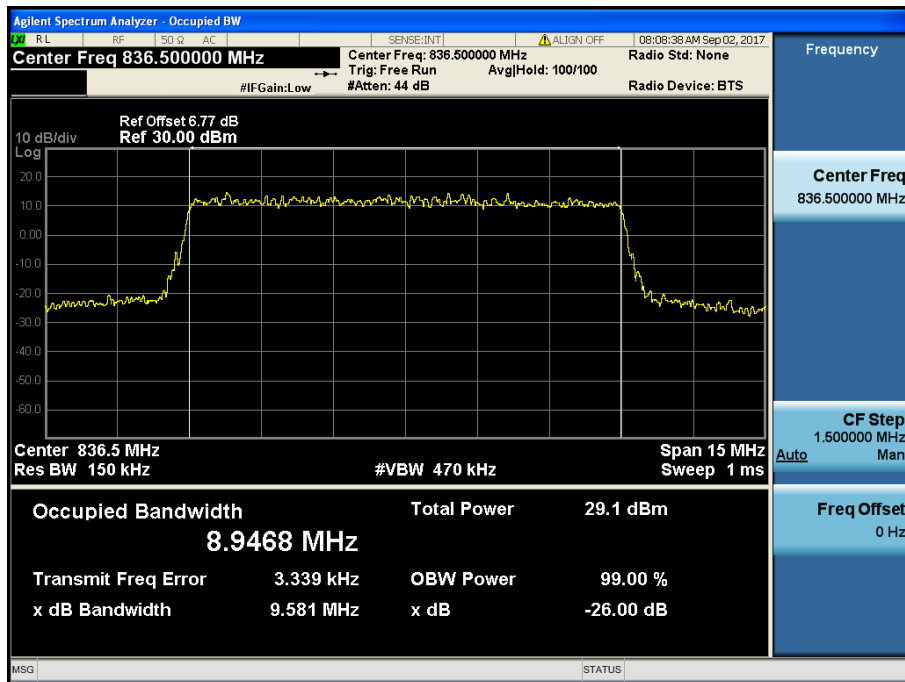

LTE Band 5 / 10 MHz / 64QAM - RB Size 50

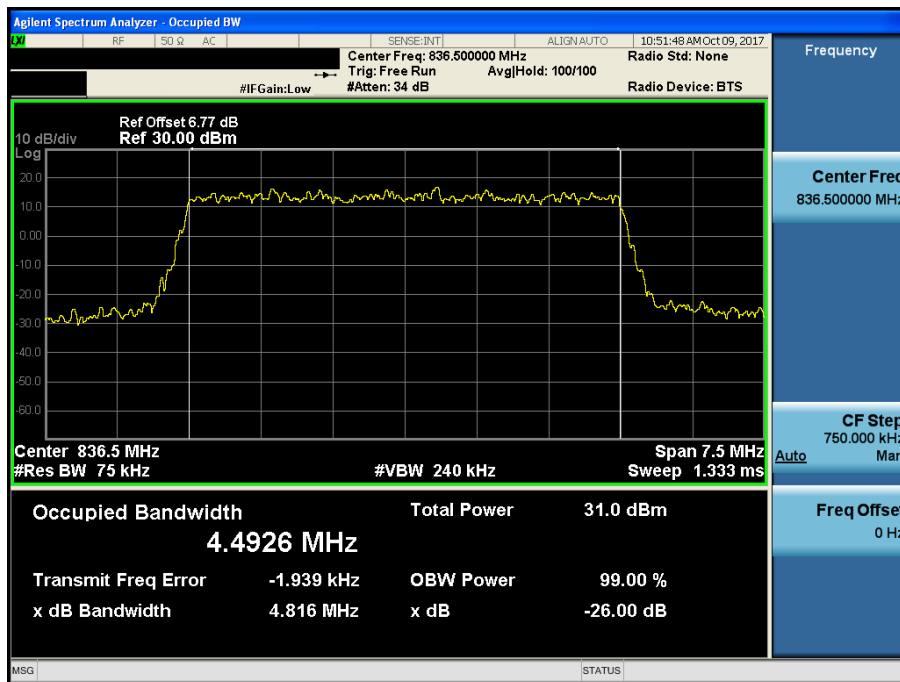

LTE Band 5 / 5 MHz / QPSK - RB Size 25

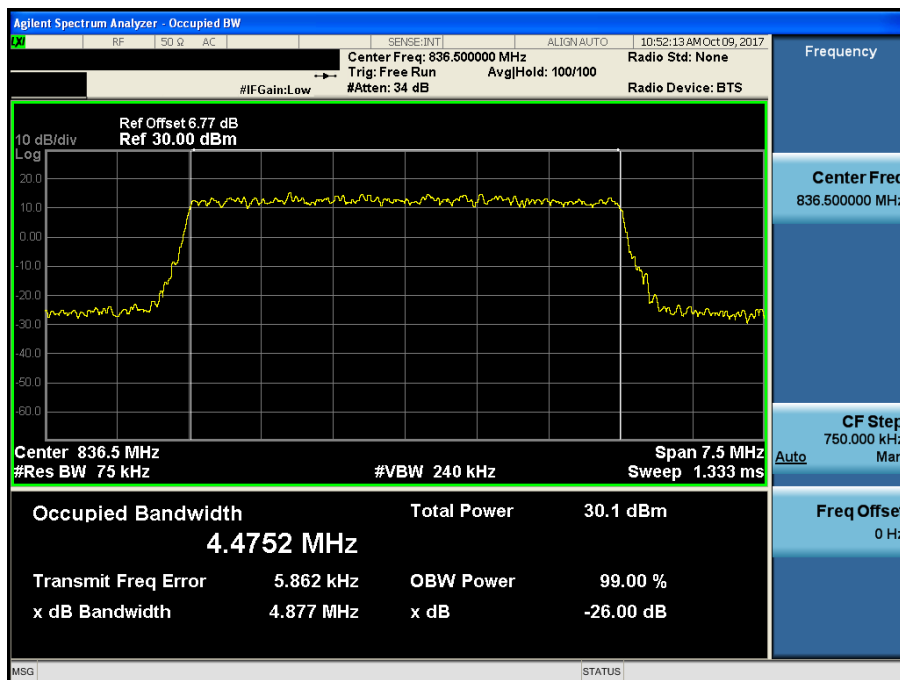

LTE Band 5 / 5 MHz / 16QAM - RB Size 25

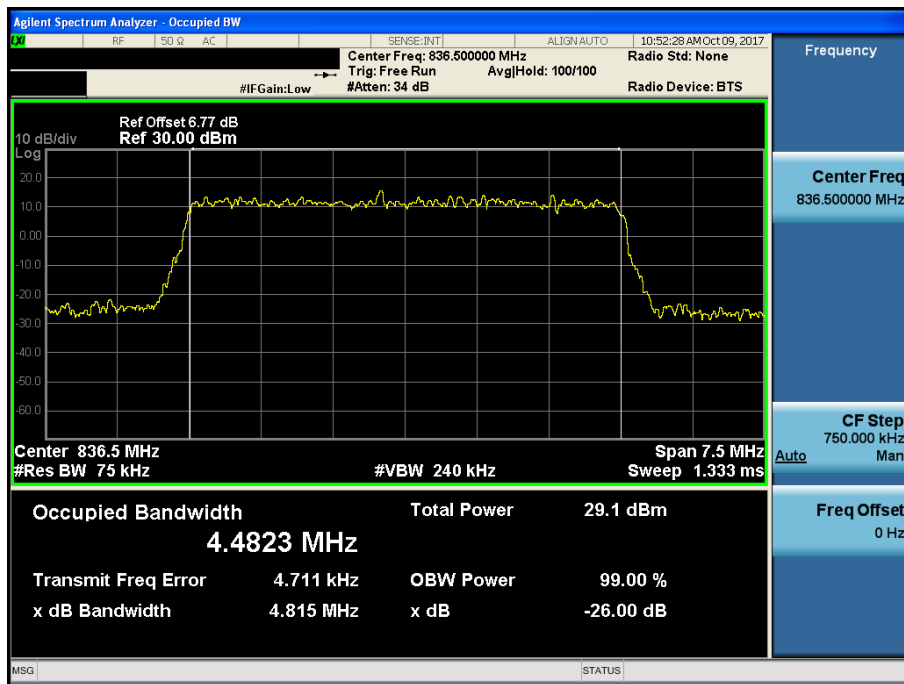

LTE Band 5 / 5 MHz / 64QAM - RB Size 25

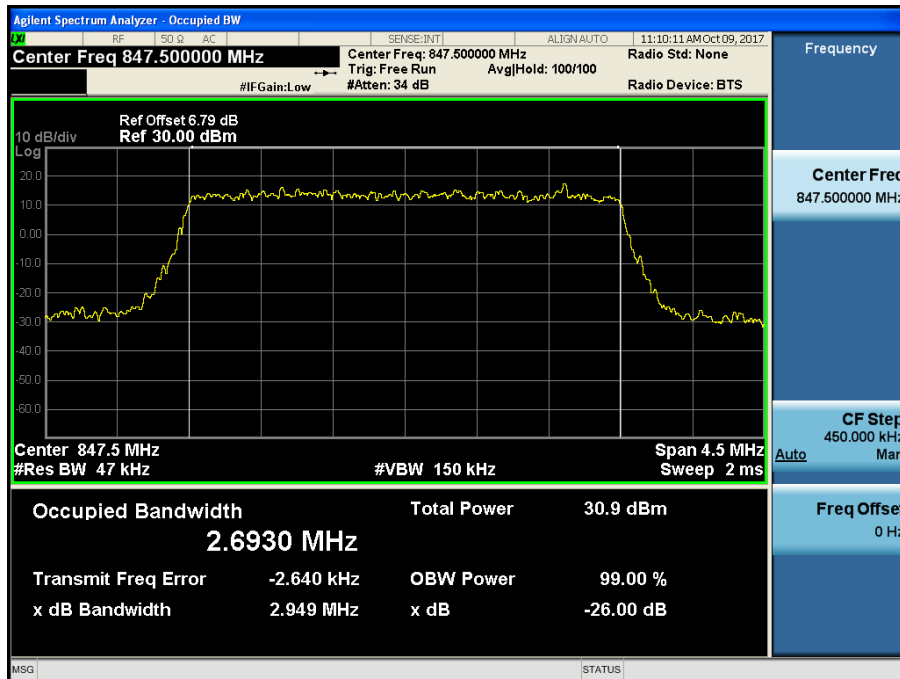

LTE Band 5 / 3 MHz / QPSK - RB Size 15

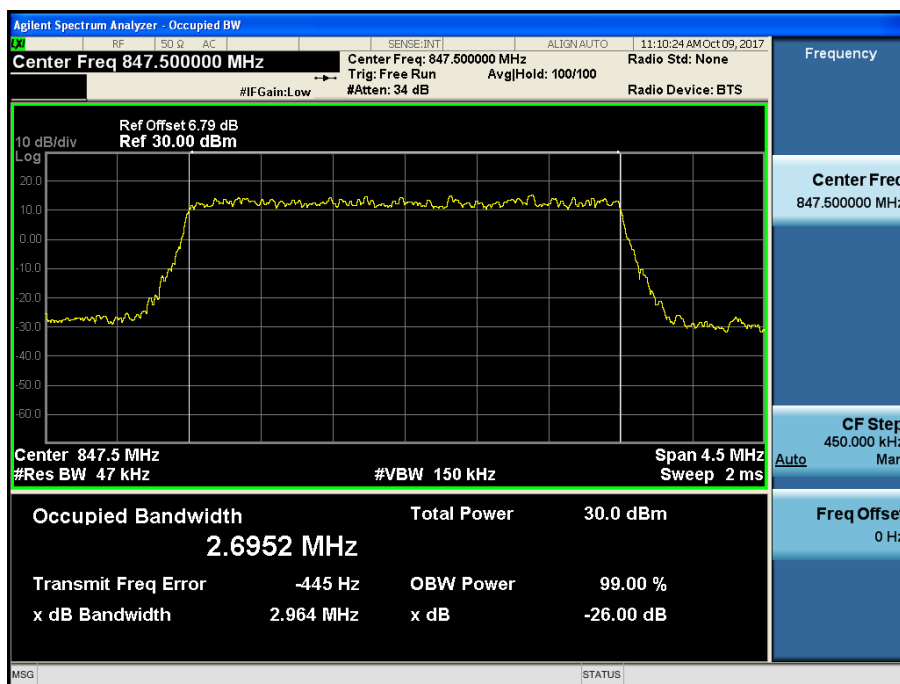

LTE Band 5 / 3 MHz / 16QAM - RB Size 15

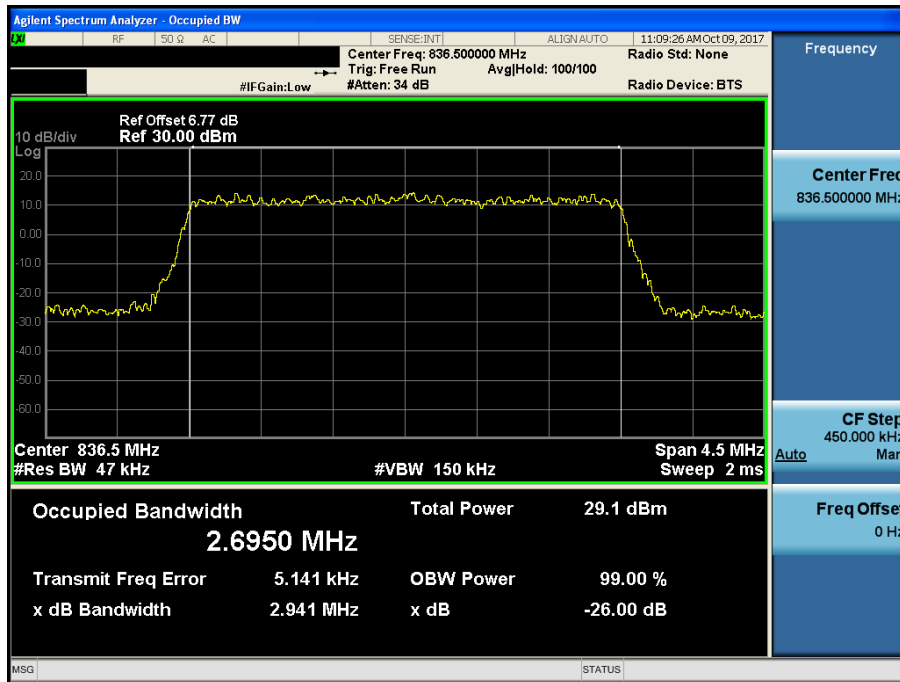

LTE Band 5 / 3 MHz / 64QAM - RB Size 15

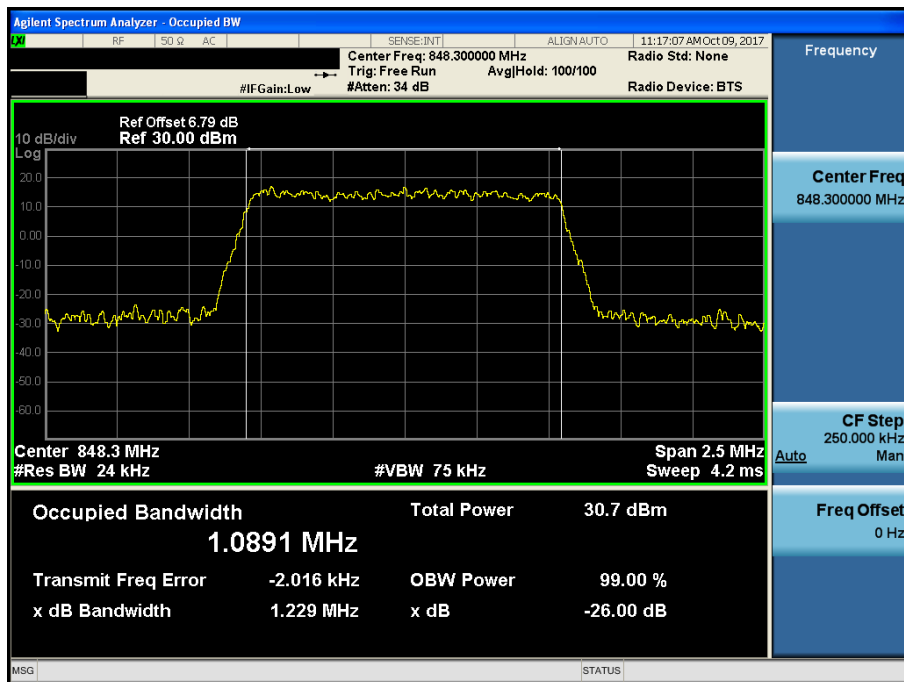

LTE Band 5 / 1.4 MHz / QPSK - RB Size 6

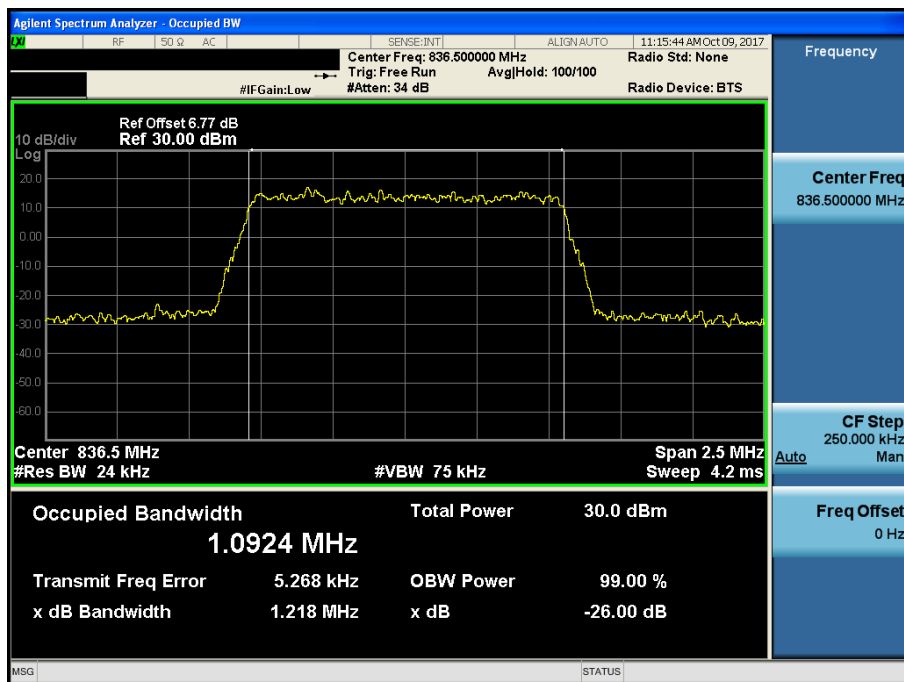

LTE Band 5 / 1.4 MHz / 16QAM - RB Size 6

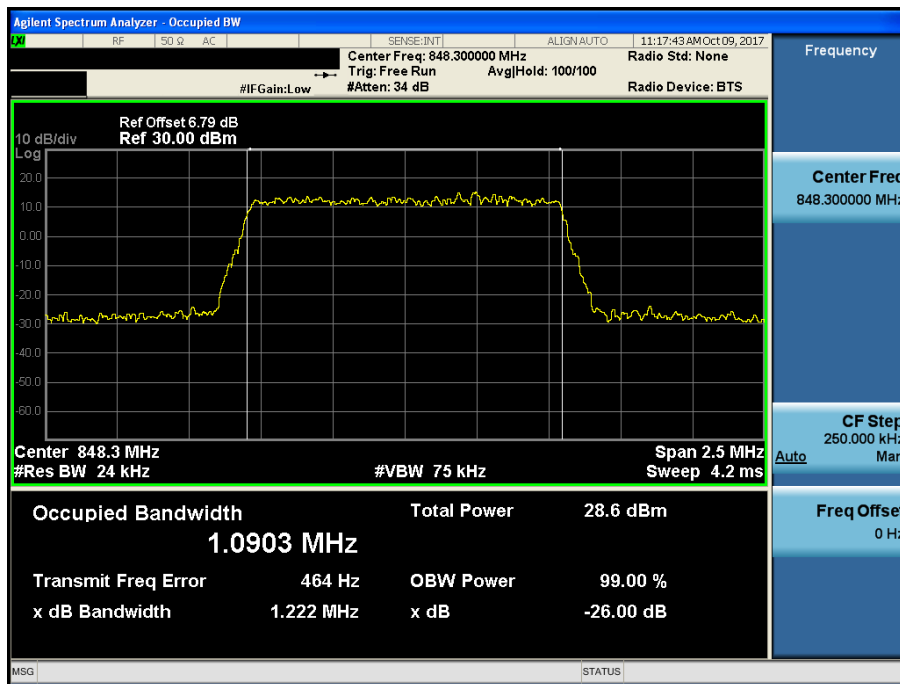

LTE Band 5 / 1.4 MHz / 64QAM - RB Size 6

8.2 PEAK TO AVERAGE RATIO

8.2.1 LTE Band 17

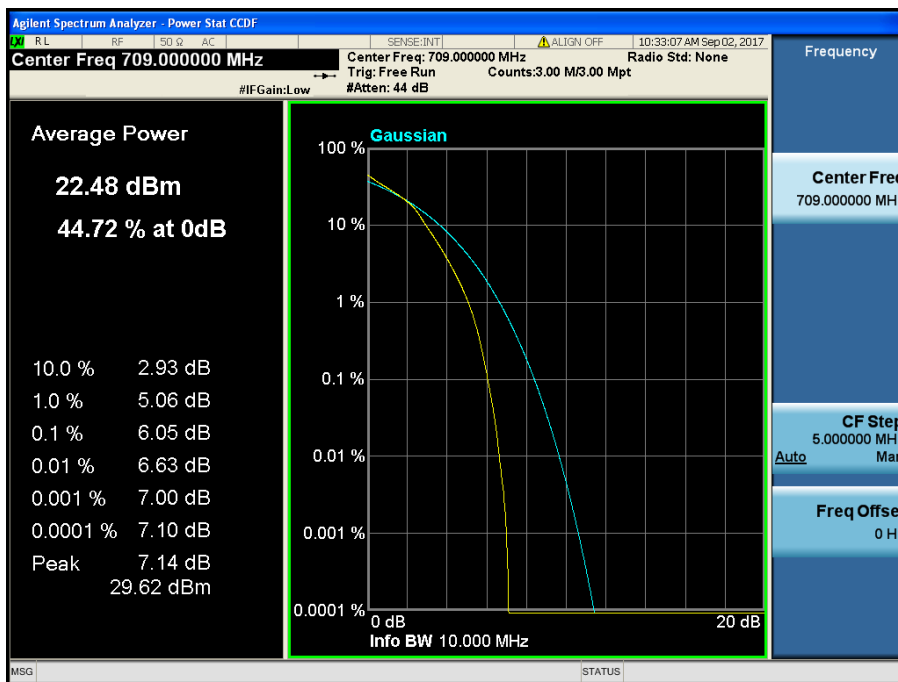
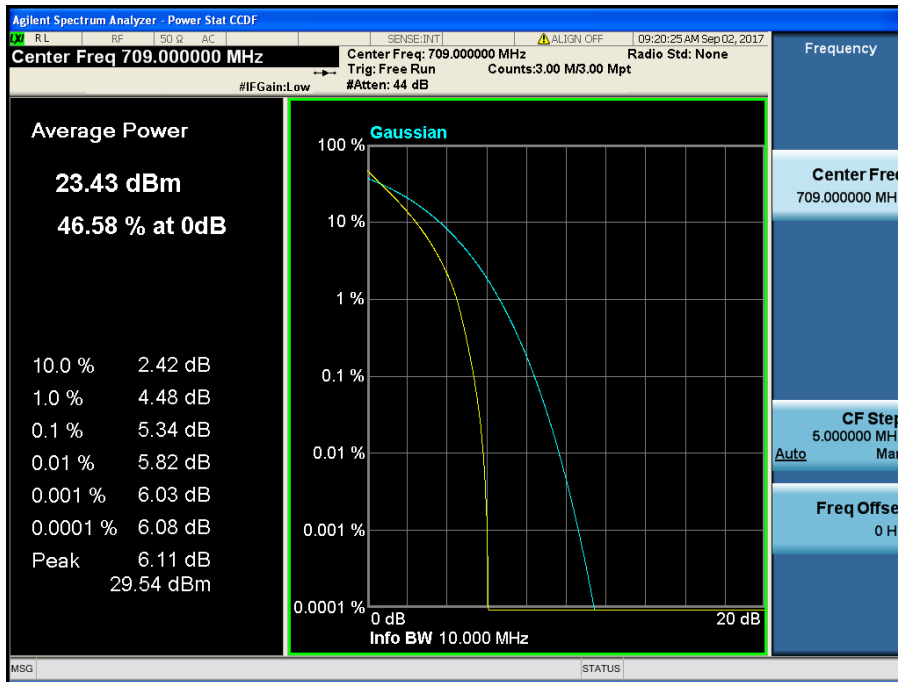

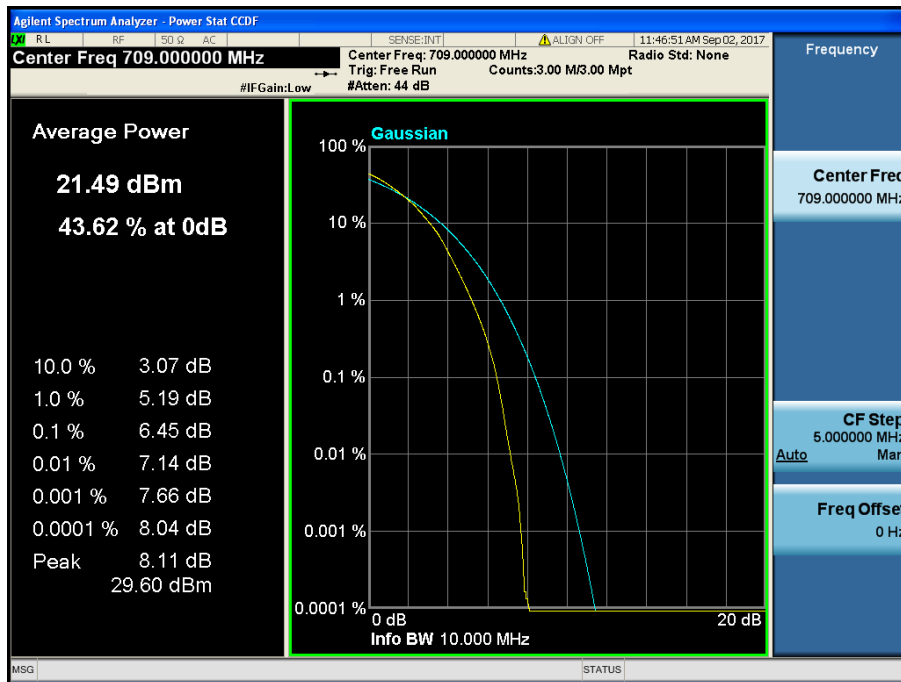

LTE Band 17 / 10 MHz / 64QAM - RB Size 50

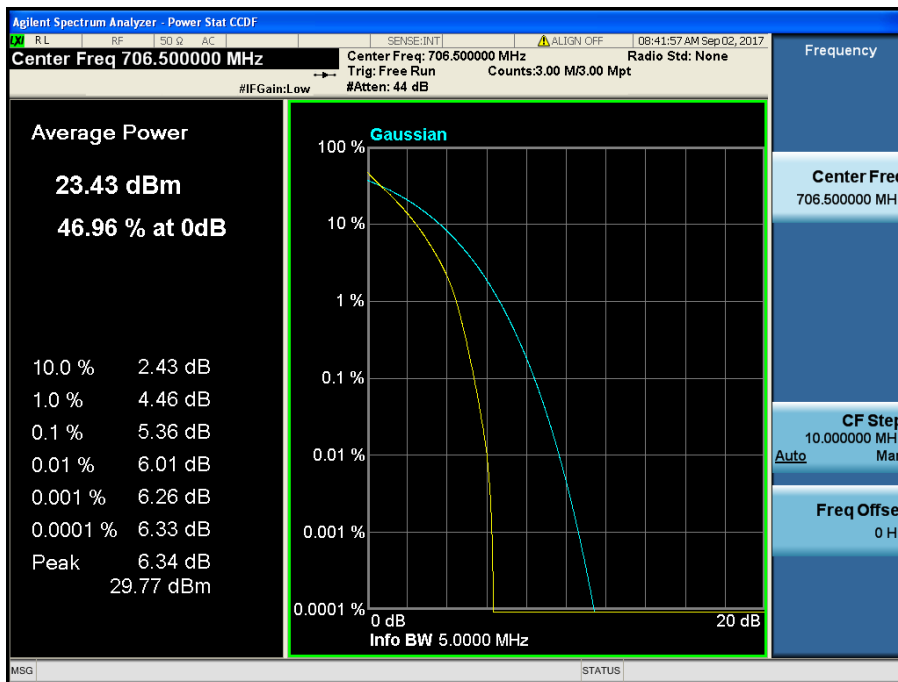

LTE Band 17 / 5 MHz / QPSK - RB Size 25

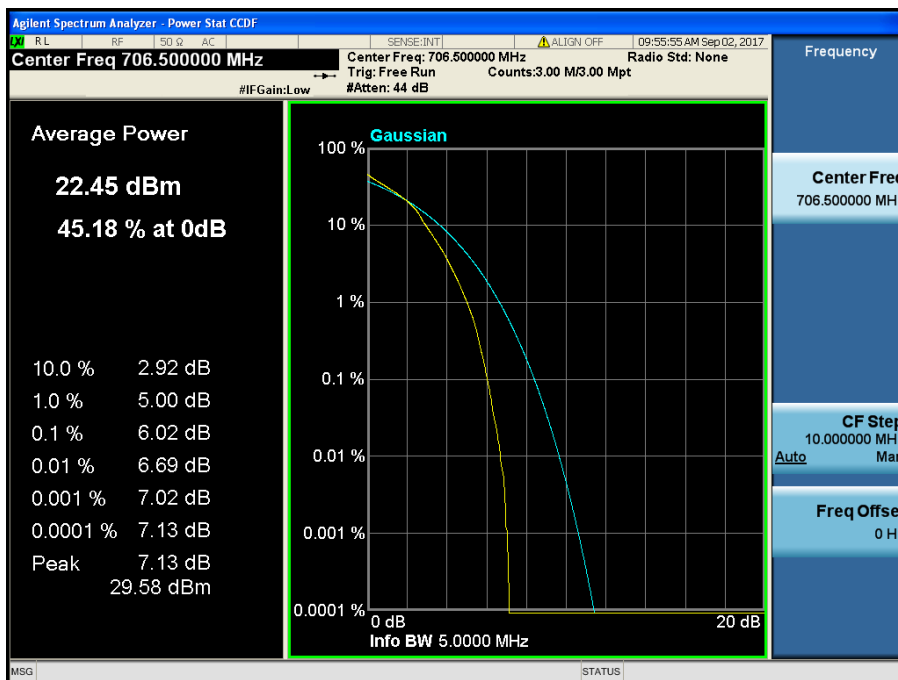

LTE Band 17 / 5 MHz / 16QAM - RB Size 25

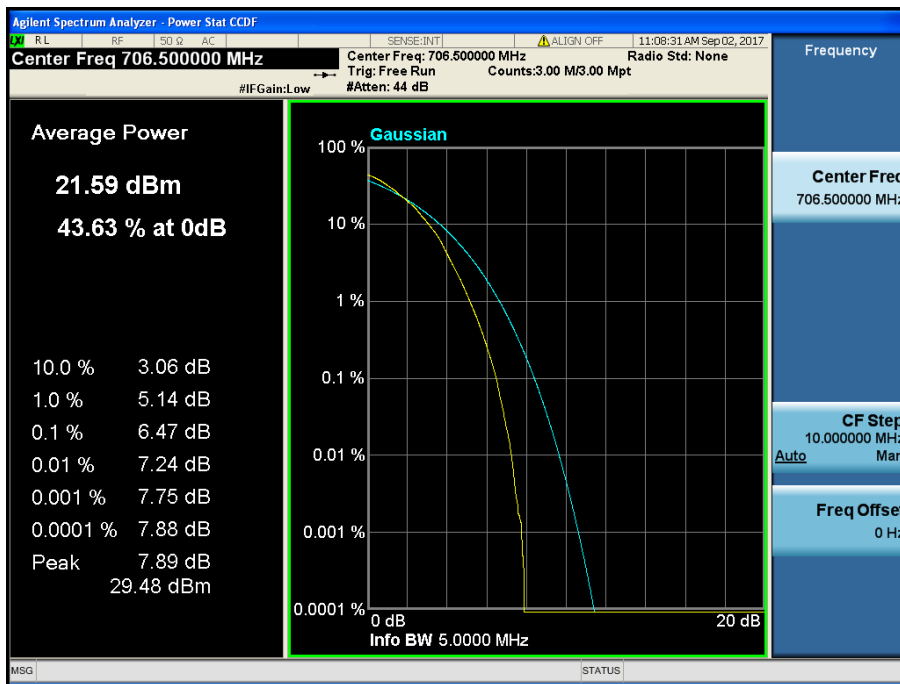

LTE Band 17 / 5 MHz / 64QAM - RB Size 25

8.2.2 LTE Band 13

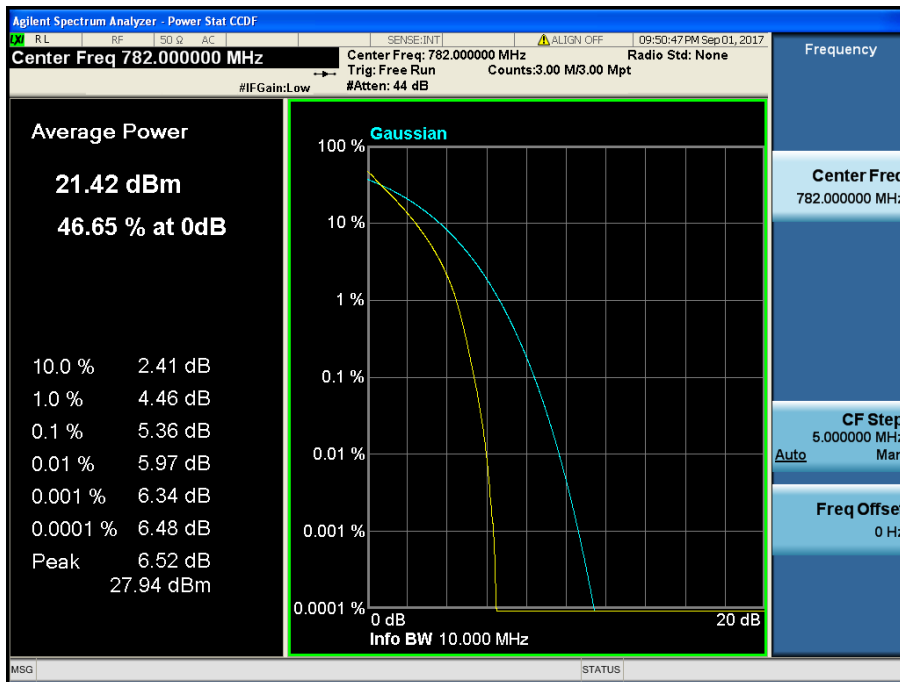

LTE Band 13 / 10 MHz / QPSK - RB Size 50

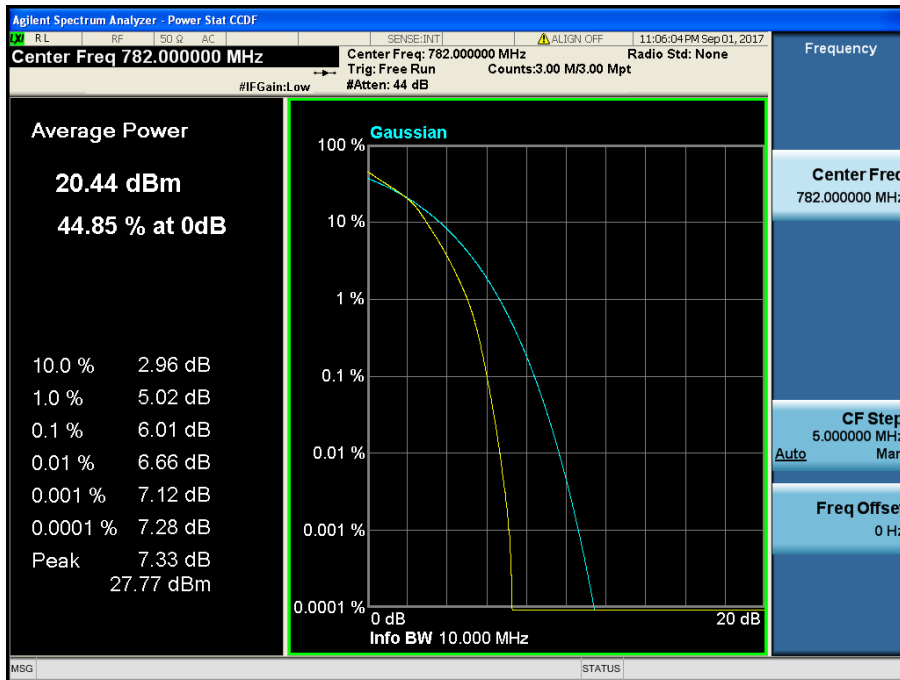

LTE Band 13 / 10 MHz / 16QAM - RB Size 50

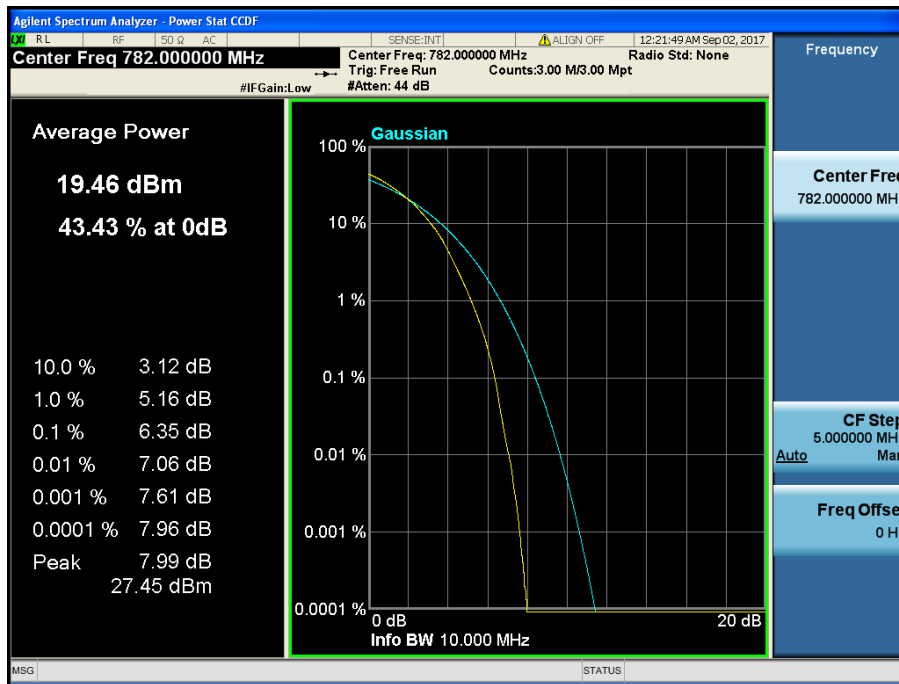

LTE Band 13 / 10 MHz / 64QAM - RB Size 50

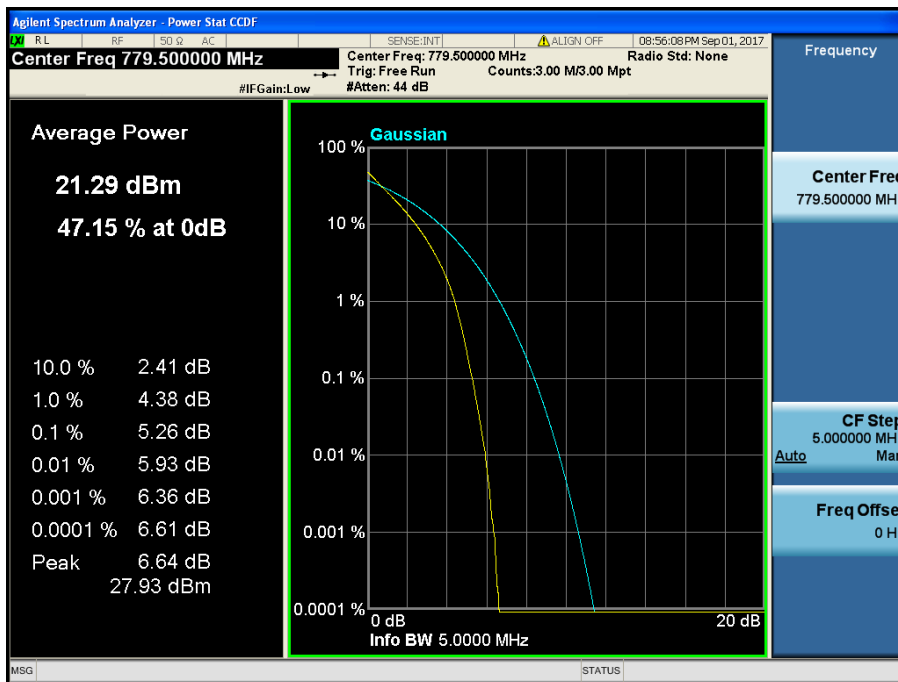

LTE Band 13 / 5 MHz / QPSK - RB Size 25

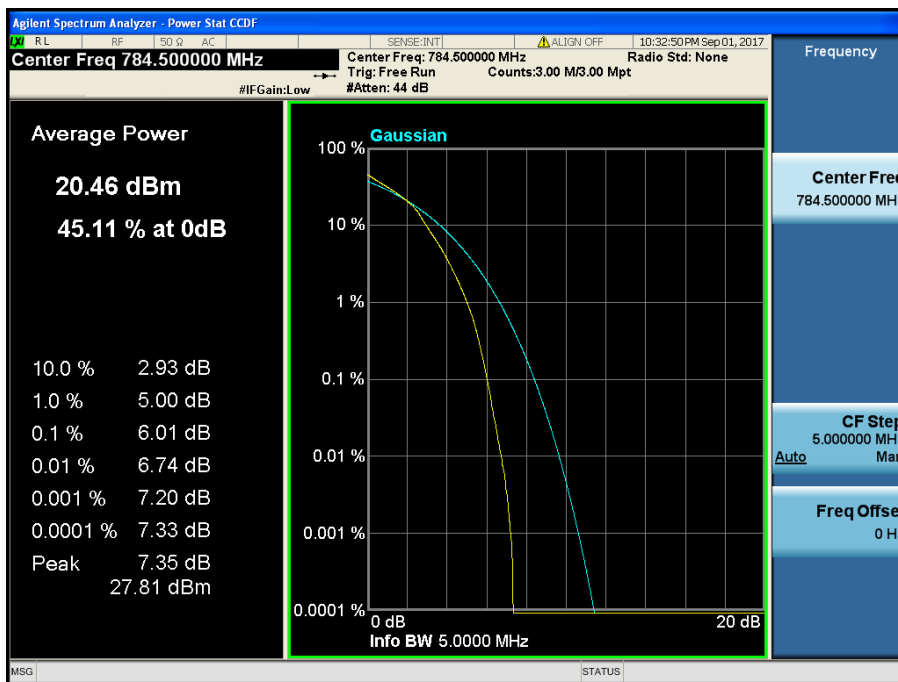

LTE Band 13 / 5 MHz / 16QAM - RB Size 25

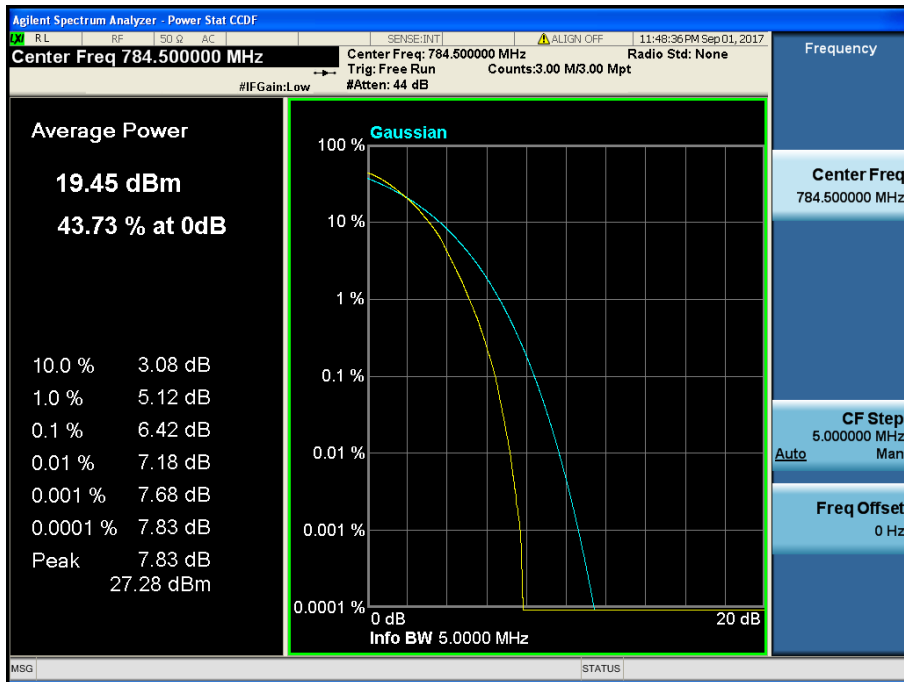

LTE Band 13 / 5 MHz / 64QAM - RB Size 25

8.2.3 LTE Band 5

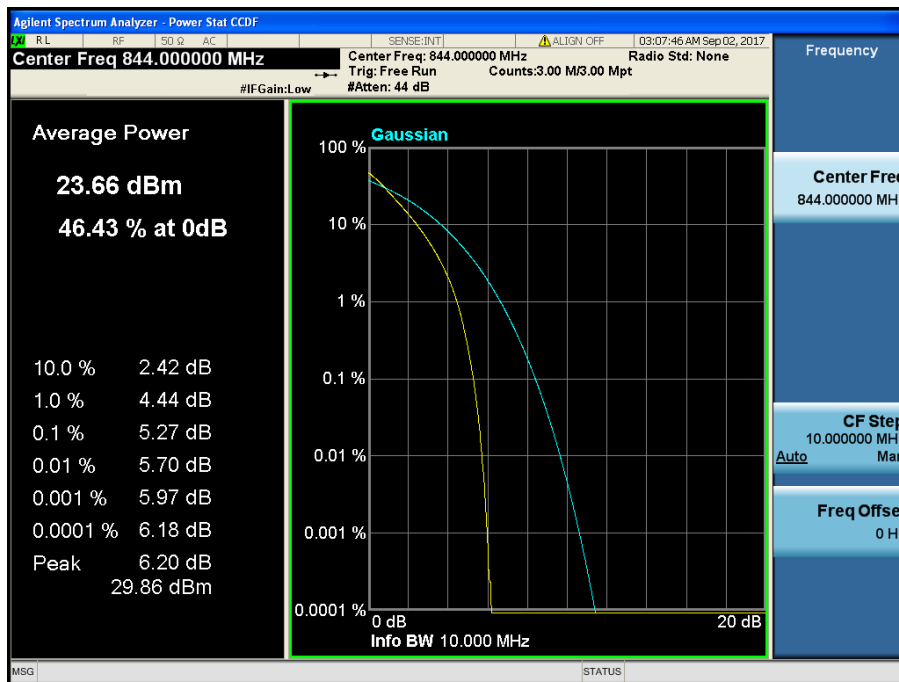

LTE Band 5 / 10 MHz / QPSK - RB Size 50

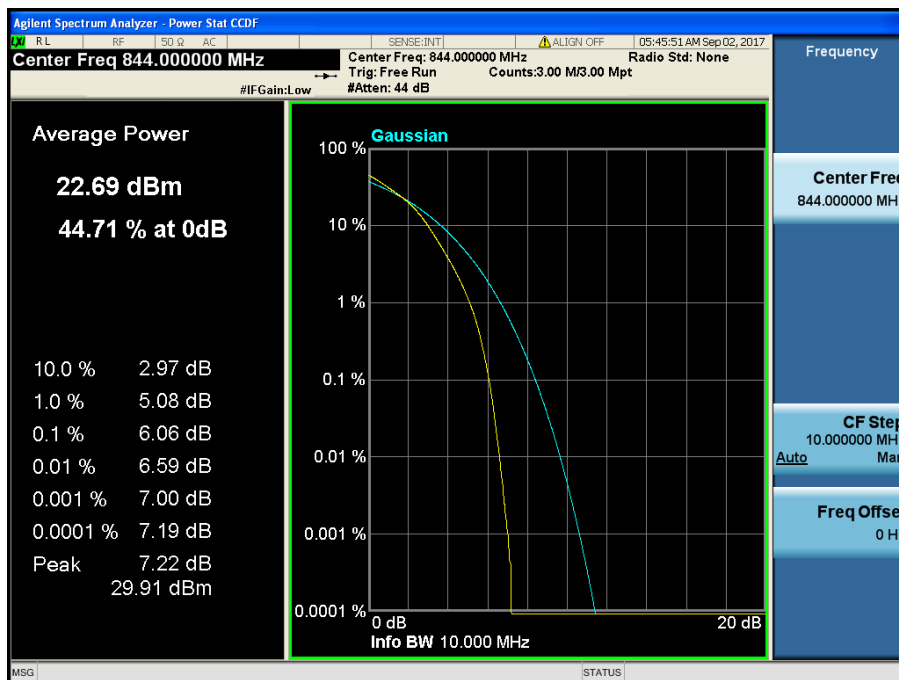

LTE Band 5 / 10 MHz / 16QAM - RB Size 50

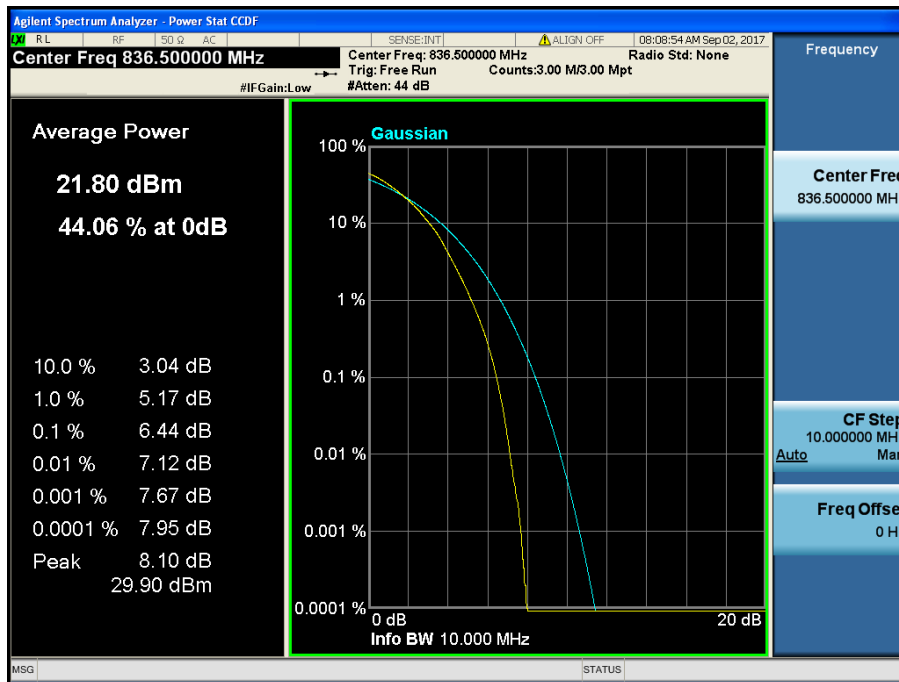

LTE Band 5 / 10 MHz / 64QAM - RB Size 50

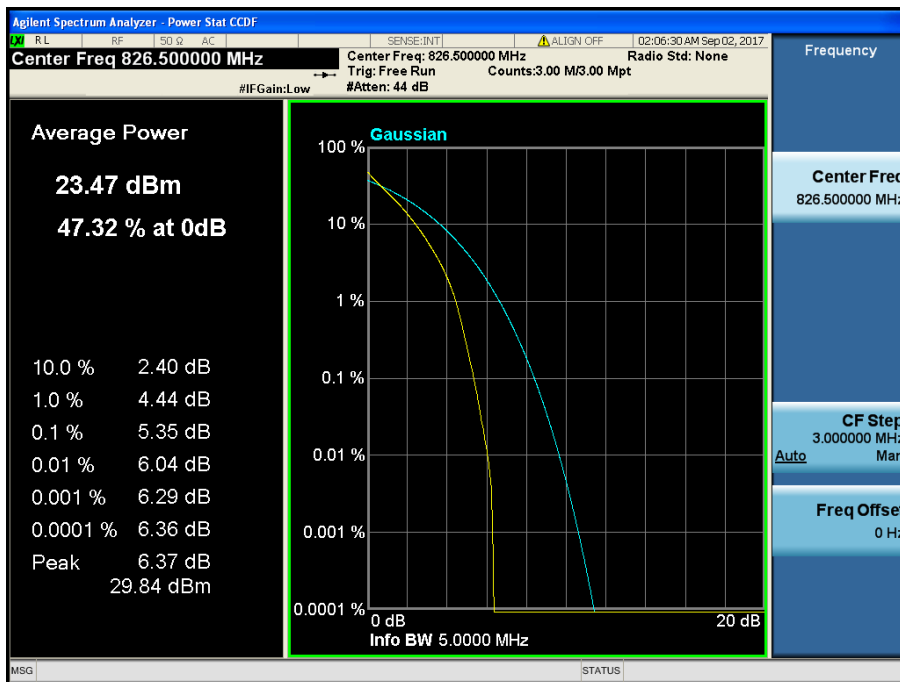

LTE Band 5 / 5 MHz / QPSK - RB Size 25

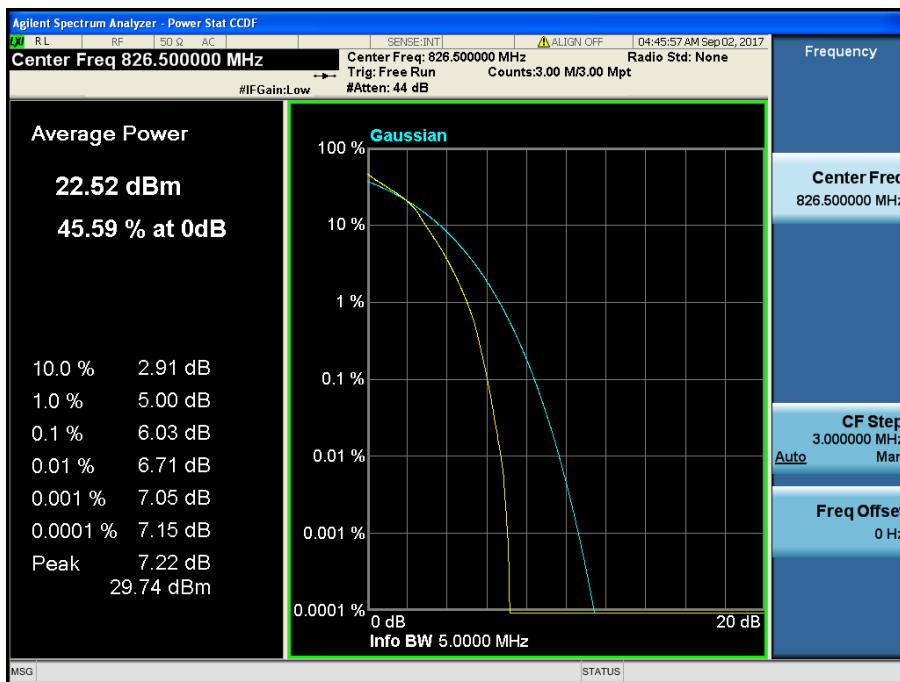

LTE Band 5 / 5 MHz / 16QAM - RB Size 25

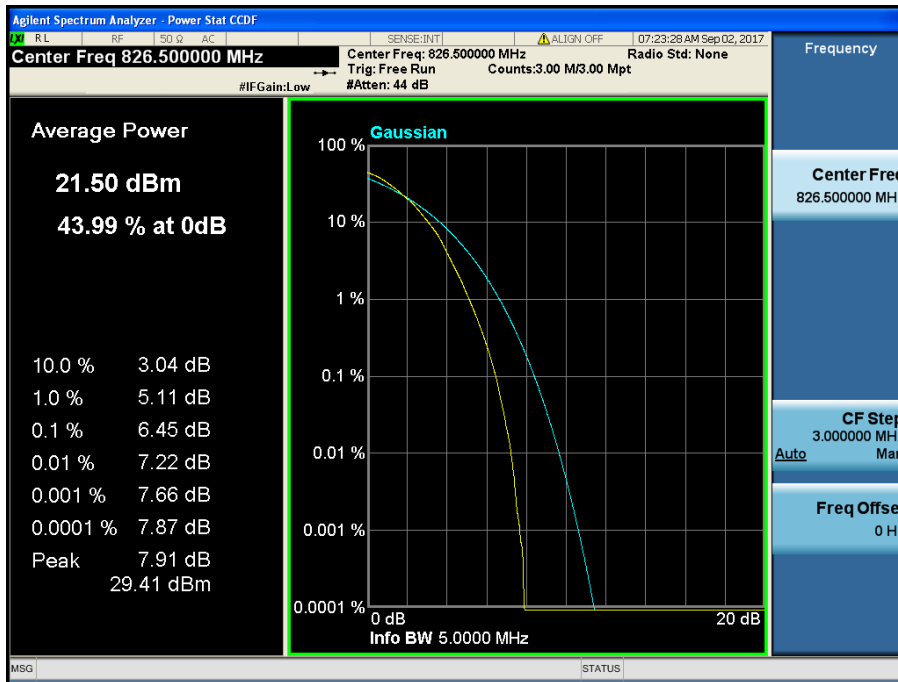

LTE Band 5 / 5 MHz / 64QAM - RB Size 25

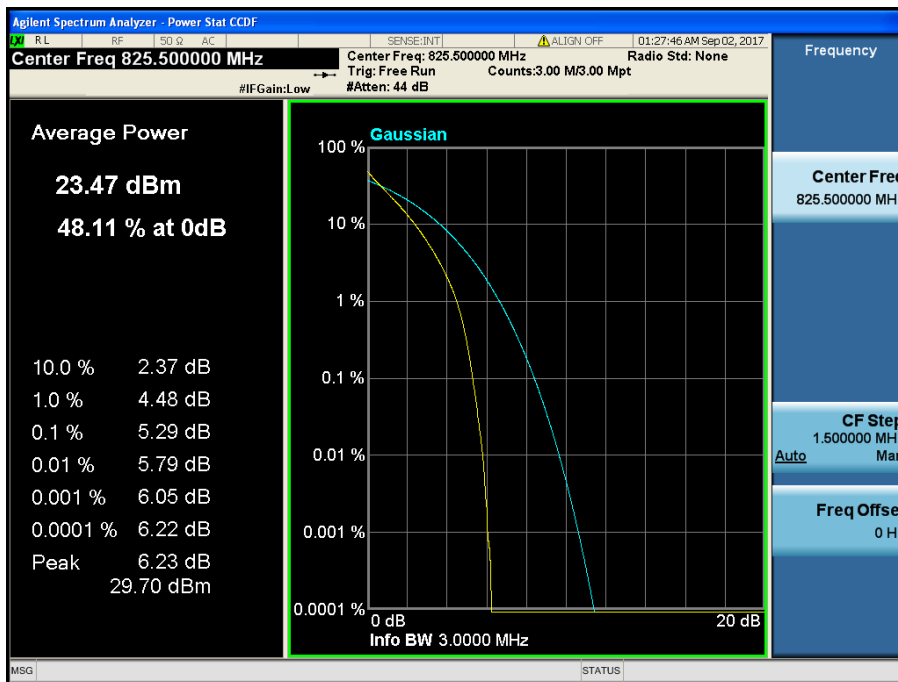

LTE Band 5 / 3 MHz / QPSK - RB Size 15

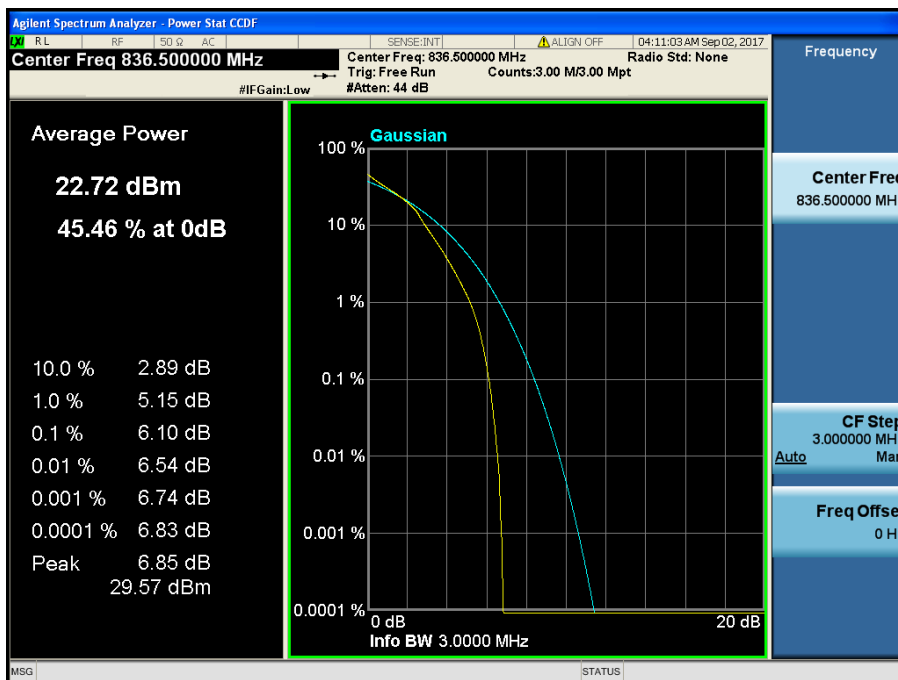

LTE Band 5 / 3 MHz / 16QAM - RB Size 15

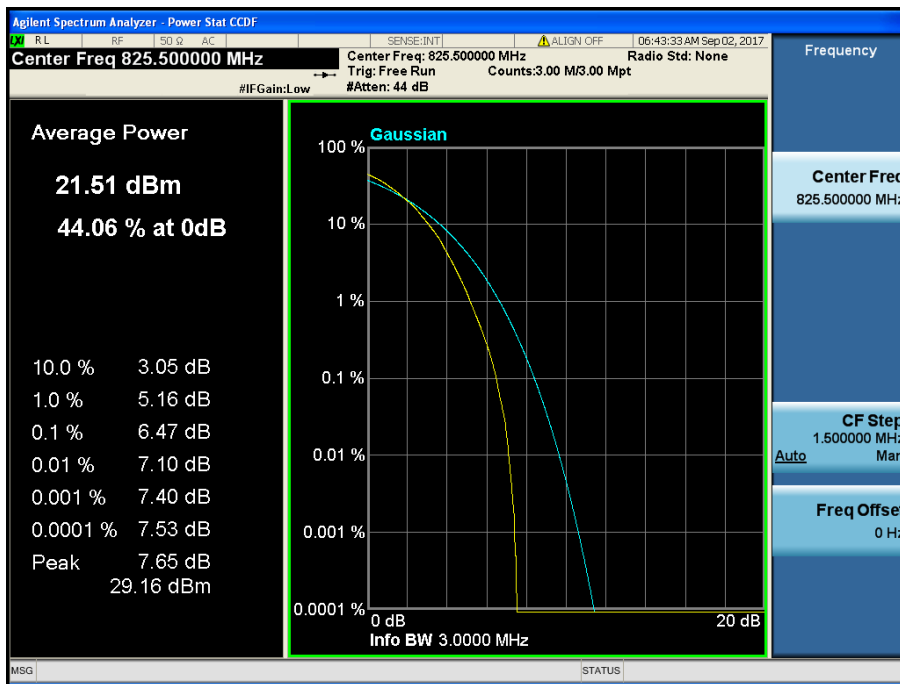

LTE Band 5 / 3 MHz / 64QAM - RB Size 15

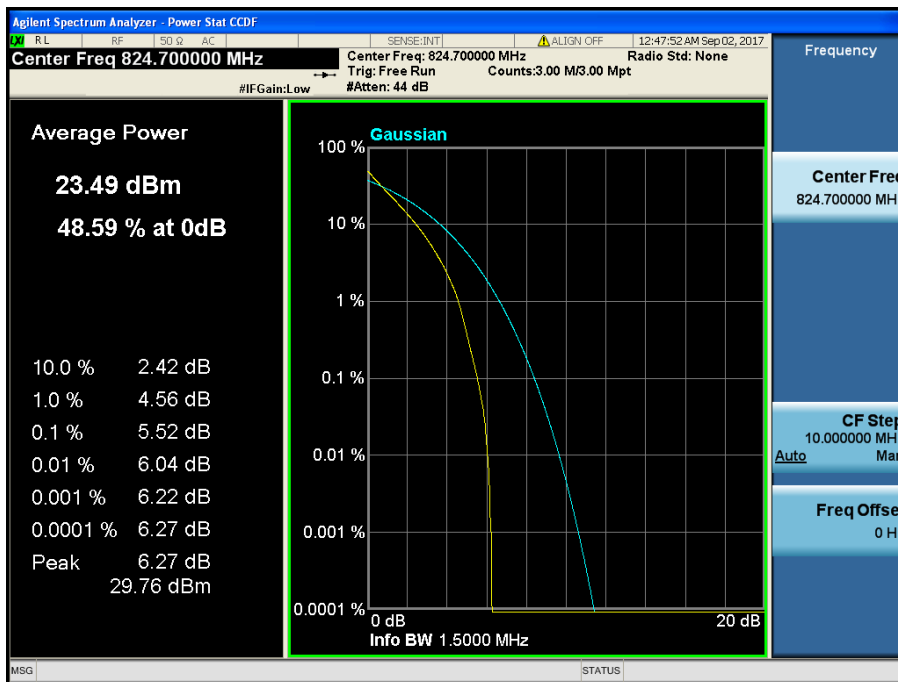

LTE Band 5 / 1.4 MHz / QPSK - RB Size 6

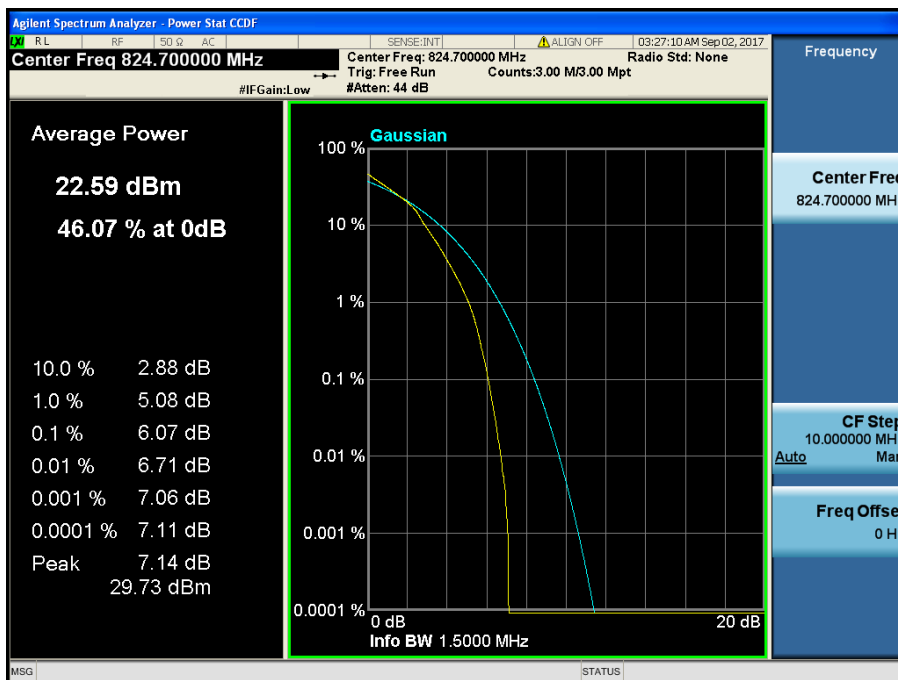

LTE Band 5 / 1.4 MHz / 16QAM - RB Size 6

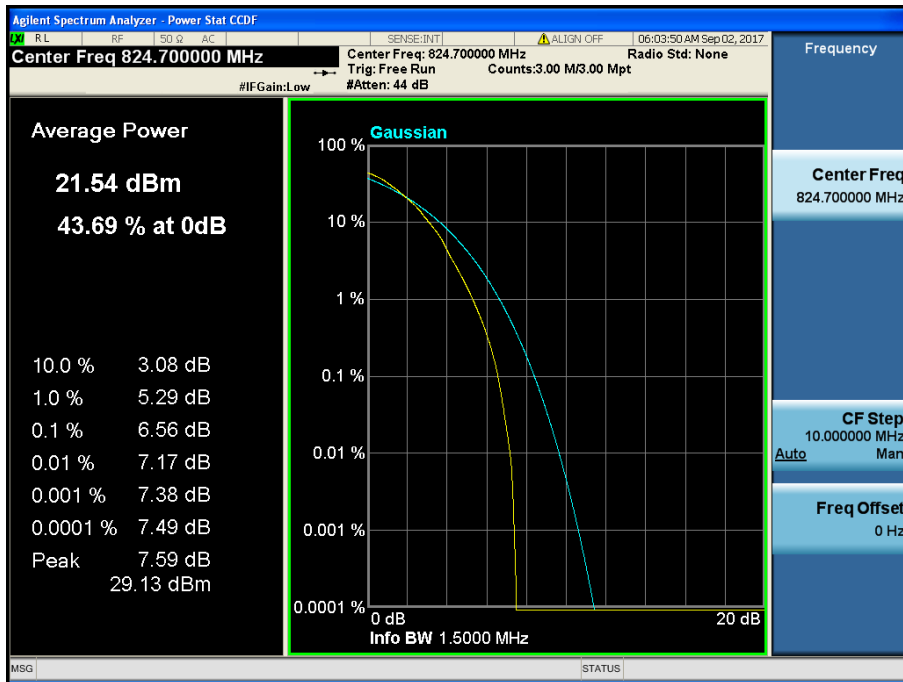

LTE Band 5 / 1.4 MHz / 64QAM - RB Size 6

8.3 BAND EDGE EMISSIONS(Conducted)

8.3.1 LTE Band 17

- Lower Band Edge

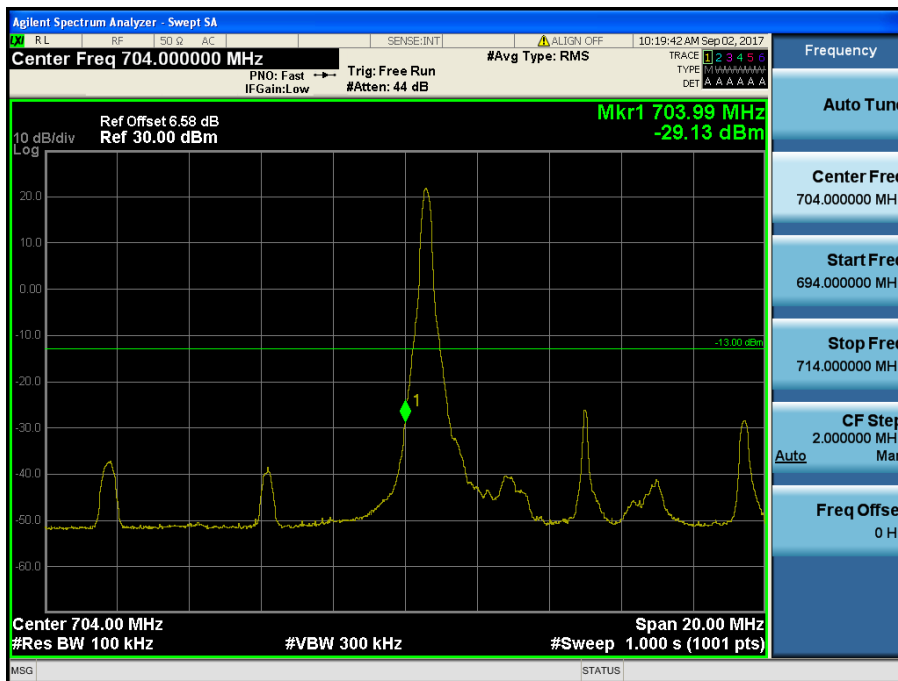

LTE Band 17 / 10MHz / 16QAM - RB Size/Offset (1/0)

- Lower Extended Band Edge 1

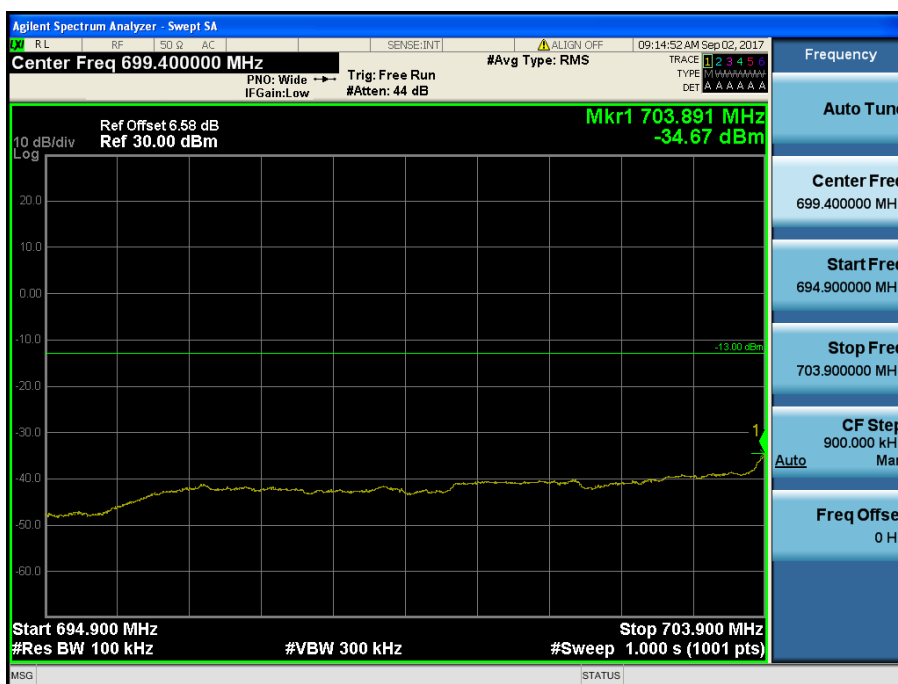

LTE Band 17 / 10MHz / QPSK - RB Size/Offset (25/0)

- Lower Extended Band Edge 2

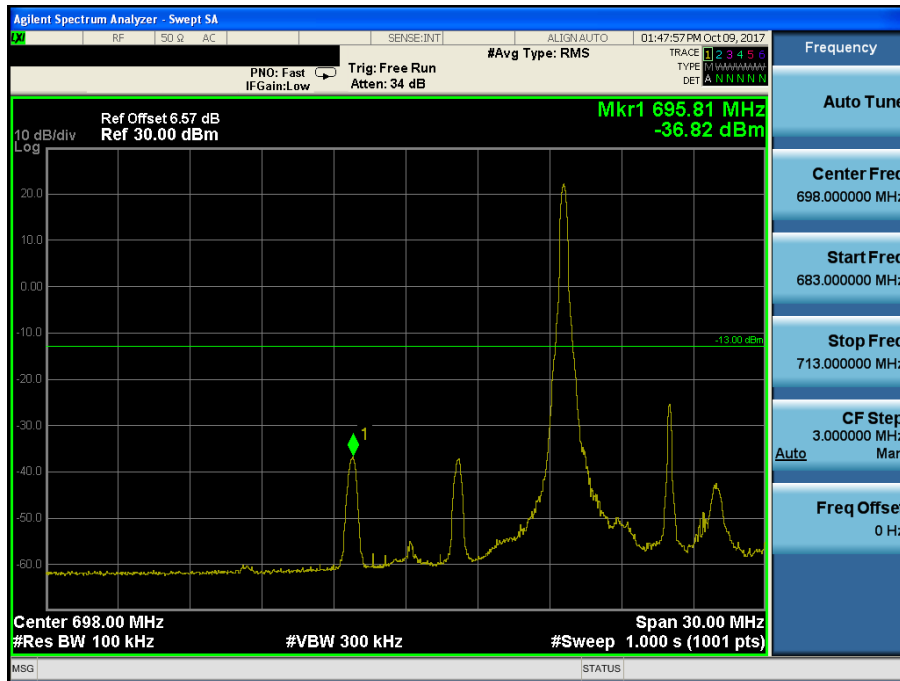

LTE Band 17 / 10MHz / QPSK - RB Size/Offset (1/0)

- Upper Band Edge

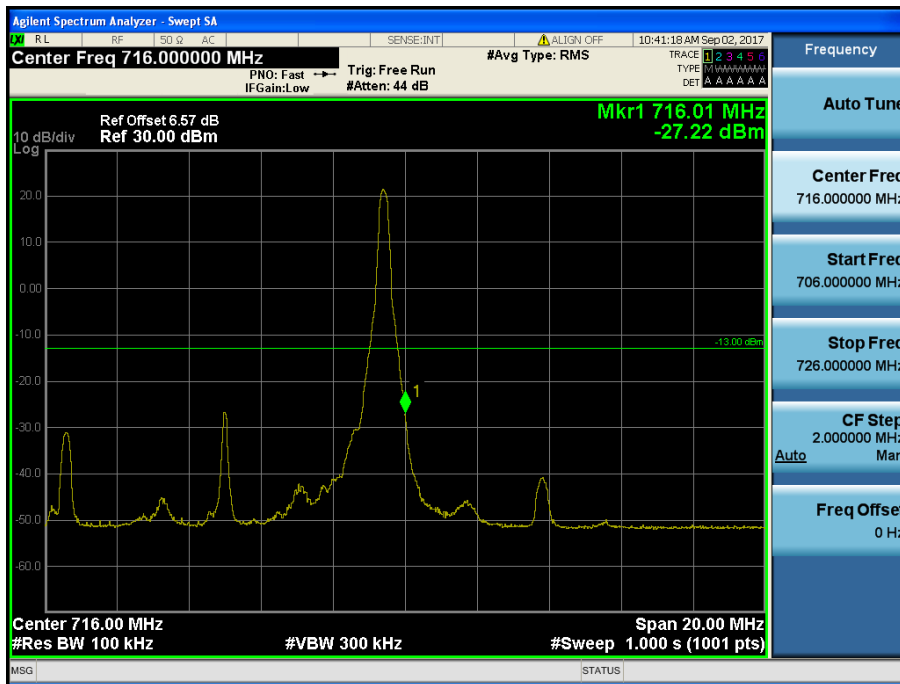

LTE Band 17 / 10MHz / 16QAM - RB Size/Offset (1/49)

- Upper Extended Band Edge

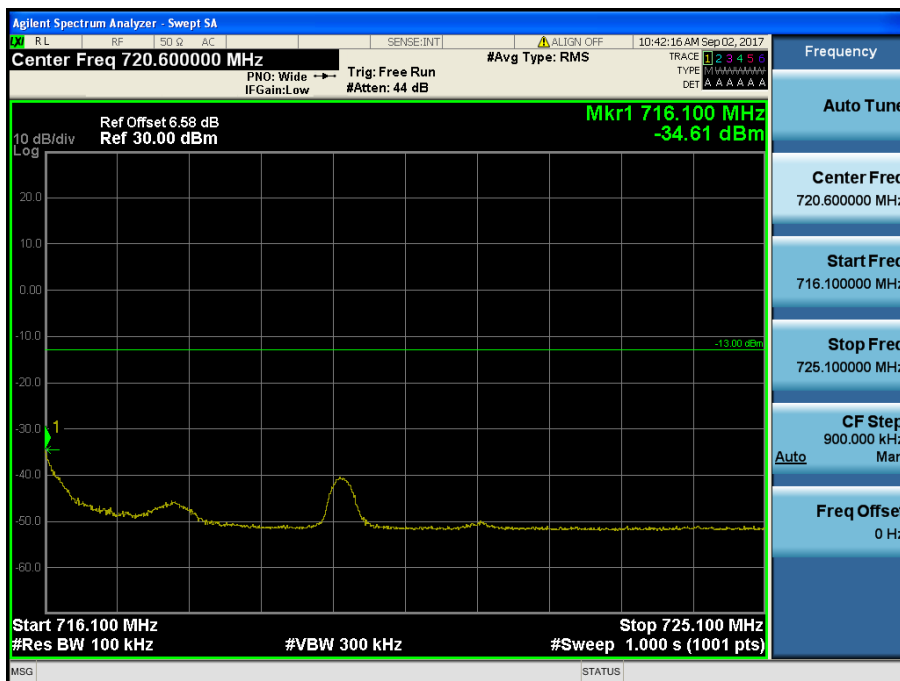

LTE Band 17 / 10MHz / 16QAM - RB Size/Offset (1/49)

- Lower Band Edge



LTE Band 17 / 5MHz / 16QAM RB Size/Offset (1/0)

- Lower Extended Band Edge 1

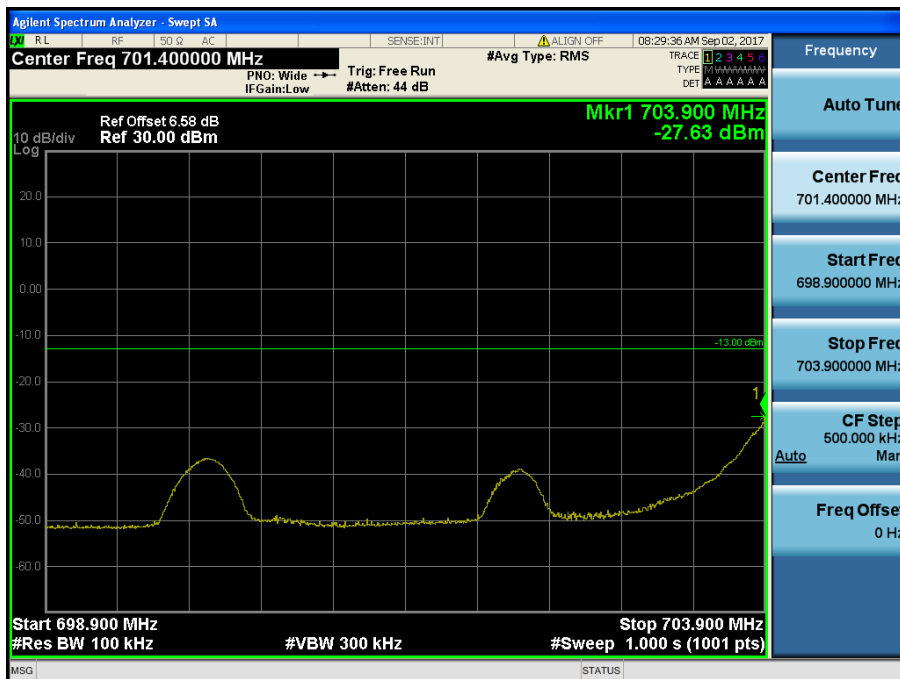

LTE Band 17 / 5MHz / QPSK RB Size/Offset (1/0)

- Lower Extended Band Edge 2



LTE Band 17 / 5MHz / QPSK RB Size/Offset (25/0)

8.3.2 LTE Band 13

- Lower Band Edge

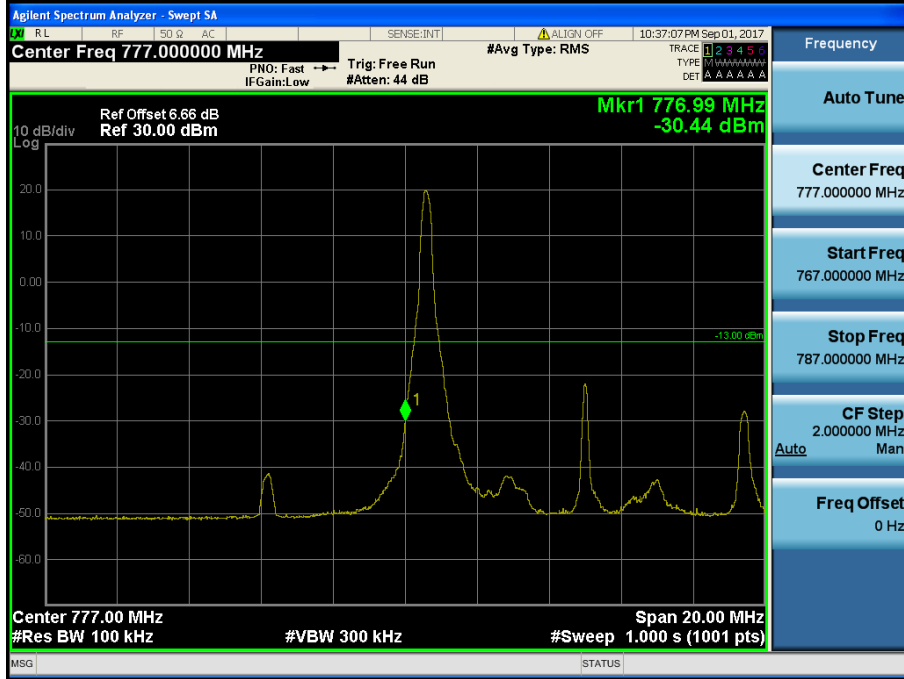

LTE Band 13 / 10MHz / 16QAM - RB Size/Offset (1/0)

- Lower Extended Band Edge



LTE Band 13 / 10MHz / 64QAM - RB Size/Offset (25/0)

- Lower (763 ~ 775 MHz)

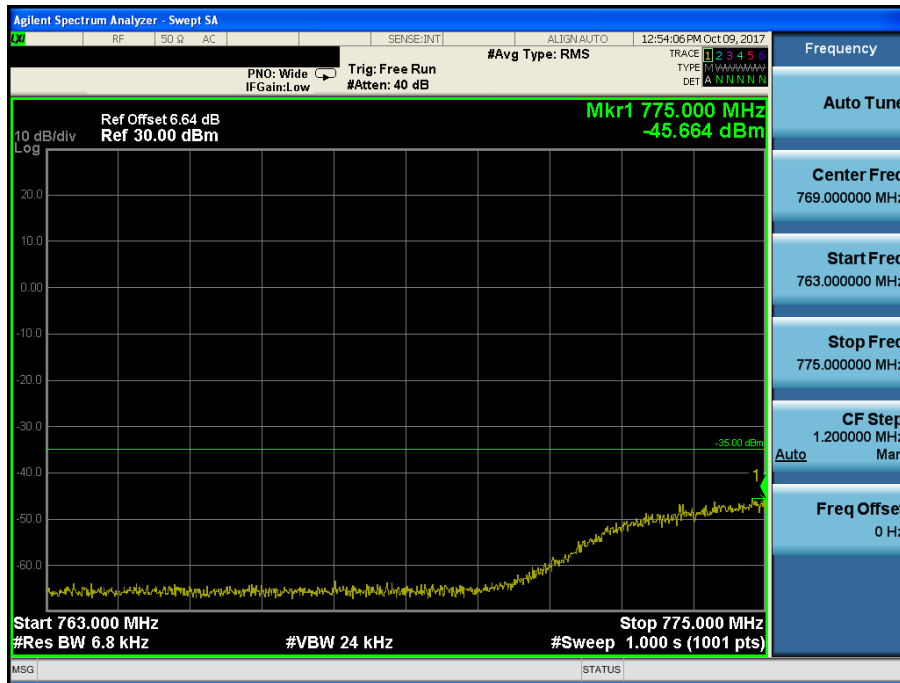

LTE Band 13 / 10MHz / 64QAM - RB Size/Offset (25/0)

- Upper Band Edge

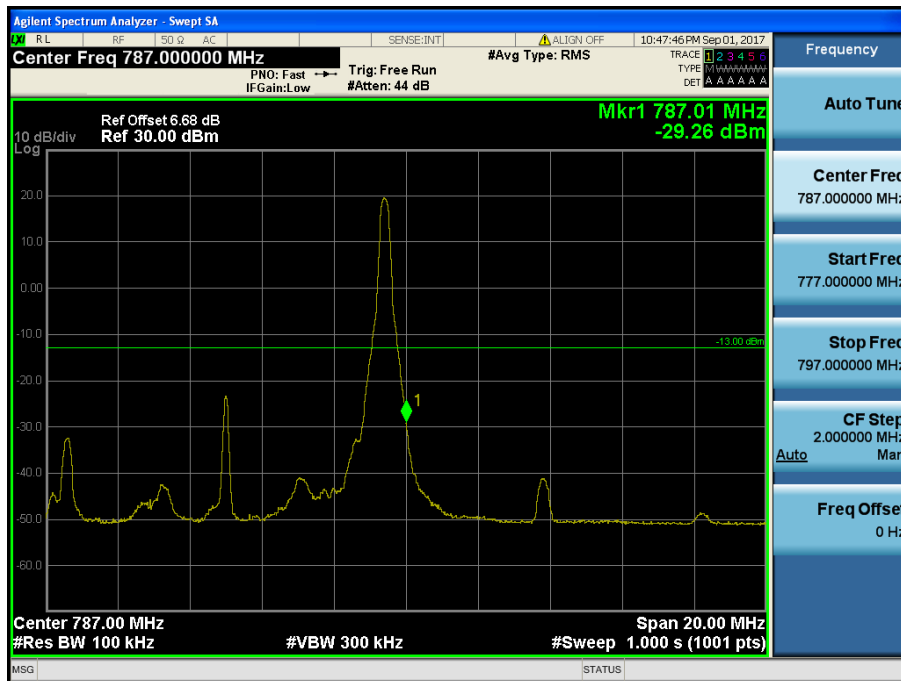

LTE Band 13 / 10MHz / 16QAM - RB Size/Offset (1/49)

- Upper Extended Band Edge



LTE Band 13 / 10MHz / 64QAM - RB Size/Offset (25/25)

- Upper (793 ~ 805 MHz)

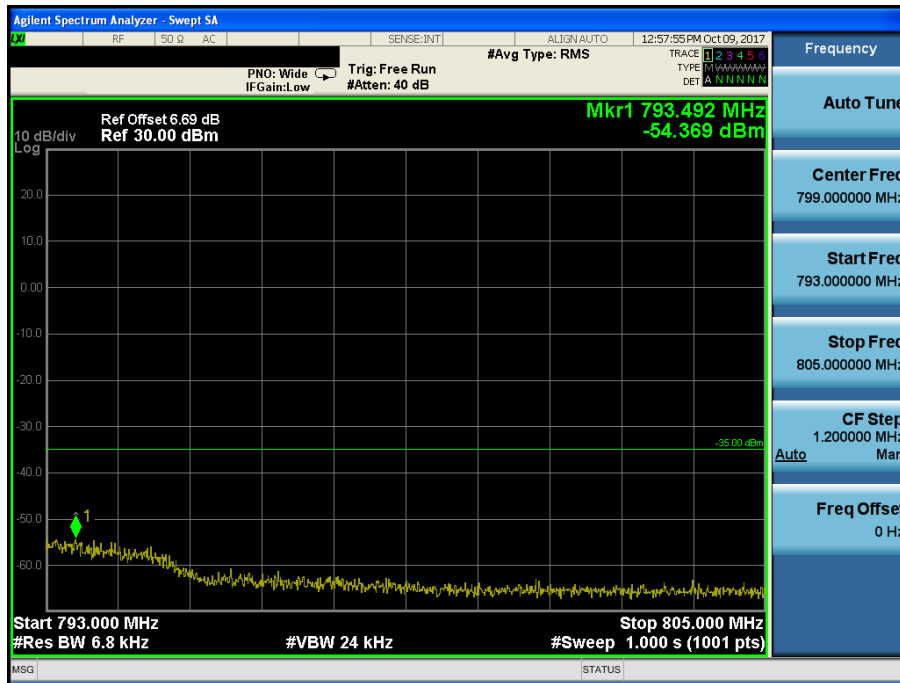

LTE Band 13 / 10MHz / QPSK - RB Size/Offset (50/0)

- Lower Band Edge



LTE Band 13 / 5MHz / 16QAM - RB Size/Offset (1/0)

- Lower Extended Band Edge

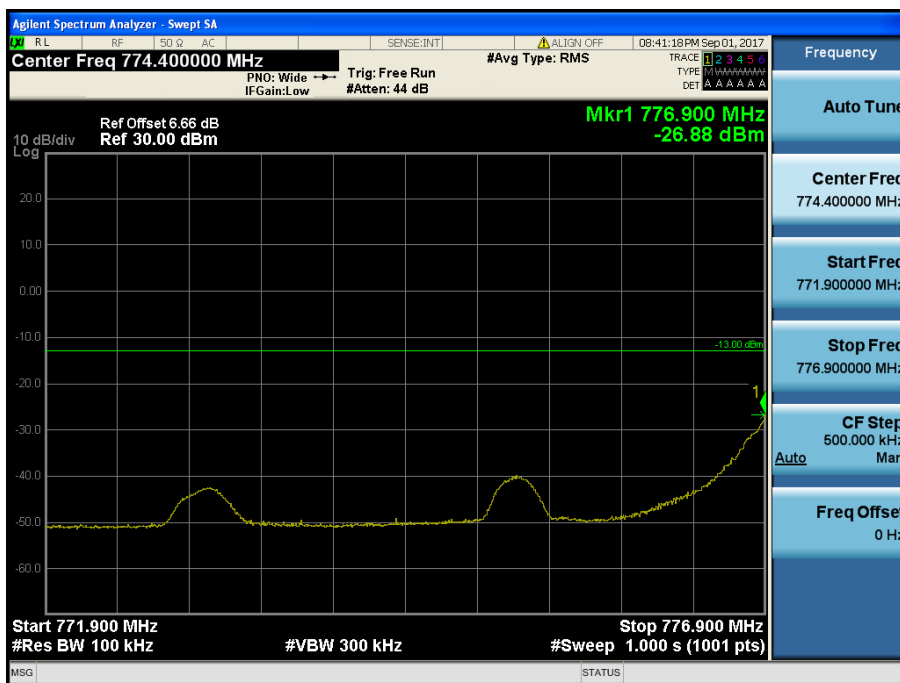

LTE Band 13 / 5MHz / QPSK - RB Size/Offset (1/0)

- Lower (763 ~ 775 MHz)

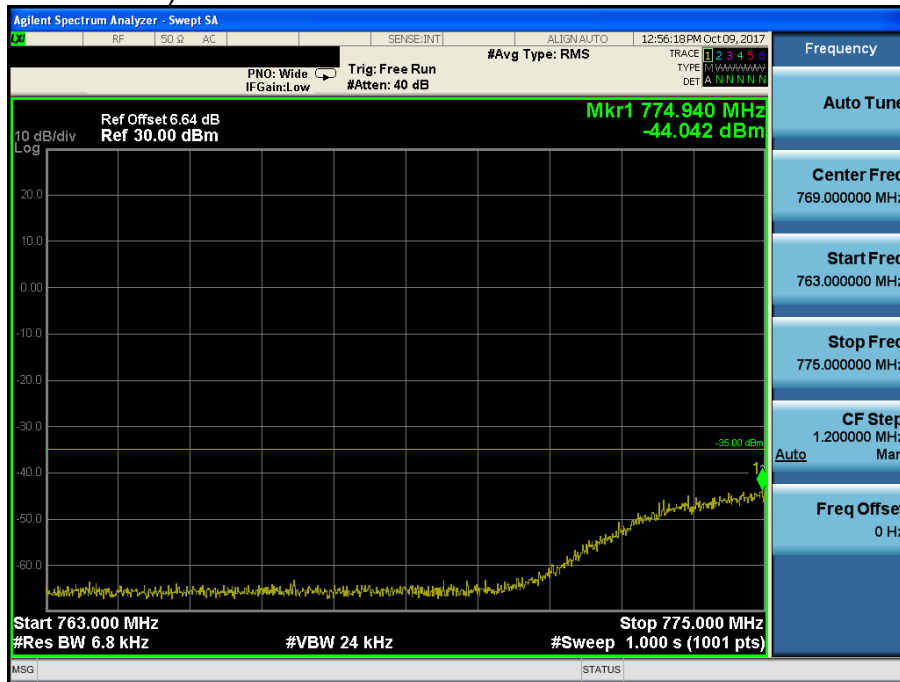

LTE Band 13 / 5MHz / 64QAM - RB Size/Offset (25/0)

- Upper Band Edge

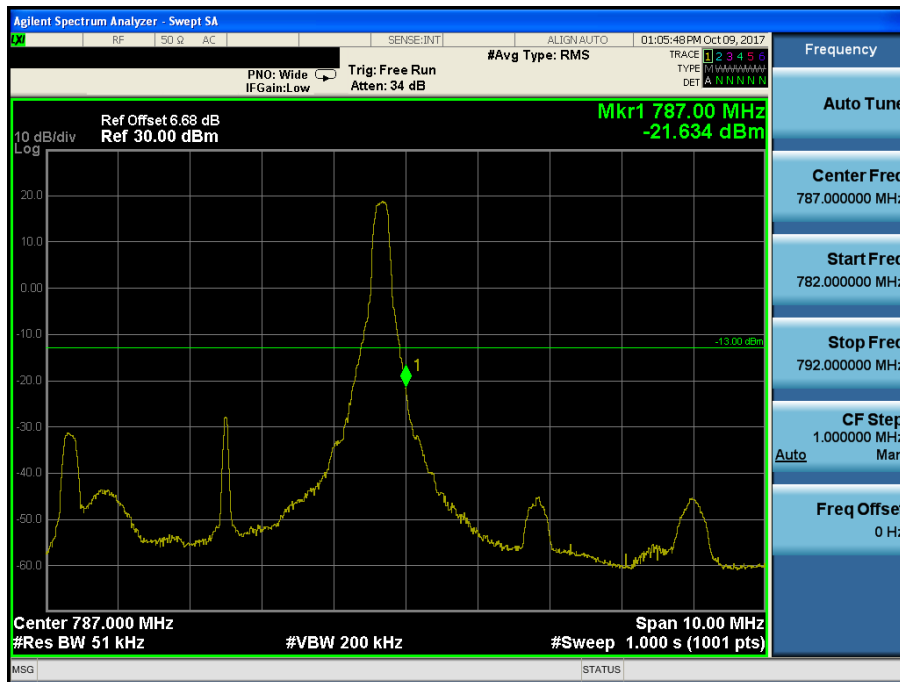

LTE Band 13 / 5MHz / QPSK - RB Size/Offset (1/24)

- Upper Extended Band Edge

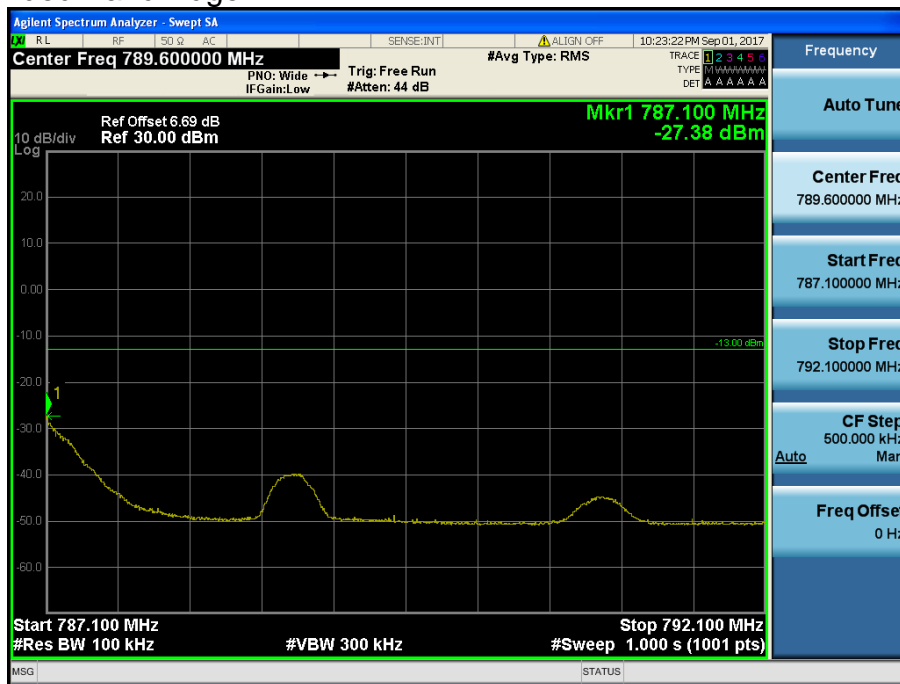

LTE Band 13 / 5MHz / 16QAM - RB Size/Offset (1/24)

- Upper (793 ~ 805 MHz)

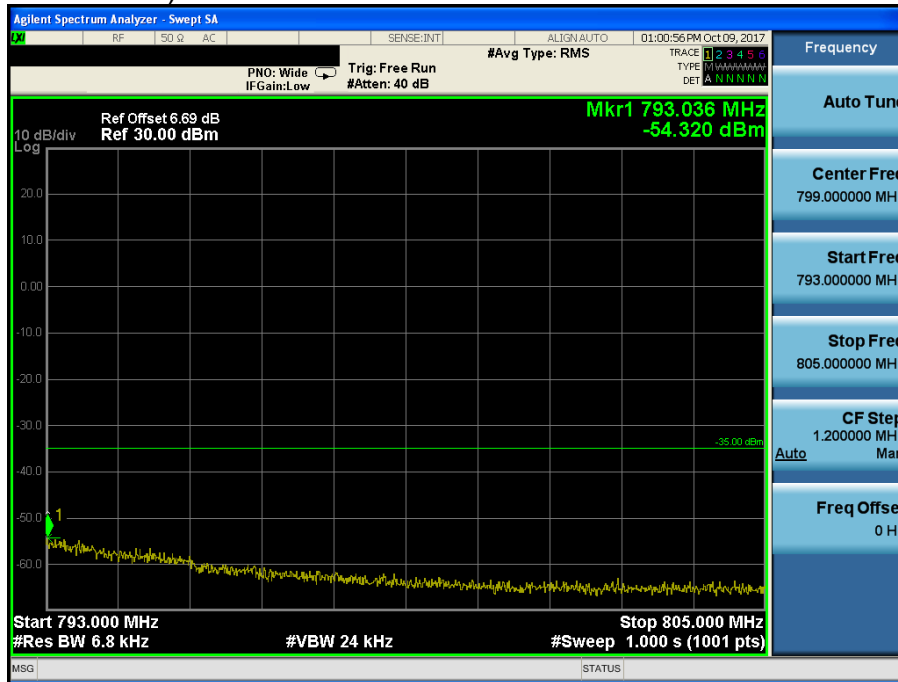

LTE Band 13 / 5MHz / 64QAM - RB Size/Offset (25/0)

8.3.3 LTE Band 5

- Lower Band Edge

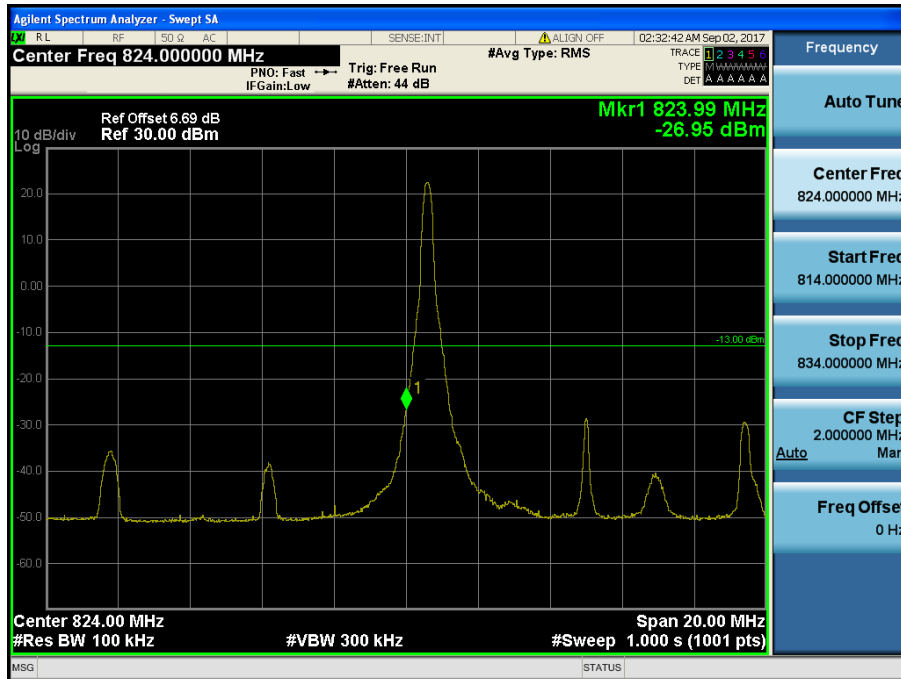

LTE Band 5 / 10MHz / QPSK - RB Size/Offset (1/0)

- Lower Extended Band Edge



LTE Band 5 / 10MHz / 64QAM - RB Size/Offset (25/0)

- Upper Band Edge

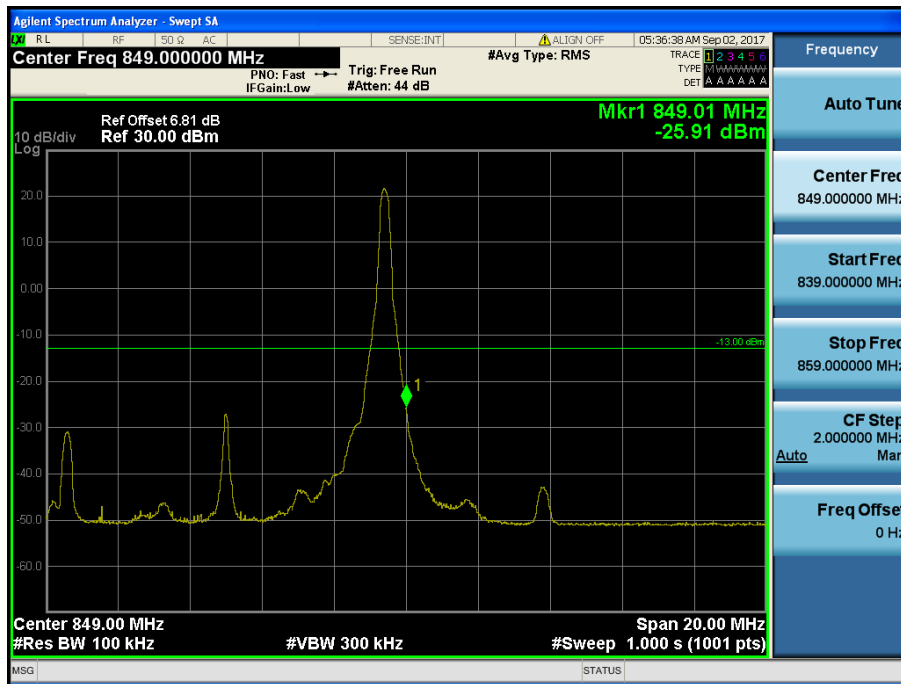

LTE Band 5 / 10MHz / 16QAM - RB Size/Offset (1/49)

- Upper Extended Band Edge



LTE Band 5 / 10MHz / QPSK - RB Size/Offset (50/0)

- Lower Band Edge



LTE Band 5 / 5MHz / 16QAM Offset/Size (1/0)

- Lower Extended Band Edge



LTE Band 5 / 5MHz / 64QAM Offset/Size (12/0)

- Upper Band Edge



LTE Band 5 / 5MHz / 16QAM - RB Size/Offset (1/24)

- Upper Extended Band Edge



LTE Band 5 / 5MHz / 64QAM - RB Size/Offset (25/0)

- Upper Band Edge

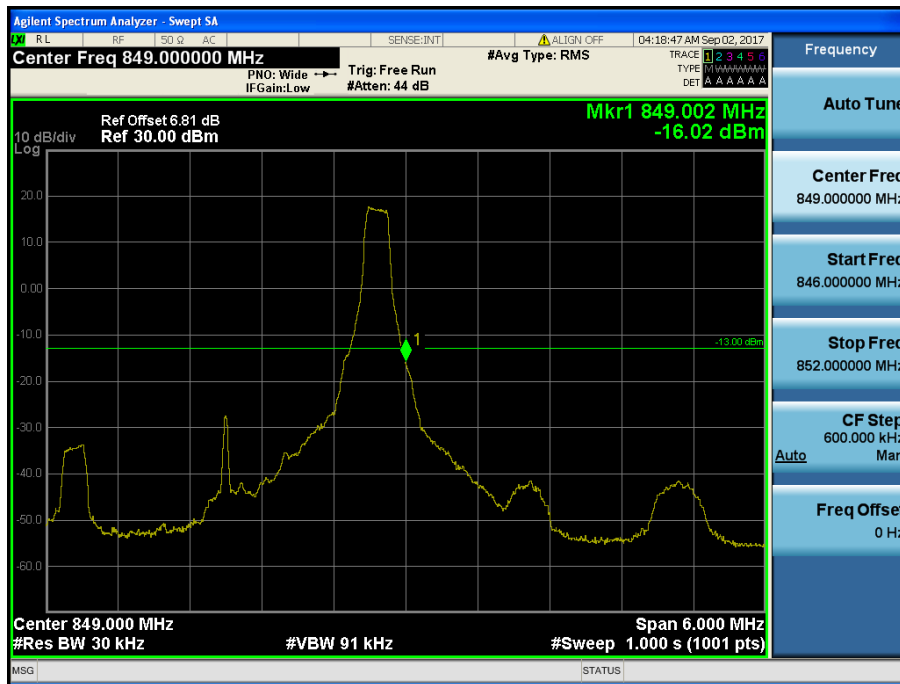

LTE Band 5 / 3MHz / 16QAM - RB Size/Offset (1/14)

- Upper Extended Band Edge



LTE Band 5 / 3MHz / 64QAM - RB Size/Offset (8/7)

- Lower Band Edge



LTE Band 5 / 1.4MHz / 16QAM - RB Size/Offset (1/0)

- Lower Extended Band Edge



LTE Band 5 / 1.4MHz / 64QAM - RB Size/Offset (6/0)

- Upper Band Edge



LTE Band 5 / 1.4MHz / QPSK - RB Size/Offset (3/3)

- Upper Extended Band Edge



LTE Band 5 / 1.4MHz / 64QAM - RB Size/Offset (6/0)

8.4 SPURIOUS AND HARMONICS EMISSIONS(Conducted)

8.4.1 LTE Band 17

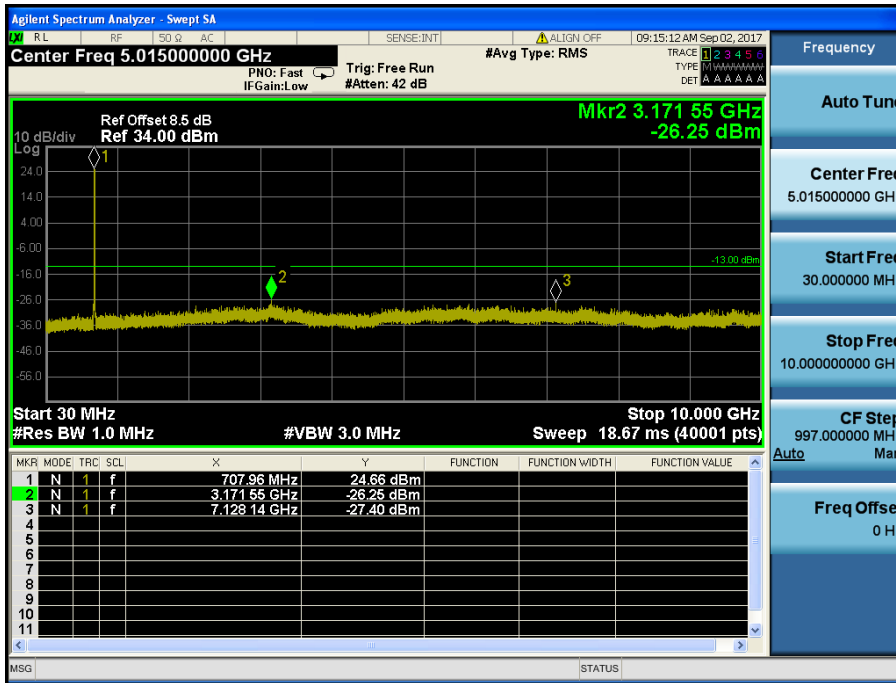

LTE Band 17 / 10MHz / QPSK - RB Size/Offset (25/0) – Low Channel

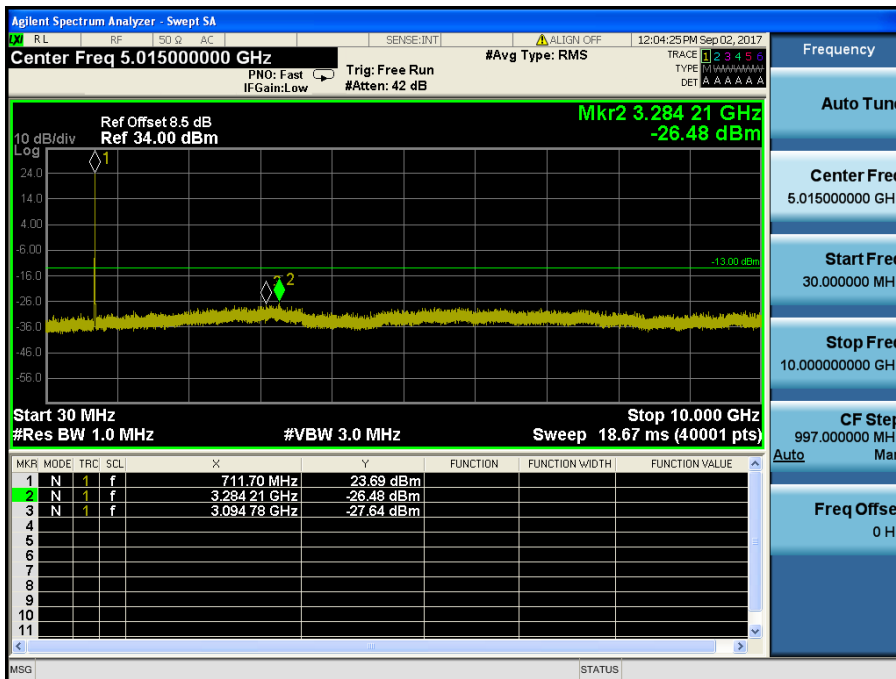

LTE Band 17 / 10MHz / 64QAM - RB Size/Offset (25/25) – High Channel

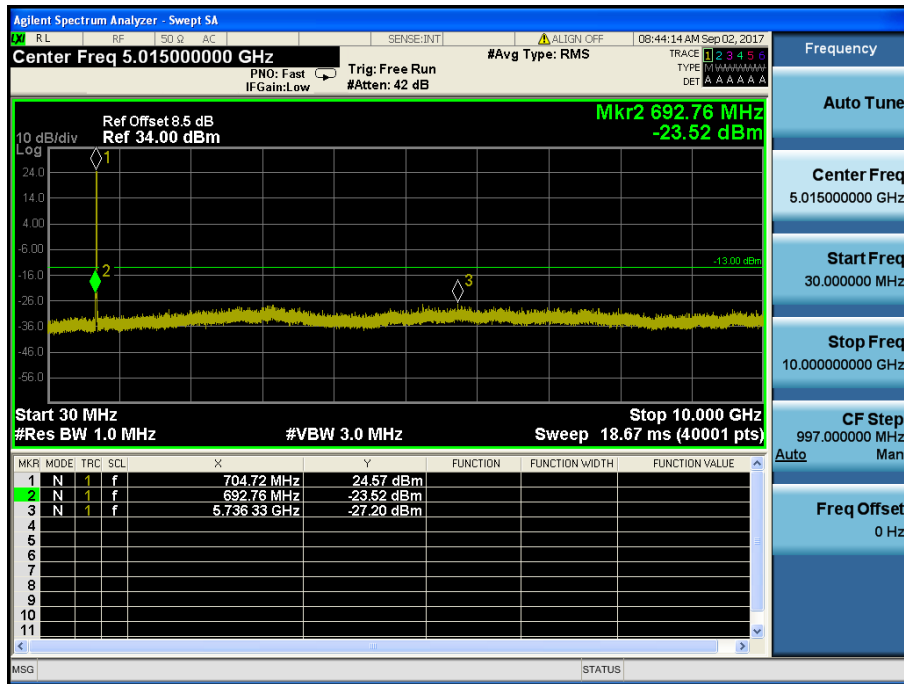

LTE Band 17 / 5MHz / QPSK - RB Size/Offset (25/0) – Low Channel

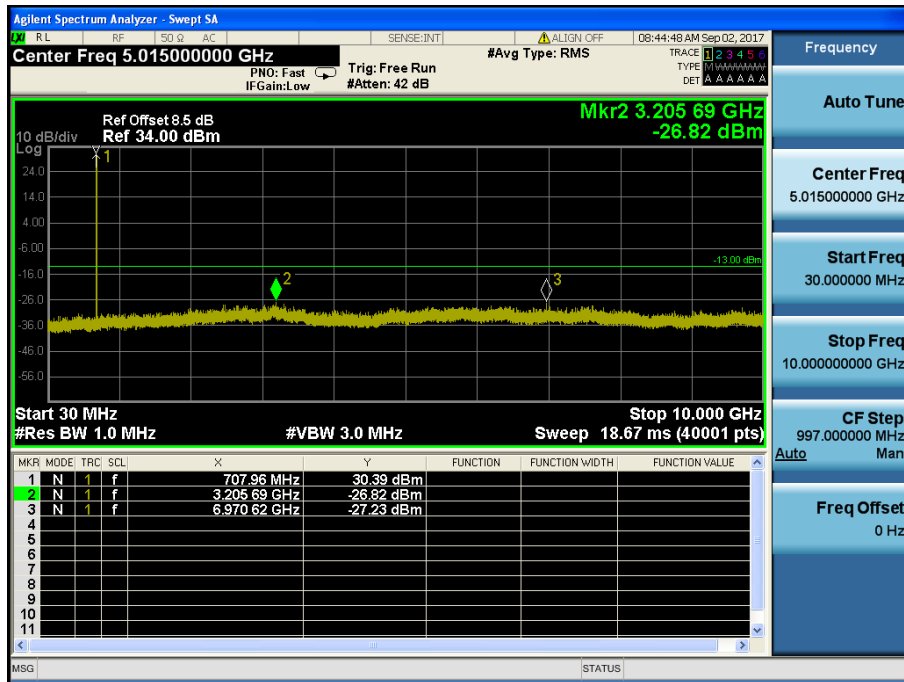

LTE Band 17 / 5MHz / QPSK - RB Size/Offset (1/0)–Mid Channel

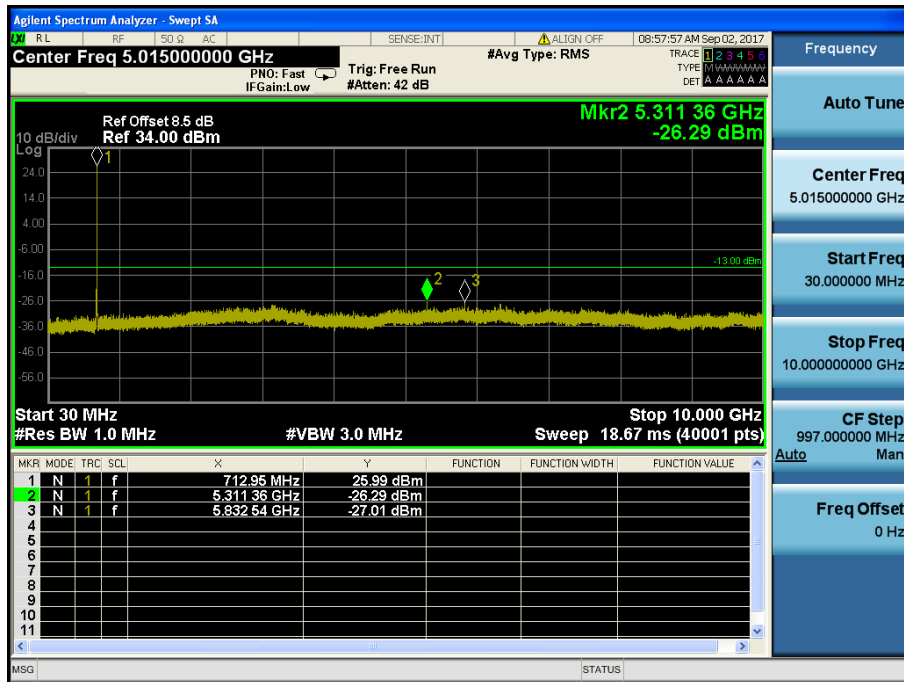

LTE Band 17 / 5MHz / QPSK - RB Size/Offset (12/0) – High Channel

8.4.2 LTE Band 13

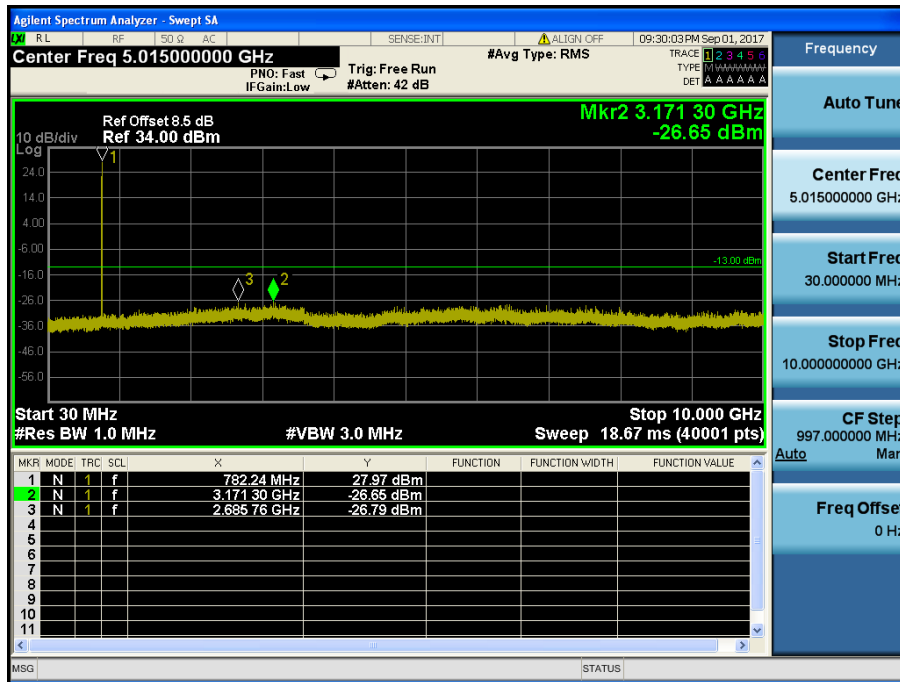

LTE Band 13 / 10MHz / QPSK - RB Size/Offset (1/25) – Low Channel

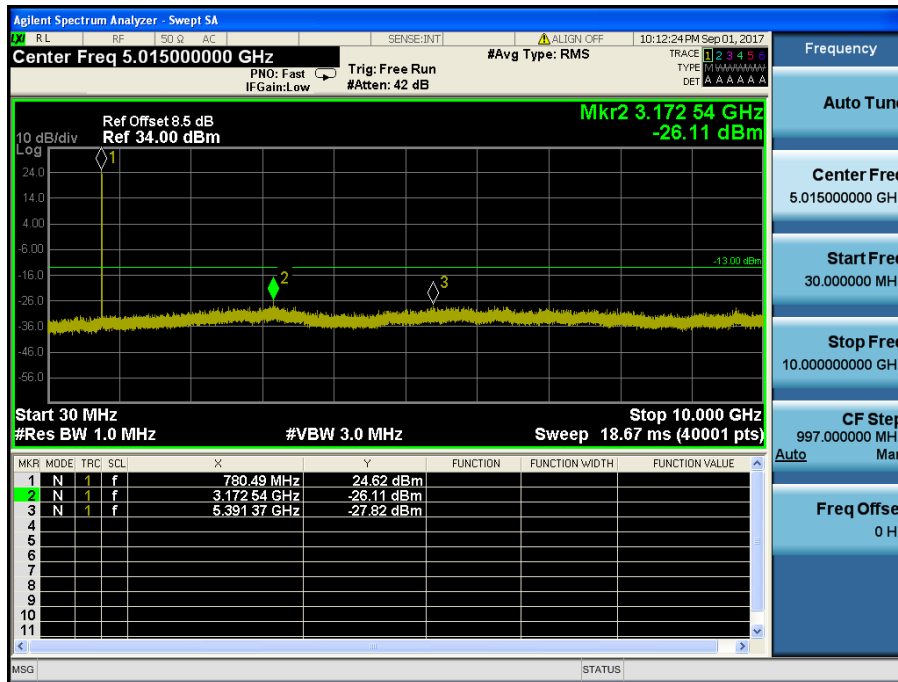

LTE Band 13 / 5MHz / 16QAM - RB Size/Offset (12/13) – Low Channel

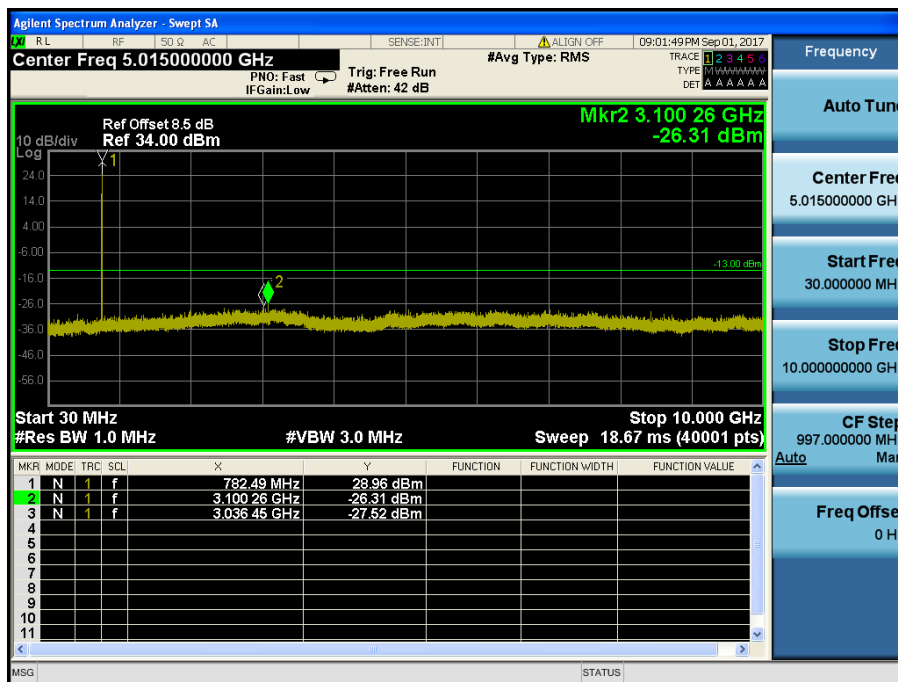

LTE Band 13 / 5MHz / QPSK - RB Size/Offset (1/0) – High Channel

8.4.3 LTE Band 5

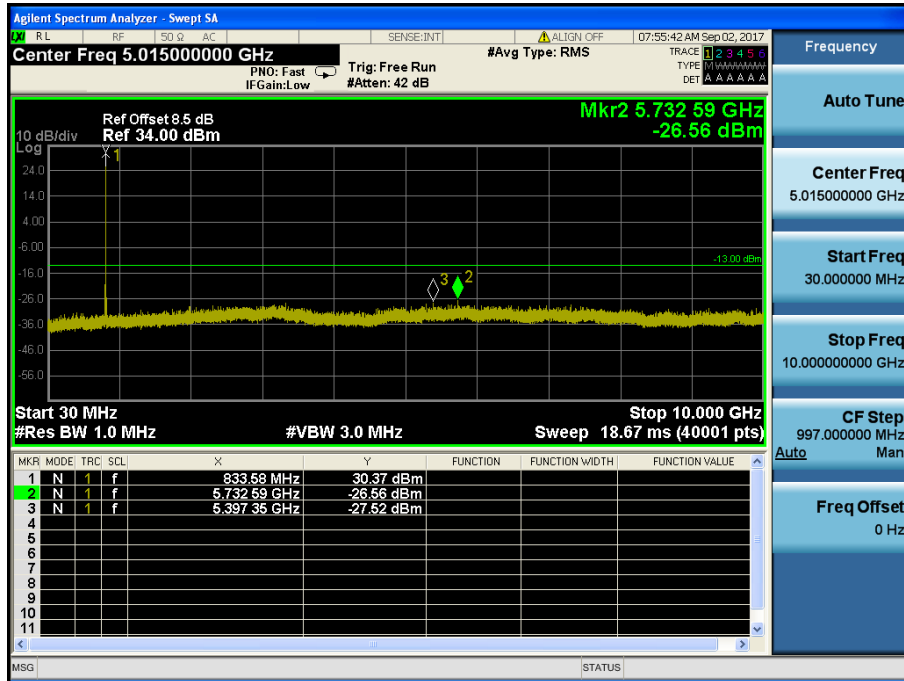

LTE Band 5 / 10MHz / 64QAM - RB Size/Offset (1/49) – Low Channel

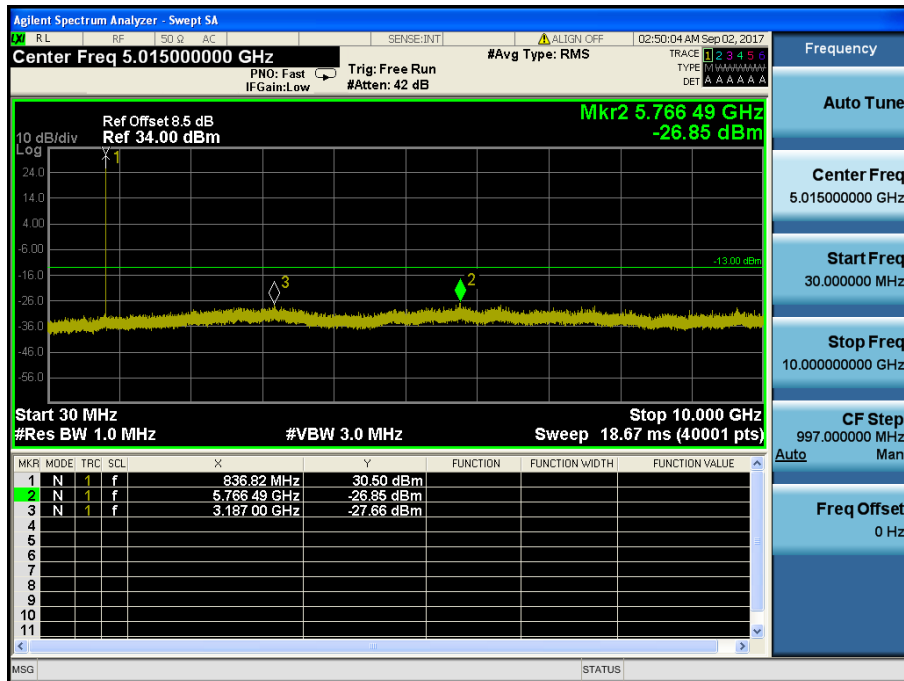

LTE Band 5 / 10MHz / QPSK - RB Size/Offset (1/25) – Mid Channel

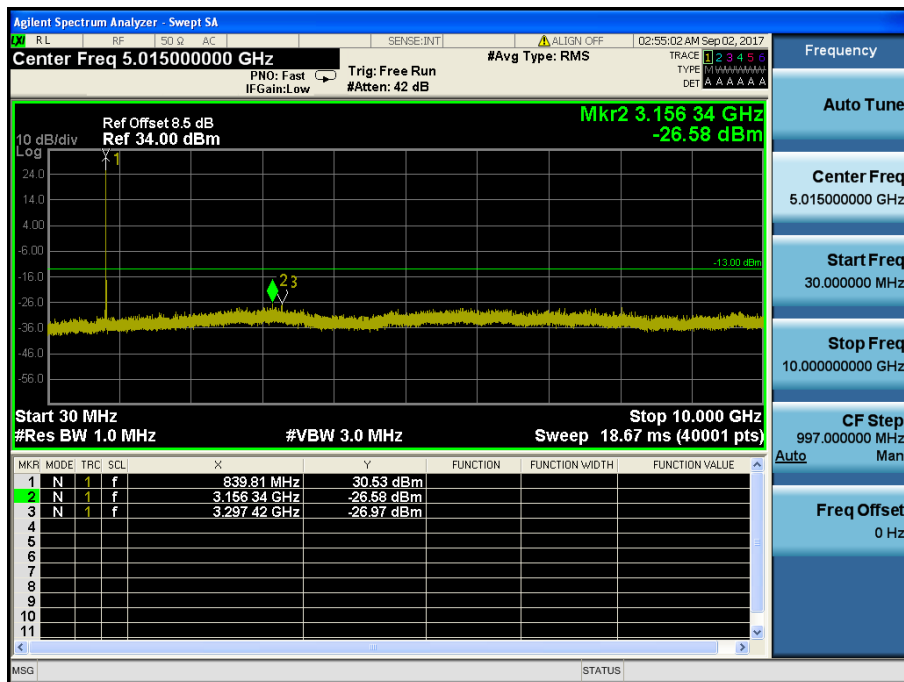

LTE Band 5 / 10MHz / QPSK - RB Size/Offset (1/0) – High Channel

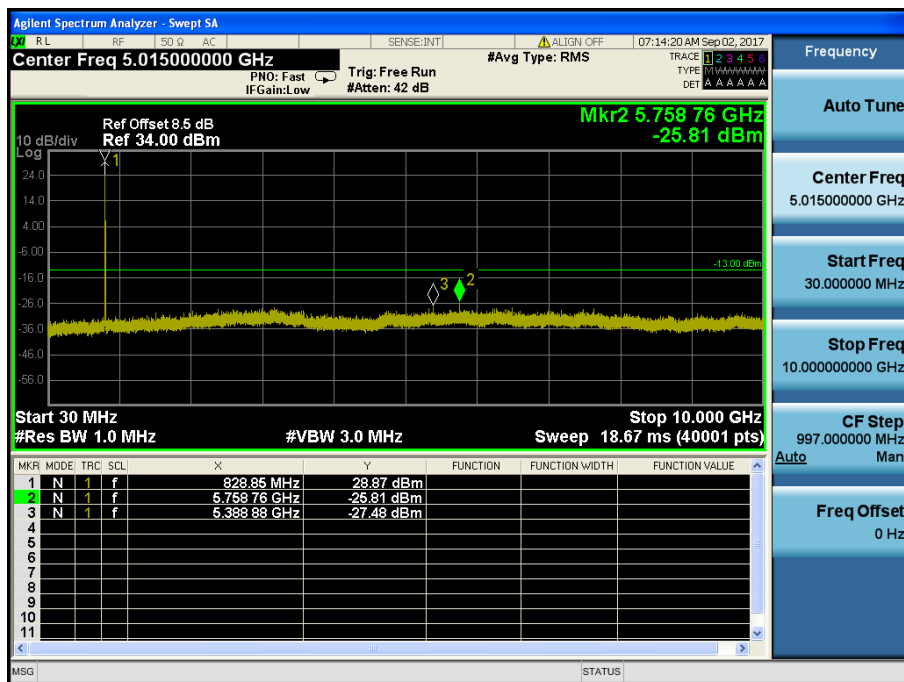

LTE Band 5 / 5MHz / 64QAM - RB Size/Offset (1/24) – Low Channel

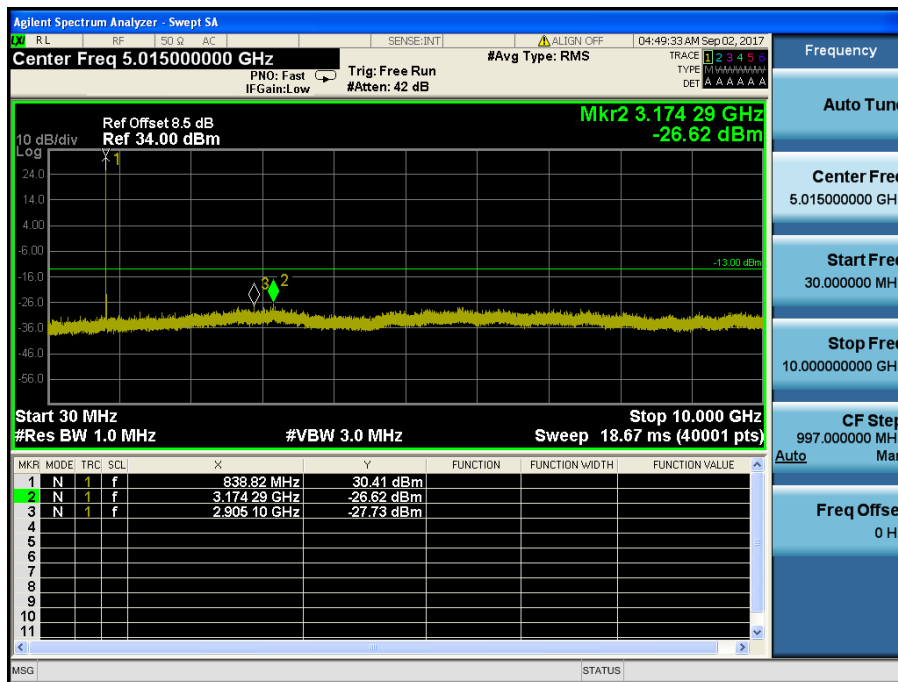

LTE Band 5 / 5MHz / 16QAM - RB Size/Offset (1/24) – Mid Channel

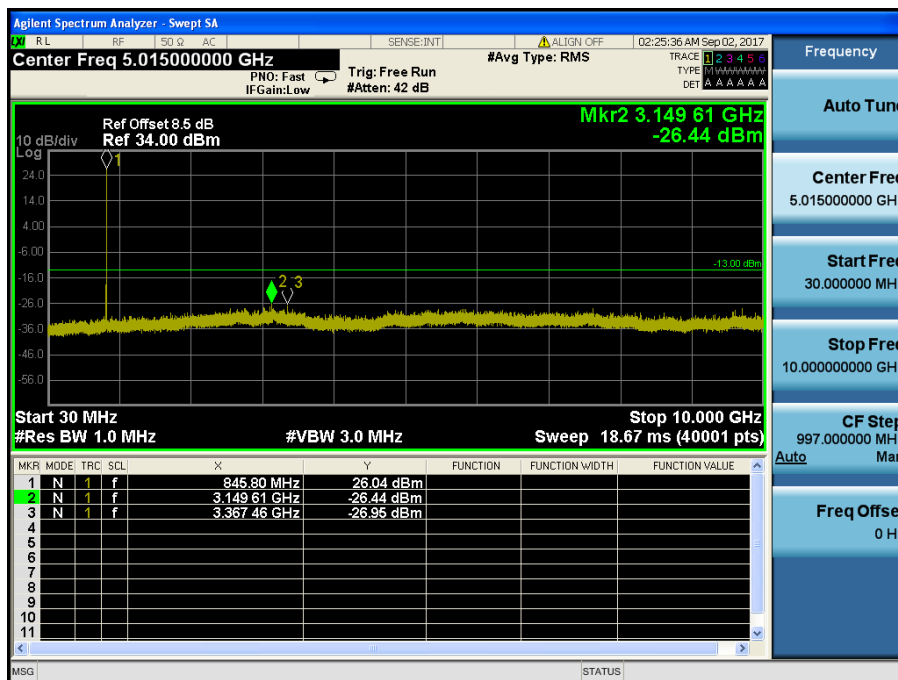

LTE Band 5 / 5MHz / QPSK - RB Size/Offset (12/6) – High Channel

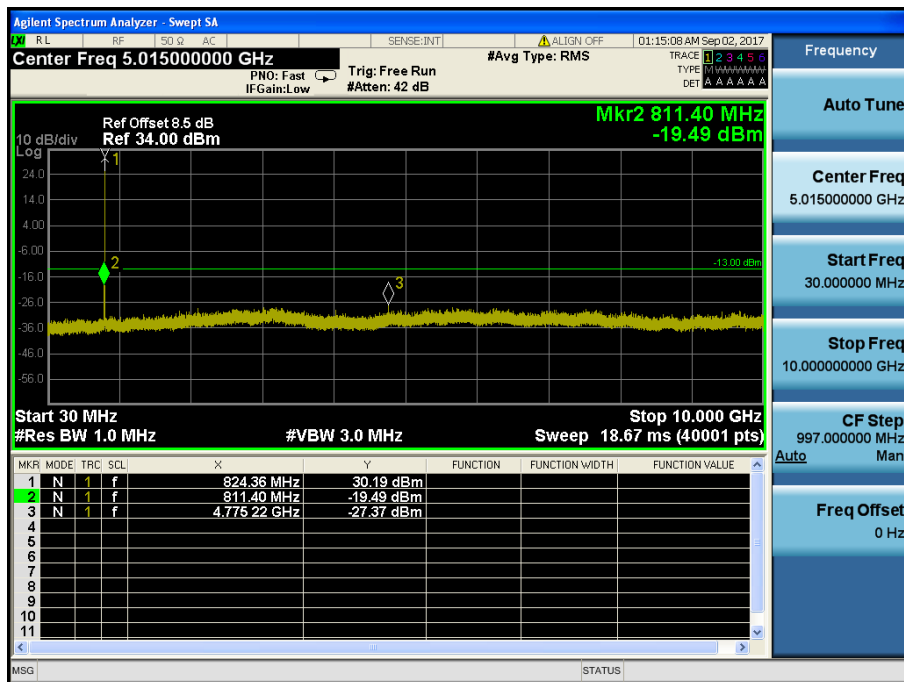

LTE Band 5 / 3MHz / QPSK - RB Size/Offset (1/0) – Low Channel

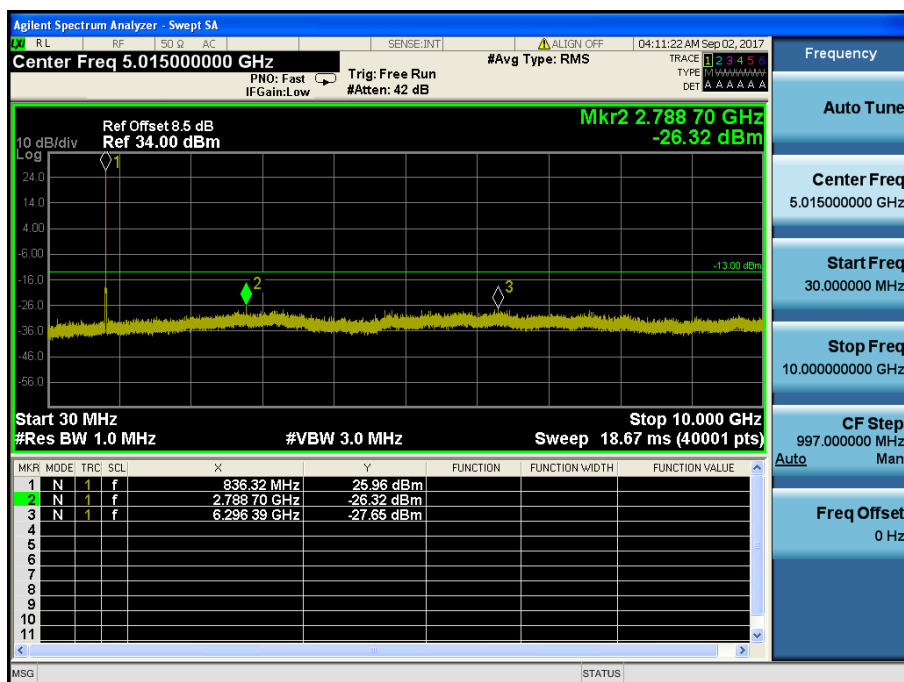

LTE Band 5 / 3MHz / 16QAM - RB Size/Offset (15/0) – Mid Channel

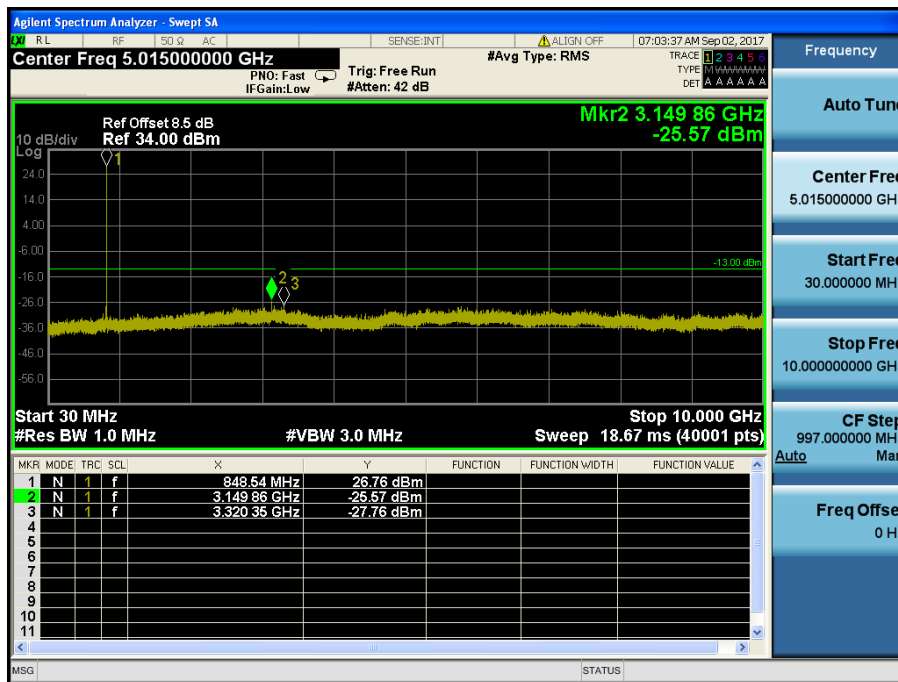

LTE Band 5 / 3MHz / 64QAM - RB Size/Offset (8/7) – High Channel

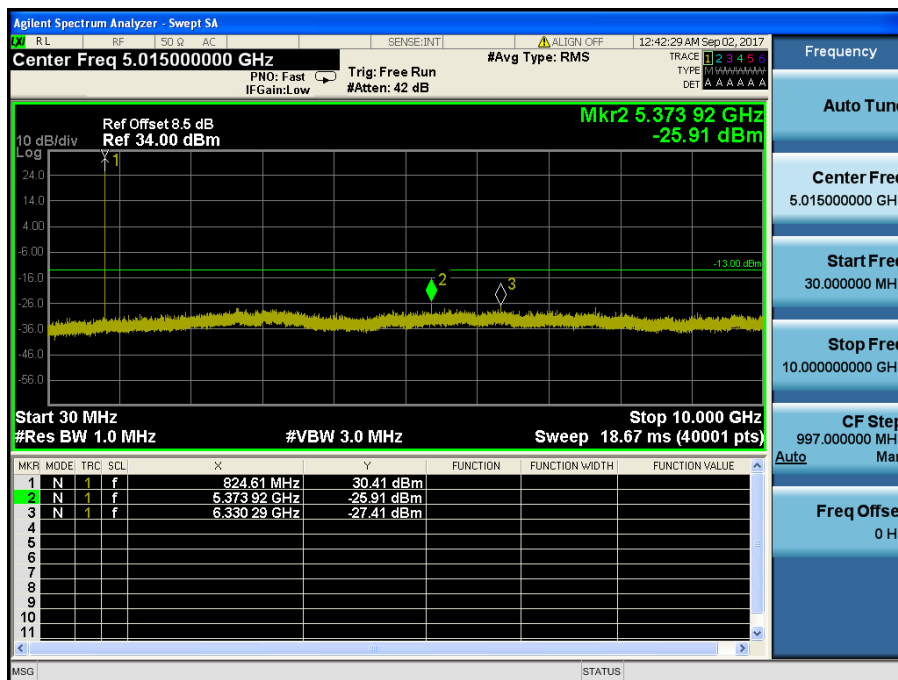

LTE Band 5 / 1.4MHz / QPSK - RB Size/Offset (3/0) – Low Channel

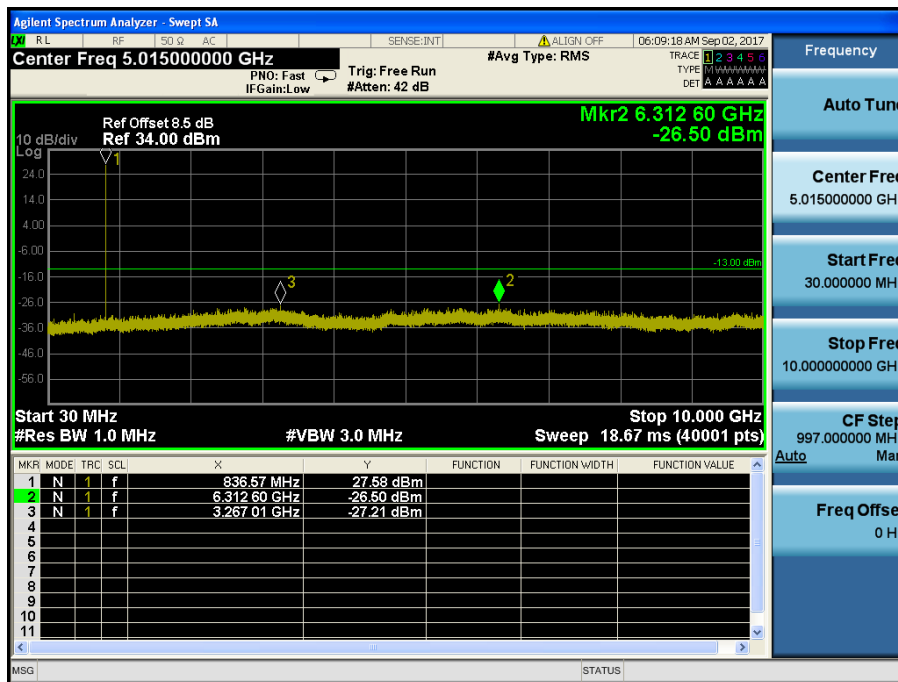

LTE Band 5 / 1.4MHz / 64QAM - RB Size/Offset (6/0) – Mid Channel

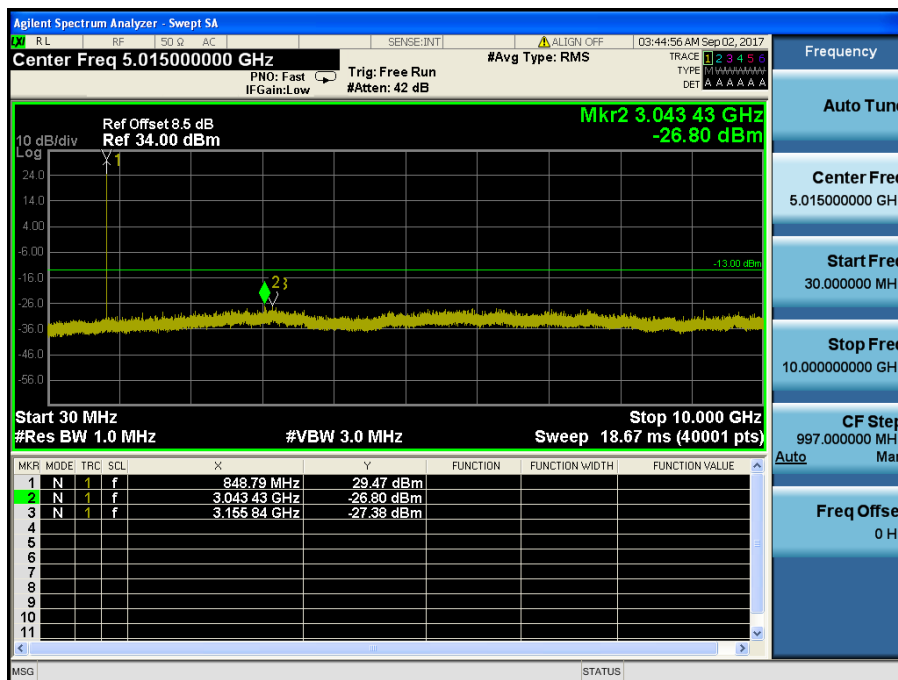

LTE Band 5 / 1.4MHz / 16QAM - RB Size/Offset (3/1) – High Channel