

PCTEST ENGINEERING LABORATORY, INC.

DUT: ZNFQ720CS; Type: Portable Handset; Serial: 03109

Communication System: UID 0, LTE Band 30; Frequency: 2310 MHz; Duty Cycle: 1:1
Medium: 2450 Body Medium parameters used:
 $f = 2310 \text{ MHz}$; $\sigma = 1.87 \text{ S/m}$; $\epsilon_r = 52.431$; $\rho = 1000 \text{ kg/m}^3$
Phantom section: Flat Section; Space: 1.0 cm

Test Date: 04-11-2019; Ambient Temp: 23.5°C; Tissue Temp: 22.1°C

Probe: EX3DV4 - SN7417; ConvF(7.64, 7.64, 7.64) @ 2310 MHz; Calibrated: 2/19/2019
Sensor-Surface: 1.4mm (Mechanical Surface Detection)
Electronics: DAE4 Sn665; Calibrated: 2/13/2019
Phantom: LeftTwin-SAM V5.0; Type: QD 000 P40 CD; Serial: TP1375
Measurement SW: DASY52, Version 52.10 (2);SEMCAD X Version 14.6.12 (7450)

Mode: LTE Band 30, Body SAR, Back side, Mid.ch
10 MHz Bandwidth, QPSK, 1 RB, 49 RB Offset

Area Scan (11x18x1): Measurement grid: $dx=12\text{mm}$, $dy=12\text{mm}$
Zoom Scan (7x7x7)/Cube 0: Measurement grid: $dx=5\text{mm}$, $dy=5\text{mm}$, $dz=5\text{mm}$
Reference Value = 15.49 V/m; Power Drift = 0.01 dB
Peak SAR (extrapolated) = 0.744 W/kg
SAR(1 g) = 0.399 W/kg

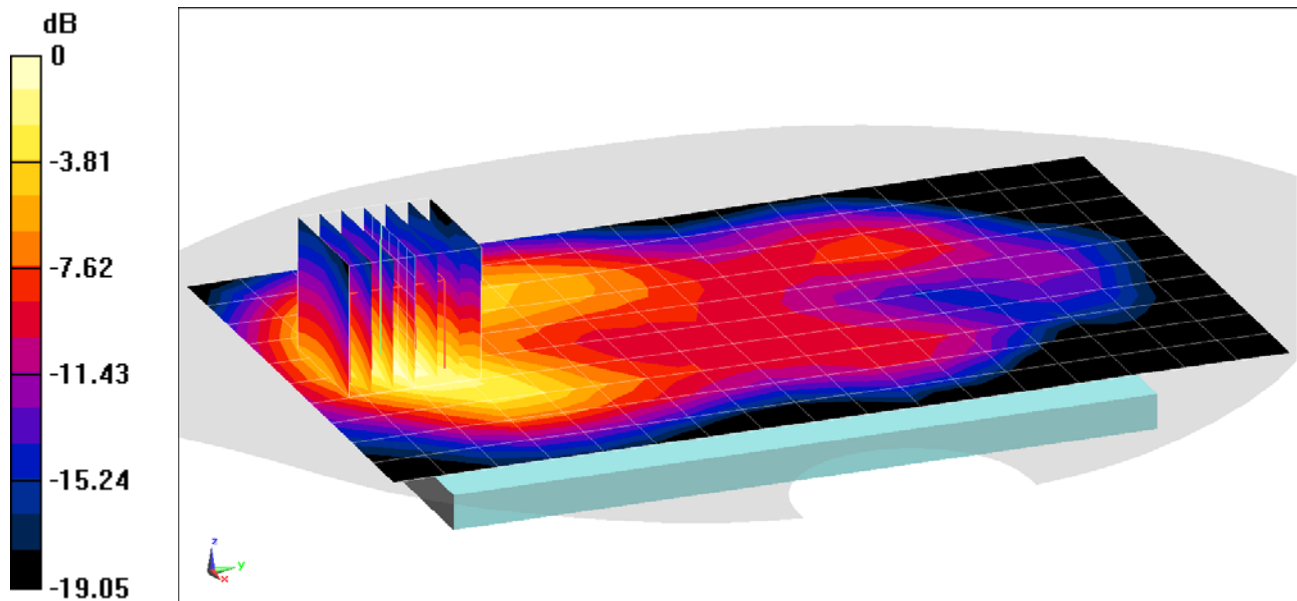

0 dB = 0.617 W/kg = -2.10 dBW/kg

PCTEST ENGINEERING LABORATORY, INC.

DUT: ZNFQ720CS; Type: Portable Handset; Serial: 03109

Communication System: UID 0, LTE Band 30; Frequency: 2310 MHz; Duty Cycle: 1:1

Medium: 2450 Body Medium parameters used:

$f = 2310 \text{ MHz}$; $\sigma = 1.87 \text{ S/m}$; $\epsilon_r = 52.431$; $\rho = 1000 \text{ kg/m}^3$

Phantom section: Flat Section; Space: 1.0 cm

Test Date: 04-11-2019; Ambient Temp: 23.5°C; Tissue Temp: 22.1°C

Probe: EX3DV4 - SN7417; ConvF(7.64, 7.64, 7.64) @ 2310 MHz; Calibrated: 2/19/2019

Sensor-Surface: 1.4mm (Mechanical Surface Detection)

Electronics: DAE4 Sn665; Calibrated: 2/13/2019

Phantom: LeftTwin-SAM V5.0; Type: QD 000 P40 CD; Serial: TP1375

Measurement SW: DASY52, Version 52.10 (2);SEMCAD X Version 14.6.12 (7450)

Mode: LTE Band 30, Body SAR, Bottom Edge, Mid.ch
10 MHz Bandwidth, QPSK, 1 RB, 49 RB Offset

Area Scan (11x10x1): Measurement grid: dx=5mm, dy=12mm

Zoom Scan (7x7x7)/Cube 0: Measurement grid: dx=5mm, dy=5mm, dz=5mm

Reference Value = 23.53 V/m; Power Drift = -0.03 dB

Peak SAR (extrapolated) = 1.79 W/kg

SAR(1 g) = 0.918 W/kg

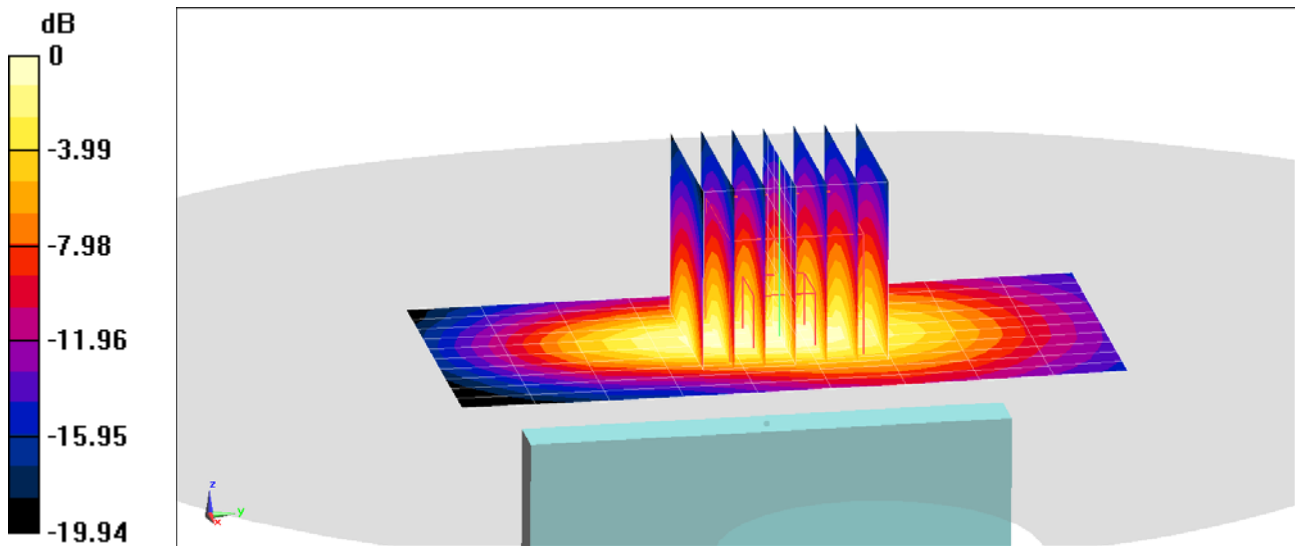

0 dB = 1.46 W/kg = 1.64 dBW/kg

PCTEST ENGINEERING LABORATORY, INC.

DUT: ZNFQ720CS; Type: Portable Handset; Serial: 03117

Communication System: UID 0, _IEEE 802.11b; Frequency: 2412 MHz; Duty Cycle: 1:1
Medium: 2450 Body Medium parameters used (interpolated):
 $f = 2412 \text{ MHz}$; $\sigma = 1.989 \text{ S/m}$; $\epsilon_r = 52.134$; $\rho = 1000 \text{ kg/m}^3$
Phantom section: Flat Section; Space: 1.0 cm

Test Date: 04-11-2019; Ambient Temp: 23.5°C; Tissue Temp: 22.1°C

Probe: EX3DV4 - SN7417; ConvF(7.51, 7.51, 7.51) @ 2412 MHz; Calibrated: 2/19/2019
Sensor-Surface: 1.4mm (Mechanical Surface Detection)
Electronics: DAE4 Sn665; Calibrated: 2/13/2019
Phantom: LeftTwin-SAM V5.0; Type: QD 000 P40 CD; Serial: TP1375
Measurement SW: DASY52, Version 52.10 (2);SEMCAD X Version 14.6.12 (7450)

Mode: IEEE 802.11b, 22 MHz Bandwidth, Body SAR, Ch 1, 1 Mbps, Back Side

Area Scan (11x17x1): Measurement grid: dx=12mm, dy=12mm

Zoom Scan (7x7x7)/Cube 0: Measurement grid: dx=5mm, dy=5mm, dz=5mm

Reference Value = 16.92 V/m; Power Drift = 0.12 dB

Peak SAR (extrapolated) = 1.04 W/kg

SAR(1 g) = 0.499 W/kg

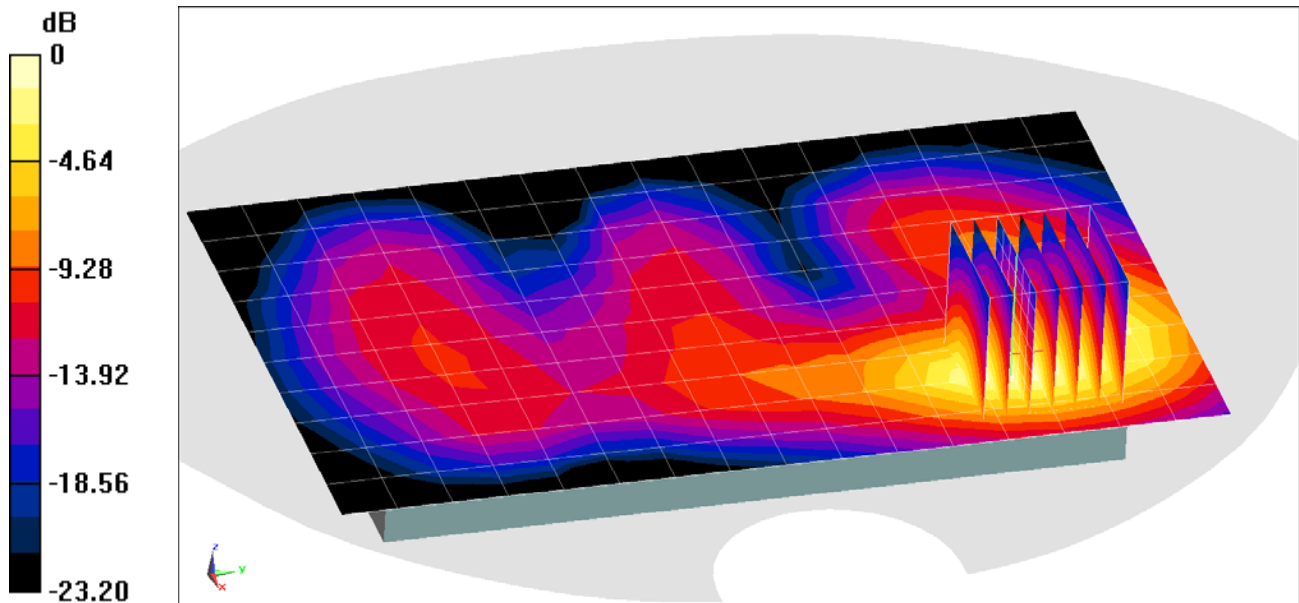

0 dB = 0.829 W/kg = -0.81 dBW/kg

PCTEST ENGINEERING LABORATORY, INC.

DUT: ZNFQ720CS; Type: Portable Handset; Serial: 03117

Communication System: UID 0, 802.11a 5.2-5.8 GHz Band; Frequency: 5520 MHz; Duty Cycle: 1:1

Medium: 5GHz Body Medium parameters used

$f = 5520 \text{ MHz}$; $\sigma = 5.827 \text{ S/m}$; $\epsilon_r = 46.728$; $\rho = 1000 \text{ kg/m}^3$

Phantom section: Flat Section; Space: 1.0 cm

Test Date: 04-05-2019; Ambient Temp: 23.4°C; Tissue Temp: 21.5°C

Probe: EX3DV4 - SN7308; ConvF(4, 4, 4) @ 5520 MHz; Calibrated: 8/23/2018

Sensor-Surface: 1.4mm (Mechanical Surface Detection)

Electronics: DAE4 Sn1558; Calibrated: 10/3/2018

Phantom: Twin-SAM V5.0; Type: QD 000 P40 CD; Serial: 1630

Measurement SW: DASY52, Version 52.10 (2);SEMCAD X Version 14.6.12 (7450)

Mode: IEEE 802.11a, UNII-2C, 20 MHz Bandwidth, Body SAR, Ch 104, 6 Mbps, Back Side

Area Scan (13x21x1): Measurement grid: dx=10mm, dy=10mm

Zoom Scan (7x7x7)/Cube 0: Measurement grid: dx=4mm, dy=4mm, dz=1.4mm; Graded Ratio: 1.4

Reference Value = 11.13 V/m; Power Drift = -0.06 dB

Peak SAR (extrapolated) = 2.52 W/kg

SAR(1 g) = 0.653 W/kg

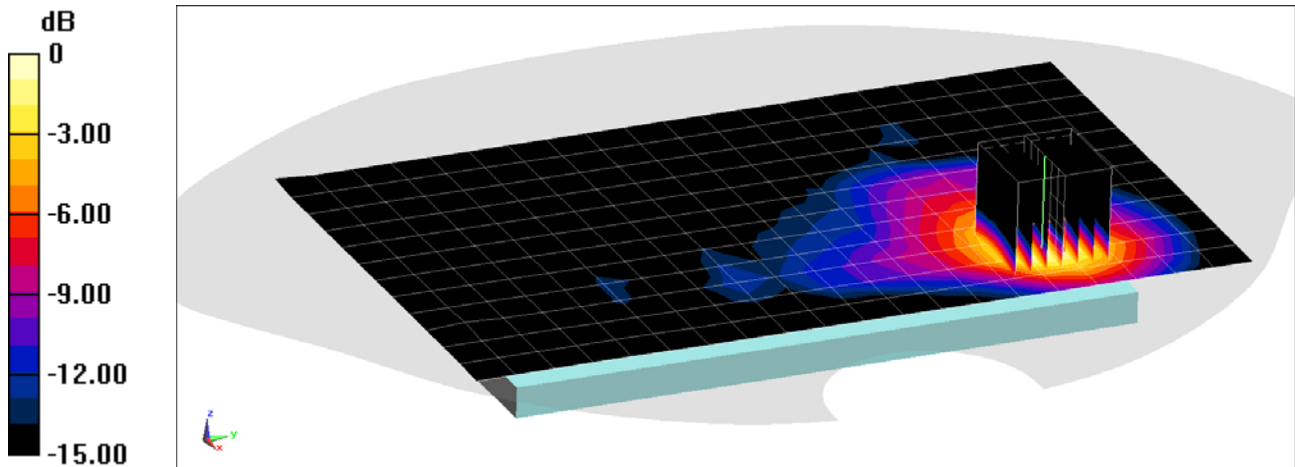

0 dB = 1.54 W/kg = 1.88 dBW/kg

PCTEST ENGINEERING LABORATORY, INC.

DUT: ZNFQ720CS; Type: Portable Handset; Serial: 03117

Communication System: UID 0, 802.11a 5.2-5.8 GHz Band; Frequency: 5220 MHz; Duty Cycle: 1:1

Medium: 5 GHz Body Medium parameters used:

$f = 5220 \text{ MHz}$; $\sigma = 5.337 \text{ S/m}$; $\epsilon_r = 47.394$; $\rho = 1000 \text{ kg/m}^3$

Phantom section: Flat Section; Space: 1.0 cm

Test Date: 04-14-2019; Ambient Temp: 22.0°C; Tissue Temp: 21.5°C

Probe: EX3DV4 - SN7308; ConvF(4.48, 4.48, 4.48) @ 5220 MHz; Calibrated: 8/23/2018

Sensor-Surface: 1.4mm (Mechanical Surface Detection)

Electronics: DAE4 Sn1558; Calibrated: 10/3/2018

Phantom: Twin-SAM V5.0; Type: QD 000 P40 CD; Serial: 1630

Measurement SW: DASY52, Version 52.10 (2); SEMCAD X Version 14.6.12 (7450)

Mode: IEEE 802.11a, UNII-1, 20 MHz Bandwidth, Body SAR, Ch 44, 6 Mbps, Back Side

Area Scan (13x21x1): Measurement grid: dx=10mm, dy=10mm

Zoom Scan (7x7x7)/Cube 0: Measurement grid: dx=4mm, dy=4mm, dz=1.4mm; Graded Ratio: 1.4

Reference Value = 12.53 V/m; Power Drift = -0.16 dB

Peak SAR (extrapolated) = 2.56 W/kg

SAR(1 g) = 0.718 W/kg

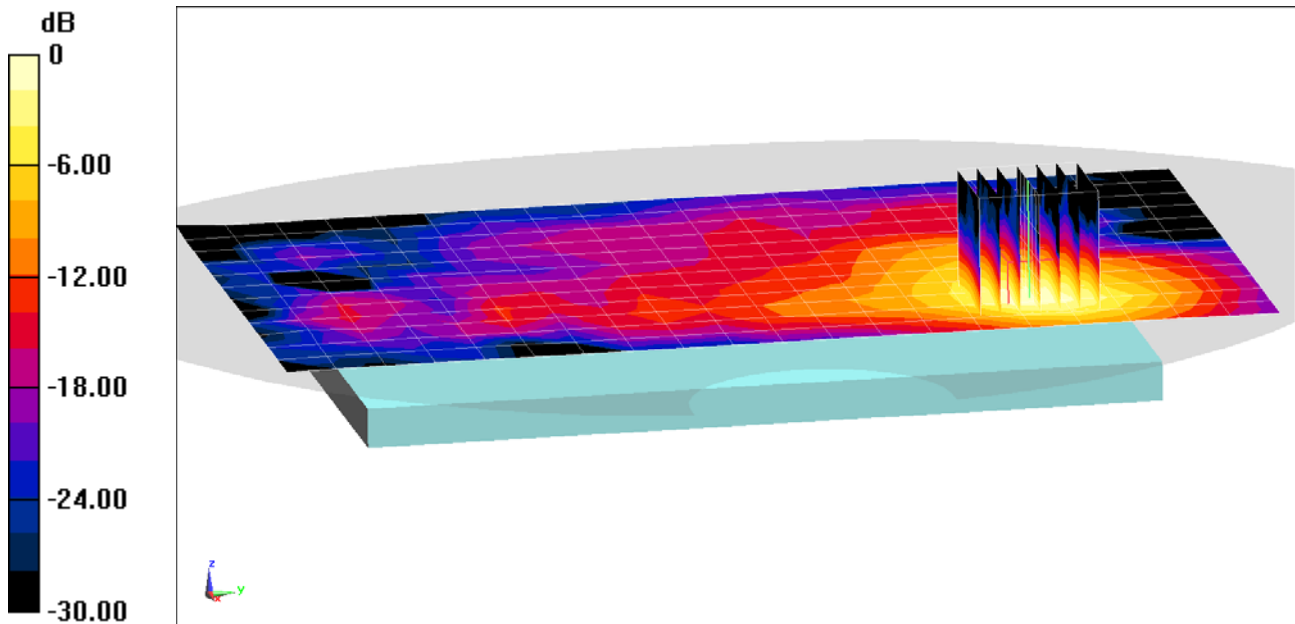

0 dB = 1.76 W/kg = 2.46 dBW/kg

PCTEST ENGINEERING LABORATORY, INC.

DUT: ZNFQ720CS; Type: Portable Handset; Serial: 03117

Communication System: UID 0, Bluetooth; Frequency: 2441 MHz; Duty Cycle: 1:1.294

Medium: 2450 Body Medium parameters used (interpolated):

$f = 2441 \text{ MHz}$; $\sigma = 2.023 \text{ S/m}$; $\epsilon_r = 52.052$; $\rho = 1000 \text{ kg/m}^3$

Phantom section: Flat Section; Space: 1.0 cm

Test Date: 04-11-2019; Ambient Temp: 23.5°C; Tissue Temp: 22.1°C

Probe: EX3DV4 - SN7417; ConvF(7.51, 7.51, 7.51) @ 2441 MHz; Calibrated: 2/19/2019

Sensor-Surface: 1.4mm (Mechanical Surface Detection)

Electronics: DAE4 Sn665; Calibrated: 2/13/2019

Phantom: LeftTwin-SAM V5.0; Type: QD 000 P40 CD; Serial: TP1375

Measurement SW: DASY52, Version 52.10 (2);SEMCAD X Version 14.6.12 (7450)

Mode: Bluetooth, Body SAR, Ch 39, 1 Mbps, Back Side

Area Scan (11x17x1): Measurement grid: dx=12mm, dy=12mm

Zoom Scan (8x8x7)/Cube 0: Measurement grid: dx=5mm, dy=5mm, dz=5mm

Reference Value = 4.197 V/m; Power Drift = 0.16 dB

Peak SAR (extrapolated) = 0.0700 W/kg

SAR(1 g) = 0.031 W/kg

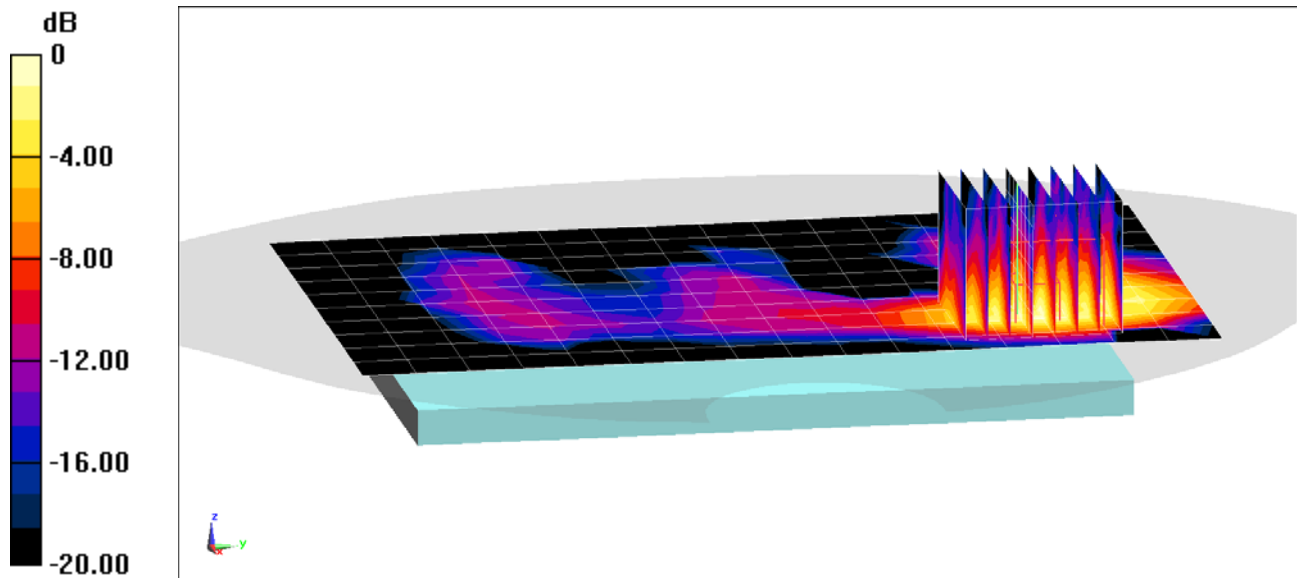

0 dB = 0.0522 W/kg = -12.82 dBW/kg

PCTEST ENGINEERING LABORATORY, INC.

DUT: ZNFQ720CS; Type: Portable Handset; Serial: 03109

Communication System: UID 0, LTE Band 30; Frequency: 2310 MHz; Duty Cycle: 1:1

Medium: 2450 Body Medium parameters used:

$f = 2310 \text{ MHz}$; $\sigma = 1.87 \text{ S/m}$; $\epsilon_r = 52.431$; $\rho = 1000 \text{ kg/m}^3$

Phantom section: Flat Section; Space: 0.0 cm

Test Date: 04-11-2019; Ambient Temp: 23.5°C; Tissue Temp: 22.1°C

Probe: EX3DV4 - SN7417; ConvF(7.64, 7.64, 7.64) @ 2310 MHz; Calibrated: 2/19/2019

Sensor-Surface: 1.4mm (Mechanical Surface Detection)

Electronics: DAE4 Sn665; Calibrated: 2/13/2019

Phantom: LeftTwin-SAM V5.0; Type: QD 000 P40 CD; Serial: TP1375

Measurement SW: DASY52, Version 52.10 (2);SEMCAD X Version 14.6.12 (7450)

Mode: LTE Band 30, Phablet SAR, Bottom Edge, Mid.ch

10 MHz Bandwidth, QPSK, 1 RB, 0 RB Offset

Area Scan (11x10x1): Measurement grid: dx=5mm, dy=12mm

Zoom Scan (7x8x7)/Cube 0: Measurement grid: dx=5mm, dy=5mm, dz=5mm

Reference Value = 60.02 V/m; Power Drift = -0.03 dB

Peak SAR (extrapolated) = 17.1 W/kg

SAR(10 g) = 2.16 W/kg

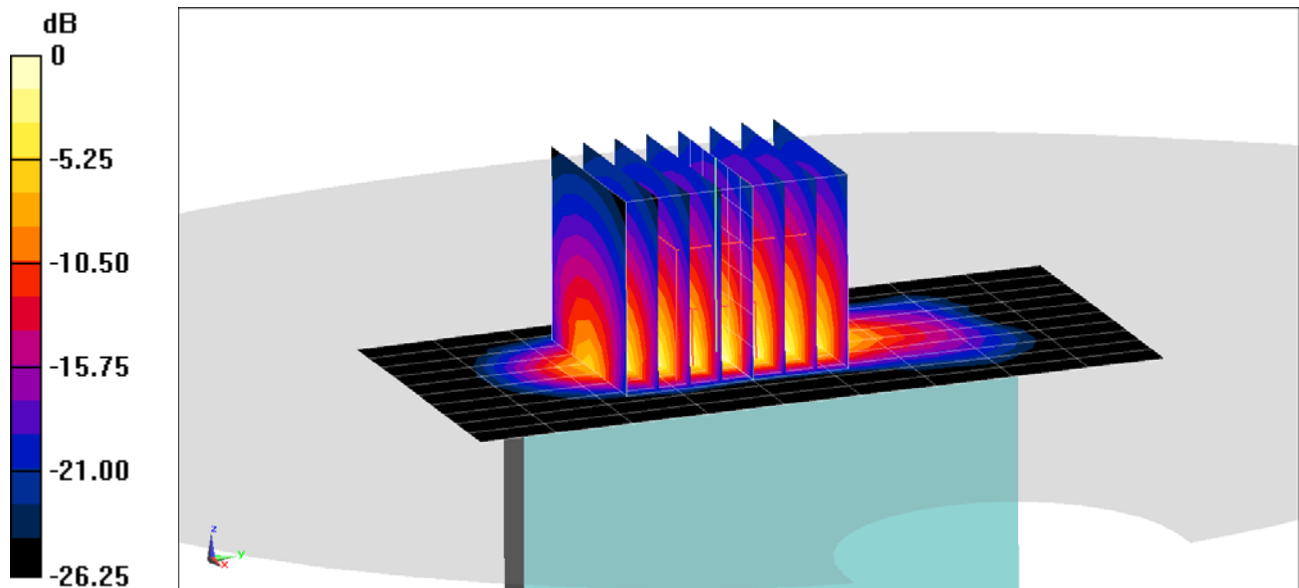

0 dB = 12.5 W/kg = 10.97 dBW/kg

PCTEST ENGINEERING LABORATORY, INC.

DUT: ZNFQ720CS; Type: Portable Handset; Serial: 03117

Communication System: UID 0, 802.11a 5.2-5.8 GHz Band; Frequency: 5280 MHz; Duty Cycle: 1:1

Medium: 5GHz Body Medium parameters used:

$f = 5280 \text{ MHz}$; $\sigma = 5.486 \text{ S/m}$; $\epsilon_r = 47.209$; $\rho = 1000 \text{ kg/m}^3$

Phantom section: Flat Section; Space: 0.0 cm

Test Date: 04-05-2019; Ambient Temp: 23.4°C; Tissue Temp: 21.5°C

Probe: EX3DV4 - SN7308; ConvF(4.48, 4.48, 4.48) @ 5280 MHz; Calibrated: 8/23/2018

Sensor-Surface: 1.4mm (Mechanical Surface Detection)

Electronics: DAE4 Sn1558; Calibrated: 10/3/2018

Phantom: Twin-SAM V5.0; Type: QD 000 P40 CD; Serial: 1630

Measurement SW: DASY52, Version 52.10 (2);SEMCAD X Version 14.6.12 (7450)

Mode: SAR IEEE 802.11a, U-NII-2A, 20 MHz Bandwidth, Phablet SAR, Ch 56, 6 Mbps, Back Side

Area Scan (13x20x1): Measurement grid: dx=10mm, dy=10mm

Zoom Scan (8x8x7)/Cube 0: Measurement grid: dx=4mm, dy=4mm, dz=1.4mm; Graded Ratio: 1.4

Reference Value = 38.78 V/m; Power Drift = 0.09 dB

Peak SAR (extrapolated) = 30.4 W/kg

SAR(10 g) = 2.02 W/kg

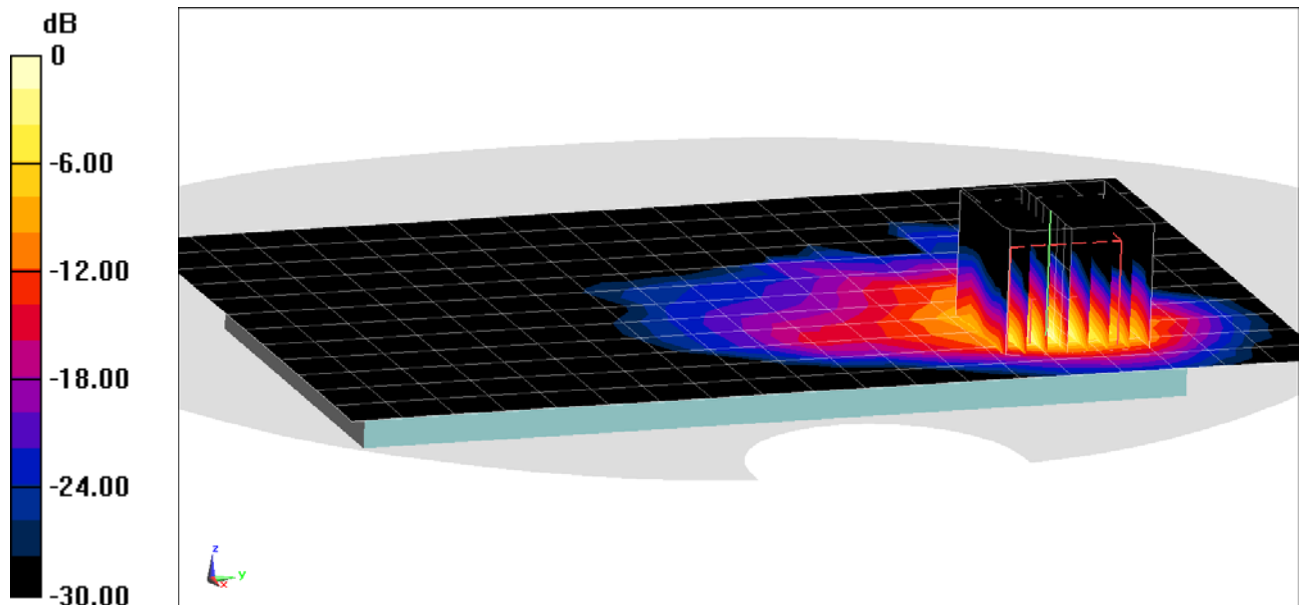

0 dB = 18.4 W/kg = 12.65 dBW/kg

APPENDIX B: SYSTEM VERIFICATION

PCTEST ENGINEERING LABORATORY, INC.

DUT: Dipole 750 MHz; Type: D750V3; Serial: 1003

Communication System: UID 0, CW; Frequency: 750 MHz; Duty Cycle: 1:1

Medium: 750 HEAD Medium parameters used (interpolated):

$f = 750 \text{ MHz}$; $\sigma = 0.89 \text{ S/m}$; $\epsilon_r = 41.649$; $\rho = 1000 \text{ kg/m}^3$

Phantom section: Flat Section; Space: 1.5 cm

Test Date: 04-08-2019; Ambient Temp: 23.3°C; Tissue Temp: 21.9°C

Probe: EX3DV4 - SN3589; ConvF(8.67, 8.67, 8.67) @ 750 MHz; Calibrated: 1/25/2019

Sensor-Surface: 1.4mm (Mechanical Surface Detection)

Electronics: DAE4 Sn1450; Calibrated: 8/22/2018

Phantom: Twin-SAM V5.0 (30); Type: QD 000 P40 CD; Serial: 1647

Measurement SW: DASY52, Version 52.10 (2);SEMCAD X Version 14.6.12 (7450)

750 MHz System Verification at 23.0 dBm (200 mW)

Area Scan (7x15x1): Measurement grid: dx=15mm, dy=15mm

Zoom Scan (5x5x7)/Cube 0: Measurement grid: dx=8mm, dy=8mm, dz=5mm

Peak SAR (extrapolated) = 2.48 W/kg

SAR(1 g) = 1.61 W/kg

Deviation(1 g) = -2.78%

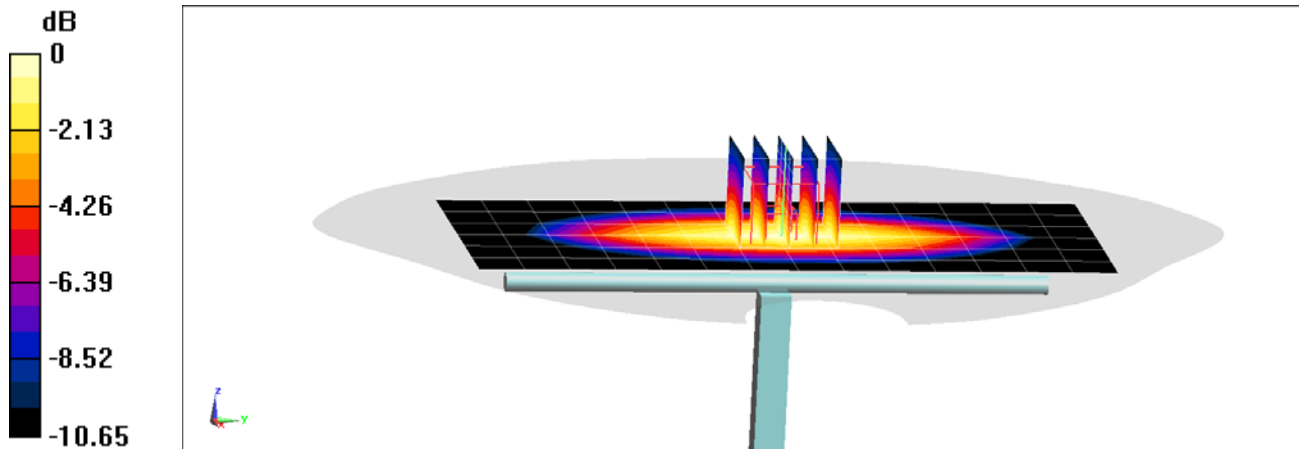

0 dB = 2.18 W/kg = 3.38 dBW/kg

PCTEST ENGINEERING LABORATORY, INC.

DUT: Dipole 835 MHz; Type: D835V2; Serial: 4d133

Communication System: UID 0, CW; Frequency: 835 MHz; Duty Cycle: 1:1

Medium: 835 Head Medium parameters used:

$f = 835 \text{ MHz}$; $\sigma = 0.916 \text{ S/m}$; $\epsilon_r = 42.45$; $\rho = 1000 \text{ kg/m}^3$

Phantom section: Flat Section; Space: 1.5 cm

Test Date: 04-01-2019; Ambient Temp: 22.4°C; Tissue Temp: 21.3°C

Probe: EX3DV4 - SN7357; ConvF(10.11, 10.11, 10.11) @ 835 MHz; Calibrated: 4/18/2018

Sensor-Surface: 1.4mm (Mechanical Surface Detection)

Electronics: DAE4 Sn1407; Calibrated: 4/11/2018

Phantom: Left For Head SAM with CRP v5.0; Type: QD000P40CD; Serial: TP:1687

Measurement SW: DASY52, Version 52.10 (2);SEMCAD X Version 14.6.12 (7450)

835 MHz System Verification at 23.0 dBm (200 mW)

Area Scan (7x14x1): Measurement grid: dx=15mm, dy=15mm

Zoom Scan (5x5x7)/Cube 0: Measurement grid: dx=8mm, dy=8mm, dz=5mm

Peak SAR (extrapolated) = 2.93 W/kg

SAR(1 g) = 1.92 W/kg;

Deviation(1 g) = 1.80%

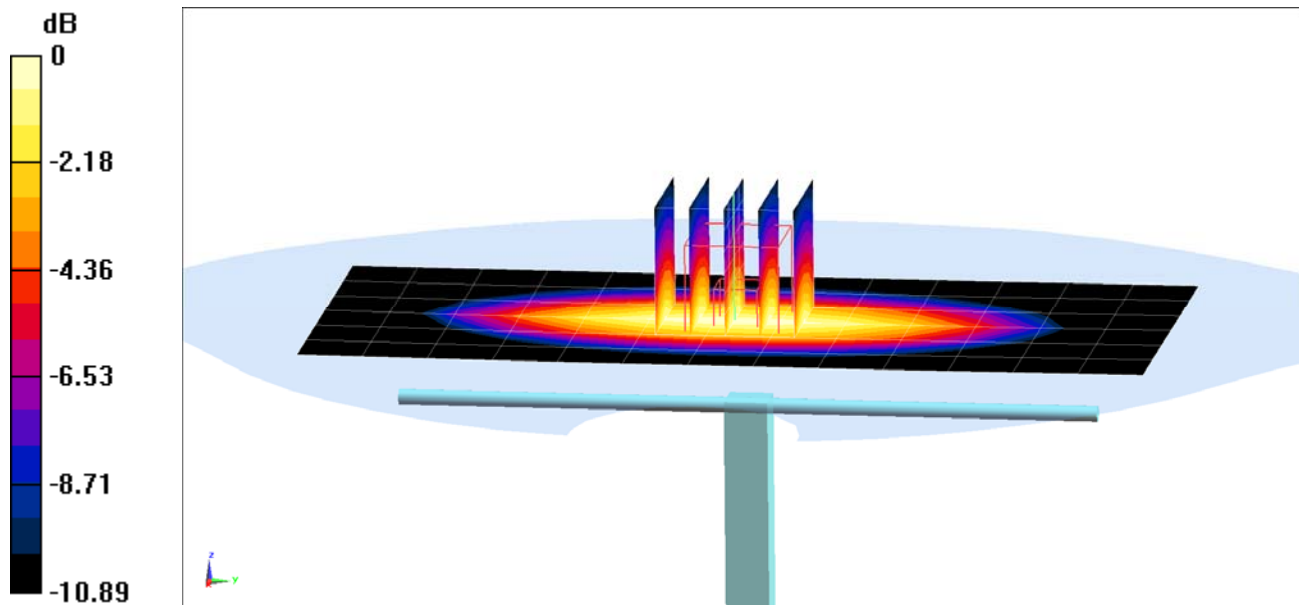

0 dB = 2.60 W/kg = 4.15 dBW/kg

PCTEST ENGINEERING LABORATORY, INC.

DUT: Dipole 835 MHz; Type: D835V2; Serial: 4d133

Communication System: UID 0, CW; Frequency: 835 MHz; Duty Cycle: 1:1

Medium: 835 Head Medium parameters used:

$f = 835 \text{ MHz}$; $\sigma = 0.89 \text{ S/m}$; $\epsilon_r = 39.846$; $\rho = 1000 \text{ kg/m}^3$

Phantom section: Flat Section; Space: 1.5 cm

Test Date: 04-04-2019; Ambient Temp: 22.7°C; Tissue Temp: 23.4°C

Probe: EX3DV4 - SN7357; ConvF(10.11, 10.11, 10.11) @ 835 MHz; Calibrated: 4/18/2018

Sensor-Surface: 1.4mm (Mechanical Surface Detection)

Electronics: DAE4 Sn1407; Calibrated: 4/11/2018

Phantom: SAM with CRP v5.0 Left; Type: QD000P40CD; Serial: 1687

Measurement SW: DASY52, Version 52.10 (2);SEMCAD X Version 14.6.12 (7450)

835 MHz System Verification at 23.0 dBm (200 mW)

Area Scan (7x14x1): Measurement grid: dx=15mm, dy=15mm

Zoom Scan (5x5x7)/Cube 0: Measurement grid: dx=8mm, dy=8mm, dz=5mm

Peak SAR (extrapolated) = 2.98 W/kg

SAR(1 g) = 1.94 W/kg

Deviation(1 g) = 2.86%

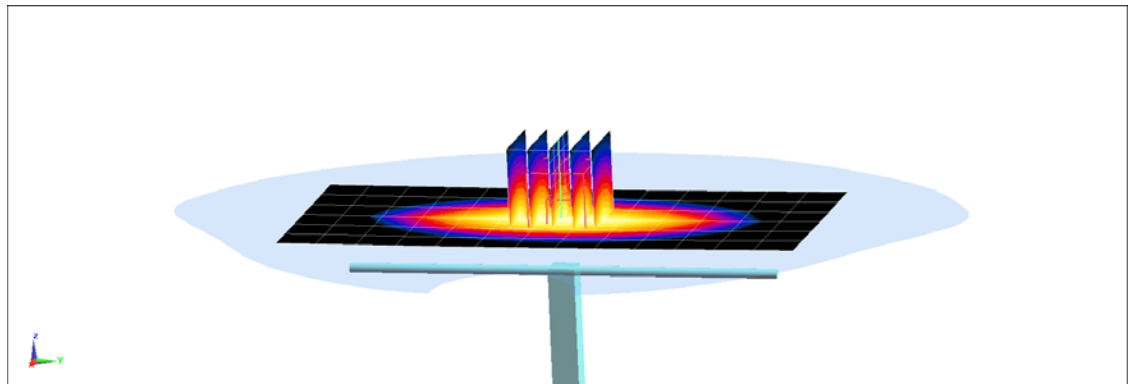
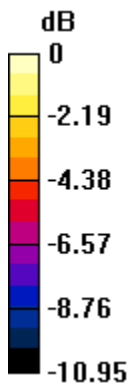

0 dB = 2.62 W/kg = 4.18 dBW/kg

PCTEST ENGINEERING LABORATORY, INC.

DUT: Dipole 1750 MHz; Type: D1750V2; Serial: 1150

Communication System: UID 0, CW; Frequency: 1750 MHz; Duty Cycle: 1:1

Medium: 1750 Head Medium parameters used:

$f = 1750 \text{ MHz}$; $\sigma = 1.35 \text{ S/m}$; $\epsilon_r = 38.66$; $\rho = 1000 \text{ kg/m}^3$

Phantom section: Flat Section; Space: 1.0 cm

Test Date: 04-10-2019; Ambient Temp: 23.0°C; Tissue Temp: 22.7°C

Probe: EX3DV4 - SN7308; ConvF(8.66, 8.66, 8.66) @ 1750 MHz; Calibrated: 8/23/2018

Sensor-Surface: 1.4mm (Mechanical Surface Detection)

Electronics: DAE4 Sn1558; Calibrated: 10/3/2018

Phantom: Twin-SAM V8.0; Type: QD 000 P41 Ax; Serial: 1966

Measurement SW: DASY52, Version 52.10 (2);SEMCAD X Version 14.6.12 (7450)

1750 MHz System Verification at 20.0 dBm (100 mW)

Area Scan (7x9x1): Measurement grid: dx=15mm, dy=15mm

Zoom Scan (5x5x7)/Cube 0: Measurement grid: dx=8mm, dy=8mm, dz=5mm

Peak SAR (extrapolated) = 6.98 W/kg

SAR(1 g) = 3.59 W/kg

Deviation(1 g) = -1.64%

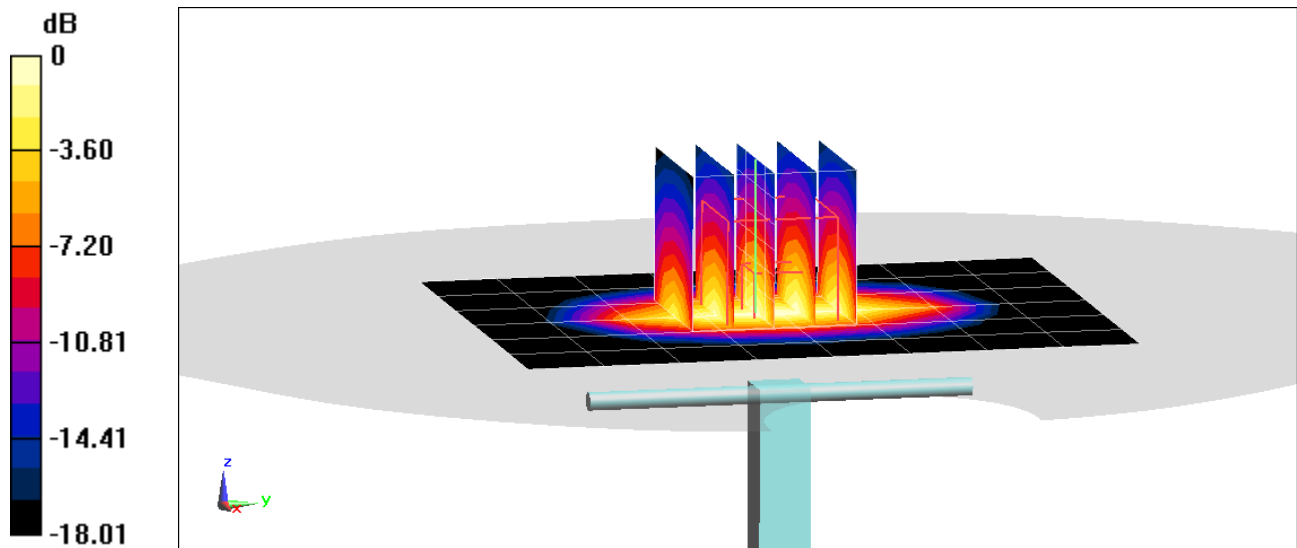

0 dB = 5.63 W/kg = 7.51 dBW/kg

PCTEST ENGINEERING LABORATORY, INC.

DUT: Dipole 1900 MHz; Type: D1900V2; Serial: 5d149

Communication System: UID 0, CW; Frequency: 1900 MHz; Duty Cycle: 1:1
Medium: 1900 Head Medium parameters used (interpolated):
 $f = 1900 \text{ MHz}$; $\sigma = 1.453 \text{ S/m}$; $\epsilon_r = 39.926$; $\rho = 1000 \text{ kg/m}^3$
Phantom section: Flat Section; Space: 1.0 cm

Test Date: 04-08-2019; Ambient Temp: 22.3°C; Tissue Temp: 21.5°C

Probe: EX3DV4 - SN7357; ConvF(8.47, 8.47, 8.47) @ 1900 MHz; Calibrated: 4/18/2018
Sensor-Surface: 1.4mm (Mechanical Surface Detection)
Electronics: DAE4 Sn1407; Calibrated: 4/11/2018
Phantom: Left For Head SAM with CRP v5.0; Type: QD000P40CD; Serial: TP:1687
Measurement SW: DASY52, Version 52.10 (2);SEMCAD X Version 14.6.12 (7450)

1900 MHz System Verification at 20.0 dBm (100 mW)

Area Scan (7x11x1): Measurement grid: dx=15mm, dy=15mm

Zoom Scan (5x5x7)/Cube 0: Measurement grid: dx=8mm, dy=8mm, dz=5mm

Peak SAR (extrapolated) = 8.07 W/kg

SAR(1 g) = 4.07 W/kg

Deviation(1 g) = 3.56%

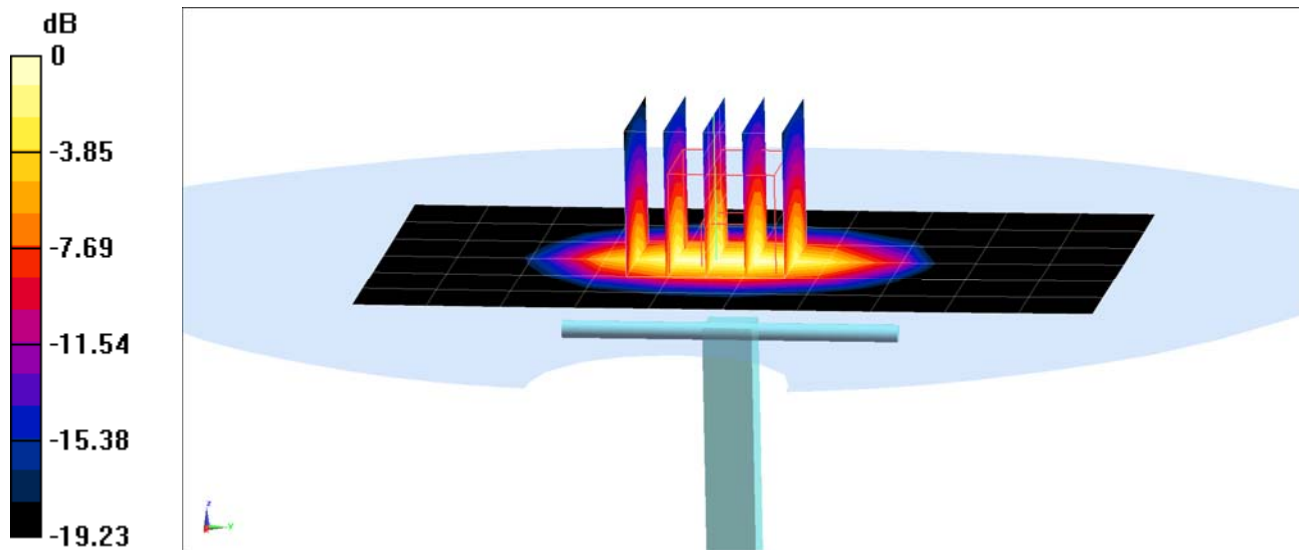

0 dB = 6.54 W/kg = 8.16 dBW/kg

PCTEST ENGINEERING LABORATORY, INC.

DUT: Dipole 1900 MHz; Type: D1900V2; Serial: 5d080

Communication System: UID 0, CW; Frequency: 1900 MHz; Duty Cycle: 1:1
Medium: 1900 Head Medium parameters used (interpolated):
 $f = 1900 \text{ MHz}$; $\sigma = 1.446 \text{ S/m}$; $\epsilon_r = 41.042$; $\rho = 1000 \text{ kg/m}^3$
Phantom section: Flat Section; Space: 1.0 cm

Test Date: 04-10-2019; Ambient Temp: 23.7°C; Tissue Temp: 22.1°C

Probe: EX3DV4 - SN7357; ConvF(8.47, 8.47, 8.47) @ 1900 MHz; Calibrated: 4/18/2018
Sensor-Surface: 1.4mm (Mechanical Surface Detection)
Electronics: DAE4 Sn1407; Calibrated: 4/11/2018
Phantom: Left For Head SAM with CRP v5.0; Type: QD000P40CD; Serial: TP:1687
Measurement SW: DASY52, Version 52.10 (2);SEMCAD X Version 14.6.12 (7450)

1900 MHz System Verification at 20.0 dBm (100 mW)

Area Scan (7x11x1): Measurement grid: dx=15mm, dy=15mm

Zoom Scan (5x5x7)/Cube 0: Measurement grid: dx=8mm, dy=8mm, dz=5mm

Peak SAR (extrapolated) = 8.37 W/kg

SAR(1 g) = 4.29 W/kg

Deviation(1 g) = 7.79%

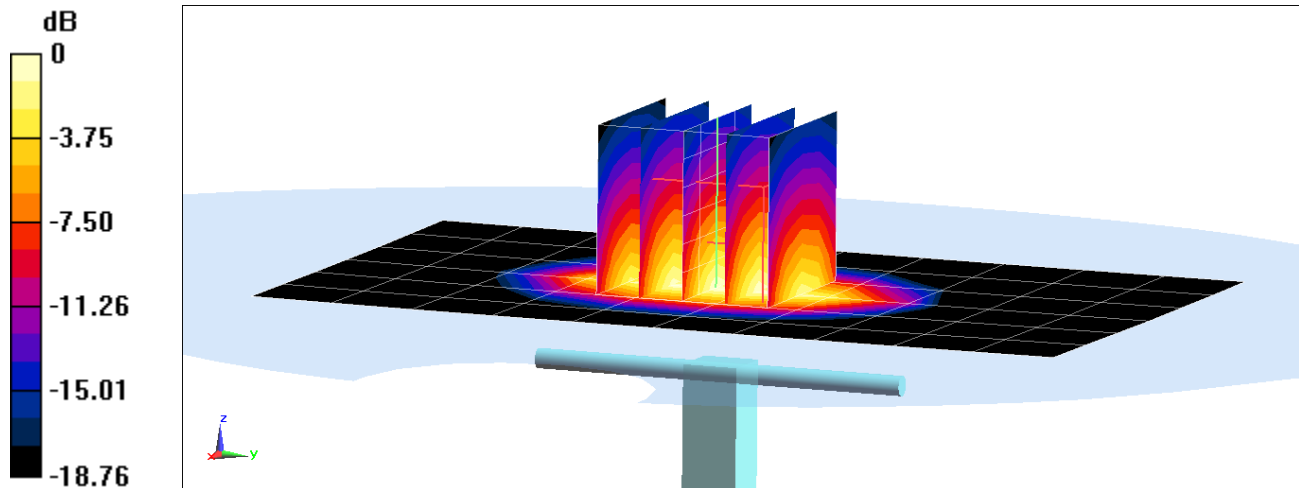

0 dB = 6.80 W/kg = 8.33 dBW/kg

PCTEST ENGINEERING LABORATORY, INC.

DUT: Dipole 2300 MHz; Type: D2300V2; Serial: 1064

Communication System: UID 0, CW; Frequency: 2300 MHz; Duty Cycle: 1:1

Medium: 2450 Head Medium parameters used:

$f = 2300 \text{ MHz}$; $\sigma = 1.692 \text{ S/m}$; $\epsilon_r = 38.06$; $\rho = 1000 \text{ kg/m}^3$

Phantom section: Flat Section; Space: 1.0 cm

Test Date: 04-03-2019; Ambient Temp: 24.0°C; Tissue Temp: 21.6°C

Probe: EX3DV4 - SN3589; ConvF(6.77, 6.77, 6.77) @ 2300 MHz; Calibrated: 1/25/2019

Sensor-Surface: 1.4mm (Mechanical Surface Detection)

Electronics: DAE4 Sn1450; Calibrated: 8/22/2018

Phantom: Twin-SAM V5.0 (30); Type: QD 000 P40 CD; Serial: 1647

Measurement SW: DASY52, Version 52.10 (2);SEMCAD X Version 14.6.12 (7450)

2300 MHz System Verification at 20.0 dBm (100 mW)

Area Scan (8x9x1): Measurement grid: dx=12mm, dy=12mm

Zoom Scan (7x7x7)/Cube 0: Measurement grid: dx=5mm, dy=5mm, dz=5mm

Peak SAR (extrapolated) = 10.2 W/kg

SAR(1 g) = 4.77 W/kg

Deviation(1 g) = 0.21%

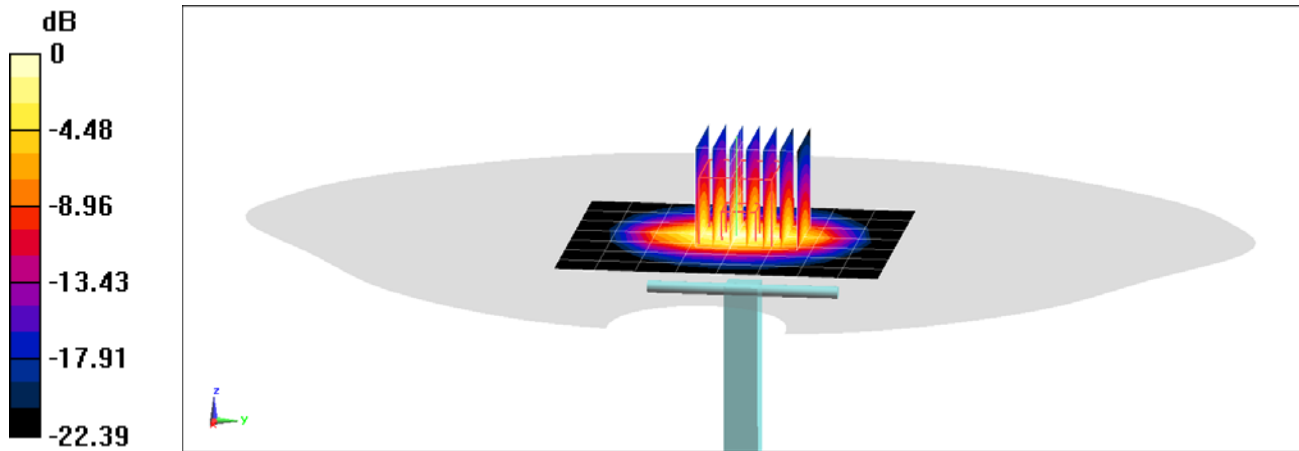

0 dB = 8.08 W/kg = 9.07 dBW/kg

PCTEST ENGINEERING LABORATORY, INC.

DUT: Dipole 2450 MHz; Type: D2450V2; Serial: 981

Communication System: UID 0, CW; Frequency: 2450 MHz; Duty Cycle: 1:1

Medium: 2450 HEAD Medium parameters used:

$f = 2450$ MHz; $\sigma = 1.814$ S/m; $\epsilon_r = 37.503$; $\rho = 1000$ kg/m³

Phantom section: Flat Section; Space: 1.0 cm

Test Date: 04-09-2019; Ambient Temp: 23.5°C; Tissue Temp: 21.9°C

Probe: EX3DV4 - SN3589; ConvF(6.46, 6.46, 6.46) @ 2450 MHz; Calibrated: 1/25/2019

Sensor-Surface: 1.4mm (Mechanical Surface Detection)

Electronics: DAE4 Sn1450; Calibrated: 8/22/2018

Phantom: Twin-SAM V5.0 (30); Type: QD 000 P40 CD; Serial: 1647

Measurement SW: DASY52, Version 52.10 (2); SEMCAD X Version 14.6.12 (7450)

2450 MHz System Verification at 20.0 dBm (100 mW)

Area Scan (8x9x1): Measurement grid: dx=12mm, dy=12mm

Zoom Scan (7x7x7)/Cube 0: Measurement grid: dx=5mm, dy=5mm, dz=5mm

Peak SAR (extrapolated) = 11.4 W/kg

SAR(1 g) = 5.25 W/kg

Deviation(1 g) = 0.38%

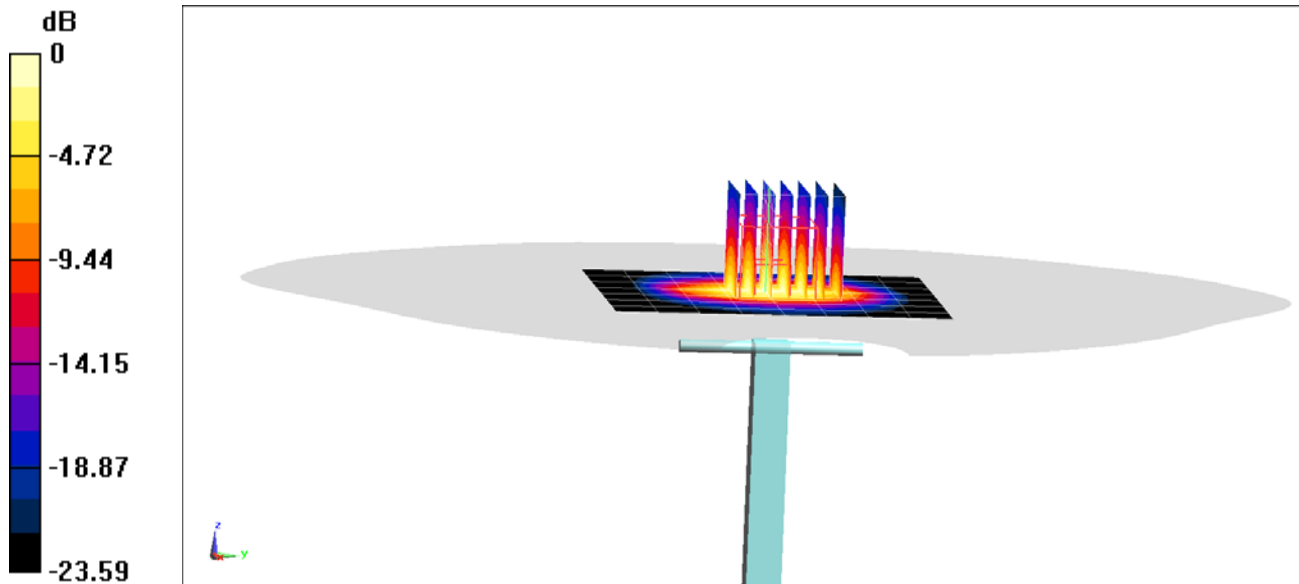

0 dB = 8.94 W/kg = 9.51 dBW/kg

PCTEST ENGINEERING LABORATORY, INC.

DUT: Dipole 5 GHz; Type: D5GHzV2; Serial: 1057

Communication System: UID 0, CW; Frequency: 5250 MHz; Duty Cycle: 1:1
Medium: 5GHz Head; Medium parameters used (interpolated):
 $f = 5250 \text{ MHz}$; $\sigma = 4.599 \text{ S/m}$; $\epsilon_r = 35.598$; $\rho = 1000 \text{ kg/m}^3$
Phantom section: Flat Section; Space: 1.0 cm

Test Date: 04-08-2019; Ambient Temp: 20.9°C; Tissue Temp: 20.5°C

Probe: EX3DV4 - SN7409; ConvF(5.2, 5.2, 5.2) @ 5250 MHz; Calibrated: 6/25/2018
Sensor-Surface: 1.4mm (Mechanical Surface Detection)
Electronics: DAE4 Sn1334; Calibrated: 6/18/2018
Phantom: SAM with CRP v5.0 (Right); Type: QD000P40CD; Serial: TP:1759
Measurement SW: DASY52, Version 52.10 (2);SEMCAD X Version 14.6.12 (7450)

5250 MHz System Verification at 17.0 dBm (50 mW)

Area Scan (7x7x1): Measurement grid: dx=10mm, dy=10mm

Zoom Scan (8x8x7)/Cube 0: Measurement grid: dx=4mm, dy=4mm, dz=1.4mm; Graded Ratio: 1.4

Peak SAR (extrapolated) = 15.6 W/kg

SAR(1 g) = 3.73 W/kg

Deviation(1 g) = -5.81%

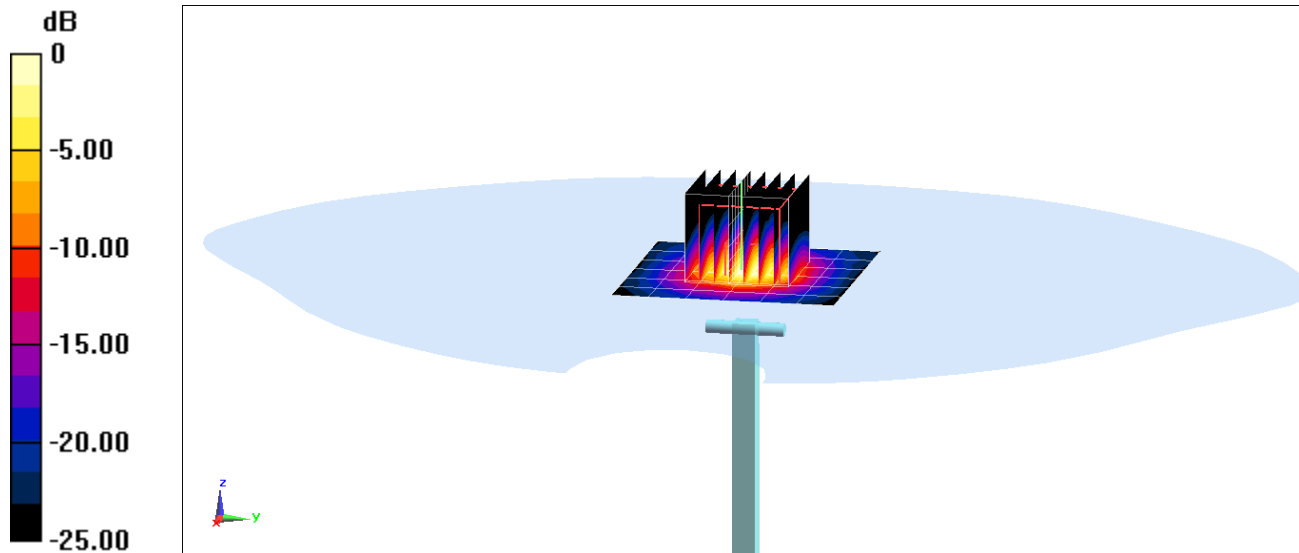

0 dB = 9.08 W/kg = 9.58 dBW/kg

PCTEST ENGINEERING LABORATORY, INC.

DUT: Dipole 5 GHz; Type: D5GHzV2; Serial: 1057

Communication System: UID 0, CW; Frequency: 5600 MHz; Duty Cycle: 1:1

Medium: 5GHz Head; Medium parameters used:

$f = 5600$ MHz; $\sigma = 4.994$ S/m; $\epsilon_r = 34.982$; $\rho = 1000$ kg/m³

Phantom section: Flat Section; Space: 1.0 cm

Test Date: 04-08-2019; Ambient Temp: 20.9°C; Tissue Temp: 20.5°C

Probe: EX3DV4 - SN7409; ConvF(4.77, 4.77, 4.77) @ 5600 MHz; Calibrated: 6/25/2018

Sensor-Surface: 1.4mm (Mechanical Surface Detection)

Electronics: DAE4 Sn1334; Calibrated: 6/18/2018

Phantom: SAM with CRP v5.0 (Right); Type: QD000P40CD; Serial: TP:1759

Measurement SW: DASY52, Version 52.10 (2);SEMCAD X Version 14.6.12 (7450)

5600 MHz System Verification at 17.0 dBm (50 mW)

Area Scan (7x7x1): Measurement grid: dx=10mm, dy=10mm

Zoom Scan (8x8x7)/Cube 0: Measurement grid: dx=4mm, dy=4mm, dz=1.4mm; Graded Ratio: 1.4

Peak SAR (extrapolated) = 18.5 W/kg

SAR(1 g) = 4.05 W/kg

Deviation(1 g) = -3.69%

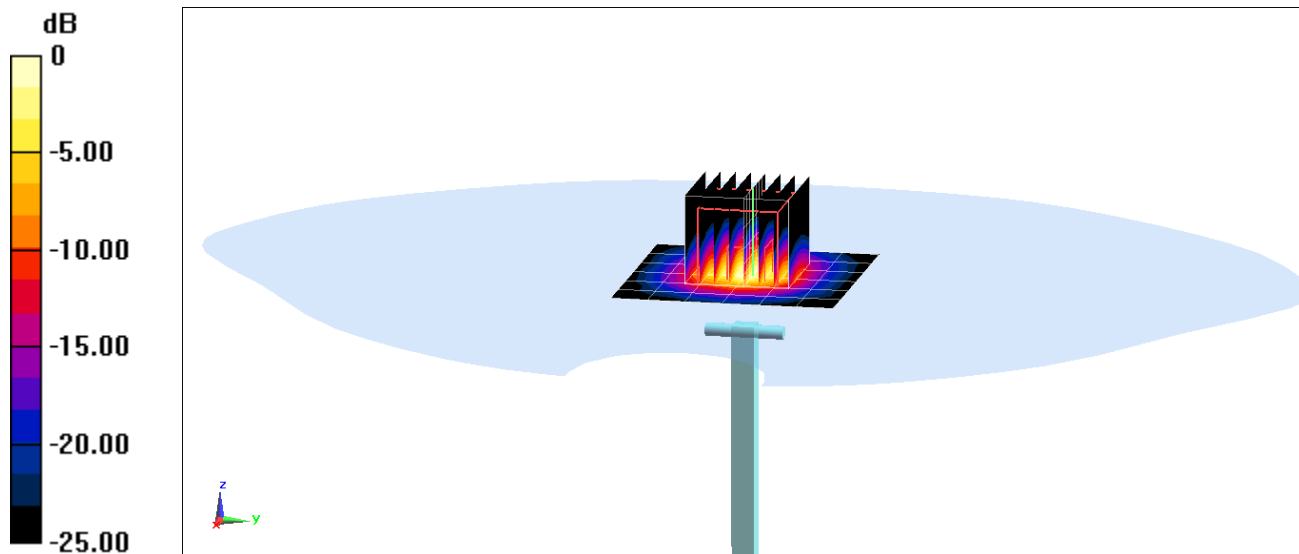

0 dB = 10.3 W/kg = 10.13 dBW/kg

PCTEST ENGINEERING LABORATORY, INC.

DUT: Dipole 5 GHz; Type: D5GHzV2; Serial: 1057

Communication System: UID 0, CW; Frequency: 5750 MHz; Duty Cycle: 1:1
Medium: 5GHz Head; Medium parameters used (interpolated):
 $f = 5750 \text{ MHz}$; $\sigma = 5.171 \text{ S/m}$; $\epsilon_r = 34.716$; $\rho = 1000 \text{ kg/m}^3$
Phantom section: Flat Section; Space: 1.0 cm

Test Date: 04-08-2019; Ambient Temp: 20.9°C; Tissue Temp: 20.5°C

Probe: EX3DV4 - SN7409; ConvF(4.82, 4.82, 4.82) @ 5750 MHz; Calibrated: 6/25/2018
Sensor-Surface: 1.4mm (Mechanical Surface Detection)
Electronics: DAE4 Sn1334; Calibrated: 6/18/2018
Phantom: SAM with CRP v5.0 (Right); Type: QD000P40CD; Serial: TP:1759
Measurement SW: DASY52, Version 52.10 (2);SEMCAD X Version 14.6.12 (7450)

5750 MHz System Verification at 17.0 dBm (50 mW)

Area Scan (7x7x1): Measurement grid: dx=10mm, dy=10mm

Zoom Scan (8x8x7)/Cube 0: Measurement grid: dx=4mm, dy=4mm, dz=1.4mm; Graded Ratio: 1.4

Peak SAR (extrapolated) = 17.5 W/kg

SAR(1 g) = 3.76 W/kg

Deviation(1 g) = -6.58%

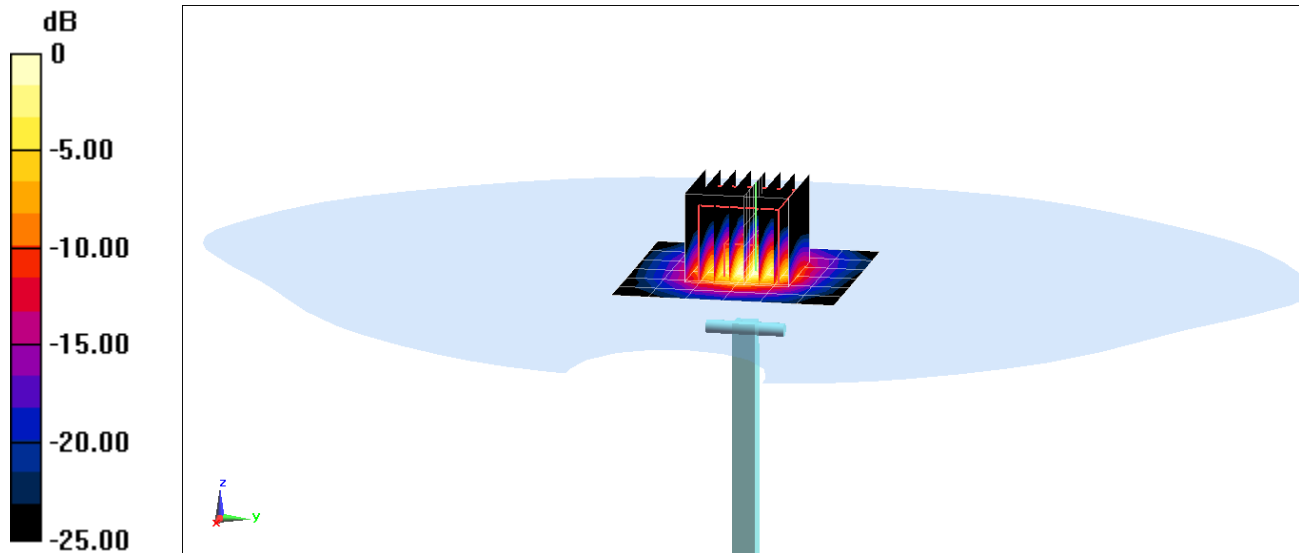

PCTEST ENGINEERING LABORATORY, INC.

DUT: Dipole 750 MHz; Type: D750V3; Serial: 1161

Communication System: UID 0, CW; Frequency: 750 MHz; Duty Cycle: 1:1

Medium: 750MHz Body Medium parameters used (interpolated):

$f = 750 \text{ MHz}$; $\sigma = 0.958 \text{ S/m}$; $\epsilon_r = 53.844$; $\rho = 1000 \text{ kg/m}^3$

Phantom section: Flat Section; Space: 1.5 cm

Test Date: 04-03-2019; Ambient Temp: 21.7°C; Tissue Temp: 22.3°C

Probe: EX3DV4 - SN7308; ConvF(10.38, 10.38, 10.38) @ 750 MHz; Calibrated: 8/23/2018

Sensor-Surface: 1.4mm (Mechanical Surface Detection)

Electronics: DAE4 Sn1558; Calibrated: 10/3/2018

Phantom: Twin-SAM V5.0; Type: QD 000 P40 CD; Serial: 1630

Measurement SW: DASY52, Version 52.10 (2);SEMCAD X Version 14.6.12 (7450)

750 MHz System Verification at 23.0 dBm (200 mW)

Area Scan (7x15x1): Measurement grid: dx=15mm, dy=15mm

Zoom Scan (5x5x7)/Cube 0: Measurement grid: dx=8mm, dy=8mm, dz=5mm

Peak SAR (extrapolated) = 2.38 W/kg

SAR(1 g) = 1.59 W/kg

Deviation(1 g) = -5.69%

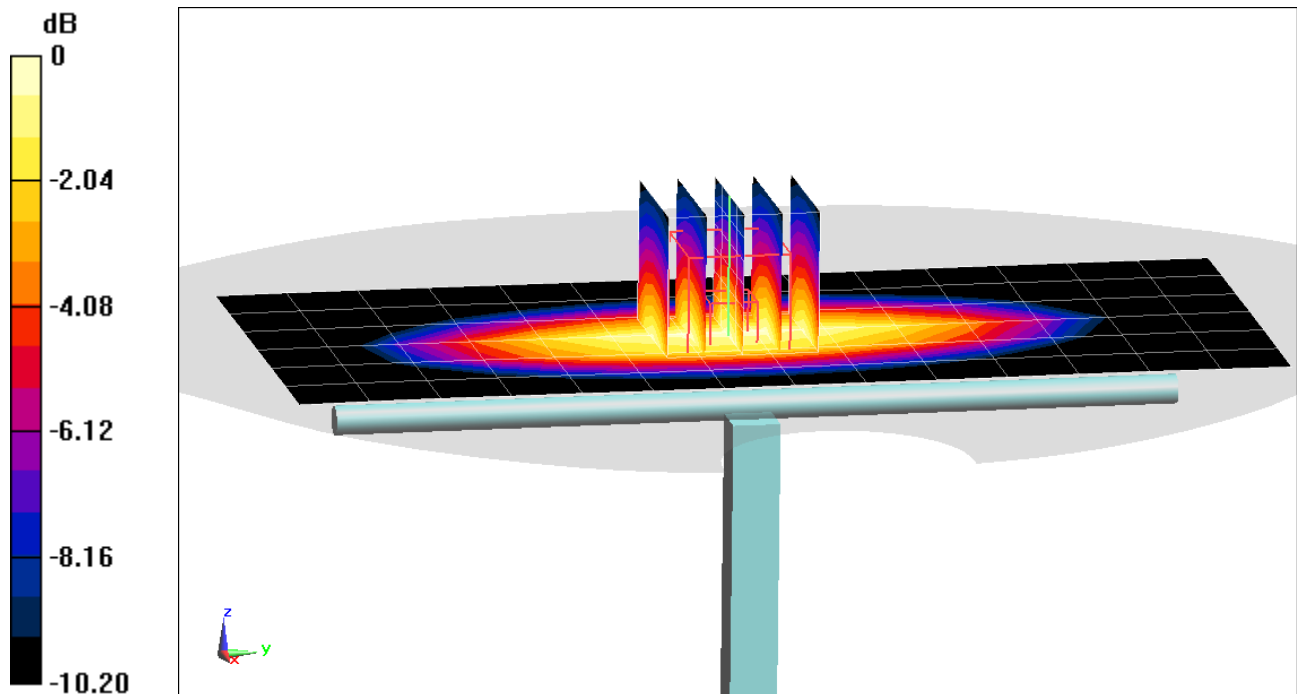

0 dB = 2.12 W/kg = 3.26 dBW/kg

PCTEST ENGINEERING LABORATORY, INC.

DUT: Dipole 835 MHz; Type: D835V2; Serial: 4d133

Communication System: UID 0, CW; Frequency: 835 MHz; Duty Cycle: 1:1

Medium: 835 Body Medium parameters used:

$f = 835 \text{ MHz}$; $\sigma = 0.98 \text{ S/m}$; $\epsilon_r = 54.237$; $\rho = 1000 \text{ kg/m}^3$

Phantom section: Flat Section; Space: 1.5 cm

Test Date: 04-05-2019; Ambient Temp: 22.0°C; Tissue Temp: 21.8°C

Probe: EX3DV4 - SN7357; ConvF(10.17, 10.17, 10.17) @ 835 MHz; Calibrated: 4/18/2018

Sensor-Surface: 1.4mm (Mechanical Surface Detection)

Electronics: DAE4 Sn1407; Calibrated: 4/11/2018

Phantom: SAM with CRP v5.0 Front; Type: QD000P40CD; Serial: 1646

Measurement SW: DASY52, Version 52.10 (2);SEMCAD X Version 14.6.12 (7450)

835 MHz System Verification at 23.0 dBm (200 mW)

Area Scan (7x14x1): Measurement grid: dx=15mm, dy=15mm

Zoom Scan (5x5x7)/Cube 0: Measurement grid: dx=8mm, dy=8mm, dz=5mm

Peak SAR (extrapolated) = 3.16 W/kg

SAR(1 g) = 2.08 W/kg

Deviation(1 g) = 6.67%

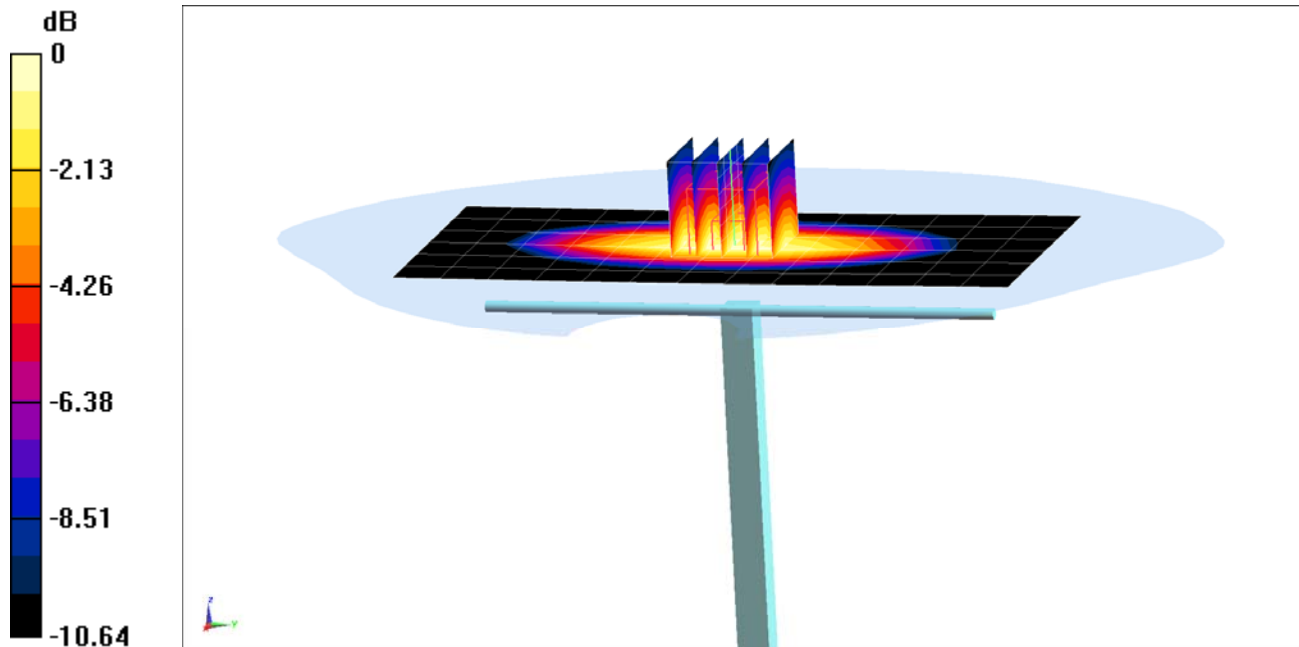

0 dB = 2.78 W/kg = 4.44 dBW/kg

PCTEST ENGINEERING LABORATORY, INC.

DUT: Dipole 835 MHz; Type: D835V2; Serial: 4d132

Communication System: UID 0, CW; Frequency: 835 MHz; Duty Cycle: 1:1

Medium: 835 Body Medium parameters used:

$f = 835 \text{ MHz}$; $\sigma = 0.988 \text{ S/m}$; $\epsilon_r = 54.474$; $\rho = 1000 \text{ kg/m}^3$

Phantom section: Flat Section; Space: 1.5 cm

Test Date: 04-16-2019; Ambient Temp: 24.2°C; Tissue Temp: 22.6°C

Probe: EX3DV4 - SN7488; ConvF(11.03, 11.03, 11.03) @ 835 MHz; Calibrated: 1/24/2019

Sensor-Surface: 1.4mm (Mechanical Surface Detection)

Electronics: DAE4 Sn1530; Calibrated: 1/15/2019

Phantom: Twin-SAM V5.0; Type: QD 000 P40 CD; Serial: 1800

Measurement SW: DASY52, Version 52.10 (2);SEMCAD X Version 14.6.12 (7450)

835 MHz System Verification at 23.0 dBm (200 mW)

Area Scan (7x14x1): Measurement grid: dx=15mm, dy=15mm

Zoom Scan (5x5x7)/Cube 0: Measurement grid: dx=8mm, dy=8mm, dz=5mm

Peak SAR (extrapolated) = 2.90 W/kg

SAR(1 g) = 1.88 W/kg

Deviation(1 g) = -2.79%

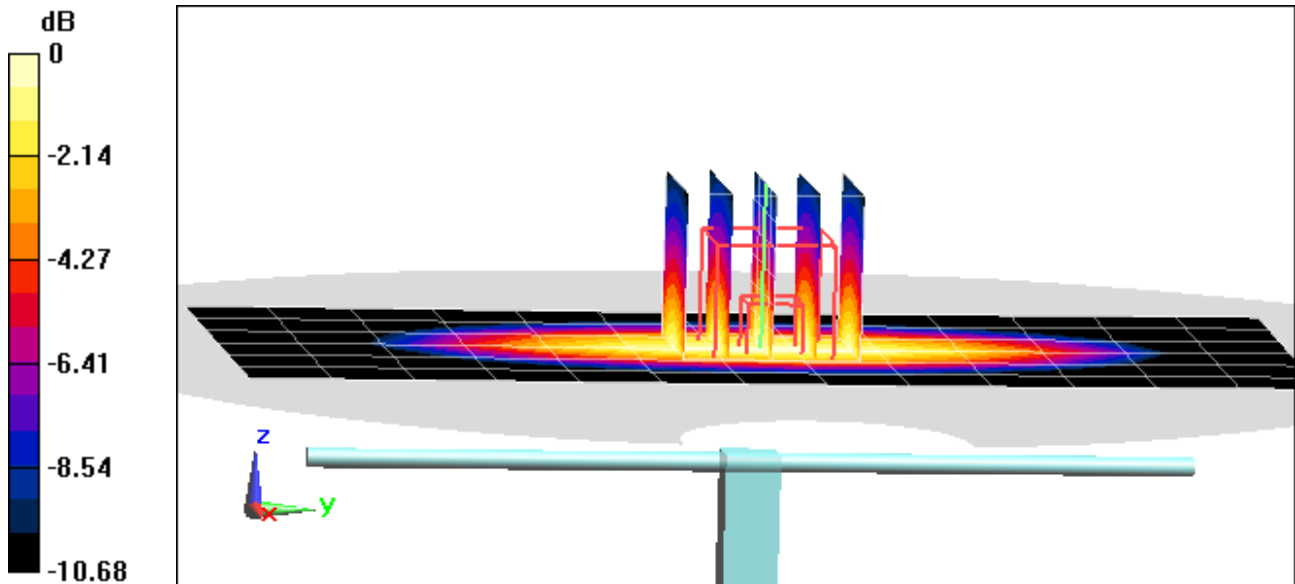

0 dB = 2.53 W/kg = 4.03 dBW/kg

PCTEST ENGINEERING LABORATORY, INC.

DUT: Dipole 1750 MHz; Type: D1750V2; Serial: 1148

Communication System: UID 0, CW; Frequency: 1750 MHz; Duty Cycle: 1:1

Medium: 1750 Body Medium parameters used:

$f = 1750 \text{ MHz}$; $\sigma = 1.539 \text{ S/m}$; $\epsilon_r = 51.042$; $\rho = 1000 \text{ kg/m}^3$

Phantom section: Flat Section; Space: 1.0 cm

Test Date: 04-05-2019; Ambient Temp: 22.3°C; Tissue Temp: 19.7°C

Probe: EX3DV4 - SN7488; ConvF(8.68, 8.68, 8.68) @ 1750 MHz; Calibrated: 1/24/2019

Sensor-Surface: 1.4mm (Mechanical Surface Detection)

Electronics: DAE4 Sn1530; Calibrated: 1/15/2019

Phantom: SAM Left; Type: QD000P40CC; Serial: TP: 1375

Measurement SW: DASY52, Version 52.10 (2);SEMCAD X Version 14.6.12 (7450)

1750 MHz System Verification at 20.0 dBm (100 mW)

Area Scan (7x9x1): Measurement grid: dx=15mm, dy=15mm

Zoom Scan (5x5x7)/Cube 0: Measurement grid: dx=8mm, dy=8mm, dz=5mm

Peak SAR (extrapolated) = 6.44 W/kg

SAR(1 g) = 3.59 W/kg

Deviation(1 g) = -2.97%

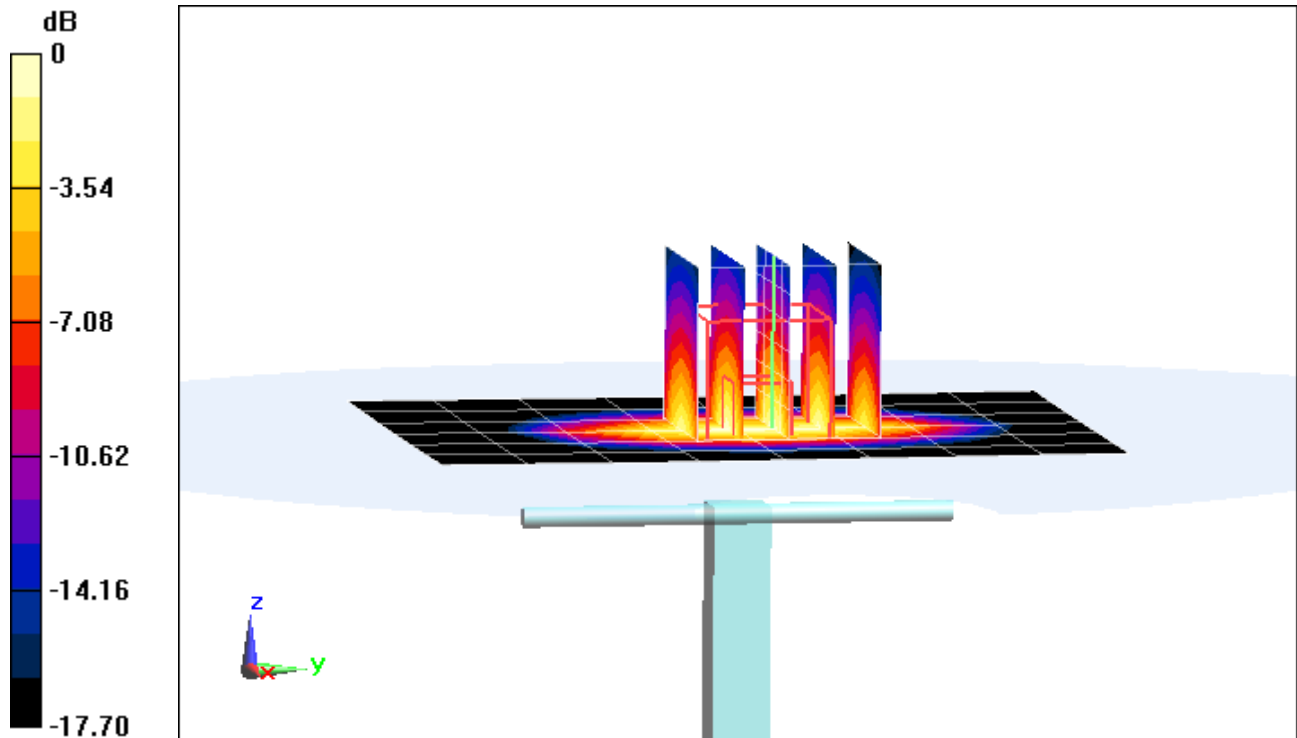

0 dB = 5.42 W/kg = 7.34 dBW/kg

PCTEST ENGINEERING LABORATORY, INC.

DUT: Dipole 1750 MHz; Type: D1750V2; Serial: 1148

Communication System: UID 0, CW; Frequency: 1750 MHz; Duty Cycle: 1:1

Medium: 1750 Body Medium parameters used:

$f = 1750$ MHz; $\sigma = 1.483$ S/m; $\epsilon_r = 51.102$; $\rho = 1000$ kg/m³

Phantom section: Flat Section; Space: 1.0 cm

Test Date: 04-08-2019; Ambient Temp: 20.4°C; Tissue Temp: 19.8°C

Probe: EX3DV4 - SN7488; ConvF(8.68, 8.68, 8.68) @ 1750 MHz; Calibrated: 1/24/2019

Sensor-Surface: 1.4mm (Mechanical Surface Detection)

Electronics: DAE4 Sn1530; Calibrated: 1/15/2019

Phantom: SAM Left; Type: QD000P40CC; Serial: TP: 1375

Measurement SW: DASY52, Version 52.10 (2);SEMCAD X Version 14.6.12 (7450)

1750 MHz System Verification at 20.0 dBm (100 mW)

Area Scan (7x9x1): Measurement grid: dx=15mm, dy=15mm

Zoom Scan (5x5x7)/Cube 0: Measurement grid: dx=8mm, dy=8mm, dz=5mm

Peak SAR (extrapolated) = 6.26 W/kg

SAR(1 g) = 3.51 W/kg

Deviation(1 g) = -5.14%

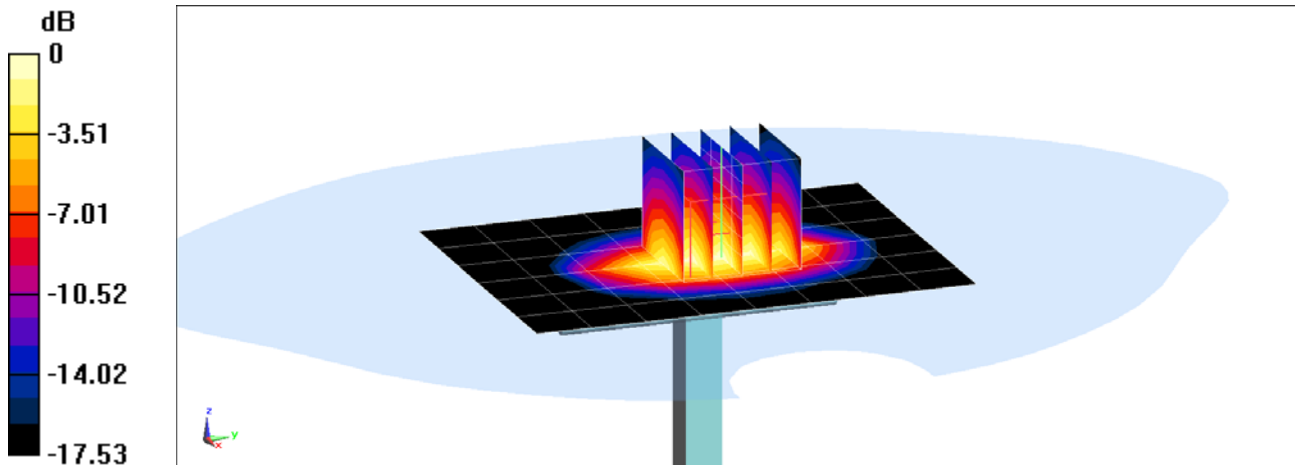

0 dB = 5.29 W/kg = 7.23 dBW/kg

PCTEST ENGINEERING LABORATORY, INC.

DUT: Dipole 1750 MHz; Type: D1765V2; Serial: 1008

Communication System: UID 0, CW; Frequency: 1750 MHz; Duty Cycle: 1:1

Medium: 1750 Body Medium parameters used:

$f = 1750 \text{ MHz}$; $\sigma = 1.495 \text{ S/m}$; $\epsilon_r = 51.531$; $\rho = 1000 \text{ kg/m}^3$

Phantom section: Flat Section; Space: 1.0 cm

Test Date: 04-11-2019; Ambient Temp: 22.5°C; Tissue Temp: 21.5°C

Probe: EX3DV4 - SN7488; ConvF(8.68, 8.68, 8.68) @ 1750 MHz; Calibrated: 1/24/2019

Sensor-Surface: 1.4mm (Mechanical Surface Detection)

Electronics: DAE4 Sn1530; Calibrated: 1/15/2019

Phantom: SAM Left; Type: QD000P40CC; Serial: TP: 1375

Measurement SW: DASY52, Version 52.10 (2);SEMCAD X Version 14.6.12 (7450)

1750 MHz System Verification at 20.0 dBm (100 mW)

Area Scan (7x9x1): Measurement grid: dx=15mm, dy=15mm

Zoom Scan (5x5x7)/Cube 0: Measurement grid: dx=8mm, dy=8mm, dz=5mm

Peak SAR (extrapolated) = 6.56 W/kg

SAR(1 g) = 3.6 W/kg

Deviation(1 g) = -3.74%

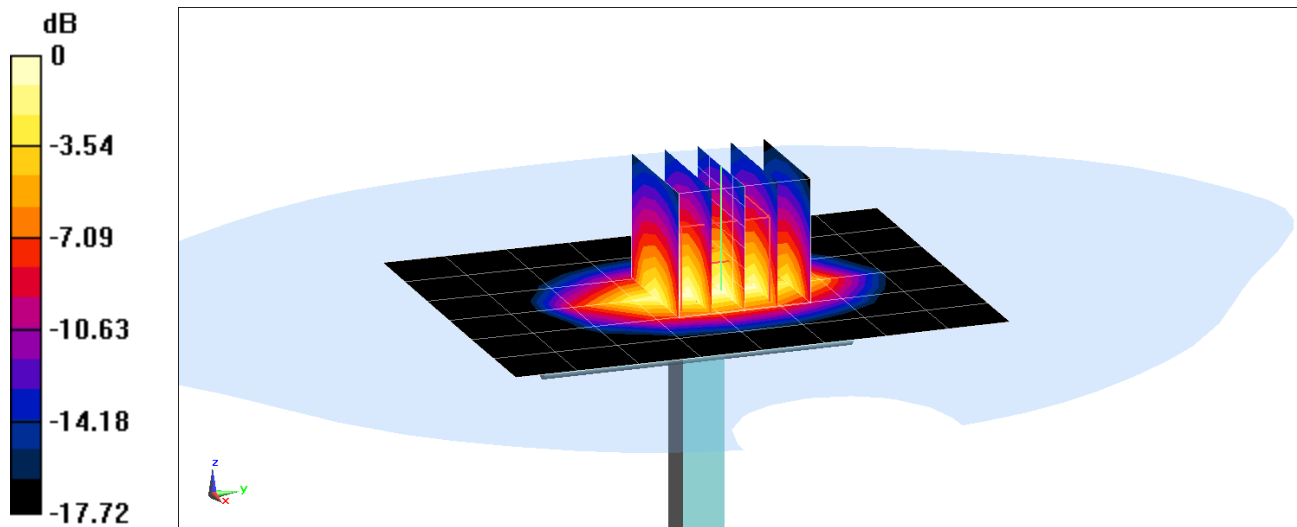

0 dB = 5.49 W/kg = 7.40 dBW/kg

PCTEST ENGINEERING LABORATORY, INC.

DUT: Dipole 1900 MHz; Type: D1900V2; Serial: 5d080

Communication System: UID 0, CW; Frequency: 1900 MHz; Duty Cycle: 1:1
Medium: 1900 Body Medium parameters used (interpolated):
 $f = 1900 \text{ MHz}$; $\sigma = 1.569 \text{ S/m}$; $\epsilon_r = 52.137$; $\rho = 1000 \text{ kg/m}^3$
Phantom section: Flat Section; Space: 1.0 cm

Test Date: 04-03-2019; Ambient Temp: 22.2°C; Tissue Temp: 22.5°C

Probe: EX3DV4 - SN7410; ConvF(7.78, 7.78, 7.78) @ 1900 MHz; Calibrated: 7/20/2018
Sensor-Surface: 1.4mm (Mechanical Surface Detection)
Electronics: DAE4 Sn1322; Calibrated: 7/11/2018
Phantom: Front; Type: QD 000 P40 CD; Serial: 1686
Measurement SW: DASY52, Version 52.10 (2);SEMCAD X Version 14.6.12 (7450)

1900 MHz System Verification at 20.0 dBm (100 mW)

Area Scan (7x11x1): Measurement grid: dx=15mm, dy=15mm

Zoom Scan (5x5x7)/Cube 0: Measurement grid: dx=8mm, dy=8mm, dz=5mm

Peak SAR (extrapolated) = 7.67 W/kg

SAR(1 g) = 4.21 W/kg

Deviation(1 g) = 7.40%

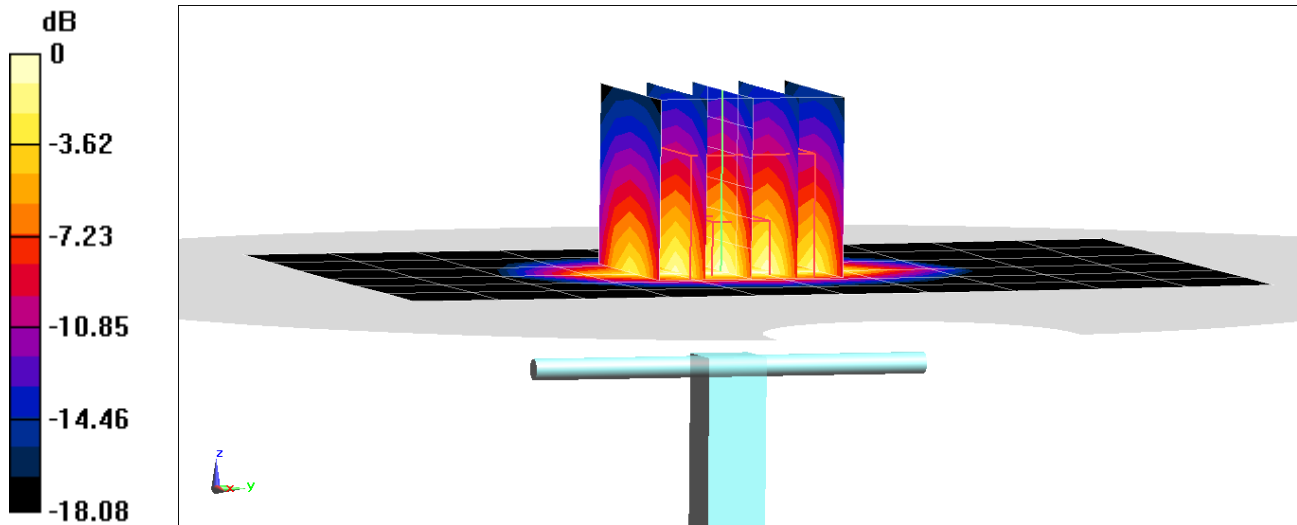

0 dB = 6.49 W/kg = 8.12 dBW/kg

PCTEST ENGINEERING LABORATORY, INC.

DUT: Dipole 1900 MHz; Type: D1900V2; Serial: 5d149

Communication System: UID 0, CW; Frequency: 1900 MHz; Duty Cycle: 1:1
Medium: 1900 Body Medium parameters used (interpolated):
 $f = 1900 \text{ MHz}$; $\sigma = 1.574 \text{ S/m}$; $\epsilon_r = 52.499$; $\rho = 1000 \text{ kg/m}^3$
Phantom section: Flat Section; Space: 1.0 cm

Test Date: 04-25-2019; Ambient Temp: 23.4°C; Tissue Temp: 22.7°C

Probe: EX3DV4 - SN7410; ConvF(7.78, 7.78, 7.78) @ 1900 MHz; Calibrated: 7/20/2018
Sensor-Surface: 1.4mm (Mechanical Surface Detection)
Electronics: DAE4 Sn1322; Calibrated: 7/11/2018
Phantom: Front; Type: QD 000 P40 CD; Serial: 1686
Measurement SW: DASY52, Version 52.10 (2);SEMCAD X Version 14.6.12 (7450)

1900 MHz System Verification at 20.0 dBm (100 mW)

Area Scan (7x10x1): Measurement grid: dx=15mm, dy=15mm
Zoom Scan (5x5x7)/Cube 0: Measurement grid: dx=8mm, dy=8mm, dz=5mm
Peak SAR (extrapolated) = 7.77 W/kg
SAR(1 g) = 4.25 W/kg
Deviation(1 g) = 7.87%

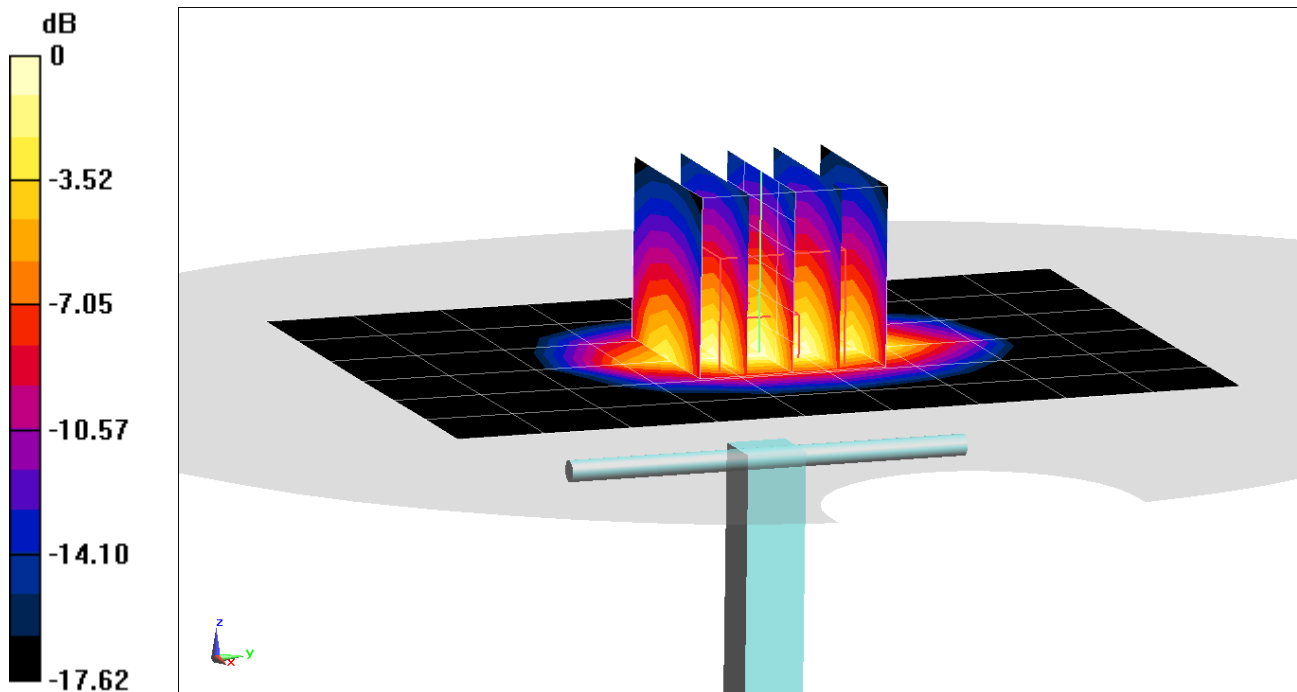

0 dB = 5.42 W/kg = 7.34 dBW/kg

PCTEST ENGINEERING LABORATORY, INC.

DUT: Dipole 1900 MHz; Type: D1900V2; Serial: 5d149

Communication System: UID 0, CW; Frequency: 1900 MHz; Duty Cycle: 1:1

Medium: 1900 Body Medium parameters used (interpolated):

$f = 1900$ MHz; $\sigma = 1.579$ S/m; $\epsilon_r = 52.361$; $\rho = 1000$ kg/m³

Phantom section: Flat Section; Space: 10 cm

Test Date: 05-01-2019; Ambient Temp: 23.2°C; Tissue Temp: 21.7°C

Probe: EX3DV4 - SN7410; ConvF(7.78, 7.78, 7.78) @ 1900 MHz; Calibrated: 7/20/2018

Sensor-Surface: 1.4mm (Mechanical Surface Detection)

Electronics: DAE4 Sn1322; Calibrated: 7/11/2018

Phantom: Front; Type: QD 000 P40 CD; Serial: 1686

Measurement SW: DASY52, Version 52.10 (2);SEMCAD X Version 14.6.12 (7450)

1900 MHz System Verification at 20.0 dBm (100 mW)

Area Scan (7x11x1): Measurement grid: dx=15mm, dy=15mm

Zoom Scan (5x5x7)/Cube 0: Measurement grid: dx=8mm, dy=8mm, dz=5mm

Peak SAR (extrapolated) = 7.87 W/kg

SAR(1 g) = 4.21 W/kg

Deviation(1 g) = 6.85%

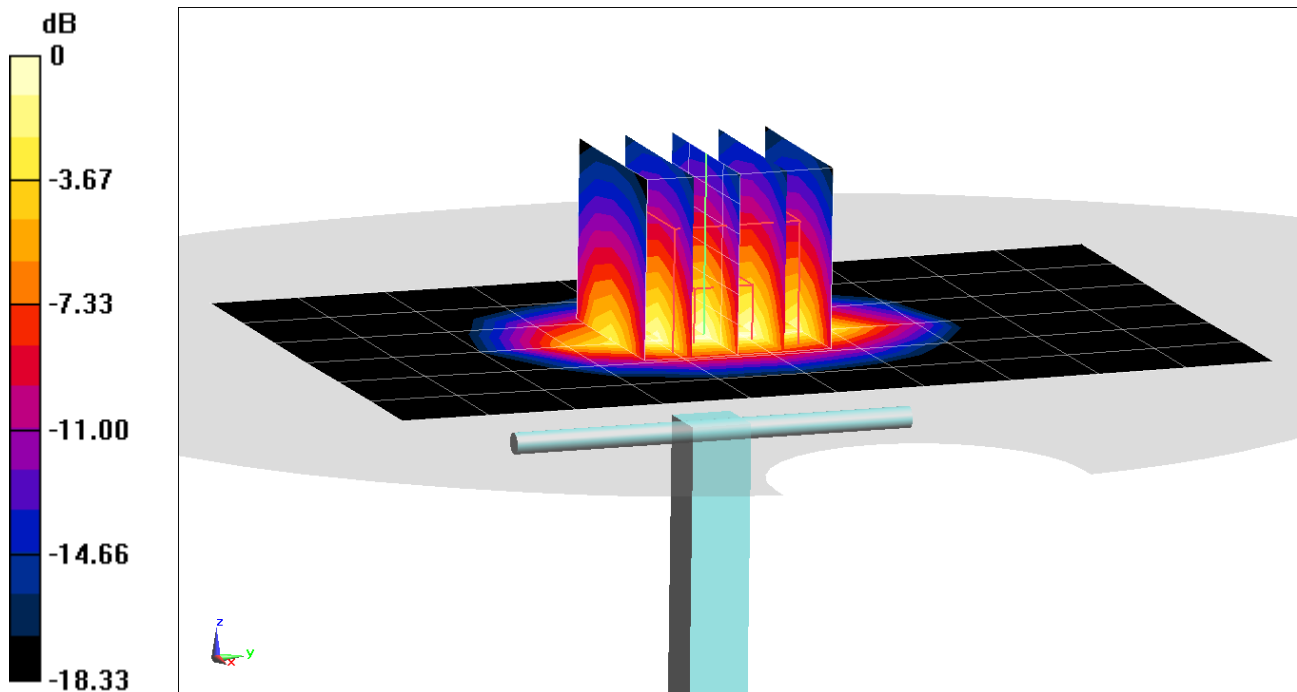

0 dB = 6.59 W/kg = 8.19 dBW/kg

PCTEST ENGINEERING LABORATORY, INC.

DUT: Dipole 2300 MHz; Type: D2300V2; Serial: 1073

Communication System: UID 0, CW; Frequency: 2300 MHz; Duty Cycle: 1:1

Medium: 2450 Body; Medium parameters used:

$f = 2300$ MHz; $\sigma = 1.858$ S/m; $\epsilon_r = 52.457$; $\rho = 1000$ kg/m³

Phantom section: Flat Section; Space: 1.0 cm

Test Date: 04-11-2019; Ambient Temp: 23.5°C; Tissue Temp: 22.1°C

Probe: EX3DV4 - SN7417; ConvF(7.64, 7.64, 7.64) @ 2300 MHz; Calibrated: 2/19/2019

Sensor-Surface: 1.4mm (Mechanical Surface Detection)

Electronics: DAE4 Sn665; Calibrated: 2/13/2019

Phantom: Left Twin-SAM V5.0; Type: QD 000 P40 CD; Serial: TP1375

Measurement SW: DASY52, Version 52.10 (2);SEMCAD X Version 14.6.12 (7450)

2300 MHz System Verification at 20.0 dBm (100 mW)

Area Scan (8x9x1): Measurement grid: dx=12mm, dy=12mm

Zoom Scan (7x7x7)/Cube 0: Measurement grid: dx=5mm, dy=5mm, dz=5mm

Peak SAR (extrapolated) = 10.1 W/kg

SAR(1 g) = 5.07 W/kg; SAR(10 g) = 2.4 W/kg

Deviation(1 g) = 6.29%; Deviation(10 g) = 3.45%

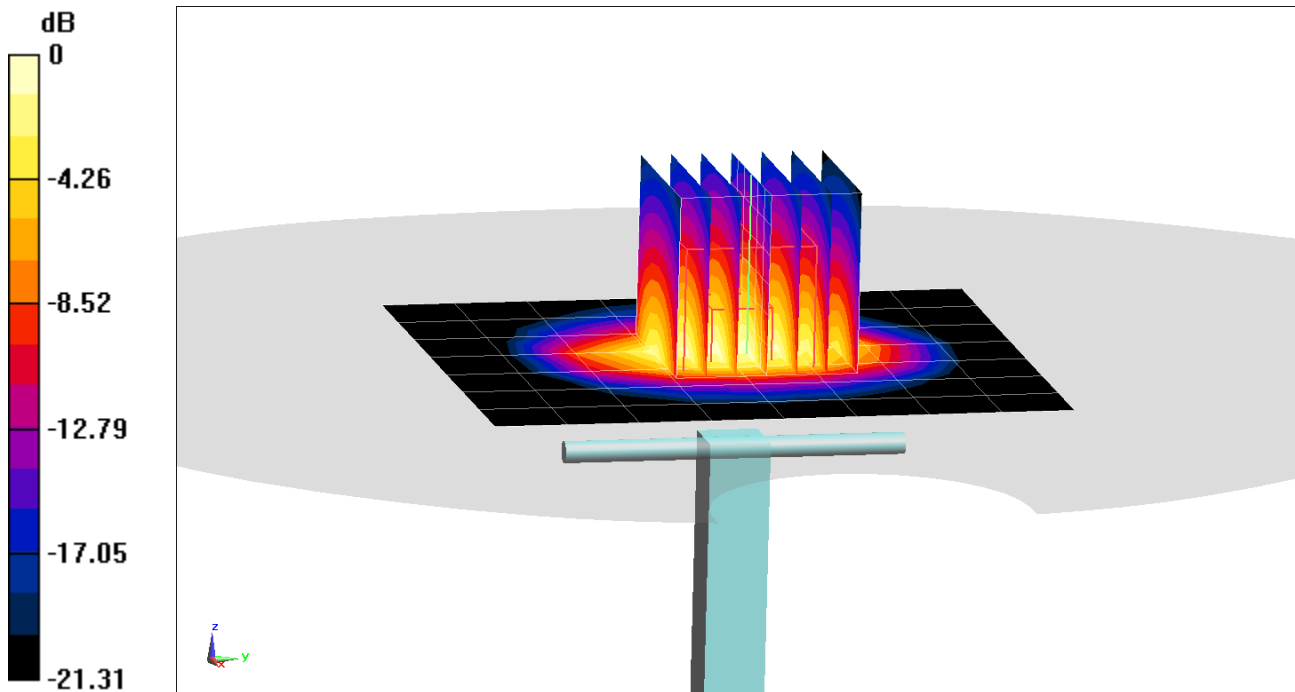

0 dB = 8.21 W/kg = 9.14 dBW/kg

PCTEST ENGINEERING LABORATORY, INC.

DUT: Dipole 2450 MHz; Type: D2450V2; Serial: 719

Communication System: UID 0, CW; Frequency: 2450 MHz; Duty Cycle: 1:1

Medium: 2450 Body; Medium parameters used:

$f = 2450$ MHz; $\sigma = 2.033$ S/m; $\epsilon_r = 52.027$; $\rho = 1000$ kg/m³

Phantom section: Flat Section; Space: 1.0 cm

Test Date: 04-11-2019; Ambient Temp: 23.5°C; Tissue Temp: 22.1°C

Probe: EX3DV4 - SN7417; ConvF(7.51, 7.51, 7.51) @ 2450 MHz; Calibrated: 2/19/2019

Sensor-Surface: 1.4mm (Mechanical Surface Detection)

Electronics: DAE4 Sn665; Calibrated: 2/13/2019

Phantom: Left Twin-SAM V5.0; Type: QD 000 P40 CD; Serial: TP1375

Measurement SW: DASY52, Version 52.10 (2);SEMCAD X Version 14.6.12 (7450)

2450 MHz System Verification at 20.0 dBm (100 mW)

Area Scan (8x9x1): Measurement grid: dx=12mm, dy=12mm

Zoom Scan (7x7x7)/Cube 0: Measurement grid: dx=5mm, dy=5mm, dz=5mm

Peak SAR (extrapolated) = 10.8 W/kg

SAR(1 g) = 5.21 W/kg

Deviation(1 g) = 3.99%

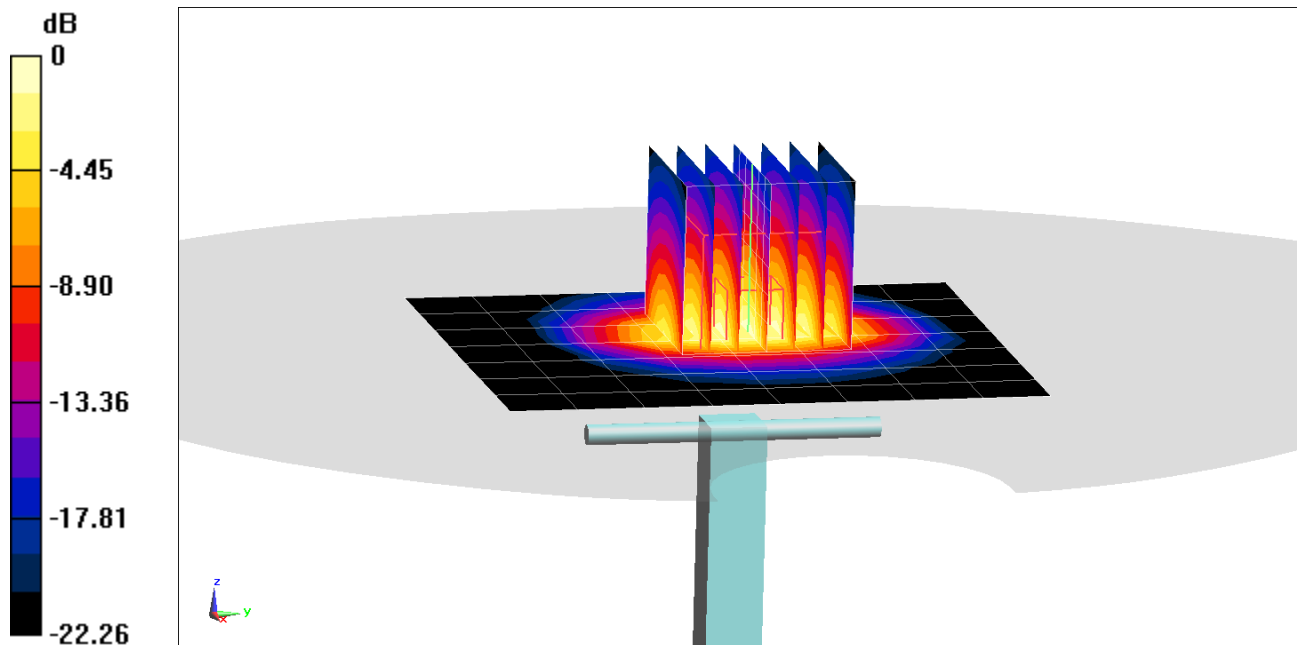

0 dB = 8.81 W/kg = 9.45 dBW/kg

PCTEST ENGINEERING LABORATORY, INC.

DUT: Dipole 5 GHz; Type: D5GHzV2; Serial: 1191

Communication System: UID 0, CW; Frequency: 5250 MHz; Duty Cycle: 1:1

Medium: 5GHz Body Medium parameters used (interpolated):

$f = 5250 \text{ MHz}$; $\sigma = 5.445 \text{ S/m}$; $\epsilon_r = 47.261$; $\rho = 1000 \text{ kg/m}^3$

Phantom section: Flat Section; Space: 1.0 cm

Test Date: 04-05-2019; Ambient Temp: 23.4°C; Tissue Temp: 21.5°C

Probe: EX3DV4 - SN7308; ConvF(4.48, 4.48, 4.48) @ 5250 MHz; Calibrated: 8/23/2018

Sensor-Surface: 1.4mm (Mechanical Surface Detection)

Electronics: DAE4 Sn1558; Calibrated: 10/3/2018

Phantom: Twin-SAM V5.0; Type: QD 000 P40 CD; Serial: 1630

Measurement SW: DASY52, Version 52.10 (2); SEMCAD X Version 14.6.12 (7450)

5250 MHz System Verification at 17.0 dBm (50 mW)

Area Scan (7x7x1): Measurement grid: dx=10mm, dy=10mm

Zoom Scan (8x8x7)/Cube 0: Measurement grid: dx=4mm, dy=4mm, dz=1.4mm; Graded Ratio: 1.4

Peak SAR (extrapolated) = 15.5 W/kg

SAR(1 g) = 3.84 W/kg; SAR(10 g) = 1.07 W/kg

Deviation(1 g) = -0.26%; Deviation(10 g) = -0.93%

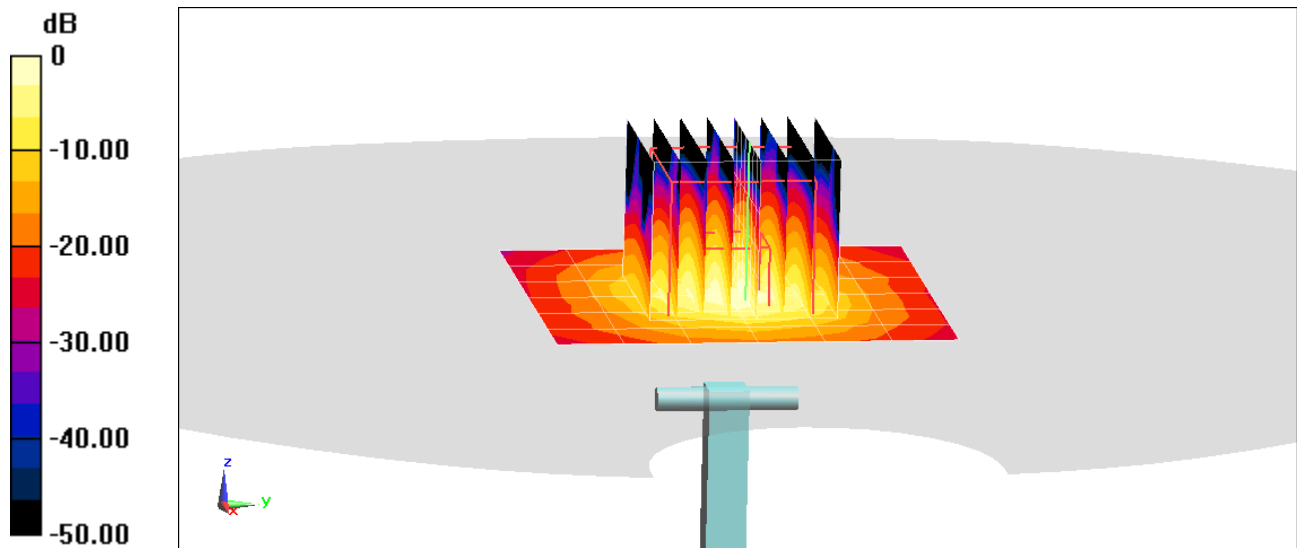

PCTEST ENGINEERING LABORATORY, INC.

DUT: Dipole 5 GHz; Type: D5GHzV2; Serial: 1191

Communication System: UID 0, CW; Frequency: 5600 MHz; Duty Cycle: 1:1

Medium: 5GHz Body Medium parameters used:

$f = 5600 \text{ MHz}$; $\sigma = 5.948 \text{ S/m}$; $\epsilon_r = 46.593$; $\rho = 1000 \text{ kg/m}^3$

Phantom section: Flat Section; Space: 1.0 cm

Test Date: 04-05-2019; Ambient Temp: 23.4°C; Tissue Temp: 21.5°C

Probe: EX3DV4 - SN7308; ConvF(4, 4, 4) @ 5600 MHz; Calibrated: 8/23/2018

Sensor-Surface: 1.4mm (Mechanical Surface Detection)

Electronics: DAE4 Sn1558; Calibrated: 10/3/2018

Phantom: Twin-SAM V5.0; Type: QD 000 P40 CD; Serial: 1630

Measurement SW: DASY52, Version 52.10 (2); SEMCAD X Version 14.6.12 (7450)

5600 MHz System Verification at 17.0 dBm (50 mW)

Area Scan (7x7x1): Measurement grid: dx=10mm, dy=10mm

Zoom Scan (8x8x7)/Cube 0: Measurement grid: dx=4mm, dy=4mm, dz=1.4mm; Graded Ratio: 1.4

Peak SAR (extrapolated) = 17.7 W/kg

SAR(1 g) = 4.03 W/kg; SAR(10 g) = 1.11 W/kg

Deviation(1 g) = 1.77%; Deviation(10 g) = 0.00%

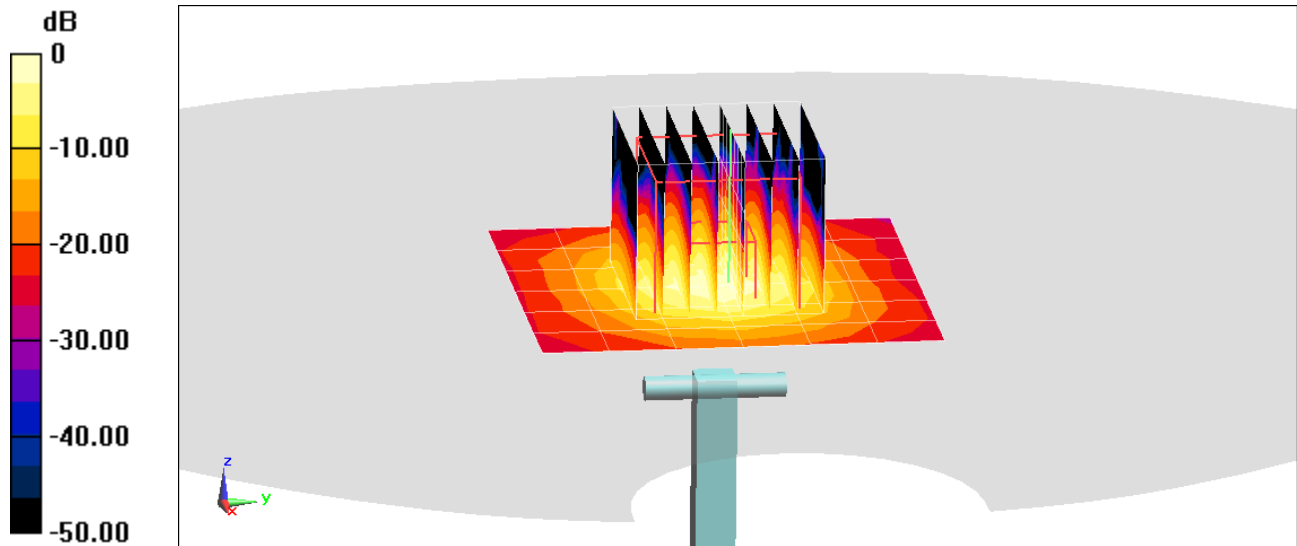

0 dB = 9.58 W/kg = 9.81 dBW/kg

PCTEST ENGINEERING LABORATORY, INC.

DUT: Dipole 5 GHz; Type: D5GHzV2; Serial: 1191

Communication System: UID 0, CW; Frequency: 5750 MHz; Duty Cycle: 1:1

Medium: 5GHz Body Medium parameters used (interpolated):

$f = 5750 \text{ MHz}$; $\sigma = 6.176 \text{ S/m}$; $\epsilon_r = 46.282$; $\rho = 1000 \text{ kg/m}^3$

Phantom section: Flat Section; Space: 1.0 cm

Test Date: 04-05-2019; Ambient Temp: 23.4°C; Tissue Temp: 21.5°C

Probe: EX3DV4 - SN7308; ConvF(4.18, 4.18, 4.18) @ 5750 MHz; Calibrated: 8/23/2018

Sensor-Surface: 1.4mm (Mechanical Surface Detection)

Electronics: DAE4 Sn1558; Calibrated: 10/3/2018

Phantom: Twin-SAM V5.0; Type: QD 000 P40 CD; Serial: 1630

Measurement SW: DASY52, Version 52.10 (2); SEMCAD X Version 14.6.12 (7450)

5750 MHz System Verification at 17.0 dBm (50 mW)

Area Scan (7x7x1): Measurement grid: dx=10mm, dy=10mm

Zoom Scan (8x8x7)/Cube 0: Measurement grid: dx=4mm, dy=4mm, dz=1.4mm; Graded Ratio: 1.4

Peak SAR (extrapolated) = 17.0 W/kg

SAR(1 g) = 3.66 W/kg

Deviation(1 g) = -3.81%

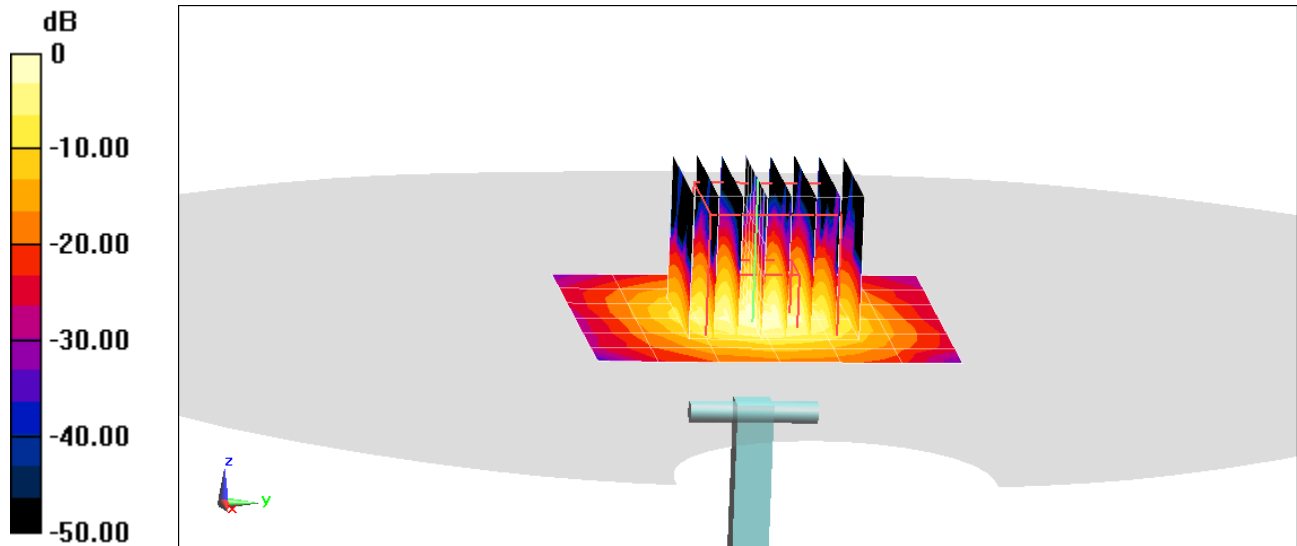

0 dB = 9.00 W/kg = 9.54 dBW/kg

PCTEST ENGINEERING LABORATORY, INC.

DUT: Dipole 5 GHz; Type: D5GHzV2; Serial: 1057

Communication System: UID 0, CW; Frequency: 5250 MHz; Duty Cycle: 1:1
Medium: 5 GHz Body Medium parameters used (interpolated):
 $f = 5250 \text{ MHz}$; $\sigma = 5.38 \text{ S/m}$; $\epsilon_r = 47.328$; $\rho = 1000 \text{ kg/m}^3$
Phantom section: Flat Section; Space: 1.0 cm

Test Date: 04-14-2019; Ambient Temp: 22.0°C; Tissue Temp: 21.5°C

Probe: EX3DV4 - SN7308; ConvF(4.48, 4.48, 4.48) @ 5250 MHz; Calibrated: 8/23/2018
Sensor-Surface: 1.4mm (Mechanical Surface Detection)
Electronics: DAE4 Sn1558; Calibrated: 10/3/2018
Phantom: Twin-SAM V5.0; Type: QD 000 P40 CD; Serial: 1630
Measurement SW: DASY52, Version 52.10 (2); SEMCAD X Version 14.6.12 (7450)

5250 MHz System Verification at 17.0 dBm (50 mW)

Area Scan (7x7x1): Measurement grid: dx=10mm, dy=10mm

Zoom Scan (8x8x7)/Cube 0: Measurement grid: dx=4mm, dy=4mm, dz=1.4mm; Graded Ratio: 1.4

Peak SAR (extrapolated) = 14.5 W/kg

SAR(1 g) = 3.56 W/kg

Deviation(1 g) = -6.19%

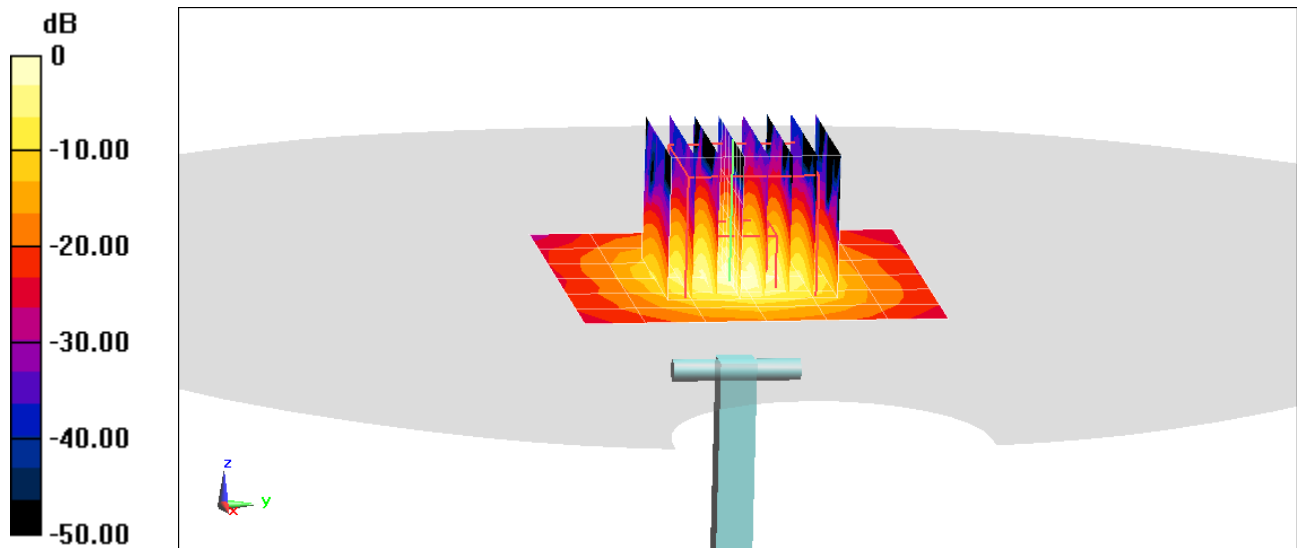

0 dB = 8.55 W/kg = 9.32 dBW/kg

PCTEST ENGINEERING LABORATORY, INC.

DUT: Dipole 5 GHz; Type: D5GHzV2; Serial: 1057

Communication System: UID 0, CW; Frequency: 5600 MHz; Duty Cycle: 1:1

Medium: 5 GHz Body Medium parameters used:

$f = 5600 \text{ MHz}$; $\sigma = 5.876 \text{ S/m}$; $\epsilon_r = 46.696$; $\rho = 1000 \text{ kg/m}^3$

Phantom section: Flat Section; Space: 1.0 cm

Test Date: 04-14-2019; Ambient Temp: 22.0°C; Tissue Temp: 21.5°C

Probe: EX3DV4 - SN7308; ConvF(4, 4, 4) @ 5600 MHz; Calibrated: 8/23/2018

Sensor-Surface: 1.4mm (Mechanical Surface Detection)

Electronics: DAE4 Sn1558; Calibrated: 10/3/2018

Phantom: Twin-SAM V5.0; Type: QD 000 P40 CD; Serial: 1630

Measurement SW: DASY52, Version 52.10 (2); SEMCAD X Version 14.6.12 (7450)

5600 MHz System Verification at 17.0 dBm (50 mW)

Area Scan (7x7x1): Measurement grid: dx=10mm, dy=10mm

Zoom Scan (8x8x7)/Cube 0: Measurement grid: dx=4mm, dy=4mm, dz=1.4mm; Graded Ratio: 1.4

Peak SAR (extrapolated) = 18.1 W/kg

SAR(1 g) = 4.02 W/kg

Deviation(1 g) = 0.63%

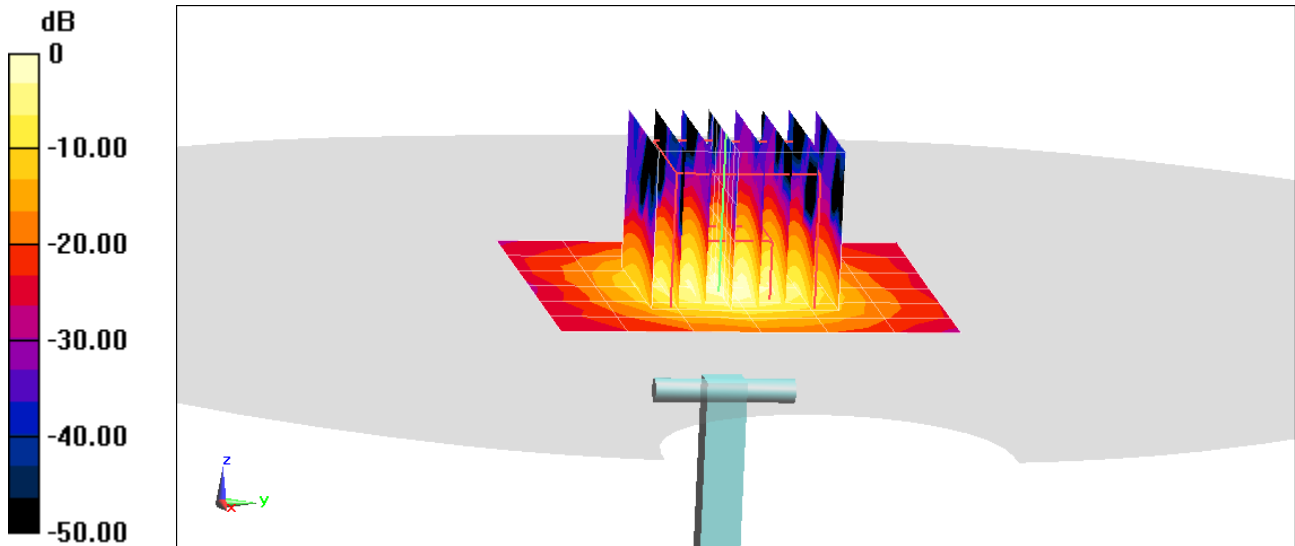

PCTEST ENGINEERING LABORATORY, INC.

DUT: Dipole 5 GHz; Type: D5GHzV2; Serial: 1057

Communication System: UID 0, CW; Frequency: 5750 MHz; Duty Cycle: 1:1
Medium: 5 GHz Body Medium parameters used (interpolated):
 $f = 5750 \text{ MHz}$; $\sigma = 6.103 \text{ S/m}$; $\epsilon_r = 46.395$; $\rho = 1000 \text{ kg/m}^3$
Phantom section: Flat Section; Space: 1.0 cm

Test Date: 04-14-2019; Ambient Temp: 22.0°C; Tissue Temp: 21.5°C

Probe: EX3DV4 - SN7308; ConvF(4.18, 4.18, 4.18) @ 5750 MHz; Calibrated: 8/23/2018
Sensor-Surface: 1.4mm (Mechanical Surface Detection)
Electronics: DAE4 Sn1558; Calibrated: 10/3/2018
Phantom: Twin-SAM V5.0; Type: QD 000 P40 CD; Serial: 1630
Measurement SW: DASY52, Version 52.10 (2); SEMCAD X Version 14.6.12 (7450)

5750 MHz System Verification at 17.0 dBm (50 mW)

Area Scan (7x7x1): Measurement grid: dx=10mm, dy=10mm

Zoom Scan (8x8x7)/Cube 0: Measurement grid: dx=4mm, dy=4mm, dz=1.4mm; Graded Ratio: 1.4

Peak SAR (extrapolated) = 16.6 W/kg

SAR(1 g) = 3.54 W/kg

Deviation(1 g) = -7.69%

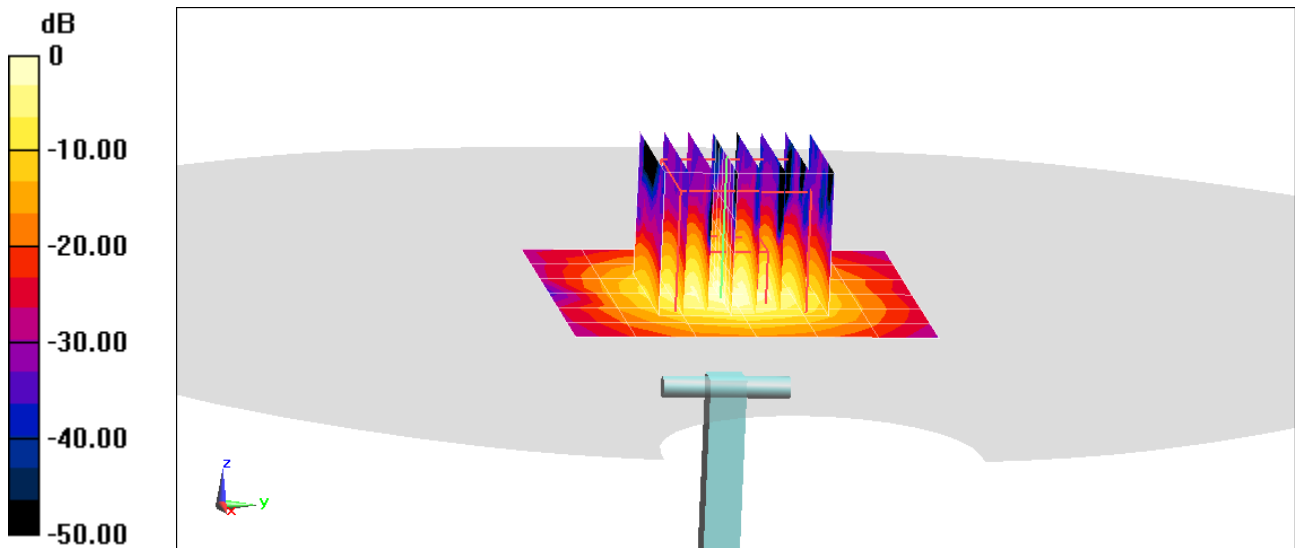

0 dB = 8.88 W/kg = 9.48 dBW/kg

APPENDIX C: PROBE CALIBRATION



Accredited by the Swiss Accreditation Service (SAS)
The Swiss Accreditation Service is one of the signatories to the EA
Multilateral Agreement for the recognition of calibration certificates

Accreditation No.: **SCS 0108**

Client **PC Test**

Certificate No: **D750V3-1003_Jan18**

CALIBRATION CERTIFICATE

Object **D750V3 - SN:1003**

Calibration procedure(s) **QA CAL-05.v9
Calibration procedure for dipole validation kits above 700 MHz**

Calibration date: **January 15, 2018**

BN ✓
01-25-2018

This calibration certificate documents the traceability to national standards, which realize the physical units of measurements (SI).
The measurements and the uncertainties with confidence probability are given on the following pages and are part of the certificate.

BN ✓
02/06/2019

All calibrations have been conducted in the closed laboratory facility; environment temperature (22 ± 3)°C and humidity < 70%.

Calibration Equipment used (M&TE critical for calibration)

| Primary Standards | ID # | Cal Date (Certificate No.) | Scheduled Calibration |
|-----------------------------|--------------------|---------------------------------|-----------------------|
| Power meter NRP | SN: 104778 | 04-Apr-17 (No. 217-02521/02522) | Apr-18 |
| Power sensor NRP-Z91 | SN: 103244 | 04-Apr-17 (No. 217-02521) | Apr-18 |
| Power sensor NRP-Z91 | SN: 103245 | 04-Apr-17 (No. 217-02522) | Apr-18 |
| Reference 20 dB Attenuator | SN: 5058 (20k) | 07-Apr-17 (No. 217-02528) | Apr-18 |
| Type-N mismatch combination | SN: 5047.2 / 06327 | 07-Apr-17 (No. 217-02529) | Apr-18 |
| Reference Probe EX3DV4 | SN: 7349 | 30-Dec-17 (No. EX3-7349_Dec17) | Dec-18 |
| DAE4 | SN: 601 | 26-Oct-17 (No. DAE4-601_Oct17) | Oct-18 |

| Secondary Standards | ID # | Check Date (in house) | Scheduled Check |
|---------------------------|----------------|-----------------------------------|------------------------|
| Power meter EPM-442A | SN: GB37480704 | 07-Oct-15 (in house check Oct-16) | In house check: Oct-18 |
| Power sensor HP 8481A | SN: US37292783 | 07-Oct-15 (in house check Oct-16) | In house check: Oct-18 |
| Power sensor HP 8481A | SN: MY41092317 | 07-Oct-15 (in house check Oct-16) | In house check: Oct-18 |
| RF generator R&S SMT-06 | SN: 100972 | 15-Jun-15 (in house check Oct-16) | In house check: Oct-18 |
| Network Analyzer HP 8753E | SN: US37390585 | 18-Oct-01 (in house check Oct-17) | In house check: Oct-18 |

Calibrated by: **Lefi Klysner** Name: **Lefi Klysner** Function: **Laboratory Technician**

Approved by: **Katja Pokovic** Name: **Katja Pokovic** Function: **Technical Manager**

Signature
Lefi Klysner
Katja Pokovic

Issued: January 15, 2018

This calibration certificate shall not be reproduced except in full without written approval of the laboratory.



Accredited by the Swiss Accreditation Service (SAS)
The Swiss Accreditation Service is one of the signatories to the EA
Multilateral Agreement for the recognition of calibration certificates

Accreditation No.: **SCS 0108**

Glossary:

| | |
|-------|---------------------------------|
| TSL | tissue simulating liquid |
| ConvF | sensitivity in TSL / NORM x,y,z |
| N/A | not applicable or not measured |

Calibration is Performed According to the Following Standards:

- IEEE Std 1528-2013, "IEEE Recommended Practice for Determining the Peak Spatial-Averaged Specific Absorption Rate (SAR) in the Human Head from Wireless Communications Devices: Measurement Techniques", June 2013
- IEC 62209-1, "Measurement procedure for the assessment of Specific Absorption Rate (SAR) from hand-held and body-mounted devices used next to the ear (frequency range of 300 MHz to 6 GHz)", July 2016
- IEC 62209-2, "Procedure to determine the Specific Absorption Rate (SAR) for wireless communication devices used in close proximity to the human body (frequency range of 30 MHz to 6 GHz)", March 2010
- KDB 865664, "SAR Measurement Requirements for 100 MHz to 6 GHz"

Additional Documentation:

- DASY4/5 System Handbook

Methods Applied and Interpretation of Parameters:

- Measurement Conditions:** Further details are available from the Validation Report at the end of the certificate. All figures stated in the certificate are valid at the frequency indicated.
- Antenna Parameters with TSL:** The dipole is mounted with the spacer to position its feed point exactly below the center marking of the flat phantom section, with the arms oriented parallel to the body axis.
- Feed Point Impedance and Return Loss:** These parameters are measured with the dipole positioned under the liquid filled phantom. The impedance stated is transformed from the measurement at the SMA connector to the feed point. The Return Loss ensures low reflected power. No uncertainty required.
- Electrical Delay:** One-way delay between the SMA connector and the antenna feed point. No uncertainty required.
- SAR measured:** SAR measured at the stated antenna input power.
- SAR normalized:** SAR as measured, normalized to an input power of 1 W at the antenna connector.
- SAR for nominal TSL parameters:** The measured TSL parameters are used to calculate the nominal SAR result.

The reported uncertainty of measurement is stated as the standard uncertainty of measurement multiplied by the coverage factor $k=2$, which for a normal distribution corresponds to a coverage probability of approximately 95%.

Measurement Conditions

DASY system configuration, as far as not given on page 1.

| | | |
|-------------------------------------|------------------------|-------------|
| DASY Version | DASY5 | V52.10.0 |
| Extrapolation | Advanced Extrapolation | |
| Phantom | Modular Flat Phantom | |
| Distance Dipole Center - TSL | 15 mm | with Spacer |
| Zoom Scan Resolution | dx, dy, dz = 5.0 mm | |
| Frequency | 750 MHz \pm 1 MHz | |

Head TSL parameters

The following parameters and calculations were applied.

| | Temperature | Permittivity | Conductivity |
|--|---------------------|----------------|----------------------|
| Nominal Head TSL parameters | 22.0 °C | 41.9 | 0.89 mho/m |
| Measured Head TSL parameters | (22.0 \pm 0.2) °C | 40.9 \pm 6 % | 0.90 mho/m \pm 6 % |
| Head TSL temperature change during test | < 0.5 °C | ---- | ---- |

SAR result with Head TSL

| SAR averaged over 1 cm³ (1 g) of Head TSL | Condition | |
|---|--------------------|--|
| SAR measured | 250 mW input power | 2.10 W/kg |
| SAR for nominal Head TSL parameters | normalized to 1W | 8.28 W/kg \pm 17.0 % (k=2) |

| SAR averaged over 10 cm³ (10 g) of Head TSL | condition | |
|---|--------------------|--|
| SAR measured | 250 mW input power | 1.37 W/kg |
| SAR for nominal Head TSL parameters | normalized to 1W | 5.42 W/kg \pm 16.5 % (k=2) |

Body TSL parameters

The following parameters and calculations were applied.

| | Temperature | Permittivity | Conductivity |
|--|---------------------|----------------|----------------------|
| Nominal Body TSL parameters | 22.0 °C | 55.5 | 0.96 mho/m |
| Measured Body TSL parameters | (22.0 \pm 0.2) °C | 55.0 \pm 6 % | 0.96 mho/m \pm 6 % |
| Body TSL temperature change during test | < 0.5 °C | ---- | ---- |

SAR result with Body TSL

| SAR averaged over 1 cm³ (1 g) of Body TSL | Condition | |
|---|--------------------|--|
| SAR measured | 250 mW input power | 2.15 W/kg |
| SAR for nominal Body TSL parameters | normalized to 1W | 8.58 W/kg \pm 17.0 % (k=2) |

| SAR averaged over 10 cm³ (10 g) of Body TSL | condition | |
|---|--------------------|--|
| SAR measured | 250 mW input power | 1.43 W/kg |
| SAR for nominal Body TSL parameters | normalized to 1W | 5.71 W/kg \pm 16.5 % (k=2) |

Appendix (Additional assessments outside the scope of SCS 0108)

Antenna Parameters with Head TSL

| | |
|--------------------------------------|--------------------------------|
| Impedance, transformed to feed point | 53.8 Ω - 2.1 j Ω |
| Return Loss | - 27.6 dB |

Antenna Parameters with Body TSL

| | |
|--------------------------------------|--------------------------------|
| Impedance, transformed to feed point | 49.2 Ω - 6.2 j Ω |
| Return Loss | - 24.0 dB |

General Antenna Parameters and Design

| | |
|----------------------------------|----------|
| Electrical Delay (one direction) | 1.043 ns |
|----------------------------------|----------|

After long term use with 100W radiated power, only a slight warming of the dipole near the feedpoint can be measured.

The dipole is made of standard semirigid coaxial cable. The center conductor of the feeding line is directly connected to the second arm of the dipole. The antenna is therefore short-circuited for DC-signals. On some of the dipoles, small end caps are added to the dipole arms in order to improve matching when loaded according to the position as explained in the "Measurement Conditions" paragraph. The SAR data are not affected by this change. The overall dipole length is still according to the Standard.

No excessive force must be applied to the dipole arms, because they might bend or the soldered connections near the feedpoint may be damaged.

Additional EUT Data

| | |
|-----------------|------------------|
| Manufactured by | SPEAG |
| Manufactured on | January 21, 2009 |

Appendix (Additional assessments outside the scope of SCS 0108)

Measurement Conditions

DASY system configuration, as far as not given on page 1 and 3.

| | | |
|---------|------------------|-----------------------------|
| Phantom | SAM Head Phantom | For usage with cSAR3DV2-R/L |
|---------|------------------|-----------------------------|

SAR result with SAM Head (Top)

| SAR averaged over 1 cm ³ (1 g) of Head TSL | Condition | |
|---|--------------------|--------------------------|
| SAR measured | 250 mW input power | 1.98 W/kg |
| SAR for nominal Head TSL parameters | normalized to 1W | 7.94 W/kg ± 17.5 % (k=2) |

| SAR averaged over 10 cm ³ (10 g) of Head TSL | condition | |
|---|--------------------|--------------------------|
| SAR measured | 250 mW input power | 1.33 W/kg |
| SAR for nominal Head TSL parameters | normalized to 1W | 5.32 W/kg ± 16.9 % (k=2) |

SAR result with SAM Head (Mouth)

| SAR averaged over 1 cm ³ (1 g) of Head TSL | Condition | |
|---|--------------------|--------------------------|
| SAR measured | 250 mW input power | 2.05 W/kg |
| SAR for nominal Head TSL parameters | normalized to 1W | 8.22 W/kg ± 17.5 % (k=2) |

| SAR averaged over 10 cm ³ (10 g) of Head TSL | condition | |
|---|--------------------|--------------------------|
| SAR measured | 250 mW input power | 1.38 W/kg |
| SAR for nominal Head TSL parameters | normalized to 1W | 5.52 W/kg ± 16.9 % (k=2) |

SAR result with SAM Head (Neck)

| SAR averaged over 1 cm ³ (1 g) of Head TSL | Condition | |
|---|--------------------|--------------------------|
| SAR measured | 250 mW input power | 2.01 W/kg |
| SAR for nominal Head TSL parameters | normalized to 1W | 8.06 W/kg ± 17.5 % (k=2) |

| SAR averaged over 10 cm ³ (10 g) of Head TSL | condition | |
|---|--------------------|--------------------------|
| SAR measured | 250 mW input power | 1.38 W/kg |
| SAR for nominal Head TSL parameters | normalized to 1W | 5.52 W/kg ± 16.9 % (k=2) |

SAR result with SAM Head (Ear)

| SAR averaged over 1 cm ³ (1 g) of Head TSL | Condition | |
|---|--------------------|--------------------------|
| SAR measured | 250 mW input power | 1.67 W/kg |
| SAR for nominal Head TSL parameters | normalized to 1W | 6.70 W/kg ± 17.5 % (k=2) |

| SAR averaged over 10 cm ³ (10 g) of Head TSL | condition | |
|---|--------------------|--------------------------|
| SAR measured | 250 mW input power | 1.15 W/kg |
| SAR for nominal Head TSL parameters | normalized to 1W | 4.60 W/kg ± 16.9 % (k=2) |

DASY5 Validation Report for Head TSL

Date: 12.01.2018

Test Laboratory: SPEAG, Zurich, Switzerland

DUT: Dipole 750 MHz; Type: D750V3; Serial: D750V3 - SN:1003

Communication System: UID 0 - CW; Frequency: 750 MHz

Medium parameters used: $f = 750$ MHz; $\sigma = 0.9$ S/m; $\epsilon_r = 40.9$; $\rho = 1000$ kg/m³

Phantom section: Flat Section

Measurement Standard: DASY5 (IEEE/IEC/ANSI C63.19-2011)

DASY52 Configuration:

- Probe: EX3DV4 - SN7349; ConvF(10.22, 10.22, 10.22); Calibrated: 30.12.2017;
- Sensor-Surface: 1.4mm (Mechanical Surface Detection)
- Electronics: DAE4 Sn601; Calibrated: 26.10.2017
- Phantom: Flat Phantom 4.9 (front); Type: QD 00L P49 AA; Serial: 1001
- DASY52 52.10.0(1446); SEMCAD X 14.6.10(7417)

Dipole Calibration for Head Tissue/Pin=250 mW, d=15mm/Zoom Scan (7x7x7)/Cube 0:

Measurement grid: dx=5mm, dy=5mm, dz=5mm

Reference Value = 59.11 V/m; Power Drift = -0.04 dB

Peak SAR (extrapolated) = 3.15 W/kg

SAR(1 g) = 2.1 W/kg; SAR(10 g) = 1.37 W/kg

Maximum value of SAR (measured) = 2.80 W/kg

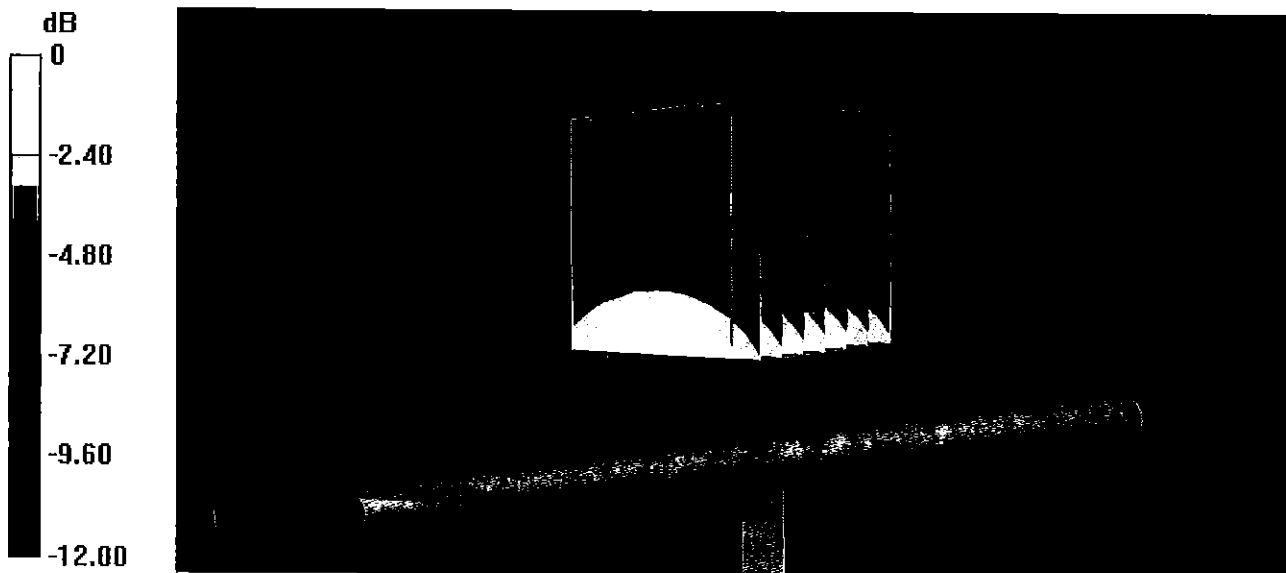

0 dB = 2.80 W/kg = 4.47 dBW/kg

Impedance Measurement Plot for Head TSL

12 Jan 2018 13:14:07
CH1 S11 1 U FS 1: 53.754 Ω -2.0996 Ω 101.07 pF 750.000 000 MHz

*
Del
CA

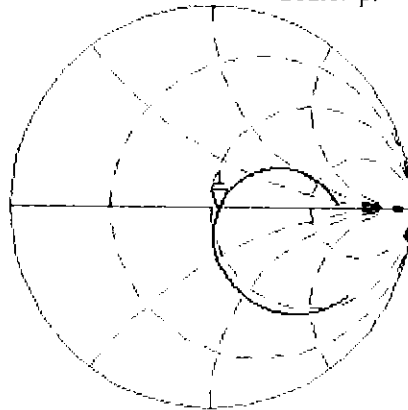

Avg
16

H1d

CH2 S11 LOG 5 dB/REF -20 dB 1: -27.643 dB 750.000 000 MHz

CA

Avg
16

H1d

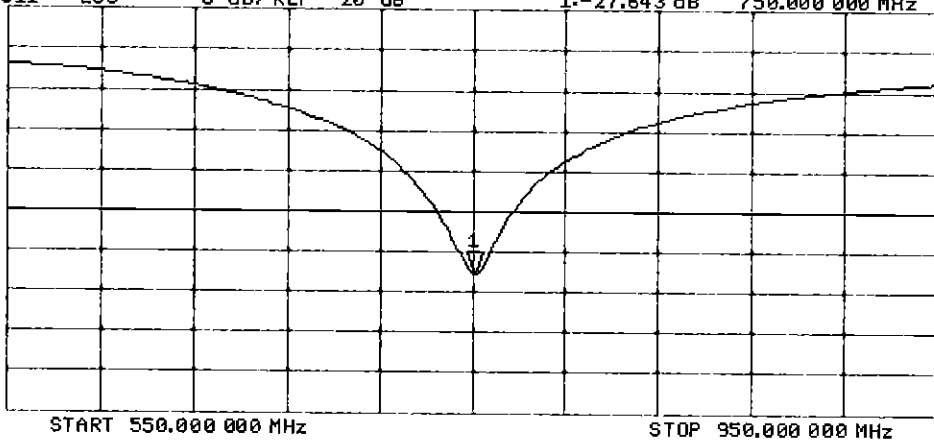

DASY5 Validation Report for Body TSL

Date: 12.01.2018

Test Laboratory: SPEAG, Zurich, Switzerland

DUT: Dipole 750 MHz; Type: D750V3; Serial: D750V3 - SN:1003

Communication System: UID 0 - CW; Frequency: 750 MHz

Medium parameters used: $f = 750$ MHz; $\sigma = 0.96$ S/m; $\epsilon_r = 55$; $\rho = 1000$ kg/m³

Phantom section: Flat Section

Measurement Standard: DASY5 (IEEE/IEC/ANSI C63.19-2011)

DASY52 Configuration:

- Probe: EX3DV4 - SN7349; ConvF(10.19, 10.19, 10.19); Calibrated: 30.12.2017;
- Sensor-Surface: 1.4mm (Mechanical Surface Detection)
- Electronics: DAE4 Sn601; Calibrated: 26.10.2017
- Phantom: Flat Phantom 4.9 (Back); Type: QD 00R P49 AA; Serial: 1005
- DASY52 52.10.0(1446); SEMCAD X 14.6.10(7417)

Dipole Calibration for Body Tissue/Pin=250 mW, d=15mm/Zoom Scan (7x8x7)/Cube 0:

Measurement grid: dx=5mm, dy=5mm, dz=5mm

Reference Value = 57.31 V/m; Power Drift = -0.01 dB

Peak SAR (extrapolated) = 3.17 W/kg

SAR(1 g) = 2.15 W/kg; SAR(10 g) = 1.43 W/kg

Maximum value of SAR (measured) = 2.83 W/kg

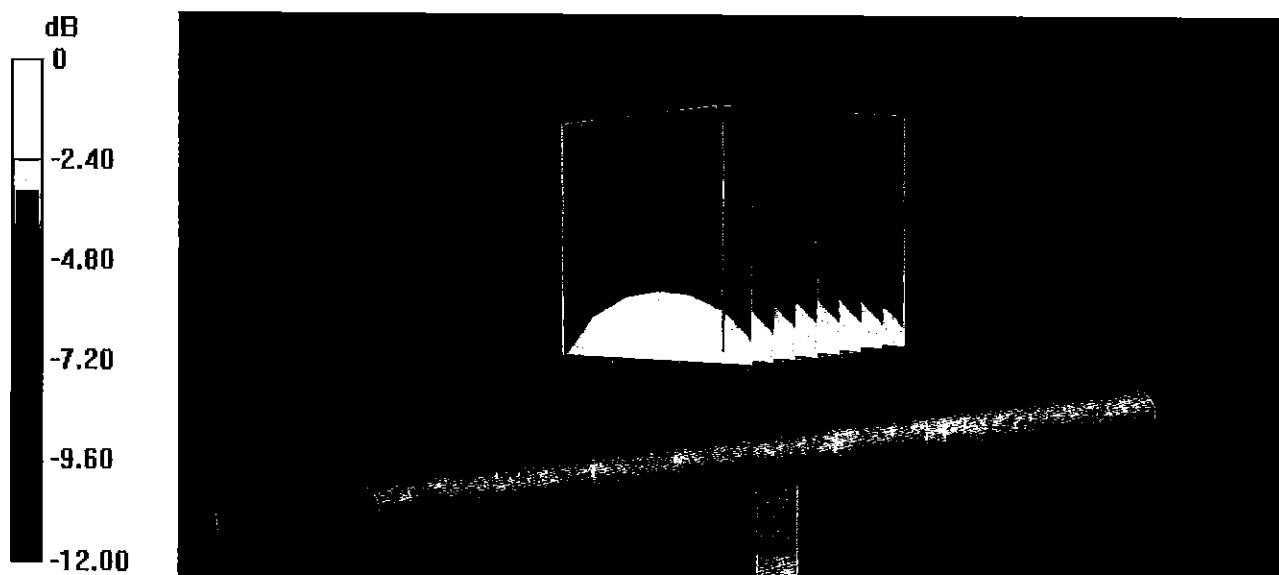

0 dB = 2.83 W/kg = 4.52 dBW/kg

Impedance Measurement Plot for Body TSL

12 Jan 2018 13:13:21
CH1 S11 1 U FS 1: 49.234 Ω -6.1934 Ω 34.264 pF 750.000 000 MHz

*
 De1

CA

Avg
 16

H1d

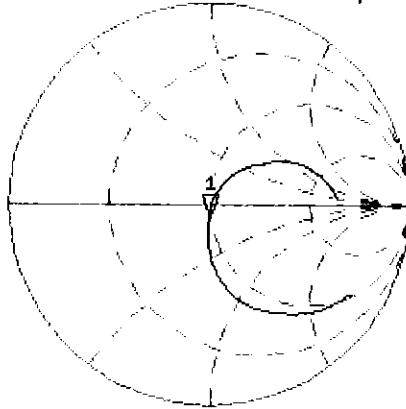

CH2 S11 LOG 5 dB/REF -20 dB 1:-24.047 dB 750.000 000 MHz

CA

Avg
 16

H1d

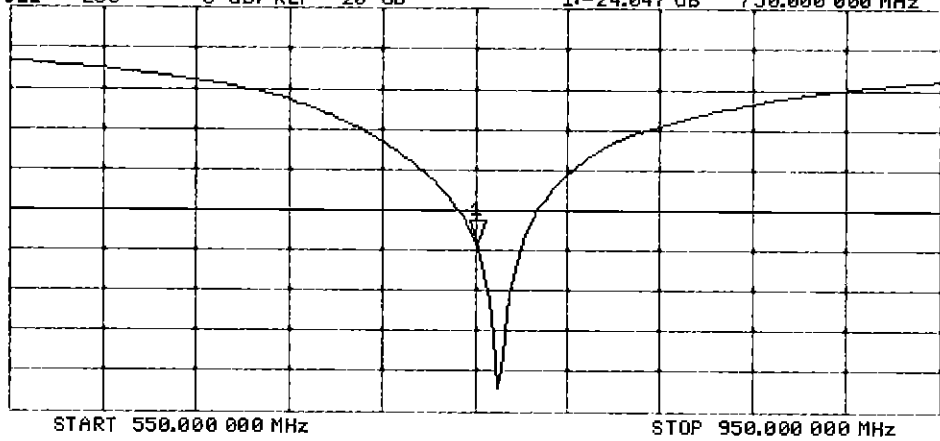

DASY5 Validation Report for SAM Head

Date: 15.01.2018

Test Laboratory: SPEAG, Zurich, Switzerland

DUT: Dipole 750 MHz; Type: D750V3; Serial: D750V3 - SN:1003

Communication System: UID 0 - CW; Frequency: 750 MHz

Medium parameters used: $f = 750$ MHz; $\sigma = 0.9$ S/m; $\epsilon_r = 44.2$; $\rho = 1000$ kg/m³

Measurement Standard: DASY5 (IEEE/IEC/ANSI C63.19-2011)

DASY52 Configuration:

- Probe: EX3DV4 - SN7349; ConvF(10.22, 10.22, 10.22); Calibrated: 30.12.2017;
- Sensor-Surface: 1.4mm (Mechanical Surface Detection)
- Electronics: DAE4 Sn601; Calibrated: 26.10.2017
- Phantom: SAM Head
- DASY52 52.10.0(1446); SEMCAD X 14.6.10(7417)

SAM Head/Top/Zoom Scan (7x7x7)/Cube 0: Measurement grid: dx=5mm, dy=5mm, dz=5mm

Reference Value = 56.79 V/m; Power Drift = -0.01 dB

Peak SAR (extrapolated) = 2.89 W/kg

SAR(1 g) = 1.98 W/kg; SAR(10 g) = 1.33 W/kg

Maximum value of SAR (measured) = 2.58 W/kg

SAM Head/Mouth/Zoom Scan (7x7x7)/Cube 0: Measurement grid: dx=5mm, dy=5mm, dz=5mm

Reference Value = 56.85 V/m; Power Drift = -0.06 dB

Peak SAR (extrapolated) = 2.94 W/kg

SAR(1 g) = 2.05 W/kg; SAR(10 g) = 1.38 W/kg

Maximum value of SAR (measured) = 2.62 W/kg

SAM Head/Neck/Zoom Scan (7x7x7)/Cube 0: Measurement grid: dx=5mm, dy=5mm, dz=5mm

Reference Value = 56.29 V/m; Power Drift = 0.04 dB

Peak SAR (extrapolated) = 2.78 W/kg

SAR(1 g) = 2.01 W/kg; SAR(10 g) = 1.38 W/kg

Maximum value of SAR (measured) = 2.56 W/kg

SAM Head/Ear/Zoom Scan (7x7x7)/Cube 0: Measurement grid: dx=5mm, dy=5mm, dz=5mm

Reference Value = 51.01 V/m; Power Drift = 0.02 dB

Peak SAR (extrapolated) = 2.31 W/kg

SAR(1 g) = 1.67 W/kg; SAR(10 g) = 1.15 W/kg

Maximum value of SAR (measured) = 2.11 W/kg

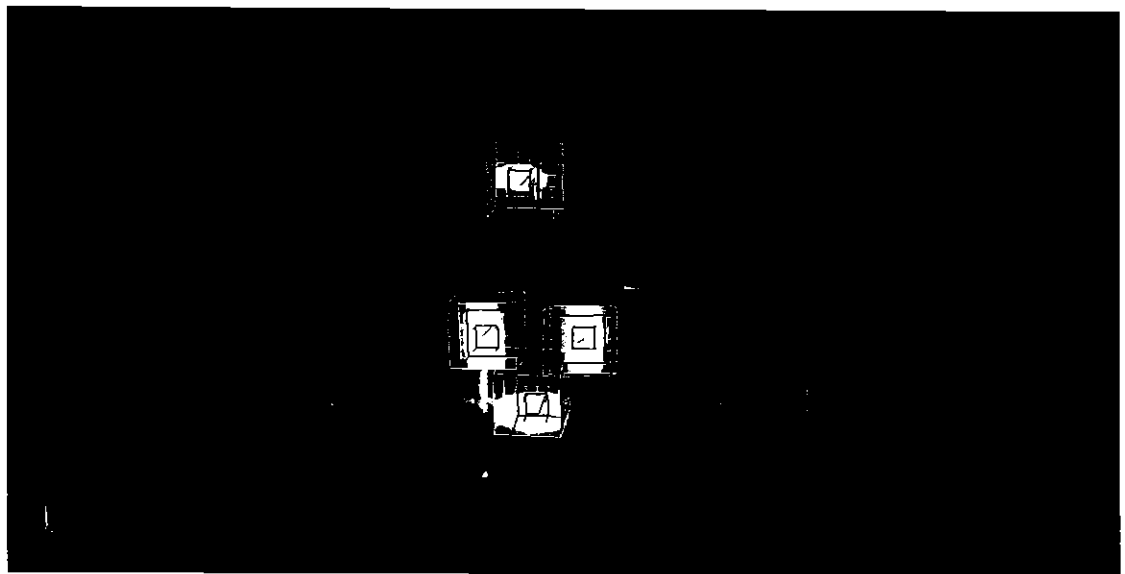
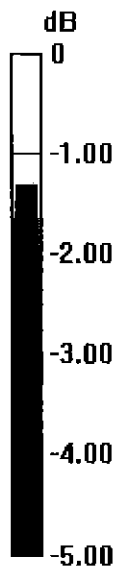

0 dB = 2.58 W/kg = 4.12 dBW/kg

Certification of Calibration

Object: D750V3 – SN: 1003

Calibration procedure(s): Procedure for Calibration Extension for SAR Dipoles.

Extension Calibration date: 1/15/2019

Description: SAR Validation Dipole at 750 MHz.

Calibration Equipment used:

| Manufacturer | Model | Description | Cal Date | Cal Interval | Cal Due | Serial Number |
|-----------------------|-----------|---|------------|--------------|------------|---------------|
| Agilent | 8753ES | S-Parameter Network Analyzer | 2/8/2018 | Annual | 2/8/2019 | US39170122 |
| Agilent | N5182A | MXG Vector Signal Generator | 4/18/2018 | Annual | 4/18/2019 | MY47420800 |
| Amplifier Research | 15S1G6 | Amplifier | CBT | N/A | CBT | 433971 |
| Anritsu | MA2411B | Pulse Power Sensor | 3/2/2018 | Annual | 3/2/2019 | 1207364 |
| Anritsu | MA2411B | Pulse Power Sensor | 3/2/2018 | Annual | 3/2/2019 | 1339018 |
| Anritsu | ML2495A | Power Meter | 10/21/2018 | Annual | 10/21/2019 | 941001 |
| Control Company | 4040 | Therm./Clock/Humidity Monitor | 3/31/2017 | Biennial | 3/31/2019 | 170232394 |
| Control Company | 4352 | Ultra Long Stem Thermometer | 5/2/2017 | Biennial | 5/2/2019 | 170330156 |
| Keysight | 772D | Dual Directional Coupler | CBT | N/A | CBT | MY52180215 |
| Keysight Technologies | 85033E | Standard Mechanical Calibration Kit (DC to 9GHz, 3.5mm) | 6/4/2018 | Annual | 6/4/2019 | MY53401181 |
| MiniCircuits | VLF-6000+ | Low Pass Filter | CBT | N/A | CBT | N/A |
| Mini-Circuits | BW-N20W5+ | DC to 18 GHz Precision Fixed 20 dB Attenuator | CBT | N/A | CBT | N/A |
| Narda | 4772-3 | Attenuator (3dB) | CBT | N/A | CBT | 9406 |
| Pasternack | PE2208-6 | Bidirectional Coupler | CBT | N/A | CBT | N/A |
| Seekonk | NC-100 | Torque Wrench | 7/11/2018 | Annual | 7/11/2019 | N/A |
| SPEAG | DAE4 | Dasy Data Acquisition Electronics | 10/3/2018 | Annual | 10/3/2019 | 1558 |
| SPEAG | DAE4 | Dasy Data Acquisition Electronics | 6/18/2018 | Annual | 6/18/2019 | 1334 |
| SPEAG | DAK-3.5 | Dielectric Assessment Kit | 9/11/2018 | Annual | 9/11/2019 | 1091 |
| SPEAG | EX3DV4 | SAR Probe | 8/23/2018 | Annual | 8/23/2019 | 7308 |
| SPEAG | EX3DV4 | SAR Probe | 6/25/2018 | Annual | 6/25/2019 | 7409 |

Measurement Uncertainty = $\pm 23\%$ (k=2)

| | Name | Function | Signature |
|----------------|------------------|--------------------------|-------------------------|
| Calibrated By: | Brodie Halfoster | Test Engineer | <i>BRODIE HALFOSTER</i> |
| Approved By: | Kaitlin O'Keefe | Senior Technical Manager | <i>KOK</i> |

DIPOLE CALIBRATION EXTENSION

Per KDB 865664 D01, calibration intervals of up to three years may be considered for reference dipoles when it is demonstrated that the SAR target, impedance and return loss of a dipole have remained stable according to the following requirements:

1. The measured SAR does not deviate more than 10% from the target on the calibration certificate.
2. The return-loss does not deviate more than 20% from the previous measurement and meets the required 20dB minimum return-loss requirement.
3. The measurement of real or imaginary parts of impedance does not deviate more than 5Ω from the previous measurement.

The following dipole was checked to pass the above 3 requirements to have 2-year calibration period from the calibration date:

| Calibration Date | Extension Date | Certificate Electrical Delay (ns) | Certificate SAR Target Head (1g) W/kg @ 23.0 dBm | Measured Head SAR (1g) W/kg @ 23.0 dBm | Deviation 1g (%) | Certificate SAR Target Head (10g) W/kg @ 23.0 dBm | Measured Head SAR (10g) W/kg @ 23.0 dBm | Deviation 10g (%) | Certificate Impedance Head (Ohm) Real | Measured Impedance Head (Ohm) Real | Difference (Ohm) Real | Certificate Impedance Head (Ohm) Imaginary | Measured Impedance Head (Ohm) Imaginary | Difference (Ohm) Imaginary | Certificate Return Loss Head (dB) | Measured Return Loss Head (dB) | Deviation (%) | PASS/FAIL |
|------------------|----------------|-----------------------------------|--|--|------------------|---|---|-------------------|---------------------------------------|------------------------------------|-----------------------|--|---|----------------------------|-----------------------------------|--------------------------------|---------------|-----------|
| 1/15/2018 | 1/15/2019 | 1.043 | 1.656 | 1.75 | 5.68% | 1.08 | 1.15 | 6.09% | 53.8 | 54.8 | 1 | -2.1 | -2.2 | 0.1 | -27.6 | -25.8 | 6.50% | PASS |
| Calibration Date | Extension Date | Certificate Electrical Delay (ns) | Certificate SAR Target Body (1g) W/kg @ 23.0 dBm | Measured Body SAR (1g) W/kg @ 23.0 dBm | Deviation 1g (%) | Certificate SAR Target Body (10g) W/kg @ 23.0 dBm | Measured Body SAR (10g) W/kg @ 23.0 dBm | Deviation 10g (%) | Certificate Impedance Body (Ohm) Real | Measured Impedance Body (Ohm) Real | Difference (Ohm) Real | Certificate Impedance Body (Ohm) Imaginary | Measured Impedance Body (Ohm) Imaginary | Difference (Ohm) Imaginary | Certificate Return Loss Body (dB) | Measured Return Loss Body (dB) | Deviation (%) | PASS/FAIL |
| 1/15/2018 | 1/15/2019 | 1.043 | 1.716 | 1.84 | 7.23% | 1.14 | 1.23 | 7.71% | 49.2 | 49 | 0.2 | -6.2 | -5.1 | 1.1 | -24 | -25.6 | -6.80% | PASS |

Impedance & Return-Loss Measurement Plot for Head TSL

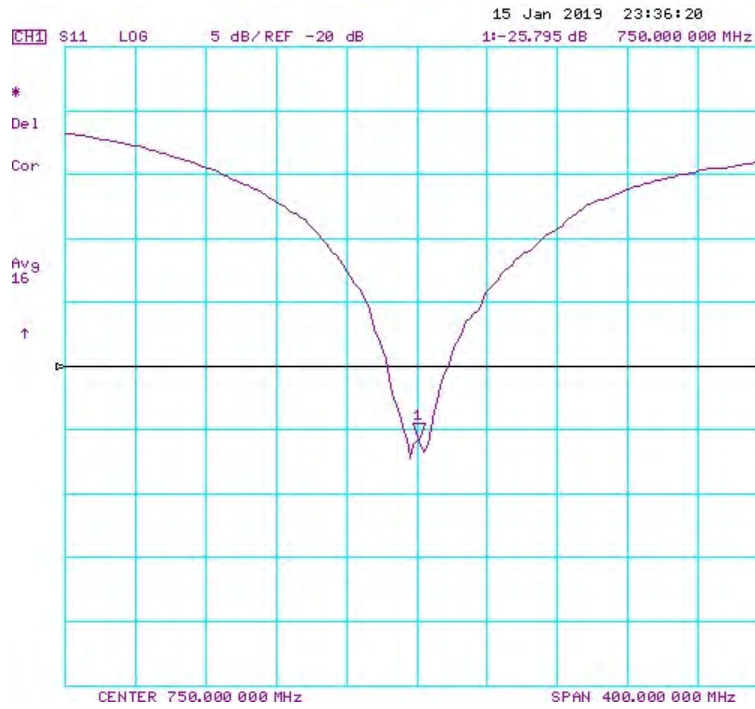
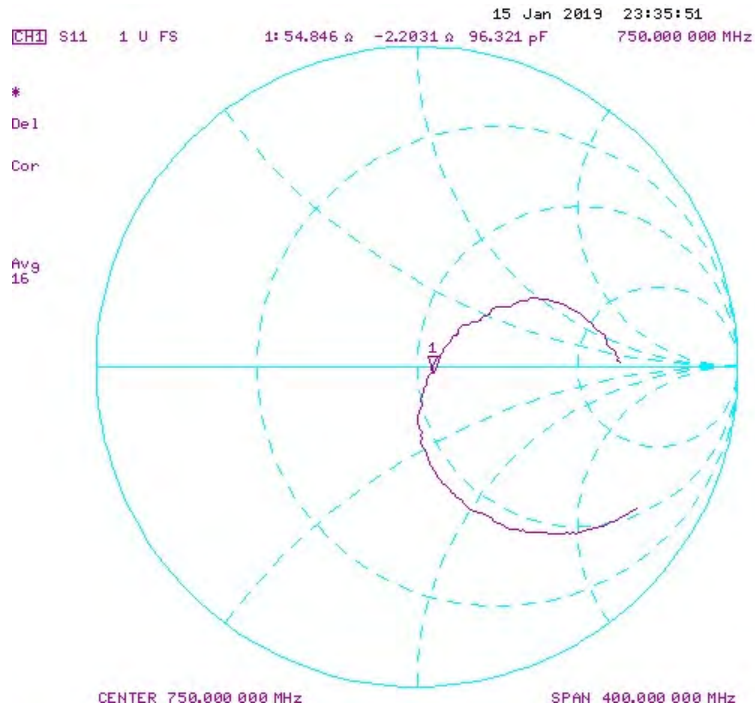

Impedance & Return-Loss Measurement Plot for Body TSL

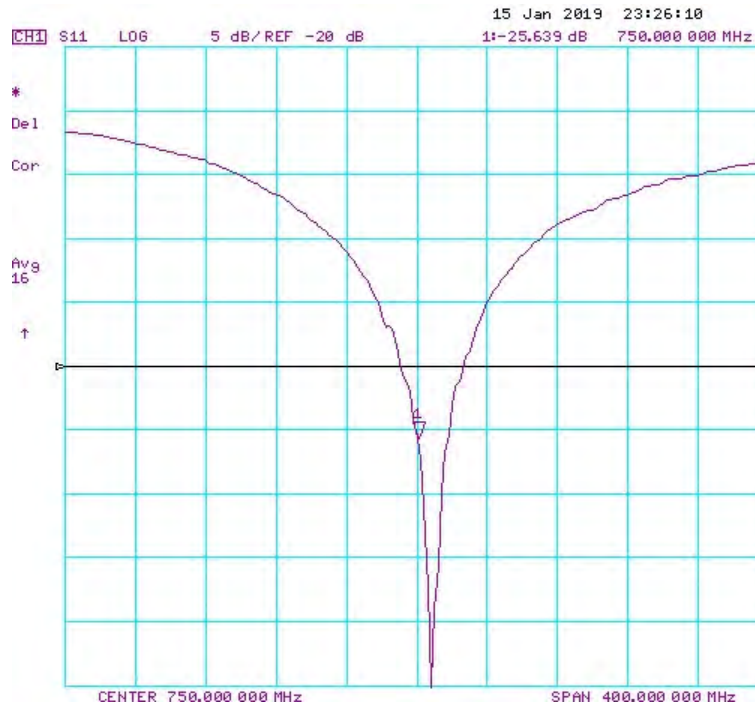
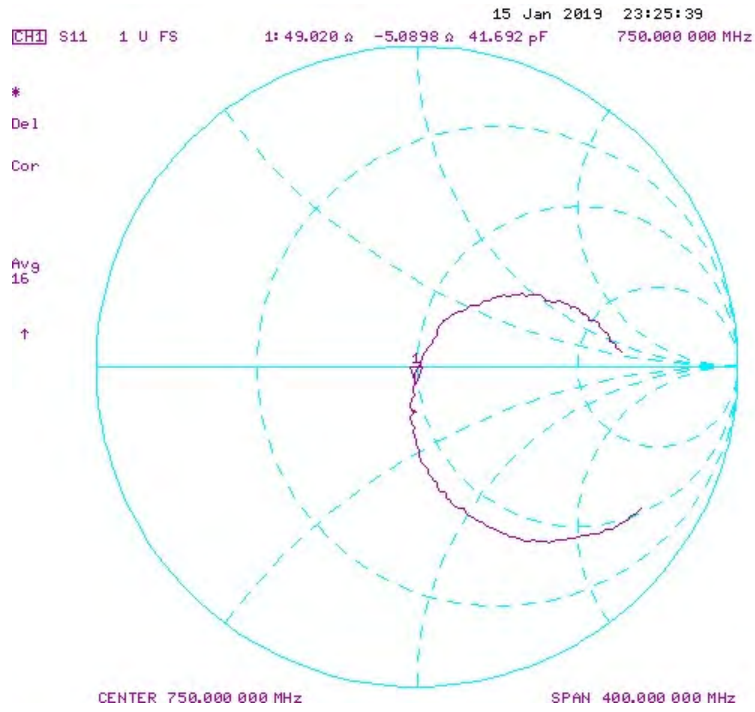



Accredited by the Swiss Accreditation Service (SAS)
The Swiss Accreditation Service is one of the signatories to the EA
Multilateral Agreement for the recognition of calibration certificates

Accreditation No.: **SCS 0108**

Client **PC Test**

Certificate No: **D750V3-1161_Oct18**

CALIBRATION CERTIFICATE

Object **D750V3 - SN:1161**

Calibration procedure(s) **QA CAL-05.v10
Calibration procedure for dipole validation kits above 700 MHz**

Calibration date: **October 19, 2018**

*BN ✓
10-30-2018*

This calibration certificate documents the traceability to national standards, which realize the physical units of measurements (SI).
The measurements and the uncertainties with confidence probability are given on the following pages and are part of the certificate.

All calibrations have been conducted in the closed laboratory facility: environment temperature (22 ± 3)°C and humidity < 70%.

Calibration Equipment used (M&TE critical for calibration)

| Primary Standards | ID # | Cal Date (Certificate No.) | Scheduled Calibration |
|-----------------------------|--------------------|---------------------------------|-----------------------|
| Power meter NRP | SN: 104778 | 04-Apr-18 (No. 217-02672/02673) | Apr-19 |
| Power sensor NRP-Z91 | SN: 103244 | 04-Apr-18 (No. 217-02672) | Apr-19 |
| Power sensor NRP-Z91 | SN: 103245 | 04-Apr-18 (No. 217-02673) | Apr-19 |
| Reference 20 dB Attenuator | SN: 5058 (20k) | 04-Apr-18 (No. 217-02682) | Apr-19 |
| Type-N mismatch combination | SN: 5047.2 / 06327 | 04-Apr-18 (No. 217-02683) | Apr-19 |
| Reference Probe EX3DV4 | SN: 7349 | 30-Dec-17 (No. EX3-7349_Dec17) | Dec-18 |
| DAE4 | SN: 601 | 04-Oct-18 (No. DAE4-601_Oct18) | Oct-19 |

| Secondary Standards | ID # | Check Date (in house) | Scheduled Check |
|---------------------------------|----------------|-----------------------------------|------------------------|
| Power meter EPM-442A | SN: GB37480704 | 07-Oct-15 (in house check Oct-18) | In house check: Oct-20 |
| Power sensor HP 8481A | SN: US37292783 | 07-Oct-15 (in house check Oct-18) | In house check: Oct-20 |
| Power sensor HP 8481A | SN: MY41092317 | 07-Oct-15 (in house check Oct-18) | In house check: Oct-20 |
| RF generator R&S SMT-06 | SN: 100972 | 15-Jun-15 (in house check Oct-18) | In house check: Oct-20 |
| Network Analyzer Agilent E8358A | SN: US41080477 | 31-Mar-14 (in house check Oct-18) | In house check: Oct-19 |

Calibrated by: **Manu Seitz** Name: **Manu Seitz** Function: **Laboratory Technician**

Approved by: **Katja Pokovic** Name: **Katja Pokovic** Function: **Technical Manager**

Issued: October 22, 2018

This calibration certificate shall not be reproduced except in full without written approval of the laboratory.



Accredited by the Swiss Accreditation Service (SAS)
The Swiss Accreditation Service is one of the signatories to the EA
Multilateral Agreement for the recognition of calibration certificates

Accreditation No.: **SCS 0108**

Glossary:

| | |
|-------|---------------------------------|
| TSL | tissue simulating liquid |
| ConvF | sensitivity in TSL / NORM x,y,z |
| N/A | not applicable or not measured |

Calibration is Performed According to the Following Standards:

- IEEE Std 1528-2013, "IEEE Recommended Practice for Determining the Peak Spatial-Averaged Specific Absorption Rate (SAR) in the Human Head from Wireless Communications Devices: Measurement Techniques", June 2013
- IEC 62209-1, "Measurement procedure for the assessment of Specific Absorption Rate (SAR) from hand-held and body-mounted devices used next to the ear (frequency range of 300 MHz to 6 GHz)", July 2016
- IEC 62209-2, "Procedure to determine the Specific Absorption Rate (SAR) for wireless communication devices used in close proximity to the human body (frequency range of 30 MHz to 6 GHz)", March 2010
- KDB 865664, "SAR Measurement Requirements for 100 MHz to 6 GHz"

Additional Documentation:

- DASY4/5 System Handbook

Methods Applied and Interpretation of Parameters:

- Measurement Conditions:** Further details are available from the Validation Report at the end of the certificate. All figures stated in the certificate are valid at the frequency indicated.
- Antenna Parameters with TSL:** The dipole is mounted with the spacer to position its feed point exactly below the center marking of the flat phantom section, with the arms oriented parallel to the body axis.
- Feed Point Impedance and Return Loss:** These parameters are measured with the dipole positioned under the liquid filled phantom. The impedance stated is transformed from the measurement at the SMA connector to the feed point. The Return Loss ensures low reflected power. No uncertainty required.
- Electrical Delay:** One-way delay between the SMA connector and the antenna feed point. No uncertainty required.
- SAR measured:** SAR measured at the stated antenna input power.
- SAR normalized:** SAR as measured, normalized to an input power of 1 W at the antenna connector.
- SAR for nominal TSL parameters:** The measured TSL parameters are used to calculate the nominal SAR result.

The reported uncertainty of measurement is stated as the standard uncertainty of measurement multiplied by the coverage factor $k=2$, which for a normal distribution corresponds to a coverage probability of approximately 95%.

Measurement Conditions

DASY system configuration, as far as not given on page 1.

| | | |
|-------------------------------------|------------------------|-------------|
| DASY Version | DASY5 | V52.10.2 |
| Extrapolation | Advanced Extrapolation | |
| Phantom | Modular Flat Phantom | |
| Distance Dipole Center - TSL | 15 mm | with Spacer |
| Zoom Scan Resolution | dx, dy, dz = 5 mm | |
| Frequency | 750 MHz \pm 1 MHz | |

Head TSL parameters

The following parameters and calculations were applied.

| | Temperature | Permittivity | Conductivity |
|--|---------------------|----------------|----------------------|
| Nominal Head TSL parameters | 22.0 °C | 41.9 | 0.89 mho/m |
| Measured Head TSL parameters | (22.0 \pm 0.2) °C | 40.8 \pm 6 % | 0.89 mho/m \pm 6 % |
| Head TSL temperature change during test | < 0.5 °C | ---- | ---- |

SAR result with Head TSL

| SAR averaged over 1 cm³ (1 g) of Head TSL | Condition | |
|---|--------------------|--|
| SAR measured | 250 mW input power | 2.02 W/kg |
| SAR for nominal Head TSL parameters | normalized to 1W | 8.03 W/kg \pm 17.0 % (k=2) |

| SAR averaged over 10 cm³ (10 g) of Head TSL | condition | |
|---|--------------------|--|
| SAR measured | 250 mW input power | 1.32 W/kg |
| SAR for nominal Head TSL parameters | normalized to 1W | 5.26 W/kg \pm 16.5 % (k=2) |

Body TSL parameters

The following parameters and calculations were applied.

| | Temperature | Permittivity | Conductivity |
|--|---------------------|----------------|----------------------|
| Nominal Body TSL parameters | 22.0 °C | 55.5 | 0.96 mho/m |
| Measured Body TSL parameters | (22.0 \pm 0.2) °C | 55.1 \pm 6 % | 0.96 mho/m \pm 6 % |
| Body TSL temperature change during test | < 0.5 °C | ---- | ---- |

SAR result with Body TSL

| SAR averaged over 1 cm³ (1 g) of Body TSL | Condition | |
|---|--------------------|--|
| SAR measured | 250 mW input power | 2.11 W/kg |
| SAR for nominal Body TSL parameters | normalized to 1W | 8.43 W/kg \pm 17.0 % (k=2) |

| SAR averaged over 10 cm³ (10 g) of Body TSL | condition | |
|---|--------------------|--|
| SAR measured | 250 mW input power | 1.39 W/kg |
| SAR for nominal Body TSL parameters | normalized to 1W | 5.55 W/kg \pm 16.5 % (k=2) |

Appendix (Additional assessments outside the scope of SCS 0108)

Antenna Parameters with Head TSL

| | |
|--------------------------------------|--------------------------------|
| Impedance, transformed to feed point | 55.6 Ω - 1.9 j Ω |
| Return Loss | - 25.0 dB |

Antenna Parameters with Body TSL

| | |
|--------------------------------------|--------------------------------|
| Impedance, transformed to feed point | 50.6 Ω - 4.2 j Ω |
| Return Loss | - 27.6 dB |

General Antenna Parameters and Design

| | |
|----------------------------------|----------|
| Electrical Delay (one direction) | 1.032 ns |
|----------------------------------|----------|

After long term use with 100W radiated power, only a slight warming of the dipole near the feedpoint can be measured.

The dipole is made of standard semirigid coaxial cable. The center conductor of the feeding line is directly connected to the second arm of the dipole. The antenna is therefore short-circuited for DC-signals. On some of the dipoles, small end caps are added to the dipole arms in order to improve matching when loaded according to the position as explained in the "Measurement Conditions" paragraph. The SAR data are not affected by this change. The overall dipole length is still according to the Standard.

No excessive force must be applied to the dipole arms, because they might bend or the soldered connections near the feedpoint may be damaged.

Additional EUT Data

| | |
|-----------------|-------------------|
| Manufactured by | SPEAG |
| Manufactured on | November 19, 2015 |

DASY5 Validation Report for Head TSL

Date: 19.10.2018

Test Laboratory: SPEAG, Zurich, Switzerland

DUT: Dipole 750 MHz; Type: D750V3; Serial: D750V3 - SN:1161

Communication System: UID 0 - CW; Frequency: 750 MHz

Medium parameters used: $f = 750$ MHz; $\sigma = 0.89$ S/m; $\epsilon_r = 40.8$; $\rho = 1000$ kg/m³

Phantom section: Flat Section

Measurement Standard: DASY5 (IEEE/IEC/ANSI C63.19-2011)

DASY52 Configuration:

- Probe: EX3DV4 - SN7349; ConvF(10.22, 10.22, 10.22) @ 750 MHz; Calibrated: 30.12.2017
- Sensor-Surface: 1.4mm (Mechanical Surface Detection)
- Electronics: DAE4 Sn601; Calibrated: 04.10.2018
- Phantom: Flat Phantom 4.9 (front); Type: QD 00L P49 AA; Serial: 1001
- DASY52 52.10.2(1495); SEMCAD X 14.6.12(7450)

Dipole Calibration for Head Tissue/Pin=250 mW, d=15mm/Zoom Scan (7x7x7)/Cube 0:

Measurement grid: dx=5mm, dy=5mm, dz=5mm

Reference Value = 58.51 V/m; Power Drift = -0.04 dB

Peak SAR (extrapolated) = 3.04 W/kg

SAR(1 g) = 2.02 W/kg; SAR(10 g) = 1.32 W/kg

Maximum value of SAR (measured) = 2.70 W/kg

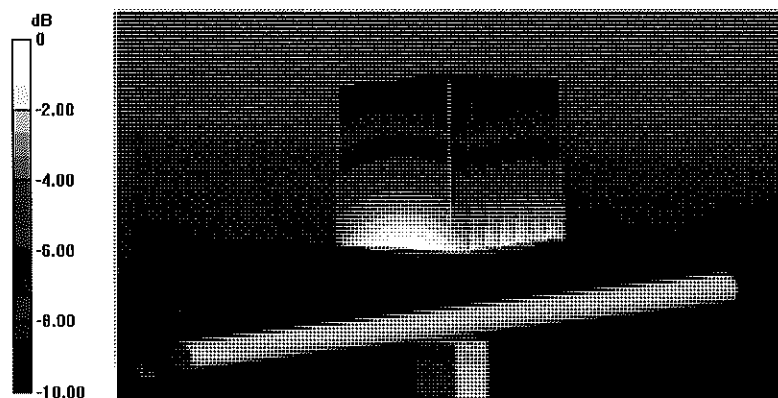

0 dB = 2.70 W/kg = 4.31 dBW/kg

Impedance Measurement Plot for Head TSL

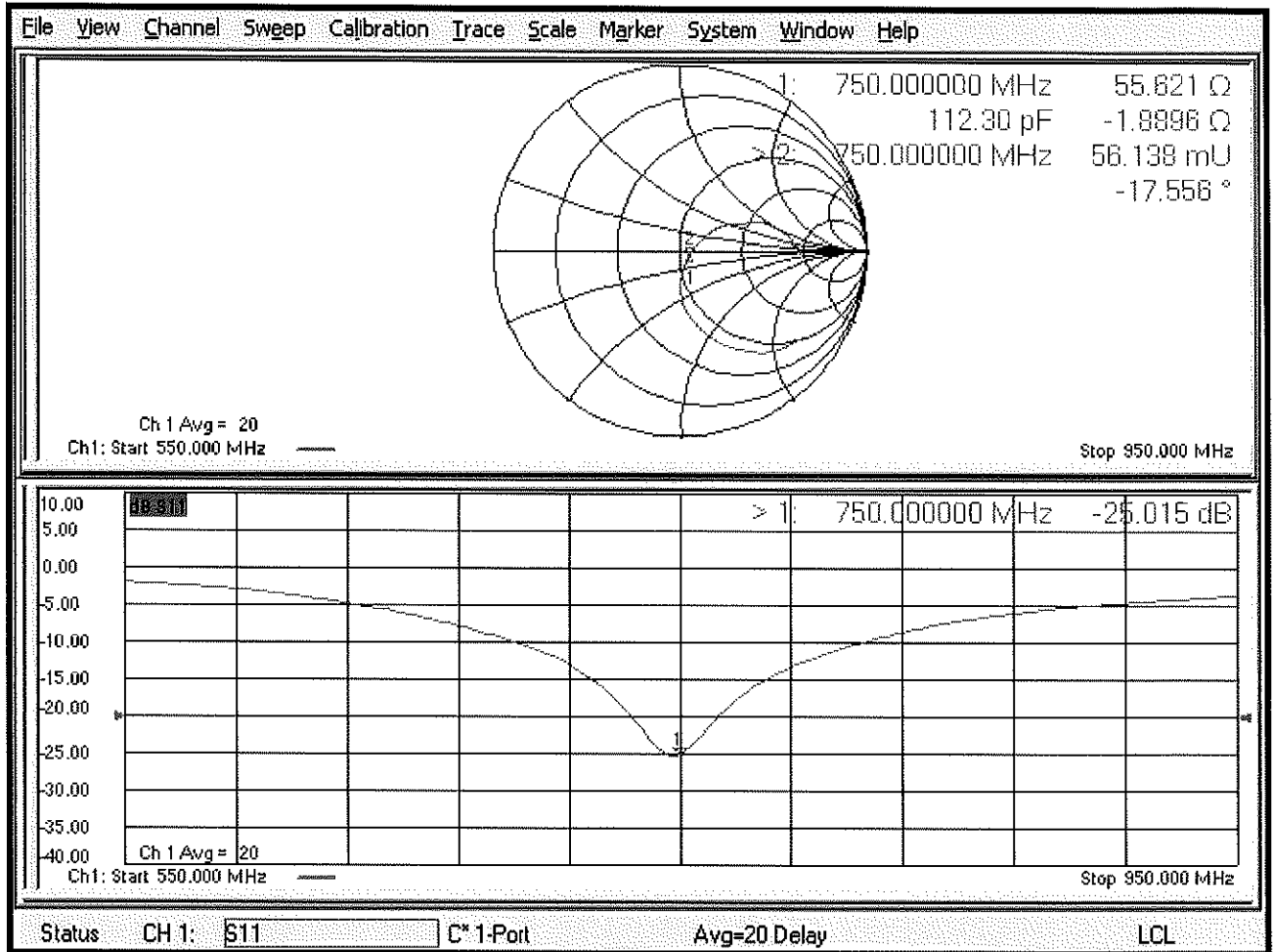

DASY5 Validation Report for Body TSL

Date: 19.10.2018

Test Laboratory: SPEAG, Zurich, Switzerland

DUT: Dipole 750 MHz; Type: D750V3; Serial: D750V3 - SN:1161

Communication System: UID 0 - CW; Frequency: 750 MHz

Medium parameters used: $f = 750$ MHz; $\sigma = 0.96$ S/m; $\epsilon_r = 55.1$; $\rho = 1000$ kg/m³

Phantom section: Flat Section

Measurement Standard: DASY5 (IEEE/IEC/ANSI C63.19-2011)

DASY52 Configuration:

- Probe: EX3DV4 - SN7349; ConvF(10.19, 10.19, 10.19) @ 750 MHz; Calibrated: 30.12.2017
- Sensor-Surface: 1.4mm (Mechanical Surface Detection)
- Electronics: DAE4 Sn601; Calibrated: 04.10.2018
- Phantom: Flat Phantom 4.9 (Back); Type: QD 00R P49 AA; Serial: 1005
- DASY52 52.10.2(1495); SEMCAD X 14.6.12(7450)

Dipole Calibration for Body Tissue/Pin=250 mW, d=15mm/Zoom Scan (7x7x7)/Cube 0:

Measurement grid: dx=5mm, dy=5mm, dz=5mm

Reference Value = 57.57 V/m; Power Drift = -0.02 dB

Peak SAR (extrapolated) = 3.18 W/kg

SAR(1 g) = 2.11 W/kg; SAR(10 g) = 1.39 W/kg

Maximum value of SAR (measured) = 2.83 W/kg

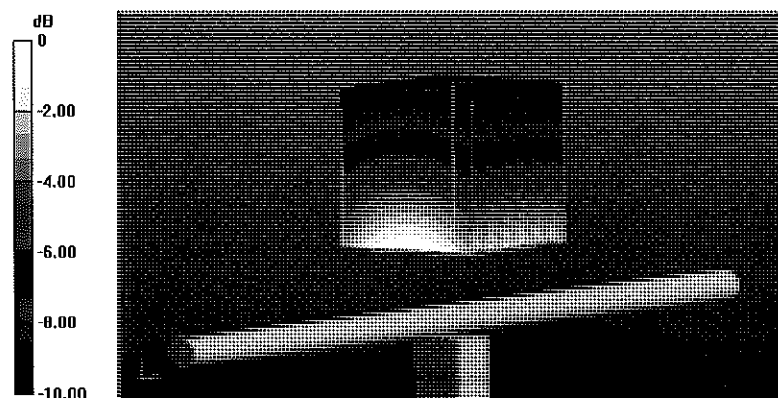

Impedance Measurement Plot for Body TSL

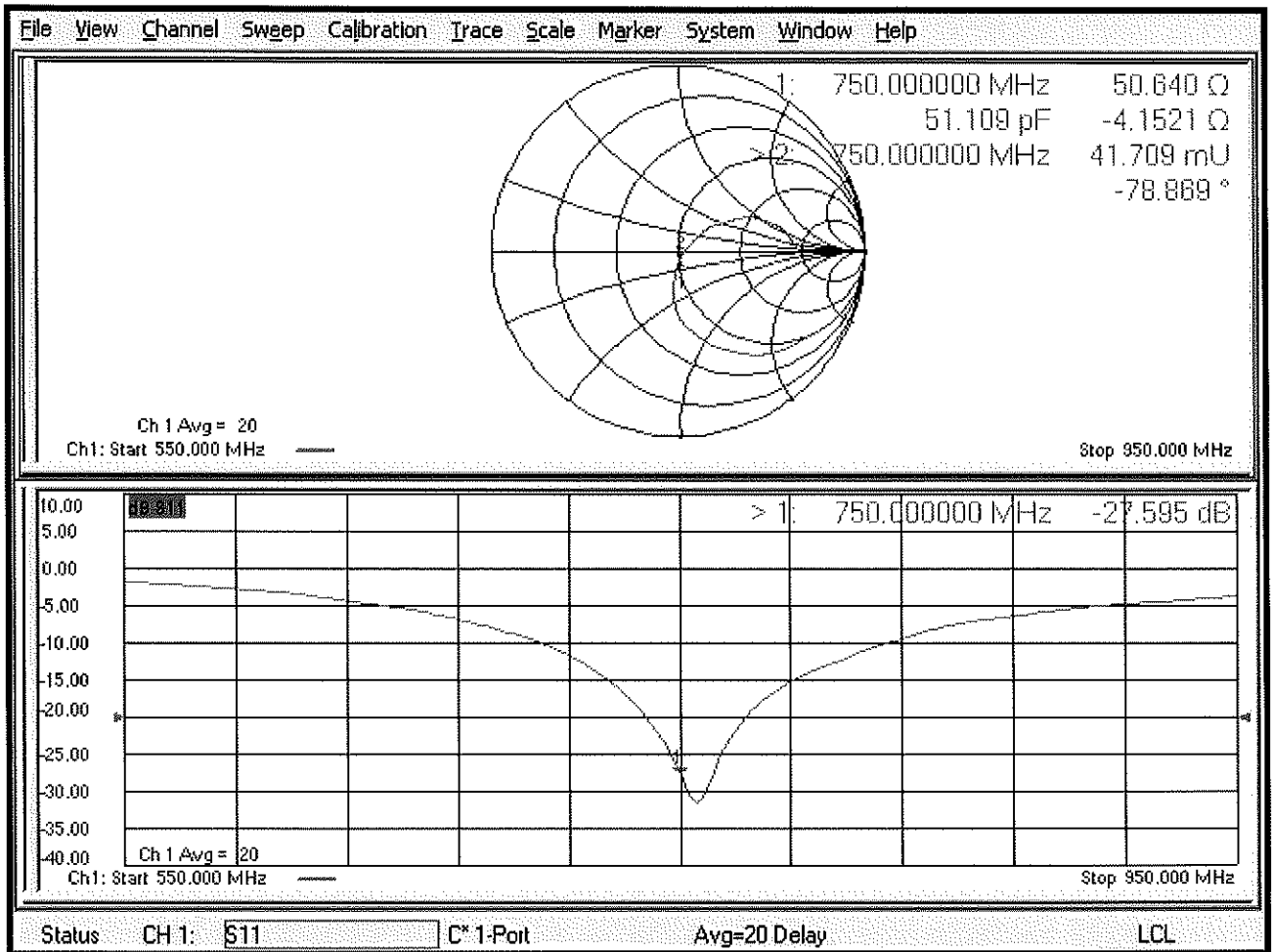



Accredited by the Swiss Accreditation Service (SAS)
The Swiss Accreditation Service is one of the signatories to the EA
Multilateral Agreement for the recognition of calibration certificates

Accreditation No.: **SCS 0108**

Client **PC Test**

Certificate No: **D835V2-4d132_Jan19**

CALIBRATION CERTIFICATE

Object **D835V2 - SN:4d132**

Calibration procedure(s) **QA CAL-05.v11
Calibration Procedure for SAR Validation Sources between 0.7-3 GHz**

*BN ✓
02/06/2019*

Calibration date: **January 22, 2019**

This calibration certificate documents the traceability to national standards, which realize the physical units of measurements (SI).
The measurements and the uncertainties with confidence probability are given on the following pages and are part of the certificate.

All calibrations have been conducted in the closed laboratory facility: environment temperature (22 ± 3)°C and humidity < 70%.

Calibration Equipment used (M&TE critical for calibration)

| Primary Standards | ID # | Cal Date (Certificate No.) | Scheduled Calibration |
|-----------------------------|--------------------|---------------------------------|-----------------------|
| Power meter NRP | SN: 104778 | 04-Apr-18 (No. 217-02672/02673) | Apr-19 |
| Power sensor NRP-Z91 | SN: 103244 | 04-Apr-18 (No. 217-02672) | Apr-19 |
| Power sensor NRP-Z91 | SN: 103245 | 04-Apr-18 (No. 217-02673) | Apr-19 |
| Reference 20 dB Attenuator | SN: 5058 (20k) | 04-Apr-18 (No. 217-02682) | Apr-19 |
| Type-N mismatch combination | SN: 5047.2 / 06327 | 04-Apr-18 (No. 217-02683) | Apr-19 |
| Reference Probe EX3DV4 | SN: 7349 | 31-Dec-18 (No. EX3-7349_Dec18) | Dec-19 |
| DAE4 | SN: 601 | 04-Oct-18 (No. DAE4-601_Oct18) | Oct-19 |

| Secondary Standards | ID # | Check Date (in house) | Scheduled Check |
|---------------------------------|----------------|-----------------------------------|------------------------|
| Power meter EPM-442A | SN: GB37480704 | 07-Oct-15 (in house check Oct-18) | In house check: Oct-20 |
| Power sensor HP 8481A | SN: US37292783 | 07-Oct-15 (in house check Oct-18) | In house check: Oct-20 |
| Power sensor HP 8481A | SN: MY41092317 | 07-Oct-15 (in house check Oct-18) | In house check: Oct-20 |
| RF generator R&S SMT-06 | SN: 100972 | 15-Jun-15 (in house check Oct-18) | In house check: Oct-20 |
| Network Analyzer Agilent E8358A | SN: US41080477 | 31-Mar-14 (in house check Oct-18) | In house check: Oct-19 |

Calibrated by: **Leif Klynsner** Name: **Leif Klynsner** Function: **Laboratory Technician** Signature: *Leif Klynsner*

Approved by: **Katja Pokovic** Name: **Katja Pokovic** Function: **Technical Manager** Signature: *Katja Pokovic*

Issued: January 22, 2019

This calibration certificate shall not be reproduced except in full without written approval of the laboratory.



Accredited by the Swiss Accreditation Service (SAS)

The Swiss Accreditation Service is one of the signatories to the EA Multilateral Agreement for the recognition of calibration certificates

Accreditation No.: **SCS 0108**

Glossary:

| | |
|-------|---------------------------------|
| TSL | tissue simulating liquid |
| ConvF | sensitivity in TSL / NORM x,y,z |
| N/A | not applicable or not measured |

Calibration is Performed According to the Following Standards:

- IEEE Std 1528-2013, "IEEE Recommended Practice for Determining the Peak Spatial-Averaged Specific Absorption Rate (SAR) in the Human Head from Wireless Communications Devices: Measurement Techniques", June 2013
- IEC 62209-1, "Measurement procedure for the assessment of Specific Absorption Rate (SAR) from hand-held and body-mounted devices used next to the ear (frequency range of 300 MHz to 6 GHz)", July 2016
- IEC 62209-2, "Procedure to determine the Specific Absorption Rate (SAR) for wireless communication devices used in close proximity to the human body (frequency range of 30 MHz to 6 GHz)", March 2010
- KDB 865664, "SAR Measurement Requirements for 100 MHz to 6 GHz"

Additional Documentation:

- DASY4/5 System Handbook

Methods Applied and Interpretation of Parameters:

- Measurement Conditions:** Further details are available from the Validation Report at the end of the certificate. All figures stated in the certificate are valid at the frequency indicated.
- Antenna Parameters with TSL:** The dipole is mounted with the spacer to position its feed point exactly below the center marking of the flat phantom section, with the arms oriented parallel to the body axis.
- Feed Point Impedance and Return Loss:** These parameters are measured with the dipole positioned under the liquid filled phantom. The impedance stated is transformed from the measurement at the SMA connector to the feed point. The Return Loss ensures low reflected power. No uncertainty required.
- Electrical Delay:** One-way delay between the SMA connector and the antenna feed point. No uncertainty required.
- SAR measured:** SAR measured at the stated antenna input power.
- SAR normalized:** SAR as measured, normalized to an input power of 1 W at the antenna connector.
- SAR for nominal TSL parameters:** The measured TSL parameters are used to calculate the nominal SAR result.

The reported uncertainty of measurement is stated as the standard uncertainty of measurement multiplied by the coverage factor $k=2$, which for a normal distribution corresponds to a coverage probability of approximately 95%.

Measurement Conditions

DASY system configuration, as far as not given on page 1.

| | | |
|-------------------------------------|------------------------|-------------|
| DASY Version | DASY5 | V52.10.2 |
| Extrapolation | Advanced Extrapolation | |
| Phantom | Modular Flat Phantom | |
| Distance Dipole Center - TSL | 15 mm | with Spacer |
| Zoom Scan Resolution | dx, dy, dz = 5.0 mm | |
| Frequency | 835 MHz \pm 1 MHz | |

Head TSL parameters

The following parameters and calculations were applied.

| | Temperature | Permittivity | Conductivity |
|--|---------------------|----------------|----------------------|
| Nominal Head TSL parameters | 22.0 °C | 41.5 | 0.90 mho/m |
| Measured Head TSL parameters | (22.0 \pm 0.2) °C | 41.3 \pm 6 % | 0.92 mho/m \pm 6 % |
| Head TSL temperature change during test | < 0.5 °C | ---- | ---- |

SAR result with Head TSL

| SAR averaged over 1 cm³ (1 g) of Head TSL | Condition | |
|---|--------------------|--|
| SAR measured | 250 mW input power | 2.44 W/kg |
| SAR for nominal Head TSL parameters | normalized to 1W | 9.59 W/kg \pm 17.0 % (k=2) |

| SAR averaged over 10 cm³ (10 g) of Head TSL | condition | |
|---|--------------------|--|
| SAR measured | 250 mW input power | 1.58 W/kg |
| SAR for nominal Head TSL parameters | normalized to 1W | 6.23 W/kg \pm 16.5 % (k=2) |

Body TSL parameters

The following parameters and calculations were applied.

| | Temperature | Permittivity | Conductivity |
|--|---------------------|----------------|----------------------|
| Nominal Body TSL parameters | 22.0 °C | 55.2 | 0.97 mho/m |
| Measured Body TSL parameters | (22.0 \pm 0.2) °C | 54.6 \pm 6 % | 0.99 mho/m \pm 6 % |
| Body TSL temperature change during test | < 0.5 °C | ---- | ---- |

SAR result with Body TSL

| SAR averaged over 1 cm³ (1 g) of Body TSL | Condition | |
|---|--------------------|--|
| SAR measured | 250 mW input power | 2.46 W/kg |
| SAR for nominal Body TSL parameters | normalized to 1W | 9.67 W/kg \pm 17.0 % (k=2) |

| SAR averaged over 10 cm³ (10 g) of Body TSL | condition | |
|---|--------------------|--|
| SAR measured | 250 mW input power | 1.61 W/kg |
| SAR for nominal Body TSL parameters | normalized to 1W | 6.35 W/kg \pm 16.5 % (k=2) |

Appendix (Additional assessments outside the scope of SCS 0108)

Antenna Parameters with Head TSL

| | |
|--------------------------------------|--------------------------------|
| Impedance, transformed to feed point | 49.6 Ω - 3.6 j Ω |
| Return Loss | - 28.7 dB |

Antenna Parameters with Body TSL

| | |
|--------------------------------------|--------------------------------|
| Impedance, transformed to feed point | 47.4 Ω - 6.2 j Ω |
| Return Loss | - 23.2 dB |

General Antenna Parameters and Design

| | |
|----------------------------------|----------|
| Electrical Delay (one direction) | 1.387 ns |
|----------------------------------|----------|

After long term use with 100W radiated power, only a slight warming of the dipole near the feedpoint can be measured.

The dipole is made of standard semirigid coaxial cable. The center conductor of the feeding line is directly connected to the second arm of the dipole. The antenna is therefore short-circuited for DC-signals. On some of the dipoles, small end caps are added to the dipole arms in order to improve matching when loaded according to the position as explained in the "Measurement Conditions" paragraph. The SAR data are not affected by this change. The overall dipole length is still according to the Standard.

No excessive force must be applied to the dipole arms, because they might bend or the soldered connections near the feedpoint may be damaged.

Additional EUT Data

| | |
|-----------------|-------|
| Manufactured by | SPEAG |
|-----------------|-------|

Appendix (Additional assessments outside the scope of SCS 0108)

Measurement Conditions

DASY system configuration, as far as not given on page 1 and 3.

| | | |
|---------|------------------|-----------------------------|
| Phantom | SAM Head Phantom | For usage with cSAR3DV2-R/L |
|---------|------------------|-----------------------------|

SAR result with SAM Head (Top)

| SAR averaged over 1 cm ³ (1 g) of Head TSL | Condition | |
|---|--------------------|---------------------------------|
| SAR measured | 250 mW input power | 2.35 W/kg |
| SAR for nominal Head TSL parameters | normalized to 1W | 9.38 W/kg ± 17.5 % (k=2) |

| SAR averaged over 10 cm ³ (10 g) of Head TSL | condition | |
|---|--------------------|---------------------------------|
| SAR measured | 250 mW input power | 1.57 W/kg |
| SAR for nominal Head TSL parameters | normalized to 1W | 6.26 W/kg ± 16.9 % (k=2) |

SAR result with SAM Head (Mouth)

| SAR averaged over 1 cm ³ (1 g) of Head TSL | Condition | |
|---|--------------------|---------------------------------|
| SAR measured | 250 mW input power | 2.47 W/kg |
| SAR for nominal Head TSL parameters | normalized to 1W | 9.86 W/kg ± 17.5 % (k=2) |

| SAR averaged over 10 cm ³ (10 g) of Head TSL | condition | |
|---|--------------------|---------------------------------|
| SAR measured | 250 mW input power | 1.65 W/kg |
| SAR for nominal Head TSL parameters | normalized to 1W | 6.58 W/kg ± 16.9 % (k=2) |

SAR result with SAM Head (Neck)

| SAR averaged over 1 cm ³ (1 g) of Head TSL | Condition | |
|---|--------------------|---------------------------------|
| SAR measured | 250 mW input power | 2.36 W/kg |
| SAR for nominal Head TSL parameters | normalized to 1W | 9.42 W/kg ± 17.5 % (k=2) |

| SAR averaged over 10 cm ³ (10 g) of Head TSL | condition | |
|---|--------------------|---------------------------------|
| SAR measured | 250 mW input power | 1.60 W/kg |
| SAR for nominal Head TSL parameters | normalized to 1W | 6.38 W/kg ± 16.9 % (k=2) |

SAR result with SAM Head (Ear)

| SAR averaged over 1 cm ³ (1 g) of Head TSL | Condition | |
|---|--------------------|---------------------------------|
| SAR measured | 250 mW input power | 2.02 W/kg |
| SAR for nominal Head TSL parameters | normalized to 1W | 8.06 W/kg ± 17.5 % (k=2) |

| SAR averaged over 10 cm ³ (10 g) of Head TSL | condition | |
|---|--------------------|---------------------------------|
| SAR measured | 250 mW input power | 1.36 W/kg |
| SAR for nominal Head TSL parameters | normalized to 1W | 5.42 W/kg ± 16.9 % (k=2) |

DASY5 Validation Report for Head TSL

Date: 17.01.2019

Test Laboratory: SPEAG, Zurich, Switzerland

DUT: Dipole 835 MHz; Type: D835V2; Serial: D835V2 - SN:4d132

Communication System: UID 0 - CW; Frequency: 835 MHz

Medium parameters used: $f = 835$ MHz; $\sigma = 0.92$ S/m; $\epsilon_r = 41.3$; $\rho = 1000$ kg/m³

Phantom section: Flat Section

Measurement Standard: DASY5 (IEEE/IEC/ANSI C63.19-2011)

DASY52 Configuration:

- Probe: EX3DV4 - SN7349; ConvF(10, 10, 10) @ 835 MHz; Calibrated: 31.12.2018
- Sensor-Surface: 1.4mm (Mechanical Surface Detection)
- Electronics: DAE4 Sn601; Calibrated: 04.10.2018
- Phantom: Flat Phantom 4.9 (front); Type: QD 00L P49 AA; Serial: 1001
- DASY52 52.10.2(1495); SEMCAD X 14.6.12(7450)

Dipole Calibration for Head Tissue/Pin=250 mW, d=15mm/Zoom Scan (7x7x7)/Cube 0:

Measurement grid: dx=5mm, dy=5mm, dz=5mm

Reference Value = 34.24 V/m; Power Drift = -0.00 dB

Peak SAR (extrapolated) = 3.73 W/kg

SAR(1 g) = 2.44 W/kg; SAR(10 g) = 1.58 W/kg

Maximum value of SAR (measured) = 3.28 W/kg

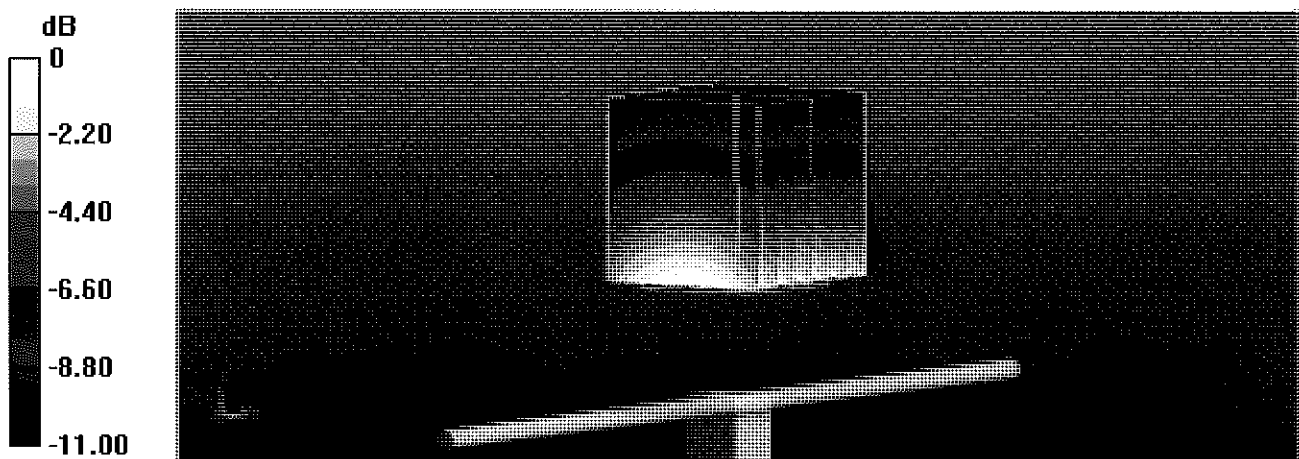

0 dB = 3.28 W/kg = 5.16 dBW/kg

Impedance Measurement Plot for Head TSL

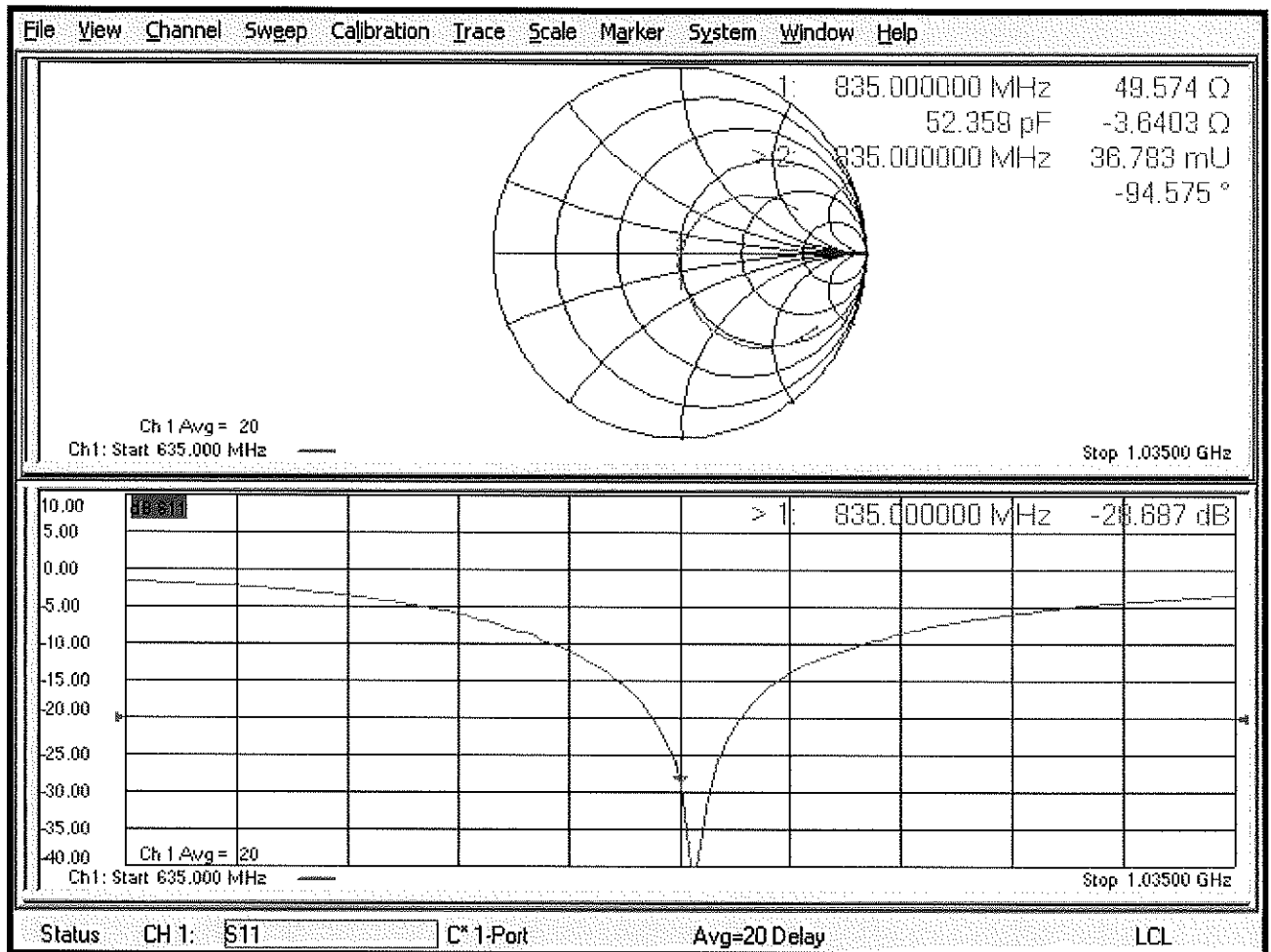

DASY5 Validation Report for Body TSL

Date: 17.01.2019

Test Laboratory: SPEAG, Zurich, Switzerland

DUT: Dipole 835 MHz; Type: D835V2; Serial: D835V2 - SN:4d132

Communication System: UID 0 - CW; Frequency: 835 MHz

Medium parameters used: $f = 835$ MHz; $\sigma = 0.99$ S/m; $\epsilon_r = 54.6$; $\rho = 1000$ kg/m³

Phantom section: Flat Section

Measurement Standard: DASY5 (IEEE/IEC/ANSI C63.19-2011)

DASY52 Configuration:

- Probe: EX3DV4 - SN7349; ConvF(10.15, 10.15, 10.15) @ 835 MHz; Calibrated: 31.12.2018
- Sensor-Surface: 1.4mm (Mechanical Surface Detection)
- Electronics: DAE4 Sn601; Calibrated: 04.10.2018
- Phantom: Flat Phantom 4.9 (Back); Type: QD 00R P49 AA; Serial: 1005
- DASY52 52.10.2(1495); SEMCAD X 14.6.12(7450)

Dipole Calibration for Body Tissue/Pin=250 mW, d=15mm/Zoom Scan (7x7x7)/Cube 0:

Measurement grid: dx=5mm, dy=5mm, dz=5mm

Reference Value = 63.32 V/m; Power Drift = -0.07 dB

Peak SAR (extrapolated) = 3.64 W/kg

SAR(1 g) = 2.46 W/kg; SAR(10 g) = 1.61 W/kg

Maximum value of SAR (measured) = 3.26 W/kg

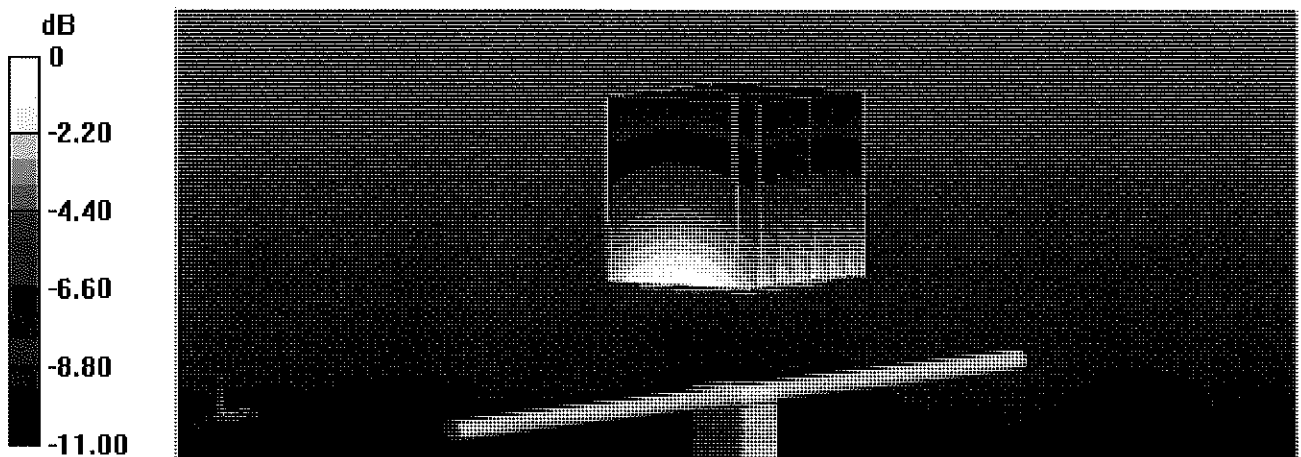

0 dB = 3.26 W/kg = 5.13 dBW/kg

Impedance Measurement Plot for Body TSL

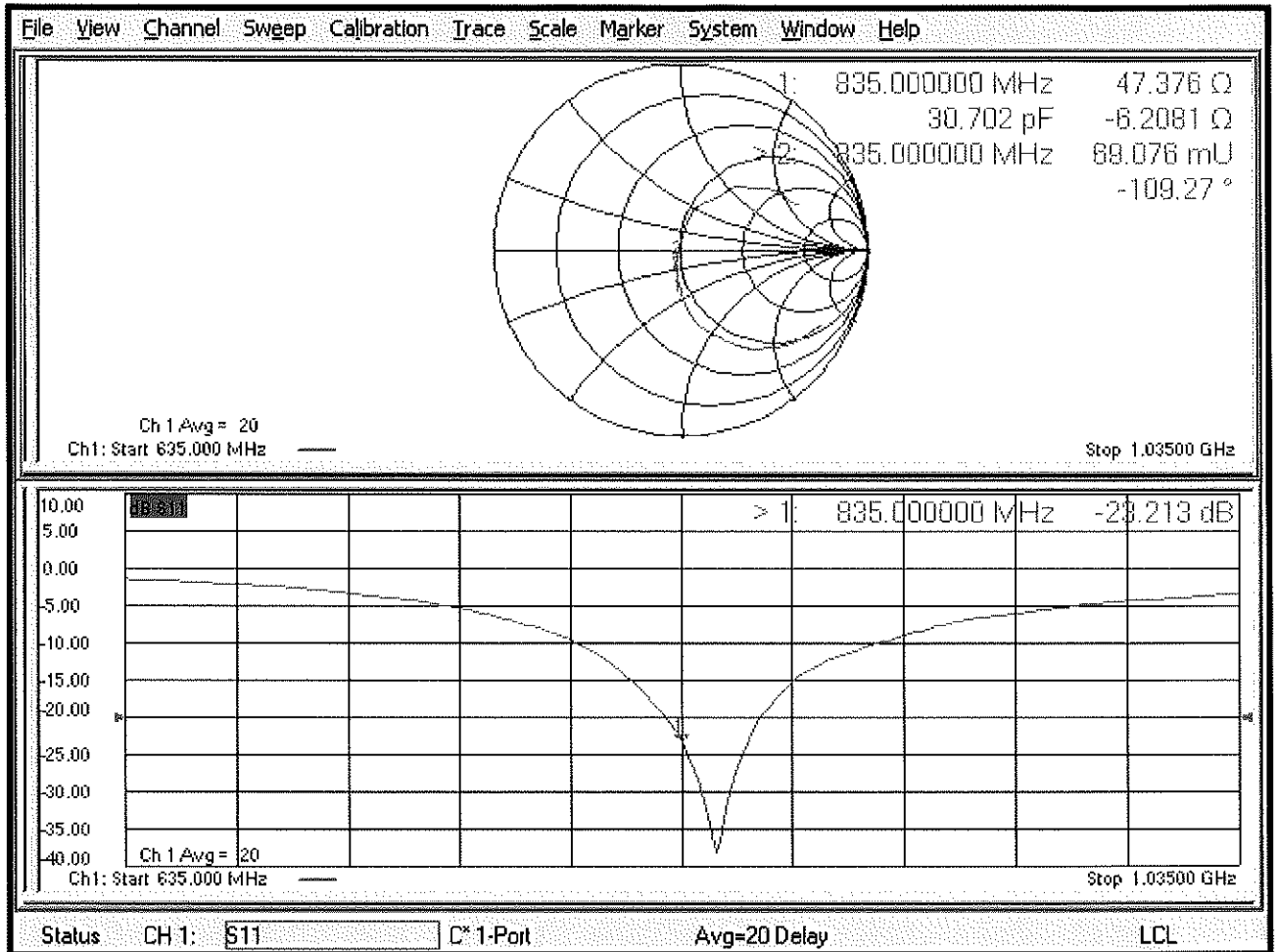

DASY5 Validation Report for SAM Head

Date: 22.01.2019

Test Laboratory: SPEAG, Zurich, Switzerland

DUT: Dipole 835 MHz; Type: D835V2; Serial: D835V2 - SN:4d132

Communication System: UID 0 - CW; Frequency: 835 MHz

Medium parameters used: $f = 835$ MHz; $\sigma = 0.92$ S/m; $\epsilon_r = 44.4$; $\rho = 1000$ kg/m³

Measurement Standard: DASY5 (IEEE/IEC/ANSI C63.19-2011)

DASY52 Configuration:

- Probe: EX3DV4 - SN7349; ConvF(10, 10, 10) @ 835 MHz; Calibrated: 31.12.2018
- Sensor-Surface: 1.4mm (Mechanical Surface Detection)
- Electronics: DAE4 Sn601; Calibrated: 04.10.2018
- Phantom: SAM Head
- DASY52 52.10.2(1495); SEMCAD X 14.6.12(7450)

SAM/Head/Top/Zoom Scan (7x7x7)/Cube 0: Measurement grid: dx=5mm, dy=5mm, dz=5mm

Reference Value = 61.32 V/m; Power Drift = -0.04 dB

Peak SAR (extrapolated) = 3.51 W/kg

SAR(1 g) = 2.35 W/kg; SAR(10 g) = 1.57 W/kg

Maximum value of SAR (measured) = 3.12 W/kg

SAM/Head/Mouth/Zoom Scan (7x7x7)/Cube 0: Measurement grid: dx=5mm, dy=5mm, dz=5mm

Reference Value = 62.25 V/m; Power Drift = 0.01 dB

Peak SAR (extrapolated) = 3.67 W/kg

SAR(1 g) = 2.47 W/kg; SAR(10 g) = 1.65 W/kg

Maximum value of SAR (measured) = 3.24 W/kg

SAM/Head/Neck/Zoom Scan (7x7x7)/Cube 0: Measurement grid: dx=5mm, dy=5mm, dz=5mm

Reference Value = 60.69 V/m; Power Drift = 0.05 dB

Peak SAR (extrapolated) = 3.43 W/kg

SAR(1 g) = 2.36 W/kg; SAR(10 g) = 1.6 W/kg

Maximum value of SAR (measured) = 3.08 W/kg

SAM/Head/Ear/Zoom Scan (8x7x7)/Cube 0: Measurement grid: dx=5mm, dy=5mm, dz=5mm

Reference Value = 55.79 V/m; Power Drift = 0.05 dB

Peak SAR (extrapolated) = 2.94 W/kg

SAR(1 g) = 2.02 W/kg; SAR(10 g) = 1.36 W/kg

Maximum value of SAR (measured) = 2.62 W/kg

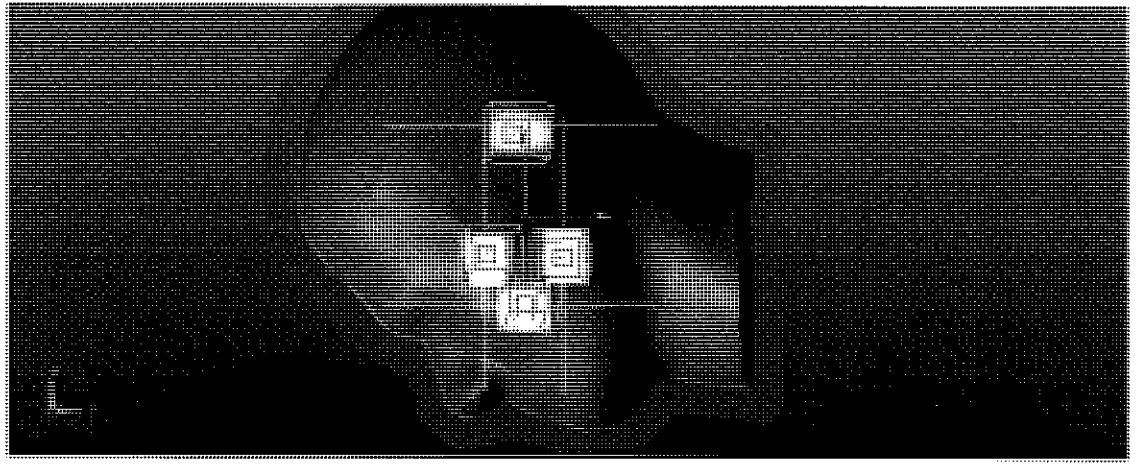
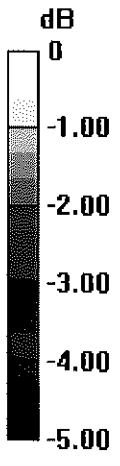

0 dB = 2.62 W/kg = 4.18 dBW/kg



Accredited by the Swiss Accreditation Service (SAS)
The Swiss Accreditation Service is one of the signatories to the EA
Multilateral Agreement for the recognition of calibration certificates

Accreditation No.: **SCS 0108**

Client **PC Test**

Certificate No: **D835V2-4d133_Oct18**

CALIBRATION CERTIFICATE

Object **D835V2 - SN:4d133**

Calibration procedure(s) **QA CAL-05.v10
Calibration procedure for dipole validation kits above 700 MHz**

*BN ✓
10/30/2018*

Calibration date: **October 19, 2018**

This calibration certificate documents the traceability to national standards, which realize the physical units of measurements (SI).
The measurements and the uncertainties with confidence probability are given on the following pages and are part of the certificate.

All calibrations have been conducted in the closed laboratory facility: environment temperature (22 ± 3)°C and humidity < 70%.

Calibration Equipment used (M&TE critical for calibration)

| Primary Standards | ID # | Cal Date (Certificate No.) | Scheduled Calibration |
|-----------------------------|--------------------|---------------------------------|-----------------------|
| Power meter NRP | SN: 104778 | 04-Apr-18 (No. 217-02672/02673) | Apr-19 |
| Power sensor NRP-Z91 | SN: 103244 | 04-Apr-18 (No. 217-02672) | Apr-19 |
| Power sensor NRP-Z91 | SN: 103245 | 04-Apr-18 (No. 217-02673) | Apr-19 |
| Reference 20 dB Attenuator | SN: 5058 (20k) | 04-Apr-18 (No. 217-02682) | Apr-19 |
| Type-N mismatch combination | SN: 5047.2 / 06327 | 04-Apr-18 (No. 217-02683) | Apr-19 |
| Reference Probe EX3DV4 | SN: 7349 | 30-Dec-17 (No. EX3-7349_Dec17) | Dec-18 |
| DAE4 | SN: 601 | 04-Oct-18 (No. DAE4-601_Oct18) | Oct-19 |

| Secondary Standards | ID # | Check Date (in house) | Scheduled Check |
|---------------------------------|----------------|-----------------------------------|------------------------|
| Power meter EPM-442A | SN: GB37480704 | 07-Oct-15 (in house check Oct-18) | In house check: Oct-20 |
| Power sensor HP 8481A | SN: US37292783 | 07-Oct-15 (in house check Oct-18) | In house check: Oct-20 |
| Power sensor HP 8481A | SN: MY41092317 | 07-Oct-15 (in house check Oct-18) | In house check: Oct-20 |
| RF generator R&S SMT-06 | SN: 100972 | 15-Jun-15 (in house check Oct-18) | In house check: Oct-20 |
| Network Analyzer Agilent E8358A | SN: US41080477 | 31-Mar-14 (in house check Oct-18) | In house check: Oct-19 |

Calibrated by: **Manu Seitz** Name: **Manu Seitz** Function: **Laboratory Technician** Signature: *[Signature]*

Approved by: **Katja Pokovic** Name: **Katja Pokovic** Function: **Technical Manager** Signature: *[Signature]*

Issued: October 22, 2018

This calibration certificate shall not be reproduced except in full without written approval of the laboratory.



Accredited by the Swiss Accreditation Service (SAS)

The Swiss Accreditation Service is one of the signatories to the EA
Multilateral Agreement for the recognition of calibration certificates

Accreditation No.: **SCS 0108**

Glossary:

| | |
|-------|---------------------------------|
| TSL | tissue simulating liquid |
| ConvF | sensitivity in TSL / NORM x,y,z |
| N/A | not applicable or not measured |

Calibration is Performed According to the Following Standards:

- IEEE Std 1528-2013, "IEEE Recommended Practice for Determining the Peak Spatial-Averaged Specific Absorption Rate (SAR) in the Human Head from Wireless Communications Devices: Measurement Techniques", June 2013
- IEC 62209-1, "Measurement procedure for the assessment of Specific Absorption Rate (SAR) from hand-held and body-mounted devices used next to the ear (frequency range of 300 MHz to 6 GHz)", July 2016
- IEC 62209-2, "Procedure to determine the Specific Absorption Rate (SAR) for wireless communication devices used in close proximity to the human body (frequency range of 30 MHz to 6 GHz)", March 2010
- KDB 865664, "SAR Measurement Requirements for 100 MHz to 6 GHz"

Additional Documentation:

- DASY4/5 System Handbook

Methods Applied and Interpretation of Parameters:

- Measurement Conditions:** Further details are available from the Validation Report at the end of the certificate. All figures stated in the certificate are valid at the frequency indicated.
- Antenna Parameters with TSL:** The dipole is mounted with the spacer to position its feed point exactly below the center marking of the flat phantom section, with the arms oriented parallel to the body axis.
- Feed Point Impedance and Return Loss:** These parameters are measured with the dipole positioned under the liquid filled phantom. The impedance stated is transformed from the measurement at the SMA connector to the feed point. The Return Loss ensures low reflected power. No uncertainty required.
- Electrical Delay:** One-way delay between the SMA connector and the antenna feed point. No uncertainty required.
- SAR measured:** SAR measured at the stated antenna input power.
- SAR normalized:** SAR as measured, normalized to an input power of 1 W at the antenna connector.
- SAR for nominal TSL parameters:** The measured TSL parameters are used to calculate the nominal SAR result.

The reported uncertainty of measurement is stated as the standard uncertainty of measurement multiplied by the coverage factor $k=2$, which for a normal distribution corresponds to a coverage probability of approximately 95%.

Measurement Conditions

DASY system configuration, as far as not given on page 1.

| | | |
|-------------------------------------|------------------------|-------------|
| DASY Version | DASY5 | V52.10.2 |
| Extrapolation | Advanced Extrapolation | |
| Phantom | Modular Flat Phantom | |
| Distance Dipole Center - TSL | 15 mm | with Spacer |
| Zoom Scan Resolution | dx, dy, dz = 5 mm | |
| Frequency | 835 MHz \pm 1 MHz | |

Head TSL parameters

The following parameters and calculations were applied.

| | Temperature | Permittivity | Conductivity |
|--|---------------------|----------------|----------------------|
| Nominal Head TSL parameters | 22.0 °C | 41.5 | 0.90 mho/m |
| Measured Head TSL parameters | (22.0 \pm 0.2) °C | 40.6 \pm 6 % | 0.91 mho/m \pm 6 % |
| Head TSL temperature change during test | < 0.5 °C | ---- | ---- |

SAR result with Head TSL

| SAR averaged over 1 cm³ (1 g) of Head TSL | Condition | |
|---|--------------------|--|
| SAR measured | 250 mW input power | 2.39 W/kg |
| SAR for nominal Head TSL parameters | normalized to 1W | 9.43 W/kg \pm 17.0 % (k=2) |

| SAR averaged over 10 cm³ (10 g) of Head TSL | condition | |
|---|--------------------|--|
| SAR measured | 250 mW input power | 1.54 W/kg |
| SAR for nominal Head TSL parameters | normalized to 1W | 6.10 W/kg \pm 16.5 % (k=2) |

Body TSL parameters

The following parameters and calculations were applied.

| | Temperature | Permittivity | Conductivity |
|--|---------------------|----------------|----------------------|
| Nominal Body TSL parameters | 22.0 °C | 55.2 | 0.97 mho/m |
| Measured Body TSL parameters | (22.0 \pm 0.2) °C | 54.9 \pm 6 % | 0.98 mho/m \pm 6 % |
| Body TSL temperature change during test | < 0.5 °C | ---- | ---- |

SAR result with Body TSL

| SAR averaged over 1 cm³ (1 g) of Body TSL | Condition | |
|---|--------------------|--|
| SAR measured | 250 mW input power | 2.46 W/kg |
| SAR for nominal Body TSL parameters | normalized to 1W | 9.75 W/kg \pm 17.0 % (k=2) |

| SAR averaged over 10 cm³ (10 g) of Body TSL | condition | |
|---|--------------------|--|
| SAR measured | 250 mW input power | 1.61 W/kg |
| SAR for nominal Body TSL parameters | normalized to 1W | 6.40 W/kg \pm 16.5 % (k=2) |

Appendix (Additional assessments outside the scope of SCS 0108)

Antenna Parameters with Head TSL

| | |
|--------------------------------------|--------------------------------|
| Impedance, transformed to feed point | 50.6 Ω - 2.4 j Ω |
| Return Loss | - 32.2 dB |

Antenna Parameters with Body TSL

| | |
|--------------------------------------|--------------------------------|
| Impedance, transformed to feed point | 45.0 Ω - 6.7 j Ω |
| Return Loss | - 21.1 dB |

General Antenna Parameters and Design

| | |
|----------------------------------|----------|
| Electrical Delay (one direction) | 1.397 ns |
|----------------------------------|----------|

After long term use with 100W radiated power, only a slight warming of the dipole near the feedpoint can be measured.

The dipole is made of standard semirigid coaxial cable. The center conductor of the feeding line is directly connected to the second arm of the dipole. The antenna is therefore short-circuited for DC-signals. On some of the dipoles, small end caps are added to the dipole arms in order to improve matching when loaded according to the position as explained in the "Measurement Conditions" paragraph. The SAR data are not affected by this change. The overall dipole length is still according to the Standard.

No excessive force must be applied to the dipole arms, because they might bend or the soldered connections near the feedpoint may be damaged.

Additional EUT Data

| | |
|-----------------|---------------|
| Manufactured by | SPEAG |
| Manufactured on | July 22, 2011 |

DASY5 Validation Report for Head TSL

Date: 19.10.2018

Test Laboratory: The name of your organization

DUT: Dipole 835 MHz; Type: D835V2; Serial: D835V2 - SN:4d133

Communication System: UID 0 - CW; Frequency: 835 MHz

Medium parameters used: $f = 835$ MHz; $\sigma = 0.91$ S/m; $\epsilon_r = 40.6$; $\rho = 1000$ kg/m³

Phantom section: Flat Section

Measurement Standard: DASY5 (IEEE/IEC/ANSI C63.19-2011)

DASY52 Configuration:

- Probe: EX3DV4 - SN7349; ConvF(9.9, 9.9, 9.9) @ 835 MHz; Calibrated: 30.12.2017
- Sensor-Surface: 1.4mm (Mechanical Surface Detection)
- Electronics: DAE4 Sn601; Calibrated: 04.10.2018
- Phantom: Flat Phantom 4.9 (front); Type: QD 00L P49 AA; Serial: 1001
- DASY52 52.10.2(1495); SEMCAD X 14.6.12(7450)

Dipole Calibration for Head Tissue/Pin=250 mW, d=15mm/Zoom Scan (7x7x7)/Cube 0:

Measurement grid: dx=5mm, dy=5mm, dz=5mm

Reference Value = 63.02 V/m; Power Drift = -0.02 dB

Peak SAR (extrapolated) = 3.68 W/kg

SAR(1 g) = 2.39 W/kg; SAR(10 g) = 1.54 W/kg

Maximum value of SAR (measured) = 3.24 W/kg

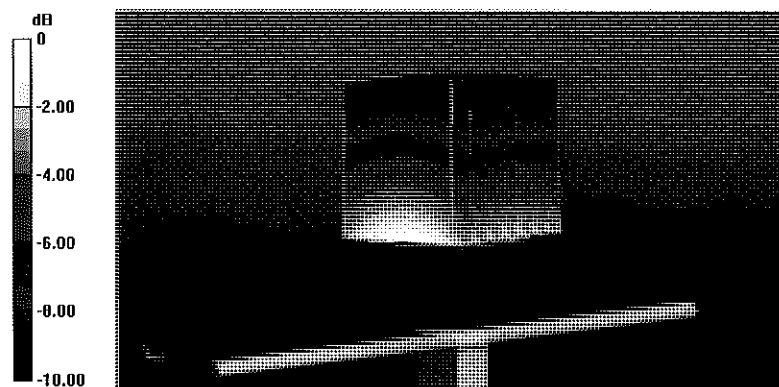

Impedance Measurement Plot for Head TSL

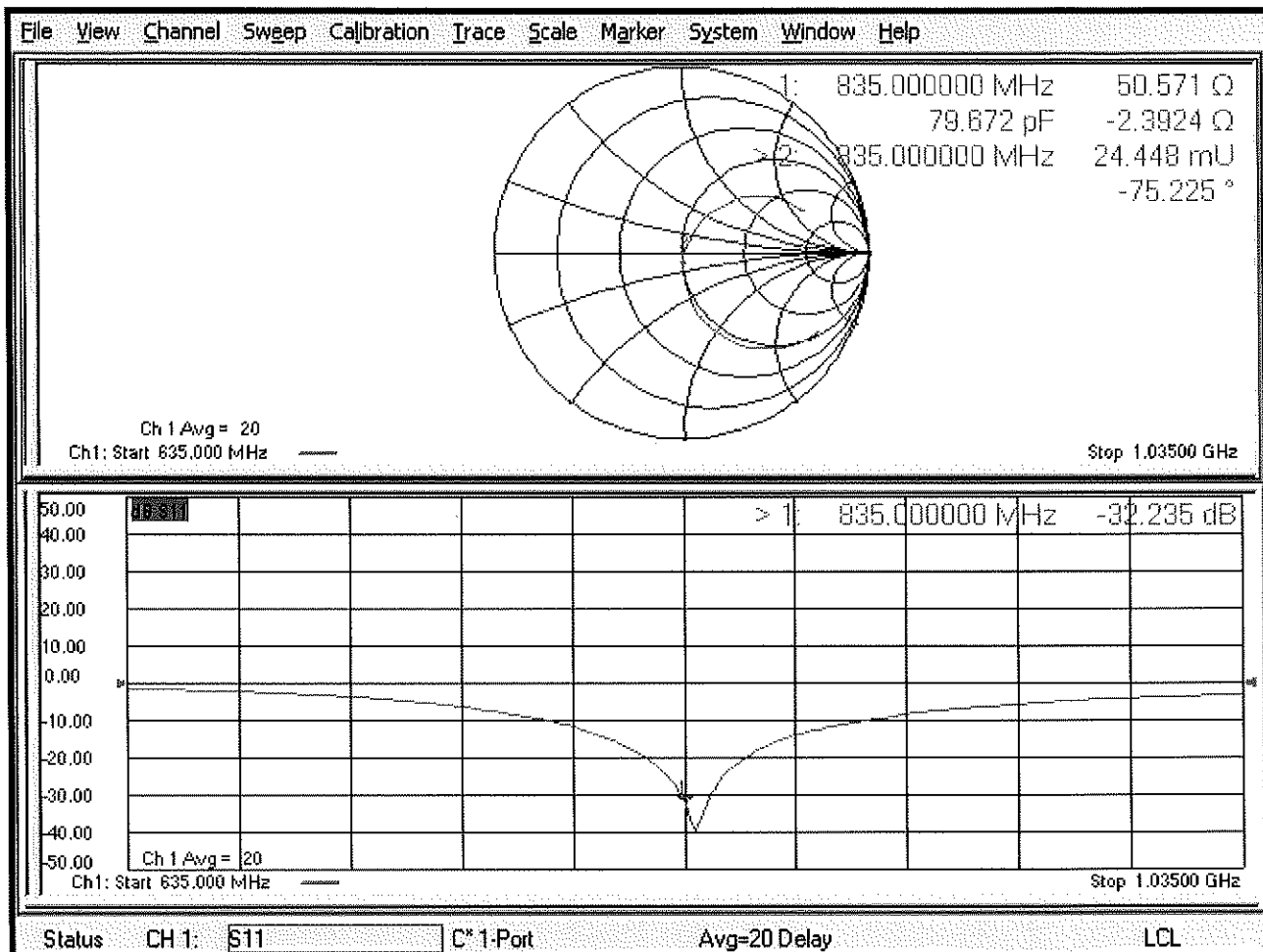

DASY5 Validation Report for Body TSL

Date: 19.10.2018

Test Laboratory: SPEAG, Zurich, Switzerland

DUT: Dipole 835 MHz; Type: D835V2; Serial: D835V2 - SN:4d133

Communication System: UID 0 - CW; Frequency: 835 MHz

Medium parameters used: $f = 835$ MHz; $\sigma = 0.98$ S/m; $\epsilon_r = 54.9$; $\rho = 1000$ kg/m³

Phantom section: Flat Section

Measurement Standard: DASY5 (IEEE/IEC/ANSI C63.19-2011)

DASY52 Configuration:

- Probe: EX3DV4 - SN7349; ConvF(10.05, 10.05, 10.05) @ 835 MHz; Calibrated: 30.12.2017
- Sensor-Surface: 1.4mm (Mechanical Surface Detection)
- Electronics: DAE4 Sn601; Calibrated: 04.10.2018
- Phantom: Flat Phantom 4.9 (Back); Type: QD 00R P49 AA; Serial: 1005
- DASY52 52.10.2(1495); SEMCAD X 14.6.12(7450)

Dipole Calibration for Body Tissue/Pin=250 mW, d=15mm/Zoom Scan (7x7x7)/Cube 0:

Measurement grid: dx=5mm, dy=5mm, dz=5mm

Reference Value = 61.61 V/m; Power Drift = -0.02 dB

Peak SAR (extrapolated) = 3.69 W/kg

SAR(1 g) = 2.46 W/kg; SAR(10 g) = 1.61 W/kg

Maximum value of SAR (measured) = 3.28 W/kg

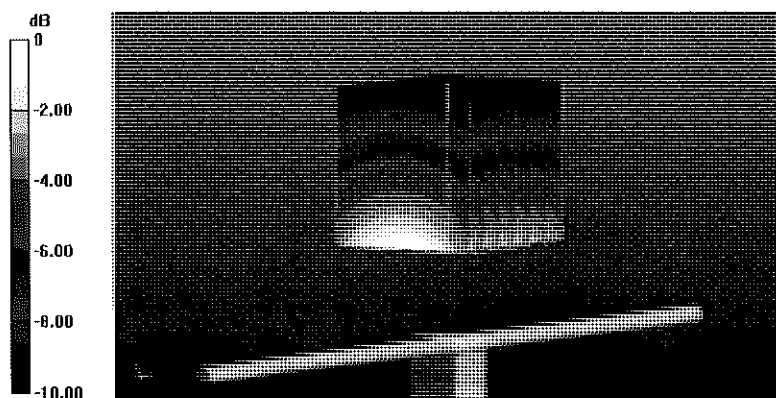

0 dB = 3.28 W/kg = 5.16 dBW/kg

Impedance Measurement Plot for Body TSL

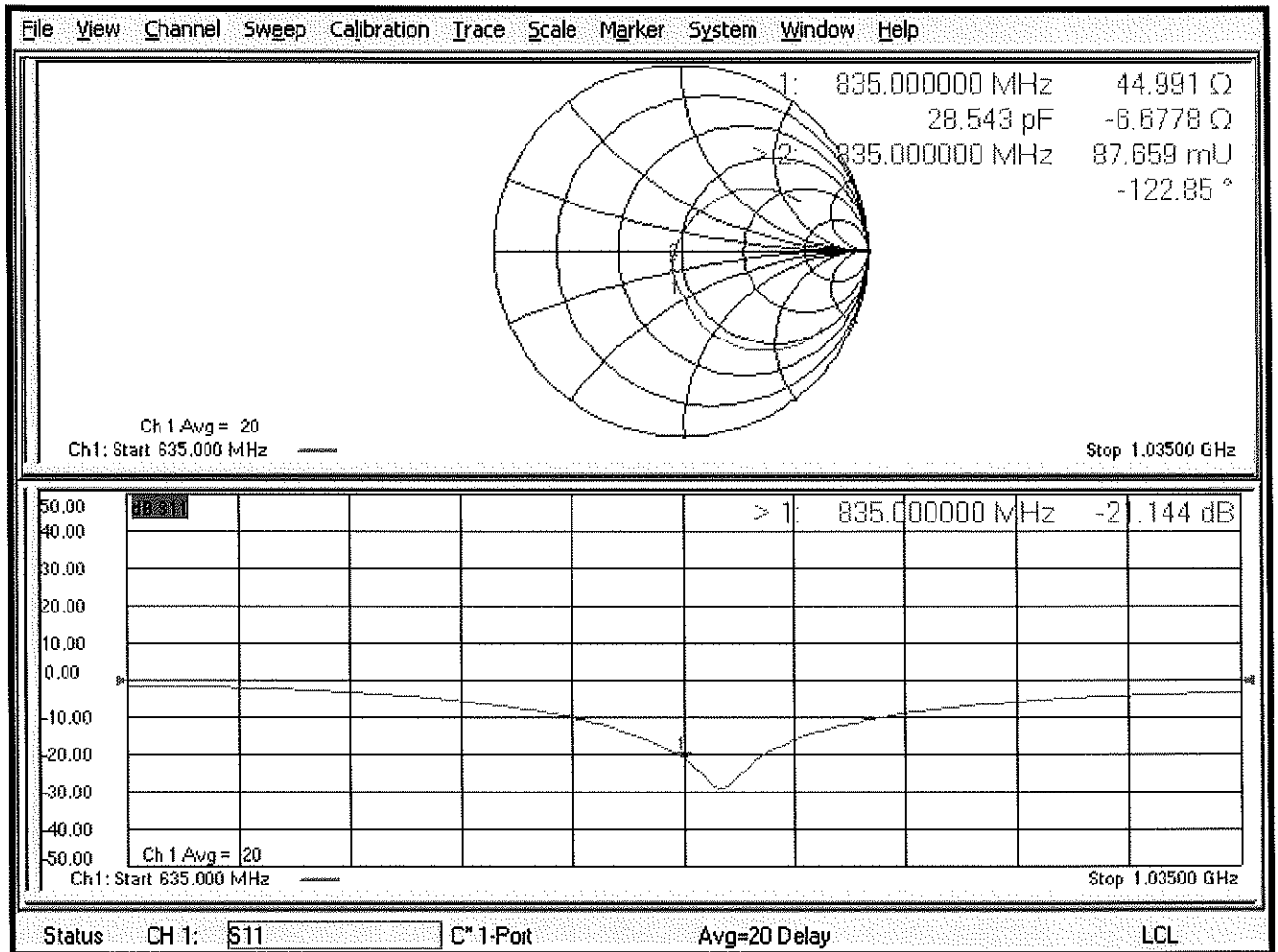



Accredited by the Swiss Accreditation Service (SAS)
The Swiss Accreditation Service is one of the signatories to the EA
Multilateral Agreement for the recognition of calibration certificates

Accreditation No.: **SCS 0108**

Client **PC-Test**

Certificate No: **D1750V2-1148_May17**

CALIBRATION CERTIFICATE

Object **D1750V2 - SN:1148**

Calibration procedure(s) **QA CAL-05.v9
Calibration procedure for dipole validation kits above 700 MHz**

Calibration date: **May 09, 2017**

*BN ✓
05-23-2017
BN ✓
05-09-2018*

This calibration certificate documents the traceability to national standards, which realize the physical units of measurements (SI).
The measurements and the uncertainties with confidence probability are given on the following pages and are part of the certificate.

All calibrations have been conducted in the closed laboratory facility: environment temperature (22 ± 3)°C and humidity < 70%.

Calibration Equipment used (M&TE critical for calibration)

| Primary Standards | ID # | Cal Date (Certificate No.) | Scheduled Calibration |
|-----------------------------|--------------------|---------------------------------|-----------------------|
| Power meter NRP | SN: 104778 | 04-Apr-17 (No. 217-02521/02522) | Apr-18 |
| Power sensor NRP-Z91 | SN: 103244 | 04-Apr-17 (No. 217-02521) | Apr-18 |
| Power sensor NRP-Z91 | SN: 103245 | 04-Apr-17 (No. 217-02522) | Apr-18 |
| Reference 20 dB Attenuator | SN: 5058 (20k) | 07-Apr-17 (No. 217-02528) | Apr-18 |
| Type-N mismatch combination | SN: 5047.2 / 06327 | 07-Apr-17 (No. 217-02529) | Apr-18 |
| Reference Probe EX3DV4 | SN: 7349 | 31-Dec-16 (No. EX3-7349_Dec16) | Dec-17 |
| DAE4 | SN: 601 | 28-Mar-17 (No. DAE4-601_Mar17) | Mar-18 |

| Secondary Standards | ID # | Check Date (in house) | Scheduled Check |
|---------------------------|----------------|-----------------------------------|------------------------|
| Power meter EPM-442A | SN: GB37480704 | 07-Oct-15 (in house check Oct-16) | In house check: Oct-18 |
| Power sensor HP 8481A | SN: US37292783 | 07-Oct-15 (in house check Oct-16) | in house check: Oct-18 |
| Power sensor HP 8481A | SN: MY41092317 | 07-Oct-15 (in house check Oct-16) | in house check: Oct-18 |
| RF generator R&S SMT-06 | SN: 100972 | 15-Jun-15 (in house check Oct-16) | in house check: Oct-18 |
| Network Analyzer HP 8753E | SN: US37390585 | 18-Oct-01 (in house check Oct-16) | In house check: Oct-17 |

Calibrated by: **Claudio Leubler** Name: Claudio Leubler Function: Laboratory Technician Signature: *[Signature]*

Approved by: **Katja Pokovic** Name: Katja Pokovic Function: Technical Manager Signature: *[Signature]*

Issued: May 11, 2017

This calibration certificate shall not be reproduced except in full without written approval of the laboratory.



Accredited by the Swiss Accreditation Service (SAS)

Accreditation No.: **SCS 0108**

The Swiss Accreditation Service is one of the signatories to the EA Multilateral Agreement for the recognition of calibration certificates

Glossary:

| | |
|-------|---------------------------------|
| TSL | tissue simulating liquid |
| ConvF | sensitivity in TSL / NORM x,y,z |
| N/A | not applicable or not measured |

Calibration is Performed According to the Following Standards:

- IEEE Std 1528-2013, "IEEE Recommended Practice for Determining the Peak Spatial-Averaged Specific Absorption Rate (SAR) in the Human Head from Wireless Communications Devices: Measurement Techniques", June 2013
- IEC 62209-1, "Procedure to measure the Specific Absorption Rate (SAR) for hand-held devices used in close proximity to the ear (frequency range of 300 MHz to 3 GHz)", February 2005
- IEC 62209-2, "Procedure to determine the Specific Absorption Rate (SAR) for wireless communication devices used in close proximity to the human body (frequency range of 30 MHz to 6 GHz)", March 2010
- KDB 865664, "SAR Measurement Requirements for 100 MHz to 6 GHz"

Additional Documentation:

- DASY4/5 System Handbook

Methods Applied and Interpretation of Parameters:

- Measurement Conditions:** Further details are available from the Validation Report at the end of the certificate. All figures stated in the certificate are valid at the frequency indicated.
- Antenna Parameters with TSL:** The dipole is mounted with the spacer to position its feed point exactly below the center marking of the flat phantom section, with the arms oriented parallel to the body axis.
- Feed Point Impedance and Return Loss:** These parameters are measured with the dipole positioned under the liquid filled phantom. The impedance stated is transformed from the measurement at the SMA connector to the feed point. The Return Loss ensures low reflected power. No uncertainty required.
- Electrical Delay:** One-way delay between the SMA connector and the antenna feed point. No uncertainty required.
- SAR measured:** SAR measured at the stated antenna input power.
- SAR normalized:** SAR as measured, normalized to an input power of 1 W at the antenna connector.
- SAR for nominal TSL parameters:** The measured TSL parameters are used to calculate the nominal SAR result.

The reported uncertainty of measurement is stated as the standard uncertainty of measurement multiplied by the coverage factor $k=2$, which for a normal distribution corresponds to a coverage probability of approximately 95%.

Measurement Conditions

DASY system configuration, as far as not given on page 1.

| | | |
|------------------------------|------------------------|-------------|
| DASY Version | DASY5 | V52.10.0 |
| Extrapolation | Advanced Extrapolation | |
| Phantom | Modular Flat Phantom | |
| Distance Dipole Center - TSL | 10 mm | with Spacer |
| Zoom Scan Resolution | dx, dy, dz = 5 mm | |
| Frequency | 1750 MHz ± 1 MHz | |

Head TSL parameters

The following parameters and calculations were applied.

| | Temperature | Permittivity | Conductivity |
|---|-----------------|--------------|------------------|
| Nominal Head TSL parameters | 22.0 °C | 40.1 | 1.37 mho/m |
| Measured Head TSL parameters | (22.0 ± 0.2) °C | 39.0 ± 6 % | 1.36 mho/m ± 6 % |
| Head TSL temperature change during test | < 0.5 °C | ---- | ---- |

SAR result with Head TSL

| SAR averaged over 1 cm ³ (1 g) of Head TSL | Condition | |
|---|--------------------|--------------------------|
| SAR measured | 250 mW input power | 9.11 W/kg |
| SAR for nominal Head TSL parameters | normalized to 1W | 36.4 W/kg ± 17.0 % (k=2) |

| SAR averaged over 10 cm ³ (10 g) of Head TSL | condition | |
|---|--------------------|--------------------------|
| SAR measured | 250 mW input power | 4.83 W/kg |
| SAR for nominal Head TSL parameters | normalized to 1W | 19.3 W/kg ± 16.5 % (k=2) |

Body TSL parameters

The following parameters and calculations were applied.

| | Temperature | Permittivity | Conductivity |
|---|-----------------|--------------|------------------|
| Nominal Body TSL parameters | 22.0 °C | 53.4 | 1.49 mho/m |
| Measured Body TSL parameters | (22.0 ± 0.2) °C | 53.7 ± 6 % | 1.47 mho/m ± 6 % |
| Body TSL temperature change during test | < 0.5 °C | ---- | ---- |

SAR result with Body TSL

| SAR averaged over 1 cm ³ (1 g) of Body TSL | Condition | |
|---|--------------------|--------------------------|
| SAR measured | 250 mW input power | 9.17 W/kg |
| SAR for nominal Body TSL parameters | normalized to 1W | 37.0 W/kg ± 17.0 % (k=2) |

| SAR averaged over 10 cm ³ (10 g) of Body TSL | condition | |
|---|--------------------|--------------------------|
| SAR measured | 250 mW input power | 4.93 W/kg |
| SAR for nominal Body TSL parameters | normalized to 1W | 19.8 W/kg ± 16.5 % (k=2) |

Appendix (Additional assessments outside the scope of SCS 0108)

Antenna Parameters with Head TSL

| | |
|--------------------------------------|--------------------------------|
| Impedance, transformed to feed point | 49.8 Ω - 0.7 j Ω |
| Return Loss | - 42.9 dB |

Antenna Parameters with Body TSL

| | |
|--------------------------------------|--------------------------------|
| Impedance, transformed to feed point | 45.7 Ω - 0.5 j Ω |
| Return Loss | - 26.9 dB |

General Antenna Parameters and Design

| | |
|----------------------------------|----------|
| Electrical Delay (one direction) | 1.223 ns |
|----------------------------------|----------|

After long term use with 100W radiated power, only a slight warming of the dipole near the feedpoint can be measured.

The dipole is made of standard semirigid coaxial cable. The center conductor of the feeding line is directly connected to the second arm of the dipole. The antenna is therefore short-circuited for DC-signals. On some of the dipoles, small end caps are added to the dipole arms in order to improve matching when loaded according to the position as explained in the "Measurement Conditions" paragraph. The SAR data are not affected by this change. The overall dipole length is still according to the Standard.

No excessive force must be applied to the dipole arms, because they might bend or the soldered connections near the feedpoint may be damaged.

Additional EUT Data

| | |
|-----------------|--------------------|
| Manufactured by | SPEAG |
| Manufactured on | September 30, 2014 |

DASY5 Validation Report for Head TSL

Date: 09.05.2017

Test Laboratory: SPEAG, Zurich, Switzerland

DUT: Dipole 1750 MHz; Type: D1750V2; Serial: D1750V2 - SN:1148

Communication System: UID 0 - CW; Frequency: 1750 MHz

Medium parameters used: $f = 1750$ MHz; $\sigma = 1.36$ S/m; $\epsilon_r = 39$; $\rho = 1000$ kg/m³

Phantom section: Flat Section

Measurement Standard: DASY5 (IEEE/IEC/ANSI C63.19-2011)

DASY52 Configuration:

- Probe: EX3DV4 - SN7349; ConvF(8.46, 8.46, 8.46); Calibrated: 31.12.2016;
- Sensor-Surface: 1.4mm (Mechanical Surface Detection)
- Electronics: DAE4 Sn601; Calibrated: 28.03.2017
- Phantom: Flat Phantom 5.0 (front); Type: QD000P50AA; Serial: 1001
- DASY52 52.10.0(1442); SEMCAD X 14.6.10(7413)

Dipole Calibration for Head Tissue/Pin=250 mW, d=10mm/Zoom Scan (7x7x7)/Cube 0:

Measurement grid: dx=5mm, dy=5mm, dz=5mm

Reference Value = 105.4 V/m; Power Drift = -0.01 dB

Peak SAR (extrapolated) = 16.5 W/kg

SAR(1 g) = 9.11 W/kg; SAR(10 g) = 4.83 W/kg

Maximum value of SAR (measured) = 13.9 W/kg

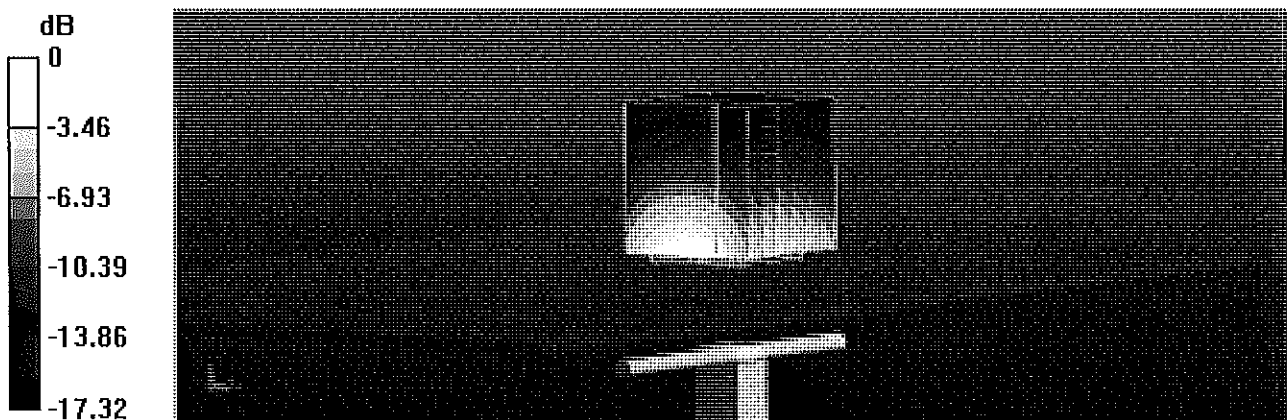

0 dB = 13.9 W/kg = 11.43 dBW/kg

Impedance Measurement Plot for Head TSL

9 May 2017 14:43:11

CH1 S11 1 U FS 1: 49.777 Ω -683.59 m Ω 133.04 pF 1 750.000 000 MHz

*
De1
CA
AVG
16
H1d

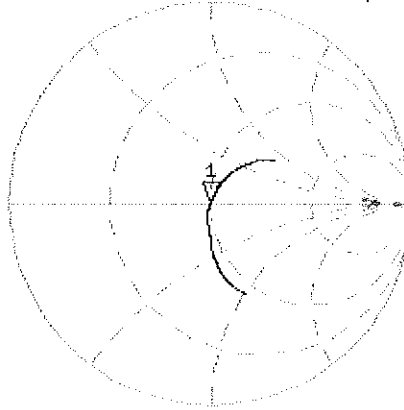

CH2 S11 LOG 5 dB/REF -20 dB 1: -42.893 dB 1 750.000 000 MHz

CA
AVG
16
H1d

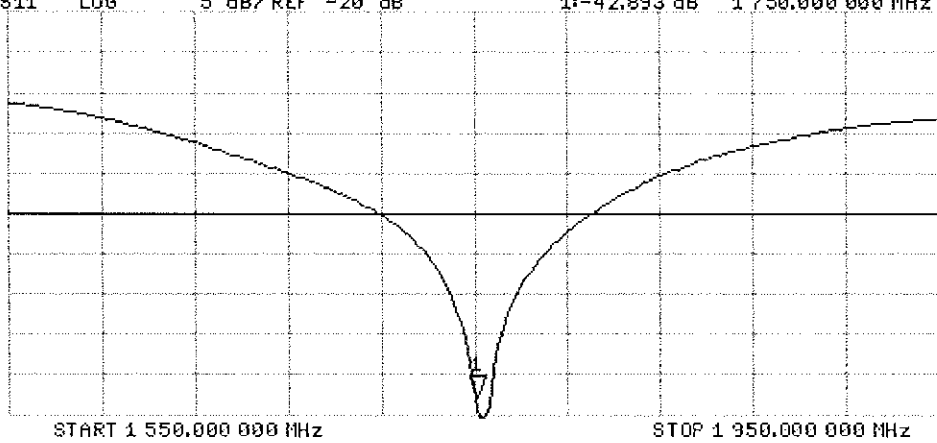

DASY5 Validation Report for Body TSL

Date: 09.05.2017

Test Laboratory: SPEAG, Zurich, Switzerland

DUT: Dipole 1750 MHz; Type: D1750V2; Serial: D1750V2 - SN:1148

Communication System: UID 0 - CW; Frequency: 1750 MHz

Medium parameters used: $f = 1750$ MHz; $\sigma = 1.47$ S/m; $\epsilon_r = 53.7$; $\rho = 1000$ kg/m³

Phantom section: Flat Section

Measurement Standard: DASY5 (IEEE/IEC/ANSI C63.19-2011)

DASY52 Configuration:

- Probe: EX3DV4 - SN7349; ConvF(8.25, 8.25, 8.25); Calibrated: 31.12.2016;
- Sensor-Surface: 1.4mm (Mechanical Surface Detection)
- Electronics: DAE4 Sn601; Calibrated: 28.03.2017
- Phantom: Flat Phantom 5.0 (back); Type: QD 000 P50 AA; Serial: 1002
- DASY52 52.10.0(1442); SEMCAD X 14.6.10(7413)

Dipole Calibration for Body Tissue/Pin=250 mW, d=10mm/Zoom Scan (7x7x7)/Cube 0:

Measurement grid: dx=5mm, dy=5mm, dz=5mm

Reference Value = 99.49 V/m; Power Drift = -0.04 dB

Peak SAR (extrapolated) = 15.9 W/kg

SAR(1 g) = 9.17 W/kg; SAR(10 g) = 4.93 W/kg

Maximum value of SAR (measured) = 13.1 W/kg

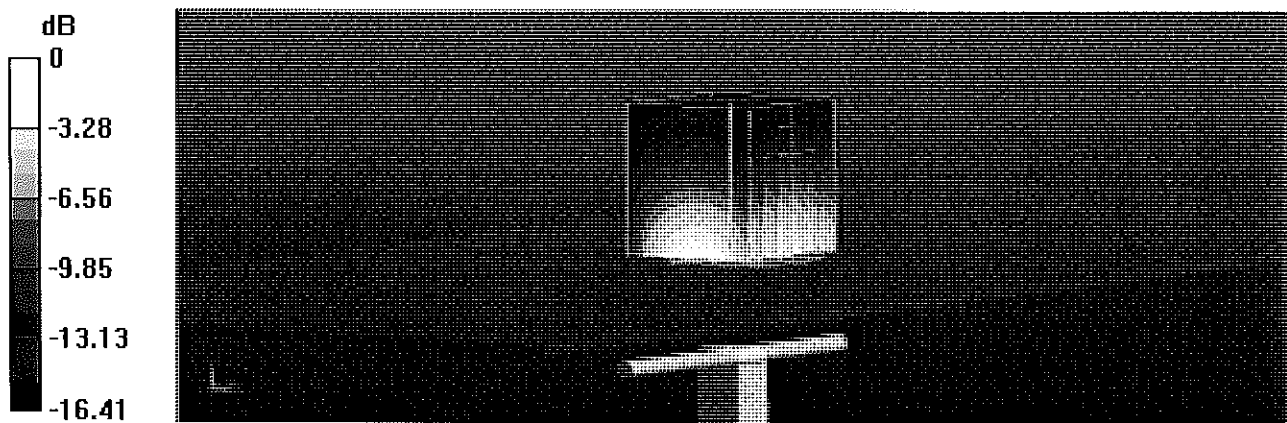

0 dB = 13.1 W/kg = 11.17 dBW/kg

Impedance Measurement Plot for Body TSL

9 May 2017 14:42:25

[CH1] S11 1 U FS 1: 45.707 Ω -513.67 $m\Omega$ 177.05 pF 1 750.000 000 MHz

*

De1

CA

Avg
16

H1d

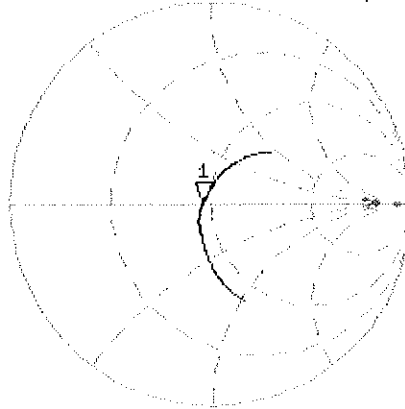

CH2 S11 LOG 5 dB/REF -20 dB 1:-26.901 dB 1 750.000 000 MHz

CA

Avg
16

H1d

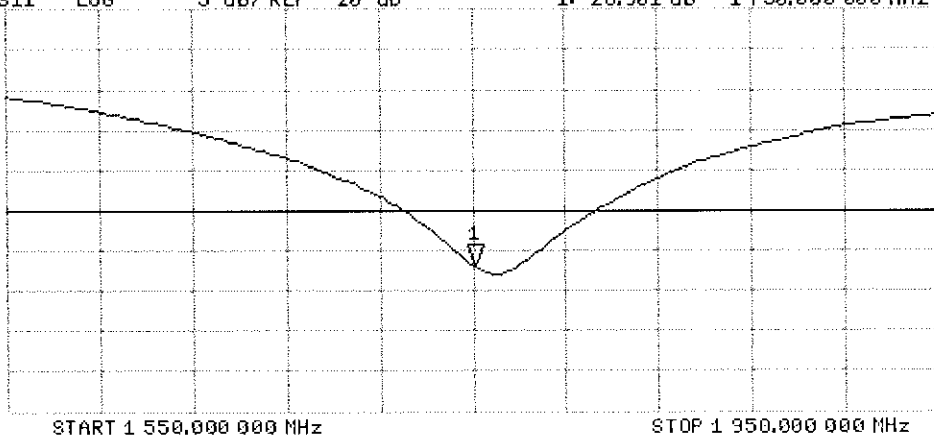

Certification of Calibration

Object: D1750V2 – SN: 1148

Calibration procedure(s): Procedure for Calibration Extension for SAR Dipoles.

Extended Calibration date: May 09, 2018

Description: SAR Validation Dipole at 1750 MHz.

Calibration Equipment used:

| Manufacturer | Model | Description | Cal Date | Cal Interval | Cal Due | Serial Number |
|-----------------------|-----------|---|------------|--------------|------------|---------------|
| Control Company | 4040 | Therm./Clock/Humidity Monitor | 3/31/2017 | Biennial | 3/31/2019 | 170232394 |
| Control Company | 4352 | Ultra Long Stem Thermometer | 5/2/2017 | Biennial | 5/2/2019 | 170330156 |
| Amplifier Research | 15S1G6 | Amplifier | CBT | N/A | CBT | 433971 |
| Narda | 4772-3 | Attenuator (3dB) | CBT | N/A | CBT | 9406 |
| Keysight | 772D | Dual Directional Coupler | CBT | N/A | CBT | MY52180215 |
| Keysight Technologies | 85033E | Standard Mechanical Calibration Kit (DC to 9GHz, 3.5mm) | 6/1/2017 | Annual | 6/1/2018 | MY53401181 |
| Mini-Circuits | BW-N20W5+ | DC to 18 GHz Precision Fixed 20 dB Attenuator | CBT | N/A | CBT | N/A |
| SPEAG | DAE4 | Dasy Data Acquisition Electronics | 2/9/2018 | Annual | 2/9/2019 | 1272 |
| SPEAG | DAE4 | Dasy Data Acquisition Electronics | 6/21/2017 | Annual | 6/21/2018 | 1333 |
| SPEAG | DAK-3.5 | Dielectric Assessment Kit | 9/12/2017 | Annual | 9/12/2018 | 1091 |
| SPEAG | ES3DV3 | SAR Probe | 9/18/2017 | Annual | 9/18/2018 | 3287 |
| SPEAG | ES3DV3 | SAR Probe | 2/13/2018 | Annual | 2/13/2019 | 3213 |
| Anritsu | MA2411B | Pulse Power Sensor | 3/2/2018 | Annual | 3/2/2019 | 1207364 |
| Anritsu | MA2411B | Pulse Power Sensor | 3/2/2018 | Annual | 3/2/2019 | 1339018 |
| Agilent | N5182A | MXG Vector Signal Generator | 4/18/2018 | Annual | 4/18/2019 | MY47420800 |
| Mini-Circuits | NLP-2950+ | Low Pass Filter DC to 2700 MHz | CBT | N/A | CBT | N/A |
| Pasternack | PE2209-10 | Bidirectional Coupler | CBT | N/A | CBT | N/A |
| Agilent | 8753ES | S-Parameter Network Analyzer | 9/14/2017 | Annual | 9/14/2018 | US39170118 |
| Pasternack | NC-100 | Torque Wrench | 4/18/2018 | Annual | 4/18/2019 | 1445 |
| Anritsu | ML2495A | Power Meter | 10/22/2017 | Annual | 10/22/2018 | 941001 |

Measurement Uncertainty = $\pm 23\%$ (k=2)

| | Name | Function | Signature |
|----------------|------------------|--------------------------|-------------------------|
| Calibrated By: | Brodie Halfoster | Test Engineer | <i>BRODIE HALFOSTER</i> |
| Approved By: | Kaitlin O'Keefe | Senior Technical Manager | <i>KOK</i> |

DIPOLE CALIBRATION EXTENSION

Per KDB 865664 D01, calibration intervals of up to three years may be considered for reference dipoles when it is demonstrated that the SAR target, impedance and return loss of a dipole have remained stable according to the following requirements:

1. The measured SAR does not deviate more than 10% from the target on the calibration certificate.
2. The return-loss does not deviate more than 20% from the previous measurement and meets the required 20dB minimum return-loss requirement.
3. The measurement of real or imaginary parts of impedance does not deviate more than 5Ω from the previous measurement.

The following dipole was checked to pass the above 3 requirements to have 2-year calibration period from the calibration date:

| Calibration Date | Extension Date | Certificate Electrical Delay (ns) | Certificate SAR Target Head (1g) W/kg @ 20.0 dBm | Measured Head SAR (1g) W/kg @ 20.0 dBm | Deviation 1g (%) | Certificate SAR Target Head (10g) W/kg @ 20.0 dBm | Measured Head SAR (10g) W/kg @ 20.0 dBm | Deviation 10g (%) | Certificate Impedance Head (Ohm) Real | Measured Impedance Head (Ohm) Real | Difference (Ohm) Real | Certificate Impedance Head (Ohm) Imaginary | Measured Impedance Head (Ohm) Imaginary | Difference (Ohm) Imaginary | Certificate Return Loss Head (dB) | Measured Return Loss Head (dB) | Deviation (%) | PASS/FAIL |
|------------------|----------------|-----------------------------------|--|--|------------------|---|---|-------------------|---------------------------------------|------------------------------------|-----------------------|--|---|----------------------------|-----------------------------------|--------------------------------|---------------|-----------|
| 5/9/2017 | 5/9/2018 | 1.223 | 3.64 | 3.55 | -1.37% | 1.53 | 1.51 | -1.04% | 49.8 | 49.0 | 0.8 | -0.7 | 0.1 | 0.8 | -42.9 | -38.7 | 9.90% | PASS |
| Calibration Date | Extension Date | Certificate Electrical Delay (ns) | Certificate SAR Target Body (1g) W/kg @ 20.0 dBm | Measured Body SAR (1g) W/kg @ 20.0 dBm | Deviation 1g (%) | Certificate SAR Target Body (10g) W/kg @ 20.0 dBm | Measured Body SAR (10g) W/kg @ 20.0 dBm | Deviation 10g (%) | Certificate Impedance Body (Ohm) Real | Measured Impedance Body (Ohm) Real | Difference (Ohm) Real | Certificate Impedance Body (Ohm) Imaginary | Measured Impedance Body (Ohm) Imaginary | Difference (Ohm) Imaginary | Certificate Return Loss Body (dB) | Measured Return Loss Body (dB) | Deviation (%) | PASS/FAIL |
| 5/9/2017 | 5/9/2018 | 1.223 | 3.7 | 3.88 | 4.86% | 1.98 | 2.06 | 4.04% | 45.7 | 45.4 | 0.3 | -0.5 | -2.6 | 2.1 | -26.9 | -25.0 | 7.20% | PASS |

Impedance & Return-Loss Measurement Plot for Head TSL

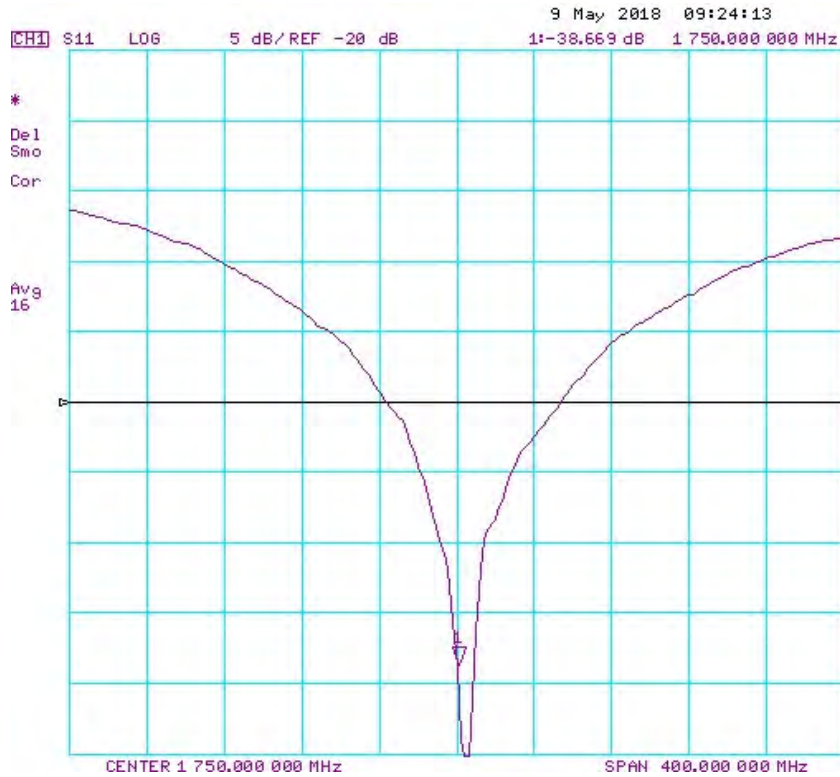
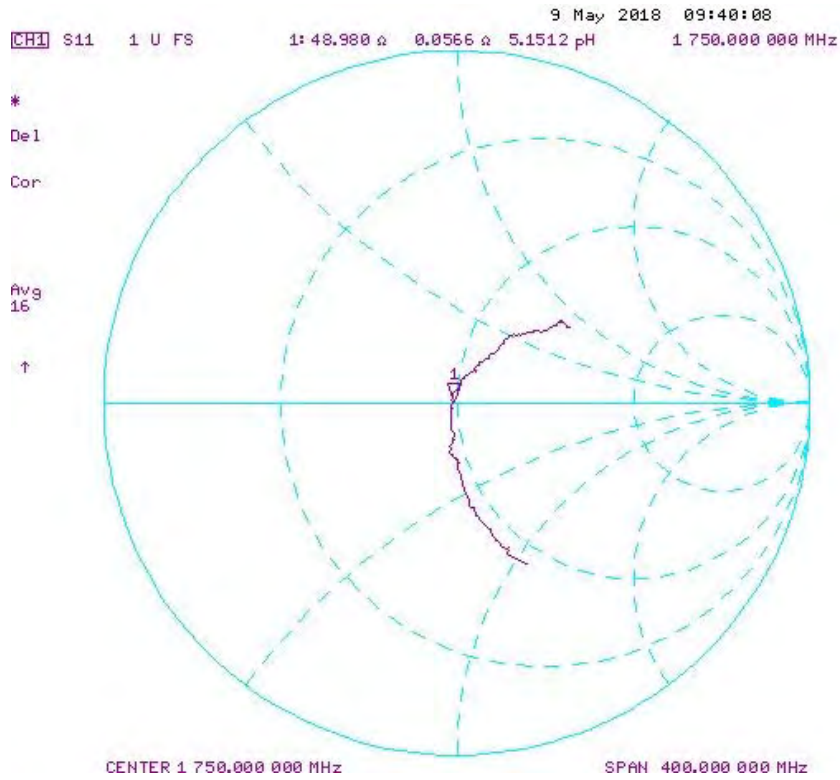

Impedance & Return-Loss Measurement Plot for Body TSL

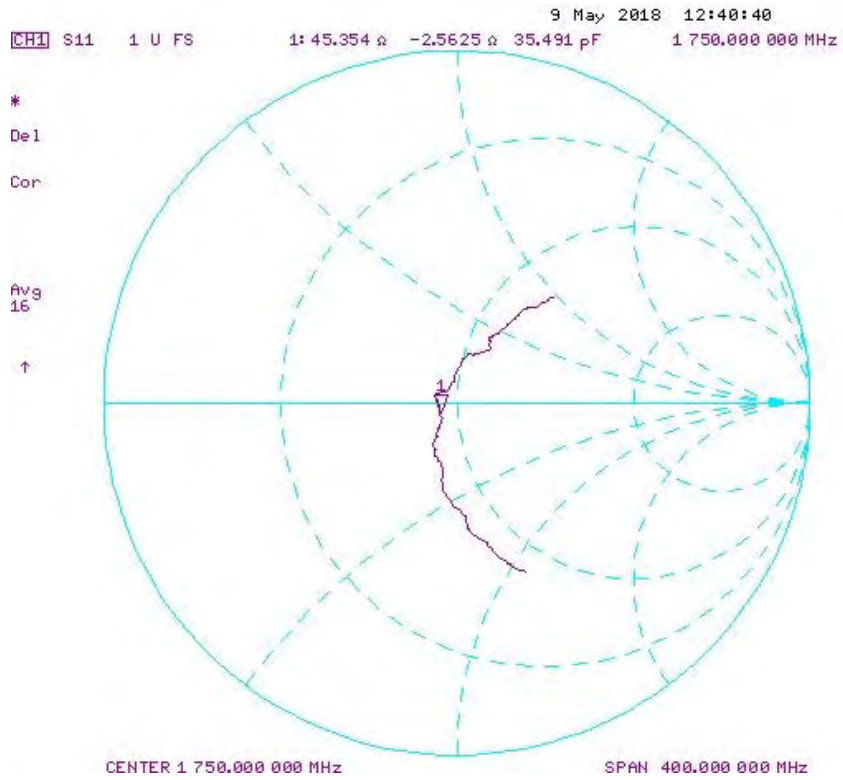



Accredited by the Swiss Accreditation Service (SAS)
The Swiss Accreditation Service is one of the signatories to the EA
Multilateral Agreement for the recognition of calibration certificates

Accreditation No.: **SCS 0108**

Client **PC Test**

Certificate No: **D1750V2-1150_Oct18**

CALIBRATION CERTIFICATE

Object **D1750V2 - SN:1150**

Calibration procedure(s) **QA CAL-05.v10
Calibration procedure for dipole validation kits above 700 MHz**

Calibration date: **October 22, 2018**

*BN ✓
10/30/2018*

This calibration certificate documents the traceability to national standards, which realize the physical units of measurements (SI).
The measurements and the uncertainties with confidence probability are given on the following pages and are part of the certificate.

All calibrations have been conducted in the closed laboratory facility: environment temperature (22 ± 3)°C and humidity < 70%.

Calibration Equipment used (M&TE critical for calibration)

| Primary Standards | ID # | Cal Date (Certificate No.) | Scheduled Calibration |
|-----------------------------|--------------------|---------------------------------|-----------------------|
| Power meter NRP | SN: 104778 | 04-Apr-18 (No. 217-02672/02673) | Apr-19 |
| Power sensor NRP-Z91 | SN: 103244 | 04-Apr-18 (No. 217-02672) | Apr-19 |
| Power sensor NRP-Z91 | SN: 103245 | 04-Apr-18 (No. 217-02673) | Apr-19 |
| Reference 20 dB Attenuator | SN: 5058 (20k) | 04-Apr-18 (No. 217-02682) | Apr-19 |
| Type-N mismatch combination | SN: 5047.2 / 06327 | 04-Apr-18 (No. 217-02683) | Apr-19 |
| Reference Probe EX3DV4 | SN: 7349 | 30-Dec-17 (No. EX3-7349_Dec17) | Dec-18 |
| DAE4 | SN: 601 | 04-Oct-18 (No. DAE4-601_Oct18) | Oct-19 |

| Secondary Standards | ID # | Check Date (in house) | Scheduled Check |
|---------------------------------|----------------|-----------------------------------|------------------------|
| Power meter EPM-442A | SN: GB37480704 | 07-Oct-15 (in house check Oct-18) | In house check: Oct-20 |
| Power sensor HP 8481A | SN: US37292783 | 07-Oct-15 (in house check Oct-18) | In house check: Oct-20 |
| Power sensor HP 8481A | SN: MY41092317 | 07-Oct-15 (in house check Oct-18) | In house check: Oct-20 |
| RF generator R&S SMT-06 | SN: 100972 | 15-Jun-15 (in house check Oct-18) | In house check: Oct-20 |
| Network Analyzer Agilent E8358A | SN: US41080477 | 31-Mar-14 (in house check Oct-18) | In house check: Oct-19 |

| | | | |
|----------------|------------------------------|--|--------------------------------|
| Calibrated by: | Name Michael Weber | Function Laboratory Technician | Signature <i>M. Weber</i> |
| Approved by: | Name Katja Pokovic | Function Technical Manager | Signature <i>K. Pokovic</i> |

Issued: October 22, 2018

This calibration certificate shall not be reproduced except in full without written approval of the laboratory.



Accredited by the Swiss Accreditation Service (SAS)
The Swiss Accreditation Service is one of the signatories to the EA
Multilateral Agreement for the recognition of calibration certificates

Accreditation No.: **SCS 0108**

Glossary:

| | |
|-------|---------------------------------|
| TSL | tissue simulating liquid |
| ConvF | sensitivity in TSL / NORM x,y,z |
| N/A | not applicable or not measured |

Calibration is Performed According to the Following Standards:

- IEEE Std 1528-2013, "IEEE Recommended Practice for Determining the Peak Spatial-Averaged Specific Absorption Rate (SAR) in the Human Head from Wireless Communications Devices: Measurement Techniques", June 2013
- IEC 62209-1, "Measurement procedure for the assessment of Specific Absorption Rate (SAR) from hand-held and body-mounted devices used next to the ear (frequency range of 300 MHz to 6 GHz)", July 2016
- IEC 62209-2, "Procedure to determine the Specific Absorption Rate (SAR) for wireless communication devices used in close proximity to the human body (frequency range of 30 MHz to 6 GHz)", March 2010
- KDB 865664, "SAR Measurement Requirements for 100 MHz to 6 GHz"

Additional Documentation:

- DASY4/5 System Handbook

Methods Applied and Interpretation of Parameters:

- Measurement Conditions:** Further details are available from the Validation Report at the end of the certificate. All figures stated in the certificate are valid at the frequency indicated.
- Antenna Parameters with TSL:** The dipole is mounted with the spacer to position its feed point exactly below the center marking of the flat phantom section, with the arms oriented parallel to the body axis.
- Feed Point Impedance and Return Loss:** These parameters are measured with the dipole positioned under the liquid filled phantom. The impedance stated is transformed from the measurement at the SMA connector to the feed point. The Return Loss ensures low reflected power. No uncertainty required.
- Electrical Delay:** One-way delay between the SMA connector and the antenna feed point. No uncertainty required.
- SAR measured:** SAR measured at the stated antenna input power.
- SAR normalized:** SAR as measured, normalized to an input power of 1 W at the antenna connector.
- SAR for nominal TSL parameters:** The measured TSL parameters are used to calculate the nominal SAR result.

The reported uncertainty of measurement is stated as the standard uncertainty of measurement multiplied by the coverage factor $k=2$, which for a normal distribution corresponds to a coverage probability of approximately 95%.

Measurement Conditions

DASY system configuration, as far as not given on page 1.

| | | |
|-------------------------------------|------------------------|-------------|
| DASY Version | DASY5 | V52.10.2 |
| Extrapolation | Advanced Extrapolation | |
| Phantom | Modular Flat Phantom | |
| Distance Dipole Center - TSL | 10 mm | with Spacer |
| Zoom Scan Resolution | dx, dy, dz = 5 mm | |
| Frequency | 1750 MHz \pm 1 MHz | |

Head TSL parameters

The following parameters and calculations were applied.

| | Temperature | Permittivity | Conductivity |
|--|---------------------|----------------|----------------------|
| Nominal Head TSL parameters | 22.0 °C | 40.1 | 1.37 mho/m |
| Measured Head TSL parameters | (22.0 \pm 0.2) °C | 38.8 \pm 6 % | 1.33 mho/m \pm 6 % |
| Head TSL temperature change during test | < 0.5 °C | ---- | ---- |

SAR result with Head TSL

| SAR averaged over 1 cm³ (1 g) of Head TSL | Condition | |
|---|--------------------|--|
| SAR measured | 250 mW input power | 9.02 W/kg |
| SAR for nominal Head TSL parameters | normalized to 1W | 36.5 W/kg \pm 17.0 % (k=2) |

| SAR averaged over 10 cm³ (10 g) of Head TSL | condition | |
|---|--------------------|--|
| SAR measured | 250 mW input power | 4.76 W/kg |
| SAR for nominal Head TSL parameters | normalized to 1W | 19.2 W/kg \pm 16.5 % (k=2) |

Body TSL parameters

The following parameters and calculations were applied.

| | Temperature | Permittivity | Conductivity |
|--|---------------------|----------------|----------------------|
| Nominal Body TSL parameters | 22.0 °C | 53.4 | 1.49 mho/m |
| Measured Body TSL parameters | (22.0 \pm 0.2) °C | 53.5 \pm 6 % | 1.46 mho/m \pm 6 % |
| Body TSL temperature change during test | < 0.5 °C | ---- | ---- |

SAR result with Body TSL

| SAR averaged over 1 cm³ (1 g) of Body TSL | Condition | |
|---|--------------------|--|
| SAR measured | 250 mW input power | 9.04 W/kg |
| SAR for nominal Body TSL parameters | normalized to 1W | 36.6 W/kg \pm 17.0 % (k=2) |

| SAR averaged over 10 cm³ (10 g) of Body TSL | condition | |
|---|--------------------|--|
| SAR measured | 250 mW input power | 4.82 W/kg |
| SAR for nominal Body TSL parameters | normalized to 1W | 19.4 W/kg \pm 16.5 % (k=2) |

Appendix (Additional assessments outside the scope of SCS 0108)

Antenna Parameters with Head TSL

| | |
|--------------------------------------|--------------------------------|
| Impedance, transformed to feed point | 50.9 Ω - 0.4 j Ω |
| Return Loss | - 40.1 dB |

Antenna Parameters with Body TSL

| | |
|--------------------------------------|--------------------------------|
| Impedance, transformed to feed point | 46.6 Ω - 0.1 j Ω |
| Return Loss | - 29.2 dB |

General Antenna Parameters and Design

| | |
|----------------------------------|----------|
| Electrical Delay (one direction) | 1.217 ns |
|----------------------------------|----------|

After long term use with 100W radiated power, only a slight warming of the dipole near the feedpoint can be measured.

The dipole is made of standard semirigid coaxial cable. The center conductor of the feeding line is directly connected to the second arm of the dipole. The antenna is therefore short-circuited for DC-signals. On some of the dipoles, small end caps are added to the dipole arms in order to improve matching when loaded according to the position as explained in the "Measurement Conditions" paragraph. The SAR data are not affected by this change. The overall dipole length is still according to the Standard.

No excessive force must be applied to the dipole arms, because they might bend or the soldered connections near the feedpoint may be damaged.

Additional EUT Data

| | |
|-----------------|----------------|
| Manufactured by | SPEAG |
| Manufactured on | April 10, 2015 |

DASY5 Validation Report for Head TSL

Date: 22.10.2018

Test Laboratory: SPEAG, Zurich, Switzerland

DUT: Dipole 1750 MHz; Type: D1750V2; Serial: D1750V2 - SN:1150

Communication System: UID 0 - CW; Frequency: 1750 MHz

Medium parameters used: $f = 1750$ MHz; $\sigma = 1.33$ S/m; $\epsilon_r = 38.8$; $\rho = 1000$ kg/m³

Phantom section: Flat Section

Measurement Standard: DASY5 (IEEE/IEC/ANSI C63.19-2011)

DASY52 Configuration:

- Probe: EX3DV4 - SN7349; ConvF(8.5, 8.5, 8.5) @ 1750 MHz; Calibrated: 30.12.2017
- Sensor-Surface: 1.4mm (Mechanical Surface Detection)
- Electronics: DAE4 Sn601; Calibrated: 04.10.2018
- Phantom: Flat Phantom 5.0 (front); Type: QD 000 P50 AA; Serial: 1001
- DASY52 52.10.2(1495); SEMCAD X 14.6.12(7450)

Dipole Calibration for Head Tissue/Pin=250 mW, d=10mm/Zoom Scan (7x7x7)/Cube 0:

Measurement grid: dx=5mm, dy=5mm, dz=5mm

Reference Value = 108.1 V/m; Power Drift = -0.09 dB

Peak SAR (extrapolated) = 16.7 W/kg

SAR(1 g) = 9.02 W/kg; SAR(10 g) = 4.76 W/kg

Maximum value of SAR (measured) = 14.0 W/kg

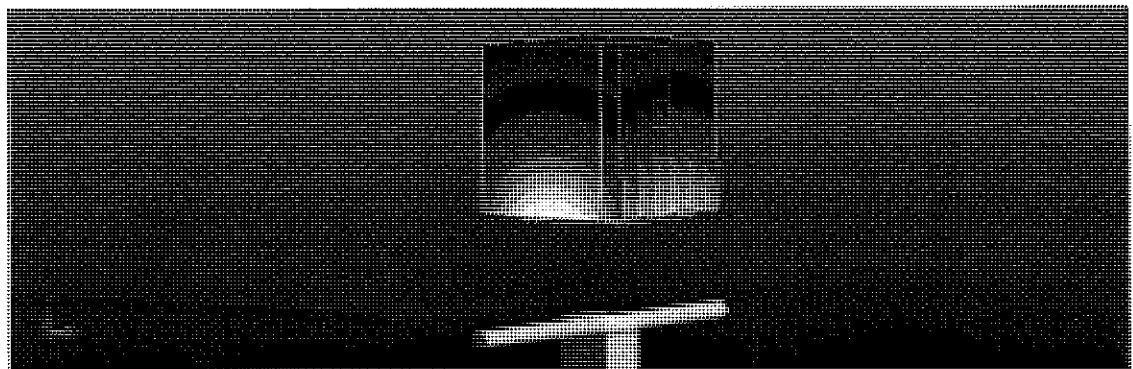
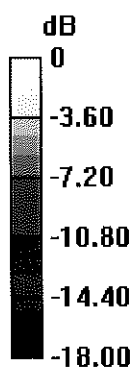

0 dB = 14.0 W/kg = 11.46 dBW/kg

Impedance Measurement Plot for Head TSL

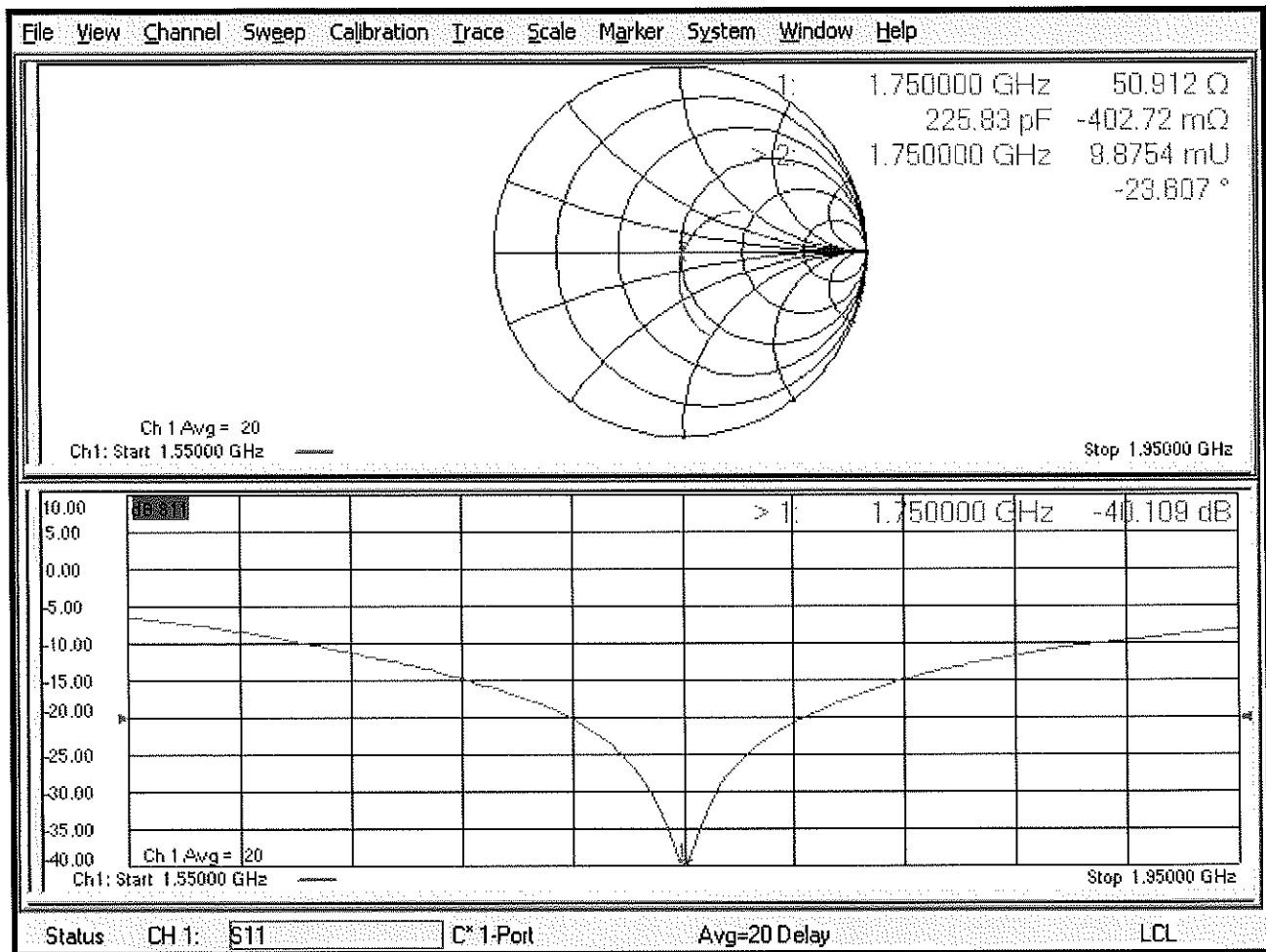

DASY5 Validation Report for Body TSL

Date: 22.10.2018

Test Laboratory: SPEAG, Zurich, Switzerland

DUT: Dipole 1750 MHz; Type: D1750V2; Serial: D1750V2 - SN:1150

Communication System: UID 0 - CW; Frequency: 1750 MHz

Medium parameters used: $f = 1750$ MHz; $\sigma = 1.46$ S/m; $\epsilon_r = 53.5$; $\rho = 1000$ kg/m³

Phantom section: Flat Section

Measurement Standard: DASY5 (IEEE/IEC/ANSI C63.19-2011)

DASY52 Configuration:

- Probe: EX3DV4 - SN7349; ConvF(8.35, 8.35, 8.35) @ 1750 MHz; Calibrated: 30.12.2017
- Sensor-Surface: 1.4mm (Mechanical Surface Detection)
- Electronics: DAE4 Sn601; Calibrated: 04.10.2018
- Phantom: Flat Phantom 5.0 (back); Type: QD 000 P50 AA; Serial: 1002
- DASY52 52.10.2(1495); SEMCAD X 14.6.12(7450)

Dipole Calibration for Body Tissue/Pin=250 mW, d=10mm/Zoom Scan (7x7x7)/Cube 0:

Measurement grid: dx=5mm, dy=5mm, dz=5mm

Reference Value = 102.1 V/m; Power Drift = -0.09 dB

Peak SAR (extrapolated) = 16.0 W/kg

SAR(1 g) = 9.04 W/kg; SAR(10 g) = 4.82 W/kg

Maximum value of SAR (measured) = 13.6 W/kg

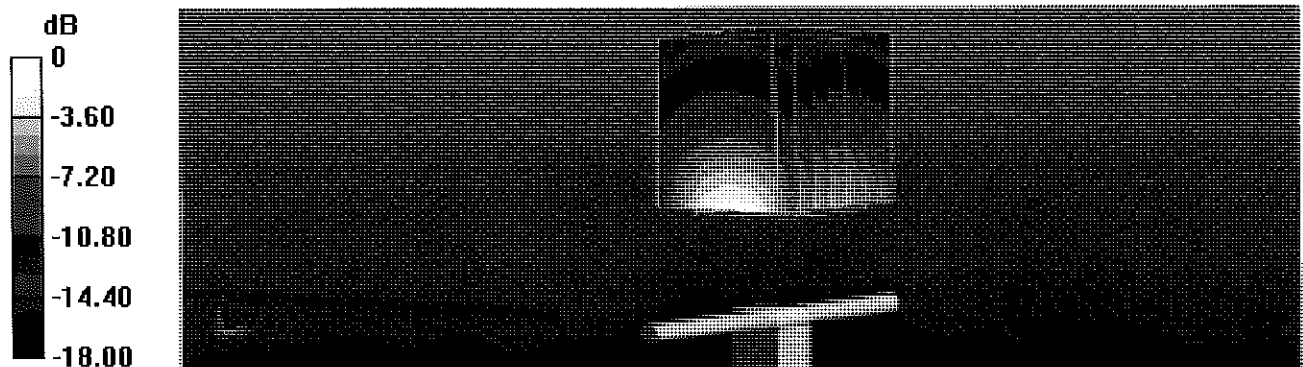

0 dB = 13.6 W/kg = 11.34 dBW/kg

Impedance Measurement Plot for Body TSL

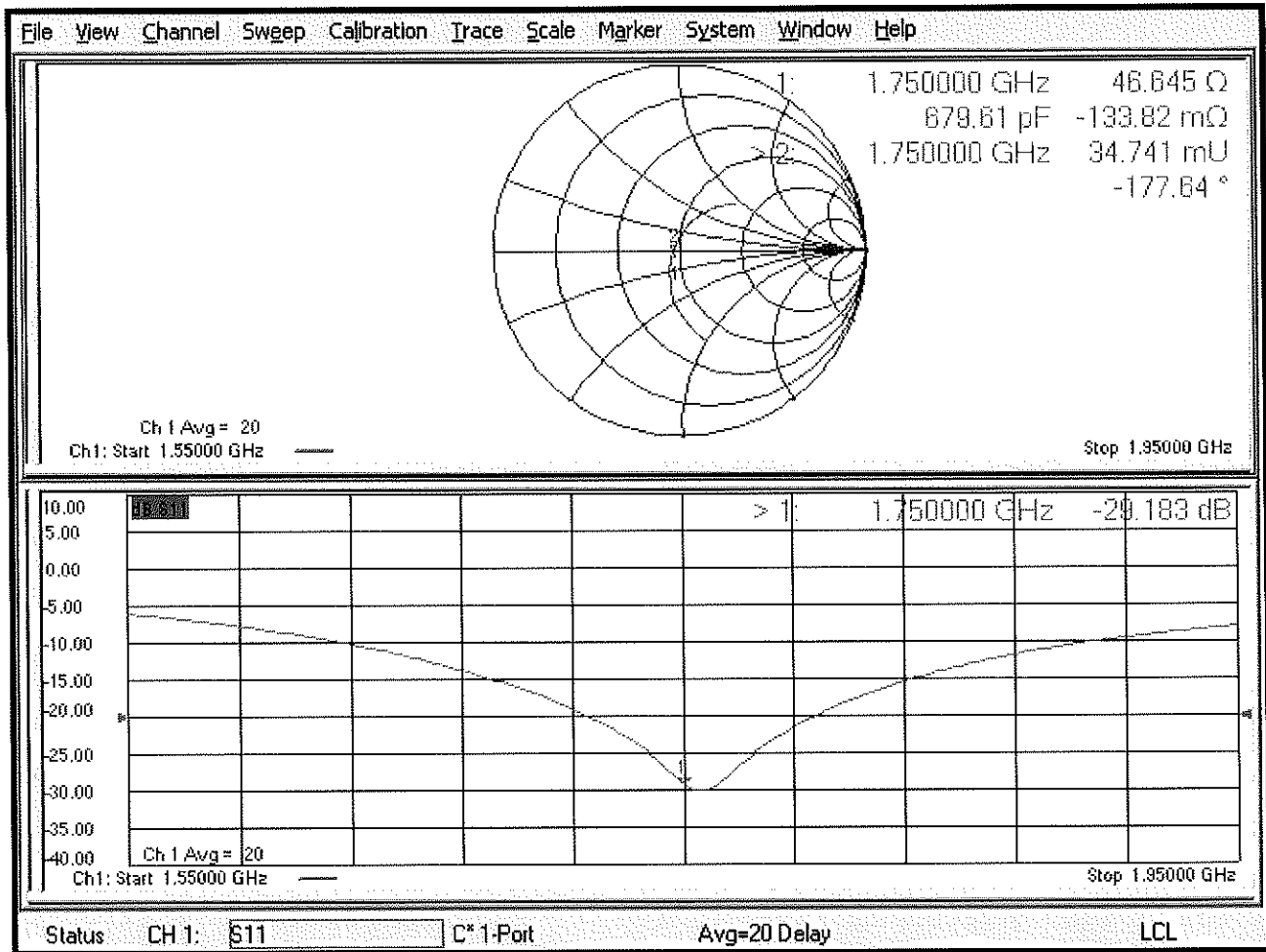



Accredited by the Swiss Accreditation Service (SAS)
The Swiss Accreditation Service is one of the signatories to the EA
Multilateral Agreement for the recognition of calibration certificates

Accreditation No.: **SCS 0108**

Client **PC Test**

Certificate No: **D1765V2-1008_May18**

CALIBRATION CERTIFICATE

Object **D1765V2 - SN:1008**

Calibration procedure(s) **QA CAL-05.v10
Calibration procedure for dipole validation kits above 700 MHz**

*BNW
7/11/2018*

Calibration date: **May 23, 2018**

This calibration certificate documents the traceability to national standards, which realize the physical units of measurements (SI).
The measurements and the uncertainties with confidence probability are given on the following pages and are part of the certificate.

All calibrations have been conducted in the closed laboratory facility: environment temperature (22 ± 3)°C and humidity < 70%.

Calibration Equipment used (M&TE critical for calibration)

| Primary Standards | ID # | Cal Date (Certificate No.) | Scheduled Calibration |
|-----------------------------|--------------------|---------------------------------|-----------------------|
| Power meter NRP | SN: 104778 | 04-Apr-18 (No. 217-02672/02673) | Apr-19 |
| Power sensor NRP-Z91 | SN: 103244 | 04-Apr-18 (No. 217-02672) | Apr-19 |
| Power sensor NRP-Z91 | SN: 103245 | 04-Apr-18 (No. 217-02673) | Apr-19 |
| Reference 20 dB Attenuator | SN: 5058 (20k) | 04-Apr-18 (No. 217-02682) | Apr-19 |
| Type-N mismatch combination | SN: 5047.2 / 06327 | 04-Apr-18 (No. 217-02683) | Apr-19 |
| Reference Probe EX3DV4 | SN: 7349 | 30-Dec-17 (No. EX3-7349_Dec17) | Dec-18 |
| DAE4 | SN: 601 | 26-Oct-17 (No. DAE4-601_Oct17) | Oct-18 |

| Secondary Standards | ID # | Check Date (in house) | Scheduled Check |
|---------------------------|----------------|-----------------------------------|------------------------|
| Power meter EPM-442A | SN: GB37480704 | 07-Oct-15 (in house check Oct-16) | In house check: Oct-18 |
| Power sensor HP 8481A | SN: US37292783 | 07-Oct-15 (in house check Oct-16) | In house check: Oct-18 |
| Power sensor HP 8481A | SN: MY41092317 | 07-Oct-15 (in house check Oct-16) | In house check: Oct-18 |
| RF generator R&S SMT-06 | SN: 100972 | 15-Jun-15 (in house check Oct-16) | In house check: Oct-18 |
| Network Analyzer HP 8753E | SN: US37390585 | 18-Oct-01 (in house check Oct-17) | In house check: Oct-18 |

Calibrated by: **Manu Seltz** Name: **Manu Seltz** Function: **Laboratory Technician**

Signature *[Handwritten Signature]*

Approved by: **Katja Pokovic** Name: **Katja Pokovic** Function: **Technical Manager**

Signature *[Handwritten Signature]*

Issued: May 23, 2018

This calibration certificate shall not be reproduced except in full without written approval of the laboratory.



Accredited by the Swiss Accreditation Service (SAS)

The Swiss Accreditation Service is one of the signatories to the EA
Multilateral Agreement for the recognition of calibration certificates

Accreditation No.: **SCS 0108**

Glossary:

| | |
|-------|---------------------------------|
| TSL | tissue simulating liquid |
| ConvF | sensitivity in TSL / NORM x,y,z |
| N/A | not applicable or not measured |

Calibration is Performed According to the Following Standards:

- IEEE Std 1528-2013, "IEEE Recommended Practice for Determining the Peak Spatial-Averaged Specific Absorption Rate (SAR) in the Human Head from Wireless Communications Devices: Measurement Techniques", June 2013
- IEC 62209-1, "Measurement procedure for the assessment of Specific Absorption Rate (SAR) from hand-held and body-mounted devices used next to the ear (frequency range of 300 MHz to 6 GHz)", July 2016
- IEC 62209-2, "Procedure to determine the Specific Absorption Rate (SAR) for wireless communication devices used in close proximity to the human body (frequency range of 30 MHz to 6 GHz)", March 2010
- KDB 865664, "SAR Measurement Requirements for 100 MHz to 6 GHz"

Additional Documentation:

- DASY4/5 System Handbook

Methods Applied and Interpretation of Parameters:

- Measurement Conditions:** Further details are available from the Validation Report at the end of the certificate. All figures stated in the certificate are valid at the frequency indicated.
- Antenna Parameters with TSL:** The dipole is mounted with the spacer to position its feed point exactly below the center marking of the flat phantom section, with the arms oriented parallel to the body axis.
- Feed Point Impedance and Return Loss:** These parameters are measured with the dipole positioned under the liquid filled phantom. The impedance stated is transformed from the measurement at the SMA connector to the feed point. The Return Loss ensures low reflected power. No uncertainty required.
- Electrical Delay:** One-way delay between the SMA connector and the antenna feed point. No uncertainty required.
- SAR measured:** SAR measured at the stated antenna input power.
- SAR normalized:** SAR as measured, normalized to an input power of 1 W at the antenna connector.
- SAR for nominal TSL parameters:** The measured TSL parameters are used to calculate the nominal SAR result.

The reported uncertainty of measurement is stated as the standard uncertainty of measurement multiplied by the coverage factor $k=2$, which for a normal distribution corresponds to a coverage probability of approximately 95%.

Measurement Conditions

DASY system configuration, as far as not given on page 1.

| | | |
|-------------------------------------|------------------------|-------------|
| DASY Version | DASY5 | V52.10.1 |
| Extrapolation | Advanced Extrapolation | |
| Phantom | Modular Flat Phantom | |
| Distance Dipole Center - TSL | 10 mm | with Spacer |
| Zoom Scan Resolution | dx, dy, dz = 5.0 mm | |
| Frequency | 1750 MHz \pm 1 MHz | |

Head TSL parameters

The following parameters and calculations were applied.

| | Temperature | Permittivity | Conductivity |
|--|---------------------|----------------|----------------------|
| Nominal Head TSL parameters | 22.0 °C | 40.1 | 1.37 mho/m |
| Measured Head TSL parameters | (22.0 \pm 0.2) °C | 39.0 \pm 6 % | 1.34 mho/m \pm 6 % |
| Head TSL temperature change during test | < 0.5 °C | ---- | ---- |

SAR result with Head TSL

| SAR averaged over 1 cm³ (1 g) of Head TSL | Condition | |
|---|--------------------|--|
| SAR measured | 250 mW input power | 8.94 W/kg |
| SAR for nominal Head TSL parameters | normalized to 1W | 36.2 W/kg \pm 17.0 % (k=2) |

| SAR averaged over 10 cm³ (10 g) of Head TSL | condition | |
|---|--------------------|--|
| SAR measured | 250 mW input power | 4.71 W/kg |
| SAR for nominal Head TSL parameters | normalized to 1W | 19.0 W/kg \pm 16.5 % (k=2) |

Body TSL parameters

The following parameters and calculations were applied.

| | Temperature | Permittivity | Conductivity |
|--|---------------------|----------------|----------------------|
| Nominal Body TSL parameters | 22.0 °C | 53.4 | 1.49 mho/m |
| Measured Body TSL parameters | (22.0 \pm 0.2) °C | 53.2 \pm 6 % | 1.46 mho/m \pm 6 % |
| Body TSL temperature change during test | < 0.5 °C | ---- | ---- |

SAR result with Body TSL

| SAR averaged over 1 cm³ (1 g) of Body TSL | Condition | |
|---|--------------------|--|
| SAR measured | 250 mW input power | 9.21 W/kg |
| SAR for nominal Body TSL parameters | normalized to 1W | 37.4 W/kg \pm 17.0 % (k=2) |

| SAR averaged over 10 cm³ (10 g) of Body TSL | condition | |
|---|--------------------|--|
| SAR measured | 250 mW input power | 4.92 W/kg |
| SAR for nominal Body TSL parameters | normalized to 1W | 19.9 W/kg \pm 16.5 % (k=2) |

Appendix (Additional assessments outside the scope of SCS 0108)

Antenna Parameters with Head TSL

| | |
|--------------------------------------|--------------------------------|
| Impedance, transformed to feed point | 47.7 Ω - 6.5 j Ω |
| Return Loss | - 23.0 dB |

Antenna Parameters with Body TSL

| | |
|--------------------------------------|--------------------------------|
| Impedance, transformed to feed point | 43.3 Ω - 6.0 j Ω |
| Return Loss | - 20.3 dB |

General Antenna Parameters and Design

| | |
|----------------------------------|----------|
| Electrical Delay (one direction) | 1.210 ns |
|----------------------------------|----------|

After long term use with 100W radiated power, only a slight warming of the dipole near the feedpoint can be measured.

The dipole is made of standard semirigid coaxial cable. The center conductor of the feeding line is directly connected to the second arm of the dipole. The antenna is therefore short-circuited for DC-signals. On some of the dipoles, small end caps are added to the dipole arms in order to improve matching when loaded according to the position as explained in the "Measurement Conditions" paragraph. The SAR data are not affected by this change. The overall dipole length is still according to the Standard.

No excessive force must be applied to the dipole arms, because they might bend or the soldered connections near the feedpoint may be damaged.

Additional EUT Data

| | |
|-----------------|------------------|
| Manufactured by | SPEAG |
| Manufactured on | October 06, 2005 |

Appendix (Additional assessments outside the scope of SCS 0108)

Measurement Conditions

DASY system configuration, as far as not given on page 1 and 3.

| | | |
|---------|------------------|-----------------------------|
| Phantom | SAM Head Phantom | For usage with cSAR3DV2-R/L |
|---------|------------------|-----------------------------|

SAR result with SAM Head (Top)

| SAR averaged over 1 cm ³ (1 g) of Head TSL | Condition | |
|---|--------------------|---------------------------------|
| SAR measured | 250 mW input power | 9.26 W/kg |
| SAR for nominal Head TSL parameters | normalized to 1W | 37.4 W/kg ± 17.5 % (k=2) |

| SAR averaged over 10 cm ³ (10 g) of Head TSL | condition | |
|---|--------------------|---------------------------------|
| SAR measured | 250 mW input power | 4.95 W/kg |
| SAR for nominal Head TSL parameters | normalized to 1W | 19.9 W/kg ± 16.9 % (k=2) |

SAR result with SAM Head (Mouth)

| SAR averaged over 1 cm ³ (1 g) of Head TSL | Condition | |
|---|--------------------|---------------------------------|
| SAR measured | 250 mW input power | 9.47 W/kg |
| SAR for nominal Head TSL parameters | normalized to 1W | 38.2 W/kg ± 17.5 % (k=2) |

| SAR averaged over 10 cm ³ (10 g) of Head TSL | condition | |
|---|--------------------|---------------------------------|
| SAR measured | 250 mW input power | 5.06 W/kg |
| SAR for nominal Head TSL parameters | normalized to 1W | 20.4 W/kg ± 16.9 % (k=2) |

SAR result with SAM Head (Neck)

| SAR averaged over 1 cm ³ (1 g) of Head TSL | Condition | |
|---|--------------------|---------------------------------|
| SAR measured | 250 mW input power | 9.26 W/kg |
| SAR for nominal Head TSL parameters | normalized to 1W | 37.4 W/kg ± 17.5 % (k=2) |

| SAR averaged over 10 cm ³ (10 g) of Head TSL | condition | |
|---|--------------------|---------------------------------|
| SAR measured | 250 mW input power | 5.02 W/kg |
| SAR for nominal Head TSL parameters | normalized to 1W | 20.2 W/kg ± 16.9 % (k=2) |

SAR result with SAM Head (Ear)

| SAR averaged over 1 cm ³ (1 g) of Head TSL | Condition | |
|---|--------------------|---------------------------------|
| SAR measured | 250 mW input power | 7.12 W/kg |
| SAR for nominal Head TSL parameters | normalized to 1W | 28.7 W/kg ± 17.5 % (k=2) |

| SAR averaged over 10 cm ³ (10 g) of Head TSL | condition | |
|---|--------------------|---------------------------------|
| SAR measured | 250 mW input power | 4.01 W/kg |
| SAR for nominal Head TSL parameters | normalized to 1W | 16.1 W/kg ± 16.9 % (k=2) |

DASY5 Validation Report for Head TSL

Date: 15.05.2018

Test Laboratory: SPEAG, Zurich, Switzerland

DUT: Dipole 1765 MHz; Type: D1765V2; Serial: D1765V2 - SN:1008

Communication System: UID 0 - CW; Frequency: 1750 MHz

Medium parameters used: $f = 1750$ MHz; $\sigma = 1.34$ S/m; $\epsilon_r = 39$; $\rho = 1000$ kg/m³

Phantom section: Flat Section

Measurement Standard: DASY5 (IEEE/IEC/ANSI C63.19-2011)

DASY52 Configuration:

- Probe: EX3DV4 - SN7349; ConvF(8.5, 8.5, 8.5) @ 1750 MHz; Calibrated: 30.12.2017
- Sensor-Surface: 1.4mm (Mechanical Surface Detection)
- Electronics: DAE4 Sn601; Calibrated: 26.10.2017
- Phantom: Flat Phantom 5.0 (front); Type: QD 000 P50 AA; Serial: 1001
- DASY52 52.10.1(1476); SEMCAD X 14.6.11(7439)

Dipole Calibration for Head Tissue/Pin=250 mW, d=10mm/Zoom Scan (7x7x7)/Cube 0:

Measurement grid: dx=5mm, dy=5mm, dz=5mm

Reference Value = 106.6 V/m; Power Drift = -0.02 dB

Peak SAR (extrapolated) = 16.4 W/kg

SAR(1 g) = 8.94 W/kg; SAR(10 g) = 4.71 W/kg

Maximum value of SAR (measured) = 13.8 W/kg

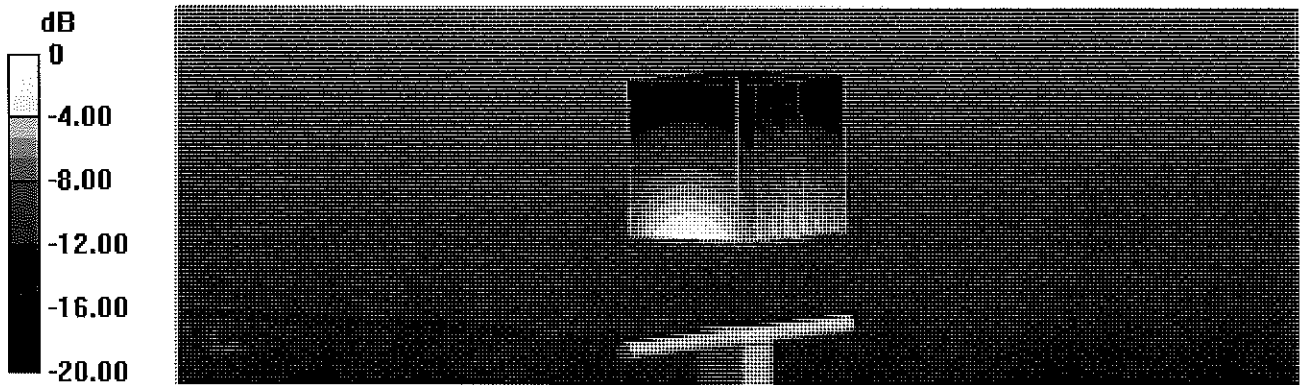

Impedance Measurement Plot for Head TSL

15 May 2018 11:19:20

CH1 S11 1 U FS 1: 47.658 Ω -6.5039 Ω 13.983 pF 1 750.000 000 MHz

*
Del
CA
Avg
16
H1d

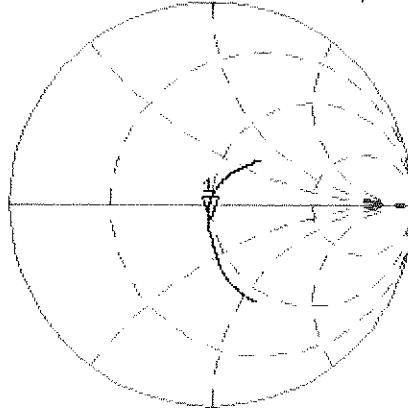

CH2 S11 LOG 5 dB/REF -20 dB 1:-23.017 dB 1 750.000 000 MHz

CA
Avg
16
H1d

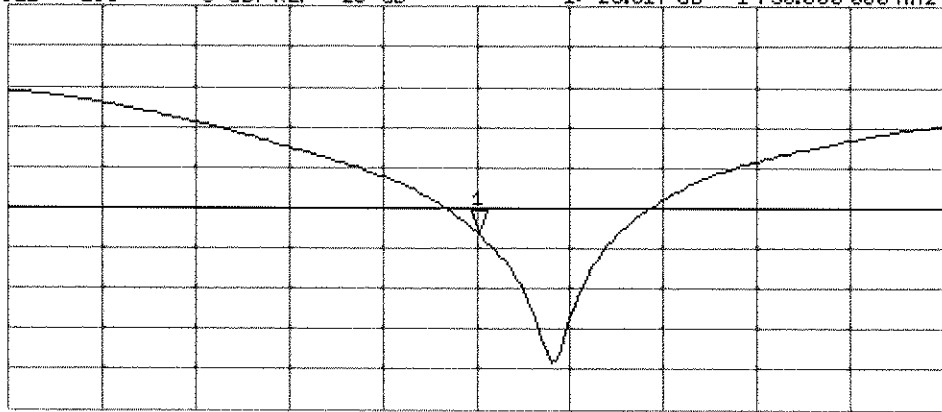

START 1 550.000 000 MHz

STOP 1 950.000 000 MHz

DASY5 Validation Report for Body TSL

Date: 15.05.2018

Test Laboratory: SPEAG, Zurich, Switzerland

DUT: Dipole 1765 MHz; Type: D1765V2; Serial: D1765V2 - SN:1008

Communication System: UID 0 - CW; Frequency: 1750 MHz

Medium parameters used: $f = 1750$ MHz; $\sigma = 1.46$ S/m; $\epsilon_r = 53.2$; $\rho = 1000$ kg/m³

Phantom section: Flat Section

Measurement Standard: DASY5 (IEEE/IEC/ANSI C63.19-2011)

DASY52 Configuration:

- Probe: EX3DV4 - SN7349; ConvF(8.35, 8.35, 8.35) @ 1750 MHz; Calibrated: 30.12.2017
- Sensor-Surface: 1.4mm (Mechanical Surface Detection)
- Electronics: DAE4 Sn601; Calibrated: 26.10.2017
- Phantom: Flat Phantom 5.0 (back); Type: QD 000 P50 AA; Serial: 1002
- DASY52 52.10.1(1476); SEMCAD X 14.6.11(7439)

Dipole Calibration for Body Tissue/Pin=250 mW, d=10mm/Zoom Scan (7x7x7)/Cube 0:

Measurement grid: dx=5mm, dy=5mm, dz=5mm

Reference Value = 102.4 V/m; Power Drift = -0.06 dB

Peak SAR (extrapolated) = 16.1 W/kg

SAR(1 g) = 9.21 W/kg; SAR(10 g) = 4.92 W/kg

Maximum value of SAR (measured) = 13.7 W/kg

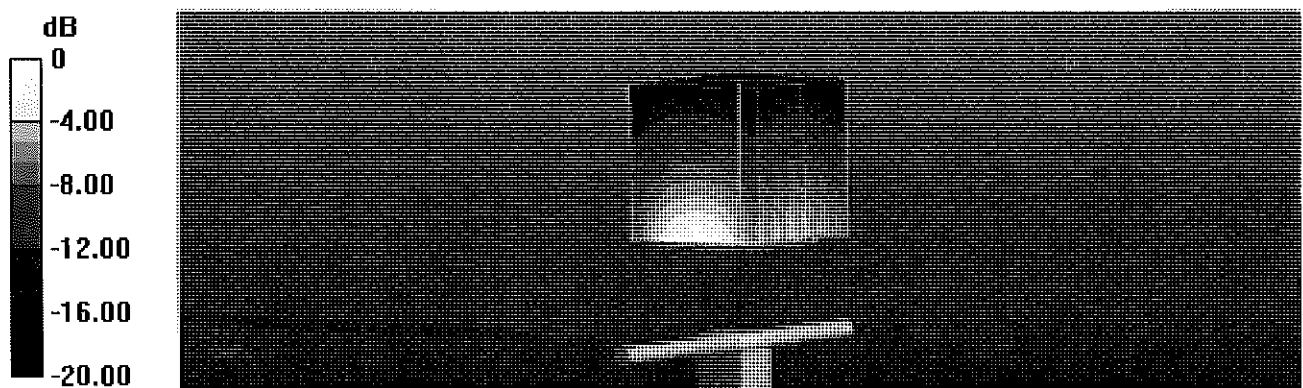

Impedance Measurement Plot for Body TSL

15 May 2018 11:18:17

CH1 S11 1 U FS 1: 43.322 Ω -6.0117 Ω 15.128 pF 1 750.000 000 MHz

*
De1
CA
Avg
16
H1d

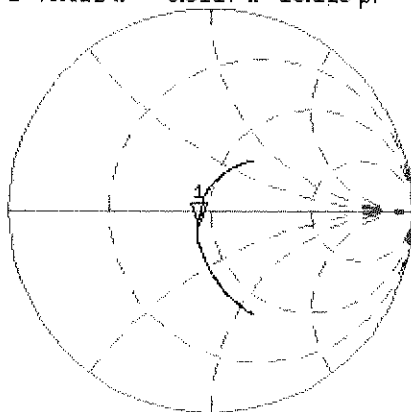

CH2 S11 LOG 5 dB/REF -20 dB 1:-20.349 dB 1 750.000 000 MHz

CA
Avg
16
H1d

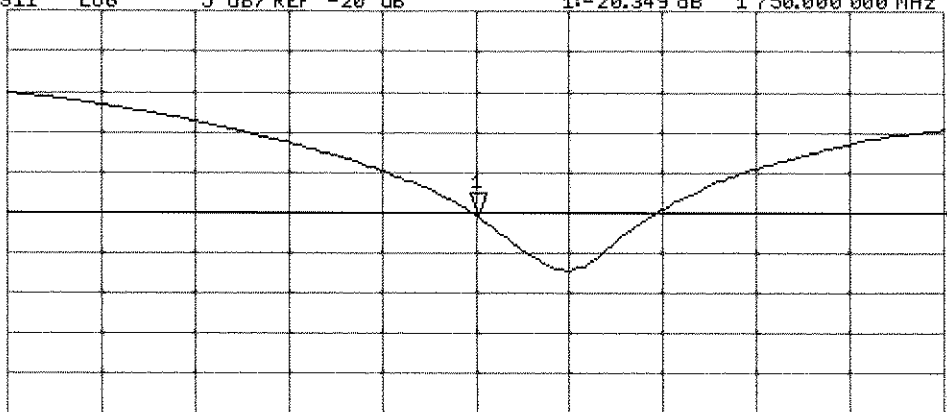

START 1 550.000 000 MHz

STOP 1 950.000 000 MHz

DASY5 Validation Report for SAM Head

Date: 23.05.2018

Test Laboratory: SPEAG, Zurich, Switzerland

DUT: Dipole 1765 MHz; Type: D1765V2; Serial: D1765V2 - SN:1008

Communication System: UID 0 - CW; Frequency: 1750 MHz

Medium parameters used: $f = 1750$ MHz; $\sigma = 1.37$ S/m; $\epsilon_r = 41.8$; $\rho = 1000$ kg/m³

Measurement Standard: DASY5 (IEEE/IEC/ANSI C63.19-2011)

DASY52 Configuration:

- Probe: EX3DV4 - SN7349; ConvF(8.5, 8.5, 8.5) @ 1750 MHz; Calibrated: 30.12.2017
- Sensor-Surface: 1.4mm (Mechanical Surface Detection)
- Electronics: DAE4 Sn601; Calibrated: 26.10.2017
- Phantom: SAM Head
- DASY52 52.10.1(1476); SEMCAD X 14.6.11(7439)

SAM/Head/Top/Zoom Scan (7x7x7)/Cube 0: Measurement grid: dx=5mm, dy=5mm, dz=5mm

Reference Value = 105.8 V/m; Power Drift = 0.02 dB

Peak SAR (extrapolated) = 16.4 W/kg

SAR(1 g) = 9.26 W/kg; SAR(10 g) = 4.95 W/kg

Maximum value of SAR (measured) = 13.9 W/kg

SAM/Head/Mouth/Zoom Scan (7x7x7)/Cube 0: Measurement grid: dx=5mm, dy=5mm, dz=5mm

Reference Value = 104.2 V/m; Power Drift = -0.04 dB

Peak SAR (extrapolated) = 16.6 W/kg

SAR(1 g) = 9.47 W/kg; SAR(10 g) = 5.06 W/kg

Maximum value of SAR (measured) = 13.7 W/kg

SAM/Head/Neck/Zoom Scan (7x7x7)/Cube 0: Measurement grid: dx=5mm, dy=5mm, dz=5mm

Reference Value = 104.7 V/m; Power Drift = 0.02 dB

Peak SAR (extrapolated) = 15.8 W/kg

SAR(1 g) = 9.26 W/kg; SAR(10 g) = 5.02 W/kg

Maximum value of SAR (measured) = 13.8 W/kg

SAM/Head/Ear/Zoom Scan (7x7x7)/Cube 0: Measurement grid: dx=5mm, dy=5mm, dz=5mm

Reference Value = 90.46 V/m; Power Drift = -0.02 dB

Peak SAR (extrapolated) = 11.8 W/kg

SAR(1 g) = 7.12 W/kg; SAR(10 g) = 4.01 W/kg

Maximum value of SAR (measured) = 10.3 W/kg

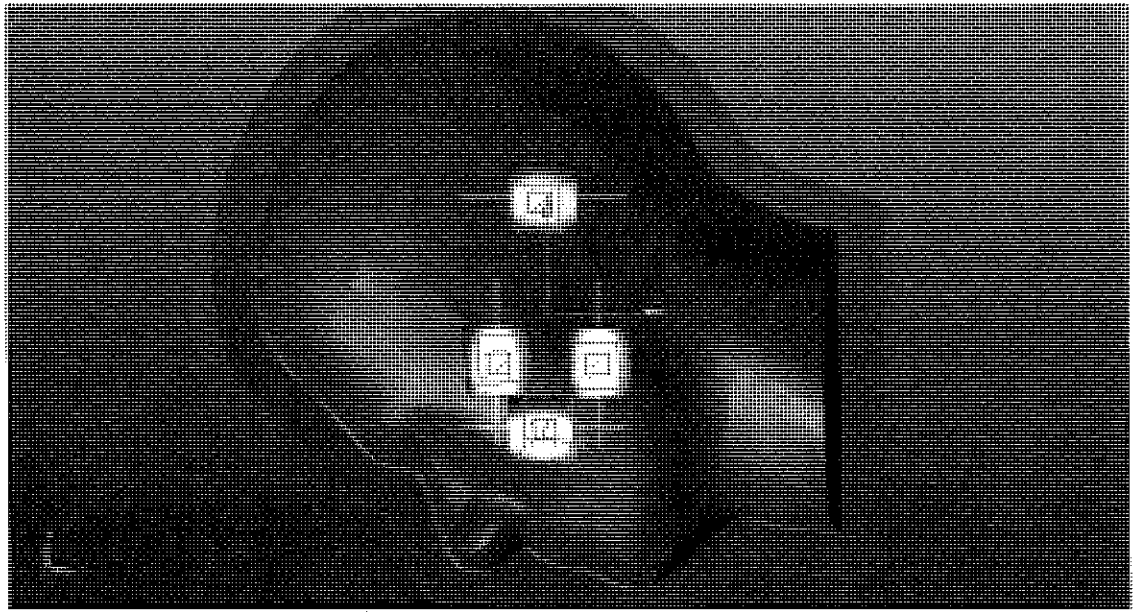
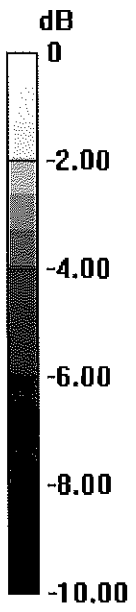

0 dB = 10.3 W/kg = 10.13 dBW/kg



Accredited by the Swiss Accreditation Service (SAS)
The Swiss Accreditation Service is one of the signatories to the EA
Multilateral Agreement for the recognition of calibration certificates

Accreditation No.: **SCS 0108**

Client **PC Test**

Certificate No: **D1900V2-5d080_Oct18**

CALIBRATION CERTIFICATE

Object **D1900V2 - SN:5d080**

Calibration procedure(s) **QA CAL-05.v10
Calibration procedure for dipole validation kits above 700 MHz**

Calibration date: **October 23, 2018**

*BN ✓
10-30-2018*

This calibration certificate documents the traceability to national standards, which realize the physical units of measurements (SI).
The measurements and the uncertainties with confidence probability are given on the following pages and are part of the certificate.

All calibrations have been conducted in the closed laboratory facility: environment temperature (22 ± 3)°C and humidity < 70%.

Calibration Equipment used (M&TE critical for calibration)

| Primary Standards | ID # | Cal Date (Certificate No.) | Scheduled Calibration |
|---------------------------------|--------------------|-----------------------------------|------------------------|
| Power meter NRP | SN: 104778 | 04-Apr-18 (No. 217-02672/02673) | Apr-19 |
| Power sensor NRP-Z91 | SN: 103244 | 04-Apr-18 (No. 217-02672) | Apr-19 |
| Power sensor NRP-Z91 | SN: 103245 | 04-Apr-18 (No. 217-02673) | Apr-19 |
| Reference 20 dB Attenuator | SN: 5058 (20k) | 04-Apr-18 (No. 217-02682) | Apr-19 |
| Type-N mismatch combination | SN: 5047.2 / 06327 | 04-Apr-18 (No. 217-02683) | Apr-19 |
| Reference Probe EX3DV4 | SN: 7349 | 30-Dec-17 (No. EX3-7349_Dec17) | Dec-18 |
| DAE4 | SN: 601 | 04-Oct-18 (No. DAE4-601_Oct18) | Oct-19 |
| Secondary Standards | ID # | Check Date (in house) | Scheduled Check |
| Power meter EPM-442A | SN: GB37480704 | 07-Oct-15 (in house check Oct-18) | In house check: Oct-20 |
| Power sensor HP 8481A | SN: US37292783 | 07-Oct-15 (in house check Oct-18) | In house check: Oct-20 |
| Power sensor HP 8481A | SN: MY41092317 | 07-Oct-15 (in house check Oct-18) | In house check: Oct-20 |
| RF generator R&S SMT-06 | SN: 100972 | 15-Jun-15 (in house check Oct-18) | In house check: Oct-20 |
| Network Analyzer Agilent E8358A | SN: US41080477 | 31-Mar-14 (in house check Oct-18) | In house check: Oct-19 |

| | | | |
|----------------|-----------------------|--|---------------|
| Calibrated by: | Jeton Kastrati | Function Laboratory Technician | Signature |
| Approved by: | Katja Pokovic | Technical Manager | |

Issued: October 23, 2018

This calibration certificate shall not be reproduced except in full without written approval of the laboratory.



Accredited by the Swiss Accreditation Service (SAS)

The Swiss Accreditation Service is one of the signatories to the EA Multilateral Agreement for the recognition of calibration certificates

Glossary:

| | |
|-------|---------------------------------|
| TSL | tissue simulating liquid |
| ConvF | sensitivity in TSL / NORM x,y,z |
| N/A | not applicable or not measured |

Calibration is Performed According to the Following Standards:

- IEEE Std 1528-2013, "IEEE Recommended Practice for Determining the Peak Spatial-Averaged Specific Absorption Rate (SAR) in the Human Head from Wireless Communications Devices: Measurement Techniques", June 2013
- IEC 62209-1, "Measurement procedure for the assessment of Specific Absorption Rate (SAR) from hand-held and body-mounted devices used next to the ear (frequency range of 300 MHz to 6 GHz)", July 2016
- IEC 62209-2, "Procedure to determine the Specific Absorption Rate (SAR) for wireless communication devices used in close proximity to the human body (frequency range of 30 MHz to 6 GHz)", March 2010
- KDB 865664, "SAR Measurement Requirements for 100 MHz to 6 GHz"

Additional Documentation:

- DASY4/5 System Handbook

Methods Applied and Interpretation of Parameters:

- Measurement Conditions:** Further details are available from the Validation Report at the end of the certificate. All figures stated in the certificate are valid at the frequency indicated.
- Antenna Parameters with TSL:** The dipole is mounted with the spacer to position its feed point exactly below the center marking of the flat phantom section, with the arms oriented parallel to the body axis.
- Feed Point Impedance and Return Loss:** These parameters are measured with the dipole positioned under the liquid filled phantom. The impedance stated is transformed from the measurement at the SMA connector to the feed point. The Return Loss ensures low reflected power. No uncertainty required.
- Electrical Delay:** One-way delay between the SMA connector and the antenna feed point. No uncertainty required.
- SAR measured:** SAR measured at the stated antenna input power.
- SAR normalized:** SAR as measured, normalized to an input power of 1 W at the antenna connector.
- SAR for nominal TSL parameters:** The measured TSL parameters are used to calculate the nominal SAR result.

The reported uncertainty of measurement is stated as the standard uncertainty of measurement multiplied by the coverage factor $k=2$, which for a normal distribution corresponds to a coverage probability of approximately 95%.

Measurement Conditions

DASY system configuration, as far as not given on page 1.

| | | |
|-------------------------------------|------------------------|-------------|
| DASY Version | DASY5 | V52.10.2 |
| Extrapolation | Advanced Extrapolation | |
| Phantom | Modular Flat Phantom | |
| Distance Dipole Center - TSL | 10 mm | with Spacer |
| Zoom Scan Resolution | dx, dy, dz = 5 mm | |
| Frequency | 1900 MHz ± 1 MHz | |

Head TSL parameters

The following parameters and calculations were applied.

| | Temperature | Permittivity | Conductivity |
|--|-----------------|--------------|------------------|
| Nominal Head TSL parameters | 22.0 °C | 40.0 | 1.40 mho/m |
| Measured Head TSL parameters | (22.0 ± 0.2) °C | 40.3 ± 6 % | 1.40 mho/m ± 6 % |
| Head TSL temperature change during test | < 0.5 °C | ---- | ---- |

SAR result with Head TSL

| SAR averaged over 1 cm³ (1 g) of Head TSL | Condition | |
|---|--------------------|---------------------------------|
| SAR measured | 250 mW input power | 9.93 W/kg |
| SAR for nominal Head TSL parameters | normalized to 1W | 39.8 W/kg ± 17.0 % (k=2) |

| SAR averaged over 10 cm³ (10 g) of Head TSL | condition | |
|---|--------------------|---------------------------------|
| SAR measured | 250 mW input power | 5.18 W/kg |
| SAR for nominal Head TSL parameters | normalized to 1W | 20.7 W/kg ± 16.5 % (k=2) |

Body TSL parameters

The following parameters and calculations were applied.

| | Temperature | Permittivity | Conductivity |
|--|-----------------|--------------|------------------|
| Nominal Body TSL parameters | 22.0 °C | 53.3 | 1.52 mho/m |
| Measured Body TSL parameters | (22.0 ± 0.2) °C | 52.9 ± 6 % | 1.47 mho/m ± 6 % |
| Body TSL temperature change during test | < 0.5 °C | ---- | ---- |

SAR result with Body TSL

| SAR averaged over 1 cm³ (1 g) of Body TSL | Condition | |
|---|--------------------|---------------------------------|
| SAR measured | 250 mW input power | 9.62 W/kg |
| SAR for nominal Body TSL parameters | normalized to 1W | 39.2 W/kg ± 17.0 % (k=2) |

| SAR averaged over 10 cm³ (10 g) of Body TSL | condition | |
|---|--------------------|---------------------------------|
| SAR measured | 250 mW input power | 5.09 W/kg |
| SAR for nominal Body TSL parameters | normalized to 1W | 20.6 W/kg ± 16.5 % (k=2) |

Appendix (Additional assessments outside the scope of SCS 0108)

Antenna Parameters with Head TSL

| | |
|--------------------------------------|-----------------------------|
| Impedance, transformed to feed point | $52.5 \Omega + 7.9 j\Omega$ |
| Return Loss | - 21.8 dB |

Antenna Parameters with Body TSL

| | |
|--------------------------------------|-----------------------------|
| Impedance, transformed to feed point | $48.1 \Omega + 8.1 j\Omega$ |
| Return Loss | - 21.5 dB |

General Antenna Parameters and Design

| | |
|----------------------------------|----------|
| Electrical Delay (one direction) | 1.193 ns |
|----------------------------------|----------|

After long term use with 100W radiated power, only a slight warming of the dipole near the feedpoint can be measured.

The dipole is made of standard semirigid coaxial cable. The center conductor of the feeding line is directly connected to the second arm of the dipole. The antenna is therefore short-circuited for DC-signals. On some of the dipoles, small end caps are added to the dipole arms in order to improve matching when loaded according to the position as explained in the "Measurement Conditions" paragraph. The SAR data are not affected by this change. The overall dipole length is still according to the Standard.

No excessive force must be applied to the dipole arms, because they might bend or the soldered connections near the feedpoint may be damaged.

Additional EUT Data

| | |
|-----------------|---------------|
| Manufactured by | SPEAG |
| Manufactured on | June 28, 2006 |

DASY5 Validation Report for Head TSL

Date: 23.10.2018

Test Laboratory: SPEAG, Zurich, Switzerland

DUT: Dipole 1900 MHz; Type: D1900V2; Serial: D1900V2 - SN:5d080

Communication System: UID 0 - CW; Frequency: 1900 MHz

Medium parameters used: $f = 1900$ MHz; $\sigma = 1.4$ S/m; $\epsilon_r = 40.3$; $\rho = 1000$ kg/m³

Phantom section: Flat Section

Measurement Standard: DASY5 (IEEE/IEC/ANSI C63.19-2011)

DASY52 Configuration:

- Probe: EX3DV4 - SN7349; ConvF(8.18, 8.18, 8.18) @ 1900 MHz; Calibrated: 30.12.2017
- Sensor-Surface: 1.4mm (Mechanical Surface Detection)
- Electronics: DAE4 Sn601; Calibrated: 04.10.2018
- Phantom: Flat Phantom 5.0 (front); Type: QD 000 P50 AA; Serial: 1001
- DASY52 52.10.2(1495); SEMCAD X 14.6.12(7450)

Dipole Calibration for Head Tissue/Pin=250 mW, d=10mm/Zoom Scan (7x7x7)/Cube 0:

Measurement grid: dx=5mm, dy=5mm, dz=5mm

Reference Value = 110.0 V/m; Power Drift = -0.05 dB

Peak SAR (extrapolated) = 18.7 W/kg

SAR(1 g) = 9.93 W/kg; SAR(10 g) = 5.18 W/kg

Maximum value of SAR (measured) = 15.6 W/kg

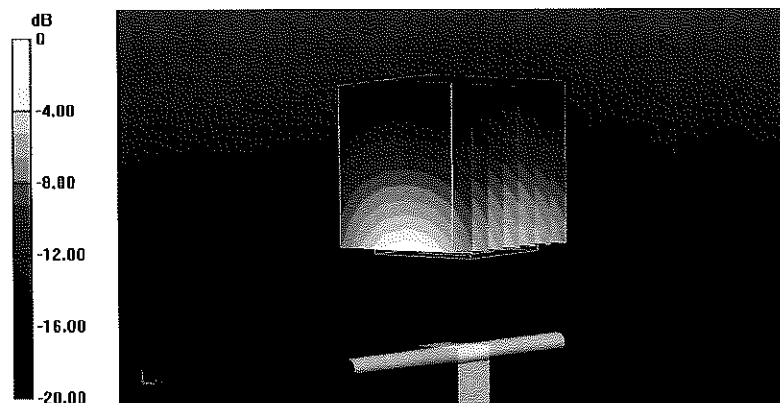

0 dB = 15.6 W/kg = 11.93 dBW/kg

Impedance Measurement Plot for Head TSL

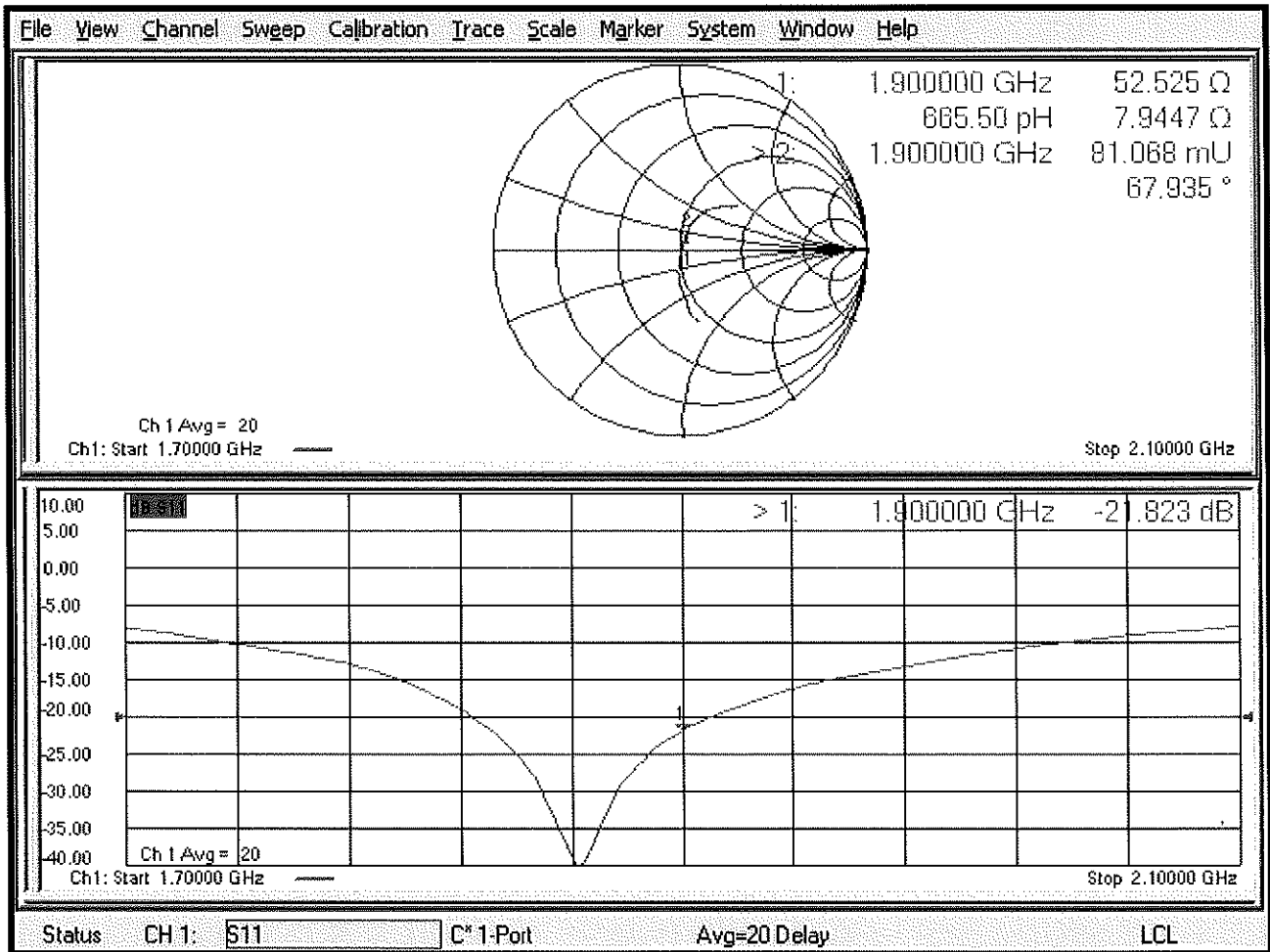

DASY5 Validation Report for Body TSL

Date: 23.10.2018

Test Laboratory: SPEAG, Zurich, Switzerland

DUT: Dipole 1900 MHz; Type: D1900V2; Serial: D1900V2 - SN:5d080

Communication System: UID 0 - CW; Frequency: 1900 MHz

Medium parameters used: $f = 1900$ MHz; $\sigma = 1.47$ S/m; $\epsilon_r = 52.9$; $\rho = 1000$ kg/m³

Phantom section: Flat Section

Measurement Standard: DASY5 (IEEE/IEC/ANSI C63.19-2011)

DASY52 Configuration:

- Probe: EX3DV4 - SN7349; ConvF(8.15, 8.15, 8.15) @ 1900 MHz; Calibrated: 30.12.2017
- Sensor-Surface: 1.4mm (Mechanical Surface Detection)
- Electronics: DAE4 Sn601; Calibrated: 04.10.2018
- Phantom: Flat Phantom 5.0 (back); Type: QD 000 P50 AA; Serial: 1002
- DASY52 52.10.2(1495); SEMCAD X 14.6.12(7450)

Dipole Calibration for Body Tissue/Pin=250 mW, d=10mm/Zoom Scan (7x7x7)/Cube 0:

Measurement grid: dx=5mm, dy=5mm, dz=5mm

Reference Value = 99.86 V/m; Power Drift = 0.00 dB

Peak SAR (extrapolated) = 17.3 W/kg

SAR(1 g) = 9.62 W/kg; SAR(10 g) = 5.09 W/kg

Maximum value of SAR (measured) = 14.1 W/kg

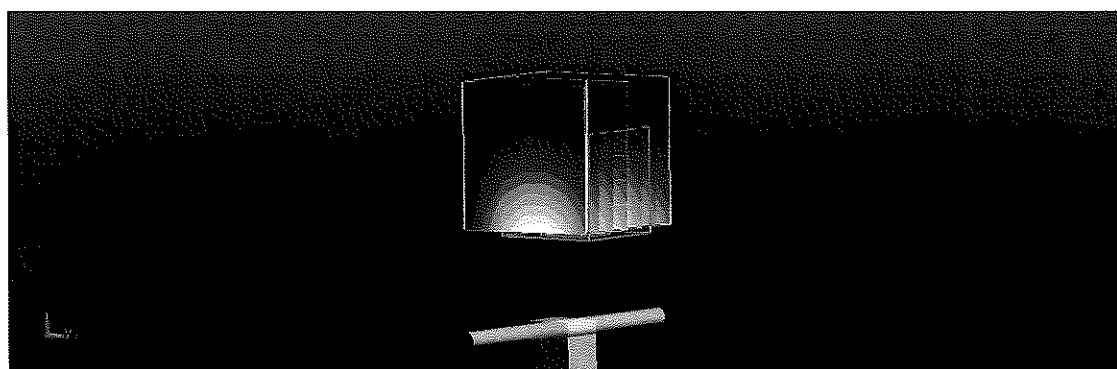
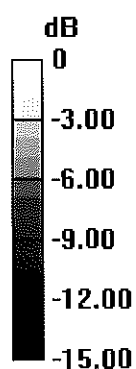

0 dB = 14.1 W/kg = 11.49 dBW/kg



Accredited by the Swiss Accreditation Service (SAS)
The Swiss Accreditation Service is one of the signatories to the EA
Multilateral Agreement for the recognition of calibration certificates

Accreditation No.: **SCS 0108**

Client **PC Test**

Certificate No: **D1900V2-5d149_Oct18**

CALIBRATION CERTIFICATE

Object **D1900V2 - SN:5d149**

Calibration procedure(s) **QA CAL-05.v10
Calibration procedure for dipole validation kits above 700 MHz**

Calibration date: **October 23, 2018**

*BNV
10-30-2018*

This calibration certificate documents the traceability to national standards, which realize the physical units of measurements (SI).
The measurements and the uncertainties with confidence probability are given on the following pages and are part of the certificate.

All calibrations have been conducted in the closed laboratory facility: environment temperature (22 ± 3)°C and humidity < 70%.

Calibration Equipment used (M&TE critical for calibration)

| Primary Standards | ID # | Cal Date (Certificate No.) | Scheduled Calibration |
|-----------------------------|--------------------|---------------------------------|-----------------------|
| Power meter NRP | SN: 104778 | 04-Apr-18 (No. 217-02672/02673) | Apr-19 |
| Power sensor NRP-Z91 | SN: 103244 | 04-Apr-18 (No. 217-02672) | Apr-19 |
| Power sensor NRP-Z91 | SN: 103245 | 04-Apr-18 (No. 217-02673) | Apr-19 |
| Reference 20 dB Attenuator | SN: 5058 (20k) | 04-Apr-18 (No. 217-02682) | Apr-19 |
| Type-N mismatch combination | SN: 5047.2 / 06327 | 04-Apr-18 (No. 217-02683) | Apr-19 |
| Reference Probe EX3DV4 | SN: 7349 | 30-Dec-17 (No. EX3-7349_Dec17) | Dec-18 |
| DAE4 | SN: 601 | 04-Oct-18 (No. DAE4-601_Oct18) | Oct-19 |

| Secondary Standards | ID # | Check Date (in house) | Scheduled Check |
|---------------------------------|----------------|-----------------------------------|------------------------|
| Power meter EPM-442A | SN: GB37480704 | 07-Oct-15 (in house check Oct-18) | In house check: Oct-20 |
| Power sensor HP 8481A | SN: US37292783 | 07-Oct-15 (in house check Oct-18) | In house check: Oct-20 |
| Power sensor HP 8481A | SN: MY41092317 | 07-Oct-15 (in house check Oct-18) | In house check: Oct-20 |
| RF generator R&S SMT-06 | SN: 100972 | 15-Jun-15 (in house check Oct-18) | In house check: Oct-20 |
| Network Analyzer Agilent E8358A | SN: US41080477 | 31-Mar-14 (in house check Oct-18) | In house check: Oct-19 |

Calibrated by: **Jeton Kastrati** **Function: Laboratory Technician**

Approved by: **Katja Pokovic** **Technical Manager**

Signature
[Handwritten signatures]

Issued: October 23, 2018

This calibration certificate shall not be reproduced except in full without written approval of the laboratory.



Accredited by the Swiss Accreditation Service (SAS)

The Swiss Accreditation Service is one of the signatories to the EA
Multilateral Agreement for the recognition of calibration certificates

Accreditation No.: **SCS 0108**

Glossary:

| | |
|-------|---------------------------------|
| TSL | tissue simulating liquid |
| ConvF | sensitivity in TSL / NORM x,y,z |
| N/A | not applicable or not measured |

Calibration is Performed According to the Following Standards:

- IEEE Std 1528-2013, "IEEE Recommended Practice for Determining the Peak Spatial-Averaged Specific Absorption Rate (SAR) in the Human Head from Wireless Communications Devices: Measurement Techniques", June 2013
- IEC 62209-1, "Measurement procedure for the assessment of Specific Absorption Rate (SAR) from hand-held and body-mounted devices used next to the ear (frequency range of 300 MHz to 6 GHz)", July 2016
- IEC 62209-2, "Procedure to determine the Specific Absorption Rate (SAR) for wireless communication devices used in close proximity to the human body (frequency range of 30 MHz to 6 GHz)", March 2010
- KDB 865664, "SAR Measurement Requirements for 100 MHz to 6 GHz"

Additional Documentation:

- DASY4/5 System Handbook

Methods Applied and Interpretation of Parameters:

- Measurement Conditions:** Further details are available from the Validation Report at the end of the certificate. All figures stated in the certificate are valid at the frequency indicated.
- Antenna Parameters with TSL:** The dipole is mounted with the spacer to position its feed point exactly below the center marking of the flat phantom section, with the arms oriented parallel to the body axis.
- Feed Point Impedance and Return Loss:** These parameters are measured with the dipole positioned under the liquid filled phantom. The impedance stated is transformed from the measurement at the SMA connector to the feed point. The Return Loss ensures low reflected power. No uncertainty required.
- Electrical Delay:** One-way delay between the SMA connector and the antenna feed point. No uncertainty required.
- SAR measured:** SAR measured at the stated antenna input power.
- SAR normalized:** SAR as measured, normalized to an input power of 1 W at the antenna connector.
- SAR for nominal TSL parameters:** The measured TSL parameters are used to calculate the nominal SAR result.

The reported uncertainty of measurement is stated as the standard uncertainty of measurement multiplied by the coverage factor $k=2$, which for a normal distribution corresponds to a coverage probability of approximately 95%.

Measurement Conditions

DASY system configuration, as far as not given on page 1.

| | | |
|-------------------------------------|------------------------|-------------|
| DASY Version | DASY5 | V52.10.2 |
| Extrapolation | Advanced Extrapolation | |
| Phantom | Modular Flat Phantom | |
| Distance Dipole Center - TSL | 10 mm | with Spacer |
| Zoom Scan Resolution | dx, dy, dz = 5 mm | |
| Frequency | 1900 MHz \pm 1 MHz | |

Head TSL parameters

The following parameters and calculations were applied.

| | Temperature | Permittivity | Conductivity |
|--|---------------------|----------------|----------------------|
| Nominal Head TSL parameters | 22.0 °C | 40.0 | 1.40 mho/m |
| Measured Head TSL parameters | (22.0 \pm 0.2) °C | 40.3 \pm 6 % | 1.40 mho/m \pm 6 % |
| Head TSL temperature change during test | < 0.5 °C | ---- | ---- |

SAR result with Head TSL

| SAR averaged over 1 cm³ (1 g) of Head TSL | Condition | |
|---|--------------------|--|
| SAR measured | 250 mW input power | 9.80 W/kg |
| SAR for nominal Head TSL parameters | normalized to 1W | 39.3 W/kg \pm 17.0 % (k=2) |

| SAR averaged over 10 cm³ (10 g) of Head TSL | condition | |
|---|--------------------|--|
| SAR measured | 250 mW input power | 5.11 W/kg |
| SAR for nominal Head TSL parameters | normalized to 1W | 20.5 W/kg \pm 16.5 % (k=2) |

Body TSL parameters

The following parameters and calculations were applied.

| | Temperature | Permittivity | Conductivity |
|--|---------------------|----------------|----------------------|
| Nominal Body TSL parameters | 22.0 °C | 53.3 | 1.52 mho/m |
| Measured Body TSL parameters | (22.0 \pm 0.2) °C | 52.9 \pm 6 % | 1.47 mho/m \pm 6 % |
| Body TSL temperature change during test | < 0.5 °C | ---- | ---- |

SAR result with Body TSL

| SAR averaged over 1 cm³ (1 g) of Body TSL | Condition | |
|---|--------------------|--|
| SAR measured | 250 mW input power | 9.68 W/kg |
| SAR for nominal Body TSL parameters | normalized to 1W | 39.4 W/kg \pm 17.0 % (k=2) |

| SAR averaged over 10 cm³ (10 g) of Body TSL | condition | |
|---|--------------------|--|
| SAR measured | 250 mW input power | 5.11 W/kg |
| SAR for nominal Body TSL parameters | normalized to 1W | 20.7 W/kg \pm 16.5 % (k=2) |

Appendix (Additional assessments outside the scope of SCS 0108)

Antenna Parameters with Head TSL

| | |
|--------------------------------------|--------------------------------|
| Impedance, transformed to feed point | 52.9 Ω + 6.3 j Ω |
| Return Loss | - 23.4 dB |

Antenna Parameters with Body TSL

| | |
|--------------------------------------|--------------------------------|
| Impedance, transformed to feed point | 48.5 Ω + 8.2 j Ω |
| Return Loss | - 21.5 dB |

General Antenna Parameters and Design

| | |
|----------------------------------|----------|
| Electrical Delay (one direction) | 1.193 ns |
|----------------------------------|----------|

After long term use with 100W radiated power, only a slight warming of the dipole near the feedpoint can be measured.

The dipole is made of standard semirigid coaxial cable. The center conductor of the feeding line is directly connected to the second arm of the dipole. The antenna is therefore short-circuited for DC-signals. On some of the dipoles, small end caps are added to the dipole arms in order to improve matching when loaded according to the position as explained in the "Measurement Conditions" paragraph. The SAR data are not affected by this change. The overall dipole length is still according to the Standard.

No excessive force must be applied to the dipole arms, because they might bend or the soldered connections near the feedpoint may be damaged.

Additional EUT Data

| | |
|-----------------|----------------|
| Manufactured by | SPEAG |
| Manufactured on | March 11, 2011 |

DASY5 Validation Report for Head TSL

Date: 23.10.2018

Test Laboratory: SPEAG, Zurich, Switzerland

DUT: Dipole 1900 MHz; Type: D1900V2; Serial: D1900V2 - SN:5d149

Communication System: UID 0 - CW; Frequency: 1900 MHz

Medium parameters used: $f = 1900$ MHz; $\sigma = 1.4$ S/m; $\epsilon_r = 40.3$; $\rho = 1000$ kg/m³

Phantom section: Flat Section

Measurement Standard: DASY5 (IEEE/IEC/ANSI C63.19-2011)

DASY52 Configuration:

- Probe: EX3DV4 - SN7349; ConvF(8.18, 8.18, 8.18) @ 1900 MHz; Calibrated: 30.12.2017
- Sensor-Surface: 1.4mm (Mechanical Surface Detection)
- Electronics: DAE4 Sn601; Calibrated: 04.10.2018
- Phantom: Flat Phantom 5.0 (front); Type: QD 000 P50 AA; Serial: 1001
- DASY52 52.10.2(1495); SEMCAD X 14.6.12(7450)

Dipole Calibration for Head Tissue/Pin=250 mW, d=10mm/Zoom Scan (7x7x7)/Cube 0:

Measurement grid: dx=5mm, dy=5mm, dz=5mm

Reference Value = 110.0 V/m; Power Drift = -0.03 dB

Peak SAR (extrapolated) = 18.5 W/kg

SAR(1 g) = 9.8 W/kg; SAR(10 g) = 5.11 W/kg

Maximum value of SAR (measured) = 15.4 W/kg

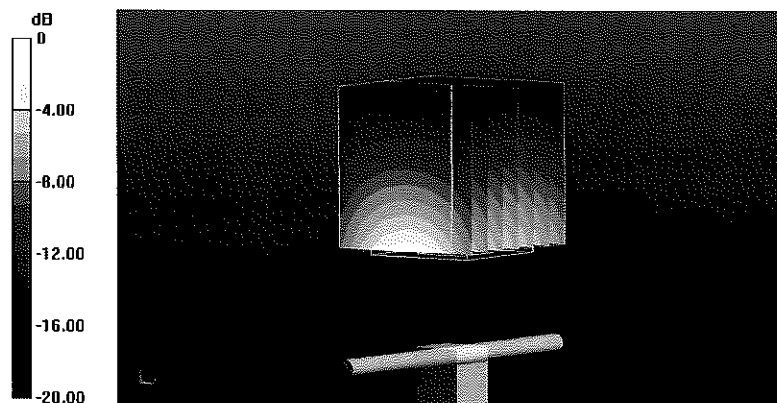

0 dB = 15.4 W/kg = 11.88 dBW/kg

Impedance Measurement Plot for Head TSL

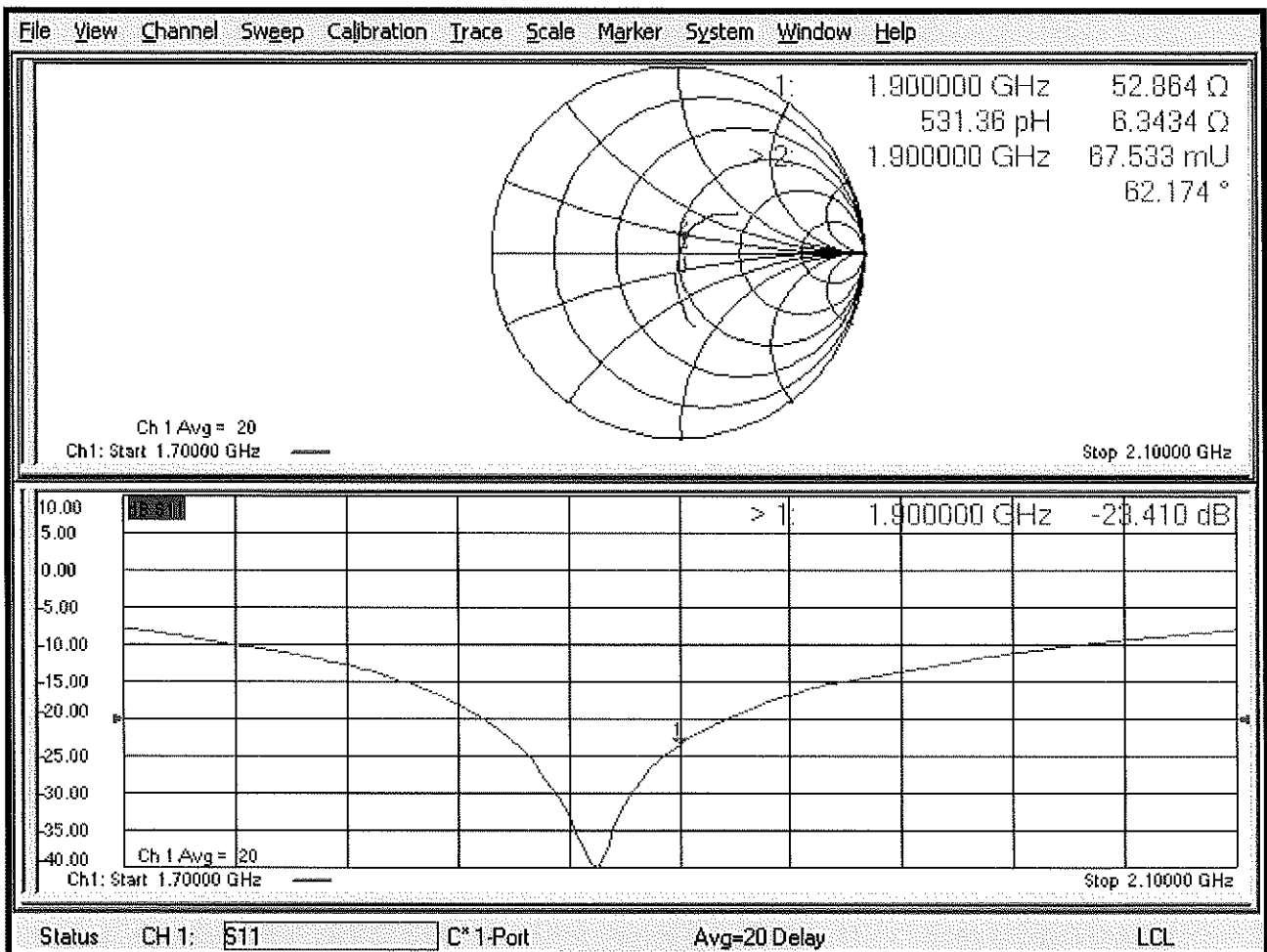

DASY5 Validation Report for Body TSL

Date: 23.10.2018

Test Laboratory: SPEAG, Zurich, Switzerland

DUT: Dipole 1900 MHz; Type: D1900V2; Serial: D1900V2 - SN:5d149

Communication System: UID 0 - CW; Frequency: 1900 MHz

Medium parameters used: $f = 1900$ MHz; $\sigma = 1.47$ S/m; $\epsilon_r = 52.9$; $\rho = 1000$ kg/m³

Phantom section: Flat Section

Measurement Standard: DASY5 (IEEE/IEC/ANSI C63.19-2011)

DASY52 Configuration:

- Probe: EX3DV4 - SN7349; ConvF(8.15, 8.15, 8.15) @ 1900 MHz; Calibrated: 30.12.2017
- Sensor-Surface: 1.4mm (Mechanical Surface Detection)
- Electronics: DAE4 Sn601; Calibrated: 04.10.2018
- Phantom: Flat Phantom 5.0 (back); Type: QD 000 P50 AA; Serial: 1002
- DASY52 52.10.2(1495); SEMCAD X 14.6.12(7450)

Dipole Calibration for Body Tissue/Pin=250 mW, d=10mm/Zoom Scan (7x7x7)/Cube 0:

Measurement grid: dx=5mm, dy=5mm, dz=5mm

Reference Value = 103.1 V/m; Power Drift = -0.03 dB

Peak SAR (extrapolated) = 17.5 W/kg

SAR(1 g) = 9.68 W/kg; SAR(10 g) = 5.11 W/kg

Maximum value of SAR (measured) = 14.2 W/kg

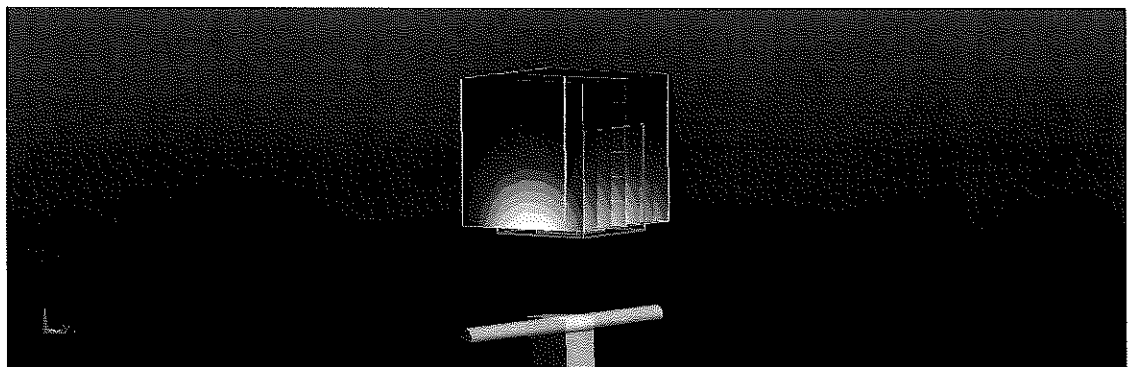
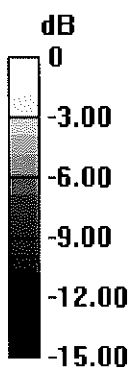

0 dB = 14.2 W/kg = 11.52 dBW/kg

Impedance Measurement Plot for Body TSL

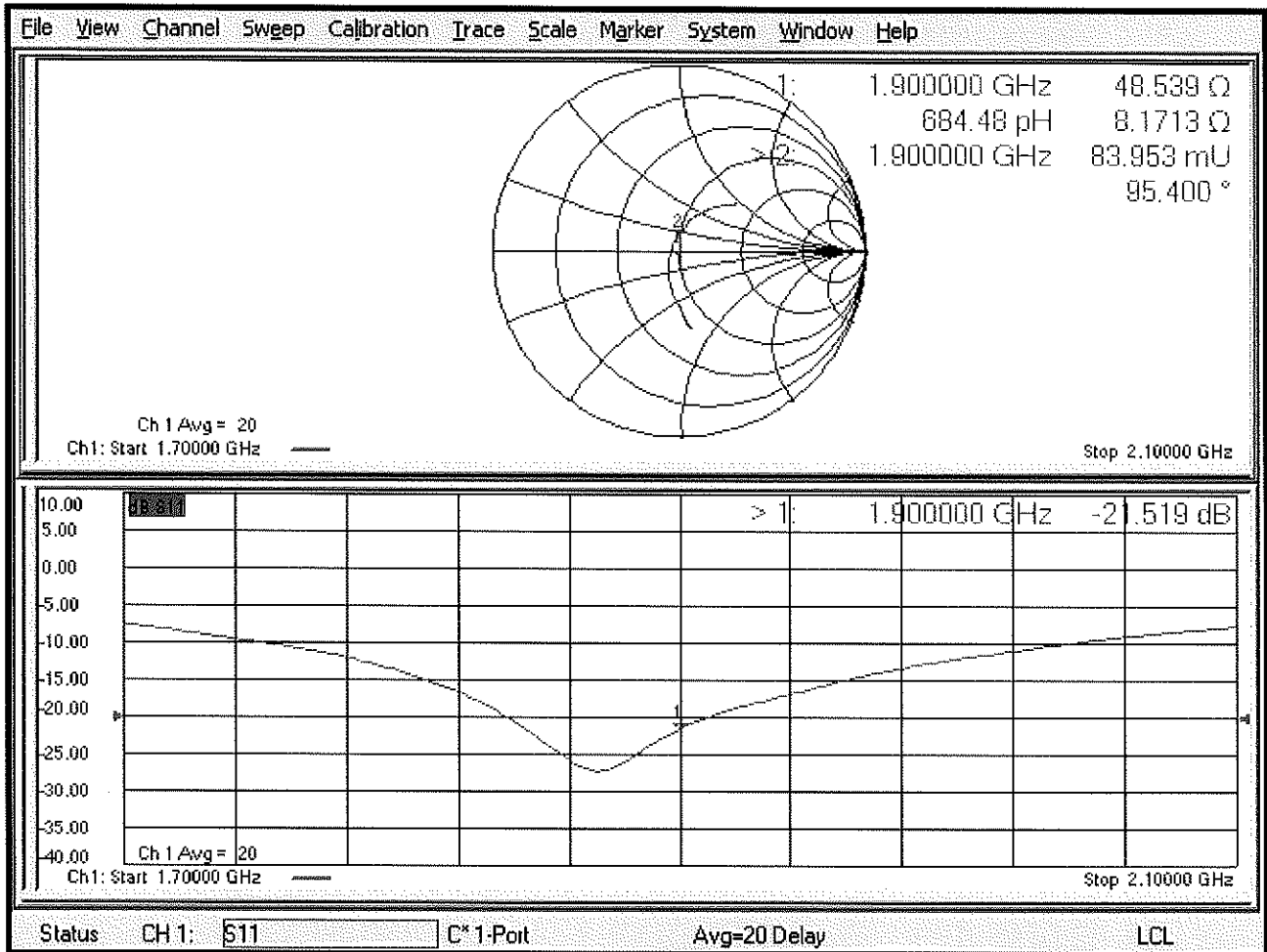



Accredited by the Swiss Accreditation Service (SAS)
The Swiss Accreditation Service is one of the signatories to the EA
Multilateral Agreement for the recognition of calibration certificates

Accreditation No.: **SCS 0108**

Client **PC Test**

Certificate No: **D2300V2-1064_Nov17**

CALIBRATION CERTIFICATE

Object **D2300V2 - SN:1064**

Calibration procedure(s) **QA CAL-05.V9
Calibration procedure for dipole validation kits above 700 MHz**

Calibration date: **November 08, 2017** PN ✓
02/04/2017

This calibration certificate documents the traceability to national standards, which realize the physical units of measurements (SI).
The measurements and the uncertainties with confidence probability are given on the following pages and are part of the certificate. PN ✓
11/21/2018

All calibrations have been conducted in the closed laboratory facility: environment temperature (22 ± 3)°C and humidity < 70%.

Calibration Equipment used (M&TE critical for calibration)

| Primary Standards | ID # | Cal Date (Certificate No.) | Scheduled Calibration |
|-----------------------------|--------------------|-----------------------------------|------------------------|
| Power meter NRP | SN: 104778 | 04-Apr-17 (No. 217-02521/02522) | Apr-18 |
| Power sensor NRP-Z91 | SN: 103244 | 04-Apr-17 (No. 217-02521) | Apr-18 |
| Power sensor NRP-Z91 | SN: 103245 | 04-Apr-17 (No. 217-02522) | Apr-18 |
| Reference 20 dB Attenuator | SN: 5058 (20k) | 07-Apr-17 (No. 217-02528) | Apr-18 |
| Type-N mismatch combination | SN: 5047.2 / 06327 | 07-Apr-17 (No. 217-02529) | Apr-18 |
| Reference Probe EX3DV4 | SN: 7349 | 31-May-17 (No. EX3-7349_May17) | May-18 |
| DAE4 | SN: 601 | 26-Oct-17 (No. DAE4-601_Oct17) | Oct-18 |
| Secondary Standards | ID # | Check Date (in house) | Scheduled Check |
| Power meter EPM-442A | SN: GB37480704 | 07-Oct-15 (in house check Oct-16) | In house check: Oct-18 |
| Power sensor HP 8481A | SN: US37292783 | 07-Oct-15 (in house check Oct-16) | In house check: Oct-18 |
| Power sensor HP 8481A | SN: MY41092317 | 07-Oct-15 (in house check Oct-16) | In house check: Oct-18 |
| RF generator R&S SMT-06 | SN: 100972 | 15-Jun-15 (in house check Oct-16) | In house check: Oct-18 |
| Network Analyzer HP 8753E | SN: US37390585 | 18-Oct-01 (in house check Oct-17) | In house check: Oct-18 |

Calibrated by: **Jeton Kastrati** Signature
Name: **Jeton Kastrati** Function: **Laboratory Technician**

Approved by: **Katja Pokovic** Signature
Name: **Katja Pokovic** Function: **Technical Manager**

Issued: November 8, 2017

This calibration certificate shall not be reproduced except in full without written approval of the laboratory.



Accredited by the Swiss Accreditation Service (SAS)
The Swiss Accreditation Service is one of the signatories to the EA
Multilateral Agreement for the recognition of calibration certificates

Accreditation No.: **SCS 0108**

Glossary:

TSL tissue simulating liquid
ConvF sensitivity in TSL / NORM x,y,z
N/A not applicable or not measured

Calibration is Performed According to the Following Standards:

- a) IEEE Std 1528-2013, "IEEE Recommended Practice for Determining the Peak Spatial-Averaged Specific Absorption Rate (SAR) in the Human Head from Wireless Communications Devices: Measurement Techniques", June 2013
- b) IEC 62209-1, "Measurement procedure for the assessment of Specific Absorption Rate (SAR) from hand-held and body-mounted devices used next to the ear (frequency range of 300 MHz to 6 GHz)", July 2016
- c) IEC 62209-2, "Procedure to determine the Specific Absorption Rate (SAR) for wireless communication devices used in close proximity to the human body (frequency range of 30 MHz to 6 GHz)", March 2010
- d) KDB 865664, "SAR Measurement Requirements for 100 MHz to 6 GHz"

Additional Documentation:

- e) DASY4/5 System Handbook

Methods Applied and Interpretation of Parameters:

- *Measurement Conditions:* Further details are available from the Validation Report at the end of the certificate. All figures stated in the certificate are valid at the frequency indicated.
- *Antenna Parameters with TSL:* The dipole is mounted with the spacer to position its feed point exactly below the center marking of the flat phantom section, with the arms oriented parallel to the body axis.
- *Feed Point Impedance and Return Loss:* These parameters are measured with the dipole positioned under the liquid filled phantom. The impedance stated is transformed from the measurement at the SMA connector to the feed point. The Return Loss ensures low reflected power. No uncertainty required.
- *Electrical Delay:* One-way delay between the SMA connector and the antenna feed point. No uncertainty required.
- *SAR measured:* SAR measured at the stated antenna input power.
- *SAR normalized:* SAR as measured, normalized to an input power of 1 W at the antenna connector.
- *SAR for nominal TSL parameters:* The measured TSL parameters are used to calculate the nominal SAR result.

The reported uncertainty of measurement is stated as the standard uncertainty of measurement multiplied by the coverage factor $k=2$, which for a normal distribution corresponds to a coverage probability of approximately 95%.

Measurement Conditions

DASY system configuration, as far as not given on page 1.

| | | |
|-------------------------------------|------------------------|-------------|
| DASY Version | DASY5 | V52.10.0 |
| Extrapolation | Advanced Extrapolation | |
| Phantom | Modular Flat Phantom | |
| Distance Dipole Center - TSL | 10 mm | with Spacer |
| Zoom Scan Resolution | dx, dy, dz = 5 mm | |
| Frequency | 2300 MHz ± 1 MHz | |

Head TSL parameters

The following parameters and calculations were applied.

| | Temperature | Permittivity | Conductivity |
|--|-----------------|--------------|------------------|
| Nominal Head TSL parameters | 22.0 °C | 39.5 | 1.67 mho/m |
| Measured Head TSL parameters | (22.0 ± 0.2) °C | 38.3 ± 6 % | 1.70 mho/m ± 6 % |
| Head TSL temperature change during test | < 0.5 °C | ---- | ---- |

SAR result with Head TSL

| SAR averaged over 1 cm³ (1 g) of Head TSL | Condition | |
|---|--------------------|---------------------------------|
| SAR measured | 250 mW input power | 12.1 W/kg |
| SAR for nominal Head TSL parameters | normalized to 1W | 47.6 W/kg ± 17.0 % (k=2) |

| SAR averaged over 10 cm³ (10 g) of Head TSL | condition | |
|---|--------------------|---------------------------------|
| SAR measured | 250 mW input power | 5.84 W/kg |
| SAR for nominal Head TSL parameters | normalized to 1W | 23.1 W/kg ± 16.5 % (k=2) |

Body TSL parameters

The following parameters and calculations were applied.

| | Temperature | Permittivity | Conductivity |
|--|-----------------|--------------|------------------|
| Nominal Body TSL parameters | 22.0 °C | 52.9 | 1.81 mho/m |
| Measured Body TSL parameters | (22.0 ± 0.2) °C | 51.9 ± 6 % | 1.85 mho/m ± 6 % |
| Body TSL temperature change during test | < 0.5 °C | ---- | ---- |

SAR result with Body TSL

| SAR averaged over 1 cm³ (1 g) of Body TSL | Condition | |
|---|--------------------|---------------------------------|
| SAR measured | 250 mW input power | 11.8 W/kg |
| SAR for nominal Body TSL parameters | normalized to 1W | 46.5 W/kg ± 17.0 % (k=2) |

| SAR averaged over 10 cm³ (10 g) of Body TSL | condition | |
|---|--------------------|---------------------------------|
| SAR measured | 250 mW input power | 5.69 W/kg |
| SAR for nominal Body TSL parameters | normalized to 1W | 22.6 W/kg ± 16.5 % (k=2) |

Appendix (Additional assessments outside the scope of SCS 0108)

Antenna Parameters with Head TSL

| | |
|--------------------------------------|--------------------------------|
| Impedance, transformed to feed point | 48.4 Ω - 5.2 j Ω |
| Return Loss | - 25.1 dB |

Antenna Parameters with Body TSL

| | |
|--------------------------------------|--------------------------------|
| Impedance, transformed to feed point | 45.1 Ω - 4.1 j Ω |
| Return Loss | - 23.5 dB |

General Antenna Parameters and Design

| | |
|----------------------------------|----------|
| Electrical Delay (one direction) | 1.168 ns |
|----------------------------------|----------|

After long term use with 100W radiated power, only a slight warming of the dipole near the feedpoint can be measured.

The dipole is made of standard semirigid coaxial cable. The center conductor of the feeding line is directly connected to the second arm of the dipole. The antenna is therefore short-circuited for DC-signals. On some of the dipoles, small end caps are added to the dipole arms in order to improve matching when loaded according to the position as explained in the "Measurement Conditions" paragraph. The SAR data are not affected by this change. The overall dipole length is still according to the Standard.

No excessive force must be applied to the dipole arms, because they might bend or the soldered connections near the feedpoint may be damaged.

Additional EUT Data

| | |
|-----------------|-----------------|
| Manufactured by | SPEAG |
| Manufactured on | August 20, 2015 |

DASY5 Validation Report for Head TSL

Date: 08.11.2017

Test Laboratory: SPEAG, Zurich, Switzerland

DUT: Dipole 2300 MHz; Type: D2300V2; Serial: D2300V2 - SN:1064

Communication System: UID 0 - CW; Frequency: 2300 MHz

Medium parameters used: $f = 2300$ MHz; $\sigma = 1.7$ S/m; $\epsilon_r = 38.3$; $\rho = 1000$ kg/m³

Phantom section: Flat Section

Measurement Standard: DASY5 (IEEE/IEC/ANSI C63.19-2011)

DASY52 Configuration:

- Probe: EX3DV4 - SN7349; ConvF(8.31, 8.31, 8.31); Calibrated: 31.05.2017;
- Sensor-Surface: 1.4mm (Mechanical Surface Detection)
- Electronics: DAE4 Sn601; Calibrated: 26.10.2017
- Phantom: Flat Phantom 5.0 (front); Type: QD 000 P50 AA; Serial: 1001
- DASY52 52.10.0(1446); SEMCAD X 14.6.10(7417)

Dipole Calibration for Head Tissue/ $P_{in}=250$ mW, $d=10$ mm/Zoom Scan (7x7x7)/Cube 0:

Measurement grid: $dx=5$ mm, $dy=5$ mm, $dz=5$ mm

Reference Value = 112.6 V/m; Power Drift = 0.04 dB

Peak SAR (extrapolated) = 23.8 W/kg

SAR(1 g) = 12.1 W/kg; SAR(10 g) = 5.84 W/kg

Maximum value of SAR (measured) = 19.5 W/kg

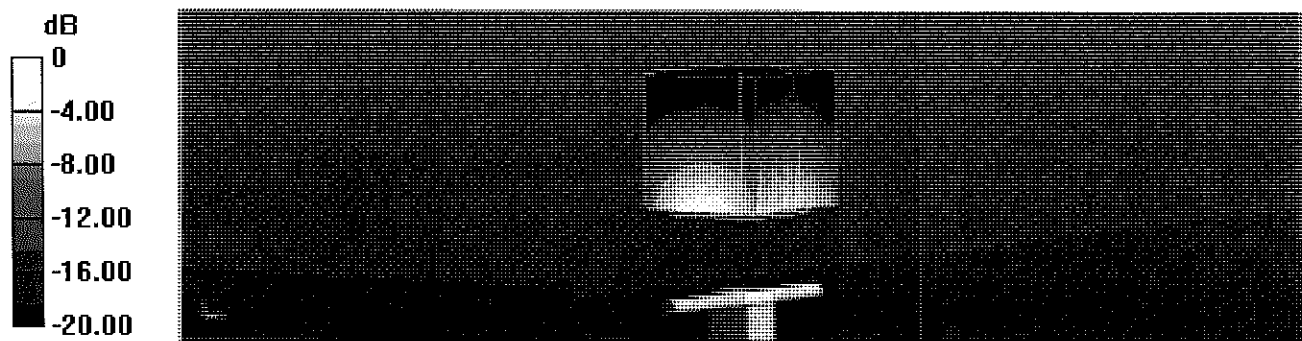

0 dB = 19.5 W/kg = 12.90 dBW/kg

Impedance Measurement Plot for Head TSL

CH1 S11 1 U FS 8 Nov 2017 15:26:40
 1: 48.379 Ω -5.2344 Ω 13.220 pF 2 300.000 000 MHz

*
 De1
 C Δ
 Avg
 15
 H1d

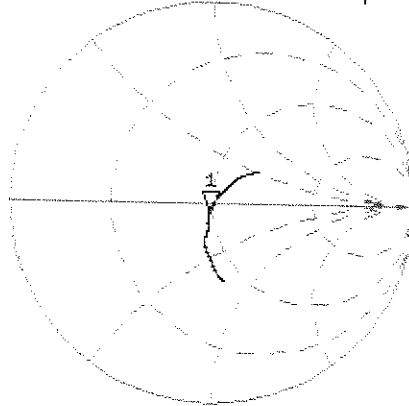

CH2 S11 LOG 5 dB/REF -20 dB 1: -25.097 dB 2 300.000 000 MHz

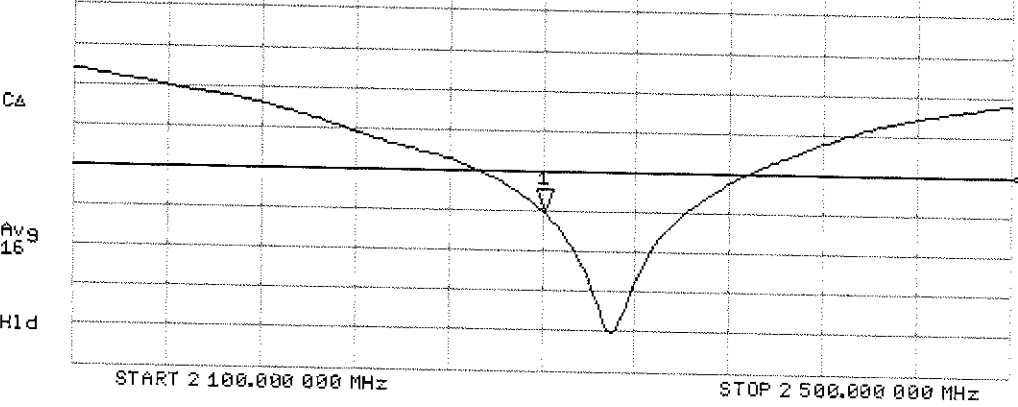

DASY5 Validation Report for Body TSL

Date: 08.11.2017

Test Laboratory: SPEAG, Zurich, Switzerland

DUT: Dipole 2300 MHz; Type: D2300V2; Serial: D2300V2 - SN:1064

Communication System: UID 0 - CW; Frequency: 2300 MHz

Medium parameters used: $f = 2300$ MHz; $\sigma = 1.85$ S/m; $\epsilon_r = 51.9$; $\rho = 1000$ kg/m³

Phantom section: Flat Section

Measurement Standard: DASY5 (IEEE/IEC/ANSI C63.19-2011)

DASY52 Configuration:

- Probe: EX3DV4 - SN7349; ConvF(8.22, 8.22, 8.22); Calibrated: 31.05.2017;
- Sensor-Surface: 1.4mm (Mechanical Surface Detection)
- Electronics: DAE4 Sn601; Calibrated: 26.10.2017
- Phantom: Flat Phantom 5.0 (back); Type: QD 000 P50 AA; Serial: 1002
- DASY52 52.10.0(1446); SEMCAD X 14.6.10(7417)

Dipole Calibration for Body Tissue/ $P_{in}=250$ mW, $d=10$ mm/Zoom Scan (7x7x7)/Cube 0:

Measurement grid: $dx=5$ mm, $dy=5$ mm, $dz=5$ mm

Reference Value = 105.6 V/m; Power Drift = -0.07 dB

Peak SAR (extrapolated) = 22.6 W/kg

SAR(1 g) = 11.8 W/kg; SAR(10 g) = 5.69 W/kg

Maximum value of SAR (measured) = 18.4 W/kg

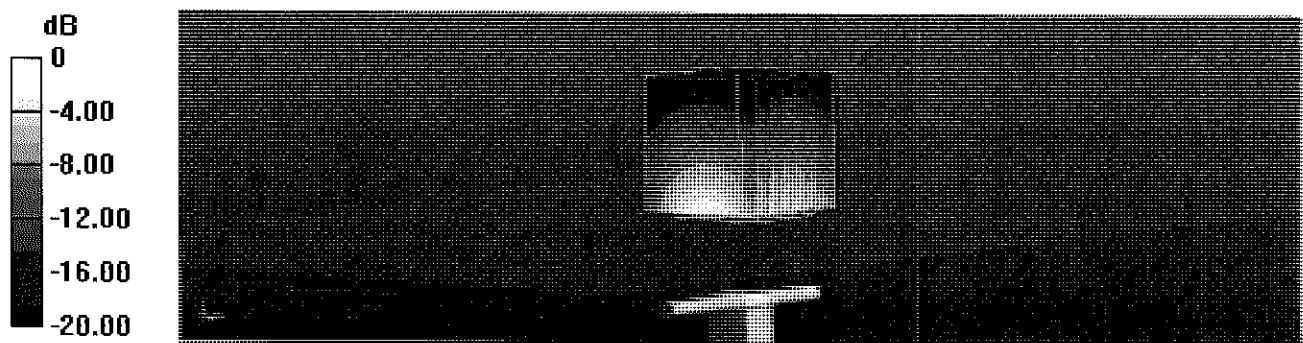

0 dB = 18.4 W/kg = 12.65 dBW/kg

Impedance Measurement Plot for Body TSL

8 Nov 2017 15:26:06
CH1 S11 1 U FS 1: 45.111 Ω -4.0645 \angle 17.025 pF 2 300.000 000 MHz

*
De1
CA
Avg
16
H1d

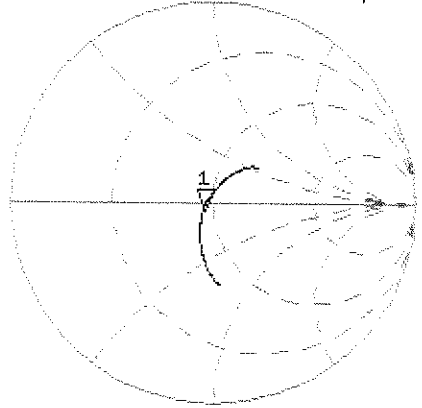

CH2 S11 LOG 5 dB/REF -20 dB 1: -23.504 dB 2 300.000 000 MHz

CA
Avg
16
H1d

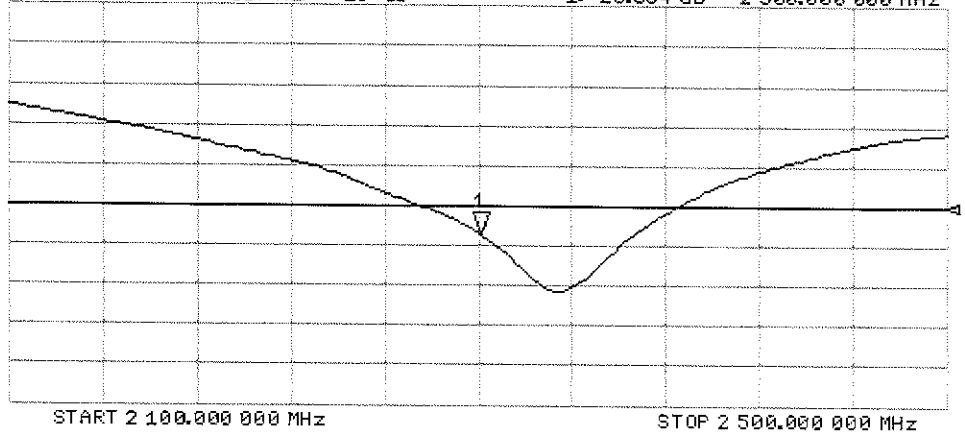

Certification of Calibration

Object D2300V2 – SN: 1064

Calibration procedure(s) Procedure for Calibration Extension for SAR Dipoles.

Extended Calibration date: November 20, 2018

Description: SAR Validation Dipole at 2300 MHz.

Calibration Equipment used:

| Manufacturer | Model | Description | Cal Date | Cal Interval | Cal Due | Serial Number |
|-----------------------|-----------|---|------------|--------------|------------|---------------|
| Agilent | 8753ES | S-Parameter Vector Network Analyzer | 8/30/2018 | Annual | 8/30/2019 | MY40003841 |
| Agilent | N5182A | MXG Vector Signal Generator | 4/18/2018 | Annual | 4/18/2019 | MY47420800 |
| Amplifier Research | 15S1G6 | Amplifier | CBT | N/A | CBT | 433971 |
| Anritsu | MA2411B | Pulse Power Sensor | 3/2/2018 | Annual | 3/2/2019 | 1207364 |
| Anritsu | MA2411B | Pulse Power Sensor | 3/2/2018 | Annual | 3/2/2019 | 1339018 |
| Anritsu | ML2495A | Power Meter | 10/22/2017 | Annual | 10/22/2018 | 1328004 |
| Control Company | 4040 | Therm./Clock/Humidity Monitor | 3/31/2017 | Biennial | 3/31/2019 | 170232394 |
| Control Company | 4352 | Ultra Long Stem Thermometer | 5/2/2017 | Biennial | 5/2/2019 | 170330156 |
| Keysight | 772D | Dual Directional Coupler | CBT | N/A | CBT | MY52180215 |
| Keysight Technologies | 85033E | Standard Mechanical Calibration Kit (DC to 9GHz, 3.5mm) | 6/4/2018 | Annual | 6/4/2019 | MY53401181 |
| MiniCircuits | VLF-6000+ | Low Pass Filter | CBT | N/A | CBT | N/A |
| Mini-Circuits | BW-N20W5+ | DC to 18 GHz Precision Fixed 20 dB Attenuator | CBT | N/A | CBT | N/A |
| Narda | 4772-3 | Attenuator (3dB) | CBT | N/A | CBT | 9406 |
| Seekonk | NC-100 | Torque Wrench | 7/11/2018 | Annual | 7/11/2019 | N/A |
| SPEAG | DAE4 | Dasy Data Acquisition Electronics | 6/18/2018 | Annual | 6/18/2019 | 1334 |
| SPEAG | DAE4 | Dasy Data Acquisition Electronics | 7/11/2018 | Annual | 7/11/2019 | 1322 |
| SPEAG | DAK-3.5 | Dielectric Assessment Kit | 5/15/2018 | Annual | 5/15/2019 | 1070 |
| SPEAG | EX3DV4 | SAR Probe | 6/25/2018 | Annual | 6/25/2019 | 7409 |
| SPEAG | EX3DV4 | SAR Probe | 7/20/2018 | Annual | 7/20/2019 | 7410 |

Measurement Uncertainty = $\pm 23\%$ (k=2)

| | Name | Function | Signature |
|----------------|-------------------|--------------------------|--------------------------|
| Calibrated By: | Brodie Halbfoster | SAR Test Engineer | <i>BRODIE HALBFOSTER</i> |
| Approved By: | Kaitlin O'Keefe | Senior Technical Manager | <i>KOK</i> |

DIPOLE CALIBRATION EXTENSION

Per KDB 865664 D01, calibration intervals of up to three years may be considered for reference dipoles when it is demonstrated that the SAR target, impedance and return loss of a dipole have remained stable according to the following requirements:

1. The measured SAR does not deviate more than 10% from the target on the calibration certificate.
2. The return-loss does not deviate more than 20% from the previous measurement and meets the required 20dB minimum return-loss requirement.
3. The measurement of real or imaginary parts of impedance does not deviate more than 5Ω from the previous measurement.

The following dipole was checked to pass the above 3 requirements to have 2-year calibration period from the calibration date:

| Calibration Date | Extension Date | Certificate Electrical Delay (ns) | Certificate SAR Target Head (1g) W/kg @ 20.0 dBm | Measured Head SAR (1g) W/kg @ 20.0 dBm | Deviation 1g (%) | Certificate SAR Target Head (10g) W/kg @ 20.0 dBm | Measured Head SAR (10g) W/kg @ 20.0 dBm | Deviation 10g (%) | Certificate Impedance Head (Ohm) Real | Measured Impedance Head (Ohm) Real | Difference (Ohm) Real | Certificate Impedance Head (Ohm) Imaginary | Measured Impedance Head (Ohm) Imaginary | Difference (Ohm) Imaginary | Certificate Return Loss Head (dB) | Measured Return Loss Head (dB) | Deviation (%) | PASS/FAIL |
|------------------|----------------|-----------------------------------|--|--|------------------|---|---|-------------------|---------------------------------------|------------------------------------|-----------------------|--|---|----------------------------|-----------------------------------|--------------------------------|---------------|-----------|
| 11/8/2017 | 11/20/2018 | 1.168 | 4.76 | 4.69 | -1.47% | 2.31 | 2.24 | -3.03% | 48.4 | 46.3 | 2.1 | -5.2 | -3.3 | 1.9 | -25.1 | -25.7 | -2.20% | PASS |
| Calibration Date | Extension Date | Certificate Electrical Delay (ns) | Certificate SAR Target Body (1g) W/kg @ 20.0 dBm | Measured Body SAR (1g) W/kg @ 20.0 dBm | Deviation 1g (%) | Certificate SAR Target Body (10g) W/kg @ 20.0 dBm | Measured Body SAR (10g) W/kg @ 20.0 dBm | Deviation 10g (%) | Certificate Impedance Body (Ohm) Real | Measured Impedance Body (Ohm) Real | Difference (Ohm) Real | Certificate Impedance Body (Ohm) Imaginary | Measured Impedance Body (Ohm) Imaginary | Difference (Ohm) Imaginary | Certificate Return Loss Body (dB) | Measured Return Loss Body (dB) | Deviation (%) | PASS/FAIL |
| 11/8/2017 | 11/20/2018 | 1.168 | 4.65 | 4.83 | 3.87% | 2.26 | 2.29 | 1.33% | 45.1 | 45.2 | 0.1 | -4.1 | -3.4 | 0.7 | -23.5 | -24.1 | -2.40% | PASS |

Impedance & Return-Loss Measurement Plot for Head TSL

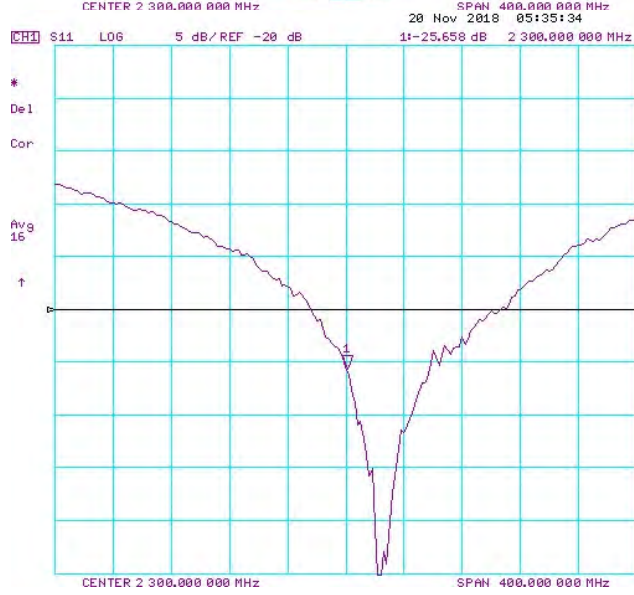
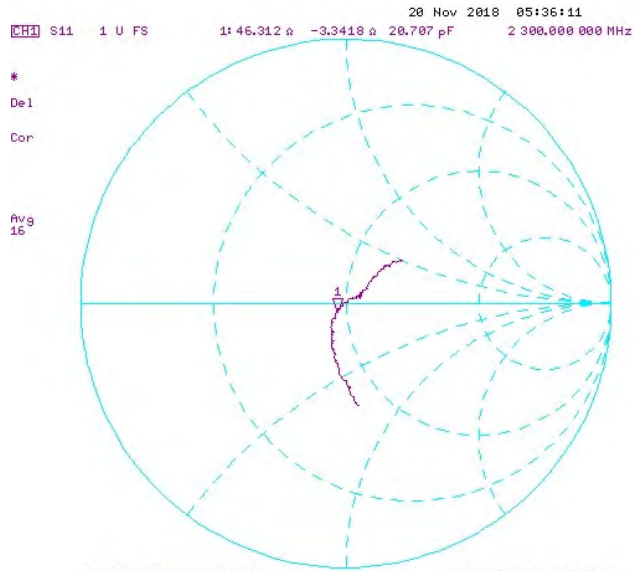

Impedance & Return-Loss Measurement Plot for Body TSL

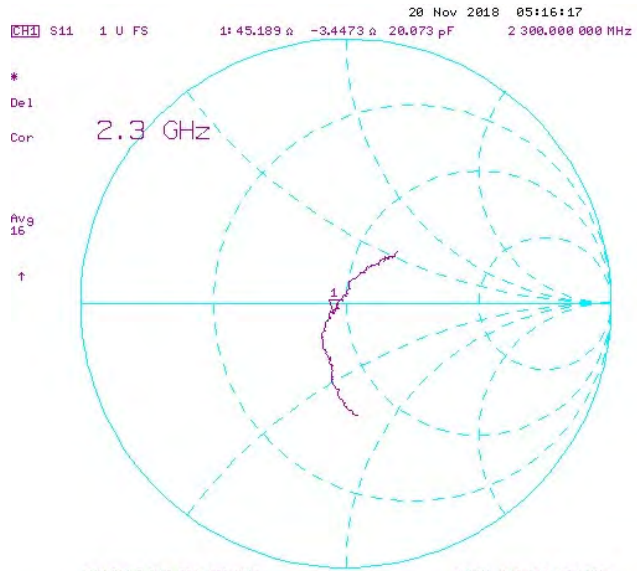



Accredited by the Swiss Accreditation Service (SAS)
The Swiss Accreditation Service is one of the signatories to the EA
Multilateral Agreement for the recognition of calibration certificates

Accreditation No.: **SCS 0108**

Client **PC Test**

Certificate No: **D2300V2-1073_Aug18**

CALIBRATION CERTIFICATE

Object **D2300V2 - SN:1073**

Calibration procedure(s) **QA CAL-05.v10**
Calibration procedure for dipole validation kits above 700 MHz

Calibration date: **August 13, 2018**

BNW
09-06-2018

This calibration certificate documents the traceability to national standards, which realize the physical units of measurements (SI).
The measurements and the uncertainties with confidence probability are given on the following pages and are part of the certificate.

All calibrations have been conducted in the closed laboratory facility: environment temperature (22 ± 3)°C and humidity < 70%.

Calibration Equipment used (M&TE critical for calibration)

| Primary Standards | ID # | Cal Date (Certificate No.) | Scheduled Calibration |
|---------------------------------|--------------------|-----------------------------------|------------------------|
| Power meter NRP | SN: 104778 | 04-Apr-18 (No. 217-02672/02673) | Apr-19 |
| Power sensor NRP-Z91 | SN: 103244 | 04-Apr-18 (No. 217-02672) | Apr-19 |
| Power sensor NRP-Z91 | SN: 103245 | 04-Apr-18 (No. 217-02673) | Apr-19 |
| Reference 20 dB Attenuator | SN: 5058 (20k) | 04-Apr-18 (No. 217-02682) | Apr-19 |
| Type-N mismatch combination | SN: 5047.2 / 06327 | 04-Apr-18 (No. 217-02683) | Apr-19 |
| Reference Probe EX3DV4 | SN: 7349 | 30-Dec-17 (No. EX3-7349_Dec17) | Dec-18 |
| DAE4 | SN: 601 | 26-Oct-17 (No. DAE4-601_Oct17) | Oct-18 |
| Secondary Standards | ID # | Check Date (in house) | Scheduled Check |
| Power meter EPM-442A | SN: GB37480704 | 07-Oct-15 (in house check Oct-16) | In house check: Oct-18 |
| Power sensor HP 8481A | SN: US37292783 | 07-Oct-15 (in house check Oct-16) | In house check: Oct-18 |
| Power sensor HP 8481A | SN: MY41092317 | 07-Oct-15 (in house check Oct-16) | In house check: Oct-18 |
| RF generator R&S SMT-06 | SN: 100972 | 15-Jun-15 (in house check Oct-16) | In house check: Oct-18 |
| Network Analyzer Agilent E8358A | SN: US41080477 | 31-Mar-14 (in house check Oct-17) | In house check: Oct-18 |

Calibrated by: **Michael Weber** Name: Michael Weber Function: Laboratory Technician

Signature: *M. Weber*

Approved by: **Katja Pokovic** Name: Katja Pokovic Function: Technical Manager

Signature: *K. Pokovic*

Issued: August 13, 2018

This calibration certificate shall not be reproduced except in full without written approval of the laboratory.



Accredited by the Swiss Accreditation Service (SAS)

The Swiss Accreditation Service is one of the signatories to the EA
Multilateral Agreement for the recognition of calibration certificates

Accreditation No.: **SCS 0108**

Glossary:

| | |
|-------|---------------------------------|
| TSL | tissue simulating liquid |
| ConvF | sensitivity in TSL / NORM x,y,z |
| N/A | not applicable or not measured |

Calibration is Performed According to the Following Standards:

- IEEE Std 1528-2013, "IEEE Recommended Practice for Determining the Peak Spatial-Averaged Specific Absorption Rate (SAR) in the Human Head from Wireless Communications Devices: Measurement Techniques", June 2013
- IEC 62209-1, "Measurement procedure for the assessment of Specific Absorption Rate (SAR) from hand-held and body-mounted devices used next to the ear (frequency range of 300 MHz to 6 GHz)", July 2016
- IEC 62209-2, "Procedure to determine the Specific Absorption Rate (SAR) for wireless communication devices used in close proximity to the human body (frequency range of 30 MHz to 6 GHz)", March 2010
- KDB 865664, "SAR Measurement Requirements for 100 MHz to 6 GHz"

Additional Documentation:

- DASY4/5 System Handbook

Methods Applied and Interpretation of Parameters:

- Measurement Conditions:** Further details are available from the Validation Report at the end of the certificate. All figures stated in the certificate are valid at the frequency indicated.
- Antenna Parameters with TSL:** The dipole is mounted with the spacer to position its feed point exactly below the center marking of the flat phantom section, with the arms oriented parallel to the body axis.
- Feed Point Impedance and Return Loss:** These parameters are measured with the dipole positioned under the liquid filled phantom. The impedance stated is transformed from the measurement at the SMA connector to the feed point. The Return Loss ensures low reflected power. No uncertainty required.
- Electrical Delay:** One-way delay between the SMA connector and the antenna feed point. No uncertainty required.
- SAR measured:** SAR measured at the stated antenna input power.
- SAR normalized:** SAR as measured, normalized to an input power of 1 W at the antenna connector.
- SAR for nominal TSL parameters:** The measured TSL parameters are used to calculate the nominal SAR result.

The reported uncertainty of measurement is stated as the standard uncertainty of measurement multiplied by the coverage factor $k=2$, which for a normal distribution corresponds to a coverage probability of approximately 95%.

Measurement Conditions

DASY system configuration, as far as not given on page 1.

| | | |
|-------------------------------------|------------------------|-------------|
| DASY Version | DASY5 | V52.10.1 |
| Extrapolation | Advanced Extrapolation | |
| Phantom | Modular Flat Phantom | |
| Distance Dipole Center - TSL | 10 mm | with Spacer |
| Zoom Scan Resolution | dx, dy, dz = 5 mm | |
| Frequency | 2300 MHz \pm 1 MHz | |

Head TSL parameters

The following parameters and calculations were applied.

| | Temperature | Permittivity | Conductivity |
|--|---------------------|----------------|----------------------|
| Nominal Head TSL parameters | 22.0 °C | 39.5 | 1.67 mho/m |
| Measured Head TSL parameters | (22.0 \pm 0.2) °C | 38.2 \pm 6 % | 1.70 mho/m \pm 6 % |
| Head TSL temperature change during test | < 0.5 °C | ---- | ---- |

SAR result with Head TSL

| SAR averaged over 1 cm³ (1 g) of Head TSL | Condition | |
|---|--------------------|--|
| SAR measured | 250 mW input power | 12.5 W/kg |
| SAR for nominal Head TSL parameters | normalized to 1W | 49.2 W/kg \pm 17.0 % (k=2) |

| SAR averaged over 10 cm³ (10 g) of Head TSL | condition | |
|---|--------------------|--|
| SAR measured | 250 mW input power | 6.02 W/kg |
| SAR for nominal Head TSL parameters | normalized to 1W | 23.8 W/kg \pm 16.5 % (k=2) |

Body TSL parameters

The following parameters and calculations were applied.

| | Temperature | Permittivity | Conductivity |
|--|---------------------|----------------|----------------------|
| Nominal Body TSL parameters | 22.0 °C | 52.9 | 1.81 mho/m |
| Measured Body TSL parameters | (22.0 \pm 0.2) °C | 52.2 \pm 6 % | 1.85 mho/m \pm 6 % |
| Body TSL temperature change during test | < 0.5 °C | ---- | ---- |

SAR result with Body TSL

| SAR averaged over 1 cm³ (1 g) of Body TSL | Condition | |
|---|--------------------|--|
| SAR measured | 250 mW input power | 12.1 W/kg |
| SAR for nominal Body TSL parameters | normalized to 1W | 47.7 W/kg \pm 17.0 % (k=2) |

| SAR averaged over 10 cm³ (10 g) of Body TSL | condition | |
|---|--------------------|--|
| SAR measured | 250 mW input power | 5.86 W/kg |
| SAR for nominal Body TSL parameters | normalized to 1W | 23.2 W/kg \pm 16.5 % (k=2) |

Appendix (Additional assessments outside the scope of SCS 0108)

Antenna Parameters with Head TSL

| | |
|--------------------------------------|--------------------------------|
| Impedance, transformed to feed point | 50.1 Ω - 5.2 j Ω |
| Return Loss | - 25.7 dB |

Antenna Parameters with Body TSL

| | |
|--------------------------------------|--------------------------------|
| Impedance, transformed to feed point | 45.5 Ω - 4.1 j Ω |
| Return Loss | - 23.9 dB |

General Antenna Parameters and Design

| | |
|----------------------------------|----------|
| Electrical Delay (one direction) | 1.171 ns |
|----------------------------------|----------|

After long term use with 100W radiated power, only a slight warming of the dipole near the feedpoint can be measured.

The dipole is made of standard semirigid coaxial cable. The center conductor of the feeding line is directly connected to the second arm of the dipole. The antenna is therefore short-circuited for DC-signals. On some of the dipoles, small end caps are added to the dipole arms in order to improve matching when loaded according to the position as explained in the "Measurement Conditions" paragraph. The SAR data are not affected by this change. The overall dipole length is still according to the Standard.

No excessive force must be applied to the dipole arms, because they might bend or the soldered connections near the feedpoint may be damaged.

Additional EUT Data

| | |
|-----------------|-------------------|
| Manufactured by | SPEAG |
| Manufactured on | November 16, 2015 |

DASY5 Validation Report for Head TSL

Date: 13.08.2018

Test Laboratory: SPEAG, Zurich, Switzerland

DUT: Dipole 2300 MHz; Type: D2300V2; Serial: D2300V2 - SN: 1073

Communication System: UID 0 - CW; Frequency: 2300 MHz

Medium parameters used: $f = 2300$ MHz; $\sigma = 1.7$ S/m; $\epsilon_r = 38.2$; $\rho = 1000$ kg/m³

Phantom section: Flat Section

Measurement Standard: DASY5 (IEEE/IEC/ANSI C63.19-2011)

DASY52 Configuration:

- Probe: EX3DV4 - SN7349; ConvF(8.08, 8.08, 8.08) @ 2300 MHz; Calibrated: 30.12.2017
- Sensor-Surface: 1.4mm (Mechanical Surface Detection)
- Electronics: DAE4 Sn601; Calibrated: 26.10.2017
- Phantom: Flat Phantom 5.0 (front); Type: QD 000 P50 AA; Serial: 1001
- DASY52 52.10.1(1476); SEMCAD X 14.6.11(7439)

Dipole Calibration for Head Tissue/Pin=250 mW, d=10mm/Zoom Scan (7x7x7)/Cube 0:

Measurement grid: $dx=5$ mm, $dy=5$ mm, $dz=5$ mm

Reference Value = 115.9 V/m; Power Drift = -0.05 dB

Peak SAR (extrapolated) = 24.1 W/kg

SAR(1 g) = 12.5 W/kg; SAR(10 g) = 6.02 W/kg

Maximum value of SAR (measured) = 20.2 W/kg

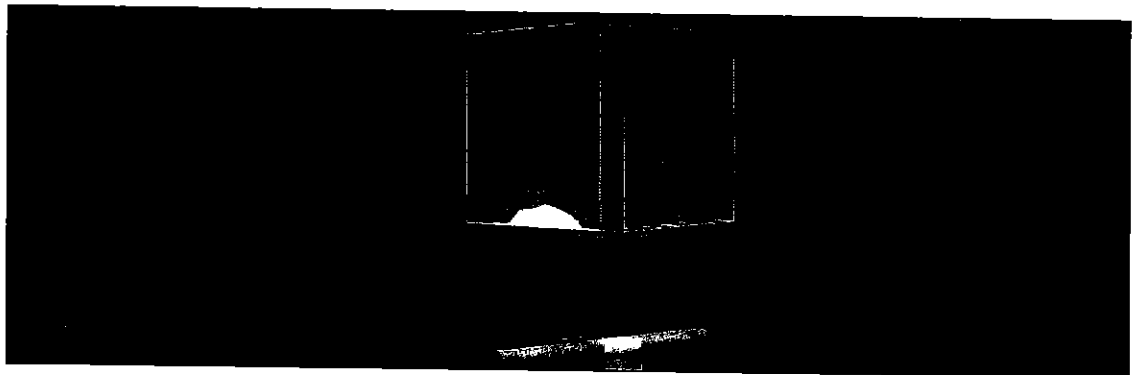
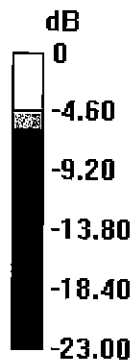

0 dB = 20.2 W/kg = 13.05 dBW/kg

Impedance Measurement Plot for Head TSL

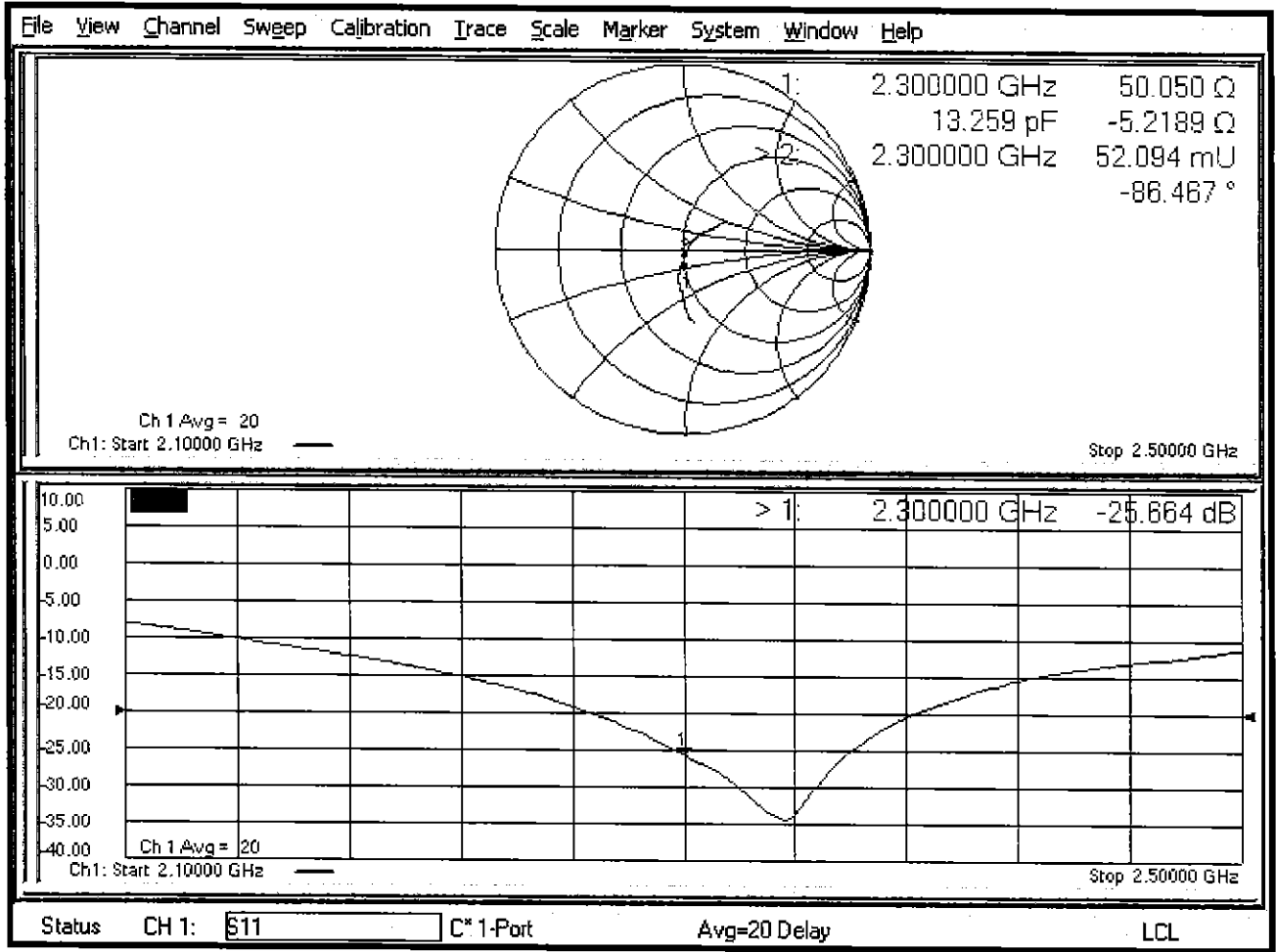

DASY5 Validation Report for Body TSL

Date: 13.08.2018

Test Laboratory: SPEAG, Zurich, Switzerland

DUT: Dipole 2300 MHz; Type: D2300V2; Serial: D2300V2 - SN: 1073

Communication System: UID 0 - CW; Frequency: 2300 MHz

Medium parameters used: $f = 2300$ MHz; $\sigma = 1.85$ S/m; $\epsilon_r = 52.2$; $\rho = 1000$ kg/m³

Phantom section: Flat Section

Measurement Standard: DASY5 (IEEE/IEC/ANSI C63.19-2011)

DASY52 Configuration:

- Probe: EX3DV4 - SN7349; ConvF(8.08, 8.08, 8.08) @ 2300 MHz; Calibrated: 30.12.2017
- Sensor-Surface: 1.4mm (Mechanical Surface Detection)
- Electronics: DAE4 Sn601; Calibrated: 26.10.2017
- Phantom: Flat Phantom 5.0 (back); Type: QD 000 P50 AA; Serial: 1002
- DASY52 52.10.1(1476); SEMCAD X 14.6.11(7439)

Dipole Calibration for Body Tissue/Pin=250 mW, d=10mm/Zoom Scan (7x7x7)/Cube 0:

Measurement grid: dx=5mm, dy=5mm, dz=5mm

Reference Value = 107.5 V/m; Power Drift = -0.08 dB

Peak SAR (extrapolated) = 22.9 W/kg

SAR(1 g) = 12.1 W/kg; SAR(10 g) = 5.86 W/kg

Maximum value of SAR (measured) = 19.1 W/kg

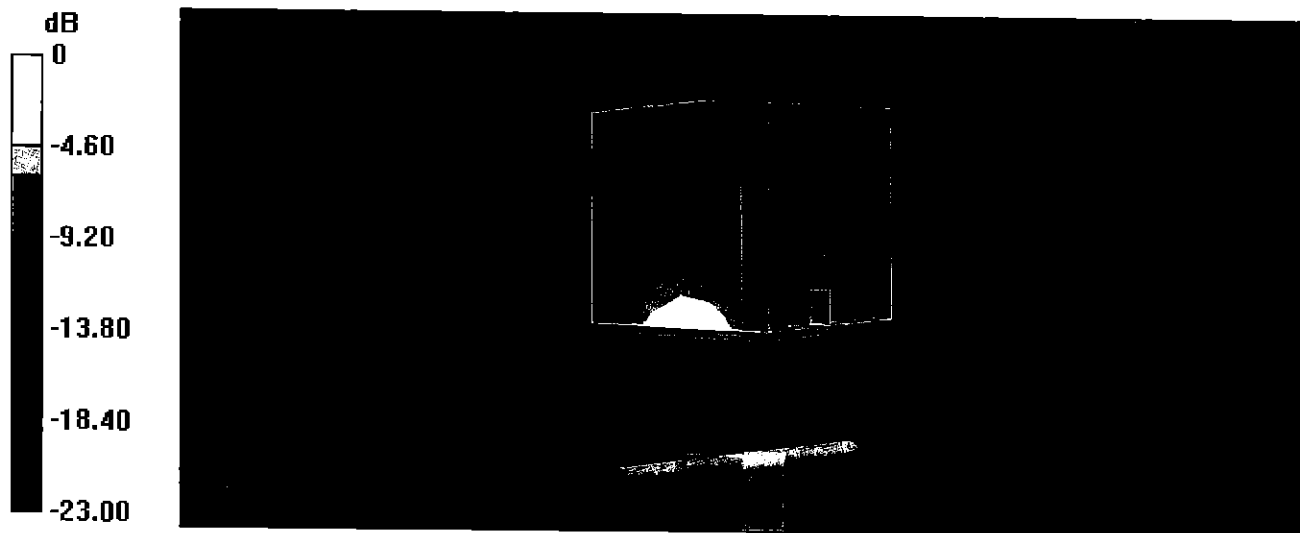

0 dB = 19.1 W/kg = 12.81 dBW/kg

Impedance Measurement Plot for Body TSL

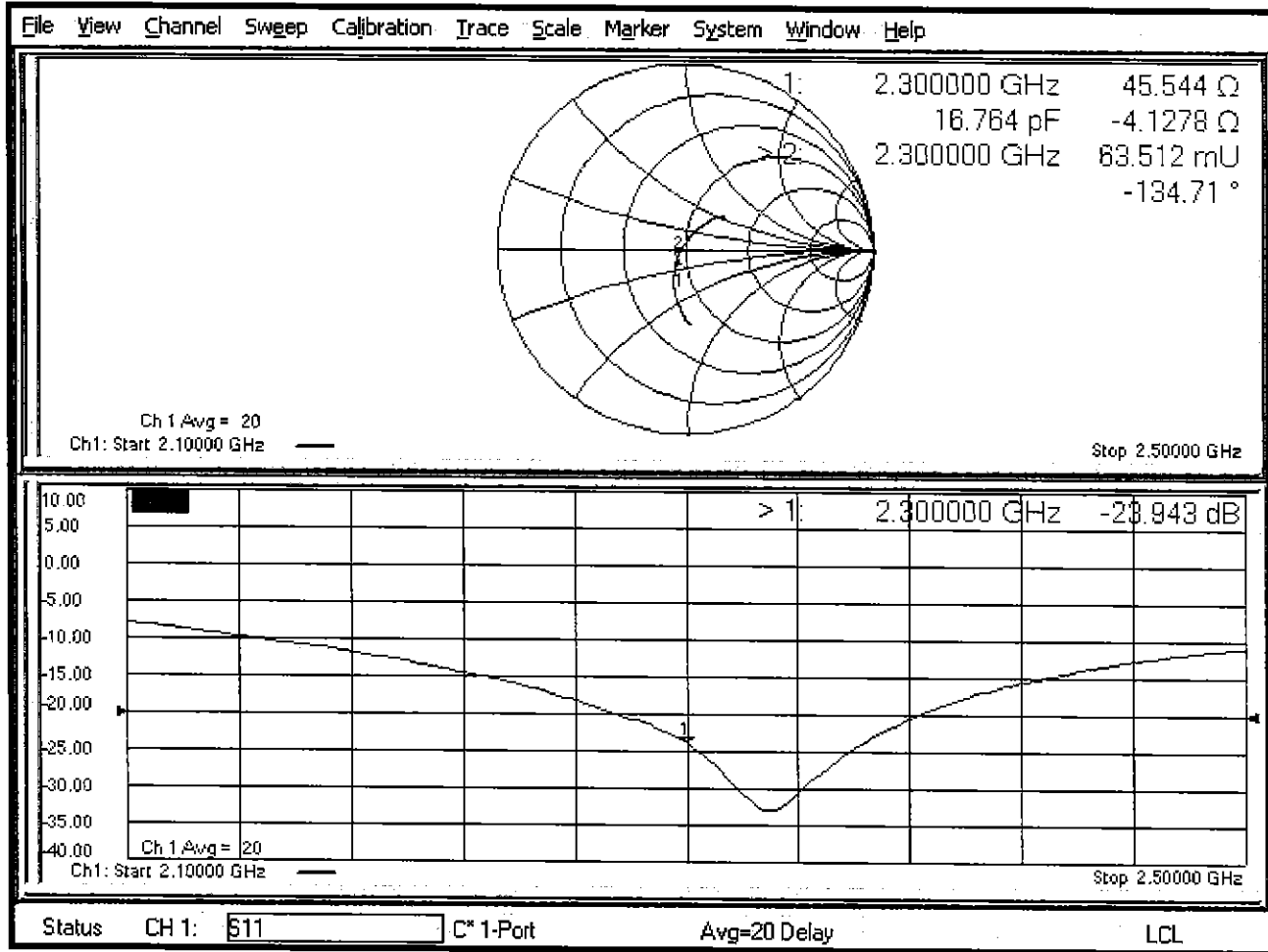

**Calibration Laboratory of
Schmid & Partner
Engineering AG**
Zeughausstrasse 43, 8004 Zurich, Switzerland



S Schweizerischer Kalibrierdienst
C Service suisse d'étalonnage
S Servizio svizzero di taratura
S Swiss Calibration Service

Accredited by the Swiss Accreditation Service (SAS)
The Swiss Accreditation Service is one of the signatories to the EA
Multilateral Agreement for the recognition of calibration certificates

Accreditation No.: **SCS 0108**

Client **PC Test**

Certificate No: **D2450V2-719_Aug17**

CALIBRATION CERTIFICATE

Object **D2450V2 - SN:719**

Calibration procedure(s) **QA CAL-05.v9**
Calibration procedure for dipole validation kits above 700 MHz

Calibration date: **August 17, 2017**

PMV ✓
8/27/17
Extended
BN ✓
7/19/2018

This calibration certificate documents the traceability to national standards, which realize the physical units of measurements (SI). The measurements and the uncertainties with confidence probability are given on the following pages and are part of the certificate.

All calibrations have been conducted in the closed laboratory facility: environment temperature (22 ± 3)°C and humidity < 70%.

Calibration Equipment used (M&TE critical for calibration)

| Primary Standards | ID # | Cal Date (Certificate No.) | Scheduled Calibration |
|-----------------------------|--------------------|---------------------------------|-----------------------|
| Power meter NRP | SN: 104778 | 04-Apr-17 (No. 217-02521/02522) | Apr-18 |
| Power sensor NRP-Z91 | SN: 103244 | 04-Apr-17 (No. 217-02521) | Apr-18 |
| Power sensor NRP-Z91 | SN: 103245 | 04-Apr-17 (No. 217-02522) | Apr-18 |
| Reference 20 dB Attenuator | SN: 5058 (20K) | 07-Apr-17 (No. 217-02528) | Apr-18 |
| Type-N mismatch combination | SN: 5047.2 / 06327 | 07-Apr-17 (No. 217-02529) | Apr-18 |
| Reference Probe EX3DV4 | SN: 7349 | 31-May-17 (No. EX3-7349_May17) | May-18 |
| DAE4 | SN: 601 | 28-Mar-17 (No. DAE4-601_Mar17) | Mar-18 |

| Secondary Standards | ID # | Check Date (in house) | Scheduled Check |
|---------------------------|----------------|-----------------------------------|------------------------|
| Power meter EPM-442A | SN: GB37480704 | 07-Oct-15 (in house check Oct-16) | In house check: Oct-18 |
| Power sensor HP 8481A | SN: US37292783 | 07-Oct-15 (in house check Oct-16) | In house check: Oct-18 |
| Power sensor HP 8481A | SN: MY41092317 | 07-Oct-15 (in house check Oct-16) | In house check: Oct-18 |
| RF generator R&S SMT-06 | SN: 100972 | 15-Jun-15 (in house check Oct-16) | In house check: Oct-18 |
| Network Analyzer HP 8753E | SN: US37390585 | 18-Oct-01 (in house check Oct-16) | In house check: Oct-17 |

Calibrated by: **Michael Weber** Name: Michael Weber Function: Laboratory Technician Signature: *M. Weber*

Approved by: **Katja Pokovic** Name: Katja Pokovic Function: Technical Manager Signature: *K. Pokovic*

Issued: August 17, 2017

This calibration certificate shall not be reproduced except in full without written approval of the laboratory.



Accredited by the Swiss Accreditation Service (SAS)
The Swiss Accreditation Service is one of the signatories to the EA
Multilateral Agreement for the recognition of calibration certificates

Accreditation No.: **SCS 0108**

Glossary:

| | |
|-------|---------------------------------|
| TSL | tissue simulating liquid |
| ConvF | sensitivity in TSL / NORM x,y,z |
| N/A | not applicable or not measured |

Calibration is Performed According to the Following Standards:

- IEEE Std 1528-2013, "IEEE Recommended Practice for Determining the Peak Spatial-Averaged Specific Absorption Rate (SAR) in the Human Head from Wireless Communications Devices: Measurement Techniques", June 2013
- IEC 62209-1, "Measurement procedure for the assessment of Specific Absorption Rate (SAR) from hand-held and body-mounted devices used next to the ear (frequency range of 300 MHz to 6 GHz)", July 2016
- IEC 62209-2, "Procedure to determine the Specific Absorption Rate (SAR) for wireless communication devices used in close proximity to the human body (frequency range of 30 MHz to 6 GHz)", March 2010
- KDB 865664, "SAR Measurement Requirements for 100 MHz to 6 GHz"

Additional Documentation:

- DASY4/5 System Handbook

Methods Applied and Interpretation of Parameters:

- Measurement Conditions:** Further details are available from the Validation Report at the end of the certificate. All figures stated in the certificate are valid at the frequency indicated.
- Antenna Parameters with TSL:** The dipole is mounted with the spacer to position its feed point exactly below the center marking of the flat phantom section, with the arms oriented parallel to the body axis.
- Feed Point Impedance and Return Loss:** These parameters are measured with the dipole positioned under the liquid filled phantom. The impedance stated is transformed from the measurement at the SMA connector to the feed point. The Return Loss ensures low reflected power. No uncertainty required.
- Electrical Delay:** One-way delay between the SMA connector and the antenna feed point. No uncertainty required.
- SAR measured:** SAR measured at the stated antenna input power.
- SAR normalized:** SAR as measured, normalized to an input power of 1 W at the antenna connector.
- SAR for nominal TSL parameters:** The measured TSL parameters are used to calculate the nominal SAR result.

The reported uncertainty of measurement is stated as the standard uncertainty of measurement multiplied by the coverage factor $k=2$, which for a normal distribution corresponds to a coverage probability of approximately 95%.

Measurement Conditions

DASY system configuration, as far as not given on page 1.

| | | |
|-------------------------------------|------------------------|-------------|
| DASY Version | DASY5 | V52.10.0 |
| Extrapolation | Advanced Extrapolation | |
| Phantom | Modular Flat Phantom | |
| Distance Dipole Center - TSL | 10 mm | with Spacer |
| Zoom Scan Resolution | dx, dy, dz = 5 mm | |
| Frequency | 2450 MHz ± 1 MHz | |

Head TSL parameters

The following parameters and calculations were applied.

| | Temperature | Permittivity | Conductivity |
|--|-----------------|--------------|------------------|
| Nominal Head TSL parameters | 22.0 °C | 39.2 | 1.80 mho/m |
| Measured Head TSL parameters | (22.0 ± 0.2) °C | 37.8 ± 6 % | 1.86 mho/m ± 6 % |
| Head TSL temperature change during test | < 0.5 °C | ---- | ---- |

SAR result with Head TSL

| SAR averaged over 1 cm³ (1 g) of Head TSL | Condition | |
|---|--------------------|---------------------------------|
| SAR measured | 250 mW input power | 13.3 W/kg |
| SAR for nominal Head TSL parameters | normalized to 1W | 51.9 W/kg ± 17.0 % (k=2) |

| SAR averaged over 10 cm³ (10 g) of Head TSL | condition | |
|---|--------------------|---------------------------------|
| SAR measured | 250 mW input power | 6.15 W/kg |
| SAR for nominal Head TSL parameters | normalized to 1W | 24.3 W/kg ± 16.5 % (k=2) |

Body TSL parameters

The following parameters and calculations were applied.

| | Temperature | Permittivity | Conductivity |
|--|-----------------|--------------|------------------|
| Nominal Body TSL parameters | 22.0 °C | 52.7 | 1.95 mho/m |
| Measured Body TSL parameters | (22.0 ± 0.2) °C | 51.9 ± 6 % | 2.03 mho/m ± 6 % |
| Body TSL temperature change during test | < 0.5 °C | ---- | ---- |

SAR result with Body TSL

| SAR averaged over 1 cm³ (1 g) of Body TSL | Condition | |
|---|--------------------|---------------------------------|
| SAR measured | 250 mW input power | 12.8 W/kg |
| SAR for nominal Body TSL parameters | normalized to 1W | 50.1 W/kg ± 17.0 % (k=2) |

| SAR averaged over 10 cm³ (10 g) of Body TSL | condition | |
|---|--------------------|---------------------------------|
| SAR measured | 250 mW input power | 6.00 W/kg |
| SAR for nominal Body TSL parameters | normalized to 1W | 23.7 W/kg ± 16.5 % (k=2) |

Appendix (Additional assessments outside the scope of SCS 0108)

Antenna Parameters with Head TSL

| | |
|--------------------------------------|--------------------------------|
| Impedance, transformed to feed point | 55.7 Ω + 7.0 j Ω |
| Return Loss | - 21.4 dB |

Antenna Parameters with Body TSL

| | |
|--------------------------------------|--------------------------------|
| Impedance, transformed to feed point | 51.4 Ω + 8.1 j Ω |
| Return Loss | - 21.8 dB |

General Antenna Parameters and Design

| | |
|----------------------------------|----------|
| Electrical Delay (one direction) | 1.150 ns |
|----------------------------------|----------|

After long term use with 100W radiated power, only a slight warming of the dipole near the feedpoint can be measured.

The dipole is made of standard semirigid coaxial cable. The center conductor of the feeding line is directly connected to the second arm of the dipole. The antenna is therefore short-circuited for DC-signals. On some of the dipoles, small end caps are added to the dipole arms in order to improve matching when loaded according to the position as explained in the "Measurement Conditions" paragraph. The SAR data are not affected by this change. The overall dipole length is still according to the Standard.

No excessive force must be applied to the dipole arms, because they might bend or the soldered connections near the feedpoint may be damaged.

Additional EUT Data

| | |
|-----------------|--------------------|
| Manufactured by | SPEAG |
| Manufactured on | September 10, 2002 |

DASY5 Validation Report for Head TSL

Date: 17.08.2017

Test Laboratory: SPEAG, Zurich, Switzerland

DUT: Dipole 2450 MHz; Type: D2450V2; Serial: D2450V2 - SN: 719

Communication System: UID 0 - CW; Frequency: 2450 MHz

Medium parameters used: $f = 2450$ MHz; $\sigma = 1.86$ S/m; $\epsilon_r = 37.8$; $\rho = 1000$ kg/m³

Phantom section: Flat Section

Measurement Standard: DASY5 (IEEE/IEC/ANSI C63.19-2011)

DASY52 Configuration:

- Probe: EX3DV4 - SN7349; ConvF(8.12, 8.12, 8.12); Calibrated: 31.05.2017;
- Sensor-Surface: 1.4mm (Mechanical Surface Detection)
- Electronics: DAE4 Sn601; Calibrated: 28.03.2017
- Phantom: Flat Phantom 5.0 (front); Type: QD 000 P50 AA; Serial: 1001
- DASY52 52.10.0(1446); SEMCAD X 14.6.10(7417)

Dipole Calibration for Head Tissue/Pin=250 mW, d=10mm/Zoom Scan (7x7x7)/Cube 0:

Measurement grid: dx=5mm, dy=5mm, dz=5mm

Reference Value = 112.8 V/m; Power Drift = -0.01 dB

Peak SAR (extrapolated) = 26.9 W/kg

SAR(1 g) = 13.3 W/kg; SAR(10 g) = 6.15 W/kg

Maximum value of SAR (measured) = 21.6 W/kg

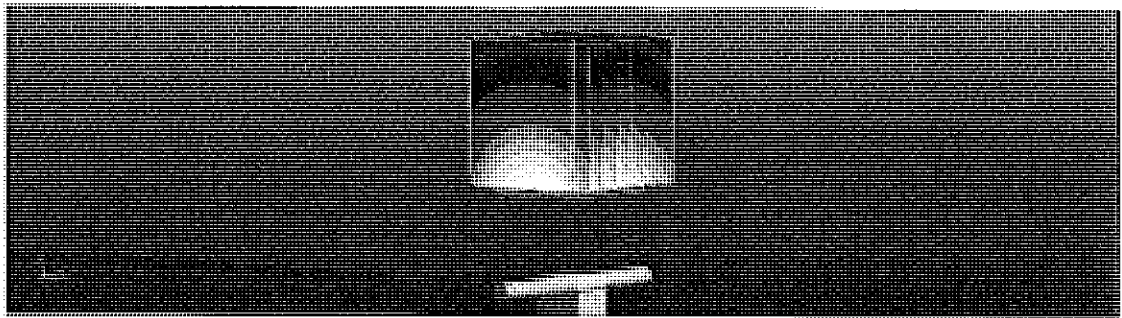
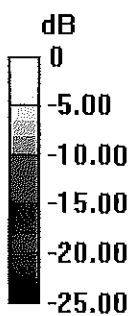

0 dB = 21.6 W/kg = 13.34 dBW/kg

Impedance Measurement Plot for Head TSL

17 Aug 2017 12:38:03
CH1 S11 1 U FS 1: 55.682 Ω 6.9766 Ω 453.21 μ H 2 450.000 000 MHz

*
Oe1
CA

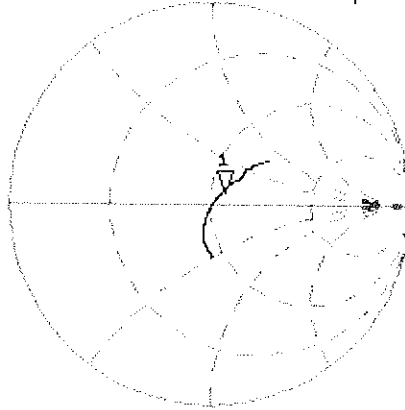

Avg
16

H1d

CH2 S11 LOG 5 dB/REF -20 dB 1: -21.413 dB 2 450.000 000 MHz

CA

Avg
16

H1d

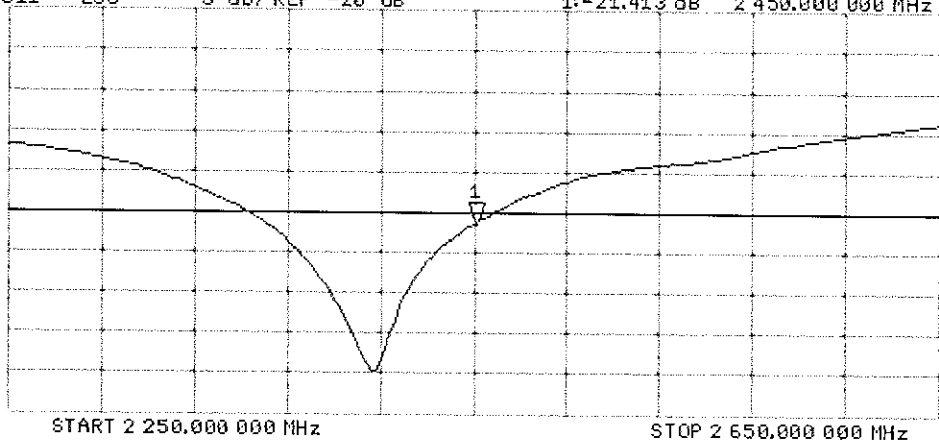

DASY5 Validation Report for Body TSL

Date: 17.08.2017

Test Laboratory: SPEAG, Zurich, Switzerland

DUT: Dipole 2450 MHz; Type: D2450V2; Serial: D2450V2 - SN: 719

Communication System: UID 0 - CW; Frequency: 2450 MHz

Medium parameters used: $f = 2450$ MHz; $\sigma = 2.03$ S/m; $\epsilon_r = 51.9$; $\rho = 1000$ kg/m³

Phantom section: Flat Section

Measurement Standard: DASY5 (IEEE/IEC/ANSI C63.19-2011)

DASY52 Configuration:

- Probe: EX3DV4 - SN7349; ConvF(8.1, 8.1, 8.1); Calibrated: 31.05.2017;
- Sensor-Surface: 1.4mm (Mechanical Surface Detection)
- Electronics: DAE4 Sn601; Calibrated: 28.03.2017
- Phantom: Flat Phantom 5.0 (back); Type: QD 000 P50 AA; Serial: 1002
- DASY52 52.10.0(1446); SEMCAD X 14.6.10(7417)

Dipole Calibration for Body Tissue/Pin=250 mW, d=10mm/Zoom Scan (7x7x7)/Cube 0:

Measurement grid: dx=5mm, dy=5mm, dz=5mm

Reference Value = 103.0 V/m; Power Drift = -0.07 dB

Peak SAR (extrapolated) = 25.2 W/kg

SAR(1 g) = 12.8 W/kg; SAR(10 g) = 6 W/kg

Maximum value of SAR (measured) = 19.8 W/kg

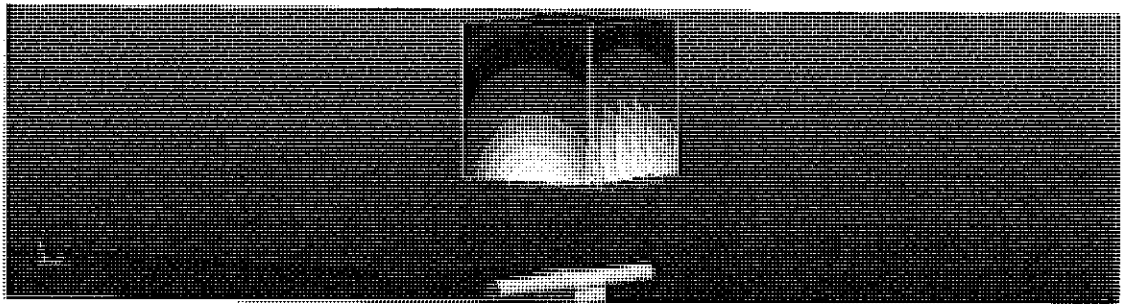
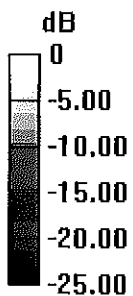

0 dB = 19.8 W/kg = 12.97 dBW/kg

Impedance Measurement Plot for Body TSL

17 Aug 2017 12:37:27
[CH1] S11 1 U FS 1: 51.379 Ω 8.1367 Ω 528.57 pF 2 450.000 000 MHz

*
De1
C4

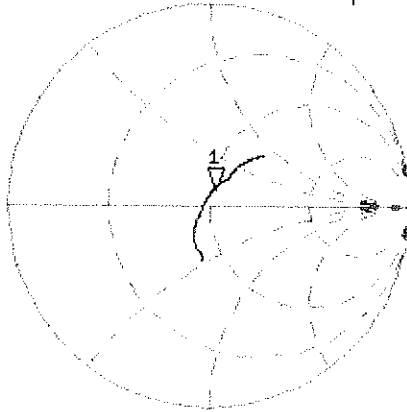

Avg
16

H1d

CH2 S11 LOG 5 dB/REF -20 dB 1: -21.809 dB 2 450.000 000 MHz

C4

Avg
16

H1d

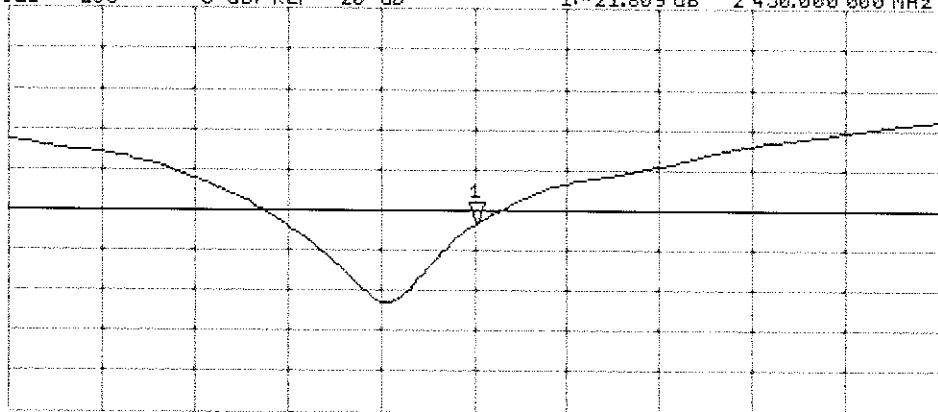

START 2 250.000 000 MHz

STOP 2 650.000 000 MHz

Certification of Calibration

Object: D2450V2 – SN: 719

Calibration procedure(s): Procedure for Calibration Extension for SAR Dipoles.

Extended Calibration date: 07/18/2018

Description: SAR Validation Dipole at 2450 MHz.

Calibration Equipment used:

| Manufacturer | Model | Description | Cal Date | Cal Interval | Cal Due | Serial Number |
|-----------------------|-----------|---|------------|--------------|------------|---------------|
| Agilent | E4438C | ESG Vector Signal Generator | 3/24/2017 | Biennial | 3/24/2019 | MY42082385 |
| Agilent | 8753ES | S-Parameter Network Analyzer | 9/14/2017 | Annual | 9/14/2018 | US39170118 |
| Amplifier Research | 15S1G6 | Amplifier | CBT | N/A | CBT | 433971 |
| Anritsu | ML2495A | Power Meter | 11/28/2017 | Annual | 11/28/2018 | 1039008 |
| Anritsu | MA2411B | Pulse Power Sensor | 3/2/2018 | Annual | 3/2/2019 | 1207364 |
| Anritsu | MA2411B | Pulse Power Sensor | 11/15/2017 | Annual | 11/15/2018 | 1339007 |
| Control Company | 4040 | Therm./Clock/Humidity Monitor | 3/31/2017 | Biennial | 3/31/2019 | 170232394 |
| Control Company | 4352 | Ultra Long Stem Thermometer | 5/2/2017 | Biennial | 5/2/2019 | 170330156 |
| Keysight | 772D | Dual Directional Coupler | CBT | N/A | CBT | MY52180215 |
| Keysight Technologies | 85033E | Standard Mechanical Calibration Kit (DC to 9GHz, 3.5mm) | 6/4/2018 | Annual | 6/4/2019 | MY53401181 |
| Mini-Circuits | BW-N20W5+ | DC to 18 GHz Precision Fixed 20 dB Attenuator | CBT | N/A | CBT | N/A |
| Mini-Circuits | NLP-2950+ | Low Pass Filter DC to 2700 MHz | CBT | N/A | CBT | N/A |
| Narda | 4772-3 | Attenuator (3dB) | CBT | N/A | CBT | 9406 |
| Pasternack | PE2209-10 | Bidirectional Coupler | CBT | N/A | CBT | N/A |
| Pasternack | PE5011-1 | Torque Wrench | 7/19/2017 | Biennial | 7/19/2019 | N/A |
| SPEAG | DAE4 | Dasy Data Acquisition Electronics | 3/7/2018 | Annual | 3/7/2019 | 1368 |
| SPEAG | DAE4 | Dasy Data Acquisition Electronics | 8/9/2017 | Annual | 8/9/2018 | 1323 |
| SPEAG | DAK-3.5 | Dielectric Assessment Kit | 9/12/2017 | Annual | 9/12/2018 | 1091 |
| SPEAG | ES3DV3 | SAR Probe | 3/13/2018 | Annual | 3/13/2019 | 3319 |
| SPEAG | ES3DV3 | SAR Probe | 8/14/2017 | Annual | 8/14/2018 | 3332 |

Measurement Uncertainty = $\pm 23\%$ (k=2)

| | Name | Function | Signature |
|----------------|------------------|--------------------------|-------------------------|
| Calibrated By: | Brodie Halfoster | Test Engineer | <i>BRODIE HALFOSTER</i> |
| Approved By: | Kaitlin O'Keefe | Senior Technical Manager | <i>KOK</i> |

DIPOLE CALIBRATION EXTENSION

Per KDB 865664 D01, calibration intervals of up to three years may be considered for reference dipoles when it is demonstrated that the SAR target, impedance and return loss of a dipole have remained stable according to the following requirements:

1. The measured SAR does not deviate more than 10% from the target on the calibration certificate.
2. The return-loss does not deviate more than 20% from the previous measurement and meets the required 20dB minimum return-loss requirement.
3. The measurement of real or imaginary parts of impedance does not deviate more than 5Ω from the previous measurement.

The following dipole was checked to pass the above 3 requirements to have 2-year calibration period from the calibration date:

| Calibration Date | Extension Date | Certificate Electrical Delay (ns) | Certificate SAR Target Head (1g) W/kg @ 20.0 dBm | Measured Head SAR (1g) W/kg @ 20.0 dBm | Deviation 1g (%) | Certificate SAR Target Head (10g) W/kg @ 20.0 dBm | Measured Head SAR (10g) W/kg @ 20.0 dBm | Deviation 10g (%) | Certificate Impedance Head (Ohm) Real | Measured Impedance Head (Ohm) Real | Difference (Ohm) Real | Certificate Impedance Head (Ohm) Imaginary | Measured Impedance Head (Ohm) Imaginary | Difference (Ohm) Imaginary | Certificate Return Loss Head (dB) | Measured Return Loss Head (dB) | Deviation (%) | PASS/FAIL |
|------------------|----------------|-----------------------------------|--|--|------------------|---|---|-------------------|---------------------------------------|------------------------------------|-----------------------|--|---|----------------------------|-----------------------------------|--------------------------------|---------------|-----------|
| 8/17/2017 | 7/18/2018 | 1.150 | 5.19 | 5.46 | 5.20% | 2.43 | 2.51 | 3.29% | 55.7 | 53.9 | 1.8 | 7.0 | 2.9 | 4.1 | -21.4 | -25.4 | -18.70% | PASS |
| Calibration Date | Extension Date | Certificate Electrical Delay (ns) | Certificate SAR Target Body (1g) W/kg @ 20.0 dBm | Measured Body SAR (1g) W/kg @ 20.0 dBm | Deviation 1g (%) | Certificate SAR Target Body (10g) W/kg @ 20.0 dBm | Measured Body SAR (10g) W/kg @ 20.0 dBm | Deviation 10g (%) | Certificate Impedance Body (Ohm) Real | Measured Impedance Body (Ohm) Real | Difference (Ohm) Real | Certificate Impedance Body (Ohm) Imaginary | Measured Impedance Body (Ohm) Imaginary | Difference (Ohm) Imaginary | Certificate Return Loss Body (dB) | Measured Return Loss Body (dB) | Deviation (%) | PASS/FAIL |
| 8/17/2017 | 7/18/2018 | 1.150 | 5.01 | 5.19 | 3.59% | 2.37 | 2.38 | 0.42% | 51.4 | 50.2 | 1.2 | 8.1 | 5.9 | 2.2 | -21.8 | -24.6 | -12.80% | PASS |

Impedance & Return-Loss Measurement Plot for Head TSL

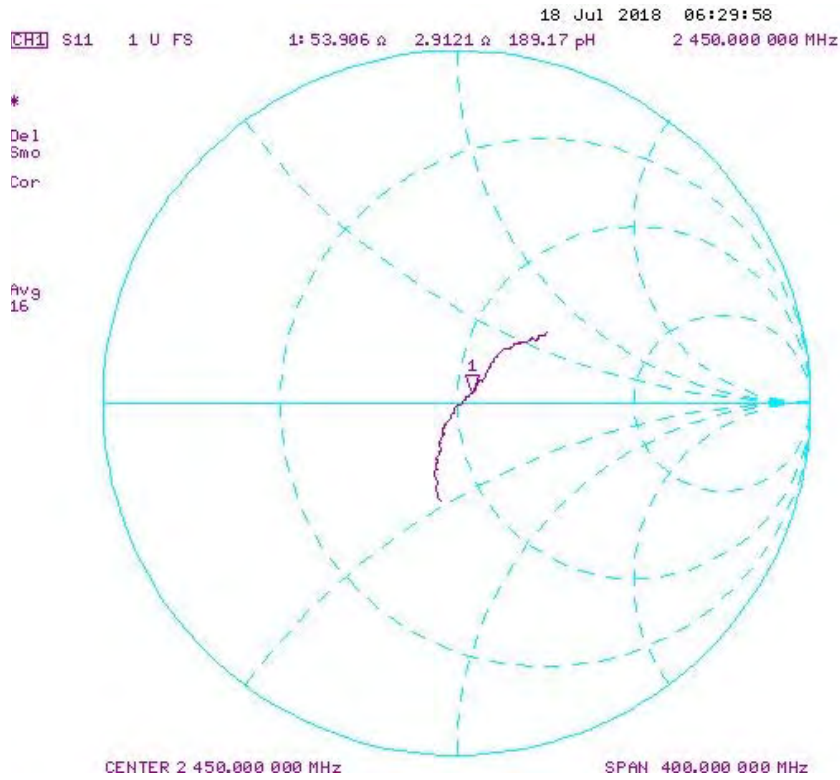

Impedance & Return-Loss Measurement Plot for Body TSL

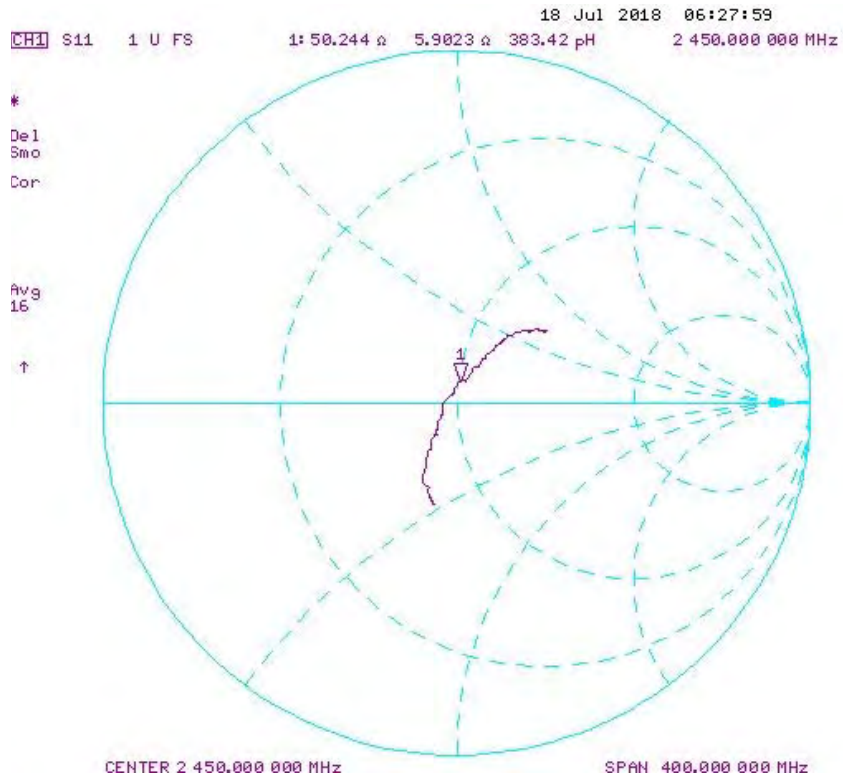



Accredited by the Swiss Accreditation Service (SAS)
The Swiss Accreditation Service is one of the signatories to the EA
Multilateral Agreement for the recognition of calibration certificates

Accreditation No.: **SCS 0108**

Client **PC Test**

Certificate No: **D2450V2-981_Aug18**

CALIBRATION CERTIFICATE

Object **D2450V2 - SN:981**

Calibration procedure(s) **QA CAL-05.v10
Calibration procedure for dipole validation kits above 700 MHz**

Calibration date: **August 16, 2018**

*BN ✓
09-26/2018*

This calibration certificate documents the traceability to national standards, which realize the physical units of measurements (SI).
The measurements and the uncertainties with confidence probability are given on the following pages and are part of the certificate.

All calibrations have been conducted in the closed laboratory facility: environment temperature (22 ± 3)°C and humidity < 70%.

Calibration Equipment used (M&TE critical for calibration)

| Primary Standards | ID # | Cal Date (Certificate No.) | Scheduled Calibration |
|---------------------------------|--------------------|-----------------------------------|------------------------|
| Power meter NRP | SN: 104778 | 04-Apr-18 (No. 217-02672/02673) | Apr-19 |
| Power sensor NRP-Z91 | SN: 103244 | 04-Apr-18 (No. 217-02672) | Apr-19 |
| Power sensor NRP-Z91 | SN: 103245 | 04-Apr-18 (No. 217-02673) | Apr-19 |
| Reference 20 dB Attenuator | SN: 5058 (20k) | 04-Apr-18 (No. 217-02682) | Apr-19 |
| Type-N mismatch combination | SN: 5047.2 / 06327 | 04-Apr-18 (No. 217-02683) | Apr-19 |
| Reference Probe EX3DV4 | SN: 7349 | 30-Dec-17 (No. EX3-7349_Dec17) | Dec-18 |
| DAE4 | SN: 601 | 26-Oct-17 (No. DAE4-601_Oct17) | Oct-18 |
| Secondary Standards | ID # | Check Date (in house) | Scheduled Check |
| Power meter EPM-442A | SN: GB37480704 | 07-Oct-15 (in house check Oct-16) | In house check: Oct-18 |
| Power sensor HP 8481A | SN: US37292783 | 07-Oct-15 (in house check Oct-16) | In house check: Oct-18 |
| Power sensor HP 8481A | SN: MY41092317 | 07-Oct-15 (in house check Oct-16) | In house check: Oct-18 |
| RF generator R&S SMT-06 | SN: 100972 | 15-Jun-15 (in house check Oct-16) | In house check: Oct-18 |
| Network Analyzer Agilent E8358A | SN: US41080477 | 31-Mar-14 (in house check Oct-17) | In house check: Oct-18 |

Calibrated by: **Leif Klysner** Function: **Laboratory Technician**

Approved by: **Katja Pokovic** Technical Manager

Signature
Leif Klysner

[Signature]

Issued: August 23, 2018

This calibration certificate shall not be reproduced except in full without written approval of the laboratory.



Accredited by the Swiss Accreditation Service (SAS)
The Swiss Accreditation Service is one of the signatories to the EA
Multilateral Agreement for the recognition of calibration certificates

Accreditation No.: **SCS 0108**

Glossary:

| | |
|-------|---------------------------------|
| TSL | tissue simulating liquid |
| ConvF | sensitivity in TSL / NORM x,y,z |
| N/A | not applicable or not measured |

Calibration is Performed According to the Following Standards:

- a) IEEE Std 1528-2013, "IEEE Recommended Practice for Determining the Peak Spatial-Averaged Specific Absorption Rate (SAR) in the Human Head from Wireless Communications Devices: Measurement Techniques", June 2013
- b) IEC 62209-1, "Measurement procedure for the assessment of Specific Absorption Rate (SAR) from hand-held and body-mounted devices used next to the ear (frequency range of 300 MHz to 6 GHz)", July 2016
- c) IEC 62209-2, "Procedure to determine the Specific Absorption Rate (SAR) for wireless communication devices used in close proximity to the human body (frequency range of 30 MHz to 6 GHz)", March 2010
- d) KDB 865664, "SAR Measurement Requirements for 100 MHz to 6 GHz"

Additional Documentation:

- e) DASy4/5 System Handbook

Methods Applied and Interpretation of Parameters:

- *Measurement Conditions:* Further details are available from the Validation Report at the end of the certificate. All figures stated in the certificate are valid at the frequency indicated.
- *Antenna Parameters with TSL:* The dipole is mounted with the spacer to position its feed point exactly below the center marking of the flat phantom section, with the arms oriented parallel to the body axis.
- *Feed Point Impedance and Return Loss:* These parameters are measured with the dipole positioned under the liquid filled phantom. The impedance stated is transformed from the measurement at the SMA connector to the feed point. The Return Loss ensures low reflected power. No uncertainty required.
- *Electrical Delay:* One-way delay between the SMA connector and the antenna feed point. No uncertainty required.
- *SAR measured:* SAR measured at the stated antenna input power.
- *SAR normalized:* SAR as measured, normalized to an input power of 1 W at the antenna connector.
- *SAR for nominal TSL parameters:* The measured TSL parameters are used to calculate the nominal SAR result.

The reported uncertainty of measurement is stated as the standard uncertainty of measurement multiplied by the coverage factor $k=2$, which for a normal distribution corresponds to a coverage probability of approximately 95%.

Measurement Conditions

DASY system configuration, as far as not given on page 1.

| | | |
|------------------------------|------------------------|-------------|
| DASY Version | DASY5 | V52.10.1 |
| Extrapolation | Advanced Extrapolation | |
| Phantom | Modular Flat Phantom | |
| Distance Dipole Center - TSL | 10 mm | with Spacer |
| Zoom Scan Resolution | dx, dy, dz = 5.0 mm | |
| Frequency | 2450 MHz \pm 1 MHz | |

Head TSL parameters

The following parameters and calculations were applied.

| | Temperature | Permittivity | Conductivity |
|---|---------------------|----------------|----------------------|
| Nominal Head TSL parameters | 22.0 °C | 39.2 | 1.80 mho/m |
| Measured Head TSL parameters | (22.0 \pm 0.2) °C | 37.7 \pm 6 % | 1.86 mho/m \pm 6 % |
| Head TSL temperature change during test | < 0.5 °C | ---- | ---- |

SAR result with Head TSL

| SAR averaged over 1 cm ³ (1 g) of Head TSL | Condition | |
|---|--------------------|--|
| SAR measured | 250 mW input power | 13.4 W/kg |
| SAR for nominal Head TSL parameters | normalized to 1W | 52.3 W/kg \pm 17.0 % (k=2) |

| SAR averaged over 10 cm ³ (10 g) of Head TSL | condition | |
|---|--------------------|--|
| SAR measured | 250 mW input power | 6.20 W/kg |
| SAR for nominal Head TSL parameters | normalized to 1W | 24.4 W/kg \pm 16.5 % (k=2) |

Body TSL parameters

The following parameters and calculations were applied.

| | Temperature | Permittivity | Conductivity |
|---|---------------------|----------------|----------------------|
| Nominal Body TSL parameters | 22.0 °C | 52.7 | 1.95 mho/m |
| Measured Body TSL parameters | (22.0 \pm 0.2) °C | 51.8 \pm 6 % | 2.02 mho/m \pm 6 % |
| Body TSL temperature change during test | < 0.5 °C | ---- | ---- |

SAR result with Body TSL

| SAR averaged over 1 cm ³ (1 g) of Body TSL | Condition | |
|---|--------------------|--|
| SAR measured | 250 mW input power | 13.0 W/kg |
| SAR for nominal Body TSL parameters | normalized to 1W | 50.9 W/kg \pm 17.0 % (k=2) |

| SAR averaged over 10 cm ³ (10 g) of Body TSL | condition | |
|---|--------------------|--|
| SAR measured | 250 mW input power | 6.11 W/kg |
| SAR for nominal Body TSL parameters | normalized to 1W | 24.2 W/kg \pm 16.5 % (k=2) |

Appendix (Additional assessments outside the scope of SCS 0108)

Antenna Parameters with Head TSL

| | |
|--------------------------------------|--------------------------------|
| Impedance, transformed to feed point | 55.0 Ω + 2.3 j Ω |
| Return Loss | - 25.6 dB |

Antenna Parameters with Body TSL

| | |
|--------------------------------------|--------------------------------|
| Impedance, transformed to feed point | 50.2 Ω + 4.7 j Ω |
| Return Loss | - 26.6 dB |

General Antenna Parameters and Design

| | |
|----------------------------------|----------|
| Electrical Delay (one direction) | 1.162 ns |
|----------------------------------|----------|

After long term use with 100W radiated power, only a slight warming of the dipole near the feedpoint can be measured.

The dipole is made of standard semirigid coaxial cable. The center conductor of the feeding line is directly connected to the second arm of the dipole. The antenna is therefore short-circuited for DC-signals. On some of the dipoles, small end caps are added to the dipole arms in order to improve matching when loaded according to the position as explained in the "Measurement Conditions" paragraph. The SAR data are not affected by this change. The overall dipole length is still according to the Standard.

No excessive force must be applied to the dipole arms, because they might bend or the soldered connections near the feedpoint may be damaged.

Additional EUT Data

| | |
|-----------------|-------------------|
| Manufactured by | SPEAG |
| Manufactured on | December 30, 2014 |

Appendix (Additional assessments outside the scope of SCS 0108)

Measurement Conditions

DASY system configuration, as far as not given on page 1 and 3.

| | | |
|---------|------------------|-----------------------------|
| Phantom | SAM Head Phantom | For usage with cSAR3DV2-R/L |
|---------|------------------|-----------------------------|

SAR result with SAM Head (Top)

| SAR averaged over 1 cm ³ (1 g) of Head TSL | Condition | |
|---|--------------------|---------------------------------|
| SAR measured | 250 mW input power | 13.6 W/kg |
| SAR for nominal Head TSL parameters | normalized to 1W | 54.0 W/kg ± 17.5 % (k=2) |

| SAR averaged over 10 cm ³ (10 g) of Head TSL | condition | |
|---|--------------------|---------------------------------|
| SAR measured | 250 mW input power | 6.33 W/kg |
| SAR for nominal Head TSL parameters | normalized to 1W | 25.2 W/kg ± 16.9 % (k=2) |

SAR result with SAM Head (Mouth)

| SAR averaged over 1 cm ³ (1 g) of Head TSL | Condition | |
|---|--------------------|---------------------------------|
| SAR measured | 250 mW input power | 13.6 W/kg |
| SAR for nominal Head TSL parameters | normalized to 1W | 54.0 W/kg ± 17.5 % (k=2) |

| SAR averaged over 10 cm ³ (10 g) of Head TSL | condition | |
|---|--------------------|---------------------------------|
| SAR measured | 250 mW input power | 6.35 W/kg |
| SAR for nominal Head TSL parameters | normalized to 1W | 25.3 W/kg ± 16.9 % (k=2) |

SAR result with SAM Head (Neck)

| SAR averaged over 1 cm ³ (1 g) of Head TSL | Condition | |
|---|--------------------|---------------------------------|
| SAR measured | 250 mW input power | 12.9 W/kg |
| SAR for nominal Head TSL parameters | normalized to 1W | 51.2 W/kg ± 17.5 % (k=2) |

| SAR averaged over 10 cm ³ (10 g) of Head TSL | condition | |
|---|--------------------|---------------------------------|
| SAR measured | 250 mW input power | 6.11 W/kg |
| SAR for nominal Head TSL parameters | normalized to 1W | 24.4 W/kg ± 16.9 % (k=2) |

SAR result with SAM Head (Ear)

| SAR averaged over 1 cm ³ (1 g) of Head TSL | Condition | |
|---|--------------------|---------------------------------|
| SAR measured | 250 mW input power | 8.74 W/kg |
| SAR for nominal Head TSL parameters | normalized to 1W | 34.7 W/kg ± 17.5 % (k=2) |

| SAR averaged over 10 cm ³ (10 g) of Head TSL | condition | |
|---|--------------------|---------------------------------|
| SAR measured | 250 mW input power | 4.40 W/kg |
| SAR for nominal Head TSL parameters | normalized to 1W | 17.5 W/kg ± 16.9 % (k=2) |

DASY5 Validation Report for Head TSL

Date: 13.08.2018

Test Laboratory: SPEAG, Zurich, Switzerland

DUT: Dipole 2450 MHz; Type: D2450V2; Serial: D2450V2 - SN:981

Communication System: UID 0 - CW; Frequency: 2450 MHz

Medium parameters used: $f = 2450$ MHz; $\sigma = 1.86$ S/m; $\epsilon_r = 37.7$; $\rho = 1000$ kg/m³

Phantom section: Flat Section

Measurement Standard: DASY5 (IEEE/IEC/ANSI C63.19-2011)

DASY52 Configuration:

- Probe: EX3DV4 - SN7349; ConvF(7.88, 7.88, 7.88) @ 2450 MHz; Calibrated: 30.12.2017
- Sensor-Surface: 1.4mm (Mechanical Surface Detection)
- Electronics: DAE4 Sn601; Calibrated: 26.10.2017
- Phantom: Flat Phantom 5.0 (front); Type: QD 000 P50 AA; Serial: 1001
- DASY52 52.10.1(1476); SEMCAD X 14.6.11(7439)

Dipole Calibration for Head Tissue/Pin=250 mW, d=10mm/Zoom Scan (7x7x7)/Cube 0:

Measurement grid: dx=5mm, dy=5mm, dz=5mm

Reference Value = 116.6 V/m; Power Drift = -0.03 dB

Peak SAR (extrapolated) = 26.7 W/kg

SAR(1 g) = 13.4 W/kg; SAR(10 g) = 6.2 W/kg

Maximum value of SAR (measured) = 22.1 W/kg



Impedance Measurement Plot for Head TSL

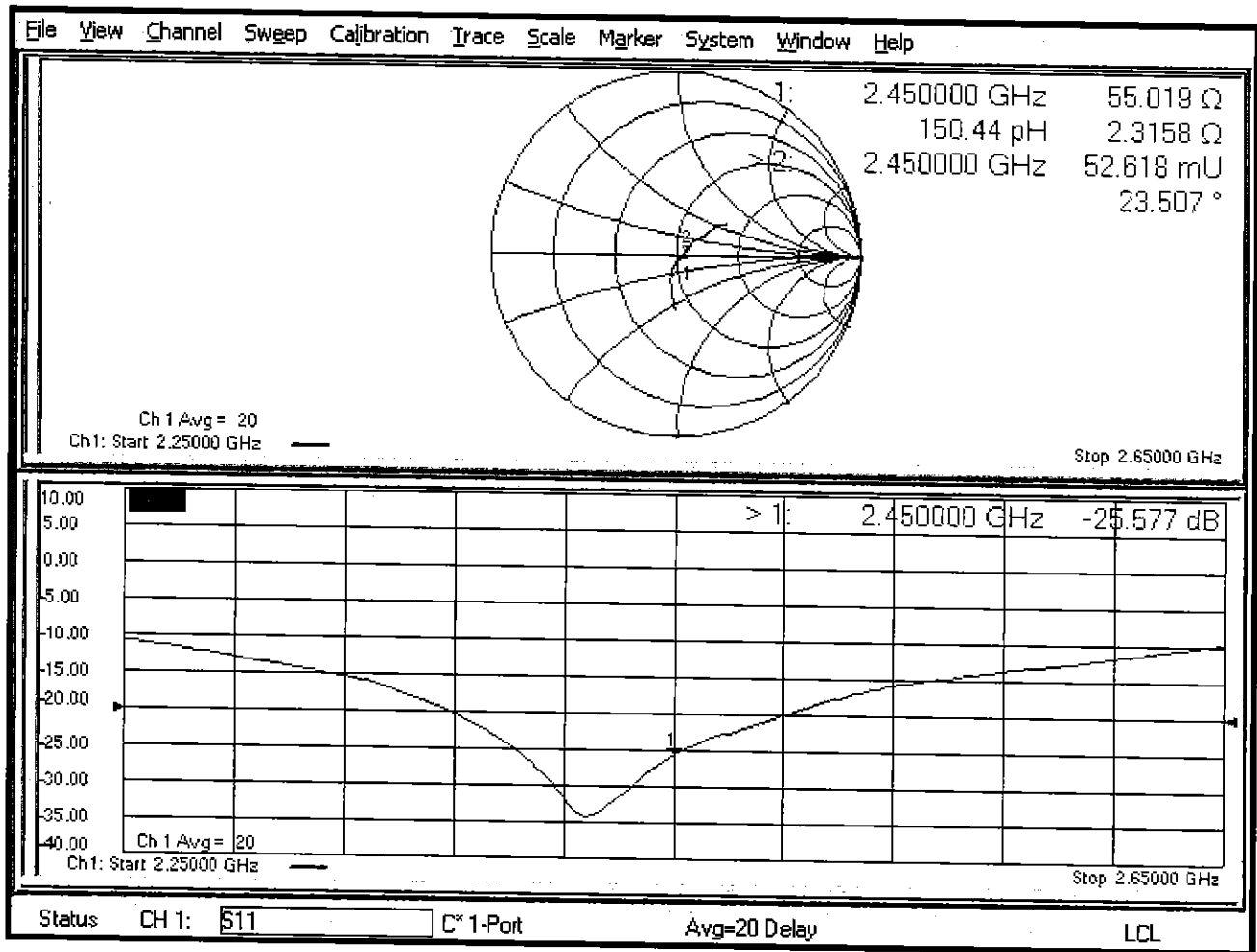

DASY5 Validation Report for Body TSL

Date: 13.08.2018

Test Laboratory: SPEAG, Zurich, Switzerland

DUT: Dipole 2450 MHz; Type: D2450V2; Serial: D2450V2 - SN:981

Communication System: UID 0 - CW; Frequency: 2450 MHz

Medium parameters used: $f = 2450$ MHz; $\sigma = 2.02$ S/m; $\epsilon_r = 51.8$; $\rho = 1000$ kg/m³

Phantom section: Flat Section

Measurement Standard: DASY5 (IEEE/IEC/ANSI C63.19-2011)

DASY52 Configuration:

- Probe: EX3DV4 - SN7349; ConvF(8.01, 8.01, 8.01) @ 2450 MHz; Calibrated: 30.12.2017
- Sensor-Surface: 1.4mm (Mechanical Surface Detection)
- Electronics: DAE4 Sn601; Calibrated: 26.10.2017
- Phantom: Flat Phantom 5.0 (back); Type: QD 000 P50 AA; Serial: 1002
- DASY52 52.10.1(1476); SEMCAD X 14.6.11(7439)

Dipole Calibration for Body Tissue/Pin=250 mW, d=10mm/Zoom Scan (7x7x7)/Cube 0:

Measurement grid: dx=5mm, dy=5mm, dz=5mm

Reference Value = 107.0 V/m; Power Drift = -0.08 dB

Peak SAR (extrapolated) = 25.3 W/kg

SAR(1 g) = 13 W/kg; SAR(10 g) = 6.11 W/kg

Maximum value of SAR (measured) = 20.7 W/kg



0 dB = 20.7 W/kg = 13.16 dBW/kg

Impedance Measurement Plot for Body TSL

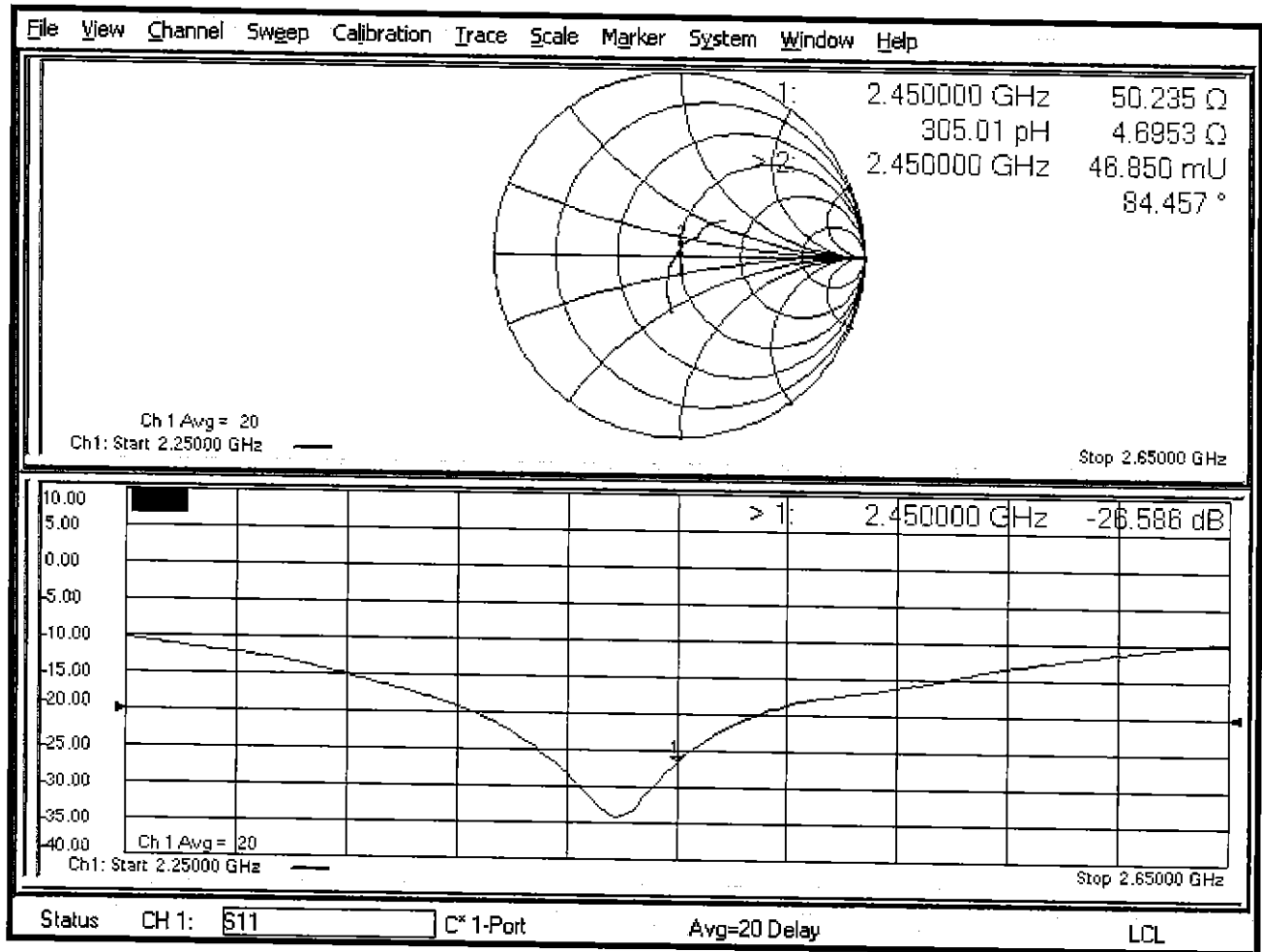

DASY5 Validation Report for SAM Head

Date: 16.08.2018

Test Laboratory: SPEAG, Zurich, Switzerland

DUT: Dipole 2450 MHz; Type: D2450V2; Serial: D2450V2 - SN:981

Communication System: UID 0 - CW ; Frequency: 2450 MHz

Medium parameters used: $f = 2450$ MHz; $\sigma = 1.85$ S/m; $\epsilon_r = 40.2$; $\rho = 1000$ kg/m³

Measurement Standard: DASY5 (IEEE/IEC/ANSI C63.19-2011)

DASY52 Configuration:

- Probe: EX3DV4 - SN7349; ConvF(7.88, 7.88, 7.88) @ 2450 MHz; Calibrated: 30.12.2017
- Sensor-Surface: 1.4mm (Mechanical Surface Detection)
- Electronics: DAE4 Sn601; Calibrated: 26.10.2017
- Phantom: SAM Head
- DASY52 52.10.1(1476); SEMCAD X 14.6.11(7439)

SAM Head Top/Zoom Scan (7x7x7)/Cube 0: Measurement grid: dx=5mm, dy=5mm, dz=5mm

Reference Value = 116.2 V/m; Power Drift = 0.00 dB

Peak SAR (extrapolated) = 26.4 W/kg

SAR(1 g) = 13.6 W/kg; SAR(10 g) = 6.33 W/kg

Maximum value of SAR (measured) = 22.0 W/kg

SAM Head Mouth/Zoom Scan (7x7x7)/Cube 0: Measurement grid: dx=5mm, dy=5mm, dz=5mm

Reference Value = 116.9 V/m; Power Drift = 0.01 dB

Peak SAR (extrapolated) = 26.3 W/kg

SAR(1 g) = 13.6 W/kg; SAR(10 g) = 6.35 W/kg

Maximum value of SAR (measured) = 21.7 W/kg

SAM Head Neck/Zoom Scan (7x7x7)/Cube 0: Measurement grid: dx=5mm, dy=5mm, dz=5mm

Reference Value = 112.0 V/m; Power Drift = 0.03 dB

Peak SAR (extrapolated) = 24.1 W/kg

SAR(1 g) = 12.9 W/kg; SAR(10 g) = 6.11 W/kg

Maximum value of SAR (measured) = 20.5 W/kg

SAM Head Ear/Zoom Scan (7x7x7)/Cube 0: Measurement grid: dx=5mm, dy=5mm, dz=5mm

Reference Value = 91.03 V/m; Power Drift = -0.01 dB

Peak SAR (extrapolated) = 15.8 W/kg

SAR(1 g) = 8.74 W/kg; SAR(10 g) = 4.4 W/kg

Maximum value of SAR (measured) = 13.5 W/kg

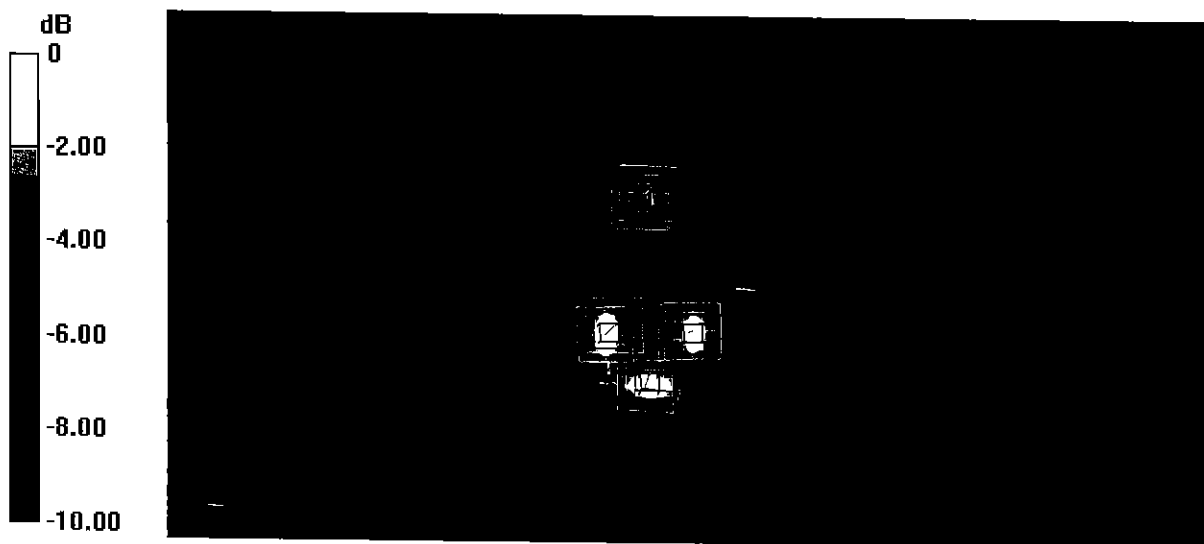

0 dB = 22.0 W/kg = 13.42 dBW/kg



Accredited by the Swiss Accreditation Service (SAS)
The Swiss Accreditation Service is one of the signatories to the EA
Multilateral Agreement for the recognition of calibration certificates

Accreditation No.: **SCS 0108**

Client **PC Test**

Certificate No: **D5GHzV2-1057_Jan18**

CALIBRATION CERTIFICATE

Object **D5GHzV2 - SN:1057**

Calibration procedure(s) **QA CAL-22.v2
Calibration procedure for dipole validation kits between 3-6 GHz**

Calibration date: **January 16, 2018**

*BN ✓
01-25-2018*

This calibration certificate documents the traceability to national standards, which realize the physical units of measurements (SI).
The measurements and the uncertainties with confidence probability are given on the following pages and are part of the certificate.

*BN ✓
02/06/2019*

All calibrations have been conducted in the closed laboratory facility: environment temperature (22 ± 3)°C and humidity < 70%.

Calibration Equipment used (M&TE critical for calibration)

| Primary Standards | ID # | Cal Date (Certificate No.) | Scheduled Calibration |
|-----------------------------|--------------------|---------------------------------|-----------------------|
| Power meter NRP | SN: 104778 | 04-Apr-17 (No. 217-02521/02522) | Apr-18 |
| Power sensor NRP-Z91 | SN: 103244 | 04-Apr-17 (No. 217-02521) | Apr-18 |
| Power sensor NRP-Z91 | SN: 103245 | 04-Apr-17 (No. 217-02522) | Apr-18 |
| Reference 20 dB Attenuator | SN: 5058 (20k) | 07-Apr-17 (No. 217-02528) | Apr-18 |
| Type-N mismatch combination | SN: 5047.2 / 06327 | 07-Apr-17 (No. 217-02529) | Apr-18 |
| Reference Probe EX3DV4 | SN: 3503 | 30-Dec-17 (No. EX3-3503_Dec17) | Dec-18 |
| DAE4 | SN: 601 | 26-Oct-17 (No. DAE4-601_Oct17) | Oct-18 |

| Secondary Standards | ID # | Check Date (in house) | Scheduled Check |
|---------------------------|----------------|-----------------------------------|------------------------|
| Power meter EPM-442A | SN: GB37490704 | 07-Oct-15 (in house check Oct-16) | In house check: Oct-18 |
| Power sensor HP 8481A | SN: US37292783 | 07-Oct-15 (in house check Oct-16) | In house check: Oct-18 |
| Power sensor HP 8481A | SN: MY41092317 | 07-Oct-15 (in house check Oct-16) | In house check: Oct-18 |
| RF generator R&S SMT-06 | SN: 100972 | 15-Jun-15 (in house check Oct-16) | In house check: Oct-18 |
| Network Analyzer HP 8753E | SN: US37390585 | 18-Oct-01 (in house check Oct-17) | In house check: Oct-18 |

Calibrated by: **Leif Klysner** Name: **Leif Klysner** Function: **Laboratory Technician**

Signature
[Handwritten Signature]

Approved by: **Katja Pokovic** Name: **Katja Pokovic** Function: **Technical Manager**

[Handwritten Signature]

Issued: January 18, 2018

This calibration certificate shall not be reproduced except in full without written approval of the laboratory.



Accredited by the Swiss Accreditation Service (SAS)
The Swiss Accreditation Service is one of the signatories to the EA
Multilateral Agreement for the recognition of calibration certificates

Glossary:

| | |
|-------|---------------------------------|
| TSL | tissue simulating liquid |
| ConvF | sensitivity in TSL / NORM x,y,z |
| N/A | not applicable or not measured |

Calibration is Performed According to the Following Standards:

- IEEE Std 1528-2013, "IEEE Recommended Practice for Determining the Peak Spatial-Averaged Specific Absorption Rate (SAR) in the Human Head from Wireless Communications Devices: Measurement Techniques", June 2013
- IEC 62209-1, "Measurement procedure for the assessment of Specific Absorption Rate (SAR) from hand-held and body-mounted devices used next to the ear (frequency range of 300 MHz to 6 GHz)", July 2016
- IEC 62209-2, "Procedure to determine the Specific Absorption Rate (SAR) for wireless communication devices used in close proximity to the human body (frequency range of 30 MHz to 6 GHz)", March 2010
- KDB 865664, "SAR Measurement Requirements for 100 MHz to 6 GHz"

Additional Documentation:

- DASY4/5 System Handbook

Methods Applied and Interpretation of Parameters:

- Measurement Conditions:* Further details are available from the Validation Report at the end of the certificate. All figures stated in the certificate are valid at the frequency indicated.
- Antenna Parameters with TSL:* The dipole is mounted with the spacer to position its feed point exactly below the center marking of the flat phantom section, with the arms oriented parallel to the body axis.
- Feed Point Impedance and Return Loss:* These parameters are measured with the dipole positioned under the liquid filled phantom. The impedance stated is transformed from the measurement at the SMA connector to the feed point. The Return Loss ensures low reflected power. No uncertainty required.
- Electrical Delay:* One-way delay between the SMA connector and the antenna feed point. No uncertainty required.
- SAR measured:* SAR measured at the stated antenna input power.
- SAR normalized:* SAR as measured, normalized to an input power of 1 W at the antenna connector.
- SAR for nominal TSL parameters:* The measured TSL parameters are used to calculate the nominal SAR result.

The reported uncertainty of measurement is stated as the standard uncertainty of measurement multiplied by the coverage factor $k=2$, which for a normal distribution corresponds to a coverage probability of approximately 95%.

Measurement Conditions

DASY system configuration, as far as not given on page 1.

| | | |
|-------------------------------------|--|----------------------------------|
| DASY Version | DASY5 | V52.10.0 |
| Extrapolation | Advanced Extrapolation | |
| Phantom | Modular Flat Phantom V5.0 | |
| Distance Dipole Center - TSL | 10 mm | with Spacer |
| Zoom Scan Resolution | dx, dy = 4.0 mm, dz = 1.4 mm | Graded Ratio = 1.4 (Z direction) |
| Frequency | 5200 MHz ± 1 MHz 5250 MHz ± 1 MHz 5600 MHz ± 1 MHz 5750 MHz ± 1 MHz 5800 MHz ± 1 MHz | |

Head TSL parameters at 5250 MHz

The following parameters and calculations were applied.

| | Temperature | Permittivity | Conductivity |
|--|-----------------|--------------|------------------|
| Nominal Head TSL parameters | 22.0 °C | 35.9 | 4.71 mho/m |
| Measured Head TSL parameters | (22.0 ± 0.2) °C | 36.2 ± 6 % | 4.55 mho/m ± 6 % |
| Head TSL temperature change during test | < 0.5 °C | ---- | ---- |

SAR result with Head TSL at 5250 MHz

| SAR averaged over 1 cm³ (1 g) of Head TSL | Condition | |
|---|--------------------|---------------------------------|
| SAR measured | 100 mW input power | 7.91 W/kg |
| SAR for nominal Head TSL parameters | normalized to 1W | 79.2 W/kg ± 19.9 % (k=2) |

| SAR averaged over 10 cm³ (10 g) of Head TSL | condition | |
|---|--------------------|---------------------------------|
| SAR measured | 100 mW input power | 2.28 W/kg |
| SAR for nominal Head TSL parameters | normalized to 1W | 22.8 W/kg ± 19.5 % (k=2) |

Head TSL parameters at 5600 MHz

The following parameters and calculations were applied.

| | Temperature | Permittivity | Conductivity |
|---|-----------------|--------------|------------------|
| Nominal Head TSL parameters | 22.0 °C | 35.5 | 5.07 mho/m |
| Measured Head TSL parameters | (22.0 ± 0.2) °C | 35.8 ± 6 % | 4.90 mho/m ± 6 % |
| Head TSL temperature change during test | < 0.5 °C | ---- | ---- |

SAR result with Head TSL at 5600 MHz

| SAR averaged over 1 cm ³ (1 g) of Head TSL | Condition | |
|---|--------------------|--------------------------|
| SAR measured | 100 mW input power | 8.41 W/kg |
| SAR for nominal Head TSL parameters | normalized to 1W | 84.1 W/kg ± 19.9 % (k=2) |

| SAR averaged over 10 cm ³ (10 g) of Head TSL | condition | |
|---|--------------------|--------------------------|
| SAR measured | 100 mW input power | 2.40 W/kg |
| SAR for nominal Head TSL parameters | normalized to 1W | 24.0 W/kg ± 19.5 % (k=2) |

Head TSL parameters at 5750 MHz

The following parameters and calculations were applied.

| | Temperature | Permittivity | Conductivity |
|---|-----------------|--------------|------------------|
| Nominal Head TSL parameters | 22.0 °C | 35.4 | 5.22 mho/m |
| Measured Head TSL parameters | (22.0 ± 0.2) °C | 35.5 ± 6 % | 5.06 mho/m ± 6 % |
| Head TSL temperature change during test | < 0.5 °C | ---- | ---- |

SAR result with Head TSL at 5750 MHz

| SAR averaged over 1 cm ³ (1 g) of Head TSL | Condition | |
|---|--------------------|--------------------------|
| SAR measured | 100 mW input power | 8.06 W/kg |
| SAR for nominal Head TSL parameters | normalized to 1W | 80.5 W/kg ± 19.9 % (k=2) |

| SAR averaged over 10 cm ³ (10 g) of Head TSL | condition | |
|---|--------------------|--------------------------|
| SAR measured | 100 mW input power | 2.30 W/kg |
| SAR for nominal Head TSL parameters | normalized to 1W | 23.0 W/kg ± 19.5 % (k=2) |

Body TSL parameters at 5200 MHz

The following parameters and calculations were applied.

| | Temperature | Permittivity | Conductivity |
|---|-----------------|--------------|------------------|
| Nominal Body TSL parameters | 22.0 °C | 49.0 | 5.30 mho/m |
| Measured Body TSL parameters | (22.0 ± 0.2) °C | 47.3 ± 6 % | 5.41 mho/m ± 6 % |
| Body TSL temperature change during test | < 0.5 °C | ---- | ---- |

SAR result with Body TSL at 5200 MHz

| SAR averaged over 1 cm ³ (1 g) of Body TSL | Condition | |
|---|--------------------|--------------------------|
| SAR measured | 100 mW input power | 7.36 W/kg |
| SAR for nominal Body TSL parameters | normalized to 1W | 73.1 W/kg ± 19.9 % (k=2) |

| SAR averaged over 10 cm ³ (10 g) of Body TSL | condition | |
|---|--------------------|--------------------------|
| SAR measured | 100 mW input power | 2.06 W/kg |
| SAR for nominal Body TSL parameters | normalized to 1W | 20.4 W/kg ± 19.5 % (k=2) |

Body TSL parameters at 5250 MHz

The following parameters and calculations were applied.

| | Temperature | Permittivity | Conductivity |
|---|-----------------|--------------|------------------|
| Nominal Body TSL parameters | 22.0 °C | 48.9 | 5.36 mho/m |
| Measured Body TSL parameters | (22.0 ± 0.2) °C | 47.2 ± 6 % | 5.48 mho/m ± 6 % |
| Body TSL temperature change during test | < 0.5 °C | ---- | ---- |

SAR result with Body TSL at 5250 MHz

| SAR averaged over 1 cm ³ (1 g) of Body TSL | Condition | |
|---|--------------------|--------------------------|
| SAR measured | 100 mW input power | 7.64 W/kg |
| SAR for nominal Body TSL parameters | normalized to 1W | 75.9 W/kg ± 19.9 % (k=2) |

| SAR averaged over 10 cm ³ (10 g) of Body TSL | condition | |
|---|--------------------|--------------------------|
| SAR measured | 100 mW input power | 2.13 W/kg |
| SAR for nominal Body TSL parameters | normalized to 1W | 21.1 W/kg ± 19.5 % (k=2) |

Body TSL parameters at 5600 MHz

The following parameters and calculations were applied.

| | Temperature | Permittivity | Conductivity |
|---|-----------------|--------------|------------------|
| Nominal Body TSL parameters | 22.0 °C | 48.5 | 5.77 mho/m |
| Measured Body TSL parameters | (22.0 ± 0.2) °C | 46.6 ± 6 % | 5.94 mho/m ± 6 % |
| Body TSL temperature change during test | < 0.5 °C | ---- | ---- |

SAR result with Body TSL at 5600 MHz

| SAR averaged over 1 cm ³ (1 g) of Body TSL | Condition | |
|---|--------------------|--------------------------|
| SAR measured | 100 mW input power | 8.05 W/kg |
| SAR for nominal Body TSL parameters | normalized to 1W | 79.9 W/kg ± 19.9 % (k=2) |

| SAR averaged over 10 cm ³ (10 g) of Body TSL | condition | |
|---|--------------------|--------------------------|
| SAR measured | 100 mW input power | 2.25 W/kg |
| SAR for nominal Body TSL parameters | normalized to 1W | 22.3 W/kg ± 19.5 % (k=2) |

Body TSL parameters at 5750 MHz

The following parameters and calculations were applied.

| | Temperature | Permittivity | Conductivity |
|---|-----------------|--------------|------------------|
| Nominal Body TSL parameters | 22.0 °C | 48.3 | 5.94 mho/m |
| Measured Body TSL parameters | (22.0 ± 0.2) °C | 46.3 ± 6 % | 6.15 mho/m ± 6 % |
| Body TSL temperature change during test | < 0.5 °C | ---- | ---- |

SAR result with Body TSL at 5750 MHz

| SAR averaged over 1 cm ³ (1 g) of Body TSL | Condition | |
|---|--------------------|--------------------------|
| SAR measured | 100 mW input power | 7.72 W/kg |
| SAR for nominal Body TSL parameters | normalized to 1W | 76.7 W/kg ± 19.9 % (k=2) |

| SAR averaged over 10 cm ³ (10 g) of Body TSL | condition | |
|---|--------------------|--------------------------|
| SAR measured | 100 mW input power | 2.14 W/kg |
| SAR for nominal Body TSL parameters | normalized to 1W | 21.2 W/kg ± 19.5 % (k=2) |

Body TSL parameters at 5800 MHz

The following parameters and calculations were applied.

| | Temperature | Permittivity | Conductivity |
|---|-----------------|--------------|------------------|
| Nominal Body TSL parameters | 22.0 °C | 48.2 | 6.00 mho/m |
| Measured Body TSL parameters | (22.0 ± 0.2) °C | 46.2 ± 6 % | 6.22 mho/m ± 6 % |
| Body TSL temperature change during test | < 0.5 °C | ---- | ---- |

SAR result with Body TSL at 5800 MHz

| SAR averaged over 1 cm ³ (1 g) of Body TSL | Condition | |
|---|--------------------|---------------------------------|
| SAR measured | 100 mW input power | 7.68 W/kg |
| SAR for nominal Body TSL parameters | normalized to 1W | 76.3 W/kg ± 19.9 % (k=2) |

| SAR averaged over 10 cm ³ (10 g) of Body TSL | condition | |
|---|--------------------|---------------------------------|
| SAR measured | 100 mW input power | 2.13 W/kg |
| SAR for nominal Body TSL parameters | normalized to 1W | 21.1 W/kg ± 19.5 % (k=2) |

Appendix (Additional assessments outside the scope of SCS 0108)

Antenna Parameters with Head TSL at 5250 MHz

| | |
|--------------------------------------|--------------------------------|
| Impedance, transformed to feed point | 50.0 Ω - 5.5 j Ω |
| Return Loss | - 25.2 dB |

Antenna Parameters with Head TSL at 5600 MHz

| | |
|--------------------------------------|--------------------------------|
| Impedance, transformed to feed point | 54.7 Ω - 2.1 j Ω |
| Return Loss | - 26.2 dB |

Antenna Parameters with Head TSL at 5750 MHz

| | |
|--------------------------------------|--------------------------------|
| Impedance, transformed to feed point | 52.7 Ω + 0.0 j Ω |
| Return Loss | - 31.5 dB |

Antenna Parameters with Body TSL at 5200 MHz

| | |
|--------------------------------------|--------------------------------|
| Impedance, transformed to feed point | 49.3 Ω - 6.7 j Ω |
| Return Loss | - 23.4 dB |

Antenna Parameters with Body TSL at 5250 MHz

| | |
|--------------------------------------|--------------------------------|
| Impedance, transformed to feed point | 48.4 Ω - 3.9 j Ω |
| Return Loss | - 27.4 dB |

Antenna Parameters with Body TSL at 5600 MHz

| | |
|--------------------------------------|--------------------------------|
| Impedance, transformed to feed point | 55.3 Ω - 1.6 j Ω |
| Return Loss | - 25.6 dB |

Antenna Parameters with Body TSL at 5750 MHz

| | |
|--------------------------------------|--------------------------------|
| Impedance, transformed to feed point | 52.6 Ω + 1.1 j Ω |
| Return Loss | - 31.2 dB |

Antenna Parameters with Body TSL at 5800 MHz

| | |
|--------------------------------------|--------------------------------|
| Impedance, transformed to feed point | 51.8 Ω - 0.4 j Ω |
| Return Loss | - 34.9 dB |

General Antenna Parameters and Design

| | |
|----------------------------------|----------|
| Electrical Delay (one direction) | 1.203 ns |
|----------------------------------|----------|

After long term use with 100W radiated power, only a slight warming of the dipole near the feedpoint can be measured.

The dipole is made of standard semirigid coaxial cable. The center conductor of the feeding line is directly connected to the second arm of the dipole. The antenna is therefore short-circuited for DC-signals. On some of the dipoles, small end caps are added to the dipole arms in order to improve matching when loaded according to the position as explained in the "Measurement Conditions" paragraph. The SAR data are not affected by this change. The overall dipole length is still according to the Standard.

No excessive force must be applied to the dipole arms, because they might bend or the soldered connections near the feedpoint may be damaged.

Additional EUT Data

| | |
|-----------------|-------------------|
| Manufactured by | SPEAG |
| Manufactured on | November 27, 2006 |

Appendix (Additional assessments outside the scope of SCS 0108)

Measurement Conditions (f=5200 MHz)

DASY system configuration, as far as not given on page 1 and 3.

| | | |
|---------|------------------|-----------------------------|
| Phantom | SAM Head Phantom | For usage with cSAR3DV2-R/L |
|---------|------------------|-----------------------------|

SAR result with SAM Head (Top)

| SAR averaged over 1 cm ³ (1 g) of Head TSL | Condition | |
|---|--------------------|---------------------------------|
| SAR measured | 100 mW input power | 8.24 W/kg |
| SAR for nominal Head TSL parameters | normalized to 1W | 82.6 W/kg ± 20.3 % (k=2) |

| SAR averaged over 10 cm ³ (10 g) of Head TSL | condition | |
|---|--------------------|---------------------------------|
| SAR measured | 100 mW input power | 2.35 W/kg |
| SAR for nominal Head TSL parameters | normalized to 1W | 23.6 W/kg ± 19.9 % (k=2) |

SAR result with SAM Head (Mouth)

| SAR averaged over 1 cm ³ (1 g) of Head TSL | Condition | |
|---|--------------------|---------------------------------|
| SAR measured | 100 mW input power | 8.54 W/kg |
| SAR for nominal Head TSL parameters | normalized to 1W | 85.6 W/kg ± 20.3 % (k=2) |

| SAR averaged over 10 cm ³ (10 g) of Head TSL | condition | |
|---|--------------------|---------------------------------|
| SAR measured | 100 mW input power | 2.37 W/kg |
| SAR for nominal Head TSL parameters | normalized to 1W | 23.7 W/kg ± 19.9 % (k=2) |

SAR result with SAM Head (Neck)

| SAR averaged over 1 cm ³ (1 g) of Head TSL | Condition | |
|---|--------------------|---------------------------------|
| SAR measured | 100 mW input power | 8.14 W/kg |
| SAR for nominal Head TSL parameters | normalized to 1W | 81.6 W/kg ± 20.3 % (k=2) |

| SAR averaged over 10 cm ³ (10 g) of Head TSL | condition | |
|---|--------------------|---------------------------------|
| SAR measured | 100 mW input power | 2.37 W/kg |
| SAR for nominal Head TSL parameters | normalized to 1W | 23.7 W/kg ± 19.9 % (k=2) |

SAR result with SAM Head (Ear)

| SAR averaged over 1 cm ³ (1 g) of Head TSL | Condition | |
|---|--------------------|---------------------------------|
| SAR measured | 100 mW input power | 5.16 W/kg |
| SAR for nominal Head TSL parameters | normalized to 1W | 51.7 W/kg ± 20.3 % (k=2) |

| SAR averaged over 10 cm ³ (10 g) of Head TSL | condition | |
|---|--------------------|---------------------------------|
| SAR measured | 100 mW input power | 1.76 W/kg |
| SAR for nominal Head TSL parameters | normalized to 1W | 17.7 W/kg ± 19.9 % (k=2) |

Measurement Conditions (f=5800 MHz)

DASY system configuration, as far as not given on page 1 and 3.

| | | |
|---------|------------------|-----------------------------|
| Phantom | SAM Head Phantom | For usage with cSAR3DV2-R/L |
|---------|------------------|-----------------------------|

SAR result with SAM Head (Top)

| SAR averaged over 1 cm ³ (1 g) of Head TSL | Condition | |
|---|--------------------|--------------------------|
| SAR measured | 100 mW input power | 8.62 W/kg |
| SAR for nominal Head TSL parameters | normalized to 1W | 86.3 W/kg ± 20.3 % (k=2) |

| SAR averaged over 10 cm ³ (10 g) of Head TSL | condition | |
|---|--------------------|--------------------------|
| SAR measured | 100 mW input power | 2.41 W/kg |
| SAR for nominal Head TSL parameters | normalized to 1W | 24.1 W/kg ± 19.9 % (k=2) |

SAR result with SAM Head (Mouth)

| SAR averaged over 1 cm ³ (1 g) of Head TSL | Condition | |
|---|--------------------|--------------------------|
| SAR measured | 100 mW input power | 8.88 W/kg |
| SAR for nominal Head TSL parameters | normalized to 1W | 88.9 W/kg ± 20.3 % (k=2) |

| SAR averaged over 10 cm ³ (10 g) of Head TSL | condition | |
|---|--------------------|--------------------------|
| SAR measured | 100 mW input power | 2.44 W/kg |
| SAR for nominal Head TSL parameters | normalized to 1W | 24.4 W/kg ± 19.9 % (k=2) |

SAR result with SAM Head (Neck)

| SAR averaged over 1 cm ³ (1 g) of Head TSL | Condition | |
|---|--------------------|--------------------------|
| SAR measured | 100 mW input power | 8.33 W/kg |
| SAR for nominal Head TSL parameters | normalized to 1W | 83.4 W/kg ± 20.3 % (k=2) |

| SAR averaged over 10 cm ³ (10 g) of Head TSL | condition | |
|---|--------------------|--------------------------|
| SAR measured | 100 mW input power | 2.35 W/kg |
| SAR for nominal Head TSL parameters | normalized to 1W | 23.5 W/kg ± 19.9 % (k=2) |

SAR result with SAM Head (Ear)

| SAR averaged over 1 cm ³ (1 g) of Head TSL | Condition | |
|---|--------------------|--------------------------|
| SAR measured | 100 mW input power | 5.68 W/kg |
| SAR for nominal Head TSL parameters | normalized to 1W | 56.8 W/kg ± 20.3 % (k=2) |

| SAR averaged over 10 cm ³ (10 g) of Head TSL | condition | |
|---|--------------------|--------------------------|
| SAR measured | 100 mW input power | 1.89 W/kg |
| SAR for nominal Head TSL parameters | normalized to 1W | 18.9 W/kg ± 19.9 % (k=2) |

Test Laboratory: SPEAG, Zurich, Switzerland

DUT: Dipole D5GHzV2; Type: D5GHzV2; Serial: D5GHzV2 - SN:1057

Communication System: UID 0 - CW; Frequency: 5250 MHz, Frequency: 5600 MHz, Frequency: 5750 MHz
Medium parameters used: $f = 5250$ MHz; $\sigma = 4.55$ S/m; $\epsilon_r = 36.2$; $\rho = 1000$ kg/m³,
Medium parameters used: $f = 5600$ MHz; $\sigma = 4.9$ S/m; $\epsilon_r = 35.8$; $\rho = 1000$ kg/m³,
Medium parameters used: $f = 5750$ MHz; $\sigma = 5.06$ S/m; $\epsilon_r = 35.5$; $\rho = 1000$ kg/m³
Phantom section: Flat Section
Measurement Standard: DASY5 (IEEE/IEC/ANSI C63.19-2011)

DASY52 Configuration:

- Probe: EX3DV4 - SN3503; ConvF(5.51, 5.51, 5.51); Calibrated: 30.12.2017, ConvF(5.05, 5.05, 5.05); Calibrated: 30.12.2017, ConvF(4.98, 4.98, 4.98); Calibrated: 30.12.2017;
- Sensor-Surface: 1.4mm (Mechanical Surface Detection)
- Electronics: DAE4 Sn601 - modified; Calibrated: 26.10.2017
- Phantom: Flat Phantom 5.0 (front); Type: QD 000 P50 AA; Serial: 1001
- DASY52 52.10.0(1446); SEMCAD X 14.6.10(7417)

Dipole Calibration for Head Tissue/Pin=100mW, dist=10mm, f=5250 MHz/Zoom Scan, dist=1.4mm (8x8x7)/Cube 0: Measurement grid: dx=4mm, dy=4mm, dz=1.4mm
Reference Value = 72.54 V/m; Power Drift = -0.02 dB
Peak SAR (extrapolated) = 27.5 W/kg
SAR(1 g) = 7.91 W/kg; SAR(10 g) = 2.28 W/kg
Maximum value of SAR (measured) = 17.7 W/kg

Dipole Calibration for Head Tissue/Pin=100mW, dist=10mm, f=5600 MHz/Zoom Scan, dist=1.4mm (8x8x7)/Cube 0: Measurement grid: dx=4mm, dy=4mm, dz=1.4mm
Reference Value = 72.77 V/m; Power Drift = -0.07 dB
Peak SAR (extrapolated) = 32.2 W/kg
SAR(1 g) = 8.41 W/kg; SAR(10 g) = 2.4 W/kg
Maximum value of SAR (measured) = 19.7 W/kg

Dipole Calibration for Head Tissue/Pin=100mW, dist=10mm, f=5750 MHz/Zoom Scan, dist=1.4mm (8x8x7)/Cube 0: Measurement grid: dx=4mm, dy=4mm, dz=1.4mm
Reference Value = 70.93 V/m; Power Drift = -0.09 dB
Peak SAR (extrapolated) = 31.4 W/kg
SAR(1 g) = 8.06 W/kg; SAR(10 g) = 2.3 W/kg
Maximum value of SAR (measured) = 18.9 W/kg

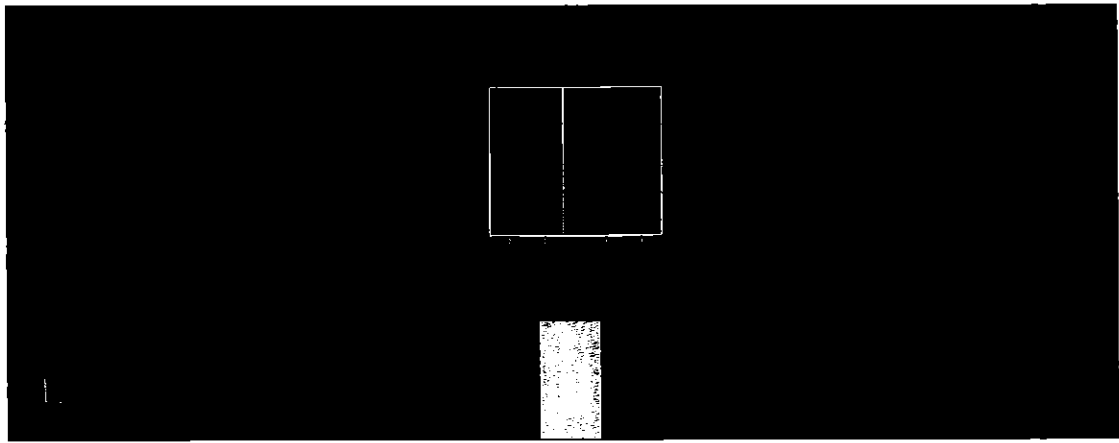
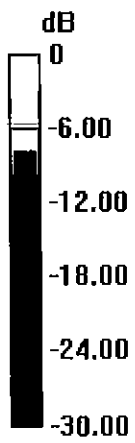

0 dB = 18.9 W/kg = 12.76 dBW/kg

Impedance Measurement Plot for Head TSL

11 Jan 2018 15:50:25

CH1 S11 1 U FS 1: 50.010 Ω -5.5215 Ω 5.4904 pF 5 250.000 000 MHz

De1
Cor
Avg
15
H1d

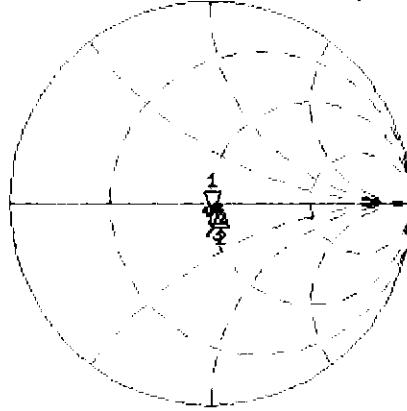

CH1 Markers
2: 54.660 Ω
-2.1445 Ω
5.60000 GHz
3: 52.729 Ω
-44.922 m Ω
5.75000 GHz

CH2 S11 LOG 5 dB/ REF -20 dB 1: -25.170 dB 5 250.000 000 MHz

Cor
Avg
15
H1d

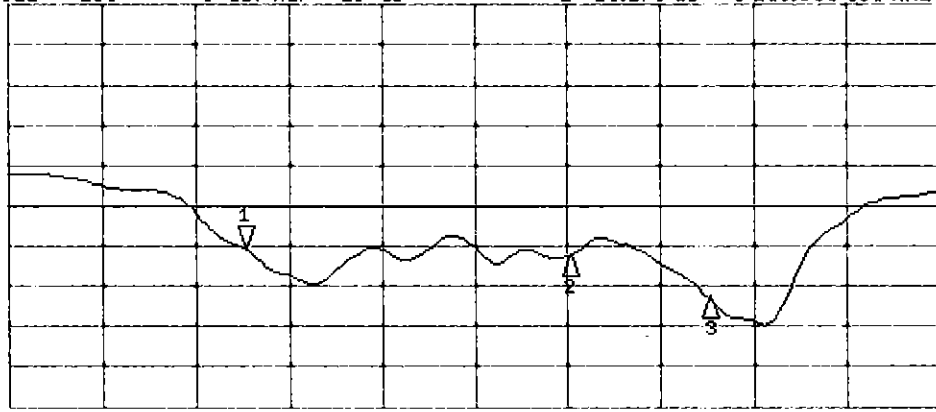

CH2 Markers
2: -26.187 dB
5.60000 GHz
3: -31.504 dB
5.75000 GHz

START 5 000.000 000 MHz

STOP 6 000.000 000 MHz

DASY5 Validation Report for Body TSL

Date: 10.01.2018

Test Laboratory: SPEAG, Zurich, Switzerland

DUT: Dipole D5GHzV2; Type: D5GHzV2; Serial: D5GHzV2 - SN:1057

Communication System: UID 0 - CW; Frequency: 5200 MHz, Frequency: 5250 MHz, Frequency: 5600 MHz, Frequency: 5750 MHz, Frequency: 5800 MHz

Medium parameters used: $f = 5200$ MHz; $\sigma = 5.41$ S/m; $\epsilon_r = 47.3$; $\rho = 1000$ kg/m³,

Medium parameters used: $f = 5250$ MHz; $\sigma = 5.48$ S/m; $\epsilon_r = 47.2$; $\rho = 1000$ kg/m³,

Medium parameters used: $f = 5600$ MHz; $\sigma = 5.94$ S/m; $\epsilon_r = 46.6$; $\rho = 1000$ kg/m³,

Medium parameters used: $f = 5750$ MHz; $\sigma = 6.15$ S/m; $\epsilon_r = 46.3$; $\rho = 1000$ kg/m³,

Medium parameters used: $f = 5800$ MHz; $\sigma = 6.22$ S/m; $\epsilon_r = 46.2$; $\rho = 1000$ kg/m³

Phantom section: Flat Section

Measurement Standard: DASY5 (IEEE/IEC/ANSI C63.19-2011)

DASY52 Configuration:

- Probe: EX3DV4 - SN3503; ConvF(5.35, 5.35, 5.35); Calibrated: 30.12.2017, ConvF(5.26, 5.26, 5.26); Calibrated: 30.12.2017, ConvF(4.65, 4.65, 4.65); Calibrated: 30.12.2017, ConvF(4.57, 4.57, 4.57); Calibrated: 30.12.2017, ConvF(4.53, 4.53, 4.53); Calibrated: 30.12.2017;
- Sensor-Surface: 1.4mm (Mechanical Surface Detection)
- Electronics: DAE4 Sn601; Calibrated: 26.10.2017
- Phantom: Flat Phantom 5.0 (back); Type: QD 000 P50 AA; Serial: 1002
- DASY52 52.10.0(1446); SEMCAD X 14.6.10(7417)

Dipole Calibration for Body Tissue/Pin=100mW, dist=10mm, f=5200 MHz/Zoom Scan, dist=1.4mm (8x8x7)/Cube 0: Measurement grid: dx=4mm, dy=4mm, dz=1.4mm

Reference Value = 64.05 V/m; Power Drift = -0.03 dB

Peak SAR (extrapolated) = 27.6 W/kg

SAR(1 g) = 7.36 W/kg; SAR(10 g) = 2.06 W/kg

Maximum value of SAR (measured) = 17.1 W/kg

Dipole Calibration for Body Tissue/Pin=100mW, dist=10mm, f=5250 MHz/Zoom Scan, dist=1.4mm (8x8x7)/Cube 0: Measurement grid: dx=4mm, dy=4mm, dz=1.4mm

Reference Value = 64.53 V/m; Power Drift = -0.02 dB

Peak SAR (extrapolated) = 29.4 W/kg

SAR(1 g) = 7.64 W/kg; SAR(10 g) = 2.13 W/kg

Maximum value of SAR (measured) = 17.9 W/kg

Dipole Calibration for Body Tissue/Pin=100mW, dist=10mm, f=5600 MHz/Zoom Scan, dist=1.4mm (8x8x7)/Cube 0: Measurement grid: dx=4mm, dy=4mm, dz=1.4mm
Reference Value = 65.09 V/m; Power Drift = -0.08 dB
Peak SAR (extrapolated) = 34.0 W/kg
SAR(1 g) = 8.05 W/kg; SAR(10 g) = 2.25 W/kg
Maximum value of SAR (measured) = 19.5 W/kg

Dipole Calibration for Body Tissue/Pin=100mW, dist=10mm, f=5750 MHz/Zoom Scan, dist=1.4mm (8x8x7)/Cube 0: Measurement grid: dx=4mm, dy=4mm, dz=1.4mm
Reference Value = 63.45 V/m; Power Drift = -0.06 dB
Peak SAR (extrapolated) = 32.9 W/kg
SAR(1 g) = 7.72 W/kg; SAR(10 g) = 2.14 W/kg
Maximum value of SAR (measured) = 18.9 W/kg

Dipole Calibration for Body Tissue/Pin=100mW, dist=10mm, f=5800 MHz/Zoom Scan, dist=1.4mm (8x8x7)/Cube 0: Measurement grid: dx=4mm, dy=4mm, dz=1.4mm
Reference Value = 63.14 V/m; Power Drift = -0.08 dB
Peak SAR (extrapolated) = 33.3 W/kg
SAR(1 g) = 7.68 W/kg; SAR(10 g) = 2.13 W/kg

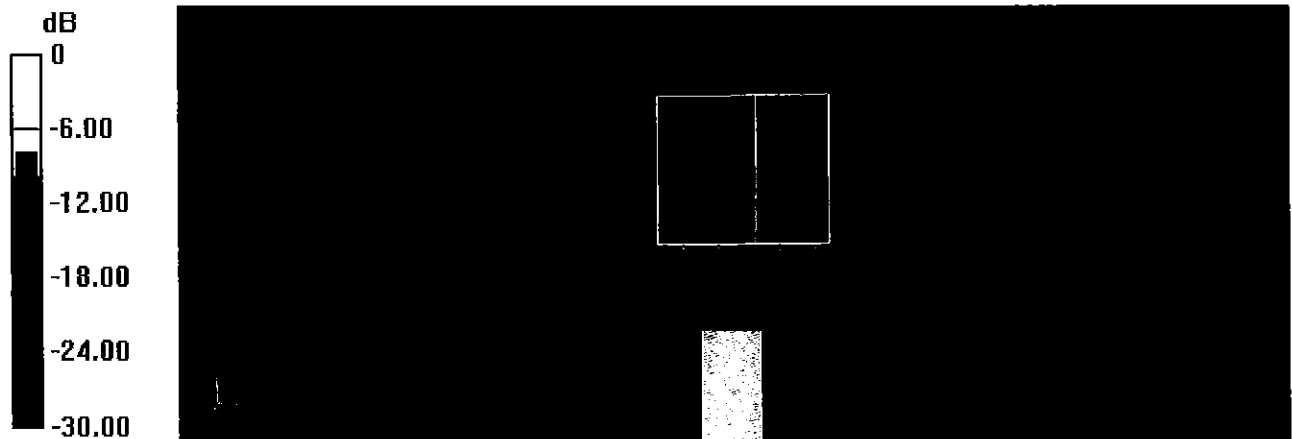

0 dB = 18.9 W/kg = 12.76 dBW/kg

Impedance Measurement Plot for Body TSL

10 Jan 2018 17:45:41

CH1 S11 1 U FS 1: 49.266 Ω -6.6719 Ω 4.5874 pF 5 200.000 000 MHz

*
Del
Cor
Avg 16
H1d

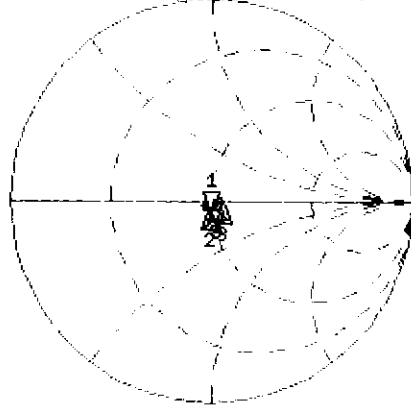

CH1 Markers

- 2: 48.449 Ω
-3.9297 Ω
5.25000 GHz
- 3: 55.279 Ω
-1.5723 Ω
5.60000 GHz
- 4: 52.627 Ω
1.0625 Ω
5.75000 GHz
- 5: 51.801 Ω
-375.00 m Ω
5.80000 GHz

CH2 S11 LOG 5 dB/REF -20 dB 1: -23.417 dB 5 200.000 000 MHz

Cor
Avg 16
H1d

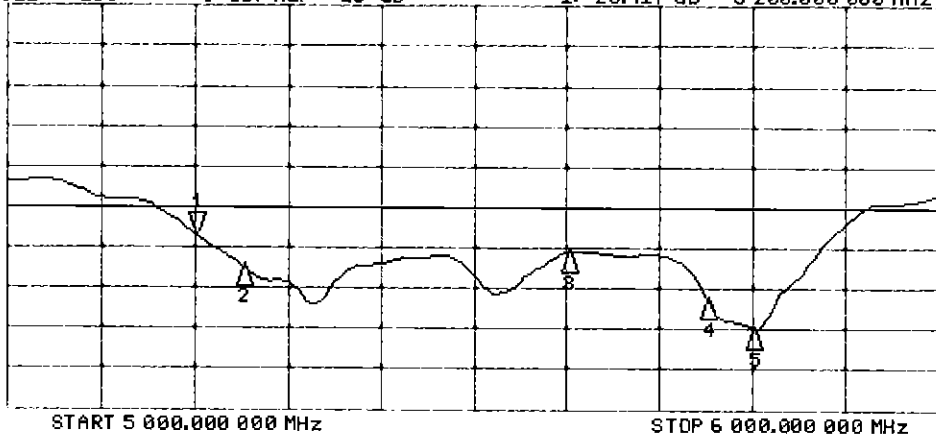

CH2 Markers

- 2: -27.356 dB
5.25000 GHz
- 3: -25.621 dB
5.60000 GHz
- 4: -31.162 dB
5.75000 GHz
- 5: -34.851 dB
5.80000 GHz

DASY5 Validation Report for SAM Head

Date: 16.01.2018

Test Laboratory: SPEAG, Zurich, Switzerland

DUT: Dipole 5GHz; Type: D5GHzV2; Serial: D5GHzV2 - SN:1057

Communication System: UID 0 - CW; Frequency: 5200 MHz, Frequency: 5800 MHz
Medium parameters used: $f = 5200$ MHz; $\sigma = 4.59$ S/m; $\epsilon_r = 36.5$; $\rho = 1000$ kg/m³ ,
Medium parameters used: $f = 5800$ MHz; $\sigma = 5.28$ S/m; $\epsilon_r = 35.4$; $\rho = 1000$ kg/m³
Measurement Standard: DASY5 (IEEE/IEC/ANSI C63.19-2007)

DASY52 Configuration:

- Probe: EX3DV4 - SN3503; ConvF(5.75, 5.75, 5.75); Calibrated: 30.12.2017, ConvF(4.96, 4.96, 4.96); Calibrated: 30.12.2017;
- Sensor-Surface: 1.4mm (Mechanical Surface Detection)
- Electronics: DAE4 Sn601; Calibrated: 26.10.2017
- Phantom: SAM Head
- DASY52 52.10.0(1446); SEMCAD X 14.6.10(7417)

SAM Head/Top - 5200/Zoom Scan (8x8x7)/Cube 0: Measurement grid: dx=4mm, dy=4mm, dz=1.4mm

Reference Value = 72.99 V/m; Power Drift = 0.04 dB
Peak SAR (extrapolated) = 30.6 W/kg
SAR(1 g) = 8.24 W/kg; SAR(10 g) = 2.35 W/kg
Maximum value of SAR (measured) = 19.7 W/kg

SAM Head/Top - 5800/Zoom Scan (8x8x7)/Cube 0: Measurement grid: dx=4mm, dy=4mm, dz=1.4mm

Reference Value = 73.00 V/m; Power Drift = 0.07 dB
Peak SAR (extrapolated) = 36.5 W/kg
SAR(1 g) = 8.62 W/kg; SAR(10 g) = 2.41 W/kg
Maximum value of SAR (measured) = 21.9 W/kg

SAM Head/Mouth - 5200/Zoom Scan (8x8x7)/Cube 0: Measurement grid: dx=4mm, dy=4mm, dz=1.4mm

Reference Value = 72.79 V/m; Power Drift = -0.04 dB
Peak SAR (extrapolated) = 29.5 W/kg
SAR(1 g) = 8.54 W/kg; SAR(10 g) = 2.37 W/kg
Maximum value of SAR (measured) = 20.7 W/kg

SAM Head/Mouth - 5800/Zoom Scan (8x8x7)/Cube 0: Measurement grid: dx=4mm, dy=4mm, dz=1.4mm

Reference Value = 71.69 V/m; Power Drift = -0.07 dB

Peak SAR (extrapolated) = 34.9 W/kg

SAR(1 g) = 8.88 W/kg; SAR(10 g) = 2.44 W/kg

Maximum value of SAR (measured) = 23.0 W/kg

SAM Head/Neck - 5200/Zoom Scan (8x8x7)/Cube 0: Measurement grid: dx=4mm, dy=4mm, dz=1.4mm

Reference Value = 72.48 V/m; Power Drift = 0.05 dB

Peak SAR (extrapolated) = 27.9 W/kg

SAR(1 g) = 8.14 W/kg; SAR(10 g) = 2.37 W/kg

Maximum value of SAR (measured) = 19.3 W/kg

SAM Head/Neck - 5800/Zoom Scan (8x8x7)/Cube 0: Measurement grid: dx=4mm, dy=4mm, dz=1.4mm

Reference Value = 72.90 V/m; Power Drift = 0.01 dB

Peak SAR (extrapolated) = 33.4 W/kg

SAR(1 g) = 8.33 W/kg; SAR(10 g) = 2.35 W/kg

Maximum value of SAR (measured) = 21.8 W/kg

SAM Head/Ear - 5200/Zoom Scan (8x8x7)/Cube 0: Measurement grid: dx=4mm, dy=4mm, dz=1.4mm

Reference Value = 54.68 V/m; Power Drift = 0.03 dB

Peak SAR (extrapolated) = 16.3 W/kg

SAR(1 g) = 5.16 W/kg; SAR(10 g) = 1.76 W/kg

Maximum value of SAR (measured) = 11.1 W/kg

SAM Head/Ear - 5800/Zoom Scan (8x8x7)/Cube 0: Measurement grid: dx=4mm, dy=4mm, dz=1.4mm

Reference Value = 56.96 V/m; Power Drift = -0.05 dB

Peak SAR (extrapolated) = 21.2 W/kg

SAR(1 g) = 5.68 W/kg; SAR(10 g) = 1.89 W/kg

Maximum value of SAR (measured) = 13.8 W/kg

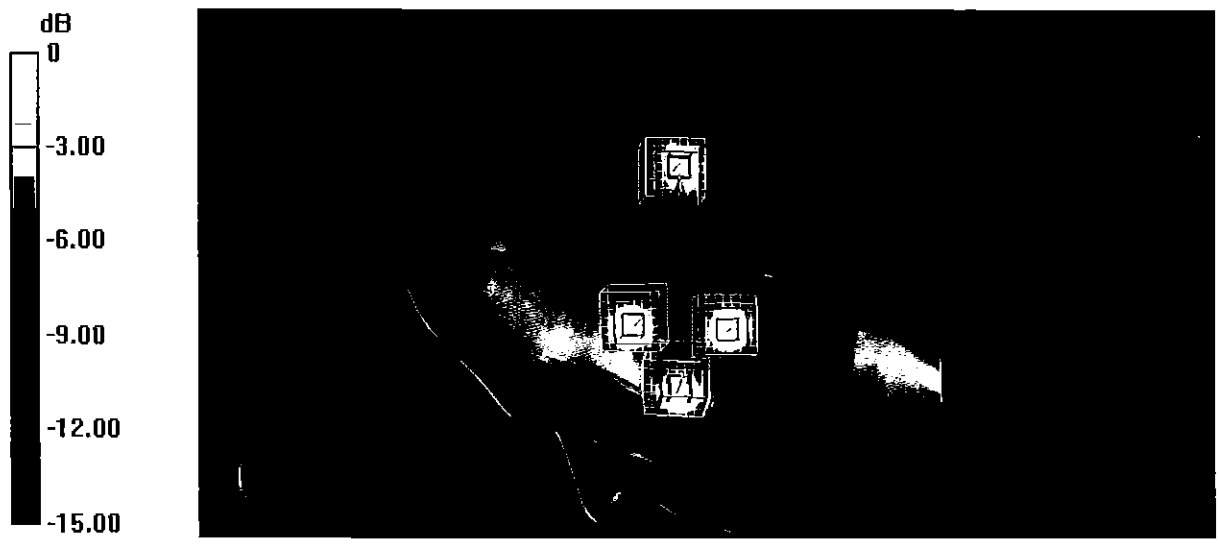

0 dB = 13.8 W/kg = 11.40 dBW/kg

Certification of Calibration

Object: D5GHzV2 – SN: 1057

Calibration procedure(s): Procedure for Calibration Extension for SAR Dipoles.

Extension Calibration date: 1/16/2019

Description: SAR Validation Dipole at 5250, 5600, and 5750 MHz.

Calibration Equipment used:

| Manufacturer | Model | Description | Cal Date | Cal Interval | Cal Due | Serial Number |
|-----------------------|-----------|---|------------|--------------|------------|---------------|
| Agilent | 8753ES | S-Parameter Network Analyzer | 2/8/2018 | Annual | 2/8/2019 | US39170122 |
| Agilent | N5182A | MXG Vector Signal Generator | 4/18/2018 | Annual | 4/18/2019 | MY47420800 |
| Amplifier Research | 15S1G6 | Amplifier | CBT | N/A | CBT | 433971 |
| Anritsu | MA2411B | Pulse Power Sensor | 3/2/2018 | Annual | 3/2/2019 | 1207364 |
| Anritsu | MA2411B | Pulse Power Sensor | 3/2/2018 | Annual | 3/2/2019 | 1339018 |
| Anritsu | ML2495A | Power Meter | 10/21/2018 | Annual | 10/21/2019 | 941001 |
| Control Company | 4040 | Therm./Clock/Humidity Monitor | 3/31/2017 | Biennial | 3/31/2019 | 170232394 |
| Control Company | 4352 | Ultra Long Stem Thermometer | 5/2/2017 | Biennial | 5/2/2019 | 170330156 |
| Keysight | 772D | Dual Directional Coupler | CBT | N/A | CBT | MY52180215 |
| Keysight Technologies | 85033E | Standard Mechanical Calibration Kit (DC to 9GHz, 3.5mm) | 6/4/2018 | Annual | 6/4/2019 | MY53401181 |
| MiniCircuits | VLF-6000+ | Low Pass Filter | CBT | N/A | CBT | N/A |
| Mini-Circuits | BW-N20W5+ | DC to 18 GHz Precision Fixed 20 dB Attenuator | CBT | N/A | CBT | N/A |
| Narda | 4772-3 | Attenuator (3dB) | CBT | N/A | CBT | 9406 |
| Pasternack | PE2209-10 | Bidirectional Coupler | CBT | N/A | CBT | N/A |
| Seekonk | NC-100 | Torque Wrench | 7/11/2018 | Annual | 7/11/2019 | N/A |
| SPEAG | DAE4 | Dasy Data Acquisition Electronics | 10/3/2018 | Annual | 10/3/2019 | 1558 |
| SPEAG | DAE4 | Dasy Data Acquisition Electronics | 6/18/2018 | Annual | 6/18/2019 | 1334 |
| SPEAG | DAK-3.5 | Dielectric Assessment Kit | 9/11/2018 | Annual | 9/11/2019 | 1091 |
| SPEAG | EX3DV4 | SAR Probe | 8/23/2018 | Annual | 8/23/2019 | 7308 |
| SPEAG | EX3DV4 | SAR Probe | 6/25/2018 | Annual | 6/25/2019 | 7409 |

Measurement Uncertainty = $\pm 23\%$ (k=2)

| | Name | Function | Signature |
|----------------|------------------|--------------------------|-------------------------|
| Calibrated By: | Brodie Halfoster | Test Engineer | <i>BRODIE HALFOSTER</i> |
| Approved By: | Kaitlin O'Keefe | Senior Technical Manager | <i>KOK</i> |

DIPOLE CALIBRATION EXTENSION

Per KDB 865664 D01, calibration intervals of up to three years may be considered for reference dipoles when it is demonstrated that the SAR target, impedance and return loss of a dipole have remained stable according to the following requirements:

1. The measured SAR does not deviate more than 10% from the target on the calibration certificate.
2. The return-loss does not deviate more than 20% from the previous measurement and meets the required 20dB minimum return-loss requirement.
3. The measurement of real or imaginary parts of impedance does not deviate more than 5Ω from the previous measurement.

The following dipole was checked to pass the above 3 requirements to have 2-year calibration period from the calibration date:

| Frequency (MHz) | Calibration Date | Extension Date | Certificate Electrical Delay (ns) | Certificate SAR Target Head (1g) W/kg @ 17.0 dBm | Measured Head SAR (1g) W/kg @ 17.0 dBm | Deviation 1g (%) | Certificate SAR Target Head (10g) W/kg @ 17.0 dBm | Measured Head SAR (10g) W/kg @ 17.0 dBm | Deviation 10g (%) | Certificate Impedance Head (Ohm) Real | Measured Impedance Head (Ohm) Real | Difference (Ohm) Real | Certificate Impedance Head (Ohm) Imaginary | Measured Impedance Head (Ohm) Imaginary | Difference (Ohm) Imaginary | Certificate Return Loss Head (dB) | Measured Return Loss Head (dB) | Deviation (%) | PASS/FAIL |
|-----------------|------------------|----------------|-----------------------------------|--|--|------------------|---|---|-------------------|---------------------------------------|------------------------------------|-----------------------|--|---|----------------------------|-----------------------------------|--------------------------------|---------------|-----------|
| 5250 | 1/16/2018 | 1/16/2019 | 1.203 | 3.95 | 3.63 | -8.33% | 1.14 | 1.04 | -8.77% | 50 | 47.6 | 2.4 | -5.5 | -8.7 | 1.2 | -25.2 | -22.8 | 9.60% | PASS |
| 5600 | 1/16/2018 | 1/16/2019 | 1.203 | 4.205 | 3.84 | -8.88% | 1.2 | 1.09 | -9.17% | 54.7 | 52.5 | 2.2 | -2.1 | 1.6 | 3.7 | -26.2 | -30.6 | -16.80% | PASS |
| 5750 | 1/16/2018 | 1/16/2019 | 1.203 | 4.025 | 3.76 | -6.58% | 1.15 | 1.07 | -6.96% | 52.7 | 54.4 | 1.7 | 0 | 0.1 | 0.1 | -31.5 | -27.5 | 12.70% | PASS |
| Frequency (MHz) | Calibration Date | Extension Date | Certificate Electrical Delay (ns) | Certificate SAR Target Body (1g) W/kg @ 17.0 dBm | Measured Body SAR (1g) W/kg @ 17.0 dBm | Deviation 1g (%) | Certificate SAR Target Body (10g) W/kg @ 17.0 dBm | Measured Body SAR (10g) W/kg @ 17.0 dBm | Deviation 10g (%) | Certificate Impedance Body (Ohm) Real | Measured Impedance Body (Ohm) Real | Difference (Ohm) Real | Certificate Impedance Body (Ohm) Imaginary | Measured Impedance Body (Ohm) Imaginary | Difference (Ohm) Imaginary | Certificate Return Loss Body (dB) | Measured Return Loss Body (dB) | Deviation (%) | PASS/FAIL |
| 5250 | 1/16/2018 | 1/16/2019 | 1.203 | 3.795 | 3.73 | -1.71% | 1.06 | 1.03 | -2.37% | 48.4 | 45.9 | 2.5 | -3.9 | -4 | 0.1 | -27.4 | -24.5 | 10.50% | PASS |
| 5600 | 1/16/2018 | 1/16/2019 | 1.203 | 3.995 | 4.06 | 1.63% | 1.12 | 1.12 | 0.46% | 55.3 | 51 | 4.3 | -1.6 | 2.8 | 4.4 | -25.6 | -30.7 | -20.00% | PASS |
| 5750 | 1/16/2018 | 1/16/2019 | 1.203 | 3.835 | 3.65 | -4.82% | 1.06 | 1.02 | -3.77% | 52.6 | 52.9 | 0.3 | 1.1 | 0.6 | 0.5 | -31.2 | -30.7 | 1.60% | PASS |

Impedance & Return-Loss Measurement Plot for Head TSL

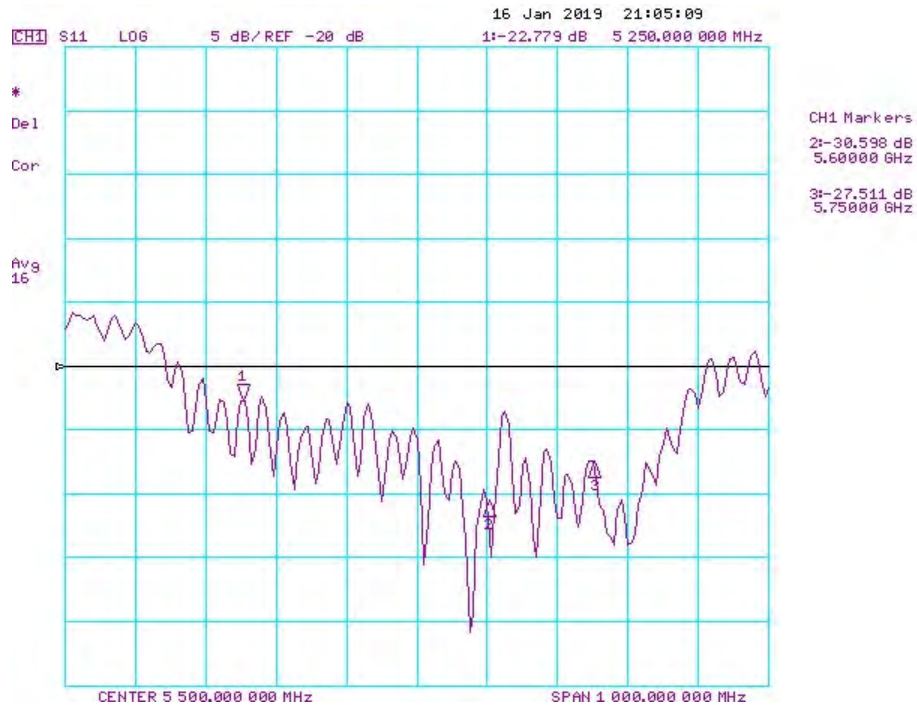
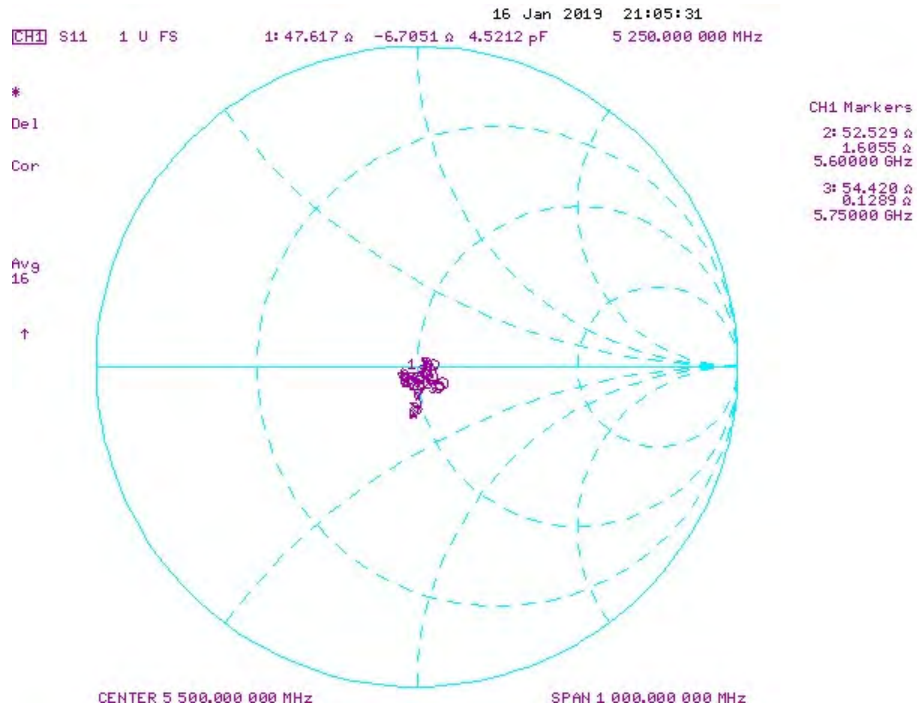

Impedance & Return-Loss Measurement Plot for Body TSL

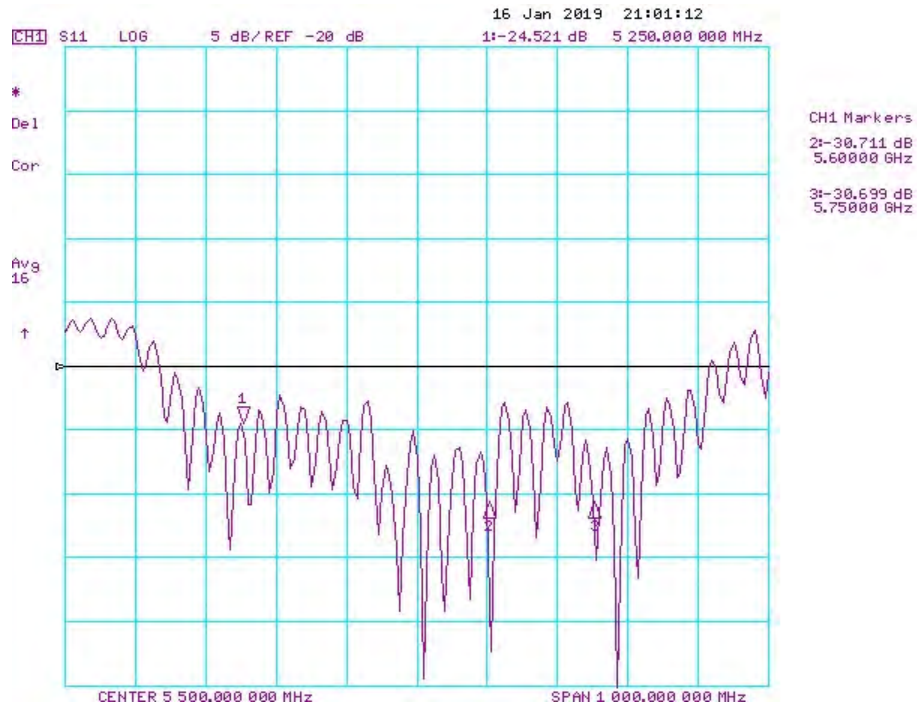
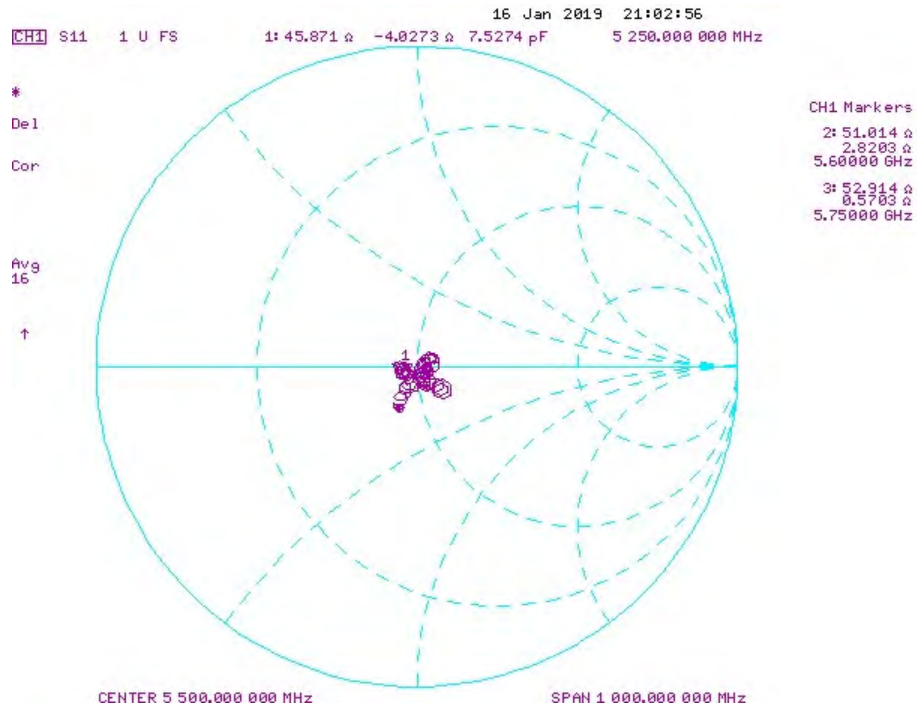



Accredited by the Swiss Accreditation Service (SAS)
The Swiss Accreditation Service is one of the signatories to the EA
Multilateral Agreement for the recognition of calibration certificates

Accreditation No.: **SCS 0108**

Client **PC Test**

Certificate No: **D5GHzV2-1191_Sep16**

CALIBRATION CERTIFICATE

Object **D5GHzV2 - SN:1191**

Calibration procedure(s) **QA CAL-22.v2**
Calibration procedure for dipole validation kits between 3-6 GHz

Calibration date: **September 21, 2016**

BNV
09-28-2016

Extended PMV
9/20/2018

This calibration certificate documents the traceability to national standards, which realize the physical units of measurements (SI).
The measurements and the uncertainties with confidence probability are given on the following pages and are part of the certificate.

All calibrations have been conducted in the closed laboratory facility: environment temperature (22 ± 3)°C and humidity < 70%.

Calibration Equipment used (M&TE critical for calibration)

| Primary Standards | ID # | Cal Date (Certificate No.) | Scheduled Calibration |
|-----------------------------|--------------------|---------------------------------|-----------------------|
| Power meter NRP | SN: 104778 | 06-Apr-16 (No. 217-02288/02289) | Apr-17 |
| Power sensor NRP-Z91 | SN: 103244 | 08-Apr-16 (No. 217-02288) | Apr-17 |
| Power sensor NRP-Z91 | SN: 103245 | 06-Apr-16 (No. 217-02289) | Apr-17 |
| Reference 20 dB Attenuator | SN: 5058 (20k) | 05-Apr-16 (No. 217-02292) | Apr-17 |
| Type-N mismatch combination | SN: 5047.2 / 06327 | 05-Apr-16 (No. 217-02295) | Apr-17 |
| Reference Probe EX3DV4 | SN: 3503 | 30-Jun-16 (No. EX3-3503_Jun16) | Jun-17 |
| DAE4 | SN: 601 | 30-Dec-15 (No. DAE4-601_Dec15) | Dec-16 |

| Secondary Standards | ID # | Check Date (in house) | Scheduled Check |
|---------------------------|----------------|-----------------------------------|------------------------|
| Power meter EPM-442A | SN: GB37480704 | 07-Oct-15 (No. 217-02222) | In house check: Oct-16 |
| Power sensor HP 8481A | SN: US37292783 | 07-Oct-15 (No. 217-02222) | In house check: Oct-16 |
| Power sensor HP 8481A | SN: MY41092317 | 07-Oct-15 (No. 217-02223) | In house check: Oct-16 |
| RF generator R&S SMT-06 | SN: 100972 | 15-Jun-15 (in house check Jun-15) | In house check: Oct-16 |
| Network Analyzer HP 8753E | SN: US37390585 | 18-Oct-01 (in house check Oct-15) | In house check: Oct-16 |

Calibrated by: **Leif Klysner** Name: **Leif Klysner** Function: **Laboratory Technician**

Approved by: **Katja Pokovic** Name: **Katja Pokovic** Function: **Technical Manager**

Signature
Leif Klysner
Katja Pokovic

Issued: September 22, 2016

This calibration certificate shall not be reproduced except in full without written approval of the laboratory.

**Calibration Laboratory of
Schmid & Partner
Engineering AG**
Zeughausstrasse 43, 8004 Zurich, Switzerland



S Schweizerischer Kalibrierdienst
C Service suisse d'étalonnage
S Servizio svizzero di taratura
S Swiss Calibration Service

Accredited by the Swiss Accreditation Service (SAS)
The Swiss Accreditation Service is one of the signatories to the EA
Multilateral Agreement for the recognition of calibration certificates

Accreditation No.: **SCS 0108**

Glossary:

| | |
|-------|---------------------------------|
| TSL | tissue simulating liquid |
| ConvF | sensitivity in TSL / NORM x,y,z |
| N/A | not applicable or not measured |

Calibration is Performed According to the Following Standards:

- IEEE Std 1528-2013, "IEEE Recommended Practice for Determining the Peak Spatial-Averaged Specific Absorption Rate (SAR) in the Human Head from Wireless Communications Devices: Measurement Techniques", June 2013
- IEC 62209-2, "Procedure to determine the Specific Absorption Rate (SAR) for wireless communication devices used in close proximity to the human body (frequency range of 30 MHz to 6 GHz)", March 2010
- KDB 865664, "SAR Measurement Requirements for 100 MHz to 6 GHz"

Additional Documentation:

- DASY4/5 System Handbook

Methods Applied and Interpretation of Parameters:

- Measurement Conditions:** Further details are available from the Validation Report at the end of the certificate. All figures stated in the certificate are valid at the frequency indicated.
- Antenna Parameters with TSL:** The dipole is mounted with the spacer to position its feed point exactly below the center marking of the flat phantom section, with the arms oriented parallel to the body axis.
- Feed Point Impedance and Return Loss:** These parameters are measured with the dipole positioned under the liquid filled phantom. The impedance stated is transformed from the measurement at the SMA connector to the feed point. The Return Loss ensures low reflected power. No uncertainty required.
- Electrical Delay:** One-way delay between the SMA connector and the antenna feed point. No uncertainty required.
- SAR measured:** SAR measured at the stated antenna input power.
- SAR normalized:** SAR as measured, normalized to an input power of 1 W at the antenna connector.
- SAR for nominal TSL parameters:** The measured TSL parameters are used to calculate the nominal SAR result.

The reported uncertainty of measurement is stated as the standard uncertainty of measurement multiplied by the coverage factor $k=2$, which for a normal distribution corresponds to a coverage probability of approximately 95%.

Measurement Conditions

DASY system configuration, as far as not given on page 1.

| | | |
|------------------------------|--|----------------------------------|
| DASY Version | DASY5 | V52.8.8 |
| Extrapolation | Advanced Extrapolation | |
| Phantom | Modular Flat Phantom V5.0 | |
| Distance Dipole Center - TSL | 10 mm | with Spacer |
| Zoom Scan Resolution | dx, dy = 4.0 mm, dz = 1.4 mm | Graded Ratio = 1.4 (Z direction) |
| Frequency | 5250 MHz ± 1 MHz 5600 MHz ± 1 MHz 5750 MHz ± 1 MHz | |

Head TSL parameters at 5250 MHz

The following parameters and calculations were applied.

| | Temperature | Permittivity | Conductivity |
|---|-----------------|--------------|------------------|
| Nominal Head TSL parameters | 22.0 °C | 35.9 | 4.71 mho/m |
| Measured Head TSL parameters | (22.0 ± 0.2) °C | 34.5 ± 6 % | 4.59 mho/m ± 6 % |
| Head TSL temperature change during test | < 0.5 °C | ---- | ---- |

SAR result with Head TSL at 5250 MHz

| SAR averaged over 1 cm ³ (1 g) of Head TSL | Condition | |
|---|--------------------|--------------------------|
| SAR measured | 100 mW input power | 7.96 W/kg |
| SAR for nominal Head TSL parameters | normalized to 1W | 78.9 W/kg ± 19.9 % (k=2) |

| SAR averaged over 10 cm ³ (10 g) of Head TSL | condition | |
|---|--------------------|--------------------------|
| SAR measured | 100 mW input power | 2.29 W/kg |
| SAR for nominal Head TSL parameters | normalized to 1W | 22.6 W/kg ± 19.5 % (k=2) |

Head TSL parameters at 5600 MHz

The following parameters and calculations were applied.

| | Temperature | Permittivity | Conductivity |
|---|-----------------|--------------|------------------|
| Nominal Head TSL parameters | 22.0 °C | 35.5 | 5.07 mho/m |
| Measured Head TSL parameters | (22.0 ± 0.2) °C | 34.0 ± 6 % | 4.93 mho/m ± 6 % |
| Head TSL temperature change during test | < 0.5 °C | ---- | ---- |

SAR result with Head TSL at 5600 MHz

| SAR averaged over 1 cm ³ (1 g) of Head TSL | Condition | |
|---|--------------------|----------------------------|
| SAR measured | 100 mW input power | 8.45 W/kg |
| SAR for nominal Head TSL parameters | normalized to 1W | 83.6 W / kg ± 19.9 % (k=2) |

| SAR averaged over 10 cm ³ (10 g) of Head TSL | condition | |
|---|--------------------|--------------------------|
| SAR measured | 100 mW input power | 2.41 W/kg |
| SAR for nominal Head TSL parameters | normalized to 1W | 23.8 W/kg ± 19.5 % (k=2) |

Head TSL parameters at 5750 MHz

The following parameters and calculations were applied.

| | Temperature | Permittivity | Conductivity |
|---|-----------------|--------------|------------------|
| Nominal Head TSL parameters | 22.0 °C | 35.4 | 5.22 mho/m |
| Measured Head TSL parameters | (22.0 ± 0.2) °C | 33.8 ± 6 % | 5.08 mho/m ± 6 % |
| Head TSL temperature change during test | < 0.5 °C | ---- | ---- |

SAR result with Head TSL at 5750 MHz

| SAR averaged over 1 cm ³ (1 g) of Head TSL | Condition | |
|---|--------------------|--------------------------|
| SAR measured | 100 mW input power | 7.99 W/kg |
| SAR for nominal Head TSL parameters | normalized to 1W | 79.1 W/kg ± 19.9 % (k=2) |

| SAR averaged over 10 cm ³ (10 g) of Head TSL | condition | |
|---|--------------------|--------------------------|
| SAR measured | 100 mW input power | 2.27 W/kg |
| SAR for nominal Head TSL parameters | normalized to 1W | 22.4 W/kg ± 19.5 % (k=2) |

Body TSL parameters at 5250 MHz

The following parameters and calculations were applied.

| | Temperature | Permittivity | Conductivity |
|---|-----------------|--------------|------------------|
| Nominal Body TSL parameters | 22.0 °C | 48.9 | 5.36 mho/m |
| Measured Body TSL parameters | (22.0 ± 0.2) °C | 47.4 ± 6 % | 5.52 mho/m ± 6 % |
| Body TSL temperature change during test | < 0.5 °C | ---- | ---- |

SAR result with Body TSL at 5250 MHz

| SAR averaged over 1 cm ³ (1 g) of Body TSL | Condition | |
|---|--------------------|--------------------------|
| SAR measured | 100 mW input power | 7.74 W/kg |
| SAR for nominal Body TSL parameters | normalized to 1W | 77.0 W/kg ± 19.9 % (k=2) |

| SAR averaged over 10 cm ³ (10 g) of Body TSL | condition | |
|---|--------------------|--------------------------|
| SAR measured | 100 mW input power | 2.17 W/kg |
| SAR for nominal Body TSL parameters | normalized to 1W | 21.6 W/kg ± 19.5 % (k=2) |

Body TSL parameters at 5600 MHz

The following parameters and calculations were applied.

| | Temperature | Permittivity | Conductivity |
|---|-----------------|--------------|------------------|
| Nominal Body TSL parameters | 22.0 °C | 48.5 | 5.77 mho/m |
| Measured Body TSL parameters | (22.0 ± 0.2) °C | 46.8 ± 6 % | 6.00 mho/m ± 6 % |
| Body TSL temperature change during test | < 0.5 °C | ---- | ---- |

SAR result with Body TSL at 5600 MHz

| SAR averaged over 1 cm ³ (1 g) of Body TSL | Condition | |
|---|--------------------|--------------------------|
| SAR measured | 100 mW input power | 7.96 W/kg |
| SAR for nominal Body TSL parameters | normalized to 1W | 79.2 W/kg ± 19.9 % (k=2) |

| SAR averaged over 10 cm ³ (10 g) of Body TSL | condition | |
|---|--------------------|--------------------------|
| SAR measured | 100 mW input power | 2.24 W/kg |
| SAR for nominal Body TSL parameters | normalized to 1W | 22.2 W/kg ± 19.5 % (k=2) |

Body TSL parameters at 5750 MHz

The following parameters and calculations were applied.

| | Temperature | Permittivity | Conductivity |
|---|-----------------|--------------|------------------|
| Nominal Body TSL parameters | 22.0 °C | 48.3 | 5.94 mho/m |
| Measured Body TSL parameters | (22.0 ± 0.2) °C | 46.5 ± 6 % | 6.21 mho/m ± 6 % |
| Body TSL temperature change during test | < 0.5 °C | ---- | ---- |

SAR result with Body TSL at 5750 MHz

| SAR averaged over 1 cm ³ (1 g) of Body TSL | Condition | |
|---|--------------------|--------------------------|
| SAR measured | 100 mW input power | 7.65 W/kg |
| SAR for nominal Body TSL parameters | normalized to 1W | 76.1 W/kg ± 19.9 % (k=2) |

| SAR averaged over 10 cm ³ (10 g) of Body TSL | condition | |
|---|--------------------|--------------------------|
| SAR measured | 100 mW input power | 2.14 W/kg |
| SAR for nominal Body TSL parameters | normalized to 1W | 21.2 W/kg ± 19.5 % (k=2) |

Appendix (Additional assessments outside the scope of SCS 0108)

Antenna Parameters with Head TSL at 5250 MHz

| | |
|--------------------------------------|--------------------------------|
| Impedance, transformed to feed point | 55.7 Ω - 4.3 j Ω |
| Return Loss | - 23.4 dB |

Antenna Parameters with Head TSL at 5600 MHz

| | |
|--------------------------------------|--------------------------------|
| Impedance, transformed to feed point | 58.3 Ω - 3.2 j Ω |
| Return Loss | - 21.8 dB |

Antenna Parameters with Head TSL at 5750 MHz

| | |
|--------------------------------------|--------------------------------|
| Impedance, transformed to feed point | 58.1 Ω + 4.8 j Ω |
| Return Loss | - 21.2 dB |

Antenna Parameters with Body TSL at 5250 MHz

| | |
|--------------------------------------|--------------------------------|
| Impedance, transformed to feed point | 56.1 Ω - 3.7 j Ω |
| Return Loss | - 23.4 dB |

Antenna Parameters with Body TSL at 5600 MHz

| | |
|--------------------------------------|--------------------------------|
| Impedance, transformed to feed point | 58.9 Ω - 1.7 j Ω |
| Return Loss | - 21.7 dB |

Antenna Parameters with Body TSL at 5750 MHz

| | |
|--------------------------------------|--------------------------------|
| Impedance, transformed to feed point | 59.5 Ω + 6.9 j Ω |
| Return Loss | - 19.4 dB |

General Antenna Parameters and Design

| | |
|----------------------------------|----------|
| Electrical Delay (one direction) | 1.204 ns |
|----------------------------------|----------|

After long term use with 100W radiated power, only a slight warming of the dipole near the feedpoint can be measured.

The dipole is made of standard semirigid coaxial cable. The center conductor of the feeding line is directly connected to the second arm of the dipole. The antenna is therefore short-circuited for DC-signals. On some of the dipoles, small end caps are added to the dipole arms in order to improve matching when loaded according to the position as explained in the "Measurement Conditions" paragraph. The SAR data are not affected by this change. The overall dipole length is still according to the Standard.

No excessive force must be applied to the dipole arms, because they might bend or the soldered connections near the feedpoint may be damaged.

Additional EUT Data

| | |
|-----------------|-----------------|
| Manufactured by | SPEAG |
| Manufactured on | August 28, 2003 |

DASY5 Validation Report for Head TSL

Date: 21.09.2016

Test Laboratory: SPEAG, Zurich, Switzerland

DUT: Dipole D5GHzV2; Type: D5GHzV2; Serial: D5GHzV2 - SN:1191

Communication System: UID 0 - CW; Frequency: 5250 MHz, Frequency: 5600 MHz, Frequency: 5750 MHz
Medium parameters used: $f = 5250$ MHz; $\sigma = 4.59$ S/m; $\epsilon_r = 34.5$; $\rho = 1000$ kg/m³, Medium parameters used: $f = 5600$ MHz; $\sigma = 4.93$ S/m; $\epsilon_r = 34$; $\rho = 1000$ kg/m³, Medium parameters used: $f = 5750$ MHz; $\sigma = 5.08$ S/m; $\epsilon_r = 33.8$; $\rho = 1000$ kg/m³

Phantom section: Flat Section

Measurement Standard: DASY5 (IEEE/IEC/ANSI C63.19-2011)

DASY52 Configuration:

- Probe: EX3DV4 - SN3503; ConvF(5.42, 5.42, 5.42); Calibrated: 30.06.2016, ConvF(4.89, 4.89, 4.89); Calibrated: 30.06.2016, ConvF(4.85, 4.85, 4.85); Calibrated: 30.06.2016;
- Sensor-Surface: 1.4mm (Mechanical Surface Detection)
- Electronics: DAE4 Sn601; Calibrated: 30.12.2015
- Phantom: Flat Phantom 5.0 (front); Type: QD000P50AA; Serial: 1001
- DASY52 52.8.8(1258); SEMCAD X 14.6.10(7372)

Dipole Calibration for Head Tissue/Pin=100mW, dist=10mm, f=5250 MHz/Zoom Scan,

dist=1.4mm (8x8x7)/Cube 0: Measurement grid: dx=4mm, dy=4mm, dz=1.4mm

Reference Value = 68.49 V/m; Power Drift = 0.01 dB

Peak SAR (extrapolated) = 28.6 W/kg

SAR(1 g) = 7.96 W/kg; SAR(10 g) = 2.29 W/kg

Maximum value of SAR (measured) = 18.2 W/kg

Dipole Calibration for Head Tissue/Pin=100mW, dist=10mm, f=5600 MHz/Zoom Scan,

dist=1.4mm (8x8x7)/Cube 0: Measurement grid: dx=4mm, dy=4mm, dz=1.4mm

Reference Value = 69.34 V/m; Power Drift = -0.00 dB

Peak SAR (extrapolated) = 32.9 W/kg

SAR(1 g) = 8.45 W/kg; SAR(10 g) = 2.41 W/kg

Maximum value of SAR (measured) = 20.0 W/kg

Dipole Calibration for Head Tissue/Pin=100mW, dist=10mm, f=5750 MHz/Zoom Scan,

dist=1.4mm (8x8x7)/Cube 0: Measurement grid: dx=4mm, dy=4mm, dz=1.4mm

Reference Value = 67.15 V/m; Power Drift = 0.02 dB

Peak SAR (extrapolated) = 32.3 W/kg

SAR(1 g) = 7.99 W/kg; SAR(10 g) = 2.27 W/kg

Maximum value of SAR (measured) = 19.3 W/kg

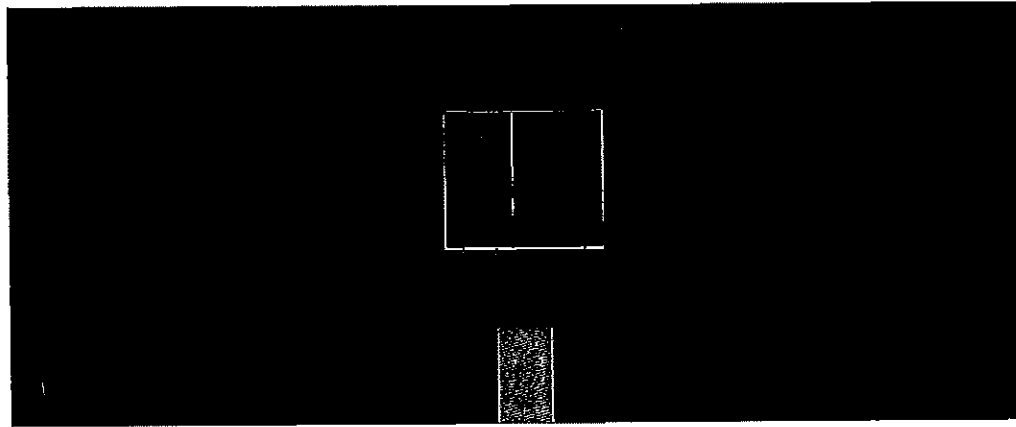
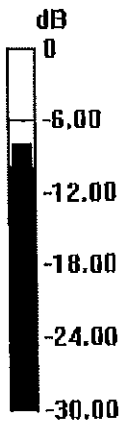

0 dB = 18.2 W/kg = 12.60 dBW/kg

Impedance Measurement Plot for Head TSL

20 Sep 2016 13:20:17
CH1 S11 1 U FS 1: 55.695 Ω -4.2793 Ω 7.0042 pF 5 250.000 000 MHz

*
 De1
 Cor
 Avg
 16
 H1d

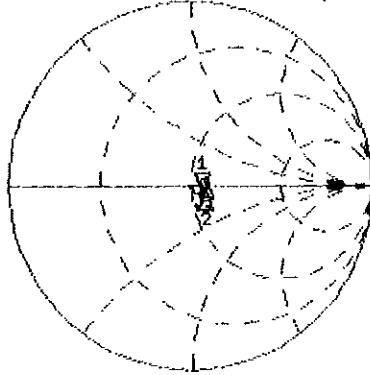

CH1 Markers
 2: 58.262 Ω
 -3.1738 Ω
 5.60000 GHz
 3: 58.078 Ω
 4.7969 Ω
 5.75000 GHz

CH2 S11 LOG 5 dB/REF -20 dB 1: -23.432 dB 5 250.000 000 MHz

Cor
 Avg
 16
 H1d

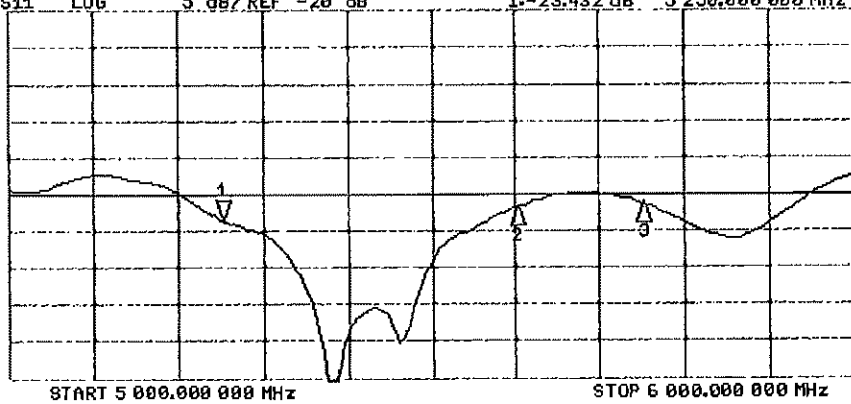

CH2 Markers
 2: -21.752 dB
 5.60000 GHz
 3: -21.226 dB
 5.75000 GHz

DASY5 Validation Report for Body TSL

Date: 20.09.2016

Test Laboratory: SPEAG, Zurich, Switzerland

DUT: Dipole D5GHzV2; Type: D5GHzV2; Serial: D5GHzV2 - SN:1191

Communication System: UID 0 - CW; Frequency: 5250 MHz, Frequency: 5600 MHz, Frequency: 5750 MHz
Medium parameters used: $f = 5250$ MHz; $\sigma = 5.52$ S/m; $\epsilon_r = 47.4$; $\rho = 1000$ kg/m³, Medium parameters used: $f = 5600$ MHz; $\sigma = 6$ S/m; $\epsilon_r = 46.8$; $\rho = 1000$ kg/m³, Medium parameters used: $f = 5750$ MHz; $\sigma = 6.21$ S/m; $\epsilon_r = 46.5$; $\rho = 1000$ kg/m³

Phantom section: Flat Section

Measurement Standard: DASY5 (IEEE/IEC/ANSI C63.19-2011)

DASY52 Configuration:

- Probe: EX3DV4 - SN3503; ConvF(4.85, 4.85, 4.85); Calibrated: 30.06.2016, ConvF(4.35, 4.35, 4.35); Calibrated: 30.06.2016, ConvF(4.3, 4.3, 4.3); Calibrated: 30.06.2016;
- Sensor-Surface: 1.4mm (Mechanical Surface Detection)
- Electronics: DAE4 Sn601; Calibrated: 30.12.2015
- Phantom: Flat Phantom 5.0 (back); Type: QD000P50AA; Serial: 1002
- DASY52 52.8.8(1258); SEMCAD X 14.6.10(7372)

Dipole Calibration for Body Tissue/Pin=100mW, dist=10mm, f=5250MHz/Zoom Scan, dist=1.4mm (8x8x7)/Cube 0: Measurement grid: dx=4mm, dy=4mm, dz=1.4mm

Reference Value = 66.49 V/m; Power Drift = -0.07 dB

Peak SAR (extrapolated) = 29.1 W/kg

SAR(1 g) = 7.74 W/kg; SAR(10 g) = 2.17 W/kg

Maximum value of SAR (measured) = 17.7 W/kg

Dipole Calibration for Body Tissue/Pin=100mW, dist=10mm, f=5600 MHz/Zoom Scan, dist=1.4mm (8x8x7)/Cube 0: Measurement grid: dx=4mm, dy=4mm, dz=1.4mm

Reference Value = 65.85 V/m; Power Drift = -0.09 dB

Peak SAR (extrapolated) = 32.5 W/kg

SAR(1 g) = 7.96 W/kg; SAR(10 g) = 2.24 W/kg

Maximum value of SAR (measured) = 18.8 W/kg

Dipole Calibration for Body Tissue/Pin=100mW, dist=10mm, f=5750 MHz/Zoom Scan, dist=1.4mm (8x8x7)/Cube 0: Measurement grid: dx=4mm, dy=4mm, dz=1.4mm

Reference Value = 64.21 V/m; Power Drift = -0.09 dB

Peak SAR (extrapolated) = 32.7 W/kg

SAR(1 g) = 7.65 W/kg; SAR(10 g) = 2.14 W/kg

Maximum value of SAR (measured) = 18.5 W/kg

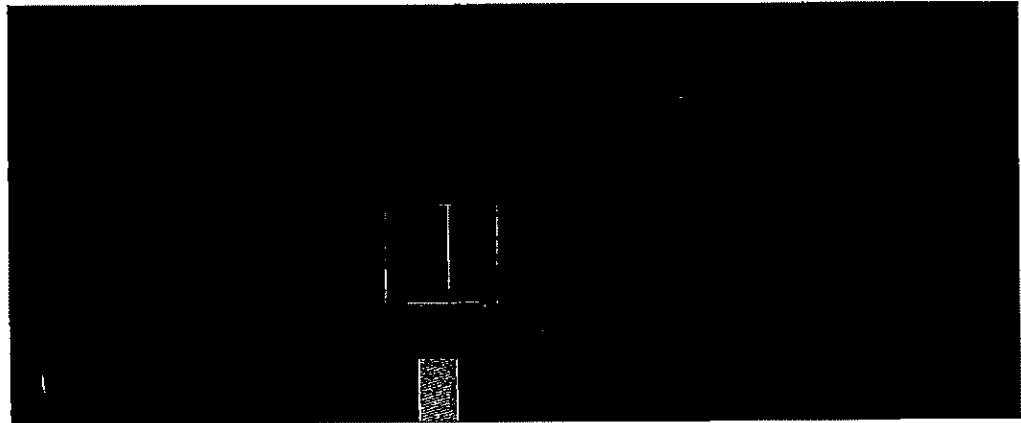
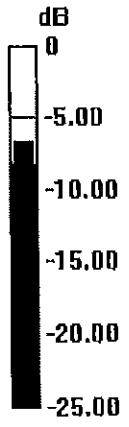

0 dB = 17.7 W/kg = 12.48 dBW/kg

Impedance Measurement Plot for Body TSL

20 Sep 2016 13:19:13

CH1 S11 1 U FS 1: 56.143 Ω -3.6992 Ω 8.1950 pF 5 250.000 000 MHz

De l
Cor
Avg
16
H1 d

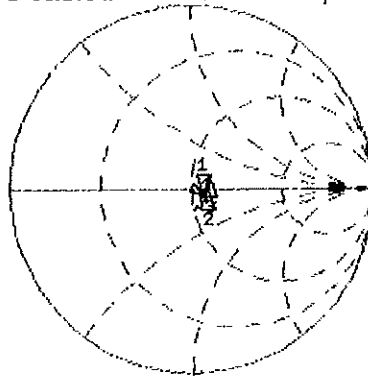

CH1 Markers
2: 56.087 Ω
-1.6504 Ω
5.60000 GHz
3: 59.510 Ω
6.9121 Ω
5.75000 GHz

CH2 S11 LOG 5 dB/ REF -20 dB 1: -23.406 dB 5 250.000 000 MHz

Cor
Avg
16
H1 d

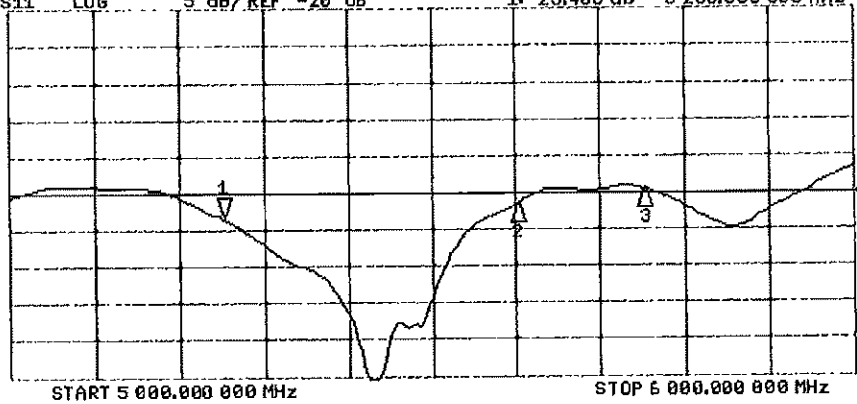

CH2 Markers
2: -21.616 dB
5.60000 GHz
3: -19.400 dB
5.75000 GHz

Certification of Calibration

Object: D5GHzV2 – SN: 1191

Calibration procedure(s): Procedure for Calibration Extension for SAR Dipoles.

Extension Calibration date: 9/19/2017

Description: SAR Validation Dipole at 5250, 5600, and 5750 MHz.

Calibration Equipment used:

| Manufacturer | Model | Description | Cal Date | Cal Interval | Cal Due | Serial Number |
|-----------------------|-----------|---|------------|--------------|------------|---------------|
| Control Company | 4040 | Therm./Clock/Humidity Monitor | 3/31/2017 | Biennial | 3/31/2019 | 170232394 |
| Control Company | 4352 | Ultra Long Stem Thermometer | 5/2/2017 | Biennial | 5/2/2019 | 170330156 |
| Amplifier Research | 15S1G6 | Amplifier | CBT | N/A | CBT | 433971 |
| Narda | 4772-3 | Attenuator (3dB) | CBT | N/A | CBT | 9406 |
| Keysight | 7720 | Dual Directional Coupler | CBT | N/A | CBT | MYS2180215 |
| Keysight Technologies | 85033E | Standard Mechanical Calibration Kit (DC to 9GHz, 3.5mm) | 6/1/2017 | Annual | 6/1/2018 | MYS3401181 |
| Agilent | 8753ES | S-Parameter Network Analyzer | 10/26/2016 | Annual | 10/26/2017 | US39170118 |
| Mini-Circuits | BW-N20W5+ | DC to 18 GHz Precision Fixed 20 dB Attenuator | CBT | N/A | CBT | N/A |
| SPEAG | DAK-3.S | Dielectric Assessment Kit | 5/10/2017 | Annual | 5/10/2018 | 1070 |
| SPEAG | EX3DV4 | SAR Probe | 1/13/2017 | Annual | 1/13/2018 | 3589 |
| SPEAG | EX3DV4 | SAR Probe | 2/13/2017 | Annual | 2/13/2018 | 3914 |
| SPEAG | DAE4 | Dasy Data Acquisition Electronics | 1/16/2017 | Annual | 1/16/2018 | 1466 |
| SPEAG | DAE4 | Dasy Data Acquisition Electronics | 2/9/2017 | Annual | 2/9/2018 | 665 |
| Anritsu | MA2411B | Pulse Power Sensor | 2/10/2017 | Annual | 2/10/2018 | 1207364 |
| Anritsu | MA2411B | Pulse Power Sensor | 2/10/2017 | Annual | 2/10/2018 | 1339018 |
| Anritsu | ML2495A | Power Meter | 10/16/2015 | Biennial | 10/16/2017 | 941001 |
| Agilent | N5182A | MXG Vector Signal Generator | 2/28/2017 | Annual | 2/28/2018 | MY47420800 |
| Seekonk | NC-100 | Torque Wrench | 11/6/2015 | Biennial | 11/6/2017 | N/A |
| MiniCircuits | VLF-6000+ | Low Pass Filter | CBT | N/A | CBT | N/A |
| Narda | 4014C-6 | 4 - 8 GHz SMA 6 dB Directional Coupler | CBT | N/A | CBT | N/A |

Measurement Uncertainty = $\pm 23\%$ (k=2)

| | Name | Function | Signature |
|----------------|------------------|--------------------------|-------------------------|
| Calibrated By: | Brodie Halfoster | Test Engineer | <i>BRODIE HALFOSTER</i> |
| Approved By: | Kaitlin O'Keefe | Senior Technical Manager | <i>KOK</i> |

DIPOLE CALIBRATION EXTENSION

Per KDB 865664 D01, calibration intervals of up to three years may be considered for reference dipoles when it is demonstrated that the SAR target, impedance and return loss of a dipole have remained stable according to the following requirements:

1. The measured SAR does not deviate more than 10% from the target on the calibration certificate.
2. The return-loss does not deviate more than 20% from the previous measurement and meets the required 20dB minimum return-loss requirement.
3. The measurement of real or imaginary parts of impedance does not deviate more than 5Ω from the previous measurement.

The following dipole was checked to pass the above 3 requirements to have 2-year calibration period from the calibration date:

| Frequency (MHz) | Calibration Date | Extension Date | Certificate Electrical Delay (ns) | Certificate SAR Target Head (1g W/kg @ 17.0 dBm) | Measured Head SAR (1g) W/kg @ 17.0 dBm | Deviation 1g (%) | Certificate SAR Target Head (10g W/kg @ 17.0 dBm) | Measured Head SAR (10g) W/kg @ 17.0 dBm | Deviation 10g (%) | Certificate Impedance Head (Ohm) Real | Measured Impedance Head (Ohm) Real | Difference (Ohm) Real | Certificate Impedance Head (Ohm) Imaginary | Measured Impedance Head (Ohm) Imaginary | Difference (Ohm) Imaginary | Certificate Return Loss Head (dB) | Measured Return Loss Head (dB) | Deviation (%) | PASS/FAIL |
|-----------------|------------------|----------------|-----------------------------------|--|--|------------------|---|---|-------------------|---------------------------------------|------------------------------------|-----------------------|--|---|----------------------------|-----------------------------------|--------------------------------|---------------|-----------|
| 5250 | 9/21/2016 | 9/19/2017 | 1.204 | 3.95 | 3.70 | -6.21% | 1.13 | 1.05 | -7.08% | 55.7 | 53.4 | 2.3 | -4.3 | -6.4 | 2.1 | -23.4 | -26.9 | -15.00% | PASS |
| 5600 | 9/21/2016 | 9/19/2017 | 1.204 | 4.18 | 4.03 | -3.59% | 1.19 | 1.13 | -5.04% | 58.3 | 55.8 | 2.7 | -3.2 | -1.2 | 2.0 | -21.8 | -26.1 | -19.80% | PASS |
| 5750 | 9/21/2016 | 9/19/2017 | 1.204 | 3.96 | 3.84 | -3.08% | 1.12 | 1.10 | -1.79% | 58.1 | 57.4 | 0.7 | 4.8 | 3.2 | 1.6 | -21.2 | -21.0 | 0.90% | PASS |

| Frequency (MHz) | Calibration Date | Extension Date | Certificate Electrical Delay (ns) | Certificate SAR Target Body (1g W/kg @ 17.0 dBm) | Measured Body SAR (1g) W/kg @ 17.0 dBm | Deviation 1g (%) | Certificate SAR Target Body (10g W/kg @ 17.0 dBm) | Measured Body SAR (10g) W/kg @ 17.0 dBm | Deviation 10g (%) | Certificate Impedance Body (Ohm) Real | Measured Impedance Body (Ohm) Real | Difference (Ohm) Real | Certificate Impedance Body (Ohm) Imaginary | Measured Impedance Body (Ohm) Imaginary | Difference (Ohm) Imaginary | Certificate Return Loss Body (dB) | Measured Return Loss Body (dB) | Deviation (%) | PASS/FAIL |
|-----------------|------------------|----------------|-----------------------------------|--|--|------------------|---|---|-------------------|---------------------------------------|------------------------------------|-----------------------|--|---|----------------------------|-----------------------------------|--------------------------------|---------------|-----------|
| 5250 | 9/21/2016 | 9/19/2017 | 1.204 | 3.85 | 3.80 | -1.30% | 1.08 | 1.06 | -1.85% | 56.1 | 54.0 | 2.1 | -3.7 | -3.3 | 0.4 | -23.4 | -26.0 | -11.10% | PASS |
| 5600 | 9/21/2016 | 9/19/2017 | 1.204 | 3.96 | 4.06 | 2.53% | 1.11 | 1.13 | 1.80% | 58.9 | 56.5 | 2.4 | -1.7 | 0.5 | 2.2 | -21.7 | -24.5 | -12.80% | PASS |
| 5750 | 9/21/2016 | 9/19/2017 | 1.204 | 3.81 | 3.66 | -3.81% | 1.06 | 1.02 | -3.77% | 59.5 | 58.0 | 1.5 | 6.9 | 5.2 | 1.7 | -19.4 | -21.1 | -8.70% | PASS |

Impedance & Return-Loss Measurement Plot for Head TSL

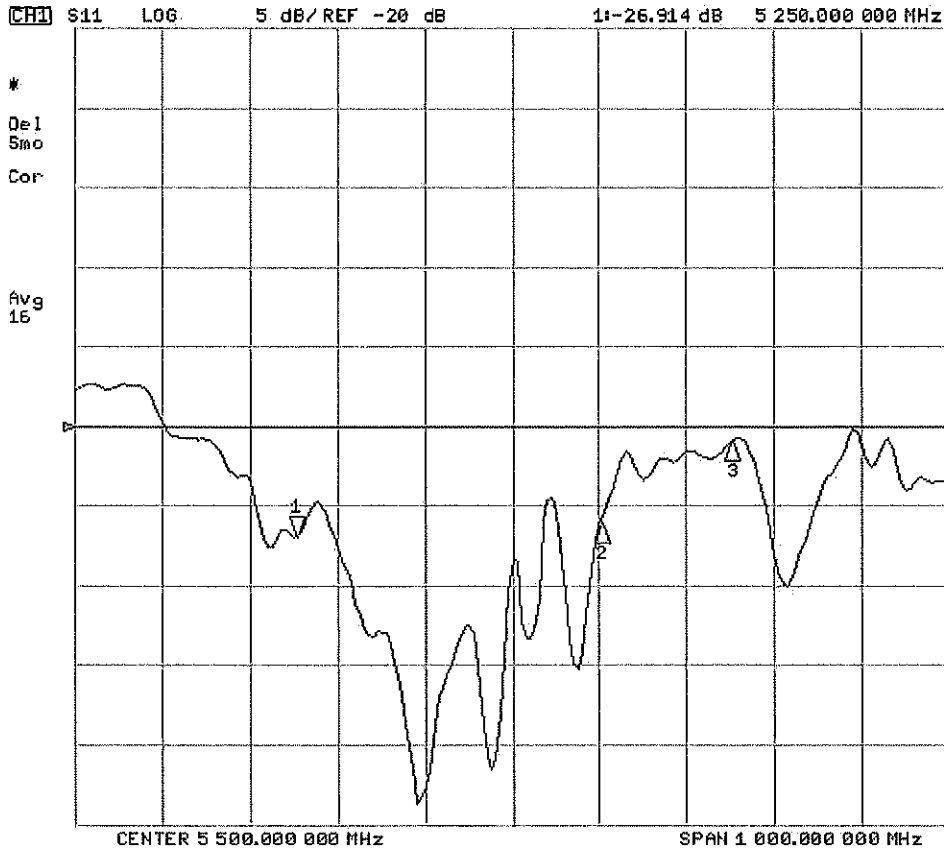
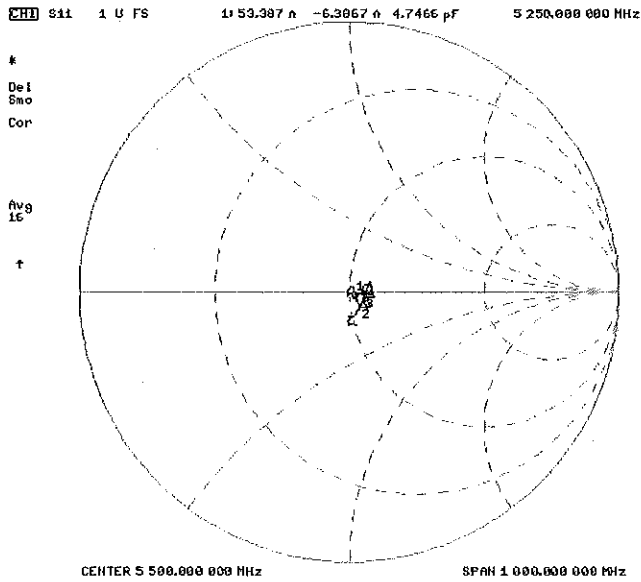

Impedance & Return-Loss Measurement Plot for Body TSL

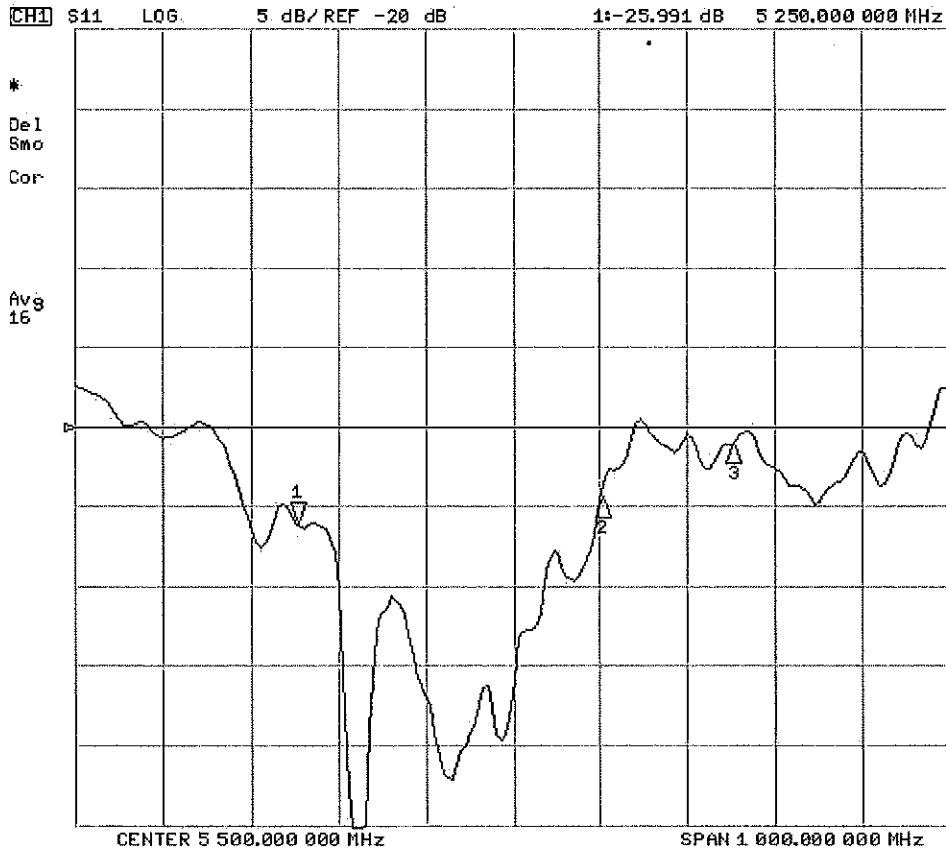
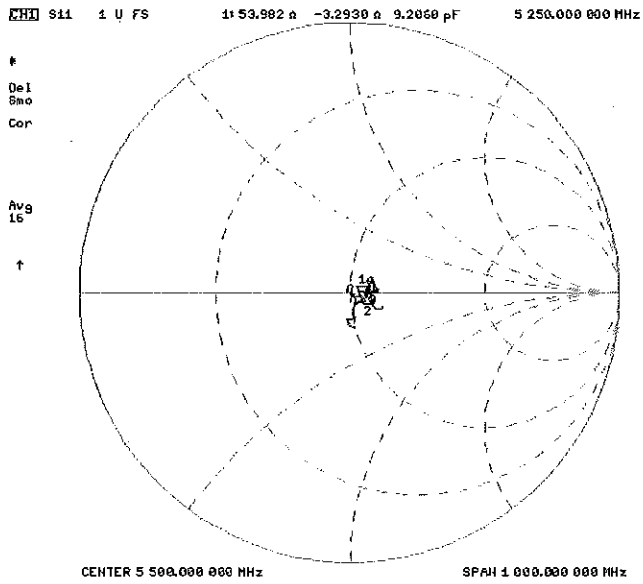

Certification of Calibration

Object: D5GHzV2 – SN: 1191

Calibration procedure(s): Procedure for Calibration Extension for SAR Dipoles.

Extension Calibration date: 9/11/2018

Description: SAR Validation Dipole at 5250, 5600, and 5750 MHz.

Calibration Equipment used:

| Manufacturer | Model | Description | Cal Date | Cal Interval | Cal Due | Serial Number |
|-----------------------|-----------|---|------------|--------------|------------|---------------|
| Control Company | 4040 | Therm./Clock/Humidity Monitor | 3/31/2017 | Biennial | 3/31/2019 | 170232394 |
| Control Company | 4352 | Ultra Long Stem Thermometer | 5/2/2017 | Biennial | 5/2/2019 | 170330156 |
| Amplifier Research | 1551G6 | Amplifier | CBT | N/A | CBT | 433971 |
| Narda | 4772-3 | Attenuator (3dB) | CBT | N/A | CBT | 9406 |
| Keysight | 772D | Dual Directional Coupler | CBT | N/A | CBT | MY52180215 |
| Keysight Technologies | 85033E | Standard Mechanical Calibration Kit (DC to 9GHz, 3.5mm) | 6/4/2018 | Annual | 6/4/2019 | MY53401181 |
| Agilent | 8753ES | S-Parameter Vector Network Analyzer | 8/30/2018 | Annual | 8/30/2019 | MY40003841 |
| Mini-Circuits | BW-N20W5+ | DC to 18 GHz Precision Fixed 20 dB Attenuator | CBT | N/A | CBT | N/A |
| SPEAG | DAK-3.5 | Dielectric Assessment Kit | 5/15/2018 | Annual | 5/15/2019 | 1070 |
| SPEAG | EX3DV4 | SAR Probe | 6/25/2018 | Annual | 6/25/2019 | 7409 |
| SPEAG | DAE4 | Dasy Data Acquisition Electronics | 6/18/2018 | Annual | 6/18/2019 | 1334 |
| SPEAG | EX3DV4 | SAR Probe | 4/18/2018 | Annual | 4/18/2019 | 7357 |
| SPEAG | DAE4 | Dasy Data Acquisition Electronics | 4/11/2018 | Annual | 4/11/2019 | 1407 |
| Anritsu | MA2411B | Pulse Power Sensor | 3/2/2018 | Annual | 3/2/2019 | 1207364 |
| Anritsu | MA2411B | Pulse Power Sensor | 3/2/2018 | Annual | 3/2/2019 | 1339018 |
| Anritsu | ML2495A | Power Meter | 10/22/2017 | Annual | 10/22/2018 | 1328004 |
| Agilent | N5182A | MXG Vector Signal Generator | 4/18/2018 | Annual | 4/18/2019 | MY47420800 |
| Seekonk | NC-100 | Torque Wrench | 7/11/2018 | Annual | 7/11/2019 | N/A |
| MiniCircuits | VLF-6000+ | Low Pass Filter | CBT | N/A | CBT | N/A |
| Narda | 4014C-6 | 4 - 8 GHz SMA 6 dB Directional Coupler | CBT | N/A | CBT | N/A |

Note: CBT (Calibrated Before Testing). Prior to testing, the measurement paths containing a cable, amplifier, attenuator, coupler or filter were connected to a calibrated source (i.e. a signal generator) to determine the losses of the measurement path.

Measurement Uncertainty = ±23% (k=2)

| | Name | Function | Signature |
|----------------|------------------|--------------------------|-------------------------|
| Calibrated By: | Brodie Halfoster | Test Engineer | <i>BRODIE HALFOSTER</i> |
| Approved By: | Kaitlin O'Keefe | Senior Technical Manager | <i>KOK</i> |

DIPOLE CALIBRATION EXTENSION

Per KDB 865664 D01, calibration intervals of up to three years may be considered for reference dipoles when it is demonstrated that the SAR target, impedance and return loss of a dipole have remained stable according to the following requirements:

1. The measured SAR does not deviate more than 10% from the target on the calibration certificate.
2. The return-loss does not deviate more than 20% from the previous measurement and meets the required 20dB minimum return-loss requirement.
3. The measurement of real or imaginary parts of impedance does not deviate more than 5Ω from the previous measurement.

The following dipole was checked to pass the above 3 requirements to have 3-year calibration period from the calibration date:

| Frequency (MHz) | Calibration Date | Extension Date | Certificate Electrical Delay (ns) | Certificate SAR Target Head (1g) W/kg @ 17.0 dBm | Measured Head SAR (1g) W/kg @ 17.0 dBm | Deviation 1g (%) | Certificate SAR Target Head (10g) W/kg @ 17.0 dBm | Measured Head SAR (10g) W/kg @ 17.0 dBm | Deviation 10g (%) | Certificate Impedance Head (Ohm) Real | Measured Impedance Head (Ohm) Real | Difference (Ohm) Real | Certificate Impedance Head (Ohm) Imaginary | Measured Impedance Head (Ohm) Imaginary | Difference (Ohm) Imaginary | Certificate Return Loss Head (dB) | Measured Return Loss Head (dB) | Deviation (%) | PASS/FAIL |
|-----------------|------------------|----------------|-----------------------------------|--|--|------------------|---|---|-------------------|---------------------------------------|------------------------------------|-----------------------|--|---|----------------------------|-----------------------------------|--------------------------------|---------------|-----------|
| 5250 | 9/21/2016 | 9/11/2018 | 1.204 | 3.945 | 3.9 | -1.14% | 1.13 | 1.11 | -1.77% | 55.7 | 54.9 | 0.8 | -4.3 | -7.7 | 3.4 | -23.4 | -21.3 | 9.10% | PASS |
| 5600 | 9/21/2016 | 9/11/2018 | 1.204 | 4.18 | 4.19 | 0.24% | 1.19 | 1.18 | -0.84% | 58.3 | 54.6 | 3.7 | -3.2 | -6.2 | 3 | -21.8 | -22.7 | -4.30% | PASS |
| 5750 | 9/21/2016 | 9/11/2018 | 1.204 | 3.955 | 3.82 | -3.41% | 1.12 | 1.08 | -3.57% | 58.1 | 58.7 | 0.6 | 4.8 | 7.4 | 2.6 | -21.2 | -19.5 | 7.80% | PASS |
| Frequency (MHz) | Calibration Date | Extension Date | Certificate Electrical Delay (ns) | Certificate SAR Target Body (1g) W/kg @ 17.0 dBm | Measured Body SAR (1g) W/kg @ 17.0 dBm | Deviation 1g (%) | Certificate SAR Target Body (10g) W/kg @ 17.0 dBm | Measured Body SAR (10g) W/kg @ 17.0 dBm | Deviation 10g (%) | Certificate Impedance Body (Ohm) Real | Measured Impedance Body (Ohm) Real | Difference (Ohm) Real | Certificate Impedance Body (Ohm) Imaginary | Measured Impedance Body (Ohm) Imaginary | Difference (Ohm) Imaginary | Certificate Return Loss Body (dB) | Measured Return Loss Body (dB) | Deviation (%) | PASS/FAIL |
| 5250 | 9/21/2016 | 9/11/2018 | 1.204 | 3.85 | 3.6 | -6.49% | 1.08 | 1.01 | -6.48% | 56.1 | 53.6 | 2.5 | -3.7 | -5.5 | 1.8 | -23.4 | -24 | -2.40% | PASS |
| 5600 | 9/21/2016 | 9/11/2018 | 1.204 | 3.96 | 4.01 | 1.26% | 1.11 | 1.1 | -0.90% | 58.9 | 57 | 1.9 | -1.7 | 0.1 | 1.8 | -21.7 | -23.8 | -9.70% | PASS |
| 5750 | 9/21/2016 | 9/11/2018 | 1.204 | 3.805 | 3.88 | 1.97% | 1.06 | 1.06 | 0.00% | 59.5 | 60.3 | 0.8 | 6.9 | 6.1 | 0.8 | -19.4 | -19.2 | 1.00% | PASS |

Impedance & Return-Loss Measurement Plot for Head TSL

11 Sep 2018 05:03:18
 [CH1] S11 1 U FS 1: 54.093 Ω -7.7207 Ω 3.9265 pF 5 250.000 000 MHz

*
 Del
 Smo
 Cor
 Avg
 16

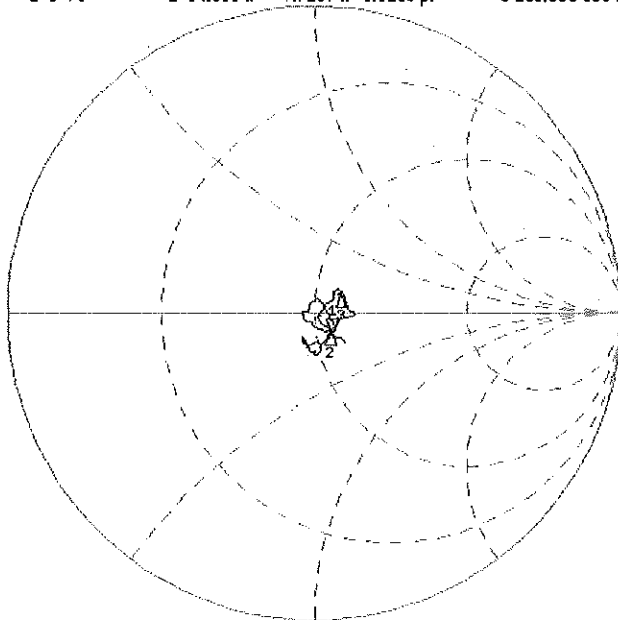

CH1 Markers
 2: 54.590 Ω
 -6.1797 Ω
 5.60000 GHz
 3: 50.559 Ω
 7.3097 Ω
 5.75000 GHz

CENTER 5 500.000 000 MHz SPAN 1 000.000 000 MHz
 11 Sep 2018 05:01:49

[CH1] S11 LOG 5 dB/REF -20 dB 1: -21.279 dB 5 250.000 000 MHz

*
 Del
 Smo
 Cor
 Avg
 16

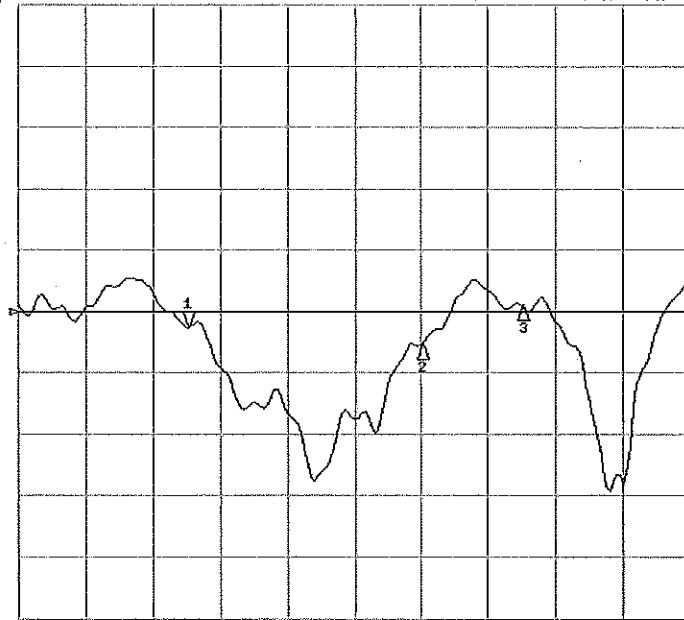

CH1 Markers
 2: -22.747 dB
 5.60000 GHz
 3: -19.546 dB
 5.75000 GHz

CENTER 5 500.000 000 MHz SPAN 1 000.000 000 MHz

Impedance & Return-Loss Measurement Plot for Body TSL

11 Sep 2018 05:00:12
 [CH1] S11 1 U F6 1: 53.613 n -5.4005 n 5.5315 pF 5 250.000 000 MHz

*
 Del
 Smo
 Cor
 Avg
 16

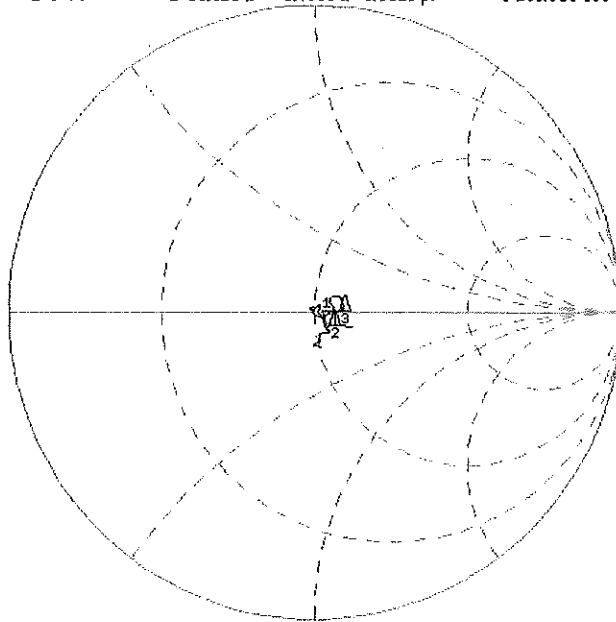

CH1 Markers
 2: 56.973 n
 0.0742 n
 5.60000 GHz
 3: 60.309 n
 0.0377 n
 5.75000 GHz

CENTER 5 500.000 000 MHz SPAN 1 000.000 000 MHz
 11 Sep 2018 05:00:43

[CH1] S11 LOG 5 dB/REF -20 dB 1: -23.952 dB 5 250.000 000 MHz

*
 Del
 Smo
 Cor
 Avg
 16
 f

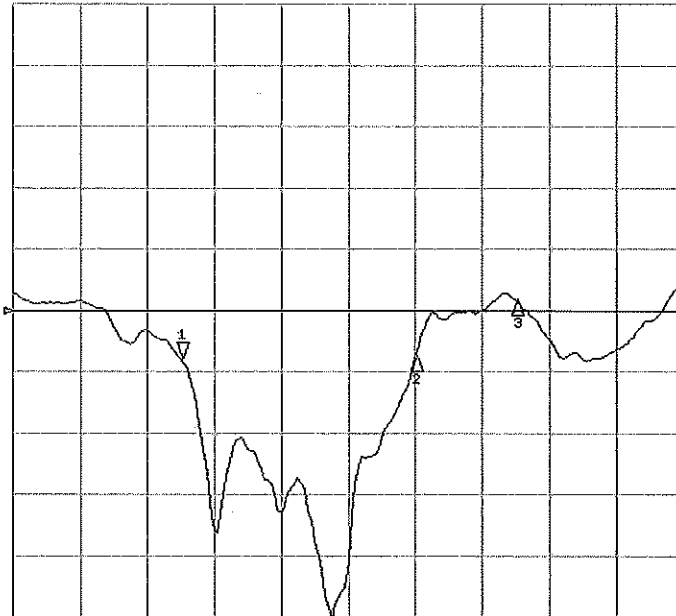

CH1 Markers
 2: -23.952 dB
 5.60000 GHz
 3: -19.200 dB
 5.75000 GHz

CENTER 5 500.000 000 MHz SPAN 1 000.000 000 MHz



Accredited by the Swiss Accreditation Service (SAS)
The Swiss Accreditation Service is one of the signatories to the EA
Multilateral Agreement for the recognition of calibration certificates

Accreditation No.: **SCS 0108**

Client **PC Test**

Certificate No: **EX3-3589_Jan19**

CALIBRATION CERTIFICATE

Object **EX3DV4 - SN:3589**

Calibration procedure(s) **QA CAL-01.v9, QA CAL-14.v5, QA CAL-23.v5, QA CAL-25.v7
Calibration procedure for dosimetric E-field probes**

*BN ✓
02-06-2019*

Calibration date: **January 25, 2019**

This calibration certificate documents the traceability to national standards, which realize the physical units of measurements (SI).
The measurements and the uncertainties with confidence probability are given on the following pages and are part of the certificate.

All calibrations have been conducted in the closed laboratory facility: environment temperature (22 ± 3)°C and humidity < 70%.

Calibration Equipment used (M&TE critical for calibration)

| Primary Standards | ID | Cal Date (Certificate No.) | Scheduled Calibration |
|----------------------------|------------------|-----------------------------------|------------------------|
| Power meter NRP | SN: 104778 | 04-Apr-18 (No. 217-02672/02673) | Apr-19 |
| Power sensor NRP-Z91 | SN: 103244 | 04-Apr-18 (No. 217-02672) | Apr-19 |
| Power sensor NRP-Z91 | SN: 103245 | 04-Apr-18 (No. 217-02673) | Apr-19 |
| Reference 20 dB Attenuator | SN: S5277 (20x) | 04-Apr-18 (No. 217-02682) | Apr-19 |
| DAE4 | SN: 660 | 19-Dec-18 (No. DAE4-660_Dec18) | Dec-19 |
| Reference Probe ES3DV2 | SN: 3013 | 31-Dec-18 (No. ES3-3013_Dec18) | Dec-19 |
| Secondary Standards | ID | Check Date (in house) | Scheduled Check |
| Power meter E4419B | SN: GB41293874 | 06-Apr-16 (in house check Jun-18) | In house check: Jun-20 |
| Power sensor E4412A | SN: MY41498087 | 06-Apr-16 (in house check Jun-18) | In house check: Jun-20 |
| Power sensor E4412A | SN: 000110210 | 06-Apr-16 (in house check Jun-18) | In house check: Jun-20 |
| RF generator HP 8648C | SN: US3642U01700 | 04-Aug-99 (in house check Jun-18) | In house check: Jun-20 |
| Network Analyzer E8358A | SN: US41080477 | 31-Mar-14 (in house check Oct-18) | In house check: Oct-19 |

| | | | |
|----------------|-------------------------------|--|---------------|
| Calibrated by: | Name Jeton Kastrati | Function Laboratory Technician | Signature |
| Approved by: | Name Katja Pokovic | Function Technical Manager | |

Issued: January 29, 2019

This calibration certificate shall not be reproduced except in full without written approval of the laboratory.



Accredited by the Swiss Accreditation Service (SAS)

Accreditation No.: **SCS 0108**

The Swiss Accreditation Service is one of the signatories to the EA
Multilateral Agreement for the recognition of calibration certificates

Glossary:

| | |
|--------------------------|---|
| TSL | tissue simulating liquid |
| NORM _{x,y,z} | sensitivity in free space |
| ConvF | sensitivity in TSL / NORM _{x,y,z} |
| DCP | diode compression point |
| CF | crest factor (1/duty_cycle) of the RF signal |
| A, B, C, D | modulation dependent linearization parameters |
| Polarization φ | φ rotation around probe axis |
| Polarization ϑ | ϑ rotation around an axis that is in the plane normal to probe axis (at measurement center), i.e., $\vartheta = 0$ is normal to probe axis |
| Connector Angle | information used in DASY system to align probe sensor X to the robot coordinate system |

Calibration is Performed According to the Following Standards:

- IEEE Std 1528-2013, "IEEE Recommended Practice for Determining the Peak Spatial-Averaged Specific Absorption Rate (SAR) in the Human Head from Wireless Communications Devices: Measurement Techniques", June 2013
- IEC 62209-1, "Measurement procedure for the assessment of Specific Absorption Rate (SAR) from hand-held and body-mounted devices used next to the ear (frequency range of 300 MHz to 6 GHz)", July 2016
- IEC 62209-2, "Procedure to determine the Specific Absorption Rate (SAR) for wireless communication devices used in close proximity to the human body (frequency range of 30 MHz to 6 GHz)", March 2010
- KDB 865664, "SAR Measurement Requirements for 100 MHz to 6 GHz"

Methods Applied and Interpretation of Parameters:

- NORM_{x,y,z}**: Assessed for E-field polarization $\vartheta = 0$ ($f \leq 900$ MHz in TEM-cell; $f > 1800$ MHz: R22 waveguide). NORM_{x,y,z} are only intermediate values, i.e., the uncertainties of NORM_{x,y,z} does not affect the E^2 -field uncertainty inside TSL (see below ConvF).
- NORM(f)_{x,y,z}** = NORM_{x,y,z} * frequency_response (see Frequency Response Chart). This linearization is implemented in DASY4 software versions later than 4.2. The uncertainty of the frequency response is included in the stated uncertainty of ConvF.
- DCP_{x,y,z}**: DCP are numerical linearization parameters assessed based on the data of power sweep with CW signal (no uncertainty required). DCP does not depend on frequency nor media.
- PAR**: PAR is the Peak to Average Ratio that is not calibrated but determined based on the signal characteristics
- A_{x,y,z}; B_{x,y,z}; C_{x,y,z}; D_{x,y,z}; VR_{x,y,z}**: A, B, C, D are numerical linearization parameters assessed based on the data of power sweep for specific modulation signal. The parameters do not depend on frequency nor media. VR is the maximum calibration range expressed in RMS voltage across the diode.
- ConvF and Boundary Effect Parameters**: Assessed in flat phantom using E-field (or Temperature Transfer Standard for $f \leq 800$ MHz) and inside waveguide using analytical field distributions based on power measurements for $f > 800$ MHz. The same setups are used for assessment of the parameters applied for boundary compensation (alpha, depth) of which typical uncertainty values are given. These parameters are used in DASY4 software to improve probe accuracy close to the boundary. The sensitivity in TSL corresponds to NORM_{x,y,z} * ConvF whereby the uncertainty corresponds to that given for ConvF. A frequency dependent ConvF is used in DASY version 4.4 and higher which allows extending the validity from ± 50 MHz to ± 100 MHz.
- Spherical isotropy (3D deviation from isotropy)**: in a field of low gradients realized using a flat phantom exposed by a patch antenna.
- Sensor Offset**: The sensor offset corresponds to the offset of virtual measurement center from the probe tip (on probe axis). No tolerance required.
- Connector Angle**: The angle is assessed using the information gained by determining the NORM_x (no uncertainty required).

DASY/EASY - Parameters of Probe: EX3DV4 - SN:3589

Basic Calibration Parameters

| | Sensor X | Sensor Y | Sensor Z | Unc (k=2) |
|---|----------|----------|----------|-----------|
| Norm ($\mu\text{V}/(\text{V}/\text{m})^2$) ^A | 0.44 | 0.40 | 0.39 | ± 10.1 % |
| DCP (mV) ^B | 104.1 | 102.3 | 101.6 | |

Calibration Results for Modulation Response

| UID | Communication System Name | | A dB | B dB $\sqrt{\mu\text{V}}$ | C | D dB | VR mV | Max dev. | Max Unc ^E (k=2) |
|---------------|-----------------------------|---|---------|------------------------------|-------|---------|----------|-------------|----------------------------------|
| 0 | CW | X | 0.00 | 0.00 | 1.00 | 0.00 | 161.0 | ± 2.2 % | ± 4.7 % |
| | | Y | 0.00 | 0.00 | 1.00 | | 172.8 | | |
| | | Z | 0.00 | 0.00 | 1.00 | | 161.9 | | |
| 10352- AAA | Pulse Waveform (200Hz, 10%) | X | 15.00 | 89.05 | 22.73 | 10.00 | 60.0 | ± 1.8 % | ± 9.6 % |
| | | Y | 15.00 | 87.03 | 21.09 | | 60.0 | | |
| | | Z | 15.00 | 88.89 | 22.24 | | 60.0 | | |
| 10353- AAA | Pulse Waveform (200Hz, 20%) | X | 15.00 | 89.55 | 21.62 | 6.99 | 80.0 | ± 0.9 % | ± 9.6 % |
| | | Y | 15.00 | 87.28 | 19.70 | | 80.0 | | |
| | | Z | 15.00 | 89.25 | 21.07 | | 80.0 | | |
| 10354- AAA | Pulse Waveform (200Hz, 40%) | X | 15.00 | 91.62 | 21.02 | 3.98 | 95.0 | ± 0.9 % | ± 9.6 % |
| | | Y | 15.00 | 87.00 | 17.73 | | 95.0 | | |
| | | Z | 15.00 | 91.02 | 20.33 | | 95.0 | | |
| 10355- AAA | Pulse Waveform (200Hz, 60%) | X | 15.00 | 97.72 | 22.56 | 2.22 | 120.0 | ± 1.3 % | ± 9.6 % |
| | | Y | 15.00 | 85.70 | 15.52 | | 120.0 | | |
| | | Z | 15.00 | 94.39 | 20.55 | | 120.0 | | |
| 10387- AAA | QPSK Waveform, 1 MHz | X | 0.93 | 64.13 | 11.59 | 0.00 | 150.0 | ± 3.0 % | ± 9.6 % |
| | | Y | 0.57 | 60.00 | 7.45 | | 150.0 | | |
| | | Z | 0.83 | 63.49 | 10.36 | | 150.0 | | |
| 10388- AAA | QPSK Waveform, 10 MHz | X | 2.36 | 68.76 | 16.09 | 0.00 | 150.0 | ± 1.5 % | ± 9.6 % |
| | | Y | 1.95 | 66.09 | 14.43 | | 150.0 | | |
| | | Z | 2.37 | 69.14 | 16.27 | | 150.0 | | |
| 10396- AAA | 64-QAM Waveform, 100 kHz | X | 3.76 | 72.95 | 19.72 | 3.01 | 150.0 | ± 0.7 % | ± 9.6 % |
| | | Y | 3.11 | 69.51 | 18.06 | | 150.0 | | |
| | | Z | 4.24 | 75.35 | 20.59 | | 150.0 | | |
| 10399- AAA | 64-QAM Waveform, 40 MHz | X | 3.57 | 67.40 | 15.92 | 0.00 | 150.0 | ± 2.7 % | ± 9.6 % |
| | | Y | 3.33 | 66.26 | 15.18 | | 150.0 | | |
| | | Z | 3.47 | 67.09 | 15.77 | | 150.0 | | |
| 10414- AAA | WLAN CCDF, 64-QAM, 40MHz | X | 4.95 | 65.72 | 15.56 | 0.00 | 150.0 | ± 4.8 % | ± 9.6 % |
| | | Y | 4.74 | 65.16 | 15.23 | | 150.0 | | |
| | | Z | 4.81 | 65.57 | 15.48 | | 150.0 | | |

Note: For details on UID parameters see Appendix

The reported uncertainty of measurement is stated as the standard uncertainty of measurement multiplied by the coverage factor k=2, which for a normal distribution corresponds to a coverage probability of approximately 95%.

^A The uncertainties of Norm X,Y,Z do not affect the E²-field uncertainty inside TSL (see Pages 5 and 6).

^B Numerical linearization parameter: uncertainty not required.

^E Uncertainty is determined using the max. deviation from linear response applying rectangular distribution and is expressed for the square of the field value.

DASY/EASY - Parameters of Probe: EX3DV4 - SN:3589

Sensor Model Parameters

| | C1 fF | C2 fF | α V ⁻¹ | T1 ms.V ⁻² | T2 ms.V ⁻¹ | T3 ms | T4 V ⁻² | T5 V ⁻¹ | T6 |
|---|----------|----------|-----------------------------|--------------------------|--------------------------|----------|-----------------------|-----------------------|------|
| X | 55.3 | 407.97 | 34.85 | 27.50 | 1.34 | 5.10 | 1.23 | 0.50 | 1.01 |
| Y | 46.7 | 357.99 | 37.12 | 21.71 | 1.59 | 5.07 | 0.00 | 0.73 | 1.01 |
| Z | 46.1 | 339.04 | 34.64 | 23.94 | 1.27 | 5.07 | 1.73 | 0.40 | 1.01 |

Other Probe Parameters

| | |
|---|------------|
| Sensor Arrangement | Triangular |
| Connector Angle (°) | -30.3 |
| Mechanical Surface Detection Mode | enabled |
| Optical Surface Detection Mode | disabled |
| Probe Overall Length | 337 mm |
| Probe Body Diameter | 10 mm |
| Tip Length | 9 mm |
| Tip Diameter | 2.5 mm |
| Probe Tip to Sensor X Calibration Point | 1 mm |
| Probe Tip to Sensor Y Calibration Point | 1 mm |
| Probe Tip to Sensor Z Calibration Point | 1 mm |
| Recommended Measurement Distance from Surface | 1.4 mm |

DASY/EASY - Parameters of Probe: EX3DV4 - SN:3589

Calibration Parameter Determined in Head Tissue Simulating Media

| f (MHz) ^C | Relative Permittivity ^F | Conductivity (S/m) ^F | ConvF X | ConvF Y | ConvF Z | Alpha ^G | Depth (mm) ^G | Unc (k=2) |
|----------------------|------------------------------------|---------------------------------|---------|---------|---------|--------------------|-------------------------|-----------|
| 750 | 41.9 | 0.89 | 8.67 | 8.67 | 8.67 | 0.70 | 0.80 | ± 12.0 % |
| 835 | 41.5 | 0.90 | 8.39 | 8.39 | 8.39 | 0.63 | 0.81 | ± 12.0 % |
| 1750 | 40.1 | 1.37 | 7.31 | 7.31 | 7.31 | 0.40 | 0.80 | ± 12.0 % |
| 1900 | 40.0 | 1.40 | 7.08 | 7.08 | 7.08 | 0.39 | 0.80 | ± 12.0 % |
| 2300 | 39.5 | 1.67 | 6.77 | 6.77 | 6.77 | 0.31 | 0.85 | ± 12.0 % |
| 2450 | 39.2 | 1.80 | 6.46 | 6.46 | 6.46 | 0.30 | 0.85 | ± 12.0 % |
| 2600 | 39.0 | 1.96 | 6.25 | 6.25 | 6.25 | 0.40 | 0.83 | ± 12.0 % |
| 3500 | 37.9 | 2.91 | 6.16 | 6.16 | 6.16 | 0.26 | 1.20 | ± 13.1 % |
| 3700 | 37.7 | 3.12 | 6.02 | 6.02 | 6.02 | 0.26 | 1.20 | ± 13.1 % |

^C Frequency validity above 300 MHz of ± 100 MHz only applies for DASY v4.4 and higher (see Page 2), else it is restricted to ± 50 MHz. The uncertainty is the RSS of the ConvF uncertainty at calibration frequency and the uncertainty for the indicated frequency band. Frequency validity below 300 MHz is ± 10, 25, 40, 50 and 70 MHz for ConvF assessments at 30, 64, 128, 150 and 220 MHz respectively. Validity of ConvF assessed at 6 MHz is 4-9 MHz, and ConvF assessed at 13 MHz is 9-19 MHz. Above 5 GHz frequency validity can be extended to ± 110 MHz.

^F At frequencies below 3 GHz, the validity of tissue parameters (ϵ and σ) can be relaxed to ± 10% if liquid compensation formula is applied to measured SAR values. At frequencies above 3 GHz, the validity of tissue parameters (ϵ and σ) is restricted to ± 5%. The uncertainty is the RSS of the ConvF uncertainty for indicated target tissue parameters.

^G Alpha/Depth are determined during calibration. SPEAG warrants that the remaining deviation due to the boundary effect after compensation is always less than ± 1% for frequencies below 3 GHz and below ± 2% for frequencies between 3-6 GHz at any distance larger than half the probe tip diameter from the boundary.

DASY/EASY - Parameters of Probe: EX3DV4 - SN:3589

Calibration Parameter Determined in Body Tissue Simulating Media

| f (MHz) ^C | Relative Permittivity ^F | Conductivity (S/m) ^F | ConvF X | ConvF Y | ConvF Z | Alpha ^G | Depth ^G (mm) | Unc (k=2) |
|----------------------|------------------------------------|---------------------------------|---------|---------|---------|--------------------|-------------------------|-----------|
| 750 | 55.5 | 0.96 | 8.34 | 8.34 | 8.34 | 0.42 | 0.84 | ± 12.0 % |
| 835 | 55.2 | 0.97 | 8.29 | 8.29 | 8.29 | 0.41 | 0.84 | ± 12.0 % |
| 1750 | 53.4 | 1.49 | 6.82 | 6.82 | 6.82 | 0.43 | 0.80 | ± 12.0 % |
| 1900 | 53.3 | 1.52 | 6.75 | 6.75 | 6.75 | 0.35 | 0.85 | ± 12.0 % |
| 2300 | 52.9 | 1.81 | 6.71 | 6.71 | 6.71 | 0.36 | 0.87 | ± 12.0 % |
| 2450 | 52.7 | 1.95 | 6.66 | 6.66 | 6.66 | 0.34 | 0.88 | ± 12.0 % |
| 2600 | 52.5 | 2.16 | 6.47 | 6.47 | 6.47 | 0.28 | 0.95 | ± 12.0 % |
| 3500 | 51.3 | 3.31 | 6.21 | 6.21 | 6.21 | 0.25 | 1.25 | ± 13.1 % |
| 3700 | 51.0 | 3.55 | 6.13 | 6.13 | 6.13 | 0.20 | 1.25 | ± 13.1 % |

^C Frequency validity above 300 MHz of ± 100 MHz only applies for DASY v4.4 and higher (see Page 2), else it is restricted to ± 50 MHz. The uncertainty is the RSS of the ConvF uncertainty at calibration frequency and the uncertainty for the indicated frequency band. Frequency validity below 300 MHz is ± 10, 25, 40, 50 and 70 MHz for ConvF assessments at 30, 64, 128, 150 and 220 MHz respectively. Validity of ConvF assessed at 6 MHz is 4-9 MHz, and ConvF assessed at 13 MHz is 9-19 MHz. Above 5 GHz frequency validity can be extended to ± 110 MHz.

^F At frequencies below 3 GHz, the validity of tissue parameters (ϵ and σ) can be relaxed to ± 10% if liquid compensation formula is applied to measured SAR values. At frequencies above 3 GHz, the validity of tissue parameters (ϵ and σ) is restricted to ± 5%. The uncertainty is the RSS of the ConvF uncertainty for indicated target tissue parameters.

^G Alpha/Depth are determined during calibration. SPEAG warrants that the remaining deviation due to the boundary effect after compensation is always less than ± 1% for frequencies below 3 GHz and below ± 2% for frequencies between 3-6 GHz at any distance larger than half the probe tip diameter from the boundary.

Frequency Response of E-Field (TEM-Cell:ifi110 EXX, Waveguide: R22)

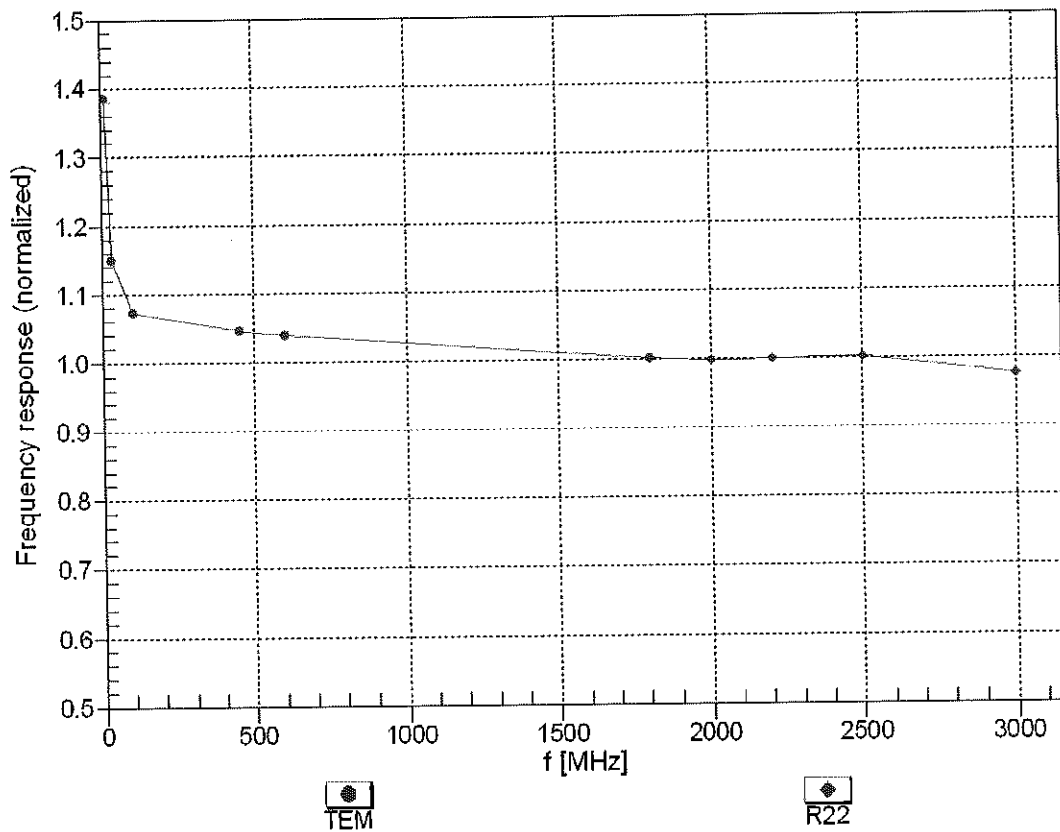

Uncertainty of Frequency Response of E-field: $\pm 6.3\%$ (k=2)

Receiving Pattern (ϕ), $\vartheta = 0^\circ$

f=600 MHz, TEM

f=1800 MHz, R22

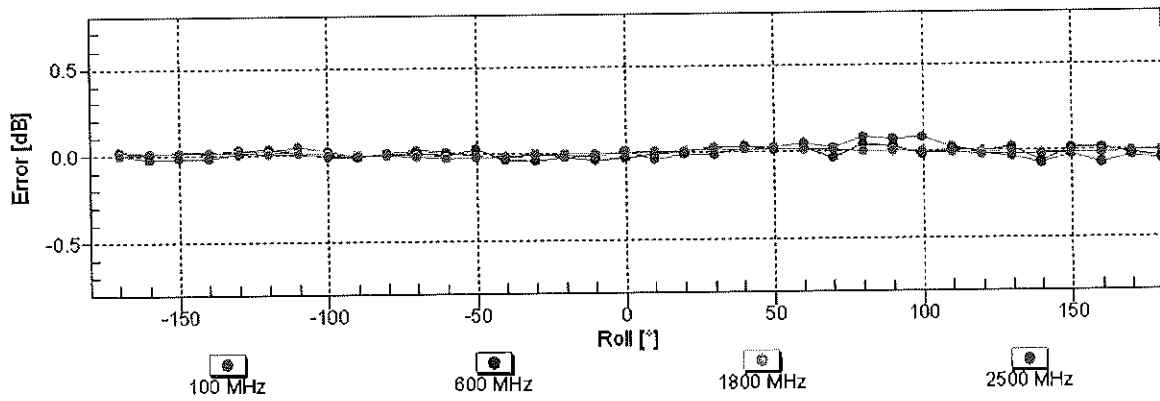
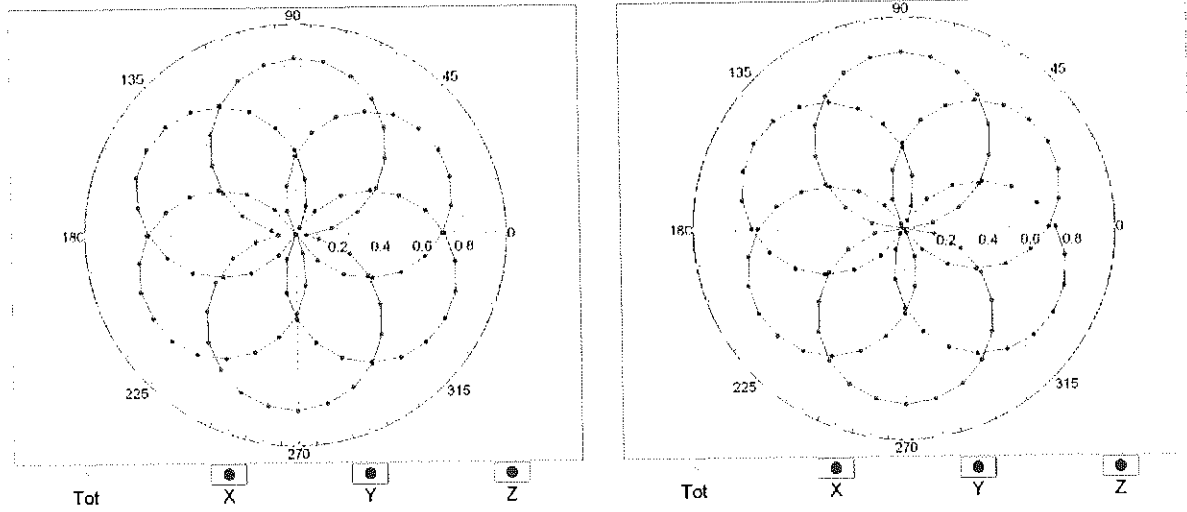

Uncertainty of Axial Isotropy Assessment: $\pm 0.5\%$ ($k=2$)

Dynamic Range f(SAR_{head}) (TEM cell , f_{eval}= 1900 MHz)

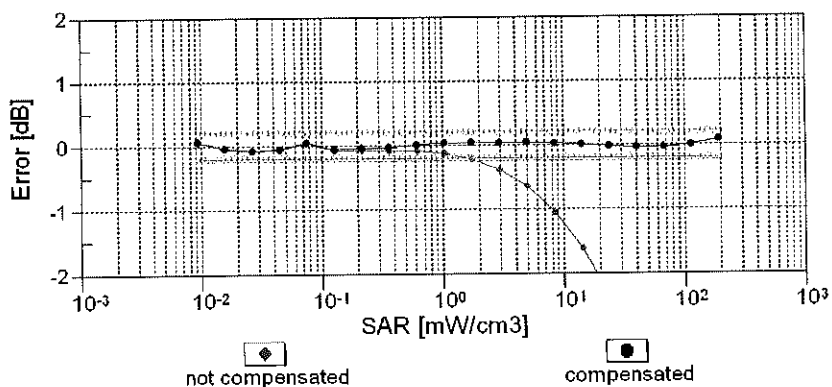
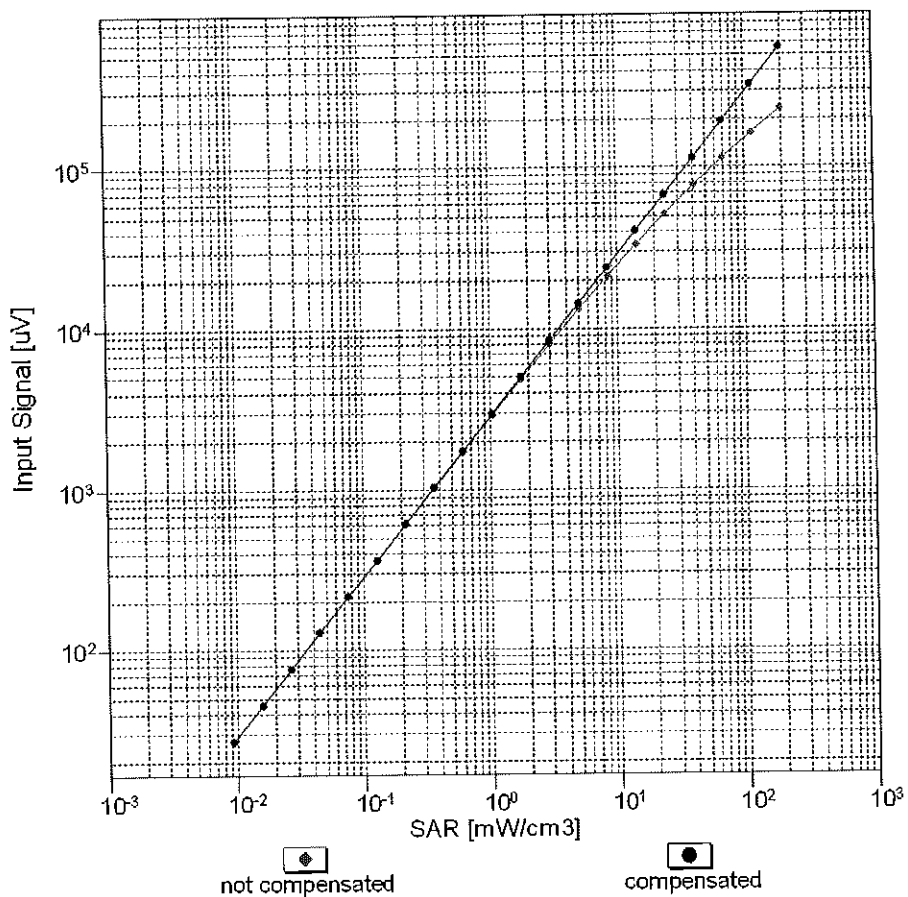

Uncertainty of Linearity Assessment: ± 0.6% (k=2)

Conversion Factor Assessment

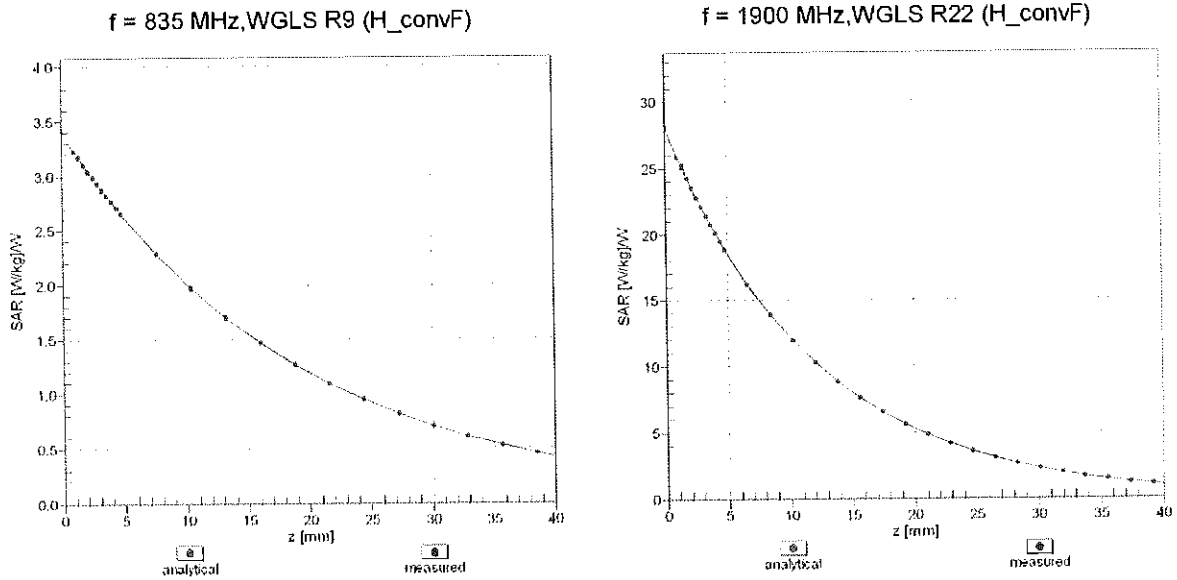

Deviation from Isotropy in Liquid Error (ϕ, θ), f = 900 MHz

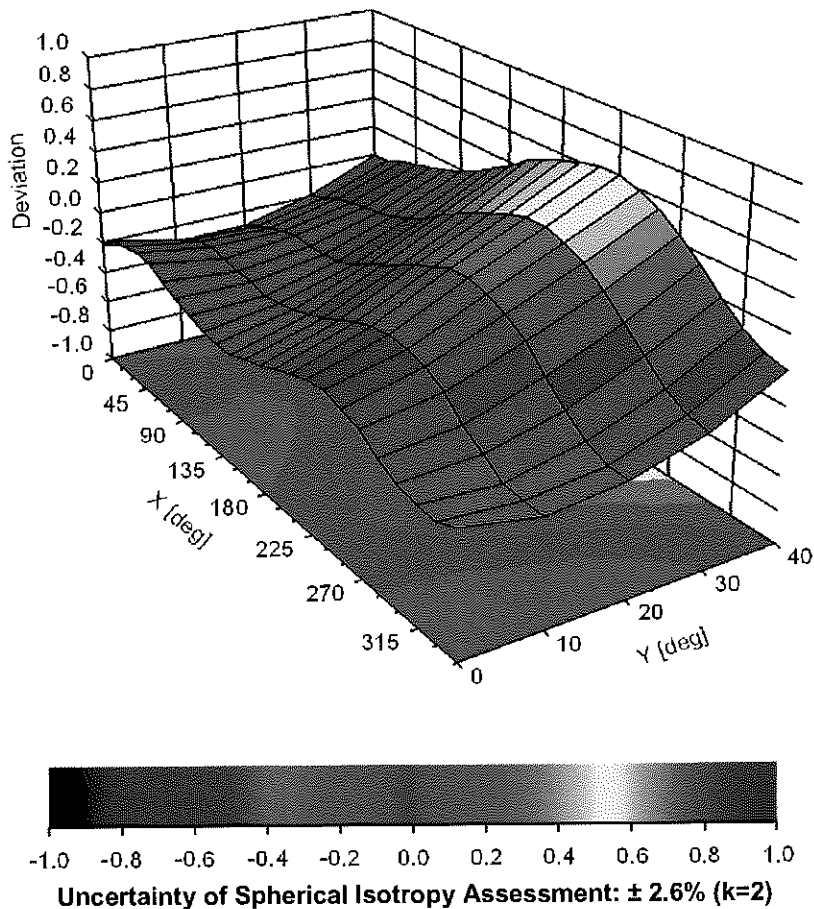

Appendix: Modulation Calibration Parameters

| UID | Rev | Communication System Name | Group | PAR (dB) | Unc ^E (k=2) |
|-------|-----|---|-----------|----------|------------------------|
| 0 | | CW | CW | 0.00 | ± 4.7 % |
| 10010 | CAA | SAR Validation (Square, 100ms, 10ms) | Test | 10.00 | ± 9.6 % |
| 10011 | CAB | UMTS-FDD (WCDMA) | WCDMA | 2.91 | ± 9.6 % |
| 10012 | CAB | IEEE 802.11b WiFi 2.4 GHz (DSSS, 1 Mbps) | WLAN | 1.87 | ± 9.6 % |
| 10013 | CAB | IEEE 802.11g WiFi 2.4 GHz (DSSS-OFDM, 6 Mbps) | WLAN | 9.46 | ± 9.6 % |
| 10021 | DAC | GSM-FDD (TDMA, GMSK) | GSM | 9.39 | ± 9.6 % |
| 10023 | DAC | GPRS-FDD (TDMA, GMSK, TN 0) | GSM | 9.57 | ± 9.6 % |
| 10024 | DAC | GPRS-FDD (TDMA, GMSK, TN 0-1) | GSM | 6.56 | ± 9.6 % |
| 10025 | DAC | EDGE-FDD (TDMA, 8PSK, TN 0) | GSM | 12.62 | ± 9.6 % |
| 10026 | DAC | EDGE-FDD (TDMA, 8PSK, TN 0-1) | GSM | 9.55 | ± 9.6 % |
| 10027 | DAC | GPRS-FDD (TDMA, GMSK, TN 0-1-2) | GSM | 4.80 | ± 9.6 % |
| 10028 | DAC | GPRS-FDD (TDMA, GMSK, TN 0-1-2-3) | GSM | 3.55 | ± 9.6 % |
| 10029 | DAC | EDGE-FDD (TDMA, 8PSK, TN 0-1-2) | GSM | 7.78 | ± 9.6 % |
| 10030 | CAA | IEEE 802.15.1 Bluetooth (GFSK, DH1) | Bluetooth | 5.30 | ± 9.6 % |
| 10031 | CAA | IEEE 802.15.1 Bluetooth (GFSK, DH3) | Bluetooth | 1.87 | ± 9.6 % |
| 10032 | CAA | IEEE 802.15.1 Bluetooth (GFSK, DH5) | Bluetooth | 1.16 | ± 9.6 % |
| 10033 | CAA | IEEE 802.15.1 Bluetooth (PI/4-DQPSK, DH1) | Bluetooth | 7.74 | ± 9.6 % |
| 10034 | CAA | IEEE 802.15.1 Bluetooth (PI/4-DQPSK, DH3) | Bluetooth | 4.53 | ± 9.6 % |
| 10035 | CAA | IEEE 802.15.1 Bluetooth (PI/4-DQPSK, DH5) | Bluetooth | 3.83 | ± 9.6 % |
| 10036 | CAA | IEEE 802.15.1 Bluetooth (8-DPSK, DH1) | Bluetooth | 8.01 | ± 9.6 % |
| 10037 | CAA | IEEE 802.15.1 Bluetooth (8-DPSK, DH3) | Bluetooth | 4.77 | ± 9.6 % |
| 10038 | CAA | IEEE 802.15.1 Bluetooth (8-DPSK, DH5) | Bluetooth | 4.10 | ± 9.6 % |
| 10039 | CAB | CDMA2000 (1xRTT, RC1) | CDMA2000 | 4.57 | ± 9.6 % |
| 10042 | CAB | IS-54 / IS-136 FDD (TDMA/FDM, PI/4-DQPSK, Halfrate) | AMPS | 7.78 | ± 9.6 % |
| 10044 | CAA | IS-91/EIA/TIA-553 FDD (FDMA, FM) | AMPS | 0.00 | ± 9.6 % |
| 10048 | CAA | DECT (TDD, TDMA/FDM, GFSK, Full Slot, 24) | DECT | 13.80 | ± 9.6 % |
| 10049 | CAA | DECT (TDD, TDMA/FDM, GFSK, Double Slot, 12) | DECT | 10.79 | ± 9.6 % |
| 10056 | CAA | UMTS-TDD (TD-SCDMA, 1.28 Mcps) | TD-SCDMA | 11.01 | ± 9.6 % |
| 10058 | DAC | EDGE-FDD (TDMA, 8PSK, TN 0-1-2-3) | GSM | 6.52 | ± 9.6 % |
| 10059 | CAB | IEEE 802.11b WiFi 2.4 GHz (DSSS, 2 Mbps) | WLAN | 2.12 | ± 9.6 % |
| 10060 | CAB | IEEE 802.11b WiFi 2.4 GHz (DSSS, 5.5 Mbps) | WLAN | 2.83 | ± 9.6 % |
| 10061 | CAB | IEEE 802.11b WiFi 2.4 GHz (DSSS, 11 Mbps) | WLAN | 3.60 | ± 9.6 % |
| 10062 | CAC | IEEE 802.11a/h WiFi 5 GHz (OFDM, 6 Mbps) | WLAN | 8.68 | ± 9.6 % |
| 10063 | CAC | IEEE 802.11a/h WiFi 5 GHz (OFDM, 9 Mbps) | WLAN | 8.63 | ± 9.6 % |
| 10064 | CAC | IEEE 802.11a/h WiFi 5 GHz (OFDM, 12 Mbps) | WLAN | 9.09 | ± 9.6 % |
| 10065 | CAC | IEEE 802.11a/h WiFi 5 GHz (OFDM, 18 Mbps) | WLAN | 9.00 | ± 9.6 % |
| 10066 | CAC | IEEE 802.11a/h WiFi 5 GHz (OFDM, 24 Mbps) | WLAN | 9.38 | ± 9.6 % |
| 10067 | CAC | IEEE 802.11a/h WiFi 5 GHz (OFDM, 36 Mbps) | WLAN | 10.12 | ± 9.6 % |
| 10068 | CAC | IEEE 802.11a/h WiFi 5 GHz (OFDM, 48 Mbps) | WLAN | 10.24 | ± 9.6 % |
| 10069 | CAC | IEEE 802.11a/h WiFi 5 GHz (OFDM, 54 Mbps) | WLAN | 10.56 | ± 9.6 % |
| 10071 | CAB | IEEE 802.11g WiFi 2.4 GHz (DSSS/OFDM, 9 Mbps) | WLAN | 9.83 | ± 9.6 % |
| 10072 | CAB | IEEE 802.11g WiFi 2.4 GHz (DSSS/OFDM, 12 Mbps) | WLAN | 9.62 | ± 9.6 % |
| 10073 | CAB | IEEE 802.11g WiFi 2.4 GHz (DSSS/OFDM, 18 Mbps) | WLAN | 9.94 | ± 9.6 % |
| 10074 | CAB | IEEE 802.11g WiFi 2.4 GHz (DSSS/OFDM, 24 Mbps) | WLAN | 10.30 | ± 9.6 % |
| 10075 | CAB | IEEE 802.11g WiFi 2.4 GHz (DSSS/OFDM, 36 Mbps) | WLAN | 10.77 | ± 9.6 % |
| 10076 | CAB | IEEE 802.11g WiFi 2.4 GHz (DSSS/OFDM, 48 Mbps) | WLAN | 10.94 | ± 9.6 % |
| 10077 | CAB | IEEE 802.11g WiFi 2.4 GHz (DSSS/OFDM, 54 Mbps) | WLAN | 11.00 | ± 9.6 % |
| 10081 | CAB | CDMA2000 (1xRTT, RC3) | CDMA2000 | 3.97 | ± 9.6 % |
| 10082 | CAB | IS-54 / IS-136 FDD (TDMA/FDM, PI/4-DQPSK, Fullrate) | AMPS | 4.77 | ± 9.6 % |
| 10090 | DAC | GPRS-FDD (TDMA, GMSK, TN 0-4) | GSM | 6.56 | ± 9.6 % |
| 10097 | CAB | UMTS-FDD (HSDPA) | WCDMA | 3.98 | ± 9.6 % |
| 10098 | CAB | UMTS-FDD (HSUPA, Subtest 2) | WCDMA | 3.98 | ± 9.6 % |
| 10099 | DAC | EDGE-FDD (TDMA, 8PSK, TN 0-4) | GSM | 9.55 | ± 9.6 % |
| 10100 | CAE | LTE-FDD (SC-FDMA, 100% RB, 20 MHz, QPSK) | LTE-FDD | 5.67 | ± 9.6 % |
| 10101 | CAE | LTE-FDD (SC-FDMA, 100% RB, 20 MHz, 16-QAM) | LTE-FDD | 6.42 | ± 9.6 % |
| 10102 | CAE | LTE-FDD (SC-FDMA, 100% RB, 20 MHz, 64-QAM) | LTE-FDD | 6.60 | ± 9.6 % |
| 10103 | CAG | LTE-TDD (SC-FDMA, 100% RB, 20 MHz, QPSK) | LTE-TDD | 9.29 | ± 9.6 % |
| 10104 | CAG | LTE-TDD (SC-FDMA, 100% RB, 20 MHz, 16-QAM) | LTE-TDD | 9.97 | ± 9.6 % |
| 10105 | CAG | LTE-TDD (SC-FDMA, 100% RB, 20 MHz, 64-QAM) | LTE-TDD | 10.01 | ± 9.6 % |
| 10108 | CAG | LTE-FDD (SC-FDMA, 100% RB, 10 MHz, QPSK) | LTE-FDD | 5.80 | ± 9.6 % |

| | | | | | |
|-------|-----|--|---------|-------|---------|
| 10109 | CAG | LTE-FDD (SC-FDMA, 100% RB, 10 MHz, 16-QAM) | LTE-FDD | 6.43 | ± 9.6 % |
| 10110 | CAG | LTE-FDD (SC-FDMA, 100% RB, 5 MHz, QPSK) | LTE-FDD | 5.75 | ± 9.6 % |
| 10111 | CAG | LTE-FDD (SC-FDMA, 100% RB, 5 MHz, 16-QAM) | LTE-FDD | 6.44 | ± 9.6 % |
| 10112 | CAG | LTE-FDD (SC-FDMA, 100% RB, 10 MHz, 64-QAM) | LTE-FDD | 6.59 | ± 9.6 % |
| 10113 | CAG | LTE-FDD (SC-FDMA, 100% RB, 5 MHz, 64-QAM) | LTE-FDD | 6.62 | ± 9.6 % |
| 10114 | CAC | IEEE 802.11n (HT Greenfield, 13.5 Mbps, BPSK) | WLAN | 8.10 | ± 9.6 % |
| 10115 | CAC | IEEE 802.11n (HT Greenfield, 81 Mbps, 16-QAM) | WLAN | 8.46 | ± 9.6 % |
| 10116 | CAC | IEEE 802.11n (HT Greenfield, 135 Mbps, 64-QAM) | WLAN | 8.15 | ± 9.6 % |
| 10117 | CAC | IEEE 802.11n (HT Mixed, 13.5 Mbps, BPSK) | WLAN | 8.07 | ± 9.6 % |
| 10118 | CAC | IEEE 802.11n (HT Mixed, 81 Mbps, 16-QAM) | WLAN | 8.59 | ± 9.6 % |
| 10119 | CAC | IEEE 802.11n (HT Mixed, 135 Mbps, 64-QAM) | WLAN | 8.13 | ± 9.6 % |
| 10140 | CAE | LTE-FDD (SC-FDMA, 100% RB, 15 MHz, 16-QAM) | LTE-FDD | 6.49 | ± 9.6 % |
| 10141 | CAE | LTE-FDD (SC-FDMA, 100% RB, 15 MHz, 64-QAM) | LTE-FDD | 6.53 | ± 9.6 % |
| 10142 | CAE | LTE-FDD (SC-FDMA, 100% RB, 3 MHz, QPSK) | LTE-FDD | 5.73 | ± 9.6 % |
| 10143 | CAE | LTE-FDD (SC-FDMA, 100% RB, 3 MHz, 16-QAM) | LTE-FDD | 6.35 | ± 9.6 % |
| 10144 | CAE | LTE-FDD (SC-FDMA, 100% RB, 3 MHz, 64-QAM) | LTE-FDD | 6.65 | ± 9.6 % |
| 10145 | CAF | LTE-FDD (SC-FDMA, 100% RB, 1.4 MHz, QPSK) | LTE-FDD | 5.76 | ± 9.6 % |
| 10146 | CAF | LTE-FDD (SC-FDMA, 100% RB, 1.4 MHz, 16-QAM) | LTE-FDD | 6.41 | ± 9.6 % |
| 10147 | CAF | LTE-FDD (SC-FDMA, 100% RB, 1.4 MHz, 64-QAM) | LTE-FDD | 6.72 | ± 9.6 % |
| 10149 | CAE | LTE-FDD (SC-FDMA, 50% RB, 20 MHz, 16-QAM) | LTE-FDD | 6.42 | ± 9.6 % |
| 10150 | CAE | LTE-FDD (SC-FDMA, 50% RB, 20 MHz, 64-QAM) | LTE-FDD | 6.60 | ± 9.6 % |
| 10151 | CAG | LTE-TDD (SC-FDMA, 50% RB, 20 MHz, QPSK) | LTE-TDD | 9.28 | ± 9.6 % |
| 10152 | CAG | LTE-TDD (SC-FDMA, 50% RB, 20 MHz, 16-QAM) | LTE-TDD | 9.92 | ± 9.6 % |
| 10153 | CAG | LTE-TDD (SC-FDMA, 50% RB, 20 MHz, 64-QAM) | LTE-TDD | 10.05 | ± 9.6 % |
| 10154 | CAG | LTE-FDD (SC-FDMA, 50% RB, 10 MHz, QPSK) | LTE-FDD | 5.75 | ± 9.6 % |
| 10155 | CAG | LTE-FDD (SC-FDMA, 50% RB, 10 MHz, 16-QAM) | LTE-FDD | 6.43 | ± 9.6 % |
| 10156 | CAG | LTE-FDD (SC-FDMA, 50% RB, 5 MHz, QPSK) | LTE-FDD | 5.79 | ± 9.6 % |
| 10157 | CAG | LTE-FDD (SC-FDMA, 50% RB, 5 MHz, 16-QAM) | LTE-FDD | 6.49 | ± 9.6 % |
| 10158 | CAG | LTE-FDD (SC-FDMA, 50% RB, 10 MHz, 64-QAM) | LTE-FDD | 6.62 | ± 9.6 % |
| 10159 | CAG | LTE-FDD (SC-FDMA, 50% RB, 5 MHz, 64-QAM) | LTE-FDD | 6.56 | ± 9.6 % |
| 10160 | CAE | LTE-FDD (SC-FDMA, 50% RB, 15 MHz, QPSK) | LTE-FDD | 5.82 | ± 9.6 % |
| 10161 | CAE | LTE-FDD (SC-FDMA, 50% RB, 15 MHz, 16-QAM) | LTE-FDD | 6.43 | ± 9.6 % |
| 10162 | CAE | LTE-FDD (SC-FDMA, 50% RB, 15 MHz, 64-QAM) | LTE-FDD | 6.58 | ± 9.6 % |
| 10166 | CAF | LTE-FDD (SC-FDMA, 50% RB, 1.4 MHz, QPSK) | LTE-FDD | 5.46 | ± 9.6 % |
| 10167 | CAF | LTE-FDD (SC-FDMA, 50% RB, 1.4 MHz, 16-QAM) | LTE-FDD | 6.21 | ± 9.6 % |
| 10168 | CAF | LTE-FDD (SC-FDMA, 50% RB, 1.4 MHz, 64-QAM) | LTE-FDD | 6.79 | ± 9.6 % |
| 10169 | CAE | LTE-FDD (SC-FDMA, 1 RB, 20 MHz, QPSK) | LTE-FDD | 5.73 | ± 9.6 % |
| 10170 | CAE | LTE-FDD (SC-FDMA, 1 RB, 20 MHz, 16-QAM) | LTE-FDD | 6.52 | ± 9.6 % |
| 10171 | AAE | LTE-FDD (SC-FDMA, 1 RB, 20 MHz, 64-QAM) | LTE-FDD | 6.49 | ± 9.6 % |
| 10172 | CAG | LTE-TDD (SC-FDMA, 1 RB, 20 MHz, QPSK) | LTE-TDD | 9.21 | ± 9.6 % |
| 10173 | CAG | LTE-TDD (SC-FDMA, 1 RB, 20 MHz, 16-QAM) | LTE-TDD | 9.48 | ± 9.6 % |
| 10174 | CAG | LTE-TDD (SC-FDMA, 1 RB, 20 MHz, 64-QAM) | LTE-TDD | 10.25 | ± 9.6 % |
| 10175 | CAG | LTE-FDD (SC-FDMA, 1 RB, 10 MHz, QPSK) | LTE-FDD | 5.72 | ± 9.6 % |
| 10176 | CAG | LTE-FDD (SC-FDMA, 1 RB, 10 MHz, 16-QAM) | LTE-FDD | 6.52 | ± 9.6 % |
| 10177 | CAI | LTE-FDD (SC-FDMA, 1 RB, 5 MHz, QPSK) | LTE-FDD | 5.73 | ± 9.6 % |
| 10178 | CAG | LTE-FDD (SC-FDMA, 1 RB, 5 MHz, 16-QAM) | LTE-FDD | 6.52 | ± 9.6 % |
| 10179 | CAG | LTE-FDD (SC-FDMA, 1 RB, 10 MHz, 64-QAM) | LTE-FDD | 6.50 | ± 9.6 % |
| 10180 | CAG | LTE-FDD (SC-FDMA, 1 RB, 5 MHz, 64-QAM) | LTE-FDD | 6.50 | ± 9.6 % |
| 10181 | CAE | LTE-FDD (SC-FDMA, 1 RB, 15 MHz, QPSK) | LTE-FDD | 5.72 | ± 9.6 % |
| 10182 | CAE | LTE-FDD (SC-FDMA, 1 RB, 15 MHz, 16-QAM) | LTE-FDD | 6.52 | ± 9.6 % |
| 10183 | AAD | LTE-FDD (SC-FDMA, 1 RB, 15 MHz, 64-QAM) | LTE-FDD | 6.50 | ± 9.6 % |
| 10184 | CAE | LTE-FDD (SC-FDMA, 1 RB, 3 MHz, QPSK) | LTE-FDD | 5.73 | ± 9.6 % |
| 10185 | CAE | LTE-FDD (SC-FDMA, 1 RB, 3 MHz, 16-QAM) | LTE-FDD | 6.51 | ± 9.6 % |
| 10186 | AAE | LTE-FDD (SC-FDMA, 1 RB, 3 MHz, 64-QAM) | LTE-FDD | 6.50 | ± 9.6 % |
| 10187 | CAF | LTE-FDD (SC-FDMA, 1 RB, 1.4 MHz, QPSK) | LTE-FDD | 5.73 | ± 9.6 % |
| 10188 | CAF | LTE-FDD (SC-FDMA, 1 RB, 1.4 MHz, 16-QAM) | LTE-FDD | 6.52 | ± 9.6 % |
| 10189 | AAF | LTE-FDD (SC-FDMA, 1 RB, 1.4 MHz, 64-QAM) | LTE-FDD | 6.50 | ± 9.6 % |
| 10193 | CAC | IEEE 802.11n (HT Greenfield, 6.5 Mbps, BPSK) | WLAN | 8.09 | ± 9.6 % |
| 10194 | CAC | IEEE 802.11n (HT Greenfield, 39 Mbps, 16-QAM) | WLAN | 8.12 | ± 9.6 % |
| 10195 | CAC | IEEE 802.11n (HT Greenfield, 65 Mbps, 64-QAM) | WLAN | 8.21 | ± 9.6 % |
| 10196 | CAC | IEEE 802.11n (HT Mixed, 6.5 Mbps, BPSK) | WLAN | 8.10 | ± 9.6 % |
| 10197 | CAC | IEEE 802.11n (HT Mixed, 39 Mbps, 16-QAM) | WLAN | 8.13 | ± 9.6 % |
| 10198 | CAC | IEEE 802.11n (HT Mixed, 65 Mbps, 64-QAM) | WLAN | 8.27 | ± 9.6 % |
| 10219 | CAC | IEEE 802.11n (HT Mixed, 7.2 Mbps, BPSK) | WLAN | 8.03 | ± 9.6 % |

| | | | | | |
|-------|-----|---|----------|-------|---------|
| 10220 | CAC | IEEE 802.11n (HT Mixed, 43.3 Mbps, 16-QAM) | WLAN | 8.13 | ± 9.6 % |
| 10221 | CAC | IEEE 802.11n (HT Mixed, 72.2 Mbps, 64-QAM) | WLAN | 8.27 | ± 9.6 % |
| 10222 | CAC | IEEE 802.11n (HT Mixed, 15 Mbps, BPSK) | WLAN | 8.06 | ± 9.6 % |
| 10223 | CAC | IEEE 802.11n (HT Mixed, 90 Mbps, 16-QAM) | WLAN | 8.48 | ± 9.6 % |
| 10224 | CAC | IEEE 802.11n (HT Mixed, 150 Mbps, 64-QAM) | WLAN | 8.08 | ± 9.6 % |
| 10225 | CAB | UMTS-FDD (HSPA+) | WCDMA | 5.97 | ± 9.6 % |
| 10226 | CAA | LTE-TDD (SC-FDMA, 1 RB, 1.4 MHz, 16-QAM) | LTE-TDD | 9.49 | ± 9.6 % |
| 10227 | CAA | LTE-TDD (SC-FDMA, 1 RB, 1.4 MHz, 64-QAM) | LTE-TDD | 10.26 | ± 9.6 % |
| 10228 | CAA | LTE-TDD (SC-FDMA, 1 RB, 1.4 MHz, QPSK) | LTE-TDD | 9.22 | ± 9.6 % |
| 10229 | CAC | LTE-TDD (SC-FDMA, 1 RB, 3 MHz, 16-QAM) | LTE-TDD | 9.48 | ± 9.6 % |
| 10230 | CAC | LTE-TDD (SC-FDMA, 1 RB, 3 MHz, 64-QAM) | LTE-TDD | 10.25 | ± 9.6 % |
| 10231 | CAC | LTE-TDD (SC-FDMA, 1 RB, 3 MHz, QPSK) | LTE-TDD | 9.19 | ± 9.6 % |
| 10232 | CAF | LTE-TDD (SC-FDMA, 1 RB, 5 MHz, 16-QAM) | LTE-TDD | 9.48 | ± 9.6 % |
| 10233 | CAF | LTE-TDD (SC-FDMA, 1 RB, 5 MHz, 64-QAM) | LTE-TDD | 10.25 | ± 9.6 % |
| 10234 | CAF | LTE-TDD (SC-FDMA, 1 RB, 5 MHz, QPSK) | LTE-TDD | 9.21 | ± 9.6 % |
| 10235 | CAF | LTE-TDD (SC-FDMA, 1 RB, 10 MHz, 16-QAM) | LTE-TDD | 9.48 | ± 9.6 % |
| 10236 | CAF | LTE-TDD (SC-FDMA, 1 RB, 10 MHz, 64-QAM) | LTE-TDD | 10.25 | ± 9.6 % |
| 10237 | CAF | LTE-TDD (SC-FDMA, 1 RB, 10 MHz, QPSK) | LTE-TDD | 9.21 | ± 9.6 % |
| 10238 | CAF | LTE-TDD (SC-FDMA, 1 RB, 15 MHz, 16-QAM) | LTE-TDD | 9.48 | ± 9.6 % |
| 10239 | CAF | LTE-TDD (SC-FDMA, 1 RB, 15 MHz, 64-QAM) | LTE-TDD | 10.25 | ± 9.6 % |
| 10240 | CAF | LTE-TDD (SC-FDMA, 1 RB, 15 MHz, QPSK) | LTE-TDD | 9.21 | ± 9.6 % |
| 10241 | CAA | LTE-TDD (SC-FDMA, 50% RB, 1.4 MHz, 16-QAM) | LTE-TDD | 9.82 | ± 9.6 % |
| 10242 | CAA | LTE-TDD (SC-FDMA, 50% RB, 1.4 MHz, 64-QAM) | LTE-TDD | 9.86 | ± 9.6 % |
| 10243 | CAA | LTE-TDD (SC-FDMA, 50% RB, 1.4 MHz, QPSK) | LTE-TDD | 9.46 | ± 9.6 % |
| 10244 | CAC | LTE-TDD (SC-FDMA, 50% RB, 3 MHz, 16-QAM) | LTE-TDD | 10.06 | ± 9.6 % |
| 10245 | CAC | LTE-TDD (SC-FDMA, 50% RB, 3 MHz, 64-QAM) | LTE-TDD | 10.06 | ± 9.6 % |
| 10246 | CAC | LTE-TDD (SC-FDMA, 50% RB, 3 MHz, QPSK) | LTE-TDD | 9.30 | ± 9.6 % |
| 10247 | CAF | LTE-TDD (SC-FDMA, 50% RB, 5 MHz, 16-QAM) | LTE-TDD | 9.91 | ± 9.6 % |
| 10248 | CAF | LTE-TDD (SC-FDMA, 50% RB, 5 MHz, 64-QAM) | LTE-TDD | 10.09 | ± 9.6 % |
| 10249 | CAF | LTE-TDD (SC-FDMA, 50% RB, 5 MHz, QPSK) | LTE-TDD | 9.29 | ± 9.6 % |
| 10250 | CAF | LTE-TDD (SC-FDMA, 50% RB, 10 MHz, 16-QAM) | LTE-TDD | 9.81 | ± 9.6 % |
| 10251 | CAF | LTE-TDD (SC-FDMA, 50% RB, 10 MHz, 64-QAM) | LTE-TDD | 10.17 | ± 9.6 % |
| 10252 | CAF | LTE-TDD (SC-FDMA, 50% RB, 10 MHz, QPSK) | LTE-TDD | 9.24 | ± 9.6 % |
| 10253 | CAF | LTE-TDD (SC-FDMA, 50% RB, 15 MHz, 16-QAM) | LTE-TDD | 9.90 | ± 9.6 % |
| 10254 | CAF | LTE-TDD (SC-FDMA, 50% RB, 15 MHz, 64-QAM) | LTE-TDD | 10.14 | ± 9.6 % |
| 10255 | CAF | LTE-TDD (SC-FDMA, 50% RB, 15 MHz, QPSK) | LTE-TDD | 9.20 | ± 9.6 % |
| 10256 | CAA | LTE-TDD (SC-FDMA, 100% RB, 1.4 MHz, 16-QAM) | LTE-TDD | 9.96 | ± 9.6 % |
| 10257 | CAA | LTE-TDD (SC-FDMA, 100% RB, 1.4 MHz, 64-QAM) | LTE-TDD | 10.08 | ± 9.6 % |
| 10258 | CAA | LTE-TDD (SC-FDMA, 100% RB, 1.4 MHz, QPSK) | LTE-TDD | 9.34 | ± 9.6 % |
| 10259 | CAC | LTE-TDD (SC-FDMA, 100% RB, 3 MHz, 16-QAM) | LTE-TDD | 9.98 | ± 9.6 % |
| 10260 | CAC | LTE-TDD (SC-FDMA, 100% RB, 3 MHz, 64-QAM) | LTE-TDD | 9.97 | ± 9.6 % |
| 10261 | CAC | LTE-TDD (SC-FDMA, 100% RB, 3 MHz, QPSK) | LTE-TDD | 9.24 | ± 9.6 % |
| 10262 | CAF | LTE-TDD (SC-FDMA, 100% RB, 5 MHz, 16-QAM) | LTE-TDD | 9.83 | ± 9.6 % |
| 10263 | CAF | LTE-TDD (SC-FDMA, 100% RB, 5 MHz, 64-QAM) | LTE-TDD | 10.16 | ± 9.6 % |
| 10264 | CAF | LTE-TDD (SC-FDMA, 100% RB, 5 MHz, QPSK) | LTE-TDD | 9.23 | ± 9.6 % |
| 10265 | CAF | LTE-TDD (SC-FDMA, 100% RB, 10 MHz, 16-QAM) | LTE-TDD | 9.92 | ± 9.6 % |
| 10266 | CAF | LTE-TDD (SC-FDMA, 100% RB, 10 MHz, 64-QAM) | LTE-TDD | 10.07 | ± 9.6 % |
| 10267 | CAF | LTE-TDD (SC-FDMA, 100% RB, 10 MHz, QPSK) | LTE-TDD | 9.30 | ± 9.6 % |
| 10268 | CAF | LTE-TDD (SC-FDMA, 100% RB, 15 MHz, 16-QAM) | LTE-TDD | 10.06 | ± 9.6 % |
| 10269 | CAF | LTE-TDD (SC-FDMA, 100% RB, 15 MHz, 64-QAM) | LTE-TDD | 10.13 | ± 9.6 % |
| 10270 | CAF | LTE-TDD (SC-FDMA, 100% RB, 15 MHz, QPSK) | LTE-TDD | 9.58 | ± 9.6 % |
| 10274 | CAB | UMTS-FDD (HSUPA, Subtest 5, 3GPP Rel8.10) | WCDMA | 4.87 | ± 9.6 % |
| 10275 | CAB | UMTS-FDD (HSUPA, Subtest 5, 3GPP Rel8.4) | WCDMA | 3.96 | ± 9.6 % |
| 10277 | CAA | PHS (QPSK) | PHS | 11.81 | ± 9.6 % |
| 10278 | CAA | PHS (QPSK, BW 884MHz, Rolloff 0.5) | PHS | 11.81 | ± 9.6 % |
| 10279 | CAA | PHS (QPSK, BW 884MHz, Rolloff 0.38) | PHS | 12.18 | ± 9.6 % |
| 10290 | AAB | CDMA2000, RC1, SO55, Full Rate | CDMA2000 | 3.91 | ± 9.6 % |
| 10291 | AAB | CDMA2000, RC3, SO55, Full Rate | CDMA2000 | 3.46 | ± 9.6 % |
| 10292 | AAB | CDMA2000, RC3, SO32, Full Rate | CDMA2000 | 3.39 | ± 9.6 % |
| 10293 | AAB | CDMA2000, RC3, SO3, Full Rate | CDMA2000 | 3.50 | ± 9.6 % |
| 10295 | AAB | CDMA2000, RC1, SO3, 1/8th Rate 25 fr. | CDMA2000 | 12.49 | ± 9.6 % |
| 10297 | AAD | LTE-FDD (SC-FDMA, 50% RB, 20 MHz, QPSK) | LTE-FDD | 5.81 | ± 9.6 % |
| 10298 | AAD | LTE-FDD (SC-FDMA, 50% RB, 3 MHz, QPSK) | LTE-FDD | 5.72 | ± 9.6 % |
| 10299 | AAD | LTE-FDD (SC-FDMA, 50% RB, 3 MHz, 16-QAM) | LTE-FDD | 6.39 | ± 9.6 % |

| | | | | | |
|-------|-----|---|----------|-------|---------|
| 10300 | AAD | LTE-FDD (SC-FDMA, 50% RB, 3 MHz, 64-QAM) | LTE-FDD | 6.60 | ± 9.6 % |
| 10301 | AAA | IEEE 802.16e WiMAX (29:18, 5ms, 10MHz, QPSK, PUSC) | WiMAX | 12.03 | ± 9.6 % |
| 10302 | AAA | IEEE 802.16e WiMAX (29:18, 5ms, 10MHz, QPSK, PUSC, 3 CTRL symbols) | WiMAX | 12.57 | ± 9.6 % |
| 10303 | AAA | IEEE 802.16e WiMAX (31:15, 5ms, 10MHz, 64QAM, PUSC) | WiMAX | 12.52 | ± 9.6 % |
| 10304 | AAA | IEEE 802.16e WiMAX (29:18, 5ms, 10MHz, 64QAM, PUSC) | WiMAX | 11.86 | ± 9.6 % |
| 10305 | AAA | IEEE 802.16e WiMAX (31:15, 10ms, 10MHz, 64QAM, PUSC, 15 symbols) | WiMAX | 15.24 | ± 9.6 % |
| 10306 | AAA | IEEE 802.16e WiMAX (29:18, 10ms, 10MHz, 64QAM, PUSC, 18 symbols) | WiMAX | 14.67 | ± 9.6 % |
| 10307 | AAA | IEEE 802.16e WiMAX (29:18, 10ms, 10MHz, QPSK, PUSC, 18 symbols) | WiMAX | 14.49 | ± 9.6 % |
| 10308 | AAA | IEEE 802.16e WiMAX (29:18, 10ms, 10MHz, 16QAM, PUSC) | WiMAX | 14.46 | ± 9.6 % |
| 10309 | AAA | IEEE 802.16e WiMAX (29:18, 10ms, 10MHz, 16QAM, AMC 2x3, 18 symbols) | WiMAX | 14.58 | ± 9.6 % |
| 10310 | AAA | IEEE 802.16e WiMAX (29:18, 10ms, 10MHz, QPSK, AMC 2x3, 18 symbols) | WiMAX | 14.57 | ± 9.6 % |
| 10311 | AAD | LTE-FDD (SC-FDMA, 100% RB, 15 MHz, QPSK) | LTE-FDD | 6.06 | ± 9.6 % |
| 10313 | AAA | iDEN 1:3 | iDEN | 10.51 | ± 9.6 % |
| 10314 | AAA | iDEN 1:6 | iDEN | 13.48 | ± 9.6 % |
| 10315 | AAB | IEEE 802.11b WiFi 2.4 GHz (DSSS, 1 Mbps, 96pc duty cycle) | WLAN | 1.71 | ± 9.6 % |
| 10316 | AAB | IEEE 802.11g WiFi 2.4 GHz (ERP-OFDM, 6 Mbps, 96pc duty cycle) | WLAN | 8.36 | ± 9.6 % |
| 10317 | AAC | IEEE 802.11a WiFi 5 GHz (OFDM, 6 Mbps, 96pc duty cycle) | WLAN | 8.36 | ± 9.6 % |
| 10352 | AAA | Pulse Waveform (200Hz, 10%) | Generic | 10.00 | ± 9.6 % |
| 10353 | AAA | Pulse Waveform (200Hz, 20%) | Generic | 6.99 | ± 9.6 % |
| 10354 | AAA | Pulse Waveform (200Hz, 40%) | Generic | 3.98 | ± 9.6 % |
| 10355 | AAA | Pulse Waveform (200Hz, 60%) | Generic | 2.22 | ± 9.6 % |
| 10356 | AAA | Pulse Waveform (200Hz, 80%) | Generic | 0.97 | ± 9.6 % |
| 10387 | AAA | QPSK Waveform, 1 MHz | Generic | 5.10 | ± 9.6 % |
| 10388 | AAA | QPSK Waveform, 10 MHz | Generic | 5.22 | ± 9.6 % |
| 10396 | AAA | 64-QAM Waveform, 100 kHz | Generic | 6.27 | ± 9.6 % |
| 10399 | AAA | 64-QAM Waveform, 40 MHz | Generic | 6.27 | ± 9.6 % |
| 10400 | AAD | IEEE 802.11ac WiFi (20MHz, 64-QAM, 99pc duty cycle) | WLAN | 8.37 | ± 9.6 % |
| 10401 | AAD | IEEE 802.11ac WiFi (40MHz, 64-QAM, 99pc duty cycle) | WLAN | 8.60 | ± 9.6 % |
| 10402 | AAD | IEEE 802.11ac WiFi (80MHz, 64-QAM, 99pc duty cycle) | WLAN | 8.53 | ± 9.6 % |
| 10403 | AAB | CDMA2000 (1xEV-DO, Rev. 0) | CDMA2000 | 3.76 | ± 9.6 % |
| 10404 | AAB | CDMA2000 (1xEV-DO, Rev. A) | CDMA2000 | 3.77 | ± 9.6 % |
| 10406 | AAB | CDMA2000, RC3, SO32, SCH0, Full Rate | CDMA2000 | 5.22 | ± 9.6 % |
| 10410 | AAF | LTE-TDD (SC-FDMA, 1 RB, 10 MHz, QPSK, UL Subframe=2,3,4,7,8,9, Subframe Conf=4) | LTE-TDD | 7.82 | ± 9.6 % |
| 10414 | AAA | WLAN CCDF, 64-QAM, 40MHz | Generic | 8.54 | ± 9.6 % |
| 10415 | AAA | IEEE 802.11b WiFi 2.4 GHz (DSSS, 1 Mbps, 99pc duty cycle) | WLAN | 1.54 | ± 9.6 % |
| 10416 | AAA | IEEE 802.11g WiFi 2.4 GHz (ERP-OFDM, 6 Mbps, 99pc duty cycle) | WLAN | 8.23 | ± 9.6 % |
| 10417 | AAB | IEEE 802.11a/h WiFi 5 GHz (OFDM, 6 Mbps, 99pc duty cycle) | WLAN | 8.23 | ± 9.6 % |
| 10418 | AAA | IEEE 802.11g WiFi 2.4 GHz (DSSS-OFDM, 6 Mbps, 99pc duty cycle, Long preamble) | WLAN | 8.14 | ± 9.6 % |
| 10419 | AAA | IEEE 802.11g WiFi 2.4 GHz (DSSS-OFDM, 6 Mbps, 99pc duty cycle, Short preamble) | WLAN | 8.19 | ± 9.6 % |
| 10422 | AAB | IEEE 802.11n (HT Greenfield, 7.2 Mbps, BPSK) | WLAN | 8.32 | ± 9.6 % |
| 10423 | AAB | IEEE 802.11n (HT Greenfield, 43.3 Mbps, 16-QAM) | WLAN | 8.47 | ± 9.6 % |
| 10424 | AAB | IEEE 802.11n (HT Greenfield, 72.2 Mbps, 64-QAM) | WLAN | 8.40 | ± 9.6 % |
| 10425 | AAB | IEEE 802.11n (HT Greenfield, 15 Mbps, BPSK) | WLAN | 8.41 | ± 9.6 % |
| 10426 | AAB | IEEE 802.11n (HT Greenfield, 90 Mbps, 16-QAM) | WLAN | 8.45 | ± 9.6 % |
| 10427 | AAB | IEEE 802.11n (HT Greenfield, 150 Mbps, 64-QAM) | WLAN | 8.41 | ± 9.6 % |
| 10430 | AAD | LTE-FDD (OFDMA, 5 MHz, E-TM 3.1) | LTE-FDD | 8.28 | ± 9.6 % |
| 10431 | AAD | LTE-FDD (OFDMA, 10 MHz, E-TM 3.1) | LTE-FDD | 8.38 | ± 9.6 % |
| 10432 | AAC | LTE-FDD (OFDMA, 15 MHz, E-TM 3.1) | LTE-FDD | 8.34 | ± 9.6 % |
| 10433 | AAC | LTE-FDD (OFDMA, 20 MHz, E-TM 3.1) | LTE-FDD | 8.34 | ± 9.6 % |
| 10434 | AAA | W-CDMA (BS Test Model 1, 64 DPCH) | WCDMA | 8.60 | ± 9.6 % |
| 10435 | AAF | LTE-TDD (SC-FDMA, 1 RB, 20 MHz, QPSK, UL Subframe=2,3,4,7,8,9) | LTE-TDD | 7.82 | ± 9.6 % |
| 10447 | AAD | LTE-FDD (OFDMA, 5 MHz, E-TM 3.1, Clipping 44%) | LTE-FDD | 7.56 | ± 9.6 % |
| 10448 | AAD | LTE-FDD (OFDMA, 10 MHz, E-TM 3.1, Clipping 44%) | LTE-FDD | 7.53 | ± 9.6 % |
| 10449 | AAC | LTE-FDD (OFDMA, 15 MHz, E-TM 3.1, Clipping 44%) | LTE-FDD | 7.51 | ± 9.6 % |
| 10450 | AAC | LTE-FDD (OFDMA, 20 MHz, E-TM 3.1, Clipping 44%) | LTE-FDD | 7.48 | ± 9.6 % |

| | | | | | |
|-------|-----|--|----------|------|---------|
| 10451 | AAA | W-CDMA (BS Test Model 1, 64 DPCH, Clipping 44%) | WCDMA | 7.59 | ± 9.6 % |
| 10456 | AAB | IEEE 802.11ac WiFi (160MHz, 64-QAM, 99pc duty cycle) | WLAN | 8.63 | ± 9.6 % |
| 10457 | AAA | UMTS-FDD (DC-HSDPA) | WCDMA | 6.62 | ± 9.6 % |
| 10458 | AAA | CDMA2000 (1xEV-DO, Rev. B, 2 carriers) | CDMA2000 | 6.55 | ± 9.6 % |
| 10459 | AAA | CDMA2000 (1xEV-DO, Rev. B, 3 carriers) | CDMA2000 | 8.25 | ± 9.6 % |
| 10460 | AAA | UMTS-FDD (WCDMA, AMR) | WCDMA | 2.39 | ± 9.6 % |
| 10461 | AAA | LTE-TDD (SC-FDMA, 1 RB, 1.4 MHz, QPSK, UL Subframe=2,3,4,7,8,9) | LTE-TDD | 7.82 | ± 9.6 % |
| 10462 | AAA | LTE-TDD (SC-FDMA, 1 RB, 1.4 MHz, 16-QAM, UL Subframe=2,3,4,7,8,9) | LTE-TDD | 8.30 | ± 9.6 % |
| 10463 | AAA | LTE-TDD (SC-FDMA, 1 RB, 1.4 MHz, 64-QAM, UL Subframe=2,3,4,7,8,9) | LTE-TDD | 8.56 | ± 9.6 % |
| 10464 | AAB | LTE-TDD (SC-FDMA, 1 RB, 3 MHz, QPSK, UL Subframe=2,3,4,7,8,9) | LTE-TDD | 7.82 | ± 9.6 % |
| 10465 | AAB | LTE-TDD (SC-FDMA, 1 RB, 3 MHz, 16-QAM, UL Subframe=2,3,4,7,8,9) | LTE-TDD | 8.32 | ± 9.6 % |
| 10466 | AAB | LTE-TDD (SC-FDMA, 1 RB, 3 MHz, 64-QAM, UL Subframe=2,3,4,7,8,9) | LTE-TDD | 8.57 | ± 9.6 % |
| 10467 | AAE | LTE-TDD (SC-FDMA, 1 RB, 5 MHz, QPSK, UL Subframe=2,3,4,7,8,9) | LTE-TDD | 7.82 | ± 9.6 % |
| 10468 | AAE | LTE-TDD (SC-FDMA, 1 RB, 5 MHz, 16-QAM, UL Subframe=2,3,4,7,8,9) | LTE-TDD | 8.32 | ± 9.6 % |
| 10469 | AAE | LTE-TDD (SC-FDMA, 1 RB, 5 MHz, 64-QAM, UL Subframe=2,3,4,7,8,9) | LTE-TDD | 8.56 | ± 9.6 % |
| 10470 | AAE | LTE-TDD (SC-FDMA, 1 RB, 10 MHz, QPSK, UL Subframe=2,3,4,7,8,9) | LTE-TDD | 7.82 | ± 9.6 % |
| 10471 | AAE | LTE-TDD (SC-FDMA, 1 RB, 10 MHz, 16-QAM, UL Subframe=2,3,4,7,8,9) | LTE-TDD | 8.32 | ± 9.6 % |
| 10472 | AAE | LTE-TDD (SC-FDMA, 1 RB, 10 MHz, 64-QAM, UL Subframe=2,3,4,7,8,9) | LTE-TDD | 8.57 | ± 9.6 % |
| 10473 | AAE | LTE-TDD (SC-FDMA, 1 RB, 15 MHz, QPSK, UL Subframe=2,3,4,7,8,9) | LTE-TDD | 7.82 | ± 9.6 % |
| 10474 | AAE | LTE-TDD (SC-FDMA, 1 RB, 15 MHz, 16-QAM, UL Subframe=2,3,4,7,8,9) | LTE-TDD | 8.32 | ± 9.6 % |
| 10475 | AAE | LTE-TDD (SC-FDMA, 1 RB, 15 MHz, 64-QAM, UL Subframe=2,3,4,7,8,9) | LTE-TDD | 8.57 | ± 9.6 % |
| 10477 | AAF | LTE-TDD (SC-FDMA, 1 RB, 20 MHz, 16-QAM, UL Subframe=2,3,4,7,8,9) | LTE-TDD | 8.32 | ± 9.6 % |
| 10478 | AAF | LTE-TDD (SC-FDMA, 1 RB, 20 MHz, 64-QAM, UL Subframe=2,3,4,7,8,9) | LTE-TDD | 8.57 | ± 9.6 % |
| 10479 | AAA | LTE-TDD (SC-FDMA, 50% RB, 1.4 MHz, QPSK, UL Subframe=2,3,4,7,8,9) | LTE-TDD | 7.74 | ± 9.6 % |
| 10480 | AAA | LTE-TDD (SC-FDMA, 50% RB, 1.4 MHz, 16-QAM, UL Subframe=2,3,4,7,8,9) | LTE-TDD | 8.18 | ± 9.6 % |
| 10481 | AAA | LTE-TDD (SC-FDMA, 50% RB, 1.4 MHz, 64-QAM, UL Subframe=2,3,4,7,8,9) | LTE-TDD | 8.45 | ± 9.6 % |
| 10482 | AAB | LTE-TDD (SC-FDMA, 50% RB, 3 MHz, QPSK, UL Subframe=2,3,4,7,8,9) | LTE-TDD | 7.71 | ± 9.6 % |
| 10483 | AAB | LTE-TDD (SC-FDMA, 50% RB, 3 MHz, 16-QAM, UL Subframe=2,3,4,7,8,9) | LTE-TDD | 8.39 | ± 9.6 % |
| 10484 | AAB | LTE-TDD (SC-FDMA, 50% RB, 3 MHz, 64-QAM, UL Subframe=2,3,4,7,8,9) | LTE-TDD | 8.47 | ± 9.6 % |
| 10485 | AAE | LTE-TDD (SC-FDMA, 50% RB, 5 MHz, QPSK, UL Subframe=2,3,4,7,8,9) | LTE-TDD | 7.59 | ± 9.6 % |
| 10486 | AAE | LTE-TDD (SC-FDMA, 50% RB, 5 MHz, 16-QAM, UL Subframe=2,3,4,7,8,9) | LTE-TDD | 8.38 | ± 9.6 % |
| 10487 | AAE | LTE-TDD (SC-FDMA, 50% RB, 5 MHz, 64-QAM, UL Subframe=2,3,4,7,8,9) | LTE-TDD | 8.60 | ± 9.6 % |
| 10488 | AAE | LTE-TDD (SC-FDMA, 50% RB, 10 MHz, QPSK, UL Subframe=2,3,4,7,8,9) | LTE-TDD | 7.70 | ± 9.6 % |
| 10489 | AAE | LTE-TDD (SC-FDMA, 50% RB, 10 MHz, 16-QAM, UL Subframe=2,3,4,7,8,9) | LTE-TDD | 8.31 | ± 9.6 % |
| 10490 | AAE | LTE-TDD (SC-FDMA, 50% RB, 10 MHz, 64-QAM, UL Subframe=2,3,4,7,8,9) | LTE-TDD | 8.54 | ± 9.6 % |
| 10491 | AAE | LTE-TDD (SC-FDMA, 50% RB, 15 MHz, QPSK, UL Subframe=2,3,4,7,8,9) | LTE-TDD | 7.74 | ± 9.6 % |