

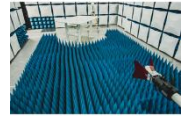

PCTEST ENGINEERING LABORATORY, INC.

7185 Oakland Mills Road, Columbia, MD 21046 USA
Tel. 410.290.6652 / Fax 410.290.6654
<http://www.pctest.com>



MEASUREMENT REPORT FCC PART 15.407 / ISED RSS-247 DFS

Applicant Name:
LG Electronics USA, Inc.
1000 Sylvan Avenue
Englewood Cliffs, NJ 07632
United States

Date of Testing:
7/8 - 8/2/2019
Test Site/Location:
PCTEST Lab. Columbia, MD, USA
Test Report Serial No.:
1M1907080114-08-R1.ZNF

FCC ID:	ZNFQ720AM
APPLICANT:	LG Electronics USA, Inc.

Application Type: Certification
Model: LM-Q720AM
Additional Model(s): LMQ720AM, Q720AM
EUT Type: Client Only Device, No Radar Detection Capability
Max. RF Output Power: 80.353 mW (19.05 dBm) Conducted Power (802.11a UNII Band 2C)
Frequency Range: 5500 – 5700 MHz (UNII-2C Band)
FCC Classification: Unlicensed National Information Infrastructure (UNII)
FCC Rule Part(s): Part 15.407(UNII)
Test Procedure(s): KDB 905462 D02 v02

This equipment has been shown to be capable of compliance with the applicable technical standards as indicated in the measurement report and was tested in accordance with the measurement procedures specified in KDB 905462 D02 v02 Compliance Measurement Procedures for Unlicensed-National Information Infrastructure Devices Operating in the 5.25 – 5.35 GHz and 5.47 – 5.725 GHz Bands Incorporating Dynamic Frequency Selection. Test results reported herein relate only to the item(s) tested.

Note: This revised Test Report (S/N: 1M1907080114-08-R1.ZNF) supersedes and replaces the previously issued test report on the same subject device for the same type of testing as indicated. Please discard or destroy the previously issued test report(s) and dispose of it accordingly.

Randy Ortanez
President



FCC ID: ZNFQ720AM		MEASUREMENT REPORT (CERTIFICATION)		Approved by: Quality Manager
Test Report S/N: 1M1907080114-08-R1.ZNF	Test Dates: 7/8 - 8/2/2019	EUT Type: Portable Handset		Page 1 of 17

TABLE OF CONTENTS

1.0	INTRODUCTION	3
1.1	Scope	3
1.2	PCTEST Test Location	3
1.3	Test Facility / Accreditations	3
2.0	PRODUCT INFORMATION	4
2.1	Equipment Description	4
2.2	EUT Capabilities	4
2.3	Modifications	5
3.0	TEST EQUIPMENT	6
3.1	Additional Equipment	6
4.0	DESCRIPTION OF DYNAMIC FREQUENCY SELECTION TEST	7
4.1	Applicability	7
4.2	Requirements	8
4.3	DFS Detection Threshold Values	9
4.1	DFS Response Requirements	9
4.2	Parameters of DFS Test Signals	10
4.3	Procedure	11
5.0	EUT TEST SETUP	12
6.0	TEST RESULTS	13
6.1	Summary	13
6.2	Channel Loading	14
6.3	Channel Move/ Closing Transmission Time	15
6.4	Non-Occupancy Period	16
7.0	CONCLUSION	17

FCC ID: ZNFQ720AM	 PCTEST <small>ENGINEERING LABORATORY, INC.</small>	MEASUREMENT REPORT (CERTIFICATION)	 LG	Approved by: Quality Manager
Test Report S/N: 1M1907080114-08-R1.ZNF	Test Dates: 7/8 - 8/2/2019	EUT Type: Portable Handset	Page 2 of 17	

1.0 INTRODUCTION

1.1 Scope

This report has been prepared to demonstrate compliance with the requirements for Dynamic Frequency Selection (DFS) as stated in KDB 905462 D02 v02. Testing was performed on the **LG Portable Handset FCC ID: ZNFQ720AM**. As of July 20, 2007 all devices operating in the 5250 – 5350 MHz and/or the 5470 – 5725 MHz bands must comply with the DFS requirements. As the EUT does not have radar detection capability it was evaluated as a Client Only Device. All test results reported herein are applicable to the sample selected for testing. The unit used for testing was supplied by LG Electronics USA, Inc..

1.2 PCTEST Test Location

These measurement tests were conducted at the PCTEST Engineering Laboratory, Inc. facility located at 7185 Oakland Mills Road, Columbia, MD 21046. The measurement facility is compliant with the test site requirements specified in ANSI C63.4-2014 and KDB 414788 D01 v01.

1.3 Test Facility / Accreditations

Measurements were performed at PCTEST Engineering Lab located in Columbia, MD 21046, U.S.A.

- PCTEST is an ISO 17025-2005 accredited test facility under the American Association for Laboratory Accreditation (A2LA) with Certificate number 2041.02 for Specific Absorption Rate (SAR), Hearing Aid Compatibility (HAC) testing, where applicable, and Electromagnetic Compatibility (EMC) testing for FCC and Innovation, Science, and Economic Development Canada rules.
- PCTEST TCB is a Telecommunication Certification Body (TCB) accredited to ISO/IEC 17065-2012 by A2LA (Certificate number 2041.03) in all scopes of FCC Rules and ISED Standards (RSS).
- PCTEST facility is a registered (2451B) test laboratory with the site description on file with ISED.

FCC ID: ZNFQ720AM		MEASUREMENT REPORT (CERTIFICATION)		Approved by: Quality Manager
Test Report S/N: 1M1907080114-08-R1.ZNF	Test Dates: 7/8 - 8/2/2019	EUT Type: Portable Handset	Page 3 of 17	

2.0 PRODUCT INFORMATION

2.1 Equipment Description

The Equipment Under Test (EUT) is the **LG Portable Handset FCC ID: ZNFQ720AM**.

Mode of Operation:

Master Device	<input type="checkbox"/>
Client Device (No radar detection)	<input checked="" type="checkbox"/>
Client Device with Radar Detection	<input type="checkbox"/>

Test Device Serial No.: 06779

2.2 EUT Capabilities

This device contains the following capabilities:

850/1900 GSM/GPRS/EDGE, 850/1700/1900 WCDMA/HSPA, Multi-band LTE, 802.11b/g/n WLAN, 802.11a/n/ac UNII, Bluetooth (1x, EDR, LE), NFC

Band 2A

Ch.	Frequency (MHz)
52	5260
:	:
56	5280
:	:
64	5320

Band 2C

Ch.	Frequency (MHz)
100	5500
:	:
120	5600
:	:
140	5700

Table 2-1. 802.11a / 802.11n / 802.11ac (20MHz) Frequency / Channel Operations

Band 2A

Ch.	Frequency (MHz)
54	5270
:	:
62	5310

Band 2C

Ch.	Frequency (MHz)
102	5510
:	:
118	5590
:	:
134	5670

Table 2-2. 802.11n / 802.11ac (40MHz BW) Frequency / Channel Operations

Band 2A

Ch.	Frequency (MHz)
58	5290

Band 2C

Ch.	Frequency (MHz)
106	5530
:	:
122	5610

Table 2-3. 802.11ac (80MHz BW) Frequency / Channel Operations

FCC ID: ZNFQ720AM		MEASUREMENT REPORT (CERTIFICATION)		Approved by: Quality Manager
Test Report S/N: 1M1907080114-08-R1.ZNF	Test Dates: 7/8 - 8/2/2019	EUT Type: Portable Handset		Page 4 of 17

2.3 Modifications

No modifications to the EUT were required in order to comply with the DFS specifications.

FCC ID: ZNFQ720AM	 MEASUREMENT REPORT (CERTIFICATION)		 Approved by: Quality Manager
Test Report S/N: 1M1907080114-08-R1.ZNF	Test Dates: 7/8 - 8/2/2019	EUT Type: Portable Handset	Page 5 of 17

3.0 TEST EQUIPMENT

Test Equipment Calibration is traceable to the National Institute of Standards and Technology (NIST). Measurements antennas used during testing were calibrated in accordance to the requirements of ANSI C63.5-2006.

Manufacturer	Model	Description	Cal Date	Cal Interval	Cal Due	Serial Number
Aeroflex	PXI 82531	PXI RF Synthesizer	2/18/2019	Biennial	2/18/2021	1082329
Agilent	N9038A	MXE EMI Receiver	7/17/2019	Annual	7/17/2020	MY51210133

Table 3-1. Annual Test Equipment Calibration Schedule

Note:

For equipment listed above that has a calibration date or calibration due date that falls within the test date range, care was taken to ensure that this equipment was used after the calibration date and before the calibration due date.

3.1 Additional Equipment

The following equipment was used in support of the DFS testing.

Device	Manufacturer	Model/Description	Description	S/N:
Master	Samsung	WEA453e	Access Point	2XLU060011P
		WEC8050	Controller	2XGV250016L

Table 3-2. Support Equipment

FCC ID: ZNFQ720AM		MEASUREMENT REPORT (CERTIFICATION)		Approved by: Quality Manager
Test Report S/N: 1M1907080114-08-R1.ZNF	Test Dates: 7/8 - 8/2/2019	EUT Type: Portable Handset	Page 6 of 17	

4.0 DESCRIPTION OF DYNAMIC FREQUENCY SELECTION TEST

4.1 Applicability

The following table from KDB 905462 D02 v02 lists the applicable requirements for the DFS testing. The device evaluated in this report is considered a client device without radar detection capability.

Requirement	Operational Mode		
	Master	Client Without Radar Detection	Client With Radar Detection
Non-Occupancy Period	Yes	Not required	Yes
DFS Detection Threshold	Yes	Not required	Yes
Channel Availability Check Time	Yes	Not required	Not required
U-NII Detection Bandwidth	Yes	Not required	Yes

Table 4-1. DFS Applicability

Requirement	Operational Mode		
	Master	Client Without Radar Detection	Client With Radar Detection
DFS Detection Threshold	Yes	Not required	Yes
Channel Closing Transmission Time	Yes	Yes	Yes
Channel Move Time	Yes	Yes	Yes
U-NII Detection Bandwidth	Yes	Not required	Yes

Table 4-2. DFS Applicability During Normal Operation

Additional requirements for devices with multiple bandwidth modes	Master Device or Client with Radar Detection	Client without Radar Detection
U-NII Detection Bandwidth and Statistical Performance Check	All BW modes must be tested	Not required
Channel Move Time and Channel Closing Transmission Time	Test using widest BW mode available	Test using the widest BW mode available for the link
All other tests	Any single BW mode	Not required
<p>Note: Frequencies selected for statistical performance check (Section 7.8.4) should include several frequencies within the radar detection bandwidth and frequencies near the edge of the radar detection bandwidth. For 802.11 devices it is suggested to select frequencies in each of the bonded 20 MHz channels and the channel center frequency.</p>		

Table 4-3. Additional Requirement for Devices with Multiple Bandwidth Modes

FCC ID: ZNFQ720AM		MEASUREMENT REPORT (CERTIFICATION)		Approved by: Quality Manager
Test Report S/N: 1M1907080114-08-R1.ZNF	Test Dates: 7/8 - 8/2/2019	EUT Type: Portable Handset	Page 7 of 17	

4.2 Requirements

Per KDB 905462 D02 v02 the following are the requirements for Client Devices:

- a) A Client Device will not transmit before having received appropriate control signals from a Master Device.
- b) A Client Device will stop all its transmissions whenever instructed by a Master Device to which it is associated and will meet the Channel Move Time and Channel Closing Transmission Time requirements. The Client Device will not resume any transmissions until it has again received control signals from a Master Device.
- c) If a Client Device is performing In-Service Monitoring and detects a Radar Waveform above the DFS Detection Threshold, it will inform the Master Device. This is equivalent to the Master Device detecting the Radar Waveform and d) through f) of section 5.1.1 apply.
- d) Irrespective of Client Device or Master Device detection the Channel Move Time and Channel Closing Transmission Time requirements remain the same.
- e) The client test frequency must be monitored to ensure no transmission of any type has occurred for 30 minutes.
Note: If the client moves with the master, the device is considered compliant if nothing appears in the client non-occupancy period test. For devices that shutdown (rather than moving channels), no beacons should appear.

Channel Move Time and Channel Closing Transmission Time requirements are listed in the following table.

Parameter	Value
Non-occupancy period	Minimum 30 minutes
Channel Availability Check Time	60 seconds
Channel Move Time	10 seconds See Note 1.
Channel Closing Transmission Time	200 milliseconds + an aggregate of 60 milliseconds over remaining 10 second period. See Notes 1 and 2.
U-NII Detection Bandwidth	Minimum 100% of the U-NII 99% transmission power bandwidth. See Note 3.
<p>Note 1: <i>Channel Move Time</i> and the <i>Channel Closing Transmission Time</i> should be performed with Radar Type 0. The measurement timing begins at the end of the Radar Type 0 burst.</p> <p>Note 2: The <i>Channel Closing Transmission Time</i> is comprised of 200 milliseconds starting at the beginning of the <i>Channel Move Time</i> plus any additional intermittent control signals required to facilitate a <i>Channel</i> move (an aggregate of 60 milliseconds) during the remainder of the 10 second period. The aggregate duration of control signals will not count quiet periods in between transmissions.</p> <p>Note 3: During the <i>U-NII Detection Bandwidth</i> detection test, radar type 0 should be used. For each frequency step the minimum percentage of detection is 90 percent. Measurements are performed with no data traffic.</p>	

Table 4-4: DFS Response Requirements

FCC ID: ZNFQ720AM		MEASUREMENT REPORT (CERTIFICATION)		Approved by: Quality Manager
Test Report S/N: 1M1907080114-08-R1.ZNF	Test Dates: 7/8 - 8/2/2019	EUT Type: Portable Handset	Page 8 of 17	

4.3 DFS Detection Threshold Values

The DFS detection thresholds are defined for Master devices and Client Devices with In-service monitoring. These detection thresholds are listed in the following table.

Maximum Transmit Power	Value (See Notes 1 and 2)
≥ 200 milliwatt	-64 dBm
< 200 milliwatt	-62 dBm
<p>Note 1: This is the level at the input of the receiver assuming a 0 dBi receive antenna.</p> <p>Note 2: Throughout these test procedures an additional 1 dB has been added to the amplitude of the test transmission waveforms to account for variations in measurement equipment. This will ensure that the test signal is at or above the detection threshold level to trigger a DFS response.</p>	

Table 4-5: Detection Thresholds for Master Devices and Client Devices with Radar Detection

4.1 DFS Response Requirements

DFS response requirements for Master and Client Devices are listed in the following table.

Parameter	Value
Non-occupancy period	Minimum 30 minutes
Channel Availability Check Time	60 seconds
Channel Move Time	10 seconds See Note1
Channel Closing Transmission Time	200 milliseconds + an aggregate of 60 milliseconds over remaining 10 second period. See Note 1 and 2.
U-NII Detection Bandwidth	Minimum 100% of the U- NII 99% transmission power bandwidth. See Note 3.
<p>Note 1: Channel Move Time and the Channel Closing Transmission Time should be performed with Radar Type 0. The measurement timing begins at the end of the Radar Type 0 burst</p> <p>Note 2: The Channel Closing Transmission Time is comprised of 200 milliseconds starting at the beginning of the Channel Move Time plus any additional intermittent control signals required to facilitate a Channel move (an aggregate of 60 milliseconds) during the remainder of the 10 second period. The aggregate duration of control signals will not count quiet periods in between transmissions.</p> <p>frequency step the minimum percentage of detection is 90 percent. Measurements are performed with no data traffic.</p>	

Table 4-6: DFS Response Requirements

FCC ID: ZNFQ720AM		MEASUREMENT REPORT (CERTIFICATION)		Approved by: Quality Manager
Test Report S/N: 1M1907080114-08-R1.ZNF	Test Dates: 7/8 - 8/2/2019	EUT Type: Portable Handset	Page 9 of 17	

4.2 Parameters of DFS Test Signals

As the EUT is a Client Device with no Radar Detection only one type radar pulse is required for the testing. Radar Pulse type 1 was used in the evaluation of the Client device for the purpose of measuring the Channel Move Time and the Channel Closing Transmission Time. Table 4-7 lists the parameters for the Short Pulse Radar Waveforms. A plot of the Radar Pulse Type 1 used for testing is included in Section **Error! Reference source not found.** of this report.

Radar Type	Pulse Width (µsec)	PRI (µsec)	Number of Pulses	Minimum Percentage of Successful Detection	Minimum Number of Trials
0	1	1425	18	See Note 1	See Note 1
1	1	Test A: 15 unique PRI values randomly selected from the list of 23 PRI values in Table 5a	$\text{Roundup} \left\{ \left(\frac{1}{360} \right) \cdot \left(\frac{19 \cdot 10^6}{PRI_{\mu\text{sec}}} \right) \right\}$	60%	30
		Test B: 15 unique PRI values randomly selected within the range of 518-3066 µsec, with a minimum increment of 1 µsec, excluding PRI values selected in Test A			
2	1-5	150-230	23-29	60%	30
3	6-10	200-500	16-18	60%	30
4	11-20	200-500	12-16	60%	30
Aggregate (Radar Types 1-4)				80%	120
Note 1: Short Pulse Radar Type 0 should be used for the detection bandwidth test, channel move time, and channel closing time tests.					

Table 4-7: Parameters for Short Pulse Radar Waveforms

Radar Type	Pulse Width (µsec)	Chirp Width (MHz)	PRI (µsec)	Number of Pulses per Burst	Number of Bursts	Minimum Percentage of Successful Detection	Minimum Number of Trials
5	50 - 100	5 - 20	1000-2000	1 - 3	8 - 20	80%	30

Table 4-8. Parameters for Long Pulse Radar Waveforms

Radar Type	Pulse Width (µsec)	PRI (µsec)	Pulses per Hop	Hopping Rate (kHz)	Hopping Sequence Length (msec)	Minimum Percentage of Successful Detection	Minimum Number of Trials
6	1	333	9	0.333	300	70%	30

Table 4-9. Parameters for Frequency Hopping Radar Waveforms

FCC ID: ZNFQ720AM		MEASUREMENT REPORT (CERTIFICATION)			Approved by: Quality Manager
Test Report S/N: 1M1907080114-08-R1.ZNF	Test Dates: 7/8 - 8/2/2019	EUT Type: Portable Handset		Page 10 of 17	

4.3 Procedure

DFS Test Setup:

Radiated DFS Test Setup	<input type="checkbox"/>
Conducted DFS Test Setup	<input checked="" type="checkbox"/>

KDB 905462 D02 v02 describes a radiated test setup and a conducted test setup. The conducted test setup was used for this testing. Figure 4-1 shows the typical test setup. In Band 2C, one channel selected between 5500 and 5700 MHz was chosen for testing.

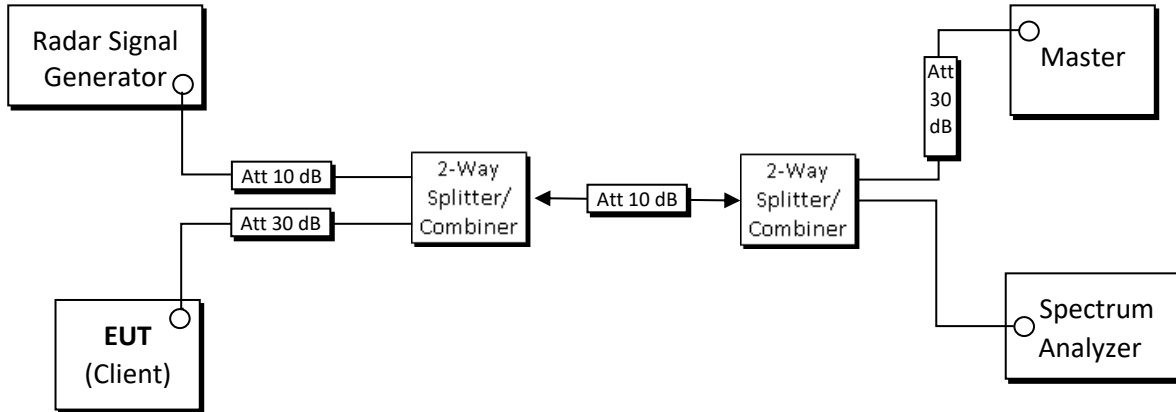

Figure 4-1. Conducted Test Setup for DFS

1. The “Aeroflex PXI DFS Radar Simulator and Analyzer Test Suite” is setup to provide a simulated radar pulse at the frequency that the Master and Client are operating. A Type 0 radar pulse was used.
2. The Client Device (EUT) is set up per the diagram in Figure 4-1 and communications between the Master device and the Client is established.
3. An MPEG or data file that is typical for the device is streamed from the Master to the Client to properly load the network.
4. The “Aeroflex PXI DFS Radar Simulator and Analyzer Test Suite” is set to record and display 12 seconds of time, starting from where the simulated radar is generated. This time domain plot captures any transmissions occurring up to and after 10sec. Aggregate time is computed to ensure compliance. (Note: the channel may be different since the Master and Client have changed channels due to the detection of the initial radar pulse.)
5. After the initial radar burst the channel is monitored for 10 minutes to ensure no transmissions or beacons occur. A second monitoring setup is used to verify that the Master and Client have both moved to different channels.

FCC ID: ZNFQ720AM		MEASUREMENT REPORT (CERTIFICATION)		Approved by: Quality Manager
Test Report S/N: 1M1907080114-08-R1.ZNF	Test Dates: 7/8 - 8/2/2019	EUT Type: Portable Handset		Page 11 of 17

5.0 EUT TEST SETUP

Client is connected to Master (AP) via WLAN network and plays a video test file “6 ½ Magic Hours” in a Server (Laptop). This Server is connected to the Master (AP) via ethernet cable. The Vivaldi antenna is adjusted so that the WLAN traffic level, as displayed on the spectrum analyzer, is at lower amplitude than the radar detection threshold.

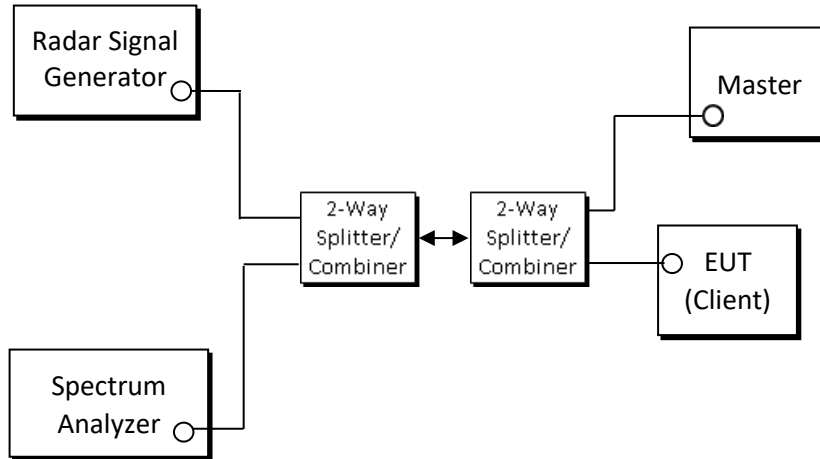

Figure 5-1. Test Setup

FCC ID: ZNFQ720AM		MEASUREMENT REPORT (CERTIFICATION)		Approved by: Quality Manager
Test Report S/N: 1M1907080114-08-R1.ZNF	Test Dates: 7/8 - 8/2/2019	EUT Type: Portable Handset		Page 12 of 17

6.0 TEST RESULTS

6.1 Summary

Company Name: LG Electronics USA, Inc.
 FCC ID: ZNFQ720AM
 FCC Classification: Unlicensed National Information Infrastructure (UNII)

	Parameter	Measured	Limit	Result
5470 – 5725 MHz UNII – 2C Band	Channel Move Time	0.24 s	10 seconds	Pass
	Channel Closing Transmission Time	< 200ms + 0.01 ms (aggregate)	200ms + aggregate of 60ms over remaining 10 second period	Pass
	Client beacon test	Monitored for 30 minutes with no client transmission	No client transmission occurred	Pass

Table 6-1. Summary of Test Results

Notes:

- 1) The EUT was found to be compliant with the requirements for DFS as required for a Client Device per Part 15.407(h), RSS-247 and KDB 905462 D02 v02.
- 2) Automated test software was used to measure emissions and capture the corresponding plots necessary to show compliance. The list is given below,
 - DFS Radar Simulator and Analyzer v2.8 (Aeroflex Inc.)
 - iPerf Software

FCC ID: ZNFQ720AM	 PCTEST ENGINEERING LABORATORY, INC.	MEASUREMENT REPORT (CERTIFICATION)		 LG	Approved by: Quality Manager
Test Report S/N: 1M1907080114-08-R1.ZNF	Test Dates: 7/8 - 8/2/2019	EUT Type: Portable Handset		Page 13 of 17	

6.2 Channel Loading

Channel Loading Notes:

Per KDB 905462 D02 v02, timing plots are required with calculations demonstrating a minimum channel loading of approximately 17% or greater. For example, you can zero span the spectrum analyzer and approximate the transmission time.

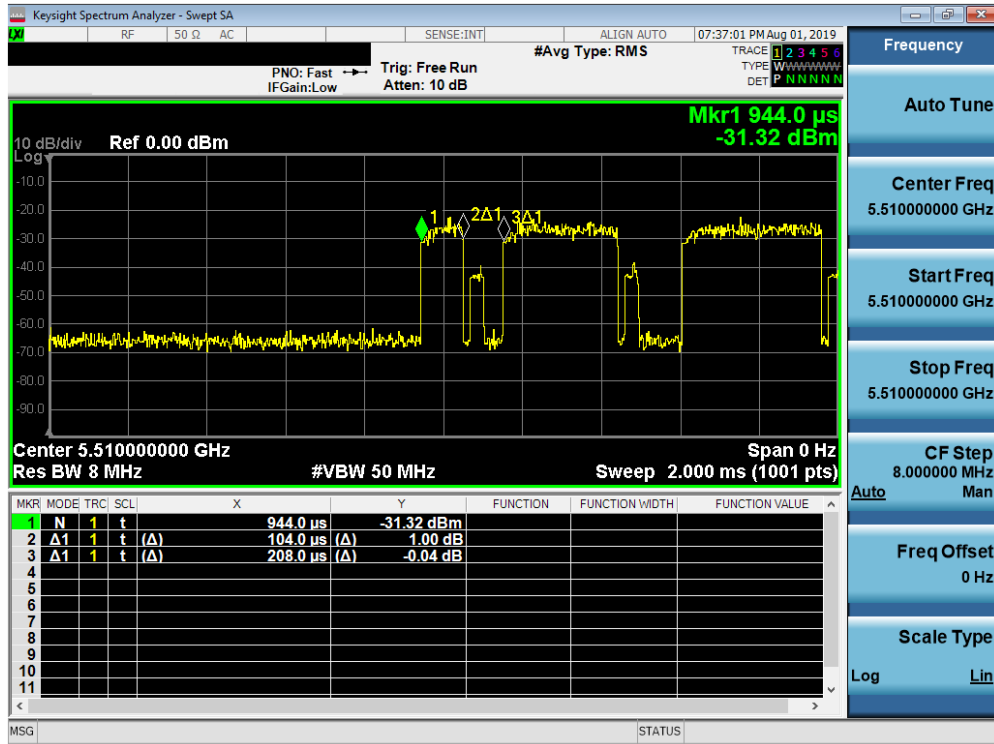

Figure 6-1. Band 2C Pulse Width and Period

$$\text{Channel Loading} = \text{Pulse Width} / \text{Period} = 104 \mu\text{s} / 208 \mu\text{s} = 50\%$$

FCC ID: ZNFQ720AM		MEASUREMENT REPORT (CERTIFICATION)		Approved by: Quality Manager
Test Report S/N: 1M1907080114-08-R1.ZNF	Test Dates: 7/8 - 8/2/2019	EUT Type: Portable Handset		Page 14 of 17

6.3 Channel Move/ Closing Transmission Time

Move Time and Aggregate Time Notes:

1. Trigger Threshold was configured to only capture client pulses. The pulses shown in the plots below have been determined to be from the Master AP.
2. Marker Info and Aggregate time results are shown on the right side of the plots below.

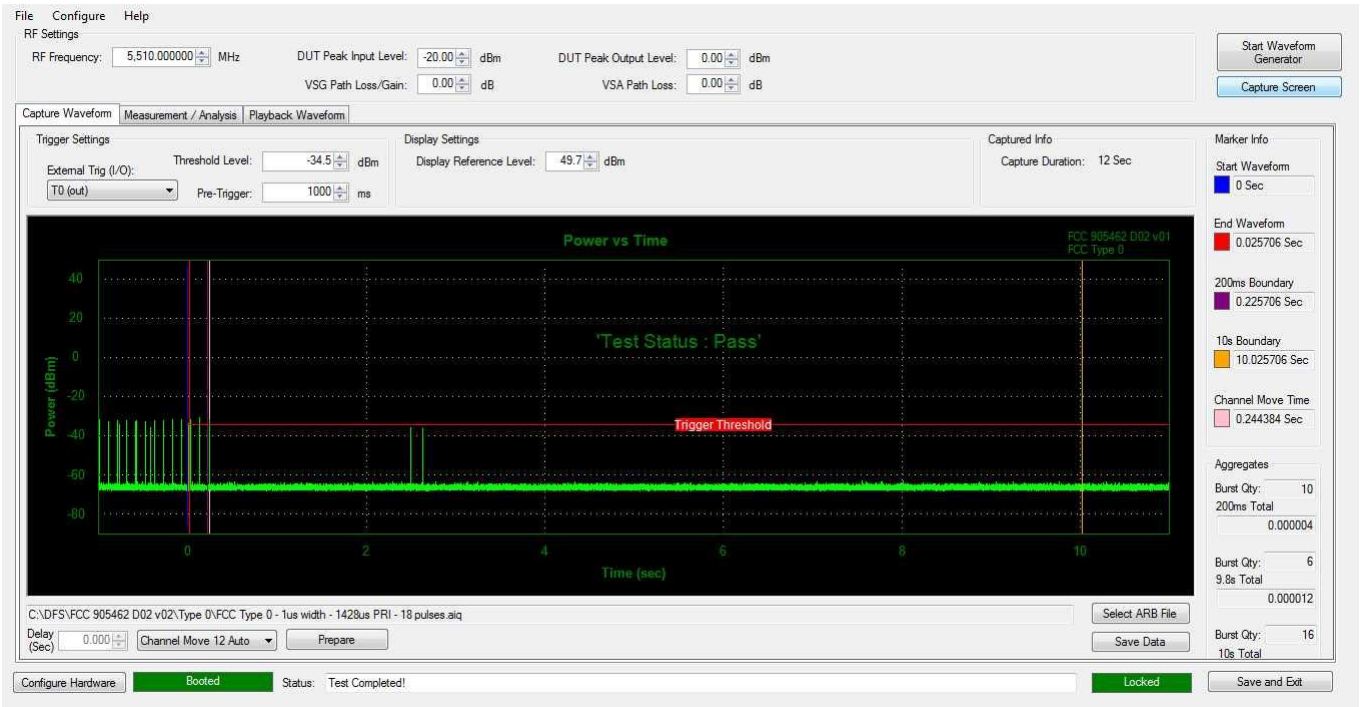

Figure 6-2. Band 2C Move Time and Aggregate Time

FCC ID: ZNFQ720AM		MEASUREMENT REPORT (CERTIFICATION)		Approved by: Quality Manager
Test Report S/N: 1M1907080114-08-R1.ZNF	Test Dates: 7/8 - 8/2/2019	EUT Type: Portable Handset		Page 15 of 17

6.4 Non-Occupancy Period

Notes:

No frequency transmission detected during the Non-Occupancy Period of 30 minutes monitoring.

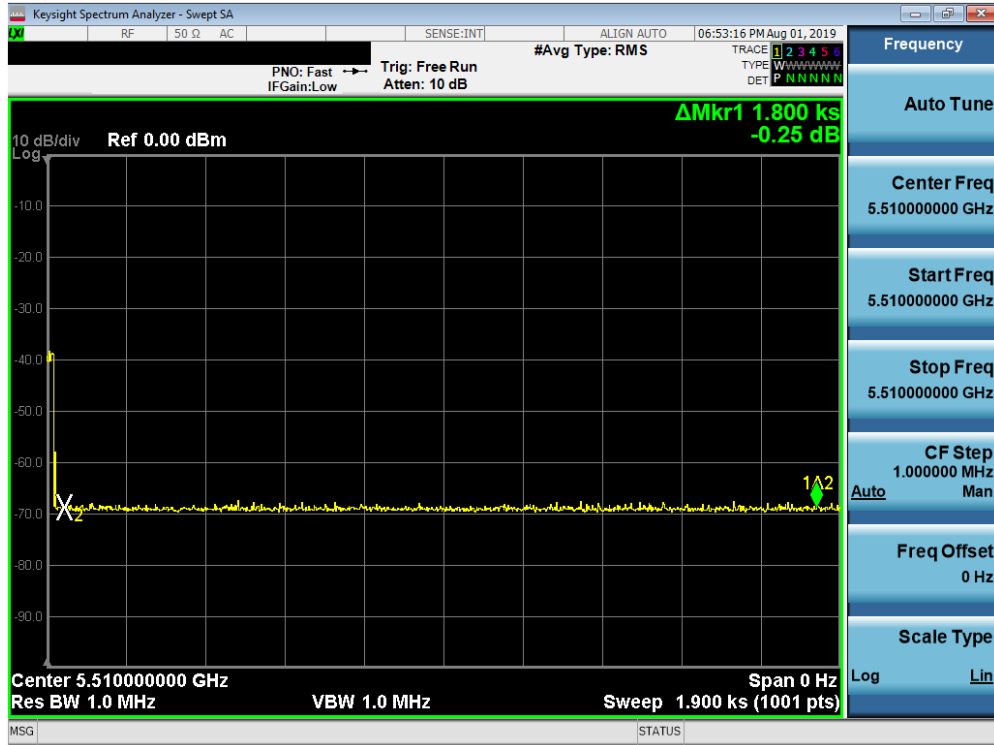

Figure 6-3. Band 2C Client Beacon Test – Monitoring live spectrum – Elapse time 30 minutes

FCC ID: ZNFQ720AM		MEASUREMENT REPORT (CERTIFICATION)		Approved by: Quality Manager
Test Report S/N: 1M1907080114-08-R1.ZNF	Test Dates: 7/8 - 8/2/2019	EUT Type: Portable Handset		Page 16 of 17

7.0 CONCLUSION

The data collected relate only to the item(s) tested and show that the **LG Portable Handset FCC ID: ZNFQ720AM** is in compliance with the DFS requirements for a Client Device without radar detection in accordance with Part 15.407 of the FCC Rules.

FCC ID: ZNFQ720AM	 MEASUREMENT REPORT (CERTIFICATION) 		Approved by: Quality Manager
Test Report S/N: 1M1907080114-08-R1.ZNF	Test Dates: 7/8 - 8/2/2019	EUT Type: Portable Handset	Page 17 of 17