



## SAR EVALUATION REPORT

**Applicant Name:**  
 LG Electronics U.S.A., Inc.  
 1000 Sylvan Avenue  
 Englewood Cliffs, NJ 07632  
 United States

**Date of Testing:**  
 07/08/19 - 07/19/19  
**Test Site/Location:**  
 PCTEST Lab, Columbia, MD, USA  
**Document Serial No.:**  
 1M1907080114-01-R1.ZNF

**FCC ID:** ZNFQ720AM

**APPLICANT:** LG ELECTRONICS U.S.A., INC.

**DUT Type:** Portable Handset  
**Application Type:** Certification  
**FCC Rule Part(s):** CFR §2.1093  
**Model:** LM-Q720AM  
**Additional Model(s):** LMQ720AM, Q720AM

Equipment Class	Band & Mode	Tx Frequency	SAR			
			1g Head (W/kg)	1g Body-Worn (W/kg)	1g Hotspot (W/kg)	10g Phablet (W/kg)
PCE	GSM/GPRS/EDGE 850	824.20 - 848.80 MHz	0.17	0.74	0.74	N/A
PCE	GSM/GPRS/EDGE 1900	1850.20 - 1909.80 MHz	< 0.1	0.33	0.81	N/A
PCE	UMTS 850	826.40 - 846.60 MHz	0.16	0.60	0.60	N/A
PCE	UMTS 1750	1712.4 - 1752.6 MHz	0.13	0.57	0.99	N/A
PCE	UMTS 1900	1852.4 - 1907.6 MHz	0.14	0.47	0.97	N/A
PCE	LTE Band 12	699.7 - 715.3 MHz	0.18	0.55	0.55	N/A
PCE	LTE Band 14	790.5 - 795.5 MHz	0.21	0.67	0.67	N/A
PCE	LTE Band 5 (Cell)	824.7 - 848.3 MHz	0.21	0.59	0.62	N/A
PCE	LTE Band 66 (AWS)	1710.7 - 1779.3 MHz	0.10	0.50	0.90	N/A
PCE	LTE Band 4 (AWS)	1710.7 - 1754.3 MHz	N/A	N/A	N/A	N/A
PCE	LTE Band 2 (PCS)	1850.7 - 1909.3 MHz	0.11	0.42	1.04	N/A
PCE	LTE Band 30	2307.5 - 2312.5 MHz	< 0.1	0.39	0.75	2.86
DTS	2.4 GHz WLAN	2412 - 2462 MHz	1.03	0.79	0.79	N/A
NIJ	U-NII-1	5180 - 5240 MHz	N/A	N/A	0.82	N/A
NIJ	U-NII-2A	5260 - 5320 MHz	0.54	0.71	N/A	2.04
NIJ	U-NII-2C	5500 - 5700 MHz	0.66	0.58	N/A	1.45
NIJ	U-NII-3	5745 - 5825 MHz	0.77	0.58	N/A	N/A
DSS/DTS	Bluetooth	2402 - 2480 MHz	0.11	< 0.1	< 0.1	N/A
Simultaneous SAR per KDB 690783 D01v01r03:			1.25	1.53	1.59	3.29

Note: This revised Test Report (S/N: 1M1907080114-01-R1.ZNF) supersedes and replaces the previously issued test report on the same subject device for the same type of testing as indicated. Please discard or destroy the previously issued test report(s) and dispose of it accordingly.

This wireless portable device has been shown to be capable of compliance for localized specific absorption rate (SAR) for uncontrolled environment/general population exposure limits specified in ANSI/IEEE C95.1-1992 and has been tested in accordance with the measurement procedures specified in Section 1.8 of this report; for North American frequency bands only.

I attest to the accuracy of data. All measurements reported herein were performed by me or were made under my supervision and are correct to the best of my knowledge and belief. I assume full responsibility for the completeness of these measurements and vouch for the qualifications of all persons taking them. Test results reported herein relate only to the item(s) tested.

Randy Ortañez  
 President





The SAR Tick is an initiative of the Mobile & Wireless Forum (MWF). While a product may be considered eligible, use of the SAR Tick logo requires an agreement with the MWF. Further details can be obtained by emailing: sartick@mwfai.info.

FCC ID: ZNFQ720AM		SAR EVALUATION REPORT		Approved by: Quality Manager
Document S/N: 1M1907080114-01-R1.ZNF	Test Dates: 07/08/19 - 07/19/19	DUT Type: Portable Handset		Page 1 of 83

# TABLE OF CONTENTS

1	DEVICE UNDER TEST .....	3
2	LTE INFORMATION .....	11
3	INTRODUCTION .....	12
4	DOSIMETRIC ASSESSMENT .....	13
5	DEFINITION OF REFERENCE POINTS .....	14
6	TEST CONFIGURATION POSITIONS .....	15
7	RF EXPOSURE LIMITS .....	19
8	FCC MEASUREMENT PROCEDURES.....	20
9	RF CONDUCTED POWERS .....	25
10	SYSTEM VERIFICATION.....	46
11	SAR DATA SUMMARY .....	51
12	FCC MULTI-TX AND ANTENNA SAR CONSIDERATIONS.....	66
13	SAR MEASUREMENT VARIABILITY .....	77
14	EQUIPMENT LIST .....	79
16	MEASUREMENT UNCERTAINTIES.....	80
17	CONCLUSION.....	81
18	REFERENCES .....	82
APPENDIX A: SAR TEST PLOTS		
APPENDIX B: SAR DIPOLE VERIFICATION PLOTS		
APPENDIX C: PROBE AND DIPOLE CALIBRATION CERTIFICATES		
APPENDIX D: SAR TISSUE SPECIFICATIONS		
APPENDIX E: SAR SYSTEM VALIDATION		
APPENDIX F: DUT ANTENNA DIAGRAM & SAR TEST SETUP PHOTOGRAPHS		
APPENDIX G: POWER REDUCTION VERIFICATION		
APPENDIX H: DOWNLINK LTE CA RF CONDUCTED POWERS		

FCC ID: ZNFQ720AM		SAR EVALUATION REPORT		Approved by: Quality Manager
Document S/N: 1M1907080114-01-R1.ZNF	Test Dates: 07/08/19 - 07/19/19	DUT Type: Portable Handset	Page 2 of 83	

# 1 DEVICE UNDER TEST

## 1.1 Device Overview

Band & Mode	Operating Modes	Tx Frequency
GSM/GPRS/EDGE 850	Voice/Data	824.20 - 848.80 MHz
GSM/GPRS/EDGE 1900	Voice/Data	1850.20 - 1909.80 MHz
UMTS 850	Voice/Data	826.40 - 846.60 MHz
UMTS 1750	Voice/Data	1712.4 - 1752.6 MHz
UMTS 1900	Voice/Data	1852.4 - 1907.6 MHz
LTE Band 12	Voice/Data	699.7 - 715.3 MHz
LTE Band 14	Voice/Data	790.5 - 795.5 MHz
LTE Band 5 (Cell)	Voice/Data	824.7 - 848.3 MHz
LTE Band 66 (AWS)	Voice/Data	1710.7 - 1779.3 MHz
LTE Band 4 (AWS)	Voice/Data	1710.7 - 1754.3 MHz
LTE Band 2 (PCS)	Voice/Data	1850.7 - 1909.3 MHz
LTE Band 30	Voice/Data	2307.5 - 2312.5 MHz
2.4 GHz WLAN	Voice/Data	2412 - 2462 MHz
U-NII-1	Voice/Data	5180 - 5240 MHz
U-NII-2A	Voice/Data	5260 - 5320 MHz
U-NII-2C	Voice/Data	5500 - 5700 MHz
U-NII-3	Voice/Data	5745 - 5825 MHz
Bluetooth	Data	2402 - 2480 MHz
NFC	Data	13.56 MHz



## 1.2 Power Reduction for SAR

This device uses a power reduction mechanism for SAR compliance. The power reduction mechanism is activated when the device is used in close proximity to the user's body. FCC KDB Publication 616217 D04v01r02 Section 6 was used as a guideline for selecting SAR test distances for this device. Detailed descriptions of the power reduction mechanism are included in the operational description.

This device uses an independent fixed level power reduction mechanism for WLAN operations during voice or VoIP held to ear scenarios. Per FCC Guidance, the held-to-ear exposure conditions were evaluated at reduced power according to the head SAR positions described in IEEE 1528-2013. Detailed descriptions of the power reduction mechanism are included in the operational description.

## 1.3 Nominal and Maximum Output Power Specifications

This device operates using the following maximum and nominal output power specifications. SAR values were scaled to the maximum allowed power to determine compliance per KDB Publication 447498 D01v06.



FCC ID: ZNFQ720AM	 <b>PCTEST</b> ENGINEERING LABORATORY, INC.	<b>SAR EVALUATION REPORT</b>	 <b>LG</b>	<b>Approved by:</b> Quality Manager
<b>Document S/N:</b> 1M1907080114-01-R1.ZNF	<b>Test Dates:</b> 07/08/19 - 07/19/19	<b>DUT Type:</b> Portable Handset	Page 3 of 83	

### 1.3.1

### Maximum Output Power

Mode / Band		Voice (dBm)	Burst Average GMSK (dBm)		Burst Average 8-PSK (dBm)	
		1 TX Slot	1 TX Slots	2 TX Slots	1 TX Slots	2 TX Slots
GSM/GPRS/EDGE 850	Maximum	<b>33.2</b>	<b>33.2</b>	<b>32.2</b>	<b>27.7</b>	<b>27.7</b>
	Nominal	<b>32.7</b>	<b>32.7</b>	<b>31.7</b>	<b>27.2</b>	<b>27.2</b>
GSM/GPRS/EDGE 1900	Maximum	<b>30.7</b>	<b>30.7</b>	<b>28.7</b>	<b>26.2</b>	<b>26.2</b>
	Nominal	<b>30.2</b>	<b>30.2</b>	<b>28.2</b>	<b>25.7</b>	<b>25.7</b>



Mode / Band		Modulated Average (dBm)		
		3GPP WCDMA	3GPP HSDPA	3GPP HSUPA
UMTS Band 5 (850 MHz)	Maximum	<b>25.5</b>	<b>25.5</b>	<b>25.5</b>
	Nominal	<b>25.0</b>	<b>25.0</b>	<b>25.0</b>
UMTS Band 4 (1750 MHz)	Maximum	<b>24.0</b>	<b>24.0</b>	<b>24.0</b>
	Nominal	<b>23.5</b>	<b>23.5</b>	<b>23.5</b>
UMTS Band 2 (1900 MHz)	Maximum	<b>24.0</b>	<b>24.0</b>	<b>24.0</b>
	Nominal	<b>23.5</b>	<b>23.5</b>	<b>23.5</b>

FCC ID: ZNFQ720AM		SAR EVALUATION REPORT		Approved by: Quality Manager
Document S/N: 1M1907080114-01-R1.ZNF	Test Dates: 07/08/19 - 07/19/19	DUT Type: Portable Handset	Page 4 of 83	

Mode / Band		Modulated Average (dBm)
LTE Band 12	Maximum	25.5
	Nominal	25.0
LTE Band 14	Maximum	25.5
	Nominal	25.0
LTE Band 5 (Cell)	Maximum	25.5
	Nominal	25.0
LTE Band 66 (AWS)	Maximum	24.0
	Nominal	23.5
LTE Band 4 (AWS)	Maximum	24.0
	Nominal	23.5
LTE Band 2 (PCS)	Maximum	24.0
	Nominal	23.5
LTE Band 30	Maximum	24.0
	Nominal	23.5

Mode / Band		Modulated Average (dBm)				
Channel		1	2	3-9	10	11
IEEE 802.11b (2.4 GHz)	Maximum	23.0				
	Nominal	22.0				
IEEE 802.11g (2.4 GHz)	Maximum	19.0	20.0	22.0	20.0	18.5
	Nominal	18.0	19.0	21.0	19.0	17.5
IEEE 802.11n (2.4 GHz)	Maximum	18.0	19.0	21.0	19.0	17.5
	Nominal	17.0	18.0	20.0	18.0	16.5

Mode / Band		Modulated Average - Single Tx Chain (dBm)																	
		20 MHz Bandwidth								40 MHz Bandwidth						80 MHz Bandwidth			
		Channel	36	40-60	64 - 100	104-136	140-149	153-161	165	38	46-54	62 - 102	110	118-126	134	151-159	42	58	106
IEEE 802.11a (5 GHz)	Maximum	16.0	19.5	16.0	19.5	18.0	20.0	18.0											
	Nominal	15.0	18.5	15.0	18.5	17.0	19.0	17.0											
IEEE 802.11n (5 GHz)	Maximum	15.0	18.5	15.0	18.5	17.0	19.0	17.0	13.0	15.0	13.0	15.0	15.0	15.0	15.0				
	Nominal	14.0	17.5	14.0	17.5	16.0	18.0	16.0	12.0	14.0	12.0	14.0	14.0	14.0	14.0				
IEEE 802.11ac (5 GHz)	Maximum	12.0	15.5	12.0	15.5	14.0	16.0	14.0	12.0	13.0	12.0	13.0	13.0	13.0	13.0	11.0	12.0	11.0	13.0
	Nominal	11.0	14.5	11.0	14.5	13.0	15.0	13.0	11.0	12.0	11.0	12.0	12.0	12.0	12.0	10.0	11.0	10.0	12.0

FCC ID: ZNFQ720AM	 PCTEST ENGINEERING LABORATORY, INC.	SAR EVALUATION REPORT	 LG	Approved by: Quality Manager
Document S/N: 1M1907080114-01-R1.ZNF	Test Dates: 07/08/19 - 07/19/19	DUT Type: Portable Handset	Page 5 of 83	



Mode/Band		Modulated Average (dBm)
Bluetooth	Maximum	<b>11.0</b>
	Nominal	<b>10.0</b>
Bluetooth (2-DH5)	Maximum	<b>11.0</b>
	Nominal	<b>10.0</b>
Bluetooth (3-DH5)	Maximum	<b>11.0</b>
	Nominal	<b>10.0</b>
Bluetooth LE	Maximum	<b>2.0</b>
	Nominal	<b>1.0</b>

### 1.3.2 Reduced Output Power

Mode / Band		Modulated Average (dBm)
LTE Band 30	Maximum	<b>22.0</b>
	Nominal	<b>21.5</b>

Mode / Band		Modulated Average (dBm)				
Channel		1	2	3-9	10	11
IEEE 802.11b (2.4 GHz)	Maximum	<b>19.0</b>				
	Nominal	<b>18.0</b>				
IEEE 802.11g (2.4 GHz)	Maximum	<b>16.0</b>	<b>17.0</b>	<b>19.0</b>	<b>17.0</b>	<b>15.5</b>
	Nominal	<b>15.0</b>	<b>16.0</b>	<b>18.0</b>	<b>16.0</b>	<b>14.5</b>
IEEE 802.11n (2.4 GHz)	Maximum	<b>16.0</b>	<b>17.0</b>	<b>19.0</b>	<b>17.0</b>	<b>15.5</b>
	Nominal	<b>15.0</b>	<b>16.0</b>	<b>18.0</b>	<b>16.0</b>	<b>14.5</b>

Mode / Band	Channel	Modulated Average - Single Tx Chain (dBm)																			
		20 MHz Bandwidth							40 MHz Bandwidth							80 MHz Bandwidth					
		36	40-60	64 - 100	104-136	144-149	153-161	165	38	46-54	62 - 102	110	118-126	134	151-159	42	58	106	122-155		
IEEE 802.11a (5 GHz)	Maximum	<b>14.0</b>	<b>17.5</b>	<b>14.0</b>	<b>17.5</b>	<b>16.0</b>	<b>18.0</b>	<b>16.0</b>													
	Nominal	<b>13.0</b>	<b>16.5</b>	<b>13.0</b>	<b>16.5</b>	<b>15.0</b>	<b>17.0</b>	<b>15.0</b>													
IEEE 802.11n (5 GHz)	Maximum	<b>14.0</b>	<b>17.5</b>	<b>14.0</b>	<b>17.5</b>	<b>16.0</b>	<b>18.0</b>	<b>16.0</b>	<b>13.0</b>	<b>15.0</b>	<b>13.0</b>	<b>15.0</b>	<b>15.0</b>	<b>15.0</b>	<b>15.0</b>						
	Nominal	<b>13.0</b>	<b>16.5</b>	<b>13.0</b>	<b>16.5</b>	<b>15.0</b>	<b>17.0</b>	<b>15.0</b>	<b>12.0</b>	<b>14.0</b>	<b>12.0</b>	<b>14.0</b>	<b>14.0</b>	<b>14.0</b>	<b>14.0</b>						
IEEE 802.11ac (5 GHz)	Maximum	<b>12.0</b>	<b>15.5</b>	<b>12.0</b>	<b>15.5</b>	<b>14.0</b>	<b>16.0</b>	<b>14.0</b>	<b>12.0</b>	<b>13.0</b>	<b>12.0</b>	<b>13.0</b>	<b>13.0</b>	<b>13.0</b>	<b>13.0</b>	<b>11.0</b>	<b>12.0</b>	<b>11.0</b>	<b>13.0</b>		
	Nominal	<b>11.0</b>	<b>14.5</b>	<b>11.0</b>	<b>14.5</b>	<b>13.0</b>	<b>15.0</b>	<b>13.0</b>	<b>11.0</b>	<b>12.0</b>	<b>11.0</b>	<b>12.0</b>	<b>12.0</b>	<b>12.0</b>	<b>12.0</b>	<b>10.0</b>	<b>11.0</b>	<b>10.0</b>	<b>12.0</b>		

FCC ID: ZNFQ720AM	 <b>PCTEST</b> ENGINEERING LABORATORY, INC.	<b>SAR EVALUATION REPORT</b>	 <b>LG</b>	Approved by: Quality Manager
Document S/N: 1M1907080114-01-R1.ZNF	Test Dates: 07/08/19 - 07/19/19	DUT Type: Portable Handset	Page 6 of 83	

## 1.4 DUT Antenna Locations

The overall dimensions of this device are > 9 x 5 cm. A diagram showing the location of the device antennas can be found in Appendix F. Since the diagonal dimension of this device is > 160 mm and <200 mm, it is considered a “phablet.”

**Table 1-1  
Device Edges/Sides for SAR Testing**

Mode	Back	Front	Top	Bottom	Right	Left
GPRS 850	Yes	Yes	No	Yes	No	Yes
GPRS 1900	Yes	Yes	No	Yes	Yes	No
UMTS 850	Yes	Yes	No	Yes	No	Yes
UMTS 1750	Yes	Yes	No	Yes	Yes	No
UMTS 1900	Yes	Yes	No	Yes	Yes	No
LTE Band 12	Yes	Yes	No	Yes	No	Yes
LTE Band 14	Yes	Yes	No	Yes	No	Yes
LTE Band 5 (Cell)	Yes	Yes	No	Yes	No	Yes
LTE Band 66 (AWS)	Yes	Yes	No	Yes	Yes	No
LTE Band 2 (PCS)	Yes	Yes	No	Yes	Yes	No
LTE Band 30	Yes	Yes	No	Yes	Yes	No
2.4 GHz WLAN	Yes	Yes	Yes	No	No	Yes
5 GHz WLAN	Yes	Yes	Yes	No	No	Yes
Bluetooth	Yes	Yes	Yes	No	No	Yes

Note: Particular DUT edges were not required to be evaluated for wireless router SAR or phablet SAR if the edges were greater than 2.5 cm from the transmitting antenna according to FCC KDB Publication 941225 D06v02r01 Section III and FCC KDB Publication 648474 D04v01r03. The distances between the transmit antennas and the edges of the device are included in the filing. When wireless router mode is enabled, U-NII-2A, U-NII-2C operations are disabled.



## 1.5 Near Field Communications (NFC) Antenna

This DUT has NFC operations. The NFC antenna is integrated into the device for this model. Therefore, all SAR tests were performed with the device which already incorporates the NFC antenna. A diagram showing the location of the NFC antenna can be found in Appendix F.

## 1.6 Simultaneous Transmission Capabilities

According to FCC KDB Publication 447498 D01v06, transmitters are considered to be operating simultaneously when there is overlapping transmission, with the exception of transmissions during network hand-offs with maximum hand-off duration less than 30 seconds.

This device contains multiple transmitters that may operate simultaneously, and therefore requires a simultaneous transmission analysis according to FCC KDB Publication 447498 D01v06 4.3.2 procedures.

FCC ID: ZNFQ720AM		SAR EVALUATION REPORT		Approved by: Quality Manager
Document S/N: 1M1907080114-01-R1.ZNF	Test Dates: 07/08/19 - 07/19/19	DUT Type: Portable Handset	Page 7 of 83	

**Table 1-2  
Simultaneous Transmission Scenarios**

No.	Capable Transmit Configuration	Head	Body-Worn Accessory	Wireless Router	Phablet	Notes
1	GSM voice + 2.4 GHz Wi-Fi	Yes	Yes	N/A	Yes	
2	GSM voice + 5 GHz Wi-Fi	Yes	Yes	N/A	Yes	
3	GSM voice + 2.4 GHz Bluetooth	Yes^	Yes	N/A	Yes	^Bluetooth Tethering is considered
4	GSM voice + 2.4 GHz Bluetooth + 5 GHz Wi-Fi	Yes^	Yes	N/A	Yes	^Bluetooth Tethering is considered
5	UMTS + 2.4 GHz Wi-Fi	Yes	Yes	Yes	Yes	
6	UMTS + 5 GHz Wi-Fi	Yes	Yes	Yes	Yes	
7	UMTS + 2.4 GHz Bluetooth	Yes^	Yes	Yes^	Yes	^Bluetooth Tethering is considered
8	UMTS + 2.4 GHz Bluetooth + 5 GHz Wi-Fi	Yes^	Yes	Yes^	Yes	^Bluetooth Tethering is considered
9	LTE + 2.4 GHz Wi-Fi	Yes	Yes	Yes	Yes	
10	LTE + 5 GHz Wi-Fi	Yes	Yes	Yes	Yes	
11	LTE + 2.4 GHz Bluetooth	Yes^	Yes	Yes^	Yes	^Bluetooth Tethering is considered
12	LTE + 2.4 GHz Bluetooth + 5 GHz Wi-Fi	Yes^	Yes	Yes^	Yes	^Bluetooth Tethering is considered
13	GPRS/EDGE + 2.4 GHz Wi-Fi	Yes*	Yes*	Yes	Yes	* Pre-installed VOIP applications are considered
14	GPRS/EDGE + 5 GHz Wi-Fi	Yes*	Yes*	Yes	Yes	* Pre-installed VOIP applications are considered
15	GPRS/EDGE + 2.4 GHz Bluetooth	Yes^	Yes*	Yes^	Yes	* Pre-installed VOIP applications are considered ^Bluetooth Tethering is considered
16	GPRS/EDGE + 2.4 GHz Bluetooth + 5 GHz Wi-Fi	Yes^	Yes*	Yes^	Yes	* Pre-installed VOIP applications are considered ^Bluetooth Tethering is considered

- 2.4 GHz WLAN, 2.4 GHz Bluetooth share the same antenna path and cannot transmit simultaneously. 2.4 GHz Bluetooth and 5 GHz WLAN can transmit simultaneously.
- All licensed modes share the same antenna path and cannot transmit simultaneously.
- When the user utilizes multiple services in UMTS 3G mode it uses multi-Radio Access Bearer or multi-RAB. The power control is based on a physical control channel (Dedicated Physical Control Channel [DPCCH]) and power control will be adjusted to meet the needs of both services. Therefore, the UMTS+WLAN scenario also represents the UMTS Voice/DATA + WLAN Hotspot scenario.
- Per the manufacturer, WIFI Direct is expected to be used in conjunction with a held-to-ear or body-worn accessory voice call. Therefore, there are no simultaneous transmission scenarios involving WIFI direct beyond that listed in the above table.
- 5 GHz Wireless Router is only supported for U-NII 1 & U-NII-3 by S/W, therefore U-NII2A and U-NII2C were not evaluated for wireless router conditions.
- This device supports VOLTE.
- This device supports VoWIFI.
- This device supports Bluetooth Tethering.



## 1.7 Miscellaneous SAR Test Considerations

### (A) WIFI/BT

Since U-NII-1 and U-NII-2A bands have the same maximum output power and the highest reported SAR for U-NII-2A is less than 1.2 W/kg, SAR is not required for U-NII-1 band according to FCC KDB Publication 248227 D01v02r02.

Since Wireless Router operations are not allowed by the chipset firmware using U-NII-2A and U-NII-2C WIFI, only 2.4 GHz, U-NII-1, and U-NII-3 WIFI Hotspot SAR tests and combinations are considered for SAR with respect to Wireless Router configurations according to FCC KDB 941225 D06v02r01.

Per FCC KDB Publication 648474 D04v01r03, this device is considered a "phablet" since the diagonal dimension is greater than 160mm and less than 200mm. Phablet SAR tests are required when wireless router mode does not apply or if wireless router 1g SAR > 1.2 W/kg. Because wireless router operations are not supported for U-NII-2A & U-NII-2C WLAN, phablet SAR tests were performed. Phablet SAR was not evaluated for 2.4 GHz WLAN, Bluetooth, U-NII-1, and U-NII-3 WLAN operations since wireless router 1g SAR was < 1.2 W/kg.

FCC ID: ZNFQ720AM		SAR EVALUATION REPORT		Approved by: Quality Manager
Document S/N: 1M1907080114-01-R1.ZNF	Test Dates: 07/08/19 - 07/19/19	DUT Type: Portable Handset		Page 8 of 83



This device supports IEEE 802.11ac with the following features:

- a. Up to 80MHz Bandwidth only
- b. No aggregate channel configurations
- c. 1 Tx antenna output
- d. 256 QAM is supported
- e. TDWR channels are supported

## (B) Licensed Transmitter(s)

GSM/GPRS/EDGE DTM is not supported for US bands. Therefore, the GSM Voice modes in this report do not transmit simultaneously with GPRS/EDGE Data.

This device is only capable of QPSK HSUPA in the uplink. Therefore, no additional SAR tests are required beyond that described for devices with HSUPA in KDB 941225 D01v03r01.

LTE SAR for the higher modulations and lower bandwidths were not tested since the maximum average output power of all required channels and configurations was not more than 0.5 dB higher than the highest bandwidth; and the reported LTE SAR for the highest bandwidth was less than 1.45 W/kg for all configurations according to FCC KDB 941225 D05v02r04.



This device supports LTE Carrier Aggregation (CA) in the downlink. All uplink communications are identical to Release 8 specifications. Per FCC KDB Publication 941225 D05A v01r02, SAR for LTE CA operations was not needed since the maximum average output power in LTE CA mode was not >0.25 dB higher than the maximum output power when downlink carrier aggregation was inactive. The downlink carrier aggregation exclusion analysis can be found in Appendix H.

Per FCC KDB Publication 648474 D04v01r03, this device is considered a "phablet" since the diagonal dimension is greater than 160mm and less than 200mm. Therefore, phablet SAR tests are required when wireless router mode does not apply or if wireless router 1g SAR > 1.2 W/kg. Phablet SAR was not evaluated for licensed technologies since wireless router 1g SAR was < 1.2 W/kg for these modes. Additional SAR tests for phablet SAR were evaluated per KDB 616217 Section 6 (See Section 6.9 for more information).

This device supports LTE capabilities with overlapping transmission frequency ranges. When the supported frequency range of an LTE Band falls completely within an LTE band with a larger transmission frequency range, both LTE bands have the same target power (or the band with the larger transmission frequency range has a higher target power), and both LTE bands share the same transmission path and signal characteristics, SAR was only assessed for the band with the larger transmission frequency range.



## 1.8 Guidance Applied

- IEEE 1528-2013
- FCC KDB Publication 941225 D01v03r01, D05v02r04, D05Av01r02, D06v02r01 (2G/3G/4G and Hotspot)
- FCC KDB Publication 248227 D01v02r02 (SAR Considerations for 802.11 Devices)
- FCC KDB Publication 447498 D01v06 (General SAR Guidance)
- FCC KDB Publication 865664 D01v01r04, D02v01r02 (SAR Measurements up to 6 GHz)
- FCC KDB Publication 648474 D04v01r03 (Phablet Procedures)
- FCC KDB Publication 616217 D04v01r02 (Proximity Sensor)
- October 2013 TCB Workshop Notes (GPRS Testing Considerations)
- April 2018 TCB Workshop Notes (LTE Carrier Aggregation)



FCC ID: ZNFQ720AM		SAR EVALUATION REPORT		Approved by: Quality Manager
Document S/N: 1M1907080114-01-R1.ZNF	Test Dates: 07/08/19 - 07/19/19	DUT Type: Portable Handset		Page 9 of 83

## 1.9 Device Serial Numbers

Several samples with identical hardware were used to support SAR testing. The manufacturer has confirmed that the device(s) tested have the same physical, mechanical and thermal characteristics and are within operational tolerances expected for production units. The serial numbers used for each test are indicated alongside the results in Section 11.

FCC ID: ZNFQ720AM		SAR EVALUATION REPORT		Approved by: Quality Manager
Document S/N: 1M1907080114-01-R1.ZNF	Test Dates: 07/08/19 - 07/19/19	DUT Type: Portable Handset	Page 10 of 83	

LTE Information			
Form Factor	Portable Handset		
Frequency Range of each LTE transmission band	LTE Band 12 (699.7 - 715.3 MHz)		
	LTE Band 14 (790.5 - 795.5 MHz)		
	LTE Band 5 (Cell) (824.7 - 848.3 MHz)		
	LTE Band 66 (AWS) (1710.7 - 1779.3 MHz)		
	LTE Band 4 (AWS) (1710.7 - 1754.3 MHz)		
	LTE Band 2 (PCS) (1850.7 - 1909.3 MHz)		
Channel Bandwidths	LTE Band 30 (2307.5 - 2312.5 MHz)		
	LTE Band 12: 1.4 MHz, 3 MHz, 5 MHz, 10 MHz		
	LTE Band 14: 5 MHz, 10 MHz		
	LTE Band 5 (Cell): 1.4 MHz, 3 MHz, 5 MHz, 10 MHz		
	LTE Band 66 (AWS): 1.4 MHz, 3 MHz, 5 MHz, 10 MHz, 15 MHz, 20 MHz		
	LTE Band 4 (AWS): 1.4 MHz, 3 MHz, 5 MHz, 10 MHz, 15 MHz, 20 MHz		
Channel Numbers and Frequencies (MHz)	LTE Band 2 (PCS): 1.4 MHz, 3 MHz, 5 MHz, 10 MHz, 15 MHz, 20 MHz		
	LTE Band 30: 5 MHz, 10 MHz		
	Low	Mid	High
LTE Band 12: 1.4 MHz	699.7 (23017)	707.5 (23095)	715.3 (23173)
LTE Band 12: 3 MHz	700.5 (23025)	707.5 (23095)	714.5 (23165)
LTE Band 12: 5 MHz	701.5 (23035)	707.5 (23095)	713.5 (23155)
LTE Band 12: 10 MHz	704 (23060)	707.5 (23095)	711 (23130)
LTE Band 14: 5 MHz	790.5 (23305)	793 (23330)	795.5 (23355)
LTE Band 14: 10 MHz	N/A	793 (23330)	N/A
LTE Band 5 (Cell): 1.4 MHz	824.7 (20407)	836.5 (20525)	848.3 (20643)
LTE Band 5 (Cell): 3 MHz	825.5 (20415)	836.5 (20525)	847.5 (20635)
LTE Band 5 (Cell): 5 MHz	826.5 (20425)	836.5 (20525)	846.5 (20625)
LTE Band 5 (Cell): 10 MHz	829 (20450)	836.5 (20525)	844 (20600)
LTE Band 66 (AWS): 1.4 MHz	1710.7 (131979)	1745 (132322)	1779.3 (132665)
LTE Band 66 (AWS): 3 MHz	1711.5 (131987)	1745 (132322)	1778.5 (132657)
LTE Band 66 (AWS): 5 MHz	1712.5 (131997)	1745 (132322)	1777.5 (132647)
LTE Band 66 (AWS): 10 MHz	1715 (132022)	1745 (132322)	1775 (132622)
LTE Band 66 (AWS): 15 MHz	1717.5 (132047)	1745 (132322)	1772.5 (132597)
LTE Band 66 (AWS): 20 MHz	1720 (132072)	1745 (132322)	1770 (132572)
LTE Band 4 (AWS): 1.4 MHz	1710.7 (19957)	1732.5 (20175)	1754.3 (20393)
LTE Band 4 (AWS): 3 MHz	1711.5 (19965)	1732.5 (20175)	1753.5 (20385)
LTE Band 4 (AWS): 5 MHz	1712.5 (19975)	1732.5 (20175)	1752.5 (20375)
LTE Band 4 (AWS): 10 MHz	1715 (20000)	1732.5 (20175)	1750 (20350)
LTE Band 4 (AWS): 15 MHz	1717.5 (20025)	1732.5 (20175)	1747.5 (20325)
LTE Band 4 (AWS): 20 MHz	1720 (20050)	1732.5 (20175)	1745 (20300)
LTE Band 2 (PCS): 1.4 MHz	1850.7 (18607)	1880 (18900)	1909.3 (19193)
LTE Band 2 (PCS): 3 MHz	1851.5 (18615)	1880 (18900)	1908.5 (19185)
LTE Band 2 (PCS): 5 MHz	1852.5 (18625)	1880 (18900)	1907.5 (19175)
LTE Band 2 (PCS): 10 MHz	1855 (18650)	1880 (18900)	1905 (19150)
LTE Band 2 (PCS): 15 MHz	1857.5 (18675)	1880 (18900)	1902.5 (19125)
LTE Band 2 (PCS): 20 MHz	1860 (18700)	1880 (18900)	1900 (19100)
LTE Band 30: 5 MHz	2307.5 (27685)	2310 (27710)	2312.5 (27735)
LTE Band 30: 10 MHz	N/A	2310 (27710)	N/A
UE Category	DL UE Cat 6, UL UE Cat 5		
Modulations Supported in UL	QPSK, 16QAM		
LTE MPR Permanently implemented per 3GPP TS 36.101 section 6.2.3-6.2.5? (manufacturer attestation to be provided)	YES		
A-MPR (Additional MPR) disabled for SAR Testing?	YES		
LTE Carrier Aggregation Possible Combinations	The technical description includes all the possible carrier aggregation combinations		
LTE Additional Information	This device does not support full CA features on 3GPP Release 10. It supports carrier aggregation as shown in Appendix H. Uplink communications are done on the PCC unless otherwise specified. The following LTE Release 10 Features are not supported: Relay, HetNet, Enhanced MIMO, eICIC, WIFI Offloading, eMBMS, Cross-Carrier Scheduling, Enhanced SC-FDMA.		

FCC ID: ZNFQ720AM		SAR EVALUATION REPORT		Approved by: Quality Manager
Document S/N: 1M1907080114-01-R1.ZNF	Test Dates: 07/08/19 - 07/19/19	DUT Type: Portable Handset		Page 11 of 83

The FCC and Innovation, Science, and Economic Development Canada have adopted the guidelines for evaluating the environmental effects of radio frequency (RF) radiation in ET Docket 93-62 on Aug. 6, 1996 and Health Canada Safety Code 6 to protect the public and workers from the potential hazards of RF emissions due to FCC-regulated portable devices. [1]

The safety limits used for the environmental evaluation measurements are based on the criteria published by the American National Standards Institute (ANSI) for localized specific absorption rate (SAR) in IEEE/ANSI C95.1-1992 Standard for Safety Levels with Respect to Human Exposure to Radio Frequency Electromagnetic Fields, 3 kHz to 300 GHz [3] and Health Canada RF Exposure Guidelines Safety Code 6 [22]. The measurement procedure described in IEEE/ANSI C95.3-2002 Recommended Practice for the Measurement of Potentially Hazardous Electromagnetic Fields - RF and Microwave [4] is used for guidance in measuring the Specific Absorption Rate (SAR) due to the RF radiation exposure from the Equipment Under Test (EUT). These criteria for SAR evaluation are similar to those recommended by the International Committee for Non-Ionizing Radiation Protection (ICNIRP) in Biological Effects and Exposure Criteria for Radiofrequency Electromagnetic Fields,” Report No. Vol 74. SAR is a measure of the rate of energy absorption due to exposure to an RF transmitting source. SAR values have been related to threshold levels for potential biological hazards.

### 3.1 SAR Definition

Specific Absorption Rate is defined as the time derivative (rate) of the incremental energy (dU) absorbed by (dissipated in) an incremental mass (dm) contained in a volume element (dV) of a given density ( $\rho$ ). It is also defined as the rate of RF energy absorption per unit mass at a point in an absorbing body (see Equation 3-1).

**Equation 3-1**  
**SAR Mathematical Equation**

$$SAR = \frac{d}{dt} \left( \frac{dU}{dm} \right) = \frac{d}{dt} \left( \frac{dU}{\rho dv} \right)$$



SAR is expressed in units of Watts per Kilogram (W/kg).

$$SAR = \frac{\sigma \cdot E^2}{\rho}$$

where:

- $\sigma$  = conductivity of the tissue-simulating material (S/m)
- $\rho$  = mass density of the tissue-simulating material (kg/m<sup>3</sup>)
- E = Total RMS electric field strength (V/m)

NOTE: The primary factors that control rate of energy absorption were found to be the wavelength of the incident field in relation to the dimensions and geometry of the irradiated organism, the orientation of the organism in relation to the polarity of field vectors, the presence of reflecting surfaces, and whether conductive contact is made by the organism with a ground plane.[6]

FCC ID: ZNFQ720AM		SAR EVALUATION REPORT		Approved by: Quality Manager
Document S/N: 1M1907080114-01-R1.ZNF	Test Dates: 07/08/19 - 07/19/19	DUT Type: Portable Handset		Page 12 of 83

# 4

## DOSIMETRIC ASSESSMENT

### 4.1 Measurement Procedure

The evaluation was performed using the following procedure compliant to FCC KDB Publication 865664 D01v01r04 and IEEE 1528-2013:

1. The SAR distribution at the exposed side of the head or body was measured at a distance no greater than 5.0 mm from the inner surface of the shell. The area covered the entire dimension of the device-head and body interface and the horizontal grid resolution was determined per FCC KDB Publication 865664 D01v01r04 (See Table 4-1) and IEEE 1528-2013.
2. The point SAR measurement was taken at the maximum SAR region determined from Step 1 to enable the monitoring of SAR fluctuations/drifts during the 1g/10g cube evaluation. SAR at this fixed point was measured and used as a reference value.
3. Based on the area scan data, the peak of the region with maximum SAR was determined by spline interpolation. Around this point, a volume was assessed according to the measurement resolution and volume size requirements of FCC KDB Publication 865664 D01v01r04 (See Table 4-1) and IEEE 1528-2013. On the basis of this data set, the spatial peak SAR value was evaluated with the following procedure (see references or the DASY manual online for more details):
  - a. SAR values at the inner surface of the phantom are extrapolated from the measured values along the line away from the surface with spacing no greater than that in Table 4-1. The extrapolation was based on a least-squares algorithm. A polynomial of the fourth order was calculated through the points in the z-axis (normal to the phantom shell).
  - b. After the maximum interpolated values were calculated between the points in the cube, the SAR was averaged over the spatial volume (1g or 10g) using a 3D-Spline interpolation algorithm. The 3D-spline is composed of three one-dimensional splines with the “Not a knot” condition (in x, y, and z directions). The volume was then integrated with the trapezoidal algorithm. One thousand points (10 x 10 x 10) were obtained through interpolation, in order to calculate the averaged SAR.
  - c. All neighboring volumes were evaluated until no neighboring volume with a higher average value was found.
4. The SAR reference value, at the same location as step 2, was re-measured after the zoom scan was complete to calculate the SAR drift. If the drift deviated by more than 5%, the SAR test and drift measurements were repeated.

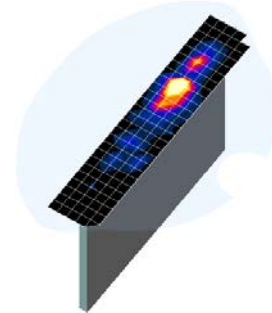

**Figure 4-1**  
Sample SAR Area Scan

**Table 4-1**  
Area and Zoom Scan Resolutions per FCC KDB Publication 865664 D01v01r04\*

Frequency	Maximum Area Scan Resolution (mm) ( $\Delta x_{\text{area}}, \Delta y_{\text{area}}$ )	Maximum Zoom Scan Resolution (mm) ( $\Delta x_{\text{zoom}}, \Delta y_{\text{zoom}}$ )	Maximum Zoom Scan Spatial Resolution (mm)			Minimum Zoom Scan Volume (mm) (x,y,z)
			Uniform Grid	Graded Grid		
			$\Delta z_{\text{zoom}}(n)$	$\Delta z_{\text{zoom}}(1)^*$	$\Delta z_{\text{zoom}}(n>1)^*$	
≤ 2 GHz	≤ 15	≤ 8	≤ 5	≤ 4	≤ 1.5* $\Delta z_{\text{zoom}}(n-1)$	≥ 30
2-3 GHz	≤ 12	≤ 5	≤ 5	≤ 4	≤ 1.5* $\Delta z_{\text{zoom}}(n-1)$	≥ 30
3-4 GHz	≤ 12	≤ 5	≤ 4	≤ 3	≤ 1.5* $\Delta z_{\text{zoom}}(n-1)$	≥ 28
4-5 GHz	≤ 10	≤ 4	≤ 3	≤ 2.5	≤ 1.5* $\Delta z_{\text{zoom}}(n-1)$	≥ 25
5-6 GHz	≤ 10	≤ 4	≤ 2	≤ 2	≤ 1.5* $\Delta z_{\text{zoom}}(n-1)$	≥ 22

\*Also compliant to IEEE 1528-2013 Table 6

FCC ID: ZNFQ720AM		SAR EVALUATION REPORT			Approved by: Quality Manager
Document S/N: 1M1907080114-01-R1.ZNF	Test Dates: 07/08/19 - 07/19/19	DUT Type: Portable Handset			Page 13 of 83

5.1 EAR REFERENCE POINT

Figure 5-2 shows the front, back and side views of the SAM Twin Phantom. The point “M” is the reference point for the center of the mouth, “LE” is the left ear reference point (ERP), and “RE” is the right ERP. The ERP is 15mm posterior to the entrance to the ear canal (EEC) along the B-M line (Back-Mouth), as shown in Figure 5-1. The plane passing through the two ear canals and M is defined as the Reference Plane. The line N-F (Neck-Front), also called the Reference Pivoting Line, is not perpendicular to the reference plane (see Figure 5-1). Line B-M is perpendicular to the N-F line. Both N-F and B-M lines are marked on the external phantom shell to facilitate handset positioning [5].

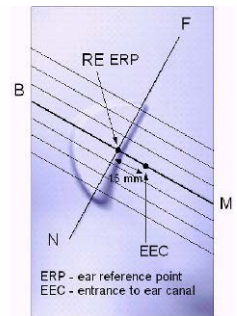

Figure 5-1  
Close-Up Side view of ERP

5.2 HANDSET REFERENCE POINTS

Two imaginary lines on the handset were established: the vertical centerline and the horizontal line. The test device was placed in a normal operating position with the acoustic output located along the “vertical centerline” on the front of the device aligned to the “ear reference point” (See Figure 5-3). The acoustic output was then located at the same level as the center of the ear reference point. The test device was positioned so that the “vertical centerline” was bisecting the front surface of the handset at its top and bottom edges, positioning the “ear reference point” on the outer surface of the both the left and right head phantoms on the ear reference point.



Figure 5-2  
Front, back and side view of SAM Twin Phantom

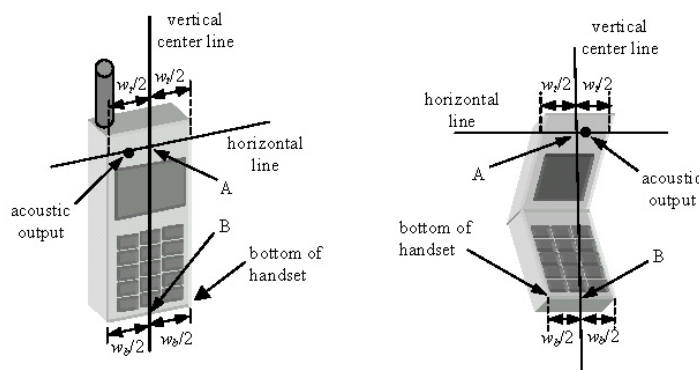



Figure 5-3  
Handset Vertical Center & Horizontal Line Reference Points

FCC ID: ZNFQ720AM	 PCTEST ENGINEERING LABORATORY, INC.	SAR EVALUATION REPORT	 LG	Approved by: Quality Manager
Document S/N: 1M1907080114-01-R1.ZNF	Test Dates: 07/08/19 - 07/19/19	DUT Type: Portable Handset		Page 14 of 83

## 6 TEST CONFIGURATION POSITIONS

### 6.1 Device Holder

The device holder is made out of low-loss POM material having the following dielectric parameters: relative permittivity  $\epsilon = 3$  and loss tangent  $\delta = 0.02$ .

### 6.2 Positioning for Cheek

1. The test device was positioned with the device close to the surface of the phantom such that point A is on the (virtual) extension of the line passing through points RE and LE on the phantom (see Figure 6-1), such that the plane defined by the vertical center line and the horizontal line of the phone is approximately parallel to the sagittal plane of the phantom.

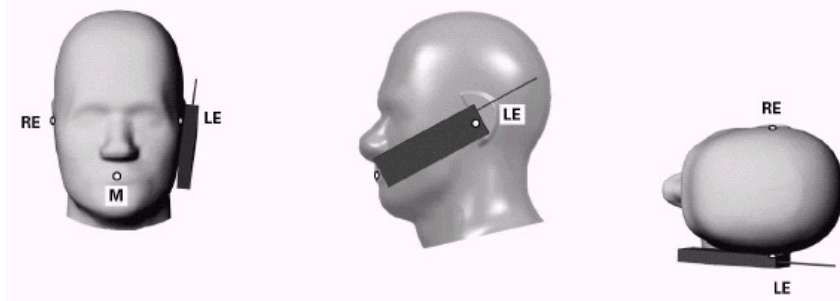



Figure 6-1 Front, Side and Top View of Cheek Position

2. The handset was translated towards the phantom along the line passing through RE & LE until the handset touches the pinna.
3. While maintaining the handset in this plane, the handset was rotated around the LE-RE line until the vertical centerline was in the reference plane.
4. The phone was then rotated around the vertical centerline until the phone (horizontal line) was symmetrical with respect to the line NF.
5. While maintaining the vertical centerline in the reference plane, keeping point A on the line passing through RE and LE, and maintaining the device contact with the ear, the device was rotated about the NF line until any point on the handset made contact with a phantom point below the ear (cheek) (See Figure 6-2).

### 6.3 Positioning for Ear / 15° Tilt

With the test device aligned in the “Cheek Position”:

1. While maintaining the orientation of the phone, the phone was retracted parallel to the reference plane far enough to enable a rotation of the phone by 15 degrees.
2. The phone was then rotated around the horizontal line by 15 degrees.
3. While maintaining the orientation of the phone, the phone was moved parallel to the reference plane until any part of the handset touched the head. (In this position, point A was located on the line RE-LE). The tilted position is obtained when the contact is on the pinna. If the contact was at any location other than the pinna, the angle of the phone would then be reduced. In this situation, the tilted position was obtained when any part of the phone was in contact of the ear as well as a second part of the phone was in contact with the head (see Figure 6-2).

FCC ID: ZNFQ720AM		SAR EVALUATION REPORT		Approved by: Quality Manager
Document S/N: 1M1907080114-01-R1.ZNF	Test Dates: 07/08/19 - 07/19/19	DUT Type: Portable Handset		Page 15 of 83

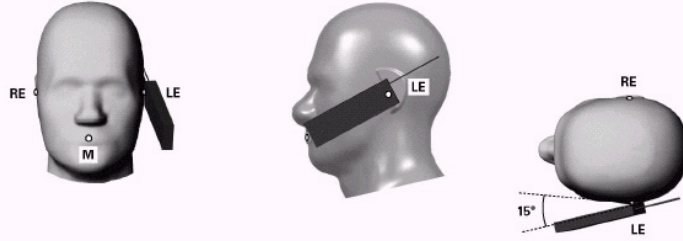

**Figure 6-2 Front, Side and Top View of Ear/15° Tilt Position**

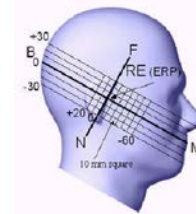

**Figure 6-3 Side view w/ relevant markings**

## 6.4 SAR Evaluations near the Mouth/Jaw Regions of the SAM Phantom

Antennas located near the bottom of a phone may require SAR measurements around the mouth and jaw regions of the SAM head phantom. This typically applies to clam-shell style phones that are generally longer in the unfolded normal use positions or to certain older style long rectangular phones. Per IEEE 1528-2013, a rotated SAM phantom is necessary to allow probe access to such regions. Both SAM heads of the TwinSAM-Chin20 are rotated 20 degrees around the NF line. Each head can be removed from the table for emptying and cleaning.

Under these circumstances, the following procedures apply, adopted from the FCC guidance on SAR handsets document FCC KDB Publication 648474 D04v01r03. The SAR required in these regions of SAM should be measured using a flat phantom. The phone should be positioned with a separation distance of 4 mm between the ear reference point (ERP) and the outer surface of the flat phantom shell. While maintaining this distance at the ERP location, the low (bottom) edge of the phone should be lowered from the phantom to establish the same separation distance between the peak SAR location identified by the truncated partial SAR distribution measured with the SAM phantom. The distance from the peak SAR location to the phone is determined by the straight line passing perpendicularly through the phantom surface. When it is not feasible to maintain 4 mm separation at the ERP while also establishing the required separation at the peak SAR location, the top edge of the phone will be allowed to touch the phantom with a separation < 4 mm at the ERP. The phone should not be tilted to the left or right while placed in this inclined position to the flat phantom.

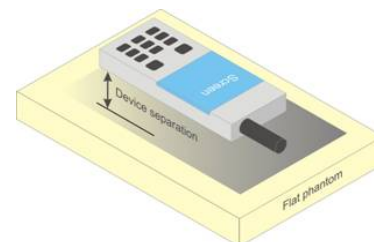

## 6.5 Body-Worn Accessory Configurations

Body-worn operating configurations are tested with the belt-clips and holsters attached to the device and positioned against a flat phantom in a normal use configuration (see Figure 6-4). Per FCC KDB Publication 648474 D04v01r03, Body-worn accessory exposure is typically related to voice mode operations when handsets are carried in body-worn accessories. The body-worn accessory procedures in FCC KDB Publication 447498 D01v06 should be used to test for body-worn accessory SAR compliance, without a headset connected to it. This enables the test results for such configuration to be compatible with that required for hotspot mode when the body-worn accessory test separation distance is greater than or equal to that required for hotspot mode, when applicable. When the reported SAR for a body-worn accessory, measured without a headset connected to the handset, is > 1.2 W/kg, the highest reported SAR configuration for that wireless mode and frequency band should be repeated for that body-worn accessory with a headset attached to the handset.



**Figure 6-4 Sample Body-Worn Diagram**

Accessories for Body-worn operation configurations are divided into two categories: those that do not contain metallic components and those that do contain metallic components. When multiple accessories that do not

FCC ID: ZNFQ720AM		SAR EVALUATION REPORT		Approved by: Quality Manager
Document S/N: 1M1907080114-01-R1.ZNF	Test Dates: 07/08/19 - 07/19/19	DUT Type: Portable Handset		Page 16 of 83



contain metallic components are supplied with the device, the device is tested with only the accessory that dictates the closest spacing to the body. Then multiple accessories that contain metallic components are tested with the device with each accessory. If multiple accessories share an identical metallic component (i.e. the same metallic belt-clip used with different holsters with no other metallic components) only the accessory that dictates the closest spacing to the body is tested.

Body-worn accessories may not always be supplied or available as options for some devices intended to be authorized for body-worn use. In this case, a test configuration with a separation distance between the back of the device and the flat phantom is used. Test position spacing was documented. Transmitters that are designed to operate in front of a person's face, as in push-to-talk configurations, are tested for SAR compliance with the front of the device positioned to face the flat phantom in head fluid. For devices that are carried next to the body such as a shoulder, waist or chest-worn transmitters, SAR compliance is tested with the accessories, including headsets and microphones, attached to the device and positioned against a flat phantom in a normal use configuration.

## 6.6 Extremity Exposure Configurations

Devices that are designed or intended for use on extremities or mainly operated in extremity only exposure conditions; i.e., hands, wrists, feet and ankles, may require extremity SAR evaluation. When the device also operates in close proximity to the user's body, SAR compliance for the body is also required. The 1g body and 10g extremity SAR Exclusion Thresholds found in KDB Publication 447498 D01v06 should be applied to determine SAR test requirements.

Per KDB Publication 447498 D01v06, Cell phones (handsets) are not normally designed to be used on extremities or operated in extremity only exposure conditions. The maximum output power levels of handsets generally do not require extremity SAR testing to show compliance. Therefore, extremity SAR was not evaluated for this device.



## 6.7 Wireless Router Configurations

Some battery-operated handsets have the capability to transmit and receive user data through simultaneous transmission of WIFI simultaneously with a separate licensed transmitter. The FCC has provided guidance in FCC KDB Publication 941225 D06v02r01 where SAR test considerations for handsets ( $L \times W \geq 9 \text{ cm} \times 5 \text{ cm}$ ) are based on a composite test separation distance of 10 mm from the front, back and edges of the device containing transmitting antennas within 2.5 cm of their edges, determined from general mixed use conditions for this type of devices. Since the hotspot SAR results may overlap with the body-worn accessory SAR requirements, the more conservative configurations can be considered, thus excluding some body-worn accessory SAR tests.

When the user enables the personal wireless router functions for the handset, actual operations include simultaneous transmission of both the WIFI transmitter and another licensed transmitter. Both transmitters often do not transmit at the same transmitting frequency and thus cannot be evaluated for SAR under actual use conditions due to the limitations of the SAR assessment probes. Therefore, SAR must be evaluated for each frequency transmission and mode separately and spatially summed with the WIFI transmitter according to FCC KDB Publication 447498 D01v06 procedures. The "Portable Hotspot" feature on the handset was NOT activated during SAR assessments, to ensure the SAR measurements were evaluated for a single transmission frequency RF signal at a time.

## 6.8 Phablet Configurations



For smart phones with a display diagonal dimension > 150 mm or an overall diagonal dimension > 160 mm that provide similar mobile web access and multimedia support found in mini-tablets or UMPC mini-tablets that

FCC ID: ZNFQ720AM		SAR EVALUATION REPORT		Approved by: Quality Manager
Document S/N: 1M1907080114-01-R1.ZNF	Test Dates: 07/08/19 - 07/19/19	DUT Type: Portable Handset	Page 17 of 83	

support voice calls next to the ear, the phablets procedures outlined in KDB Publication 648474 D04v01r03 should be applied to evaluate SAR compliance. A device marketed as phablets, regardless of form factors and operating characteristics must be tested as a phablet to determine SAR compliance.

## 6.9 Proximity Sensor Considerations

This device uses a power reduction mechanism to reduce output powers in certain use conditions when the device is used close the user's body. When the device's antenna is within a certain distance of the user, the sensor activates and reduces the maximum allowed output power. However, the sensor is not active when the device is moved beyond the sensor triggering distance and the maximum output power is no longer limited. Therefore, additional evaluation is needed in the vicinity of the triggering distance to ensure SAR is compliant when the device is allowed to operate at a nonreduced output power level. FCC KDB Publication 616217 D04v01r02 Section 6 was used as a guideline for selecting SAR test distances for this device at these additional test positions. Sensor triggering distance summary data is included in Appendix G. The sensor is designed to support sufficient detection range and sensitivity to cover regions of the sensors in all applicable directions since the sensor entirely covers the antennas.

FCC ID: ZNFQ720AM		SAR EVALUATION REPORT		Approved by: Quality Manager
Document S/N: 1M1907080114-01-R1.ZNF	Test Dates: 07/08/19 - 07/19/19	DUT Type: Portable Handset		Page 18 of 83

# 7 RF EXPOSURE LIMITS

## 7.1 Uncontrolled Environment

UNCONTROLLED ENVIRONMENTS are defined as locations where there is the exposure of individuals who have no knowledge or control of their exposure. The general population/uncontrolled exposure limits are applicable to situations in which the general public may be exposed or in which persons who are exposed as a consequence of their employment may not be made fully aware of the potential for exposure or cannot exercise control over their exposure. Members of the general public would come under this category when exposure is not employment-related; for example, in the case of a wireless transmitter that exposes persons in its vicinity.



## 7.2 Controlled Environment

CONTROLLED ENVIRONMENTS are defined as locations where there is exposure that may be incurred by persons who are aware of the potential for exposure, (i.e. as a result of employment or occupation). In general, occupational/controlled exposure limits are applicable to situations in which persons are exposed as a consequence of their employment, who have been made fully aware of the potential for exposure and can exercise control over their exposure. This exposure category is also applicable when the exposure is of a transient nature due to incidental passage through a location where the exposure levels may be higher than the general population/uncontrolled limits, but the exposed person is fully aware of the potential for exposure and can exercise control over his or her exposure by leaving the area or by some other appropriate means.

**Table 7-1  
SAR Human Exposure Specified in ANSI/IEEE C95.1-1992 and Health Canada Safety Code 6**

HUMAN EXPOSURE LIMITS		
	UNCONTROLLED ENVIRONMENT <i>General Population</i> (W/kg) or (mW/g)	CONTROLLED ENVIRONMENT <i>Occupational</i> (W/kg) or (mW/g)
<b>Peak Spatial Average SAR</b> Head	1.6	8.0
<b>Whole Body SAR</b>	0.08	0.4
<b>Peak Spatial Average SAR</b> Hands, Feet, Ankle, Wrists, etc.	4.0	20

1. The Spatial Peak value of the SAR averaged over any 1 gram of tissue (defined as a tissue volume in the shape of a cube) and over the appropriate averaging time.
2. The Spatial Average value of the SAR averaged over the whole body.
3. The Spatial Peak value of the SAR averaged over any 10 grams of tissue (defined as a tissue volume in the shape of a cube) and over the appropriate averaging time.

FCC ID: ZNFQ720AM		SAR EVALUATION REPORT		Approved by: Quality Manager
Document S/N: 1M1907080114-01-R1.ZNF	Test Dates: 07/08/19 - 07/19/19	DUT Type: Portable Handset		Page 19 of 83

Power measurements for licensed transmitters are performed using a base station simulator under digital average power.

### 8.1 Measured and Reported SAR

Per FCC KDB Publication 447498 D01v06, when SAR is not measured at the maximum power level allowed for production units, the results must be scaled to the maximum tune-up tolerance limit according to the power applied to the individual channels tested to determine compliance. For simultaneous transmission, the measured aggregate SAR must be scaled according to the sum of the differences between the maximum tune-up tolerance and actual power used to test each transmitter. When SAR is measured at or scaled to the maximum tune-up tolerance limit, the results are referred to as *reported* SAR. The highest *reported* SAR results are identified on the grant of equipment authorization according to procedures in KDB 690783 D01v01r03.

### 8.2 3G SAR Test Reduction Procedure

In FCC KDB Publication 941225 D01v03r01, certain transmission modes within a frequency band and wireless mode evaluated for SAR are defined as primary modes. The equivalent modes considered for SAR test reduction are denoted as secondary modes. When the maximum output power including tune-up tolerance specified for production units in a secondary mode is  $\leq 0.25$  dB higher than the primary mode or when the highest reported SAR of the primary mode, scaled by the ratio of specified maximum output power and tune-up tolerance of secondary to primary mode, is  $\leq 1.2$  W/kg, SAR measurements are not required for the secondary mode. These criteria are referred to as the 3G SAR test reduction procedure. When the 3G SAR test reduction procedure is not satisfied, SAR measurements are additionally required for the secondary mode.

### 8.3 Procedures Used to Establish RF Signal for SAR



The following procedures are according to FCC KDB Publication 941225 D01v03r01 “3G SAR Measurement Procedures.”

The device is placed into a simulated call using a base station simulator in a RF shielded chamber. Establishing connections in this manner ensure a consistent means for testing SAR and are recommended for evaluating SAR [4]. Devices under test are evaluated prior to testing, with a fully charged battery and were configured to operate at maximum output power. In order to verify that the device is tested throughout the SAR test at maximum output power, the SAR measurement system measures a “point SAR” at an arbitrary reference point at the start and end of the 1 gram SAR evaluation, to assess for any power drifts during the evaluation. If the power drift deviates by more than 5%, the SAR test and drift measurements are repeated.

### 8.4 SAR Measurement Conditions for UMTS

#### 8.4.1 Output Power Verification

Maximum output power is verified on the High, Middle and Low channels according to the general descriptions in section 5.2 of 3GPP TS 34.121, using the appropriate RMC with TPC (transmit power control) set to all “1s” or applying the required inner loop power control procedures to maintain maximum output power while HSUPA is active. Results for all applicable physical channel configurations (DPCCH, DPDCHn and spreading codes, HS-DPCCH etc) are tabulated in this test report. All configurations that are not supported by the DUT or cannot be measured due to technical or equipment limitations are identified.

FCC ID: ZNFQ720AM		SAR EVALUATION REPORT		Approved by: Quality Manager
Document S/N: 1M1907080114-01-R1.ZNF	Test Dates: 07/08/19 - 07/19/19	DUT Type: Portable Handset		Page 20 of 83

## 8.4.2 Head SAR Measurements

SAR for next to the ear head exposure is measured using a 12.2 kbps RMC with TPC bits configured to all “1’s”. The 3G SAR test reduction procedure is applied to AMR configurations with 12.2 kbps RMC as the primary mode. Otherwise, SAR is measured for 12.2 kbps AMR in 3.4 kbps SRB (signaling radio bearer) using the highest reported SAR configuration in 12.2 kbps RMC for head exposure.

## 8.4.3 Body SAR Measurements

SAR for body exposure configurations is measured using the 12.2 kbps RMC with the TPC bits all “1s”. The 3G SAR test reduction procedure is applied to other spreading codes and multiple DPDCH<sub>n</sub> configurations supported by the handset with 12.2 kbps RMC as the primary mode. Otherwise, SAR is measured using an applicable RMC configuration with the corresponding spreading code or DPDCH<sub>n</sub>, for the highest reported SAR configuration in 12.2 kbps RMC.

## 8.4.4 SAR Measurements with Rel 5 HSDPA

The 3G SAR test reduction procedure is applied to HSDPA body configurations with 12.2 kbps RMC as the primary mode. Otherwise, Body SAR for HSDPA is measured using an FRC with H-Set 1 in Sub-test 1 and a 12.2 kbps RMC configured in Test Loop Mode 1, for the highest reported SAR configuration in 12.2 kbps RMC without HSDPA. Handsets with both HSDPA and HSUPA are tested according to Release 6 HSPA test procedures.

## 8.4.5 SAR Measurements with Rel 6 HSUPA

The 3G SAR test reduction procedure is applied to HSPA (HSUPA/HSDPA with RMC) body configurations with 12.2 kbps RMC as the primary mode. Otherwise, Body SAR for HSPA is measured with E-DCH Sub-test 5, using H-Set 1 and QPSK for FRC and a 12.2 kbps RMC configured in Test Loop Mode 1 and power control algorithm 2, according to the highest reported body SAR configuration in 12.2 kbps RMC without HSPA.

When VOIP applies to head exposure, the 3G SAR test reduction procedure is applied with 12.2 kbps RMC as the primary mode; otherwise, the same HSPA configuration used for body SAR measurements are applied to head exposure testing.

## 8.5 SAR Measurement Conditions for LTE



LTE modes are tested according to FCC KDB 941225 D05v02r04 publication. Establishing connections with base station simulators ensure a consistent means for testing SAR and are recommended for evaluating SAR [4]. The R&S CMW500 or Anritsu MT8820C simulators are used for LTE output power measurements and SAR testing. Closed loop power control was used so the UE transmits with maximum output power during SAR testing. SAR tests were performed with the same number of RB and RB offsets transmitting on all TTI frames (maximum TTI).

### 8.5.1 Spectrum Plots for RB Configurations

A properly configured base station simulator was used for SAR tests and power measurements. Therefore, spectrum plots for RB configurations were not required to be included in this report.

### 8.5.2 MPR

MPR is permanently implemented for this device by the manufacturer. The specific manufacturer target MPR is indicated alongside the SAR results. MPR is enabled for this device, according to 3GPP TS36.101 Section 6.2.3 – 6.2.5 under Table 6.2.3-1.

FCC ID: ZNFQ720AM		SAR EVALUATION REPORT		Approved by: Quality Manager
Document S/N: 1M1907080114-01-R1.ZNF	Test Dates: 07/08/19 - 07/19/19	DUT Type: Portable Handset		Page 21 of 83

### 8.5.3 A-MPR

A-MPR (Additional MPR) has been disabled for all SAR tests by setting NS=01 on the base station simulator.

### 8.5.4 Required RB Size and RB Offsets for SAR Testing

According to FCC KDB 941225 D05v02r04:



- a. Per Section 5.2.1, SAR is required for QPSK 1 RB Allocation for the largest bandwidth
  - i. The required channel and offset combination with the highest maximum output power is required for SAR.
  - ii. When the reported SAR is  $\leq 0.8$  W/kg, testing of the remaining RB offset configurations and required test channels is not required. Otherwise, SAR is required for the remaining required test channels using the RB offset configuration with highest output power for that channel.
  - iii. When the reported SAR for a required test channel is  $> 1.45$  W/kg, SAR is required for all RB offset configurations for that channel.
- b. Per Section 5.2.2, SAR is required for 50% RB allocation using the largest bandwidth following the same procedures outlined in Section 5.2.1.
- c. Per Section 5.2.3, QPSK SAR is not required for the 100% allocation when the highest maximum output power for the 100% allocation is less than the highest maximum output power of the 1 RB and 50% RB allocations and the reported SAR for the 1 RB and 50% RB allocations is  $< 0.8$  W/kg.
- d. Per Section 5.2.4 and 5.3, SAR tests for higher order modulations and lower bandwidths configurations are not required when the conducted power of the required test configurations determined by Sections 5.2.1 through 5.2.3 is less than or equal to  $\frac{1}{2}$  dB higher than the equivalent configuration using QPSK modulation and when the QPSK SAR for those configurations is  $< 1.45$  W/kg.

### 8.5.5 Downlink Only Carrier Aggregation

Conducted power measurements with LTE Carrier Aggregation (CA) (downlink only) active are made in accordance to KDB Publication 941225 D05Av01r02. The RRC connection is only handled by one cell, the primary component carrier (PCC) for downlink and uplink communications. After making a data connection to the PCC, the UE device adds secondary component carrier(s) (SCC) on the downlink only. All uplink communications and acknowledgements remain identical to specifications when downlink carrier aggregation is inactive on the PCC. Additional conducted output powers are measured with the downlink carrier aggregation active for the configuration with highest measured maximum conducted power with downlink carrier aggregation inactive measured among the channel bandwidth, modulation, and RB combinations in each frequency band. Per FCC KDB Publication 941225 D05Av01r02, no SAR measurements are required for downlink only carrier aggregation configurations when the average output power with downlink only carrier aggregation active is not more than 0.25 dB higher than the average output power with downlink only carrier aggregation inactive.

## 8.6 SAR Testing with 802.11 Transmitters

The normal network operating configurations of 802.11 transmitters are not suitable for SAR measurements. Unpredictable fluctuations in network traffic and antenna diversity conditions can introduce undesirable variations in SAR results. The SAR for these devices should be measured using chipset based test mode software to ensure the results are consistent and reliable. See KDB Publication 248227 D01v02r02 for more details.

FCC ID: ZNFQ720AM		SAR EVALUATION REPORT		Approved by: Quality Manager
Document S/N: 1M1907080114-01-R1.ZNF	Test Dates: 07/08/19 - 07/19/19	DUT Type: Portable Handset		Page 22 of 83 REV 21.3 M 02/15/2019

### 8.6.1 General Device Setup

Chipset based test mode software is hardware dependent and generally varies among manufacturers. The device operating parameters established in test mode for SAR measurements must be identical to those programmed in production units, including output power levels, amplifier gain settings and other RF performance tuning parameters.

A periodic duty factor is required for current generation SAR systems to measure SAR. When 802.11 frame gaps are accounted for in the transmission, a maximum transmission duty factor of 92 - 96% is typically achievable in most test mode configurations. A minimum transmission duty factor of 85% is required to avoid certain hardware and device implementation issues related to wide range SAR scaling. The reported SAR is scaled to 100% transmission duty factor to determine compliance at the maximum tune-up tolerance limit.

### 8.6.2 U-NII-1 and U-NII-2A

For devices that operate in both U-NII-1 and U-NII-2A bands, when the same maximum output power is specified for both bands, SAR measurement using OFDM SAR test procedures is not required for U-NII-1 unless the highest reported SAR for U-NII-2A is  $> 1.2$  W/kg. When different maximum output powers are specified for the bands, SAR measurement for the U-NII band with the lower maximum output power is not required unless the highest reported SAR for the U-NII band with the higher maximum output power, adjusted by the ratio of lower to higher specified maximum output power for the two bands, is  $> 1.2$  W/kg. When 10g SAR measurement is considered, a factor of 2.5 is applied to the thresholds above.

### 8.6.3 U-NII-2C and U-NII-3

The frequency range covered by U-NII-2C and U-NII-3 is 380 MHz (5.47 – 5.85 GHz), which requires a minimum of at least two SAR probe calibration frequency points to support SAR measurements. When Terminal Doppler Weather Radar (TDWR) restriction applies, the channels at 5.60 – 5.65 GHz in U-NII-2C band must be disabled with acceptable mechanisms and documented in the equipment certification. Unless band gap channels are permanently disabled, SAR must be considered for these channels. Each band is tested independently according to the normally required OFDM SAR measurement and probe calibration frequency points requirements.



### 8.6.4 Initial Test Position Procedure

For exposure conditions with multiple test positions, such as handset operating next to the ear, devices with hotspot mode or UMPC mini-tablet, procedures for initial test position can be applied. Using the transmission mode determined by the DSSS procedure or initial test configuration, area scans are measured for all positions in an exposure condition. The test position with the highest extrapolated (peak) SAR is used as the initial test position. When reported SAR for the initial test position is  $\leq 0.4$  W/kg, no additional testing for the remaining test positions is required. Otherwise, SAR is evaluated at the subsequent highest peak SAR positions until the reported SAR result is  $\leq 0.8$  W/kg or all test positions are measured. When 10g SAR measurement is considered, a factor of 2.5 is applied to the thresholds above.

### 8.6.5 2.4 GHz SAR Test Requirements

SAR is measured for 2.4 GHz 802.11b DSSS using either the fixed test position or, when applicable, the initial test position procedure. SAR test reduction is determined according to the following:

- 1) When the reported SAR of the highest measured maximum output power channel for the exposure configuration is  $\leq 0.8$  W/kg, no further SAR testing is required for 802.11b DSSS in that exposure configuration.

FCC ID: ZNFQ720AM		SAR EVALUATION REPORT		Approved by: Quality Manager
Document S/N: 1M1907080114-01-R1-ZNF	Test Dates: 07/08/19 - 07/19/19	DUT Type: Portable Handset		Page 23 of 83

- 2) When the reported SAR is > 0.8 W/kg, SAR is required for that position using the next highest measured output power channel. When any reported SAR is > 1.2 W/kg, SAR is required for the third channel; i.e., all channels require testing.

2.4 GHz 802.11 g/n OFDM are additionally evaluated for SAR if the highest reported SAR for 802.11b, adjusted by the ratio of the OFDM to DSSS specified maximum output power, is > 1.2 W/kg. When SAR is required for OFDM modes in 2.4 GHz band, the Initial Test Configuration Procedures should be followed. When 10g SAR measurement is considered, a factor of 2.5 is applied to the thresholds above.

### 8.6.6 OFDM Transmission Mode and SAR Test Channel Selection

When the same maximum output power was specified for multiple OFDM transmission mode configurations in a frequency band or aggregated band, SAR is measured using the configuration with the largest channel bandwidth, lowest order modulation and lowest data rate. When the maximum output power of a channel is the same for equivalent OFDM configurations; for example, 802.11a, 802.11n and 802.11ac or 802.11g and 802.11n with the same channel bandwidth, modulation and data rate etc., the lower order 802.11 mode i.e., 802.11a, then 802.11n and 802.11ac or 802.11g then 802.11n, is used for SAR measurement. When the maximum output power are the same for multiple test channels, either according to the default or additional power measurement requirements, SAR is measured using the channel closest to the middle of the frequency band or aggregated band. When there are multiple channels with the same maximum output power, SAR is measured using the higher number channel.



### 8.6.7 Initial Test Configuration Procedure

For OFDM, an initial test configuration is determined for each frequency band and aggregated band, according to the transmission mode with the highest maximum output power specified for SAR measurements. When the same maximum output power is specified for multiple OFDM transmission mode configurations in a frequency band or aggregated band, SAR is measured using the configuration(s) with the largest channel bandwidth, lowest order modulation, lowest data rate and lowest order IEEE 802.11 mode. The channel of the transmission mode with the highest average RF output conducted power will be the initial test configuration.

When the reported SAR is  $\leq 0.8$  W/kg, no additional measurements on other test channels are required. Otherwise, SAR is evaluated using the subsequent highest average RF output channel until the reported SAR result is  $\leq 1.2$  W/kg or all channels are measured. When there are multiple untested channels having the same subsequent highest average RF output power, the channel with higher frequency from the lowest 802.11 mode is considered for SAR measurements (See Section 8.6.6). When 10g SAR measurement is considered, a factor of 2.5 is applied to the thresholds above.

### 8.6.8 Subsequent Test Configuration Procedures

For OFDM configurations in each frequency band and aggregated band, SAR is evaluated for initial test configuration using the fixed test position or the initial test position procedure. When the highest reported SAR (for the initial test configuration), adjusted by the ratio of the specified maximum output power of the subsequent test configuration to initial test configuration, is  $\leq 1.2$  W/kg, no additional SAR tests for the subsequent test configurations are required. When 10g SAR measurement is considered, a factor of 2.5 is applied to the thresholds above.

FCC ID: ZNFQ720AM		SAR EVALUATION REPORT		Approved by: Quality Manager
Document S/N: 1M1907080114-01-R1.ZNF	Test Dates: 07/08/19 - 07/19/19	DUT Type: Portable Handset	Page 24 of 83	





## 9.1 GSM Conducted Powers

Table 9-1  
Maximum Conducted Power

Maximum Burst-Averaged Output Power						
Band	Channel	Voice	GPRS/EDGE Data (GMSK)		EDGE Data (8-PSK)	
		GSM [dBm] CS (1 Slot)	GPRS [dBm] 1 Tx Slot	GPRS [dBm] 2 Tx Slot	EDGE [dBm] 1 Tx Slot	EDGE [dBm] 2 Tx Slot
GSM 850	128	32.74	32.83	<b>31.40</b>	27.35	26.18
	190	32.96	32.99	<b>31.57</b>	27.40	26.22
	251	32.63	32.70	<b>31.54</b>	27.31	26.28
GSM 1900	512	30.65	30.64	<b>28.59</b>	26.01	25.29
	661	30.69	30.68	<b>28.63</b>	26.06	25.30
	810	30.70	30.70	<b>28.70</b>	26.09	25.50

Calculated Maximum Frame-Averaged Output Power						
Band	Channel	Voice	GPRS/EDGE Data (GMSK)		EDGE Data (8-PSK)	
		GSM [dBm] CS (1 Slot)	GPRS [dBm] 1 Tx Slot	GPRS [dBm] 2 Tx Slot	EDGE [dBm] 1 Tx Slot	EDGE [dBm] 2 Tx Slot
GSM 850	128	23.71	23.80	<b>25.38</b>	18.32	20.16
	190	23.93	23.96	<b>25.55</b>	18.37	20.20
	251	23.60	23.67	<b>25.52</b>	18.28	20.26
GSM 1900	512	21.62	21.61	<b>22.57</b>	16.98	19.27
	661	21.66	21.65	<b>22.61</b>	17.03	19.28
	810	21.67	21.67	<b>22.68</b>	17.06	19.48

<b>GSM 850</b>	<b>Frame</b>	23.67	23.67	<b>25.68</b>	18.17	21.18
<b>GSM 1900</b>	<b>Avg. Targets:</b>	21.17	21.17	<b>22.18</b>	16.67	19.68



FCC ID: ZNFQ720AM		SAR EVALUATION REPORT				Approved by: Quality Manager
Document S/N: 1M1907080114-01-R1.ZNF	Test Dates: 07/08/19 - 07/19/19	DUT Type: Portable Handset		Page 25 of 83		

Note:

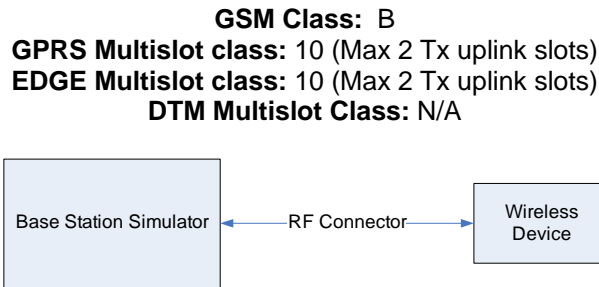
1. Both burst-averaged and calculated frame-averaged powers are included. Frame-averaged power was calculated from the measured burst-averaged power by converting the slot powers into linear units and calculating the energy over 8 timeslots.
2. GPRS/EDGE (GMSK) output powers were measured with coding scheme setting of 1 (CS1) on the base station simulator. CS1 was configured to measure GPRS output power measurements and SAR to ensure GMSK modulation in the signal. Our Investigation has shown that CS1 - CS4 settings do not have any impact on the output levels or modulation in the GPRS modes.
3. EDGE (8-PSK) output powers were measured with MCS7 on the base station simulator. MCS7 coding scheme was used to measure the output powers for EDGE since investigation has shown that choosing MCS7 coding scheme will ensure 8-PSK modulation. It has been shown that MCS levels that produce 8PSK modulation do not have an impact on output power.



**Figure 9-1**  
**Power Measurement Setup**

FCC ID: ZNFQ720AM	 PCTEST ENGINEERING LABORATORY, INC.	SAR EVALUATION REPORT	 LG	Approved by: Quality Manager
Document S/N: 1M1907080114-01-R1.ZNF	Test Dates: 07/08/19 - 07/19/19	DUT Type: Portable Handset	Page 26 of 83	

## 9.2 UMTS Conducted Powers



**Table 9-2  
Maximum Conducted Power**

3GPP Release Version	Mode	3GPP 34.121 Subtest	Cellular Band [dBm]			AWS Band [dBm]			PCS Band [dBm]			3GPP MPR [dB]
			4132	4183	4233	1312	1412	1513	9262	9400	9538	
99	WCDMA	12.2 kbps RMC	25.20	25.10	25.15	23.68	23.90	23.79	23.95	23.86	24.00	-
99		12.2 kbps AMR	25.19	25.11	25.16	23.76	23.87	23.77	23.95	23.88	23.95	-
6	HSDPA	Subtest 1	25.22	25.02	25.05	23.77	23.80	23.64	23.90	23.81	23.93	0
6		Subtest 2	25.38	25.15	25.31	23.60	23.79	23.63	23.87	23.82	23.89	0
6		Subtest 3	24.97	24.55	24.40	23.22	23.27	23.15	23.35	23.27	23.30	0.5
6		Subtest 4	24.97	24.70	24.65	23.20	23.25	23.13	23.39	23.29	23.28	0.5
6	HSUPA	Subtest 1	25.38	25.25	25.12	23.41	23.54	23.50	23.61	23.75	23.69	0
6		Subtest 2	23.28	22.86	23.01	21.77	21.69	21.65	21.88	21.89	21.98	2
6		Subtest 3	23.98	23.97	23.91	22.81	22.63	22.67	22.85	22.75	22.90	1
6		Subtest 4	23.07	23.02	23.01	21.76	21.71	21.65	21.98	21.88	21.97	2
6		Subtest 5	25.47	25.19	25.30	23.79	23.74	23.69	23.80	23.82	23.94	0

This device does not support DC-HSDPA.



**Figure 9-2  
Power Measurement Setup**

FCC ID: ZNFQ720AM	 <b>PCTEST</b> ENGINEERING LABORATORY, INC.	<b>SAR EVALUATION REPORT</b>		<b>Approved by:</b> Quality Manager
<b>Document S/N:</b> 1M1907080114-01-R1.ZNF	<b>Test Dates:</b> 07/08/19 - 07/19/19	<b>DUT Type:</b> Portable Handset	Page 27 of 83	

### 9.3 LTE Conducted Powers

#### 9.3.1 LTE Band 12



**Table 9-3  
LTE Band 12 Conducted Powers - 10 MHz Bandwidth**

LTE Band 12 10 MHz Bandwidth					
Modulation	RB Size	RB Offset	Mid Channel	MPR Allowed per 3GPP [dB]	MPR [dB]
			23095 (707.5 MHz)		
			Conducted Power [dBm]		
QPSK	1	0	25.26	0	0
	1	25	25.12		0
	1	49	25.09		0
	25	0	23.61	0-1	1
	25	12	23.55		1
	25	25	23.56		1
	50	0	23.52		1
16QAM	1	0	23.77	0-1	1
	1	25	23.75		1
	1	49	23.62		1
	25	0	22.64	0-2	2
	25	12	22.56		2
	25	25	22.60		2
	50	0	22.62		2

Note: LTE Band 12 at 10 MHz bandwidth does not support three non-overlapping channels. Per KDB Publication 941225 D05v02, when a device supports overlapping channel assignment in a channel bandwidth configuration, the middle channel of the group of overlapping channels should be selected for testing.

**Table 9-4  
LTE Band 12 Conducted Powers - 5 MHz Bandwidth**

LTE Band 12 5 MHz Bandwidth							
Modulation	RB Size	RB Offset	Low Channel	Mid Channel	High Channel	MPR Allowed per 3GPP [dB]	MPR [dB]
			23035 (701.5 MHz)	23095 (707.5 MHz)	23155 (713.5 MHz)		
			Conducted Power [dBm]				
QPSK	1	0	25.25	25.20	25.21	0	0
	1	12	25.23	25.12	25.10		0
	1	24	25.17	25.10	25.15		0
	12	0	23.49	23.56	23.50	0-1	1
	12	6	23.51	23.65	23.49		1
	12	13	23.50	23.63	23.48		1
	25	0	23.45	23.56	23.44		1
16QAM	1	0	23.84	23.83	23.86	0-1	1
	1	12	23.80	23.84	23.84		1
	1	24	23.75	23.71	23.82		1
	12	0	22.58	22.45	22.58	0-2	2
	12	6	22.55	22.48	22.55		2
	12	13	22.54	22.58	22.52		2
	25	0	22.47	22.53	22.45		2



FCC ID: ZNFQ720AM		SAR EVALUATION REPORT		Approved by: Quality Manager
Document S/N: 1M1907080114-01-R1.ZNF	Test Dates: 07/08/19 - 07/19/19	DUT Type: Portable Handset		Page 28 of 83

**Table 9-5**  
**LTE Band 12 Conducted Powers - 3 MHz Bandwidth**

LTE Band 12 3 MHz Bandwidth							
Modulation	RB Size	RB Offset	Low Channel	Mid Channel	High Channel	MPR Allowed per 3GPP [dB]	MPR [dB]
			23025 (700.5 MHz)	23095 (707.5 MHz)	23165 (714.5 MHz)		
			Conducted Power [dBm]				
QPSK	1	0	25.25	25.20	25.23	0	0
	1	7	25.32	25.22	25.21		0
	1	14	25.28	25.11	25.28		0
	8	0	23.45	23.44	23.46	0-1	1
	8	4	23.50	23.48	23.55		1
	8	7	23.50	23.49	23.49		1
	15	0	23.46	23.47	23.45		1
16QAM	1	0	23.75	23.85	23.77	0-1	1
	1	7	23.77	23.94	23.93		1
	1	14	23.80	23.85	23.80		1
	8	0	22.44	22.53	22.51	0-2	2
	8	4	22.62	22.57	22.57		2
	8	7	22.55	22.53	22.65		2
	15	0	22.45	22.46	22.45		2

**Table 9-6**  
**LTE Band 12 Conducted Powers - 1.4 MHz Bandwidth**

LTE Band 12 1.4 MHz Bandwidth							
Modulation	RB Size	RB Offset	Low Channel	Mid Channel	High Channel	MPR Allowed per 3GPP [dB]	MPR [dB]
			23017 (699.7 MHz)	23095 (707.5 MHz)	23173 (715.3 MHz)		
			Conducted Power [dBm]				
QPSK	1	0	25.02	25.15	25.14	0	0
	1	2	25.01	25.11	25.27		0
	1	5	25.07	25.10	25.33		0
	3	0	25.00	25.14	25.03		0
	3	2	25.00	25.19	25.22		0
	3	3	25.00	25.14	25.09		0
	6	0	23.34	23.36	23.45	0-1	1
16QAM	1	0	23.61	23.82	23.77	0-1	1
	1	2	23.80	23.89	23.77		1
	1	5	23.59	23.78	23.77		1
	3	0	23.39	23.53	23.50		1
	3	2	23.49	23.54	23.65		1
	3	3	23.43	23.48	23.56		1
	6	0	22.37	22.41	22.53	0-2	2

FCC ID: ZNFQ720AM		SAR EVALUATION REPORT		Approved by: Quality Manager
Document S/N: 1M1907080114-01-R1.ZNF	Test Dates: 07/08/19 - 07/19/19	DUT Type: Portable Handset		Page 29 of 83

9.3.2

LTE Band 14



**Table 9-7**  
**LTE Band 14 Conducted Powers - 10 MHz Bandwidth**

LTE Band 14 10 MHz Bandwidth					
Modulation	RB Size	RB Offset	Mid Channel	MPR Allowed per 3GPP [dB]	MPR [dB]
			23330 (793.0 MHz)		
			Conducted Power [dBm]		
QPSK	1	0	25.34	0	0
	1	25	25.29		0
	1	49	25.26		0
	25	0	23.44	0-1	1
	25	12	23.52		1
	25	25	23.45		1
	50	0	23.49		1
16QAM	1	0	23.76	0-1	1
	1	25	23.71		1
	1	49	23.59		1
	25	0	22.50	0-2	2
	25	12	22.45		2
	25	25	22.46		2
	50	0	22.35		2

**Table 9-8**  
**LTE Band 14 Conducted Powers - 5 MHz Bandwidth**

LTE Band 14 5 MHz Bandwidth					
Modulation	RB Size	RB Offset	Mid Channel	MPR Allowed per 3GPP [dB]	MPR [dB]
			23330 (793.0 MHz)		
			Conducted Power [dBm]		
QPSK	1	0	25.35	0	0
	1	12	25.30		0
	1	24	25.32		0
	12	0	23.75	0-1	1
	12	6	23.60		1
	12	13	23.48		1
	25	0	23.45		1
16QAM	1	0	23.87	0-1	1
	1	12	23.90		1
	1	24	23.81		1
	12	0	22.73	0-2	2
	12	6	22.70		2
	12	13	22.61		2
	25	0	22.60		2

Note: LTE Band 14 at 5 MHz bandwidth does not support three non-overlapping channels. Per KDB Publication 941225 D05v02, when a device supports overlapping channel assignment in a channel bandwidth configuration, the middle channel of the group of overlapping channels should be selected for testing.

FCC ID: ZNFQ720AM	 <b>PCTEST</b> ENGINEERING LABORATORY, INC.	<b>SAR EVALUATION REPORT</b>	 <b>LG</b>	<b>Approved by:</b> Quality Manager
<b>Document S/N:</b> 1M1907080114-01-R1.ZNF	<b>Test Dates:</b> 07/08/19 - 07/19/19	<b>DUT Type:</b> Portable Handset	Page 30 of 83	

### 9.3.3

### LTE Band 5 (Cell)



**Table 9-9**  
**LTE Band 5 (Cell) Conducted Powers - 10 MHz Bandwidth**

LTE Band 5 (Cell) 10 MHz Bandwidth					
Modulation	RB Size	RB Offset	Mid Channel	MPR Allowed per 3GPP [dB]	MPR [dB]
			20525 (836.5 MHz)		
			Conducted Power [dBm]		
QPSK	1	0	25.12	0	0
	1	25	25.08		0
	1	49	<b>25.14</b>		0
	25	0	<b>23.37</b>	0-1	1
	25	12	23.27		1
	25	25	23.36		1
16QAM	50	0	23.31	0-1	1
	1	0	23.63		1
	1	25	23.51		1
	1	49	23.43	0-2	1
	25	0	22.45		2
	25	12	22.34		2
	25	25	22.35		2
50	0	22.28	2		

Note: LTE Band 5 (Cell) at 10 MHz bandwidth does not support three non-overlapping channels. Per KDB Publication 941225 D05v02, when a device supports overlapping channel assignment in a channel bandwidth configuration, the middle channel of the group of overlapping channels should be selected for testing.

**Table 9-10**  
**LTE Band 5 (Cell) Conducted Powers - 5 MHz Bandwidth**

LTE Band 5 (Cell) 5 MHz Bandwidth								
Modulation	RB Size	RB Offset	Low Channel	Mid Channel	High Channel	MPR Allowed per 3GPP [dB]	MPR [dB]	
			20425 (826.5 MHz)	20525 (836.5 MHz)	20625 (846.5 MHz)			
			Conducted Power [dBm]					
QPSK	1	0	25.21	25.08	25.03	0	0	
	1	12	25.06	24.98	24.99		0	
	1	24	25.01	24.86	24.99		0	
	QPSK	12	0	23.31	23.15	23.21	0-1	1
		12	6	23.27	23.28	23.15		1
		12	13	23.25	23.16	23.13		1
		25	0	23.31	23.19	23.24		1
16QAM	1	0	23.59	23.51	23.41	0-1	1	
	1	12	23.55	23.53	23.49		1	
	1	24	23.43	23.44	23.35		1	
	16QAM	12	0	22.31	22.44	22.26	0-2	2
		12	6	22.35	22.24	22.27		2
		12	13	22.25	22.24	22.19		2
		25	0	22.36	22.21	22.26		2



FCC ID: ZNFQ720AM		SAR EVALUATION REPORT		Approved by: Quality Manager
Document S/N: 1M1907080114-01-R1.ZNF	Test Dates: 07/08/19 - 07/19/19	DUT Type: Portable Handset		Page 31 of 83

**Table 9-11**  
**LTE Band 5 (Cell) Conducted Powers - 3 MHz Bandwidth**

LTE Band 5 (Cell) 3 MHz Bandwidth							
Modulation	RB Size	RB Offset	Low Channel	Mid Channel	High Channel	MPR Allowed per 3GPP [dB]	MPR [dB]
			20415 (825.5 MHz)	20525 (836.5 MHz)	20635 (847.5 MHz)		
			Conducted Power [dBm]				
QPSK	1	0	25.14	24.93	25.11	0	0
	1	7	25.08	24.96	24.90		0
	1	14	24.94	24.83	25.02		0
	8	0	23.35	23.07	23.23	0-1	1
	8	4	23.25	23.22	23.23		1
	8	7	23.37	23.12	23.25		1
16QAM	15	0	23.24	23.18	23.27	0-1	1
	1	0	23.66	23.36	23.32		1
	1	7	23.66	23.45	23.40		1
	1	14	23.55	23.40	23.21	0-2	1
	8	0	22.44	22.24	22.23		2
	8	4	22.29	22.22	22.22		2
	8	7	22.26	22.32	22.32	2	
	15	0	22.27	22.22	22.20	2	

**Table 9-12**  
**LTE Band 5 (Cell) Conducted Powers -1.4 MHz Bandwidth**

LTE Band 5 (Cell) 1.4 MHz Bandwidth								
Modulation	RB Size	RB Offset	Low Channel	Mid Channel	High Channel	MPR Allowed per 3GPP [dB]	MPR [dB]	
			20407 (824.7 MHz)	20525 (836.5 MHz)	20643 (848.3 MHz)			
			Conducted Power [dBm]					
QPSK	1	0	25.09	24.91	25.08	0	0	
	1	2	25.06	24.95	24.96		0	
	1	5	25.00	24.86	24.96		0	
	3	0	25.05	24.91	24.83	0-1	0	
	3	2	25.07	24.98	24.96		0	
	3	3	25.06	24.84	24.91		0	
16QAM	6	0	23.26	23.12	23.22	0-1	1	
	1	0	23.64	23.38	23.41		0-1	1
	1	2	23.65	23.45	23.40			1
	1	5	23.59	23.39	23.31	1		
	3	0	23.36	23.27	23.21	1		
	3	2	23.38	23.36	23.16	1		
3	3	23.38	23.30	23.17	1			
	6	0	22.31	22.21	22.21	0-2	2	

FCC ID: ZNFQ720AM		SAR EVALUATION REPORT		Approved by: Quality Manager
Document S/N: 1M1907080114-01-R1.ZNF	Test Dates: 07/08/19 - 07/19/19	DUT Type: Portable Handset		Page 32 of 83



9.3.4



LTE Band 66 (AWS)

**Table 9-13**  
**LTE Band 66 (AWS) Conducted Powers - 20 MHz Bandwidth**

LTE Band 66 (AWS) 20 MHz Bandwidth							
Modulation	RB Size	RB Offset	Low Channel	Mid Channel	High Channel	MPR Allowed per 3GPP [dB]	MPR [dB]
			132072 (1720.0 MHz)	132322 (1745.0 MHz)	132572 (1770.0 MHz)		
			Conducted Power [dBm]				
QPSK	1	0	23.79	23.73	23.91	0	0
	1	50	23.91	23.83	23.99		0
	1	99	23.85	23.81	23.95		0
	50	0	22.89	22.75	23.00	0-1	1
	50	25	22.90	22.89	22.95		1
	50	50	22.97	22.93	22.99		1
	100	0	22.94	22.85	22.98		1
16QAM	1	0	22.72	22.85	23.00	0-1	1
	1	50	22.89	22.78	22.97		1
	1	99	22.90	22.77	22.84		1
	50	0	21.89	21.79	21.76	0-2	2
	50	25	21.88	21.89	21.88		2
	50	50	21.72	21.91	21.93		2
	100	0	21.92	21.85	21.95		2

**Table 9-14**  
**LTE Band 66 (AWS) Conducted Powers - 15 MHz Bandwidth**

LTE Band 66 (AWS) 15 MHz Bandwidth							
Modulation	RB Size	RB Offset	Low Channel	Mid Channel	High Channel	MPR Allowed per 3GPP [dB]	MPR [dB]
			132047 (1717.5 MHz)	132322 (1745.0 MHz)	132597 (1772.5 MHz)		
			Conducted Power [dBm]				
QPSK	1	0	23.98	23.94	23.95	0	0
	1	36	23.89	23.88	23.82		0
	1	74	23.91	23.88	23.92		0
	36	0	22.91	22.76	22.93	0-1	1
	36	18	22.85	22.76	22.85		1
	36	37	22.86	22.84	22.85		1
	75	0	22.80	22.71	22.88		1
16QAM	1	0	22.98	22.98	22.97	0-1	1
	1	36	22.79	22.78	22.88		1
	1	74	23.00	22.93	22.98		1
	36	0	21.80	21.71	21.84	0-2	2
	36	18	21.78	21.65	21.73		2
	36	37	21.82	21.73	21.79		2
	75	0	21.85	21.75	21.93		2



FCC ID: ZNFQ720AM		SAR EVALUATION REPORT		Approved by: Quality Manager
Document S/N: 1M1907080114-01-R1.ZNF	Test Dates: 07/08/19 - 07/19/19	DUT Type: Portable Handset		Page 33 of 83

**Table 9-15**  
**LTE Band 66 (AWS) Conducted Powers - 10 MHz Bandwidth**

LTE Band 66 (AWS) 10 MHz Bandwidth							
Modulation	RB Size	RB Offset	Low Channel	Mid Channel	High Channel	MPR Allowed per 3GPP [dB]	MPR [dB]
			132022 (1715.0 MHz)	132322 (1745.0 MHz)	132622 (1775.0 MHz)		
			Conducted Power [dBm]				
QPSK	1	0	24.00	23.84	23.90	0	0
	1	25	23.98	23.91	23.88		0
	1	49	23.93	23.88	23.95		0
	25	0	22.79	22.73	22.84	0-1	1
	25	12	22.69	22.70	22.92		1
	25	25	22.74	22.72	22.85		1
16QAM	50	0	22.75	22.81	22.93	0-1	1
	1	0	23.00	22.95	22.90		1
	1	25	22.99	22.96	22.82		1
	1	49	23.00	22.97	22.84	0-2	1
	25	0	21.73	21.78	21.84		2
	25	12	21.73	21.75	21.94		2
	25	25	21.81	21.78	21.96	2	
	50	0	21.69	21.77	21.88	2	

**Table 9-16**  
**LTE Band 66 (AWS) Conducted Powers - 5 MHz Bandwidth**

LTE Band 66 (AWS) 5 MHz Bandwidth							
Modulation	RB Size	RB Offset	Low Channel	Mid Channel	High Channel	MPR Allowed per 3GPP [dB]	MPR [dB]
			131997 (1712.5 MHz)	132322 (1745.0 MHz)	132647 (1777.5 MHz)		
			Conducted Power [dBm]				
QPSK	1	0	23.99	24.00	23.89	0	0
	1	12	23.96	23.89	23.78		0
	1	24	23.91	23.79	23.80		0
	12	0	22.94	22.81	22.86	0-1	1
	12	6	22.86	22.76	22.83		1
	12	13	22.82	22.66	22.80		1
16QAM	25	0	22.78	22.68	22.84	0-1	1
	1	0	23.00	22.85	22.92		1
	1	12	23.00	22.90	22.95		1
	1	24	22.98	22.92	22.99	0-2	1
	12	0	21.81	21.81	21.90		2
	12	6	21.78	21.78	21.84		2
	12	13	21.75	21.76	21.86	2	
	25	0	21.74	21.69	21.85	2	



FCC ID: ZNFQ720AM		SAR EVALUATION REPORT		Approved by: Quality Manager
Document S/N: 1M1907080114-01-R1.ZNF	Test Dates: 07/08/19 - 07/19/19	DUT Type: Portable Handset		Page 34 of 83

**Table 9-17**  
**LTE Band 66 (AWS) Conducted Powers - 3 MHz Bandwidth**

LTE Band 66 (AWS) 3 MHz Bandwidth							
Modulation	RB Size	RB Offset	Low Channel	Mid Channel	High Channel	MPR Allowed per 3GPP [dB]	MPR [dB]
			131987 (1711.5 MHz)	132322 (1745.0 MHz)	132657 (1778.5 MHz)		
			Conducted Power [dBm]				
QPSK	1	0	23.86	23.62	23.93	0	0
	1	7	23.90	23.56	23.79		0
	1	14	23.93	23.58	23.82		0
	8	0	22.86	22.72	22.86	0-1	1
	8	4	22.88	22.71	22.86		1
	8	7	22.71	22.73	22.85		1
	15	0	22.75	22.73	22.90		1
16QAM	1	0	22.83	22.90	22.99	0-1	1
	1	7	22.72	22.93	22.96		1
	1	14	22.76	22.85	23.00		1
	8	0	21.82	21.82	21.90	0-2	2
	8	4	21.77	21.87	21.90		2
	8	7	21.71	21.84	21.85		2
	15	0	21.69	21.69	21.83		2

**Table 9-18**  
**LTE Band 66 (AWS) Conducted Powers -1.4 MHz Bandwidth**

LTE Band 66 (AWS) 1.4 MHz Bandwidth							
Modulation	RB Size	RB Offset	Low Channel	Mid Channel	High Channel	MPR Allowed per 3GPP [dB]	MPR [dB]
			131979 (1710.7 MHz)	132322 (1745.0 MHz)	132665 (1779.3 MHz)		
			Conducted Power [dBm]				
QPSK	1	0	23.93	23.66	23.91	0	0
	1	2	23.99	23.63	23.91		0
	1	5	23.92	23.60	23.83		0
	3	0	23.75	23.63	23.77		0
	3	2	23.85	23.66	23.82		0
	3	3	23.71	23.57	23.75		0
	6	0	22.85	22.66	22.81	0-1	1
16QAM	1	0	22.96	22.80	22.95	0-1	1
	1	2	22.98	22.86	23.00		1
	1	5	22.86	22.77	22.95		1
	3	0	22.80	22.76	22.92		1
	3	2	22.84	22.84	22.96		1
	3	3	22.77	22.75	22.89		1
	6	0	21.79	21.73	21.91	0-2	2

FCC ID: ZNFQ720AM		SAR EVALUATION REPORT		Approved by: Quality Manager
Document S/N: 1M1907080114-01-R1.ZNF	Test Dates: 07/08/19 - 07/19/19	DUT Type: Portable Handset		Page 35 of 83

### 9.3.5



### LTE Band 2 (PCS)

**Table 9-19**  
**LTE Band 2 (PCS) Conducted Powers - 20 MHz Bandwidth**

LTE Band 2 (PCS) 20 MHz Bandwidth							
Modulation	RB Size	RB Offset	Low Channel	Mid Channel	High Channel	MPR Allowed per 3GPP [dB]	MPR [dB]
			18700 (1860.0 MHz)	18900 (1880.0 MHz)	19100 (1900.0 MHz)		
			Conducted Power [dBm]				
QPSK	1	0	23.86	23.65	23.75	0	0
	1	50	23.99	23.85	23.99		0
	1	99	24.00	23.62	23.75		0
	50	0	22.89	22.81	22.87	0-1	1
	50	25	22.97	22.91	22.93		1
	50	50	22.96	22.74	22.89		1
	100	0	22.95	22.89	22.89		1
16QAM	1	0	22.73	22.88	22.87	0-1	1
	1	50	22.66	23.00	23.00		1
	1	99	22.90	22.76	22.92		1
	50	0	21.75	21.80	21.64	0-2	2
	50	25	21.96	21.99	21.91		2
	50	50	21.96	21.73	21.85		2
	100	0	22.00	21.79	21.90		2

**Table 9-20**  
**LTE Band 2 (PCS) Conducted Powers - 15 MHz Bandwidth**

LTE Band 2 (PCS) 15 MHz Bandwidth							
Modulation	RB Size	RB Offset	Low Channel	Mid Channel	High Channel	MPR Allowed per 3GPP [dB]	MPR [dB]
			18675 (1857.5 MHz)	18900 (1880.0 MHz)	19125 (1902.5 MHz)		
			Conducted Power [dBm]				
QPSK	1	0	23.50	23.40	23.51	0	0
	1	36	24.00	23.80	23.92		0
	1	74	23.74	23.24	23.58		0
	36	0	22.90	22.85	22.88	0-1	1
	36	18	22.92	22.86	22.95		1
	36	37	22.92	22.75	22.91		1
	75	0	22.87	22.71	22.87		1
16QAM	1	0	22.61	22.66	22.67	0-1	1
	1	36	22.99	22.77	22.97		1
	1	74	22.53	22.31	22.67		1
	36	0	21.98	21.86	21.87	0-2	2
	36	18	21.97	21.80	21.94		2
	36	37	21.98	21.78	21.96		2
	75	0	21.90	21.80	21.95		2



FCC ID: ZNFQ720AM		SAR EVALUATION REPORT		Approved by: Quality Manager
Document S/N: 1M1907080114-01-R1.ZNF	Test Dates: 07/08/19 - 07/19/19	DUT Type: Portable Handset		Page 36 of 83

**Table 9-21**  
**LTE Band 2 (PCS) Conducted Powers - 10 MHz Bandwidth**

LTE Band 2 (PCS) 10 MHz Bandwidth							
Modulation	RB Size	RB Offset	Low Channel	Mid Channel	High Channel	MPR Allowed per 3GPP [dB]	MPR [dB]
			18650 (1855.0 MHz)	18900 (1880.0 MHz)	19150 (1905.0 MHz)		
			Conducted Power [dBm]				
QPSK	1	0	24.00	23.96	23.93	0	0
	1	25	23.96	23.93	23.89		0
	1	49	23.84	23.80	23.66		0
	25	0	22.78	22.85	22.81	0-1	1
	25	12	22.83	22.89	22.90		1
	25	25	22.79	22.85	22.75		1
	50	0	22.89	22.85	22.84		1
16QAM	1	0	23.00	23.00	23.00	0-1	1
	1	25	22.95	22.98	22.91		1
	1	49	22.84	22.95	22.97		1
	25	0	21.77	21.88	21.85	0-2	2
	25	12	21.90	21.89	21.82		2
	25	25	21.82	21.91	21.88		2
	50	0	21.88	21.86	21.90		2

**Table 9-22**  
**LTE Band 2 (PCS) Conducted Powers - 5 MHz Bandwidth**

LTE Band 2 (PCS) 5 MHz Bandwidth							
Modulation	RB Size	RB Offset	Low Channel	Mid Channel	High Channel	MPR Allowed per 3GPP [dB]	MPR [dB]
			18625 (1852.5 MHz)	18900 (1880.0 MHz)	19175 (1907.5 MHz)		
			Conducted Power [dBm]				
QPSK	1	0	24.00	23.92	23.99	0	0
	1	12	23.94	23.80	23.85		0
	1	24	23.93	23.78	23.99		0
	12	0	22.99	22.96	22.91	0-1	1
	12	6	22.92	22.91	22.83		1
	12	13	22.86	22.84	22.83		1
	25	0	22.85	22.84	22.88		1
16QAM	1	0	22.85	22.84	22.88	0-1	1
	1	12	23.00	22.80	23.00		1
	1	24	22.61	23.00	23.00		1
	12	0	21.98	21.92	21.86	0-2	2
	12	6	21.99	21.90	21.84		2
	12	13	21.92	21.89	21.87		2
	25	0	21.92	21.84	21.87		2



FCC ID: ZNFQ720AM		SAR EVALUATION REPORT		Approved by: Quality Manager
Document S/N: 1M1907080114-01-R1.ZNF	Test Dates: 07/08/19 - 07/19/19	DUT Type: Portable Handset		Page 37 of 83

**Table 9-23**  
**LTE Band 2 (PCS) Conducted Powers - 3 MHz Bandwidth**

LTE Band 2 (PCS) 3 MHz Bandwidth							
Modulation	RB Size	RB Offset	Low Channel	Mid Channel	High Channel	MPR Allowed per 3GPP [dB]	MPR [dB]
			18615 (1851.5 MHz)	18900 (1880.0 MHz)	19185 (1908.5 MHz)		
			Conducted Power [dBm]				
QPSK	1	0	24.00	23.77	23.81	0	0
	1	7	23.77	23.80	23.78		0
	1	14	23.85	23.67	23.74		0
	8	0	22.95	22.86	22.81	0-1	1
	8	4	22.91	22.84	22.82		1
	8	7	22.89	22.75	22.80		1
	15	0	22.93	22.86	22.85		1
16QAM	1	0	22.94	22.96	22.98	0-1	1
	1	7	22.90	22.89	22.94		1
	1	14	22.93	22.93	23.00		1
	8	0	21.93	22.00	21.89	0-2	2
	8	4	22.00	21.87	21.90		2
	8	7	21.91	21.84	21.80		2
	15	0	21.93	21.80	21.78		2

**Table 9-24**  
**LTE Band 2 (PCS) Conducted Powers -1.4 MHz Bandwidth**

LTE Band 2 (PCS) 1.4 MHz Bandwidth							
Modulation	RB Size	RB Offset	Low Channel	Mid Channel	High Channel	MPR Allowed per 3GPP [dB]	MPR [dB]
			18607 (1850.7 MHz)	18900 (1880.0 MHz)	19193 (1909.3 MHz)		
			Conducted Power [dBm]				
QPSK	1	0	23.94	23.73	23.90	0	0
	1	2	24.00	23.75	23.96		0
	1	5	24.00	23.56	23.91		0
	3	0	23.70	23.67	23.75		0
	3	2	23.82	23.72	23.80		0
	3	3	23.68	23.62	23.74		0
	6	0	22.86	22.73	22.75	0-1	1
16QAM	1	0	22.88	22.96	22.98	0-1	1
	1	2	23.00	23.00	22.99		1
	1	5	22.87	22.77	22.96		1
	3	0	22.89	22.94	22.87		1
	3	2	22.94	22.86	22.89		1
	3	3	22.90	22.86	22.88		1
	6	0	21.91	21.90	21.87	0-2	2

FCC ID: ZNFQ720AM		SAR EVALUATION REPORT		Approved by: Quality Manager
Document S/N: 1M1907080114-01-R1.ZNF	Test Dates: 07/08/19 - 07/19/19	DUT Type: Portable Handset		Page 38 of 83

9.3.6

LTE Band 30



**Table 9-25**  
**LTE Band 30 Maximum Conducted Powers - 10 MHz Bandwidth**

LTE Band 30 10 MHz Bandwidth					
Modulation	RB Size	RB Offset	Mid Channel	MPR Allowed per 3GPP [dB]	MPR [dB]
			27710 (2310.0 MHz) Conducted Power [dBm]		
QPSK	1	0	23.89	0	0
	1	25	23.78		0
	1	49	<b>23.95</b>		0
	25	0	22.84	0-1	1
	25	12	22.90		1
	25	25	<b>22.93</b>		1
	50	0	22.89		1
16QAM	1	0	22.80	0-1	1
	1	25	22.70		1
	1	49	22.83		1
	25	0	21.87	0-2	2
	25	12	21.91		2
	25	25	21.86		2
	50	0	21.96		2

**Table 9-26**  
**LTE Band 30 Maximum Conducted Powers - 5 MHz Bandwidth**

LTE Band 30 5 MHz Bandwidth					
Modulation	RB Size	RB Offset	Mid Channel	MPR Allowed per 3GPP [dB]	MPR [dB]
			27710 (2310.0 MHz) Conducted Power [dBm]		
QPSK	1	0	23.83	0	0
	1	12	23.78		0
	1	24	23.63		0
	12	0	22.87	0-1	1
	12	6	22.87		1
	12	13	22.61		1
	25	0	22.78		1
16QAM	1	0	22.95	0-1	1
	1	12	22.99		1
	1	24	22.91		1
	12	0	21.85	0-2	2
	12	6	21.86		2
	12	13	21.86		2
	25	0	21.83		2

Note: LTE Band 30 at 5 MHz bandwidth does not support three non-overlapping channels. Per KDB Publication 941225 D05v02, when a device supports overlapping channel assignment in a channel bandwidth configuration, the middle channel of the group of overlapping channels should be selected for testing.

FCC ID: ZNFQ720AM	 <b>PCTEST</b> ENGINEERING LABORATORY, INC.	<b>SAR EVALUATION REPORT</b>	 <b>LG</b>	<b>Approved by:</b> Quality Manager
<b>Document S/N:</b> 1M1907080114-01-R1.ZNF	<b>Test Dates:</b> 07/08/19 - 07/19/19	<b>DUT Type:</b> Portable Handset	Page 39 of 83	

**Table 9-27**  
**LTE Band 30 Reduced Conducted Powers - 10 MHz Bandwidth**

LTE Band 30 10 MHz Bandwidth					
Modulation	RB Size	RB Offset	Mid Channel	MPR Allowed per 3GPP [dB]	MPR [dB]
			27710 (2310.0 MHz)		
			Conducted Power [dBm]		
QPSK	1	0	21.35	0	0
	1	25	21.40		0
	1	49	<b>21.41</b>		0
	25	0	<b>21.42</b>	0-1	0
	25	12	21.34		0
	25	25	21.27		0
	50	0	21.27		0
16QAM	1	0	21.57	0-1	0
	1	25	21.54		0
	1	49	21.56		0
	25	0	21.22	0-2	0
	25	12	21.51		0
	25	25	21.31		0
	50	0	21.23		0

**Table 9-28**  
**LTE Band 30 Reduced Conducted Powers - 5 MHz Bandwidth**

LTE Band 30 5 MHz Bandwidth					
Modulation	RB Size	RB Offset	Mid Channel	MPR Allowed per 3GPP [dB]	MPR [dB]
			27710 (2310.0 MHz)		
			Conducted Power [dBm]		
QPSK	1	0	21.23	0	0
	1	12	21.21		0
	1	24	21.14		0
	12	0	21.25	0-1	0
	12	6	21.22		0
	12	13	21.16		0
	25	0	21.25		0
16QAM	1	0	21.45	0-1	0
	1	12	21.63		0
	1	24	21.42		0
	12	0	21.17	0-2	0
	12	6	21.28		0
	12	13	21.27		0
	25	0	21.18		0

Note: LTE Band 30 at 5 MHz bandwidth does not support three non-overlapping channels. Per KDB Publication 941225 D05v02, when a device supports overlapping channel assignment in a channel bandwidth configuration, the middle channel of the group of overlapping channels should be selected for testing.

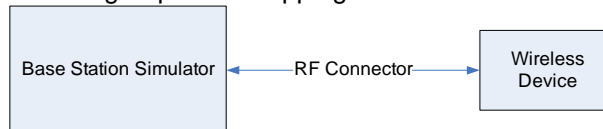

**Figure 9-3**  
**Power Measurement Setup**

FCC ID: ZNFQ720AM		SAR EVALUATION REPORT		Approved by: Quality Manager
Document S/N: 1M1907080114-01-R1.ZNF	Test Dates: 07/08/19 - 07/19/19	DUT Type: Portable Handset	Page 40 of 83	





## 9.4 WLAN Conducted Powers

**Table 9-29**  
**2.4 GHz WLAN Maximum Average RF Power**

2.4GHz Conducted Power [dBm]				
Freq [MHz]	Channel	IEEE Transmission Mode		
		802.11b	802.11g	802.11n
		Average	Average	Average
2412	1	<b>22.23</b>	18.86	17.84
2417	2	N/A	19.90	18.95
2422	3	N/A	21.87	20.86
2437	6	22.02	21.98	20.88
2452	9	N/A	21.95	20.84
2457	10	N/A	19.93	18.93
2462	11	22.04	18.49	17.47

**Table 9-30**  
**5 GHz WLAN Maximum Average RF Power**

5GHz (20MHz) Conducted Power [dBm]				
Freq [MHz]	Channel	IEEE Transmission Mode		
		802.11a	802.11n	802.11ac
		Average	Average	Average
5180	36	15.10	14.98	11.77
5200	40	18.62	18.48	15.37
5220	44	18.52	18.47	15.34
5240	48	<b>18.72</b>	18.45	15.44
5260	52	18.65	18.45	15.20
5280	56	<b>18.74</b>	18.42	15.31
5300	60	18.72	18.48	15.24
5320	64	15.69	14.96	11.88
5500	100	15.72	14.91	11.99
5520	104	19.03	18.45	15.20
5600	120	18.90	18.40	15.33
5620	124	19.00	18.37	15.29
5680	136	<b>19.05</b>	18.36	15.32
5700	140	17.62	16.99	13.72
5745	149	17.81	16.99	13.96
5765	153	19.63	18.98	15.62
5785	157	19.11	18.92	15.79
5805	161	<b>19.68</b>	18.90	15.71
5825	165	17.87	16.95	13.66

FCC ID: ZNFQ720AM		SAR EVALUATION REPORT		Approved by: Quality Manager
Document S/N: 1M1907080114-01-R1.ZNF	Test Dates: 07/08/19 - 07/19/19	DUT Type: Portable Handset		Page 41 of 83



**Table 9-31**  
**2.4 GHz WLAN Reduced Average RF Power**

2.4GHz Conducted Power [dBm]				
Freq [MHz]	Channel	IEEE Transmission Mode		
		802.11b	802.11g	802.11n
		Average	Average	Average
2412	1	18.26	15.70	15.72
2417	2	N/A	16.98	16.96
2422	3	N/A	18.42	18.37
2437	6	<b>18.33</b>	18.37	18.33
2452	9	N/A	18.19	18.30
2457	10	N/A	16.19	16.19
2462	11	18.12	14.81	14.85

**Table 9-32**  
**5 GHz WLAN Reduced Average RF Power**

5GHz (20MHz) Conducted Power [dBm]			
Freq [MHz]	Channel	IEEE Transmission Mode	
		802.11a	802.11n
		Average	Average
5180	36	13.07	13.13
5200	40	<b>16.86</b>	16.83
5220	44	16.69	16.74
5240	48	16.78	16.77
5260	52	16.62	16.64
5280	56	<b>16.64</b>	16.70
5300	60	16.63	16.65
5320	64	13.24	13.31
5500	100	13.33	13.47
5520	104	16.71	16.72
5600	120	16.51	16.59
5620	124	16.53	16.51
5680	136	<b>16.71</b>	16.68
5700	140	15.24	15.23
5745	149	15.27	15.27
5765	153	<b>17.21</b>	17.29
5785	157	17.17	17.19
5805	161	17.19	17.17
5825	165	15.52	15.48

Note: The bolded data rates and channel above were tested for SAR.

FCC ID: ZNFQ720AM		SAR EVALUATION REPORT		Approved by: Quality Manager
Document S/N: 1M1907080114-01-R1.ZNF	Test Dates: 07/08/19 - 07/19/19	DUT Type: Portable Handset		Page 42 of 83

Justification for test configurations for WLAN per KDB Publication 248227 D01v02r02:

- Power measurements were performed for the transmission mode configuration with the highest maximum output power specified for production units.
- For transmission modes with the same maximum output power specification, powers were measured for the largest channel bandwidth, lowest order modulation and lowest data rate.
- For transmission modes with identical maximum specified output power, channel bandwidth, modulation and data rates, power measurements were required for all identical configurations.
- For each transmission mode configuration, powers were measured for the highest and lowest channels; and at the mid-band channel(s) when there were at least 3 channels supported. For configurations with multiple mid-band channels, due to an even number of channels, both channels were measured.
- The bolded data rate and channel above were tested for SAR.

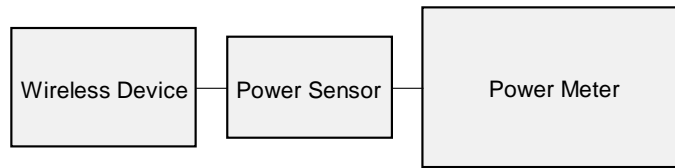



**Figure 9-4**  
**Power Measurement Setup**

## 9.5 Bluetooth Conducted Powers

**Table 9-33**  
**Bluetooth Average RF Power**

Frequency [MHz]	Data Rate [Mbps]	Channel No.	Avg Conducted Power	
			[dBm]	[mW]
2402	1.0	0	9.75	9.442
2441	1.0	39	<b>10.89</b>	12.277
2480	1.0	78	8.97	7.896
2402	2.0	0	9.09	8.116
2441	2.0	39	10.27	10.641
2480	2.0	78	8.36	6.850
2402	3.0	0	9.15	8.221
2441	3.0	39	10.30	10.726
2480	3.0	78	8.42	6.943

Note: The bolded data rates and channel above were tested for SAR.

FCC ID: ZNFQ720AM		SAR EVALUATION REPORT		Approved by: Quality Manager
Document S/N: 1M1907080114-01-R1.ZNF	Test Dates: 07/08/19 - 07/19/19	DUT Type: Portable Handset		Page 43 of 83

**Figure 9-5  
Bluetooth Transmission Plot**

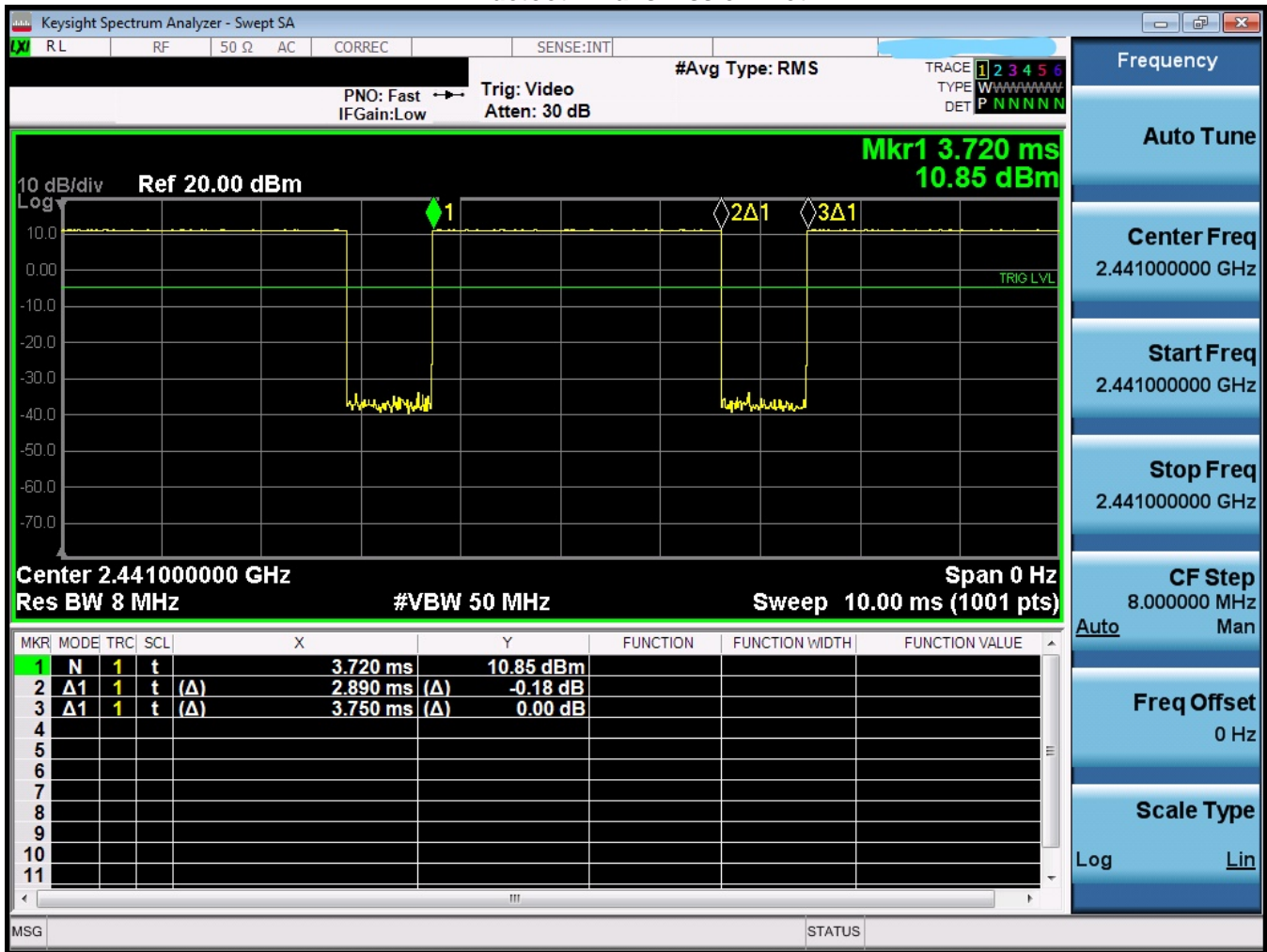



**Equation 9-1  
Bluetooth Duty Cycle Calculation**

$$Duty\ Cycle = \frac{Pulse\ Width}{Period} * 100\% = \frac{2.89ms}{3.75ms} * 100\% = 77.10\%$$

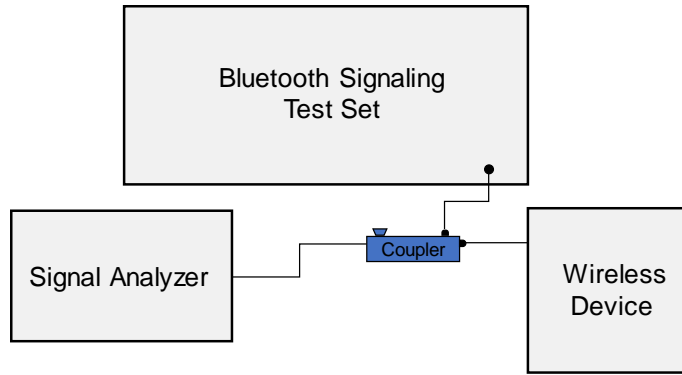
FCC ID: ZNFQ720AM		SAR EVALUATION REPORT		Approved by: Quality Manager
Document S/N: 1M1907080114-01-R1.ZNF	Test Dates: 07/08/19 - 07/19/19	DUT Type: Portable Handset		Page 44 of 83



**Figure 9-6**  
**Power Measurement Setup**



FCC ID: ZNFQ720AM		SAR EVALUATION REPORT		Approved by: Quality Manager
Document S/N: 1M1907080114-01-R1.ZNF	Test Dates: 07/08/19 - 07/19/19	DUT Type: Portable Handset	Page 45 of 83	

# 10 SYSTEM VERIFICATION

## 10.1 Tissue Verification

**Table 10-1  
Measured Tissue Properties**

Calibrated for Tests Performed on:	Tissue Type	Tissue Temp During Calibration (°C)	Measured Frequency (MHz)	Measured Conductivity, $\sigma$ (S/m)	Measured Dielectric Constant, $\epsilon$	TARGET Conductivity, $\sigma$ (S/m)	TARGET Dielectric Constant, $\epsilon$	% dev $\sigma$	% dev $\epsilon$
7/10/2019	750H	21.3	700	0.864	41.176	0.889	42.201	-2.81%	-2.43%
			710	0.867	41.149	0.890	42.149	-2.58%	-2.37%
			740	0.878	41.075	0.893	41.994	-1.68%	-2.19%
			755	0.883	41.035	0.894	41.916	-1.23%	-2.10%
			785	0.893	40.948	0.896	41.760	-0.33%	-1.94%
			800	0.899	40.907	0.897	41.682	0.22%	-1.86%
7/15/2019	835H	20.7	820	0.910	41.678	0.899	41.578	1.22%	0.24%
			835	0.916	41.627	0.900	41.500	1.78%	0.31%
			850	0.922	41.573	0.916	41.500	0.66%	0.18%
7/8/2019	1750H	21.0	1710	1.329	40.120	1.348	40.142	-1.41%	-0.05%
			1750	1.353	40.052	1.371	40.079	-1.31%	-0.07%
			1790	1.378	39.983	1.394	40.016	-1.15%	-0.08%
7/10/2019	1900H	21.6	1850	1.412	40.289	1.400	40.000	0.86%	0.72%
			1880	1.431	40.266	1.400	40.000	2.21%	0.66%
			1910	1.450	40.233	1.400	40.000	3.57%	0.58%
7/15/2019	1900H	20.7	1850	1.425	39.413	1.400	40.000	1.79%	-1.47%
			1880	1.443	39.370	1.400	40.000	3.07%	-1.58%
			1910	1.462	39.348	1.400	40.000	4.43%	-1.63%
7/12/2019	2300H	21.1	2300	1.720	38.621	1.670	39.500	2.99%	-2.23%
			2310	1.727	38.606	1.679	39.480	2.86%	-2.21%
7/15/2019	2450H	20.7	2400	1.810	38.585	1.756	39.289	3.08%	-1.79%
			2450	1.849	38.492	1.800	39.200	2.72%	-1.81%
			2500	1.890	38.417	1.855	39.136	1.89%	-1.84%
7/18/2019	2450H	20.9	2400	1.770	37.847	1.756	39.289	0.80%	-3.67%
			2450	1.806	37.758	1.800	39.200	0.33%	-3.68%
			2500	1.845	37.690	1.855	39.136	-0.54%	-3.69%



FCC ID: ZNFQ720AM		SAR EVALUATION REPORT		Approved by: Quality Manager
Document S/N: 1M1907080114-01-R1.ZNF	Test Dates: 07/08/19 - 07/19/19	DUT Type: Portable Handset		Page 46 of 83

**Table 10-2  
Measured Tissue Properties (Cont.)**

Calibrated for Tests Performed on:	Tissue Type	Tissue Temp During Calibration (°C)	Measured Frequency (MHz)	Measured Conductivity, $\sigma$ (S/m)	Measured Dielectric Constant, $\epsilon$	TARGET Conductivity, $\sigma$ (S/m)	TARGET Dielectric Constant, $\epsilon$	% dev $\sigma$	% dev $\epsilon$
07/19/2019	5200H-5800H	22.3	5180	4.480	35.191	4.635	36.009	-3.34%	-2.27%
			5200	4.505	35.161	4.655	35.986	-3.22%	-2.29%
			5220	4.522	35.132	4.676	35.963	-3.29%	-2.31%
			5240	4.542	35.097	4.696	35.940	-3.28%	-2.35%
			5260	4.562	35.050	4.717	35.917	-3.29%	-2.41%
			5280	4.587	35.007	4.737	35.894	-3.17%	-2.47%
			5300	4.611	34.996	4.758	35.871	-3.09%	-2.44%
			5320	4.631	34.961	4.778	35.849	-3.08%	-2.48%
			5500	4.822	34.643	4.963	35.643	-2.84%	-2.81%
			5520	4.845	34.604	4.983	35.620	-2.77%	-2.85%
			5540	4.874	34.565	5.004	35.597	-2.60%	-2.90%
			5560	4.898	34.531	5.024	35.574	-2.51%	-2.93%
			5580	4.919	34.494	5.045	35.551	-2.50%	-2.97%
			5600	4.939	34.452	5.065	35.529	-2.49%	-3.03%
			5620	4.964	34.419	5.086	35.506	-2.40%	-3.06%
			5640	4.990	34.382	5.106	35.483	-2.27%	-3.10%
			5660	5.011	34.342	5.127	35.460	-2.26%	-3.15%
			5680	5.033	34.331	5.147	35.437	-2.21%	-3.12%
			5700	5.057	34.293	5.168	35.414	-2.15%	-3.17%
			5745	5.112	34.202	5.214	35.363	-1.96%	-3.28%
5765	5.133	34.179	5.234	35.340	-1.93%	-3.29%			
5785	5.155	34.147	5.255	35.317	-1.90%	-3.31%			
5800	5.167	34.116	5.270	35.300	-1.95%	-3.35%			
5805	5.171	34.106	5.275	35.294	-1.97%	-3.37%			
5825	5.195	34.063	5.296	35.271	-1.91%	-3.42%			

**Table 10-3  
Measured Tissue Properties (Cont.)**



Calibrated for Tests Performed on:	Tissue Type	Tissue Temp During Calibration (°C)	Measured Frequency (MHz)	Measured Conductivity, $\sigma$ (S/m)	Measured Dielectric Constant, $\epsilon$	TARGET Conductivity, $\sigma$ (S/m)	TARGET Dielectric Constant, $\epsilon$	% dev $\sigma$	% dev $\epsilon$
7/8/2019	750B	23.8	700	0.925	57.490	0.959	55.726	-3.55%	3.17%
			710	0.929	57.470	0.960	55.687	-3.23%	3.20%
			740	0.939	57.402	0.963	55.570	-2.49%	3.30%
			755	0.945	57.369	0.964	55.512	-1.97%	3.35%
			785	0.955	57.300	0.966	55.395	-1.14%	3.44%
			800	0.960	57.269	0.967	55.336	-0.72%	3.49%
7/16/2019	835B	20.4	820	0.958	53.934	0.969	55.258	-1.14%	-2.40%
			835	0.964	53.916	0.970	55.200	-0.62%	-2.33%
			850	0.970	53.895	0.988	55.154	-1.82%	-2.28%
7/11/2019	1750B	21.7	1710	1.415	53.977	1.463	53.537	-3.28%	0.82%
			1750	1.445	53.923	1.488	53.432	-2.89%	0.92%
			1790	1.471	53.873	1.514	53.326	-2.84%	1.03%
7/17/2019	1750B	21.9	1710	1.436	54.029	1.463	53.537	-1.85%	0.92%
			1750	1.464	53.969	1.488	53.432	-1.61%	1.01%
			1790	1.491	53.914	1.514	53.326	-1.52%	1.10%
7/15/2019	1900B	22.4	1850	1.501	52.550	1.520	53.300	-1.25%	-1.41%
			1880	1.536	52.441	1.520	53.300	1.05%	-1.61%
			1910	1.573	52.361	1.520	53.300	3.49%	-1.76%
7/15/2019	2300B	22.9	2300	1.863	52.555	1.809	52.900	2.99%	-0.65%
			2310	1.875	52.522	1.816	52.887	3.25%	-0.69%
7/18/2019	2450B	22.8	2400	1.983	51.640	1.902	52.767	4.26%	-2.14%
			2450	2.041	51.486	1.950	52.700	4.67%	-2.30%
			2500	2.103	51.332	2.021	52.636	4.06%	-2.48%

FCC ID: ZNFQ720AM		<b>SAR EVALUATION REPORT</b>		Approved by: Quality Manager
Document S/N: 1M1907080114-01-R1.ZNF	Test Dates: 07/08/19 - 07/19/19	DUT Type: Portable Handset		Page 47 of 83

**Table 10-4  
Measured Tissue Properties (Cont.)**

Calibrated for Tests Performed on:	Tissue Type	Tissue Temp During Calibration (°C)	Measured Frequency (MHz)	Measured Conductivity, $\sigma$ (S/m)	Measured Dielectric Constant, $\epsilon$	TARGET Conductivity, $\sigma$ (S/m)	TARGET Dielectric Constant, $\epsilon$	% dev $\sigma$	% dev $\epsilon$
07/16/2019	5200B-5800B	21.6	5180	5.087	48.547	5.276	49.041	-3.58%	-1.01%
			5200	5.115	48.481	5.299	49.014	-3.47%	-1.09%
			5220	5.142	48.443	5.323	48.987	-3.40%	-1.11%
			5240	5.171	48.413	5.346	48.960	-3.27%	-1.12%
			5260	5.198	48.373	5.369	48.933	-3.18%	-1.14%
			5280	5.220	48.359	5.393	48.906	-3.21%	-1.12%
			5300	5.246	48.320	5.416	48.879	-3.14%	-1.14%
			5320	5.275	48.274	5.439	48.851	-3.02%	-1.18%
			5500	5.520	47.989	5.650	48.607	-2.30%	-1.27%
			5520	5.549	47.966	5.673	48.580	-2.19%	-1.26%
			5540	5.580	47.897	5.696	48.553	-2.04%	-1.35%
			5560	5.607	47.874	5.720	48.526	-1.98%	-1.34%
			5580	5.642	47.843	5.743	48.499	-1.76%	-1.35%
			5600	5.665	47.819	5.766	48.471	-1.75%	-1.35%
			5620	5.692	47.770	5.790	48.444	-1.69%	-1.39%
			5640	5.716	47.739	5.813	48.417	-1.67%	-1.40%
			5660	5.752	47.713	5.837	48.390	-1.46%	-1.40%
			5680	5.785	47.678	5.860	48.363	-1.28%	-1.42%
			5700	5.813	47.662	5.883	48.336	-1.19%	-1.39%
			5745	5.875	47.580	5.936	48.275	-1.03%	-1.44%
5765	5.904	47.528	5.959	48.248	-0.92%	-1.49%			
5785	5.936	47.497	5.982	48.220	-0.77%	-1.50%			
5800	5.960	47.486	6.000	48.200	-0.67%	-1.48%			
5805	5.969	47.477	6.006	48.193	-0.62%	-1.49%			
5825	5.996	47.447	6.029	48.166	-0.55%	-1.49%			

The above measured tissue parameters were used in the DASY software. The DASY software was used to perform interpolation to determine the dielectric parameters at the SAR test device frequencies (per KDB Publication 865664 D01v01r04 and IEEE 1528-2013 6.6.1.2). The tissue parameters listed in the SAR test plots may slightly differ from the table above due to significant digit rounding in the software.

FCC ID: ZNFQ720AM		SAR EVALUATION REPORT		Approved by: Quality Manager
Document S/N: 1M1907080114-01-R1.ZNF	Test Dates: 07/08/19 - 07/19/19	DUT Type: Portable Handset	Page 48 of 83	





## 10.2 Test System Verification

Prior to SAR assessment, the system is verified to  $\pm 10\%$  of the SAR measurement on the reference dipole at the time of calibration by the calibration facility. Full system validation status and result summary can be found in Appendix E.

**Table 10-5  
System Verification Results – 1g**

System Verification TARGET & MEASURED												
SAR System #	Tissue Frequency (MHz)	Tissue Type	Date	Amb. Temp (°C)	Liquid Temp (°C)	Input Power (W)	Source SN	Probe SN	Measured SAR <sub>1g</sub> (W/kg)	1 W Target SAR <sub>1g</sub> (W/kg)	1 W Normalized SAR <sub>1g</sub> (W/kg)	Deviation <sub>1g</sub> (%)
E	750	HEAD	07/10/2019	22.5	21.3	0.200	1003	3589	1.540	8.280	7.700	-7.00%
E	835	HEAD	07/15/2019	21.4	20.7	0.200	4d133	3589	1.850	9.430	9.250	-1.91%
E	1750	HEAD	07/08/2019	21.4	21.0	0.100	1008	3589	3.730	36.200	37.300	3.04%
G	1900	HEAD	07/10/2019	21.1	21.6	0.100	5d149	7409	4.030	39.300	40.300	2.54%
E	1900	HEAD	07/15/2019	21.4	20.7	0.100	5d080	3589	4.110	39.800	41.100	3.27%
E	2300	HEAD	07/12/2019	22.5	21.1	0.100	1073	3589	5.120	49.200	51.200	4.07%
E	2450	HEAD	07/15/2019	21.4	20.7	0.100	797	3589	5.210	52.700	52.100	-1.14%
E	2450	HEAD	07/18/2019	23.8	20.9	0.100	797	3589	5.350	52.700	53.500	1.52%
H	5250	HEAD	07/19/2019	23.4	22.3	0.050	1237	7406	3.910	81.300	78.200	-3.81%
H	5600	HEAD	07/19/2019	23.4	22.3	0.050	1237	7406	4.000	85.700	80.000	-6.65%
H	5750	HEAD	07/19/2019	23.4	22.3	0.050	1237	7406	3.980	80.600	79.600	-1.24%
D	750	BODY	07/08/2019	22.8	22.1	0.200	1003	3914	1.730	8.580	8.650	0.82%
O	835	BODY	07/16/2019	20.3	20.4	0.200	4d047	7538	2.000	9.470	10.000	5.60%
G	1750	BODY	07/11/2019	22.8	21.7	0.100	1150	7409	3.820	36.600	38.200	4.37%
G	1750	BODY	07/17/2019	22.6	21.9	0.100	1150	7409	3.880	36.600	38.800	6.01%
I	1900	BODY	07/15/2019	19.6	20.6	0.100	5d148	7357	4.020	39.100	40.200	2.81%
K	2300	BODY	07/15/2019	22.2	22.1	0.100	1073	7417	5.050	47.700	50.500	5.87%
K	2450	BODY	07/18/2019	22.6	22.2	0.100	719	7417	5.220	50.100	52.200	4.19%
L	5250	BODY	07/16/2019	23.0	20.1	0.050	1057	7308	3.870	75.900	77.400	1.98%
L	5600	BODY	07/16/2019	23.0	20.1	0.050	1057	7308	3.780	79.900	75.600	-5.38%
L	5750	BODY	07/16/2019	23.0	20.1	0.050	1057	7308	3.470	76.700	69.400	-9.52%

FCC ID: ZNFQ720AM		<b>SAR EVALUATION REPORT</b>		<b>Approved by:</b> Quality Manager
<b>Document S/N:</b> 1M1907080114-01-R1.ZNF	<b>Test Dates:</b> 07/08/19 - 07/19/19	<b>DUT Type:</b> Portable Handset	Page 49 of 83	

**Table 10-6  
System Verification Results – 10g**

System Verification TARGET & MEASURED												
SAR System #	Tissue Frequency (MHz)	Tissue Type	Date	Amb. Temp (°C)	Liquid Temp (°C)	Input Power (W)	Source SN	Probe SN	Measured SAR <sub>10g</sub> (W/kg)	1 W Target SAR <sub>10g</sub> (W/kg)	1 W Normalized SAR <sub>10g</sub> (W/kg)	Deviation <sub>10g</sub> (%)
K	2300	BODY	07/15/2019	22.2	22.1	0.100	1073	7417	2.390	23.200	23.900	3.02%
L	5250	BODY	07/16/2019	23.0	20.1	0.050	1057	7308	1.080	21.100	21.600	2.37%
L	5600	BODY	07/16/2019	23.0	20.1	0.050	1057	7308	1.040	22.300	20.800	-6.73%
L	5750	BODY	07/16/2019	23.0	20.1	0.050	1057	7308	0.965	21.200	19.300	-8.96%

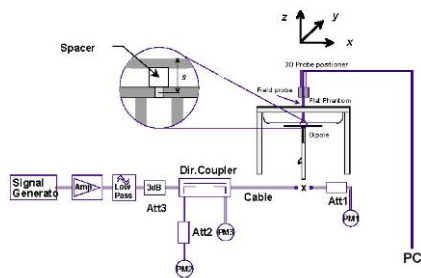

**Figure 10-1  
System Verification Setup Diagram**



**Figure 10-2  
System Verification Setup Photo**

FCC ID: ZNFQ720AM		SAR EVALUATION REPORT		Approved by: Quality Manager
Document S/N: 1M1907080114-01-R1.ZNF	Test Dates: 07/08/19 - 07/19/19	DUT Type: Portable Handset	Page 50 of 83	

# 11 SAR DATA SUMMARY



## 11.1 Standalone Head SAR Data

**Table 11-1  
GSM 850 Head SAR**

MEASUREMENT RESULTS															
FREQUENCY		Mode	Service	Maximum Allowed Power [dBm]	Conducted Power [dBm]	Power Drift [dB]	Side	Test Position	Device Serial Number	# of Time Slots	Duty Cycle	SAR (1g)	Scaling Factor	Reported SAR (1g)	Plot #
MHz	Ch.											(W/kg)		(W/kg)	
836.60	190	GSM 850	GSM	33.2	32.96	-0.04	Right	Cheek	06811	1	1:8.3	0.097	1.057	0.103	
836.60	190	GSM 850	GSM	33.2	32.96	0.06	Right	Tilt	06811	1	1:8.3	0.044	1.057	0.047	
836.60	190	GSM 850	GSM	33.2	32.96	0.16	Left	Cheek	06811	1	1:8.3	0.085	1.057	0.090	
836.60	190	GSM 850	GSM	33.2	32.96	0.04	Left	Tilt	06811	1	1:8.3	0.057	1.057	0.060	
836.60	190	GSM 850	GPRS	32.2	31.57	-0.01	Right	Cheek	06811	2	1:4.15	0.147	1.156	0.170	A1
836.60	190	GSM 850	GPRS	32.2	31.57	0.01	Right	Tilt	06811	2	1:4.15	0.067	1.156	0.077	
836.60	190	GSM 850	GPRS	32.2	31.57	-0.02	Left	Cheek	06811	2	1:4.15	0.124	1.156	0.143	
836.60	190	GSM 850	GPRS	32.2	31.57	0.06	Left	Tilt	06811	2	1:4.15	0.089	1.156	0.103	
ANSI / IEEE C95.1 1992 - SAFETY LIMIT Spatial Peak Uncontrolled Exposure/General Population							Head 1.6 W/kg (mW/g) averaged over 1 gram								

**Table 11-2  
GSM 1900 Head SAR**

MEASUREMENT RESULTS															
FREQUENCY		Mode	Service	Maximum Allowed Power [dBm]	Conducted Power [dBm]	Power Drift [dB]	Side	Test Position	Device Serial Number	# of Time Slots	Duty Cycle	SAR (1g)	Scaling Factor	Reported SAR (1g)	Plot #
MHz	Ch.											(W/kg)		(W/kg)	
1880.00	661	GSM 1900	GSM	30.7	30.69	-0.02	Right	Cheek	06811	1	1:8.3	0.076	1.002	0.076	
1880.00	661	GSM 1900	GSM	30.7	30.69	0.18	Right	Tilt	06811	1	1:8.3	0.035	1.002	0.035	
1880.00	661	GSM 1900	GSM	30.7	30.69	0.13	Left	Cheek	06811	1	1:8.3	0.062	1.002	0.062	
1880.00	661	GSM 1900	GSM	30.7	30.69	0.20	Left	Tilt	06811	1	1:8.3	0.037	1.002	0.037	
1880.00	661	GSM 1900	GPRS	28.7	28.63	0.14	Right	Cheek	06811	2	1:4.15	0.085	1.016	0.086	A2
1880.00	661	GSM 1900	GPRS	28.7	28.63	0.17	Right	Tilt	06811	2	1:4.15	0.045	1.016	0.046	
1880.00	661	GSM 1900	GPRS	28.7	28.63	0.19	Left	Cheek	06811	2	1:4.15	0.068	1.016	0.069	
1880.00	661	GSM 1900	GPRS	28.7	28.63	-0.15	Left	Tilt	06811	2	1:4.15	0.039	1.016	0.040	
ANSI / IEEE C95.1 1992 - SAFETY LIMIT Spatial Peak Uncontrolled Exposure/General Population							Head 1.6 W/kg (mW/g) averaged over 1 gram								

FCC ID: ZNFQ720AM		SAR EVALUATION REPORT		Approved by: Quality Manager
Document S/N: 1M1907080114-01-R1.ZNF	Test Dates: 07/08/19 - 07/19/19	DUT Type: Portable Handset		Page 51 of 83

**Table 11-3  
UMTS 850 Head SAR**



MEASUREMENT RESULTS														
FREQUENCY		Mode	Service	Maximum Allowed Power [dBm]	Conducted Power [dBm]	Power Drift [dB]	Side	Test Position	Device Serial Number	Duty Cycle	SAR (1g)	Scaling Factor	Reported SAR (1g)	Plot #
MHz	Ch.										(W/kg)		(W/kg)	
836.60	4183	UMTS 850	RMC	25.5	25.10	-0.10	Right	Cheek	06811	1:1	0.145	1.096	0.159	A3
836.60	4183	UMTS 850	RMC	25.5	25.10	0.03	Right	Tilt	06811	1:1	0.099	1.096	0.109	
836.60	4183	UMTS 850	RMC	25.5	25.10	0.04	Left	Cheek	06811	1:1	0.132	1.096	0.145	
836.60	4183	UMTS 850	RMC	25.5	25.10	0.06	Left	Tilt	06811	1:1	0.115	1.096	0.126	
ANSI / IEEE C95.1 1992 - SAFETY LIMIT Spatial Peak Uncontrolled Exposure/General Population							Head 1.6 W/kg (mW/g) averaged over 1 gram							

**Table 11-4  
UMTS 1750 Head SAR**

MEASUREMENT RESULTS														
FREQUENCY		Mode	Service	Maximum Allowed Power [dBm]	Conducted Power [dBm]	Power Drift [dB]	Side	Test Position	Device Serial Number	Duty Cycle	SAR (1g)	Scaling Factor	Reported SAR (1g)	Plot #
MHz	Ch.										(W/kg)		(W/kg)	
1732.40	1412	UMTS 1750	RMC	24.0	23.90	0.13	Right	Cheek	06811	1:1	0.122	1.023	0.125	A4
1732.40	1412	UMTS 1750	RMC	24.0	23.90	0.10	Right	Tilt	06811	1:1	0.103	1.023	0.105	
1732.40	1412	UMTS 1750	RMC	24.0	23.90	0.05	Left	Cheek	06811	1:1	0.105	1.023	0.107	
1732.40	1412	UMTS 1750	RMC	24.0	23.90	0.08	Left	Tilt	06811	1:1	0.068	1.023	0.070	
ANSI / IEEE C95.1 1992 - SAFETY LIMIT Spatial Peak Uncontrolled Exposure/General Population							Head 1.6 W/kg (mW/g) averaged over 1 gram							

**Table 11-5  
UMTS 1900 Head SAR**

MEASUREMENT RESULTS														
FREQUENCY		Mode	Service	Maximum Allowed Power [dBm]	Conducted Power [dBm]	Power Drift [dB]	Side	Test Position	Device Serial Number	Duty Cycle	SAR (1g)	Scaling Factor	Reported SAR (1g)	Plot #
MHz	Ch.										(W/kg)		(W/kg)	
1880.00	9400	UMTS 1900	RMC	24.0	23.86	0.08	Right	Cheek	06811	1:1	0.138	1.033	0.143	A5
1880.00	9400	UMTS 1900	RMC	24.0	23.86	0.16	Right	Tilt	06811	1:1	0.052	1.033	0.054	
1880.00	9400	UMTS 1900	RMC	24.0	23.86	0.13	Left	Cheek	06811	1:1	0.085	1.033	0.088	
1880.00	9400	UMTS 1900	RMC	24.0	23.86	0.13	Left	Tilt	06811	1:1	0.040	1.033	0.041	
ANSI / IEEE C95.1 1992 - SAFETY LIMIT Spatial Peak Uncontrolled Exposure/General Population							Head 1.6 W/kg (mW/g) averaged over 1 gram							

FCC ID: ZNFQ720AM	 PCTEST ENGINEERING LABORATORY, INC.	SAR EVALUATION REPORT	 LG	Approved by: Quality Manager
Document S/N: 1M1907080114-01-R1.ZNF	Test Dates: 07/08/19 - 07/19/19	DUT Type: Portable Handset	Page 52 of 83	

**Table 11-6  
LTE Band 12 Head SAR**



MEASUREMENT RESULTS																			
FREQUENCY		Mode	Bandwidth [MHz]	Maximum Allowed Power [dBm]	Conducted Power [dBm]	Power Drift [dB]	MPR [dB]	Side	Test Position	Modulation	RB Size	RB Offset	Device Serial Number	Duty Cycle	SAR (1g)	Scaling Factor	Reported SAR (1g)	Plot #	
MHz	Ch.														(W/kg)		(W/kg)		
707.50	23095	Mid	LTE Band 12	10	25.5	25.26	-0.19	0	Right	Cheek	QPSK	1	0	06837	1:1	0.168	1.057	0.178	A6
707.50	23095	Mid	LTE Band 12	10	24.5	23.61	0.02	1	Right	Cheek	QPSK	25	0	06837	1:1	0.104	1.227	0.128	
707.50	23095	Mid	LTE Band 12	10	25.5	25.26	0.11	0	Right	Tilt	QPSK	1	0	06837	1:1	0.099	1.057	0.105	
707.50	23095	Mid	LTE Band 12	10	24.5	23.61	0.02	1	Right	Tilt	QPSK	25	0	06837	1:1	0.065	1.227	0.080	
707.50	23095	Mid	LTE Band 12	10	25.5	25.26	-0.01	0	Left	Cheek	QPSK	1	0	06837	1:1	0.155	1.057	0.164	
707.50	23095	Mid	LTE Band 12	10	24.5	23.61	0.00	1	Left	Cheek	QPSK	25	0	06837	1:1	0.117	1.227	0.144	
707.50	23095	Mid	LTE Band 12	10	25.5	25.26	0.00	0	Left	Tilt	QPSK	1	0	06837	1:1	0.080	1.057	0.085	
707.50	23095	Mid	LTE Band 12	10	24.5	23.61	0.13	1	Left	Tilt	QPSK	25	0	06837	1:1	0.061	1.227	0.075	
ANSI / IEEE C95.1 1992 - SAFETY LIMIT Spatial Peak Uncontrolled Exposure/General Population											Head 1.6 W/kg (mW/g) averaged over 1 gram								

**Table 11-7  
LTE Band 14 Head SAR**

MEASUREMENT RESULTS																			
FREQUENCY		Mode	Bandwidth [MHz]	Maximum Allowed Power [dBm]	Conducted Power [dBm]	Power Drift [dB]	MPR [dB]	Side	Test Position	Modulation	RB Size	RB Offset	Device Serial Number	Duty Cycle	SAR (1g)	Scaling Factor	Reported SAR (1g)	Plot #	
MHz	Ch.														(W/kg)		(W/kg)		
793.00	23330	Mid	LTE Band 14	10	25.5	25.34	0.01	0	Right	Cheek	QPSK	1	0	06837	1:1	0.204	1.038	0.212	A7
793.00	23330	Mid	LTE Band 14	10	24.5	23.52	0.02	1	Right	Cheek	QPSK	25	12	06837	1:1	0.123	1.253	0.154	
793.00	23330	Mid	LTE Band 14	10	25.5	25.34	0.08	0	Right	Tilt	QPSK	1	0	06837	1:1	0.095	1.038	0.099	
793.00	23330	Mid	LTE Band 14	10	24.5	23.52	0.05	1	Right	Tilt	QPSK	25	12	06837	1:1	0.062	1.253	0.078	
793.00	23330	Mid	LTE Band 14	10	25.5	25.34	-0.19	0	Left	Cheek	QPSK	1	0	06837	1:1	0.199	1.038	0.207	
793.00	23330	Mid	LTE Band 14	10	24.5	23.52	0.11	1	Left	Cheek	QPSK	25	12	06837	1:1	0.120	1.253	0.150	
793.00	23330	Mid	LTE Band 14	10	25.5	25.34	-0.03	0	Left	Tilt	QPSK	1	0	06837	1:1	0.122	1.038	0.127	
793.00	23330	Mid	LTE Band 14	10	24.5	23.52	0.17	1	Left	Tilt	QPSK	25	12	06837	1:1	0.078	1.253	0.098	
ANSI / IEEE C95.1 1992 - SAFETY LIMIT Spatial Peak Uncontrolled Exposure/General Population											Head 1.6 W/kg (mW/g) averaged over 1 gram								

**Table 11-8  
LTE Band 5 (Cell) Head SAR**

MEASUREMENT RESULTS																			
FREQUENCY		Mode	Bandwidth [MHz]	Maximum Allowed Power [dBm]	Conducted Power [dBm]	Power Drift [dB]	MPR [dB]	Side	Test Position	Modulation	RB Size	RB Offset	Device Serial Number	Duty Cycle	SAR (1g)	Scaling Factor	Reported SAR (1g)	Plot #	
MHz	Ch.														(W/kg)		(W/kg)		
836.50	20525	Mid	LTE Band 5 (Cell)	10	25.5	25.14	-0.01	0	Right	Cheek	QPSK	1	49	06829	1:1	0.194	1.086	0.211	A8
836.50	20525	Mid	LTE Band 5 (Cell)	10	24.5	23.37	-0.01	1	Right	Cheek	QPSK	25	0	06829	1:1	0.128	1.297	0.166	
836.50	20525	Mid	LTE Band 5 (Cell)	10	25.5	25.14	-0.02	0	Right	Tilt	QPSK	1	49	06829	1:1	0.131	1.086	0.142	
836.50	20525	Mid	LTE Band 5 (Cell)	10	24.5	23.37	0.17	1	Right	Tilt	QPSK	25	0	06829	1:1	0.081	1.297	0.105	
836.50	20525	Mid	LTE Band 5 (Cell)	10	25.5	25.14	0.10	0	Left	Cheek	QPSK	1	49	06829	1:1	0.169	1.086	0.184	
836.50	20525	Mid	LTE Band 5 (Cell)	10	24.5	23.37	0.07	1	Left	Cheek	QPSK	25	0	06829	1:1	0.106	1.297	0.137	
836.50	20525	Mid	LTE Band 5 (Cell)	10	25.5	25.14	0.04	0	Left	Tilt	QPSK	1	49	06829	1:1	0.136	1.086	0.148	
836.50	20525	Mid	LTE Band 5 (Cell)	10	24.5	23.37	0.00	1	Left	Tilt	QPSK	25	0	06829	1:1	0.087	1.297	0.113	
ANSI / IEEE C95.1 1992 - SAFETY LIMIT Spatial Peak Uncontrolled Exposure/General Population											Head 1.6 W/kg (mW/g) averaged over 1 gram								

FCC ID: ZNFQ720AM		SAR EVALUATION REPORT		Approved by: Quality Manager
Document S/N: 1M1907080114-01-R1.ZNF	Test Dates: 07/08/19 - 07/19/19	DUT Type: Portable Handset		Page 53 of 83

**Table 11-9  
LTE Band 66 (AWS) Head SAR**



MEASUREMENT RESULTS																			
FREQUENCY		Mode	Bandwidth [MHz]	Maximum Allowed Power [dBm]	Conducted Power [dBm]	Power Drift [dB]	MPR [dB]	Side	Test Position	Modulation	RB Size	RB Offset	Device Serial Number	Duty Cycle	SAR (1g)	Scaling Factor	Reported SAR (1g)	Plot #	
MHz	Ch.														(W/kg)		(W/kg)		
1770.00	132572	High	LTE Band 66 (AWS)	20	24.0	23.99	0.01	0	Right	Cheek	QPSK	1	50	06837	1:1	0.104	1.002	0.104	A9
1770.00	132572	High	LTE Band 66 (AWS)	20	23.0	23.00	0.05	1	Right	Cheek	QPSK	50	0	06837	1:1	0.099	1.000	0.099	
1770.00	132572	High	LTE Band 66 (AWS)	20	24.0	23.99	0.20	0	Right	Tilt	QPSK	1	50	06837	1:1	0.069	1.002	0.069	
1770.00	132572	High	LTE Band 66 (AWS)	20	23.0	23.00	0.12	1	Right	Tilt	QPSK	50	0	06837	1:1	0.067	1.000	0.067	
1770.00	132572	High	LTE Band 66 (AWS)	20	24.0	23.99	-0.06	0	Left	Cheek	QPSK	1	50	06837	1:1	0.093	1.002	0.093	
1770.00	132572	High	LTE Band 66 (AWS)	20	23.0	23.00	0.13	1	Left	Cheek	QPSK	50	0	06837	1:1	0.090	1.000	0.090	
1770.00	132572	High	LTE Band 66 (AWS)	20	24.0	23.99	0.09	0	Left	Tilt	QPSK	1	50	06837	1:1	0.043	1.002	0.043	
1770.00	132572	High	LTE Band 66 (AWS)	20	23.0	23.00	0.17	1	Left	Tilt	QPSK	50	0	06837	1:1	0.042	1.000	0.042	
ANSI / IEEE C95.1 1992 - SAFETY LIMIT Spatial Peak Uncontrolled Exposure/General Population										Head 1.6 W/kg (mW/g) averaged over 1 gram									

**Table 11-10  
LTE Band 2 (PCS) Head SAR**

MEASUREMENT RESULTS																			
FREQUENCY		Mode	Bandwidth [MHz]	Maximum Allowed Power [dBm]	Conducted Power [dBm]	Power Drift [dB]	MPR [dB]	Side	Test Position	Modulation	RB Size	RB Offset	Device Serial Number	Duty Cycle	SAR (1g)	Scaling Factor	Reported SAR (1g)	Plot #	
MHz	Ch.														(W/kg)		(W/kg)		
1860.00	18700	Low	LTE Band 2 (PCS)	20	24.0	24.00	0.11	0	Right	Cheek	QPSK	1	99	06829	1:1	0.106	1.000	0.106	A10
1860.00	18700	Low	LTE Band 2 (PCS)	20	23.0	22.97	0.10	1	Right	Cheek	QPSK	50	25	06829	1:1	0.091	1.007	0.092	
1860.00	18700	Low	LTE Band 2 (PCS)	20	24.0	24.00	0.10	0	Right	Tilt	QPSK	1	99	06829	1:1	0.051	1.000	0.051	
1860.00	18700	Low	LTE Band 2 (PCS)	20	23.0	22.97	0.14	1	Right	Tilt	QPSK	50	25	06829	1:1	0.028	1.007	0.028	
1860.00	18700	Low	LTE Band 2 (PCS)	20	24.0	24.00	0.12	0	Left	Cheek	QPSK	1	99	06829	1:1	0.077	1.000	0.077	
1860.00	18700	Low	LTE Band 2 (PCS)	20	23.0	22.97	0.12	1	Left	Cheek	QPSK	50	25	06829	1:1	0.061	1.007	0.061	
1860.00	18700	Low	LTE Band 2 (PCS)	20	24.0	24.00	0.12	0	Left	Tilt	QPSK	1	99	06829	1:1	0.063	1.000	0.063	
1860.00	18700	Low	LTE Band 2 (PCS)	20	23.0	22.97	0.13	1	Left	Tilt	QPSK	50	25	06829	1:1	0.046	1.007	0.046	
ANSI / IEEE C95.1 1992 - SAFETY LIMIT Spatial Peak Uncontrolled Exposure/General Population										Head 1.6 W/kg (mW/g) averaged over 1 gram									

**Table 11-11  
LTE Band 30 Head SAR**

MEASUREMENT RESULTS																			
FREQUENCY		Mode	Bandwidth [MHz]	Maximum Allowed Power [dBm]	Conducted Power [dBm]	Power Drift [dB]	MPR [dB]	Side	Test Position	Modulation	RB Size	RB Offset	Device Serial Number	Duty Cycle	SAR (1g)	Scaling Factor	Reported SAR (1g)	Plot #	
MHz	Ch.														(W/kg)		(W/kg)		
2310.00	27710	Mid	LTE Band 30	10	24.0	23.95	0.10	0	Right	Cheek	QPSK	1	49	06837	1:1	0.092	1.012	0.093	A11
2310.00	27710	Mid	LTE Band 30	10	23.0	22.93	-0.01	1	Right	Cheek	QPSK	25	25	06837	1:1	0.065	1.016	0.066	
2310.00	27710	Mid	LTE Band 30	10	24.0	23.95	0.13	0	Right	Tilt	QPSK	1	49	06837	1:1	0.053	1.012	0.054	
2310.00	27710	Mid	LTE Band 30	10	23.0	22.93	0.20	1	Right	Tilt	QPSK	25	25	06837	1:1	0.036	1.016	0.037	
2310.00	27710	Mid	LTE Band 30	10	24.0	23.95	0.12	0	Left	Cheek	QPSK	1	49	06837	1:1	0.060	1.012	0.061	
2310.00	27710	Mid	LTE Band 30	10	23.0	22.93	0.07	1	Left	Cheek	QPSK	25	25	06837	1:1	0.049	1.016	0.050	
2310.00	27710	Mid	LTE Band 30	10	24.0	23.95	0.12	0	Left	Tilt	QPSK	1	49	06837	1:1	0.062	1.012	0.063	
2310.00	27710	Mid	LTE Band 30	10	23.0	22.93	0.12	1	Left	Tilt	QPSK	25	25	06837	1:1	0.047	1.016	0.048	
ANSI / IEEE C95.1 1992 - SAFETY LIMIT Spatial Peak Uncontrolled Exposure/General Population										Head 1.6 W/kg (mW/g) averaged over 1 gram									

FCC ID: ZNFQ720AM		SAR EVALUATION REPORT		Approved by: Quality Manager
Document S/N: 1M1907080114-01-R1.ZNF	Test Dates: 07/08/19 - 07/19/19	DUT Type: Portable Handset	Page 54 of 83	



**Table 11-12  
DTS Head SAR**

MEASUREMENT RESULTS																		
FREQUENCY		Mode	Service	Bandwidth [MHz]	Maximum Allowed Power [dBm]	Conducted Power [dBm]	Power Drift [dB]	Side	Test Position	Device Serial Number	Data Rate (Mbps)	Duty Cycle (%)	Peak SAR of Area Scan	SAR (1g)	Scaling Factor (Power)	Scaling Factor (Duty Cycle)	Reported SAR (1g)	Plot #
MHz	Ch.												W/kg	(W/kg)			(W/kg)	
2412	1	802.11b	DSSS	22	19.0	18.26	0.12	Right	Cheek	06795	1	99.9	1.115	0.772	1.186	1.001	0.917	
2437	6	802.11b	DSSS	22	19.0	18.33	0.13	Right	Cheek	06795	1	99.9	1.352	0.749	1.167	1.001	0.875	
2412	1	802.11b	DSSS	22	19.0	18.26	0.04	Right	Tilt	06795	1	99.9	1.282	0.758	1.186	1.001	0.900	
2437	6	802.11b	DSSS	22	19.0	18.33	0.02	Right	Tilt	06795	1	99.9	1.420	0.799	1.167	1.001	0.933	
2462	11	802.11b	DSSS	22	19.0	18.12	0.00	Right	Tilt	06795	1	99.9	1.499	0.843	1.225	1.001	1.034	A12
2437	6	802.11b	DSSS	22	19.0	18.33	-0.10	Left	Cheek	06795	1	99.9	0.390	-	1.167	1.001	-	
2437	6	802.11b	DSSS	22	19.0	18.33	0.06	Left	Tilt	06795	1	99.9	0.535	0.352	1.167	1.001	0.411	
2462	11	802.11b	DSSS	22	19.0	18.12	-0.02	Right	Tilt	06795	1	99.9	1.525	0.828	1.225	1.001	1.015	
ANSI / IEEE C95.1 1992 - SAFETY LIMIT Spatial Peak Uncontrolled Exposure/General Population								Head 1.6 W/kg (mW/g) averaged over 1 gram										

Note: Blue entry represents variability measurement.

**Table 11-13  
NII Head SAR**

MEASUREMENT RESULTS																		
FREQUENCY		Mode	Service	Bandwidth [MHz]	Maximum Allowed Power [dBm]	Conducted Power [dBm]	Power Drift [dB]	Side	Test Position	Device Serial Number	Data Rate (Mbps)	Duty Cycle (%)	Peak SAR of Area Scan	SAR (1g)	Scaling Factor (Power)	Scaling Factor (Duty Cycle)	Reported SAR (1g)	Plot #
MHz	Ch.												W/kg	(W/kg)			(W/kg)	
5280	56	802.11a	OFDM	20	17.5	16.64	0.14	Right	Cheek	06795	6	99.2	0.933	0.438	1.219	1.008	0.538	
5280	56	802.11a	OFDM	20	17.5	16.64	0.19	Right	Tilt	06795	6	99.2	0.505	0.232	1.219	1.008	0.285	
5280	56	802.11a	OFDM	20	17.5	16.64	-0.13	Left	Cheek	06795	6	99.2	0.317	-	1.219	1.008	-	
5280	56	802.11a	OFDM	20	17.5	16.64	0.12	Left	Tilt	06795	6	99.2	0.286	-	1.219	1.008	-	
5680	136	802.11a	OFDM	20	17.5	16.71	0.18	Right	Cheek	06795	6	99.2	1.210	0.545	1.199	1.008	0.659	
5680	136	802.11a	OFDM	20	17.5	16.71	0.17	Right	Tilt	06795	6	99.2	0.394	0.182	1.199	1.008	0.220	
5680	136	802.11a	OFDM	20	17.5	16.71	0.11	Left	Cheek	06795	6	99.2	0.254	-	1.199	1.008	-	
5680	136	802.11a	OFDM	20	17.5	16.71	0.12	Left	Tilt	06795	6	99.2	0.220	-	1.199	1.008	-	
5765	153	802.11a	OFDM	20	18.0	17.21	0.13	Right	Cheek	06795	6	99.2	1.238	0.635	1.199	1.008	0.767	A13
5785	157	802.11a	OFDM	20	18.0	17.17	0.17	Right	Cheek	06795	6	99.2	1.447	0.597	1.211	1.008	0.729	
5805	161	802.11a	OFDM	20	18.0	17.19	0.13	Right	Cheek	06795	6	99.2	1.445	0.606	1.205	1.008	0.736	
5765	153	802.11a	OFDM	20	18.0	17.21	0.12	Right	Tilt	06795	6	99.2	0.472	0.181	1.199	1.008	0.219	
5765	153	802.11a	OFDM	20	18.0	17.21	0.13	Left	Cheek	06795	6	99.2	0.286	-	1.199	1.008	-	
5765	153	802.11a	OFDM	20	18.0	17.21	0.17	Left	Tilt	06795	6	99.2	0.245	-	1.199	1.008	-	
ANSI / IEEE C95.1 1992 - SAFETY LIMIT Spatial Peak Uncontrolled Exposure/General Population								Head 1.6 W/kg (mW/g) averaged over 1 gram										

FCC ID: ZNFQ720AM		SAR EVALUATION REPORT		Approved by: Quality Manager
Document S/N: 1M1907080114-01-R1.ZNF	Test Dates: 07/08/19 - 07/19/19	DUT Type: Portable Handset		Page 55 of 83



**Table 11-14  
DSS Head SAR**

MEASUREMENT RESULTS																
FREQUENCY		Mode	Service	Maximum Allowed Power [dBm]	Conducted Power [dBm]	Power Drift [dB]	Side	Test Position	Device Serial Number	Data Rate (Mbps)	Duty Cycle (%)	SAR (1g)	Scaling Factor (Cond Power)	Scaling Factor (Duty Cycle)	Reported SAR (1g)	Plot #
MHz	Ch.											(W/kg)			(W/kg)	
2441.00	39	Bluetooth	FHSS	11.0	10.89	0.12	Right	Cheek	06795	1	77.1	0.084	1.026	1.297	0.112	A14
2441.00	39	Bluetooth	FHSS	11.0	10.89	0.14	Right	Tilt	06795	1	77.1	0.081	1.026	1.297	0.108	
2441.00	39	Bluetooth	FHSS	11.0	10.89	0.12	Left	Cheek	06795	1	77.1	0.023	1.026	1.297	0.031	
2441.00	39	Bluetooth	FHSS	11.0	10.89	0.17	Left	Tilt	06795	1	77.1	0.031	1.026	1.297	0.041	
ANSI / IEEE C95.1 1992 - SAFETY LIMIT Spatial Peak Uncontrolled Exposure/General Population							Head 1.6 W/kg (mW/g) averaged over 1 gram									

## 11.2 Standalone Body-Worn SAR Data

**Table 11-15  
GSM/UMTS Body-Worn SAR Data**

MEASUREMENT RESULTS															
FREQUENCY		Mode	Service	Maximum Allowed Power [dBm]	Conducted Power [dBm]	Power Drift [dB]	Spacing	Device Serial Number	# of Time Slots	Duty Cycle	Side	SAR (1g)	Scaling Factor	Reported SAR (1g)	Plot #
MHz	Ch.											(W/kg)		(W/kg)	
836.60	190	GSM 850	GSM	33.2	32.96	-0.06	10 mm	06811	1	1:8.3	back	0.414	1.057	0.438	
824.20	128	GSM 850	GPRS	32.2	31.40	-0.04	10 mm	06811	2	1:4.15	back	0.558	1.202	0.671	
836.60	190	GSM 850	GPRS	32.2	31.57	0.02	10 mm	06811	2	1:4.15	back	0.639	1.156	0.739	A15
848.80	251	GSM 850	GPRS	32.2	31.54	-0.10	10 mm	06811	2	1:4.15	back	0.557	1.164	0.648	
1880.00	661	GSM 1900	GSM	30.7	30.69	0.00	10 mm	06811	1	1:8.3	back	0.291	1.002	0.292	
1880.00	661	GSM 1900	GPRS	28.7	28.63	0.01	10 mm	06811	2	1:4.15	back	0.325	1.016	0.330	A16
836.60	4183	UMTS 850	RMC	25.5	25.10	-0.04	10 mm	06811	N/A	1:1	back	0.545	1.096	0.597	A18
1732.40	1412	UMTS 1750	RMC	24.0	23.90	-0.05	10 mm	06811	N/A	1:1	back	0.555	1.023	0.568	A19
1880.00	9400	UMTS 1900	RMC	24.0	23.86	0.01	10 mm	06811	N/A	1:1	back	0.450	1.033	0.465	A21
ANSI / IEEE C95.1 1992 - SAFETY LIMIT Spatial Peak Uncontrolled Exposure/General Population							Body 1.6 W/kg (mW/g) averaged over 1 gram								

FCC ID: ZNFQ720AM		SAR EVALUATION REPORT		Approved by: Quality Manager
Document S/N: 1M1907080114-01-R1.ZNF	Test Dates: 07/08/19 - 07/19/19	DUT Type: Portable Handset	Page 56 of 83	



**Table 11-16  
LTE Body-Worn SAR**



MEASUREMENT RESULTS																			
FREQUENCY		Mode	Bandwidth [MHz]	Maximum Allowed Power [dBm]	Conducted Power [dBm]	Power Drift [dB]	MPR [dB]	Device Serial Number	Modulation	RB Size	RB Offset	Spacing	Side	Duty Cycle	SAR (1g)	Scaling Factor	Reported SAR (1g)	Plot #	
MHz	Ch.														(W/kg)		(W/kg)		
707.50	23095	Mid	LTE Band 12	10	25.5	25.26	0.00	0	06829	QPSK	1	0	10 mm	back	1:1	0.518	1.057	0.548	A23
707.50	23095	Mid	LTE Band 12	10	24.5	23.61	0.01	1	06829	QPSK	25	0	10 mm	back	1:1	0.349	1.227	0.428	
793.00	23330	Mid	LTE Band 14	10	25.5	25.34	-0.04	0	06829	QPSK	1	0	10 mm	back	1:1	0.643	1.038	0.667	A24
793.00	23330	Mid	LTE Band 14	10	24.5	23.52	0.07	1	06829	QPSK	25	12	10 mm	back	1:1	0.400	1.253	0.501	
836.50	20525	Mid	LTE Band 5 (Cell)	10	25.5	25.14	-0.04	0	06829	QPSK	1	49	10 mm	back	1:1	0.546	1.086	0.593	A25
836.50	20525	Mid	LTE Band 5 (Cell)	10	24.5	23.37	0.04	1	06829	QPSK	25	0	10 mm	back	1:1	0.359	1.297	0.466	
1770.00	132572	High	LTE Band 66 (AWS)	20	24.0	23.99	-0.03	0	06829	QPSK	1	50	10 mm	back	1:1	0.494	1.002	0.495	A27
1770.00	132572	High	LTE Band 66 (AWS)	20	23.0	23.00	-0.09	1	06829	QPSK	50	0	10 mm	back	1:1	0.474	1.000	0.474	
1860.00	18700	Low	LTE Band 2 (PCS)	20	24.0	24.00	0.05	0	06829	QPSK	1	99	10 mm	back	1:1	0.422	1.000	0.422	A29
1860.00	18700	Low	LTE Band 2 (PCS)	20	23.0	22.97	-0.01	1	06829	QPSK	50	25	10 mm	back	1:1	0.393	1.007	0.396	
2310.00	27710	Mid	LTE Band 30	10	24.0	23.95	-0.06	0	06837	QPSK	1	49	10 mm	back	1:1	0.388	1.012	0.393	A31
2310.00	27710	Mid	LTE Band 30	10	23.0	22.93	0.04	1	06837	QPSK	25	25	10 mm	back	1:1	0.304	1.016	0.309	
ANSI / IEEE C95.1 1992 - SAFETY LIMIT Spatial Peak Uncontrolled Exposure/General Population									Body 1.6 W/kg (mW/g) averaged over 1 gram										

**Table 11-17  
DTS Body-Worn SAR**

MEASUREMENT RESULTS																		
FREQUENCY		Mode	Service	Bandwidth [MHz]	Maximum Allowed Power [dBm]	Conducted Power [dBm]	Power Drift [dB]	Spacing	Device Serial Number	Data Rate (Mbps)	Side	Duty Cycle (%)	Peak SAR of Area Scan	SAR (1g)	Scaling Factor (Power)	Scaling Factor (Duty Cycle)	Reported SAR (1g)	Plot #
MHz	Ch.												(W/kg)	(W/kg)			(W/kg)	
2412	1	802.11b	DSSS	22	23.0	22.23	-0.05	10 mm	06795	1	back	99.9	1.042	0.640	1.194	1.001	0.765	A33
2437	6	802.11b	DSSS	22	23.0	22.02	0.00	10 mm	06795	1	back	99.9	0.848	0.624	1.253	1.001	0.783	
2462	11	802.11b	DSSS	22	23.0	22.04	0.06	10 mm	06795	1	back	99.9	0.787	0.633	1.247	1.001	0.790	
ANSI / IEEE C95.1 1992 - SAFETY LIMIT Spatial Peak Uncontrolled Exposure/General Population									Body 1.6 W/kg (mW/g) averaged over 1 gram									

**Table 11-18  
NII Body-Worn SAR**

MEASUREMENT RESULTS																		
FREQUENCY		Mode	Service	Bandwidth [MHz]	Maximum Allowed Power [dBm]	Conducted Power [dBm]	Power Drift [dB]	Spacing	Device Serial Number	Data Rate (Mbps)	Side	Duty Cycle (%)	Peak SAR of Area Scan	SAR (1g)	Scaling Factor (Power)	Scaling Factor (Duty Cycle)	Reported SAR (1g)	Plot #
MHz	Ch.												(W/kg)	(W/kg)			(W/kg)	
5260	52	802.11a	OFDM	20	19.5	18.65	-0.11	10 mm	06795	6	back	99.2	1.128	0.578	1.216	1.008	0.708	A34
5280	56	802.11a	OFDM	20	19.5	18.74	-0.18	10 mm	06795	6	back	99.2	1.111	0.575	1.191	1.008	0.690	
5300	60	802.11a	OFDM	20	19.5	18.72	-0.11	10 mm	06795	6	back	99.2	1.164	0.555	1.197	1.008	0.670	
5680	136	802.11a	OFDM	20	19.5	19.05	0.00	10 mm	06795	6	back	99.2	1.169	0.514	1.109	1.008	0.575	
5805	161	802.11a	OFDM	20	20.0	19.68	-0.12	10 mm	06795	6	back	99.2	1.330	0.536	1.076	1.008	0.581	
ANSI / IEEE C95.1 1992 - SAFETY LIMIT Spatial Peak Uncontrolled Exposure/General Population									Body 1.6 W/kg (mW/g) averaged over 1 gram									

FCC ID: ZNFQ720AM		SAR EVALUATION REPORT		Approved by: Quality Manager
Document S/N: 1M1907080114-01-R1.ZNF	Test Dates: 07/08/19 - 07/19/19	DUT Type: Portable Handset	Page 57 of 83	

**Table 11-19  
DSS Body-Worn SAR**



MEASUREMENT RESULTS																
FREQUENCY		Mode	Service	Maximum Allowed Power [dBm]	Conducted Power [dBm]	Power Drift [dB]	Spacing	Device Serial Number	Data Rate (Mbps)	Side	Duty Cycle (%)	SAR (1g)	Scaling Factor (Cond Power)	Scaling Factor (Duty Cycle)	Reported SAR (1g)	Plot #
MHz	Ch.											(W/kg)			(W/kg)	
2441	39	Bluetooth	FHSS	11.0	10.89	0.13	10 mm	06795	1	back	77.1	0.024	1.026	1.297	0.032	A36
ANSI / IEEE C95.1 1992 - SAFETY LIMIT Spatial Peak Uncontrolled Exposure/General Population							Body 1.6 W/kg (mW/g) averaged over 1 gram									

### 11.3 Standalone Hotspot SAR Data

**Table 11-20  
GPRS/UMTS Hotspot SAR Data**

MEASUREMENT RESULTS																
FREQUENCY		Mode	Service	Maximum Allowed Power [dBm]	Conducted Power [dBm]	Power Drift [dB]	Spacing	Device Serial Number	# of Time Slots	Duty Cycle	Side	SAR (1g)	Scaling Factor	Reported SAR (1g)	Plot #	
MHz	Ch.											(W/kg)		(W/kg)		
824.20	128	GSM 850	GPRS	32.2	31.40	-0.04	10 mm	06811	2	1:4.15	back	0.558	1.202	0.671		
836.60	190	GSM 850	GPRS	32.2	31.57	0.02	10 mm	06811	2	1:4.15	back	0.639	1.156	0.739	A15	
848.80	251	GSM 850	GPRS	32.2	31.54	-0.10	10 mm	06811	2	1:4.15	back	0.557	1.164	0.648		
836.60	190	GSM 850	GPRS	32.2	31.57	-0.02	10 mm	06811	2	1:4.15	front	0.520	1.156	0.601		
836.60	190	GSM 850	GPRS	32.2	31.57	-0.04	10 mm	06811	2	1:4.15	bottom	0.262	1.156	0.303		
836.60	190	GSM 850	GPRS	32.2	31.57	-0.13	10 mm	06811	2	1:4.15	left	0.078	1.156	0.090		
1880.00	661	GSM 1900	GPRS	28.7	28.63	0.01	10 mm	06811	2	1:4.15	back	0.325	1.016	0.330		
1880.00	661	GSM 1900	GPRS	28.7	28.63	0.01	10 mm	06811	2	1:4.15	front	0.358	1.016	0.364		
1850.20	512	GSM 1900	GPRS	28.7	28.59	-0.01	10 mm	06811	2	1:4.15	bottom	0.672	1.026	0.689		
1880.00	661	GSM 1900	GPRS	28.7	28.63	-0.08	10 mm	06811	2	1:4.15	bottom	0.786	1.016	0.799		
1909.80	810	GSM 1900	GPRS	28.7	28.70	0.03	10 mm	06811	2	1:4.15	bottom	0.812	1.000	0.812	A17	
1880.00	661	GSM 1900	GPRS	28.7	28.63	-0.06	10 mm	06811	2	1:4.15	right	0.099	1.016	0.101		
836.60	4183	UMTS 850	RMC	25.5	25.10	-0.04	10 mm	06811	N/A	1:1	back	0.545	1.096	0.597	A18	
836.60	4183	UMTS 850	RMC	25.5	25.10	0.02	10 mm	06811	N/A	1:1	front	0.376	1.096	0.412		
836.60	4183	UMTS 850	RMC	25.5	25.10	0.02	10 mm	06811	N/A	1:1	bottom	0.211	1.096	0.231		
836.60	4183	UMTS 850	RMC	25.5	25.10	-0.03	10 mm	06811	N/A	1:1	left	0.085	1.096	0.093		
1732.40	1412	UMTS 1750	RMC	24.0	23.90	-0.05	10 mm	06811	N/A	1:1	back	0.555	1.023	0.568		
1732.40	1412	UMTS 1750	RMC	24.0	23.90	0.03	10 mm	06811	N/A	1:1	front	0.595	1.023	0.609		
1712.40	1312	UMTS 1750	RMC	24.0	23.68	-0.03	10 mm	06811	N/A	1:1	bottom	0.790	1.076	0.850		
1732.40	1412	UMTS 1750	RMC	24.0	23.90	-0.01	10 mm	06811	N/A	1:1	bottom	0.855	1.023	0.875		
1752.60	1513	UMTS 1750	RMC	24.0	23.79	-0.13	10 mm	06811	N/A	1:1	bottom	0.936	1.050	0.983		
1732.40	1412	UMTS 1750	RMC	24.0	23.90	-0.02	10 mm	06811	N/A	1:1	right	0.253	1.023	0.259		
1752.60	1513	UMTS 1750	RMC	24.0	23.79	0.00	10 mm	06811	N/A	1:1	bottom	0.939	1.050	0.986	A20	
1880.00	9400	UMTS 1900	RMC	24.0	23.86	0.01	10 mm	06811	N/A	1:1	back	0.450	1.033	0.465		
1880.00	9400	UMTS 1900	RMC	24.0	23.86	0.02	10 mm	06811	N/A	1:1	front	0.484	1.033	0.500		
1852.40	9262	UMTS 1900	RMC	24.0	23.95	-0.01	10 mm	06811	N/A	1:1	bottom	0.836	1.012	0.846		
1880.00	9400	UMTS 1900	RMC	24.0	23.86	0.02	10 mm	06811	N/A	1:1	bottom	0.940	1.033	0.971		
1907.60	9538	UMTS 1900	RMC	24.0	24.00	-0.02	10 mm	06811	N/A	1:1	bottom	0.973	1.000	0.973	A22	
1880.00	9400	UMTS 1900	RMC	24.0	23.86	0.11	10 mm	06811	N/A	1:1	right	0.133	1.033	0.137		
ANSI / IEEE C95.1 1992 - SAFETY LIMIT Spatial Peak Uncontrolled Exposure/General Population							Body 1.6 W/kg (mW/g) averaged over 1 gram									

Note: Blue entry represents variability measurement.

FCC ID: ZNFQ720AM		SAR EVALUATION REPORT		Approved by: Quality Manager
Document S/N: 1M1907080114-01-R1.ZNF	Test Dates: 07/08/19 - 07/19/19	DUT Type: Portable Handset	Page 58 of 83	

**Table 11-21  
LTE Band 12 Hotspot SAR**



MEASUREMENT RESULTS																			
FREQUENCY		Mode	Bandwidth [MHz]	Maximum Allowed Power [dBm]	Conducted Power [dBm]	Power Drift [dB]	MPR [dB]	Device Serial Number	Modulation	RB Size	RB Offset	Spacing	Side	Duty Cycle	SAR (1g)	Scaling Factor	Reported SAR (1g)	Plot #	
MHz	Ch.														(W/kg)		(W/kg)		
707.50	23095	Mid	LTE Band 12	10	25.5	25.26	0.00	0	06829	QPSK	1	0	10 mm	back	1:1	0.518	1.057	0.548	A23
707.50	23095	Mid	LTE Band 12	10	24.5	23.61	0.01	1	06829	QPSK	25	0	10 mm	back	1:1	0.349	1.227	0.428	
707.50	23095	Mid	LTE Band 12	10	25.5	25.26	-0.05	0	06829	QPSK	1	0	10 mm	front	1:1	0.364	1.057	0.385	
707.50	23095	Mid	LTE Band 12	10	24.5	23.61	-0.03	1	06829	QPSK	25	0	10 mm	front	1:1	0.244	1.227	0.299	
707.50	23095	Mid	LTE Band 12	10	25.5	25.26	0.00	0	06829	QPSK	1	0	10 mm	bottom	1:1	0.115	1.057	0.122	
707.50	23095	Mid	LTE Band 12	10	24.5	23.61	0.02	1	06829	QPSK	25	0	10 mm	bottom	1:1	0.079	1.227	0.097	
707.50	23095	Mid	LTE Band 12	10	25.5	25.26	0.01	0	06829	QPSK	1	0	10 mm	left	1:1	0.508	1.057	0.537	
707.50	23095	Mid	LTE Band 12	10	24.5	23.61	0.01	1	06829	QPSK	25	0	10 mm	left	1:1	0.316	1.227	0.388	
ANSI / IEEE C95.1 1992 - SAFETY LIMIT Spatial Peak Uncontrolled Exposure/General Population								Body 1.6 W/kg (mW/g) averaged over 1 gram											

**Table 11-22  
LTE Band 14 Hotspot SAR**

MEASUREMENT RESULTS																			
FREQUENCY		Mode	Bandwidth [MHz]	Maximum Allowed Power [dBm]	Conducted Power [dBm]	Power Drift [dB]	MPR [dB]	Device Serial Number	Modulation	RB Size	RB Offset	Spacing	Side	Duty Cycle	SAR (1g)	Scaling Factor	Reported SAR (1g)	Plot #	
MHz	Ch.														(W/kg)		(W/kg)		
793.00	23330	Mid	LTE Band 14	10	25.5	25.34	-0.04	0	06829	QPSK	1	0	10 mm	back	1:1	0.643	1.038	0.667	A24
793.00	23330	Mid	LTE Band 14	10	24.5	23.52	0.07	1	06829	QPSK	25	12	10 mm	back	1:1	0.400	1.253	0.501	
793.00	23330	Mid	LTE Band 14	10	25.5	25.34	0.01	0	06829	QPSK	1	0	10 mm	front	1:1	0.444	1.038	0.461	
793.00	23330	Mid	LTE Band 14	10	24.5	23.52	0.05	1	06829	QPSK	25	12	10 mm	front	1:1	0.277	1.253	0.347	
793.00	23330	Mid	LTE Band 14	10	25.5	25.34	-0.05	0	06829	QPSK	1	0	10 mm	bottom	1:1	0.168	1.038	0.174	
793.00	23330	Mid	LTE Band 14	10	24.5	23.52	0.05	1	06829	QPSK	25	12	10 mm	bottom	1:1	0.114	1.253	0.143	
793.00	23330	Mid	LTE Band 14	10	25.5	25.34	-0.07	0	06829	QPSK	1	0	10 mm	left	1:1	0.214	1.038	0.222	
793.00	23330	Mid	LTE Band 14	10	24.5	23.52	0.04	1	06829	QPSK	25	12	10 mm	left	1:1	0.126	1.253	0.158	
ANSI / IEEE C95.1 1992 - SAFETY LIMIT Spatial Peak Uncontrolled Exposure/General Population								Body 1.6 W/kg (mW/g) averaged over 1 gram											

**Table 11-23  
LTE Band 5 (Cell) Hotspot SAR**

MEASUREMENT RESULTS																			
FREQUENCY		Mode	Bandwidth [MHz]	Maximum Allowed Power [dBm]	Conducted Power [dBm]	Power Drift [dB]	MPR [dB]	Device Serial Number	Modulation	RB Size	RB Offset	Spacing	Side	Duty Cycle	SAR (1g)	Scaling Factor	Reported SAR (1g)	Plot #	
MHz	Ch.														(W/kg)		(W/kg)		
836.50	20525	Mid	LTE Band 5 (Cell)	10	25.5	25.14	-0.04	0	06829	QPSK	1	49	10 mm	back	1:1	0.546	1.086	0.593	
836.50	20525	Mid	LTE Band 5 (Cell)	10	24.5	23.37	0.04	1	06829	QPSK	25	0	10 mm	back	1:1	0.359	1.297	0.466	
836.50	20525	Mid	LTE Band 5 (Cell)	10	25.5	25.14	-0.17	0	06829	QPSK	1	49	10 mm	front	1:1	0.567	1.086	0.616	A26
836.50	20525	Mid	LTE Band 5 (Cell)	10	24.5	23.37	0.05	1	06829	QPSK	25	0	10 mm	front	1:1	0.315	1.297	0.409	
836.50	20525	Mid	LTE Band 5 (Cell)	10	25.5	25.14	-0.07	0	06829	QPSK	1	49	10 mm	bottom	1:1	0.284	1.086	0.308	
836.50	20525	Mid	LTE Band 5 (Cell)	10	24.5	23.37	0.03	1	06829	QPSK	25	0	10 mm	bottom	1:1	0.159	1.297	0.206	
836.50	20525	Mid	LTE Band 5 (Cell)	10	25.5	25.14	-0.07	0	06829	QPSK	1	49	10 mm	left	1:1	0.132	1.086	0.143	
836.50	20525	Mid	LTE Band 5 (Cell)	10	24.5	23.37	0.11	1	06829	QPSK	25	0	10 mm	left	1:1	0.064	1.297	0.083	
ANSI / IEEE C95.1 1992 - SAFETY LIMIT Spatial Peak Uncontrolled Exposure/General Population								Body 1.6 W/kg (mW/g) averaged over 1 gram											

FCC ID: ZNFQ720AM		SAR EVALUATION REPORT		Approved by: Quality Manager
Document S/N: 1M1907080114-01-R1.ZNF	Test Dates: 07/08/19 - 07/19/19	DUT Type: Portable Handset	Page 59 of 83	



**Table 11-24  
LTE Band 66 (AWS) Hotspot SAR**

MEASUREMENT RESULTS																			
FREQUENCY		Mode	Bandwidth [MHz]	Maximum Allowed Power [dBm]	Conducted Power [dBm]	Power Drift [dB]	MPR [dB]	Device Serial Number	Modulation	RB Size	RB Offset	Spacing	Side	Duty Cycle	SAR (1g)	Scaling Factor	Reported SAR (1g)	Plot #	
MHz	Ch.														(W/kg)		(W/kg)		
1770.00	132572	High	LTE Band 66 (AWS)	20	24.0	23.99	-0.03	0	06829	QPSK	1	50	10 mm	back	1:1	0.494	1.002	0.495	
1770.00	132572	High	LTE Band 66 (AWS)	20	23.0	23.00	-0.09	1	06829	QPSK	50	0	10 mm	back	1:1	0.474	1.000	0.474	
1770.00	132572	High	LTE Band 66 (AWS)	20	24.0	23.99	0.02	0	06829	QPSK	1	50	10 mm	front	1:1	0.516	1.002	0.517	
1770.00	132572	High	LTE Band 66 (AWS)	20	23.0	23.00	-0.03	1	06829	QPSK	50	0	10 mm	front	1:1	0.502	1.000	0.502	
1720.00	132072	Low	LTE Band 66 (AWS)	20	24.0	23.91	-0.02	0	06829	QPSK	1	50	10 mm	bottom	1:1	0.757	1.021	0.773	
1745.00	132322	Mid	LTE Band 66 (AWS)	20	24.0	23.83	-0.02	0	06829	QPSK	1	50	10 mm	bottom	1:1	0.831	1.040	0.864	
1770.00	132572	High	LTE Band 66 (AWS)	20	24.0	23.99	-0.03	0	06829	QPSK	1	50	10 mm	bottom	1:1	0.896	1.002	0.898	A28
1720.00	132072	Low	LTE Band 66 (AWS)	20	23.0	22.97	-0.04	1	06829	QPSK	50	50	10 mm	bottom	1:1	0.698	1.007	0.703	
1745.00	132322	Mid	LTE Band 66 (AWS)	20	23.0	22.93	-0.04	1	06829	QPSK	50	50	10 mm	bottom	1:1	0.711	1.016	0.722	
1770.00	132572	High	LTE Band 66 (AWS)	20	23.0	23.00	-0.07	1	06829	QPSK	50	0	10 mm	bottom	1:1	0.859	1.000	0.859	
1770.00	132572	High	LTE Band 66 (AWS)	20	23.0	22.98	-0.06	1	06829	QPSK	100	0	10 mm	bottom	1:1	0.873	1.005	0.877	
1770.00	132572	High	LTE Band 66 (AWS)	20	24.0	23.99	0.00	0	06829	QPSK	1	50	10 mm	right	1:1	0.221	1.002	0.221	
1770.00	132572	High	LTE Band 66 (AWS)	20	23.0	23.00	0.04	1	06829	QPSK	50	0	10 mm	right	1:1	0.200	1.000	0.200	
ANSI / IEEE C95.1 1992 - SAFETY LIMIT Spatial Peak Uncontrolled Exposure/General Population										Body 1.6 W/kg (mW/g) averaged over 1 gram									

**Table 11-25  
LTE Band 2 (PCS) Hotspot SAR**

MEASUREMENT RESULTS																			
FREQUENCY		Mode	Bandwidth [MHz]	Maximum Allowed Power [dBm]	Conducted Power [dBm]	Power Drift [dB]	MPR [dB]	Device Serial Number	Modulation	RB Size	RB Offset	Spacing	Side	Duty Cycle	SAR (1g)	Scaling Factor	Reported SAR (1g)	Plot #	
MHz	Ch.														(W/kg)		(W/kg)		
1860.00	18700	Low	LTE Band 2 (PCS)	20	24.0	24.00	0.05	0	06829	QPSK	1	99	10 mm	back	1:1	0.422	1.000	0.422	
1860.00	18700	Low	LTE Band 2 (PCS)	20	23.0	22.97	-0.01	1	06829	QPSK	50	25	10 mm	back	1:1	0.393	1.007	0.396	
1860.00	18700	Low	LTE Band 2 (PCS)	20	24.0	24.00	0.01	0	06829	QPSK	1	99	10 mm	front	1:1	0.478	1.000	0.478	
1860.00	18700	Low	LTE Band 2 (PCS)	20	23.0	22.97	0.03	1	06829	QPSK	50	25	10 mm	front	1:1	0.434	1.007	0.437	
1860.00	18700	Low	LTE Band 2 (PCS)	20	24.0	24.00	-0.03	0	06829	QPSK	1	99	10 mm	bottom	1:1	0.927	1.000	0.927	
1880.00	18900	Mid	LTE Band 2 (PCS)	20	24.0	23.85	0.00	0	06829	QPSK	1	50	10 mm	bottom	1:1	0.970	1.035	1.004	
1900.00	19100	High	LTE Band 2 (PCS)	20	24.0	23.99	0.01	0	06829	QPSK	1	50	10 mm	bottom	1:1	1.040	1.002	1.042	A30
1860.00	18700	Low	LTE Band 2 (PCS)	20	23.0	22.97	-0.01	1	06829	QPSK	50	25	10 mm	bottom	1:1	0.831	1.007	0.837	
1880.00	18900	Mid	LTE Band 2 (PCS)	20	23.0	22.91	0.02	1	06829	QPSK	50	25	10 mm	bottom	1:1	0.849	1.021	0.867	
1900.00	19100	High	LTE Band 2 (PCS)	20	23.0	22.93	-0.01	1	06829	QPSK	50	25	10 mm	bottom	1:1	0.887	1.016	0.901	
1860.00	18700	Low	LTE Band 2 (PCS)	20	23.0	22.95	-0.01	1	06829	QPSK	100	0	10 mm	bottom	1:1	0.827	1.012	0.837	
1860.00	18700	Low	LTE Band 2 (PCS)	20	24.0	24.00	0.08	0	06829	QPSK	1	99	10 mm	right	1:1	0.132	1.000	0.132	
1860.00	18700	Low	LTE Band 2 (PCS)	20	23.0	22.97	0.04	1	06829	QPSK	50	25	10 mm	right	1:1	0.113	1.007	0.114	
1900.00	19100	High	LTE Band 2 (PCS)	20	24.0	23.99	-0.01	0	06829	QPSK	1	50	10 mm	bottom	1:1	1.020	1.002	1.022	
ANSI / IEEE C95.1 1992 - SAFETY LIMIT Spatial Peak Uncontrolled Exposure/General Population										Body 1.6 W/kg (mW/g) averaged over 1 gram									

Note: Blue entry represents variability measurement.



FCC ID: ZNFQ720AM		SAR EVALUATION REPORT		Approved by: Quality Manager
Document S/N: 1M1907080114-01-R1.ZNF	Test Dates: 07/08/19 - 07/19/19	DUT Type: Portable Handset	Page 60 of 83	

**Table 11-26  
LTE Band 30 Hotspot SAR**

MEASUREMENT RESULTS																			
FREQUENCY		Mode	Bandwidth [MHz]	Maximum Allowed Power [dBm]	Conducted Power [dBm]	Power Drift [dB]	MPR [dB]	Device Serial Number	Modulation	RB Size	RB Offset	Spacing	Side	Duty Cycle	SAR (1g)	Scaling Factor	Reported SAR (1g)	Plot #	
MHz	Ch.														(W/kg)		(W/kg)		
2310.00	27710	Mid	LTE Band 30	10	24.0	23.95	-0.06	0	06837	QPSK	1	49	10 mm	back	1:1	0.388	1.012	0.393	
2310.00	27710	Mid	LTE Band 30	10	23.0	22.93	0.04	1	06837	QPSK	25	25	10 mm	back	1:1	0.304	1.016	0.309	
2310.00	27710	Mid	LTE Band 30	10	24.0	23.95	-0.01	0	06837	QPSK	1	49	10 mm	front	1:1	0.323	1.012	0.327	
2310.00	27710	Mid	LTE Band 30	10	23.0	22.93	0.00	1	06837	QPSK	25	25	10 mm	front	1:1	0.252	1.016	0.256	
2310.00	27710	Mid	LTE Band 30	10	24.0	23.95	0.00	0	06837	QPSK	1	49	10 mm	bottom	1:1	0.736	1.012	0.745	A32
2310.00	27710	Mid	LTE Band 30	10	23.0	22.93	-0.01	1	06837	QPSK	25	25	10 mm	bottom	1:1	0.589	1.016	0.598	
2310.00	27710	Mid	LTE Band 30	10	24.0	23.95	0.05	0	06837	QPSK	1	49	10 mm	right	1:1	0.101	1.012	0.102	
2310.00	27710	Mid	LTE Band 30	10	23.0	22.93	-0.04	1	06837	QPSK	25	25	10 mm	right	1:1	0.084	1.016	0.085	
ANSI / IEEE C95.1 1992 - SAFETY LIMIT Spatial Peak Uncontrolled Exposure/General Population								Body 1.6 W/kg (mW/g) averaged over 1 gram											

**Table 11-27  
WLAN Hotspot SAR**

MEASUREMENT RESULTS																		
FREQUENCY		Mode	Service	Bandwidth [MHz]	Maximum Allowed Power [dBm]	Conducted Power [dBm]	Power Drift [dB]	Spacing	Device Serial Number	Data Rate (Mbps)	Side	Duty Cycle (%)	Peak SAR of Area Scan	SAR (1g)	Scaling Factor (Power)	Scaling Factor (Duty Cycle)	Reported SAR (1g)	Plot #
MHz	Ch.												(W/kg)	(W/kg)			(W/kg)	
2412	1	802.11b	DSSS	22	23.0	22.23	-0.05	10 mm	06795	1	back	99.9	1.042	0.640	1.194	1.001	0.765	A33
2437	6	802.11b	DSSS	22	23.0	22.02	0.00	10 mm	06795	1	back	99.9	0.848	0.624	1.253	1.001	0.783	
2462	11	802.11b	DSSS	22	23.0	22.04	0.06	10 mm	06795	1	back	99.9	0.787	0.633	1.247	1.001	0.790	
2412	1	802.11b	DSSS	22	23.0	22.23	0.13	10 mm	06795	1	front	99.9	0.536	-	1.194	1.001	-	
2412	1	802.11b	DSSS	22	23.0	22.23	0.12	10 mm	06795	1	top	99.9	0.700	-	1.194	1.001	-	
2412	1	802.11b	DSSS	22	23.0	22.23	0.14	10 mm	06795	1	left	99.9	0.905	0.516	1.194	1.001	0.617	
5200	40	802.11a	OFDM	20	19.5	18.62	-0.07	10 mm	06795	6	back	99.2	1.275	0.661	1.225	1.008	0.816	A35
5220	44	802.11a	OFDM	20	19.5	18.52	-0.13	10 mm	06795	6	back	99.2	1.259	0.612	1.253	1.008	0.773	
5240	48	802.11a	OFDM	20	19.5	18.72	0.00	10 mm	06795	6	back	99.2	1.167	0.563	1.197	1.008	0.679	
5240	48	802.11a	OFDM	20	19.5	18.72	-0.16	10 mm	06795	6	front	99.2	0.213	-	1.197	1.008	-	
5240	48	802.11a	OFDM	20	19.5	18.72	-0.13	10 mm	06795	6	top	99.2	0.118	-	1.197	1.008	-	
5240	48	802.11a	OFDM	20	19.5	18.72	-0.17	10 mm	06795	6	left	99.2	0.826	0.393	1.197	1.008	0.474	
5805	161	802.11a	OFDM	20	20.0	19.68	-0.12	10 mm	06795	6	back	99.2	1.330	0.536	1.076	1.008	0.581	
5805	161	802.11a	OFDM	20	20.0	19.68	-0.16	10 mm	06795	6	front	99.2	0.309	-	1.076	1.008	-	
5805	161	802.11a	OFDM	20	20.0	19.68	0.14	10 mm	06795	6	top	99.2	0.107	-	1.076	1.008	-	
5805	161	802.11a	OFDM	20	20.0	19.68	-0.20	10 mm	06795	6	left	99.2	0.715	0.312	1.076	1.008	0.338	
ANSI / IEEE C95.1 1992 - SAFETY LIMIT Spatial Peak Uncontrolled Exposure/General Population								Body 1.6 W/kg (mW/g) averaged over 1 gram										

FCC ID: ZNFQ720AM		SAR EVALUATION REPORT		Approved by: Quality Manager
Document S/N: 1M1907080114-01-R1.ZNF	Test Dates: 07/08/19 - 07/19/19	DUT Type: Portable Handset	Page 61 of 83	

**Table 11-28  
DSS Hotspot SAR**



MEASUREMENT RESULTS																
FREQUENCY		Mode	Service	Maximum Allowed Power [dBm]	Conducted Power [dBm]	Power Drift [dB]	Spacing	Device Serial Number	Data Rate (Mbps)	Side	Duty Cycle (%)	SAR (1g)	Scaling Factor (Cond Power)	Scaling Factor (Duty Cycle)	Reported SAR (1g)	Plot #
MHz	Ch.											(W/kg)			(W/kg)	
2441	39	Bluetooth	FHSS	11.0	10.89	0.13	10 mm	06795	1	back	77.1	0.024	1.026	1.297	0.032	
2441	39	Bluetooth	FHSS	11.0	10.89	0.14	10 mm	06795	1	front	77.1	0.019	1.026	1.297	0.025	
2441	39	Bluetooth	FHSS	11.0	10.89	0.01	10 mm	06795	1	top	77.1	0.033	1.026	1.297	0.044	A37
2441	39	Bluetooth	FHSS	11.0	10.89	0.12	10 mm	06795	1	left	77.1	0.027	1.026	1.297	0.036	
ANSI / IEEE C95.1 1992 - SAFETY LIMIT Spatial Peak Uncontrolled Exposure/General Population							Body 1.6 W/kg (mW/g) averaged over 1 gram									

**11.4 Standalone Phablet SAR Data**

**Table 11-29  
LTE Band 30 Phablet SAR**

MEASUREMENT RESULTS																			
FREQUENCY		Mode	Bandwidth [MHz]	Maximum Allowed Power [dBm]	Conducted Power [dBm]	Power Drift [dB]	MPR [dB]	Serial Number	Modulation	RB Size	RB Offset	Spacing	Side	Duty Cycle	SAR (10g)	Scaling Factor	Reported SAR (10g)	Plot #	
MHz	Ch.														(W/kg)		(W/kg)		
2310.00	27710	Mid	LTE Band 30	10	24.0	23.95	-0.13	0	06837	QPSK	1	49	1 mm	back	1:1	1.230	1.012	1.245	
2310.00	27710	Mid	LTE Band 30	10	23.0	22.93	-0.09	1	06837	QPSK	25	25	1 mm	back	1:1	0.971	1.016	0.987	
2310.00	27710	Mid	LTE Band 30	10	24.0	23.95	0.09	0	06837	QPSK	1	49	1 mm	front	1:1	1.560	1.012	1.579	
2310.00	27710	Mid	LTE Band 30	10	23.0	22.93	-0.04	1	06837	QPSK	25	25	1 mm	front	1:1	1.240	1.016	1.260	
2310.00	27710	Mid	LTE Band 30	10	24.0	23.95	-0.16	0	06837	QPSK	1	49	3 mm	bottom	1:1	1.720	1.012	1.741	
2310.00	27710	Mid	LTE Band 30	10	23.0	22.93	-0.12	1	06837	QPSK	25	25	3 mm	bottom	1:1	1.360	1.016	1.382	
2310.00	27710	Mid	LTE Band 30	10	23.0	22.89	-0.13	1	06837	QPSK	50	0	3 mm	bottom	1:1	1.360	1.026	1.395	
2310.00	27710	Mid	LTE Band 30	10	24.0	23.95	0.05	0	06837	QPSK	1	49	0 mm	right	1:1	0.353	1.012	0.357	
2310.00	27710	Mid	LTE Band 30	10	23.0	22.93	-0.06	1	06837	QPSK	25	25	0 mm	right	1:1	0.277	1.016	0.281	
2310.00	27710	Mid	LTE Band 30	10	22.0	21.41	0.08	0	06837	QPSK	1	49	0 mm	back	1:1	0.975	1.146	1.117	
2310.00	27710	Mid	LTE Band 30	10	22.0	21.42	0.05	0	06837	QPSK	25	0	0 mm	back	1:1	0.945	1.143	1.080	
2310.00	27710	Mid	LTE Band 30	10	22.0	21.41	0.20	0	06837	QPSK	1	49	0 mm	front	1:1	1.330	1.146	1.524	
2310.00	27710	Mid	LTE Band 30	10	22.0	21.42	0.20	0	06837	QPSK	25	0	0 mm	front	1:1	1.300	1.143	1.486	
2310.00	27710	Mid	LTE Band 30	10	22.0	21.41	-0.13	0	06837	QPSK	1	49	0 mm	bottom	1:1	2.460	1.146	2.819	A38
2310.00	27710	Mid	LTE Band 30	10	22.0	21.42	-0.09	0	06837	QPSK	25	0	0 mm	bottom	1:1	2.420	1.143	2.766	
2310.00	27710	Mid	LTE Band 30	10	22.0	21.27	-0.07	0	06837	QPSK	50	0	0 mm	bottom	1:1	2.420	1.183	2.863	
2310.00	27710	Mid	LTE Band 30	10	22.0	21.41	-0.12	0	06837	QPSK	1	49	0 mm	bottom	1:1	2.440	1.146	2.796	
ANSI / IEEE C95.1 1992 - SAFETY LIMIT Spatial Peak Uncontrolled Exposure/General Population							Phablet 4.0 W/kg (mW/g) averaged over 10 grams												

Note: Blue entry represents variability measurement.

FCC ID: ZNFQ720AM		SAR EVALUATION REPORT		Approved by: Quality Manager
Document S/N: 1M1907080114-01-R1.ZNF	Test Dates: 07/08/19 - 07/19/19	DUT Type: Portable Handset	Page 62 of 83	



**Table 11-30  
WLAN Phablet SAR**

MEASUREMENT RESULTS																		
FREQUENCY		Mode	Service	Bandwidth [MHz]	Maximum Allowed Power [dBm]	Conducted Power [dBm]	Power Drift [dB]	Spacing	Device Serial Number	Data Rate (Mbps)	Side	Duty Cycle (%)	Peak SAR of Area Scan	SAR (10g)	Scaling Factor (Power)	Scaling Factor (Duty Cycle)	Reported SAR (10g)	Plot #
MHz	Ch.												W/kg	(W/kg)			(W/kg)	
5260	52	802.11a	OFDM	20	19.5	18.65	-0.05	0 mm	06795	6	back	99.2	10.320	1.650	1.216	1.008	2.022	
5280	56	802.11a	OFDM	20	19.5	18.74	-0.07	0 mm	06795	6	back	99.2	10.899	1.700	1.191	1.008	2.041	A39
5300	60	802.11a	OFDM	20	19.5	18.72	-0.04	0 mm	06795	6	back	99.2	10.665	1.680	1.197	1.008	2.027	
5280	56	802.11a	OFDM	20	19.5	18.74	-0.01	0 mm	06795	6	front	99.2	5.199	0.581	1.191	1.008	0.698	
5280	56	802.11a	OFDM	20	19.5	18.74	-0.14	0 mm	06795	6	top	99.2	3.638	-	1.191	1.008	-	
5280	56	802.11a	OFDM	20	19.5	18.74	-0.13	0 mm	06795	6	left	99.2	13.600	1.220	1.191	1.008	1.465	
5680	136	802.11a	OFDM	20	19.5	19.05	-0.02	0 mm	06795	6	back	99.2	9.242	1.300	1.109	1.008	1.453	
5680	136	802.11a	OFDM	20	19.5	19.05	0.11	0 mm	06795	6	front	99.2	6.196	-	1.109	1.008	-	
5680	136	802.11a	OFDM	20	19.5	19.05	-0.15	0 mm	06795	6	top	99.2	2.833	-	1.109	1.008	-	
5680	136	802.11a	OFDM	20	19.5	19.05	-0.12	0 mm	06795	6	left	99.2	11.349	1.070	1.109	1.008	1.196	
ANSI / IEEE C95.1 1992 - SAFETY LIMIT Spatial Peak Uncontrolled Exposure/General Population									Phablet 4.0 W/kg (mW/g) averaged over 10 grams									

## 11.5 SAR Test Notes

### General Notes:

- The test data reported are the worst-case SAR values according to test procedures specified in IEEE 1528-2013, and FCC KDB Publication 447498 D01v06.
- Batteries are fully charged at the beginning of the SAR measurements.
- Liquid tissue depth was at least 15.0 cm for all frequencies.
- The manufacturer has confirmed that the device(s) tested have the same physical, mechanical and thermal characteristics and are within operational tolerances expected for production units.
- SAR results were scaled to the maximum allowed power to demonstrate compliance per FCC KDB Publication 447498 D01v06.
- Device was tested using a fixed spacing for body-worn accessory testing. A separation distance of 10 mm was considered because the manufacturer has determined that there will be body-worn accessories available in the marketplace for users to support this separation distance.
- Per FCC KDB Publication 648474 D04v01r03, body-worn SAR was evaluated without a headset connected to the device. Since the standalone reported body-worn SAR was  $\leq 1.2$  W/kg, no additional body-worn SAR evaluations using a headset cable were required.
- Per FCC KDB 865664 D01v01r04, variability SAR tests were performed when the measured SAR results for a frequency band were greater than or equal to 0.8 W/kg. Repeated SAR measurements are highlighted in the tables above for clarity. Please see Section 13 for variability analysis.
- During SAR Testing for the Wireless Router conditions per FCC KDB Publication 941225 D06v02r01, the actual Portable Hotspot operation (with actual simultaneous transmission of a transmitter with WIFI) was not activated (See Section 6.7 for more details).
- Per FCC KDB Publication 648474 D04v01r03, this device is considered a "phablet" since the diagonal dimension is  $> 160$  mm and  $< 200$  mm. Therefore, phablet SAR tests are required when wireless router mode does not apply or if wireless router 1g SAR  $> 1.2$  W/kg.
- Unless otherwise noted, when 10g SAR measurement is considered, a factor of 2.5 is applied to the thresholds below.
- Additional SAR test for phablet SAR were evaluated per KDB 616217 Section 6 (see Section 6.9 for more information)

FCC ID: ZNFQ720AM	 PCTEST ENGINEERING LABORATORY, INC.	SAR EVALUATION REPORT	 LG	Approved by: Quality Manager
Document S/N: 1M1907080114-01-R1-ZNF	Test Dates: 07/08/19 - 07/19/19	DUT Type: Portable Handset	Page 63 of 83	

**GSM Test Notes:**

1. Body-Worn accessory testing is typically associated with voice operations. Therefore, GSM voice was evaluated for body-worn SAR.
2. Justification for reduced test configurations per KDB Publication 941225 D01v03r01 and October 2013 TCB Workshop Notes: The source-based frame-averaged output power was evaluated for all GPRS/EDGE slot configurations. The configuration with the highest target frame averaged output power was evaluated for hotspot SAR. When the maximum frame-averaged powers are equivalent across two or more slots (within 0.25 dB), the configuration with the most number of time slots was tested.
3. Per FCC KDB Publication 447498 D01v06, if the reported (scaled) SAR measured at the middle channel or highest output power channel for each test configuration is  $\leq 0.8$  W/kg for 1g evaluations then testing at the other channels is not required for such test configuration(s). When the maximum output power variation across the required test channels is  $> \frac{1}{2}$  dB, instead of the middle channel, the highest output power channel was used.
4. GPRS was additionally evaluated for head and body-worn exposure conditions to address possible VoIP scenarios.

**UMTS Notes:**



1. UMTS mode in was tested under RMC 12.2 kbps with HSPA Inactive per KDB Publication 941225 D01v03r01. AMR and HSPA SAR was not required per the 3G Test Reduction Procedure in KDB Publication 941225 D01v03r01.
2. Per FCC KDB Publication 447498 D01v06, if the reported (scaled) SAR measured at the middle channel or highest output power channel for each test configuration is  $\leq 0.8$  W/kg for 1g evaluations then testing at the other channels is not required for such test configuration(s). When the maximum output power variation across the required test channels is  $> \frac{1}{2}$  dB, instead of the middle channel, the highest output power channel was used.

**LTE Notes:**

1. LTE Considerations: LTE test configurations are determined according to SAR Evaluation Considerations for LTE Devices in FCC KDB Publication 941225 D05v02r04. The general test procedures used for testing can be found in Section 8.5.4.
2. MPR is permanently implemented for this device by the manufacturer. The specific manufacturer target MPR is indicated alongside the SAR results. MPR is enabled for this device, according to 3GPP TS36.101 Section 6.2.3 – 6.2.5 under Table 6.2.3-1.
3. A-MPR was disabled for all SAR tests by setting NS=01 and MCC=001 on the base station simulator. SAR tests were performed with the same number of RB and RB offsets transmitting on all TTI frames (maximum TTI).
4. Per KDB Publication 941225 D05Av01r02, SAR for downlink only LTE CA operations was not needed since the maximum average output power in LTE CA mode was not  $>0.25$  dB higher than the maximum output power when downlink carrier aggregation was inactive.

**WLAN Notes:**

1. For held-to-ear, hotspot, and phablet operations, the initial test position procedures were applied. The test position with the highest extrapolated peak SAR will be used as the initial test position. When reported SAR for the initial test position is  $\leq 0.4$  W/kg for 1g evaluations, no additional testing for the remaining test positions was required. Otherwise, SAR is evaluated at the subsequent highest peak SAR positions until the reported SAR result is  $\leq 0.8$  W/kg or all test positions are measured.
2. Justification for test configurations for WLAN per KDB Publication 248227 D01v02r02 for 2.4 GHz WIFI operations, the highest measured maximum output power channel for DSSS was selected for SAR

FCC ID: ZNFQ720AM		SAR EVALUATION REPORT		Approved by: Quality Manager
Document S/N: 1M1907080114-01-R1.ZNF	Test Dates: 07/08/19 - 07/19/19	DUT Type: Portable Handset	Page 64 of 83	





measurement. SAR for OFDM modes (2.4 GHz 802.11g/n) was not required due to the maximum allowed powers and the highest reported DSSS SAR. See Section 8.6.5 for more information.

3. Justification for test configurations for WLAN per KDB Publication 248227 D01v02r02 for 5 GHz WIFI operations, the initial test configuration was selected according to the transmission mode with the highest maximum allowed powers. Other transmission modes were not investigated since the highest reported SAR for initial test configuration adjusted by the ratio of maximum output powers is less than 1.2 W/kg for 1g evaluations. See Section 8.6.6 for more information.
4. When the maximum reported 1g averaged SAR is  $\leq 0.8$  W/kg, SAR testing on additional channels was not required. Otherwise, SAR for the next highest output power channel was required until the reported SAR result was  $\leq 1.20$  W/kg for 1g evaluations or all test channels were measured.
5. The device was configured to transmit continuously at the required data rate, channel bandwidth and signal modulation, using the highest transmission duty factor supported by the test mode tools. The reported SAR was scaled to the 100% transmission duty factor to determine compliance. Procedures used to measure the duty factor are identical to that in the associated EMC test reports.

#### Bluetooth Notes

1. Bluetooth SAR was measured with the device connected to a call box with hopping disabled with DH5 operation and Tx Tests test mode type. Per October 2016 TCB Workshop Notes, the reported SAR was scaled to the 100% transmission duty factor to determine compliance. See Section 9.5 for the time domain plot and calculation for the duty factor of the device.

FCC ID: ZNFQ720AM	 <b>SAR EVALUATION REPORT</b> 		<b>Approved by:</b> Quality Manager
<b>Document S/N:</b> 1M1907080114-01-R1.ZNF	<b>Test Dates:</b> 07/08/19 - 07/19/19	<b>DUT Type:</b> Portable Handset	Page 65 of 83

## 12 FCC MULTI-TX AND ANTENNA SAR CONSIDERATIONS

### 12.1 Introduction

The following procedures adopted from FCC KDB Publication 447498 D01v06 are applicable to devices with built-in unlicensed transmitters such as 802.11 and Bluetooth devices which may simultaneously transmit with the licensed transmitter.



### 12.2 Simultaneous Transmission Procedures

This device contains transmitters that may operate simultaneously. Therefore, simultaneous transmission analysis is required. Per FCC KDB Publication 447498 D01v06 4.3.2 and IEEE 1528-2013 Section 6.3.4.1.2, simultaneous transmission SAR test exclusion may be applied when the sum of the 1g SAR for all the simultaneous transmitting antennas in a specific a physical test configuration is  $\leq 1.6$  W/kg. The different test positions in an exposure condition may be considered collectively to determine SAR test exclusion according to the sum of 1g or 10g SAR.

### 12.3 Head SAR Simultaneous Transmission Analysis

**Table 12-1**  
**Simultaneous Transmission Scenario with 2.4 GHz WLAN (Held to Ear)**

Exposure Condition	Mode	2G/3G/4G SAR (W/kg)	2.4 GHz WLAN SAR (W/kg)	$\Sigma$ SAR (W/kg)
		1	2	1+2
Head SAR	GSM/GPRS 850	0.170	1.034	1.204
	GSM/GPRS 1900	0.086	1.034	1.120
	UMTS 850	0.159	1.034	1.193
	UMTS 1750	0.125	1.034	1.159
	UMTS 1900	0.143	1.034	1.177
	LTE Band 12	0.178	1.034	1.212
	LTE Band 14	0.212	1.034	<b>1.246</b>
	LTE Band 5 (Cell)	0.211	1.034	1.245
	LTE Band 66 (AWS)	0.104	1.034	1.138
	LTE Band 2 (PCS)	0.106	1.034	1.140
	LTE Band 30	0.093	1.034	1.127



FCC ID: ZNFQ720AM		SAR EVALUATION REPORT		Approved by: Quality Manager
Document S/N: 1M1907080114-01-R1.ZNF	Test Dates: 07/08/19 - 07/19/19	DUT Type: Portable Handset		Page 66 of 83

**Table 12-2  
Simultaneous Transmission Scenario with 5 GHz WLAN (Held to Ear)**

Exposure Condition	Mode	2G/3G/4G SAR (W/kg)	5 GHz WLAN SAR (W/kg)	Σ SAR (W/kg)
		1	2	1+2
Head SAR	GSM/GPRS 850	0.170	0.767	0.937
	GSM/GPRS 1900	0.086	0.767	0.853
	UMTS 850	0.159	0.767	0.926
	UMTS 1750	0.125	0.767	0.892
	UMTS 1900	0.143	0.767	0.910
	LTE Band 12	0.178	0.767	0.945
	LTE Band 14	0.212	0.767	<b>0.979</b>
	LTE Band 5 (Cell)	0.211	0.767	0.978
	LTE Band 66 (AWS)	0.104	0.767	0.871
	LTE Band 2 (PCS)	0.106	0.767	0.873
	LTE Band 30	0.093	0.767	0.860

**Table 12-3  
Simultaneous Transmission Scenario with Bluetooth (Held to Ear)**

Exposure Condition	Mode	2G/3G/4G SAR (W/kg)	Bluetooth SAR (W/kg)	Σ SAR (W/kg)
		1	2	1+2
Head SAR	GSM/GPRS 850	0.170	0.112	0.282
	GSM/GPRS 1900	0.086	0.112	0.198
	UMTS 850	0.159	0.112	0.271
	UMTS 1750	0.125	0.112	0.237
	UMTS 1900	0.143	0.112	0.255
	LTE Band 12	0.178	0.112	0.290
	LTE Band 14	0.212	0.112	<b>0.324</b>
	LTE Band 5 (Cell)	0.211	0.112	0.323
	LTE Band 66 (AWS)	0.104	0.112	0.216
	LTE Band 2 (PCS)	0.106	0.112	0.218
	LTE Band 30	0.093	0.112	0.205

FCC ID: ZNFQ720AM		SAR EVALUATION REPORT		Approved by: Quality Manager
Document S/N: 1M1907080114-01-R1.ZNF	Test Dates: 07/08/19 - 07/19/19	DUT Type: Portable Handset		Page 67 of 83



**Table 12-4**  
**Simultaneous Transmission Scenario with 5 GHz WLAN and Bluetooth (Held to Ear)**

Exposure Condition	Mode	2G/3G/4G SAR (W/kg)	5 GHz WLAN SAR (W/kg)	Bluetooth SAR (W/kg)	Σ SAR (W/kg)
		1	2	3	1+2+3
Head SAR	GSM/GPRS 850	0.170	0.767	0.112	1.049
	GSM/GPRS 1900	0.086	0.767	0.112	0.965
	UMTS 850	0.159	0.767	0.112	1.038
	UMTS 1750	0.125	0.767	0.112	1.004
	UMTS 1900	0.143	0.767	0.112	1.022
	LTE Band 12	0.178	0.767	0.112	1.057
	LTE Band 14	0.212	0.767	0.112	<b>1.091</b>
	LTE Band 5 (Cell)	0.211	0.767	0.112	1.090
	LTE Band 66 (AWS)	0.104	0.767	0.112	0.983
	LTE Band 2 (PCS)	0.106	0.767	0.112	0.985
	LTE Band 30	0.093	0.767	0.112	0.972

## 12.4 Body-Worn Simultaneous Transmission Analysis

**Table 12-5**  
**Simultaneous Transmission Scenario with 2.4 GHz WLAN (Body-Worn at 1.0 cm)**

Exposure Condition	Mode	2G/3G/4G SAR (W/kg)	2.4 GHz WLAN SAR (W/kg)	Σ SAR (W/kg)
		1	2	1+2
Body-Worn	GSM/GPRS 850	0.739	0.790	<b>1.529</b>
	GSM/GPRS 1900	0.330	0.790	1.120
	UMTS 850	0.597	0.790	1.387
	UMTS 1750	0.568	0.790	1.358
	UMTS 1900	0.465	0.790	1.255
	LTE Band 12	0.548	0.790	1.338
	LTE Band 14	0.667	0.790	1.457
	LTE Band 5 (Cell)	0.593	0.790	1.383
	LTE Band 66 (AWS)	0.495	0.790	1.285
	LTE Band 2 (PCS)	0.422	0.790	1.212
	LTE Band 30	0.393	0.790	1.183



FCC ID: ZNFQ720AM		SAR EVALUATION REPORT		Approved by: Quality Manager
Document S/N: 1M1907080114-01-R1.ZNF	Test Dates: 07/08/19 - 07/19/19	DUT Type: Portable Handset		Page 68 of 83

**Table 12-6**  
**Simultaneous Transmission Scenario with 5 GHz WLAN (Body-Worn at 1.0 cm)**



Exposure Condition	Mode	2G/3G/4G SAR (W/kg)	5 GHz WLAN SAR (W/kg)	Σ SAR (W/kg)
		1	2	1+2
Body-Worn	GSM/GPRS 850	0.739	0.708	<b>1.447</b>
	GSM/GPRS 1900	0.330	0.708	1.038
	UMTS 850	0.597	0.708	1.305
	UMTS 1750	0.568	0.708	1.276
	UMTS 1900	0.465	0.708	1.173
	LTE Band 12	0.548	0.708	1.256
	LTE Band 14	0.667	0.708	1.375
	LTE Band 5 (Cell)	0.593	0.708	1.301
	LTE Band 66 (AWS)	0.495	0.708	1.203
	LTE Band 2 (PCS)	0.422	0.708	1.130
	LTE Band 30	0.393	0.708	1.101

**Table 12-7**  
**Simultaneous Transmission Scenario with Bluetooth (Body-Worn at 1.0 cm)**

Exposure Condition	Mode	2G/3G/4G SAR (W/kg)	Bluetooth SAR (W/kg)	Σ SAR (W/kg)
		1	2	1+2
Body-Worn	GSM/GPRS 850	0.739	0.032	<b>0.771</b>
	GSM/GPRS 1900	0.330	0.032	0.362
	UMTS 850	0.597	0.032	0.629
	UMTS 1750	0.568	0.032	0.600
	UMTS 1900	0.465	0.032	0.497
	LTE Band 12	0.548	0.032	0.580
	LTE Band 14	0.667	0.032	0.699
	LTE Band 5 (Cell)	0.593	0.032	0.625
	LTE Band 66 (AWS)	0.495	0.032	0.527
	LTE Band 2 (PCS)	0.422	0.032	0.454
	LTE Band 30	0.393	0.032	0.425

FCC ID: ZNFQ720AM		SAR EVALUATION REPORT		Approved by: Quality Manager
Document S/N: 1M1907080114-01-R1.ZNF	Test Dates: 07/08/19 - 07/19/19	DUT Type: Portable Handset		Page 69 of 83

Exposure Condition	Mode	2G/3G/4G SAR (W/kg)	Bluetooth SAR (W/kg)	$\Sigma$ SAR (W/kg)
		1	2	1+2
Body-Worn	GSM/GPRS 850	0.739	0.032	0.771
	GSM/GPRS 1900	0.330	0.032	0.362
	UMTS 850	0.597	0.032	0.629
	UMTS 1750	0.568	0.032	0.600
	UMTS 1900	0.465	0.032	0.497
	LTE Band 12	0.548	0.032	0.580
	LTE Band 14	0.667	0.032	0.699
	LTE Band 5 (Cell)	0.593	0.032	0.625
	LTE Band 66 (AWS)	0.495	0.032	0.527
	LTE Band 2 (PCS)	0.422	0.032	0.454
	LTE Band 30	0.393	0.032	0.425

FCC ID: ZNFQ720AM	 <b>PCTEST</b> ENGINEERING LABORATORY, INC.	SAR EVALUATION REPORT	 <b>LG</b>	Approved by: Quality Manager
Document S/N: 1M1907080114-01-R1.ZNF	Test Dates: 07/08/19 - 07/19/19	DUT Type: Portable Handset	Page 70 of 83	



**Table 12-8  
Simultaneous Transmission Scenario with 5 GHz WLAN and Bluetooth (Body-Worn at 1.0 cm)**

Exposure Condition	Mode	2G/3G/4G SAR (W/kg)	5 GHz WLAN SAR (W/kg)	Bluetooth SAR (W/kg)	Σ SAR (W/kg)
		1	2	3	1+2+3
Body-Worn	GSM/GPRS 850	0.739	0.708	0.032	<b>1.479</b>
	GSM/GPRS 1900	0.330	0.708	0.032	1.070
	UMTS 850	0.597	0.708	0.032	1.337
	UMTS 1750	0.568	0.708	0.032	1.308
	UMTS 1900	0.465	0.708	0.032	1.205
	LTE Band 12	0.548	0.708	0.032	1.288
	LTE Band 14	0.667	0.708	0.032	1.407
	LTE Band 5 (Cell)	0.593	0.708	0.032	1.333
	LTE Band 66 (AWS)	0.495	0.708	0.032	1.235
	LTE Band 2 (PCS)	0.422	0.708	0.032	1.162
LTE Band 30	0.393	0.708	0.032	1.133	

## 12.5 Hotspot SAR Simultaneous Transmission Analysis

Per FCC KDB Publication 941225 D06v02r01, the devices edges with antennas more than 2.5 cm from edge are not required to be evaluated for SAR (“-”).

(\*) For test positions that were not required to be evaluated for WLAN SAR per FCC KDB publication 248227, the worst case WLAN SAR result for the applicable exposure conditions was used for simultaneous transmission analysis.

FCC ID: ZNFQ720AM		SAR EVALUATION REPORT		Approved by: Quality Manager
Document S/N: 1M1907080114-01-R1.ZNF	Test Dates: 07/08/19 - 07/19/19	DUT Type: Portable Handset		Page 71 of 83



**Table 12-9**  
**Simultaneous Transmission Scenario with 2.4 GHz WLAN (Hotspot at 1.0 cm)**

Exposure Condition	Mode	2G/3G/4G SAR (W/kg)	2.4 GHz WLAN SAR (W/kg)	Σ SAR (W/kg)
		1	2	1+2
Hotspot SAR	GPRS 850	0.739	0.790	1.529
	GPRS 1900	0.812	0.790	See Table Below
	UMTS 850	0.597	0.790	1.387
	UMTS 1750	0.986	0.790	See Table Below
	UMTS 1900	0.973	0.790	See Table Below
	LTE Band 12	0.548	0.790	1.338
	LTE Band 14	0.667	0.790	1.457
	LTE Band 5 (Cell)	0.616	0.790	1.406
	LTE Band 66 (AWS)	0.898	0.790	See Table Below
	LTE Band 2 (PCS)	1.042	0.790	See Table Below
	LTE Band 30	0.745	0.790	<b>1.535</b>

Simult Tx	Configuration	GPRS 1900 SAR (W/kg)	2.4 GHz WLAN SAR (W/kg)	Σ SAR (W/kg)	Simult Tx	Configuration	UMTS 1750 SAR (W/kg)	2.4 GHz WLAN SAR (W/kg)	Σ SAR (W/kg)
		1	2	1+2			1	2	1+2
Hotspot SAR	Back	0.330	0.790	1.120	Hotspot SAR	Back	0.568	0.790	1.358
	Front	0.364	0.790*	1.154		Front	0.609	0.790*	1.399
	Top	-	0.790*	0.790		Top	-	0.790*	0.790
	Bottom	0.812	-	0.812		Bottom	0.986	-	0.986
	Right	0.101	-	0.101		Right	0.259	-	0.259
	Left	-	0.617	0.617		Left	-	0.617	0.617

Simult Tx	Configuration	UMTS 1900 SAR (W/kg)	2.4 GHz WLAN SAR (W/kg)	Σ SAR (W/kg)	Simult Tx	Configuration	LTE Band 66 (AWS) SAR (W/kg)	2.4 GHz WLAN SAR (W/kg)	Σ SAR (W/kg)
		1	2	1+2			1	2	1+2
Hotspot SAR	Back	0.465	0.790	1.255	Hotspot SAR	Back	0.495	0.790	1.285
	Front	0.500	0.790*	1.290		Front	0.517	0.790*	1.307
	Top	-	0.790*	0.790		Top	-	0.790*	0.790
	Bottom	0.973	-	0.973		Bottom	0.898	-	0.898
	Right	0.137	-	0.137		Right	0.221	-	0.221
	Left	-	0.617	0.617		Left	-	0.617	0.617

Simult Tx	Configuration	LTE Band 2 (PCS) SAR (W/kg)	2.4 GHz WLAN SAR (W/kg)	Σ SAR (W/kg)
		1	2	1+2
Hotspot SAR	Back	0.422	0.790	1.212
	Front	0.478	0.790*	1.268
	Top	-	0.790*	0.790
	Bottom	1.042	-	1.042
	Right	0.132	-	0.132
	Left	-	0.617	0.617

FCC ID: ZNFQ720AM		SAR EVALUATION REPORT		Approved by: Quality Manager
Document S/N: 1M1907080114-01-R1.ZNF	Test Dates: 07/08/19 - 07/19/19	DUT Type: Portable Handset	Page 72 of 83	





**Table 12-10**  
**Simultaneous Transmission Scenario with 5 GHz WLAN (Hotspot at 1.0 cm)**

Exposure Condition	Mode	2G/3G/4G SAR (W/kg)	5 GHz WLAN SAR (W/kg)	Σ SAR (W/kg)
		1	2	1+2
Hotspot SAR	GPRS 850	0.739	0.816	1.555
	GPRS 1900	0.812	0.816	See Table Below
	UMTS 850	0.597	0.816	1.413
	UMTS 1750	0.986	0.816	See Table Below
	UMTS 1900	0.973	0.816	See Table Below
	LTE Band 12	0.548	0.816	1.364
	LTE Band 14	0.667	0.816	1.483
	LTE Band 5 (Cell)	0.616	0.816	1.432
	LTE Band 66 (AWS)	0.898	0.816	See Table Below
	LTE Band 2 (PCS)	1.042	0.816	See Table Below
	LTE Band 30	0.745	0.816	<b>1.561</b>

Simult Tx	Configuration	GPRS 1900 SAR (W/kg)	5 GHz WLAN SAR (W/kg)	Σ SAR (W/kg)	Simult Tx	Configuration	UMTS 1750 SAR (W/kg)	5 GHz WLAN SAR (W/kg)	Σ SAR (W/kg)
		1	2	1+2			1	2	1+2
Hotspot SAR	Back	0.330	0.816	1.146	Hotspot SAR	Back	0.568	0.816	1.384
	Front	0.364	0.816*	<b>1.180</b>		Front	0.609	0.816*	<b>1.425</b>
	Top	-	0.816*	0.816		Top	-	0.816*	0.816
	Bottom	0.812	-	0.812		Bottom	0.986	-	0.986
	Right	0.101	-	0.101		Right	0.259	-	0.259
	Left	-	0.474	0.474		Left	-	0.474	0.474

Simult Tx	Configuration	UMTS 1900 SAR (W/kg)	5 GHz WLAN SAR (W/kg)	Σ SAR (W/kg)	Simult Tx	Configuration	LTE Band 66 (AWS) SAR (W/kg)	5 GHz WLAN SAR (W/kg)	Σ SAR (W/kg)
		1	2	1+2			1	2	1+2
Hotspot SAR	Back	0.465	0.816	1.281	Hotspot SAR	Back	0.495	0.816	1.311
	Front	0.500	0.816*	<b>1.316</b>		Front	0.517	0.816*	<b>1.333</b>
	Top	-	0.816*	0.816		Top	-	0.816*	0.816
	Bottom	0.973	-	0.973		Bottom	0.898	-	0.898
	Right	0.137	-	0.137		Right	0.221	-	0.221
	Left	-	0.474	0.474		Left	-	0.474	0.474

Simult Tx	Configuration	LTE Band 2 (PCS) SAR (W/kg)	5 GHz WLAN SAR (W/kg)	Σ SAR (W/kg)
		1	2	1+2
Hotspot SAR	Back	0.422	0.816	1.238
	Front	0.478	0.816*	<b>1.294</b>
	Top	-	0.816*	0.816
	Bottom	1.042	-	1.042
	Right	0.132	-	0.132
	Left	-	0.474	0.474



FCC ID: ZNFQ720AM		SAR EVALUATION REPORT		Approved by: Quality Manager
Document S/N: 1M1907080114-01-R1.ZNF	Test Dates: 07/08/19 - 07/19/19	DUT Type: Portable Handset	Page 73 of 83	

**Table 12-11**  
**Simultaneous Transmission Scenario with Bluetooth (Hotspot at 1.0 cm)**

Exposure Condition	Mode	2G/3G/4G SAR (W/kg)	Bluetooth SAR (W/kg)	Σ SAR (W/kg)
		1	2	
Hotspot SAR	GPRS 850	0.739	0.044	0.783
	GPRS 1900	0.812	0.044	0.856
	UMTS 850	0.597	0.044	0.641
	UMTS 1750	0.986	0.044	1.030
	UMTS 1900	0.973	0.044	1.017
	LTE Band 12	0.548	0.044	0.592
	LTE Band 14	0.667	0.044	0.711
	LTE Band 5 (Cell)	0.616	0.044	0.660
	LTE Band 66 (AWS)	0.898	0.044	0.942
	LTE Band 2 (PCS)	1.042	0.044	<b>1.086</b>
	LTE Band 30	0.745	0.044	0.789

**Table 12-12**  
**Simultaneous Transmission Scenario with 5 GHz WLAN and Bluetooth (Hotspot at 1.0 cm)**

Exposure Condition	Mode	2G/3G/4G SAR (W/kg)	5 GHz WLAN SAR (W/kg)	Bluetooth SAR (W/kg)	Σ SAR (W/kg)
		1	2	3	
Hotspot SAR	GPRS 850	0.739	0.816	0.044	See Table Below
	GPRS 1900	0.812	0.816	0.044	See Table Below
	UMTS 850	0.597	0.816	0.044	1.457
	UMTS 1750	0.986	0.816	0.044	See Table Below
	UMTS 1900	0.973	0.816	0.044	See Table Below
	LTE Band 12	0.548	0.816	0.044	1.408
	LTE Band 14	0.667	0.816	0.044	1.527
	LTE Band 5 (Cell)	0.616	0.816	0.044	1.476
	LTE Band 66 (AWS)	0.898	0.816	0.044	See Table Below
	LTE Band 2 (PCS)	1.042	0.816	0.044	See Table Below
	LTE Band 30	0.745	0.816	0.044	See Table Below

FCC ID: ZNFQ720AM		SAR EVALUATION REPORT		Approved by: Quality Manager
Document S/N: 1M1907080114-01-R1.ZNF	Test Dates: 07/08/19 - 07/19/19	DUT Type: Portable Handset		Page 74 of 83

Simult Tx	Configuration	GPRS 850 SAR (W/kg)	5 GHz WLAN SAR (W/kg)	Bluetooth SAR (W/kg)	Σ SAR (W/kg)	Simult Tx	Configuration	GPRS 1900 SAR (W/kg)	5 GHz WLAN SAR (W/kg)	Bluetooth SAR (W/kg)	Σ SAR (W/kg)
		1	2	3	1+2+3			1	2	3	1+2+3
Hotspot SAR	Back	0.739	0.816	0.032	1.590	Hotspot SAR	Back	0.330	0.816	0.032	1.178
	Front	0.601	0.816*	0.025	1.442		Front	0.364	0.816*	0.025	1.205
	Top	-	0.816*	0.044	0.860		Top	-	0.816*	0.044	0.860
	Bottom	0.303	-	-	0.303		Bottom	0.812	-	-	0.812
	Right	-	-	-	N/A		Right	0.101	-	-	0.101
	Left	0.090	0.474	0.036	0.600		Left	-	0.474	0.036	0.510

Simult Tx	Configuration	UMTS 1750 SAR (W/kg)	5 GHz WLAN SAR (W/kg)	Bluetooth SAR (W/kg)	Σ SAR (W/kg)	Simult Tx	Configuration	UMTS 1900 SAR (W/kg)	5 GHz WLAN SAR (W/kg)	Bluetooth SAR (W/kg)	Σ SAR (W/kg)
		1	2	3	1+2+3			1	2	3	1+2+3
Hotspot SAR	Back	0.568	0.816	0.032	1.416	Hotspot SAR	Back	0.465	0.816	0.032	1.313
	Front	0.609	0.816*	0.025	1.450		Front	0.500	0.816*	0.025	1.341
	Top	-	0.816*	0.044	0.860		Top	-	0.816*	0.044	0.860
	Bottom	0.986	-	-	0.986		Bottom	0.973	-	-	0.973
	Right	0.259	-	-	0.259		Right	0.137	-	-	0.137
	Left	-	0.474	0.036	0.510		Left	-	0.474	0.036	0.510

Simult Tx	Configuration	LTE Band 66 (AWS) SAR (W/kg)	5 GHz WLAN SAR (W/kg)	Bluetooth SAR (W/kg)	Σ SAR (W/kg)	Simult Tx	Configuration	LTE Band 2 (PCS) SAR (W/kg)	5 GHz WLAN SAR (W/kg)	Bluetooth SAR (W/kg)	Σ SAR (W/kg)
		1	2	3	1+2+3			1	2	3	1+2+3
Hotspot SAR	Back	0.495	0.816	0.032	1.343	Hotspot SAR	Back	0.422	0.816	0.032	1.270
	Front	0.517	0.816*	0.025	1.358		Front	0.478	0.816*	0.025	1.319
	Top	-	0.816*	0.044	0.860		Top	-	0.816*	0.044	0.860
	Bottom	0.898	-	-	0.898		Bottom	1.042	-	-	1.042
	Right	0.221	-	-	0.221		Right	0.132	-	-	0.132
	Left	-	0.474	0.036	0.510		Left	-	0.474	0.036	0.510



Simult Tx	Configuration	LTE Band 30 SAR (W/kg)	5 GHz WLAN SAR (W/kg)	Bluetooth SAR (W/kg)	Σ SAR (W/kg)
		1	2	3	1+2+3
Hotspot SAR	Back	0.393	0.816	0.032	1.241
	Front	0.327	0.816*	0.025	1.168
	Top	-	0.816*	0.044	0.860
	Bottom	0.745	-	-	0.745
	Right	0.102	-	-	0.102
	Left	-	0.474	0.036	0.510

## 12.6 Phablet Simultaneous Transmission Analysis

Per FCC KDB Publication 941225 D06v02r01, the devices edges with antennas more than 2.5 cm from edge are not required to be evaluated for SAR (“-”).

(\*) For test positions that were not required to be evaluated for WLAN SAR per FCC KDB publication 248227, the worst case WLAN SAR result for the applicable exposure conditions was used for simultaneous transmission analysis.

For SAR summation, the highest reported SAR across all test distances was used as the most conservative evaluation for simultaneous transmission analysis for each device edge.



FCC ID: ZNFQ720AM	 <b>PCTEST</b> ENGINEERING LABORATORY, INC.	<b>SAR EVALUATION REPORT</b>		<b>Approved by:</b> Quality Manager
<b>Document S/N:</b> 1M1907080114-01-R1.ZNF	<b>Test Dates:</b> 07/08/19 - 07/19/19	<b>DUT Type:</b> Portable Handset	Page 75 of 83	

**Table 12-13  
Simultaneous Transmission Scenario with 5 GHz WLAN (Phablet)**

Simult Tx	Configuration	LTE Band 30 SAR (W/kg)	5 GHz WLAN SAR (W/kg)	$\Sigma$ SAR (W/kg)
		1	2	1+2
Phablet SAR	Back	1.245	2.041	<b>3.286</b>
	Front	1.579	0.698	2.277
	Top	-	2.041*	2.041
	Bottom	2.863	-	2.863
	Right	0.357	-	0.357
	Left	-	1.465	1.465

### 12.7 Simultaneous Transmission Conclusion

The above numerical summed SAR results for all the worst-case simultaneous transmission conditions were below the SAR limit. Therefore, the above analysis is sufficient to determine that simultaneous transmission cases will not exceed the SAR limit and therefore no measured volumetric simultaneous SAR summation is required per FCC KDB Publication 447498 D01v06 and IEEE 1528-2013 Section 6.3.4.1.2.

FCC ID: ZNFQ720AM	 <b>PCTEST</b> ENGINEERING LABORATORY, INC.	<b>SAR EVALUATION REPORT</b>		<b>Approved by:</b> Quality Manager
<b>Document S/N:</b> 1M1907080114-01-R1.ZNF	<b>Test Dates:</b> 07/08/19 - 07/19/19	<b>DUT Type:</b> Portable Handset	Page 76 of 83	

# 13 SAR MEASUREMENT VARIABILITY

## 13.1 Measurement Variability

Per FCC KDB Publication 865664 D01v01r04, SAR measurement variability was assessed for each frequency band, which was determined by the SAR probe calibration point and tissue-equivalent medium used for the device measurements. When both head and body tissue-equivalent media were required for SAR measurements in a frequency band, the variability measurement procedures were applied to the tissue medium with the highest measured SAR, using the highest measured SAR configuration for that tissue-equivalent medium. These additional measurements were repeated after the completion of all measurements requiring the same head or body tissue-equivalent medium in a frequency band. The test device was returned to ambient conditions (normal room temperature) with the battery fully charged before it was re-mounted on the device holder for the repeated measurement(s) to minimize any unexpected variations in the repeated results.

SAR Measurement Variability was assessed using the following procedures for each frequency band:



- 1) When the original highest measured SAR is  $\geq 0.80$  W/kg, the measurement was repeated once.
- 2) A second repeated measurement was performed only if the ratio of largest to smallest SAR for the original and first repeated measurements was  $> 1.20$  or when the original or repeated measurement was  $\geq 1.45$  W/kg (~ 10% from the 1g SAR limit).
- 3) A third repeated measurement was performed only if the original, first or second repeated measurement was  $\geq 1.5$  W/kg and the ratio of largest to smallest SAR for the original, first and second repeated measurements is  $> 1.20$ .
- 4) Repeated measurements are not required when the original highest measured SAR is  $< 0.80$  W/kg
- 5) When 10g SAR measurement is considered, a factor of 2.5 is applied to the thresholds above.

**Table 13-1  
Head SAR Measurement Variability Results**

HEAD VARIABILITY RESULTS														
Band	FREQUENCY		Mode	Service	Side	Test Position	Data Rate (Mbps)	Measured SAR (1g)	1st Repeated SAR (1g)	Ratio	2nd Repeated SAR (1g)	Ratio	3rd Repeated SAR (1g)	Ratio
	MHz	Ch.						(W/kg)	(W/kg)		(W/kg)		(W/kg)	
2450	2462.00	11	802.11b, 22 MHz Bandwidth	DSSS	Right	Tilt	1	0.843	0.828	1.02	N/A	N/A	N/A	N/A
ANSI / IEEE C95.1 1992 - SAFETY LIMIT Spatial Peak Uncontrolled Exposure/General Population						Head 1.6 W/kg (mW/g) averaged over 1 gram								

**Table 13-2  
Body SAR Measurement Variability Results**

BODY VARIABILITY RESULTS													
Band	FREQUENCY		Mode	Service	Side	Spacing	Measured SAR (1g)	1st Repeated SAR (1g)	Ratio	2nd Repeated SAR (1g)	Ratio	3rd Repeated SAR (1g)	Ratio
	MHz	Ch.					(W/kg)	(W/kg)		(W/kg)		(W/kg)	
1750	1752.60	1513	UMTS 1750	RMC	bottom	10 mm	0.936	0.939	1.00	N/A	N/A	N/A	N/A
1900	1900.00	19100	LTE Band 2 (PCS), 20 MHz Bandwidth	QPSK, 1 RB, 50 RB Offset	bottom	10 mm	1.040	1.020	1.02	N/A	N/A	N/A	N/A
ANSI / IEEE C95.1 1992 - SAFETY LIMIT Spatial Peak Uncontrolled Exposure/General Population						Body 1.6 W/kg (mW/g) averaged over 1 gram							



FCC ID: ZNFQ720AM		SAR EVALUATION REPORT		Approved by: Quality Manager
Document S/N: 1M1907080114-01-R1.ZNF	Test Dates: 07/08/19 - 07/19/19	DUT Type: Portable Handset	Page 77 of 83	

**Table 13-3  
Phablet SAR Measurement Variability Results**

PHABLET VARIABILITY RESULTS													
Band	FREQUENCY		Mode	Service	Side	Spacing	Measured SAR (10g)	1st Repeated SAR (10g)	Ratio	2nd Repeated SAR (10g)	Ratio	3rd Repeated SAR (10g)	Ratio
	MHz	Ch.					(W/kg)	(W/kg)		(W/kg)		(W/kg)	
2300	2310.00	27710	LTE Band 30, 10 MHz Bandwidth	QPSK, 1 RB, 49 RB Offset	bottom	0 mm	2.460	2.440	1.01	N/A	N/A	N/A	N/A
ANSI / IEEE C95.1 1992 - SAFETY LIMIT Spatial Peak Uncontrolled Exposure/General Population						Phablet 4.0 W/kg (mW/g) averaged over 10 grams							



### 13.2 Measurement Uncertainty

The measured SAR was <1.5 W/kg for 1g and <3.75 W/kg for 10g for all frequency bands. Therefore, per KDB Publication 865664 D01v01r04, the extended measurement uncertainty analysis per IEEE 1528-2013 was not required.



FCC ID: ZNFQ720AM	 PCTEST ENGINEERING LABORATORY, INC.	SAR EVALUATION REPORT	 LG	Approved by: Quality Manager
Document S/N: 1M1907080114-01-R1.ZNF	Test Dates: 07/08/19 - 07/19/19	DUT Type: Portable Handset		Page 78 of 83

Manufacturer	Model	Description	Cal Date	Cal Interval	Cal Due	Serial Number
Agilent	8594A	(9kHz-2.9GHz) Spectrum Analyzer	CBT	N/A	CBT	3051A00187
Agilent	8753ES	S-Parameter Network Analyzer	7/30/2018	Annual	7/30/2019	MY40000670
Agilent	8753ES	S-Parameter Network Analyzer	10/2/2018	Annual	10/2/2019	US39170118
Agilent	E4438C	ESG Vector Signal Generator	3/8/2019	Biennial	3/8/2021	MY42082385
Agilent	E4438C	ESG Vector Signal Generator	6/1/2019	Biennial	6/1/2021	MY42082659
Agilent	E5515C	Wireless Communications Test Set	2/28/2018	Biennial	2/28/2020	GB41450275
Agilent	E5515C	Wireless Communications Test Set	5/22/2018	Biennial	5/22/2020	GB43193563
Agilent	N4010A	Wireless Connectivity Test Set	CBT	N/A	CBT	GB44450273
Agilent	N4010A	Wireless Connectivity Test Set	CBT	N/A	CBT	GB46170464
Amplifier Research	1551G6	Amplifier	CBT	N/A	CBT	433971
Amplifier Research	1551G6	Amplifier	CBT	N/A	CBT	433972
Anritsu	MA24106A	USB Power Sensor	5/22/2019	Annual	5/22/2020	1231535
Anritsu	MA24106A	USB Power Sensor	5/6/2019	Annual	5/6/2020	1231538
Anritsu	MA24106A	USB Power Sensor	1/31/2019	Annual	1/31/2020	1244524
Anritsu	MA2411B	Pulse Power Sensor	10/30/2018	Annual	10/30/2019	1126066
Anritsu	MA2411B	Pulse Power Sensor	6/11/2019	Annual	6/11/2020	1207364
Anritsu	ML2495A	Power Meter	10/21/2018	Annual	10/21/2019	941001
Anritsu	MT8820C	Radio Communication Analyzer	3/29/2019	Annual	3/29/2020	6201300731
Anritsu	MT8821C	Radio Communication Analyzer	11/6/2018	Annual	11/6/2019	6200901190
Anritsu	MT8821C	Radio Communication Analyzer	3/18/2019	Annual	3/18/2020	6201144419
COMTECH	AR85729-5	Solid State Amplifier	CBT	N/A	CBT	M155A00-009
COMTECH	AR85729-5/5759B	Solid State Amplifier	CBT	N/A	CBT	M3W1A00-1002
Control Company	4040	Therm./ Clock/ Humidity Monitor	1/8/2019	Annual	1/8/2020	160473909
Control Company	4040	Therm./ Clock/ Humidity Monitor	1/8/2019	Annual	1/8/2020	160574418
Control Company	4352	Ultra Long Stem Thermometer	2/28/2018	Biennial	2/28/2020	170330160
MiniCircuits	VLF-6000+	Low Pass Filter	CBT	N/A	CBT	N/A
Mini-Circuits	NLP-1200+	Low Pass Filter DC to 1000 MHz	CBT	N/A	CBT	N/A
Mini-Circuits	NLP-2950+	Low Pass Filter DC to 2700 MHz	CBT	N/A	CBT	N/A
Narda	4772-3	Attenuator (3dB)	CBT	N/A	CBT	9406
Narda	BW-53W2	Attenuator (3dB)	CBT	N/A	CBT	120
Pasternack	PE2208-6	Bidirectional Coupler	CBT	N/A	CBT	N/A
Pasternack	PE2209-10	Bidirectional Coupler	CBT	N/A	CBT	N/A
Rohde & Schwarz	CMW500	Radio Communication Tester	11/14/2018	Annual	11/14/2019	100976
Rohde & Schwarz	CMW500	Radio Communication Tester	6/24/2019	Annual	6/24/2020	101699
Rohde & Schwarz	CMW500	Radio Communication Tester	6/26/2019	Annual	6/26/2020	108843
Seekonk	NC-100	Torque Wrench	11/1/2017	Biennial	11/1/2019	22313
SPEAG	D1750V2	1750 MHz SAR Dipole	10/22/2018	Annual	10/22/2019	1150
SPEAG	D1765V2	1765 MHz SAR Dipole	5/23/2018	Biennial	5/23/2020	1008
SPEAG	D1900V2	1900 MHz SAR Dipole	10/23/2018	Annual	10/23/2019	5d080
SPEAG	D1900V2	1900 MHz SAR Dipole	2/21/2019	Annual	2/21/2020	5d148
SPEAG	D1900V2	1900 MHz SAR Dipole	10/23/2018	Annual	10/23/2019	5d149
SPEAG	D2300V2	2300 MHz SAR Dipole	8/13/2018	Annual	8/13/2019	1073
SPEAG	D2450V2	2450 MHz SAR Dipole	8/17/2017	Biennial	8/17/2019	719
SPEAG	D2450V2	2450 MHz SAR Dipole	9/11/2017	Biennial	9/11/2019	797
SPEAG	D5GHZV2	5 GHz SAR Dipole	1/16/2018	Biennial	1/16/2020	1057
SPEAG	D5GHZV2	5 GHz SAR Dipole	8/10/2018	Annual	8/10/2019	1237
SPEAG	D750V3	750 MHz SAR Dipole	1/15/2018	Biennial	1/15/2020	1003
SPEAG	D835V2	835 MHz SAR Dipole	3/13/2019	Annual	3/13/2020	4d047
SPEAG	D835V2	835 MHz SAR Dipole	10/19/2018	Annual	10/19/2019	4d133
SPEAG	DAE4	Dasy Data Acquisition Electronics	2/13/2019	Annual	2/13/2020	665
SPEAG	DAE4	Dasy Data Acquisition Electronics	5/8/2019	Annual	5/8/2020	728
SPEAG	DAE4	Dasy Data Acquisition Electronics	5/8/2019	Annual	5/8/2020	859
SPEAG	DAE4	Dasy Data Acquisition Electronics	2/14/2019	Annual	2/14/2020	1272
SPEAG	DAE4	Dasy Data Acquisition Electronics	6/20/2019	Annual	6/20/2020	1334
SPEAG	DAE4	Dasy Data Acquisition Electronics	4/18/2019	Annual	4/18/2020	1407
SPEAG	DAE4	Dasy Data Acquisition Electronics	8/22/2018	Annual	8/22/2019	1450
SPEAG	DAE4	Dasy Data Acquisition Electronics	10/3/2018	Annual	10/3/2019	1558
SPEAG	DAK-3.5	Dielectric Assessment Kit	5/7/2019	Annual	5/7/2020	1070
SPEAG	DAK-3.5	Dielectric Assessment Kit	9/11/2018	Annual	9/11/2019	1091
SPEAG	DAKS-3.5	Portable Dielectric Assessment Kit	8/22/2018	Annual	8/22/2019	1041
SPEAG	DAKS-3.5	Portable DAK	9/11/2018	Annual	9/11/2019	1045
SPEAG	EX3DV4	SAR Probe	1/25/2019	Annual	1/25/2020	3589
SPEAG	EX3DV4	SAR Probe	2/19/2019	Annual	2/19/2020	3914
SPEAG	EX3DV4	SAR Probe	8/23/2018	Annual	8/23/2019	7308
SPEAG	EX3DV4	SAR Probe	4/24/2019	Annual	4/24/2020	7357
SPEAG	EX3DV4	SAR Probe	5/16/2019	Annual	5/16/2020	7406
SPEAG	EX3DV4	SAR Probe	6/19/2019	Annual	6/19/2020	7409
SPEAG	EX3DV4	SAR Probe	2/19/2019	Annual	2/19/2020	7417
SPEAG	EX3DV4	SAR Probe	5/16/2019	Annual	5/16/2020	7538

Note: CBT (Calibrated Before Testing). Prior to testing, the measurement paths containing a cable, amplifier, attenuator, coupler or filter were connected to a calibrated source (i.e. a signal generator) to determine the losses of the measurement path. The power meter offset was then adjusted to compensate for the measurement system losses. This level offset is stored within the power meter before measurements are made. This calibration verification procedure applies to the system verification and output power measurements. The calibrated reading is then taken directly from the power meter after compensation of the losses for all final power measurements.

FCC ID: ZNFQ720AM		SAR EVALUATION REPORT		Approved by: Quality Manager
Document S/N: 1M1907080114-01-R1.ZNF	Test Dates: 07/08/19 - 07/19/19	DUT Type: Portable Handset		Page 79 of 83

a	c	d	e= f(d,k)	f	g	h = c x f/e	i = c x g/e	k
Uncertainty Component	Tol. (± %)	Prob. Dist.	Div.	c <sub>i</sub> 1gm	c <sub>i</sub> 10 gms	1gm u <sub>i</sub> (± %)	10gms u <sub>i</sub> (± %)	v <sub>i</sub>
<b>Measurement System</b>								
Probe Calibration	6.55	N	1	1.0	1.0	6.6	6.6	∞
Axial Isotropy	0.25	N	1	0.7	0.7	0.2	0.2	∞
Hemishperical Isotropy	1.3	N	1	0.7	0.7	0.9	0.9	∞
Boundary Effect	2.0	R	1.73	1.0	1.0	1.2	1.2	∞
Linearity	0.3	N	1	1.0	1.0	0.3	0.3	∞
System Detection Limits	0.25	R	1.73	1.0	1.0	0.1	0.1	∞
Readout Electronics	0.3	N	1	1.0	1.0	0.3	0.3	∞
Response Time	0.8	R	1.73	1.0	1.0	0.5	0.5	∞
Integration Time	2.6	R	1.73	1.0	1.0	1.5	1.5	∞
RF Ambient Conditions - Noise	3.0	R	1.73	1.0	1.0	1.7	1.7	∞
RF Ambient Conditions - Reflections	3.0	R	1.73	1.0	1.0	1.7	1.7	∞
Probe Positioner Mechanical Tolerance	0.4	R	1.73	1.0	1.0	0.2	0.2	∞
Probe Positioning w/ respect to Phantom	6.7	R	1.73	1.0	1.0	3.9	3.9	∞
Extrapolation, Interpolation & Integration algorithms for Max. SAR Evaluation	4.0	R	1.73	1.0	1.0	2.3	2.3	∞
<b>Test Sample Related</b>								
Test Sample Positioning	2.7	N	1	1.0	1.0	2.7	2.7	35
Device Holder Uncertainty	1.67	N	1	1.0	1.0	1.7	1.7	5
Output Power Variation - SAR drift measurement	5.0	R	1.73	1.0	1.0	2.9	2.9	∞
SAR Scaling	0.0	R	1.73	1.0	1.0	0.0	0.0	∞
<b>Phantom &amp; Tissue Parameters</b>								
Phantom Uncertainty (Shape & Thickness tolerances)	7.6	R	1.73	1.0	1.0	4.4	4.4	∞
Liquid Conductivity - measurement uncertainty	4.2	N	1	0.78	0.71	3.3	3.0	10
Liquid Permittivity - measurement uncertainty	4.1	N	1	0.23	0.26	1.0	1.1	10
Liquid Conductivity - Temperature Uncertainty	3.4	R	1.73	0.78	0.71	1.5	1.4	∞
Liquid Permittivity - Temperature Uncertainty	0.6	R	1.73	0.23	0.26	0.1	0.1	∞
Liquid Conductivity - deviation from target values	5.0	R	1.73	0.64	0.43	1.8	1.2	∞
Liquid Permittivity - deviation from target values	5.0	R	1.73	0.60	0.49	1.7	1.4	∞
<b>Combined Standard Uncertainty (k=1)</b>	RSS					11.5	11.3	60
<b>Expanded Uncertainty</b> (95% CONFIDENCE LEVEL)	k=2					23.0	22.6	

FCC ID: ZNFQ720AM		SAR EVALUATION REPORT		Approved by: Quality Manager
Document S/N: 1M1907080114-01-R1.ZNF	Test Dates: 07/08/19 - 07/19/19	DUT Type: Portable Handset		Page 80 of 83





## 16 CONCLUSION

### 16.1 Measurement Conclusion



The SAR evaluation indicates that the EUT complies with the RF radiation exposure limits of the FCC and Innovation, Science, and Economic Development Canada, with respect to all parameters subject to this test. These measurements were taken to simulate the RF effects of RF exposure under worst-case conditions. Precise laboratory measures were taken to assure repeatability of the tests. The results and statements relate only to the item(s) tested.

Please note that the absorption and distribution of electromagnetic energy in the body are very complex phenomena that depend on the mass, shape, and size of the body, the orientation of the body with respect to the field vectors, and the electrical properties of both the body and the environment. Other variables that may play a substantial role in possible biological effects are those that characterize the environment (e.g. ambient temperature, air velocity, relative humidity, and body insulation) and those that characterize the individual (e.g. age, gender, activity level, debilitation, or disease). Because various factors may interact with one another to vary the specific biological outcome of an exposure to electromagnetic fields, any protection guide should consider maximal amplification of biological effects as a result of field-body interactions, environmental conditions, and physiological variables. [3]



FCC ID: ZNFQ720AM		SAR EVALUATION REPORT		Approved by: Quality Manager
Document S/N: 1M1907080114-01-R1.ZNF	Test Dates: 07/08/19 - 07/19/19	DUT Type: Portable Handset		Page 81 of 83

# 17 REFERENCES

- [1] Federal Communications Commission, ET Docket 93-62, Guidelines for Evaluating the Environmental Effects of Radiofrequency Radiation, Aug. 1996.
- [2] ANSI/IEEE C95.1-2005, American National Standard safety levels with respect to human exposure to radio frequency electromagnetic fields, 3kHz to 300GHz, New York: IEEE, 2006.
- [3] ANSI/IEEE C95.1-1992, American National Standard safety levels with respect to human exposure to radio frequency electromagnetic fields, 3kHz to 300GHz, New York: IEEE, Sept. 1992.
- [4] ANSI/IEEE C95.3-2002, IEEE Recommended Practice for the Measurement of Potentially Hazardous Electromagnetic Fields - RF and Microwave, New York: IEEE, December 2002.
- [5] IEEE Standards Coordinating Committee 39 –Standards Coordinating Committee 34 – IEEE Std. 1528-2013, IEEE Recommended Practice for Determining the Peak Spatial-Average Specific Absorption Rate (SAR) in the Human Head from Wireless Communications Devices: Measurement Techniques.
- [6] NCRP, National Council on Radiation Protection and Measurements, Biological Effects and Exposure Criteria for RadioFrequency Electromagnetic Fields, NCRP Report No. 86, 1986. Reprinted Feb. 1995.
- [7] T. Schmid, O. Egger, N. Kuster, Automated E-field scanning system for dosimetric assessments, IEEE Transaction on Microwave Theory and Techniques, vol. 44, Jan. 1996, pp. 105-113.
- [8] K. Pokovic, T. Schmid, N. Kuster, Robust setup for precise calibration of E-field probes in tissue simulating liquids at mobile communications frequencies, ICECOM97, Oct. 1997, pp. 1 -124.
- [9] K. Pokovic, T. Schmid, and N. Kuster, E-field Probe with improved isotropy in brain simulating liquids, Proceedings of the ELMAR, Zadar, Croatia, June 23-25, 1996, pp. 172-175.
- [10] Schmid & Partner Engineering AG, Application Note: Data Storage and Evaluation, June 1998, p2.
- [11] V. Hombach, K. Meier, M. Burkhardt, E. Kuhn, N. Kuster, The Dependence of EM Energy Absorption upon Human Modeling at 900 MHz, IEEE Transaction on Microwave Theory and Techniques, vol. 44 no. 10, Oct. 1996, pp. 1865-1873.
- [12] N. Kuster and Q. Balzano, Energy absorption mechanism by biological bodies in the near field of dipole antennas above 300MHz, IEEE Transaction on Vehicular Technology, vol. 41, no. 1, Feb. 1992, pp. 17-23.
- [13] G. Hartsgrove, A. Kraszewski, A. Surowiec, Simulated Biological Materials for Electromagnetic Radiation Absorption Studies, University of Ottawa, Bioelectromagnetics, Canada: 1987, pp. 29-36.
- [14] Q. Balzano, O. Garay, T. Manning Jr., Electromagnetic Energy Exposure of Simulated Users of Portable Cellular Telephones, IEEE Transactions on Vehicular Technology, vol. 44, no.3, Aug. 1995.
- [15] W. Gander, Computermathematik, Birkhaeuser, Basel, 1992.
- [16] W.H. Press, S.A. Teukolsky, W.T. Vetterling, and B.P. Flannery, Numerical Recipes in C, The Art of Scientific Computing, Second edition, Cambridge University Press, 1992.
- [17] N. Kuster, R. Kastle, T. Schmid, Dosimetric evaluation of mobile communications equipment with known precision, IEEE Transaction on Communications, vol. E80-B, no. 5, May 1997, pp. 645-652.

FCC ID: ZNFQ720AM	 <b>PCTEST</b> ENGINEERING LABORATORY, INC.	<b>SAR EVALUATION REPORT</b>	 <b>LG</b>	<b>Approved by:</b> Quality Manager
<b>Document S/N:</b> 1M1907080114-01-R1.ZNF	<b>Test Dates:</b> 07/08/19 - 07/19/19	<b>DUT Type:</b> Portable Handset	Page 82 of 83	

- [18] CENELEC CLC/SC111B, European Prestandard (prENV 50166-2), Human Exposure to Electromagnetic Fields High-frequency: 10kHz-300GHz, Jan. 1995.
- [19] Prof. Dr. Niels Kuster, ETH, Eidgenössische Technische Hochschule Zürich, Dosimetric Evaluation of the Cellular Phone.
- [20] IEC 62209-1, Measurement procedure for the assessment of specific absorption rate of human exposure to radio frequency fields from hand-held and body-mounted wireless communication devices - Part 1: Devices used next to the ear (Frequency range of 300 MHz to 6 GHz), July 2016.
- [21] Innovation, Science, Economic Development Canada RSS-102 Radio Frequency Exposure Compliance of Radiocommunication Apparatus (All Frequency Bands) Issue 5, March 2015.
- [22] Health Canada Safety Code 6 Limits of Human Exposure to Radio Frequency Electromagnetic Fields in the Frequency Range from 3 kHz – 300 GHz, 2015
- [23] FCC SAR Test Procedures for 2G-3G Devices, Mobile Hotspot and UMPC Devices KDB Publications 941225, D01-D07
- [24] SAR Measurement Guidance for IEEE 802.11 Transmitters, KDB Publication 248227 D01
- [25] FCC SAR Considerations for Handsets with Multiple Transmitters and Antennas, KDB Publications 648474 D03-D04
- [26] FCC SAR Evaluation Considerations for Laptop, Notebook, Netbook and Tablet Computers, FCC KDB Publication 616217 D04
- [27] FCC SAR Measurement and Reporting Requirements for 100MHz – 6 GHz, KDB Publications 865664 D01-D02
- [28] FCC General RF Exposure Guidance and SAR Procedures for Dongles, KDB Publication 447498, D01-D02
- [29] Anexo à Resolução No. 533, de 10 de Setembro de 2009.
- [30] IEC 62209-2, Human exposure to radio frequency fields from hand-held and body-mounted wireless communication devices - Human models, instrumentation, and procedures - Part 2: Procedure to determine the specific absorption rate (SAR) for wireless communication devices used in close proximity to the human body (frequency range of 30 MHz to 6 GHz), Mar. 2010.

FCC ID: ZNFQ720AM	 <b>SAR EVALUATION REPORT</b> 		<b>Approved by:</b> Quality Manager
Document S/N: 1M1907080114-01-R1.ZNF	Test Dates: 07/08/19 - 07/19/19	DUT Type: Portable Handset	Page 83 of 83

## APPENDIX A: SAR TEST DATA

# PCTEST ENGINEERING LABORATORY, INC.

**DUT: ZNFQ720AM; Type: Portable Handset; Serial: 06811**

Communication System: UID 0, \_GSM GPRS; 2 Tx slots; Frequency: 836.6 MHz; Duty Cycle: 1:4.15  
Medium: 835 Head; Medium parameters used (interpolated):  
 $f = 836.6 \text{ MHz}$ ;  $\sigma = 0.917 \text{ S/m}$ ;  $\epsilon_r = 41.621$ ;  $\rho = 1000 \text{ kg/m}^3$   
Phantom section: Right Section

Test Date: 07-15-2019; Ambient Temp: 21.4°C; Tissue Temp: 20.7°C

Probe: EX3DV4 - SN3589; ConvF(8.39, 8.39, 8.39) @ 836.6 MHz; Calibrated: 1/25/2019  
Sensor-Surface: 1.4mm (Mechanical Surface Detection)  
Electronics: DAE4 Sn1450; Calibrated: 8/22/2018  
Phantom: Twin-SAM V5.0 (30); Type: QD 000 P40 CD; Serial: 1647  
Measurement SW: DASY52, Version 52.10 (2);SEMCAD X Version 14.6.12 (7450)

**Mode: GPRS 850, Right Head, Cheek, Mid.ch, 2 Tx slots**

**Area Scan (9x15x1):** Measurement grid: dx=15mm, dy=15mm

**Zoom Scan (6x5x7)/Cube 0:** Measurement grid: dx=8mm, dy=8mm, dz=5mm

Reference Value = 13.10 V/m; Power Drift = -0.01 dB

Peak SAR (extrapolated) = 0.191 W/kg

**SAR(1 g) = 0.147 W/kg**

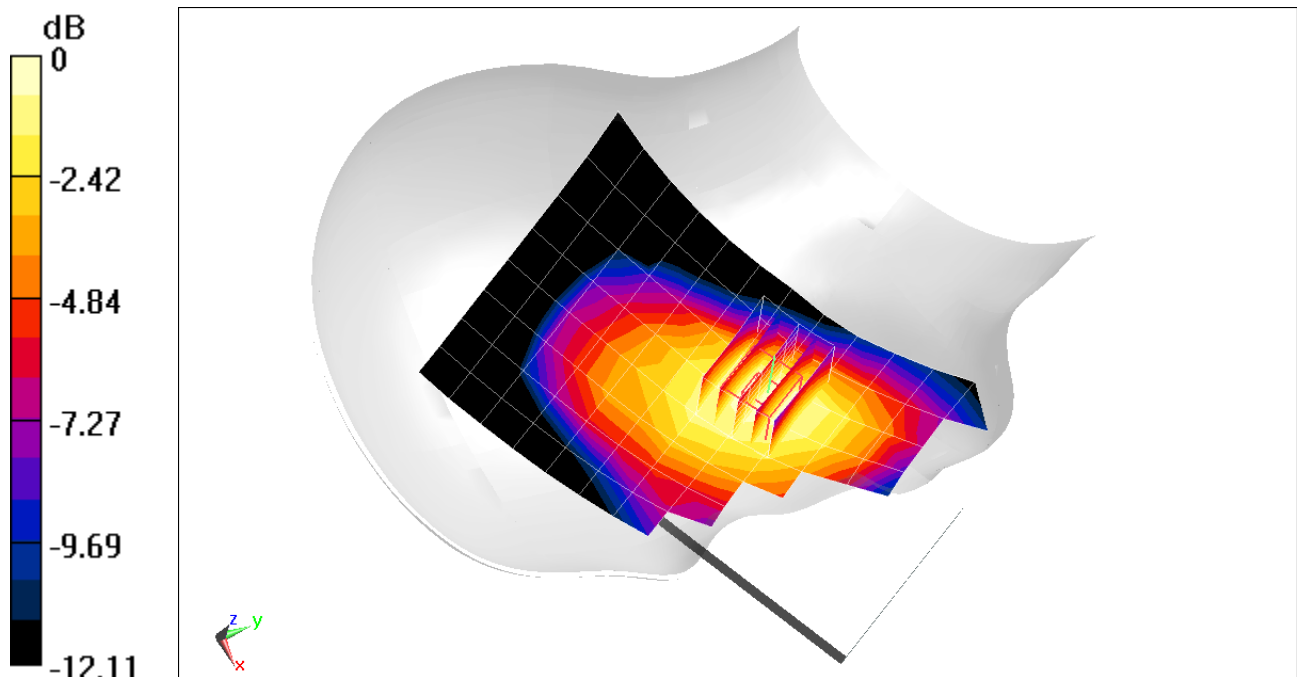

0 dB = 0.175 W/kg = -7.57 dBW/kg

# PCTEST ENGINEERING LABORATORY, INC.

**DUT: ZNFQ720AM; Type: Portable Handset; Serial: 06811**

Communication System: UID 0, \_GSM GPRS; 2 Tx slots; Frequency: 1880 MHz; Duty Cycle: 1:4.15

Medium: 1900 Head; Medium parameters used:

$f = 1880 \text{ MHz}$ ;  $\sigma = 1.431 \text{ S/m}$ ;  $\epsilon_r = 40.266$ ;  $\rho = 1000 \text{ kg/m}^3$

Phantom section: Right Section

Test Date: 07-10-2019; Ambient Temp: 21.1°C; Tissue Temp: 21.6°C

Probe: EX3DV4 - SN7409; ConvF(8.01, 8.01, 8.01) @ 1880 MHz; Calibrated: 6/19/2019

Sensor-Surface: 1.4mm (Mechanical Surface Detection)

Electronics: DAE4 Sn1334; Calibrated: 6/20/2019

Phantom: Front; Type: QD 000 P40 CD; Serial: 1686

Measurement SW: DASY52, Version 52.10 (2);SEMCAD X Version 14.6.12 (7450)

**Mode: GPRS 1900, Right Head, Cheek, Mid.ch, 2 Tx slots**

**Area Scan (9x15x1):** Measurement grid: dx=15mm, dy=15mm

**Zoom Scan (5x5x7)/Cube 0:** Measurement grid: dx=8mm, dy=8mm, dz=5mm

Reference Value = 8.031 V/m; Power Drift = 0.14 dB

Peak SAR (extrapolated) = 0.132 W/kg

**SAR(1 g) = 0.085 W/kg**

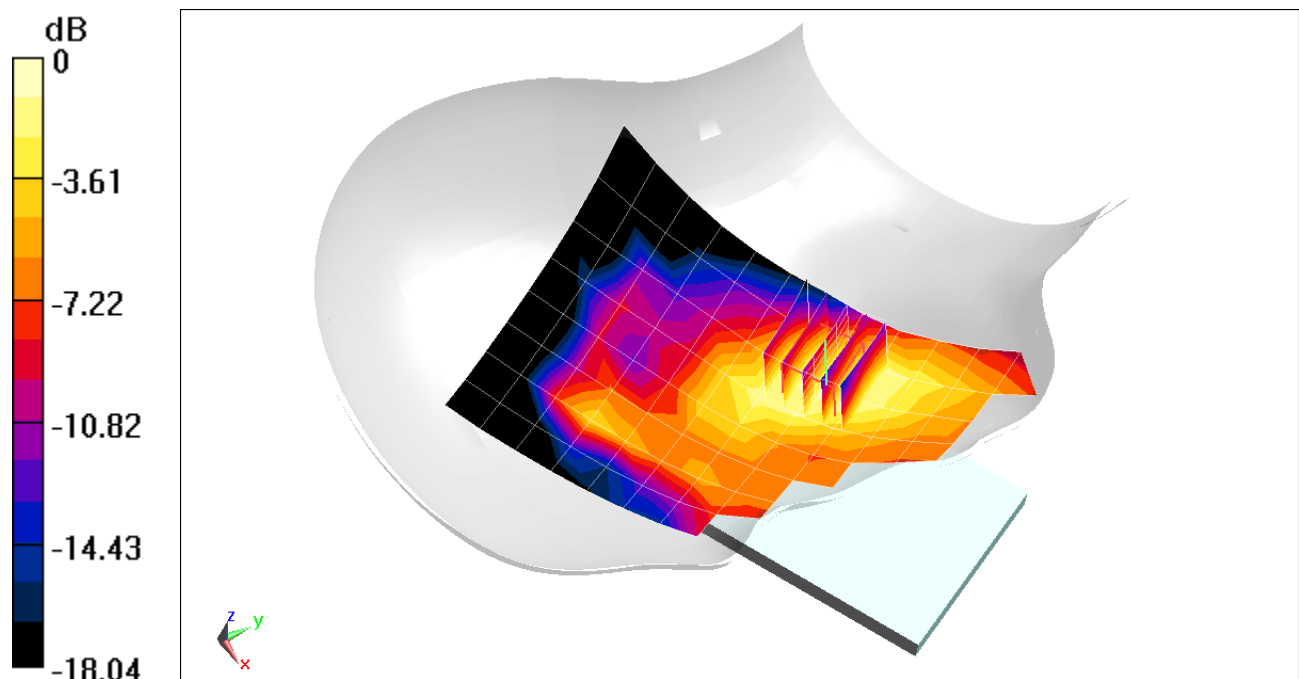

0 dB = 0.111 W/kg = -9.55 dBW/kg

# PCTEST ENGINEERING LABORATORY, INC.

**DUT: ZNFQ720AM; Type: Portable Handset; Serial: 06811**

Communication System: UID 0, UMTS; Frequency: 836.6 MHz; Duty Cycle: 1:1  
Medium: 835 Head; Medium parameters used (interpolated):  
 $f = 836.6 \text{ MHz}$ ;  $\sigma = 0.917 \text{ S/m}$ ;  $\epsilon_r = 41.621$ ;  $\rho = 1000 \text{ kg/m}^3$   
Phantom section: Right Section

Test Date: 07-15-2019; Ambient Temp: 21.4°C; Tissue Temp: 20.7°C

Probe: EX3DV4 - SN3589; ConvF(8.39, 8.39, 8.39) @ 836.6 MHz; Calibrated: 1/25/2019  
Sensor-Surface: 1.4mm (Mechanical Surface Detection)  
Electronics: DAE4 Sn1450; Calibrated: 8/22/2018  
Phantom: Twin-SAM V5.0 (30); Type: QD 000 P40 CD; Serial: 1647  
Measurement SW: DASY52, Version 52.10 (2);SEMCAD X Version 14.6.12 (7450)

**Mode: UMTS 850, Right Head, Cheek, Mid.ch**

**Area Scan (9x15x1):** Measurement grid: dx=15mm, dy=15mm

**Zoom Scan (6x5x7)/Cube 0:** Measurement grid: dx=8mm, dy=8mm, dz=5mm

Reference Value = 13.00 V/m; Power Drift = -0.10 dB

Peak SAR (extrapolated) = 0.190 W/kg

**SAR(1 g) = 0.145 W/kg**

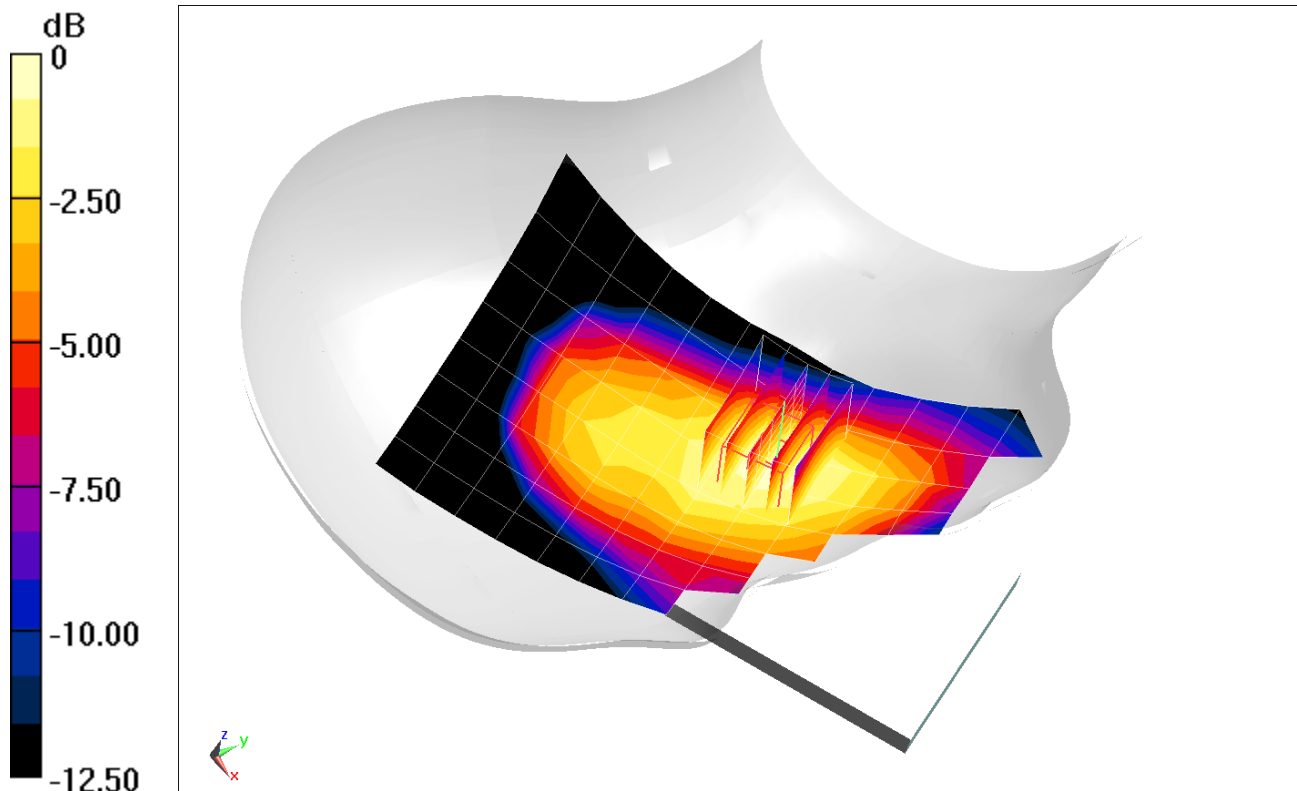

0 dB = 0.175 W/kg = -7.57 dBW/kg

# PCTEST ENGINEERING LABORATORY, INC.

**DUT: ZNFQ720AM; Type: Portable Handset; Serial: 06811**

Communication System: UID 0, UMTS; Frequency: 1732.4 MHz; Duty Cycle: 1:1  
Medium: 1750 Head; Medium parameters used (interpolated):  
 $f = 1732.4$  MHz;  $\sigma = 1.342$  S/m;  $\epsilon_r = 40.082$ ;  $\rho = 1000$  kg/m<sup>3</sup>  
Phantom section: Right Section

Test Date: 07-08-2019; Ambient Temp: 21.4°C; Tissue Temp: 21.0°C

Probe: EX3DV4 - SN3589; ConvF(7.31, 7.31, 7.31) @ 1732.4 MHz; Calibrated: 1/25/2019  
Sensor-Surface: 1.4mm (Mechanical Surface Detection)  
Electronics: DAE4 Sn1450; Calibrated: 8/22/2018  
Phantom: Twin-SAM V5.0 (30); Type: QD 000 P40 CD; Serial: 1647  
Measurement SW: DASY52, Version 52.10 (2);SEMCAD X Version 14.6.12 (7450)

**Mode: UMTS 1750, Right Head, Cheek, Mid.ch**

**Area Scan (9x15x1):** Measurement grid: dx=15mm, dy=15mm

**Zoom Scan (5x5x7)/Cube 0:** Measurement grid: dx=8mm, dy=8mm, dz=5mm

Reference Value = 9.745 V/m; Power Drift = 0.13 dB

Peak SAR (extrapolated) = 0.191 W/kg

**SAR(1 g) = 0.122 W/kg**

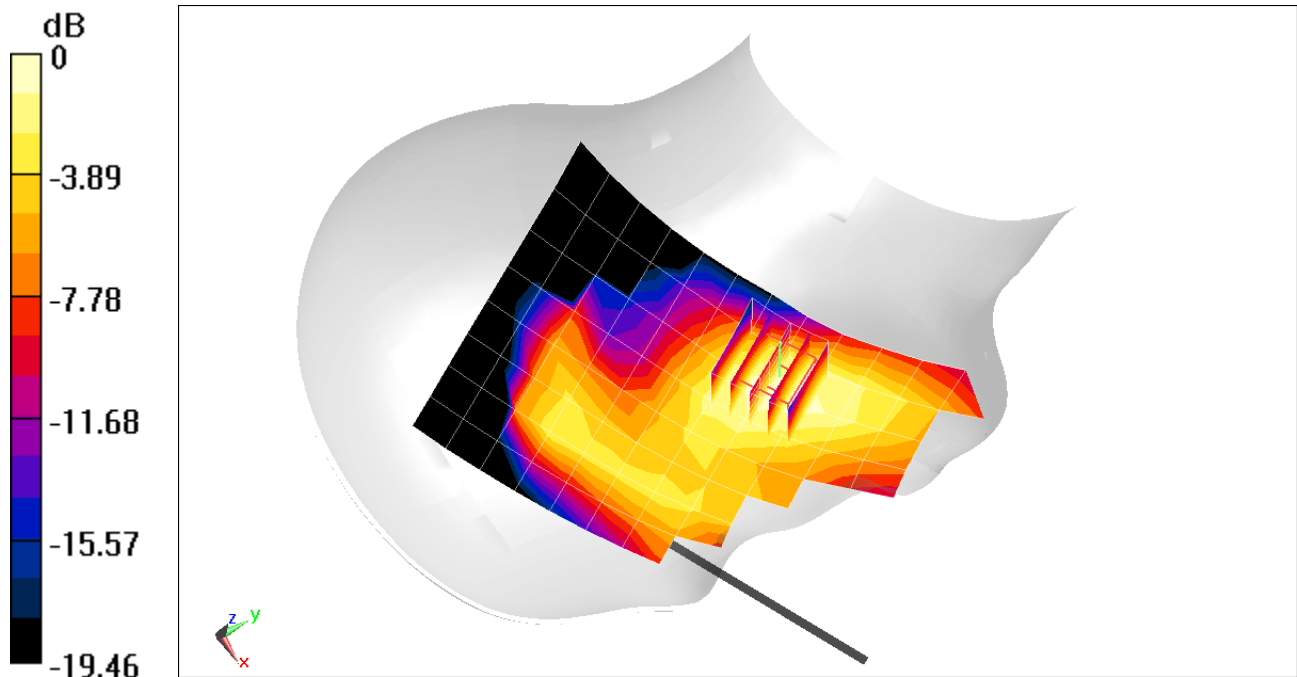

0 dB = 0.158 W/kg = -8.01 dBW/kg



# PCTEST ENGINEERING LABORATORY, INC.

**DUT: ZNFQ720AM; Type: Portable Handset; Serial: 06811**

Communication System: UID 0, UMTS; Frequency: 1880 MHz; Duty Cycle: 1:1

Medium: 1900 Head; Medium parameters used:

$f = 1880 \text{ MHz}$ ;  $\sigma = 1.431 \text{ S/m}$ ;  $\epsilon_r = 40.266$ ;  $\rho = 1000 \text{ kg/m}^3$

Phantom section: Right Section

Test Date: 07-10-2019; Ambient Temp: 21.1°C; Tissue Temp: 21.6°C

Probe: EX3DV4 - SN7409; ConvF(8.01, 8.01, 8.01) @ 1880 MHz; Calibrated: 6/19/2019

Sensor-Surface: 1.4mm (Mechanical Surface Detection)

Electronics: DAE4 Sn1334; Calibrated: 6/20/2019

Phantom: Front; Type: QD 000 P40 CD; Serial: 1686

Measurement SW: DASY52, Version 52.10 (2);SEMCAD X Version 14.6.12 (7450)

**Mode: UMTS 1900, Right Head, Cheek, Mid.ch**

**Area Scan (9x15x1):** Measurement grid: dx=15mm, dy=15mm

**Zoom Scan (5x5x7)/Cube 0:** Measurement grid: dx=8mm, dy=8mm, dz=5mm

Reference Value = 10.14 V/m; Power Drift = 0.08 dB

Peak SAR (extrapolated) = 0.230 W/kg

**SAR(1 g) = 0.138 W/kg**

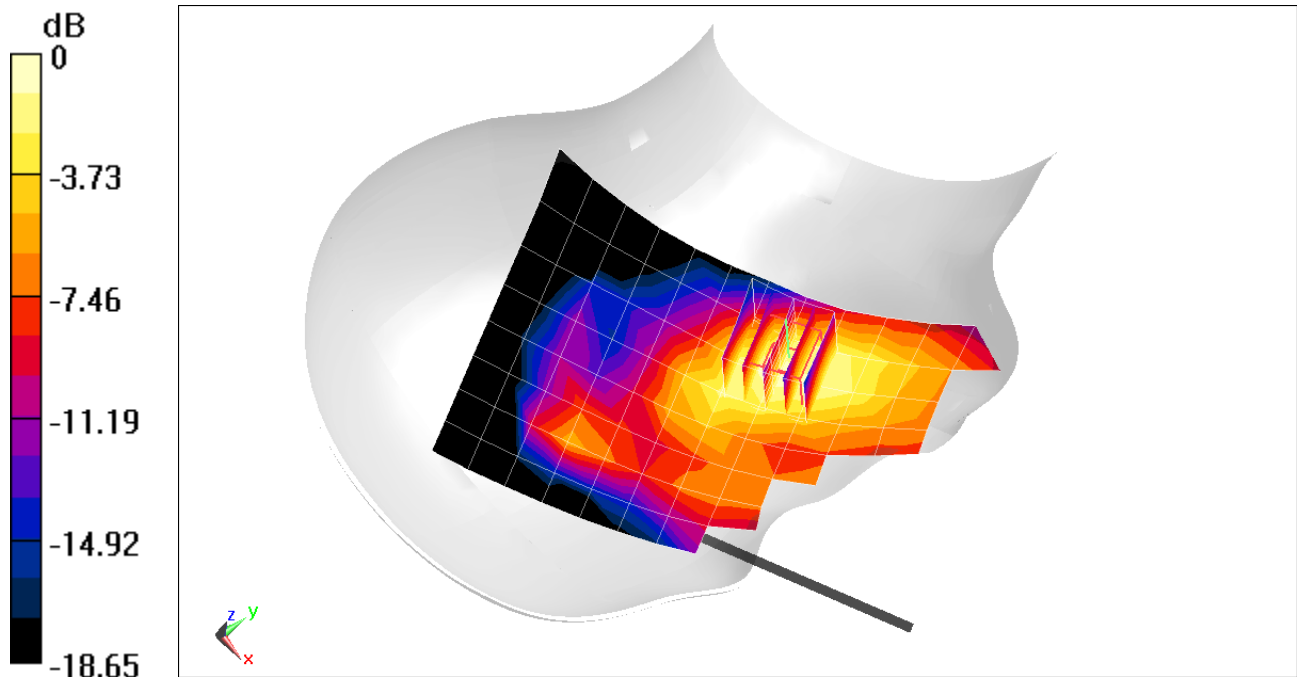

0 dB = 0.184 W/kg = -7.35 dBW/kg

# PCTEST ENGINEERING LABORATORY, INC.

**DUT: ZNFQ720AM; Type: Portable Handset; Serial: 06837**

Communication System: UID 0, LTE Band 12; Frequency: 707.5 MHz; Duty Cycle: 1:1  
Medium: 750 Head; Medium parameters used (interpolated):  
 $f = 707.5 \text{ MHz}$ ;  $\sigma = 0.866 \text{ S/m}$ ;  $\epsilon_r = 41.156$ ;  $\rho = 1000 \text{ kg/m}^3$   
Phantom section: Right Section

Test Date: 07-10-2019; Ambient Temp: 22.5°C; Tissue Temp: 21.3°C

Probe: EX3DV4 - SN3589; ConvF(8.67, 8.67, 8.67) @ 707.5 MHz; Calibrated: 1/25/2019  
Sensor-Surface: 1.4mm (Mechanical Surface Detection)  
Electronics: DAE4 Sn1450; Calibrated: 8/22/2018  
Phantom: Twin-SAM V5.0 (30); Type: QD 000 P40 CD; Serial: 1647  
Measurement SW: DASY52, Version 52.10 (2); SEMCAD X Version 14.6.12 (7450)

**Mode: LTE Band 12, Right Head, Cheek, Mid.ch**  
**10 MHz Bandwidth, QPSK, 1 RB, 0 RB Offset**

**Area Scan (9x13x1):** Measurement grid: dx=15mm, dy=15mm

**Zoom Scan (6x5x7)/Cube 0:** Measurement grid: dx=8mm, dy=8mm, dz=5mm

Reference Value = 14.69 V/m; Power Drift = -0.19 dB

Peak SAR (extrapolated) = 0.213 W/kg

**SAR(1 g) = 0.168 W/kg**

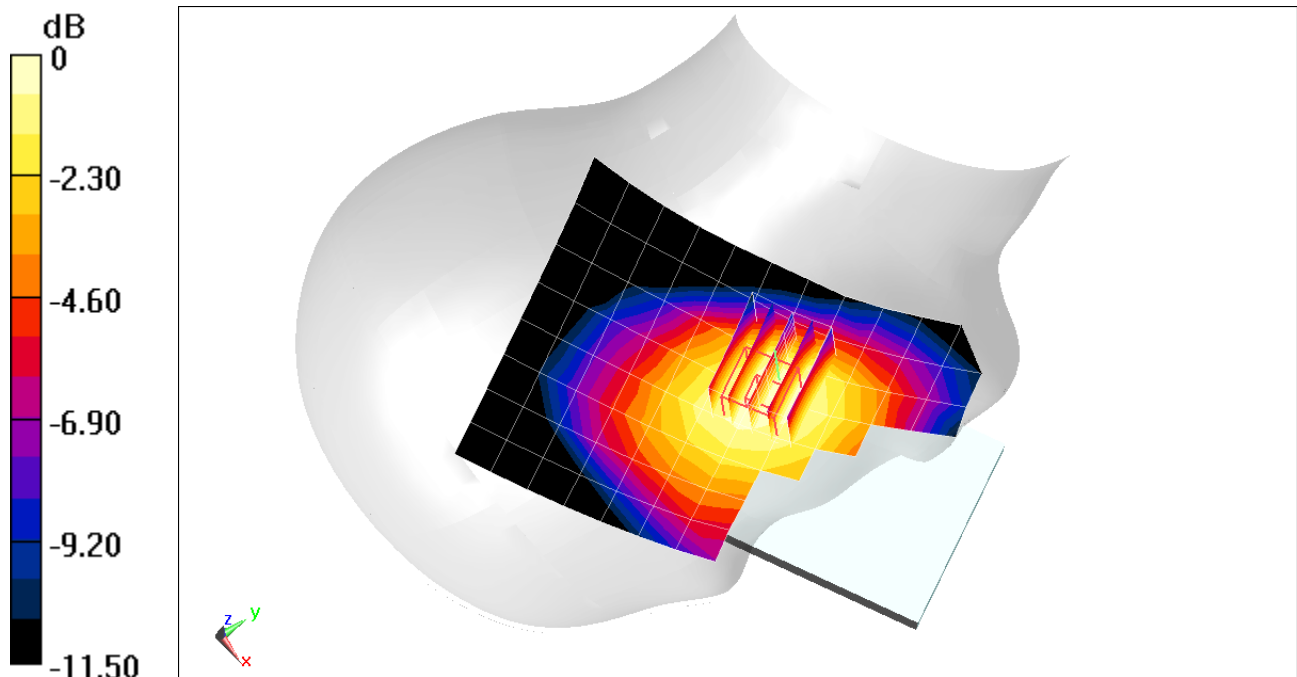

0 dB = 0.195 W/kg = -7.10 dBW/kg

# PCTEST ENGINEERING LABORATORY, INC.

**DUT: ZNFQ720AM; Type: Portable Handset; Serial: 06837**

Communication System: UID 0, LTE Band 14; Frequency: 793 MHz; Duty Cycle: 1:1  
Medium: 750 Head; Medium parameters used (interpolated):  
 $f = 793 \text{ MHz}$ ;  $\sigma = 0.896 \text{ S/m}$ ;  $\epsilon_r = 40.926$ ;  $\rho = 1000 \text{ kg/m}^3$   
Phantom section: Right Section

Test Date: 07-10-2019; Ambient Temp: 22.5°C; Tissue Temp: 21.3°C

Probe: EX3DV4 - SN3589; ConvF(8.67, 8.67, 8.67) @ 793 MHz; Calibrated: 1/25/2019  
Sensor-Surface: 1.4mm (Mechanical Surface Detection)  
Electronics: DAE4 Sn1450; Calibrated: 8/22/2018  
Phantom: Twin-SAM V5.0 (30); Type: QD 000 P40 CD; Serial: 1647  
Measurement SW: DASY52, Version 52.10 (2);SEMCAD X Version 14.6.12 (7450)

**Mode: LTE Band 14, Right Head, Cheek, Mid.ch**  
**10 MHz Bandwidth, QPSK, 1 RB, 0 RB Offset**

**Area Scan (9x13x1):** Measurement grid: dx=15mm, dy=15mm

**Zoom Scan (6x5x7)/Cube 0:** Measurement grid: dx=8mm, dy=8mm, dz=5mm

Reference Value = 16.00 V/m; Power Drift = 0.01 dB

Peak SAR (extrapolated) = 0.261 W/kg

**SAR(1 g) = 0.204 W/kg**

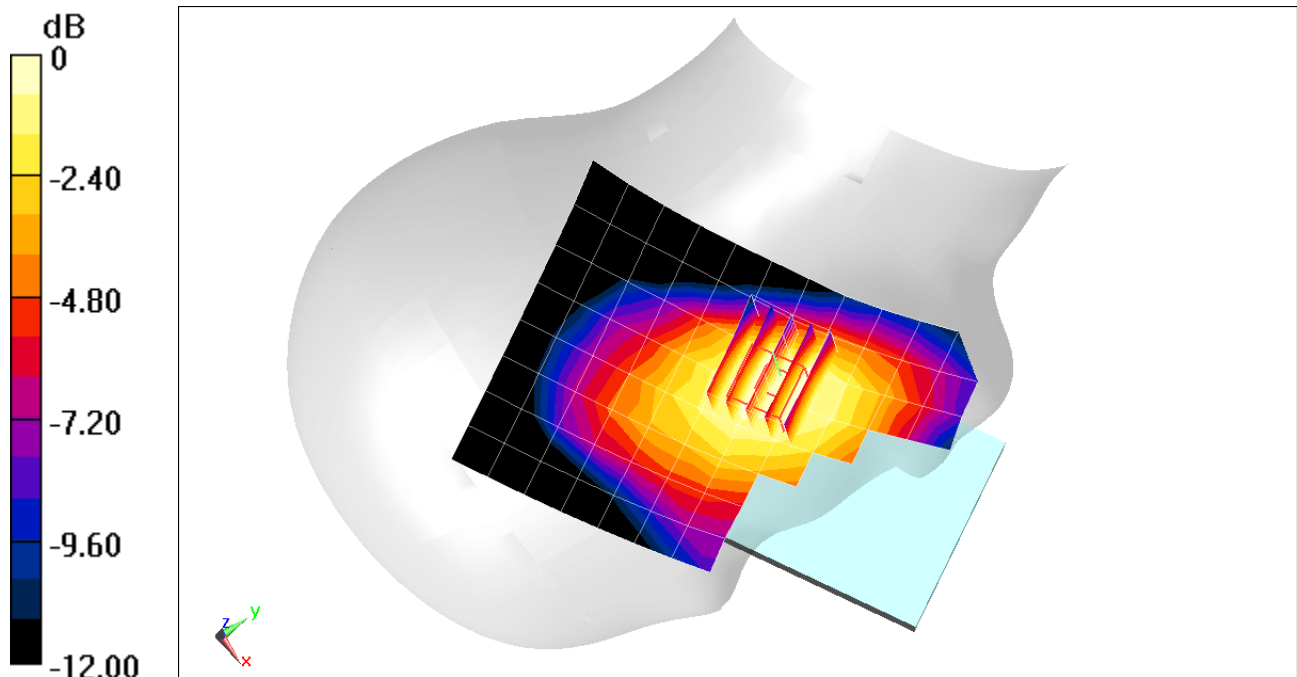

0 dB = 0.241 W/kg = -6.18 dBW/kg

# PCTEST ENGINEERING LABORATORY, INC.

**DUT: ZNFQ720AM; Type: Portable Handset; Serial: 06829**

Communication System: UID 0, LTE Band 5 (Cell.); Frequency: 836.5 MHz; Duty Cycle: 1:1  
Medium: 835 Head; Medium parameters used (interpolated):  
 $f = 836.5 \text{ MHz}$ ;  $\sigma = 0.917 \text{ S/m}$ ;  $\epsilon_r = 41.622$ ;  $\rho = 1000 \text{ kg/m}^3$   
Phantom section: Right Section

Test Date: 07-15-2019; Ambient Temp: 21.4°C; Tissue Temp: 20.7°C

Probe: EX3DV4 - SN3589; ConvF(8.39, 8.39, 8.39) @ 836.5 MHz; Calibrated: 1/25/2019  
Sensor-Surface: 1.4mm (Mechanical Surface Detection)  
Electronics: DAE4 Sn1450; Calibrated: 8/22/2018  
Phantom: Twin-SAM V5.0 (30); Type: QD 000 P40 CD; Serial: 1647  
Measurement SW: DASY52, Version 52.10 (2); SEMCAD X Version 14.6.12 (7450)

**Mode: LTE Band 5 (Cell.), Right Head, Cheek, Mid.ch**  
**10 MHz Bandwidth, QPSK, 1 RB, 49 RB Offset**

**Area Scan (9x15x1):** Measurement grid: dx=15mm, dy=15mm

**Zoom Scan (6x6x7)/Cube 0:** Measurement grid: dx=8mm, dy=8mm, dz=5mm

Reference Value = 15.42 V/m; Power Drift = -0.01 dB

Peak SAR (extrapolated) = 0.262 W/kg

**SAR(1 g) = 0.194 W/kg**

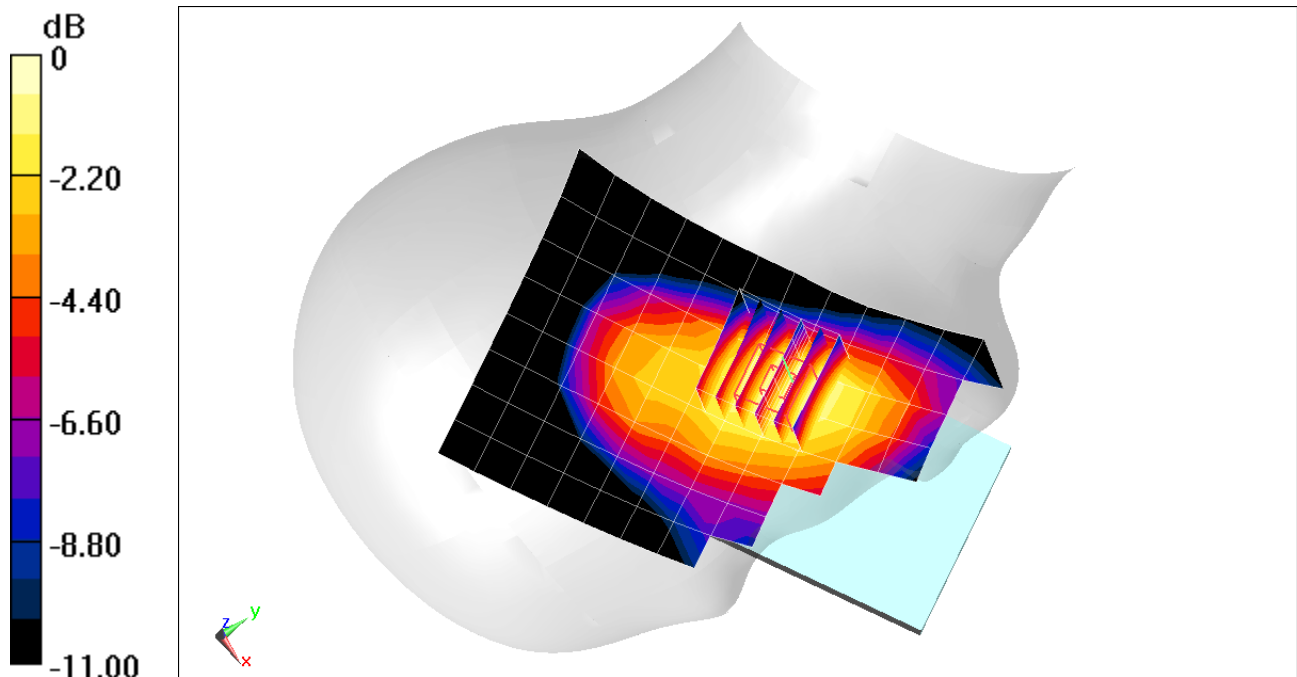

0 dB = 0.233 W/kg = -6.33 dBW/kg

# PCTEST ENGINEERING LABORATORY, INC.

**DUT: ZNFQ720AM; Type: Portable Handset; Serial: 06837**

Communication System: UID 0, LTE Band 66 (AWS); Frequency: 1770 MHz; Duty Cycle: 1:1  
Medium: 1750 Head; Medium parameters used (interpolated):  
 $f = 1770 \text{ MHz}$ ;  $\sigma = 1.365 \text{ S/m}$ ;  $\epsilon_r = 40.017$ ;  $\rho = 1000 \text{ kg/m}^3$   
Phantom section: Right Section

Test Date: 07-08-2019; Ambient Temp: 21.4°C; Tissue Temp: 21.0°C

Probe: EX3DV4 - SN3589; ConvF(7.31, 7.31, 7.31) @ 1770 MHz; Calibrated: 1/25/2019  
Sensor-Surface: 1.4mm (Mechanical Surface Detection)  
Electronics: DAE4 Sn1450; Calibrated: 8/22/2018  
Phantom: Twin-SAM V5.0 (30); Type: QD 000 P40 CD; Serial: 1647  
Measurement SW: DASY52, Version 52.10 (2);SEMCAD X Version 14.6.12 (7450)

**Mode: LTE Band 66 (AWS), Right Head, Cheek, High.ch**  
**20 MHz Bandwidth, QPSK, 1 RB, 50 RB Offset**

**Area Scan (9x15x1):** Measurement grid: dx=15mm, dy=15mm

**Zoom Scan (5x5x7)/Cube 0:** Measurement grid: dx=8mm, dy=8mm, dz=5mm

Reference Value = 9.315 V/m; Power Drift = 0.01 dB

Peak SAR (extrapolated) = 0.166 W/kg

**SAR(1 g) = 0.104 W/kg**

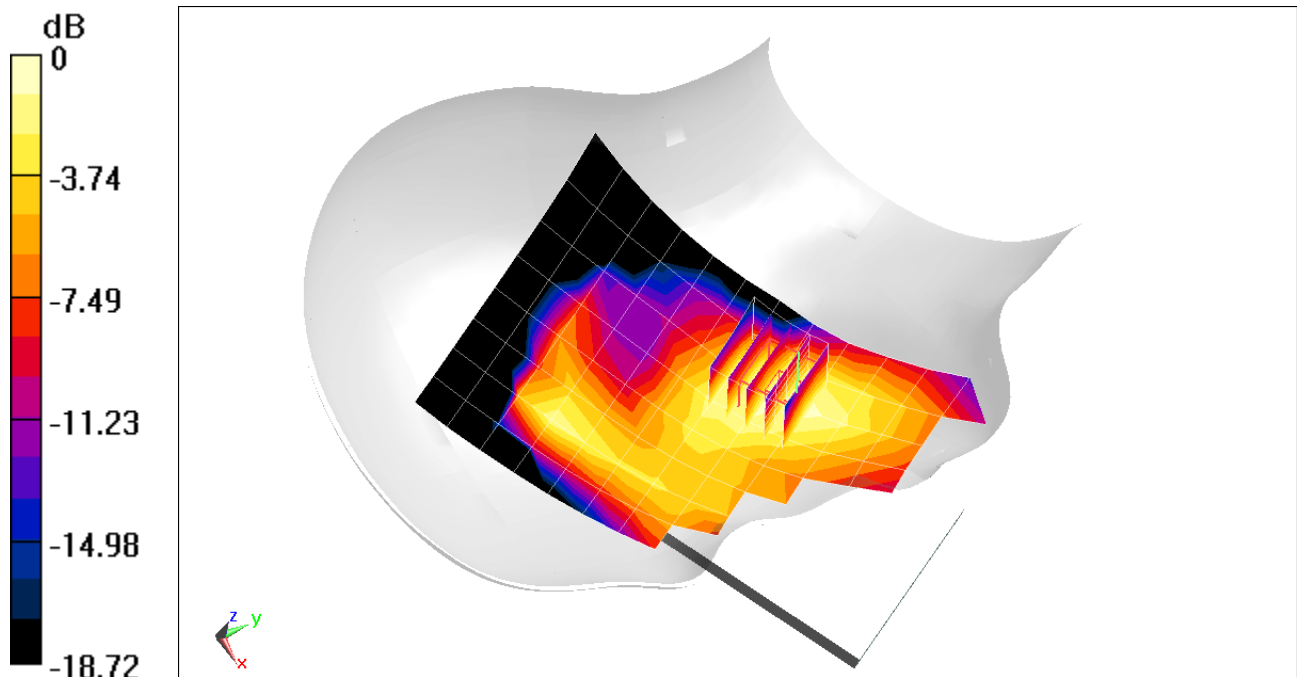

0 dB = 0.139 W/kg = -8.57 dBW/kg

# PCTEST ENGINEERING LABORATORY, INC.

**DUT: ZNFQ720AM; Type: Portable Handset; Serial: 06829**

Communication System: UID 0, \_LTE Band 2 (PCS); Frequency: 1860 MHz; Duty Cycle: 1:1  
Medium: 1900 Head; Medium parameters used (interpolated):  
 $f = 1860 \text{ MHz}$ ;  $\sigma = 1.431 \text{ S/m}$ ;  $\epsilon_r = 39.399$ ;  $\rho = 1000 \text{ kg/m}^3$   
Phantom section: Right Section

Test Date: 07-15-2019; Ambient Temp: 21.4°C; Tissue Temp: 20.7°C

Probe: EX3DV4 - SN3589; ConvF(7.08, 7.08, 7.08) @ 1860 MHz; Calibrated: 1/25/2019  
Sensor-Surface: 1.4mm (Mechanical Surface Detection)  
Electronics: DAE4 Sn1450; Calibrated: 8/22/2018  
Phantom: Twin-SAM V5.0 (30); Type: QD 000 P40 CD; Serial: 1647  
Measurement SW: DASY52, Version 52.10 (2);SEMCAD X Version 14.6.12 (7450)

**Mode: LTE Band 2 (PCS), Right Head, Cheek, Low.ch**  
**20 MHz Bandwidth, QPSK, 1 RB, 99 RB Offset**

**Area Scan (9x14x1):** Measurement grid: dx=15mm, dy=15mm

**Zoom Scan (5x5x7)/Cube 0:** Measurement grid: dx=8mm, dy=8mm, dz=5mm

Reference Value = 9.322 V/m; Power Drift = 0.11 dB

Peak SAR (extrapolated) = 0.170 W/kg

**SAR(1 g) = 0.106 W/kg**

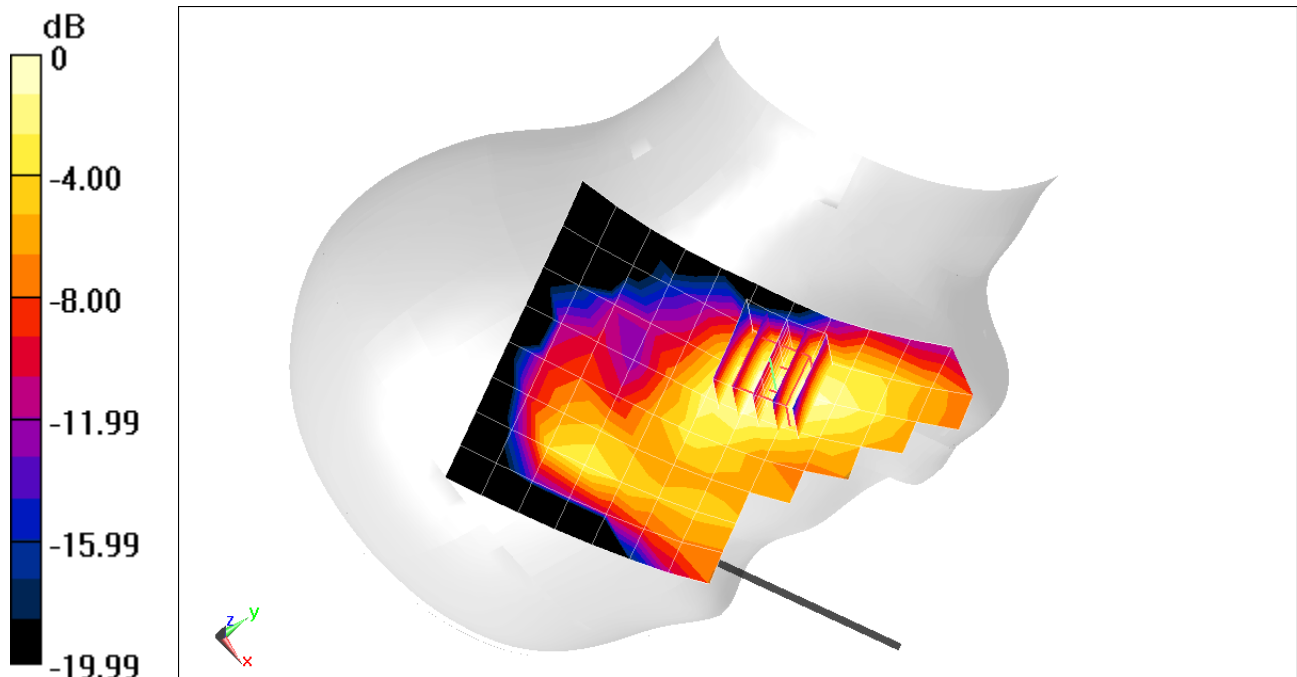

0 dB = 0.143 W/kg = -8.45 dBW/kg

# PCTEST ENGINEERING LABORATORY, INC.

**DUT: ZNFQ720AM; Type: Portable Handset; Serial: 06837**

Communication System: UID 0, LTE Band 30; Frequency: 2310 MHz; Duty Cycle: 1:1

Medium: 2300 Head; Medium parameters used:

$f = 2310 \text{ MHz}$ ;  $\sigma = 1.727 \text{ S/m}$ ;  $\epsilon_r = 38.606$ ;  $\rho = 1000 \text{ kg/m}^3$

Phantom section: Right Section

Test Date: 07-12-2019; Ambient Temp: 22.5°C; Tissue Temp: 21.1°C

Probe: EX3DV4 - SN3589; ConvF(6.77, 6.77, 6.77) @ 2310 MHz; Calibrated: 1/25/2019

Sensor-Surface: 1.4mm (Mechanical Surface Detection)

Electronics: DAE4 Sn1450; Calibrated: 8/22/2018

Phantom: Twin-SAM V5.0 (30); Type: QD 000 P40 CD; Serial: 1647

Measurement SW: DASY52, Version 52.10 (2);SEMCAD X Version 14.6.12 (7450)

**Mode: LTE Band 30, Right Head, Cheek, Mid.ch**  
**10 MHz Bandwidth, QPSK, 1 RB, 49 RB Offset**

**Area Scan (11x18x1):** Measurement grid: dx=12mm, dy=12mm

**Zoom Scan (8x7x7)/Cube 0:** Measurement grid: dx=5mm, dy=5mm, dz=5mm

Reference Value = 7.951 V/m; Power Drift = 0.10 dB

Peak SAR (extrapolated) = 0.169 W/kg

**SAR(1 g) = 0.092 W/kg**

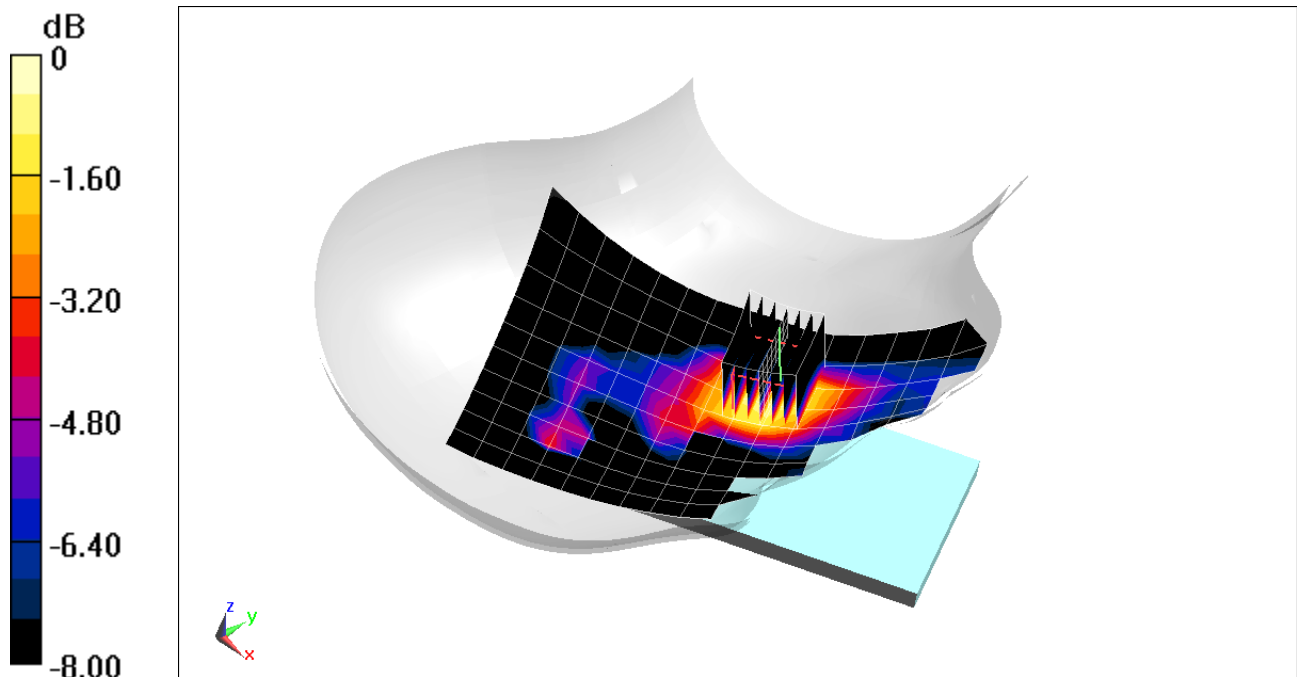

0 dB = 0.135 W/kg = -8.70 dBW/kg

# PCTEST ENGINEERING LABORATORY, INC.

**DUT: ZNFQ720AM; Type: Portable Handset; Serial: 06795**

Communication System: UID 0, \_IEEE 802.11b; Frequency: 2462 MHz; Duty Cycle: 1:1  
Medium: 2450 Head; Medium parameters used (interpolated):  
 $f = 2462 \text{ MHz}$ ;  $\sigma = 1.859 \text{ S/m}$ ;  $\epsilon_r = 38.474$ ;  $\rho = 1000 \text{ kg/m}^3$   
Phantom section: Right Section

Test Date: 07-15-2019; Ambient Temp: 21.4°C; Tissue Temp: 20.7°C

Probe: EX3DV4 - SN3589; ConvF(6.46, 6.46, 6.46) @ 2462 MHz; Calibrated: 1/25/2019  
Sensor-Surface: 1.4mm (Mechanical Surface Detection)  
Electronics: DAE4 Sn1450; Calibrated: 8/22/2018  
Phantom: Twin-SAM V5.0 (30); Type: QD 000 P40 CD; Serial: 1647  
Measurement SW: DASY52, Version 52.10 (2);SEMCAD X Version 14.6.12 (7450)

**Mode: IEEE 802.11b, 22 MHz Bandwidth, Right Head, Tilt, Ch 11, 1 Mbps**

**Area Scan (11x17x1):** Measurement grid: dx=12mm, dy=12mm

**Zoom Scan (7x7x7)/Cube 0:** Measurement grid: dx=5mm, dy=5mm, dz=5mm

Reference Value = 13.36 V/m; Power Drift = 0.00 dB

Peak SAR (extrapolated) = 2.08 W/kg

**SAR(1 g) = 0.843 W/kg**

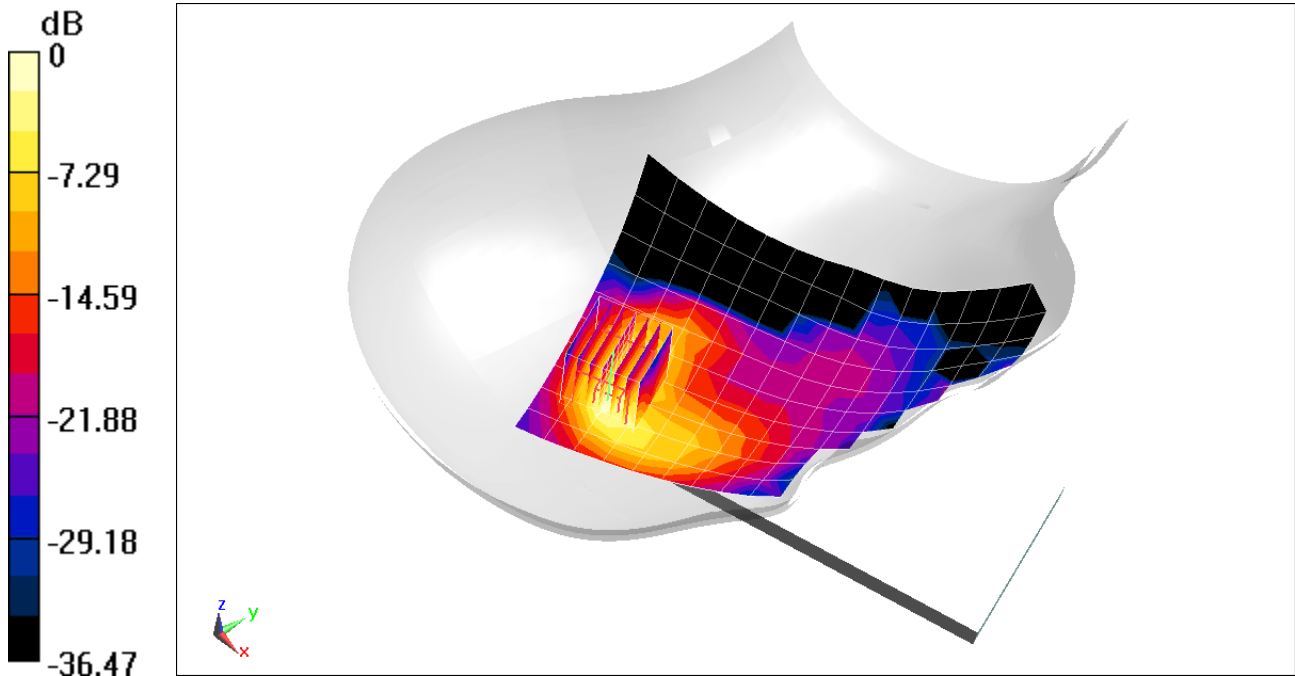

0 dB = 1.52 W/kg = 1.82 dBW/kg



# PCTEST ENGINEERING LABORATORY, INC.

**DUT: ZNFQ720AM; Type: Portable Handset; Serial: 06795**

Communication System: UID 0, 802.11a 5.2-5.8 GHz Band; Frequency: 5765 MHz; Duty Cycle: 1:1

Medium: 5HGzHead; Medium parameters used:

$f = 5765 \text{ MHz}$ ;  $\sigma = 5.133 \text{ S/m}$ ;  $\epsilon_r = 34.179$ ;  $\rho = 1000 \text{ kg/m}^3$

Phantom section: Right Section;

Test Date: 07-19-2019; Ambient Temp: 23.4°C; Tissue Temp: 22.3°C

Probe: EX3DV4 - SN7406; ConvF(5.23, 5.23, 5.23) @ 5765 MHz; Calibrated: 5/16/2019

Sensor-Surface: 1.4mm (Mechanical Surface Detection)

Electronics: DAE4 Sn859; Calibrated: 5/8/2019

Phantom: Twin-SAM V5.0 Right 20; Type: QD 000 P40 CD; Serial: 1759

Measurement SW: DASY52, Version 52.10 (2);SEMCAD X Version 14.6.12 (7450)

**Mode: IEEE 802.11a, U-NII-3, 20 MHz Bandwidth, Right Head, Cheek, Ch 153, 6 Mbps**

**Area Scan (13x21x1):** Measurement grid: dx=10mm, dy=10mm

**Zoom Scan (7x7x7)/Cube 0:** Measurement grid: dx=4mm, dy=4mm, dz=1.4mm; Graded Ratio: 1.4

Reference Value = 1.901 V/m; Power Drift = 0.13 dB

Peak SAR (extrapolated) = 3.50 W/kg

**SAR(1 g) = 0.635 W/kg**

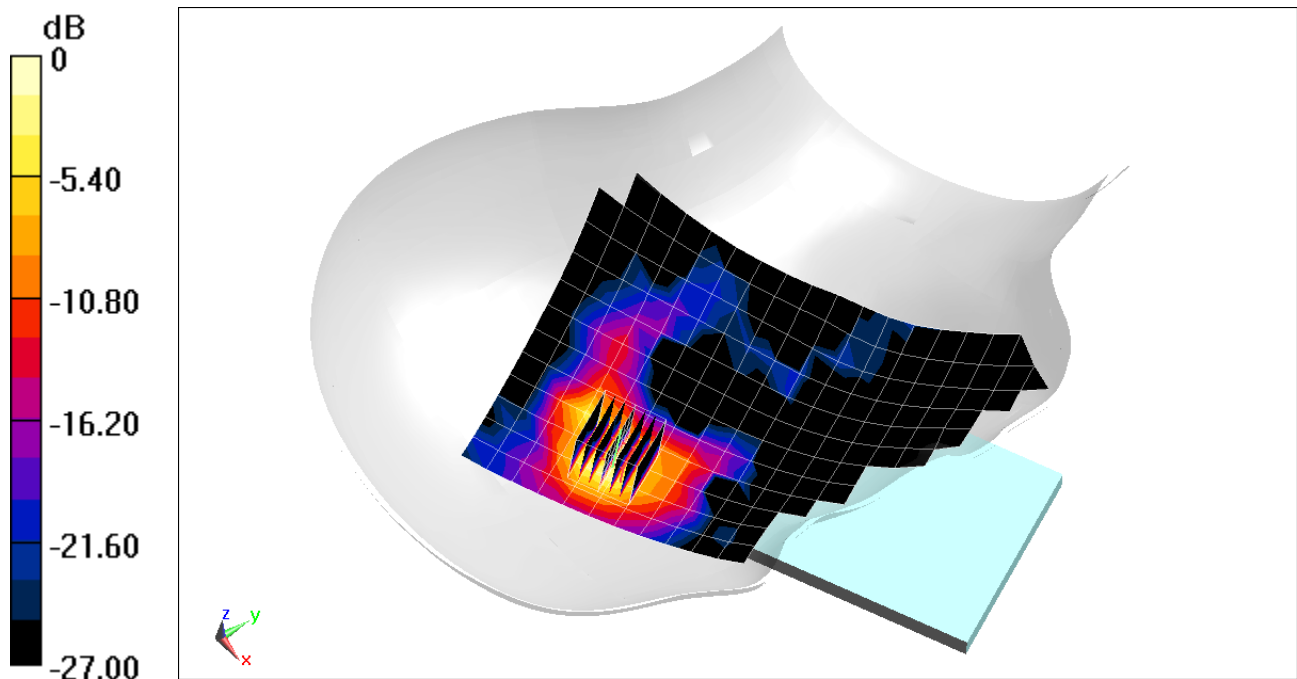

0 dB = 1.89 W/kg = 2.76 dBW/kg

# PCTEST ENGINEERING LABORATORY, INC.

**DUT: ZNFQ720AM; Type: Portable Handset; Serial: 06795**

Communication System: UID 0, Bluetooth; Frequency: 2441 MHz; Duty Cycle: 1:1.297

Medium: 835 to 2450 Head; Medium parameters used (interpolated):

$f = 2441$  MHz;  $\sigma = 1.842$  S/m;  $\epsilon_r = 38.509$ ;  $\rho = 1000$  kg/m<sup>3</sup>

Phantom section: Right Section

Test Date: 07-15-2019; Ambient Temp: 21.4°C; Tissue Temp: 20.7°C

Probe: EX3DV4 - SN3589; ConvF(6.46, 6.46, 6.46) @ 2441 MHz; Calibrated: 1/25/2019

Sensor-Surface: 1.4mm (Mechanical Surface Detection)

Electronics: DAE4 Sn1450; Calibrated: 8/22/2018

Phantom: Twin-SAM V5.0 (30); Type: QD 000 P40 CD; Serial: 1647

Measurement SW: DASY52, Version 52.10 (2);SEMCAD X Version 14.6.12 (7450)

**Mode: Bluetooth, Right Head, Cheek, Ch 39, 1Mbps**

**Area Scan (11x19x1):** Measurement grid: dx=12mm, dy=12mm

**Zoom Scan (7x7x7)/Cube 0:** Measurement grid: dx=5mm, dy=5mm, dz=5mm

Reference Value = 7.678 V/m; Power Drift = 0.12 dB

Peak SAR (extrapolated) = 0.206 W/kg

**SAR(1 g) = 0.084 W/kg**

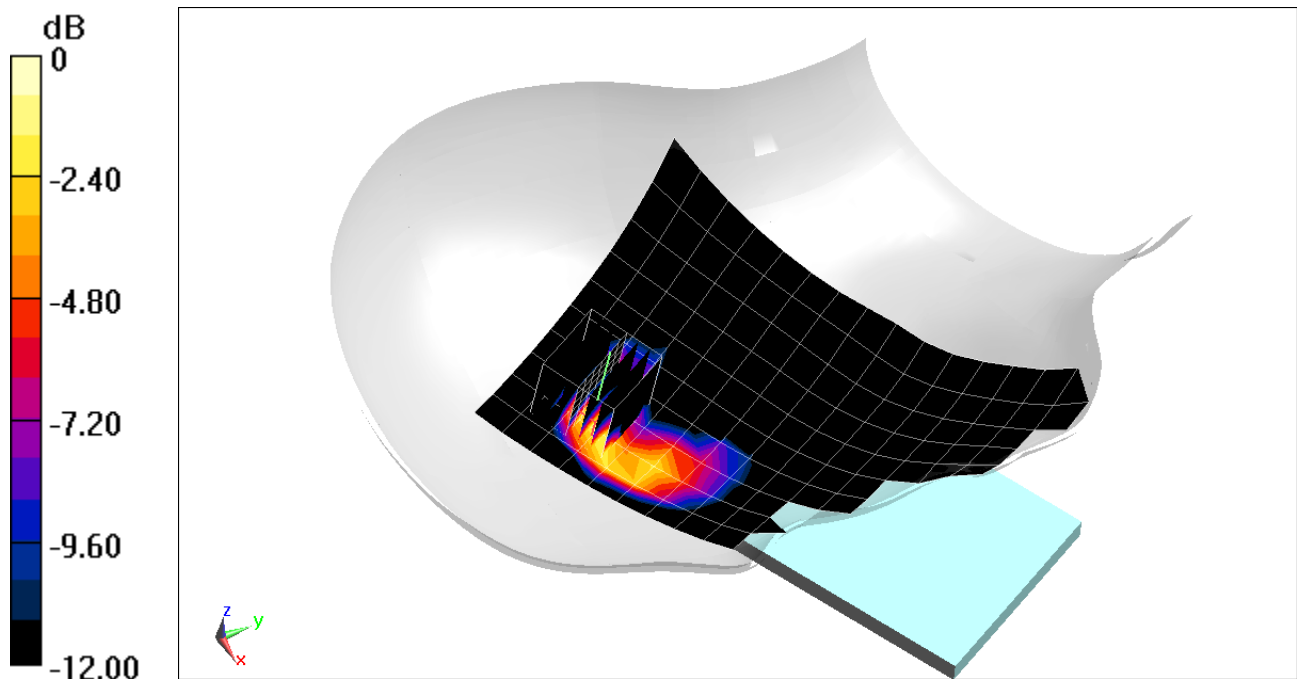

0 dB = 0.156 W/kg = -8.07 dBW/kg

# PCTEST ENGINEERING LABORATORY, INC.

**DUT: ZNFQ720AM; Type: Portable Handset; Serial: 06811**

Communication System: UID 0, GSM GPRS; 2 Tx slots; Frequency: 836.6 MHz; Duty Cycle: 1:4.15  
Medium: 835 Body; Medium parameters used (interpolated):  
 $f = 836.6 \text{ MHz}$ ;  $\sigma = 0.965 \text{ S/m}$ ;  $\epsilon_r = 53.914$ ;  $\rho = 1000 \text{ kg/m}^3$   
Phantom section: Flat Section; Space: 1.0 cm

Test Date: 07-16-2019; Ambient Temp: 20.3°C; Tissue Temp: 20.4°C

Probe: EX3DV4 - SN7538; ConvF(9.85, 9.85, 9.85) @ 836.6 MHz; Calibrated: 5/16/2019  
Sensor-Surface: 1.4mm (Mechanical Surface Detection)  
Electronics: DAE4 Sn728; Calibrated: 5/8/2019  
Phantom: Left Twin-SAM V5.0 30; Type: QD 000 P40 CD; Serial: 1792  
Measurement SW: DASY52, Version 52.10 (2);SEMCAD X Version 14.6.12 (7450)

**Mode: GPRS 850, Body SAR, Back side, Mid.ch, 2 Tx Slots**

**Area Scan (9x15x1):** Measurement grid: dx=15mm, dy=15mm  
**Zoom Scan (5x5x7)/Cube 0:** Measurement grid: dx=8mm, dy=8mm, dz=5mm  
Reference Value = 26.40 V/m; Power Drift = 0.02 dB  
Peak SAR (extrapolated) = 1.15 W/kg  
**SAR(1 g) = 0.639 W/kg**

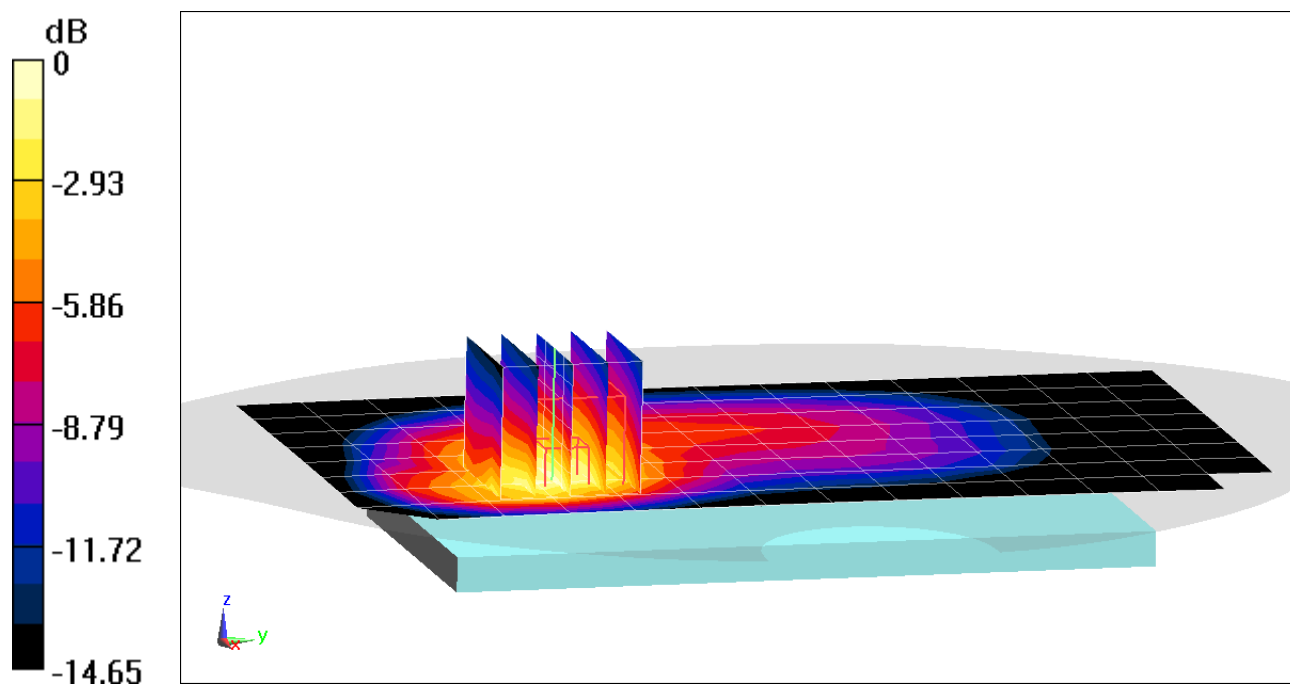

0 dB = 0.951 W/kg = -0.22 dBW/kg

# PCTEST ENGINEERING LABORATORY, INC.

**DUT: ZNFQ720AM; Type: Portable Handset; Serial: 06811**

Communication System: UID 0, GSM GPRS; 2 Tx slots; Frequency: 1880 MHz; Duty Cycle: 1:4.15

Medium: 1900 Body; Medium parameters used:

$f = 1880 \text{ MHz}$ ;  $\sigma = 1.536 \text{ S/m}$ ;  $\epsilon_r = 52.441$ ;  $\rho = 1000 \text{ kg/m}^3$

Phantom section: Flat Section; Space: 1.0 cm

Test Date: 07-15-2019; Ambient Temp: 19.6°C; Tissue Temp: 20.6°C

Probe: EX3DV4 - SN7357; ConvF(7.93, 7.93, 7.93) @ 1880 MHz; Calibrated: 4/24/2019

Sensor-Surface: 1.4mm (Mechanical Surface Detection)

Electronics: DAE4 Sn1407; Calibrated: 4/18/2019

Phantom: Twin-SAM V4.0 Front Right; Type: QD 000 P40 CC; Serial: 1167

Measurement SW: DASY52, Version 52.10 (2);SEMCAD X Version 14.6.12 (7450)

**Mode: GRPS 1900, Body SAR, Back side, Mid.ch, 2 Tx Slots**

**Area Scan (9x15x1):** Measurement grid: dx=15mm, dy=15mm

**Zoom Scan (6x6x7)/Cube 0:** Measurement grid: dx=8mm, dy=8mm, dz=5mm

Reference Value = 14.99 V/m; Power Drift = 0.01 dB

Peak SAR (extrapolated) = 0.561 W/kg

**SAR(1 g) = 0.325 W/kg**

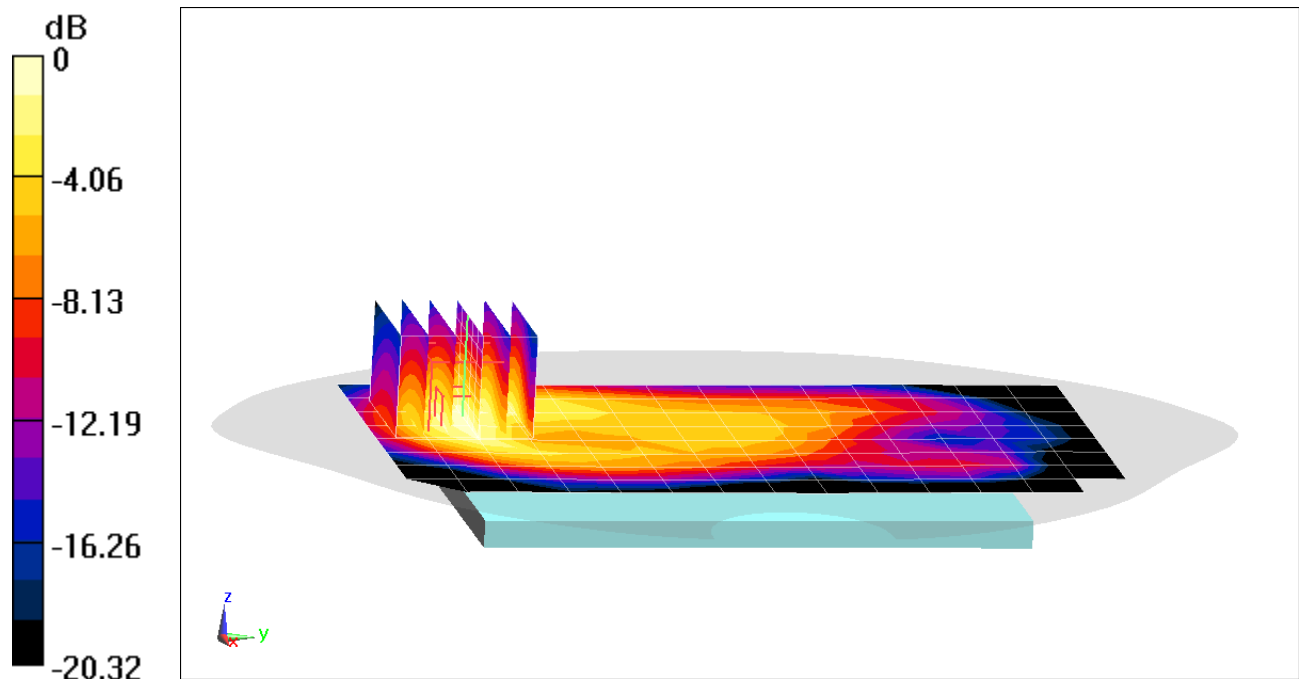

0 dB = 0.467 W/kg = -3.31 dBW/kg

# PCTEST ENGINEERING LABORATORY, INC.

**DUT: ZNFQ720AM; Type: Portable Handset; Serial: 06811**

Communication System: UID 0, GSM GPRS; 2 Tx slots; Frequency: 1909.8 MHz; Duty Cycle: 1:4.15

Medium: 1900 Body; Medium parameters used:

$f = 1910$  MHz;  $\sigma = 1.573$  S/m;  $\epsilon_r = 52.361$ ;  $\rho = 1000$  kg/m<sup>3</sup>

Phantom section: Flat Section; Space: 1.0 cm

Test Date: 07-15-2019; Ambient Temp: 19.6°C; Tissue Temp: 20.6°C

Probe: EX3DV4 - SN7357; ConvF(7.93, 7.93, 7.93) @ 1909.8 MHz; Calibrated: 4/24/2019

Sensor-Surface: 1.4mm (Mechanical Surface Detection)

Electronics: DAE4 Sn1407; Calibrated: 4/18/2019

Phantom: Twin-SAM V4.0 Front Right; Type: QD 000 P40 CC; Serial: 1167

Measurement SW: DASY52, Version 52.10 (2);SEMCAD X Version 14.6.12 (7450)

**Mode: GPRS 1900, Body SAR, Bottom Edge, High.ch, 2 Tx Slots**

**Area Scan (10x9x1):** Measurement grid: dx=5mm, dy=15mm

**Zoom Scan (5x5x7)/Cube 0:** Measurement grid: dx=8mm, dy=8mm, dz=5mm

Reference Value = 23.82 V/m; Power Drift = 0.03 dB

Peak SAR (extrapolated) = 1.44 W/kg

**SAR(1 g) = 0.812 W/kg**

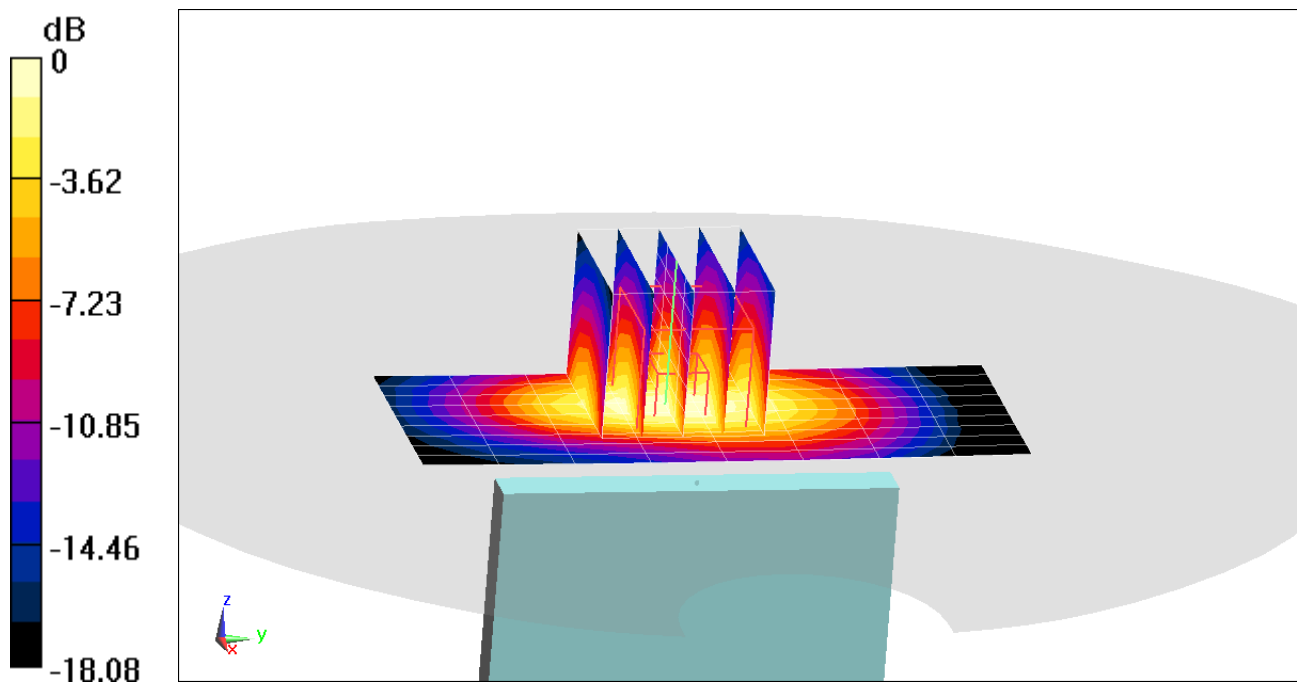

# PCTEST ENGINEERING LABORATORY, INC.

**DUT: ZNFQ720AM; Type: Portable Handset; Serial: 06811**

Communication System: UID 0, UMTS; Frequency: 836.6 MHz; Duty Cycle: 1:1  
Medium: 835 Body; Medium parameters used (interpolated):  
 $f = 836.6$  MHz;  $\sigma = 0.965$  S/m;  $\epsilon_r = 53.914$ ;  $\rho = 1000$  kg/m<sup>3</sup>  
Phantom section: Flat Section; Space: 1.0 cm

Test Date: 07-16-2019; Ambient Temp: 20.3°C; Tissue Temp: 20.4°C

Probe: EX3DV4 - SN7538; ConvF(9.85, 9.85, 9.85) @ 836.6 MHz; Calibrated: 5/16/2019  
Sensor-Surface: 1.4mm (Mechanical Surface Detection)  
Electronics: DAE4 Sn728; Calibrated: 5/8/2019  
Phantom: Left Twin-SAM V5.0 30; Type: QD 000 P40 CD; Serial: 1792  
Measurement SW: DASY52, Version 52.10 (2);SEMCAD X Version 14.6.12 (7450)

**Mode: UMTS 850, Body SAR, Back side, Mid.ch**

**Area Scan (9x15x1):** Measurement grid: dx=15mm, dy=15mm

**Zoom Scan (5x5x7)/Cube 0:** Measurement grid: dx=8mm, dy=8mm, dz=5mm

Reference Value = 24.57 V/m; Power Drift = -0.04 dB

Peak SAR (extrapolated) = 0.984 W/kg

**SAR(1 g) = 0.545 W/kg**

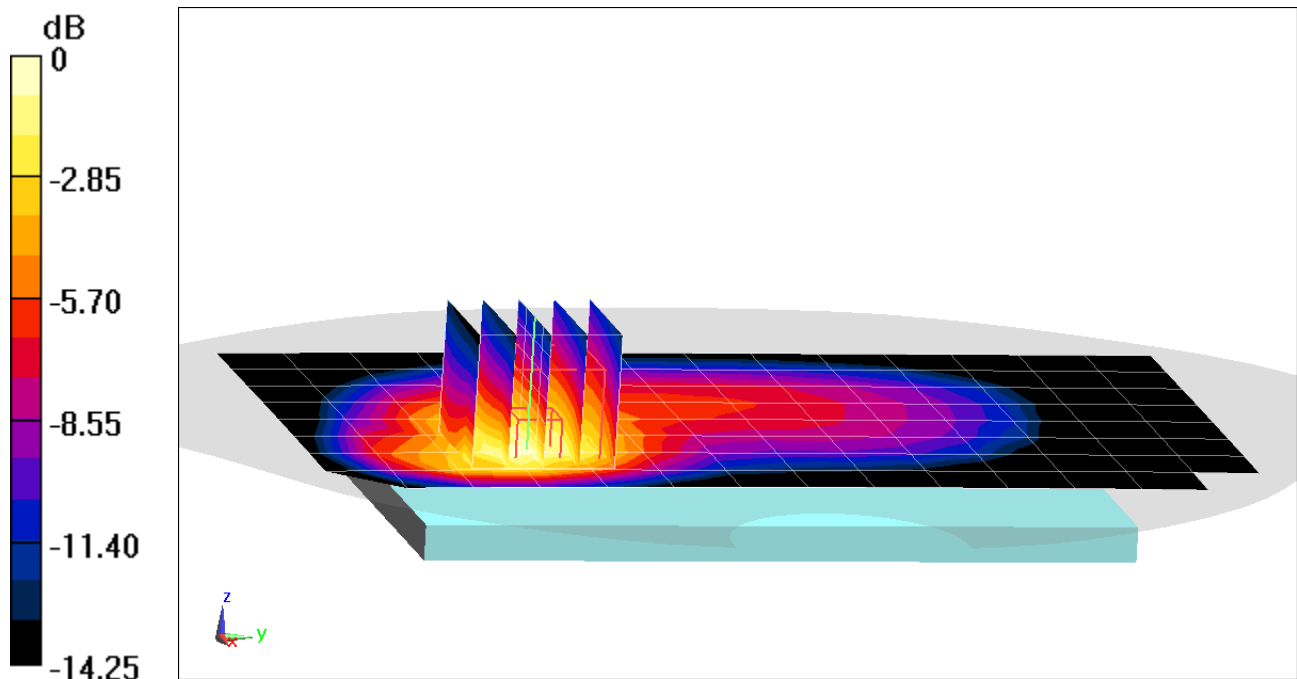

0 dB = 0.800 W/kg = -0.97 dBW/kg

# PCTEST ENGINEERING LABORATORY, INC.

**DUT: ZNFQ720AM; Type: Portable Handset; Serial: 06811**

Communication System: UID 0, UMTS; Frequency: 1732.4 MHz; Duty Cycle: 1:1  
Medium: 1750 Body; Medium parameters used (interpolated):  
 $f = 1732.4 \text{ MHz}$ ;  $\sigma = 1.452 \text{ S/m}$ ;  $\epsilon_r = 53.995$ ;  $\rho = 1000 \text{ kg/m}^3$   
Phantom section: Flat Section; Space: 1.0 cm

Test Date: 07-17-2019; Ambient Temp: 22.6°C; Tissue Temp: 21.9°C

Probe: EX3DV4 - SN7409; ConvF(7.85, 7.85, 7.85) @ 1732.4 MHz; Calibrated: 6/19/2019  
Sensor-Surface: 1.4mm (Mechanical Surface Detection)  
Electronics: DAE4 Sn1334; Calibrated: 6/20/2019  
Phantom: SAM Left; Type: QD000P40CA; Serial: TP:82355  
Measurement SW: DASY52, Version 52.10 (2);SEMCAD X Version 14.6.12 (7450)

**Mode: UMTS 1750, Body SAR, Back side, Mid.ch**

**Area Scan (9x15x1):** Measurement grid: dx=15mm, dy=15mm

**Zoom Scan (5x5x7)/Cube 0:** Measurement grid: dx=8mm, dy=8mm, dz=5mm

Reference Value = 20.40 V/m; Power Drift = -0.05 dB

Peak SAR (extrapolated) = 0.968 W/kg

**SAR(1 g) = 0.555 W/kg**

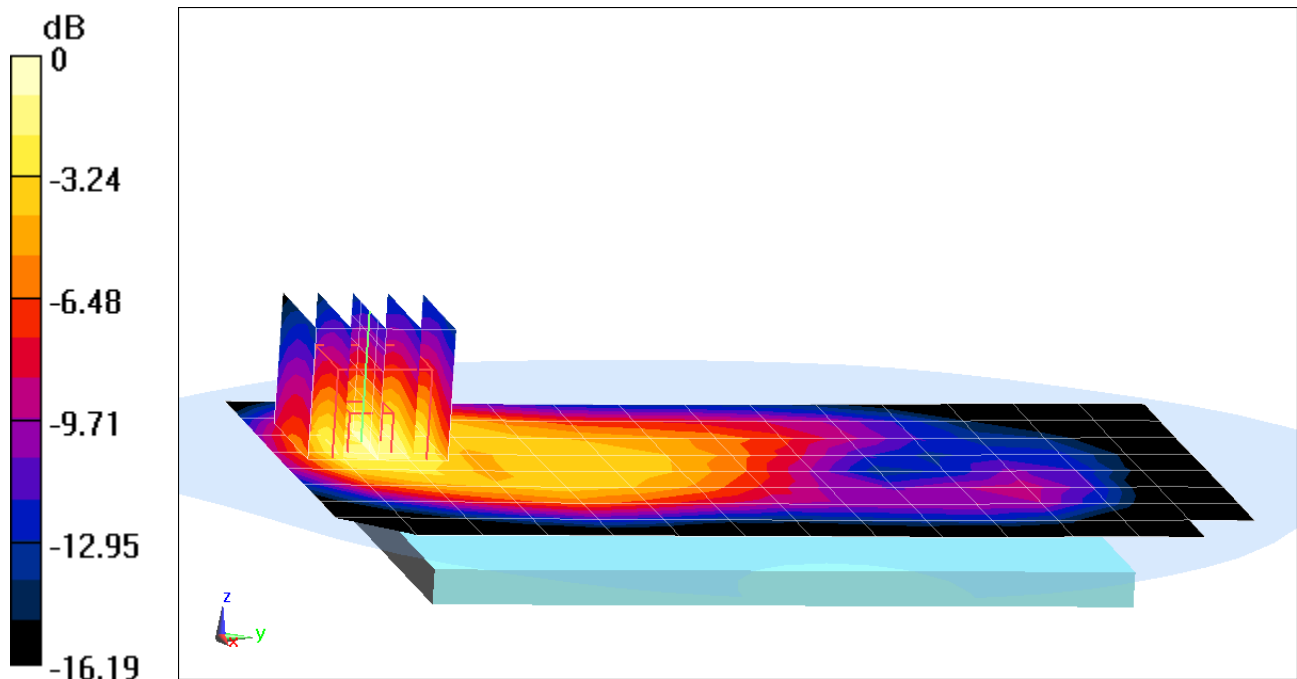

0 dB = 0.817 W/kg = -0.88 dBW/kg

# PCTEST ENGINEERING LABORATORY, INC.

**DUT: ZNFQ720AM; Type: Portable Handset; Serial: 06811**

Communication System: UID 0, \_UMTS; Frequency: 1752.6 MHz; Duty Cycle: 1:1  
Medium: 1750 Body; Medium parameters used (interpolated):  
 $f = 1752.6 \text{ MHz}$ ;  $\sigma = 1.466 \text{ S/m}$ ;  $\epsilon_r = 53.965$ ;  $\rho = 1000 \text{ kg/m}^3$   
Phantom section: Flat Section; Space: 1.0 cm

Test Date: 07-17-2019; Ambient Temp: 22.6°C; Tissue Temp: 21.9°C

Probe: EX3DV4 - SN7409; ConvF(7.85, 7.85, 7.85) @ 1752.6 MHz; Calibrated: 6/19/2019  
Sensor-Surface: 1.4mm (Mechanical Surface Detection)  
Electronics: DAE4 Sn1334; Calibrated: 6/20/2019  
Phantom: SAM Left; Type: QD000P40CA; Serial: TP:82355  
Measurement SW: DASY52, Version 52.10 (2);SEMCAD X Version 14.6.12 (7450)

**Mode: UMTS 1750, Body SAR, Bottom Edge, High.ch**

**Area Scan (10x7x1):** Measurement grid: dx=5mm, dy=15mm

**Zoom Scan (5x5x7)/Cube 0:** Measurement grid: dx=8mm, dy=8mm, dz=5mm

Reference Value = 26.33 V/m; Power Drift = 0.00 dB

Peak SAR (extrapolated) = 1.67 W/kg

**SAR(1 g) = 0.939 W/kg**

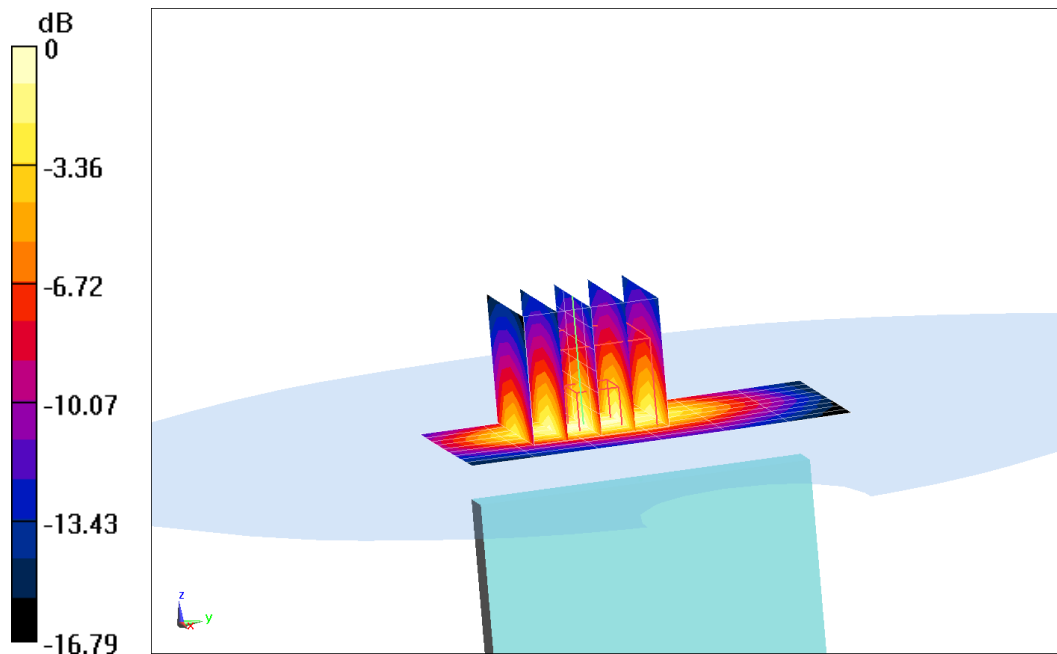

0 dB = 1.40 W/kg = 1.46 dBW/kg



# PCTEST ENGINEERING LABORATORY, INC.

**DUT: ZNFQ720AM; Type: Portable Handset; Serial: 06811**

Communication System: UID 0, UMTS; Frequency: 1880 MHz; Duty Cycle: 1:1

Medium: 1900 Body; Medium parameters used:

$f = 1880 \text{ MHz}$ ;  $\sigma = 1.536 \text{ S/m}$ ;  $\epsilon_r = 52.441$ ;  $\rho = 1000 \text{ kg/m}^3$

Phantom section: Flat Section; Space: 1.0 cm

Test Date: 07-15-2019; Ambient Temp: 19.6°C; Tissue Temp: 20.6°C

Probe: EX3DV4 - SN7357; ConvF(7.93, 7.93, 7.93) @ 1880 MHz; Calibrated: 4/24/2019

Sensor-Surface: 1.4mm (Mechanical Surface Detection)

Electronics: DAE4 Sn1407; Calibrated: 4/18/2019

Phantom: Twin-SAM V4.0 Front Right; Type: QD 000 P40 CC; Serial: 1167

Measurement SW: DASY52, Version 52.10 (2);SEMCAD X Version 14.6.12 (7450)

**Mode: UMTS 1900, Body SAR, Back side, Mid.ch**

**Area Scan (9x15x1):** Measurement grid: dx=15mm, dy=15mm

**Zoom Scan (6x6x7)/Cube 0:** Measurement grid: dx=8mm, dy=8mm, dz=5mm

Reference Value = 17.45 V/m; Power Drift = 0.01 dB

Peak SAR (extrapolated) = 0.781 W/kg

**SAR(1 g) = 0.450 W/kg**

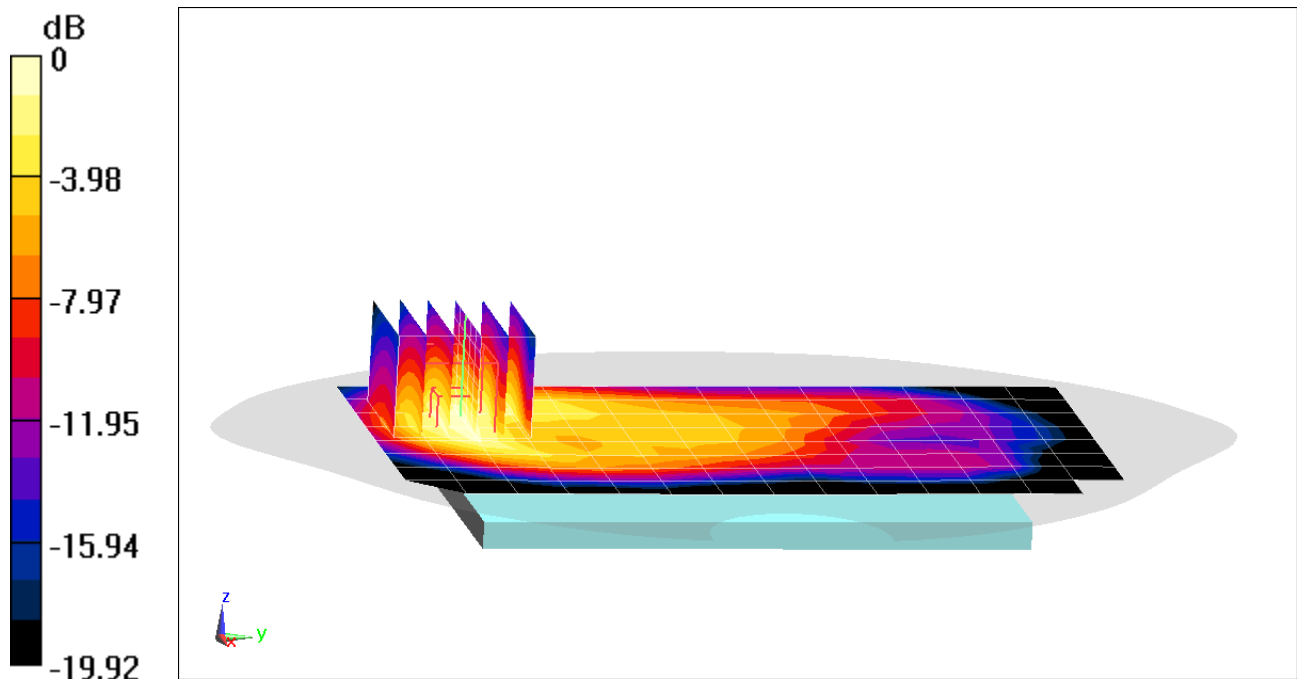

0 dB = 0.619 W/kg = -2.08 dBW/kg

# PCTEST ENGINEERING LABORATORY, INC.

**DUT: ZNFQ720AM; Type: Portable Handset; Serial: 06811**

Communication System: UID 0, UMTS; Frequency: 1907.6 MHz; Duty Cycle: 1:1  
Medium: 1900 Body; Medium parameters used (interpolated):  
 $f = 1907.6$  MHz;  $\sigma = 1.57$  S/m;  $\epsilon_r = 52.367$ ;  $\rho = 1000$  kg/m<sup>3</sup>  
Phantom section: Flat Section; Space: 1.0 cm

Test Date: 07-15-2019; Ambient Temp: 19.6°C; Tissue Temp: 20.6°C

Probe: EX3DV4 - SN7357; ConvF(7.93, 7.93, 7.93) @ 1907.6 MHz; Calibrated: 4/24/2019  
Sensor-Surface: 1.4mm (Mechanical Surface Detection)  
Electronics: DAE4 Sn1407; Calibrated: 4/18/2019  
Phantom: Twin-SAM V4.0 Front Right; Type: QD 000 P40 CC; Serial: 1167  
Measurement SW: DASY52, Version 52.10 (2);SEMCAD X Version 14.6.12 (7450)

**Mode: UMTS 1900, Body SAR, Bottom Edge, High.ch**

**Area Scan (10x9x1):** Measurement grid: dx=5mm, dy=15mm

**Zoom Scan (5x5x7)/Cube 0:** Measurement grid: dx=8mm, dy=8mm, dz=5mm

Reference Value = 26.06 V/m; Power Drift = -0.02 dB

Peak SAR (extrapolated) = 1.72 W/kg

**SAR(1 g) = 0.973 W/kg**

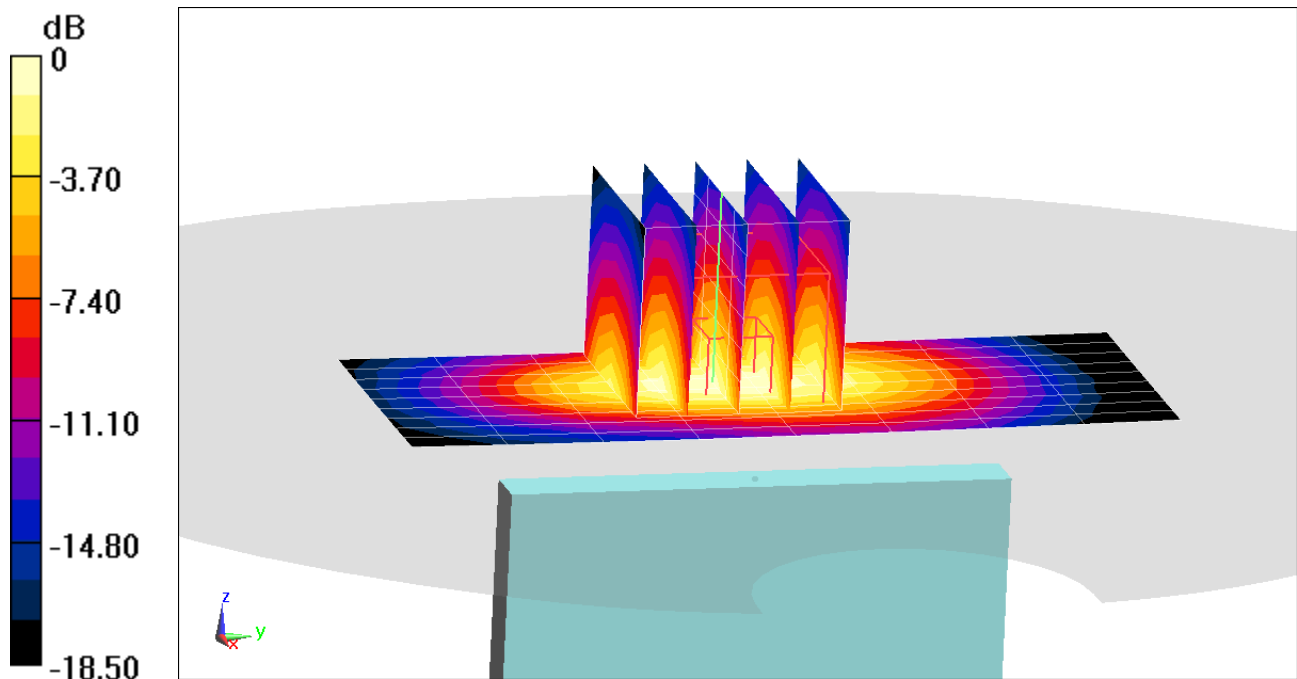

0 dB = 1.44 W/kg = 1.58 dBW/kg

# PCTEST ENGINEERING LABORATORY, INC.

**DUT: ZNFQ720AM; Type: Portable Handset; Serial: 06829**

Communication System: UID 0, LTE Band 12; Frequency: 707.5 MHz; Duty Cycle: 1:1  
Medium: 750 Body; Medium parameters used (interpolated):  
 $f = 707.5 \text{ MHz}$ ;  $\sigma = 0.928 \text{ S/m}$ ;  $\epsilon_r = 57.475$ ;  $\rho = 1000 \text{ kg/m}^3$   
Phantom section: Flat Section; Space: 1.0 cm

Test Date: 07-08-2019; Ambient Temp: 22.8°C; Tissue Temp: 22.1°C

Probe: EX3DV4 - SN3914; ConvF(9.73, 9.73, 9.73) @ 707.5 MHz; Calibrated: 2/19/2019  
Sensor-Surface: 1.4mm (Mechanical Surface Detection)  
Electronics: DAE4 Sn1272; Calibrated: 2/14/2019  
Phantom: Twin-SAM V5.0 Left 30; Type: QD 000 P40 CD; Serial: 1687  
Measurement SW: DASY52, Version 52.10 (2);SEMCAD X Version 14.6.12 (7450)

**Mode: LTE Band 12, Body SAR, Back side, Mid.ch**  
**10 MHz Bandwidth, QPSK, 1 RB, 0 RB Offset**

**Area Scan (9x15x1):** Measurement grid: dx=15mm, dy=15mm

**Zoom Scan (5x5x7)/Cube 0:** Measurement grid: dx=8mm, dy=8mm, dz=5mm

Reference Value = 24.32 V/m; Power Drift = 0.00 dB

Peak SAR (extrapolated) = 0.887 W/kg

**SAR(1 g) = 0.518 W/kg**

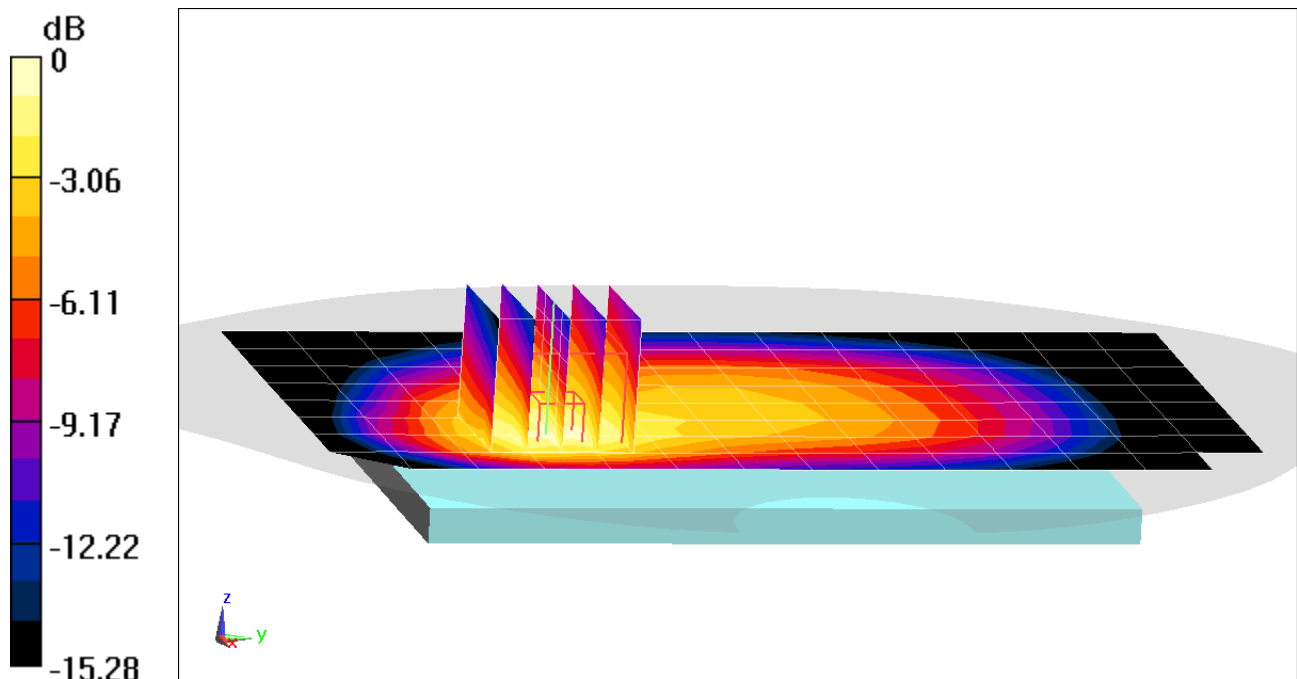

0 dB = 0.735 W/kg = -1.34 dBW/kg

# PCTEST ENGINEERING LABORATORY, INC.

**DUT: ZNFQ720AM; Type: Portable Handset; Serial: 06829**

Communication System: UID 0, LTE Band 14; Frequency: 793 MHz; Duty Cycle: 1:1  
Medium: 750 Body; Medium parameters used (interpolated):  
 $f = 793 \text{ MHz}$ ;  $\sigma = 0.958 \text{ S/m}$ ;  $\epsilon_r = 57.283$ ;  $\rho = 1000 \text{ kg/m}^3$   
Phantom section: Flat Section; Space: 1.0 cm

Test Date: 07-08-2019; Ambient Temp: 22.8°C; Tissue Temp: 22.1°C

Probe: EX3DV4 - SN3914; ConvF(9.73, 9.73, 9.73) @ 793 MHz; Calibrated: 2/19/2019  
Sensor-Surface: 1.4mm (Mechanical Surface Detection)  
Electronics: DAE4 Sn1272; Calibrated: 2/14/2019  
Phantom: Twin-SAM V5.0 Left 30; Type: QD 000 P40 CD; Serial: 1687  
Measurement SW: DASY52, Version 52.10 (2);SEMCAD X Version 14.6.12 (7450)

**Mode: LTE Band 14, Body SAR, Back side, Mid.ch**  
**10 MHz Bandwidth, QPSK, 1 RB, 0 RB Offset**

**Area Scan (9x13x1):** Measurement grid: dx=15mm, dy=15mm

**Zoom Scan (5x5x7)/Cube 0:** Measurement grid: dx=8mm, dy=8mm, dz=5mm

Reference Value = 26.64 V/m; Power Drift = -0.04 dB

Peak SAR (extrapolated) = 1.15 W/kg

**SAR(1 g) = 0.643 W/kg**

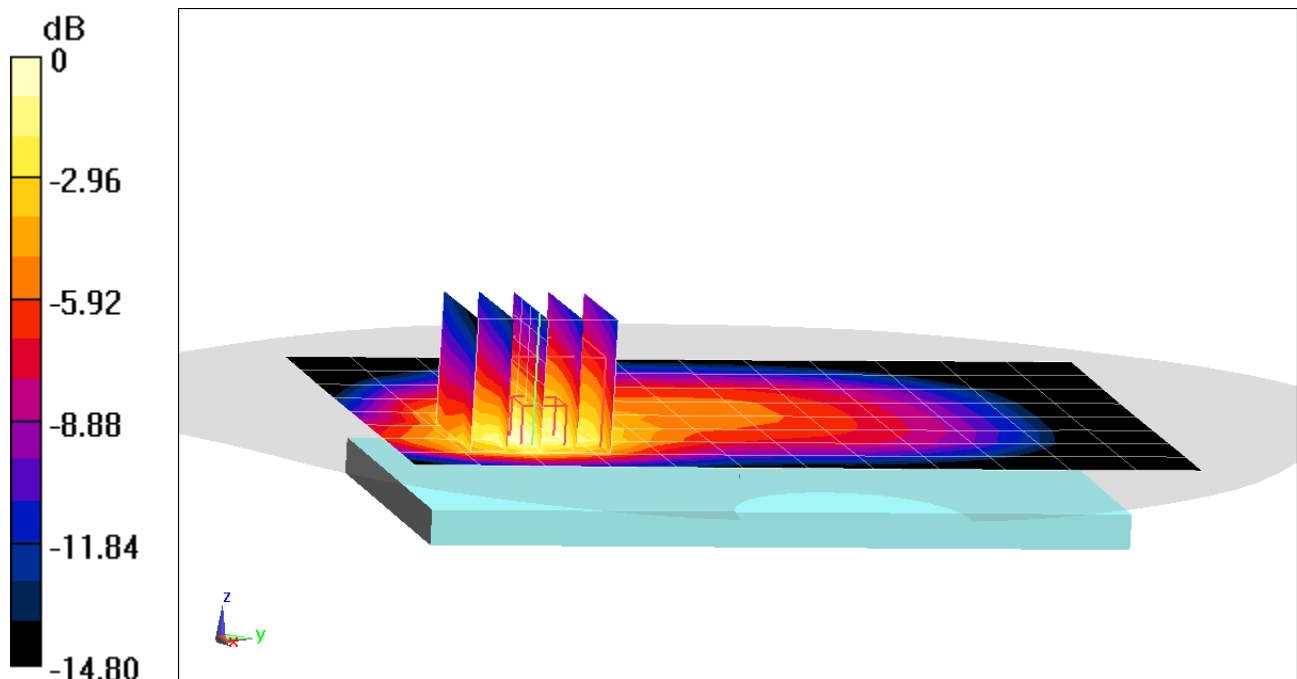

0 dB = 0.910 W/kg = -0.41 dBW/kg

# PCTEST ENGINEERING LABORATORY, INC.

**DUT: ZNFQ720AM; Type: Portable Handset; Serial: 06829**

Communication System: UID 0, LTE Band 5; Frequency: 836.5 MHz; Duty Cycle: 1:1  
Medium: 835 Body; Medium parameters used (interpolated):  
 $f = 836.5$  MHz;  $\sigma = 0.965$  S/m;  $\epsilon_r = 53.914$ ;  $\rho = 1000$  kg/m<sup>3</sup>  
Phantom section: Flat Section; Space: 1.0 cm

Test Date: 07-16-2019; Ambient Temp: 20.3°C; Tissue Temp: 20.4°C

Probe: EX3DV4 - SN7538; ConvF(9.85, 9.85, 9.85) @ 836.5 MHz; Calibrated: 5/16/2019  
Sensor-Surface: 1.4mm (Mechanical Surface Detection)  
Electronics: DAE4 Sn728; Calibrated: 5/8/2019  
Phantom: Left Twin-SAM V5.0 30; Type: QD 000 P40 CD; Serial: 1792  
Measurement SW: DASY52, Version 52.10 (2);SEMCAD X Version 14.6.12 (7450)

**Mode: LTE Band 5 (Cell.), Body SAR, Back side, Mid.ch**  
**10 MHz Bandwidth, QPSK, 1 RB, 49 RB Offset**

**Area Scan (9x15x1):** Measurement grid: dx=15mm, dy=15mm  
**Zoom Scan (6x6x7)/Cube 0:** Measurement grid: dx=8mm, dy=8mm, dz=5mm  
Reference Value = 24.55 V/m; Power Drift = -0.04 dB  
Peak SAR (extrapolated) = 0.963 W/kg  
**SAR(1 g) = 0.546 W/kg**

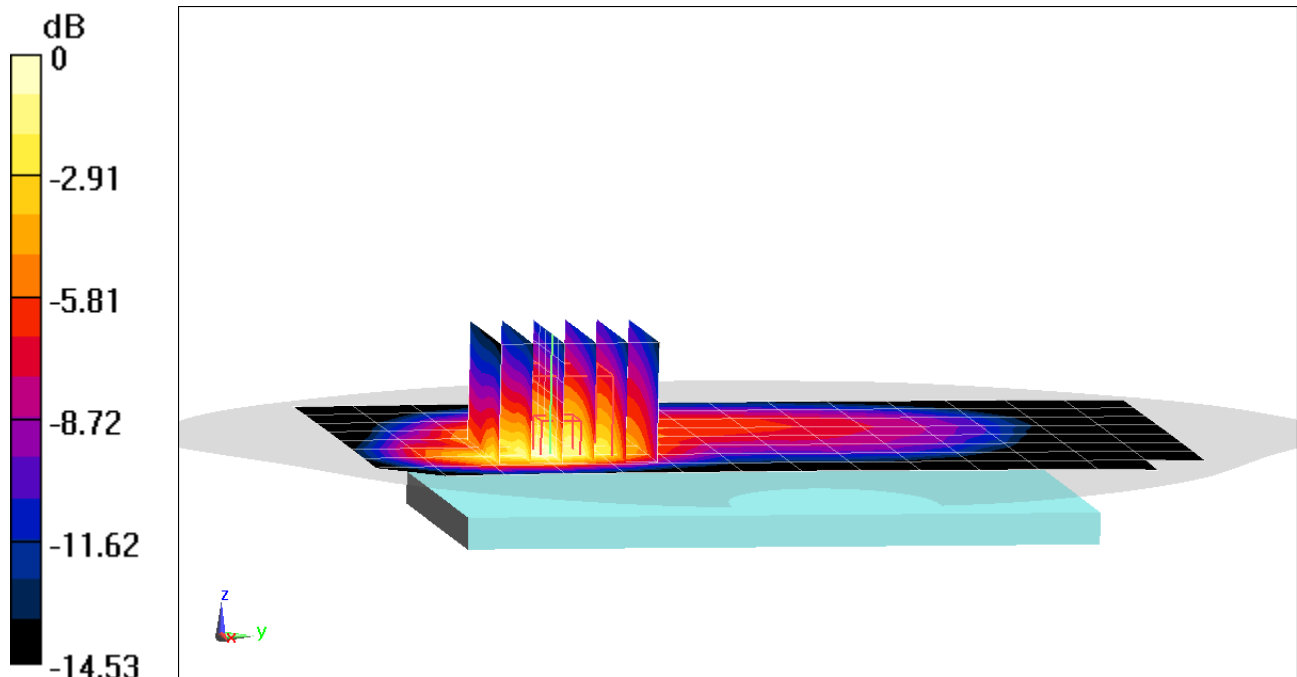

0 dB = 0.805 W/kg = -0.94 dBW/kg

# PCTEST ENGINEERING LABORATORY, INC.

**DUT: ZNFQ720AM; Type: Portable Handset; Serial: 06829**

Communication System: UID 0, LTE Band 5 (Cell.); Frequency: 836.5 MHz; Duty Cycle: 1:1  
Medium: 835 Body; Medium parameters used (interpolated):  
 $f = 836.5 \text{ MHz}$ ;  $\sigma = 0.965 \text{ S/m}$ ;  $\epsilon_r = 53.914$ ;  $\rho = 1000 \text{ kg/m}^3$   
Phantom section: Flat Section; Space: 1.0 cm

Test Date: 07-16-2019; Ambient Temp: 20.3°C; Tissue Temp: 20.4°C

Probe: EX3DV4 - SN7538; ConvF(9.85, 9.85, 9.85) @ 836.5 MHz; Calibrated: 5/16/2019  
Sensor-Surface: 1.4mm (Mechanical Surface Detection)  
Electronics: DAE4 Sn728; Calibrated: 5/8/2019  
Phantom: Left Twin-SAM V5.0 30; Type: QD 000 P40 CD; Serial: 1792  
Measurement SW: DASY52, Version 52.10 (2);SEMCAD X Version 14.6.12 (7450)

**Mode: LTE Band 5 (Cell.), Body SAR, Front side, Mid.ch**  
**10 MHz Bandwidth, QPSK, 1 RB, 49 RB Offset**

**Area Scan (9x15x1):** Measurement grid: dx=15mm, dy=15mm  
**Zoom Scan (6x5x7)/Cube 0:** Measurement grid: dx=8mm, dy=8mm, dz=5mm  
Reference Value = 25.39 V/m; Power Drift = -0.17 dB  
Peak SAR (extrapolated) = 0.891 W/kg  
**SAR(1 g) = 0.567 W/kg**

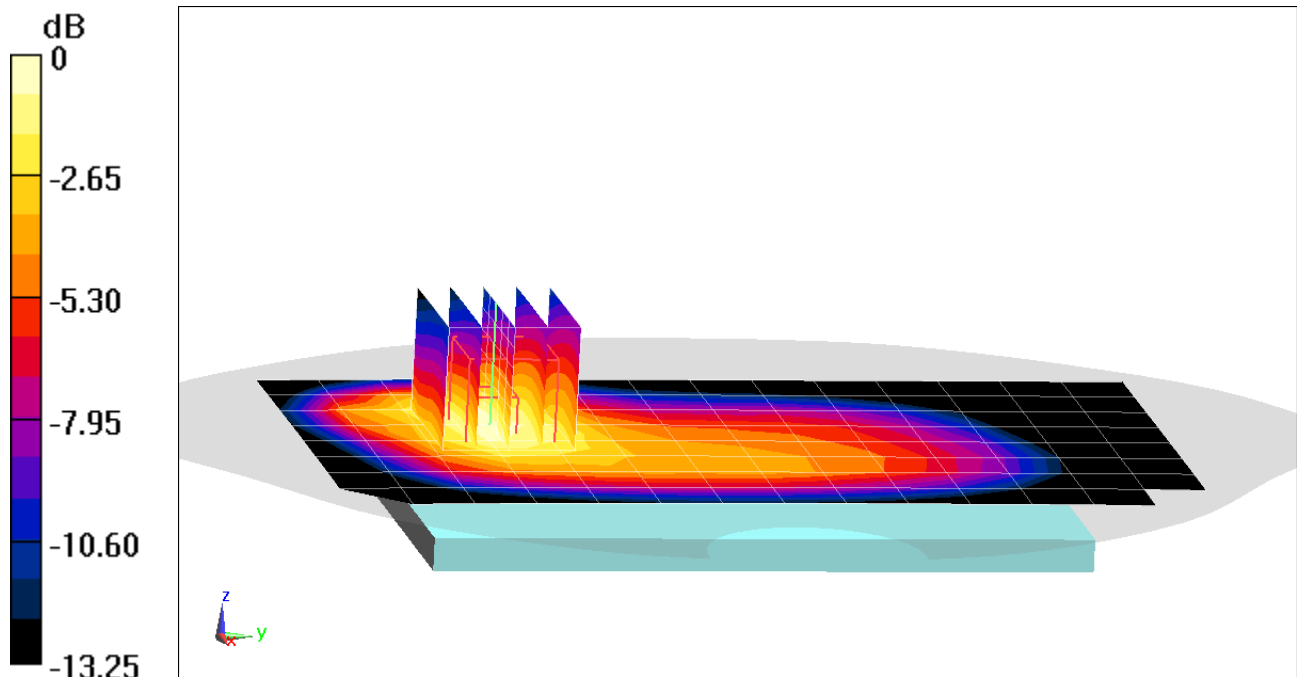

0 dB = 0.766 W/kg = -1.16 dBW/kg

# PCTEST ENGINEERING LABORATORY, INC.

**DUT: ZNFQ720AM; Type: Portable Handset; Serial: 06829**

Communication System: UID 0, LTE Band 66 (AWS); Frequency: 1770 MHz; Duty Cycle: 1:1  
Medium: 1750 Body; Medium parameters used (interpolated):  
 $f = 1770 \text{ MHz}$ ;  $\sigma = 1.458 \text{ S/m}$ ;  $\epsilon_r = 53.898$ ;  $\rho = 1000 \text{ kg/m}^3$   
Phantom section: Flat Section; Space: 1.0 cm

Test Date: 07-11-2019; Ambient Temp: 22.8°C; Tissue Temp: 21.7°C

Probe: EX3DV4 - SN7409; ConvF(7.85, 7.85, 7.85) @ 1770 MHz; Calibrated: 6/19/2019  
Sensor-Surface: 1.4mm (Mechanical Surface Detection)  
Electronics: DAE4 Sn1334; Calibrated: 6/20/2019  
Phantom: SAM Left; Type: QD000P40CA; Serial: TP:82355  
Measurement SW: DASY52, Version 52.10 (2);SEMCAD X Version 14.6.12 (7450)

**Mode: LTE Band 66 (AWS), Body SAR, Back side, High.ch**  
**20 MHz Bandwidth, QPSK, 1 RB, 50 RB Offset**

**Area Scan (9x15x1):** Measurement grid: dx=15mm, dy=15mm

**Zoom Scan (5x5x7)/Cube 0:** Measurement grid: dx=8mm, dy=8mm, dz=5mm

Reference Value = 19.46 V/m; Power Drift = -0.03 dB

Peak SAR (extrapolated) = 0.863 W/kg

**SAR(1 g) = 0.494 W/kg**

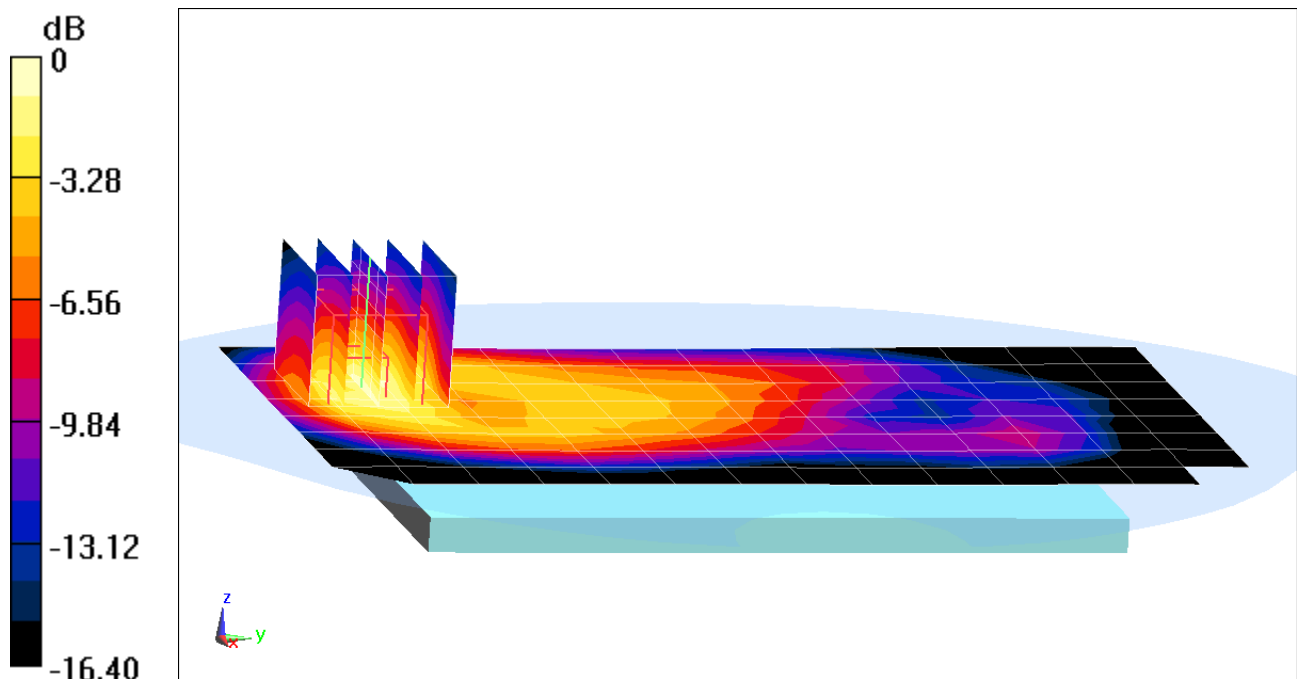

0 dB = 0.737 W/kg = -1.33 dBW/kg

# PCTEST ENGINEERING LABORATORY, INC.

**DUT: ZNFQ720AM; Type: Portable Handset; Serial: 06829**

Communication System: UID 0, \_LTE Band 66 (AWS); Frequency: 1770 MHz; Duty Cycle: 1:1  
Medium: 1750 Body; Medium parameters used (interpolated):  
 $f = 1770 \text{ MHz}$ ;  $\sigma = 1.458 \text{ S/m}$ ;  $\epsilon_r = 53.898$ ;  $\rho = 1000 \text{ kg/m}^3$   
Phantom section: Flat Section; Space: 1.0 cm

Test Date: 07-11-2019; Ambient Temp: 22.8°C; Tissue Temp: 21.7°C

Probe: EX3DV4 - SN7409; ConvF(7.85, 7.85, 7.85) @ 1770 MHz; Calibrated: 6/19/2019  
Sensor-Surface: 1.4mm (Mechanical Surface Detection)  
Electronics: DAE4 Sn1334; Calibrated: 6/20/2019  
Phantom: SAM Left; Type: QD000P40CA; Serial: TP:82355  
Measurement SW: DASY52, Version 52.10 (2);SEMCAD X Version 14.6.12 (7450)

**Mode: LTE Band 66 (AWS), Body SAR, Bottom Edge, High.ch**  
**20 MHz Bandwidth, QPSK, 1 RB, 50 RB Offset**

**Area Scan (11x7x1):** Measurement grid: dx=5mm, dy=15mm  
**Zoom Scan (5x5x7)/Cube 0:** Measurement grid: dx=8mm, dy=8mm, dz=5mm  
Reference Value = 25.85 V/m; Power Drift = -0.03 dB  
Peak SAR (extrapolated) = 1.57 W/kg  
**SAR(1 g) = 0.896 W/kg**

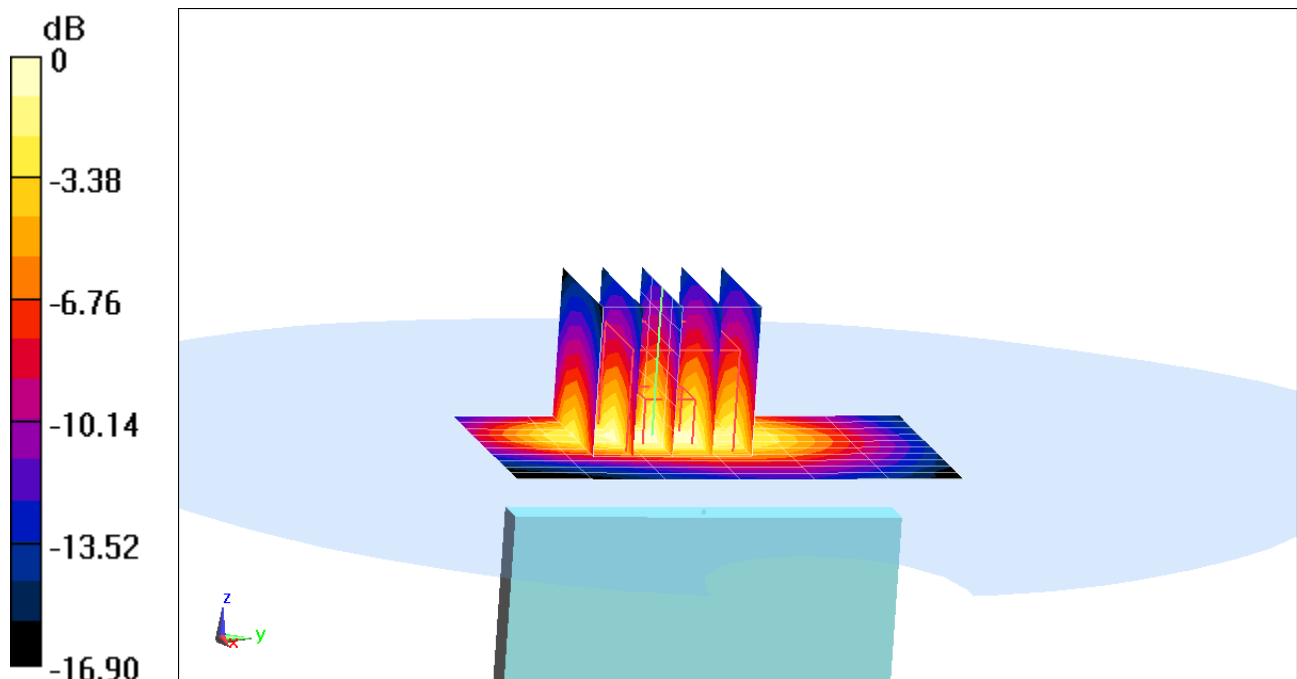

0 dB = 1.33 W/kg = 1.24 dBW/kg



# PCTEST ENGINEERING LABORATORY, INC.

**DUT: ZNFQ720AM; Type: Portable Handset; Serial: 06829**

Communication System: UID 0, LTE Band 2 (PCS); Frequency: 1860 MHz; Duty Cycle: 1:1  
Medium: 1900 Body; Medium parameters used (interpolated):  
 $f = 1860 \text{ MHz}$ ;  $\sigma = 1.513 \text{ S/m}$ ;  $\epsilon_r = 52.514$ ;  $\rho = 1000 \text{ kg/m}^3$   
Phantom section: Flat Section; Space: 1.0 cm

Test Date: 07-15-2019; Ambient Temp: 19.6°C; Tissue Temp: 20.6°C

Probe: EX3DV4 - SN7357; ConvF(7.93, 7.93, 7.93) @ 1860 MHz; Calibrated: 4/24/2019  
Sensor-Surface: 1.4mm (Mechanical Surface Detection)  
Electronics: DAE4 Sn1407; Calibrated: 4/18/2019  
Phantom: Twin-SAM V4.0 Front Right; Type: QD 000 P40 CC; Serial: 1167  
Measurement SW: DASY52, Version 52.10 (2);SEMCAD X Version 14.6.12 (7450)

**Mode: LTE Band 2 (PCS), Body SAR, Back side, Low.ch**  
**20 MHz Bandwidth, QPSK, 1 RB, 99 RB Offset**

**Area Scan (9x15x1):** Measurement grid: dx=15mm, dy=15mm  
**Zoom Scan (6x6x7)/Cube 0:** Measurement grid: dx=8mm, dy=8mm, dz=5mm  
Reference Value = 16.86 V/m; Power Drift = 0.05 dB  
Peak SAR (extrapolated) = 0.737 W/kg  
**SAR(1 g) = 0.422 W/kg**

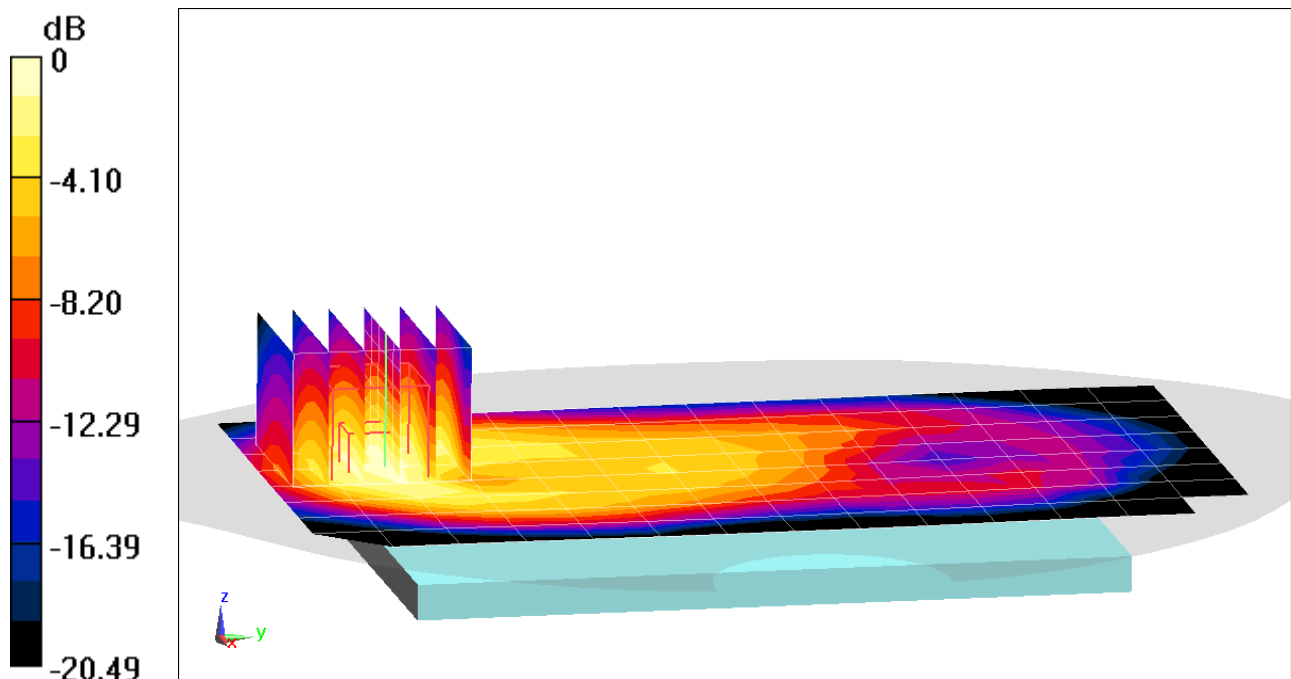

0 dB = 0.581 W/kg = -2.36 dBW/kg

# PCTEST ENGINEERING LABORATORY, INC.

**DUT: ZNFQ720AM; Type: Portable Handset; Serial: 06829**

Communication System: UID 0, LTE Band 2 (PCS); Frequency: 1900 MHz; Duty Cycle: 1:1  
Medium: 1900 Body; Medium parameters used (interpolated):  
 $f = 1900 \text{ MHz}$ ;  $\sigma = 1.561 \text{ S/m}$ ;  $\epsilon_r = 52.388$ ;  $\rho = 1000 \text{ kg/m}^3$   
Phantom section: Flat Section; Space: 1.0 cm

Test Date: 07-15-2019; Ambient Temp: 19.6°C; Tissue Temp: 20.6°C

Probe: EX3DV4 - SN7357; ConvF(7.93, 7.93, 7.93) @ 1900 MHz; Calibrated: 4/24/2019  
Sensor-Surface: 1.4mm (Mechanical Surface Detection)  
Electronics: DAE4 Sn1407; Calibrated: 4/18/2019  
Phantom: Twin-SAM V4.0 Front Right; Type: QD 000 P40 CC; Serial: 1167  
Measurement SW: DASY52, Version 52.10 (2);SEMCAD X Version 14.6.12 (7450)

**Mode: LTE Band 2 (PCS), Body SAR, Bottom Edge, High.ch**  
**20 MHz Bandwidth, QPSK, 1 RB, 50 RB Offset**

**Area Scan (10x8x1):** Measurement grid: dx=5mm, dy=15mm  
**Zoom Scan (5x5x7)/Cube 0:** Measurement grid: dx=8mm, dy=8mm, dz=5mm  
Reference Value = 27.19 V/m; Power Drift = 0.01 dB  
Peak SAR (extrapolated) = 1.87 W/kg  
**SAR(1 g) = 1.04 W/kg**

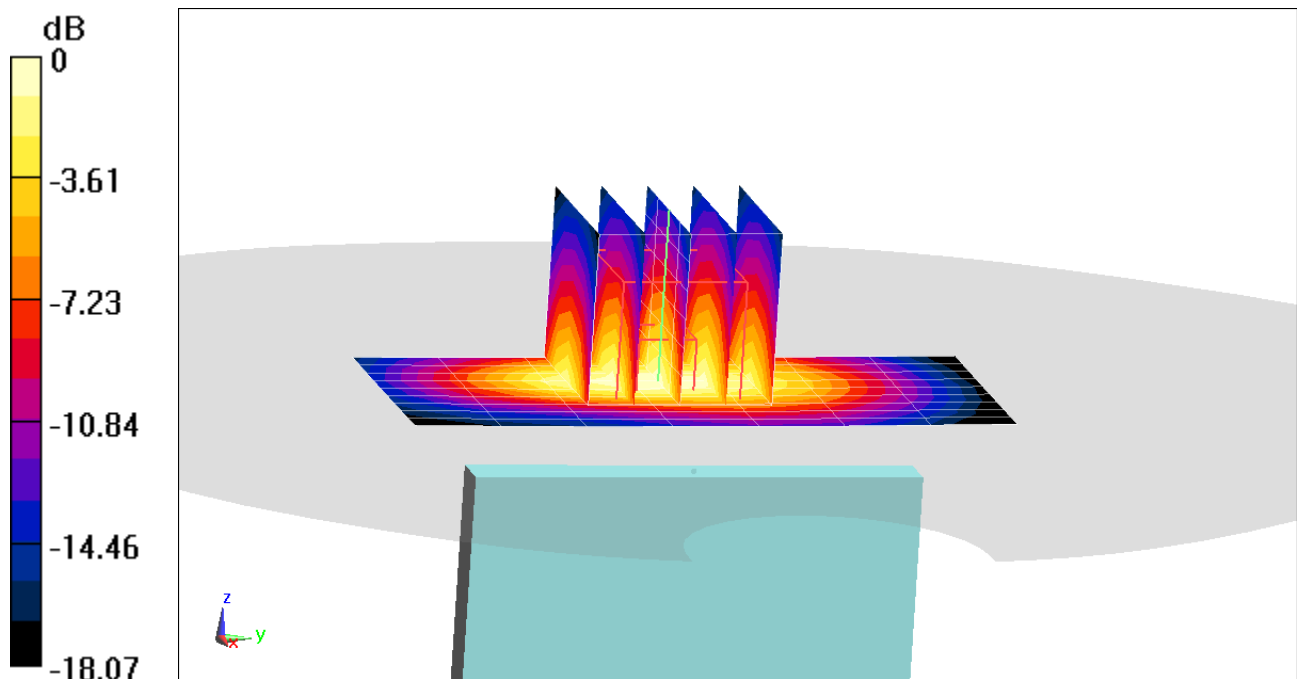

# PCTEST ENGINEERING LABORATORY, INC.

**DUT: ZNFQ720AM; Type: Portable Handset; Serial: 06837**

Communication System: UID 0, LTE Band 30; Frequency: 2310 MHz; Duty Cycle: 1:1

Medium: 2450 Body; Medium parameters used:

$f = 2310$  MHz;  $\sigma = 1.875$  S/m;  $\epsilon_r = 52.522$ ;  $\rho = 1000$  kg/m<sup>3</sup>

Phantom section: Flat Section; Space: 1.0 cm

Test Date: 07-15-2019; Ambient Temp: 22.2°C; Tissue Temp: 22.1°C

Probe: EX3DV4 - SN7417; ConvF(7.64, 7.64, 7.64) @ 2310 MHz; Calibrated: 2/19/2019

Sensor-Surface: 1.4mm (Mechanical Surface Detection)

Electronics: DAE4 Sn665; Calibrated: 2/13/2019

Phantom: LeftTwin-SAM V5.0; Type: QD 000 P40 CD; Serial: TP1375

Measurement SW: DASY52, Version 52.10 (2);SEMCAD X Version 14.6.12 (7450)

**Mode: LTE Band 30, Body SAR, Back side, Mid.ch**  
**10 MHz Bandwidth, QPSK, 1 RB, 49 RB Offset**

**Area Scan (11x18x1):** Measurement grid: dx=12mm, dy=12mm

**Zoom Scan (7x7x7)/Cube 0:** Measurement grid: dx=5mm, dy=5mm, dz=5mm

Reference Value = 15.30 V/m; Power Drift = -0.06 dB

Peak SAR (extrapolated) = 0.763 W/kg

**SAR(1 g) = 0.388 W/kg**

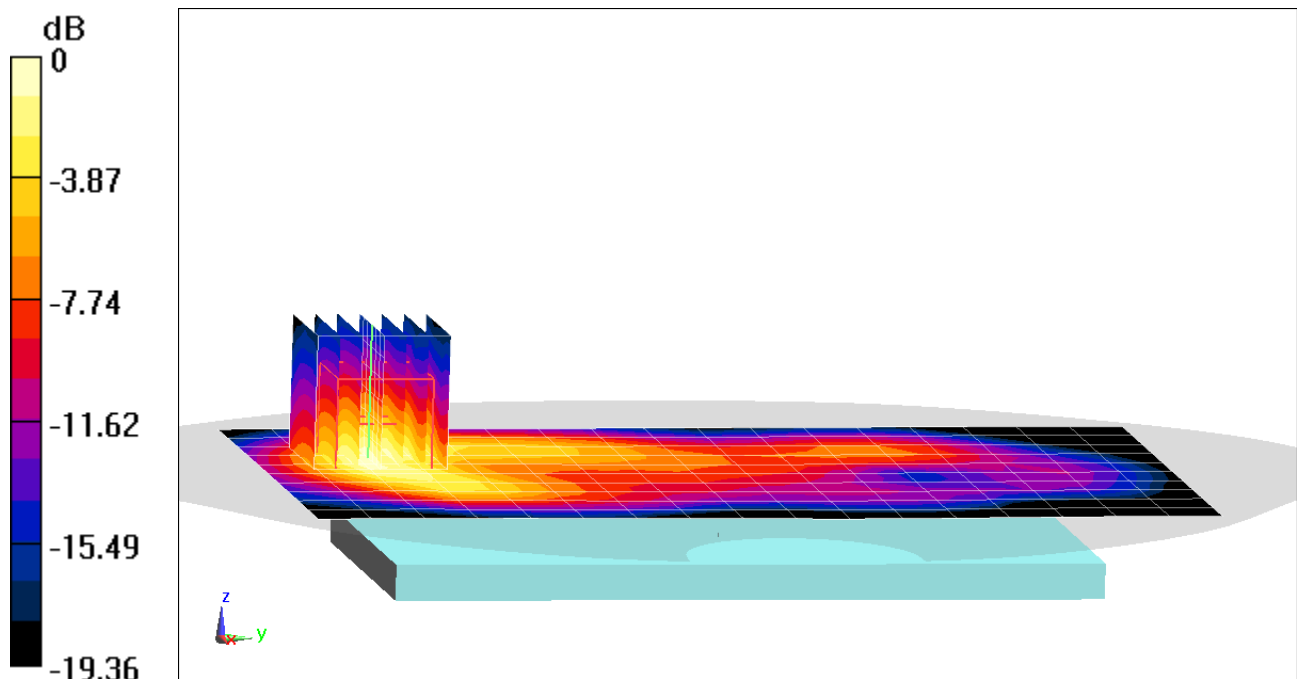

0 dB = 0.620 W/kg = -2.08 dBW/kg

# PCTEST ENGINEERING LABORATORY, INC.

**DUT: ZNFQ720AM; Type: Portable Handset; Serial: 06837**

Communication System: UID 0, LTE Band 30; Frequency: 2310 MHz; Duty Cycle: 1:1

Medium: 2450 Body; Medium parameters used:

$f = 2310$  MHz;  $\sigma = 1.875$  S/m;  $\epsilon_r = 52.522$ ;  $\rho = 1000$  kg/m<sup>3</sup>

Phantom section: Flat Section; Space: 1.0 cm

Test Date: 07-15-2019; Ambient Temp: 22.2°C; Tissue Temp: 22.1°C

Probe: EX3DV4 - SN7417; ConvF(7.64, 7.64, 7.64) @ 2310 MHz; Calibrated: 2/19/2019

Sensor-Surface: 1.4mm (Mechanical Surface Detection)

Electronics: DAE4 Sn665; Calibrated: 2/13/2019

Phantom: LeftTwin-SAM V5.0; Type: QD 000 P40 CD; Serial: TP1375

Measurement SW: DASY52, Version 52.10 (2);SEMCAD X Version 14.6.12 (7450)

**Mode: LTE Band 30, Body SAR, Bottom Edge, Mid.ch**  
**10 MHz Bandwidth, QPSK, 1 RB, 49 RB Offset**

**Area Scan (11x10x1):** Measurement grid: dx=5mm, dy=12mm

**Zoom Scan (7x8x7)/Cube 0:** Measurement grid: dx=5mm, dy=5mm, dz=5mm

Reference Value = 20.80 V/m; Power Drift = 0.00 dB

Peak SAR (extrapolated) = 1.45 W/kg

**SAR(1 g) = 0.736 W/kg**

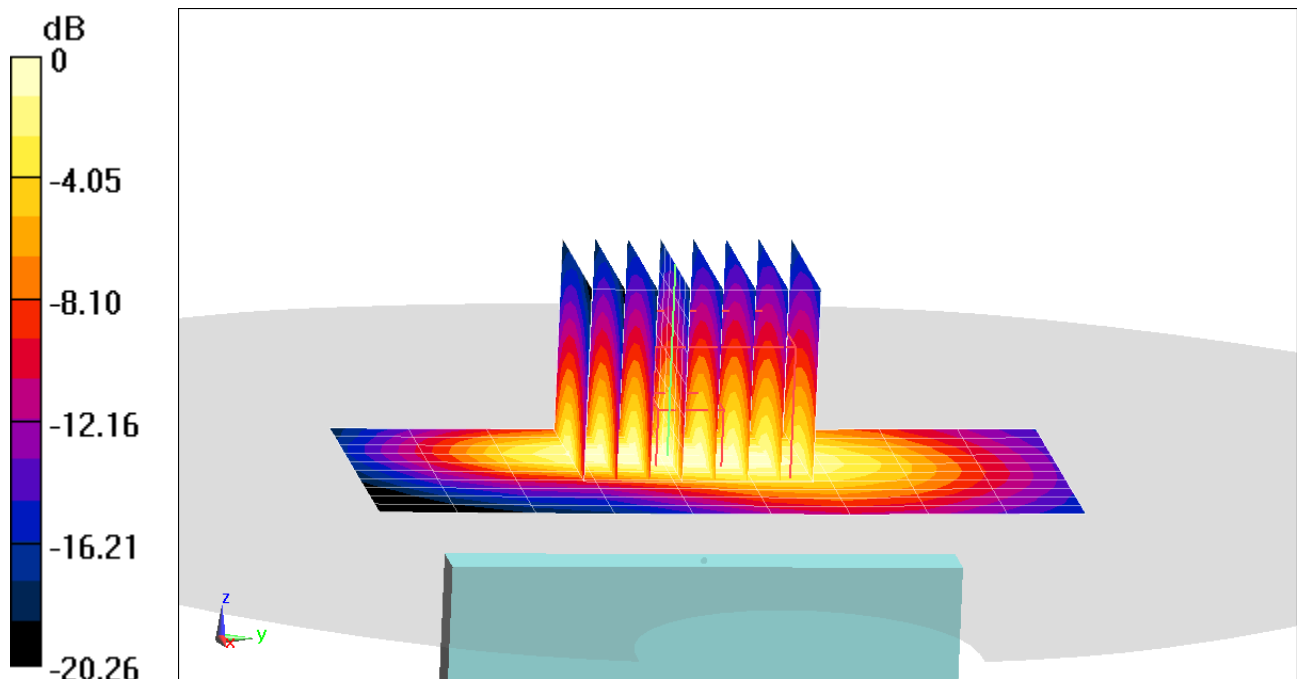

0 dB = 1.17 W/kg = 0.68 dBW/kg

# PCTEST ENGINEERING LABORATORY, INC.

**DUT: ZNFQ720AM; Type: Portable Handset; Serial: 06795**

Communication System: UID 0, \_IEEE 802.11b; Frequency: 2412 MHz; Duty Cycle: 1:1  
Medium: 2450 Body; Medium parameters used (interpolated):  
 $f = 2412 \text{ MHz}$ ;  $\sigma = 1.997 \text{ S/m}$ ;  $\epsilon_r = 51.603$ ;  $\rho = 1000 \text{ kg/m}^3$   
Phantom section: Flat Section; Space: 1.0 cm

Test Date: 07-18-2019; Ambient Temp: 22.6°C; Tissue Temp: 22.2°C

Probe: EX3DV4 - SN7417; ConvF(7.51, 7.51, 7.51) @ 2412 MHz; Calibrated: 2/19/2019  
Sensor-Surface: 1.4mm (Mechanical Surface Detection)  
Electronics: DAE4 Sn665; Calibrated: 2/13/2019  
Phantom: LeftTwin-SAM V5.0; Type: QD 000 P40 CD; Serial: TP1375  
Measurement SW: DASY52, Version 52.10 (2);SEMCAD X Version 14.6.12 (7450)

**Mode: IEEE 802.11b, 22 MHz Bandwidth, Body SAR, Ch 1, 1 Mbps, Back Side**

**Area Scan (11x17x1):** Measurement grid: dx=12mm, dy=12mm

**Zoom Scan (7x7x7)/Cube 0:** Measurement grid: dx=5mm, dy=5mm, dz=5mm

Reference Value = 19.10 V/m; Power Drift = -0.05 dB

Peak SAR (extrapolated) = 1.32 W/kg

**SAR(1 g) = 0.640 W/kg**

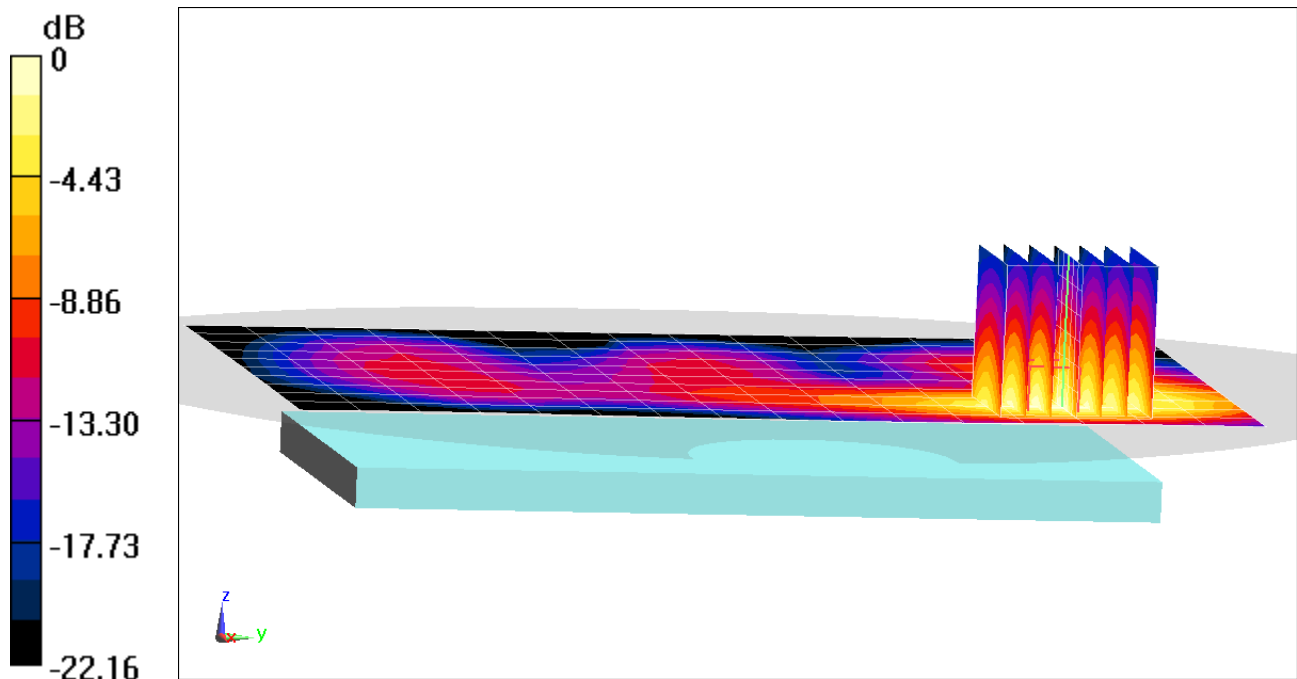

0 dB = 1.05 W/kg = 0.21 dBW/kg

# PCTEST ENGINEERING LABORATORY, INC.

**DUT: ZNFQ720AM; Type: Portable Handset; Serial: 06795**

Communication System: UID 0, 802.11a 5.2-5.8 GHz Band; Frequency: 5260 MHz; Duty Cycle: 1:1

Medium: 5GHz Body; Medium parameters used:

$f = 5260 \text{ MHz}$ ;  $\sigma = 5.198 \text{ S/m}$ ;  $\epsilon_r = 48.373$ ;  $\rho = 1000 \text{ kg/m}^3$

Phantom section: Flat Section; Space: 1.0 cm

Test Date: 07-16-2019; Ambient Temp: 23.0°C; Tissue Temp: 20.1°C

Probe: EX3DV4 - SN7308; ConvF(4.48, 4.48, 4.48) @ 5260 MHz; Calibrated: 8/23/2018

Sensor-Surface: 1.4mm (Mechanical Surface Detection)

Electronics: DAE4 Sn1558; Calibrated: 10/3/2018

Phantom: Twin-SAM V5.0; Type: QD 000 P40 CD; Serial: 1630

Measurement SW: DASY52, Version 52.10 (2);SEMCAD X Version 14.6.12 (7450)

**Mode: IEEE 802.11a, UNII-2A, 20 MHz Bandwidth, Body SAR, Ch 52, 6 Mbps, Back Side**

**Area Scan (11x21x1):** Measurement grid: dx=10mm, dy=10mm

**Zoom Scan (7x7x7)/Cube 0:** Measurement grid: dx=4mm, dy=4mm, dz=1.4mm; Graded Ratio: 1.4

Reference Value = 11.06 V/m; Power Drift = -0.11 dB

Peak SAR (extrapolated) = 2.17 W/kg

**SAR(1 g) = 0.578 W/kg**

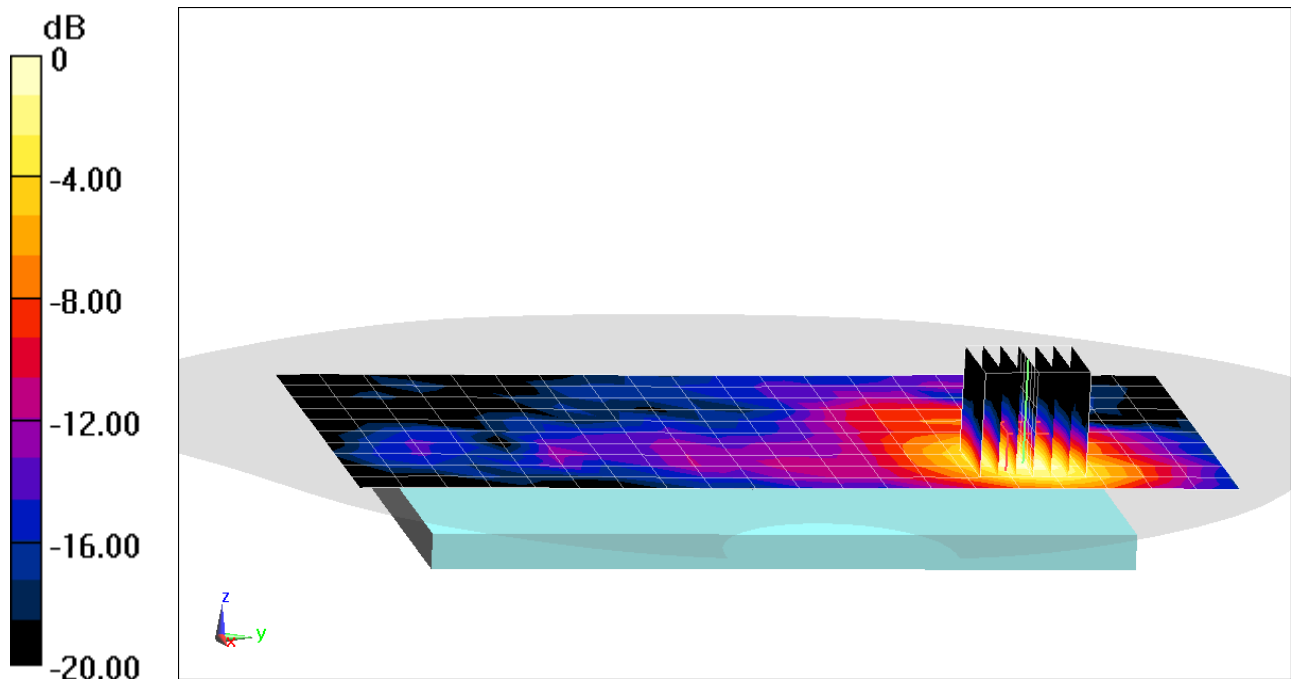

0 dB = 1.31 W/kg = 1.17 dBW/kg

# PCTEST ENGINEERING LABORATORY, INC.

**DUT: ZNFQ720AM; Type: Portable Handset; Serial: 06795**

Communication System: UID 0, 802.11a 5.2-5.8 GHz Band; Frequency: 5200 MHz; Duty Cycle: 1:1

Medium: 5GHz Body; Medium parameters used:

$f = 5200 \text{ MHz}$ ;  $\sigma = 5.115 \text{ S/m}$ ;  $\epsilon_r = 48.481$ ;  $\rho = 1000 \text{ kg/m}^3$

Phantom section: Flat Section; Space: 1.0 cm

Test Date: 07-16-2019; Ambient Temp: 23.0°C; Tissue Temp: 20.1°C

Probe: EX3DV4 - SN7308; ConvF(4.48, 4.48, 4.48) @ 5200 MHz; Calibrated: 8/23/2018

Sensor-Surface: 1.4mm (Mechanical Surface Detection)

Electronics: DAE4 Sn1558; Calibrated: 10/3/2018

Phantom: Twin-SAM V5.0; Type: QD 000 P40 CD; Serial: 1630

Measurement SW: DASY52, Version 52.10 (2);SEMCAD X Version 14.6.12 (7450)

**Mode: IEEE 802.11a, UNII-1, 20 MHz Bandwidth, Body SAR, Ch 40, 6 Mbps, Back Side**

**Area Scan (11x21x1):** Measurement grid: dx=10mm, dy=10mm

**Zoom Scan (7x7x7)/Cube 0:** Measurement grid: dx=4mm, dy=4mm, dz=1.4mm; Graded Ratio: 1.4

Reference Value = 12.01 V/m; Power Drift = -0.07 dB

Peak SAR (extrapolated) = 2.37 W/kg

**SAR(1 g) = 0.661 W/kg**

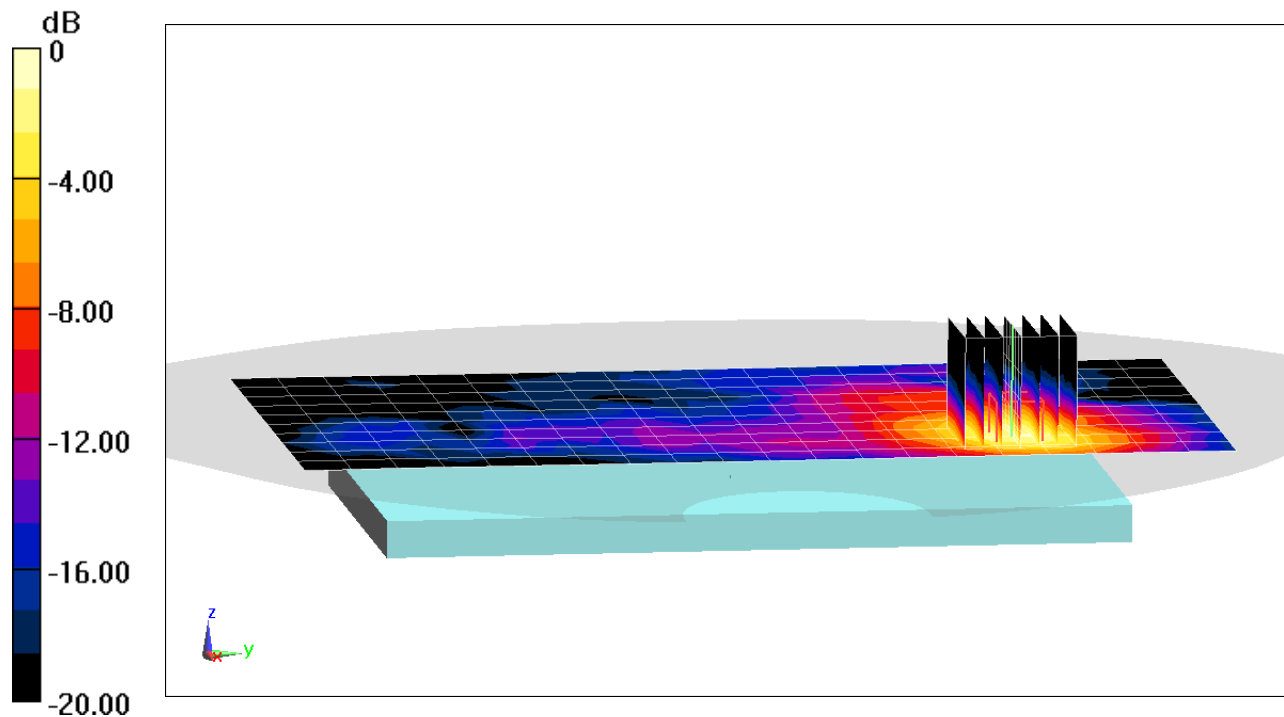

0 dB = 1.48 W/kg = 1.70 dBW/kg

# PCTEST ENGINEERING LABORATORY, INC.

**DUT: ZNFQ720AM; Type: Portable Handset; Serial: 06795**

Communication System: UID 0, Bluetooth; Frequency: 2441 MHz; Duty Cycle: 1:1.297

Medium: 2450 Body; Medium parameters used (interpolated):

$f = 2441 \text{ MHz}$ ;  $\sigma = 2.031 \text{ S/m}$ ;  $\epsilon_r = 51.514$ ;  $\rho = 1000 \text{ kg/m}^3$

Phantom section: Flat Section; Space: 1.0 cm

Test Date: 07-18-2019; Ambient Temp: 22.6°C; Tissue Temp: 22.2°C

Probe: EX3DV4 - SN7417; ConvF(7.51, 7.51, 7.51) @ 2441 MHz; Calibrated: 2/19/2019

Sensor-Surface: 1.4mm (Mechanical Surface Detection)

Electronics: DAE4 Sn665; Calibrated: 2/13/2019

Phantom: LeftTwin-SAM V5.0; Type: QD 000 P40 CD; Serial: TP1375

Measurement SW: DASY52, Version 52.10 (2);SEMCAD X Version 14.6.12 (7450)

**Mode: Bluetooth, Body SAR, Ch 39, 1 Mbps, Back Side**

**Area Scan (11x17x1):** Measurement grid: dx=12mm, dy=12mm

**Zoom Scan (7x7x7)/Cube 0:** Measurement grid: dx=5mm, dy=5mm, dz=5mm

Reference Value = 2.669 V/m; Power Drift = 0.13 dB

Peak SAR (extrapolated) = 0.0510 W/kg

**SAR(1 g) = 0.024 W/kg**

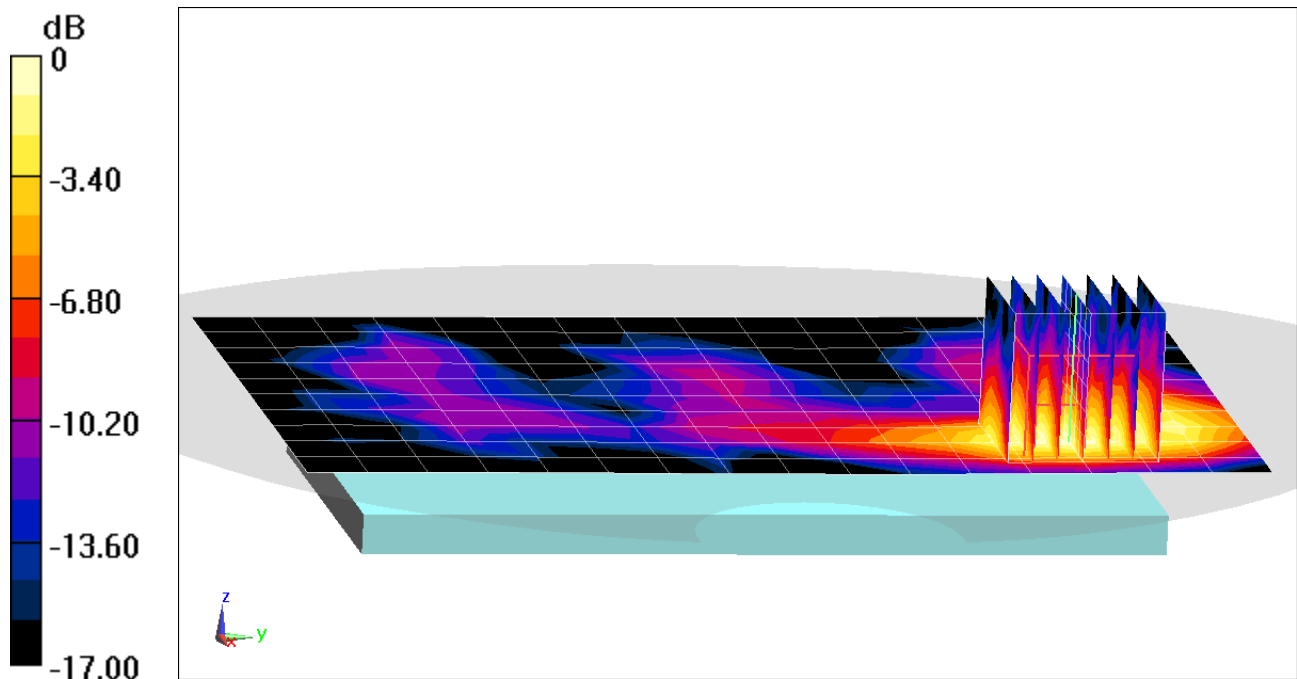

0 dB = 0.0386 W/kg = -14.13 dBW/kg



# PCTEST ENGINEERING LABORATORY, INC.

**DUT: ZNFQ720AM; Type: Portable Handset; Serial: 06795**

Communication System: UID 0, Bluetooth; Frequency: 2441 MHz; Duty Cycle: 1:1.297

Medium: 2450 Body; Medium parameters used (interpolated):

$f = 2441 \text{ MHz}$ ;  $\sigma = 2.031 \text{ S/m}$ ;  $\epsilon_r = 51.514$ ;  $\rho = 1000 \text{ kg/m}^3$

Phantom section: Flat Section; Space: 1.0 cm

Test Date: 07-18-2019; Ambient Temp: 22.6°C; Tissue Temp: 22.2°C

Probe: EX3DV4 - SN7417; ConvF(7.51, 7.51, 7.51) @ 2441 MHz; Calibrated: 2/19/2019

Sensor-Surface: 1.4mm (Mechanical Surface Detection)

Electronics: DAE4 Sn665; Calibrated: 2/13/2019

Phantom: LeftTwin-SAM V5.0; Type: QD 000 P40 CD; Serial: TP1375

Measurement SW: DASY52, Version 52.10 (2);SEMCAD X Version 14.6.12 (7450)

**Mode: Bluetooth, Body SAR, Ch 39, 1 Mbps, Top Edge**

**Area Scan (10x11x1):** Measurement grid: dx=5mm, dy=12mm

**Zoom Scan (7x7x7)/Cube 0:** Measurement grid: dx=5mm, dy=5mm, dz=5mm

Reference Value = 4.292 V/m; Power Drift = 0.01 dB

Peak SAR (extrapolated) = 0.0690 W/kg

**SAR(1 g) = 0.033 W/kg**

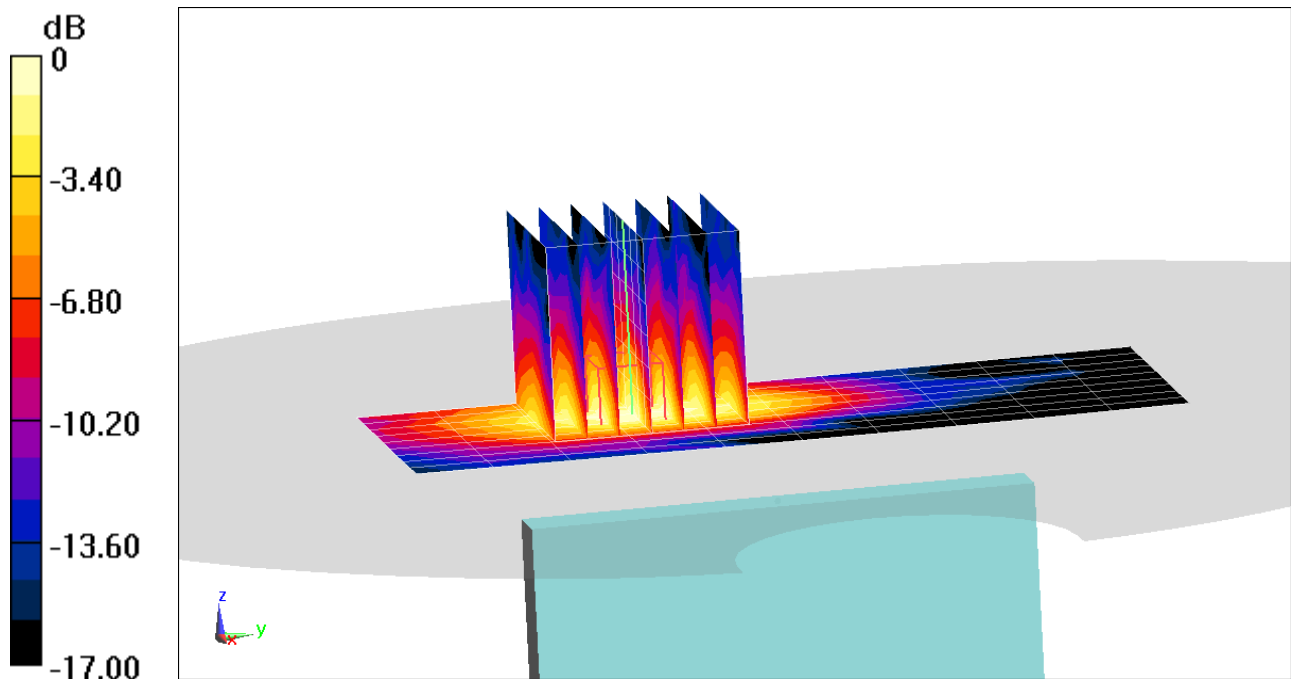

0 dB = 0.0555 W/kg = -12.56 dBW/kg

# PCTEST ENGINEERING LABORATORY, INC.

**DUT: ZNFQ720AM; Type: Portable Handset; Serial: 06837**

Communication System: UID 0, LTE Band 30; Frequency: 2310 MHz; Duty Cycle: 1:1

Medium: 2300 Body; Medium parameters used:

$f = 2310 \text{ MHz}$ ;  $\sigma = 1.875 \text{ S/m}$ ;  $\epsilon_r = 52.522$ ;  $\rho = 1000 \text{ kg/m}^3$

Phantom section: Flat Section; Space: 0.0 cm

Test Date: 07-15-2019; Ambient Temp: 22.2°C; Tissue Temp: 22.1°C

Probe: EX3DV4 - SN7417; ConvF(7.64, 7.64, 7.64) @ 2310 MHz; Calibrated: 2/19/2019

Sensor-Surface: 1.4mm (Mechanical Surface Detection)

Electronics: DAE4 Sn665; Calibrated: 2/13/2019

Phantom: LeftTwin-SAM V5.0; Type: QD 000 P40 CD; Serial: TP1375

Measurement SW: DASY52, Version 52.10 (2);SEMCAD X Version 14.6.12 (7450)

**Mode: LTE Band 30, Body SAR, Bottom Edge, Mid.ch**  
**10 MHz Bandwidth, QPSK, 1 RB, 49 RB Offset**

**Area Scan (11x10x1):** Measurement grid: dx=5mm, dy=12mm

**Zoom Scan (7x7x7)/Cube 0:** Measurement grid: dx=5mm, dy=5mm, dz=5mm

Reference Value = 66.06 V/m; Power Drift = -0.13 dB

Peak SAR (extrapolated) = 20.3 W/kg

**SAR(10 g) = 2.46 W/kg**

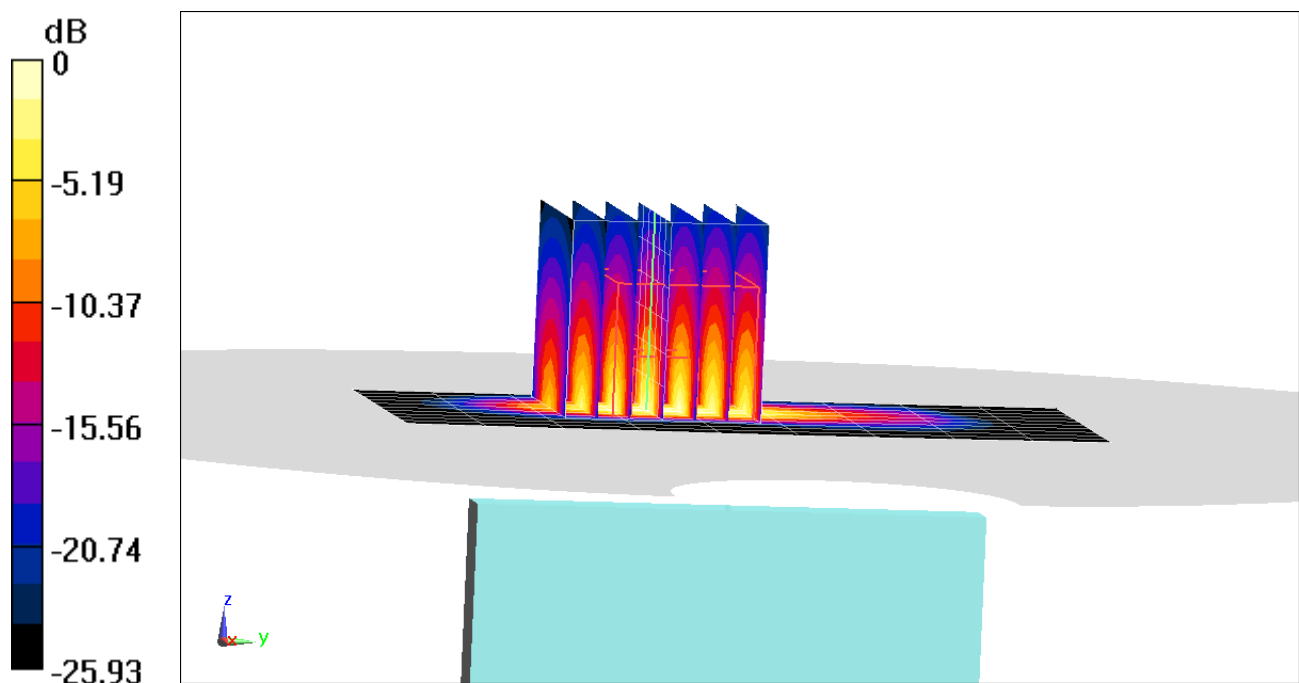

# PCTEST ENGINEERING LABORATORY, INC.

**DUT: ZNFQ720AM; Type: Portable Handset; Serial: 06795**

Communication System: UID 0, 802.11a 5.2-5.8 GHz Band; Frequency: 5280 MHz; Duty Cycle: 1:1

Medium: 5GHz Body; Medium parameters used:  
 $f = 5280 \text{ MHz}$ ;  $\sigma = 5.22 \text{ S/m}$ ;  $\epsilon_r = 48.359$ ;  $\rho = 1000 \text{ kg/m}^3$   
Phantom section: Flat Section; Space: 0.0 cm

Test Date: 07-16-2019; Ambient Temp: 23.0°C; Tissue Temp: 20.1°C

Probe: EX3DV4 - SN7308; ConvF(4.48, 4.48, 4.48) @ 5280 MHz; Calibrated: 8/23/2018

Sensor-Surface: 1.4mm (Mechanical Surface Detection)

Electronics: DAE4 Sn1558; Calibrated: 10/3/2018

Phantom: Twin-SAM V5.0; Type: QD 000 P40 CD; Serial: 1630

Measurement SW: DASY52, Version 52.10 (2);SEMCAD X Version 14.6.12 (7450)

**Mode: IEEE 802.11a, U-NII-2A, 20 MHz Bandwidth, Phablet SAR, Ch 56, 6 Mbps, Back Side**

**Area Scan (13x20x1):** Measurement grid: dx=10mm, dy=10mm

**Zoom Scan (9x9x7)/Cube 0:** Measurement grid: dx=4mm, dy=4mm, dz=1.4mm; Graded Ratio: 1.4

Reference Value = 34.60 V/m; Power Drift = -0.07 dB

Peak SAR (extrapolated) = 25.1 W/kg

**SAR(10 g) = 1.7 W/kg**

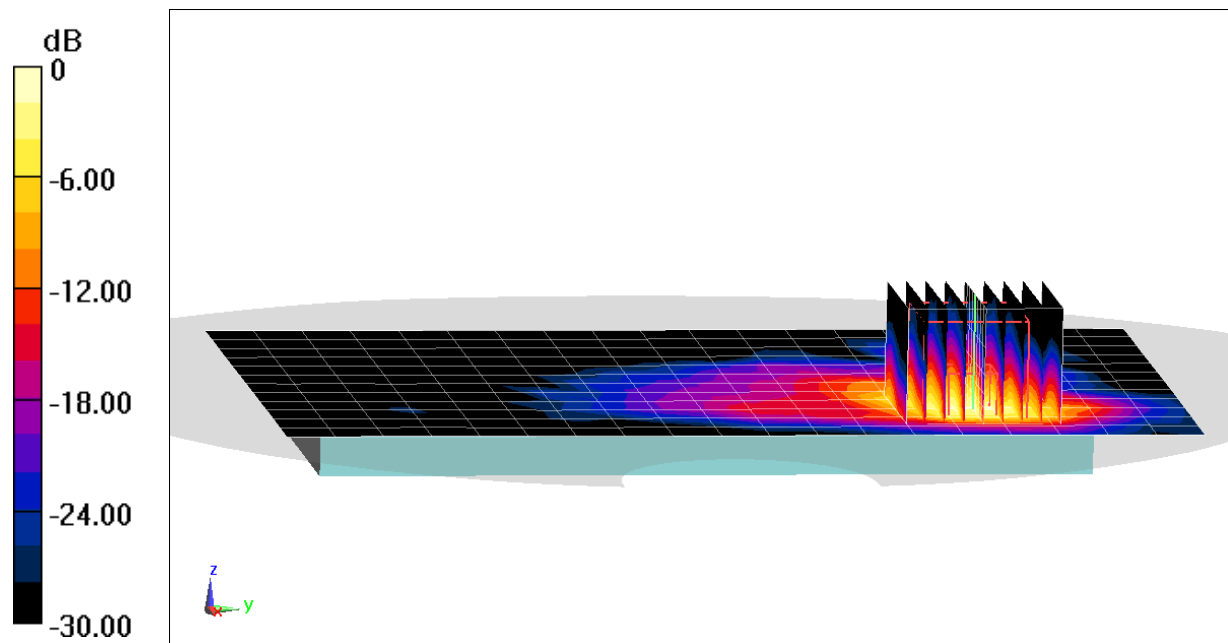

0 dB = 13.4 W/kg = 11.27 dBW/kg

## APPENDIX B: SYSTEM VERIFICATION

# PCTEST ENGINEERING LABORATORY, INC.

**DUT: Dipole 750 MHz; Type: D750V3; Serial: 1003**

Communication System: UID 0, CW; Frequency: 750 MHz; Duty Cycle: 1:1

Medium: 750 Head Medium parameters used (interpolated):

$f = 750 \text{ MHz}$ ;  $\sigma = 0.881 \text{ S/m}$ ;  $\epsilon_r = 41.048$ ;  $\rho = 1000 \text{ kg/m}^3$

Phantom section: Flat Section; Space: 1.5 cm

Test Date: 07-10-2019; Ambient Temp: 22.5°C; Tissue Temp: 21.3°C

Probe: EX3DV4 - SN3589; ConvF(8.67, 8.67, 8.67) @ 750 MHz; Calibrated: 1/25/2019

Sensor-Surface: 1.4mm (Mechanical Surface Detection)

Electronics: DAE4 Sn1450; Calibrated: 8/22/2018

Phantom: Twin-SAM V5.0 (30); Type: QD 000 P40 CD; Serial: 1647

Measurement SW: DASY52, Version 52.10 (2); SEMCAD X Version 14.6.12 (7450)

## 750 MHz System Verification at 23.0 dBm (200 mW)

**Area Scan (7x15x1):** Measurement grid: dx=15mm, dy=15mm

**Zoom Scan (5x5x7)/Cube 0:** Measurement grid: dx=8mm, dy=8mm, dz=5mm

Peak SAR (extrapolated) = 2.40 W/kg

**SAR(1 g) = 1.54 W/kg**

Deviation(1 g) = -7.00%

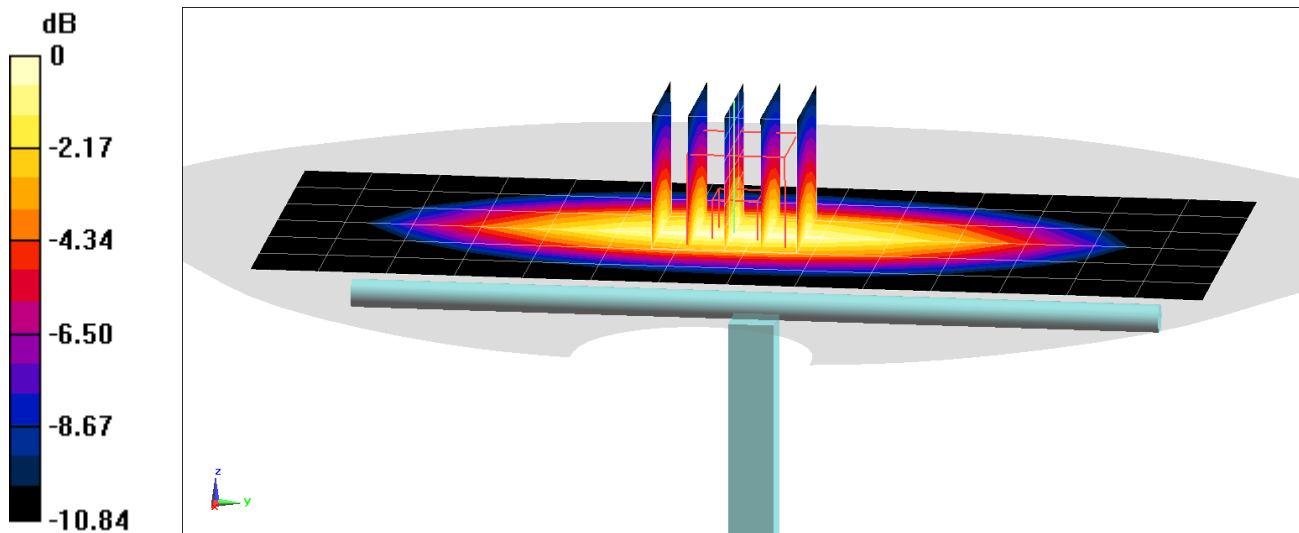

0 dB = 2.10 W/kg = 3.22 dBW/kg

# PCTEST ENGINEERING LABORATORY, INC.

**DUT: Dipole 835 MHz; Type: D835V2; Serial: 4d133**

Communication System: UID 0, CW; Frequency: 835 MHz; Duty Cycle: 1:1

Medium: 835 Head Medium parameters used:

$f = 835 \text{ MHz}$ ;  $\sigma = 0.916 \text{ S/m}$ ;  $\epsilon_r = 41.627$ ;  $\rho = 1000 \text{ kg/m}^3$

Phantom section: Flat Section; Space: 1.5 cm

Test Date: 07-15-2019; Ambient Temp: 21.4°C; Tissue Temp: 20.7°C

Probe: EX3DV4 - SN3589; ConvF(8.39, 8.39, 8.39) @ 835 MHz; Calibrated: 1/25/2019

Sensor-Surface: 1.4mm (Mechanical Surface Detection)

Electronics: DAE4 Sn1450; Calibrated: 8/22/2018

Phantom: Twin-SAM V5.0 (30); Type: QD 000 P40 CD; Serial: 1647

Measurement SW: DASY52, Version 52.10 (2); SEMCAD X Version 14.6.12 (7450)

## 835 MHz System Verification at 23.0 dBm (200 mW)

**Area Scan (7x14x1):** Measurement grid: dx=15mm, dy=15mm

**Zoom Scan (5x5x7)/Cube 0:** Measurement grid: dx=8mm, dy=8mm, dz=5mm

Peak SAR (extrapolated) = 2.84 W/kg

**SAR(1 g) = 1.85 W/kg**

Deviation(1 g) = -1.91%

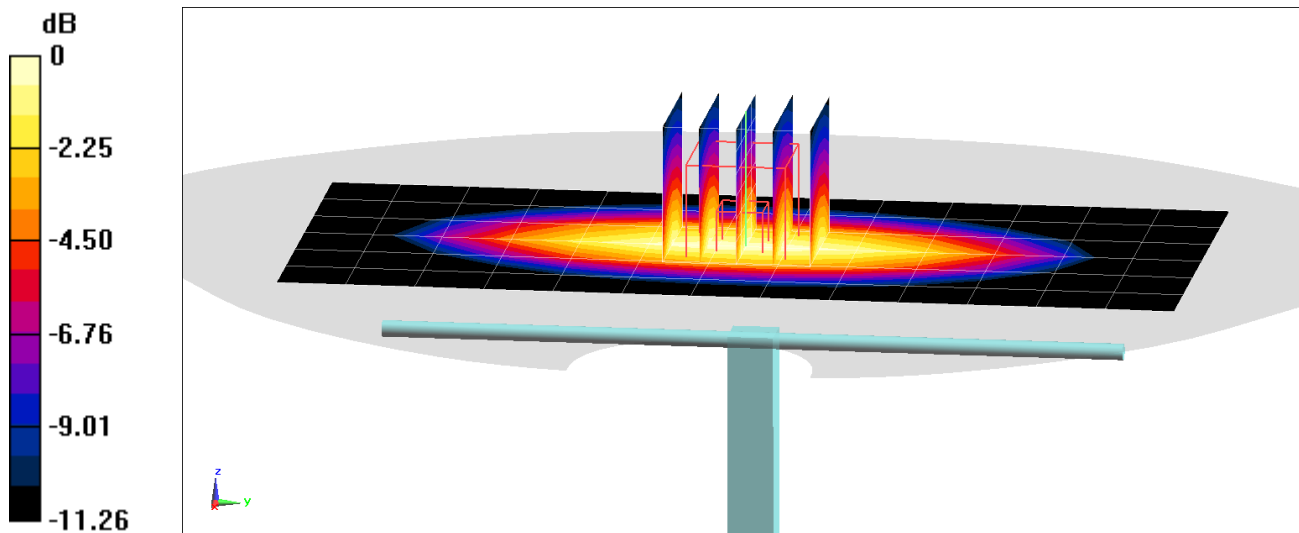

0 dB = 2.51 W/kg = 4.00 dBW/kg

# PCTEST ENGINEERING LABORATORY, INC.

**DUT: Dipole 1750 MHz; Type: D1765V2; Serial: 1008**

Communication System: UID 0, CW; Frequency: 1750 MHz; Duty Cycle: 1:1

Medium: 1750 Head Medium parameters used:

$f = 1750 \text{ MHz}$ ;  $\sigma = 1.353 \text{ S/m}$ ;  $\epsilon_r = 40.052$ ;  $\rho = 1000 \text{ kg/m}^3$

Phantom section: Flat Section; Space: 1.0 cm

Test Date: 07-08-2019; Ambient Temp: 21.4°C; Tissue Temp: 21.0°C

Probe: EX3DV4 - SN3589; ConvF(7.31, 7.31, 7.31) @ 1750 MHz; Calibrated: 1/25/2019

Sensor-Surface: 1.4mm (Mechanical Surface Detection)

Electronics: DAE4 Sn1450; Calibrated: 8/22/2018

Phantom: Twin-SAM V5.0 (30); Type: QD 000 P40 CD; Serial: 1647

Measurement SW: DASY52, Version 52.10 (2); SEMCAD X Version 14.6.12 (7450)

## 1750 MHz System Verification at 20.0 dBm (100 mW)

**Area Scan (7x9x1):** Measurement grid: dx=15mm, dy=15mm

**Zoom Scan (5x5x7)/Cube 0:** Measurement grid: dx=8mm, dy=8mm, dz=5mm

Peak SAR (extrapolated) = 7.02 W/kg

**SAR(1 g) = 3.73 W/kg**

Deviation(1 g) = 3.04%

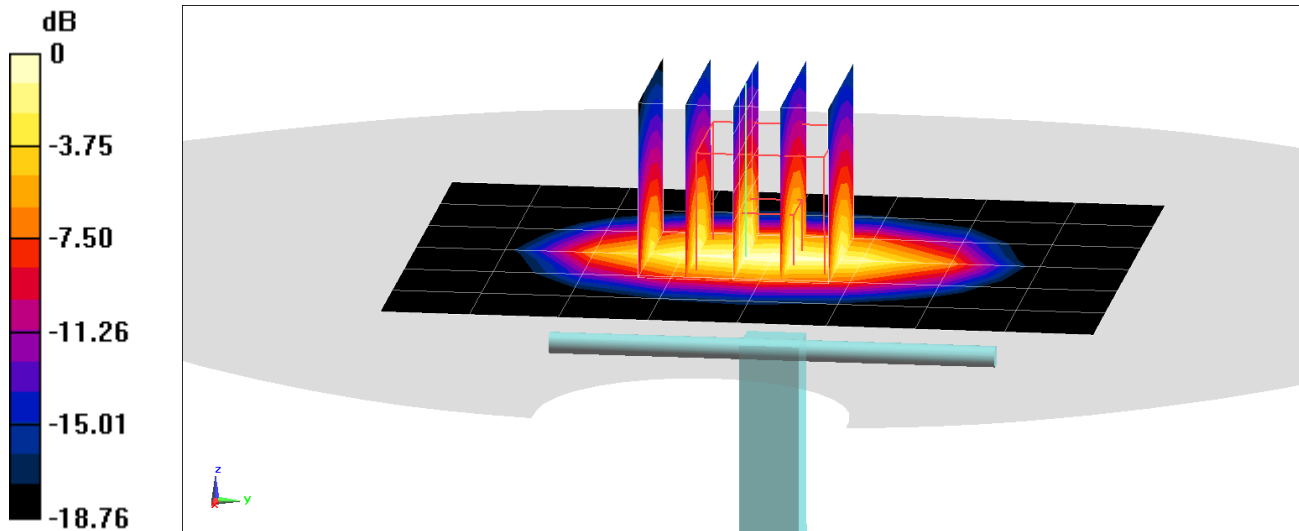

0 dB = 5.76 W/kg = 7.60 dBW/kg

# PCTEST ENGINEERING LABORATORY, INC.

**DUT: Dipole 1900 MHz; Type: D1900V2; Serial: 5d149**

Communication System: UID 0, CW; Frequency: 1900 MHz; Duty Cycle: 1:1

Medium: 1900 Head Medium parameters used (interpolated):

$f = 1900 \text{ MHz}$ ;  $\sigma = 1.444 \text{ S/m}$ ;  $\epsilon_r = 40.244$ ;  $\rho = 1000 \text{ kg/m}^3$

Phantom section: Flat Section; Space: 1.0 cm

Test Date: 07-10-2019; Ambient Temp: 21.1°C; Tissue Temp: 21.6°C

Probe: EX3DV4 - SN7409; ConvF(8.01, 8.01, 8.01) @ 1900 MHz; Calibrated: 6/19/2019

Sensor-Surface: 1.4mm (Mechanical Surface Detection)

Electronics: DAE4 Sn1334; Calibrated: 6/20/2019

Phantom: Front; Type: QD 000 P40 CD; Serial: 1686

Measurement SW: DASY52, Version 52.10 (2);SEMCAD X Version 14.6.12 (7450)

## 1900 MHz System Verification at 20.0 dBm (100 mW)

**Area Scan (7x11x1):** Measurement grid: dx=15mm, dy=15mm

**Zoom Scan (5x5x7)/Cube 0:** Measurement grid: dx=8mm, dy=8mm, dz=5mm

Peak SAR (extrapolated) = 7.71 W/kg

**SAR(1 g) = 4.03 W/kg**

Deviation(1 g) = 2.54%

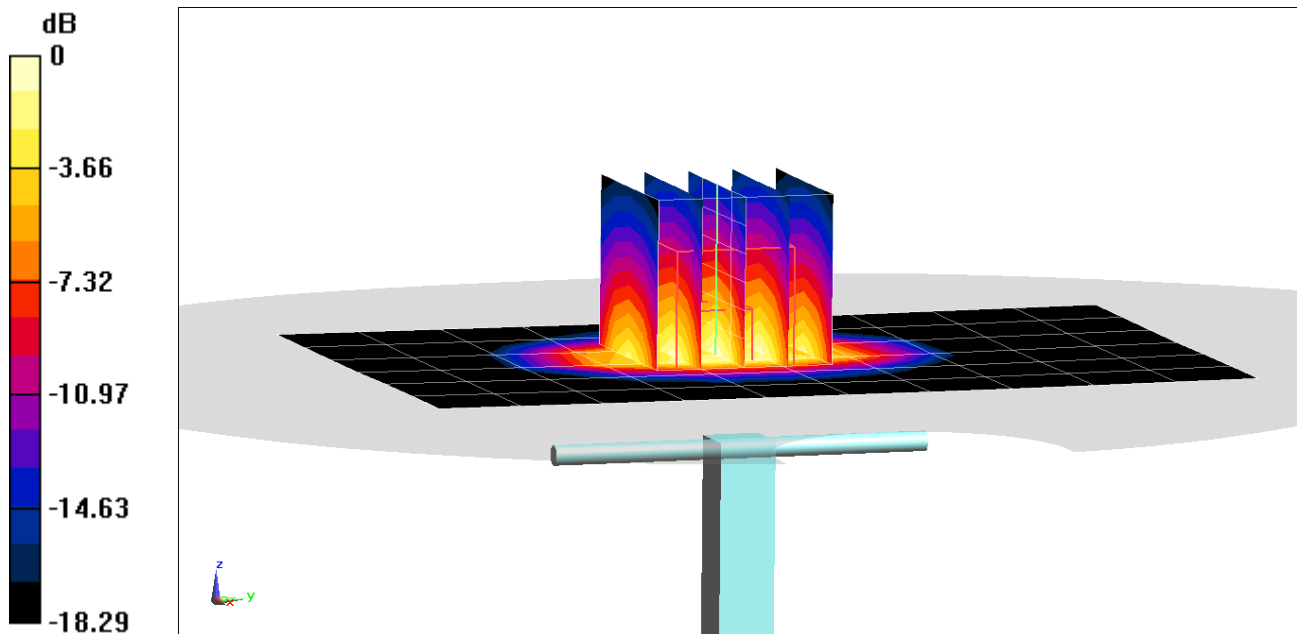

0 dB = 6.41 W/kg = 8.07 dBW/kg



# PCTEST ENGINEERING LABORATORY, INC.

**DUT: Dipole 1900 MHz; Type: D1900V2; Serial: 5d080**

Communication System: UID 0, CW; Frequency: 1900 MHz; Duty Cycle: 1:1

Medium: 1900 Head Medium parameters used (interpolated):

$f = 1900 \text{ MHz}$ ;  $\sigma = 1.456 \text{ S/m}$ ;  $\epsilon_r = 39.355$ ;  $\rho = 1000 \text{ kg/m}^3$

Phantom section: Flat Section; Space: 1.0 cm

Test Date: 07-15-2019; Ambient Temp: 21.4°C; Tissue Temp: 20.7°C

Probe: EX3DV4 - SN3589; ConvF(7.08, 7.08, 7.08) @ 1900 MHz; Calibrated: 1/25/2019

Sensor-Surface: 1.4mm (Mechanical Surface Detection)

Electronics: DAE4 Sn1450; Calibrated: 8/22/2018

Phantom: Twin-SAM V5.0 (30); Type: QD 000 P40 CD; Serial: 1647

Measurement SW: DASY52, Version 52.10 (2); SEMCAD X Version 14.6.12 (7450)

## 1900 MHz System Verification at 20.0 dBm (100 mW)

**Area Scan (7x11x1):** Measurement grid: dx=15mm, dy=15mm

**Zoom Scan (5x5x7)/Cube 0:** Measurement grid: dx=8mm, dy=8mm, dz=5mm

Peak SAR (extrapolated) = 7.90 W/kg

**SAR(1 g) = 4.11 W/kg**

Deviation(1 g) = 3.27%

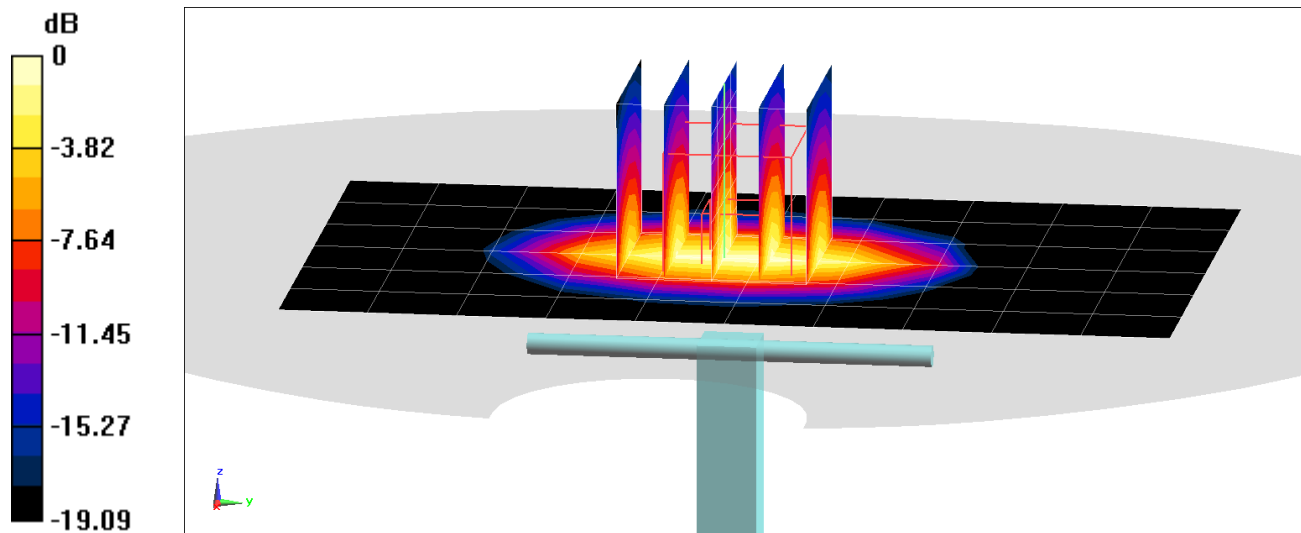

0 dB = 6.49 W/kg = 8.12 dBW/kg

# PCTEST ENGINEERING LABORATORY, INC.

**DUT: Dipole 2300 MHz; Type: D2300V2; Serial: 1073**

Communication System: UID 0, CW; Frequency: 2300 MHz; Duty Cycle: 1:1

Medium: 2450 Head Medium parameters used:

$f = 2300 \text{ MHz}$ ;  $\sigma = 1.72 \text{ S/m}$ ;  $\epsilon_r = 38.621$ ;  $\rho = 1000 \text{ kg/m}^3$

Phantom section: Flat Section; Space: 1.0 cm

Test Date: 07-12-2019; Ambient Temp: 22.5°C; Tissue Temp: 21.1°C

Probe: EX3DV4 - SN3589; ConvF(6.77, 6.77, 6.77) @ 2300 MHz; Calibrated: 1/25/2019

Sensor-Surface: 1.4mm (Mechanical Surface Detection)

Electronics: DAE4 Sn1450; Calibrated: 8/22/2018

Phantom: Twin-SAM V5.0 (30); Type: QD 000 P40 CD; Serial: 1647

Measurement SW: DASY52, Version 52.10 (2);SEMCAD X Version 14.6.12 (7450)

## 2300 MHz System Verification at 20.0 dBm (100 mW)

**Area Scan (8x9x1):** Measurement grid: dx=12mm, dy=12mm

**Zoom Scan (7x7x7)/Cube 0:** Measurement grid: dx=5mm, dy=5mm, dz=5mm

Peak SAR (extrapolated) = 10.8 W/kg

**SAR(1 g) = 5.12 W/kg**

Deviation(1 g) = 4.07%

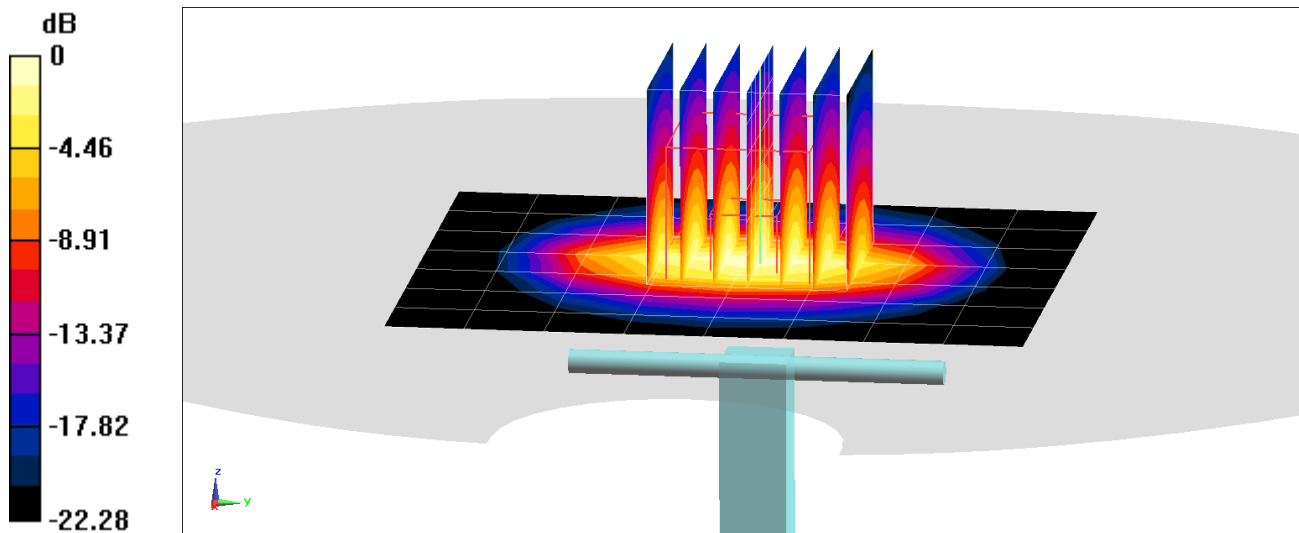

0 dB = 8.58 W/kg = 9.33 dBW/kg

# PCTEST ENGINEERING LABORATORY, INC.

**DUT: Dipole 2450 MHz; Type: D2450V2; Serial: 797**

Communication System: UID 0, CW; Frequency: 2450 MHz; Duty Cycle: 1:1

Medium: 2450 Head Medium parameters used:

$f = 2450$  MHz;  $\sigma = 1.849$  S/m;  $\epsilon_r = 38.492$ ;  $\rho = 1000$  kg/m<sup>3</sup>

Phantom section: Flat Section; Space: 1.0 cm

Test Date: 07-15-2019; Ambient Temp: 21.4°C; Tissue Temp: 20.7°C

Probe: EX3DV4 - SN3589; ConvF(6.46, 6.46, 6.46) @ 2450 MHz; Calibrated: 1/25/2019

Sensor-Surface: 1.4mm (Mechanical Surface Detection)

Electronics: DAE4 Sn1450; Calibrated: 8/22/2018

Phantom: Twin-SAM V5.0 (30); Type: QD 000 P40 CD; Serial: 1647

Measurement SW: DASY52, Version 52.10 (2);SEMCAD X Version 14.6.12 (7450)

## 2450 MHz System Verification at 20.0 dBm (100 mW)

**Area Scan (8x9x1):** Measurement grid: dx=12mm, dy=12mm

**Zoom Scan (7x7x7)/Cube 0:** Measurement grid: dx=5mm, dy=5mm, dz=5mm

Peak SAR (extrapolated) = 11.6 W/kg

**SAR(1 g) = 5.21 W/kg**

Deviation(1 g) = -1.14%

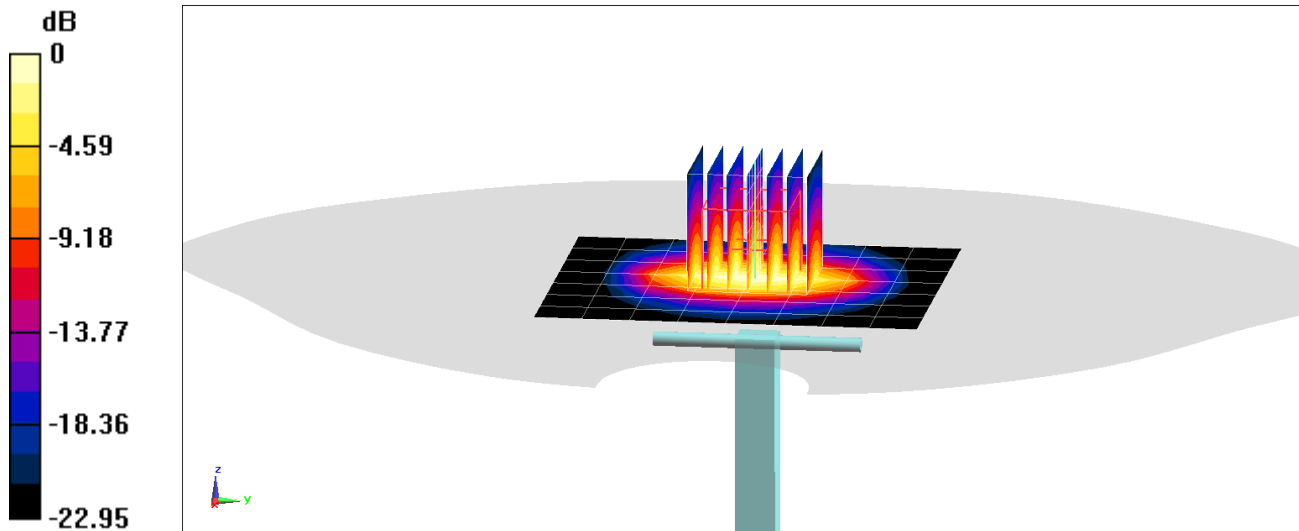

0 dB = 9.00 W/kg = 9.54 dBW/kg

# PCTEST ENGINEERING LABORATORY, INC.

**DUT: Dipole 2450 MHz; Type: D2450V2; Serial: 797**

Communication System: UID 0, CW; Frequency: 2450 MHz; Duty Cycle: 1:1

Medium: 2450 Head Medium parameters used:

$f = 2450 \text{ MHz}$ ;  $\sigma = 1.806 \text{ S/m}$ ;  $\epsilon_r = 37.758$ ;  $\rho = 1000 \text{ kg/m}^3$

Phantom section: Flat Section; Space: 1.0 cm

Test Date: 07-18-2019; Ambient Temp: 23.8°C; Tissue Temp: 20.9°C

Probe: EX3DV4 - SN3589; ConvF(6.46, 6.46, 6.46) @ 2450 MHz; Calibrated: 1/25/2019

Sensor-Surface: 1.4mm (Mechanical Surface Detection)

Electronics: DAE4 Sn1450; Calibrated: 8/22/2018

Phantom: Twin-SAM V5.0 (30); Type: QD 000 P40 CD; Serial: 1647

Measurement SW: DASY52, Version 52.10 (2); SEMCAD X Version 14.6.12 (7450)

## 2450 MHz System Verification at 20.0 dBm (100 mW)

**Area Scan (8x9x1):** Measurement grid: dx=12mm, dy=12mm

**Zoom Scan (7x7x7)/Cube 0:** Measurement grid: dx=5mm, dy=5mm, dz=5mm

Peak SAR (extrapolated) = 11.6 W/kg

**SAR(1 g) = 5.35 W/kg**

Deviation(1 g) = 1.52%

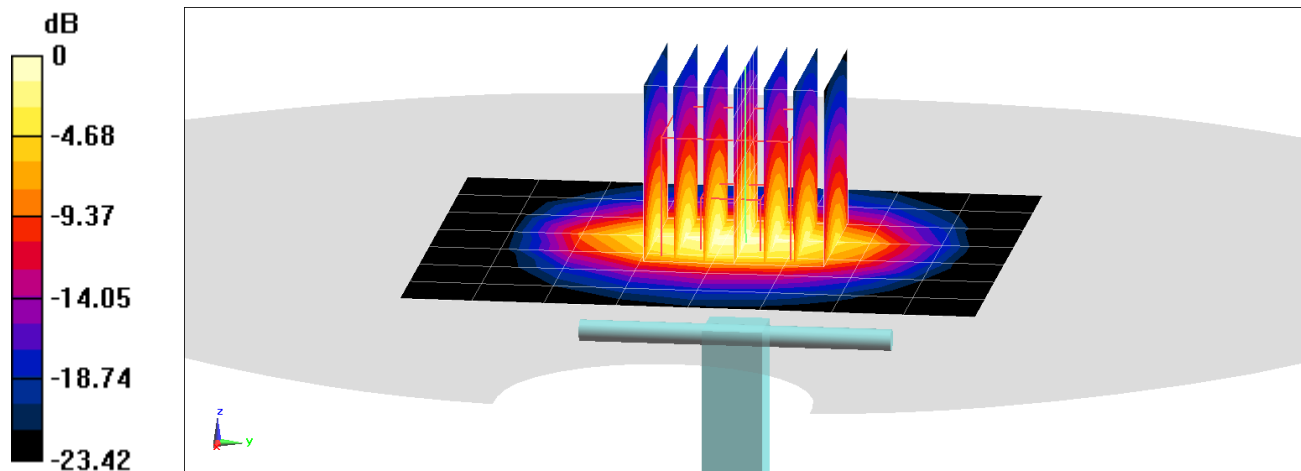

0 dB = 9.08 W/kg = 9.58 dBW/kg

# PCTEST ENGINEERING LABORATORY, INC.

**DUT: Dipole 5 GHz; Type: D5GHzV2; Serial: 1237**

Communication System: UID 0, CW; Frequency: 5250 MHz; Duty Cycle: 1:1

Medium: 5HGz Head; Medium parameters used (interpolated):

$f = 5250 \text{ MHz}$ ;  $\sigma = 4.552 \text{ S/m}$ ;  $\epsilon_r = 35.074$ ;  $\rho = 1000 \text{ kg/m}^3$

Phantom section: Flat Section; Space: 1.0 cm

Test Date: 07-19-2019; Ambient Temp: 23.4°C; Tissue Temp: 22.3°C

Probe: EX3DV4 - SN7406; ConvF(5.54, 5.54, 5.54) @ 5250 MHz; Calibrated: 5/16/2019

Sensor-Surface: 1.4mm (Mechanical Surface Detection)

Electronics: DAE4 Sn859; Calibrated: 5/8/2019

Phantom: Twin-SAM V5.0 Right 20; Type: QD 000 P40 CD; Serial: 1759

Measurement SW: DASY52, Version 52.10 (2);SEMCAD X Version 14.6.12 (7450)

## 5250 MHz System Verification at 17.0 dBm (50 mW)

**Area Scan (7x7x1):** Measurement grid: dx=10mm, dy=10mm

**Zoom Scan (8x8x7)/Cube 0:** Measurement grid: dx=4mm, dy=4mm, dz=1.4mm; Graded Ratio: 1.4

Peak SAR (extrapolated) = 15.9 W/kg

**SAR(1 g) = 3.91 W/kg**

Deviation(1 g) = -3.81%

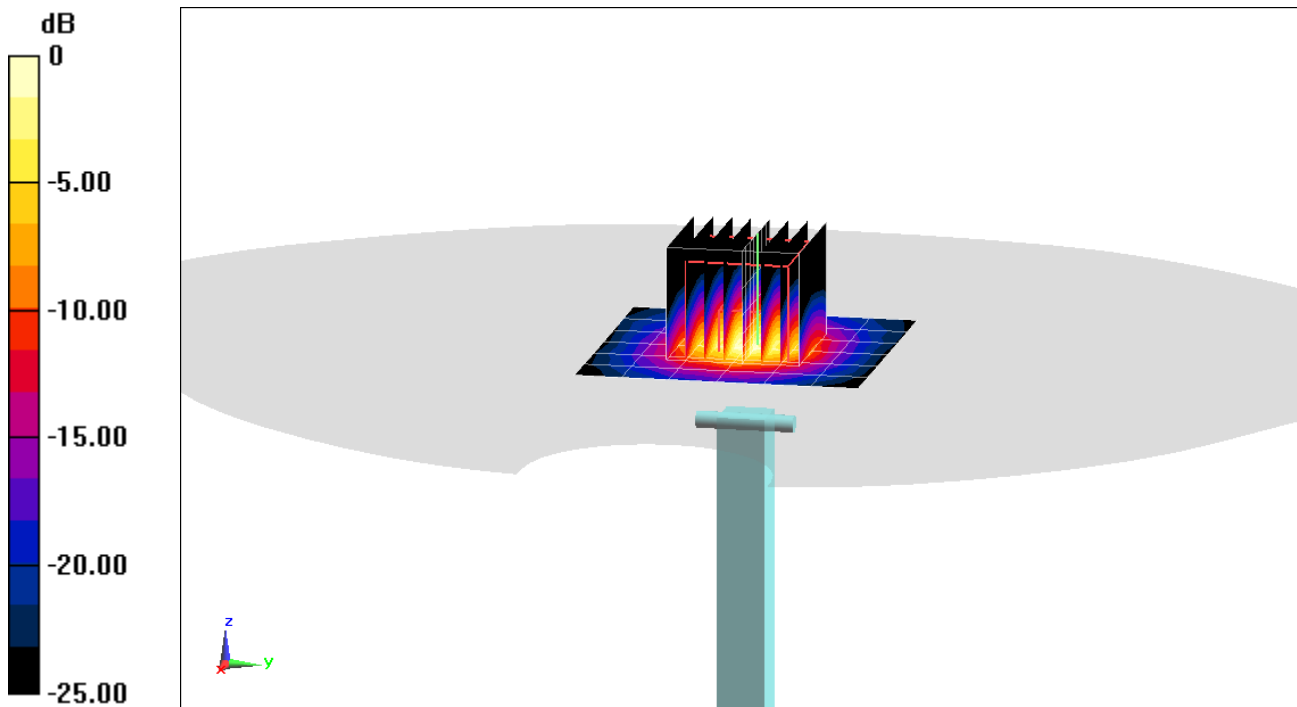

0 dB = 9.26 W/kg = 9.67 dBW/kg

# PCTEST ENGINEERING LABORATORY, INC.

**DUT: Dipole 5 GHz; Type: D5GHzV2; Serial: 1237**

Communication System: UID 0, CW; Frequency: 5600 MHz; Duty Cycle: 1:1

Medium: 5HGz Head; Medium parameters used:

$f = 5600 \text{ MHz}$ ;  $\sigma = 4.939 \text{ S/m}$ ;  $\epsilon_r = 34.452$ ;  $\rho = 1000 \text{ kg/m}^3$

Phantom section: Flat Section; Space: 1.0 cm

Test Date: 07-19-2019; Ambient Temp: 23.4°C; Tissue Temp: 22.3°C

Probe: EX3DV4 - SN7406; ConvF(4.94, 4.94, 4.94) @ 5600 MHz; Calibrated: 5/16/2019

Sensor-Surface: 1.4mm (Mechanical Surface Detection)

Electronics: DAE4 Sn859; Calibrated: 5/8/2019

Phantom: Twin-SAM V5.0 Right 20; Type: QD 000 P40 CD; Serial: 1759

Measurement SW: DASY52, Version 52.10 (2);SEMCAD X Version 14.6.12 (7450)

## 5600 MHz System Verification at 17.0 dBm (50 mW)

**Area Scan (7x7x1):** Measurement grid: dx=10mm, dy=10mm

**Zoom Scan (8x8x7)/Cube 0:** Measurement grid: dx=4mm, dy=4mm, dz=1.4mm; Graded Ratio: 1.4

Peak SAR (extrapolated) = 18.0 W/kg

**SAR(1 g) = 4 W/kg**

Deviation(1 g) = -6.65%

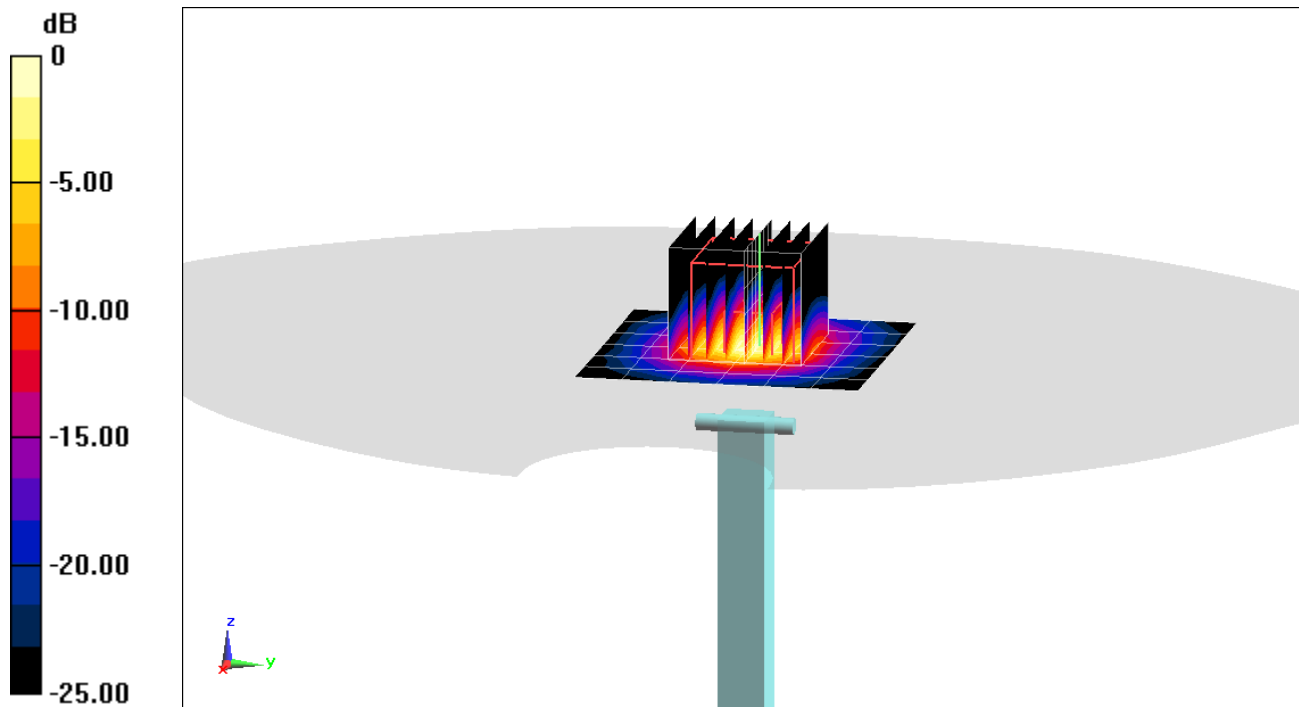

0 dB = 9.85 W/kg = 9.93 dBW/kg

# PCTEST ENGINEERING LABORATORY, INC.

**DUT: Dipole 5 GHz; Type: D5GHzV2; Serial: 1237**

Communication System: UID 0, CW; Frequency: 5750 MHz; Duty Cycle: 1:1  
Medium: 5HGz Head; Medium parameters used (interpolated):  
 $f = 5750 \text{ MHz}$ ;  $\sigma = 5.117 \text{ S/m}$ ;  $\epsilon_r = 34.196$ ;  $\rho = 1000 \text{ kg/m}^3$   
Phantom section: Flat Section; Space: 1.0 cm

Test Date: 07-19-2019; Ambient Temp: 23.4°C; Tissue Temp: 22.3°C

Probe: EX3DV4 - SN7406; ConvF(5.23, 5.23, 5.23) @ 5750 MHz; Calibrated: 5/16/2019  
Sensor-Surface: 1.4mm (Mechanical Surface Detection)  
Electronics: DAE4 Sn859; Calibrated: 5/8/2019  
Phantom: Twin-SAM V5.0 Right 20; Type: QD 000 P40 CD; Serial: 1759  
Measurement SW: DASY52, Version 52.10 (2);SEMCAD X Version 14.6.12 (7450)

## 5750 MHz System Verification at 17.0 dBm (50 mW)

**Area Scan (7x7x1):** Measurement grid: dx=10mm, dy=10mm

**Zoom Scan (8x8x7)/Cube 0:** Measurement grid: dx=4mm, dy=4mm, dz=1.4mm; Graded Ratio: 1.4

Peak SAR (extrapolated) = 17.8 W/kg

**SAR(1 g) = 3.98 W/kg**

Deviation(1 g) = -1.24%

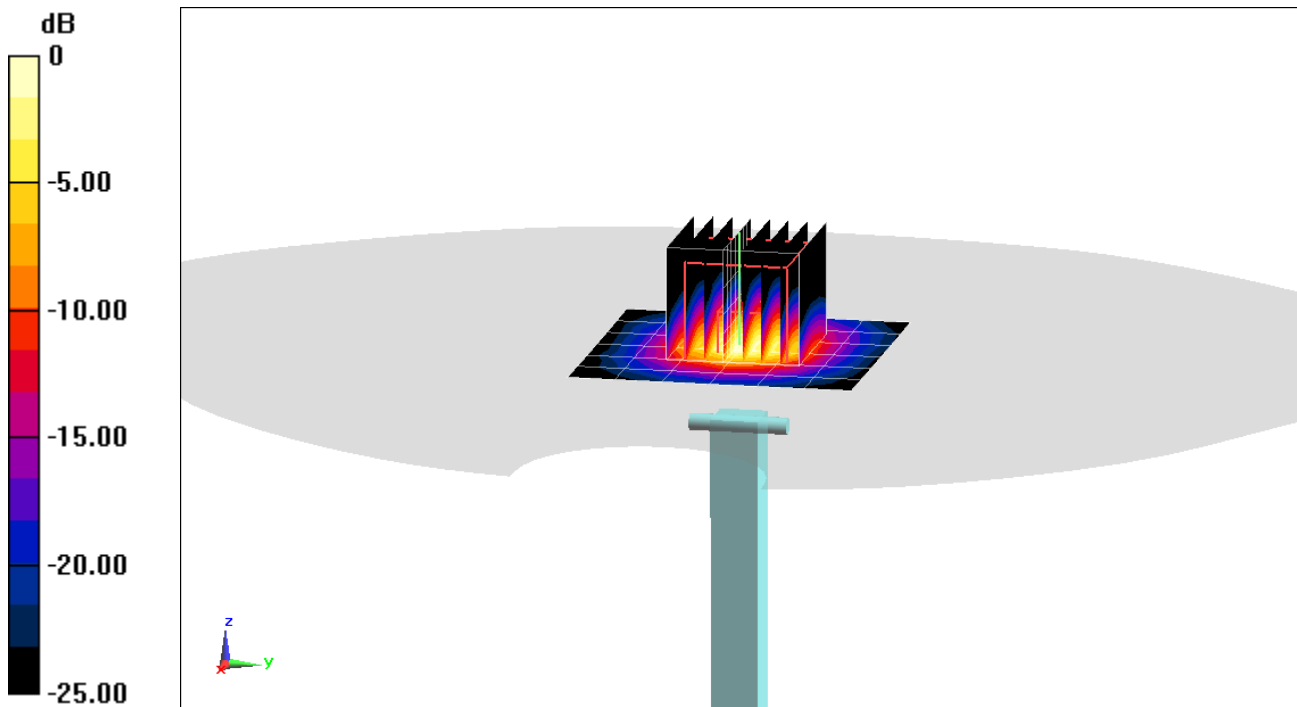

0 dB = 9.47 W/kg = 9.76 dBW/kg

# PCTEST ENGINEERING LABORATORY, INC.

**DUT: Dipole 750 MHz; Type: D750V3; Serial: 1003**

Communication System: UID 0, CW; Frequency: 750 MHz; Duty Cycle: 1:1

Medium: 750 Body Medium parameters used (interpolated):

$f = 750 \text{ MHz}$ ;  $\sigma = 0.943 \text{ S/m}$ ;  $\epsilon_r = 57.38$ ;  $\rho = 1000 \text{ kg/m}^3$

Phantom section: Flat Section; Space: 1.5 cm

Test Date: 07-08-2019; Ambient Temp: 22.8°C; Tissue Temp: 22.1°C

Probe: EX3DV4 - SN3914; ConvF(9.73, 9.73, 9.73) @ 750 MHz; Calibrated: 2/19/2019

Sensor-Surface: 1.4mm (Mechanical Surface Detection)

Electronics: DAE4 Sn1272; Calibrated: 2/14/2019

Phantom: Twin-SAM V5.0 Left 30; Type: QD 000 P40 CD; Serial: 1687

Measurement SW: DASY52, Version 52.10 (2);SEMCAD X Version 14.6.12 (7450)

## 750 MHz System Verification at 23.0 dBm (200 mW)

**Area Scan (7x15x1):** Measurement grid: dx=15mm, dy=15mm

**Zoom Scan (5x5x7)/Cube 0:** Measurement grid: dx=8mm, dy=8mm, dz=5mm

Peak SAR (extrapolated) = 2.55 W/kg

**SAR(1 g) = 1.73 W/kg**

Deviation(1 g) = 0.82%

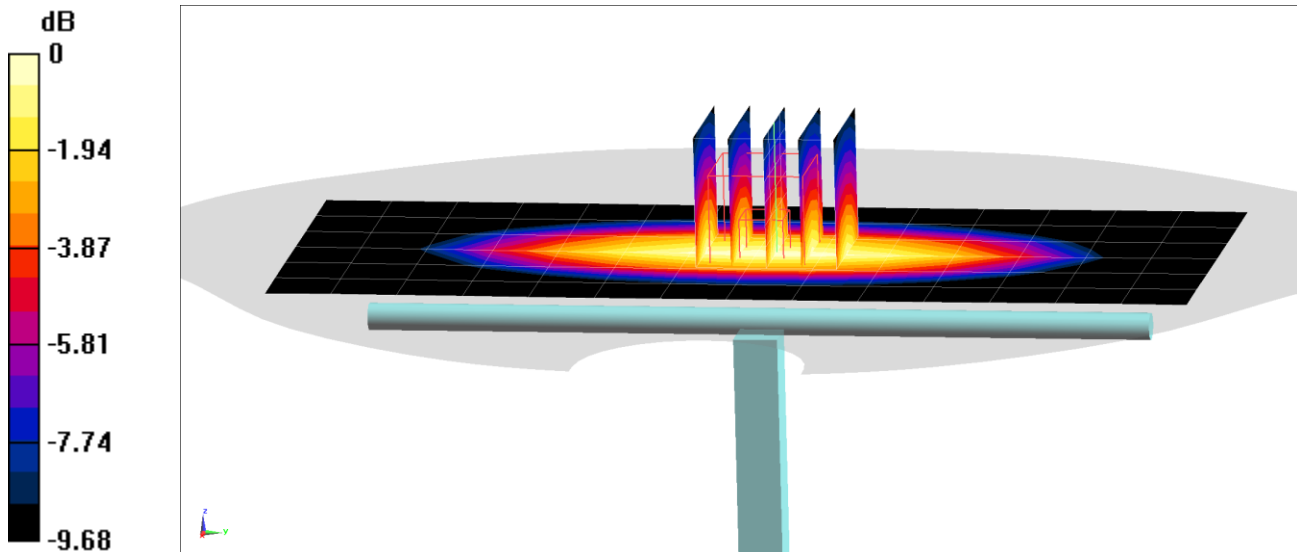

0 dB = 2.28 W/kg = 3.58 dBW/kg



# PCTEST ENGINEERING LABORATORY, INC.

**DUT: Dipole 835 MHz; Type: D835V2; Serial: 4d047**

Communication System: UID 0, CW; Frequency: 835 MHz; Duty Cycle: 1:1

Medium: 835 Body; Medium parameters used:

$f = 835 \text{ MHz}$ ;  $\sigma = 0.964 \text{ S/m}$ ;  $\epsilon_r = 53.916$ ;  $\rho = 1000 \text{ kg/m}^3$

Phantom section: Flat Section; Space: 1.5 cm

Test Date: 07-16-2019; Ambient Temp: 20.3°C; Tissue Temp: 20.4°C

Probe: EX3DV4 - SN7538; ConvF(9.85, 9.85, 9.85) @ 835 MHz; Calibrated: 5/16/2019

Sensor-Surface: 1.4mm (Mechanical Surface Detection)

Electronics: DAE4 Sn728; Calibrated: 5/8/2019

Phantom: Left Twin-SAM V5.0 30; Type: QD 000 P40 CD; Serial: 1792

Measurement SW: DASY52, Version 52.10 (2);SEMCAD X Version 14.6.12 (7450)

## 835 MHz System Verification at 23.0 dBm (200 mW)

**Area Scan (7x14x1):** Measurement grid: dx=15mm, dy=15mm

**Zoom Scan (5x5x7)/Cube 0:** Measurement grid: dx=8mm, dy=8mm, dz=5mm

Peak SAR (extrapolated) = 3.04 W/kg

**SAR(1 g) = 2 W/kg**

Deviation (1 g) = 5.60%

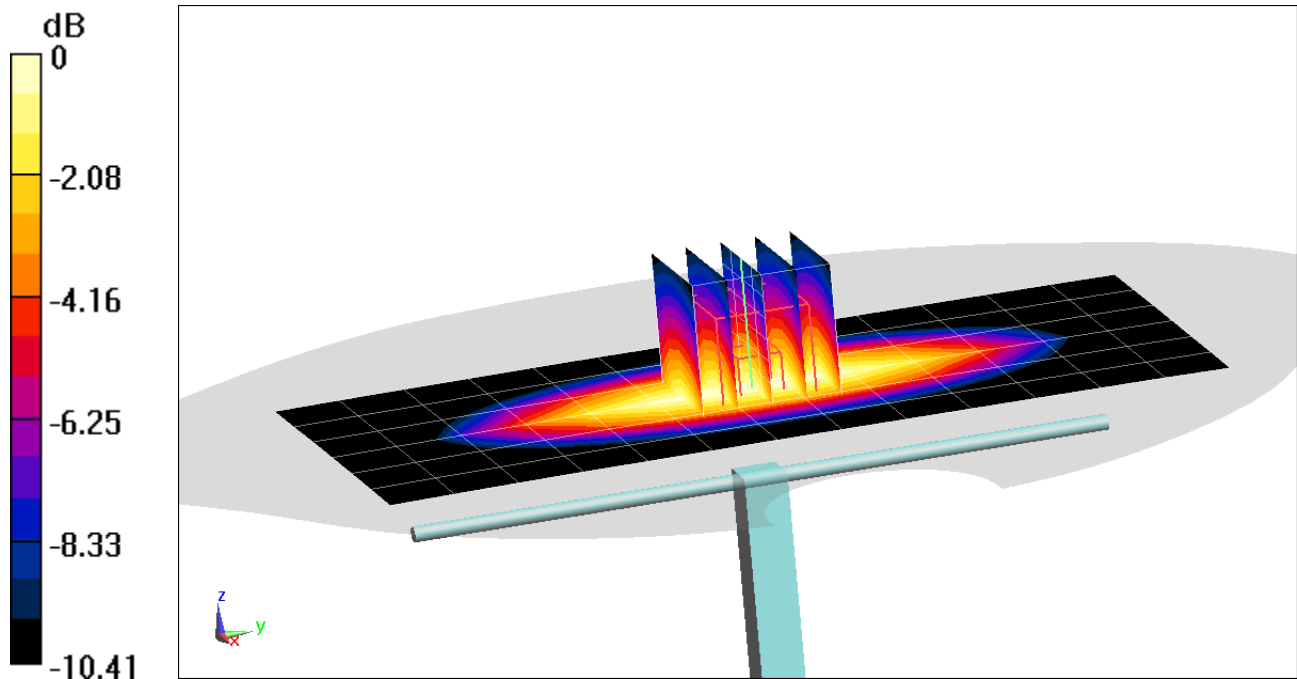

# PCTEST ENGINEERING LABORATORY, INC.

**DUT: Dipole 1750 MHz; Type: D1750V2; Serial: 1150**

Communication System: UID 0, CW; Frequency: 1750 MHz; Duty Cycle: 1:1

Medium: 1750 Body Medium parameters used:

$f = 1750$  MHz;  $\sigma = 1.445$  S/m;  $\epsilon_r = 53.923$ ;  $\rho = 1000$  kg/m<sup>3</sup>

Phantom section: Flat Section; Space: 1.0 cm

Test Date: 07-11-2019; Ambient Temp: 22.8°C; Tissue Temp: 21.7°C

Probe: EX3DV4 - SN7409; ConvF(7.85, 7.85, 7.85) @ 1750 MHz; Calibrated: 6/19/2019

Sensor-Surface: 1.4mm (Mechanical Surface Detection)

Electronics: DAE4 Sn1334; Calibrated: 6/20/2019

Phantom: SAM Left; Type: QD000P40CA; Serial: TP:82355

Measurement SW: DASY52, Version 52.10 (2); SEMCAD X Version 14.6.12 (7450)

## 1750 MHz System Verification at 20.0 dBm (100 mW)

**Area Scan (7x9x1):** Measurement grid: dx=15mm, dy=15mm

**Zoom Scan (5x5x7)/Cube 0:** Measurement grid: dx=8mm, dy=8mm, dz=5mm

Peak SAR (extrapolated) = 6.96 W/kg

**SAR(1 g) = 3.82 W/kg**

Deviation(1 g) = 4.37%

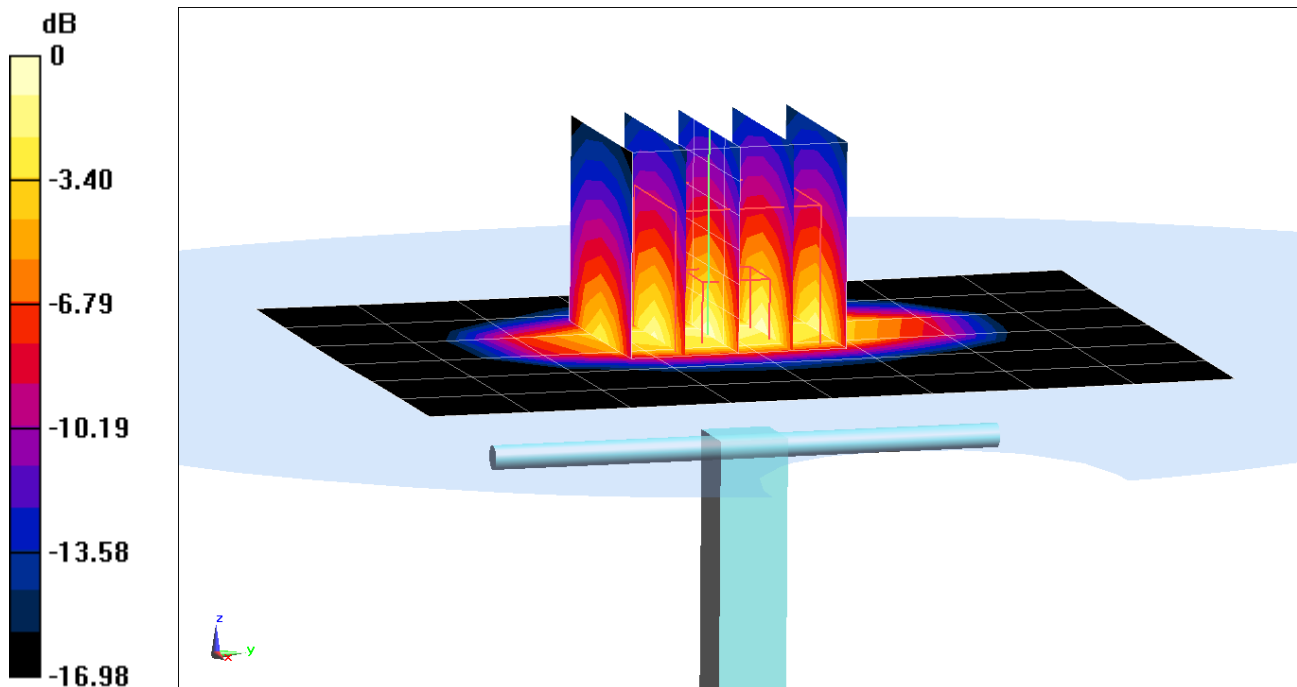

0 dB = 5.77 W/kg = 7.61 dBW/kg

# PCTEST ENGINEERING LABORATORY, INC.

**DUT: Dipole 1750 MHz; Type: D1750V2; Serial: 1150**

Communication System: UID 0, CW; Frequency: 1750 MHz; Duty Cycle: 1:1

Medium: 1750 Body Medium parameters used:

$f = 1750$  MHz;  $\sigma = 1.464$  S/m;  $\epsilon_r = 53.969$ ;  $\rho = 1000$  kg/m<sup>3</sup>

Phantom section: Flat Section; Space: 1.0 cm

Test Date: 07-17-2019; Ambient Temp: 22.6°C; Tissue Temp: 21.9°C

Probe: EX3DV4 - SN7409; ConvF(7.85, 7.85, 7.85) @ 1750 MHz; Calibrated: 6/19/2019

Sensor-Surface: 1.4mm (Mechanical Surface Detection)

Electronics: DAE4 Sn1334; Calibrated: 6/20/2019

Phantom: SAM Left; Type: QD000P40CA; Serial: TP:82355

Measurement SW: DASY52, Version 52.10 (2);SEMCAD X Version 14.6.12 (7450)

## 1750 MHz System Verification at 20.0 dBm (100 mW)

**Area Scan (7x9x1):** Measurement grid: dx=15mm, dy=15mm

**Zoom Scan (5x5x7)/Cube 0:** Measurement grid: dx=8mm, dy=8mm, dz=5m

Peak SAR (extrapolated) = 7.12 W/kg

**SAR(1 g) = 3.88 W/kg**

Deviation(1 g) = 6.01%

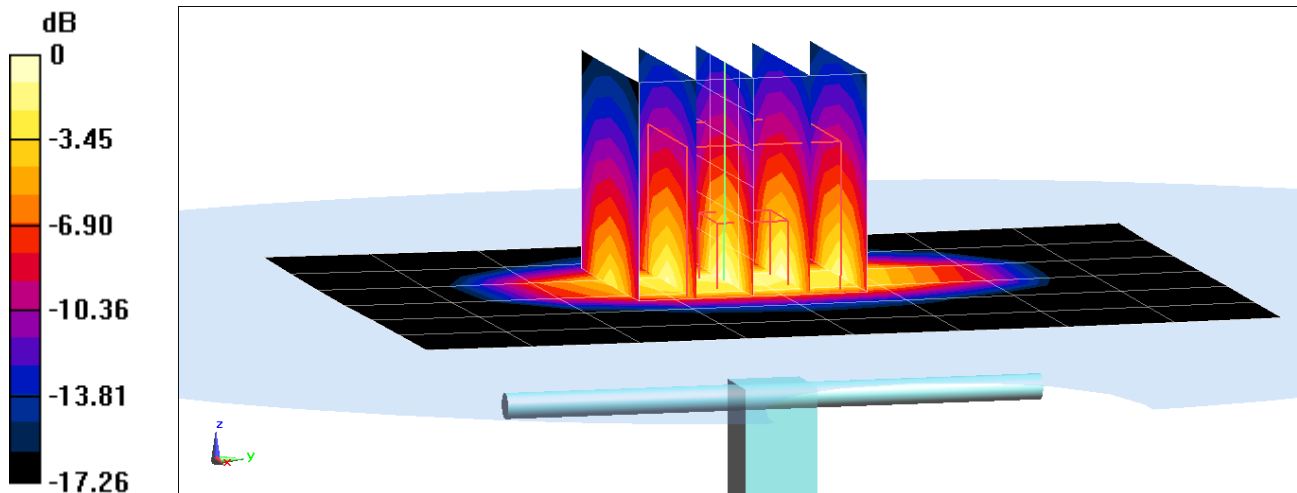

0 dB = 5.92 W/kg = 7.72 dBW/kg

# PCTEST ENGINEERING LABORATORY, INC.

**DUT: Dipole 1900 MHz; Type: D1900V2; Serial: 5d148**

Communication System: UID 0, CW; Frequency: 1900 MHz; Duty Cycle: 1:1

Medium: 1900 Body; Medium parameters used (interpolated):

$f = 1900 \text{ MHz}$ ;  $\sigma = 1.561 \text{ S/m}$ ;  $\epsilon_r = 52.388$ ;  $\rho = 1000 \text{ kg/m}^3$

Phantom section: Flat Section; Space: 1.0 cm

Test Date: 07-15-2019; Ambient Temp: 19.6°C; Tissue Temp: 20.6°C

Probe: EX3DV4 - SN7357; ConvF(7.93, 7.93, 7.93) @ 1900 MHz; Calibrated: 4/24/2019

Sensor-Surface: 1.4mm (Mechanical Surface Detection)

Electronics: DAE4 Sn1407; Calibrated: 4/18/2019

Phantom: Twin-SAM V4.0 Front Right; Type: QD 000 P40 CC; Serial: 1167

Measurement SW: DASY52, Version 52.10 (2);SEMCAD X Version 14.6.12 (7450)

## 1900 MHz System Verification at 20.0 dBm (100 mW)

**Area Scan (7x11x1):** Measurement grid: dx=15mm, dy=15mm

**Zoom Scan (5x5x7)/Cube 0:** Measurement grid: dx=8mm, dy=8mm, dz=5mm

Peak SAR (extrapolated) = 7.52 W/kg

**SAR(1 g) = 4.02 W/kg**

Deviation(1 g) = 2.81%

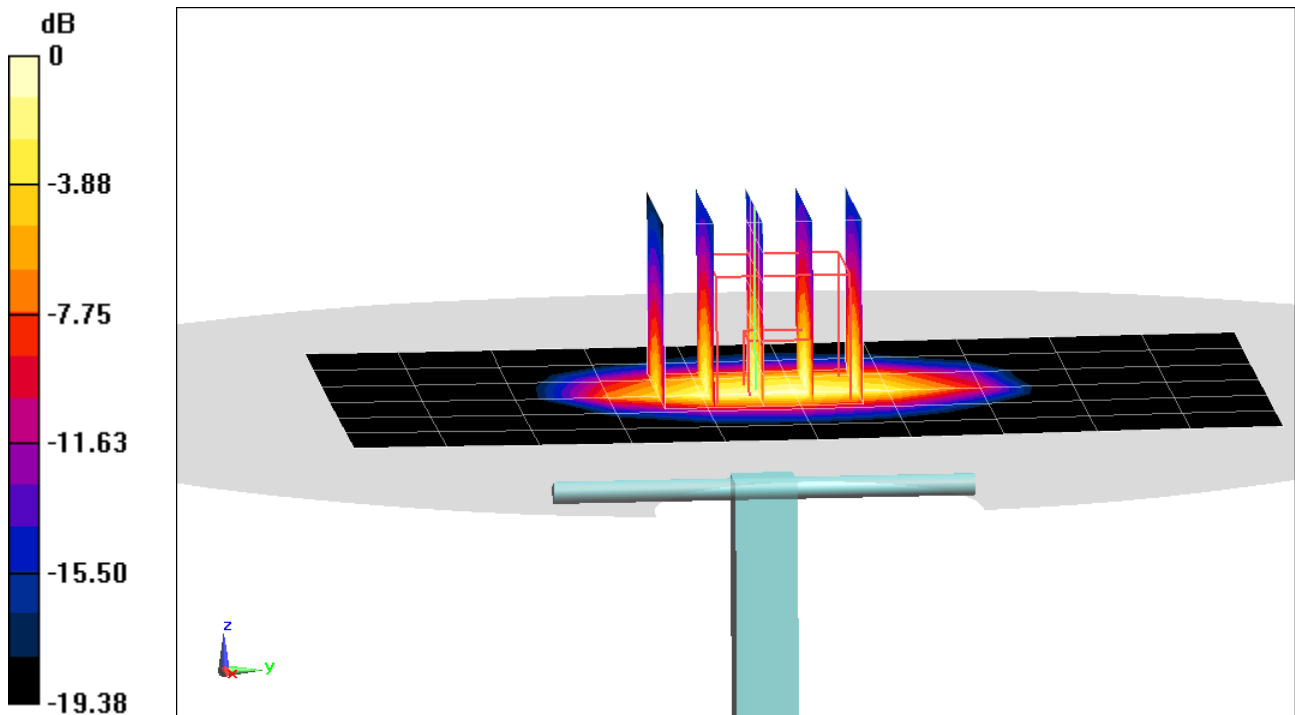

0 dB = 6.19 W/kg = 7.92 dBW/kg

# PCTEST ENGINEERING LABORATORY, INC.

**DUT: Dipole 2300 MHz; Type: D2300V2; Serial: 1073**

Communication System: UID 0, CW; Frequency: 2300 MHz; Duty Cycle: 1:1

Medium: 2450 Body; Medium parameters used:

$f = 2300$  MHz;  $\sigma = 1.863$  S/m;  $\epsilon_r = 52.555$ ;  $\rho = 1000$  kg/m<sup>3</sup>

Phantom section: Flat Section; Space: 1.0 cm

Test Date: 07-15-2019; Ambient Temp: 22.2°C; Tissue Temp: 22.1°C

Probe: EX3DV4 - SN7417; ConvF(7.64, 7.64, 7.64) @ 2300 MHz; Calibrated: 2/19/2019

Sensor-Surface: 1.4mm (Mechanical Surface Detection)

Electronics: DAE4 Sn665; Calibrated: 2/13/2019

Phantom: LeftTwin-SAM V5.0; Type: QD 000 P40 CD; Serial: TP1375

Measurement SW: DASY52, Version 52.10 (2);SEMCAD X Version 14.6.12 (7450)

## 2300 MHz System Verification at 20.0 dBm (100 mW)

**Area Scan (8x9x1):** Measurement grid: dx=12mm, dy=12mm

**Zoom Scan (7x7x7)/Cube 0:** Measurement grid: dx=5mm, dy=5mm, dz=5mm

Peak SAR (extrapolated) = 10.0 W/kg

**SAR(1 g) = 5.05 W/kg; SAR(10 g) = 2.39 W/kg**

Deviation(1 g) = 5.87%; Deviation(10 g) = 3.02%

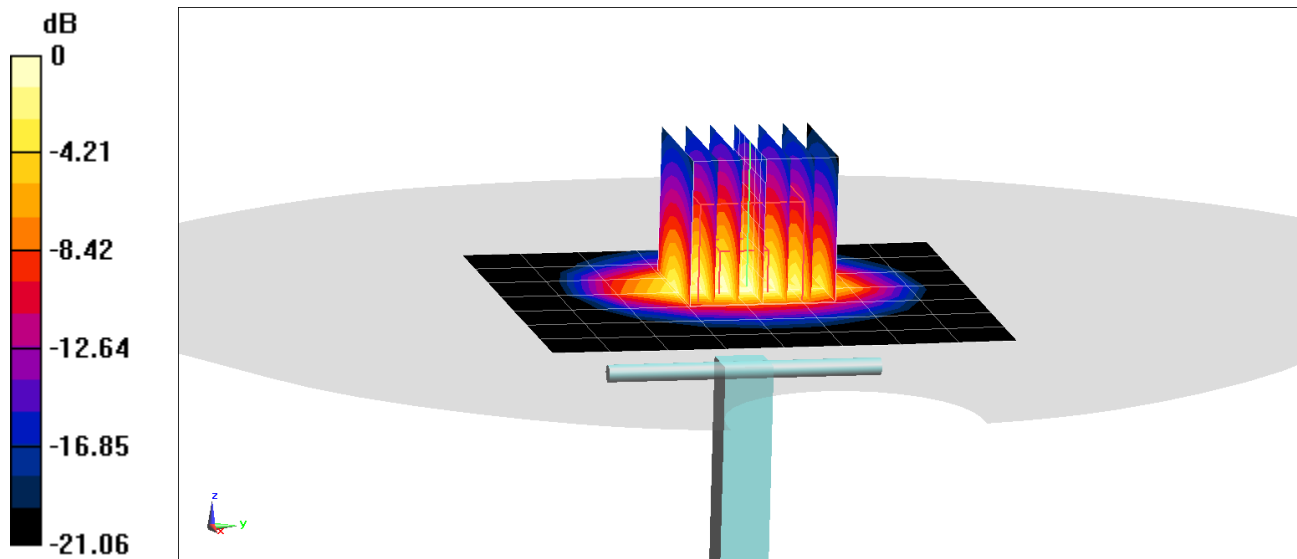

0 dB = 8.19 W/kg = 9.13 dBW/kg

# PCTEST ENGINEERING LABORATORY, INC.

**DUT: Dipole 2450 MHz; Type: D2450V2; Serial: 719**

Communication System: UID 0, CW; Frequency: 2450 MHz; Duty Cycle: 1:1

Medium: 2450 Body; Medium parameters used:

$f = 2450$  MHz;  $\sigma = 2.041$  S/m;  $\epsilon_r = 51.486$ ;  $\rho = 1000$  kg/m<sup>3</sup>

Phantom section: Flat Section; Space: 1.0 cm

Test Date: 07-18-2019; Ambient Temp: 22.6°C; Tissue Temp: 22.2°C

Probe: EX3DV4 - SN7417; ConvF(7.51, 7.51, 7.51) @ 2450 MHz; Calibrated: 2/19/2019

Sensor-Surface: 1.4mm (Mechanical Surface Detection)

Electronics: DAE4 Sn665; Calibrated: 2/13/2019

Phantom: LeftTwin-SAM V5.0; Type: QD 000 P40 CD; Serial: TP1375

Measurement SW: DASY52, Version 52.10 (2);SEMCAD X Version 14.6.12 (7450)

## 2450 MHz System Verification at 20.0 dBm (100 mW)

**Area Scan (8x9x1):** Measurement grid: dx=12mm, dy=12mm

**Zoom Scan (7x7x7)/Cube 0:** Measurement grid: dx=5mm, dy=5mm, dz=5mm

Peak SAR (extrapolated) = 10.9 W/kg

**SAR(1 g) = 5.22 W/kg**

Deviation(1 g) = 4.19%

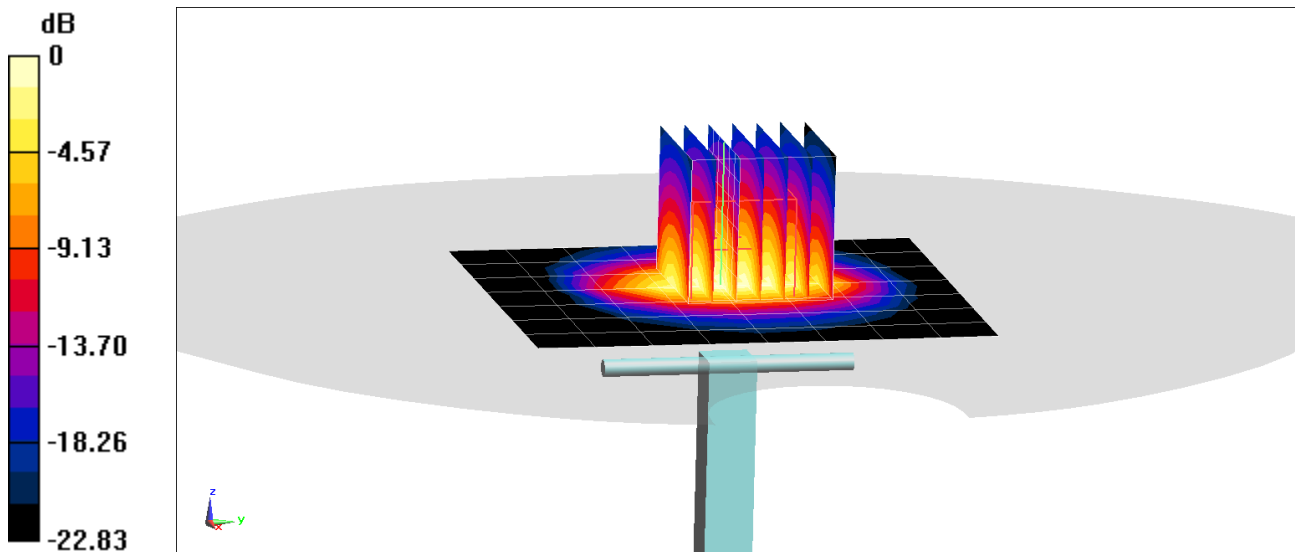

0 dB = 8.71 W/kg = 9.40 dBW/kg

# PCTEST ENGINEERING LABORATORY, INC.

**DUT: Dipole 5 GHz; Type: D5GHzV2; Serial: 1057**

Communication System: UID 0, CW; Frequency: 5250 MHz; Duty Cycle: 1:1

Medium: 5GHz Body Medium parameters used (interpolated):

$f = 5250 \text{ MHz}$ ;  $\sigma = 5.184 \text{ S/m}$ ;  $\epsilon_r = 48.393$ ;  $\rho = 1000 \text{ kg/m}^3$

Phantom section: Flat Section; Space: 1.0 cm

Test Date: 07-16-2019; Ambient Temp: 23.0°C; Tissue Temp: 20.1°C

Probe: EX3DV4 - SN7308; ConvF(4.48, 4.48, 4.48) @ 5250 MHz; Calibrated: 8/23/2018

Sensor-Surface: 1.4mm (Mechanical Surface Detection)

Electronics: DAE4 Sn1558; Calibrated: 10/3/2018

Phantom: Twin-SAM V5.0; Type: QD 000 P40 CD; Serial: 1630

Measurement SW: DASY52, Version 52.10 (2);SEMCAD X Version 14.6.12 (7450)

## 5250 MHz System Verification at 17.0 dBm (50 mW)

**Area Scan (7x7x1):** Measurement grid: dx=10mm, dy=10mm

**Zoom Scan (8x8x7)/Cube 0:** Measurement grid: dx=4mm, dy=4mm, dz=1.4mm; Graded Ratio: 1.4

Peak SAR (extrapolated) = 15.6 W/kg

**SAR(1 g) = 3.87 W/kg; SAR(10 g) = 1.08 W/kg**

Deviation(1 g) = 1.98%; Deviation(10 g) = 2.37%

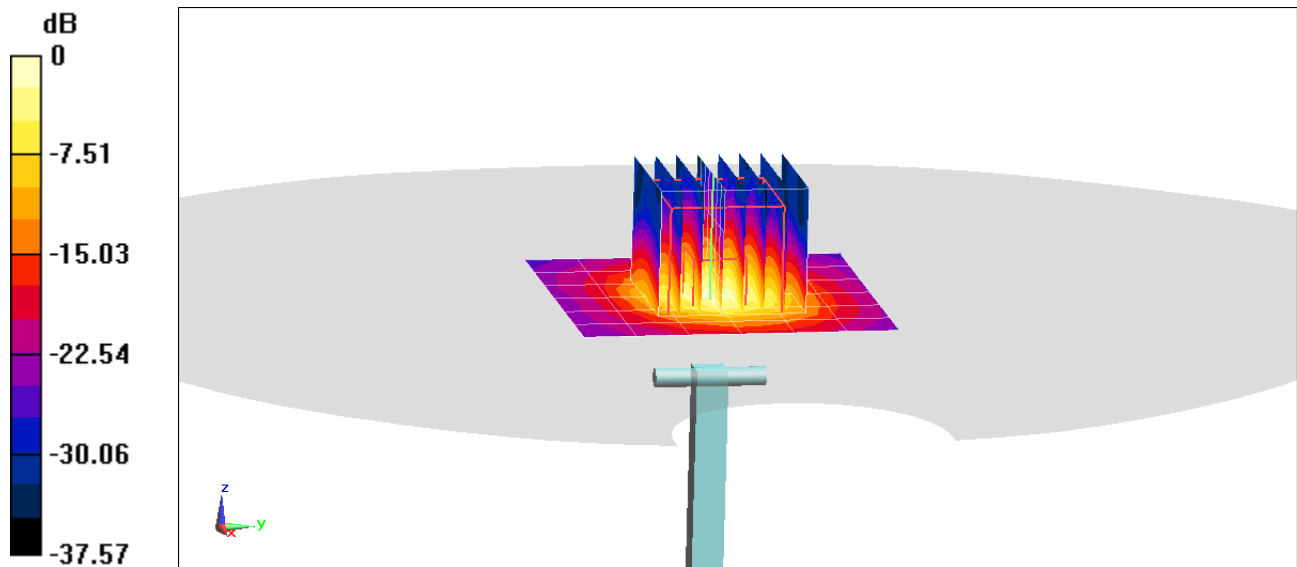

0 dB = 9.49 W/kg = 9.77 dBW/kg

# PCTEST ENGINEERING LABORATORY, INC.

**DUT: Dipole 5 GHz; Type: D5GHzV2; Serial: 1057**

Communication System: UID 0, CW; Frequency: 5600 MHz; Duty Cycle: 1:1

Medium: 5GHz Body Medium parameters used:

$f = 5600 \text{ MHz}$ ;  $\sigma = 5.665 \text{ S/m}$ ;  $\epsilon_r = 47.819$ ;  $\rho = 1000 \text{ kg/m}^3$

Phantom section: Flat Section; Space: 1.0 cm

Test Date: 07-16-2019; Ambient Temp: 23.0°C; Tissue Temp: 20.1°C

Probe: EX3DV4 - SN7308; ConvF(4, 4, 4) @ 5600 MHz; Calibrated: 8/23/2018

Sensor-Surface: 1.4mm (Mechanical Surface Detection)

Electronics: DAE4 Sn1558; Calibrated: 10/3/2018

Phantom: Twin-SAM V5.0; Type: QD 000 P40 CD; Serial: 1630

Measurement SW: DASY52, Version 52.10 (2);SEMCAD X Version 14.6.12 (7450)

## 5600 MHz System Verification at 17.0 dBm (50 mW)

**Area Scan (7x7x1):** Measurement grid: dx=10mm, dy=10mm

**Zoom Scan (8x8x7)/Cube 0:** Measurement grid: dx=4mm, dy=4mm, dz=1.4mm; Graded Ratio: 1.4

Peak SAR (extrapolated) = 16.6 W/kg

**SAR(1 g) = 3.78 W/kg; SAR(10 g) = 1.04 W/kg**

Deviation(1 g) = -5.38%; Deviation(10 g) = -6.73%

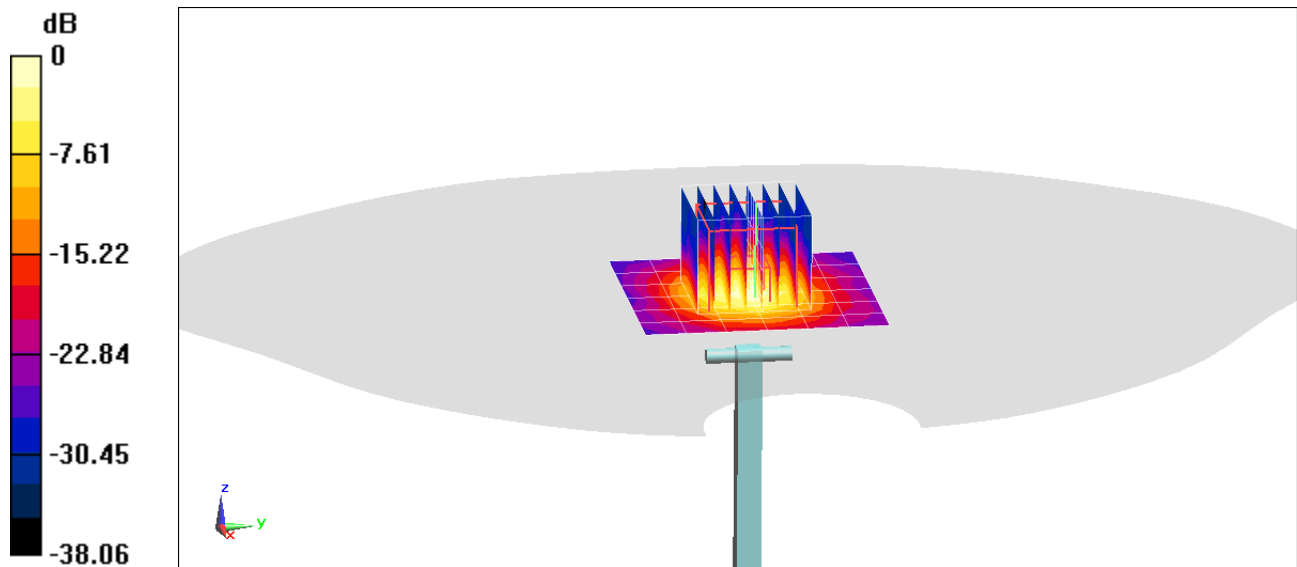

0 dB = 9.28 W/kg = 9.68 dBW/kg



# PCTEST ENGINEERING LABORATORY, INC.

**DUT: Dipole 5 GHz; Type: D5GHzV2; Serial: 1057**

Communication System: UID 0, CW; Frequency: 5750 MHz; Duty Cycle: 1:1

Medium: 5GHz Body Medium parameters used (interpolated):

$f = 5750 \text{ MHz}$ ;  $\sigma = 5.882 \text{ S/m}$ ;  $\epsilon_r = 47.567$ ;  $\rho = 1000 \text{ kg/m}^3$

Phantom section: Flat Section; Space: 1.0 cm

Test Date: 07-16-2019; Ambient Temp: 23.0°C; Tissue Temp: 20.1°C

Probe: EX3DV4 - SN7308; ConvF(4.18, 4.18, 4.18) @ 5750 MHz; Calibrated: 8/23/2018

Sensor-Surface: 1.4mm (Mechanical Surface Detection)

Electronics: DAE4 Sn1558; Calibrated: 10/3/2018

Phantom: Twin-SAM V5.0; Type: QD 000 P40 CD; Serial: 1630

Measurement SW: DASY52, Version 52.10 (2);SEMCAD X Version 14.6.12 (7450)

## 5750 MHz System Verification at 17.0 dBm (50 mW)

**Area Scan (7x7x1):** Measurement grid: dx=10mm, dy=10mm

**Zoom Scan (9x9x7)/Cube 0:** Measurement grid: dx=4mm, dy=4mm, dz=1.4mm; Graded Ratio: 1.4

Peak SAR (extrapolated) = 16.0 W/kg

**SAR(1 g) = 3.47 W/kg; SAR(10 g) = 0.965 W/kg**

Deviation(1 g) = -9.52%; Deviation(10 g) = -8.96%

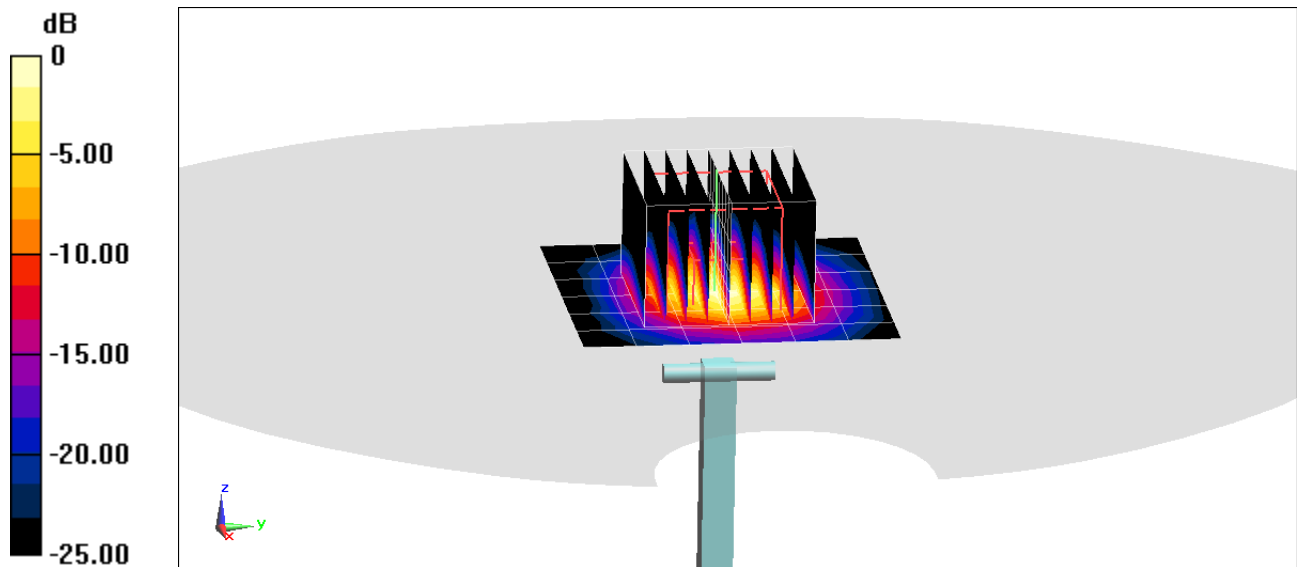

0 dB = 8.75 W/kg = 9.42 dBW/kg

## APPENDIX C: PROBE CALIBRATION



Accredited by the Swiss Accreditation Service (SAS)  
The Swiss Accreditation Service is one of the signatories to the EA  
Multilateral Agreement for the recognition of calibration certificates

Accreditation No.: **SCS 0108**

Client **PC Test**

Certificate No: **EX3-3589\_Jan19**

**CALIBRATION CERTIFICATE**

Object **EX3DV4 - SN:3589**

Calibration procedure(s) **QA CAL-01.v9, QA CAL-14.v5, QA CAL-23.v5, QA CAL-25.v7  
Calibration procedure for dosimetric E-field probes**

*BN ✓  
02-06-2019*

Calibration date: **January 25, 2019**

This calibration certificate documents the traceability to national standards, which realize the physical units of measurements (SI).  
The measurements and the uncertainties with confidence probability are given on the following pages and are part of the certificate.

All calibrations have been conducted in the closed laboratory facility: environment temperature (22 ± 3)°C and humidity < 70%.

Calibration Equipment used (M&TE critical for calibration)

Primary Standards	ID	Cal Date (Certificate No.)	Scheduled Calibration
Power meter NRP	SN: 104778	04-Apr-18 (No. 217-02672/02673)	Apr-19
Power sensor NRP-Z91	SN: 103244	04-Apr-18 (No. 217-02672)	Apr-19
Power sensor NRP-Z91	SN: 103245	04-Apr-18 (No. 217-02673)	Apr-19
Reference 20 dB Attenuator	SN: S5277 (20x)	04-Apr-18 (No. 217-02682)	Apr-19
DAE4	SN: 660	19-Dec-18 (No. DAE4-660_Dec18)	Dec-19
Reference Probe ES3DV2	SN: 3013	31-Dec-18 (No. ES3-3013_Dec18)	Dec-19
Secondary Standards	ID	Check Date (in house)	Scheduled Check
Power meter E4419B	SN: GB41293874	06-Apr-16 (in house check Jun-18)	In house check: Jun-20
Power sensor E4412A	SN: MY41498087	06-Apr-16 (in house check Jun-18)	In house check: Jun-20
Power sensor E4412A	SN: 000110210	06-Apr-16 (in house check Jun-18)	In house check: Jun-20
RF generator HP 8648C	SN: US3642U01700	04-Aug-99 (in house check Jun-18)	In house check: Jun-20
Network Analyzer E8358A	SN: US41080477	31-Mar-14 (in house check Oct-18)	In house check: Oct-19

Calibrated by:	Name <b>Jeton Kastrati</b>	Function <b>Laboratory Technician</b>	Signature 
Approved by:	Name <b>Katja Pokovic</b>	Function <b>Technical Manager</b>	
			Issued: January 29, 2019
This calibration certificate shall not be reproduced except in full without written approval of the laboratory.			



Accredited by the Swiss Accreditation Service (SAS)

Accreditation No.: **SCS 0108**

The Swiss Accreditation Service is one of the signatories to the EA  
Multilateral Agreement for the recognition of calibration certificates

### Glossary:

TSL	tissue simulating liquid
NORM <sub>x,y,z</sub>	sensitivity in free space
ConvF	sensitivity in TSL / NORM <sub>x,y,z</sub>
DCP	diode compression point
CF	crest factor (1/duty_cycle) of the RF signal
A, B, C, D	modulation dependent linearization parameters
Polarization $\varphi$	$\varphi$ rotation around probe axis
Polarization $\vartheta$	$\vartheta$ rotation around an axis that is in the plane normal to probe axis (at measurement center), i.e., $\vartheta = 0$ is normal to probe axis
Connector Angle	information used in DASY system to align probe sensor X to the robot coordinate system

### Calibration is Performed According to the Following Standards:

- IEEE Std 1528-2013, "IEEE Recommended Practice for Determining the Peak Spatial-Averaged Specific Absorption Rate (SAR) in the Human Head from Wireless Communications Devices: Measurement Techniques", June 2013
- IEC 62209-1, "Measurement procedure for the assessment of Specific Absorption Rate (SAR) from hand-held and body-mounted devices used next to the ear (frequency range of 300 MHz to 6 GHz)", July 2016
- IEC 62209-2, "Procedure to determine the Specific Absorption Rate (SAR) for wireless communication devices used in close proximity to the human body (frequency range of 30 MHz to 6 GHz)", March 2010
- KDB 865664, "SAR Measurement Requirements for 100 MHz to 6 GHz"

### Methods Applied and Interpretation of Parameters:

- NORM<sub>x,y,z</sub>**: Assessed for E-field polarization  $\vartheta = 0$  ( $f \leq 900$  MHz in TEM-cell;  $f > 1800$  MHz: R22 waveguide). NORM<sub>x,y,z</sub> are only intermediate values, i.e., the uncertainties of NORM<sub>x,y,z</sub> does not affect the  $E^2$ -field uncertainty inside TSL (see below *ConvF*).
- NORM(f)<sub>x,y,z</sub>** = NORM<sub>x,y,z</sub> \* *frequency\_response* (see Frequency Response Chart). This linearization is implemented in DASY4 software versions later than 4.2. The uncertainty of the frequency response is included in the stated uncertainty of *ConvF*.
- DCP<sub>x,y,z</sub>**: DCP are numerical linearization parameters assessed based on the data of power sweep with CW signal (no uncertainty required). DCP does not depend on frequency nor media.
- PAR**: PAR is the Peak to Average Ratio that is not calibrated but determined based on the signal characteristics
- A<sub>x,y,z</sub>; B<sub>x,y,z</sub>; C<sub>x,y,z</sub>; D<sub>x,y,z</sub>; VR<sub>x,y,z</sub>**: A, B, C, D are numerical linearization parameters assessed based on the data of power sweep for specific modulation signal. The parameters do not depend on frequency nor media. VR is the maximum calibration range expressed in RMS voltage across the diode.
- ConvF and Boundary Effect Parameters**: Assessed in flat phantom using E-field (or Temperature Transfer Standard for  $f \leq 800$  MHz) and inside waveguide using analytical field distributions based on power measurements for  $f > 800$  MHz. The same setups are used for assessment of the parameters applied for boundary compensation (alpha, depth) of which typical uncertainty values are given. These parameters are used in DASY4 software to improve probe accuracy close to the boundary. The sensitivity in TSL corresponds to NORM<sub>x,y,z</sub> \* *ConvF* whereby the uncertainty corresponds to that given for *ConvF*. A frequency dependent *ConvF* is used in DASY version 4.4 and higher which allows extending the validity from  $\pm 50$  MHz to  $\pm 100$  MHz.
- Spherical isotropy (3D deviation from isotropy)**: in a field of low gradients realized using a flat phantom exposed by a patch antenna.
- Sensor Offset**: The sensor offset corresponds to the offset of virtual measurement center from the probe tip (on probe axis). No tolerance required.
- Connector Angle**: The angle is assessed using the information gained by determining the NORM<sub>x</sub> (no uncertainty required).

## DASY/EASY - Parameters of Probe: EX3DV4 - SN:3589

### Basic Calibration Parameters

	Sensor X	Sensor Y	Sensor Z	Unc (k=2)
Norm ( $\mu\text{V}/(\text{V}/\text{m})^2$ ) <sup>A</sup>	0.44	0.40	0.39	± 10.1 %
DCP (mV) <sup>B</sup>	104.1	102.3	101.6	

### Calibration Results for Modulation Response

UID	Communication System Name		A dB	B dB/ $\mu\text{V}$	C	D dB	VR mV	Max dev.	Max Unc <sup>E</sup> (k=2)
0	CW	X	0.00	0.00	1.00	0.00	161.0	± 2.2 %	± 4.7 %
		Y	0.00	0.00	1.00		172.8		
		Z	0.00	0.00	1.00		161.9		
10352- AAA	Pulse Waveform (200Hz, 10%)	X	15.00	89.05	22.73	10.00	60.0	± 1.8 %	± 9.6 %
		Y	15.00	87.03	21.09		60.0		
		Z	15.00	88.89	22.24		60.0		
10353- AAA	Pulse Waveform (200Hz, 20%)	X	15.00	89.55	21.62	6.99	80.0	± 0.9 %	± 9.6 %
		Y	15.00	87.28	19.70		80.0		
		Z	15.00	89.25	21.07		80.0		
10354- AAA	Pulse Waveform (200Hz, 40%)	X	15.00	91.62	21.02	3.98	95.0	± 0.9 %	± 9.6 %
		Y	15.00	87.00	17.73		95.0		
		Z	15.00	91.02	20.33		95.0		
10355- AAA	Pulse Waveform (200Hz, 60%)	X	15.00	97.72	22.56	2.22	120.0	± 1.3 %	± 9.6 %
		Y	15.00	85.70	15.52		120.0		
		Z	15.00	94.39	20.55		120.0		
10387- AAA	QPSK Waveform, 1 MHz	X	0.93	64.13	11.59	0.00	150.0	± 3.0 %	± 9.6 %
		Y	0.57	60.00	7.45		150.0		
		Z	0.83	63.49	10.36		150.0		
10388- AAA	QPSK Waveform, 10 MHz	X	2.36	68.76	16.09	0.00	150.0	± 1.5 %	± 9.6 %
		Y	1.95	66.09	14.43		150.0		
		Z	2.37	69.14	16.27		150.0		
10396- AAA	64-QAM Waveform, 100 kHz	X	3.76	72.95	19.72	3.01	150.0	± 0.7 %	± 9.6 %
		Y	3.11	69.51	18.06		150.0		
		Z	4.24	75.35	20.59		150.0		
10399- AAA	64-QAM Waveform, 40 MHz	X	3.57	67.40	15.92	0.00	150.0	± 2.7 %	± 9.6 %
		Y	3.33	66.26	15.18		150.0		
		Z	3.47	67.09	15.77		150.0		
10414- AAA	WLAN CCDF, 64-QAM, 40MHz	X	4.95	65.72	15.56	0.00	150.0	± 4.8 %	± 9.6 %
		Y	4.74	65.16	15.23		150.0		
		Z	4.81	65.57	15.48		150.0		

Note: For details on UID parameters see Appendix

The reported uncertainty of measurement is stated as the standard uncertainty of measurement multiplied by the coverage factor k=2, which for a normal distribution corresponds to a coverage probability of approximately 95%.

<sup>A</sup> The uncertainties of Norm X,Y,Z do not affect the E<sup>2</sup>-field uncertainty inside TSL (see Pages 5 and 6).

<sup>B</sup> Numerical linearization parameter: uncertainty not required.

<sup>E</sup> Uncertainty is determined using the max. deviation from linear response applying rectangular distribution and is expressed for the square of the field value.

## DASY/EASY - Parameters of Probe: EX3DV4 - SN:3589

### Sensor Model Parameters

	C1 fF	C2 fF	$\alpha$ V <sup>-1</sup>	T1 ms.V <sup>-2</sup>	T2 ms.V <sup>-1</sup>	T3 ms	T4 V <sup>-2</sup>	T5 V <sup>-1</sup>	T6
X	55.3	407.97	34.85	27.50	1.34	5.10	1.23	0.50	1.01
Y	46.7	357.99	37.12	21.71	1.59	5.07	0.00	0.73	1.01
Z	46.1	339.04	34.64	23.94	1.27	5.07	1.73	0.40	1.01

### Other Probe Parameters

Sensor Arrangement	Triangular
Connector Angle (°)	-30.3
Mechanical Surface Detection Mode	enabled
Optical Surface Detection Mode	disabled
Probe Overall Length	337 mm
Probe Body Diameter	10 mm
Tip Length	9 mm
Tip Diameter	2.5 mm
Probe Tip to Sensor X Calibration Point	1 mm
Probe Tip to Sensor Y Calibration Point	1 mm
Probe Tip to Sensor Z Calibration Point	1 mm
Recommended Measurement Distance from Surface	1.4 mm

## DASY/EASY - Parameters of Probe: EX3DV4 - SN:3589

### Calibration Parameter Determined in Head Tissue Simulating Media

f (MHz) <sup>C</sup>	Relative Permittivity <sup>F</sup>	Conductivity (S/m) <sup>F</sup>	ConvF X	ConvF Y	ConvF Z	Alpha <sup>G</sup>	Depth (mm) <sup>G</sup>	Unc (k=2)
750	41.9	0.89	8.67	8.67	8.67	0.70	0.80	± 12.0 %
835	41.5	0.90	8.39	8.39	8.39	0.63	0.81	± 12.0 %
1750	40.1	1.37	7.31	7.31	7.31	0.40	0.80	± 12.0 %
1900	40.0	1.40	7.08	7.08	7.08	0.39	0.80	± 12.0 %
2300	39.5	1.67	6.77	6.77	6.77	0.31	0.85	± 12.0 %
2450	39.2	1.80	6.46	6.46	6.46	0.30	0.85	± 12.0 %
2600	39.0	1.96	6.25	6.25	6.25	0.40	0.83	± 12.0 %
3500	37.9	2.91	6.16	6.16	6.16	0.26	1.20	± 13.1 %
3700	37.7	3.12	6.02	6.02	6.02	0.26	1.20	± 13.1 %

<sup>C</sup> Frequency validity above 300 MHz of ± 100 MHz only applies for DASY v4.4 and higher (see Page 2), else it is restricted to ± 50 MHz. The uncertainty is the RSS of the ConvF uncertainty at calibration frequency and the uncertainty for the indicated frequency band. Frequency validity below 300 MHz is ± 10, 25, 40, 50 and 70 MHz for ConvF assessments at 30, 64, 128, 150 and 220 MHz respectively. Validity of ConvF assessed at 6 MHz is 4-9 MHz, and ConvF assessed at 13 MHz is 9-19 MHz. Above 5 GHz frequency validity can be extended to ± 110 MHz.

<sup>F</sup> At frequencies below 3 GHz, the validity of tissue parameters ( $\epsilon$  and  $\sigma$ ) can be relaxed to ± 10% if liquid compensation formula is applied to measured SAR values. At frequencies above 3 GHz, the validity of tissue parameters ( $\epsilon$  and  $\sigma$ ) is restricted to ± 5%. The uncertainty is the RSS of the ConvF uncertainty for indicated target tissue parameters.

<sup>G</sup> Alpha/Depth are determined during calibration. SPEAG warrants that the remaining deviation due to the boundary effect after compensation is always less than ± 1% for frequencies below 3 GHz and below ± 2% for frequencies between 3-6 GHz at any distance larger than half the probe tip diameter from the boundary.

## DASY/EASY - Parameters of Probe: EX3DV4 - SN:3589

### Calibration Parameter Determined in Body Tissue Simulating Media

f (MHz) <sup>C</sup>	Relative Permittivity <sup>F</sup>	Conductivity (S/m) <sup>F</sup>	ConvF X	ConvF Y	ConvF Z	Alpha <sup>G</sup>	Depth <sup>G</sup> (mm)	Unc (k=2)
750	55.5	0.96	8.34	8.34	8.34	0.42	0.84	± 12.0 %
835	55.2	0.97	8.29	8.29	8.29	0.41	0.84	± 12.0 %
1750	53.4	1.49	6.82	6.82	6.82	0.43	0.80	± 12.0 %
1900	53.3	1.52	6.75	6.75	6.75	0.35	0.85	± 12.0 %
2300	52.9	1.81	6.71	6.71	6.71	0.36	0.87	± 12.0 %
2450	52.7	1.95	6.66	6.66	6.66	0.34	0.88	± 12.0 %
2600	52.5	2.16	6.47	6.47	6.47	0.28	0.95	± 12.0 %
3500	51.3	3.31	6.21	6.21	6.21	0.25	1.25	± 13.1 %
3700	51.0	3.55	6.13	6.13	6.13	0.20	1.25	± 13.1 %

<sup>C</sup> Frequency validity above 300 MHz of ± 100 MHz only applies for DASY v4.4 and higher (see Page 2), else it is restricted to ± 50 MHz. The uncertainty is the RSS of the ConvF uncertainty at calibration frequency and the uncertainty for the indicated frequency band. Frequency validity below 300 MHz is ± 10, 25, 40, 50 and 70 MHz for ConvF assessments at 30, 64, 128, 150 and 220 MHz respectively. Validity of ConvF assessed at 6 MHz is 4-9 MHz, and ConvF assessed at 13 MHz is 9-19 MHz. Above 5 GHz frequency validity can be extended to ± 110 MHz.

<sup>F</sup> At frequencies below 3 GHz, the validity of tissue parameters ( $\epsilon$  and  $\sigma$ ) can be relaxed to ± 10% if liquid compensation formula is applied to measured SAR values. At frequencies above 3 GHz, the validity of tissue parameters ( $\epsilon$  and  $\sigma$ ) is restricted to ± 5%. The uncertainty is the RSS of the ConvF uncertainty for indicated target tissue parameters.

<sup>G</sup> Alpha/Depth are determined during calibration. SPEAG warrants that the remaining deviation due to the boundary effect after compensation is always less than ± 1% for frequencies below 3 GHz and below ± 2% for frequencies between 3-6 GHz at any distance larger than half the probe tip diameter from the boundary.



### Frequency Response of E-Field (TEM-Cell:ifi110 EXX, Waveguide: R22)

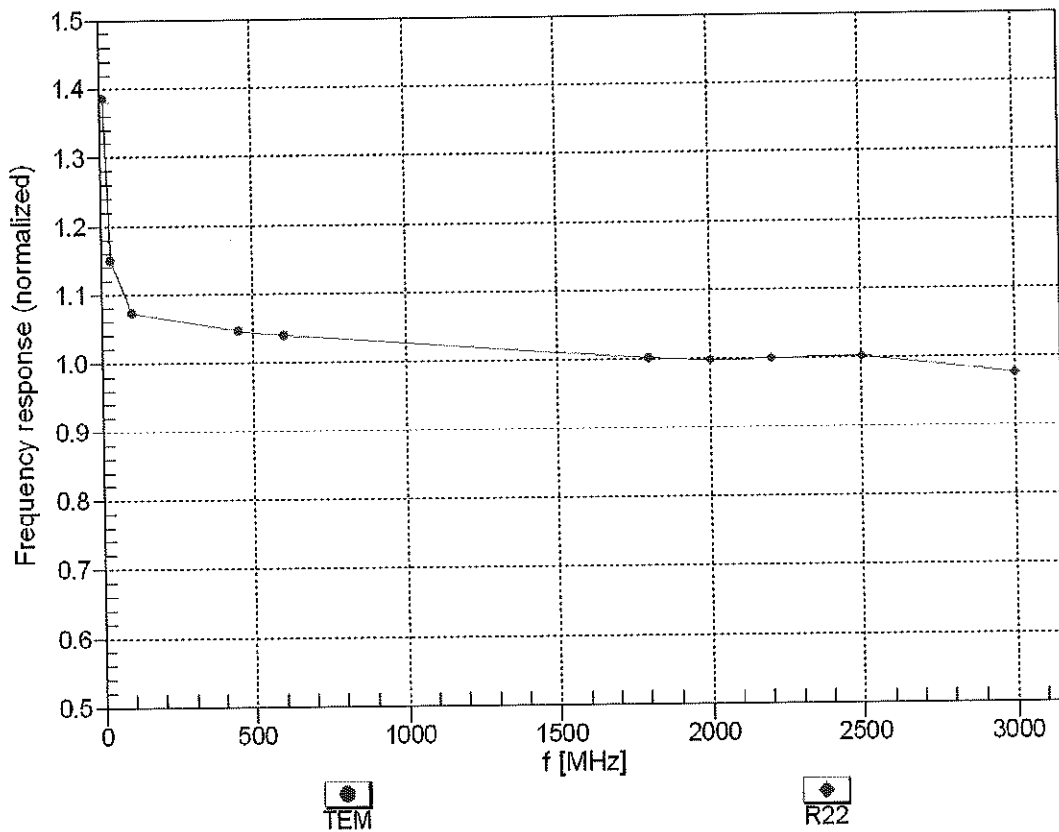

Uncertainty of Frequency Response of E-field:  $\pm 6.3\%$  (k=2)

### Receiving Pattern ( $\phi$ ), $\vartheta = 0^\circ$

f=600 MHz, TEM

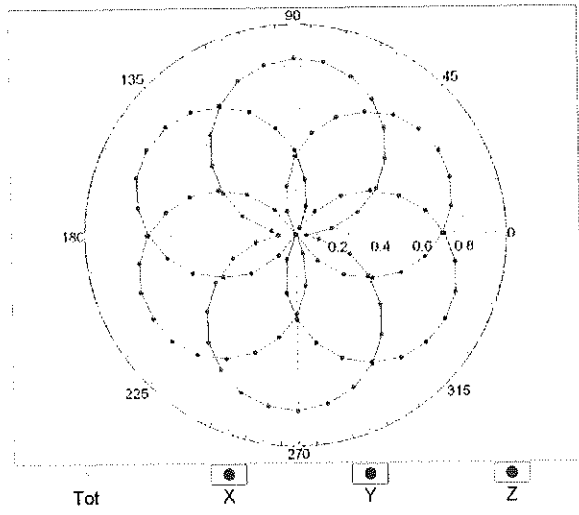

f=1800 MHz, R22

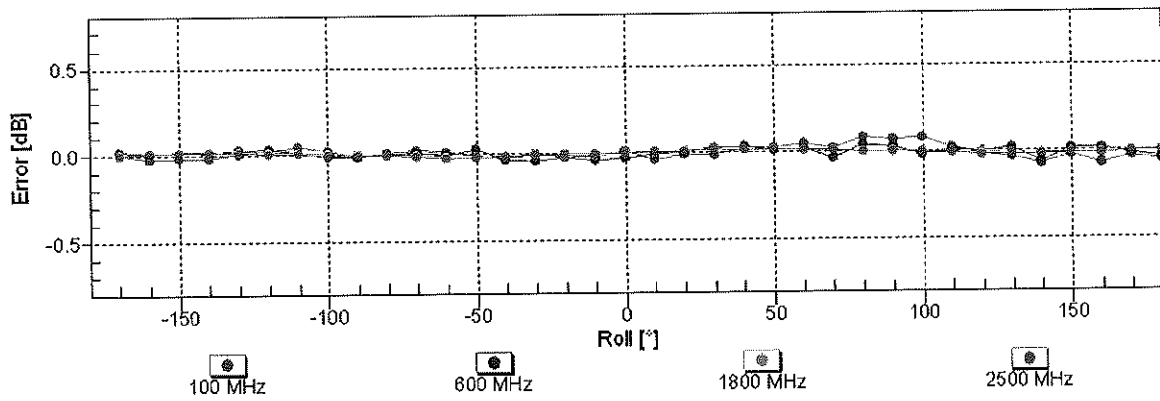
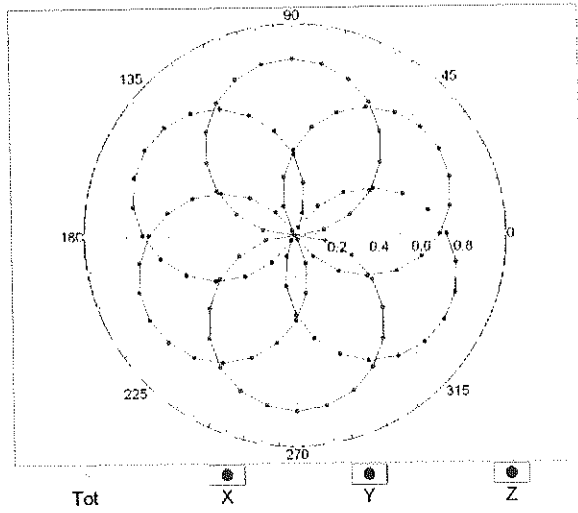

Uncertainty of Axial Isotropy Assessment:  $\pm 0.5\%$  ( $k=2$ )

### Dynamic Range f(SAR<sub>head</sub>) (TEM cell , f<sub>eval</sub>= 1900 MHz)

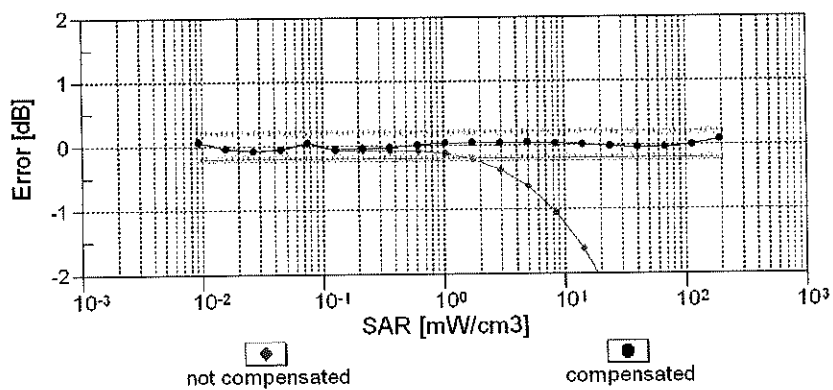
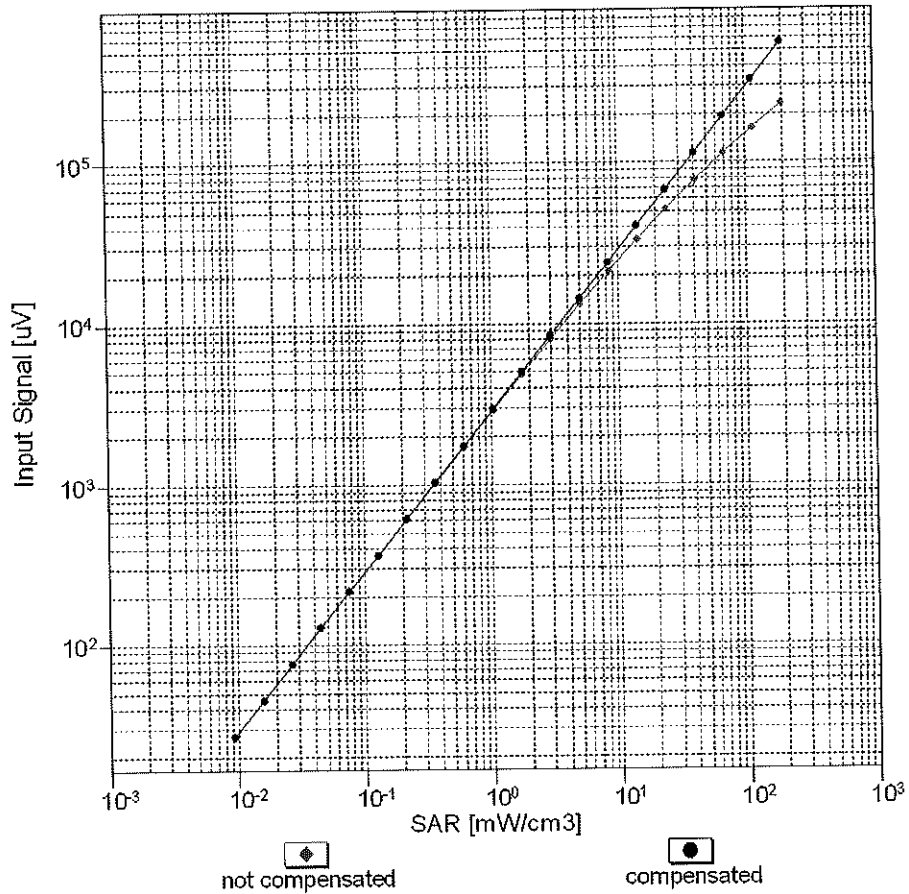

Uncertainty of Linearity Assessment: ± 0.6% (k=2)

# Conversion Factor Assessment

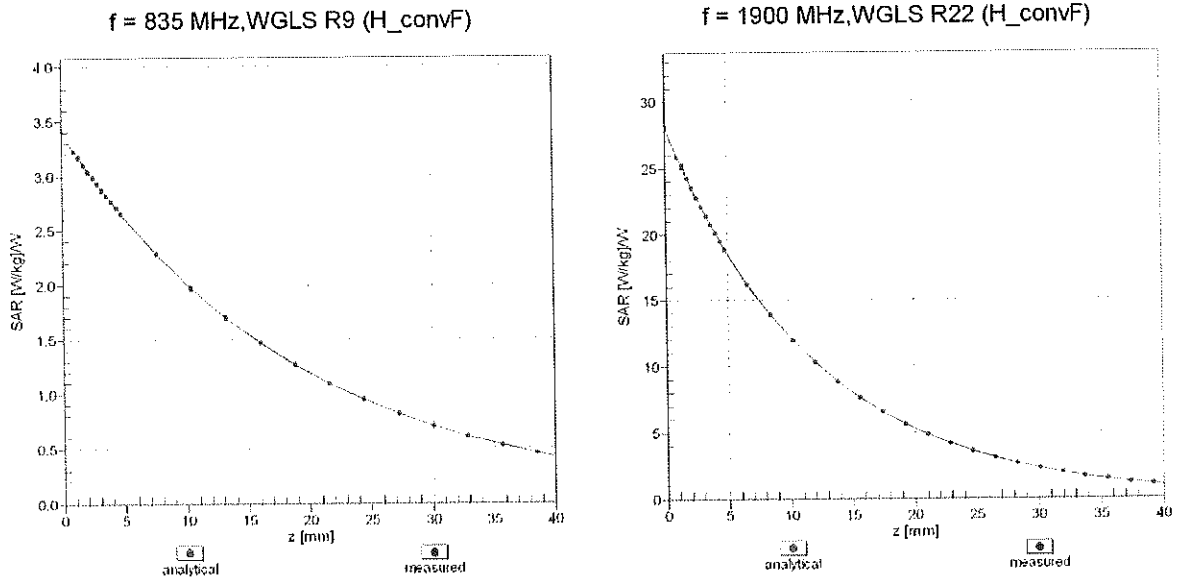

## Deviation from Isotropy in Liquid Error ( $\phi, \theta$ ), f = 900 MHz

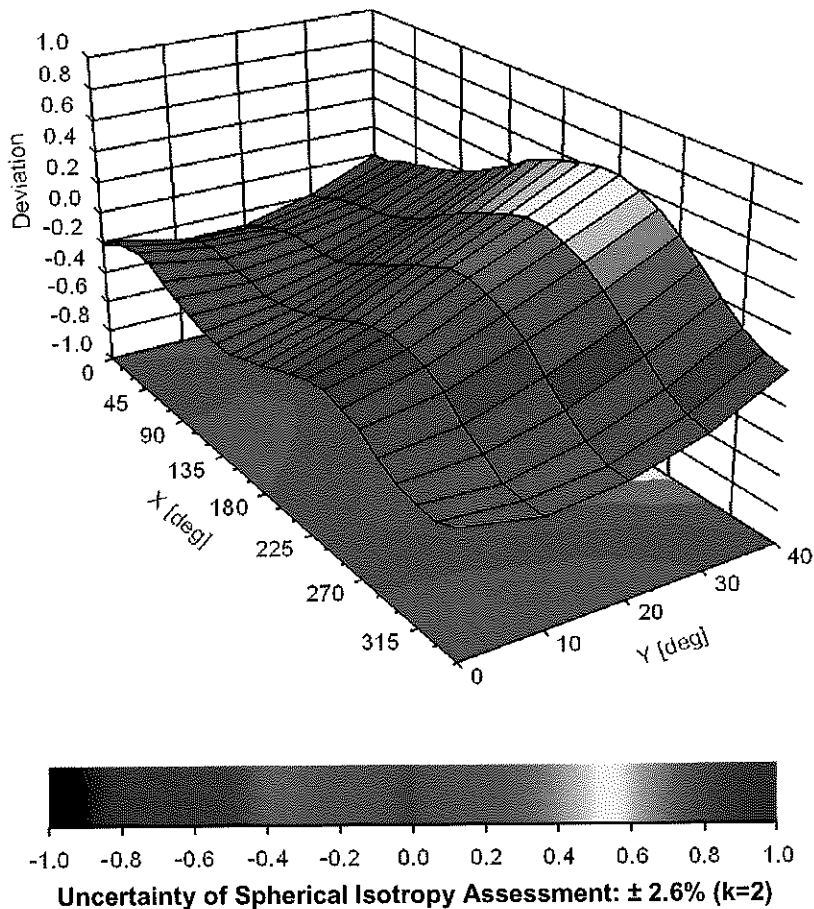

## Appendix: Modulation Calibration Parameters

UID	Rev	Communication System Name	Group	PAR (dB)	Unc <sup>E</sup> (k=2)
0		CW	CW	0.00	± 4.7 %
10010	CAA	SAR Validation (Square, 100ms, 10ms)	Test	10.00	± 9.6 %
10011	CAB	UMTS-FDD (WCDMA)	WCDMA	2.91	± 9.6 %
10012	CAB	IEEE 802.11b WiFi 2.4 GHz (DSSS, 1 Mbps)	WLAN	1.87	± 9.6 %
10013	CAB	IEEE 802.11g WiFi 2.4 GHz (DSSS-OFDM, 6 Mbps)	WLAN	9.46	± 9.6 %
10021	DAC	GSM-FDD (TDMA, GMSK)	GSM	9.39	± 9.6 %
10023	DAC	GPRS-FDD (TDMA, GMSK, TN 0)	GSM	9.57	± 9.6 %
10024	DAC	GPRS-FDD (TDMA, GMSK, TN 0-1)	GSM	6.56	± 9.6 %
10025	DAC	EDGE-FDD (TDMA, 8PSK, TN 0)	GSM	12.62	± 9.6 %
10026	DAC	EDGE-FDD (TDMA, 8PSK, TN 0-1)	GSM	9.55	± 9.6 %
10027	DAC	GPRS-FDD (TDMA, GMSK, TN 0-1-2)	GSM	4.80	± 9.6 %
10028	DAC	GPRS-FDD (TDMA, GMSK, TN 0-1-2-3)	GSM	3.55	± 9.6 %
10029	DAC	EDGE-FDD (TDMA, 8PSK, TN 0-1-2)	GSM	7.78	± 9.6 %
10030	CAA	IEEE 802.15.1 Bluetooth (GFSK, DH1)	Bluetooth	5.30	± 9.6 %
10031	CAA	IEEE 802.15.1 Bluetooth (GFSK, DH3)	Bluetooth	1.87	± 9.6 %
10032	CAA	IEEE 802.15.1 Bluetooth (GFSK, DH5)	Bluetooth	1.16	± 9.6 %
10033	CAA	IEEE 802.15.1 Bluetooth (PI/4-DQPSK, DH1)	Bluetooth	7.74	± 9.6 %
10034	CAA	IEEE 802.15.1 Bluetooth (PI/4-DQPSK, DH3)	Bluetooth	4.53	± 9.6 %
10035	CAA	IEEE 802.15.1 Bluetooth (PI/4-DQPSK, DH5)	Bluetooth	3.83	± 9.6 %
10036	CAA	IEEE 802.15.1 Bluetooth (8-DPSK, DH1)	Bluetooth	8.01	± 9.6 %
10037	CAA	IEEE 802.15.1 Bluetooth (8-DPSK, DH3)	Bluetooth	4.77	± 9.6 %
10038	CAA	IEEE 802.15.1 Bluetooth (8-DPSK, DH5)	Bluetooth	4.10	± 9.6 %
10039	CAB	CDMA2000 (1xRTT, RC1)	CDMA2000	4.57	± 9.6 %
10042	CAB	IS-54 / IS-136 FDD (TDMA/FDM, PI/4-DQPSK, Halfrate)	AMPS	7.78	± 9.6 %
10044	CAA	IS-91/EIA/TIA-553 FDD (FDMA, FM)	AMPS	0.00	± 9.6 %
10048	CAA	DECT (TDD, TDMA/FDM, GFSK, Full Slot, 24)	DECT	13.80	± 9.6 %
10049	CAA	DECT (TDD, TDMA/FDM, GFSK, Double Slot, 12)	DECT	10.79	± 9.6 %
10056	CAA	UMTS-TDD (TD-SCDMA, 1.28 Mcps)	TD-SCDMA	11.01	± 9.6 %
10058	DAC	EDGE-FDD (TDMA, 8PSK, TN 0-1-2-3)	GSM	6.52	± 9.6 %
10059	CAB	IEEE 802.11b WiFi 2.4 GHz (DSSS, 2 Mbps)	WLAN	2.12	± 9.6 %
10060	CAB	IEEE 802.11b WiFi 2.4 GHz (DSSS, 5.5 Mbps)	WLAN	2.83	± 9.6 %
10061	CAB	IEEE 802.11b WiFi 2.4 GHz (DSSS, 11 Mbps)	WLAN	3.60	± 9.6 %
10062	CAC	IEEE 802.11a/h WiFi 5 GHz (OFDM, 6 Mbps)	WLAN	8.68	± 9.6 %
10063	CAC	IEEE 802.11a/h WiFi 5 GHz (OFDM, 9 Mbps)	WLAN	8.63	± 9.6 %
10064	CAC	IEEE 802.11a/h WiFi 5 GHz (OFDM, 12 Mbps)	WLAN	9.09	± 9.6 %
10065	CAC	IEEE 802.11a/h WiFi 5 GHz (OFDM, 18 Mbps)	WLAN	9.00	± 9.6 %
10066	CAC	IEEE 802.11a/h WiFi 5 GHz (OFDM, 24 Mbps)	WLAN	9.38	± 9.6 %
10067	CAC	IEEE 802.11a/h WiFi 5 GHz (OFDM, 36 Mbps)	WLAN	10.12	± 9.6 %
10068	CAC	IEEE 802.11a/h WiFi 5 GHz (OFDM, 48 Mbps)	WLAN	10.24	± 9.6 %
10069	CAC	IEEE 802.11a/h WiFi 5 GHz (OFDM, 54 Mbps)	WLAN	10.56	± 9.6 %
10071	CAB	IEEE 802.11g WiFi 2.4 GHz (DSSS/OFDM, 9 Mbps)	WLAN	9.83	± 9.6 %
10072	CAB	IEEE 802.11g WiFi 2.4 GHz (DSSS/OFDM, 12 Mbps)	WLAN	9.62	± 9.6 %
10073	CAB	IEEE 802.11g WiFi 2.4 GHz (DSSS/OFDM, 18 Mbps)	WLAN	9.94	± 9.6 %
10074	CAB	IEEE 802.11g WiFi 2.4 GHz (DSSS/OFDM, 24 Mbps)	WLAN	10.30	± 9.6 %
10075	CAB	IEEE 802.11g WiFi 2.4 GHz (DSSS/OFDM, 36 Mbps)	WLAN	10.77	± 9.6 %
10076	CAB	IEEE 802.11g WiFi 2.4 GHz (DSSS/OFDM, 48 Mbps)	WLAN	10.94	± 9.6 %
10077	CAB	IEEE 802.11g WiFi 2.4 GHz (DSSS/OFDM, 54 Mbps)	WLAN	11.00	± 9.6 %
10081	CAB	CDMA2000 (1xRTT, RC3)	CDMA2000	3.97	± 9.6 %
10082	CAB	IS-54 / IS-136 FDD (TDMA/FDM, PI/4-DQPSK, Fullrate)	AMPS	4.77	± 9.6 %
10090	DAC	GPRS-FDD (TDMA, GMSK, TN 0-4)	GSM	6.56	± 9.6 %
10097	CAB	UMTS-FDD (HSDPA)	WCDMA	3.98	± 9.6 %
10098	CAB	UMTS-FDD (HSUPA, Subtest 2)	WCDMA	3.98	± 9.6 %
10099	DAC	EDGE-FDD (TDMA, 8PSK, TN 0-4)	GSM	9.55	± 9.6 %
10100	CAE	LTE-FDD (SC-FDMA, 100% RB, 20 MHz, QPSK)	LTE-FDD	5.67	± 9.6 %
10101	CAE	LTE-FDD (SC-FDMA, 100% RB, 20 MHz, 16-QAM)	LTE-FDD	6.42	± 9.6 %
10102	CAE	LTE-FDD (SC-FDMA, 100% RB, 20 MHz, 64-QAM)	LTE-FDD	6.60	± 9.6 %
10103	CAG	LTE-TDD (SC-FDMA, 100% RB, 20 MHz, QPSK)	LTE-TDD	9.29	± 9.6 %
10104	CAG	LTE-TDD (SC-FDMA, 100% RB, 20 MHz, 16-QAM)	LTE-TDD	9.97	± 9.6 %
10105	CAG	LTE-TDD (SC-FDMA, 100% RB, 20 MHz, 64-QAM)	LTE-TDD	10.01	± 9.6 %
10108	CAG	LTE-FDD (SC-FDMA, 100% RB, 10 MHz, QPSK)	LTE-FDD	5.80	± 9.6 %

10109	CAG	LTE-FDD (SC-FDMA, 100% RB, 10 MHz, 16-QAM)	LTE-FDD	6.43	± 9.6 %
10110	CAG	LTE-FDD (SC-FDMA, 100% RB, 5 MHz, QPSK)	LTE-FDD	5.75	± 9.6 %
10111	CAG	LTE-FDD (SC-FDMA, 100% RB, 5 MHz, 16-QAM)	LTE-FDD	6.44	± 9.6 %
10112	CAG	LTE-FDD (SC-FDMA, 100% RB, 10 MHz, 64-QAM)	LTE-FDD	6.59	± 9.6 %
10113	CAG	LTE-FDD (SC-FDMA, 100% RB, 5 MHz, 64-QAM)	LTE-FDD	6.62	± 9.6 %
10114	CAC	IEEE 802.11n (HT Greenfield, 13.5 Mbps, BPSK)	WLAN	8.10	± 9.6 %
10115	CAC	IEEE 802.11n (HT Greenfield, 81 Mbps, 16-QAM)	WLAN	8.46	± 9.6 %
10116	CAC	IEEE 802.11n (HT Greenfield, 135 Mbps, 64-QAM)	WLAN	8.15	± 9.6 %
10117	CAC	IEEE 802.11n (HT Mixed, 13.5 Mbps, BPSK)	WLAN	8.07	± 9.6 %
10118	CAC	IEEE 802.11n (HT Mixed, 81 Mbps, 16-QAM)	WLAN	8.59	± 9.6 %
10119	CAC	IEEE 802.11n (HT Mixed, 135 Mbps, 64-QAM)	WLAN	8.13	± 9.6 %
10140	CAE	LTE-FDD (SC-FDMA, 100% RB, 15 MHz, 16-QAM)	LTE-FDD	6.49	± 9.6 %
10141	CAE	LTE-FDD (SC-FDMA, 100% RB, 15 MHz, 64-QAM)	LTE-FDD	6.53	± 9.6 %
10142	CAE	LTE-FDD (SC-FDMA, 100% RB, 3 MHz, QPSK)	LTE-FDD	5.73	± 9.6 %
10143	CAE	LTE-FDD (SC-FDMA, 100% RB, 3 MHz, 16-QAM)	LTE-FDD	6.35	± 9.6 %
10144	CAE	LTE-FDD (SC-FDMA, 100% RB, 3 MHz, 64-QAM)	LTE-FDD	6.65	± 9.6 %
10145	CAF	LTE-FDD (SC-FDMA, 100% RB, 1.4 MHz, QPSK)	LTE-FDD	5.76	± 9.6 %
10146	CAF	LTE-FDD (SC-FDMA, 100% RB, 1.4 MHz, 16-QAM)	LTE-FDD	6.41	± 9.6 %
10147	CAF	LTE-FDD (SC-FDMA, 100% RB, 1.4 MHz, 64-QAM)	LTE-FDD	6.72	± 9.6 %
10149	CAE	LTE-FDD (SC-FDMA, 50% RB, 20 MHz, 16-QAM)	LTE-FDD	6.42	± 9.6 %
10150	CAE	LTE-FDD (SC-FDMA, 50% RB, 20 MHz, 64-QAM)	LTE-FDD	6.60	± 9.6 %
10151	CAG	LTE-TDD (SC-FDMA, 50% RB, 20 MHz, QPSK)	LTE-TDD	9.28	± 9.6 %
10152	CAG	LTE-TDD (SC-FDMA, 50% RB, 20 MHz, 16-QAM)	LTE-TDD	9.92	± 9.6 %
10153	CAG	LTE-TDD (SC-FDMA, 50% RB, 20 MHz, 64-QAM)	LTE-TDD	10.05	± 9.6 %
10154	CAG	LTE-FDD (SC-FDMA, 50% RB, 10 MHz, QPSK)	LTE-FDD	5.75	± 9.6 %
10155	CAG	LTE-FDD (SC-FDMA, 50% RB, 10 MHz, 16-QAM)	LTE-FDD	6.43	± 9.6 %
10156	CAG	LTE-FDD (SC-FDMA, 50% RB, 5 MHz, QPSK)	LTE-FDD	5.79	± 9.6 %
10157	CAG	LTE-FDD (SC-FDMA, 50% RB, 5 MHz, 16-QAM)	LTE-FDD	6.49	± 9.6 %
10158	CAG	LTE-FDD (SC-FDMA, 50% RB, 10 MHz, 64-QAM)	LTE-FDD	6.62	± 9.6 %
10159	CAG	LTE-FDD (SC-FDMA, 50% RB, 5 MHz, 64-QAM)	LTE-FDD	6.56	± 9.6 %
10160	CAE	LTE-FDD (SC-FDMA, 50% RB, 15 MHz, QPSK)	LTE-FDD	5.82	± 9.6 %
10161	CAE	LTE-FDD (SC-FDMA, 50% RB, 15 MHz, 16-QAM)	LTE-FDD	6.43	± 9.6 %
10162	CAE	LTE-FDD (SC-FDMA, 50% RB, 15 MHz, 64-QAM)	LTE-FDD	6.58	± 9.6 %
10166	CAF	LTE-FDD (SC-FDMA, 50% RB, 1.4 MHz, QPSK)	LTE-FDD	5.46	± 9.6 %
10167	CAF	LTE-FDD (SC-FDMA, 50% RB, 1.4 MHz, 16-QAM)	LTE-FDD	6.21	± 9.6 %
10168	CAF	LTE-FDD (SC-FDMA, 50% RB, 1.4 MHz, 64-QAM)	LTE-FDD	6.79	± 9.6 %
10169	CAE	LTE-FDD (SC-FDMA, 1 RB, 20 MHz, QPSK)	LTE-FDD	5.73	± 9.6 %
10170	CAE	LTE-FDD (SC-FDMA, 1 RB, 20 MHz, 16-QAM)	LTE-FDD	6.52	± 9.6 %
10171	AAE	LTE-FDD (SC-FDMA, 1 RB, 20 MHz, 64-QAM)	LTE-FDD	6.49	± 9.6 %
10172	CAG	LTE-TDD (SC-FDMA, 1 RB, 20 MHz, QPSK)	LTE-TDD	9.21	± 9.6 %
10173	CAG	LTE-TDD (SC-FDMA, 1 RB, 20 MHz, 16-QAM)	LTE-TDD	9.48	± 9.6 %
10174	CAG	LTE-TDD (SC-FDMA, 1 RB, 20 MHz, 64-QAM)	LTE-TDD	10.25	± 9.6 %
10175	CAG	LTE-FDD (SC-FDMA, 1 RB, 10 MHz, QPSK)	LTE-FDD	5.72	± 9.6 %
10176	CAG	LTE-FDD (SC-FDMA, 1 RB, 10 MHz, 16-QAM)	LTE-FDD	6.52	± 9.6 %
10177	CAI	LTE-FDD (SC-FDMA, 1 RB, 5 MHz, QPSK)	LTE-FDD	5.73	± 9.6 %
10178	CAG	LTE-FDD (SC-FDMA, 1 RB, 5 MHz, 16-QAM)	LTE-FDD	6.52	± 9.6 %
10179	CAG	LTE-FDD (SC-FDMA, 1 RB, 10 MHz, 64-QAM)	LTE-FDD	6.50	± 9.6 %
10180	CAG	LTE-FDD (SC-FDMA, 1 RB, 5 MHz, 64-QAM)	LTE-FDD	6.50	± 9.6 %
10181	CAE	LTE-FDD (SC-FDMA, 1 RB, 15 MHz, QPSK)	LTE-FDD	5.72	± 9.6 %
10182	CAE	LTE-FDD (SC-FDMA, 1 RB, 15 MHz, 16-QAM)	LTE-FDD	6.52	± 9.6 %
10183	AAD	LTE-FDD (SC-FDMA, 1 RB, 15 MHz, 64-QAM)	LTE-FDD	6.50	± 9.6 %
10184	CAE	LTE-FDD (SC-FDMA, 1 RB, 3 MHz, QPSK)	LTE-FDD	5.73	± 9.6 %
10185	CAE	LTE-FDD (SC-FDMA, 1 RB, 3 MHz, 16-QAM)	LTE-FDD	6.51	± 9.6 %
10186	AAE	LTE-FDD (SC-FDMA, 1 RB, 3 MHz, 64-QAM)	LTE-FDD	6.50	± 9.6 %
10187	CAF	LTE-FDD (SC-FDMA, 1 RB, 1.4 MHz, QPSK)	LTE-FDD	5.73	± 9.6 %
10188	CAF	LTE-FDD (SC-FDMA, 1 RB, 1.4 MHz, 16-QAM)	LTE-FDD	6.52	± 9.6 %
10189	AAF	LTE-FDD (SC-FDMA, 1 RB, 1.4 MHz, 64-QAM)	LTE-FDD	6.50	± 9.6 %
10193	CAC	IEEE 802.11n (HT Greenfield, 6.5 Mbps, BPSK)	WLAN	8.09	± 9.6 %
10194	CAC	IEEE 802.11n (HT Greenfield, 39 Mbps, 16-QAM)	WLAN	8.12	± 9.6 %
10195	CAC	IEEE 802.11n (HT Greenfield, 65 Mbps, 64-QAM)	WLAN	8.21	± 9.6 %
10196	CAC	IEEE 802.11n (HT Mixed, 6.5 Mbps, BPSK)	WLAN	8.10	± 9.6 %
10197	CAC	IEEE 802.11n (HT Mixed, 39 Mbps, 16-QAM)	WLAN	8.13	± 9.6 %
10198	CAC	IEEE 802.11n (HT Mixed, 65 Mbps, 64-QAM)	WLAN	8.27	± 9.6 %
10219	CAC	IEEE 802.11n (HT Mixed, 7.2 Mbps, BPSK)	WLAN	8.03	± 9.6 %

10220	CAC	IEEE 802.11n (HT Mixed, 43.3 Mbps, 16-QAM)	WLAN	8.13	± 9.6 %
10221	CAC	IEEE 802.11n (HT Mixed, 72.2 Mbps, 64-QAM)	WLAN	8.27	± 9.6 %
10222	CAC	IEEE 802.11n (HT Mixed, 15 Mbps, BPSK)	WLAN	8.06	± 9.6 %
10223	CAC	IEEE 802.11n (HT Mixed, 90 Mbps, 16-QAM)	WLAN	8.48	± 9.6 %
10224	CAC	IEEE 802.11n (HT Mixed, 150 Mbps, 64-QAM)	WLAN	8.08	± 9.6 %
10225	CAB	UMTS-FDD (HSPA+)	WCDMA	5.97	± 9.6 %
10226	CAA	LTE-TDD (SC-FDMA, 1 RB, 1.4 MHz, 16-QAM)	LTE-TDD	9.49	± 9.6 %
10227	CAA	LTE-TDD (SC-FDMA, 1 RB, 1.4 MHz, 64-QAM)	LTE-TDD	10.26	± 9.6 %
10228	CAA	LTE-TDD (SC-FDMA, 1 RB, 1.4 MHz, QPSK)	LTE-TDD	9.22	± 9.6 %
10229	CAC	LTE-TDD (SC-FDMA, 1 RB, 3 MHz, 16-QAM)	LTE-TDD	9.48	± 9.6 %
10230	CAC	LTE-TDD (SC-FDMA, 1 RB, 3 MHz, 64-QAM)	LTE-TDD	10.25	± 9.6 %
10231	CAC	LTE-TDD (SC-FDMA, 1 RB, 3 MHz, QPSK)	LTE-TDD	9.19	± 9.6 %
10232	CAF	LTE-TDD (SC-FDMA, 1 RB, 5 MHz, 16-QAM)	LTE-TDD	9.48	± 9.6 %
10233	CAF	LTE-TDD (SC-FDMA, 1 RB, 5 MHz, 64-QAM)	LTE-TDD	10.25	± 9.6 %
10234	CAF	LTE-TDD (SC-FDMA, 1 RB, 5 MHz, QPSK)	LTE-TDD	9.21	± 9.6 %
10235	CAF	LTE-TDD (SC-FDMA, 1 RB, 10 MHz, 16-QAM)	LTE-TDD	9.48	± 9.6 %
10236	CAF	LTE-TDD (SC-FDMA, 1 RB, 10 MHz, 64-QAM)	LTE-TDD	10.25	± 9.6 %
10237	CAF	LTE-TDD (SC-FDMA, 1 RB, 10 MHz, QPSK)	LTE-TDD	9.21	± 9.6 %
10238	CAF	LTE-TDD (SC-FDMA, 1 RB, 15 MHz, 16-QAM)	LTE-TDD	9.48	± 9.6 %
10239	CAF	LTE-TDD (SC-FDMA, 1 RB, 15 MHz, 64-QAM)	LTE-TDD	10.25	± 9.6 %
10240	CAF	LTE-TDD (SC-FDMA, 1 RB, 15 MHz, QPSK)	LTE-TDD	9.21	± 9.6 %
10241	CAA	LTE-TDD (SC-FDMA, 50% RB, 1.4 MHz, 16-QAM)	LTE-TDD	9.82	± 9.6 %
10242	CAA	LTE-TDD (SC-FDMA, 50% RB, 1.4 MHz, 64-QAM)	LTE-TDD	9.86	± 9.6 %
10243	CAA	LTE-TDD (SC-FDMA, 50% RB, 1.4 MHz, QPSK)	LTE-TDD	9.46	± 9.6 %
10244	CAC	LTE-TDD (SC-FDMA, 50% RB, 3 MHz, 16-QAM)	LTE-TDD	10.06	± 9.6 %
10245	CAC	LTE-TDD (SC-FDMA, 50% RB, 3 MHz, 64-QAM)	LTE-TDD	10.06	± 9.6 %
10246	CAC	LTE-TDD (SC-FDMA, 50% RB, 3 MHz, QPSK)	LTE-TDD	9.30	± 9.6 %
10247	CAF	LTE-TDD (SC-FDMA, 50% RB, 5 MHz, 16-QAM)	LTE-TDD	9.91	± 9.6 %
10248	CAF	LTE-TDD (SC-FDMA, 50% RB, 5 MHz, 64-QAM)	LTE-TDD	10.09	± 9.6 %
10249	CAF	LTE-TDD (SC-FDMA, 50% RB, 5 MHz, QPSK)	LTE-TDD	9.29	± 9.6 %
10250	CAF	LTE-TDD (SC-FDMA, 50% RB, 10 MHz, 16-QAM)	LTE-TDD	9.81	± 9.6 %
10251	CAF	LTE-TDD (SC-FDMA, 50% RB, 10 MHz, 64-QAM)	LTE-TDD	10.17	± 9.6 %
10252	CAF	LTE-TDD (SC-FDMA, 50% RB, 10 MHz, QPSK)	LTE-TDD	9.24	± 9.6 %
10253	CAF	LTE-TDD (SC-FDMA, 50% RB, 15 MHz, 16-QAM)	LTE-TDD	9.90	± 9.6 %
10254	CAF	LTE-TDD (SC-FDMA, 50% RB, 15 MHz, 64-QAM)	LTE-TDD	10.14	± 9.6 %
10255	CAF	LTE-TDD (SC-FDMA, 50% RB, 15 MHz, QPSK)	LTE-TDD	9.20	± 9.6 %
10256	CAA	LTE-TDD (SC-FDMA, 100% RB, 1.4 MHz, 16-QAM)	LTE-TDD	9.96	± 9.6 %
10257	CAA	LTE-TDD (SC-FDMA, 100% RB, 1.4 MHz, 64-QAM)	LTE-TDD	10.08	± 9.6 %
10258	CAA	LTE-TDD (SC-FDMA, 100% RB, 1.4 MHz, QPSK)	LTE-TDD	9.34	± 9.6 %
10259	CAC	LTE-TDD (SC-FDMA, 100% RB, 3 MHz, 16-QAM)	LTE-TDD	9.98	± 9.6 %
10260	CAC	LTE-TDD (SC-FDMA, 100% RB, 3 MHz, 64-QAM)	LTE-TDD	9.97	± 9.6 %
10261	CAC	LTE-TDD (SC-FDMA, 100% RB, 3 MHz, QPSK)	LTE-TDD	9.24	± 9.6 %
10262	CAF	LTE-TDD (SC-FDMA, 100% RB, 5 MHz, 16-QAM)	LTE-TDD	9.83	± 9.6 %
10263	CAF	LTE-TDD (SC-FDMA, 100% RB, 5 MHz, 64-QAM)	LTE-TDD	10.16	± 9.6 %
10264	CAF	LTE-TDD (SC-FDMA, 100% RB, 5 MHz, QPSK)	LTE-TDD	9.23	± 9.6 %
10265	CAF	LTE-TDD (SC-FDMA, 100% RB, 10 MHz, 16-QAM)	LTE-TDD	9.92	± 9.6 %
10266	CAF	LTE-TDD (SC-FDMA, 100% RB, 10 MHz, 64-QAM)	LTE-TDD	10.07	± 9.6 %
10267	CAF	LTE-TDD (SC-FDMA, 100% RB, 10 MHz, QPSK)	LTE-TDD	9.30	± 9.6 %
10268	CAF	LTE-TDD (SC-FDMA, 100% RB, 15 MHz, 16-QAM)	LTE-TDD	10.06	± 9.6 %
10269	CAF	LTE-TDD (SC-FDMA, 100% RB, 15 MHz, 64-QAM)	LTE-TDD	10.13	± 9.6 %
10270	CAF	LTE-TDD (SC-FDMA, 100% RB, 15 MHz, QPSK)	LTE-TDD	9.58	± 9.6 %
10274	CAB	UMTS-FDD (HSUPA, Subtest 5, 3GPP Rel8.10)	WCDMA	4.87	± 9.6 %
10275	CAB	UMTS-FDD (HSUPA, Subtest 5, 3GPP Rel8.4)	WCDMA	3.96	± 9.6 %
10277	CAA	PHS (QPSK)	PHS	11.81	± 9.6 %
10278	CAA	PHS (QPSK, BW 884MHz, Rolloff 0.5)	PHS	11.81	± 9.6 %
10279	CAA	PHS (QPSK, BW 884MHz, Rolloff 0.38)	PHS	12.18	± 9.6 %
10290	AAB	CDMA2000, RC1, SO55, Full Rate	CDMA2000	3.91	± 9.6 %
10291	AAB	CDMA2000, RC3, SO55, Full Rate	CDMA2000	3.46	± 9.6 %
10292	AAB	CDMA2000, RC3, SO32, Full Rate	CDMA2000	3.39	± 9.6 %
10293	AAB	CDMA2000, RC3, SO3, Full Rate	CDMA2000	3.50	± 9.6 %
10295	AAB	CDMA2000, RC1, SO3, 1/8th Rate 25 fr.	CDMA2000	12.49	± 9.6 %
10297	AAD	LTE-FDD (SC-FDMA, 50% RB, 20 MHz, QPSK)	LTE-FDD	5.81	± 9.6 %
10298	AAD	LTE-FDD (SC-FDMA, 50% RB, 3 MHz, QPSK)	LTE-FDD	5.72	± 9.6 %
10299	AAD	LTE-FDD (SC-FDMA, 50% RB, 3 MHz, 16-QAM)	LTE-FDD	6.39	± 9.6 %