



PCTEST ENGINEERING LABORATORY, INC.

7185 Oakland Mills Road, Columbia, MD 21046 USA
Tel. +1.410.290.6652 / Fax +1.410.290.6654
http://www.pctestlab.com



SAR EVALUATION REPORT

Applicant Name:
LG Electronics MobileComm U.S.A., Inc.
1000 Sylvan Avenue
Englewood Cliffs, NJ 07632
United States

Date of Testing:
01/22/2014 - 01/27/2014
Test Site/Location:
PCTEST Lab, Columbia, MD, USA
Document Serial No.:
0Y1401200112-R1.ZNF

FCC ID: ZNFL34C

APPLICANT: LG ELECTRONICS MOBILECOMM U.S.A., INC.

DUT Type: Portable Handset
Application Type: Class II Permissive Change
FCC Rule Part(s): CFR §2.1093
Model(s): LGL34C, L34C, LG-VS415PP, VS415PP, LGVS415PP, LG-VS415, VS415, LGVS415
Permissive Changes(s): See FCC Change Document
Date of Original Certification: 12/18/2013

Equipment Class	Band & Mode	Tx Frequency	Measured Conducted Power [dBm]	SAR		
				1 gm Head (W/kg)	1 gm Body-Worn (W/kg)	1 gm Hotspot (W/kg)
PCE	Cell. CDMA/EVDO	824.70 - 848.31 MHz	24.65	0.82	0.95	0.90
PCE	PCS CDMA/EVDO	1851.25 - 1908.75 MHz	24.35	0.77	0.67	0.68
DTS	2.4 GHz WLAN	2412 - 2462 MHz	14.74	0.22	0.21	0.21
DSS/DTS	Bluetooth	2402 - 2480 MHz	9.98	N/A		
Simultaneous SAR per KDB 690783 D01v01r02:				1.04	1.18	1.10

Note: Powers in the above table represent output powers for the SAR test configurations and may not represent the highest output powers for all configurations for each mode.

This revised Test Report (S/N: 0Y1401200112-R1.ZNF) supersedes and replaces the previously issued test report on the same subject device for the same type of testing as indicated. Please discard or destroy the previously issued test report(s) and dispose of it accordingly.

This wireless portable device has been shown to be capable of compliance for localized specific absorption rate (SAR) for uncontrolled environment/general population exposure limits specified in ANSI/IEEE C95.1-1992 and has been tested in accordance with the measurement procedures specified in Section 1.7 of this report; for North American frequency bands only.

All models are confirmed to be identical per the manufacturer.

I attest to the accuracy of data. All measurements reported herein were performed by me or were made under my supervision and are correct to the best of my knowledge and belief. I assume full responsibility for the completeness of these measurements and vouch for the qualifications of all persons taking them. Test results reported herein relate only to the item(s) tested.



Randy Ortanez
President



FCC ID: ZNFL34C		SAR EVALUATION REPORT		Reviewed by: Quality Manager
Document S/N: 0Y1401200112-R1.ZNF	Test Dates: 01/22/2014 - 01/27/2014	DUT Type: Portable Handset		Page 1 of 35

T A B L E O F C O N T E N T S

1	DEVICE UNDER TEST	3
2	INTRODUCTION	7
3	DOSIMETRIC ASSESSMENT	8
4	DEFINITION OF REFERENCE POINTS	9
5	TEST CONFIGURATION POSITIONS FOR HANDSETS	10
6	RF EXPOSURE LIMITS	14
7	FCC MEASUREMENT PROCEDURES.....	15
8	RF CONDUCTED POWERS.....	18
9	SYSTEM VERIFICATION.....	20
10	SAR DATA SUMMARY	22
11	FCC MULTI-TX AND ANTENNA SAR CONSIDERATIONS.....	27
12	SAR MEASUREMENT VARIABILITY	30
13	EQUIPMENT LIST.....	31
14	MEASUREMENT UNCERTAINTIES	32
15	CONCLUSION.....	33
16	REFERENCES	34
APPENDIX A: SAR TEST PLOTS		
APPENDIX B: SAR DIPOLE VERIFICATION PLOTS		
APPENDIX C: PROBE AND DIPOLE CALIBRATION CERTIFICATES		
APPENDIX D: SAR TISSUE SPECIFICATIONS		
APPENDIX E: SAR SYSTEM VALIDATION		
APPENDIX F: SAR TEST SETUP PHOTOGRAPHS		

FCC ID: ZNFL34C		SAR EVALUATION REPORT		Reviewed by: Quality Manager
Document S/N: 0Y1401200112-R1.ZNF	Test Dates: 01/22/2014 - 01/27/2014	DUT Type: Portable Handset	Page 2 of 35	

1 DEVICE UNDER TEST

1.1 Device Overview



Band & Mode	Operating Modes	Tx Frequency
Cell. CDMA/EVDO	Voice/Data	824.70 - 848.31 MHz
PCS CDMA/EVDO	Voice/Data	1851.25 - 1908.75 MHz
2.4 GHz WLAN	Data	2412 - 2462 MHz
Bluetooth	Data	2402 - 2480 MHz

1.2 Nominal and Maximum Output Power Specifications

This device operates using the following maximum and nominal output power specifications. SAR values were scaled to the maximum allowed power to determine compliance per KDB Publication 447498 D01v05.

Mode / Band		Modulated Average (dBm)
Cell. CDMA/EVDO	Maximum	24.7
	Nominal	24.2
PCS CDMA/EVDO	Maximum	24.5
	Nominal	24.0

Mode / Band		Modulated Average (dBm)
IEEE 802.11b (2.4 GHz)	Maximum	15.5
	Nominal	15.0
IEEE 802.11g (2.4 GHz)	Maximum	11.0
	Nominal	10.5
IEEE 802.11n (2.4 GHz)	Maximum	10.0
	Nominal	9.5
Bluetooth	Maximum	10.5
	Nominal	10.0
Bluetooth LE	Maximum	1.5
	Nominal	1.0

FCC ID: ZNFL34C		SAR EVALUATION REPORT		Reviewed by: Quality Manager
Document S/N: OY1401200112-R1.ZNF	Test Dates: 01/22/2014 - 01/27/2014	DUT Type: Portable Handset		Page 3 of 35

1.3 DUT Antenna Locations

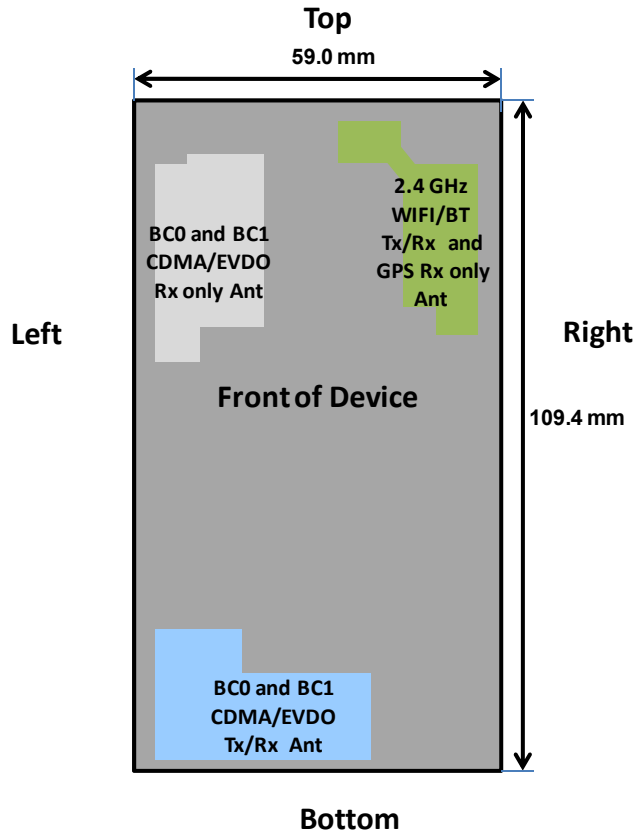



Note:
Exact antenna dimensions and separation distances are shown in the Technical Descriptions in the FCC Filing.

Figure 1-1
DUT Antenna Locations

Table 1-1
Mobile Hotspot Sides for SAR Testing

Mobile Hotspot Sides for SAR Testing						
Mode	Back	Front	Top	Bottom	Right	Left
Cell. EVDO	Yes	Yes	No	Yes	No	Yes
PCS EVDO	Yes	Yes	No	Yes	No	Yes
2.4 GHz WLAN	Yes	Yes	Yes	No	Yes	No

Note: Particular DUT edges were not required to be evaluated for Wireless Router SAR if the edges were greater than 2.5 cm from the transmitting antenna according to FCC KDB Publication 941225 D06v01 guidance, page 2.

FCC ID: ZNFL34C		SAR EVALUATION REPORT		Reviewed by: Quality Manager
Document S/N: OY1401200112-R1.ZNF	Test Dates: 01/22/2014 - 01/27/2014	DUT Type: Portable Handset		Page 4 of 35

1.4 Simultaneous Transmission Capabilities

According to FCC KDB Publication 447498 D05v01, transmitters are considered to be transmitting simultaneously when there is overlapping transmission, with the exception of transmissions during network hand-offs with maximum hand-off duration less than 30 seconds. This device contains multiple transmitters that may operate simultaneously, and therefore requires a simultaneous transmission analysis according to FCC KDB Publication 447498 D01v05 3) procedures.

**Table 1-2
Simultaneous Transmission Scenarios**

No.	Capable Transmit Configurations	Head	Body-Worn Accessory	Hotspot	Note
		IEEE 1528, Supplement C	Supplement C	FCC KDB 941225 D06 Edges/Sides	
1	CDMA BC0 Voice + WiFi 2.4GHz Data	Yes	Yes	N/A	
2	CDMA BC1 Voice + WiFi 2.4GHz Data	Yes	Yes	N/A	
3	CDMA BC0 1x Data/EVDO + WiFi 2.4 GHz Data	Yes*	Yes*	Yes	CDMA Hotspot; VOIP
4	CDMA BC1 1x Data/EVDO + WiFi 2.4 GHz Data	Yes*	Yes*	Yes	CDMA Hotspot; VOIP
5	CDMA BC0 Voice + Bluetooth 2.4 GHz	N/A	Yes	N/A	
6	CDMA BC1 Voice + Bluetooth 2.4 GHz	N/A	Yes	N/A	
Notes:					
1. Simultaneous transmission between WIFI 2.4 GHz and Bluetooth 2.4 GHz is not supported					

Notes:

- (*) = for VOIP 3rd party applications possibly installed and used by the end-user
- Per the manufacturer, WIFI Direct is expected to be used in conjunction with a held-to-ear or body-worn accessory voice call. There are no simultaneous transmission scenarios involving WIFI direct beyond that listed in the above table.

1.5 SAR Test Exclusions Applied

(A) Bluetooth

Per FCC KDB 447498 D01v05, the SAR exclusion threshold for distances <50mm is defined by the following equation:

$$\frac{\text{Max Power of Channel (mW)}}{\text{Test Separation Dist (mm)}} * \sqrt{\text{Frequency(GHz)}} \leq 3.0$$



Based on the maximum conducted power of Bluetooth (rounded to the nearest mW) and the antenna to user separation distance, Bluetooth SAR was not required; $[(11/10) * \sqrt{2.441}] = 1.7 < 3.0$. Per KDB Publication 447498 D01v05, the maximum power of the channel was rounded to the nearest mW before calculation.

1.6 Power Reduction for SAR

There is no power reduction used for any band/mode implemented in this device for SAR purposes.

1.7 Guidance Applied



- IEEE 1528-2003
- FCC KDB Publication 941225 D01-D06 (2G/3G and Hotspot)
- FCC KDB Publication 248227 D01v01r02 (SAR Considerations for 802.11 Devices)
- FCC KDB Publication 447498 D01v05 (General SAR Guidance)
- FCC KDB Publication 865664 D01-D02 (SAR Measurements up to 6 GHz)

FCC ID: ZNFL34C	 PCTEST ENGINEERING LABORATORY, INC.	SAR EVALUATION REPORT	 LG	Reviewed by: Quality Manager
Document S/N: OY1401200112-R1.ZNF	Test Dates: 01/22/2014 - 01/27/2014	DUT Type: Portable Handset	Page 5 of 35	

1.8 Device Serial Numbers

Several samples were used with identical hardware to support SAR testing. The manufacturer has confirmed that the device(s) tested have the same physical, mechanical and thermal characteristics and are within operational tolerances expected for production units.

	Head Serial Number	Body-Worn Serial Number	Hotspot Serial Number
Cell. CDMA/EVDO	2001-2	2001-2	2001-2
PCS CDMA/EVDO	2001-2	2001-2	2001-2
2.4 GHz WLAN	2001-14	2001-14	2001-14

FCC ID: ZNFL34C		SAR EVALUATION REPORT		Reviewed by: Quality Manager
Document S/N: 0Y1401200112-R1.ZNF	Test Dates: 01/22/2014 - 01/27/2014	DUT Type: Portable Handset		Page 6 of 35

2 INTRODUCTION

The FCC and Industry Canada have adopted the guidelines for evaluating the environmental effects of radio frequency (RF) radiation in ET Docket 93-62 on Aug. 6, 1996 and Health Canada Safety Code 6 to protect the public and workers from the potential hazards of RF emissions due to FCC-regulated portable devices. [1]

The safety limits used for the environmental evaluation measurements are based on the criteria published by the American National Standards Institute (ANSI) for localized specific absorption rate (SAR) in IEEE/ANSI C95.1-1992 Standard for Safety Levels with Respect to Human Exposure to Radio Frequency Electromagnetic Fields, 3 kHz to 300 GHz [3] and Health Canada RF Exposure Guidelines Safety Code 6 [24]. The measurement procedure described in IEEE/ANSI C95.3-2002 Recommended Practice for the Measurement of Potentially Hazardous Electromagnetic Fields - RF and Microwave [4] is used for guidance in measuring the Specific Absorption Rate (SAR) due to the RF radiation exposure from the Equipment Under Test (EUT). These criteria for SAR evaluation are similar to those recommended by the International Committee for Non-Ionizing Radiation Protection (ICNIRP) in Biological Effects and Exposure Criteria for Radiofrequency Electromagnetic Fields,” Report No. Vol 74. SAR is a measure of the rate of energy absorption due to exposure to an RF transmitting source. SAR values have been related to threshold levels for potential biological hazards.

2.1 SAR Definition

Specific Absorption Rate is defined as the time derivative (rate) of the incremental energy (dU) absorbed by (dissipated in) an incremental mass (dm) contained in a volume element (dV) of a given density (ρ). It is also defined as the rate of RF energy absorption per unit mass at a point in an absorbing body (see Equation 2-1).

Equation 2-1
SAR Mathematical Equation

$$SAR = \frac{d}{dt} \left(\frac{dU}{dm} \right) = \frac{d}{dt} \left(\frac{dU}{\rho dv} \right)$$



SAR is expressed in units of Watts per Kilogram (W/kg).

$$SAR = \frac{\sigma \cdot E^2}{\rho}$$

where:

- σ = conductivity of the tissue-simulating material (S/m)
- ρ = mass density of the tissue-simulating material (kg/m³)
- E = Total RMS electric field strength (V/m)

NOTE: The primary factors that control rate of energy absorption were found to be the wavelength of the incident field in relation to the dimensions and geometry of the irradiated organism, the orientation of the organism in relation to the polarity of field vectors, the presence of reflecting surfaces, and whether conductive contact is made by the organism with a ground plane.[6]

FCC ID: ZNFL34C		SAR EVALUATION REPORT		Reviewed by: Quality Manager
Document S/N: OY1401200112-R1.ZNF	Test Dates: 01/22/2014 - 01/27/2014	DUT Type: Portable Handset	Page 7 of 35	

3 DOSIMETRIC ASSESSMENT

3.1 Measurement Procedure

The evaluation was performed using the following procedure:

1. The SAR distribution at the exposed side of the head or body was measured at a distance no greater than 5.0 mm from the inner surface of the shell. The area covered the entire dimension of the device-head and body interface and the horizontal grid resolution was determined per FCC KDB Publication 865664 D01v01 (See Table 3-1).
2. The point SAR measurement was taken at the maximum SAR region determined from Step 1 to enable the monitoring of SAR fluctuations/drifts during the 1g/10g cube evaluation. SAR at this fixed point was measured and used as a reference value.
3. Based on the area scan data, the peak of the region with maximum SAR was determined by spline interpolation. Around this point, a volume was assessed according to the measurement resolution and volume size requirements of FCC KDB Publication 865664 D01v01 (See Table 3-1). On the basis of this data set, the spatial peak SAR value was evaluated with the following procedure (see references or the DASy manual online for more details):
 - a. The data was extrapolated to the surface of the outer-shell of the phantom. The combined distance extrapolated was the combined distance from the center of the dipoles 2.7mm away from the tip of the probe housing plus the 1.2 mm distance between the surface and the lowest measuring point. The extrapolation was based on a least-squares algorithm. A polynomial of the fourth order was calculated through the points in the z-axis (normal to the phantom shell).
 - b. After the maximum interpolated values were calculated between the points in the cube, the SAR was averaged over the spatial volume (1g or 10g) using a 3D-Spline interpolation algorithm. The 3D-spline is composed of three one-dimensional splines with the “Not a knot” condition (in x, y, and z directions). The volume was then integrated with the trapezoidal algorithm. One thousand points (10 x 10 x 10) were obtained through interpolation, in order to calculate the averaged SAR.
 - c. All neighboring volumes were evaluated until no neighboring volume with a higher average value was found.
4. The SAR reference value, at the same location as step 2, was re-measured after the zoom scan was complete to calculate the SAR drift. If the drift deviated by more than 5%, the SAR test and drift measurements were repeated.

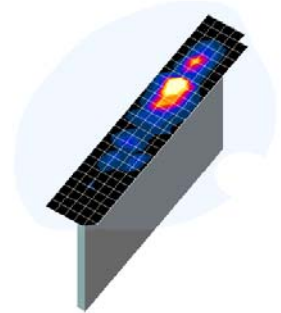



Figure 3-1
Sample SAR Area Scan

Table 3-1
Area and Zoom Scan Resolutions per FCC KDB Publication 865664 D01v01

Frequency	Maximum Area Scan Resolution (mm) ($\Delta x_{area}, \Delta y_{area}$)	Maximum Zoom Scan Resolution (mm) ($\Delta x_{zoom}, \Delta y_{zoom}$)	Maximum Zoom Scan Spatial Resolution (mm)			Minimum Zoom Scan Volume (mm) (x, y, z)
			Uniform Grid	Graded Grid		
				$\Delta z_{zoom}(n)$	$\Delta z_{zoom}(1)^*$	
≤ 2 GHz	≤ 15	≤ 8	≤ 5	≤ 4	≤ 1.5* $\Delta z_{zoom}(n-1)$	≥ 30
2-3 GHz	≤ 12	≤ 5	≤ 5	≤ 4	≤ 1.5* $\Delta z_{zoom}(n-1)$	≥ 30
3-4 GHz	≤ 12	≤ 5	≤ 4	≤ 3	≤ 1.5* $\Delta z_{zoom}(n-1)$	≥ 28
4-5 GHz	≤ 10	≤ 4	≤ 3	≤ 2.5	≤ 1.5* $\Delta z_{zoom}(n-1)$	≥ 25
5-6 GHz	≤ 10	≤ 4	≤ 2	≤ 2	≤ 1.5* $\Delta z_{zoom}(n-1)$	≥ 22

FCC ID: ZNFL34C		SAR EVALUATION REPORT		Reviewed by: Quality Manager
Document S/N: OY1401200112-R1.ZNF	Test Dates: 01/22/2014 - 01/27/2014	DUT Type: Portable Handset	Page 8 of 35	

4

DEFINITION OF REFERENCE POINTS

4.1 EAR REFERENCE POINT

Figure 4-2 shows the front, back and side views of the SAM Twin Phantom. The point “M” is the reference point for the center of the mouth, “LE” is the left ear reference point (ERP), and “RE” is the right ERP. The ERP is 15mm posterior to the entrance to the ear canal (EEC) along the B-M line (Back-Mouth), as shown in Figure 4-1. The plane passing through the two ear canals and M is defined as the Reference Plane. The line N-F (Neck-Front) is perpendicular to the reference plane and passing through the RE (or LE) is called the Reference Pivoting Line (see Figure 4-1). Line B-M is perpendicular to the N-F line. Both N-F and B-M lines are marked on the external phantom shell to facilitate handset positioning [5].

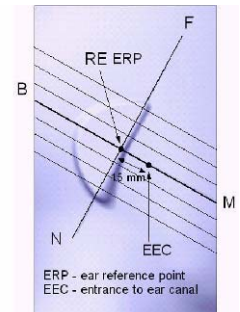

Figure 4-1
Close-Up Side view of ERP

4.2 HANDSET REFERENCE POINTS

Two imaginary lines on the handset were established: the vertical centerline and the horizontal line. The test device was placed in a normal operating position with the “test device reference point” located along the “vertical centerline” on the front of the device aligned to the “ear reference point” (See Figure 4-3). The “test device reference point” was then located at the same level as the center of the ear reference point. The test device was positioned so that the “vertical centerline” was bisecting the front surface of the handset at its top and bottom edges, positioning the “ear reference point” on the outer surface of the both the left and right head phantoms on the ear reference point.



Figure 4-2
Front, back and side view of SAM Twin Phantom

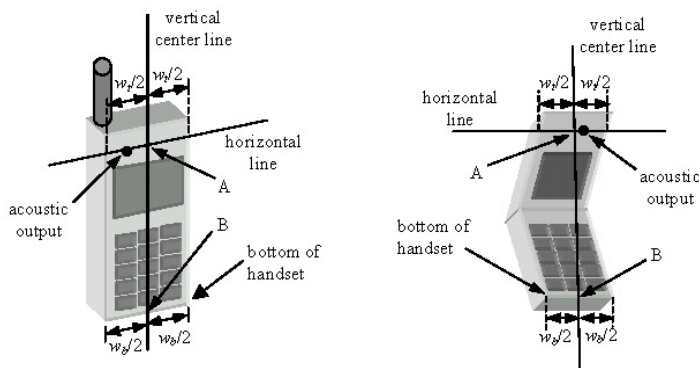



Figure 4-3
Handset Vertical Center & Horizontal Line Reference Points

FCC ID: ZNFL34C	 PCTEST ENGINEERING LABORATORY, INC.	SAR EVALUATION REPORT	 LG	Reviewed by: Quality Manager
Document S/N: OY1401200112-R1.ZNF	Test Dates: 01/22/2014 - 01/27/2014	DUT Type: Portable Handset		Page 9 of 35

5 TEST CONFIGURATION POSITIONS FOR HANDSETS

5.1 Device Holder

The device holder is made out of low-loss POM material having the following dielectric parameters: relative permittivity $\epsilon = 3$ and loss tangent $\delta = 0.02$.

5.2 Positioning for Cheek

1. The test device was positioned with the device close to the surface of the phantom such that point A is on the (virtual) extension of the line passing through points RE and LE on the phantom (see Figure 5-1), such that the plane defined by the vertical center line and the horizontal line of the phone is approximately parallel to the sagittal plane of the phantom.

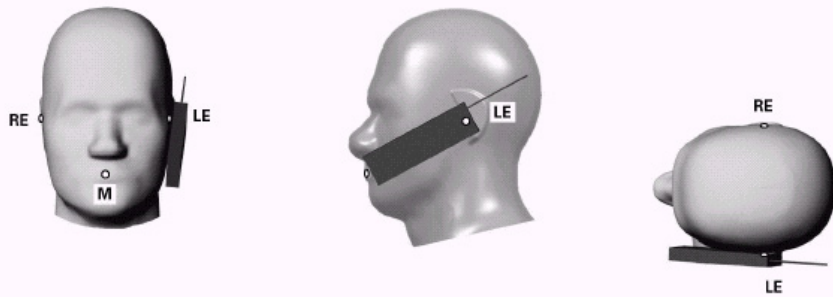



Figure 5-1 Front, Side and Top View of Cheek Position

2. The handset was translated towards the phantom along the line passing through RE & LE until the handset touches the ear.
3. While maintaining the handset in this plane, the handset was rotated around the LE-RE line until the vertical centerline was in the plane normal to MB-NF including the line MB (reference plane).
4. The phone was then rotated around the vertical centerline until the phone (horizontal line) was symmetrical with respect to the line NF.
5. While maintaining the vertical centerline in the reference plane, keeping point A on the line passing through RE and LE, and maintaining the device contact with the ear, the device was rotated about the NF line until any point on the handset made contact with a phantom point below the ear (cheek) (See Figure 5-2).

5.3 Positioning for Ear / 15° Tilt

With the test device aligned in the “Cheek Position”:

1. While maintaining the orientation of the phone, the phone was retracted parallel to the reference plane far enough to enable a rotation of the phone by 15 degrees.
2. The phone was then rotated around the horizontal line by 15 degrees.
3. While maintaining the orientation of the phone, the phone was moved parallel to the reference plane until any part of the handset touched the head. (In this position, point A was located on the line RE-LE). The tilted position is obtained when the contact is on the pinna. If the contact was at any location other than the pinna, the angle of the phone would then be reduced. The tilted position was obtained when any part of the phone was in contact of the ear as well as a second part of the phone was in contact with the head (see Figure 5-2).

FCC ID: ZNFL34C		SAR EVALUATION REPORT		Reviewed by: Quality Manager
Document S/N: OY1401200112-R1.ZNF	Test Dates: 01/22/2014 - 01/27/2014	DUT Type: Portable Handset	Page 10 of 35	

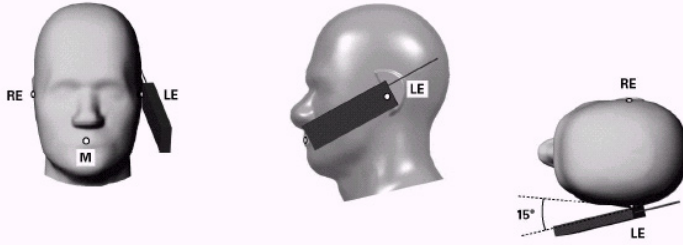

Figure 5-2 Front, Side and Top View of Ear/15° Tilt Position

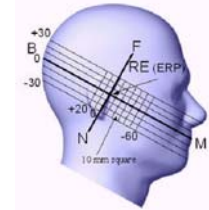

Figure 5-3 Side view w/ relevant markings

5.4 SAR Evaluations near the Mouth/Jaw Regions of the SAM Phantom

Antennas located near the bottom of a phone may require SAR measurements around the mouth and jaw regions of the SAM head phantom. This typically applies to clam-shell style phones that are generally longer in the unfolded normal use positions or to certain older style long rectangular phones.

Under these circumstances, the following procedures apply, adopted from the FCC guidance on SAR handsets document FCC KDB Publication 648474 D04_v01. The SAR required in these regions of SAM should be measured using a flat phantom. The phone should be positioned with a separation distance of 4 mm between the ear reference point (ERP) and the outer surface of the flat phantom shell. While maintaining this distance at the ERP location, the low (bottom) edge of the phone should be lowered from the phantom to establish the same separation distance between the peak SAR location identified by the truncated partial SAR distribution measured with the SAM phantom. The distance from the peak SAR location to the phone is determined by the straight line passing perpendicularly through the phantom surface. When it is not feasible to maintain 4 mm separation at the ERP while also establishing the required separation at the peak SAR location, the top edge of the phone will be allowed to touch the phantom with a separation < 4 mm at the ERP. The phone should not be tilted to the left or right while placed in this inclined position to the flat phantom.

The latest IEEE 1528 committee developments propose the usage of a tilted phantom when the antenna of the phone is mounted at the bottom or in all cases the peak absorption is in the chin region. Both SAM heads of the TwinSAM-Chin20 are rotated 20 degrees around the NF line. Each head can be removed individually from the table for emptying and cleaning.

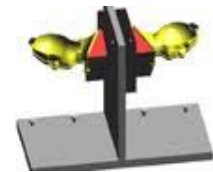



Figure 5-4 Twin SAM Chin20

FCC ID: ZNFL34C	 PCTEST ENGINEERING LABORATORY, INC.	SAR EVALUATION REPORT	 LG	Reviewed by: Quality Manager
Document S/N: OY1401200112-R1.ZNF	Test Dates: 01/22/2014 - 01/27/2014	DUT Type: Portable Handset	Page 11 of 35	

5.5 Body-Worn Accessory Configurations

Body-worn operating configurations are tested with the belt-clips and holsters attached to the device and positioned against a flat phantom in a normal use configuration (see Figure 5-5). Per FCC KDB Publication 648474 D04v01, Body-worn accessory exposure is typically related to voice mode operations when handsets are carried in body-worn accessories. The body-worn accessory procedures in FCC KDB Publication 447498 D01v05 should be used to test for body-worn accessory SAR compliance, without a headset connected to it. This enables the test results for such configuration to be compatible with that required for hotspot mode when the body-worn accessory test separation distance is greater than or equal to that required for hotspot mode, when applicable. When the reported SAR for a body-worn accessory, measured without a headset connected to the handset, is $> 1.2 \text{ W/kg}$, the highest reported SAR configuration for that wireless mode and frequency band should be repeated for that body-worn accessory with a headset attached to the handset.

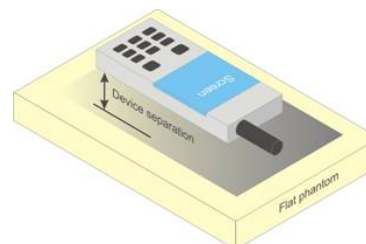

Figure 5-5
Sample Body-Worn Diagram



Accessories for Body-worn operation configurations are divided into two categories: those that do not contain metallic components and those that do contain metallic components. When multiple accessories that do not contain metallic components are supplied with the device, the device is tested with only the accessory that dictates the closest spacing to the body. Then multiple accessories that contain metallic components are tested with the device with each accessory. If multiple accessories share an identical metallic component (i.e. the same metallic belt-clip used with different holsters with no other metallic components) only the accessory that dictates the closest spacing to the body is tested.

Body-worn accessories may not always be supplied or available as options for some devices intended to be authorized for body-worn use. In this case, a test configuration with a separation distance between the back of the device and the flat phantom is used. Test position spacing was documented. Transmitters that are designed to operate in front of a person's face, as in push-to-talk configurations, are tested for SAR compliance with the front of the device positioned to face the flat phantom in head fluid. For devices that are carried next to the body such as a shoulder, waist or chest-worn transmitters, SAR compliance is tested with the accessories, including headsets and microphones, attached to the device and positioned against a flat phantom in a normal use configuration.

5.6 Extremity Exposure Configurations

Devices that are designed or intended for use on extremities or mainly operated in extremity only exposure conditions; i.e., hands, wrists, feet and ankles, may require extremity SAR evaluation. When the device also operates in close proximity to the user's body, SAR compliance for the body is also required. The 1-g body and 10-g extremity SAR Exclusion Thresholds found in KDB Publication 44798 D01v05 should be applied to determine SAR test requirements.



Per KDB Publication 44798 D01v05, Cell phones (handsets) are not normally designed to be used on extremities or operated in extremity only exposure conditions. The maximum output power levels of handsets generally do not require extremity SAR testing to show compliance. Therefore, extremity SAR was not evaluated for this device.

FCC ID: ZNFL34C		SAR EVALUATION REPORT		Reviewed by: Quality Manager
Document S/N: OY1401200112-R1.ZNF	Test Dates: 01/22/2014 - 01/27/2014	DUT Type: Portable Handset		Page 12 of 35

5.7 Wireless Router Configurations

Some battery-operated handsets have the capability to transmit and receive user data through simultaneous transmission of WIFI simultaneously with a separate licensed transmitter. The FCC has provided guidance in FCC KDB Publication 941225 D06 v01 where SAR test considerations for handsets ($L \times W \geq 9 \text{ cm} \times 5 \text{ cm}$) are based on a composite test separation distance of 10 mm from the front, back and edges of the device containing transmitting antennas within 2.5 cm of their edges, determined from general mixed use conditions for this type of devices. Since the hotspot SAR results may overlap with the body-worn accessory SAR requirements, the more conservative configurations can be considered, thus excluding some body-worn accessory SAR tests.

When the user enables the personal wireless router functions for the handset, actual operations include simultaneous transmission of both the WIFI transmitter and another licensed transmitter. Both transmitters often do not transmit at the same transmitting frequency and thus cannot be evaluated for SAR under actual use conditions due to the limitations of the SAR assessment probes. Therefore, SAR must be evaluated for each frequency transmission and mode separately and spatially summed with the WIFI transmitter according to FCC KDB Publication 447498 D01v05 publication procedures. The "Portable Hotspot" feature on the handset was NOT activated during SAR assessments, to ensure the SAR measurements were evaluated for a single transmission frequency RF signal at a time.

FCC ID: ZNFL34C		SAR EVALUATION REPORT		Reviewed by: Quality Manager
Document S/N: 0Y1401200112-R1.ZNF	Test Dates: 01/22/2014 - 01/27/2014	DUT Type: Portable Handset		Page 13 of 35

6 RF EXPOSURE LIMITS

6.1 Uncontrolled Environment

UNCONTROLLED ENVIRONMENTS are defined as locations where there is the exposure of individuals who have no knowledge or control of their exposure. The general population/uncontrolled exposure limits are applicable to situations in which the general public may be exposed or in which persons who are exposed as a consequence of their employment may not be made fully aware of the potential for exposure or cannot exercise control over their exposure. Members of the general public would come under this category when exposure is not employment-related; for example, in the case of a wireless transmitter that exposes persons in its vicinity.



6.2 Controlled Environment

CONTROLLED ENVIRONMENTS are defined as locations where there is exposure that may be incurred by persons who are aware of the potential for exposure, (i.e. as a result of employment or occupation). In general, occupational/controlled exposure limits are applicable to situations in which persons are exposed as a consequence of their employment, who have been made fully aware of the potential for exposure and can exercise control over their exposure. This exposure category is also applicable when the exposure is of a transient nature due to incidental passage through a location where the exposure levels may be higher than the general population/uncontrolled limits, but the exposed person is fully aware of the potential for exposure and can exercise control over his or her exposure by leaving the area or by some other appropriate means.

Table 6-1
SAR Human Exposure Specified in ANSI/IEEE C95.1-1992 and Health Canada Safety Code 6

HUMAN EXPOSURE LIMITS		
	UNCONTROLLED ENVIRONMENT <i>General Population</i> (W/kg) or (mW/g)	CONTROLLED ENVIRONMENT <i>Occupational</i> (W/kg) or (mW/g)
Peak Spatial Average SAR Head	1.6	8.0
Whole Body SAR	0.08	0.4
Peak Spatial Average SAR Hands, Feet, Ankle, Wrists, etc.	4.0	20

1. The Spatial Peak value of the SAR averaged over any 1 gram of tissue (defined as a tissue volume in the shape of a cube) and over the appropriate averaging time.
2. The Spatial Average value of the SAR averaged over the whole body.
3. The Spatial Peak value of the SAR averaged over any 10 grams of tissue (defined as a tissue volume in the shape of a cube) and over the appropriate averaging time.

FCC ID: ZNFL34C		SAR EVALUATION REPORT		Reviewed by: Quality Manager
Document S/N: OY1401200112-R1.ZNF	Test Dates: 01/22/2014 - 01/27/2014	DUT Type: Portable Handset		Page 14 of 35

7 FCC MEASUREMENT PROCEDURES

Power measurements were performed using a base station simulator under digital average power.

7.1 Measured and Reported SAR

Per FCC KDB Publication 447498 D01v05, When SAR is not measured at the maximum power level allowed for production units, the results must be scaled to the maximum tune-up tolerance limit according to the power applied to the individual channels tested to determine compliance. For simultaneous transmission, the measured aggregate SAR must be scaled according to the sum of the differences between the maximum tune-up tolerance and actual power used to test each transmitter. When SAR is measured at or scaled to the maximum tune-up tolerance limit, the results are referred to as *reported* SAR. The highest *reported* SAR results are identified on the grant of equipment authorization according to procedures in KDB 690783 D01v01r02.

7.2 Procedures Used to Establish RF Signal for SAR

The following procedures are according to FCC KDB Publication 941225 D01 "SAR Measurement Procedures for 3G Devices" v02, October 2007.

The device was placed into a simulated call using a base station simulator in a RF shielded chamber. Establishing connections in this manner ensure a consistent means for testing SAR and are recommended for evaluating SAR [4]. Devices under test were evaluated prior to testing, with a fully charged battery and were configured to operate at maximum output power. In order to verify that the device was tested throughout the SAR test at maximum output power, the SAR measurement system measures a "point SAR" at an arbitrary reference point at the start and end of the 1 gram SAR evaluation, to assess for any power drifts during the evaluation. If the power drift deviated by more than 5%, the SAR test and drift measurements were repeated.



7.3 SAR Measurement Conditions for CDMA2000

The following procedures were performed according to FCC KDB Publication 941225 D01 "SAR Measurement Procedures for 3G Devices" v02, October 2007.

7.3.1 Output Power Verification

See 3GPP2 C.S0011/TIA-98-E as recommended by "SAR Measurement Procedures for 3G Devices" v02, October 2007. Maximum output power is verified on the High, Middle and Low channels according to procedures in section 4.4.5.2 of 3GPP2 C.S0011/TIA-98-E. SO55 tests were measured with power control bits in the "All Up" condition.

1. If the mobile station (MS) supports Reverse TCH RC 1 and Forward TCH RC 1, set up a call using Fundamental Channel Test Mode 1 (RC=1/1) with 9600 bps data rate only.
2. Under RC1, C.S0011 Table 4.4.5.2-1, Table 7-1 parameters were applied.
3. If the MS supports the RC 3 Reverse FCH, RC3 Reverse SCH₀ and demodulation of RC 3,4, or 5, set up a call using Supplemental Channel Test Mode 3 (RC 3/3) with 9600 bps Fundamental Channel and 9600 bps SCH₀ data rate.
4. Under RC3, C.S0011 Table 4.4.5.2-2, Table 7-2 was applied.

FCC ID: ZNFL34C		SAR EVALUATION REPORT		Reviewed by: Quality Manager
Document S/N: OY1401200112-R1.ZNF	Test Dates: 01/22/2014 - 01/27/2014	DUT Type: Portable Handset		Page 15 of 35

**Table 7-1
Parameters for Max. Power for RC1**

Parameter	Units	Value
I_{or}	dBm/1.23 MHz	-104
$\frac{Pilot E_c}{I_{or}}$	dB	-7
$\frac{Traffic E_c}{I_{or}}$	dB	-7.4

**Table 7-2
Parameters for Max. Power for RC3**

Parameter	Units	Value
I_{or}	dBm/1.23 MHz	-86
$\frac{Pilot E_c}{I_{or}}$	dB	-7
$\frac{Traffic E_c}{I_{or}}$	dB	-7.4

5. FCHs were configured at full rate for maximum SAR with “All Up” power control bits.

7.3.2 Head SAR Measurements

SAR for head exposure configurations is measured in RC3 with the DUT configured to transmit at full rate using Loopback Service Option SO55. SAR for RC1 is not required when the maximum average output of each channel is less than ¼ dB higher than that measured in RC3. Otherwise, SAR is measured on the maximum output channel in RC1 using the exposure configuration that results in the highest SAR for that channel in RC3.

Head SAR was additionally evaluated using EVDO Rev. A to support compliance for VoIP operations. See Section 7.3.4 for EVDO Rev. A configuration parameters.



7.3.3 Body SAR Measurements

SAR for body exposure configurations is measured in RC3 with the DUT configured to transmit at full rate on FCH with all other code channels disabled using TDSO / SO32. SAR for multiple code channels (FCH + SCH_n) is not required when the maximum average output of each RF channel is less than ¼ dB higher than that measured with FCH only. Otherwise, SAR is measured on the maximum output channel (FCH + SCH_n) with FCH at full rate and SCH₀ enabled at 9600 bps using the exposure configuration that results in the highest SAR for that channel with FCH only. When multiple code channels are enabled, the DUT output may shift by more than 0.5 dB and lead to higher SAR drifts and SCH dropouts. Body SAR was measured using TDSO / SO32 with power control bits in the “All Up”

Body SAR in RC1 is not required when the maximum average output of each channel is less than ¼ dB higher than that measured in RC3. Otherwise, SAR is measured on the maximum output channel in RC1; with Loopback Service Option SO55, at full rate, using the body exposure configuration that results in the highest SAR for that channel in RC3.

7.3.4 Handsets with EVDO

For handsets with Ev-Do capabilities, when the maximum average output of each channel in Rev. 0 is less than ¼ dB higher than that measured in RC3 (1x RTT), body SAR for EV-DO is not required. Otherwise, SAR for Rev. 0 is measured on the maximum output channel at 153.6 kbps using the body exposure configuration that results in the highest SAR for that channel in RC3. SAR for Rev. A is not required when the maximum average output of each channel is less than that measured in Rev. 0 or less than ¼ dB higher than that measured in RC3. Otherwise, SAR is measured on the maximum output channel for Rev. A using a Reverse Data Channel payload size of 4096 bits and a Termination Target of 16 slots defined for Subtype 2 Physical Layer configurations. A Forward Traffic Channel data rate corresponding to the 2-slot version of 307.2 kbps with the ACK Channel transmitting in all slots would be configured in the downlink for both Rev. 0 and Rev. A.

FCC ID: ZNFL34C		SAR EVALUATION REPORT		Reviewed by: Quality Manager
Document S/N: OY1401200112-R1.ZNF	Test Dates: 01/22/2014 - 01/27/2014	DUT Type: Portable Handset	Page 16 of 35	

7.3.5 Body SAR Measurements for EVDO Hotspot

Hotspot Body SAR is measured using Subtype 0/1 Physical Layer configurations for Rev. 0 per KDB Publication 941225 D01 procedures for “1x Ev-Do data Devices”. SAR for Subtype 2 Physical layer configurations is not required for Rev. A when the maximum average output of each RF channels is less than that measured in Subtype 0/1 Physical layer configurations. Otherwise, SAR is measured on the maximum output channel for Rev. A using the exposure configuration that results in the highest SAR for the RF channels in Rev. 0. The AT is tested with a Reverse Data Channel rate of 153.6 kbps in Subtype 0/1 Physical Layer configurations; and a Reverse Data Channel payload size of 4096 bits and Termination Target of 16 slots in Subtype 2 Physical Layer configurations.

SAR is not required for 1x RTT for Ev-Do devices that also support 1x RTT voice and/or data operations, when the maximum average output of each channel is less than 1/4 dB higher than that measured in Subtype 0/1 Physical Layer configurations for Rev. 0. Otherwise, CDMA “Body-SAR Measurement” procedures for “CDMA 2000 1x Handsets” were applied.

7.4 SAR Testing with 802.11 Transmitters

Normal network operating configurations are not suitable for measuring the SAR of 802.11 b/g/n transmitters. Unpredictable fluctuations in network traffic and antenna diversity conditions can introduce undesirable variations in SAR results. The SAR for these devices should be measured using chipset based test mode software to ensure the results are consistent and reliable. See KDB Publication 248227 D01v01r02 for more details.



7.4.1 General Device Setup

Chipset based test mode software is hardware dependent and generally varies among manufacturers. The device operating parameters established in test mode for SAR measurements must be identical to those programmed in production units, including output power levels, amplifier gain settings and other RF performance tuning parameters. The test frequencies should correspond to actual channel frequencies defined for domestic use. SAR for devices with switched diversity should be measured with only one antenna transmitting at a time during each SAR measurement, according to a fixed modulation and data rate. The same data pattern should be used for all measurements.

7.4.2 Frequency Channel Configurations [27]

For 2.4 GHz, the highest average RF output power channel between the low, mid and high channel at the lowest data rate was selected for SAR evaluation in 802.11b mode. 802.11g/n modes and higher data rates for 802.11b were additionally evaluated for SAR if the output power of the respective mode was 0.25 dB or higher than the powers of the SAR configurations tested in the 802.11b mode.

If the maximum extrapolated peak SAR of the zoom scan for the highest output channel was less than 1.6 W/kg and if the 1g averaged SAR was less than 0.8 W/kg, SAR testing was not required for the other test channels in the band.

FCC ID: ZNFL34C		SAR EVALUATION REPORT		Reviewed by: Quality Manager
Document S/N: OY1401200112-R1.ZNF	Test Dates: 01/22/2014 - 01/27/2014	DUT Type: Portable Handset		Page 17 of 35

8 RF CONDUCTED POWERS

8.1 CDMA Conducted Powers

Band	Channel	Rule Part	Frequency	SO55 [dBm]	SO55 [dBm]	TDSO SO32 [dBm]	TDSO SO32 [dBm]	1x EvDO Rev. 0 [dBm]	1x EvDO Rev. A [dBm]
	F-RC		MHz	RC1	RC3	FCH+SCH	FCH	(RTAP)	(RETAP)
Cellular	1013	22H	824.7	24.49	24.30	24.37	24.36	24.32	24.30
	384	22H	836.52	24.51	24.41	24.47	24.41	24.65	24.45
	777	22H	848.31	24.52	24.28	24.31	24.33	24.50	24.32
PCS	25	24E	1851.25	24.43	24.20	24.20	24.25	24.35	24.30
	600	24E	1880	24.37	24.23	24.33	24.27	24.35	24.33
	1175	24E	1908.75	24.41	24.27	24.27	24.17	24.33	24.25



Note: RC1 is only applicable for IS-95 compatibility.

Per KDB Publication 941225 D01v02:

1. Head SAR was tested with SO55 RC3. SO55 RC1 was not required since the average output power was not more than 0.25 dB than the SO55 RC3 powers.
2. Body-Worn SAR was tested with 1x RTT with TDSO / SO32 FCH Only. Ev-Do and TDSO / SO32 FCH+SCH SAR tests were not required since the average output power was not more than 0.25 dB higher than the TDSO / SO32 FCH only powers.
3. Hotspot SAR is measured using Subtype 0/1 Physical Layer configurations for Rev. 0. If the average output power of Subtype 2 for Rev. A is less than the Rev. 0 power levels, then Rev. A SAR is not required. Otherwise, SAR is measured on the maximum output channel for Rev. A using the exposure configuration that results in the highest SAR for that RF channel in Rev. 0. SAR is not required for 1x RTT for Ev-Do hotspot devices when the maximum average output of each channel is less than 1/4 dB higher than that measured in Subtype 0/1 Physical Layer configurations for Rev. 0
4. Head SAR was additionally evaluated with EVDO Rev. A to determine compliance for held-to-ear VoIP operations.



Figure 8-1
Power Measurement Setup

FCC ID: ZNFL34C	 PCTEST ENGINEERING LABORATORY, INC.	SAR EVALUATION REPORT	 LG	Reviewed by: Quality Manager
Document S/N: OY1401200112-R1.ZNF	Test Dates: 01/22/2014 - 01/27/2014	DUT Type: Portable Handset	Page 18 of 35	

8.2 WLAN Conducted Powers

Table 8-1
IEEE 802.11b Average RF Power

Mode	Freq [MHz]	Channel	802.11b (2.4 GHz) Conducted Power [dBm]			
			Data Rate [Mbps]			
	1	2	5.5	11		
802.11b	2412	1	13.98	14.02	14.37	14.28
802.11b	2437	6	14.61	14.58	14.61	14.67
802.11b	2462	11	14.74	14.73	14.75	14.76

Table 8-2
IEEE 802.11g Average RF Power

Mode	Freq [MHz]	Channel	802.11g (2.4 GHz) Conducted Power [dBm]							
			Data Rate [Mbps]							
	6	9	12	18	24	36	48	54		
802.11g	2412	1	10.35	10.33	10.35	10.36	10.34	10.35	10.36	10.10
802.11g	2437	6	10.72	10.73	10.73	10.74	10.68	10.74	10.74	10.46
802.11g	2462	11	10.79	10.79	10.81	10.82	10.77	10.84	10.82	10.81

Table 8-3
IEEE 802.11n Average RF Power



Mode	Freq [MHz]	Channel	802.11n (2.4 GHz) Conducted Power [dBm]							
			Data Rate [Mbps]							
	6.5	13	20	26	39	52	58	65		
802.11n	2412	1	9.35	9.11	9.36	9.34	9.36	9.10	9.33	9.22
802.11n	2437	6	9.72	9.50	9.52	9.74	9.51	9.73	9.48	9.44
802.11n	2462	11	9.86	9.90	9.87	9.85	9.60	9.61	9.59	9.86

Justification for reduced test configurations for WIFI channels per KDB Publication 248227 D01v01r02 and October 2012/April 2013 FCC/TCB Meeting Notes:

- For 2.4 GHz, highest average RF output power channel for the lowest data rate for IEEE 802.11b were selected for SAR evaluation. Other IEEE 802.11 modes (including 802.11g/n) were not investigated since the average output powers over all channels and data rates were not more than 0.25 dB higher than the tested channel in the lowest data rate of IEEE 802.11b mode.
- Since the maximum extrapolated peak SAR of the zoom scan for the maximum output channel is <1.6 W/kg and the reported 1g averaged SAR is <0.8 W/kg, SAR testing on other channels is not required.
- The bolded data rate and channel above were tested for SAR.



Figure 8-2
Power Measurement Setup



FCC ID: ZNFL34C	 PCTEST ENGINEERING LABORATORY, INC.	SAR EVALUATION REPORT	 LG	Reviewed by: Quality Manager
Document S/N: OY1401200112-R1.ZNF	Test Dates: 01/22/2014 - 01/27/2014	DUT Type: Portable Handset	Page 19 of 35	

9.1 Tissue Verification

**Table 9-1
Measured Tissue Properties**

Calibrated for Tests Performed on:	Tissue Type	Tissue Temp During Calibration (C°)	Measured Frequency (MHz)	Measured Conductivity, σ (S/m)	Measured Dielectric Constant, ϵ	TARGET Conductivity, σ (S/m)	TARGET Dielectric Constant, ϵ	% dev σ	% dev ϵ
1/25/2014	835H	21.0	820	0.885	40.707	0.899	41.578	-1.56%	-2.09%
			835	0.899	40.511	0.900	41.500	-0.11%	-2.38%
			850	0.914	40.330	0.916	41.500	-0.22%	-2.82%
1/24/2014	1900H	21.1	1850	1.400	39.596	1.400	40.000	0.00%	-1.01%
			1880	1.432	39.444	1.400	40.000	2.29%	-1.39%
			1910	1.463	39.367	1.400	40.000	4.50%	-1.58%
1/23/2014	2450H	23.1	2401	1.757	38.539	1.756	39.287	0.06%	-1.90%
			2450	1.823	38.550	1.800	39.200	1.28%	-1.66%
			2499	1.856	38.277	1.853	39.138	0.16%	-2.20%
1/23/2014	835B	23.5	820	0.993	52.980	0.969	55.258	2.48%	-4.12%
			835	1.005	52.811	0.970	55.200	3.61%	-4.33%
			850	1.020	52.645	0.988	55.154	3.24%	-4.55%
1/27/2014	835B	22.3	820	0.964	53.001	0.969	55.258	-0.52%	-4.08%
			835	0.977	52.829	0.970	55.200	0.72%	-4.30%
			850	0.995	52.689	0.988	55.154	0.71%	-4.47%
1/22/2014	1900B	22.6	1850	1.481	52.516	1.520	53.300	-2.57%	-1.47%
			1880	1.514	52.435	1.520	53.300	-0.39%	-1.62%
			1910	1.552	52.332	1.520	53.300	2.11%	-1.82%
1/27/2014	2450B	20.9	2401	1.973	54.052	1.903	52.765	3.68%	2.44%
			2450	2.043	53.862	1.950	52.700	4.77%	2.20%
			2499	2.113	53.690	2.019	52.638	4.66%	2.00%

The above measured tissue parameters were used in the DASY software. The DASY software was used to perform interpolation to determine the dielectric parameters at the SAR test device frequencies (per IEEE 1528 6.6.1.2). The tissue parameters listed in the SAR test plots may slightly differ from the table above due to significant digit rounding in the software.

FCC ID: ZNFL34C	 PCTEST ENGINEERING LABORATORY, INC.	SAR EVALUATION REPORT	 LG	Reviewed by: Quality Manager
Document S/N: OY1401200112-R1.ZNF	Test Dates: 01/22/2014 - 01/27/2014	DUT Type: Portable Handset		Page 20 of 35

9.2 Test System Verification

Prior to SAR assessment, the system is verified to $\pm 10\%$ of the SAR measurement on the reference dipole at the time of calibration by the calibration facility. Full system validation status and result summary can be found in Appendix E.

**Table 9-2
System Verification Results**

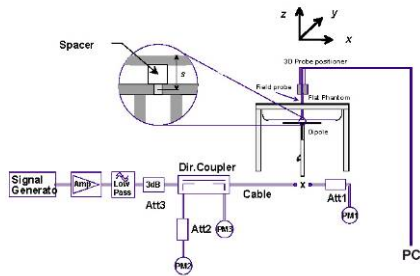

System Verification TARGET & MEASURED												
SAR System #	Tissue Frequency (MHz)	Tissue Type	Date:	Amb. Temp (°C)	Liquid Temp (°C)	Input Power (W)	Dipole SN	Probe SN	Measured SAR _{1g} (W/kg)	1 W Target SAR _{1g} (W/kg)	1 W Normalized SAR _{1g} (W/kg)	Deviation _{1g} (%)
B	835	HEAD	01/25/2014	22.8	21.2	0.100	4d133	3288	0.957	9.620	9.570	-0.52%
C	1900	HEAD	01/24/2014	20.4	20.0	0.100	5d141	3263	3.980	40.800	39.800	-2.45%
G	2450	HEAD	01/23/2014	24.4	23.1	0.100	719	3209	5.270	53.200	52.700	-0.94%
H	835	BODY	01/23/2014	24.5	23.5	0.100	4d119	3318	0.935	9.540	9.350	-1.99%
K	835	BODY	01/27/2014	23.4	22.3	0.100	4d119	3333	0.961	9.540	9.610	0.73%
I	1900	BODY	01/22/2014	23.5	22.4	0.100	5d148	3319	3.820	40.800	38.200	-6.37%
C	2450	BODY	01/27/2014	23.0	20.9	0.032	882	3263	1.670	49.900	52.188	4.59%



**Figure 9-1
System Verification Setup Diagram**



**Figure 9-2
System Verification Setup Photo**

FCC ID: ZNFL34C	 PCTEST ENGINEERING LABORATORY, INC.	SAR EVALUATION REPORT	 LG	Reviewed by: Quality Manager
Document S/N: OY1401200112-R1.ZNF	Test Dates: 01/22/2014 - 01/27/2014	DUT Type: Portable Handset	Page 21 of 35	

10 SAR DATA SUMMARY



10.1 Standalone Head SAR Data

**Table 10-1
Cell. CDMA Head SAR**

MEASUREMENT RESULTS														
FREQUENCY		Mode/Band	Service	Maximum Allowed Power [dBm]	Conducted Power [dBm]	Power Drift [dB]	Side	Test Position	Device Serial Number	Duty Cycle	SAR (1g)	Scaling Factor	Scaled SAR (1g)	Plot #
MHz	Ch.										(W/kg)		(W/kg)	
836.52	384	Cell. CDMA	RC3 / SO55	24.7	24.41	-0.02	Right	Cheek	2001-2	1:1	0.549	1.069	0.587	
836.52	384	Cell. CDMA	RC3 / SO55	24.7	24.41	0.10	Right	Tilt	2001-2	1:1	0.346	1.069	0.370	
824.70	1013	Cell. CDMA	RC3 / SO55	24.7	24.30	-0.02	Left	Cheek	2001-2	1:1	0.731	1.096	0.801	
836.52	384	Cell. CDMA	RC3 / SO55	24.7	24.41	0.03	Left	Cheek	2001-2	1:1	0.768	1.069	0.821	A1
848.31	777	Cell. CDMA	RC3 / SO55	24.7	24.28	0.00	Left	Cheek	2001-2	1:1	0.653	1.102	0.720	
836.52	384	Cell. CDMA	RC3 / SO55	24.7	24.41	0.01	Left	Tilt	2001-2	1:1	0.422	1.069	0.451	
836.52	384	Cell. CDMA	EVDO Rev. A	24.7	24.45	-0.03	Right	Cheek	2001-2	1:1	0.540	1.059	0.572	
836.52	384	Cell. CDMA	EVDO Rev. A	24.7	24.45	0.05	Right	Tilt	2001-2	1:1	0.310	1.059	0.328	
836.52	384	Cell. CDMA	EVDO Rev. A	24.7	24.45	0.00	Left	Cheek	2001-2	1:1	0.736	1.059	0.779	
836.52	384	Cell. CDMA	EVDO Rev. A	24.7	24.45	0.01	Left	Tilt	2001-2	1:1	0.378	1.059	0.400	
ANSI / IEEE C95.1 1992 - SAFETY LIMIT Spatial Peak Uncontrolled Exposure/General Population								Head 1.6 W/kg (mW/g) averaged over 1 gram						

**Table 10-2
PCS CDMA Head SAR**

MEASUREMENT RESULTS														
FREQUENCY		Mode/Band	Service	Maximum Allowed Power [dBm]	Conducted Power [dBm]	Power Drift [dB]	Side	Test Position	Device Serial Number	Duty Cycle	SAR (1g)	Scaling Factor	Scaled SAR (1g)	Plot #
MHz	Ch.										(W/kg)		(W/kg)	
1880.00	600	PCS CDMA	RC3 / SO55	24.5	24.23	-0.01	Right	Cheek	2001-2	1:1	0.523	1.064	0.556	
1880.00	600	PCS CDMA	RC3 / SO55	24.5	24.23	0.08	Right	Tilt	2001-2	1:1	0.265	1.064	0.282	
1880.00	600	PCS CDMA	RC3 / SO55	24.5	24.23	0.01	Left	Cheek	2001-2	1:1	0.720	1.064	0.766	A2
1880.00	600	PCS CDMA	RC3 / SO55	24.5	24.23	0.05	Left	Tilt	2001-2	1:1	0.271	1.064	0.288	
1880.00	600	PCS CDMA	EVDO Rev. A	24.5	24.33	-0.03	Right	Cheek	2001-2	1:1	0.555	1.040	0.577	
1880.00	600	PCS CDMA	EVDO Rev. A	24.5	24.33	0.13	Right	Tilt	2001-2	1:1	0.284	1.040	0.295	
1880.00	600	PCS CDMA	EVDO Rev. A	24.5	24.33	0.01	Left	Cheek	2001-2	1:1	0.645	1.040	0.671	
1880.00	600	PCS CDMA	EVDO Rev. A	24.5	24.33	0.14	Left	Tilt	2001-2	1:1	0.252	1.040	0.262	
ANSI / IEEE C95.1 1992 - SAFETY LIMIT Spatial Peak Uncontrolled Exposure/General Population								Head 1.6 W/kg (mW/g) averaged over 1 gram						

FCC ID: ZNFL34C		SAR EVALUATION REPORT		Reviewed by: Quality Manager
Document S/N: OY1401200112-R1.ZNF	Test Dates: 01/22/2014 - 01/27/2014	DUT Type: Portable Handset		Page 22 of 35

**Table 10-3
DTS Head SAR**

MEASUREMENT RESULTS															
FREQUENCY		Mode	Service	Maximum Allowed Power [dBm]	Conducted Power [dBm]	Power Drift [dB]	Side	Test Position	Device Serial Number	Data Rate (Mbps)	Duty Cycle	SAR (1g)	Scaling Factor	Scaled SAR (1g)	Plot #
MHz	Ch.											(W/kg)		(W/kg)	
2462	11	IEEE 802.11b	DSSS	15.5	14.74	0.05	Right	Cheek	2001-14	1	1:1	0.099	1.191	0.118	
2462	11	IEEE 802.11b	DSSS	15.5	14.74	0.11	Right	Tilt	2001-14	1	1:1	0.086	1.191	0.102	
2462	11	IEEE 802.11b	DSSS	15.5	14.74	0.13	Left	Cheek	2001-14	1	1:1	0.181	1.191	0.216	A3
2462	11	IEEE 802.11b	DSSS	15.5	14.74	-0.07	Left	Tilt	2001-14	1	1:1	0.133	1.191	0.158	
ANSI / IEEE C95.1 1992 - SAFETY LIMIT Spatial Peak Uncontrolled Exposure/General Population							Head 1.6 W/kg (mW/g) averaged over 1 gram								

10.2 Standalone Body-Worn SAR Data



**Table 10-4
Body-Worn SAR Data**

MEASUREMENT RESULTS														
FREQUENCY		Mode	Service	Maximum Allowed Power [dBm]	Conducted Power [dBm]	Power Drift [dB]	Spacing	Device Serial Number	Duty Cycle	Side	SAR (1g)	Scaling Factor	Scaled SAR (1g)	Plot #
MHz	Ch.										(W/kg)		(W/kg)	
824.70	1013	Cell. CDMA	TDSO / SO32	24.7	24.36	-0.03	10 mm	2001-2	1:1	back	0.876	1.081	0.947	
836.52	384	Cell. CDMA	TDSO / SO32	24.7	24.41	-0.05	10 mm	2001-2	1:1	back	0.882	1.069	0.943	A4
848.31	777	Cell. CDMA	TDSO / SO32	24.7	24.33	-0.02	10 mm	2001-2	1:1	back	0.675	1.089	0.735	
836.52	384	Cell. CDMA	TDSO / SO32	24.7	24.41	0.02	10 mm	2001-2	1:1	back	0.806	1.069	0.862	
1880.00	600	PCS CDMA	TDSO / SO32	24.5	24.27	-0.01	10 mm	2001-2	1:1	back	0.637	1.054	0.671	A6
ANSI / IEEE C95.1 1992 - SAFETY LIMIT Spatial Peak Uncontrolled Exposure/General Population							Body 1.6 W/kg (mW/g) averaged over 1 gram							

Note: The data highlighted above in blue represents a variability measurement.

**Table 10-5
DTS Body-Worn SAR**

MEASUREMENT RESULTS															
FREQUENCY		Mode	Service	Maximum Allowed Power [dBm]	Conducted Power [dBm]	Power Drift [dB]	Spacing	Device Serial Number	Data Rate (Mbps)	Side	Duty Cycle	SAR (1g)	Scaling Factor	Scaled SAR (1g)	Plot #
MHz	Ch.											(W/kg)		(W/kg)	
2462	11	IEEE 802.11b	DSSS	15.5	14.74	0.01	10 mm	2001-14	1	back	1:1	0.172	1.191	0.205	A8
ANSI / IEEE C95.1 1992 - SAFETY LIMIT Spatial Peak Uncontrolled Exposure/General Population							Body 1.6 W/kg (mW/g) averaged over 1 gram								

FCC ID: ZNFL34C		SAR EVALUATION REPORT		Reviewed by: Quality Manager
Document S/N: OY1401200112-R1.ZNF	Test Dates: 01/22/2014 - 01/27/2014	DUT Type: Portable Handset	Page 23 of 35	



10.3 Standalone Wireless Router SAR Data

**Table 10-6
CDMA Hotspot SAR Data**

MEASUREMENT RESULTS														
FREQUENCY		Mode	Service	Maximum Allowed Power [dBm]	Conducted Power [dBm]	Power Drift [dB]	Spacing	Device Serial Number	Duty Cycle	Side	SAR (1g)	Scaling Factor	Scaled SAR (1g)	Plot #
MHz	Ch.										(W/kg)		(W/kg)	
824.70	1013	Cell. CDMA	EVDO Rev. 0	24.7	24.32	0.03	10 mm	2001-2	1:1	back	0.820	1.091	0.895	
836.52	384	Cell. CDMA	EVDO Rev. 0	24.7	24.65	0.02	10 mm	2001-2	1:1	back	0.837	1.012	0.847	A5
848.31	777	Cell. CDMA	EVDO Rev. 0	24.7	24.50	-0.01	10 mm	2001-2	1:1	back	0.653	1.047	0.684	
836.52	384	Cell. CDMA	EVDO Rev. 0	24.7	24.65	0.07	10 mm	2001-2	1:1	front	0.646	1.012	0.654	
836.52	384	Cell. CDMA	EVDO Rev. 0	24.7	24.65	-0.07	10 mm	2001-2	1:1	bottom	0.232	1.012	0.235	
836.52	384	Cell. CDMA	EVDO Rev. 0	24.7	24.65	0.06	10 mm	2001-2	1:1	left	0.748	1.012	0.757	
1880.00	600	PCS CDMA	EVDO Rev. 0	24.5	24.35	-0.03	10 mm	2001-2	1:1	back	0.578	1.035	0.598	
1880.00	600	PCS CDMA	EVDO Rev. 0	24.5	24.35	0.08	10 mm	2001-2	1:1	front	0.374	1.035	0.387	
1880.00	600	PCS CDMA	EVDO Rev. 0	24.5	24.35	0.02	10 mm	2001-2	1:1	bottom	0.655	1.035	0.678	A7
1880.00	600	PCS CDMA	EVDO Rev. 0	24.5	24.35	0.05	10 mm	2001-2	1:1	left	0.282	1.035	0.292	
ANSI / IEEE C95.1 1992 - SAFETY LIMIT Spatial Peak Uncontrolled Exposure/General Population								Body 1.6 W/kg (mW/g) averaged over 1 gram						

**Table 10-7
WLAN Hotspot SAR**

MEASUREMENT RESULTS															
FREQUENCY		Mode	Service	Maximum Allowed Power [dBm]	Conducted Power [dBm]	Power Drift [dB]	Spacing	Device Serial Number	Data Rate (Mbps)	Side	Duty Cycle	SAR (1g)	Scaling Factor	Scaled SAR (1g)	Plot #
MHz	Ch.											(W/kg)		(W/kg)	
2462	11	IEEE 802.11b	DSSS	15.5	14.74	0.01	10 mm	2001-14	1	back	1:1	0.172	1.191	0.205	A8
2462	11	IEEE 802.11b	DSSS	15.5	14.74	-0.05	10 mm	2001-14	1	front	1:1	0.032	1.191	0.038	
2462	11	IEEE 802.11b	DSSS	15.5	14.74	0.02	10 mm	2001-14	1	top	1:1	0.057	1.191	0.068	
2462	11	IEEE 802.11b	DSSS	15.5	14.74	0.07	10 mm	2001-14	1	right	1:1	0.076	1.191	0.091	
ANSI / IEEE C95.1 1992 - SAFETY LIMIT Spatial Peak Uncontrolled Exposure/General Population								Body 1.6 W/kg (mW/g) averaged over 1 gram							

FCC ID: ZNFL34C		SAR EVALUATION REPORT		Reviewed by: Quality Manager
Document S/N: OY1401200112-R1.ZNF	Test Dates: 01/22/2014 - 01/27/2014	DUT Type: Portable Handset	Page 24 of 35	



10.4 SAR Test Notes

General Notes:

1. The test data reported are the worst-case SAR values according to test procedures specified in IEEE 1528-2003 and FCC KDB Publication 447498 D01v05.
2. Batteries are fully charged at the beginning of the SAR measurements. A standard battery was used for all SAR measurements.
3. Liquid tissue depth was at least 15.0 cm for all frequencies.
4. The manufacturer has confirmed that the device(s) tested have the same physical, mechanical and thermal characteristics and are within operational tolerances expected for production units.
5. SAR results were scaled to the maximum allowed power to demonstrate compliance per FCC KDB Publication 447498 D01v05.
6. Device was tested using a fixed spacing for body-worn accessory testing. A separation distance of 10 mm was considered because the manufacturer has determined that there will be body-worn accessories available in the marketplace for users to support this separation distance.
7. Per FCC KDB Publication 648474 D04v01, SAR was evaluated without a headset connected to the device. Since the standalone reported SAR was ≤ 1.2 W/kg, no additional SAR evaluations using a headset cable were required.
8. Per FCC KDB 865664 D01 v01, a variability SAR test was performed when the measured SAR results for a frequency band were greater than 0.8 W/kg. Repeated SAR measurements are highlighted in the tables above for clarity. Please see Section 12 for variability analysis.
9. During SAR Testing for the Wireless Router conditions per FCC KDB Publication 941225 D06v01, the actual Portable Hotspot operation (with actual simultaneous transmission of a transmitter with WIFI) was not activated (See Section 5.7 for more details).



CDMA Notes:

1. Head SAR for CDMA2000 mode was tested under RC3/SO55 per FCC KDB Publication 941225 D01v02.
2. Body-Worn SAR was tested with 1x RTT with TDSO / SO32 FCH Only. EVDO and TDSO / SO32 FCH+SCH SAR tests were not required since the average output power was not more than 0.25 dB higher than the TDSO / SO32 FCH only powers, per FCC KDB Publication 941225 D01v02.
3. CDMA Wireless Router SAR is measured using Subtype 0/1 Physical Layer configurations for Rev. 0 according to KDB 941225 D01 procedures for data devices. Since the average output power of Subtype 2 for Rev. A is less than the Rev. 0 power levels, then EVDO Rev. A SAR is not required. SAR is not required for 1x RTT for Ev-Do hotspot devices when the maximum average output of each channel is less than 1/4 dB higher than that measured in Subtype 0/1 Physical Layer configurations for Rev. 0.
4. Head SAR was additionally evaluated using EVDO Rev. A to determine compliance for VoIP operations.
5. Per FCC KDB Publication 447498 D01v05, when the reported (scaled) SAR measured at the middle channel is ≥ 0.8 W/kg then testing at the other channels is required for such test configuration(s). Since the maximum output power variation across the required test channels is $< 1/2$ dB, the middle channel was used as default.

FCC ID: ZNFL34C		SAR EVALUATION REPORT		Reviewed by: Quality Manager
Document S/N: OY1401200112-R1.ZNF	Test Dates: 01/22/2014 - 01/27/2014	DUT Type: Portable Handset	Page 25 of 35	

WLAN Notes:

1. Justification for reduced test configurations for WIFI channels per KDB Publication 248227 D01v01r02 and October 2012 FCC/TCB Meeting Notes for 2.4 GHz WIFI: Highest average RF output power channel for the lowest data rate was selected for SAR evaluation in 802.11b. Other IEEE 802.11 modes (including 802.11g/n) were not investigated since the average output powers over all channels and data rates were not more than 0.25 dB higher than the tested channel in the lowest data rate of IEEE 802.11b mode.
2. WIFI transmission was verified using an uncalibrated spectrum analyzer.
3. Since the maximum extrapolated peak SAR of the zoom scan for the maximum output channel is <1.6 W/kg and the reported 1g averaged SAR is <0.8 W/kg, SAR testing on other default channels was not required.

FCC ID: ZNFL34C		SAR EVALUATION REPORT	 Reviewed by: Quality Manager
Document S/N: 0Y1401200112-R1.ZNF	Test Dates: 01/22/2014 - 01/27/2014	DUT Type: Portable Handset	Page 26 of 35

11 FCC MULTI-TX AND ANTENNA SAR CONSIDERATIONS

11.1 Introduction

The following procedures adopted from FCC KDB Publication 447498 D01v05 are applicable to handsets with built-in unlicensed transmitters such as 802.11b/g/n and Bluetooth devices which may simultaneously transmit with the licensed transmitter.

11.2 Simultaneous Transmission Procedures



This device contains transmitters that may operate simultaneously. Therefore simultaneous transmission analysis is required. Per FCC KDB 447498 D01v05 IV.C.1.iii, simultaneous transmission SAR test exclusion may be applied when the sum of the 1-g SAR for all the simultaneous transmitting antennas in a specific a physical test configuration is ≤ 1.6 W/kg. When standalone SAR is not required to be measured, per FCC KDB 447498 D01v05 4.3.2 2), the following equation must be used to estimate the standalone 1g SAR for simultaneous transmission assessment involving that transmitter.

$$\text{Estimated SAR} = \frac{\sqrt{f(\text{GHz})}}{7.5} * \frac{(\text{Max Power of channel, mW})}{\text{Min. Separation Distance, mm}}$$

**Table 11-1
Estimated SAR**

Mode	Frequency	Maximum Allowed Power	Separation Distance (Body)	Estimated SAR (Body)
	[MHz]	[dBm]	[mm]	[W/kg]
Bluetooth	2441	10.50	10	0.229

Note: Held-to ear configurations are not applicable to Bluetooth operations and therefore were not considered for simultaneous transmission. Per KDB Publication 447498 D01v05, the maximum power of the channel was rounded to the nearest mW before calculation.

FCC ID: ZNFL34C		SAR EVALUATION REPORT		Reviewed by: Quality Manager
Document S/N: 0Y1401200112-R1.ZNF	Test Dates: 01/22/2014 - 01/27/2014	DUT Type: Portable Handset		Page 27 of 35

11.3 Head SAR Simultaneous Transmission Analysis

Table 11-2
Simultaneous Transmission Scenario with 2.4 GHz WLAN (Held to Ear)

Simult Tx	Configuration	Cell. CDMA SAR (W/kg)	2.4 GHz WLAN SAR (W/kg)	Σ SAR (W/kg)	Simult Tx	Configuration	PCS CDMA SAR (W/kg)	2.4 GHz WLAN SAR (W/kg)	Σ SAR (W/kg)
Head SAR	Right Cheek	0.587	0.118	0.705	Head SAR	Right Cheek	0.556	0.118	0.674
	Right Tilt	0.370	0.102	0.472		Right Tilt	0.282	0.102	0.384
	Left Cheek	0.821	0.216	1.037		Left Cheek	0.766	0.216	0.982
	Left Tilt	0.451	0.158	0.609		Left Tilt	0.288	0.158	0.446
Simult Tx	Configuration	Cell. EVDO SAR (W/kg)	2.4 GHz WLAN SAR (W/kg)	Σ SAR (W/kg)	Simult Tx	Configuration	PCS EVDO SAR (W/kg)	2.4 GHz WLAN SAR (W/kg)	Σ SAR (W/kg)
Head SAR	Right Cheek	0.572	0.118	0.690	Head SAR	Right Cheek	0.577	0.118	0.695
	Right Tilt	0.328	0.102	0.430		Right Tilt	0.295	0.102	0.397
	Left Cheek	0.779	0.216	0.995		Left Cheek	0.671	0.216	0.887
	Left Tilt	0.400	0.158	0.558		Left Tilt	0.262	0.158	0.420

11.4 Body-Worn Simultaneous Transmission Analysis



Table 11-3
Simultaneous Transmission Scenario with 2.4 GHz WLAN (Body-Worn at 10 mm)

Configuration	Mode	CDMA SAR (W/kg)	2.4 GHz WLAN SAR (W/kg)	Σ SAR (W/kg)
Back Side	Cell. CDMA	0.947	0.205	1.152
Back Side	PCS CDMA	0.671	0.205	0.876

Table 11-4
Simultaneous Transmission Scenario with Bluetooth (Body-Worn at 10 mm)

Configuration	Mode	CDMA SAR (W/kg)	Bluetooth SAR (W/kg)	Σ SAR (W/kg)
Back Side	Cell. CDMA	0.947	0.229	1.176
Back Side	PCS CDMA	0.671	0.229	0.900

Note: Bluetooth SAR was not required to be measured per FCC KDB 447498. Estimated SAR results were used in the above table to determine simultaneous transmission SAR test exclusion.

FCC ID: ZNFL34C	 PCTEST ENGINEERING LABORATORY, INC.	SAR EVALUATION REPORT		Reviewed by: Quality Manager
Document S/N: OY1401200112-R1.ZNF	Test Dates: 01/22/2014 - 01/27/2014	DUT Type: Portable Handset	Page 28 of 35	

11.5 Hotspot SAR Simultaneous Transmission Analysis



Per FCC KDB Publication 941225 D06v01, the devices edges with antennas more than 2.5 cm from edge are not required to be evaluated for SAR (“-”).

Table 11-5
Simultaneous Transmission Scenario (2.4 GHz Hotspot at 1.0 cm)

Simult Tx	Configuration	Cell. EVDO SAR (W/kg)	2.4 GHz WLAN SAR (W/kg)	Σ SAR (W/kg)
Body SAR	Back	0.895	0.205	1.100
	Front	0.654	0.038	0.692
	Top	-	0.068	0.068
	Bottom	0.235	-	0.235
	Right	-	0.091	0.091
	Left	0.757	-	0.757
Simult Tx	Configuration	PCS EVDO SAR (W/kg)	2.4 GHz WLAN SAR (W/kg)	Σ SAR (W/kg)
Body SAR	Back	0.598	0.205	0.803
	Front	0.387	0.038	0.425
	Top	-	0.068	0.068
	Bottom	0.678	-	0.678
	Right	-	0.091	0.091
	Left	0.292	-	0.292

11.6 Simultaneous Transmission Conclusion

The above numerical summed SAR results for all the worst-case simultaneous transmission conditions were below the SAR limit. Therefore, the above analysis is sufficient to determine that simultaneous transmission cases will not exceed the SAR limit and therefore no measured volumetric simultaneous SAR summation is required per FCC KDB Publication 447498 D01v05.

FCC ID: ZNFL34C		SAR EVALUATION REPORT		Reviewed by: Quality Manager
Document S/N: OY1401200112-R1.ZNF	Test Dates: 01/22/2014 - 01/27/2014	DUT Type: Portable Handset		Page 29 of 35

12 SAR MEASUREMENT VARIABILITY

12.1 Measurement Variability

Per FCC KDB Publication 865664 D01v01, SAR measurement variability was assessed for each frequency band, which was determined by the SAR probe calibration point and tissue-equivalent medium used for the device measurements. When both head and body tissue-equivalent media were required for SAR measurements in a frequency band, the variability measurement procedures were applied to the tissue medium with the highest measured SAR, using the highest measured SAR configuration for that tissue-equivalent medium. These additional measurements were repeated after the completion of all measurements requiring the same head or body tissue-equivalent medium in a frequency band. The test device was returned to ambient conditions (normal room temperature) with the battery fully charged before it was re-mounted on the device holder for the repeated measurement(s) to minimize any unexpected variations in the repeated results.

SAR Measurement Variability was assessed using the following procedures for each frequency band:



- 1) When the original highest measured SAR is ≥ 0.80 W/kg, the measurement was repeated once.
- 2) A second repeated measurement was performed only if the ratio of largest to smallest SAR for the original and first repeated measurements was > 1.20 or when the original or repeated measurement was ≥ 1.45 W/kg (~ 10% from the 1-g SAR limit).
- 3) A third repeated measurement was performed only if the original, first or second repeated measurement was ≥ 1.5 W/kg and the ratio of largest to smallest SAR for the original, first and second repeated measurements is > 1.20 .
- 4) Repeated measurements are not required when the original highest measured SAR is < 0.80 W/kg

**Table 12-1
Body SAR Measurement Variability Results**

BODY VARIABILITY RESULTS													
Band	FREQUENCY		Mode	Service	Side	Spacing	Measured SAR (1g)	1st Repeated SAR (1g)	Ratio	2nd Repeated SAR (1g)	Ratio	3rd Repeated SAR (1g)	Ratio
	MHz	Ch.					(W/kg)	(W/kg)		(W/kg)		(W/kg)	
835	836.52	384	Cell. CDMA	TDSO / SO32	back	10 mm	0.882	0.806	1.09	N/A	N/A	N/A	N/A
ANSI / IEEE C95.1 1992 - SAFETY LIMIT Spatial Peak Uncontrolled Exposure/General Population							Body 1.6 W/kg (mW/g) averaged over 1 gram						

12.2 Measurement Uncertainty



The measured SAR was < 1.5 W/kg for all frequency bands. Therefore, per KDB Publication 865664 D01v01, the extended measurement uncertainty analysis per IEEE 1528-2003 was not required.

FCC ID: ZNFL34C		SAR EVALUATION REPORT		Reviewed by: Quality Manager
Document S/N: OY1401200112-R1.ZNF	Test Dates: 01/22/2014 - 01/27/2014	DUT Type: Portable Handset	Page 30 of 35	

13 EQUIPMENT LIST

Manufacturer	Model	Description	Cal Date	Cal Interval	Cal Due	Serial Number
Agilent	85047A	S-Parameter Test Set	N/A	N/A	N/A	2904A00579
Agilent	85070C	Dielectric Probe Kit	2/14/2013	Annual	2/14/2014	MY44300633
Agilent	8594A	(9kHz-2.9GHz) Spectrum Analyzer	N/A	N/A	N/A	3051A00187
Agilent	8648D	(9kHz-4GHz) Signal Generator	4/17/2013	Annual	4/17/2014	3629U00687
Agilent	8753E	(30kHz-6GHz) Network Analyzer	4/16/2013	Annual	4/16/2014	JP38020182
Agilent	8753E	(30kHz-6GHz) Network Analyzer	7/23/2013	Annual	7/23/2014	US37390350
Agilent	8753ES	S-Parameter Network Analyzer	10/29/2013	Annual	10/29/2014	US39170122
Agilent	E5515C	Wireless Communications Test Set	10/18/2012	Biennial	10/18/2014	GB43193563
Agilent	E5515C	Wireless Communications Test Set	5/9/2013	Biennial	5/9/2015	GB43304447
Agilent	E8257D	(250kHz-20GHz) Signal Generator	4/16/2013	Annual	4/16/2014	MY45470194
Amplifier Research	5S1G4	5W, 800MHz-4.2GHz	CBT	N/A	CBT	21910
Anritsu	MA2411B	Pulse Power Sensor	11/14/2013	Annual	11/14/2014	1126066
Anritsu	MA2481A	Power Sensor	2/14/2013	Annual	2/14/2014	2400
Anritsu	MA2481A	Power Sensor	10/30/2013	Annual	10/30/2014	5605
Anritsu	ML2438A	Power Meter	2/14/2013	Annual	2/14/2014	98150041
Anritsu	ML2495A	Power Meter	10/31/2013	Annual	10/31/2014	1039008
COMTech	AR85729-5	Solid State Amplifier	CBT	N/A	CBT	MISSA00-009
COMTECH	AR85729-5/5759B	Solid State Amplifier	CBT	N/A	CBT	M3W1A00-1002
Fisher Scientific	15-077-960	Thermometer	11/6/2012	Biennial	11/6/2014	122640025
Fisher Scientific	15-07BJ	Long Stem Thermometer	1/7/2013	Biennial	1/7/2015	130018243
MCL	BW-N6W5+	6dB Attenuator	CBT	N/A	CBT	1139
MiniCircuits	SLP-2400+	Low Pass Filter	CBT	N/A	CBT	R8979500903
MiniCircuits	VLF-6000+	Low Pass Filter	CBT	N/A	CBT	N/A
Mini-Circuits	BW-N20W5	Power Attenuator	CBT	N/A	CBT	1226
Mini-Circuits	BW-N20W5+	DC to 18 GHz Precision Fixed 20 dB Attenuator	CBT	N/A	CBT	N/A
Mini-Circuits	NLP-1200+	Low Pass Filter DC to 1000 MHz	CBT	N/A	CBT	N/A
Mini-Circuits	NLP-2950+	Low Pass Filter DC to 2700 MHz	CBT	N/A	CBT	N/A
Narda	4014C-6	4 - 8 GHz SMA 6 dB Directional Coupler	CBT	N/A	CBT	N/A
Narda	4772-3	Attenuator (3dB)	CBT	N/A	CBT	9406
Pasternack	PE2208-6	Bidirectional Coupler	CBT	N/A	CBT	N/A
Pasternack	PE2209-10	Bidirectional Coupler	CBT	N/A	CBT	N/A
Rohde & Schwarz	CMW500	Wide Band Radio Communication Tester	2/8/2013	Annual	2/8/2014	101699
Rohde & Schwarz	SMIQ03B	Signal Generator	4/17/2013	Annual	4/17/2014	DE27259
Seekonk	NC-100	Torque Wrench (8" lb)	11/29/2011	Triennial	11/29/2014	21053
SPEAG	D1900V2	1900 MHz SAR Dipole	2/6/2013	Annual	2/6/2014	5d148
SPEAG	D1900V2	1900 MHz SAR Dipole	5/2/2013	Annual	5/2/2014	5d141
SPEAG	D2450V2	2450 MHz SAR Dipole	2/11/2013	Annual	2/11/2014	882
SPEAG	D2450V2	2450 MHz SAR Dipole	8/23/2013	Annual	8/23/2014	719
SPEAG	D835V2	835 MHz SAR Dipole	4/25/2013	Annual	4/25/2014	4d119
SPEAG	D835V2	835 MHz SAR Dipole	7/17/2013	Annual	7/17/2014	4d133
SPEAG	DAE4	Dasy Data Acquisition Electronics	3/8/2013	Annual	3/8/2014	1334
SPEAG	DAE4	Dasy Data Acquisition Electronics	4/22/2013	Annual	4/22/2014	1364
SPEAG	DAE4	Dasy Data Acquisition Electronics	4/22/2013	Annual	4/22/2014	1368
SPEAG	DAE4	Dasy Data Acquisition Electronics	5/13/2013	Annual	5/13/2014	859
SPEAG	DAE4	Dasy Data Acquisition Electronics	11/19/2013	Annual	11/19/2014	1408
SPEAG	DAE4	Dasy Data Acquisition Electronics	9/17/2013	Annual	9/17/2014	1323
SPEAG	DAK-3.5	Dielectric Assessment Kit	5/14/2013	Annual	5/14/2014	1070
SPEAG	DAKS-3.5	Portable Dielectric Assessment Kit	8/18/2013	Annual	8/18/2014	1008
SPEAG	DAKS-3.5	Portable Dielectric Assessment Kit	8/18/2013	Annual	8/18/2014	1009
SPEAG	ES3DV3	SAR Probe	3/15/2013	Annual	3/15/2014	3209
SPEAG	ES3DV3	SAR Probe	4/29/2013	Annual	4/29/2014	3318
SPEAG	ES3DV3	SAR Probe	4/29/2013	Annual	4/29/2014	3319
SPEAG	ES3DV3	SAR Probe	5/16/2013	Annual	5/16/2014	3263
SPEAG	ES3DV3	SAR Probe	11/22/2013	Annual	11/22/2014	3333
SPEAG	ES3DV3	SAR Probe	9/23/2013	Annual	9/23/2014	3288
VWR	23226-658	Long Stem Thermometer	3/30/2012	Biennial	3/30/2014	122179874



Note: CBT (Calibrated Before Testing). Prior to testing, the measurement paths containing a cable, amplifier, attenuator, coupler or filter were connected to a calibrated source (i.e. a signal generator) to determine the losses of the measurement path. The power meter offset was then adjusted to compensate for the measurement system losses. This level offset is stored within the power meter before measurements are made. This calibration verification procedure applies to the system verification and output power measurements. The calibrated reading is then taken directly from the power meter after compensation of the losses for all final power measurements.

FCC ID: ZNFL34C	 PCTEST ENGINEERING LABORATORY, INC.	SAR EVALUATION REPORT		Reviewed by: Quality Manager
Document S/N: OY1401200112-R1.ZNF	Test Dates: 01/22/2014 - 01/27/2014	DUT Type: Portable Handset		Page 31 of 35

14 MEASUREMENT UNCERTAINTIES

a	b	c	d	e= f(d,k)	f	g	h = c x f/e	i = c x g/e	k	
Uncertainty Component	IEEE 1528 Sec.	Tol. (± %)	Prob. Dist.	Div.	c _i 1gm	c _i 10 gms	1gm u _i (± %)	10gms u _i (± %)	v _i	
Measurement System										
Probe Calibration	E.2.1	6.0	N	1	1.0	1.0	6.0	6.0	∞	
Axial Isotropy	E.2.2	0.25	N	1	0.7	0.7	0.2	0.2	∞	
Hemishperical Isotropy	E.2.2	1.3	N	1	1.0	1.0	1.3	1.3	∞	
Boundary Effect	E.2.3	0.4	N	1	1.0	1.0	0.4	0.4	∞	
Linearity	E.2.4	0.3	N	1	1.0	1.0	0.3	0.3	∞	
System Detection Limits	E.2.5	5.1	N	1	1.0	1.0	5.1	5.1	∞	
Readout Electronics	E.2.6	1.0	N	1	1.0	1.0	1.0	1.0	∞	
Response Time	E.2.7	0.8	R	1.73	1.0	1.0	0.5	0.5	∞	
Integration Time	E.2.8	2.6	R	1.73	1.0	1.0	1.5	1.5	∞	
RF Ambient Conditions	E.6.1	3.0	R	1.73	1.0	1.0	1.7	1.7	∞	
Probe Positioner Mechanical Tolerance	E.6.2	0.4	R	1.73	1.0	1.0	0.2	0.2	∞	
Probe Positioning w/ respect to Phantom	E.6.3	2.9	R	1.73	1.0	1.0	1.7	1.7	∞	
Extrapolation, Interpolation & Integration algorithms for Max. SAR Evaluation	E.5	1.0	R	1.73	1.0	1.0	0.6	0.6	∞	
Test Sample Related										
Test Sample Positioning	E.4.2	6.0	N	1	1.0	1.0	6.0	6.0	287	
Device Holder Uncertainty	E.4.1	3.32	R	1.73	1.0	1.0	1.9	1.9	∞	
Output Power Variation - SAR drift measurement	6.6.2	5.0	R	1.73	1.0	1.0	2.9	2.9	∞	
Phantom & Tissue Parameters										
Phantom Uncertainty (Shape & Thickness tolerances)	E.3.1	4.0	R	1.73	1.0	1.0	2.3	2.3	∞	
Liquid Conductivity - deviation from target values	E.3.2	5.0	R	1.73	0.64	0.43	1.8	1.2	∞	
Liquid Conductivity - measurement uncertainty	E.3.3	3.8	N	1	0.64	0.43	2.4	1.6	6	
Liquid Permittivity - deviation from target values	E.3.2	5.0	R	1.73	0.60	0.49	1.7	1.4	∞	
Liquid Permittivity - measurement uncertainty	E.3.3	4.5	N	1	0.60	0.49	2.7	2.2	6	
Combined Standard Uncertainty (k=1)							RSS	12.1	11.7	299
Expanded Uncertainty (95% CONFIDENCE LEVEL)							k=2	24.2	23.5	

The above measurement uncertainties are according to IEEE Std. 1528-2003



FCC ID: ZNFL34C		SAR EVALUATION REPORT		Reviewed by: Quality Manager
Document S/N: OY1401200112-R1.ZNF	Test Dates: 01/22/2014 - 01/27/2014	DUT Type: Portable Handset		Page 32 of 35

15 CONCLUSION

15.1 Measurement Conclusion



The SAR evaluation indicates that the EUT complies with the RF radiation exposure limits of the FCC and Industry Canada, with respect to all parameters subject to this test. These measurements were taken to simulate the RF effects of RF exposure under worst-case conditions. Precise laboratory measures were taken to assure repeatability of the tests. The results and statements relate only to the item(s) tested.

Please note that the absorption and distribution of electromagnetic energy in the body are very complex phenomena that depend on the mass, shape, and size of the body, the orientation of the body with respect to the field vectors, and the electrical properties of both the body and the environment. Other variables that may play a substantial role in possible biological effects are those that characterize the environment (e.g. ambient temperature, air velocity, relative humidity, and body insulation) and those that characterize the individual (e.g. age, gender, activity level, debilitation, or disease). Because various factors may interact with one another to vary the specific biological outcome of an exposure to electromagnetic fields, any protection guide should consider maximal amplification of biological effects as a result of field-body interactions, environmental conditions, and physiological variables. [3]



FCC ID: ZNFL34C		SAR EVALUATION REPORT		Reviewed by: Quality Manager
Document S/N: 0Y1401200112-R1.ZNF	Test Dates: 01/22/2014 - 01/27/2014	DUT Type: Portable Handset		Page 33 of 35

16 REFERENCES

- [1] Federal Communications Commission, ET Docket 93-62, Guidelines for Evaluating the Environmental Effects of Radiofrequency Radiation, Aug. 1996.
- [2] ANSI/IEEE C95.1-2005, American National Standard safety levels with respect to human exposure to radio frequency electromagnetic fields, 3kHz to 300GHz, New York: IEEE, 2006.
- [3] ANSI/IEEE C95.1-1992, American National Standard safety levels with respect to human exposure to radio frequency electromagnetic fields, 3kHz to 300GHz, New York: IEEE, Sept. 1992.
- [4] ANSI/IEEE C95.3-2002, IEEE Recommended Practice for the Measurement of Potentially Hazardous Electromagnetic Fields - RF and Microwave, New York: IEEE, December 2002.
- [5] Federal Communications Commission, OET Bulletin 65 (Edition 97-01), Supplement C (Edition 01-01), Evaluating Compliance with FCC Guidelines for Human Exposure to Radiofrequency Electromagnetic Fields, June 2001.
- [6] IEEE Standards Coordinating Committee 34 – IEEE Std. 1528-2003, Recommended Practice for Determining the Peak Spatial-Average Specific Absorption Rate (SAR) in the Human Body Due to Wireless Communications Devices.
- [7] NCRP, National Council on Radiation Protection and Measurements, Biological Effects and Exposure Criteria for RadioFrequency Electromagnetic Fields, NCRP Report No. 86, 1986. Reprinted Feb. 1995.
- [8] T. Schmid, O. Egger, N. Kuster, Automated E-field scanning system for dosimetric assessments, IEEE Transaction on Microwave Theory and Techniques, vol. 44, Jan. 1996, pp. 105-113.
- [9] K. Pokovic, T. Schmid, N. Kuster, Robust setup for precise calibration of E-field probes in tissue simulating liquids at mobile communications frequencies, ICECOM97, Oct. 1997, pp. -124.
- [10] K. Pokovic, T. Schmid, and N. Kuster, E-field Probe with improved isotropy in brain simulating liquids, Proceedings of the ELMAR, Zadar, Croatia, June 23-25, 1996, pp. 172-175.
- [11] Schmid & Partner Engineering AG, Application Note: Data Storage and Evaluation, June 1998, p2.
- [12] V. Hombach, K. Meier, M. Burkhardt, E. Kuhn, N. Kuster, The Dependence of EM Energy Absorption upon Human Modeling at 900 MHz, IEEE Transaction on Microwave Theory and Techniques, vol. 44 no. 10, Oct. 1996, pp. 1865-1873.
- [13] N. Kuster and Q. Balzano, Energy absorption mechanism by biological bodies in the near field of dipole antennas above 300MHz, IEEE Transaction on Vehicular Technology, vol. 41, no. 1, Feb. 1992, pp. 17-23.
- [14] G. Hartsgrrove, A. Kraszewski, A. Surowiec, Simulated Biological Materials for Electromagnetic Radiation Absorption Studies, University of Ottawa, Bioelectromagnetics, Canada: 1987, pp. 29-36.
- [15] Q. Balzano, O. Garay, T. Manning Jr., Electromagnetic Energy Exposure of Simulated Users of Portable Cellular Telephones, IEEE Transactions on Vehicular Technology, vol. 44, no.3, Aug. 1995.
- [16] W. Gander, Computermathematik, Birkhaeuser, Basel, 1992.
- [17] W.H. Press, S.A. Teukolsky, W.T. Vetterling, and B.P. Flannery, Numerical Recipes in C, The Art of Scientific Computing, Second edition, Cambridge University Press, 1992.

FCC ID: ZNFL34C		SAR EVALUATION REPORT		Reviewed by: Quality Manager
Document S/N: OY1401200112-R1.ZNF	Test Dates: 01/22/2014 - 01/27/2014	DUT Type: Portable Handset	Page 34 of 35	

- [18] Federal Communications Commission, OET Bulletin 65, Evaluating Compliance with FCC Guidelines for Human Exposure to Radiofrequency Electromagnetic Fields. Supplement C, Dec. 1997.
- [19] N. Kuster, R. Kastle, T. Schmid, Dosimetric evaluation of mobile communications equipment with known precision, IEEE Transaction on Communications, vol. E80-B, no. 5, May 1997, pp. 645-652.
- [20] CENELEC CLC/SC111B, European Prestandard (prENV 50166-2), Human Exposure to Electromagnetic Fields High-frequency: 10kHz-300GHz, Jan. 1995.
- [21] Prof. Dr. Niels Kuster, ETH, Eidgenössische Technische Hochschule Zürich, Dosimetric Evaluation of the Cellular Phone.
- [22] IEC 62209-1, Human exposure to radio frequency fields from hand-held and body-mounted wireless communication devices - Human models, instrumentation, and procedures - Part 1: Procedure to determine the specific absorption rate (SAR) for hand-held devices used in close proximity to the ear (frequency range of 300 MHz to 3 GHz), Feb. 2005.
- [23] Industry Canada RSS-102 Radio Frequency Exposure Compliance of Radiocommunication Apparatus (All Frequency Bands) Issue 4, March 2010.
- [24] Health Canada Safety Code 6 Limits of Human Exposure to Radio Frequency Electromagnetic Fields in the Frequency Range from 3 kHz – 300 GHz, 2009
- [25] FCC Public Notice DA-02-1438. Office of Engineering and Technology Announces a Transition Period for the Phantom Requirements of Supplement C to OET Bulletin 65, June 19, 2002
- [26] FCC SAR Test Procedures for 2G-3G Devices, Mobile Hotspot and UMPC Devices KDB Publications 941225, D01-D07
- [27] SAR Measurement procedures for IEEE 802.11a/b/g KDB Publication 248227 D01v01r02
- [28] FCC SAR Considerations for Handsets with Multiple Transmitters and Antennas, KDB Publications 648474 D02-D04
- [29] FCC SAR Evaluation Considerations for Laptop, Notebook, Netbook and Tablet Computers, FCC KDB Publication 616217 D04
- [30] FCC SAR Measurement and Reporting Requirements for 100MHz – 6 GHz, KDB Publications 865664 D01-D02
- [31] FCC General RF Exposure Guidance and SAR Procedures for Dongles, KDB Publication 447498, D01-D02
- [32] Anexo à Resolução No. 533, de 10 de Setembro de 2009.
- [33] IEC 62209-2, Human exposure to radio frequency fields from hand-held and body-mounted wireless communication devices - Human models, instrumentation, and procedures - Part 2: Procedure to determine the specific absorption rate (SAR) for wireless communication devices used in close proximity to the human body (frequency range of 30 MHz to 6 GHz), Mar. 2010.

FCC ID: ZNFL34C	 SAR EVALUATION REPORT 		Reviewed by: Quality Manager
Document S/N: OY1401200112-R1.ZNF	Test Dates: 01/22/2014 - 01/27/2014	DUT Type: Portable Handset	Page 35 of 35

APPENDIX A: SAR TEST DATA

PCTEST ENGINEERING LABORATORY, INC.

DUT: ZNFL34C; Type: Portable Handset; Serial: 2001-2

Communication System: UID 0, Cellular CDMA; Frequency: 836.52 MHz; Duty Cycle: 1:1
Medium: 835 Head, Medium parameters used (interpolated):
 $f = 836.52 \text{ MHz}$; $\sigma = 0.901 \text{ S/m}$; $\epsilon_r = 40.493$; $\rho = 1000 \text{ kg/m}^3$
Phantom section: Left Section

Test Date: 01-25-2014; Ambient Temp: 22.8°C; Tissue Temp: 21.2°C

Probe: ES3DV3 - SN3288; ConvF(6.37, 6.37, 6.37); Calibrated: 9/23/2013;
Sensor-Surface: 4mm (Mechanical Surface Detection)
Electronics: DAE4 Sn1323; Calibrated: 9/17/2013
Phantom: SAM Sub Dasy B; Type: SAM 5.0; Serial: TP-1626
Measurement SW: DASY4, Version 4.7 (80); SEMCAD X Version 14.6.10 (7164)

Mode: Cellular CDMA, Left Head, Cheek, Mid.ch

Area Scan (9x11x1): Measurement grid: $dx=15\text{mm}$, $dy=15\text{mm}$
Zoom Scan (5x5x7)/Cube 0: Measurement grid: $dx=8\text{mm}$, $dy=8\text{mm}$, $dz=5\text{mm}$
Reference Value = 31.487 V/m; Power Drift = 0.03 dB
Peak SAR (extrapolated) = 0.972 W/kg
SAR(1 g) = 0.768 W/kg

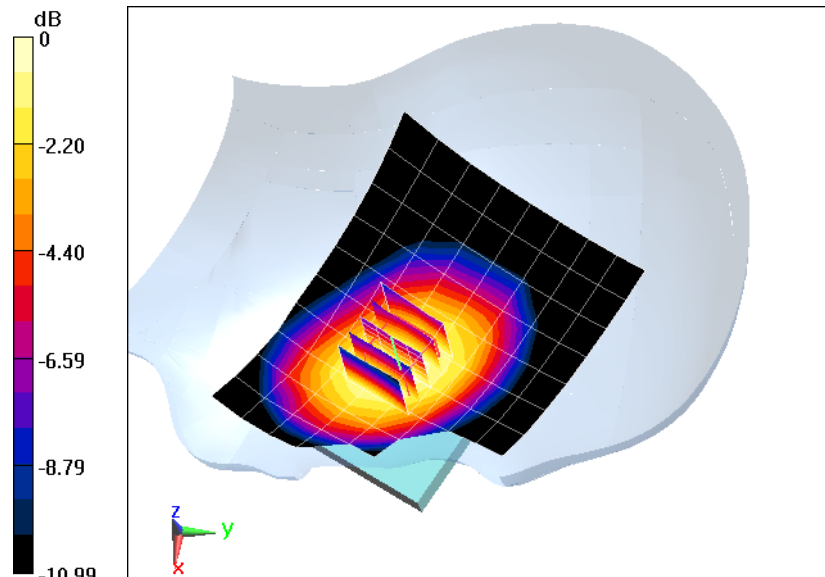

0 dB = 0.806 W/kg = -0.94 dBW/kg

PCTEST ENGINEERING LABORATORY, INC.

DUT: ZNFL34C; Type: Portable Handset; Serial: 2001-2

Communication System: UID 0, PCS CDMA; Frequency: 1880 MHz; Duty Cycle: 1:1
Medium: 1900 Head, Medium parameters used:
 $f = 1880 \text{ MHz}$; $\sigma = 1.432 \text{ S/m}$; $\epsilon_r = 39.444$; $\rho = 1000 \text{ kg/m}^3$
Phantom section: Left Section

Test Date: 01-24-2014; Ambient Temp: 20.4°C; Tissue Temp: 20.0°C

Probe: ES3DV3 - SN3263; ConvF(5.11, 5.11, 5.11); Calibrated: 5/16/2013;
Sensor-Surface: 4mm (Mechanical Surface Detection)
Electronics: DAE4 Sn859; Calibrated: 5/13/2013
Phantom: SAM Main; Type: SAM 4.0; Serial: TP-1114
Measurement SW: DASY4, Version 4.7 (80); SEMCAD X Version 14.6.10 (7164)

Mode: PCS CDMA, Left Head, Cheek, Mid.ch

Area Scan (9x11x1): Measurement grid: dx=15mm, dy=15mm
Zoom Scan (5x5x7)/Cube 0: Measurement grid: dx=8mm, dy=8mm, dz=5mm
Reference Value = 24.001 V/m; Power Drift = 0.01 dB
Peak SAR (extrapolated) = 1.27 W/kg
SAR(1 g) = 0.720 W/kg

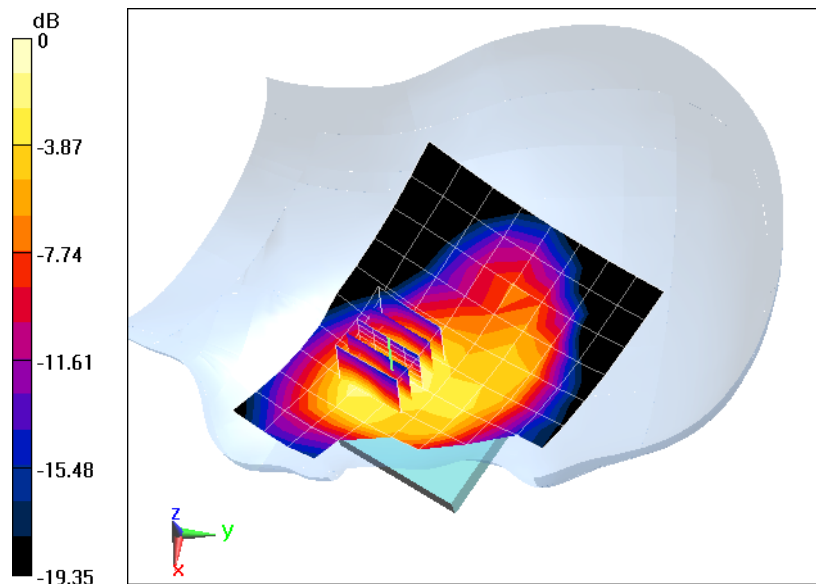

0 dB = 0.798 W/kg = -0.98 dBW/kg

PCTEST ENGINEERING LABORATORY, INC.

DUT: ZNFL34C; Type: Portable Handset; Serial: 2001-14

Communication System: UID 0, IEEE 802.11b; Frequency: 2462 MHz; Duty Cycle: 1:1
Medium: 2450 Head, Medium parameters used (interpolated):
 $f = 2462 \text{ MHz}$; $\sigma = 1.831 \text{ S/m}$; $\epsilon_r = 38.483$; $\rho = 1000 \text{ kg/m}^3$
Phantom section: Left Section

Test Date: 01-23-2014; Ambient Temp: 24.4°C; Tissue Temp: 23.1°C

Probe: ES3DV3 - SN3209; ConvF(4.57, 4.57, 4.57); Calibrated: 3/15/2013;
Sensor-Surface: 3mm (Mechanical Surface Detection)
Electronics: DAE4 Sn1334; Calibrated: 3/8/2013
Phantom: SAM Front; Type: SAM; Serial: 1686
Measurement SW: DASY52, Version 52.8 (7); SEMCAD X Version 14.6.10 (7164)

Mode: IEEE 802.11b, Left Head, Cheek, Ch 11, 1 Mbps

Area Scan (9x13x1): Measurement grid: $dx=12\text{mm}$, $dy=12\text{mm}$
Zoom Scan (7x7x7)/Cube 0: Measurement grid: $dx=5\text{mm}$, $dy=5\text{mm}$, $dz=5\text{mm}$
Reference Value = 10.034 V/m; Power Drift = 0.13 dB
Peak SAR (extrapolated) = 0.403 W/kg
SAR(1 g) = 0.181 W/kg

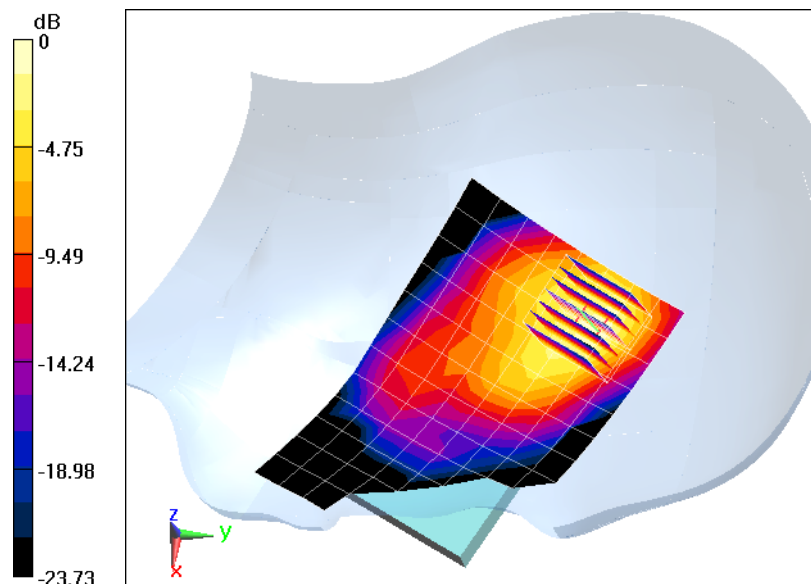

0 dB = 0.236 W/kg = -6.27 dBW/kg

PCTEST ENGINEERING LABORATORY, INC.

DUT: ZNFL34C; Type: Portable Handset; Serial: 2001-2

Communication System: UID 0, CDMA; Frequency: 836.52 MHz; Duty Cycle: 1:1
Medium: 835 Body, Medium parameters used (interpolated):
 $f = 836.52 \text{ MHz}$; $\sigma = 1.007 \text{ S/m}$; $\epsilon_r = 52.794$; $\rho = 1000 \text{ kg/m}^3$
Phantom section: Flat Section; Space: 1.0 cm

Test Date: 01-23-2014; Ambient Temp: 24.5°C; Tissue Temp: 23.5°C

Probe: ES3DV3 - SN3318; ConvF(6.21, 6.21, 6.21); Calibrated: 4/29/2013;
Sensor-Surface: 4mm (Mechanical Surface Detection)
Electronics: DAE4 Sn1364; Calibrated: 4/22/2013
Phantom: ELI left; Type: QDOVA002AA; Serial: TP:1202
Measurement SW: DASYS2, Version 52.8 (7); SEMCAD X Version 14.6.10 (7164)

Mode: Cell. CDMA, Body SAR, Back side, Mid.ch

Area Scan (9x15x1): Measurement grid: $dx=15\text{mm}$, $dy=15\text{mm}$
Zoom Scan (5x5x7)/Cube 0: Measurement grid: $dx=8\text{mm}$, $dy=8\text{mm}$, $dz=5\text{mm}$
Reference Value = 30.895 V/m; Power Drift = -0.05 dB
Peak SAR (extrapolated) = 1.13 W/kg
SAR(1 g) = 0.882 W/kg

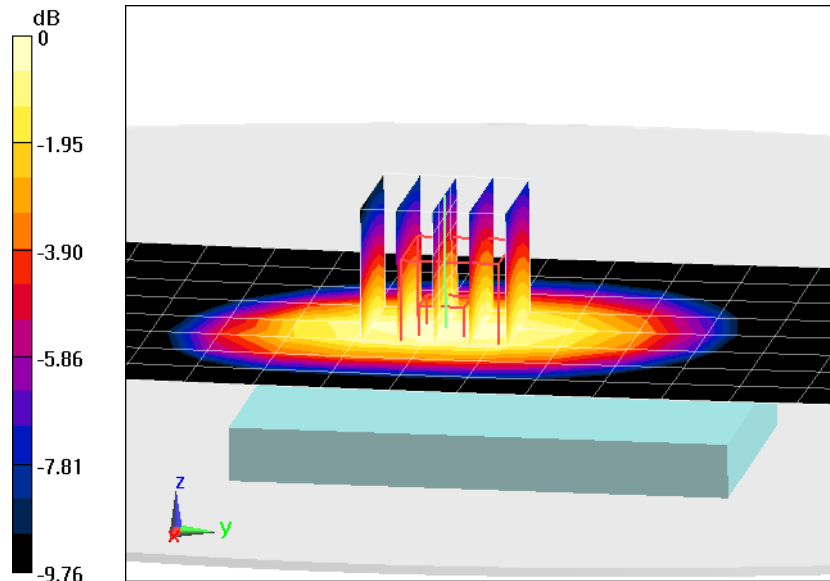

0 dB = 0.929 W/kg = -0.32 dBW/kg

PCTEST ENGINEERING LABORATORY, INC.

DUT: ZNFL34C; Type: Portable Handset; Serial: 2001-2

Communication System: UID 0, CDMA; Frequency: 836.52 MHz; Duty Cycle: 1:1
Medium: 835 Body, Medium parameters used (interpolated):
 $f = 836.52 \text{ MHz}$; $\sigma = 1.007 \text{ S/m}$; $\epsilon_r = 52.794$; $\rho = 1000 \text{ kg/m}^3$
Phantom section: Flat Section; Space: 1.0 cm

Test Date: 01-23-2014; Ambient Temp: 24.5°C; Tissue Temp: 23.5°C

Probe: ES3DV3 - SN3318; ConvF(6.21, 6.21, 6.21); Calibrated: 4/29/2013;
Sensor-Surface: 4mm (Mechanical Surface Detection)
Electronics: DAE4 Sn1364; Calibrated: 4/22/2013
Phantom: ELI left; Type: QDOVA002AA; Serial: TP:1202
Measurement SW: DASYS2, Version 52.8 (7); SEMCAD X Version 14.6.10 (7164)

Mode: Cell. EVDO, Body SAR, Back side, Mid.ch

Area Scan (9x15x1): Measurement grid: dx=15mm, dy=15mm

Zoom Scan (5x5x7)/Cube 0: Measurement grid: dx=8mm, dy=8mm, dz=5mm

Reference Value = 29.314 V/m; Power Drift = 0.02 dB

Peak SAR (extrapolated) = 1.05 W/kg

SAR(1 g) = 0.837 W/kg

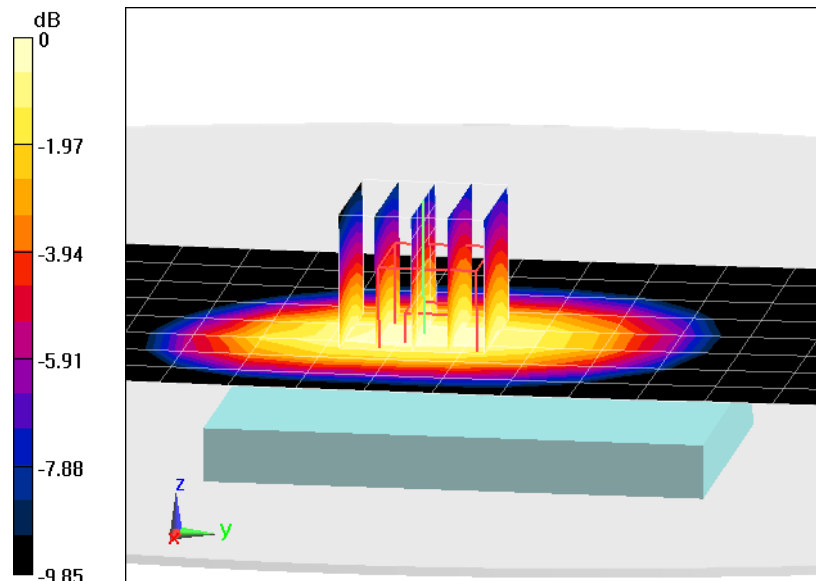

0 dB = 0.886 W/kg = -0.53 dBW/kg

PCTEST ENGINEERING LABORATORY, INC.

DUT: ZNFL34C; Type: Portable Handset; Serial: 2001-2

Communication System: UID 0, CDMA; Frequency: 1880 MHz; Duty Cycle: 1:1
Medium: 1900 Body, Medium parameters used:
 $f = 1880 \text{ MHz}$; $\sigma = 1.514 \text{ S/m}$; $\epsilon_r = 52.435$; $\rho = 1000 \text{ kg/m}^3$
Phantom section: Flat Section; Space: 1.0 cm

Test Date: 01-22-2014; Ambient Temp: 23.5°C; Tissue Temp: 22.4°C

Probe: ES3DV3 - SN3319; ConvF(4.85, 4.85, 4.85); Calibrated: 4/29/2013;
Sensor-Surface: 4mm (Mechanical Surface Detection)
Electronics: DAE4 Sn1368; Calibrated: 4/22/2013
Phantom: SAM front; Type: QD000P40CD; Serial: TP:1759
Measurement SW: DASY52, Version 52.8 (7); SEMCAD X Version 14.6.10 (7164)

Mode: PCS CDMA, Body SAR, Back side, Mid.ch

Area Scan (9x13x1): Measurement grid: $dx=15\text{mm}$, $dy=15\text{mm}$
Zoom Scan (5x5x7)/Cube 0: Measurement grid: $dx=8\text{mm}$, $dy=8\text{mm}$, $dz=5\text{mm}$
Reference Value = 21.191 V/m; Power Drift = -0.01 dB
Peak SAR (extrapolated) = 1.03 W/kg
SAR(1 g) = 0.637 W/kg

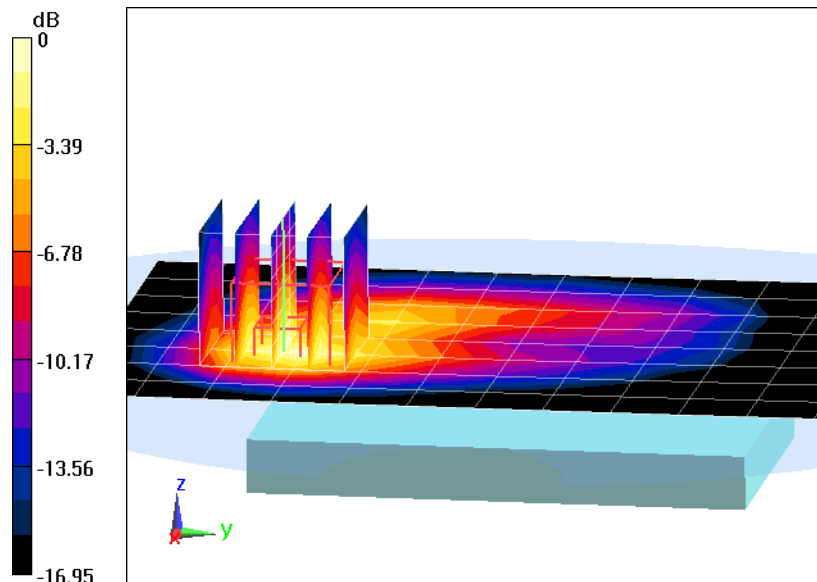

0 dB = 0.716 W/kg = -1.45 dBW/kg

PCTEST ENGINEERING LABORATORY, INC.

DUT: ZNFL34C; Type: Portable Handset; Serial: 2001-2

Communication System: UID 0, CDMA; Frequency: 1880 MHz; Duty Cycle: 1:1
Medium: 1900 Body, Medium parameters used:
 $f = 1880 \text{ MHz}$; $\sigma = 1.514 \text{ S/m}$; $\epsilon_r = 52.435$; $\rho = 1000 \text{ kg/m}^3$
Phantom section: Flat Section; Space: 1.0 cm

Test Date: 01-22-2014; Ambient Temp: 23.5°C; Tissue Temp: 22.4°C

Probe: ES3DV3 - SN3319; ConvF(4.85, 4.85, 4.85); Calibrated: 4/29/2013;
Sensor-Surface: 4mm (Mechanical Surface Detection)
Electronics: DAE4 Sn1368; Calibrated: 4/22/2013
Phantom: SAM front; Type: QD000P40CD; Serial: TP:1759
Measurement SW: DASY52, Version 52.8 (7); SEMCAD X Version 14.6.10 (7164)

Mode: PCS EVDO, Body SAR, Bottom Edge, Mid.ch

Area Scan (10x7x1): Measurement grid: $dx=5\text{mm}$, $dy=15\text{mm}$
Zoom Scan (5x5x7)/Cube 0: Measurement grid: $dx=8\text{mm}$, $dy=8\text{mm}$, $dz=5\text{mm}$
Reference Value = 21.827 V/m; Power Drift = 0.02 dB
Peak SAR (extrapolated) = 1.07 W/kg
SAR(1 g) = 0.655 W/kg

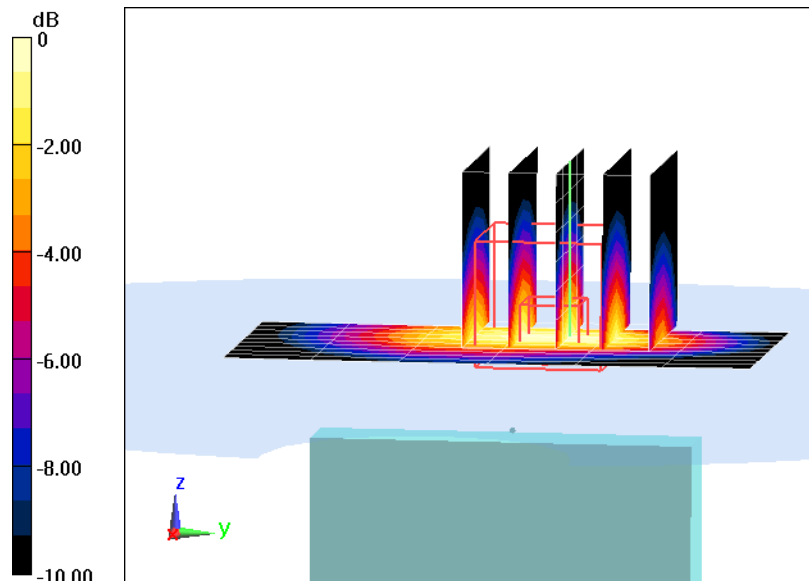

0 dB = 0.731 W/kg = -1.36 dBW/kg

PCTEST ENGINEERING LABORATORY, INC.

DUT: ZNFL34C; Type: Portable Handset; Serial: 2001-14

Communication System: UID 0, IEEE 802.11b; Frequency: 2462 MHz; Duty Cycle: 1:1
Medium: 2450 Body, Medium parameters used (interpolated):
 $f = 2462 \text{ MHz}$; $\sigma = 2.06 \text{ S/m}$; $\epsilon_r = 53.82$; $\rho = 1000 \text{ kg/m}^3$
Phantom section: Flat Section; Space: 1.0 cm

Test Date: 01-27-2014; Ambient Temp: 23.0°C; Tissue Temp: 20.9°C

Probe: ES3DV3 - SN3263; ConvF(4.33, 4.33, 4.33); Calibrated: 5/16/2013;
Sensor-Surface: 3mm (Mechanical Surface Detection)
Electronics: DAE4 Sn859; Calibrated: 5/13/2013
Phantom: SAM Sub; Type: SAM 4.0; Serial: TP-1357
Measurement SW: DASY4, Version 4.7 (80); SEMCAD X Version 14.6.10 (7164)

Mode: IEEE 802.11b, Body SAR, Ch 11, 1 Mbps, Back Side

Area Scan (9x13x1): Measurement grid: $dx=12\text{mm}$, $dy=12\text{mm}$
Zoom Scan (7x7x7)/Cube 0: Measurement grid: $dx=5\text{mm}$, $dy=5\text{mm}$, $dz=5\text{mm}$
Reference Value = 9.682 V/m; Power Drift = 0.01 dB
Peak SAR (extrapolated) = 0.388 W/kg
SAR(1 g) = 0.172 W/kg

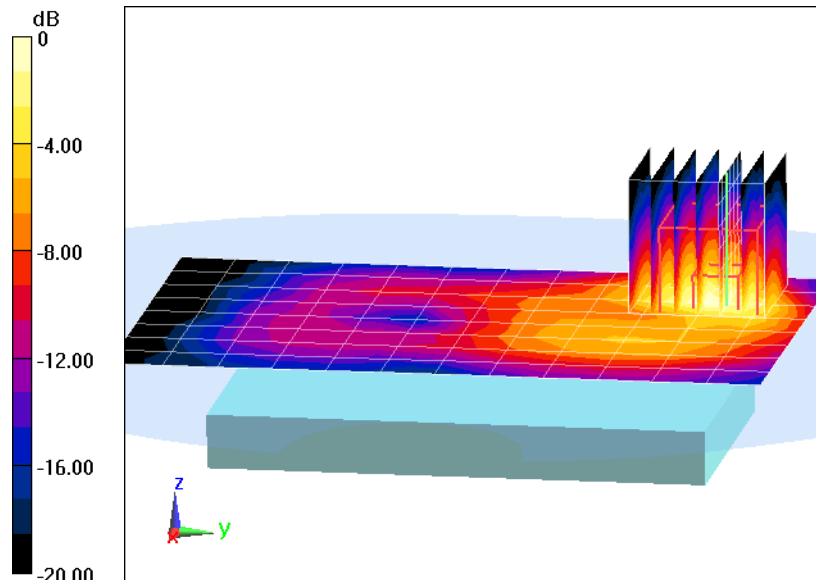

0 dB = 0.221 W/kg = -6.56 dBW/kg

APPENDIX B: SYSTEM VERIFICATION

PCTEST ENGINEERING LABORATORY, INC.

DUT: Dipole 835 MHz; Type: D835V2; Serial: 4d133

Communication System: UID 0, CW; Frequency: 835 MHz; Duty Cycle: 1:1
Medium: 835 Head, Medium parameters used:
 $f = 835 \text{ MHz}$; $\sigma = 0.899 \text{ S/m}$; $\epsilon_r = 40.511$; $\rho = 1000 \text{ kg/m}^3$
Phantom section: Flat Section; Space: 1.5 cm

Test Date: 01-25-2014; Ambient Temp: 22.8°C; Tissue Temp: 21.2°C

Probe: ES3DV3 - SN3288; ConvF(6.37, 6.37, 6.37); Calibrated: 9/23/2013;
Sensor-Surface: 4mm (Mechanical Surface Detection)
Electronics: DAE4 Sn1323; Calibrated: 9/17/2013
Phantom: SAM Sub Dasy B; Type: SAM 5.0; Serial: TP-1626
Measurement SW: DASY4, Version 4.7 (80); SEMCAD X Version 14.6.10 (7164)

835MHz System Verification

Area Scan (7x13x1): Measurement grid: dx=15mm, dy=15mm
Zoom Scan (5x5x7)/Cube 0: Measurement grid: dx=8mm, dy=8mm, dz=5mm
Input Power = 20 dBm (100 mW)
Peak SAR (extrapolated) = 1.40 W/kg
SAR(1 g) = 0.957 W/kg
Deviation = -0.52%

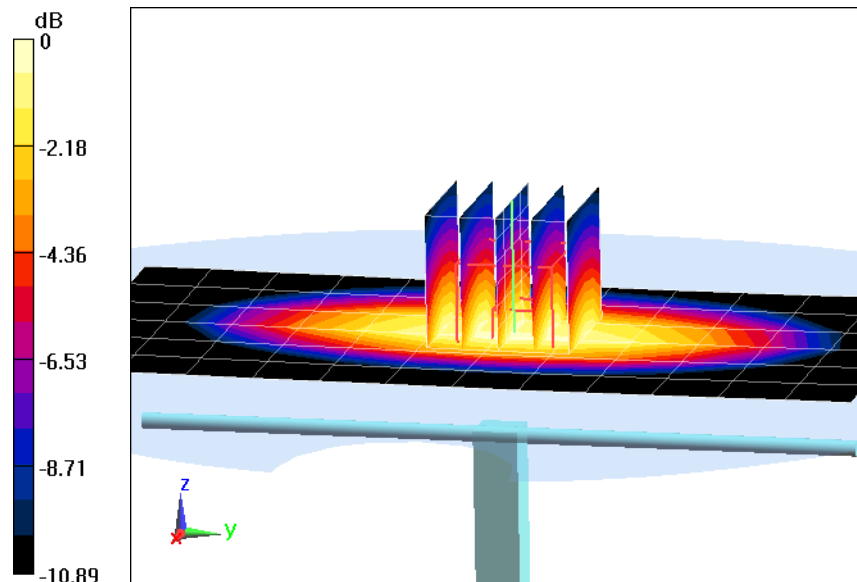

0 dB = 1.03 W/kg = 0.13 dBW/kg

PCTEST ENGINEERING LABORATORY, INC.

DUT: SAR Dipole 1900 MHz; Type: D1900V2; Serial: 5d141

Communication System: UID 0, CW; Frequency: 1900 MHz; Duty Cycle: 1:1

Medium: 1900 Head, Medium parameters used (interpolated):

$f = 1900 \text{ MHz}$; $\sigma = 1.453 \text{ S/m}$; $\epsilon_r = 39.393$; $\rho = 1000 \text{ kg/m}^3$

Phantom section: Flat Section; Space: 1.0 cm

Test Date: 01-24-2014; Ambient Temp: 20.4°C; Tissue Temp: 20.0°C

Probe: ES3DV3 - SN3263; ConvF(5.11, 5.11, 5.11); Calibrated: 5/16/2013;

Sensor-Surface: 4mm (Mechanical Surface Detection)

Electronics: DAE4 Sn859; Calibrated: 5/13/2013

Phantom: SAM Main; Type: SAM 4.0; Serial: TP-1114

Measurement SW: DASY4, Version 4.7 (80); SEMCAD X Version 14.6.10 (7164)

1900MHz System Verification

Area Scan (5x7x1): Measurement grid: dx=15mm, dy=15mm

Zoom Scan (5x5x7)/Cube 0: Measurement grid: dx=8mm, dy=8mm, dz=5mm

Input Power = 20 dBm (100 mW)

Peak SAR (extrapolated) = 7.45 W/kg

SAR(1 g) = 3.98 W/kg

Deviation = -4.66%

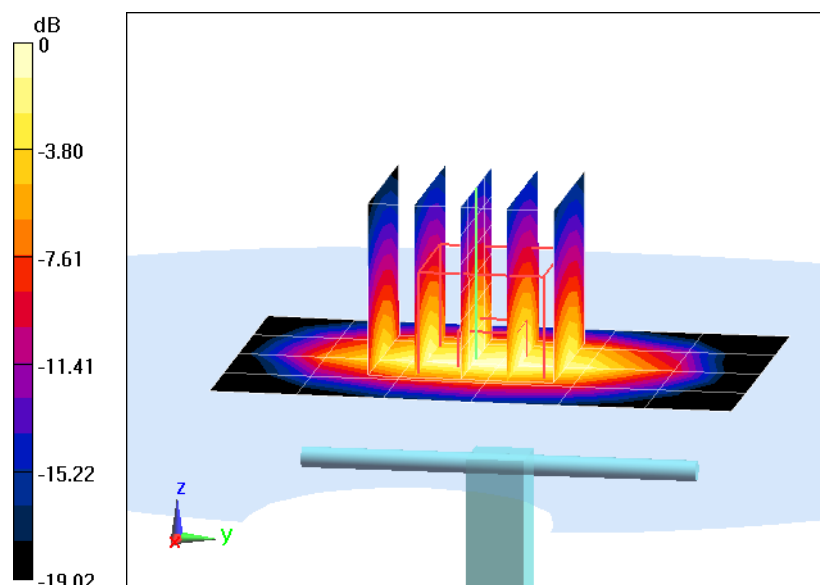

0 dB = 4.46 W/kg = 6.49 dBW/kg

PCTEST ENGINEERING LABORATORY, INC.

DUT: Dipole 2450 MHz; Type: D2450V2; Serial: 719

Communication System: UID 0, CW; Frequency: 2450 MHz; Duty Cycle: 1:1

Medium: 2450 Head, Medium parameters used:

$f = 2450 \text{ MHz}$; $\sigma = 1.823 \text{ S/m}$; $\epsilon_r = 38.55$; $\rho = 1000 \text{ kg/m}^3$

Phantom section: Flat Section; Space: 1.0 cm

Test Date: 01-23-2014; Ambient Temp: 24.4°C; Tissue Temp: 23.1°C

Probe: ES3DV3 - SN3209; ConvF(4.57, 4.57, 4.57); Calibrated: 3/15/2013;

Sensor-Surface: 3mm (Mechanical Surface Detection)

Electronics: DAE4 Sn1334; Calibrated: 3/8/2013

Phantom: SAM Front; Type: SAM; Serial: 1686

Measurement SW: DASY52, Version 52.8 (7); SEMCAD X Version 14.6.10 (7164)

2450 MHz System Verification

Area Scan (8x9x1): Measurement grid: dx=12mm, dy=12mm

Zoom Scan (7x7x7)/Cube 0: Measurement grid: dx=5mm, dy=5mm, dz=5mm

Input Power = 20 dBm (100 mW)

Peak SAR (extrapolated) = 10.7 W/kg

SAR(1 g) = 5.27 W/kg

Deviation = -0.94%

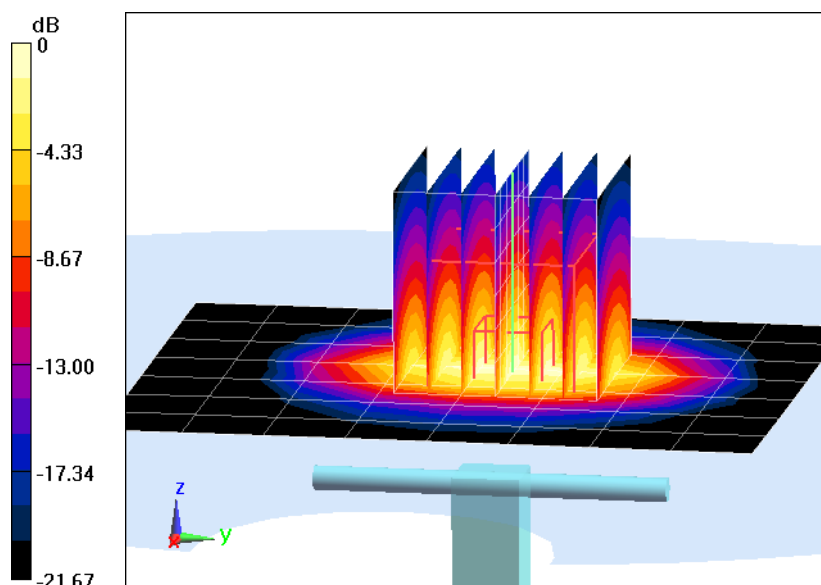

0 dB = 6.92 W/kg = 8.40 dBW/kg

PCTEST ENGINEERING LABORATORY, INC.

DUT: Dipole 835 MHz; Type: D835V2; Serial: 4d119

Communication System: UID 0, CW; Frequency: 835 MHz; Duty Cycle: 1:1
Medium: 835 Body, Medium parameters used:
 $f = 835 \text{ MHz}$; $\sigma = 1.005 \text{ S/m}$; $\epsilon_r = 52.811$; $\rho = 1000 \text{ kg/m}^3$
Phantom section: Flat Section; Space: 1.5 cm

Test Date: 01-23-2014; Ambient Temp: 24.5°C; Tissue Temp: 23.5°C

Probe: ES3DV3 - SN3318; ConvF(6.21, 6.21, 6.21); Calibrated: 4/29/2013;
Sensor-Surface: 4mm (Mechanical Surface Detection)
Electronics: DAE4 Sn1364; Calibrated: 4/22/2013
Phantom: ELI left; Type: QDOVA002AA; Serial: TP:1202
Measurement SW: DASY52, Version 52.8 (7); SEMCAD X Version 14.6.10 (7164)

835 MHz System Verification

Area Scan (7x14x1): Measurement grid: $dx=15\text{mm}$, $dy=15\text{mm}$
Zoom Scan (5x5x7)/Cube 0: Measurement grid: $dx=8\text{mm}$, $dy=8\text{mm}$, $dz=5\text{mm}$
Input Power = 20.0 dBm (100 mW)
Peak SAR (extrapolated) = 1.35 W/kg
SAR(1 g) = 0.935 W/kg
Deviation = -1.99%

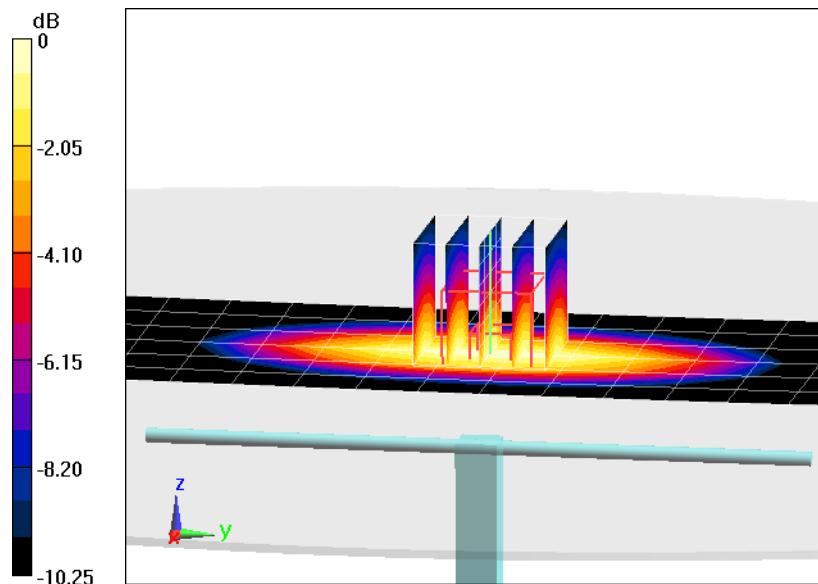

0 dB = 1.01 W/kg = 0.04 dBW/kg

PCTEST ENGINEERING LABORATORY, INC.

DUT: Dipole 835 MHz; Type: D835V2; Serial: 4d119

Communication System: UID 0, CW; Frequency: 835 MHz; Duty Cycle: 1:1
Medium: 835 Body, Medium parameters used:
 $f = 835 \text{ MHz}$; $\sigma = 0.977 \text{ S/m}$; $\epsilon_r = 52.829$; $\rho = 1000 \text{ kg/m}^3$
Phantom section: Flat Section; Space: 1.5 cm

Test Date: 01-27-2014; Ambient Temp: 23.4°C; Tissue Temp: 22.3°C

Probe: ES3DV3 - SN3333; ConvF(6.07, 6.07, 6.07); Calibrated: 11/22/2013;
Sensor-Surface: 4mm (Mechanical Surface Detection)
Electronics: DAE4 Sn1408; Calibrated: 11/19/2013
Phantom: ELI v5.0; Type: QDOVA001BB; Serial: 1229
Measurement SW: DASY52, Version 52.8 (7); SEMCAD X Version 14.6.10 (7164)

835 MHz System Verification

Area Scan (7x14x1): Measurement grid: dx=15mm, dy=15mm
Zoom Scan (5x5x7)/Cube 0: Measurement grid: dx=8mm, dy=8mm, dz=5mm
Input Power = 20 dBm (100 mW)
Peak SAR (extrapolated) = 1.41 W/kg
SAR(1 g) = 0.961 W/kg
Deviation = 0.73%

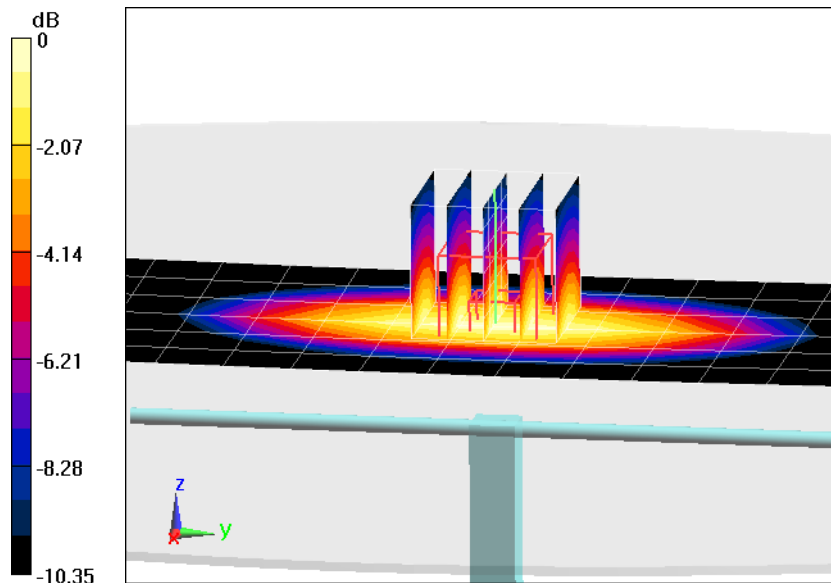

0 dB = 1.04 W/kg = 0.17 dBW/kg

PCTEST ENGINEERING LABORATORY, INC.

DUT: SAR Dipole 1900 MHz; Type: D1900V2; Serial: 5d148

Communication System: UID 0, CW; Frequency: 1900 MHz; Duty Cycle: 1:1
Medium: 1900 Body, Medium parameters used (interpolated):
 $f = 1900 \text{ MHz}$; $\sigma = 1.539 \text{ S/m}$; $\epsilon_r = 52.366$; $\rho = 1000 \text{ kg/m}^3$
Phantom section: Flat Section; Space: 1.0 cm

Test Date: 01-22-2014; Ambient Temp: 23.5°C; Tissue Temp: 22.4°C

Probe: ES3DV3 - SN3319; ConvF(4.85, 4.85, 4.85); Calibrated: 4/29/2013;
Sensor-Surface: 4mm (Mechanical Surface Detection)
Electronics: DAE4 Sn1368; Calibrated: 4/22/2013
Phantom: SAM front; Type: QD000P40CD; Serial: TP:1759
Measurement SW: DASY52, Version 52.8 (7); SEMCAD X Version 14.6.10 (7164)

1900 MHz System Verification

Area Scan (7x10x1): Measurement grid: dx=15mm, dy=15mm
Zoom Scan (5x5x7)/Cube 0: Measurement grid: dx=8mm, dy=8mm, dz=5mm
Input Power = 20 dBm (100 mW)
Peak SAR (extrapolated) = 6.89 W/kg
SAR(1 g) = 3.82 W/kg
Deviation = -6.37%

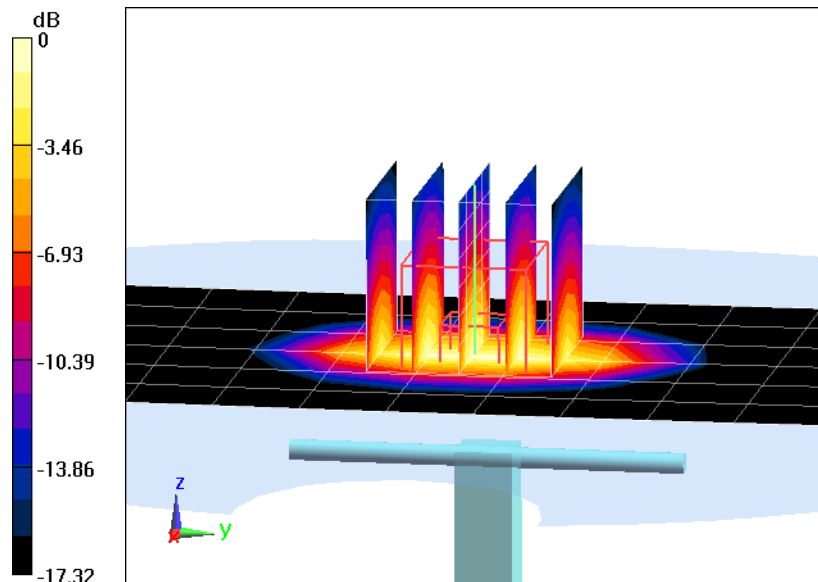

0 dB = 4.31 W/kg = 6.34 dBW/kg

PCTEST ENGINEERING LABORATORY, INC.

DUT: SAR Dipole 2450 MHz; Type: D2450V2; Serial: 882

Communication System: UID 0, CW; Frequency: 2450 MHz; Duty Cycle: 1:1
Medium: 2450 Body, Medium parameters used:
 $f = 2450 \text{ MHz}$; $\sigma = 2.043 \text{ S/m}$; $\epsilon_r = 53.862$; $\rho = 1000 \text{ kg/m}^3$
Phantom section: Flat Section; Space: 1.0 cm

Test Date: 01-27-2014; Ambient Temp: 23.0°C; Tissue Temp: 20.9°C

Probe: ES3DV3 - SN3263; ConvF(4.33, 4.33, 4.33); Calibrated: 5/16/2013;
Sensor-Surface: 3mm (Mechanical Surface Detection)
Electronics: DAE4 Sn859; Calibrated: 5/13/2013
Phantom: SAM Sub; Type: SAM 4.0; Serial: TP-1357
Measurement SW: DASY4, Version 4.7 (80); SEMCAD X Version 14.6.10 (7164)

2450MHz System Verification

Area Scan (6x9x1): Measurement grid: dx=12mm, dy=12mm
Zoom Scan (7x7x7)/Cube 0: Measurement grid: dx=5mm, dy=5mm, dz=5mm
Input Power = 15 dBm (32 mW)
Peak SAR (extrapolated) = 3.49 W/kg
SAR(1 g) = 1.67 W/kg
Deviation = 4.59%

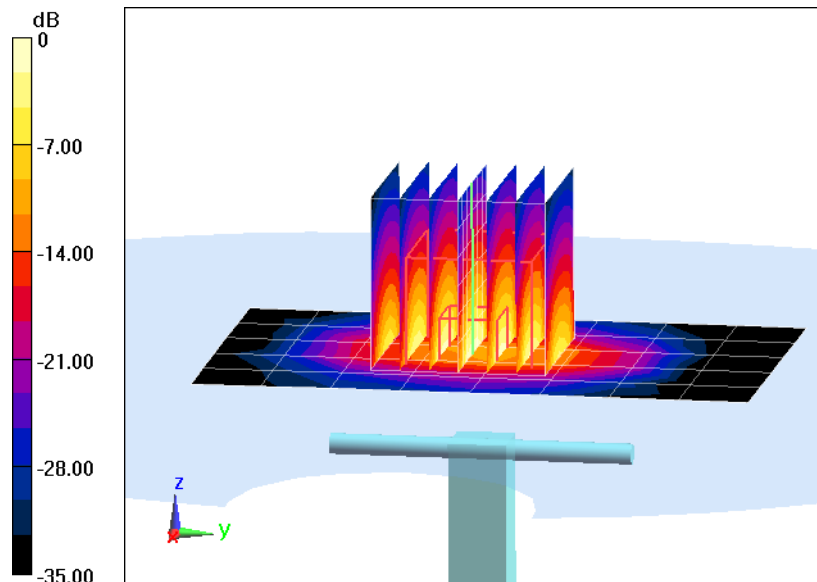

0 dB = 2.16 W/kg = 3.34 dBW/kg

APPENDIX C: PROBE CALIBRATION



Accredited by the Swiss Accreditation Service (SAS)
The Swiss Accreditation Service is one of the signatories to the EA
Multilateral Agreement for the recognition of calibration certificates

Accreditation No.: **SCS 108**

Client **PC Test**

Certificate No: **D835V2-4d133_Jul13**

CALIBRATION CERTIFICATE

Object: **D835V2 - SN: 4d133**

Calibration procedure(s): **QA CAL-05.v9
Calibration procedure for dipole validation kits above 700 MHz**

Calibration date: **July 17, 2013**

*V
KOK
8/12/13*

This calibration certificate documents the traceability to national standards, which realize the physical units of measurements (SI).
The measurements and the uncertainties with confidence probability are given on the following pages and are part of the certificate.

All calibrations have been conducted in the closed laboratory facility: environment temperature (22 ± 3)°C and humidity < 70%.

Calibration Equipment used (M&TE critical for calibration)

Primary Standards	ID #	Cal Date (Certificate No.)	Scheduled Calibration
Power meter EPM-442A	GB37480704	01-Nov-12 (No. 217-01640)	Oct-13
Power sensor HP 8481A	US37292783	01-Nov-12 (No. 217-01640)	Oct-13
Reference 20 dB Attenuator	SN: 5058 (20k)	04-Apr-13 (No. 217-01736)	Apr-14
Type-N mismatch combination	SN: 5047.3 / 06327	04-Apr-13 (No. 217-01739)	Apr-14
Reference Probe ES3DV3	SN: 3205	28-Dec-12 (No. ES3-3205_Dec12)	Dec-13
DAE4	SN: 601	25-Apr-13 (No. DAE4-601_Apr13)	Apr-14
Secondary Standards	ID #	Check Date (in house)	Scheduled Check
Power sensor HP 8481A	MY41092317	18-Oct-02 (in house check Oct-11)	In house check: Oct-13
RF generator R&S SMT-06	100005	04-Aug-99 (in house check Oct-11)	In house check: Oct-13
Network Analyzer HP 8753E	US37390585 S4206	18-Oct-01 (in house check Oct-12)	In house check: Oct-13

Calibrated by:	Name Leif Klysner	Function Laboratory Technician	Signature
Approved by:	Name Katja Pokovic	Function Technical Manager	Signature

Issued: July 18, 2013

This calibration certificate shall not be reproduced except in full without written approval of the laboratory.



Accredited by the Swiss Accreditation Service (SAS)
The Swiss Accreditation Service is one of the signatories to the EA
Multilateral Agreement for the recognition of calibration certificates

Accreditation No.: **SCS 108**

Glossary:

TSL	tissue simulating liquid
ConvF	sensitivity in TSL / NORM x,y,z
N/A	not applicable or not measured

Calibration is Performed According to the Following Standards:

- IEEE Std 1528-2003, "IEEE Recommended Practice for Determining the Peak Spatial-Averaged Specific Absorption Rate (SAR) in the Human Head from Wireless Communications Devices: Measurement Techniques", December 2003
- IEC 62209-1, "Procedure to measure the Specific Absorption Rate (SAR) for hand-held devices used in close proximity to the ear (frequency range of 300 MHz to 3 GHz)", February 2005
- Federal Communications Commission Office of Engineering & Technology (FCC OET), "Evaluating Compliance with FCC Guidelines for Human Exposure to Radiofrequency Electromagnetic Fields; Additional Information for Evaluating Compliance of Mobile and Portable Devices with FCC Limits for Human Exposure to Radiofrequency Emissions", Supplement C (Edition 01-01) to Bulletin 65

Additional Documentation:

- DASY4/5 System Handbook

Methods Applied and Interpretation of Parameters:

- Measurement Conditions:* Further details are available from the Validation Report at the end of the certificate. All figures stated in the certificate are valid at the frequency indicated.
- Antenna Parameters with TSL:* The dipole is mounted with the spacer to position its feed point exactly below the center marking of the flat phantom section, with the arms oriented parallel to the body axis.
- Feed Point Impedance and Return Loss:* These parameters are measured with the dipole positioned under the liquid filled phantom. The impedance stated is transformed from the measurement at the SMA connector to the feed point. The Return Loss ensures low reflected power. No uncertainty required.
- Electrical Delay:* One-way delay between the SMA connector and the antenna feed point. No uncertainty required.
- SAR measured:* SAR measured at the stated antenna input power.
- SAR normalized:* SAR as measured, normalized to an input power of 1 W at the antenna connector.
- SAR for nominal TSL parameters:* The measured TSL parameters are used to calculate the nominal SAR result.

The reported uncertainty of measurement is stated as the standard uncertainty of measurement multiplied by the coverage factor $k=2$, which for a normal distribution corresponds to a coverage probability of approximately 95%.

Measurement Conditions

DASY system configuration, as far as not given on page 1.

DASY Version	DASY5	V52.8.7
Extrapolation	Advanced Extrapolation	
Phantom	Modular Flat Phantom	
Distance Dipole Center - TSL	15 mm	with Spacer
Zoom Scan Resolution	dx, dy, dz = 5 mm	
Frequency	835 MHz ± 1 MHz	

Head TSL parameters

The following parameters and calculations were applied.

	Temperature	Permittivity	Conductivity
Nominal Head TSL parameters	22.0 °C	41.5	0.90 mho/m
Measured Head TSL parameters	(22.0 ± 0.2) °C	41.8 ± 6 %	0.92 mho/m ± 6 %
Head TSL temperature change during test	< 0.5 °C	----	----

SAR result with Head TSL

SAR averaged over 1 cm³ (1 g) of Head TSL	Condition	
SAR measured	250 mW input power	2.44 W/kg
SAR for nominal Head TSL parameters	normalized to 1W	9.62 W/kg ± 17.0 % (k=2)

SAR averaged over 10 cm³ (10 g) of Head TSL	condition	
SAR measured	250 mW input power	1.59 W/kg
SAR for nominal Head TSL parameters	normalized to 1W	6.28 W/kg ± 16.5 % (k=2)

Body TSL parameters

The following parameters and calculations were applied.

	Temperature	Permittivity	Conductivity
Nominal Body TSL parameters	22.0 °C	55.2	0.97 mho/m
Measured Body TSL parameters	(22.0 ± 0.2) °C	54.9 ± 6 %	1.00 mho/m ± 6 %
Body TSL temperature change during test	< 0.5 °C	----	----

SAR result with Body TSL

SAR averaged over 1 cm³ (1 g) of Body TSL	Condition	
SAR measured	250 mW input power	2.46 W/kg
SAR for nominal Body TSL parameters	normalized to 1W	9.61 W/kg ± 17.0 % (k=2)

SAR averaged over 10 cm³ (10 g) of Body TSL	condition	
SAR measured	250 mW input power	1.62 W/kg
SAR for nominal Body TSL parameters	normalized to 1W	6.36 W/kg ± 16.5 % (k=2)

Appendix

Antenna Parameters with Head TSL

Impedance, transformed to feed point	52.0 Ω - 1.8 j Ω
Return Loss	- 31.8 dB

Antenna Parameters with Body TSL

Impedance, transformed to feed point	48.2 Ω - 3.6 j Ω
Return Loss	- 27.7 dB

General Antenna Parameters and Design

Electrical Delay (one direction)	1.395 ns
----------------------------------	----------

After long term use with 100W radiated power, only a slight warming of the dipole near the feedpoint can be measured.

The dipole is made of standard semirigid coaxial cable. The center conductor of the feeding line is directly connected to the second arm of the dipole. The antenna is therefore short-circuited for DC-signals. On some of the dipoles, small end caps are added to the dipole arms in order to improve matching when loaded according to the position as explained in the "Measurement Conditions" paragraph. The SAR data are not affected by this change. The overall dipole length is still according to the Standard.

No excessive force must be applied to the dipole arms, because they might bend or the soldered connections near the feedpoint may be damaged.

Additional EUT Data

Manufactured by	SPEAG
Manufactured on	July 22, 2011

DASY5 Validation Report for Head TSL

Date: 17.07.2013

Test Laboratory: SPEAG, Zurich, Switzerland

DUT: Dipole 835 MHz; Type: D835V2; Serial: D835V2 - SN: 4d133

Communication System: UID 0 - CW ; Frequency: 835 MHz

Medium parameters used: $f = 835 \text{ MHz}$; $\sigma = 0.92 \text{ S/m}$; $\epsilon_r = 41.8$; $\rho = 1000 \text{ kg/m}^3$

Phantom section: Flat Section

Measurement Standard: DASY5 (IEEE/IEC/ANSI C63.19-2007)

DASY52 Configuration:

- Probe: ES3DV3 - SN3205; ConvF(6.05, 6.05, 6.05); Calibrated: 28.12.2012;
- Sensor-Surface: 3mm (Mechanical Surface Detection)
- Electronics: DAE4 Sn601; Calibrated: 25.04.2013
- Phantom: Flat Phantom 4.9L; Type: QD000P49AA; Serial: 1001
- DASY52 52.8.7(1137); SEMCAD X 14.6.10(7164)

Dipole Calibration for Head Tissue/Pin=250 mW, d=15mm/Zoom Scan (7x7x7)/Cube 0:

Measurement grid: $dx=5\text{mm}$, $dy=5\text{mm}$, $dz=5\text{mm}$

Reference Value = 57.188 V/m; Power Drift = 0.03 dB

Peak SAR (extrapolated) = 3.66 W/kg

SAR(1 g) = 2.44 W/kg; SAR(10 g) = 1.59 W/kg

Maximum value of SAR (measured) = 2.84 W/kg

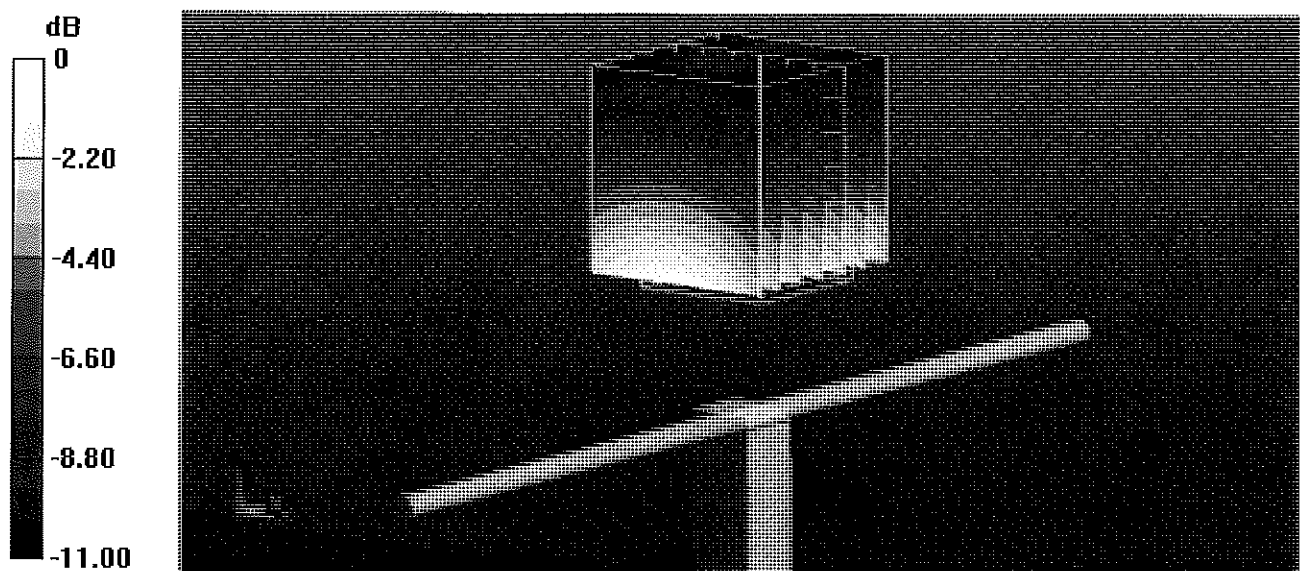

0 dB = 2.84 W/kg = 4.53 dBW/kg

Impedance Measurement Plot for Head TSL

18 Jul 2013 09:49:17

[CH1] S11 1 U FS

1: 51.957 \angle -1.7539 \angle 100.67 pF

835.000 000 MHz

*
De1
CA

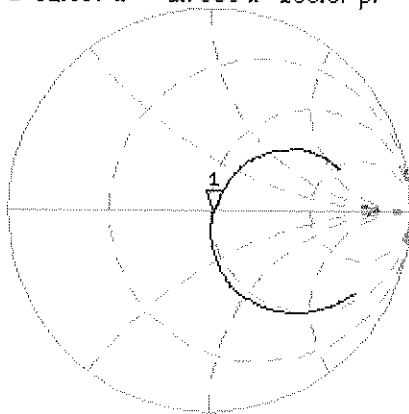

Avg
16

H1d

CH2 S11 LOG

5 dB/REF -20 dB

1: -31.772 dB

835.000 000 MHz

CA

Avg
16

H1d

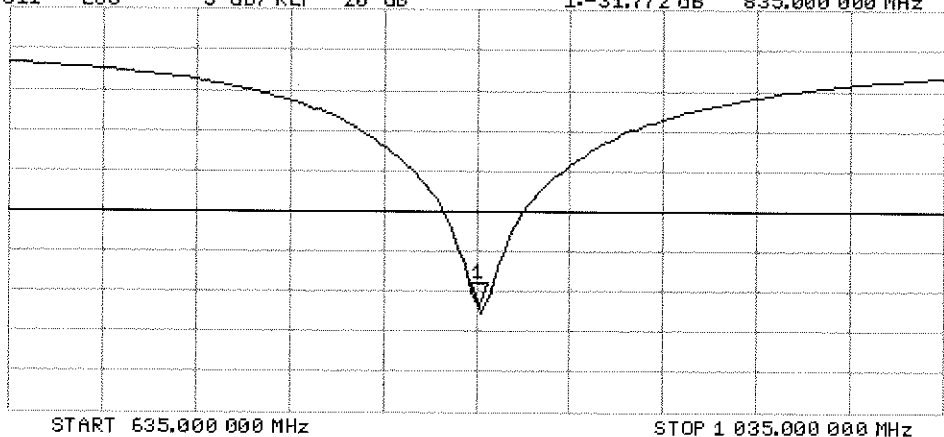

START 835.000 000 MHz

STOP 1 835.000 000 MHz

DASY5 Validation Report for Body TSL

Date: 17.07.2013

Test Laboratory: SPEAG, Zurich, Switzerland

DUT: Dipole 835 MHz; Type: D835V2; Serial: D835V2 - SN: 4d133

Communication System: UID 0 - CW ; Frequency: 835 MHz

Medium parameters used: $f = 835 \text{ MHz}$; $\sigma = 1 \text{ S/m}$; $\epsilon_r = 54.9$; $\rho = 1000 \text{ kg/m}^3$

Phantom section: Flat Section

Measurement Standard: DASY5 (IEEE/IEC/ANSI C63.19-2007)

DASY52 Configuration:

- Probe: ES3DV3 - SN3205; ConvF(6.04, 6.04, 6.04); Calibrated: 28.12.2012;
- Sensor-Surface: 3mm (Mechanical Surface Detection)
- Electronics: DAE4 Sn601; Calibrated: 25.04.2013
- Phantom: Flat Phantom 4.9L; Type: QD000P49AA; Serial: 1001
- DASY52 52.8.7(1137); SEMCAD X 14.6.10(7164)

Dipole Calibration for Body Tissue/Pin=250 mW, d=15mm/Zoom Scan (7x7x7)/Cube 0:

Measurement grid: dx=5mm, dy=5mm, dz=5mm

Reference Value = 55.351 V/m; Power Drift = 0.03 dB

Peak SAR (extrapolated) = 3.59 W/kg

SAR(1 g) = 2.46 W/kg; SAR(10 g) = 1.62 W/kg

Maximum value of SAR (measured) = 2.86 W/kg

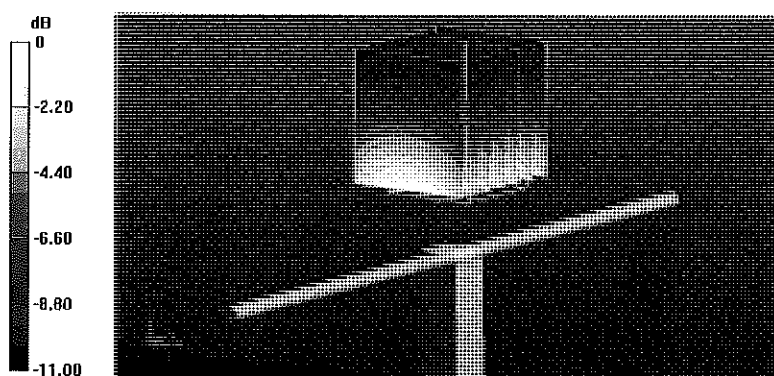

0 dB = 2.86 W/kg = 4.56 dBW/kg

Impedance Measurement Plot for Body TSL

18 Jul 2013 09:11:04
[CH1] S11 1 U FS 1: 48.184 Ω -3.6035 Ω 52.894 pF 835.000 000 MHz

*
De1
Ca

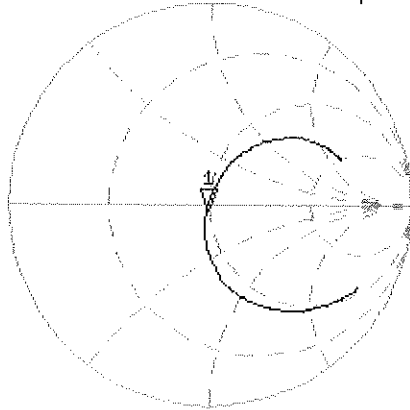

Avg
16

H1d

CH2 S11 LOG 5 dB/REF -20 dB 1: -27.734 dB 835.000 000 MHz

Ca

Avg
16

H1d

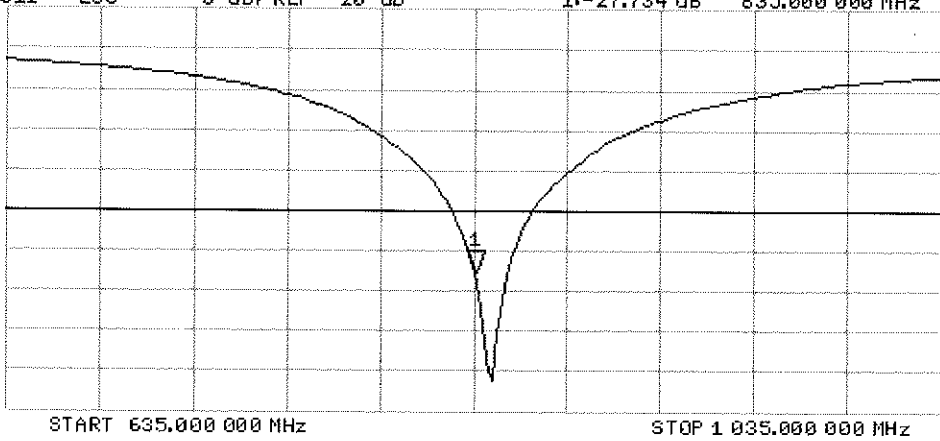



Accredited by the Swiss Accreditation Service (SAS)
The Swiss Accreditation Service is one of the signatories to the EA
Multilateral Agreement for the recognition of calibration certificates

Accreditation No.: **SCS 108**

Client **PC Test**

Certificate No: **D1900V2-5d141_May13**

CALIBRATION CERTIFICATE

Object **D1900V2 - SN: 5d141**

Calibration procedure(s) **QA CAL-05.v9
Calibration procedure for dipole validation kits above 700 MHz**

Calibration date: **May 02, 2013**

✓
5/8/13

This calibration certificate documents the traceability to national standards, which realize the physical units of measurements (SI).
The measurements and the uncertainties with confidence probability are given on the following pages and are part of the certificate.

All calibrations have been conducted in the closed laboratory facility: environment temperature (22 ± 3)°C and humidity < 70%.

Calibration Equipment used (M&TE critical for calibration)

Primary Standards	ID #	Cal Date (Certificate No.)	Scheduled Calibration
Power meter EPM-442A	GB37480704	01-Nov-12 (No. 217-01640)	Oct-13
Power sensor HP 8481A	US37292783	01-Nov-12 (No. 217-01640)	Oct-13
Reference 20 dB Attenuator	SN: 5058 (20k)	04-Apr-13 (No. 217-01736)	Apr-14
Type-N mismatch combination	SN: 5047.3 / 06327	04-Apr-13 (No. 217-01739)	Apr-14
Reference Probe ES3DV3	SN: 3205	28-Dec-12 (No. ES3-3205_Dec12)	Dec-13
DAE4	SN: 601	25-Apr-13 (No. DAE4-601_Apr13)	Apr-14

Secondary Standards	ID #	Check Date (in house)	Scheduled Check
Power sensor HP 8481A	MY41092317	18-Oct-02 (in house check Oct-11)	In house check: Oct-13
RF generator R&S SMT-06	100005	04-Aug-99 (in house check Oct-11)	In house check: Oct-13
Network Analyzer HP 8753E	US37390585 S4206	18-Oct-01 (in house check Oct-12)	In house check: Oct-13

Calibrated by: **Claudio Leubler** Name: Claudio Leubler Function: Laboratory Technician

Signature

Approved by: **Katja Pokovic** Name: Katja Pokovic Function: Technical Manager

[Handwritten Signature]

Issued: May 2, 2013

This calibration certificate shall not be reproduced except in full without written approval of the laboratory.



Accredited by the Swiss Accreditation Service (SAS)

The Swiss Accreditation Service is one of the signatories to the EA
Multilateral Agreement for the recognition of calibration certificates

Accreditation No.: **SCS 108**

Glossary:

TSL	tissue simulating liquid
ConvF	sensitivity in TSL / NORM x,y,z
N/A	not applicable or not measured

Calibration is Performed According to the Following Standards:

- IEEE Std 1528-2003, "IEEE Recommended Practice for Determining the Peak Spatial-Averaged Specific Absorption Rate (SAR) in the Human Head from Wireless Communications Devices: Measurement Techniques", December 2003
- IEC 62209-1, "Procedure to measure the Specific Absorption Rate (SAR) for hand-held devices used in close proximity to the ear (frequency range of 300 MHz to 3 GHz)", February 2005
- Federal Communications Commission Office of Engineering & Technology (FCC OET), "Evaluating Compliance with FCC Guidelines for Human Exposure to Radiofrequency Electromagnetic Fields; Additional Information for Evaluating Compliance of Mobile and Portable Devices with FCC Limits for Human Exposure to Radiofrequency Emissions", Supplement C (Edition 01-01) to Bulletin 65

Additional Documentation:

- DASY4/5 System Handbook

Methods Applied and Interpretation of Parameters:

- Measurement Conditions:** Further details are available from the Validation Report at the end of the certificate. All figures stated in the certificate are valid at the frequency indicated.
- Antenna Parameters with TSL:** The dipole is mounted with the spacer to position its feed point exactly below the center marking of the flat phantom section, with the arms oriented parallel to the body axis.
- Feed Point Impedance and Return Loss:** These parameters are measured with the dipole positioned under the liquid filled phantom. The impedance stated is transformed from the measurement at the SMA connector to the feed point. The Return Loss ensures low reflected power. No uncertainty required.
- Electrical Delay:** One-way delay between the SMA connector and the antenna feed point. No uncertainty required.
- SAR measured:** SAR measured at the stated antenna input power.
- SAR normalized:** SAR as measured, normalized to an input power of 1 W at the antenna connector.
- SAR for nominal TSL parameters:** The measured TSL parameters are used to calculate the nominal SAR result.

The reported uncertainty of measurement is stated as the standard uncertainty of measurement multiplied by the coverage factor $k=2$, which for a normal distribution corresponds to a coverage probability of approximately 95%.

Measurement Conditions

DASY system configuration, as far as not given on page 1.

DASY Version	DASY5	V52.8.6
Extrapolation	Advanced Extrapolation	
Phantom	Modular Flat Phantom	
Distance Dipole Center - TSL	10 mm	with Spacer
Zoom Scan Resolution	dx, dy, dz = 5 mm	
Frequency	1900 MHz \pm 1 MHz	

Head TSL parameters

The following parameters and calculations were applied.

	Temperature	Permittivity	Conductivity
Nominal Head TSL parameters	22.0 °C	40.0	1.40 mho/m
Measured Head TSL parameters	(22.0 \pm 0.2) °C	39.3 \pm 6 %	1.37 mho/m \pm 6 %
Head TSL temperature change during test	< 0.5 °C	----	----

SAR result with Head TSL

SAR averaged over 1 cm³ (1 g) of Head TSL	Condition	
SAR measured	250 mW input power	10.1 W/kg
SAR for nominal Head TSL parameters	normalized to 1W	40.8 W/kg \pm 17.0 % (k=2)

SAR averaged over 10 cm³ (10 g) of Head TSL	condition	
SAR measured	250 mW input power	5.30 W/kg
SAR for nominal Head TSL parameters	normalized to 1W	21.3 W/kg \pm 16.5 % (k=2)

Body TSL parameters

The following parameters and calculations were applied.

	Temperature	Permittivity	Conductivity
Nominal Body TSL parameters	22.0 °C	53.3	1.52 mho/m
Measured Body TSL parameters	(22.0 \pm 0.2) °C	54.0 \pm 6 %	1.51 mho/m \pm 6 %
Body TSL temperature change during test	< 0.5 °C	----	----

SAR result with Body TSL

SAR averaged over 1 cm³ (1 g) of Body TSL	Condition	
SAR measured	250 mW input power	10.3 W/kg
SAR for nominal Body TSL parameters	normalized to 1W	41.5 W/kg \pm 17.0 % (k=2)

SAR averaged over 10 cm³ (10 g) of Body TSL	condition	
SAR measured	250 mW input power	5.51 W/kg
SAR for nominal Body TSL parameters	normalized to 1W	22.1 W/kg \pm 16.5 % (k=2)

Appendix

Antenna Parameters with Head TSL

Impedance, transformed to feed point	52.6 Ω + 4.9 j Ω
Return Loss	- 25.3 dB

Antenna Parameters with Body TSL

Impedance, transformed to feed point	48.3 Ω + 5.9 j Ω
Return Loss	- 24.1 dB

General Antenna Parameters and Design

Electrical Delay (one direction)	1.199 ns
----------------------------------	----------

After long term use with 100W radiated power, only a slight warming of the dipole near the feedpoint can be measured.

The dipole is made of standard semirigid coaxial cable. The center conductor of the feeding line is directly connected to the second arm of the dipole. The antenna is therefore short-circuited for DC-signals. On some of the dipoles, small end caps are added to the dipole arms in order to improve matching when loaded according to the position as explained in the "Measurement Conditions" paragraph. The SAR data are not affected by this change. The overall dipole length is still according to the Standard.

No excessive force must be applied to the dipole arms, because they might bend or the soldered connections near the feedpoint may be damaged.

Additional EUT Data

Manufactured by	SPEAG
Manufactured on	March 11, 2011

DASY5 Validation Report for Head TSL

Date: 02.05.2013

Test Laboratory: SPEAG, Zurich, Switzerland

DUT: Dipole 1900 MHz; Type: D1900V2; Serial: D1900V2 - SN: 5d141

Communication System: UID 0 - CW; Frequency: 1900 MHz

Medium parameters used: $f = 1900$ MHz; $\sigma = 1.37$ S/m; $\epsilon_r = 39.3$; $\rho = 1000$ kg/m³

Phantom section: Flat Section

Measurement Standard: DASY5 (IEEE/IEC/ANSI C63.19-2007)

DASY52 Configuration:

- Probe: ES3DV3 - SN3205; ConvF(4.98, 4.98, 4.98); Calibrated: 28.12.2012;
- Sensor-Surface: 3mm (Mechanical Surface Detection)
- Electronics: DAE4 Sn601; Calibrated: 25.04.2013
- Phantom: Flat Phantom 5.0 (front); Type: QD000P50AA; Serial: 1001
- DASY52 52.8.6(1115); SEMCAD X 14.6.9(7117)

Dipole Calibration for Head Tissue/Pin=250 mW, d=10mm/Zoom Scan (7x7x7)/Cube 0:

Measurement grid: dx=5mm, dy=5mm, dz=5mm

Reference Value = 97.124 V/m; Power Drift = 0.05 dB

Peak SAR (extrapolated) = 18.2 W/kg

SAR(1 g) = 10.1 W/kg; SAR(10 g) = 5.3 W/kg

Maximum value of SAR (measured) = 12.5 W/kg

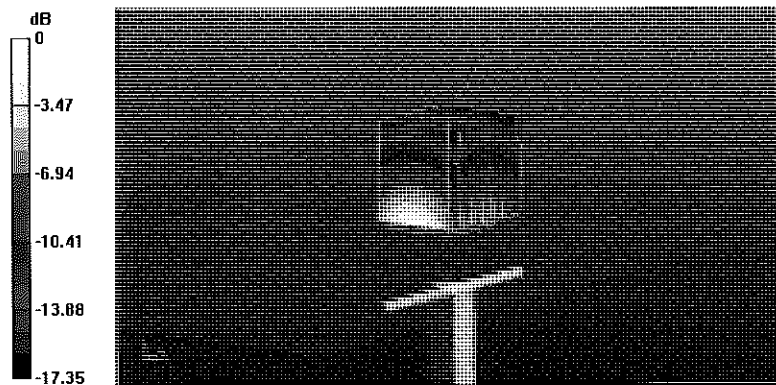

0 dB = 12.5 W/kg = 10.97 dBW/kg

Impedance Measurement Plot for Head TSL

2 May 2013 15:38:50

CH1 S11 1 U FS 1: 52.600 Ω 4.9375 Ω 413.59 μ H 1 900.000 000 MHz

*
Del
Cor
Avg
4

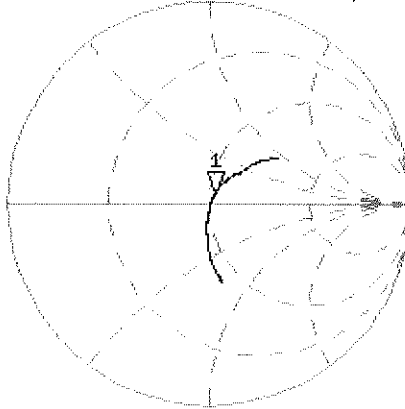

H1d

CH2 S11 LOG 5 dB/REF -20 dB 1:-25.293 dB 1 900.000 000 MHz

Cor
Avg
4

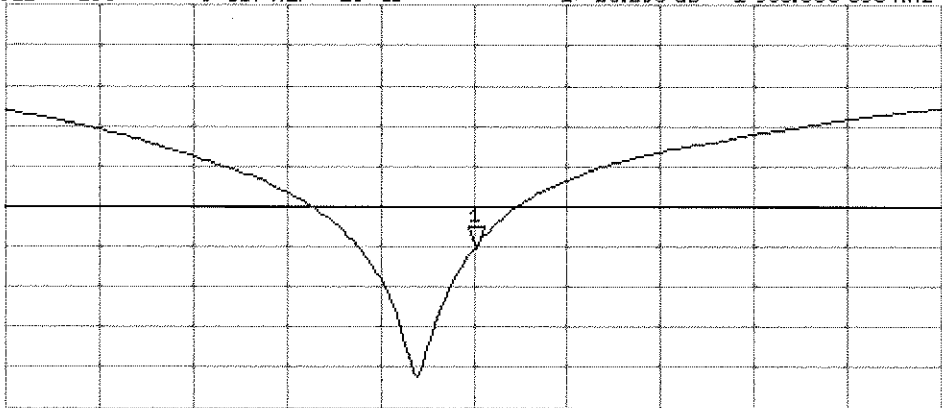

START 1 700.000 000 MHz

STOP 2 100.000 000 MHz

DASY5 Validation Report for Body TSL

Date: 02.05.2013

Test Laboratory: SPEAG, Zurich, Switzerland

DUT: Dipole 1900 MHz; Type: D1900V2; Serial: D1900V2 - SN: 5d141

Communication System: UID 0 - CW; Frequency: 1900 MHz

Medium parameters used: $f = 1900$ MHz; $\sigma = 1.51$ S/m; $\epsilon_r = 54$; $\rho = 1000$ kg/m³

Phantom section: Flat Section

Measurement Standard: DASY5 (IEEE/IEC/ANSI C63.19-2007)

DASY52 Configuration:

- Probe: ES3DV3 - SN3205; ConvF(4.6, 4.6, 4.6); Calibrated: 28.12.2012;
- Sensor-Surface: 3mm (Mechanical Surface Detection)
- Electronics: DAE4 Sn601; Calibrated: 25.04.2013
- Phantom: Flat Phantom 5.0 (back); Type: QD000P50AA; Serial: 1002
- DASY52 52.8.6(1115); SEMCAD X 14.6.9(7117)

Dipole Calibration for Body Tissue/Pin=250 mW, d=10mm/Zoom Scan (7x7x7)/Cube 0:

Measurement grid: dx=5mm, dy=5mm, dz=5mm

Reference Value = 97.124 V/m; Power Drift = -0.00 dB

Peak SAR (extrapolated) = 17.6 W/kg

SAR(1 g) = 10.3 W/kg; SAR(10 g) = 5.51 W/kg

Maximum value of SAR (measured) = 13.0 W/kg

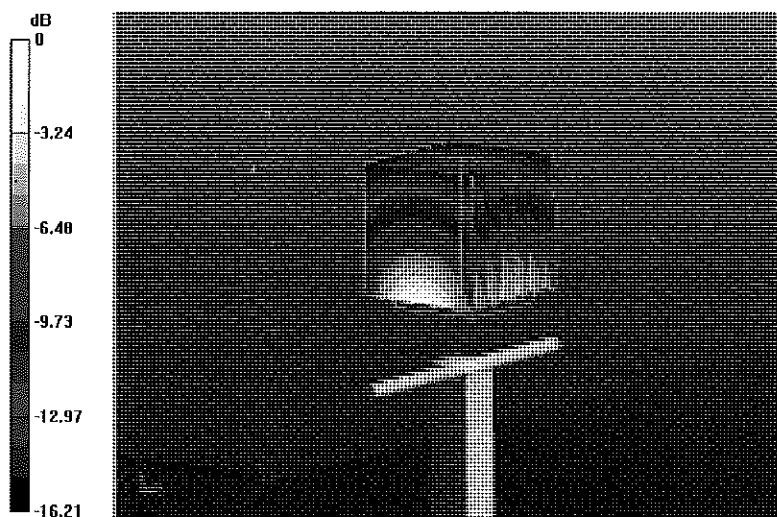

0 dB = 13.0 W/kg = 11.14 dBW/kg

Impedance Measurement Plot for Body TSL

2 May 2013 15:38:04

[CH1] S11 1 U FS 1: 48.273 Ω 5.9121 Ω 495.23 μ H 1 900.000 000 MHz

*
De1
Cor
Avg
16
H1d

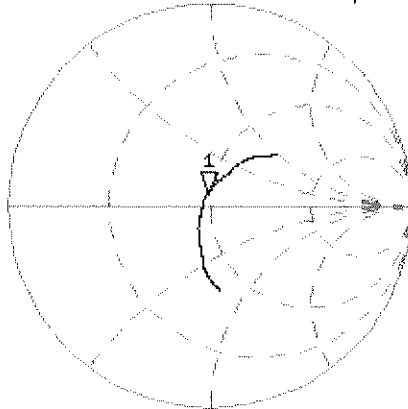

CH2 S11 LOG 5 dB/REF -20 dB 1:-24.074 dB 1 900.000 000 MHz

Cor
Avg
16
H1d

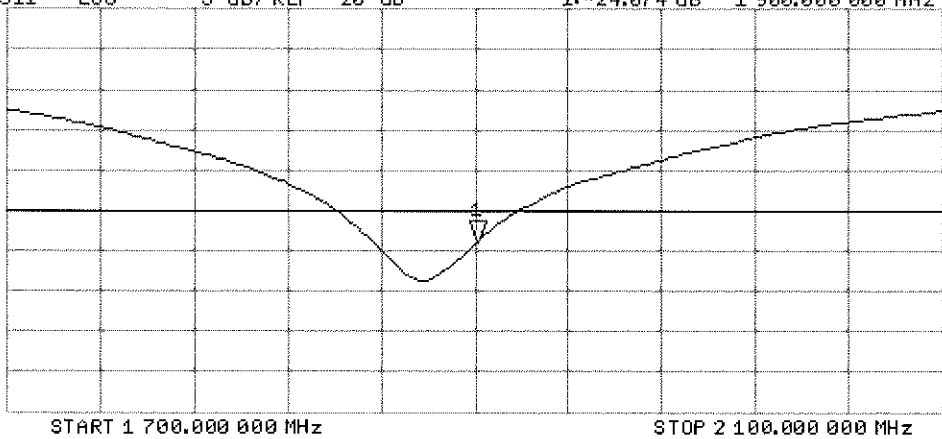



Accredited by the Swiss Accreditation Service (SAS)
The Swiss Accreditation Service is one of the signatories to the EA
Multilateral Agreement for the recognition of calibration certificates

Accreditation No.: **SCS 108**

Client **PC Test**

Certificate No: **D2450V2-719_Aug13**

CALIBRATION CERTIFICATE

Object **D2450V2 - SN: 719**

Calibration procedure(s) **QA CAL-05.v9
Calibration procedure for dipole validation kits above 700 MHz**

Calibration date: **August 23, 2013**

*✓cc
9/13/13*

This calibration certificate documents the traceability to national standards, which realize the physical units of measurements (SI).
The measurements and the uncertainties with confidence probability are given on the following pages and are part of the certificate.

All calibrations have been conducted in the closed laboratory facility: environment temperature (22 ± 3)°C and humidity < 70%.

Calibration Equipment used (M&TE critical for calibration)

Primary Standards	ID #	Cal Date (Certificate No.)	Scheduled Calibration
Power meter EPM-442A	GB37480704	01-Nov-12 (No. 217-01640)	Oct-13
Power sensor HP 8481A	US37292783	01-Nov-12 (No. 217-01640)	Oct-13
Reference 20 dB Attenuator	SN: 5058 (20k)	04-Apr-13 (No. 217-01736)	Apr-14
Type-N mismatch combination	SN: 5047.3 / 06327	04-Apr-13 (No. 217-01739)	Apr-14
Reference Probe ES3DV3	SN: 3205	28-Dec-12 (No. ES3-3205_Dec12)	Dec-13
DAE4	SN: 601	25-Apr-13 (No. DAE4-601_Apr13)	Apr-14
Secondary Standards	ID #	Check Date (in house)	Scheduled Check
Power sensor HP 8481A	MY41092317	18-Oct-02 (in house check Oct-11)	In house check: Oct-13
RF generator R&S SMT-06	100005	04-Aug-99 (in house check Oct-11)	In house check: Oct-13
Network Analyzer HP 8753E	US37390585 S4206	18-Oct-01 (in house check Oct-12)	In house check: Oct-13

Calibrated by:	Name Jeton Kastrati	Function Laboratory Technician	Signature
Approved by:	Name Katja Pokovic	Function Technical Manager	Signature

Issued: August 23, 2013

This calibration certificate shall not be reproduced except in full without written approval of the laboratory.



Accredited by the Swiss Accreditation Service (SAS)

The Swiss Accreditation Service is one of the signatories to the EA
Multilateral Agreement for the recognition of calibration certificates

Accreditation No.: **SCS 108**

Glossary:

TSL	tissue simulating liquid
ConvF	sensitivity in TSL / NORM x,y,z
N/A	not applicable or not measured

Calibration is Performed According to the Following Standards:

- IEEE Std 1528-2003, "IEEE Recommended Practice for Determining the Peak Spatial-Averaged Specific Absorption Rate (SAR) in the Human Head from Wireless Communications Devices: Measurement Techniques", December 2003
- IEC 62209-1, "Procedure to measure the Specific Absorption Rate (SAR) for hand-held devices used in close proximity to the ear (frequency range of 300 MHz to 3 GHz)", February 2005
- KDB 865664, "SAR Measurement Requirements for 100 MHz to 6 GHz"

Additional Documentation:

- DASY4/5 System Handbook

Methods Applied and Interpretation of Parameters:

- Measurement Conditions:* Further details are available from the Validation Report at the end of the certificate. All figures stated in the certificate are valid at the frequency indicated.
- Antenna Parameters with TSL:* The dipole is mounted with the spacer to position its feed point exactly below the center marking of the flat phantom section, with the arms oriented parallel to the body axis.
- Feed Point Impedance and Return Loss:* These parameters are measured with the dipole positioned under the liquid filled phantom. The impedance stated is transformed from the measurement at the SMA connector to the feed point. The Return Loss ensures low reflected power. No uncertainty required.
- Electrical Delay:* One-way delay between the SMA connector and the antenna feed point. No uncertainty required.
- SAR measured:* SAR measured at the stated antenna input power.
- SAR normalized:* SAR as measured, normalized to an input power of 1 W at the antenna connector.
- SAR for nominal TSL parameters:* The measured TSL parameters are used to calculate the nominal SAR result.

The reported uncertainty of measurement is stated as the standard uncertainty of measurement multiplied by the coverage factor $k=2$, which for a normal distribution corresponds to a coverage probability of approximately 95%.

Measurement Conditions

DASY system configuration, as far as not given on page 1.

DASY Version	DASY5	V52.8.7
Extrapolation	Advanced Extrapolation	
Phantom	Modular Flat Phantom	
Distance Dipole Center - TSL	10 mm	with Spacer
Zoom Scan Resolution	dx, dy, dz = 5 mm	
Frequency	2450 MHz \pm 1 MHz	

Head TSL parameters

The following parameters and calculations were applied.

	Temperature	Permittivity	Conductivity
Nominal Head TSL parameters	22.0 °C	39.2	1.80 mho/m
Measured Head TSL parameters	(22.0 \pm 0.2) °C	37.8 \pm 6 %	1.80 mho/m \pm 6 %
Head TSL temperature change during test	< 0.5 °C	----	----

SAR result with Head TSL

SAR averaged over 1 cm³ (1 g) of Head TSL	Condition	
SAR measured	250 mW input power	13.4 W/kg
SAR for nominal Head TSL parameters	normalized to 1W	53.2 W/kg \pm 17.0 % (k=2)

SAR averaged over 10 cm³ (10 g) of Head TSL	condition	
SAR measured	250 mW input power	6.23 W/kg
SAR for nominal Head TSL parameters	normalized to 1W	24.8 W/kg \pm 16.5 % (k=2)

Body TSL parameters

The following parameters and calculations were applied.

	Temperature	Permittivity	Conductivity
Nominal Body TSL parameters	22.0 °C	52.7	1.95 mho/m
Measured Body TSL parameters	(22.0 \pm 0.2) °C	50.6 \pm 6 %	2.03 mho/m \pm 6 %
Body TSL temperature change during test	< 0.5 °C	----	----

SAR result with Body TSL

SAR averaged over 1 cm³ (1 g) of Body TSL	Condition	
SAR measured	250 mW input power	13.3 W/kg
SAR for nominal Body TSL parameters	normalized to 1W	51.7 W/kg \pm 17.0 % (k=2)

SAR averaged over 10 cm³ (10 g) of Body TSL	condition	
SAR measured	250 mW input power	6.14 W/kg
SAR for nominal Body TSL parameters	normalized to 1W	24.1 W/kg \pm 16.5 % (k=2)

Appendix

Antenna Parameters with Head TSL

Impedance, transformed to feed point	54.6 Ω + 3.5 j Ω
Return Loss	- 25.1 dB

Antenna Parameters with Body TSL

Impedance, transformed to feed point	51.1 Ω + 5.4 j Ω
Return Loss	- 25.3 dB

General Antenna Parameters and Design

Electrical Delay (one direction)	1.149 ns
----------------------------------	----------

After long term use with 100W radiated power, only a slight warming of the dipole near the feedpoint can be measured.

The dipole is made of standard semirigid coaxial cable. The center conductor of the feeding line is directly connected to the second arm of the dipole. The antenna is therefore short-circuited for DC-signals. On some of the dipoles, small end caps are added to the dipole arms in order to improve matching when loaded according to the position as explained in the "Measurement Conditions" paragraph. The SAR data are not affected by this change. The overall dipole length is still according to the Standard.

No excessive force must be applied to the dipole arms, because they might bend or the soldered connections near the feedpoint may be damaged.

Additional EUT Data

Manufactured by	SPEAG
Manufactured on	September 10, 2002

DASY5 Validation Report for Head TSL

Date: 22.08.2013

Test Laboratory: SPEAG, Zurich, Switzerland

DUT: Dipole 2450 MHz; Type: D2450V2; Serial: D2450V2 - SN: 719

Communication System: UID 0 - CW ; Frequency: 2450 MHz

Medium parameters used: $f = 2450$ MHz; $\sigma = 1.8$ S/m; $\epsilon_r = 37.8$; $\rho = 1000$ kg/m³

Phantom section: Flat Section

Measurement Standard: DASY5 (IEEE/IEC/ANSI C63.19-2007)

DASY52 Configuration:

- Probe: ES3DV3 - SN3205; ConvF(4.52, 4.52, 4.52); Calibrated: 28.12.2012;
- Sensor-Surface: 3mm (Mechanical Surface Detection)
- Electronics: DAE4 Sn601; Calibrated: 25.04.2013
- Phantom: Flat Phantom 5.0 (front); Type: QD000P50AA; Serial: 1001
- DASY52 52.8.7(1137); SEMCAD X 14.6.10(7164)

Dipole Calibration for Head Tissue/Pin=250 mW, d=10mm/Zoom Scan (7x7x7)/Cube 0:

Measurement grid: dx=5mm, dy=5mm, dz=5mm

Reference Value = 100.7 V/m; Power Drift = 0.06 dB

Peak SAR (extrapolated) = 27.9 W/kg

SAR(1 g) = 13.4 W/kg; SAR(10 g) = 6.23 W/kg

Maximum value of SAR (measured) = 17.0 W/kg

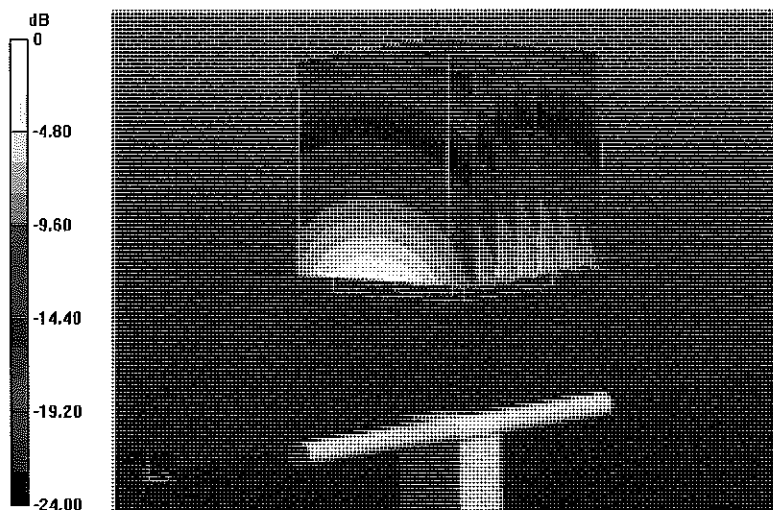

0 dB = 17.0 W/kg = 12.30 dBW/kg

Impedance Measurement Plot for Head TSL

22 Aug 2013 11:00:15

CH1 S11 1 U FS

4: 54.639 Ω 3.5215 Ω 228.76 pF

2 450.000 000 MHz

*
De1
CA

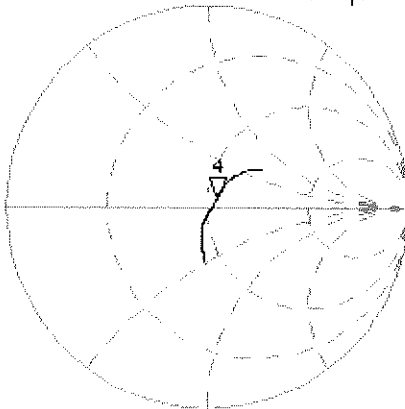

Avg
16

H1d

CH2 S11 LOG 5 dB/REF -20 dB 4: -25.093 dB 2 450.000 000 MHz

CA

Avg
16

H1d

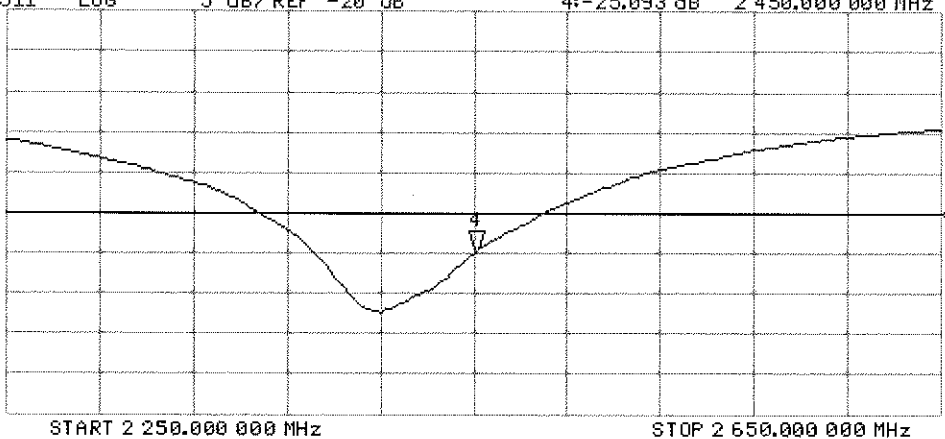

DASY5 Validation Report for Body TSL

Date: 23.08.2013

Test Laboratory: SPEAG, Zurich, Switzerland

DUT: Dipole 2450 MHz; Type: D2450V2; Serial: D2450V2 - SN: 719

Communication System: UID 0 - CW ; Frequency: 2450 MHz

Medium parameters used: $f = 2450$ MHz; $\sigma = 2.03$ S/m; $\epsilon_r = 50.6$; $\rho = 1000$ kg/m³

Phantom section: Flat Section

Measurement Standard: DASY5 (IEEE/IEC/ANSI C63.19-2007)

DASY52 Configuration:

- Probe: ES3DV3 - SN3205; ConvF(4.42, 4.42, 4.42); Calibrated: 28.12.2012;
- Sensor-Surface: 3mm (Mechanical Surface Detection)
- Electronics: DAE4 Sn601; Calibrated: 25.04.2013
- Phantom: Flat Phantom 5.0 (back); Type: QD000P50AA; Serial: 1002
- DASY52 52.8.7(1137); SEMCAD X 14.6.10(7164)

Dipole Calibration for Body Tissue/Pin=250 mW, d=10mm/Zoom Scan (7x7x7)/Cube 0:

Measurement grid: dx=5mm, dy=5mm, dz=5mm

Reference Value = 94.688 V/m; Power Drift = 0.06 dB

Peak SAR (extrapolated) = 27.9 W/kg

SAR(1 g) = 13.3 W/kg; SAR(10 g) = 6.14 W/kg

Maximum value of SAR (measured) = 17.2 W/kg

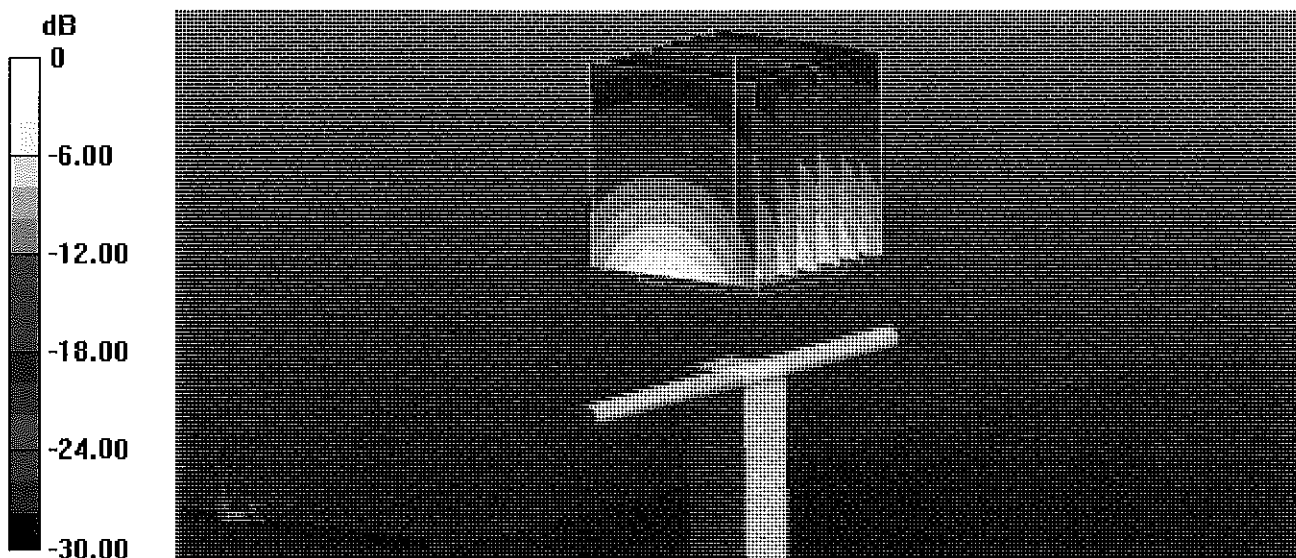

0 dB = 17.2 W/kg = 12.36 dBW/kg

Impedance Measurement Plot for Body TSL

23 Aug 2013 09:00:38

CH1 S11 1 U FS

3: 51.135 Ω 5.3965 Ω 350.56 pF

2 450.000 000 MHz

#

De1

CΔ

Avg
16

H1 d

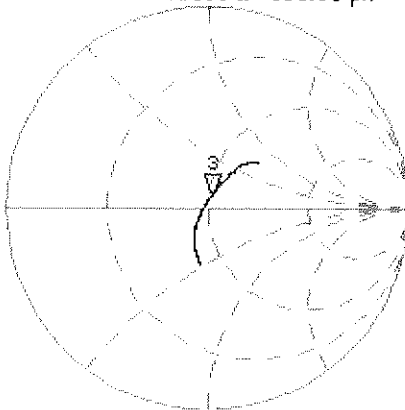

CH2 S11 LOG

5 dB/REF -20 dB

3:-25.274 dB

2 450.000 000 MHz

CΔ

Avg
16

H1 d

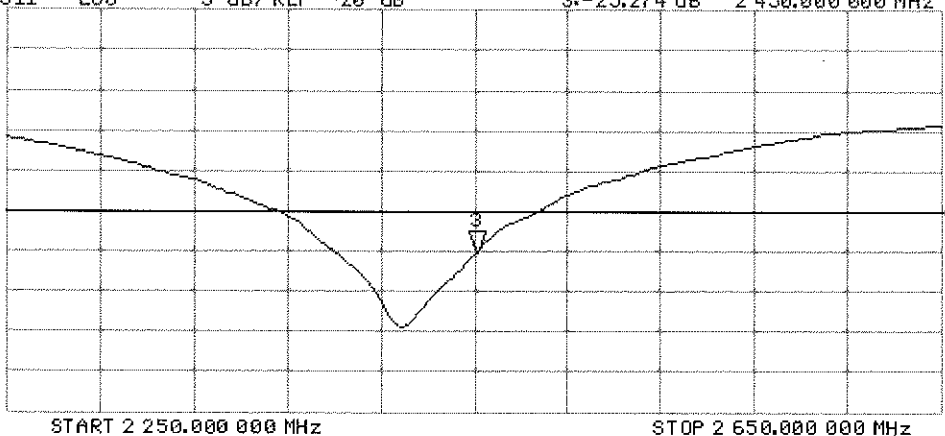



Accredited by the Swiss Accreditation Service (SAS)
The Swiss Accreditation Service is one of the signatories to the EA
Multilateral Agreement for the recognition of calibration certificates

Accreditation No.: **SCS 108**

Client **PC Test**

Certificate No: **D835V2-4d119_Apr13**

CALIBRATION CERTIFICATE

Object **D835V2 - SN: 4d119**

Calibration procedure(s) **QA CAL-05.v9
Calibration procedure for dipole validation kits above 700 MHz**

Calibration date: **April 25, 2013**

✓
KOK
5/8/13

This calibration certificate documents the traceability to national standards, which realize the physical units of measurements (SI).
The measurements and the uncertainties with confidence probability are given on the following pages and are part of the certificate.

All calibrations have been conducted in the closed laboratory facility: environment temperature (22 ± 3)°C and humidity < 70%.

Calibration Equipment used (M&TE critical for calibration)

Primary Standards	ID #	Cal Date (Certificate No.)	Scheduled Calibration
Power meter EPM-442A	GB37480704	01-Nov-12 (No. 217-01640)	Oct-13
Power sensor HP 8481A	US37292783	01-Nov-12 (No. 217-01640)	Oct-13
Reference 20 dB Attenuator	SN: 5058 (20k)	04-Apr-13 (No. 217-01736)	Apr-14
Type-N mismatch combination	SN: 5047.3 / 06327	04-Apr-13 (No. 217-01739)	Apr-14
Reference Probe ES3DV3	SN: 3205	28-Dec-12 (No. ES3-3205_Dec12)	Dec-13
DAE4	SN: 909	11-Sep-12 (No. DAE4-909_Sep12)	Sep-13
Secondary Standards	ID #	Check Date (in house)	Scheduled Check
Power sensor HP 8481A	MY41092317	18-Oct-02 (in house check Oct-11)	In house check: Oct-13
RF generator R&S SMT-06	100005	04-Aug-99 (in house check Oct-11)	In house check: Oct-13
Network Analyzer HP 8753E	US37390585 S4206	18-Oct-01 (in house check Oct-12)	In house check: Oct-13

Calibrated by: **Claudio Leubler** Name: **Claudio Leubler** Function: **Laboratory Technician**

Approved by: **Katja Pokovic** Name: **Katja Pokovic** Technical Manager

Signature

Issued: April 26, 2013

This calibration certificate shall not be reproduced except in full without written approval of the laboratory.



Accredited by the Swiss Accreditation Service (SAS)
The Swiss Accreditation Service is one of the signatories to the EA
Multilateral Agreement for the recognition of calibration certificates

Accreditation No.: **SCS 108**

Glossary:

TSL	tissue simulating liquid
ConvF	sensitivity in TSL / NORM x,y,z
N/A	not applicable or not measured

Calibration is Performed According to the Following Standards:

- IEEE Std 1528-2003, "IEEE Recommended Practice for Determining the Peak Spatial-Averaged Specific Absorption Rate (SAR) in the Human Head from Wireless Communications Devices: Measurement Techniques", December 2003
- IEC 62209-1, "Procedure to measure the Specific Absorption Rate (SAR) for hand-held devices used in close proximity to the ear (frequency range of 300 MHz to 3 GHz)", February 2005
- Federal Communications Commission Office of Engineering & Technology (FCC OET), "Evaluating Compliance with FCC Guidelines for Human Exposure to Radiofrequency Electromagnetic Fields; Additional Information for Evaluating Compliance of Mobile and Portable Devices with FCC Limits for Human Exposure to Radiofrequency Emissions", Supplement C (Edition 01-01) to Bulletin 65

Additional Documentation:

- DASY4/5 System Handbook

Methods Applied and Interpretation of Parameters:

- Measurement Conditions:* Further details are available from the Validation Report at the end of the certificate. All figures stated in the certificate are valid at the frequency indicated.
- Antenna Parameters with TSL:* The dipole is mounted with the spacer to position its feed point exactly below the center marking of the flat phantom section, with the arms oriented parallel to the body axis.
- Feed Point Impedance and Return Loss:* These parameters are measured with the dipole positioned under the liquid filled phantom. The impedance stated is transformed from the measurement at the SMA connector to the feed point. The Return Loss ensures low reflected power. No uncertainty required.
- Electrical Delay:* One-way delay between the SMA connector and the antenna feed point. No uncertainty required.
- SAR measured:* SAR measured at the stated antenna input power.
- SAR normalized:* SAR as measured, normalized to an input power of 1 W at the antenna connector.
- SAR for nominal TSL parameters:* The measured TSL parameters are used to calculate the nominal SAR result.

The reported uncertainty of measurement is stated as the standard uncertainty of measurement multiplied by the coverage factor $k=2$, which for a normal distribution corresponds to a coverage probability of approximately 95%.

Measurement Conditions

DASY system configuration, as far as not given on page 1.

DASY Version	DASY5	V52.8.6
Extrapolation	Advanced Extrapolation	
Phantom	Modular Flat Phantom	
Distance Dipole Center - TSL	15 mm	with Spacer
Zoom Scan Resolution	dx, dy, dz = 5 mm	
Frequency	835 MHz \pm 1 MHz	

Head TSL parameters

The following parameters and calculations were applied.

	Temperature	Permittivity	Conductivity
Nominal Head TSL parameters	22.0 °C	41.5	0.90 mho/m
Measured Head TSL parameters	(22.0 \pm 0.2) °C	40.8 \pm 6 %	0.94 mho/m \pm 6 %
Head TSL temperature change during test	< 0.5 °C	----	----

SAR result with Head TSL

SAR averaged over 1 cm ³ (1 g) of Head TSL	Condition	
SAR measured	250 mW input power	2.51 W/kg
SAR for nominal Head TSL parameters	normalized to 1W	9.68 W/kg \pm 17.0 % (k=2)

SAR averaged over 10 cm ³ (10 g) of Head TSL	condition	
SAR measured	250 mW input power	1.62 W/kg
SAR for nominal Head TSL parameters	normalized to 1W	6.30 W/kg \pm 16.5 % (k=2)

Body TSL parameters

The following parameters and calculations were applied.

	Temperature	Permittivity	Conductivity
Nominal Body TSL parameters	22.0 °C	55.2	0.97 mho/m
Measured Body TSL parameters	(22.0 \pm 0.2) °C	54.0 \pm 6 %	1.01 mho/m \pm 6 %
Body TSL temperature change during test	< 0.5 °C	----	----

SAR result with Body TSL

SAR averaged over 1 cm ³ (1 g) of Body TSL	Condition	
SAR measured	250 mW input power	2.47 W/kg
SAR for nominal Body TSL parameters	normalized to 1W	9.54 W/kg \pm 17.0 % (k=2)

SAR averaged over 10 cm ³ (10 g) of Body TSL	condition	
SAR measured	250 mW input power	1.62 W/kg
SAR for nominal Body TSL parameters	normalized to 1W	6.31 W/kg \pm 16.5 % (k=2)

Appendix

Antenna Parameters with Head TSL

Impedance, transformed to feed point	50.1 Ω - 4.7 j Ω
Return Loss	- 26.6 dB

Antenna Parameters with Body TSL

Impedance, transformed to feed point	45.8 Ω - 6.3 j Ω
Return Loss	- 22.1 dB

General Antenna Parameters and Design

Electrical Delay (one direction)	1.385 ns
----------------------------------	----------

After long term use with 100W radiated power, only a slight warming of the dipole near the feedpoint can be measured.

The dipole is made of standard semirigid coaxial cable. The center conductor of the feeding line is directly connected to the second arm of the dipole. The antenna is therefore short-circuited for DC-signals. On some of the dipoles, small end caps are added to the dipole arms in order to improve matching when loaded according to the position as explained in the "Measurement Conditions" paragraph. The SAR data are not affected by this change. The overall dipole length is still according to the Standard.

No excessive force must be applied to the dipole arms, because they might bend or the soldered connections near the feedpoint may be damaged.

Additional EUT Data

Manufactured by	SPEAG
Manufactured on	June 29, 2010

DASY5 Validation Report for Head TSL

Date: 25.04.2013

Test Laboratory: SPEAG, Zurich, Switzerland

DUT: Dipole 835 MHz; Type: D835V2; Serial: D835V2 - SN: 4d119

Communication System: UID 0 - CW; Frequency: 835 MHz

Medium parameters used: $f = 835$ MHz; $\sigma = 0.94$ S/m; $\epsilon_r = 40.8$; $\rho = 1000$ kg/m³

Phantom section: Flat Section

Measurement Standard: DASY5 (IEEE/IEC/ANSI C63.19-2007)

DASY52 Configuration:

- Probe: ES3DV3 - SN3205; ConvF(6.05, 6.05, 6.05); Calibrated: 28.12.2012;
- Sensor-Surface: 3mm (Mechanical Surface Detection)
- Electronics: DAE4 Sn909; Calibrated: 11.09.2012
- Phantom: Flat Phantom 4.9L; Type: QD000P49AA; Serial: 1001
- DASY52 52.8.6(1115); SEMCAD X 14.6.9(7117)

Dipole Calibration for Head Tissue/Pin=250 mW, d=15mm/Zoom Scan (7x7x7)/Cube 0:

Measurement grid: dx=5mm, dy=5mm, dz=5mm

Reference Value = 57.387 V/m; Power Drift = 0.03 dB

Peak SAR (extrapolated) = 3.86 W/kg

SAR(1 g) = 2.51 W/kg; SAR(10 g) = 1.62 W/kg

Maximum value of SAR (measured) = 2.93 W/kg

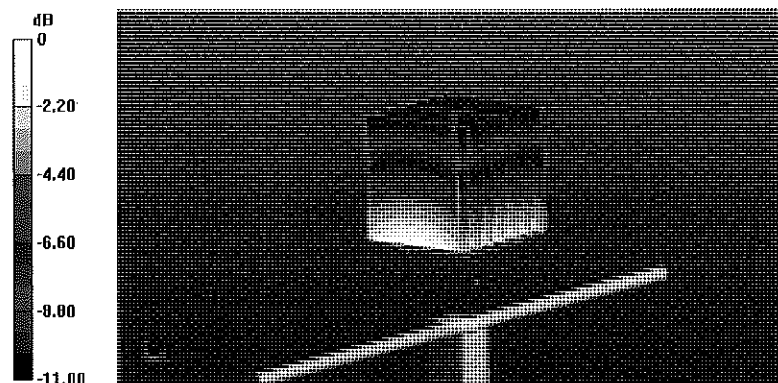

0 dB = 2.93 W/kg = 4.67 dBW/kg

Impedance Measurement Plot for Head TSL

25 Apr 2013 09:11:06

CH1 S11 1 U FS

1: 50.061 Ω -4.6621 Ω 40.884 pF

835.000 000 MHz

*
Del

CA

Avg
16

H1 d

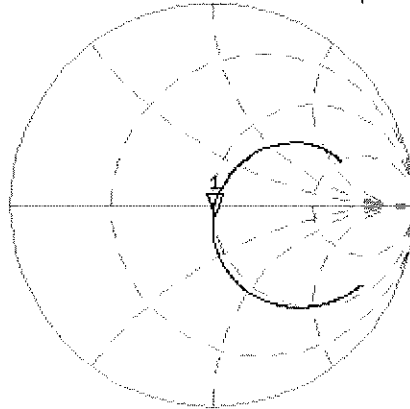

CH2 S11 LOG 5 dB/REF -20 dB 1:-26.641 dB 835.000 000 MHz

CA

Avg
16

H1 d

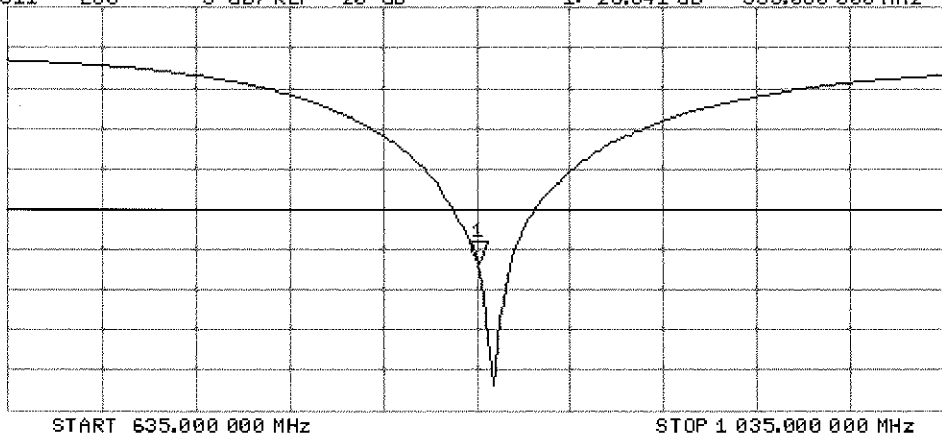

DASY5 Validation Report for Body TSL

Date: 24.04.2013

Test Laboratory: SPEAG, Zurich, Switzerland

DUT: Dipole 835 MHz; Type: D835V2; Serial: D835V2 - SN: 4d119

Communication System: UID 0 - CW; Frequency: 835 MHz

Medium parameters used: $f = 835$ MHz; $\sigma = 1.01$ S/m; $\epsilon_r = 54$; $\rho = 1000$ kg/m³

Phantom section: Flat Section

Measurement Standard: DASY5 (IEEE/IEC/ANSI C63.19-2007)

DASY52 Configuration:

- Probe: ES3DV3 - SN3205; ConvF(6.04, 6.04, 6.04); Calibrated: 28.12.2012;
- Sensor-Surface: 3mm (Mechanical Surface Detection)
- Electronics: DAE4 Sn909; Calibrated: 11.09.2012
- Phantom: Flat Phantom 4.9L; Type: QD000P49AA; Serial: 1001
- DASY52 52.8.6(1115); SEMCAD X 14.6.9(7117)

Dipole Calibration for Body Tissue/Pin=250 mW, d=15mm/Zoom Scan (7x7x7)/Cube 0:

Measurement grid: dx=5mm, dy=5mm, dz=5mm

Reference Value = 55.178 V/m; Power Drift = 0.03 dB

Peak SAR (extrapolated) = 3.68 W/kg

SAR(1 g) = 2.47 W/kg; SAR(10 g) = 1.62 W/kg

Maximum value of SAR (measured) = 2.89 W/kg

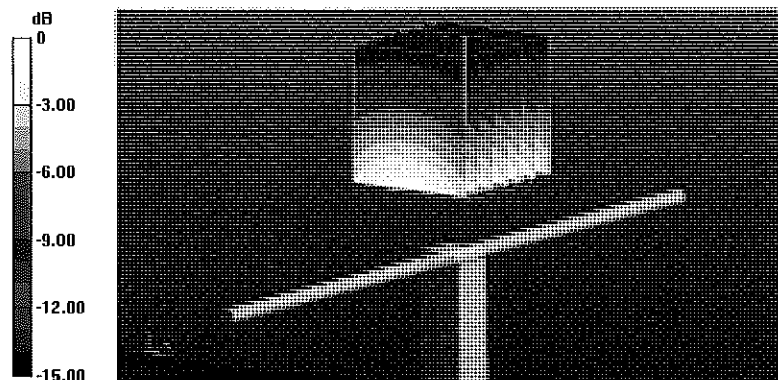

0 dB = 2.89 W/kg = 4.61 dBW/kg

Impedance Measurement Plot for Body TSL

24 Apr 2013 11:33:44

CH1 S11 1 U FS

2: 45.773 Ω -6.2773 Δ 30.364 pF

835.000 000 MHz

*
DeI

CΔ

Avg
16

H1d

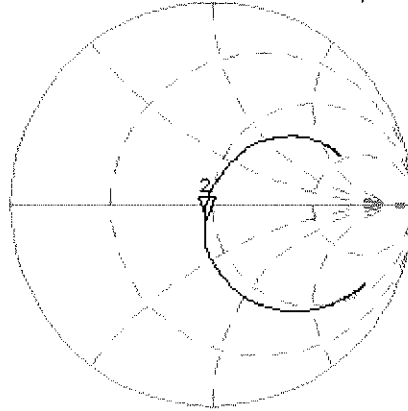

CH2 S11 LOG

5 dB/REF -20 dB

2: -22.065 dB

835.000 000 MHz

CΔ

Avg
16

H1d

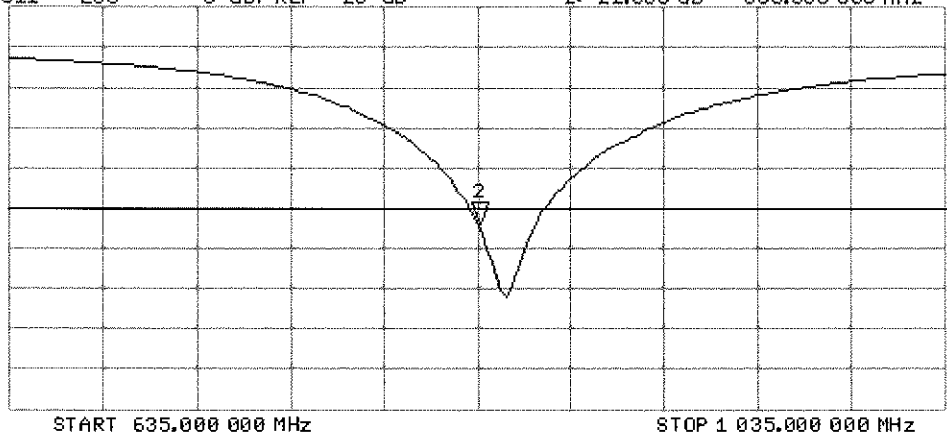



Accredited by the Swiss Accreditation Service (SAS)
The Swiss Accreditation Service is one of the signatories to the EA
Multilateral Agreement for the recognition of calibration certificates

Accreditation No.: **SCS 108**

Client **PC Test**

Certificate No: **D1900V2-5d148_Feb13**

CALIBRATION CERTIFICATE

Object **D1900V2 - SN: 5d148**

Calibration procedure(s) **QA CAL-05.v9
Calibration procedure for dipole validation kits above 700 MHz**

Calibration date: **February 06, 2013**

*KOK
2/21/13*

This calibration certificate documents the traceability to national standards, which realize the physical units of measurements (SI).
The measurements and the uncertainties with confidence probability are given on the following pages and are part of the certificate.

All calibrations have been conducted in the closed laboratory facility: environment temperature (22 ± 3)°C and humidity < 70%.

Calibration Equipment used (M&TE critical for calibration)

Primary Standards	ID #	Cal Date (Certificate No.)	Scheduled Calibration
Power meter EPM-442A	GB37480704	01-Nov-12 (No. 217-01640)	Oct-13
Power sensor HP 8481A	US37292783	01-Nov-12 (No. 217-01640)	Oct-13
Reference 20 dB Attenuator	SN: 5058 (20k)	27-Mar-12 (No. 217-01530)	Apr-13
Type-N mismatch combination	SN: 5047.3 / 06327	27-Mar-12 (No. 217-01533)	Apr-13
Reference Probe ES3DV3	SN: 3205	28-Dec-12 (No. ES3-3205_Dec12)	Dec-13
DAE4	SN: 601	27-Jun-12 (No. DAE4-601_Jun12)	Jun-13
Secondary Standards	ID #	Check Date (in house)	Scheduled Check
Power sensor HP 8481A	MY41092317	18-Oct-02 (in house check Oct-11)	In house check: Oct-13
RF generator R&S SMT-06	100005	04-Aug-99 (in house check Oct-11)	In house check: Oct-13
Network Analyzer HP 8753E	US37390585 S4206	18-Oct-01 (in house check Oct-12)	In house check: Oct-13

Calibrated by: **Leif Klysner** Name: **Leif Klysner** Function: **Laboratory Technician**

Signature: *Leif Klysner*

Approved by: **Katja Pokovic** Name: **Katja Pokovic** Technical Manager

Signature: *Katja Pokovic*

Issued: February 6, 2013

This calibration certificate shall not be reproduced except in full without written approval of the laboratory.



Accredited by the Swiss Accreditation Service (SAS)

The Swiss Accreditation Service is one of the signatories to the EA Multilateral Agreement for the recognition of calibration certificates

Accreditation No.: **SCS 108**

Glossary:

TSL	tissue simulating liquid
ConvF	sensitivity in TSL / NORM x,y,z
N/A	not applicable or not measured

Calibration is Performed According to the Following Standards:

- IEEE Std 1528-2003, "IEEE Recommended Practice for Determining the Peak Spatial-Averaged Specific Absorption Rate (SAR) in the Human Head from Wireless Communications Devices: Measurement Techniques", December 2003
- IEC 62209-1, "Procedure to measure the Specific Absorption Rate (SAR) for hand-held devices used in close proximity to the ear (frequency range of 300 MHz to 3 GHz)", February 2005
- Federal Communications Commission Office of Engineering & Technology (FCC OET), "Evaluating Compliance with FCC Guidelines for Human Exposure to Radiofrequency Electromagnetic Fields; Additional Information for Evaluating Compliance of Mobile and Portable Devices with FCC Limits for Human Exposure to Radiofrequency Emissions", Supplement C (Edition 01-01) to Bulletin 65

Additional Documentation:

- DASY4/5 System Handbook

Methods Applied and Interpretation of Parameters:

- Measurement Conditions:* Further details are available from the Validation Report at the end of the certificate. All figures stated in the certificate are valid at the frequency indicated.
- Antenna Parameters with TSL:* The dipole is mounted with the spacer to position its feed point exactly below the center marking of the flat phantom section, with the arms oriented parallel to the body axis.
- Feed Point Impedance and Return Loss:* These parameters are measured with the dipole positioned under the liquid filled phantom. The impedance stated is transformed from the measurement at the SMA connector to the feed point. The Return Loss ensures low reflected power. No uncertainty required.
- Electrical Delay:* One-way delay between the SMA connector and the antenna feed point. No uncertainty required.
- SAR measured:* SAR measured at the stated antenna input power.
- SAR normalized:* SAR as measured, normalized to an input power of 1 W at the antenna connector.
- SAR for nominal TSL parameters:* The measured TSL parameters are used to calculate the nominal SAR result.

The reported uncertainty of measurement is stated as the standard uncertainty of measurement multiplied by the coverage factor $k=2$, which for a normal distribution corresponds to a coverage probability of approximately 95%.

Measurement Conditions

DASY system configuration, as far as not given on page 1.

DASY Version	DASY5	V52.8.5
Extrapolation	Advanced Extrapolation	
Phantom	Modular Flat Phantom	
Distance Dipole Center - TSL	10 mm	with Spacer
Zoom Scan Resolution	dx, dy, dz = 5 mm	
Frequency	1900 MHz \pm 1 MHz	

Head TSL parameters

The following parameters and calculations were applied.

	Temperature	Permittivity	Conductivity
Nominal Head TSL parameters	22.0 °C	40.0	1.40 mho/m
Measured Head TSL parameters	(22.0 \pm 0.2) °C	39.4 \pm 6 %	1.38 mho/m \pm 6 %
Head TSL temperature change during test	< 0.5 °C	----	----

SAR result with Head TSL

SAR averaged over 1 cm³ (1 g) of Head TSL	Condition	
SAR measured	250 mW input power	9.87 W/kg
SAR for nominal Head TSL parameters	normalized to 1W	39.7 W/kg \pm 17.0 % (k=2)

SAR averaged over 10 cm³ (10 g) of Head TSL	condition	
SAR measured	250 mW input power	5.18 W/kg
SAR for nominal Head TSL parameters	normalized to 1W	20.8 W/kg \pm 16.5 % (k=2)

Body TSL parameters

The following parameters and calculations were applied.

	Temperature	Permittivity	Conductivity
Nominal Body TSL parameters	22.0 °C	53.3	1.52 mho/m
Measured Body TSL parameters	(22.0 \pm 0.2) °C	51.9 \pm 6 %	1.53 mho/m \pm 6 %
Body TSL temperature change during test	< 0.5 °C	----	----

SAR result with Body TSL

SAR averaged over 1 cm³ (1 g) of Body TSL	Condition	
SAR measured	250 mW input power	10.3 W/kg
SAR for nominal Body TSL parameters	normalized to 1W	40.8 W/kg \pm 17.0 % (k=2)

SAR averaged over 10 cm³ (10 g) of Body TSL	condition	
SAR measured	250 mW input power	5.45 W/kg
SAR for nominal Body TSL parameters	normalized to 1W	21.7 W/kg \pm 16.5 % (k=2)

Appendix

Antenna Parameters with Head TSL

Impedance, transformed to feed point	52.1 Ω + 5.9 j Ω
Return Loss	- 24.3 dB

Antenna Parameters with Body TSL

Impedance, transformed to feed point	48.3 Ω + 6.3 j Ω
Return Loss	- 23.6 dB

General Antenna Parameters and Design

Electrical Delay (one direction)	1.199 ns
----------------------------------	----------

After long term use with 100W radiated power, only a slight warming of the dipole near the feedpoint can be measured.

The dipole is made of standard semirigid coaxial cable. The center conductor of the feeding line is directly connected to the second arm of the dipole. The antenna is therefore short-circuited for DC-signals. On some of the dipoles, small end caps are added to the dipole arms in order to improve matching when loaded according to the position as explained in the "Measurement Conditions" paragraph. The SAR data are not affected by this change. The overall dipole length is still according to the Standard.

No excessive force must be applied to the dipole arms, because they might bend or the soldered connections near the feedpoint may be damaged.

Additional EUT Data

Manufactured by	SPEAG
Manufactured on	March 11, 2011

DASY5 Validation Report for Head TSL

Date: 06.02.2013

Test Laboratory: SPEAG, Zurich, Switzerland

DUT: Dipole 1900 MHz; Type: D1900V2; Serial: D1900V2 - SN: 5d148

Communication System: CW; Frequency: 1900 MHz

Medium parameters used: $f = 1900$ MHz; $\sigma = 1.38$ S/m; $\epsilon_r = 39.4$; $\rho = 1000$ kg/m³

Phantom section: Flat Section

Measurement Standard: DASY5 (IEEE/IEC/ANSI C63.19-2007)

DASY52 Configuration:

- Probe: ES3DV3 - SN3205; ConvF(4.98, 4.98, 4.98); Calibrated: 28.12.2012;
- Sensor-Surface: 3mm (Mechanical Surface Detection)
- Electronics: DAE4 Sn601; Calibrated: 27.06.2012
- Phantom: Flat Phantom 5.0 (front); Type: QD000P50AA; Serial: 1001
- DASY52 52.8.5(1059); SEMCAD X 14.6.8(7028)

Dipole Calibration for Head Tissue/Pin=250 mW, d=10mm/Zoom Scan (7x7x7)/Cube 0:

Measurement grid: dx=5mm, dy=5mm, dz=5mm

Reference Value = 96.534 V/m; Power Drift = 0.05 dB

Peak SAR (extrapolated) = 17.8 W/kg

SAR(1 g) = 9.87 W/kg; SAR(10 g) = 5.18 W/kg

Maximum value of SAR (measured) = 12.1 W/kg

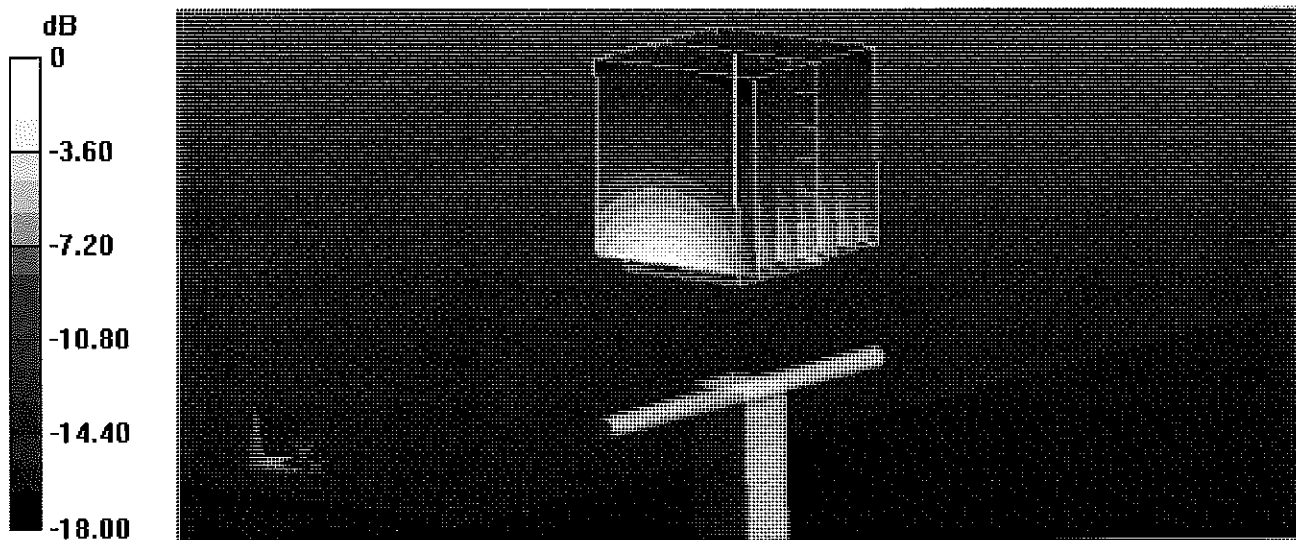

0 dB = 12.1 W/kg = 10.83 dBW/kg

Impedance Measurement Plot for Head TSL

6 Feb 2013 09:25:10

CH1 S11 1 U FS

1: 52.125 Ω 5.8711 Ω 491.80 μ H

1 900.000 000 MHz

*
Del
CA
Avg
16
H1d

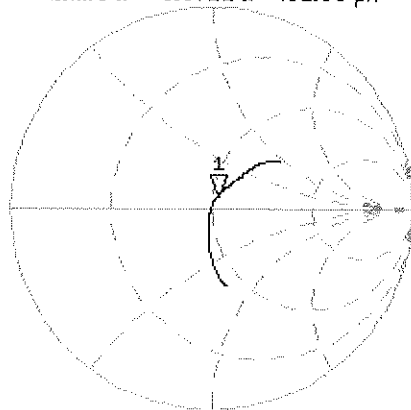

CH2 S11 LOG

5 dB/REF -20 dB

1: -24.287 dB 1 900.000 000 MHz

CA
Avg
16
H1d

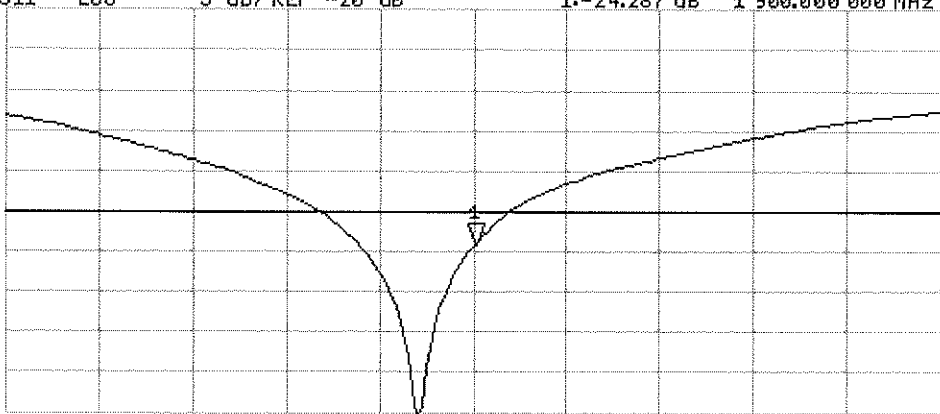

START 1 700.000 000 MHz

STOP 2 1 000.000 000 MHz

DASY5 Validation Report for Body TSL

Date: 06.02.2013

Test Laboratory: SPEAG, Zurich, Switzerland

DUT: Dipole 1900 MHz; Type: D1900V2; Serial: D1900V2 - SN: 5d148

Communication System: CW; Frequency: 1900 MHz

Medium parameters used: $f = 1900$ MHz; $\sigma = 1.53$ S/m; $\epsilon_r = 51.9$; $\rho = 1000$ kg/m³

Phantom section: Flat Section

Measurement Standard: DASY5 (IEEE/IEC/ANSI C63.19-2007)

DASY52 Configuration:

- Probe: ES3DV3 - SN3205; ConvF(4.6, 4.6, 4.6); Calibrated: 28.12.2012;
- Sensor-Surface: 3mm (Mechanical Surface Detection)
- Electronics: DAE4 Sn601; Calibrated: 27.06.2012
- Phantom: Flat Phantom 5.0 (back); Type: QD000P50AA; Serial: 1002
- DASY52 52.8.5(1059); SEMCAD X 14.6.8(7028)

Dipole Calibration for Body Tissue/Pin=250 mW, d=10mm/Zoom Scan (7x7x7)/Cube 0:

Measurement grid: dx=5mm, dy=5mm, dz=5mm

Reference Value = 96.534 V/m; Power Drift = -0.02 dB

Peak SAR (extrapolated) = 17.9 W/kg

SAR(1 g) = 10.3 W/kg; SAR(10 g) = 5.45 W/kg

Maximum value of SAR (measured) = 13.1 W/kg

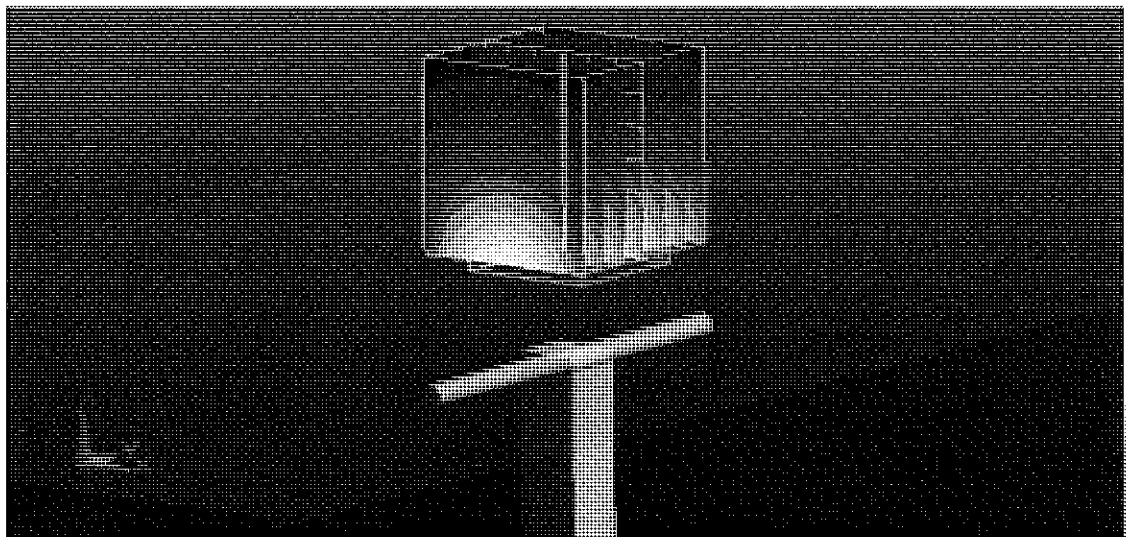
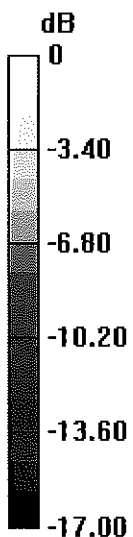

0 dB = 13.1 W/kg = 11.17 dBW/kg

Impedance Measurement Plot for Body TSL

6 Feb 2013 09:24:17

CH1 S11 1 U FS 1: 48.344 Ω 6.2715 Ω 525.34 μ H 1 900.000 000 MHz

*
De1

CA

Avg
16

H1d

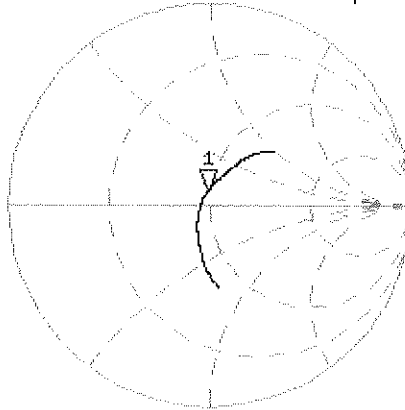

CH2 S11 LOG 5 dB/REF -20 dB 1:-23.628 dB 1 900.000 000 MHz

CA

Avg
16

H1d

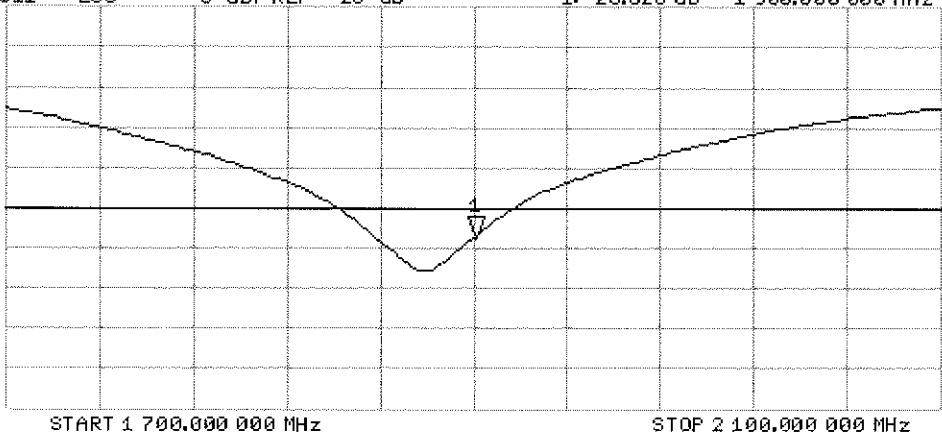



Accredited by the Swiss Accreditation Service (SAS)
The Swiss Accreditation Service is one of the signatories to the EA
Multilateral Agreement for the recognition of calibration certificates

Accreditation No.: **SCS 108**

Client **PC Test**

Certificate No: **D2450V2-882_Feb13**

CALIBRATION CERTIFICATE

Object **D2450V2 - SN: 882**

Calibration procedure(s) **QA CAL-05.v9
Calibration procedure for dipole validation kits above 700 MHz**

Calibration date: **February 11, 2013**

*KOK
2/21/13*

This calibration certificate documents the traceability to national standards, which realize the physical units of measurements (SI).
The measurements and the uncertainties with confidence probability are given on the following pages and are part of the certificate.

All calibrations have been conducted in the closed laboratory facility: environment temperature (22 ± 3)°C and humidity < 70%.

Calibration Equipment used (M&TE critical for calibration)

Primary Standards	ID #	Cal Date (Certificate No.)	Scheduled Calibration
Power meter EPM-442A	GB37480704	01-Nov-12 (No. 217-01640)	Oct-13
Power sensor HP 8481A	US37292783	01-Nov-12 (No. 217-01640)	Oct-13
Reference 20 dB Attenuator	SN: 5058 (20k)	27-Mar-12 (No. 217-01530)	Apr-13
Type-N mismatch combination	SN: 5047.3 / 06327	27-Mar-12 (No. 217-01533)	Apr-13
Reference Probe ES3DV3	SN: 3205	28-Dec-12 (No. ES3-3205_Dec12)	Dec-13
DAE4	SN: 601	27-Jun-12 (No. DAE4-601_Jun12)	Jun-13

Secondary Standards	ID #	Check Date (in house)	Scheduled Check
Power sensor HP 8481A	MY41092317	18-Oct-02 (in house check Oct-11)	In house check: Oct-13
RF generator R&S SMT-06	100005	04-Aug-99 (in house check Oct-11)	In house check: Oct-13
Network Analyzer HP 8753E	US37390585 S4206	18-Oct-01 (in house check Oct-12)	In house check: Oct-13

Calibrated by: **Israe El-Naouq** Name: **Israe El-Naouq** Function: **Laboratory Technician**

Approved by: **Katja Pokovic** Name: **Katja Pokovic** Technical Manager

Signature
Israe El-Naouq
Katja Pokovic

Issued: February 11, 2013

This calibration certificate shall not be reproduced except in full without written approval of the laboratory.



Accredited by the Swiss Accreditation Service (SAS)
The Swiss Accreditation Service is one of the signatories to the EA
Multilateral Agreement for the recognition of calibration certificates

Accreditation No.: **SCS 108**

Glossary:

TSL	tissue simulating liquid
ConvF	sensitivity in TSL / NORM x,y,z
N/A	not applicable or not measured

Calibration is Performed According to the Following Standards:

- IEEE Std 1528-2003, "IEEE Recommended Practice for Determining the Peak Spatial-Averaged Specific Absorption Rate (SAR) in the Human Head from Wireless Communications Devices: Measurement Techniques", December 2003
- IEC 62209-1, "Procedure to measure the Specific Absorption Rate (SAR) for hand-held devices used in close proximity to the ear (frequency range of 300 MHz to 3 GHz)", February 2005
- Federal Communications Commission Office of Engineering & Technology (FCC OET), "Evaluating Compliance with FCC Guidelines for Human Exposure to Radiofrequency Electromagnetic Fields; Additional Information for Evaluating Compliance of Mobile and Portable Devices with FCC Limits for Human Exposure to Radiofrequency Emissions", Supplement C (Edition 01-01) to Bulletin 65

Additional Documentation:

- DASY4/5 System Handbook

Methods Applied and Interpretation of Parameters:

- Measurement Conditions:** Further details are available from the Validation Report at the end of the certificate. All figures stated in the certificate are valid at the frequency indicated.
- Antenna Parameters with TSL:** The dipole is mounted with the spacer to position its feed point exactly below the center marking of the flat phantom section, with the arms oriented parallel to the body axis.
- Feed Point Impedance and Return Loss:** These parameters are measured with the dipole positioned under the liquid filled phantom. The impedance stated is transformed from the measurement at the SMA connector to the feed point. The Return Loss ensures low reflected power. No uncertainty required.
- Electrical Delay:** One-way delay between the SMA connector and the antenna feed point. No uncertainty required.
- SAR measured:** SAR measured at the stated antenna input power.
- SAR normalized:** SAR as measured, normalized to an input power of 1 W at the antenna connector.
- SAR for nominal TSL parameters:** The measured TSL parameters are used to calculate the nominal SAR result.

The reported uncertainty of measurement is stated as the standard uncertainty of measurement multiplied by the coverage factor $k=2$, which for a normal distribution corresponds to a coverage probability of approximately 95%.

Measurement Conditions

DASY system configuration, as far as not given on page 1.

DASY Version	DASY5	V52.8.5
Extrapolation	Advanced Extrapolation	
Phantom	Modular Flat Phantom	
Distance Dipole Center - TSL	10 mm	with Spacer
Zoom Scan Resolution	dx, dy, dz = 5 mm	
Frequency	2450 MHz \pm 1 MHz	

Head TSL parameters

The following parameters and calculations were applied.

	Temperature	Permittivity	Conductivity
Nominal Head TSL parameters	22.0 °C	39.2	1.80 mho/m
Measured Head TSL parameters	(22.0 \pm 0.2) °C	37.9 \pm 6 %	1.85 mho/m \pm 6 %
Head TSL temperature change during test	< 0.5 °C	----	----

SAR result with Head TSL

SAR averaged over 1 cm³ (1 g) of Head TSL	Condition	
SAR measured	250 mW input power	13.2 W/kg
SAR for nominal Head TSL parameters	normalized to 1W	51.7 W/kg \pm 17.0 % (k=2)

SAR averaged over 10 cm³ (10 g) of Head TSL	condition	
SAR measured	250 mW input power	6.07 W/kg
SAR for nominal Head TSL parameters	normalized to 1W	24.0 W/kg \pm 16.5 % (k=2)

Body TSL parameters

The following parameters and calculations were applied.

	Temperature	Permittivity	Conductivity
Nominal Body TSL parameters	22.0 °C	52.7	1.95 mho/m
Measured Body TSL parameters	(22.0 \pm 0.2) °C	50.9 \pm 6 %	2.02 mho/m \pm 6 %
Body TSL temperature change during test	< 0.5 °C	----	----

SAR result with Body TSL

SAR averaged over 1 cm³ (1 g) of Body TSL	Condition	
SAR measured	250 mW input power	12.8 W/kg
SAR for nominal Body TSL parameters	normalized to 1W	49.9 W/kg \pm 17.0 % (k=2)

SAR averaged over 10 cm³ (10 g) of Body TSL	condition	
SAR measured	250 mW input power	5.91 W/kg
SAR for nominal Body TSL parameters	normalized to 1W	23.3 W/kg \pm 16.5 % (k=2)

Appendix

Antenna Parameters with Head TSL

Impedance, transformed to feed point	53.6 Ω - 0.4 j Ω
Return Loss	- 29.0 dB

Antenna Parameters with Body TSL

Impedance, transformed to feed point	49.5 Ω + 1.2 j Ω
Return Loss	- 37.4 dB

General Antenna Parameters and Design

Electrical Delay (one direction)	1.157 ns
----------------------------------	----------

After long term use with 100W radiated power, only a slight warming of the dipole near the feedpoint can be measured.

The dipole is made of standard semirigid coaxial cable. The center conductor of the feeding line is directly connected to the second arm of the dipole. The antenna is therefore short-circuited for DC-signals. On some of the dipoles, small end caps are added to the dipole arms in order to improve matching when loaded according to the position as explained in the "Measurement Conditions" paragraph. The SAR data are not affected by this change. The overall dipole length is still according to the Standard.

No excessive force must be applied to the dipole arms, because they might bend or the soldered connections near the feedpoint may be damaged.

Additional EUT Data

Manufactured by	SPEAG
Manufactured on	October 06, 2011

DASY5 Validation Report for Head TSL

Date: 11.02.2013

Test Laboratory: SPEAG, Zurich, Switzerland

DUT: Dipole 2450 MHz; Type: D2450V2; Serial: D2450V2 - SN: 882

Communication System: CW; Frequency: 2450 MHz

Medium parameters used: $f = 2450$ MHz; $\sigma = 1.85$ S/m; $\epsilon_r = 37.9$; $\rho = 1000$ kg/m³

Phantom section: Flat Section

Measurement Standard: DASY5 (IEEE/IEC/ANSI C63.19-2007)

DASY52 Configuration:

- Probe: ES3DV3 - SN3205; ConvF(4.52, 4.52, 4.52); Calibrated: 28.12.2012;
- Sensor-Surface: 3mm (Mechanical Surface Detection)
- Electronics: DAE4 Sn601; Calibrated: 27.06.2012
- Phantom: Flat Phantom 5.0 (front); Type: QD000P50AA; Serial: 1001
- DASY52 52.8.5(1059); SEMCAD X 14.6.8(7028)

Dipole Calibration for Head Tissue/Pin=250 mW, d=10mm/Zoom Scan (7x7x7)/Cube 0:

Measurement grid: dx=5mm, dy=5mm, dz=5mm

Reference Value = 97.806 V/m; Power Drift = 0.05 dB

Peak SAR (extrapolated) = 27.6 W/kg

SAR(1 g) = 13.2 W/kg; SAR(10 g) = 6.07 W/kg

Maximum value of SAR (measured) = 16.7 W/kg

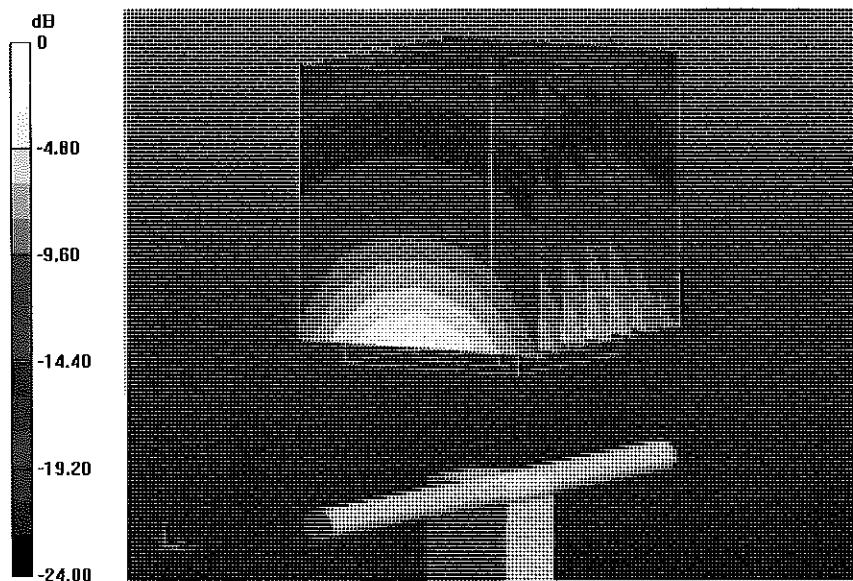

0 dB = 16.7 W/kg = 12.23 dBW/kg

Impedance Measurement Plot for Head TSL

11 Feb 2013 11:51:51

CH1 S11 1 U FS 1: 53.639 Ω -363.28 $m\Omega$ 178.82 μF 2 450.000 000 MHz

*
Del
Cor
Avg
16
H1d

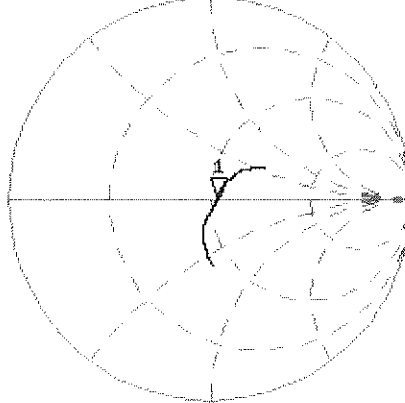

CH2 S11 LOG 5 dB/REF -20 dB 1:-29.047 dB 2 450.000 000 MHz

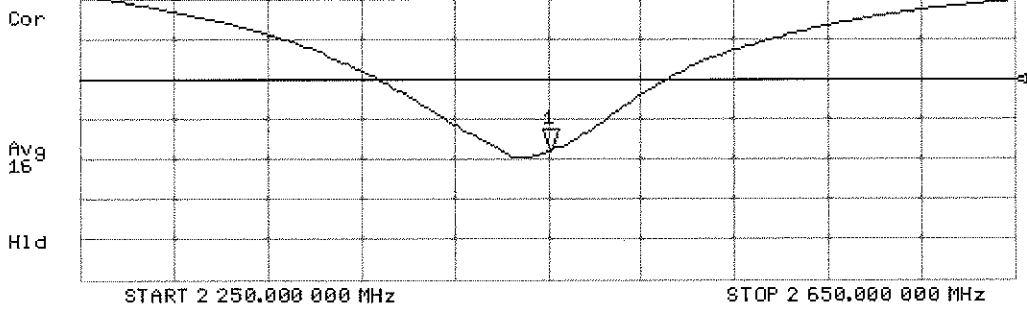

DASY5 Validation Report for Body TSL

Date: 11.02.2013

Test Laboratory: SPEAG, Zurich, Switzerland

DUT: Dipole 2450 MHz; Type: D2450V2; Serial: D2450V2 - SN: 882

Communication System: CW; Frequency: 2450 MHz

Medium parameters used: $f = 2450$ MHz; $\sigma = 2.02$ S/m; $\epsilon_r = 50.9$; $\rho = 1000$ kg/m³

Phantom section: Flat Section

Measurement Standard: DASY5 (IEEE/IEC/ANSI C63.19-2007)

DASY52 Configuration:

- Probe: ES3DV3 - SN3205; ConvF(4.42, 4.42, 4.42); Calibrated: 28.12.2012;
- Sensor-Surface: 3mm (Mechanical Surface Detection)
- Electronics: DAE4 Sn601; Calibrated: 27.06.2012
- Phantom: Flat Phantom 5.0 (back); Type: QD000P50AA; Serial: 1002
- DASY52 52.8.5(1059); SEMCAD X 14.6.8(7028)

Dipole Calibration for Body Tissue/Pin=250 mW, d=10mm/Zoom Scan (7x7x7)/Cube 0:

Measurement grid: dx=5mm, dy=5mm, dz=5mm

Reference Value = 94.474 V/m; Power Drift = 0.03 dB

Peak SAR (extrapolated) = 27.1 W/kg

SAR(1 g) = 12.8 W/kg; SAR(10 g) = 5.91 W/kg

Maximum value of SAR (measured) = 16.9 W/kg

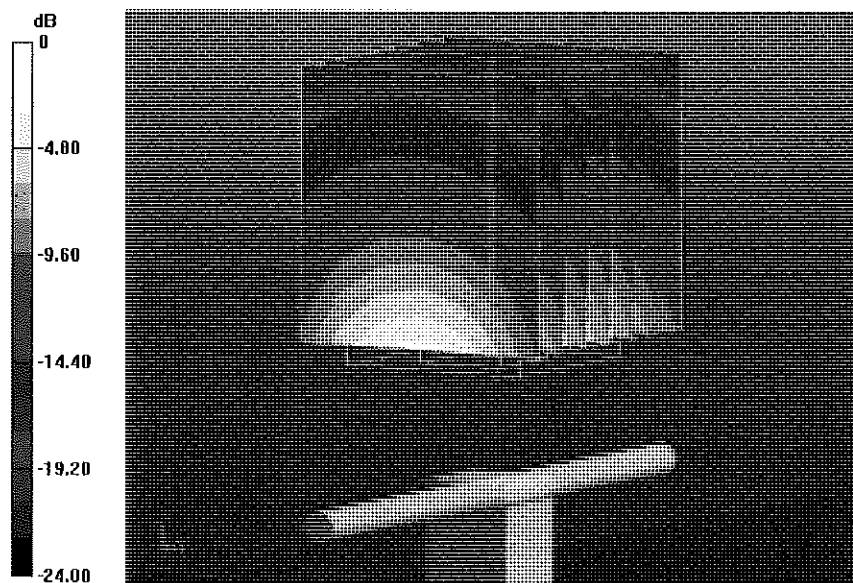

0 dB = 16.9 W/kg = 12.28 dBW/kg

Impedance Measurement Plot for Body TSL

11 Feb 2013 11:51:25

CH1 S11 1 U FS 1: 49.500 Ω 1.2461 μ 80.948 pF 2 450.000 000 MHz

*
De1
Cor
Avg
16
H1d

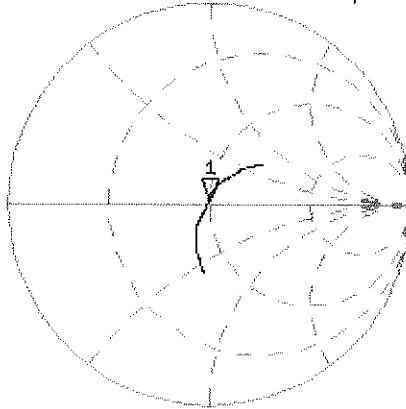

CH2 S11 LOG 5 dB/REF -20 dB 1: -37.374 dB 2 450.000 000 MHz

Cor
Avg
16
H1d

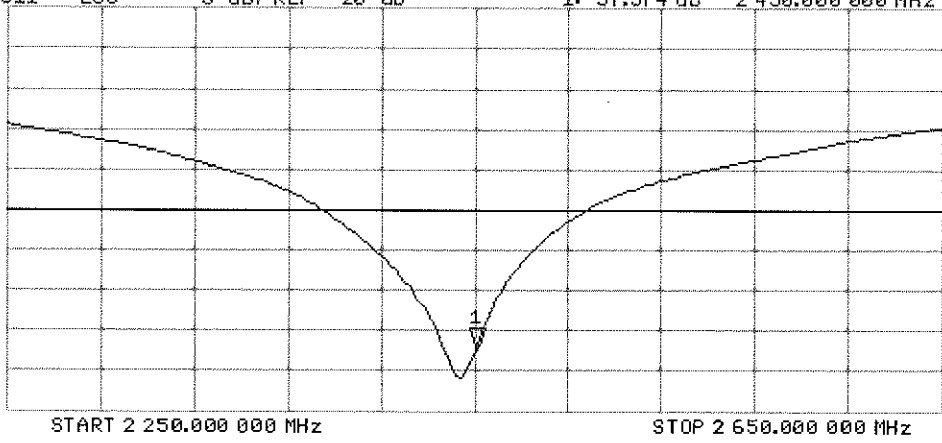



Accredited by the Swiss Accreditation Service (SAS)
The Swiss Accreditation Service is one of the signatories to the EA
Multilateral Agreement for the recognition of calibration certificates

Accreditation No.: **SCS 108**

Client **PC Test**

Certificate No: **ES3-3288_Sep13/2**

CALIBRATION CERTIFICATE (Replacement of No: ES3-3288_Sep13)

Object **ES3DV3 - SN:3288** CCV
10/4/13

Calibration procedure(s) **QA CAL-01.v9, QA CAL-23.v5, QA CAL-25.v6
Calibration procedure for dosimetric E-field probes**

Calibration date: **September 23, 2013**

This calibration certificate documents the traceability to national standards, which realize the physical units of measurements (SI).
The measurements and the uncertainties with confidence probability are given on the following pages and are part of the certificate.

All calibrations have been conducted in the closed laboratory facility: environment temperature (22 ± 3)°C and humidity < 70%.

Calibration Equipment used (M&TE critical for calibration)

Primary Standards	ID	Cal Date (Certificate No.)	Scheduled Calibration
Power meter E4419B	GB41293874	04-Apr-13 (No. 217-01733)	Apr-14
Power sensor E4412A	MY41498087	04-Apr-13 (No. 217-01733)	Apr-14
Reference 3 dB Attenuator	SN: S5054 (3c)	04-Apr-13 (No. 217-01737)	Apr-14
Reference 20 dB Attenuator	SN: S5277 (20x)	04-Apr-13 (No. 217-01735)	Apr-14
Reference 30 dB Attenuator	SN: S5129 (30b)	04-Apr-13 (No. 217-01738)	Apr-14
Reference Probe ES3DV2	SN: 3013	28-Dec-12 (No. ES3-3013_Dec12)	Dec-13
DAE4	SN: 660	4-Sep-13 (No. DAE4-660_Sep13)	Apr-14
Secondary Standards	ID	Check Date (in house)	Scheduled Check
RF generator HP 8648C	US3642U01700	4-Aug-99 (in house check Apr-13)	In house check: Apr-15
Network Analyzer HP 8753E	US37390585	18-Oct-01 (in house check Oct-12)	In house check: Oct-13

Calibrated by:	Name Jeton Kastrati	Function Laboratory Technician	Signature
Approved by:	Name Katja Pokovic	Function Technical Manager	

Issued: October 4, 2013

This calibration certificate shall not be reproduced except in full without written approval of the laboratory.

PCT# 80828

Probe ES3DV3

SN:3288

Manufactured: July 6, 2010
Calibrated: September 23, 2013

Calibrated for DASY/EASY Systems
(Note: non-compatible with DASY2 system!)



Accredited by the Swiss Accreditation Service (SAS)

Accreditation No.: **SCS 108**

The Swiss Accreditation Service is one of the signatories to the EA
Multilateral Agreement for the recognition of calibration certificates

Glossary:

TSL	tissue simulating liquid
NORM _{x,y,z}	sensitivity in free space
ConvF	sensitivity in TSL / NORM _{x,y,z}
DCP	diode compression point
CF	crest factor (1/duty_cycle) of the RF signal
A, B, C, D	modulation dependent linearization parameters
Polarization φ	φ rotation around probe axis
Polarization ϑ	ϑ rotation around an axis that is in the plane normal to probe axis (at measurement center), i.e., $\vartheta = 0$ is normal to probe axis

Calibration is Performed According to the Following Standards:

- IEEE Std 1528-2013, "IEEE Recommended Practice for Determining the Peak Spatial-Averaged Specific Absorption Rate (SAR) in the Human Head from Wireless Communications Devices: Measurement Techniques", June 2013
- IEC 62209-1, "Procedure to measure the Specific Absorption Rate (SAR) for hand-held devices used in close proximity to the ear (frequency range of 300 MHz to 3 GHz)", February 2005

Methods Applied and Interpretation of Parameters:

- NORM_{x,y,z}**: Assessed for E-field polarization $\vartheta = 0$ ($f \leq 900$ MHz in TEM-cell; $f > 1800$ MHz: R22 waveguide). NORM_{x,y,z} are only intermediate values, i.e., the uncertainties of NORM_{x,y,z} does not affect the E²-field uncertainty inside TSL (see below ConvF).
- NORM(f)_{x,y,z}** = NORM_{x,y,z} * frequency_response (see Frequency Response Chart). This linearization is implemented in DASY4 software versions later than 4.2. The uncertainty of the frequency response is included in the stated uncertainty of ConvF.
- DCP_{x,y,z}**: DCP are numerical linearization parameters assessed based on the data of power sweep with CW signal (no uncertainty required). DCP does not depend on frequency nor media.
- PAR**: PAR is the Peak to Average Ratio that is not calibrated but determined based on the signal characteristics
- A_{x,y,z}; B_{x,y,z}; C_{x,y,z}; D_{x,y,z}; VR_{x,y,z}**: A, B, C, D are numerical linearization parameters assessed based on the data of power sweep for specific modulation signal. The parameters do not depend on frequency nor media. VR is the maximum calibration range expressed in RMS voltage across the diode.
- ConvF and Boundary Effect Parameters**: Assessed in flat phantom using E-field (or Temperature Transfer Standard for $f \leq 800$ MHz) and inside waveguide using analytical field distributions based on power measurements for $f > 800$ MHz. The same setups are used for assessment of the parameters applied for boundary compensation (alpha, depth) of which typical uncertainty values are given. These parameters are used in DASY4 software to improve probe accuracy close to the boundary. The sensitivity in TSL corresponds to NORM_{x,y,z} * ConvF whereby the uncertainty corresponds to that given for ConvF. A frequency dependent ConvF is used in DASY version 4.4 and higher which allows extending the validity from ± 50 MHz to ± 100 MHz.
- Spherical isotropy (3D deviation from isotropy)**: in a field of low gradients realized using a flat phantom exposed by a patch antenna.
- Sensor Offset**: The sensor offset corresponds to the offset of virtual measurement center from the probe tip (on probe axis). No tolerance required.

DASY/EASY - Parameters of Probe: ES3DV3 - SN:3288

Basic Calibration Parameters

	Sensor X	Sensor Y	Sensor Z	Unc (k=2)
Norm ($\mu\text{V}/(\text{V}/\text{m})^2$) ^A	0.87	0.97	0.75	$\pm 10.1 \%$
DCP (mV) ^B	103.3	103.2	100.2	

Modulation Calibration Parameters

UID	Communication System Name		A dB	B dB $\sqrt{\mu\text{V}}$	C	D dB	VR mV	Unc ^E (k=2)
0	CW	X	0.0	0.0	1.0	0.00	171.1	$\pm 3.5 \%$
		Y	0.0	0.0	1.0		135.0	
		Z	0.0	0.0	1.0		154.3	

The reported uncertainty of measurement is stated as the standard uncertainty of measurement multiplied by the coverage factor k=2, which for a normal distribution corresponds to a coverage probability of approximately 95%.

^A The uncertainties of NormX,Y,Z do not affect the E²-field uncertainty inside TSL (see Pages 5 and 6).

^B Numerical linearization parameter: uncertainty not required.

^E Uncertainty is determined using the max. deviation from linear response applying rectangular distribution and is expressed for the square of the field value.

DASY/EASY - Parameters of Probe: ES3DV3 - SN:3288

Calibration Parameter Determined in Head Tissue Simulating Media

f (MHz) ^C	Relative Permittivity ^F	Conductivity (S/m) ^F	ConvF X	ConvF Y	ConvF Z	Alpha	Depth (mm)	Unct. (k=2)
750	41.9	0.89	6.56	6.56	6.56	0.32	1.89	± 12.0 %
835	41.5	0.90	6.37	6.37	6.37	0.34	1.82	± 12.0 %
1750	40.1	1.37	5.67	5.67	5.67	0.56	1.51	± 12.0 %
1900	40.0	1.40	5.47	5.47	5.47	0.80	1.29	± 12.0 %
2450	39.2	1.80	4.63	4.63	4.63	0.80	1.34	± 12.0 %
2600	39.0	1.96	4.55	4.55	4.55	0.80	1.41	± 12.0 %

^C Frequency validity of ± 100 MHz only applies for DASY v4.4 and higher (see Page 2), else it is restricted to ± 50 MHz. The uncertainty is the RSS of the ConvF uncertainty at calibration frequency and the uncertainty for the indicated frequency band.

^F At frequencies below 3 GHz, the validity of tissue parameters (ϵ and σ) can be relaxed to ± 10% if liquid compensation formula is applied to measured SAR values. At frequencies above 3 GHz, the validity of tissue parameters (ϵ and σ) is restricted to ± 5%. The uncertainty is the RSS of the ConvF uncertainty for indicated target tissue parameters.

DASY/EASY - Parameters of Probe: ES3DV3 - SN:3288

Calibration Parameter Determined in Body Tissue Simulating Media

f (MHz) ^C	Relative Permittivity ^F	Conductivity (S/m) ^F	ConvF X	ConvF Y	ConvF Z	Alpha	Depth (mm)	Unct. (k=2)
750	55.5	0.96	6.25	6.25	6.25	0.70	1.27	± 12.0 %
835	55.2	0.97	6.27	6.27	6.27	0.75	1.22	± 12.0 %
1750	53.4	1.49	5.10	5.10	5.10	0.59	1.46	± 12.0 %
1900	53.3	1.52	4.82	4.82	4.82	0.53	1.54	± 12.0 %
2450	52.7	1.95	4.37	4.37	4.37	0.80	1.02	± 12.0 %
2600	52.5	2.16	4.14	4.14	4.14	0.64	0.94	± 12.0 %

^C Frequency validity of ± 100 MHz only applies for DASY v4.4 and higher (see Page 2), else it is restricted to ± 50 MHz. The uncertainty is the RSS of the ConvF uncertainty at calibration frequency and the uncertainty for the indicated frequency band.

^F At frequencies below 3 GHz, the validity of tissue parameters (ϵ and σ) can be relaxed to ± 10% if liquid compensation formula is applied to measured SAR values. At frequencies above 3 GHz, the validity of tissue parameters (ϵ and σ) is restricted to ± 5%. The uncertainty is the RSS of the ConvF uncertainty for indicated target tissue parameters.

Frequency Response of E-Field (TEM-Cell:ifi110 EXX, Waveguide: R22)

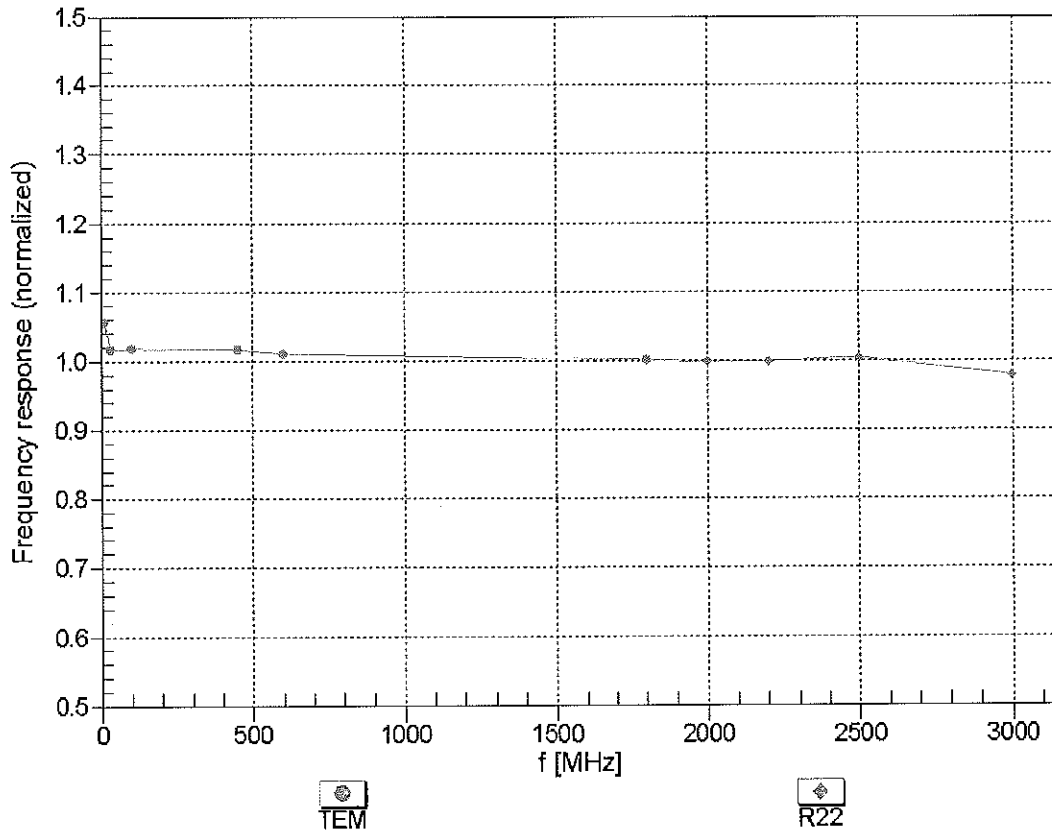

Uncertainty of Frequency Response of E-field: $\pm 6.3\%$ (k=2)

Receiving Pattern (ϕ), $\theta = 0^\circ$

f=600 MHz,TEM

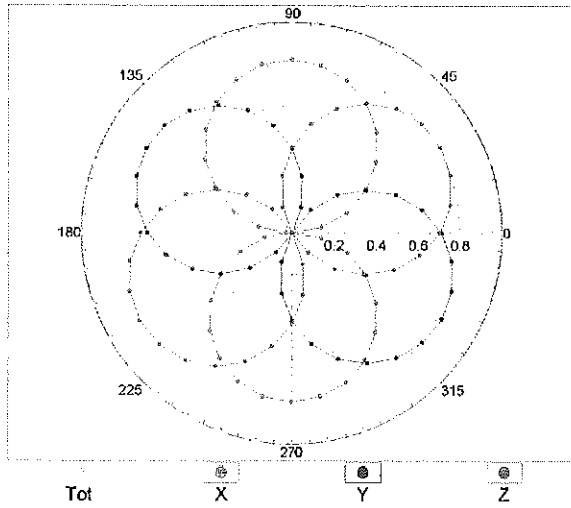

f=1800 MHz,R22

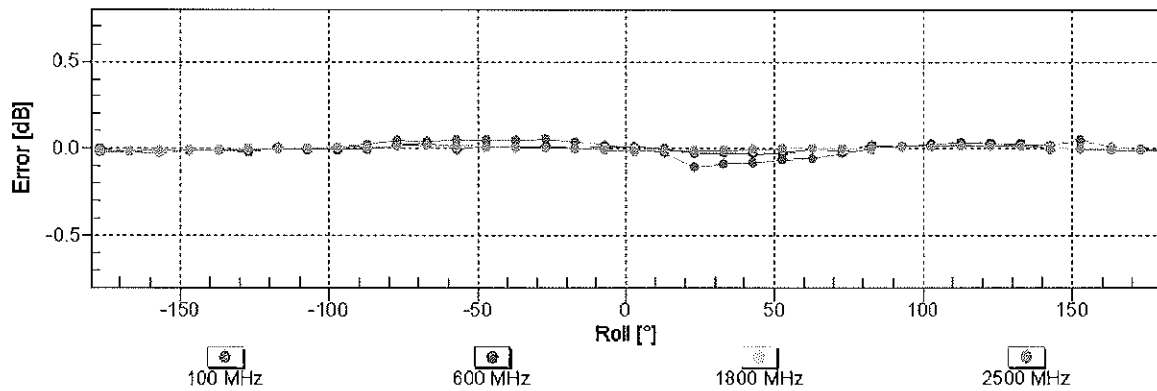
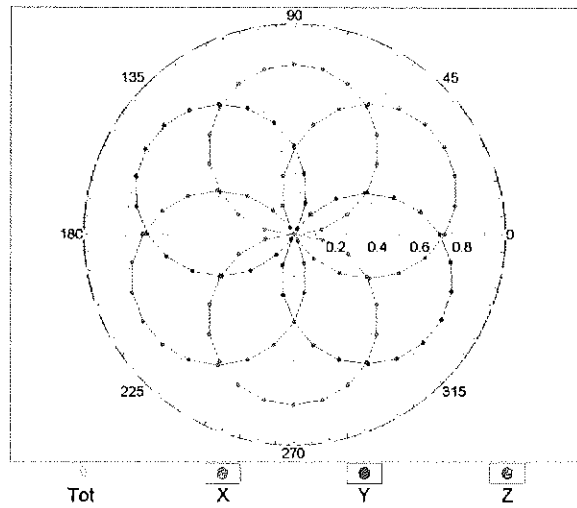

Uncertainty of Axial Isotropy Assessment: $\pm 0.5\%$ (k=2)

Dynamic Range $f(\text{SAR}_{\text{head}})$ (TEM cell , $f = 900 \text{ MHz}$)

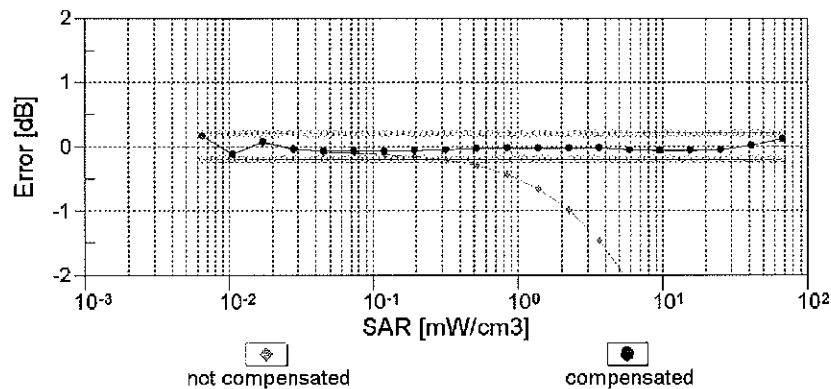
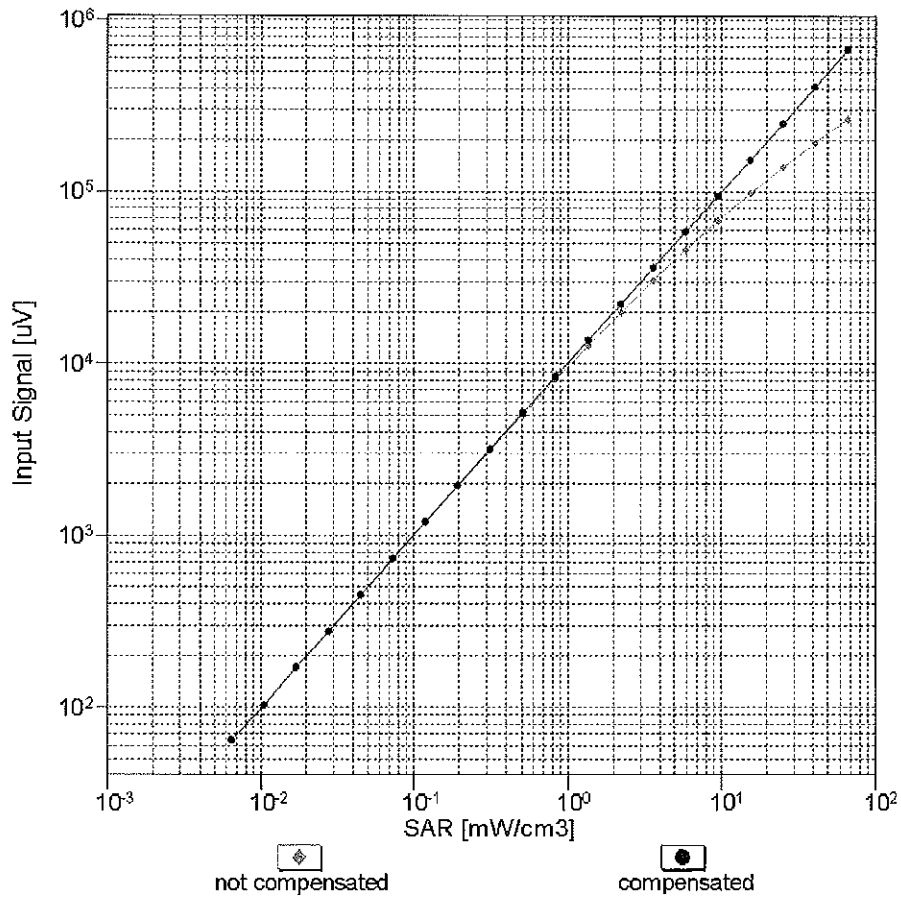

Uncertainty of Linearity Assessment: $\pm 0.6\%$ ($k=2$)

Conversion Factor Assessment

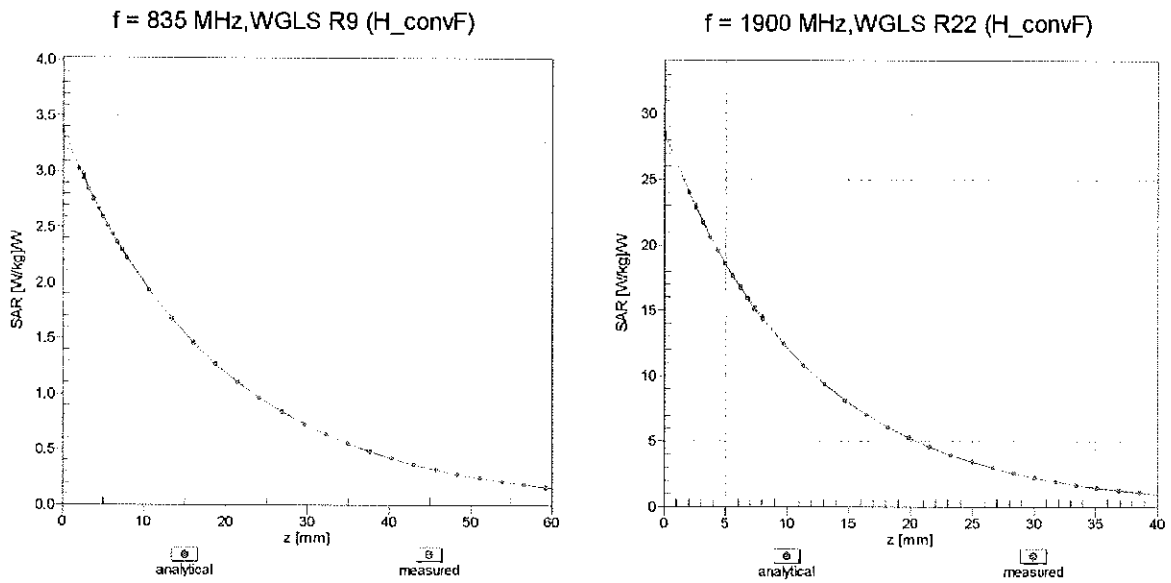

Deviation from Isotropy in Liquid Error (ϕ, θ), f = 900 MHz

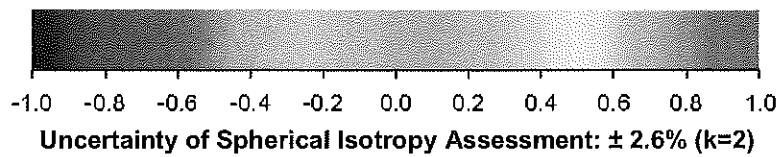
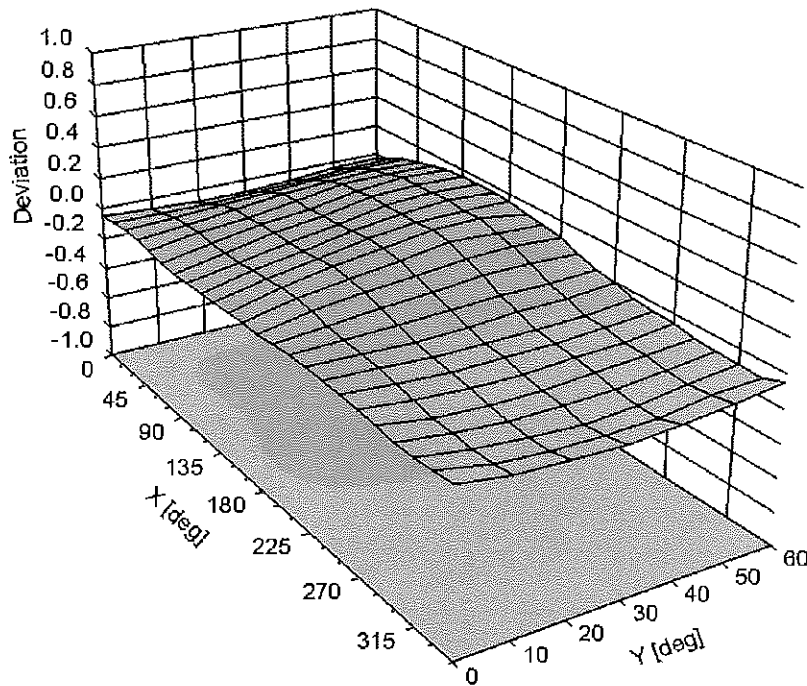

DASY/EASY - Parameters of Probe: ES3DV3 - SN:3288

Other Probe Parameters

Sensor Arrangement	Triangular
Connector Angle (°)	-127.1
Mechanical Surface Detection Mode	enabled
Optical Surface Detection Mode	disabled
Probe Overall Length	337 mm
Probe Body Diameter	10 mm
Tip Length	10 mm
Tip Diameter	4 mm
Probe Tip to Sensor X Calibration Point	2 mm
Probe Tip to Sensor Y Calibration Point	2 mm
Probe Tip to Sensor Z Calibration Point	2 mm
Recommended Measurement Distance from Surface	3 mm



Accredited by the Swiss Accreditation Service (SAS)
The Swiss Accreditation Service is one of the signatories to the EA
Multilateral Agreement for the recognition of calibration certificates

Accreditation No.: **SCS 108**

Client **PC Test**

Certificate No: **ES3-3263_May13**

CALIBRATION CERTIFICATE

Object **ES3DV3 - SN:3263**

Calibration procedure(s) **QA CAL-01.v8, QA CAL-23.v4, QA CAL-25.v4
Calibration procedure for dosimetric E-field probes**

Calibration date: **May 16, 2013**

*✓ KOK
5/23/13*

This calibration certificate documents the traceability to national standards, which realize the physical units of measurements (SI).
The measurements and the uncertainties with confidence probability are given on the following pages and are part of the certificate.

All calibrations have been conducted in the closed laboratory facility: environment temperature (22 ± 3)°C and humidity < 70%.

Calibration Equipment used (M&TE critical for calibration)

Primary Standards	ID	Cal Date (Certificate No.)	Scheduled Calibration
Power meter E4419B	GB41293874	04-Apr-13 (No. 217-01733)	Apr-14
Power sensor E4412A	MY41498087	04-Apr-13 (No. 217-01733)	Apr-14
Reference 3 dB Attenuator	SN: S5054 (3c)	04-Apr-13 (No. 217-01737)	Apr-14
Reference 20 dB Attenuator	SN: S5277 (20x)	04-Apr-13 (No. 217-01735)	Apr-14
Reference 30 dB Attenuator	SN: S5129 (30b)	04-Apr-13 (No. 217-01738)	Apr-14
Reference Probe ES3DV2	SN: 3013	28-Dec-12 (No. ES3-3013_Dec12)	Dec-13
DAE4	SN: 660	31-Jan-13 (No. DAE4-660_Jan13)	Jan-14
Secondary Standards	ID	Check Date (in house)	Scheduled Check
RF generator HP 8648C	US3642U01700	4-Aug-99 (in house check Apr-13)	In house check: Apr-15
Network Analyzer HP 8753E	US37390585	18-Oct-01 (in house check Oct-12)	In house check: Oct-13

	Name	Function	Signature
Calibrated by:	Leif Klysner	Laboratory Technician	<i>Leif Klysner</i>
Approved by:	Katja Pokovic	Technical Manager	<i>Katja Pokovic</i>
			Issued: May 17, 2013

This calibration certificate shall not be reproduced except in full without written approval of the laboratory.



Accredited by the Swiss Accreditation Service (SAS)

Accreditation No.: **SCS 108**

The Swiss Accreditation Service is one of the signatories to the EA
Multilateral Agreement for the recognition of calibration certificates

Glossary:

TSL	tissue simulating liquid
NORM _{x,y,z}	sensitivity in free space
ConvF	sensitivity in TSL / NORM _{x,y,z}
DCP	diode compression point
CF	crest factor (1/duty_cycle) of the RF signal
A, B, C, D	modulation dependent linearization parameters
Polarization φ	φ rotation around probe axis
Polarization ϑ	ϑ rotation around an axis that is in the plane normal to probe axis (at measurement center), i.e., $\vartheta = 0$ is normal to probe axis

Calibration is Performed According to the Following Standards:

- IEEE Std 1528-2003, "IEEE Recommended Practice for Determining the Peak Spatial-Averaged Specific Absorption Rate (SAR) in the Human Head from Wireless Communications Devices: Measurement Techniques", December 2003
- IEC 62209-1, "Procedure to measure the Specific Absorption Rate (SAR) for hand-held devices used in close proximity to the ear (frequency range of 300 MHz to 3 GHz)", February 2005

Methods Applied and Interpretation of Parameters:

- NORM_{x,y,z}**: Assessed for E-field polarization $\vartheta = 0$ ($f \leq 900$ MHz in TEM-cell; $f > 1800$ MHz: R22 waveguide). NORM_{x,y,z} are only intermediate values, i.e., the uncertainties of NORM_{x,y,z} does not affect the E²-field uncertainty inside TSL (see below ConvF).
- NORM(f)_{x,y,z}** = NORM_{x,y,z} * frequency_response (see Frequency Response Chart). This linearization is implemented in DASY4 software versions later than 4.2. The uncertainty of the frequency response is included in the stated uncertainty of ConvF.
- DCP_{x,y,z}**: DCP are numerical linearization parameters assessed based on the data of power sweep with CW signal (no uncertainty required). DCP does not depend on frequency nor media.
- PAR**: PAR is the Peak to Average Ratio that is not calibrated but determined based on the signal characteristics
- A_{x,y,z}; B_{x,y,z}; C_{x,y,z}; D_{x,y,z}; VR_{x,y,z}; A, B, C, D** are numerical linearization parameters assessed based on the data of power sweep for specific modulation signal. The parameters do not depend on frequency nor media. VR is the maximum calibration range expressed in RMS voltage across the diode.
- ConvF and Boundary Effect Parameters**: Assessed in flat phantom using E-field (or Temperature Transfer Standard for $f \leq 800$ MHz) and inside waveguide using analytical field distributions based on power measurements for $f > 800$ MHz. The same setups are used for assessment of the parameters applied for boundary compensation (alpha, depth) of which typical uncertainty values are given. These parameters are used in DASY4 software to improve probe accuracy close to the boundary. The sensitivity in TSL corresponds to NORM_{x,y,z} * ConvF whereby the uncertainty corresponds to that given for ConvF. A frequency dependent ConvF is used in DASY version 4.4 and higher which allows extending the validity from ± 50 MHz to ± 100 MHz.
- Spherical isotropy (3D deviation from isotropy)**: in a field of low gradients realized using a flat phantom exposed by a patch antenna.
- Sensor Offset**: The sensor offset corresponds to the offset of virtual measurement center from the probe tip (on probe axis). No tolerance required.

Probe ES3DV3

SN:3263

Manufactured: January 25, 2010
Calibrated: May 16, 2013

Calibrated for DASY/EASY Systems
(Note: non-compatible with DASY2 system!)

DASY/EASY - Parameters of Probe: ES3DV3 - SN:3263

Basic Calibration Parameters

	Sensor X	Sensor Y	Sensor Z	Unc (k=2)
Norm ($\mu\text{V}/(\text{V}/\text{m})^2$) ^A	1.21	1.25	1.12	$\pm 10.1 \%$
DCP (mV) ^B	101.2	100.2	103.7	

Modulation Calibration Parameters

UID	Communication System Name		A dB	B dB $\sqrt{\mu\text{V}}$	C	D dB	VR mV	Unc ^E (k=2)
0	CW	X	0.0	0.0	1.0	0.00	156.5	$\pm 2.5 \%$
		Y	0.0	0.0	1.0		153.2	
		Z	0.0	0.0	1.0		147.2	

The reported uncertainty of measurement is stated as the standard uncertainty of measurement multiplied by the coverage factor $k=2$, which for a normal distribution corresponds to a coverage probability of approximately 95%.

^A The uncertainties of NormX,Y,Z do not affect the E^2 -field uncertainty inside TSL (see Pages 5 and 6).

^B Numerical linearization parameter: uncertainty not required.

^E Uncertainty is determined using the max. deviation from linear response applying rectangular distribution and is expressed for the square of the field value.

DASY/EASY - Parameters of Probe: ES3DV3 - SN:3263

Calibration Parameter Determined in Head Tissue Simulating Media

f (MHz) ^C	Relative Permittivity ^F	Conductivity (S/m) ^F	ConvF X	ConvF Y	ConvF Z	Alpha	Depth (mm)	Unct. (k=2)
750	41.9	0.89	6.51	6.51	6.51	0.21	2.29	± 12.0 %
835	41.5	0.90	6.29	6.29	6.29	0.50	1.38	± 12.0 %
1750	40.1	1.37	5.30	5.30	5.30	0.45	1.54	± 12.0 %
1900	40.0	1.40	5.11	5.11	5.11	0.57	1.38	± 12.0 %
2450	39.2	1.80	4.47	4.47	4.47	0.59	1.49	± 12.0 %
2600	39.0	1.96	4.31	4.31	4.31	0.80	1.28	± 12.0 %

^C Frequency validity of ± 100 MHz only applies for DASY v4.4 and higher (see Page 2), else it is restricted to ± 50 MHz. The uncertainty is the RSS of the ConvF uncertainty at calibration frequency and the uncertainty for the indicated frequency band.

^F At frequencies below 3 GHz, the validity of tissue parameters (ϵ and σ) can be relaxed to ± 10% if liquid compensation formula is applied to measured SAR values. At frequencies above 3 GHz, the validity of tissue parameters (ϵ and σ) is restricted to ± 5%. The uncertainty is the RSS of the ConvF uncertainty for indicated target tissue parameters.

DASY/EASY - Parameters of Probe: ES3DV3 - SN:3263

Calibration Parameter Determined in Body Tissue Simulating Media

f (MHz) ^C	Relative Permittivity ^F	Conductivity (S/m) ^F	ConvF X	ConvF Y	ConvF Z	Alpha	Depth (mm)	Unct. (k=2)
750	55.5	0.96	6.37	6.37	6.37	0.34	1.82	± 12.0 %
835	55.2	0.97	6.29	6.29	6.29	0.54	1.39	± 12.0 %
1750	53.4	1.49	5.01	5.01	5.01	0.72	1.27	± 12.0 %
1900	53.3	1.52	4.78	4.78	4.78	0.53	1.56	± 12.0 %
2450	52.7	1.95	4.33	4.33	4.33	0.80	1.14	± 12.0 %
2600	52.5	2.16	4.14	4.14	4.14	0.80	1.02	± 12.0 %

^C Frequency validity of ± 100 MHz only applies for DASY v4.4 and higher (see Page 2), else it is restricted to ± 50 MHz. The uncertainty is the RSS of the ConvF uncertainty at calibration frequency and the uncertainty for the indicated frequency band.

^F At frequencies below 3 GHz, the validity of tissue parameters (ϵ and σ) can be relaxed to ± 10% if liquid compensation formula is applied to measured SAR values. At frequencies above 3 GHz, the validity of tissue parameters (ϵ and σ) is restricted to ± 5%. The uncertainty is the RSS of the ConvF uncertainty for indicated target tissue parameters.

Frequency Response of E-Field (TEM-Cell:ifi110 EXX, Waveguide: R22)

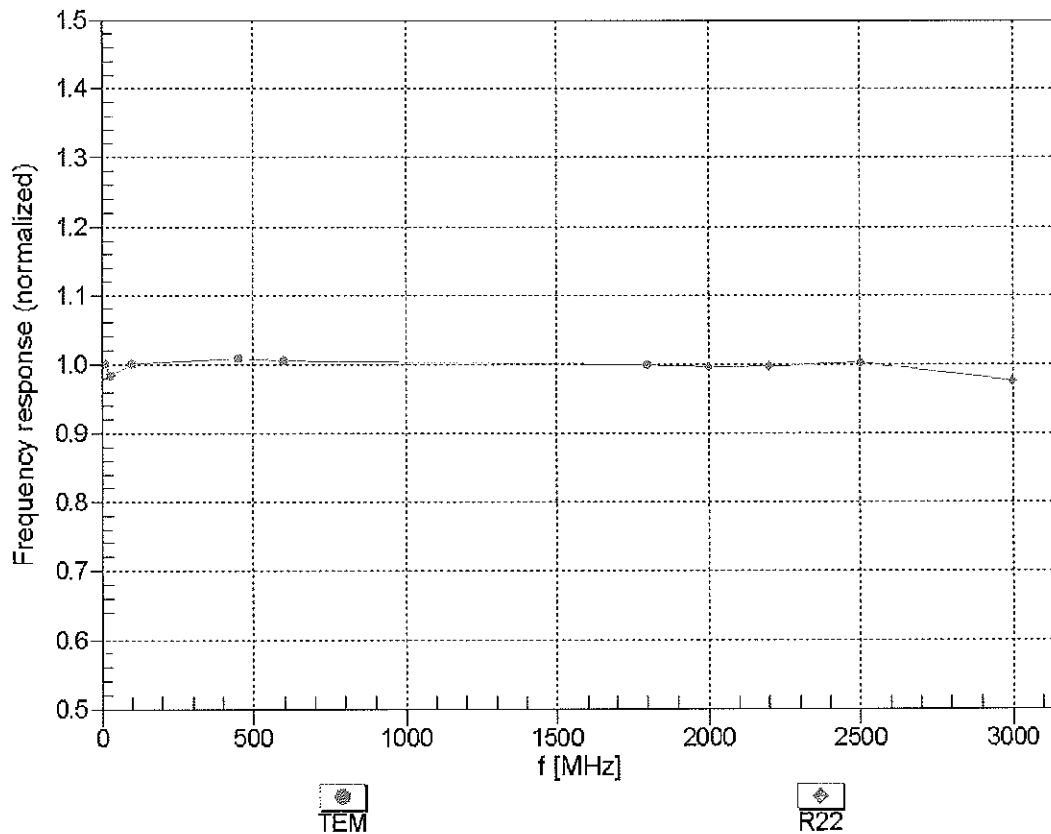

Uncertainty of Frequency Response of E-field: $\pm 6.3\%$ (k=2)

Receiving Pattern (ϕ), $\theta = 0^\circ$

f=600 MHz,TEM

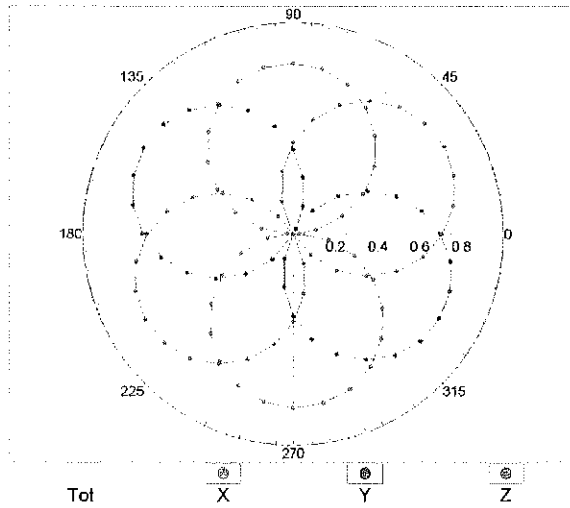

f=1800 MHz,R22

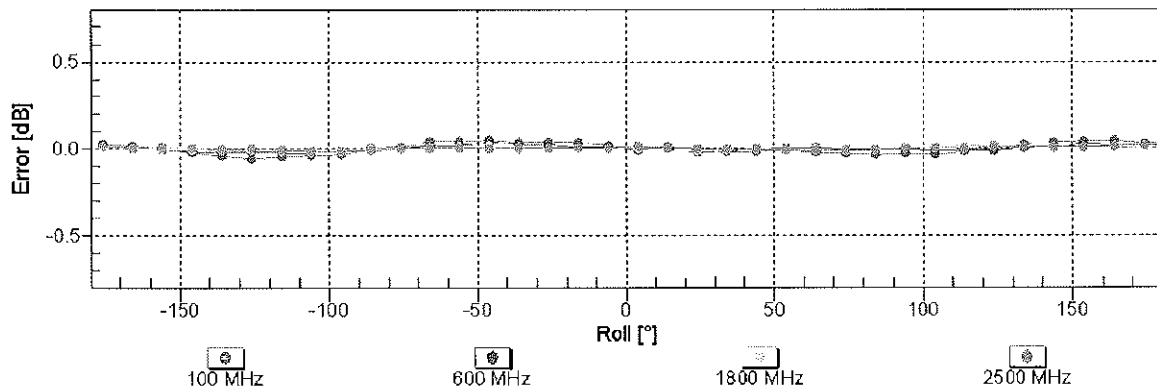
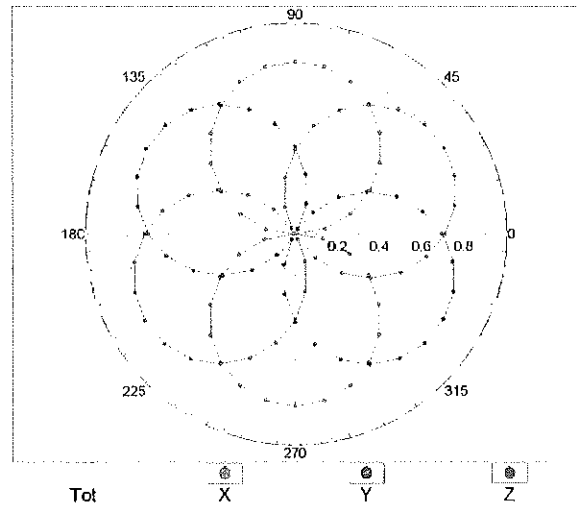

Uncertainty of Axial Isotropy Assessment: $\pm 0.5\%$ (k=2)

Dynamic Range f(SAR_{head}) (TEM cell , f = 900 MHz)

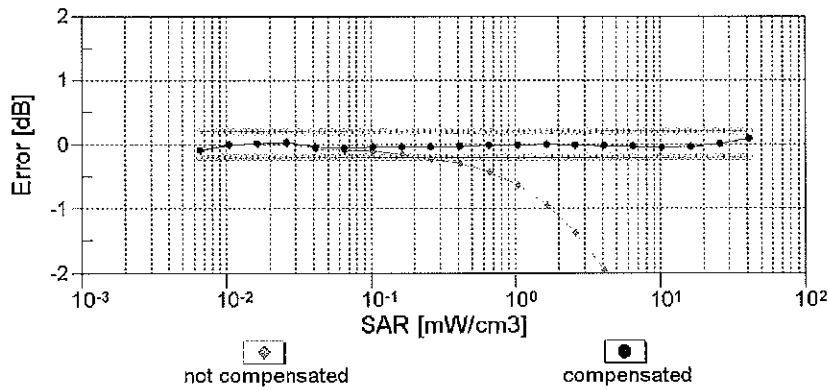
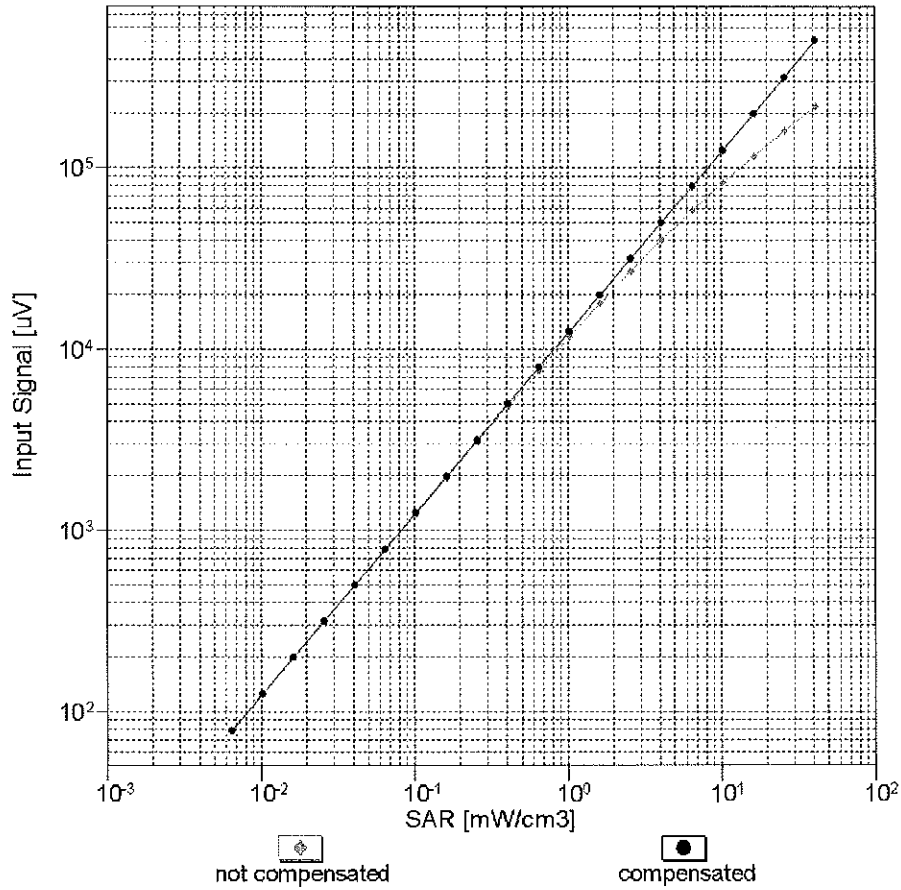

Uncertainty of Linearity Assessment: ± 0.6% (k=2)

Conversion Factor Assessment

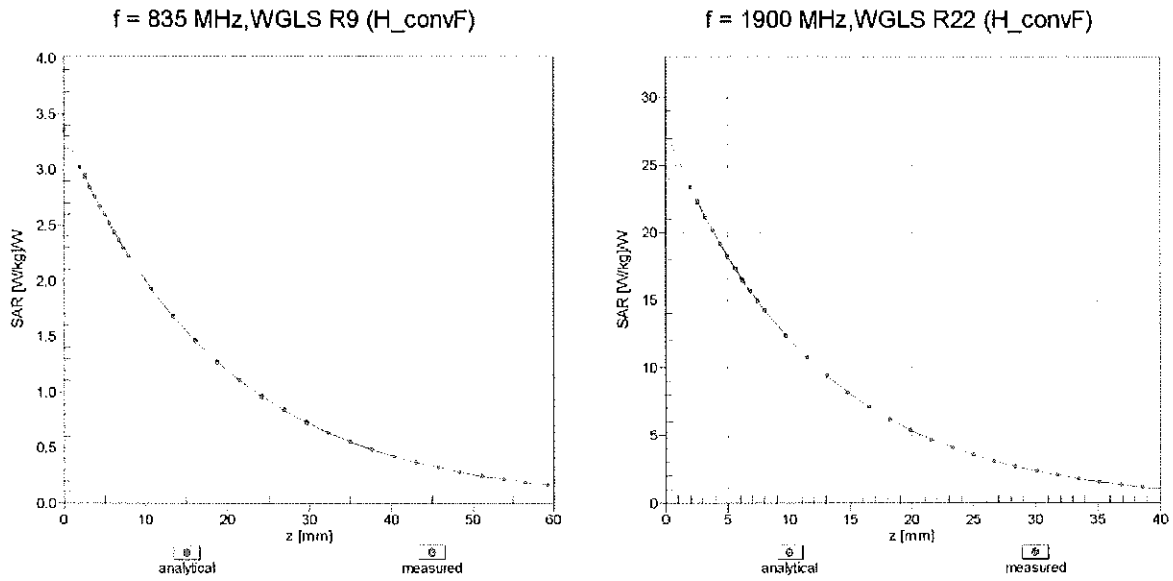

Deviation from Isotropy in Liquid Error (ϕ, θ), f = 900 MHz

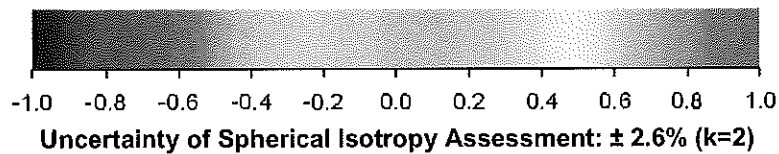
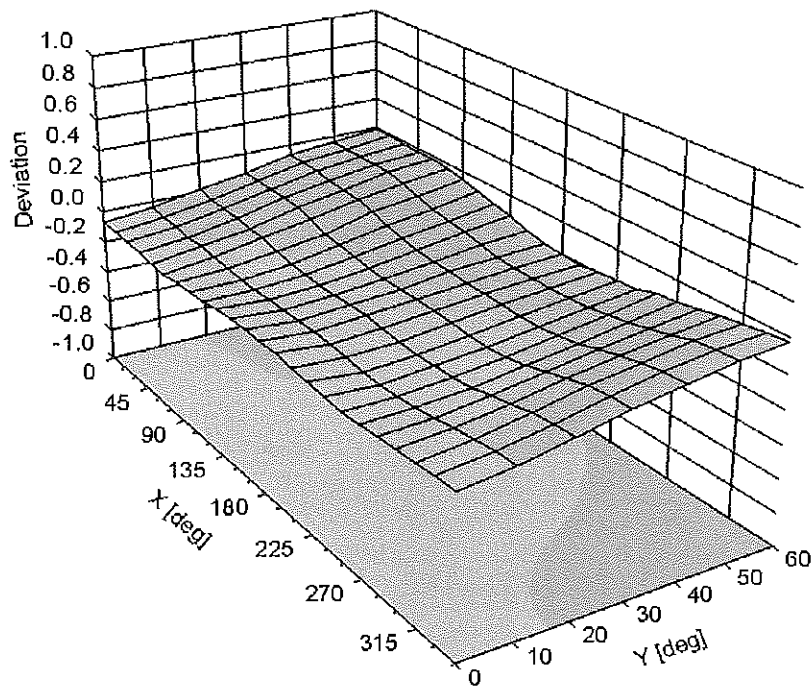

DASY/EASY - Parameters of Probe: ES3DV3 - SN:3263

Other Probe Parameters

Sensor Arrangement	Triangular
Connector Angle (°)	-116
Mechanical Surface Detection Mode	enabled
Optical Surface Detection Mode	disabled
Probe Overall Length	337 mm
Probe Body Diameter	10 mm
Tip Length	10 mm
Tip Diameter	4 mm
Probe Tip to Sensor X Calibration Point	2 mm
Probe Tip to Sensor Y Calibration Point	2 mm
Probe Tip to Sensor Z Calibration Point	2 mm
Recommended Measurement Distance from Surface	3 mm



Accredited by the Swiss Accreditation Service (SAS)
The Swiss Accreditation Service is one of the signatories to the EA
Multilateral Agreement for the recognition of calibration certificates

Accreditation No.: **SCS 108**

Client **PC Test**

Certificate No: **ES3-3209_Mar13**

CALIBRATION CERTIFICATE

Object **ES3DV3 - SN:3209**

Calibration procedure(s) **QA CAL-01.v8, QA CAL-23.v4, QA CAL-25.v4
Calibration procedure for dosimetric E-field probes**

Calibration date: **March 15, 2013**

This calibration certificate documents the traceability to national standards, which realize the physical units of measurements (SI).
The measurements and the uncertainties with confidence probability are given on the following pages and are part of the certificate.

All calibrations have been conducted in the closed laboratory facility: environment temperature (22 ± 3)°C and humidity < 70%.

✓ KOK 3/22/13

Calibration Equipment used (M&TE critical for calibration)

Primary Standards	ID	Cal Date (Certificate No.)	Scheduled Calibration
Power meter E4419B	GB41293874	29-Mar-12 (No. 217-01508)	Apr-13
Power sensor E4412A	MY41498087	29-Mar-12 (No. 217-01508)	Apr-13
Reference 3 dB Attenuator	SN: S5054 (3c)	27-Mar-12 (No. 217-01531)	Apr-13
Reference 20 dB Attenuator	SN: S5086 (20b)	27-Mar-12 (No. 217-01529)	Apr-13
Reference 30 dB Attenuator	SN: S5129 (30b)	27-Mar-12 (No. 217-01532)	Apr-13
Reference Probe ES3DV2	SN: 3013	28-Dec-12 (No. ES3-3013_Dec12)	Dec-13
DAE4	SN: 660	31-Jan-13 (No. DAE4-660_Jan13)	Jan-14
Secondary Standards	ID	Check Date (in house)	Scheduled Check
RF generator HP 8648C	US3642U01700	4-Aug-99 (in house check Apr-11)	In house check: Apr-13
Network Analyzer HP 8753E	US37390585	18-Oct-01 (in house check Oct-12)	In house check: Oct-13

	Name	Function	Signature
Calibrated by:	Israe El-Naouq	Laboratory Technician	<i>Israe El-Naouq</i>
Approved by:	Katja Pokovic	Technical Manager	<i>Katja Pokovic</i>

Issued: March 15, 2013

This calibration certificate shall not be reproduced except in full without written approval of the laboratory.

80242



Accredited by the Swiss Accreditation Service (SAS)

Accreditation No.: **SCS 108**

The Swiss Accreditation Service is one of the signatories to the EA
 Multilateral Agreement for the recognition of calibration certificates

Glossary:

TSL	tissue simulating liquid
NORM _{x,y,z}	sensitivity in free space
ConvF	sensitivity in TSL / NORM _{x,y,z}
DCP	diode compression point
CF	crest factor (1/duty_cycle) of the RF signal
A, B, C, D	modulation dependent linearization parameters
Polarization φ	φ rotation around probe axis
Polarization ϑ	ϑ rotation around an axis that is in the plane normal to probe axis (at measurement center), i.e., $\vartheta = 0$ is normal to probe axis

Calibration is Performed According to the Following Standards:

- a) IEEE Std 1528-2003, "IEEE Recommended Practice for Determining the Peak Spatial-Averaged Specific Absorption Rate (SAR) in the Human Head from Wireless Communications Devices: Measurement Techniques", December 2003
- b) IEC 62209-1, "Procedure to measure the Specific Absorption Rate (SAR) for hand-held devices used in close proximity to the ear (frequency range of 300 MHz to 3 GHz)", February 2005

Methods Applied and Interpretation of Parameters:

- *NORM_{x,y,z}*: Assessed for E-field polarization $\vartheta = 0$ ($f \leq 900$ MHz in TEM-cell; $f > 1800$ MHz: R22 waveguide). *NORM_{x,y,z}* are only intermediate values, i.e., the uncertainties of *NORM_{x,y,z}* does not affect the E^2 -field uncertainty inside TSL (see below *ConvF*).
- *NORM(f)_{x,y,z}* = *NORM_{x,y,z}* * *frequency_response* (see Frequency Response Chart). This linearization is implemented in DASY4 software versions later than 4.2. The uncertainty of the frequency response is included in the stated uncertainty of *ConvF*.
- *DCP_{x,y,z}*: DCP are numerical linearization parameters assessed based on the data of power sweep with CW signal (no uncertainty required). DCP does not depend on frequency nor media.
- *PAR*: PAR is the Peak to Average Ratio that is not calibrated but determined based on the signal characteristics
- *A_{x,y,z}; B_{x,y,z}; C_{x,y,z}; D_{x,y,z}; VR_{x,y,z}; A, B, C, D* are numerical linearization parameters assessed based on the data of power sweep for specific modulation signal. The parameters do not depend on frequency nor media. *VR* is the maximum calibration range expressed in RMS voltage across the diode.
- *ConvF and Boundary Effect Parameters*: Assessed in flat phantom using E-field (or Temperature Transfer Standard for $f \leq 800$ MHz) and inside waveguide using analytical field distributions based on power measurements for $f > 800$ MHz. The same setups are used for assessment of the parameters applied for boundary compensation (alpha, depth) of which typical uncertainty values are given. These parameters are used in DASY4 software to improve probe accuracy close to the boundary. The sensitivity in TSL corresponds to *NORM_{x,y,z}* * *ConvF* whereby the uncertainty corresponds to that given for *ConvF*. A frequency dependent *ConvF* is used in DASY version 4.4 and higher which allows extending the validity from ± 50 MHz to ± 100 MHz.
- *Spherical isotropy (3D deviation from isotropy)*: in a field of low gradients realized using a flat phantom exposed by a patch antenna.
- *Sensor Offset*: The sensor offset corresponds to the offset of virtual measurement center from the probe tip (on probe axis). No tolerance required.

Probe ES3DV3

SN:3209

Manufactured: October 14, 2008
Calibrated: March 15, 2013

Calibrated for DASY/EASY Systems
(Note: non-compatible with DASY2 system!)

DASY/EASY - Parameters of Probe: ES3DV3 - SN:3209

Basic Calibration Parameters

	Sensor X	Sensor Y	Sensor Z	Unc (k=2)
Norm ($\mu\text{V}/(\text{V}/\text{m})^2$) ^A	1.35	1.33	1.14	$\pm 10.1 \%$
DCP (mV) ^B	99.2	97.8	98.3	

Modulation Calibration Parameters

UID	Communication System Name		A dB	B dB $\sqrt{\mu\text{V}}$	C	D dB	VR mV	Unc ^E (k=2)
0	CW	X	0.0	0.0	1.0	0.00	163.6	$\pm 3.5 \%$
		Y	0.0	0.0	1.0		170.3	
		Z	0.0	0.0	1.0		158.7	

The reported uncertainty of measurement is stated as the standard uncertainty of measurement multiplied by the coverage factor $k=2$, which for a normal distribution corresponds to a coverage probability of approximately 95%.

^A The uncertainties of NormX,Y,Z do not affect the E^2 -field uncertainty inside TSL (see Pages 5 and 6).

^B Numerical linearization parameter: uncertainty not required.

^E Uncertainty is determined using the max. deviation from linear response applying rectangular distribution and is expressed for the square of the field value.

DASY/EASY - Parameters of Probe: ES3DV3 - SN:3209

Calibration Parameter Determined in Head Tissue Simulating Media

f (MHz) ^C	Relative Permittivity ^F	Conductivity (S/m) ^F	ConvF X	ConvF Y	ConvF Z	Alpha	Depth (mm)	Unct. (k=2)
750	41.9	0.89	6.74	6.74	6.74	0.76	1.18	± 12.0 %
835	41.5	0.90	6.46	6.46	6.46	0.31	1.81	± 12.0 %
1750	40.1	1.37	5.39	5.39	5.39	0.80	1.21	± 12.0 %
1900	40.0	1.40	5.21	5.21	5.21	0.78	1.26	± 12.0 %
2450	39.2	1.80	4.57	4.57	4.57	0.65	1.43	± 12.0 %
2600	39.0	1.96	4.43	4.43	4.43	0.75	1.36	± 12.0 %

^C Frequency validity of ± 100 MHz only applies for DASY v4.4 and higher (see Page 2), else it is restricted to ± 50 MHz. The uncertainty is the RSS of the ConvF uncertainty at calibration frequency and the uncertainty for the indicated frequency band.

^F At frequencies below 3 GHz, the validity of tissue parameters (ϵ and σ) can be relaxed to ± 10% if liquid compensation formula is applied to measured SAR values. At frequencies above 3 GHz, the validity of tissue parameters (ϵ and σ) is restricted to ± 5%. The uncertainty is the RSS of the ConvF uncertainty for indicated target tissue parameters.

DASY/EASY - Parameters of Probe: ES3DV3 - SN:3209

Calibration Parameter Determined in Body Tissue Simulating Media

f (MHz) ^C	Relative Permittivity ^F	Conductivity (S/m) ^F	ConvF X	ConvF Y	ConvF Z	Alpha	Depth (mm)	Unct. (k=2)
750	55.5	0.96	6.38	6.38	6.38	0.80	1.16	± 12.0 %
835	55.2	0.97	6.28	6.28	6.28	0.52	1.45	± 12.0 %
1750	53.4	1.49	5.03	5.03	5.03	0.58	1.45	± 12.0 %
1900	53.3	1.52	4.77	4.77	4.77	0.70	1.36	± 12.0 %
2450	52.7	1.95	4.34	4.34	4.34	0.80	1.15	± 12.0 %
2600	52.5	2.16	4.11	4.11	4.11	0.80	1.00	± 12.0 %

^C Frequency validity of ± 100 MHz only applies for DASY v4.4 and higher (see Page 2), else it is restricted to ± 50 MHz. The uncertainty is the RSS of the ConvF uncertainty at calibration frequency and the uncertainty for the indicated frequency band.

^F At frequencies below 3 GHz, the validity of tissue parameters (ϵ and σ) can be relaxed to ± 10% if liquid compensation formula is applied to measured SAR values. At frequencies above 3 GHz, the validity of tissue parameters (ϵ and σ) is restricted to ± 5%. The uncertainty is the RSS of the ConvF uncertainty for indicated target tissue parameters.

Frequency Response of E-Field (TEM-Cell:ifi110 EXX, Waveguide: R22)

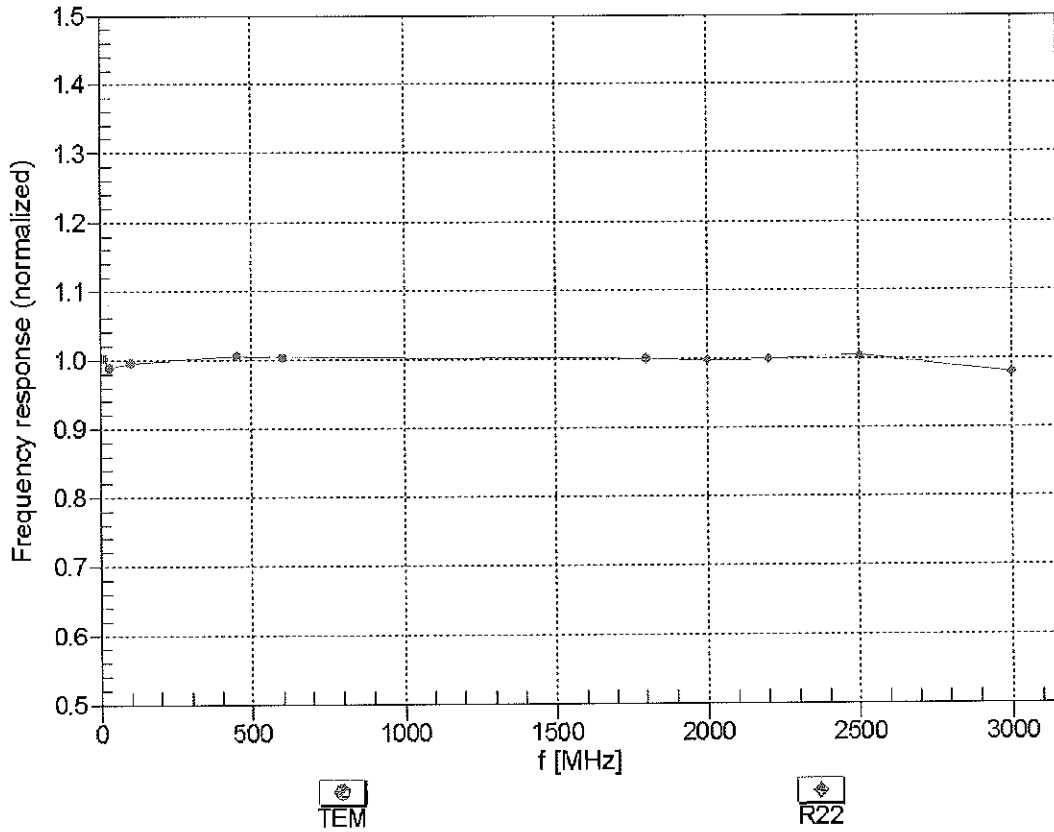

Uncertainty of Frequency Response of E-field: $\pm 6.3\%$ (k=2)

Receiving Pattern (ϕ), $\theta = 0^\circ$

f=600 MHz,TEM

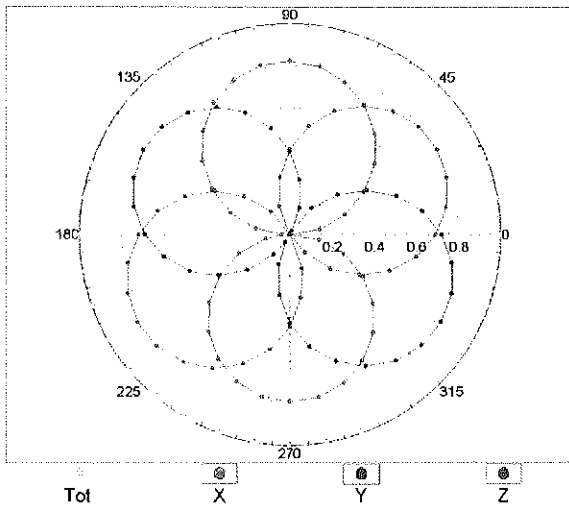

f=1800 MHz,R22

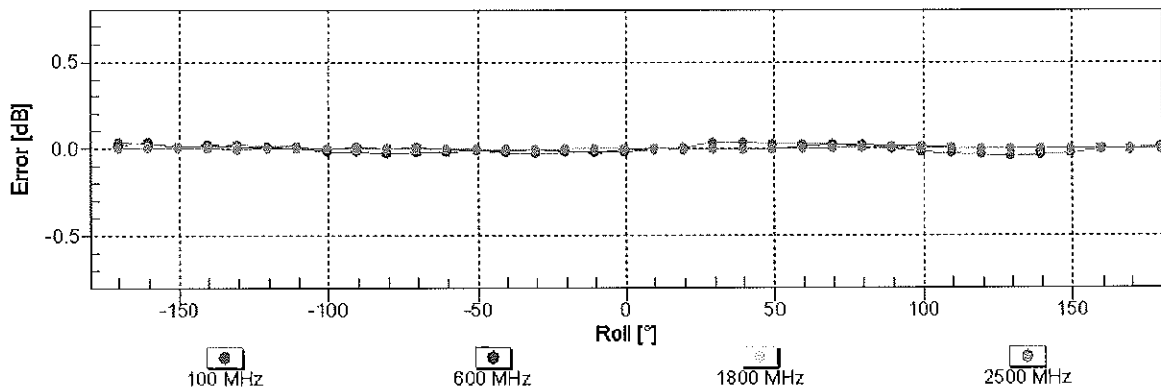
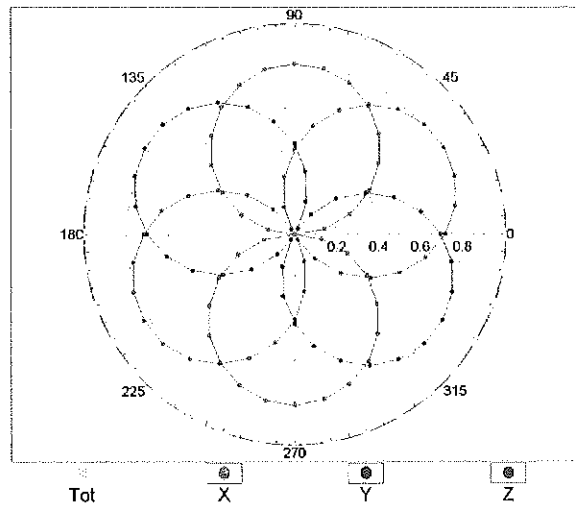

Uncertainty of Axial Isotropy Assessment: $\pm 0.5\%$ (k=2)

Dynamic Range $f(SAR_{head})$ (TEM cell , $f = 900$ MHz)

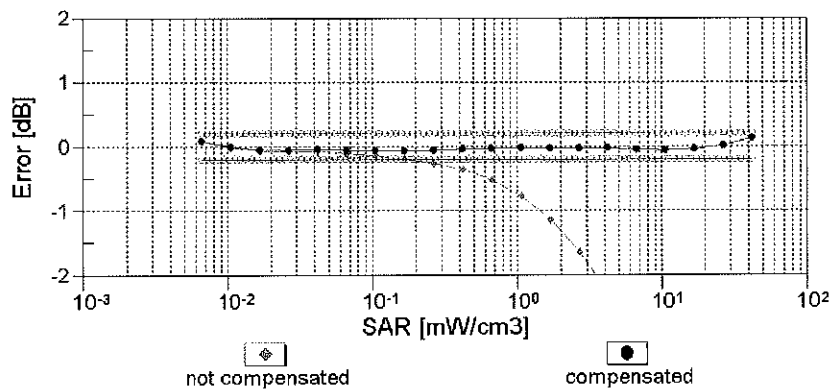
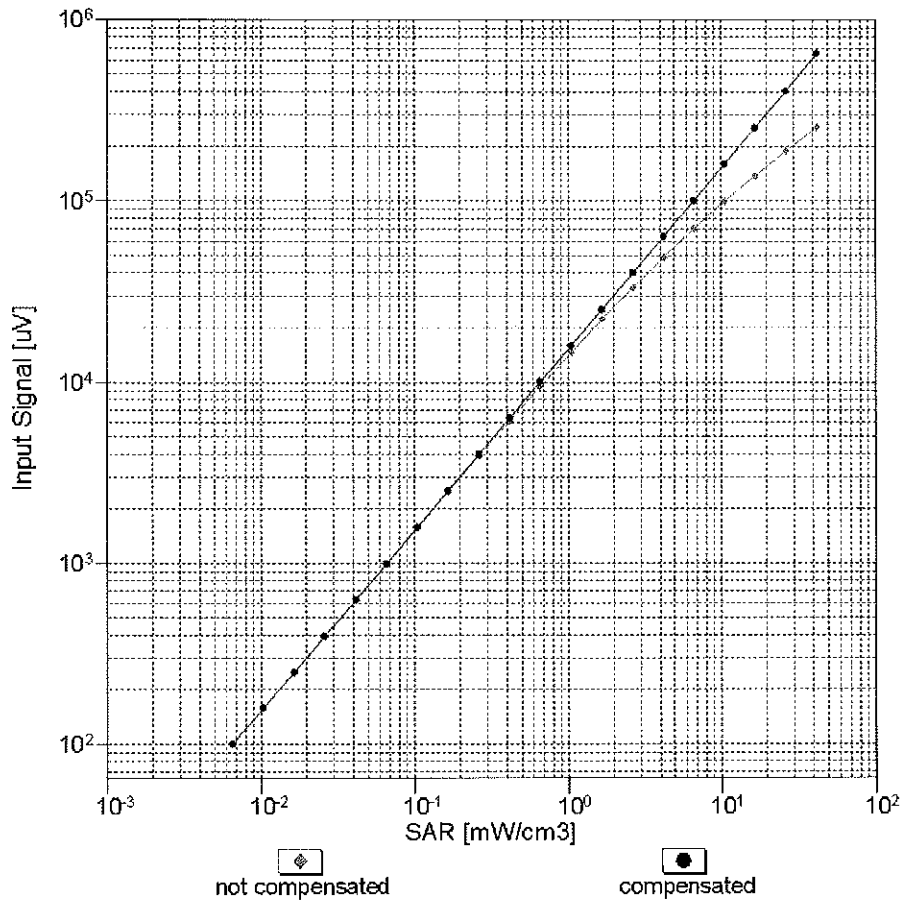

Uncertainty of Linearity Assessment: $\pm 0.6\%$ ($k=2$)

Conversion Factor Assessment

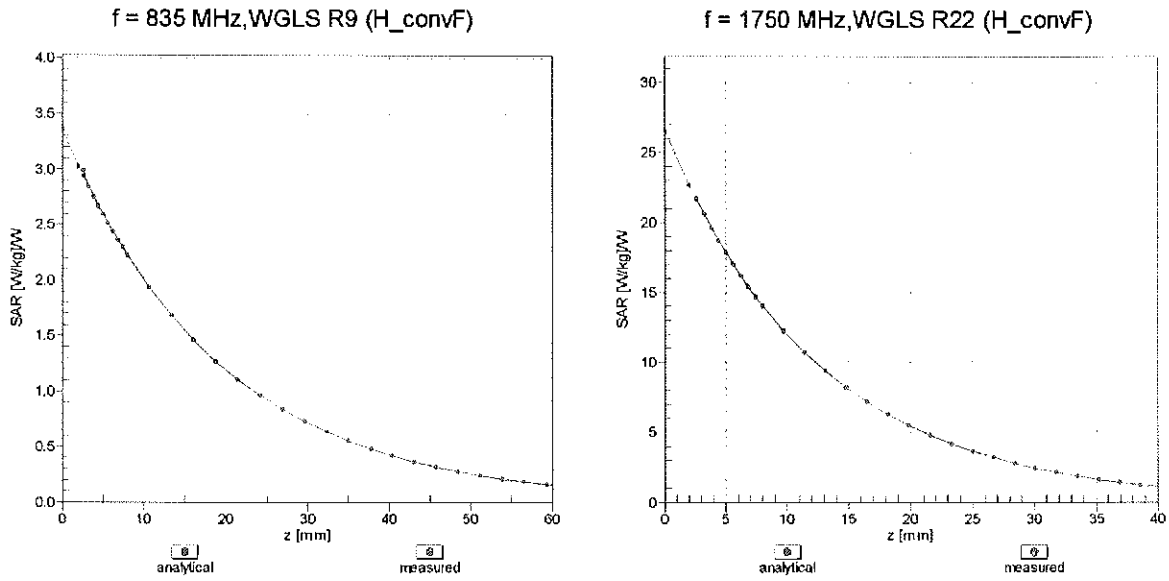

Deviation from Isotropy in Liquid Error (ϕ, θ), f = 900 MHz

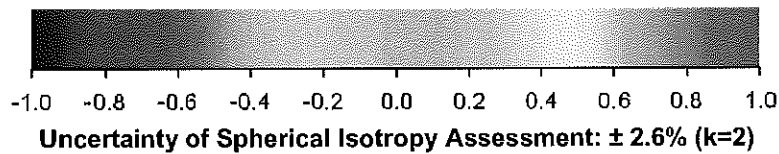
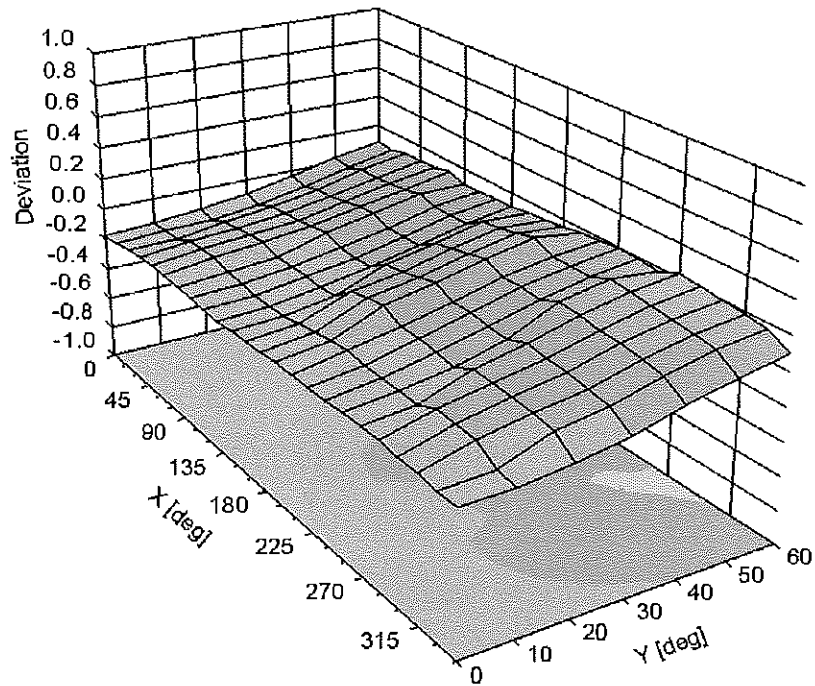

DASY/EASY - Parameters of Probe: ES3DV3 - SN:3209

Other Probe Parameters

Sensor Arrangement	Triangular
Connector Angle (°)	-40.6
Mechanical Surface Detection Mode	enabled
Optical Surface Detection Mode	disabled
Probe Overall Length	337 mm
Probe Body Diameter	10 mm
Tip Length	10 mm
Tip Diameter	4 mm
Probe Tip to Sensor X Calibration Point	2 mm
Probe Tip to Sensor Y Calibration Point	2 mm
Probe Tip to Sensor Z Calibration Point	2 mm
Recommended Measurement Distance from Surface	3 mm



Accredited by the Swiss Accreditation Service (SAS)
The Swiss Accreditation Service is one of the signatories to the EA
Multilateral Agreement for the recognition of calibration certificates

Accreditation No.: **SCS 108**

Client **PC Test**

Certificate No: **ES3-3318_Apr13**

CALIBRATION CERTIFICATE

Object: **ES3DV3 - SN:3318**

Calibration procedure(s): **QA CAL-01.v8, QA CAL-23.v4, QA CAL-25.v4
Calibration procedure for dosimetric E-field probes**

Calibration date: **April 29, 2013**

This calibration certificate documents the traceability to national standards, which realize the physical units of measurements (SI).
The measurements and the uncertainties with confidence probability are given on the following pages and are part of the certificate.

All calibrations have been conducted in the closed laboratory facility: environment temperature (22 ± 3)°C and humidity < 70%.

Calibration Equipment used (M&TE critical for calibration)

VCC
6/14/13

Primary Standards	ID	Cal Date (Certificate No.)	Scheduled Calibration
Power meter E4419B	GB41293874	04-Apr-13 (No. 217-01733)	Apr-14
Power sensor E4412A	MY41498087	04-Apr-13 (No. 217-01733)	Apr-14
Reference 3 dB Attenuator	SN: S5054 (3c)	04-Apr-13 (No. 217-01737)	Apr-14
Reference 20 dB Attenuator	SN: S5277 (20x)	04-Apr-13 (No. 217-01735)	Apr-14
Reference 30 dB Attenuator	SN: S5129 (30b)	04-Apr-13 (No. 217-01738)	Apr-14
Reference Probe ES3DV2	SN: 3013	28-Dec-12 (No. ES3-3013_Dec12)	Dec-13
DAE4	SN: 660	31-Jan-13 (No. DAE4-660_Jan13)	Jan-14
Secondary Standards	ID	Check Date (in house)	Scheduled Check
RF generator HP 8648C	US3642U01700	4-Aug-99 (in house check Apr-13)	In house check: Apr-15
Network Analyzer HP 8753E	US37390585	18-Oct-01 (in house check Oct-12)	In house check: Oct-13

	Name	Function	Signature
Calibrated by:	Dimce Iliev	Laboratory Technician	
Approved by:	Katja Pokovic	Technical Manager	

Issued: April 29, 2013

This calibration certificate shall not be reproduced except in full without written approval of the laboratory.



Accredited by the Swiss Accreditation Service (SAS)

Accreditation No.: **SCS 108**

The Swiss Accreditation Service is one of the signatories to the EA
 Multilateral Agreement for the recognition of calibration certificates

Glossary:

TSL	tissue simulating liquid
NORM _{x,y,z}	sensitivity in free space
ConvF	sensitivity in TSL / NORM _{x,y,z}
DCP	diode compression point
CF	crest factor (1/duty_cycle) of the RF signal
A, B, C, D	modulation dependent linearization parameters
Polarization φ	φ rotation around probe axis
Polarization ϑ	ϑ rotation around an axis that is in the plane normal to probe axis (at measurement center), i.e., $\vartheta = 0$ is normal to probe axis

Calibration is Performed According to the Following Standards:

- IEEE Std 1528-2003, "IEEE Recommended Practice for Determining the Peak Spatial-Averaged Specific Absorption Rate (SAR) in the Human Head from Wireless Communications Devices: Measurement Techniques", December 2003
- IEC 62209-1, "Procedure to measure the Specific Absorption Rate (SAR) for hand-held devices used in close proximity to the ear (frequency range of 300 MHz to 3 GHz)", February 2005

Methods Applied and Interpretation of Parameters:

- NORM_{x,y,z}**: Assessed for E-field polarization $\vartheta = 0$ ($f \leq 900$ MHz in TEM-cell; $f > 1800$ MHz: R22 waveguide). NORM_{x,y,z} are only intermediate values, i.e., the uncertainties of NORM_{x,y,z} does not affect the E²-field uncertainty inside TSL (see below ConvF).
- NORM(f)_{x,y,z}** = NORM_{x,y,z} * frequency_response (see Frequency Response Chart). This linearization is implemented in DASY4 software versions later than 4.2. The uncertainty of the frequency response is included in the stated uncertainty of ConvF.
- DCP_{x,y,z}**: DCP are numerical linearization parameters assessed based on the data of power sweep with CW signal (no uncertainty required). DCP does not depend on frequency nor media.
- PAR**: PAR is the Peak to Average Ratio that is not calibrated but determined based on the signal characteristics
- A_{x,y,z}; B_{x,y,z}; C_{x,y,z}; D_{x,y,z}; VR_{x,y,z}**: A, B, C, D are numerical linearization parameters assessed based on the data of power sweep for specific modulation signal. The parameters do not depend on frequency nor media. VR is the maximum calibration range expressed in RMS voltage across the diode.
- ConvF and Boundary Effect Parameters**: Assessed in flat phantom using E-field (or Temperature Transfer Standard for $f \leq 800$ MHz) and inside waveguide using analytical field distributions based on power measurements for $f > 800$ MHz. The same setups are used for assessment of the parameters applied for boundary compensation (alpha, depth) of which typical uncertainty values are given. These parameters are used in DASY4 software to improve probe accuracy close to the boundary. The sensitivity in TSL corresponds to NORM_{x,y,z} * ConvF whereby the uncertainty corresponds to that given for ConvF. A frequency dependent ConvF is used in DASY version 4.4 and higher which allows extending the validity from ± 50 MHz to ± 100 MHz.
- Spherical isotropy (3D deviation from isotropy)**: in a field of low gradients realized using a flat phantom exposed by a patch antenna.
- Sensor Offset**: The sensor offset corresponds to the offset of virtual measurement center from the probe tip (on probe axis). No tolerance required.

Probe ES3DV3

SN:3318

Manufactured: January 10, 2012
Calibrated: April 29, 2013

Calibrated for DASV/EASY Systems
(Note: non-compatible with DASV2 system!)

DASY/EASY - Parameters of Probe: ES3DV3 - SN:3318

Basic Calibration Parameters

	Sensor X	Sensor Y	Sensor Z	Unc (k=2)
Norm ($\mu\text{V}/(\text{V}/\text{m})^2$) ^A	1.15	0.92	1.29	± 10.1 %
DCP (mV) ^B	102.6	105.4	100.8	

Modulation Calibration Parameters

UID	Communication System Name		A dB	B dB/ μV	C	D dB	VR mV	Unc ^E (k=2)
0	CW	X	0.0	0.0	1.0	0.00	153.6	±3.5 %
		Y	0.0	0.0	1.0		133.8	
		Z	0.0	0.0	1.0		154.8	

The reported uncertainty of measurement is stated as the standard uncertainty of measurement multiplied by the coverage factor k=2, which for a normal distribution corresponds to a coverage probability of approximately 95%.

^A The uncertainties of NormX,Y,Z do not affect the E²-field uncertainty inside TSL (see Pages 5 and 6).

^B Numerical linearization parameter: uncertainty not required.

^E Uncertainty is determined using the max. deviation from linear response applying rectangular distribution and is expressed for the square of the field value.

DASY/EASY - Parameters of Probe: ES3DV3 - SN:3318

Calibration Parameter Determined in Head Tissue Simulating Media

f (MHz) ^C	Relative Permittivity ^F	Conductivity (S/m) ^F	ConvF X	ConvF Y	ConvF Z	Alpha	Depth (mm)	Unct. (k=2)
750	41.9	0.89	6.59	6.59	6.59	0.25	2.12	± 12.0 %
850	41.5	0.92	6.33	6.33	6.33	0.57	1.25	± 12.0 %
1900	40.0	1.40	5.22	5.22	5.22	0.79	1.25	± 12.0 %
2450	39.2	1.80	4.59	4.59	4.59	0.80	1.30	± 12.0 %

^C Frequency validity of ± 100 MHz only applies for DASY v4.4 and higher (see Page 2), else it is restricted to ± 50 MHz. The uncertainty is the RSS of the ConvF uncertainty at calibration frequency and the uncertainty for the indicated frequency band.

^F At frequencies below 3 GHz, the validity of tissue parameters (ϵ and σ) can be relaxed to ± 10% if liquid compensation formula is applied to measured SAR values. At frequencies above 3 GHz, the validity of tissue parameters (ϵ and σ) is restricted to ± 5%. The uncertainty is the RSS of the ConvF uncertainty for indicated target tissue parameters.

DASY/EASY - Parameters of Probe: ES3DV3 - SN:3318

Calibration Parameter Determined in Body Tissue Simulating Media

f (MHz) ^C	Relative Permittivity ^F	Conductivity (S/m) ^F	ConvF X	ConvF Y	ConvF Z	Alpha	Depth (mm)	Unct. (k=2)
750	55.5	0.96	6.35	6.35	6.35	0.53	1.42	± 12.0 %
850	55.2	0.99	6.21	6.21	6.21	0.57	1.38	± 12.0 %
1900	53.3	1.52	4.79	4.79	4.79	0.46	1.77	± 12.0 %
2450	52.7	1.95	4.31	4.31	4.31	0.80	1.09	± 12.0 %

^C Frequency validity of ± 100 MHz only applies for DASY v4.4 and higher (see Page 2), else it is restricted to ± 50 MHz. The uncertainty is the RSS of the ConvF uncertainty at calibration frequency and the uncertainty for the indicated frequency band.

^F At frequencies below 3 GHz, the validity of tissue parameters (ϵ and σ) can be relaxed to ± 10% if liquid compensation formula is applied to measured SAR values. At frequencies above 3 GHz, the validity of tissue parameters (ϵ and σ) is restricted to ± 5%. The uncertainty is the RSS of the ConvF uncertainty for indicated target tissue parameters.

Frequency Response of E-Field (TEM-Cell:ifi110 EXX, Waveguide: R22)

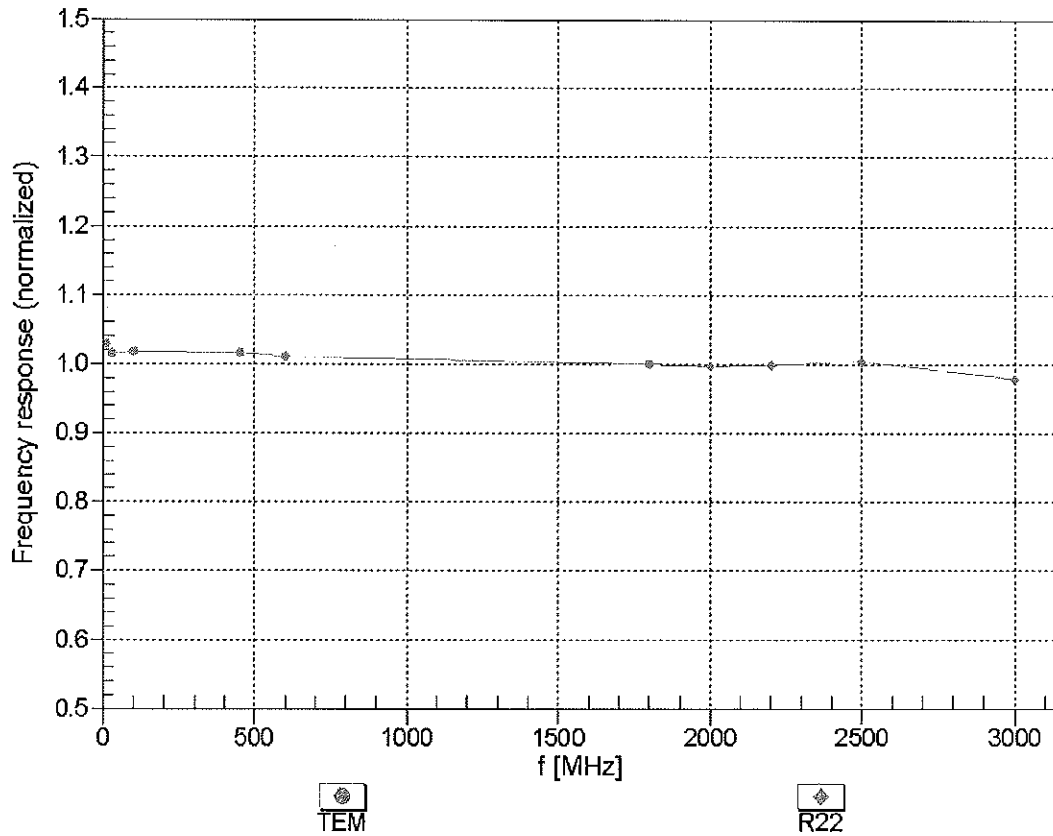

Uncertainty of Frequency Response of E-field: $\pm 6.3\%$ (k=2)

Receiving Pattern (ϕ), $\theta = 0^\circ$

f=600 MHz,TEM

f=1800 MHz,R22

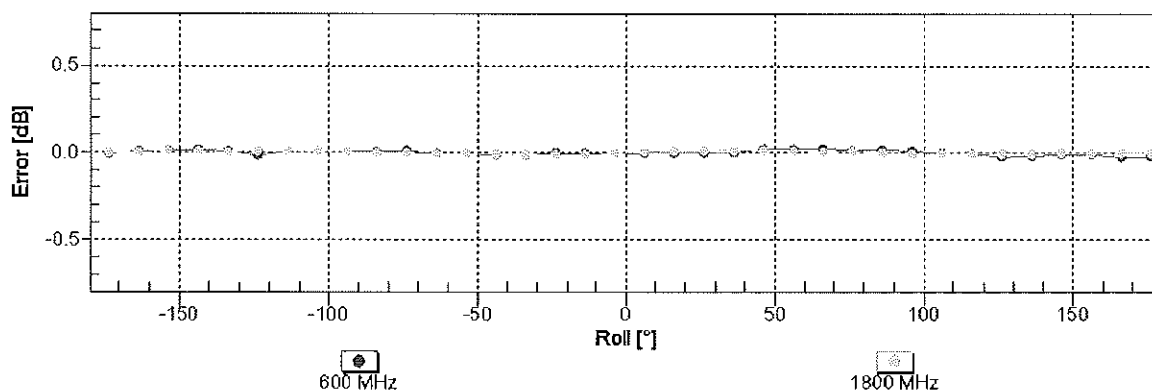
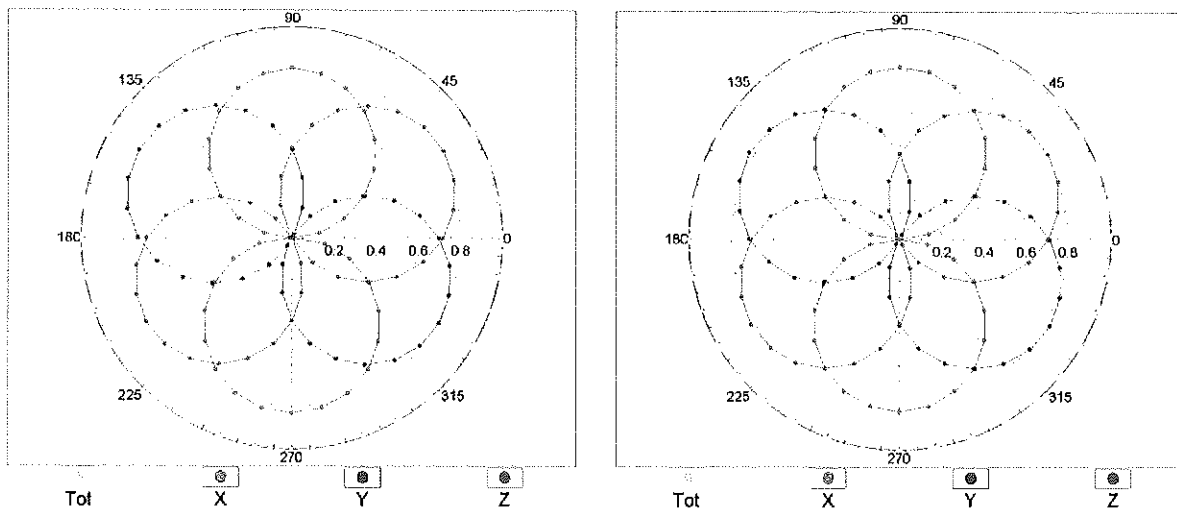

Uncertainty of Axial Isotropy Assessment: $\pm 0.5\%$ ($k=2$)

Dynamic Range $f(\text{SAR}_{\text{head}})$ (TEM cell , $f = 900 \text{ MHz}$)

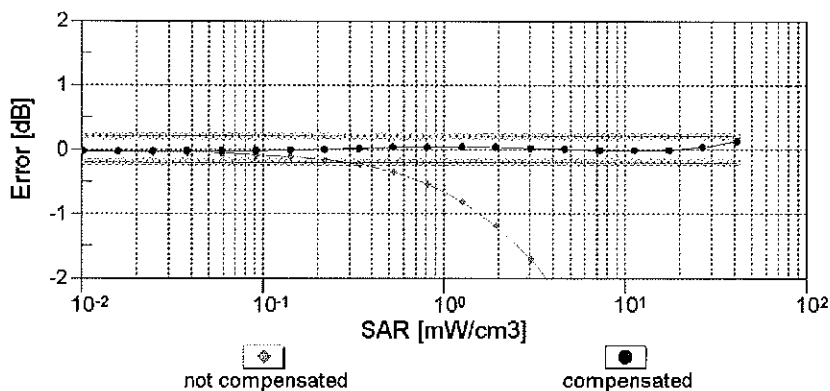
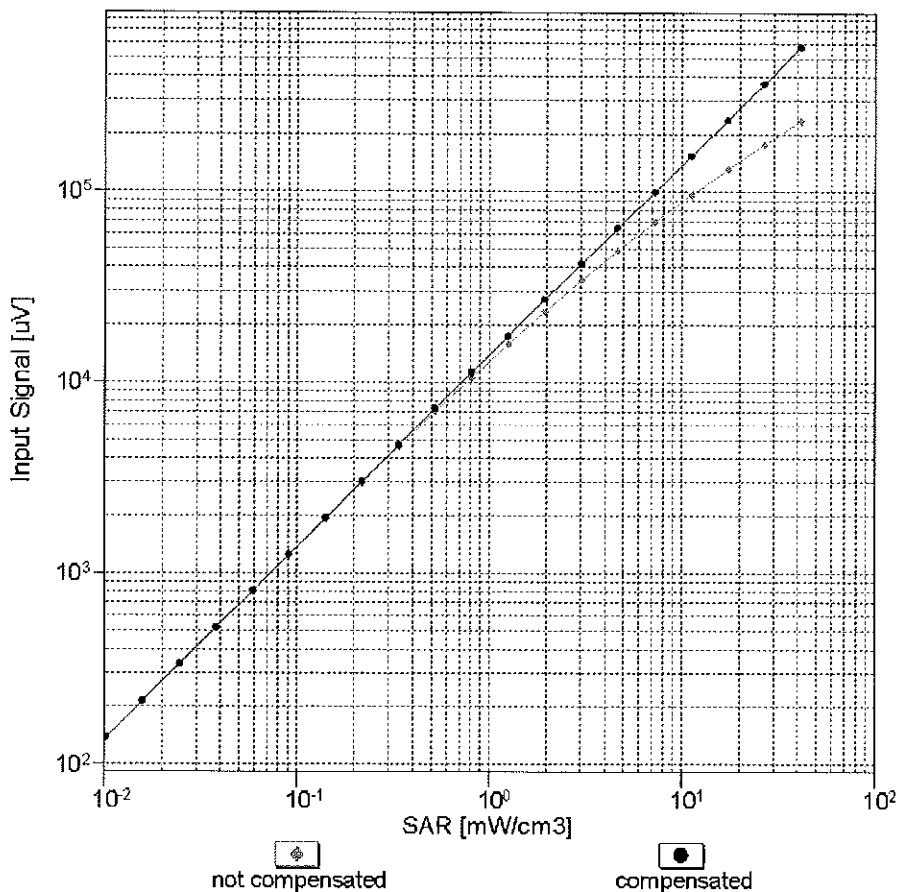

Uncertainty of Linearity Assessment: $\pm 0.6\%$ ($k=2$)

Conversion Factor Assessment

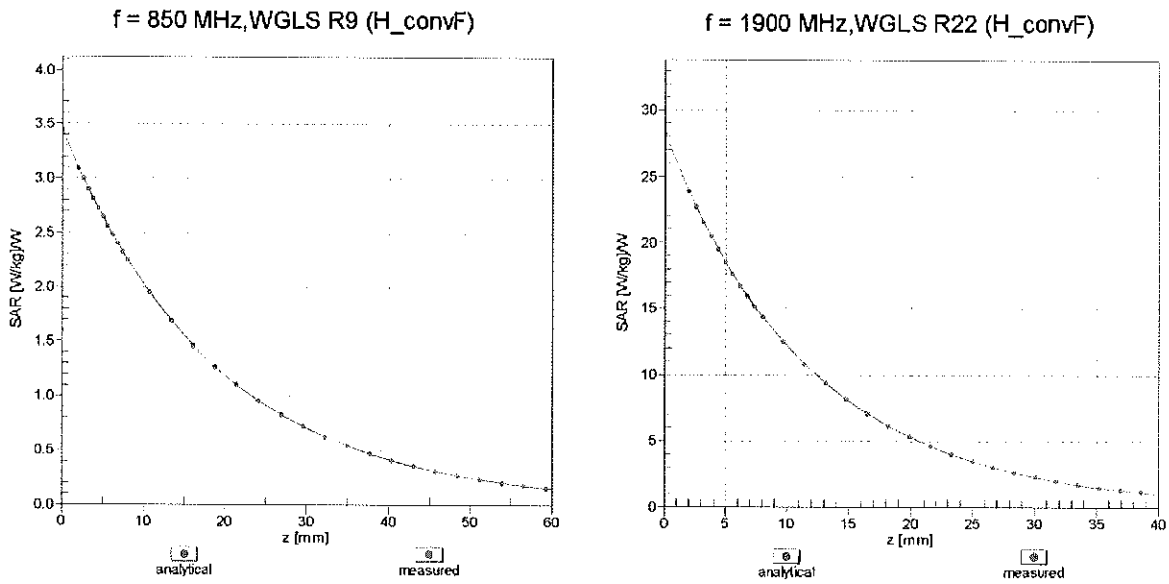

Deviation from Isotropy in Liquid Error (ϕ, θ), f = 900 MHz

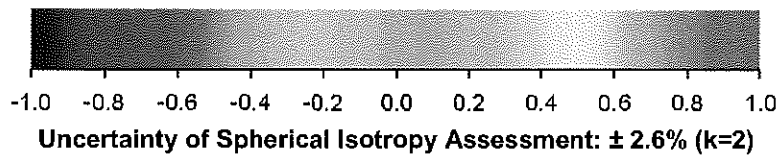
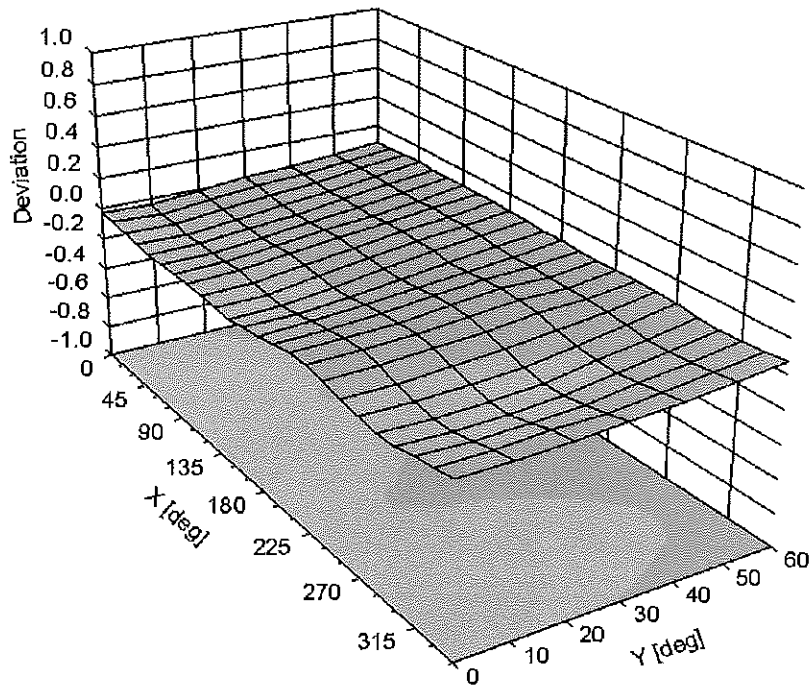

DASY/EASY - Parameters of Probe: ES3DV3 - SN:3318**Other Probe Parameters**

Sensor Arrangement	Triangular
Connector Angle (°)	-103.8
Mechanical Surface Detection Mode	enabled
Optical Surface Detection Mode	disabled
Probe Overall Length	337 mm
Probe Body Diameter	10 mm
Tip Length	10 mm
Tip Diameter	4 mm
Probe Tip to Sensor X Calibration Point	2 mm
Probe Tip to Sensor Y Calibration Point	2 mm
Probe Tip to Sensor Z Calibration Point	2 mm
Recommended Measurement Distance from Surface	3 mm

Additional Conversion Factors for Dosimetric E-Field Probe

Type:	ES3DV3
Serial Number:	3318
Place of Assessment:	Zurich
Date of Assessment:	June 19, 2013
Probe Calibration Date:	April 29, 2013

✓
Kox
6/25/13

Schmid & Partner Engineering AG hereby certifies that conversion factor(s) of this probe have been evaluated on the date indicated above. The assessment was performed using the FDTD numerical code SEMCAD of Schmid & Partner Engineering AG. The evaluation is coupled with measured conversion factors (probe calibration date indicated above). The uncertainty of the numerical assessment is based on the extrapolation from measured value at 835 MHz or at 1900 MHz.

Assessed by: 

Dosimetric E-Field Probe ES3DV3 SN:3318

Conversion factor (\pm standard deviation)

1750 \pm 50 MHz *ConvF* 5.59 \pm 7%

$\epsilon_r = 40.1 \pm 5\%$
 $\sigma = 1.37 \pm 5\%$ mho/m
(head tissue)

1750 \pm 50 MHz *ConvF* 5.22 \pm 7%

$\epsilon_r = 53.4 \pm 5\%$
 $\sigma = 1.49 \pm 5\%$ mho/m
(body tissue)

Important Note:

For numerically assessed probe conversion factors, parameters Alpha and Delta in the DASY software must have the following entries: Alpha = 0 and Delta = 1.

Please see also DASY Manual.



Accredited by the Swiss Accreditation Service (SAS)
The Swiss Accreditation Service is one of the signatories to the EA
Multilateral Agreement for the recognition of calibration certificates

Accreditation No.: **SCS 108**

Client **PC Test**

Certificate No: **ES3-3333_Nov13**

CALIBRATION CERTIFICATE

Object **ES3DV3 - SN:3333**

Calibration procedure(s) **QA CAL 01.15, QA CAL 23.15, QA CAL 25.15
Calibration procedure for dielectric E-field probes**

Calibration date: **November 22, 2013**

*KOK
11/21/14*

This calibration certificate documents the traceability to national standards, which realize the physical units of measurements (SI).
The measurements and the uncertainties with confidence probability are given on the following pages and are part of the certificate.

All calibrations have been conducted in the closed laboratory facility: environment temperature (22 ± 3)°C and humidity < 70%.

Calibration Equipment used (M&TE critical for calibration)

Primary Standards	ID	Cal Date (Certificate No.)	Scheduled Calibration
Power meter E4419B	GB41293874	04-Apr-13 (No. 217-01733)	Apr-14
Power sensor E4412A	MY41498087	04-Apr-13 (No. 217-01733)	Apr-14
Reference 3 dB Attenuator	SN: S5054 (3c)	04-Apr-13 (No. 217-01737)	Apr-14
Reference 20 dB Attenuator	SN: S5277 (20x)	04-Apr-13 (No. 217-01735)	Apr-14
Reference 30 dB Attenuator	SN: S5129 (30b)	04-Apr-13 (No. 217-01738)	Apr-14
Reference Probe ES3DV2	SN: 3013	28-Dec-12 (No. ES3-3013_Dec12)	Dec-13
DAE4	SN: 660	4-Sep-13 (No. DAE4-660_Sep13)	Sep-14
Secondary Standards	ID	Check Date (in house)	Scheduled Check
RF generator HP 8648C	US3642U01700	4-Aug-99 (in house check Apr-13)	In house check: Apr-15
Network Analyzer HP 8753E	US37390585	18-Oct-01 (in house check Oct-13)	In house check: Oct-14

	Name	Function	Signature
Calibrated by:	Jeton Kastrati	Laboratory Technician	<i>[Signature]</i>
Approved by:	Katja Pokovic	Technical Manager	<i>[Signature]</i>

Issued: November 25, 2013

This calibration certificate shell not be reproduced except in full without written approval of the laboratory.



Accredited by the Swiss Accreditation Service (SAS)

Accreditation No.: **SCS 108**

The Swiss Accreditation Service is one of the signatories to the EA
Multilateral Agreement for the recognition of calibration certificates

Glossary:

TSL	tissue simulating liquid
NORM _{x,y,z}	sensitivity in free space
ConvF	sensitivity in TSL / NORM _{x,y,z}
DCP	diode compression point
CF	crest factor (1/duty_cycle) of the RF signal
A, B, C, D	modulation dependent linearization parameters
Polarization ϕ	ϕ rotation around probe axis
Polarization ϑ	ϑ rotation around an axis that is in the plane normal to probe axis (at measurement center), i.e., $\vartheta = 0$ is normal to probe axis
Connector Angle	information used in DASY system to align probe sensor X to the robot coordinate system

Calibration is Performed According to the Following Standards:

- IEEE Std 1528-2013, "IEEE Recommended Practice for Determining the Peak Spatial-Averaged Specific Absorption Rate (SAR) in the Human Head from Wireless Communications Devices: Measurement Techniques", June 2013
- IEC 62209-1, "Procedure to measure the Specific Absorption Rate (SAR) for hand-held devices used in close proximity to the ear (frequency range of 300 MHz to 3 GHz)", February 2005

Methods Applied and Interpretation of Parameters:

- NORM_{x,y,z}**: Assessed for E-field polarization $\vartheta = 0$ ($f \leq 900$ MHz in TEM-cell; $f > 1800$ MHz: R22 waveguide). NORM_{x,y,z} are only intermediate values, i.e., the uncertainties of NORM_{x,y,z} does not affect the E²-field uncertainty inside TSL (see below ConvF).
- NORM(f)_{x,y,z}** = NORM_{x,y,z} * frequency_response (see Frequency Response Chart). This linearization is implemented in DASY4 software versions later than 4.2. The uncertainty of the frequency response is included in the stated uncertainty of ConvF.
- DCP_{x,y,z}**: DCP are numerical linearization parameters assessed based on the data of power sweep with CW signal (no uncertainty required). DCP does not depend on frequency nor media.
- PAR**: PAR is the Peak to Average Ratio that is not calibrated but determined based on the signal characteristics
- A_{x,y,z}; B_{x,y,z}; C_{x,y,z}; D_{x,y,z}; VR_{x,y,z}; A, B, C, D** are numerical linearization parameters assessed based on the data of power sweep for specific modulation signal. The parameters do not depend on frequency nor media. VR is the maximum calibration range expressed in RMS voltage across the diode.
- ConvF and Boundary Effect Parameters**: Assessed in flat phantom using E-field (or Temperature Transfer Standard for $f \leq 800$ MHz) and inside waveguide using analytical field distributions based on power measurements for $f > 800$ MHz. The same setups are used for assessment of the parameters applied for boundary compensation (alpha, depth) of which typical uncertainty values are given. These parameters are used in DASY4 software to improve probe accuracy close to the boundary. The sensitivity in TSL corresponds to NORM_{x,y,z} * ConvF whereby the uncertainty corresponds to that given for ConvF. A frequency dependent ConvF is used in DASY version 4.4 and higher which allows extending the validity from ± 50 MHz to ± 100 MHz.
- Spherical isotropy (3D deviation from isotropy)**: in a field of low gradients realized using a flat phantom exposed by a patch antenna.
- Sensor Offset**: The sensor offset corresponds to the offset of virtual measurement center from the probe tip (on probe axis). No tolerance required.
- Connector Angle**: The angle is assessed using the information gained by determining the NORM_x (no uncertainty required).

Probe ES3DV3

SN:3333

Manufactured: January 24, 2012
Calibrated: November 22, 2013

Calibrated for DASY/EASY Systems
(Note: non-compatible with DASY2 system!)

DASY/EASY - Parameters of Probe: ES3DV3 - SN:3333

Basic Calibration Parameters

	Sensor X	Sensor Y	Sensor Z	Unc (k=2)
Norm ($\mu\text{V}/(\text{V}/\text{m})^2$) ^A	1.08	0.90	0.88	$\pm 10.1 \%$
DCP (mV) ^B	104.9	103.3	101.7	

Modulation Calibration Parameters

UID	Communication System Name		A dB	B dB $\sqrt{\mu\text{V}}$	C	D dB	VR mV	Unc ^E (k=2)
0	CW	X	0.0	0.0	1.0	0.00	140.9	$\pm 2.2 \%$
		Y	0.0	0.0	1.0		132.0	
		Z	0.0	0.0	1.0		170.3	

The reported uncertainty of measurement is stated as the standard uncertainty of measurement multiplied by the coverage factor $k=2$, which for a normal distribution corresponds to a coverage probability of approximately 95%.

^A The uncertainties of NormX,Y,Z do not affect the E^2 -field uncertainty inside TSL (see Pages 5 and 6).

^B Numerical linearization parameter: uncertainty not required.

^E Uncertainty is determined using the max. deviation from linear response applying rectangular distribution and is expressed for the square of the field value.

DASY/EASY - Parameters of Probe: ES3DV3 - SN:3333

Calibration Parameter Determined in Head Tissue Simulating Media

f (MHz) ^C	Relative Permittivity ^F	Conductivity (S/m) ^F	ConvF X	ConvF Y	ConvF Z	Alpha ^G	Depth ^G (mm)	Unct. (k=2)
750	41.9	0.89	6.56	6.56	6.56	0.44	1.54	± 12.0 %
850	41.5	0.92	6.30	6.30	6.30	0.46	1.48	± 12.0 %
1750	40.1	1.37	5.23	5.23	5.23	0.77	1.17	± 12.0 %
1900	40.0	1.40	5.05	5.05	5.05	0.80	1.19	± 12.0 %
2450	39.2	1.80	4.42	4.42	4.42	0.74	1.31	± 12.0 %
2600	39.0	1.96	4.28	4.28	4.28	0.80	1.30	± 12.0 %

^C Frequency validity of ± 100 MHz only applies for DASY v4.4 and higher (see Page 2), else it is restricted to ± 50 MHz. The uncertainty is the RSS of the ConvF uncertainty at calibration frequency and the uncertainty for the indicated frequency band.

^F At frequencies below 3 GHz, the validity of tissue parameters (ϵ and σ) can be relaxed to ± 10% if liquid compensation formula is applied to measured SAR values. At frequencies above 3 GHz, the validity of tissue parameters (ϵ and σ) is restricted to ± 5%. The uncertainty is the RSS of the ConvF uncertainty for indicated target tissue parameters.

^G Alpha/Depth are determined during calibration. SPEAG warrants that the remaining deviation due to the boundary effect after compensation is always less than ± 1% for frequencies below 3 GHz and below ± 2% for frequencies between 3-6 GHz at any distance larger than half the probe tip diameter from the boundary.

DASY/EASY - Parameters of Probe: ES3DV3 - SN:3333

Calibration Parameter Determined in Body Tissue Simulating Media

f (MHz) ^C	Relative Permittivity ^F	Conductivity (S/m) ^F	ConvF X	ConvF Y	ConvF Z	Alpha ^G	Depth ^G (mm)	Unct. (k=2)
750	55.5	0.96	6.11	6.11	6.11	0.33	1.90	± 12.0 %
850	55.2	0.99	6.07	6.07	6.07	0.80	1.19	± 12.0 %
1750	53.4	1.49	4.95	4.95	4.95	0.80	1.26	± 12.0 %
1900	53.3	1.52	4.71	4.71	4.71	0.49	1.54	± 12.0 %
2450	52.7	1.95	4.22	4.22	4.22	0.80	0.95	± 12.0 %
2600	52.5	2.16	4.16	4.16	4.16	0.80	1.07	± 12.0 %

^C Frequency validity of ± 100 MHz only applies for DASY v4.4 and higher (see Page 2), else it is restricted to ± 50 MHz. The uncertainty is the RSS of the ConvF uncertainty at calibration frequency and the uncertainty for the indicated frequency band.

^F At frequencies below 3 GHz, the validity of tissue parameters (ϵ and σ) can be relaxed to ± 10% if liquid compensation formula is applied to measured SAR values. At frequencies above 3 GHz, the validity of tissue parameters (ϵ and σ) is restricted to ± 5%. The uncertainty is the RSS of the ConvF uncertainty for indicated target tissue parameters.

^G Alpha/Depth are determined during calibration. SPEAG warrants that the remaining deviation due to the boundary effect after compensation is always less than ± 1% for frequencies below 3 GHz and below ± 2% for frequencies between 3-6 GHz at any distance larger than half the probe tip diameter from the boundary.

Frequency Response of E-Field (TEM-Cell:ifi110 EXX, Waveguide: R22)

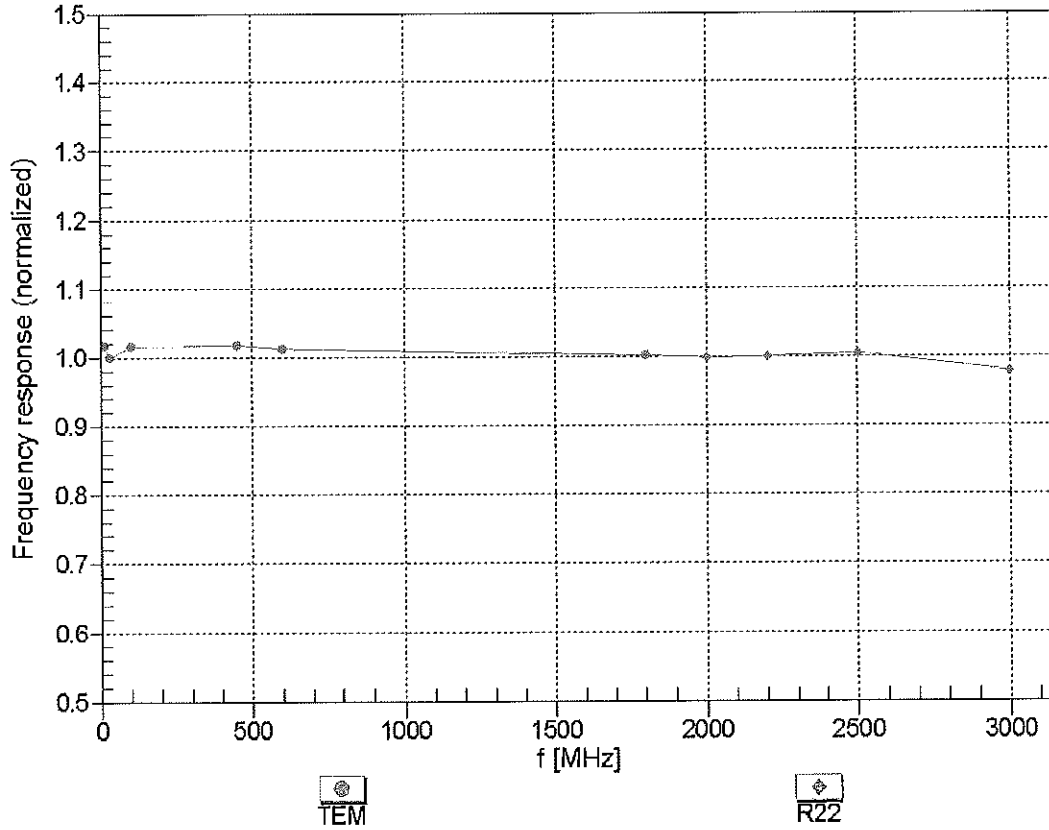

Uncertainty of Frequency Response of E-field: $\pm 6.3\%$ (k=2)

Receiving Pattern (ϕ), $\theta = 0^\circ$

f=600 MHz,TEM

f=1800 MHz,R22

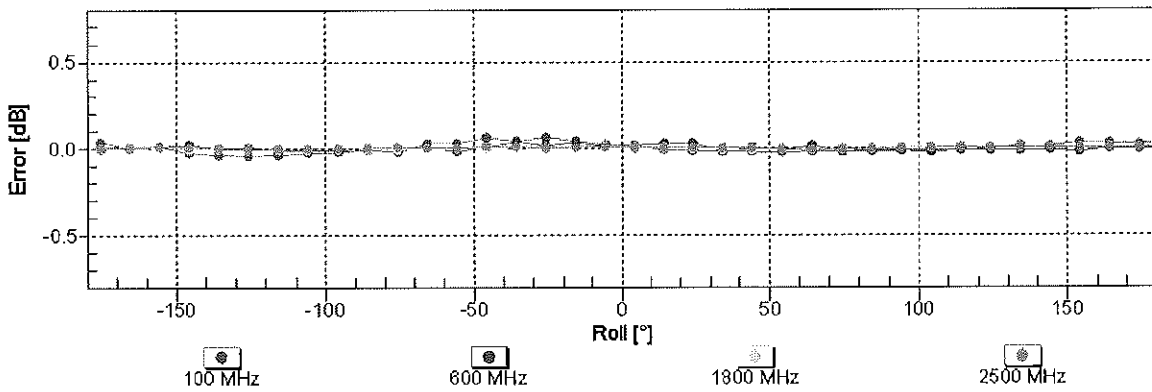
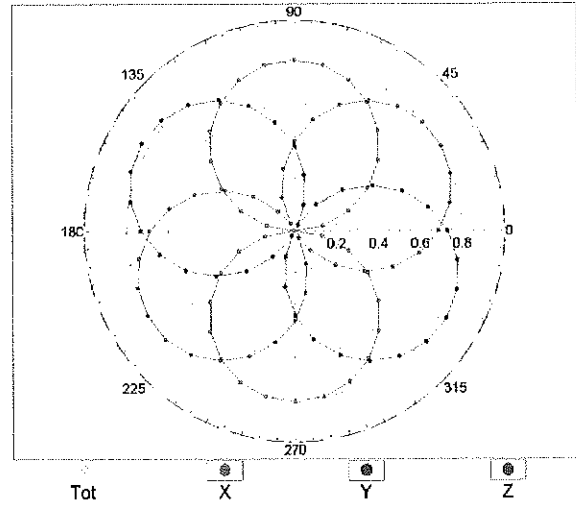
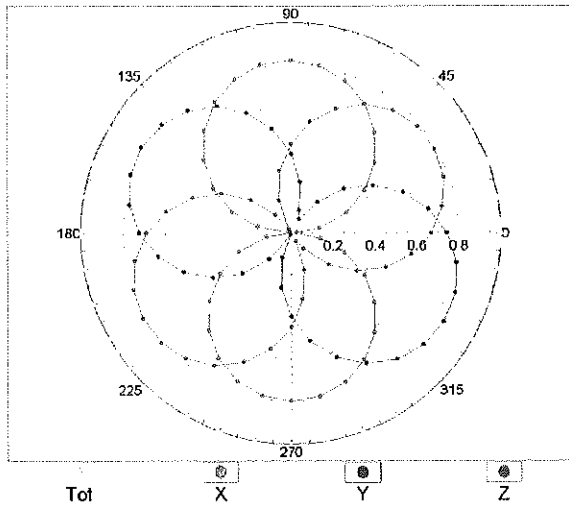

Uncertainty of Axial Isotropy Assessment: $\pm 0.5\%$ (k=2)

Dynamic Range $f(\text{SAR}_{\text{head}})$ (TEM cell , $f = 900 \text{ MHz}$)

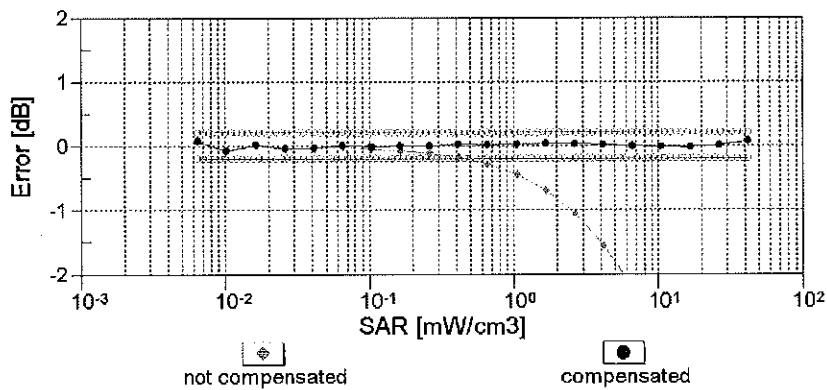
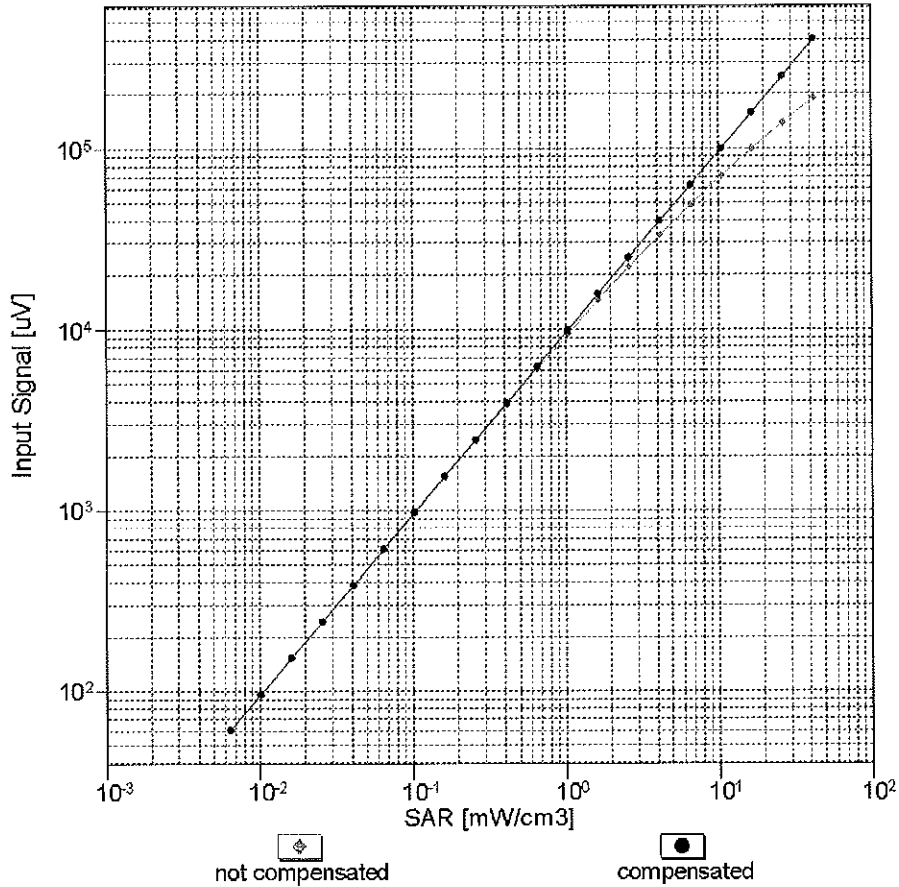

Uncertainty of Linearity Assessment: $\pm 0.6\%$ ($k=2$)

Conversion Factor Assessment

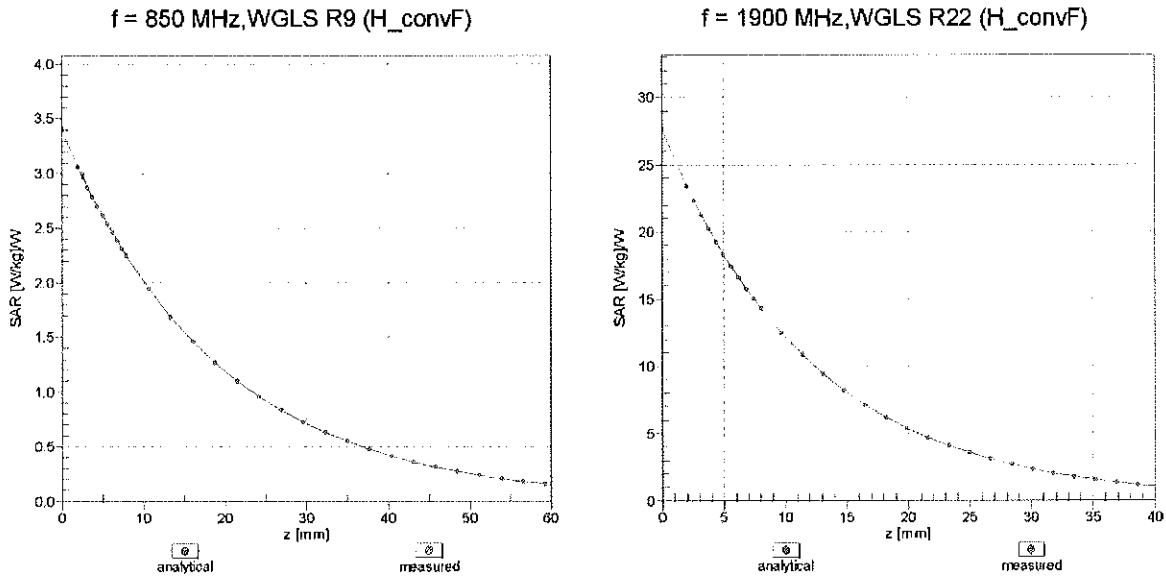

Deviation from Isotropy in Liquid Error (ϕ, θ), f = 900 MHz

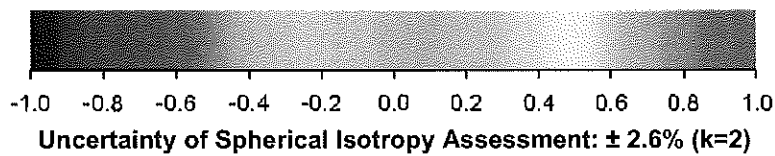
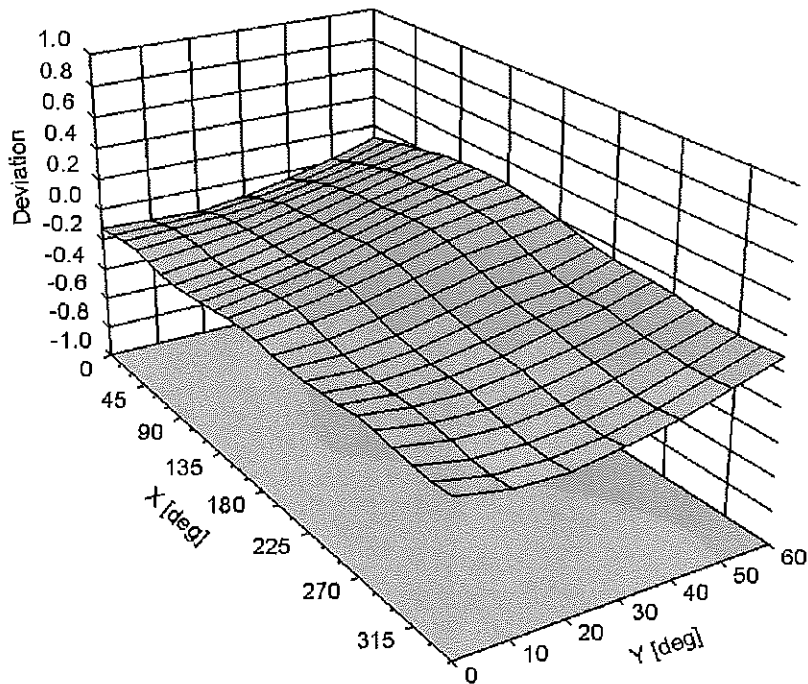

DASY/EASY - Parameters of Probe: ES3DV3 - SN:3333

Other Probe Parameters

Sensor Arrangement	Triangular
Connector Angle (°)	-35.7
Mechanical Surface Detection Mode	enabled
Optical Surface Detection Mode	disabled
Probe Overall Length	337 mm
Probe Body Diameter	10 mm
Tip Length	10 mm
Tip Diameter	4 mm
Probe Tip to Sensor X Calibration Point	2 mm
Probe Tip to Sensor Y Calibration Point	2 mm
Probe Tip to Sensor Z Calibration Point	2 mm
Recommended Measurement Distance from Surface	3 mm



Accredited by the Swiss Accreditation Service (SAS)
The Swiss Accreditation Service is one of the signatories to the EA
Multilateral Agreement for the recognition of calibration certificates

Accreditation No.: **SCS 108**

Client **PC Test**

Certificate No: **ES3-3319_Apr13**

CALIBRATION CERTIFICATE

Object **ES3DV3 - SN:3319**

Calibration procedure(s) **QA CAL-01.v8, QA CAL-23.v4, QA CAL-25.v4
Calibration procedure for dosimetric E-field probes**

Calibration date: **April 29, 2013**

*VCC
6/14/13*

This calibration certificate documents the traceability to national standards, which realize the physical units of measurements (SI).
The measurements and the uncertainties with confidence probability are given on the following pages and are part of the certificate.

All calibrations have been conducted in the closed laboratory facility: environment temperature (22 ± 3)°C and humidity < 70%.

Calibration Equipment used (M&TE critical for calibration)

Primary Standards	ID	Cal Date (Certificate No.)	Scheduled Calibration
Power meter E4419B	GB41293874	04-Apr-13 (No. 217-01733)	Apr-14
Power sensor E4412A	MY41498087	04-Apr-13 (No. 217-01733)	Apr-14
Reference 3 dB Attenuator	SN: S5054 (3c)	04-Apr-13 (No. 217-01737)	Apr-14
Reference 20 dB Attenuator	SN: S5277 (20x)	04-Apr-13 (No. 217-01735)	Apr-14
Reference 30 dB Attenuator	SN: S5129 (30b)	04-Apr-13 (No. 217-01738)	Apr-14
Reference Probe ES3DV2	SN: 3013	28-Dec-12 (No. ES3-3013_Dec12)	Dec-13
DAE4	SN: 660	31-Jan-13 (No. DAE4-660_Jan13)	Jan-14
Secondary Standards	ID	Check Date (in house)	Scheduled Check
RF generator HP 8648C	US3642U01700	4-Aug-99 (in house check Apr-13)	In house check: Apr-15
Network Analyzer HP 8753E	US37390585	18-Oct-01 (in house check Oct-12)	In house check: Oct-13

Calibrated by:	Name Dimce Iliev	Function Laboratory Technician	Signature <i>Dimce Iliev</i>
Approved by:	Name Katja Pokovic	Function Technical Manager	Signature <i>Katja Pokovic</i>
			Issued: April 29, 2013

This calibration certificate shall not be reproduced except in full without written approval of the laboratory.



Accredited by the Swiss Accreditation Service (SAS)

Accreditation No.: **SCS 108**

The Swiss Accreditation Service is one of the signatories to the EA
Multilateral Agreement for the recognition of calibration certificates

Glossary:

TSL	tissue simulating liquid
NORM _{x,y,z}	sensitivity in free space
ConvF	sensitivity in TSL / NORM _{x,y,z}
DCP	diode compression point
CF	crest factor (1/duty_cycle) of the RF signal
A, B, C, D	modulation dependent linearization parameters
Polarization φ	φ rotation around probe axis
Polarization ϑ	ϑ rotation around an axis that is in the plane normal to probe axis (at measurement center), i.e., $\vartheta = 0$ is normal to probe axis

Calibration is Performed According to the Following Standards:

- IEEE Std 1528-2003, "IEEE Recommended Practice for Determining the Peak Spatial-Averaged Specific Absorption Rate (SAR) in the Human Head from Wireless Communications Devices: Measurement Techniques", December 2003
- IEC 62209-1, "Procedure to measure the Specific Absorption Rate (SAR) for hand-held devices used in close proximity to the ear (frequency range of 300 MHz to 3 GHz)", February 2005

Methods Applied and Interpretation of Parameters:

- NORM_{x,y,z}**: Assessed for E-field polarization $\vartheta = 0$ ($f \leq 900$ MHz in TEM-cell; $f > 1800$ MHz: R22 waveguide). NORM_{x,y,z} are only intermediate values, i.e., the uncertainties of NORM_{x,y,z} does not affect the E²-field uncertainty inside TSL (see below *ConvF*).
- NORM(f)_{x,y,z}** = NORM_{x,y,z} * *frequency_response* (see Frequency Response Chart). This linearization is implemented in DASY4 software versions later than 4.2. The uncertainty of the frequency response is included in the stated uncertainty of *ConvF*.
- DCP_{x,y,z}**: DCP are numerical linearization parameters assessed based on the data of power sweep with CW signal (no uncertainty required). DCP does not depend on frequency nor media.
- PAR**: PAR is the Peak to Average Ratio that is not calibrated but determined based on the signal characteristics
- A_{x,y,z}; B_{x,y,z}; C_{x,y,z}; D_{x,y,z}; VR_{x,y,z}; A, B, C, D** are numerical linearization parameters assessed based on the data of power sweep for specific modulation signal. The parameters do not depend on frequency nor media. VR is the maximum calibration range expressed in RMS voltage across the diode.
- ConvF and Boundary Effect Parameters**: Assessed in flat phantom using E-field (or Temperature Transfer Standard for $f \leq 800$ MHz) and inside waveguide using analytical field distributions based on power measurements for $f > 800$ MHz. The same setups are used for assessment of the parameters applied for boundary compensation (alpha, depth) of which typical uncertainty values are given. These parameters are used in DASY4 software to improve probe accuracy close to the boundary. The sensitivity in TSL corresponds to NORM_{x,y,z} * *ConvF* whereby the uncertainty corresponds to that given for *ConvF*. A frequency dependent *ConvF* is used in DASY version 4.4 and higher which allows extending the validity from ± 50 MHz to ± 100 MHz.
- Spherical isotropy (3D deviation from isotropy)**: in a field of low gradients realized using a flat phantom exposed by a patch antenna.
- Sensor Offset**: The sensor offset corresponds to the offset of virtual measurement center from the probe tip (on probe axis). No tolerance required.

Probe ES3DV3

SN:3319

Manufactured: January 10, 2012
Calibrated: April 29, 2013

Calibrated for DASY/EASY Systems
(Note: non-compatible with DASY2 system!)

DASY/EASY - Parameters of Probe: ES3DV3 - SN:3319

Basic Calibration Parameters

	Sensor X	Sensor Y	Sensor Z	Unc (k=2)
Norm ($\mu\text{V}/(\text{V}/\text{m})^2$) ^A	1.12	1.20	1.22	± 10.1 %
DCP (mV) ^B	100.7	102.6	102.4	

Modulation Calibration Parameters

UID	Communication System Name		A dB	B dB/ μV	C	D dB	VR mV	Unc ^E (k=2)
0	CW	X	0.0	0.0	1.0	0.00	152.0	±3.8 %
		Y	0.0	0.0	1.0		159.0	
		Z	0.0	0.0	1.0		149.8	

The reported uncertainty of measurement is stated as the standard uncertainty of measurement multiplied by the coverage factor k=2, which for a normal distribution corresponds to a coverage probability of approximately 95%.

^A The uncertainties of NormX,Y,Z do not affect the E²-field uncertainty inside TSL (see Pages 5 and 6).

^B Numerical linearization parameter: uncertainty not required.

^E Uncertainty is determined using the max. deviation from linear response applying rectangular distribution and is expressed for the square of the field value.

DASY/EASY - Parameters of Probe: ES3DV3 - SN:3319

Calibration Parameter Determined in Head Tissue Simulating Media

f (MHz) ^C	Relative Permittivity ^F	Conductivity (S/m) ^F	ConvF X	ConvF Y	ConvF Z	Alpha	Depth (mm)	Unct. (k=2)
750	41.9	0.89	6.49	6.49	6.49	0.28	1.97	± 12.0 %
850	41.5	0.92	6.23	6.23	6.23	0.42	1.57	± 12.0 %
1900	40.0	1.40	5.22	5.22	5.22	0.80	1.24	± 12.0 %
2450	39.2	1.80	4.57	4.57	4.57	0.80	1.32	± 12.0 %

^C Frequency validity of ± 100 MHz only applies for DASY v4.4 and higher (see Page 2), else it is restricted to ± 50 MHz. The uncertainty is the RSS of the ConvF uncertainty at calibration frequency and the uncertainty for the indicated frequency band.

^F At frequencies below 3 GHz, the validity of tissue parameters (ϵ and σ) can be relaxed to ± 10% if liquid compensation formula is applied to measured SAR values. At frequencies above 3 GHz, the validity of tissue parameters (ϵ and σ) is restricted to ± 5%. The uncertainty is the RSS of the ConvF uncertainty for indicated target tissue parameters.

DASY/EASY - Parameters of Probe: ES3DV3 - SN:3319

Calibration Parameter Determined in Body Tissue Simulating Media

f (MHz) ^C	Relative Permittivity ^F	Conductivity (S/m) ^F	ConvF X	ConvF Y	ConvF Z	Alpha	Depth (mm)	Unct. (k=2)
750	55.5	0.96	6.30	6.30	6.30	0.45	1.53	± 12.0 %
850	55.2	0.99	6.15	6.15	6.15	0.42	1.65	± 12.0 %
1900	53.3	1.52	4.85	4.85	4.85	0.63	1.49	± 12.0 %
2450	52.7	1.95	4.32	4.32	4.32	0.69	1.20	± 12.0 %

^C Frequency validity of ± 100 MHz only applies for DASY v4.4 and higher (see Page 2), else it is restricted to ± 50 MHz. The uncertainty is the RSS of the ConvF uncertainty at calibration frequency and the uncertainty for the indicated frequency band.

^F At frequencies below 3 GHz, the validity of tissue parameters (ϵ and σ) can be relaxed to ± 10% if liquid compensation formula is applied to measured SAR values. At frequencies above 3 GHz, the validity of tissue parameters (ϵ and σ) is restricted to ± 5%. The uncertainty is the RSS of the ConvF uncertainty for indicated target tissue parameters.

Frequency Response of E-Field (TEM-Cell:ifi110 EXX, Waveguide: R22)

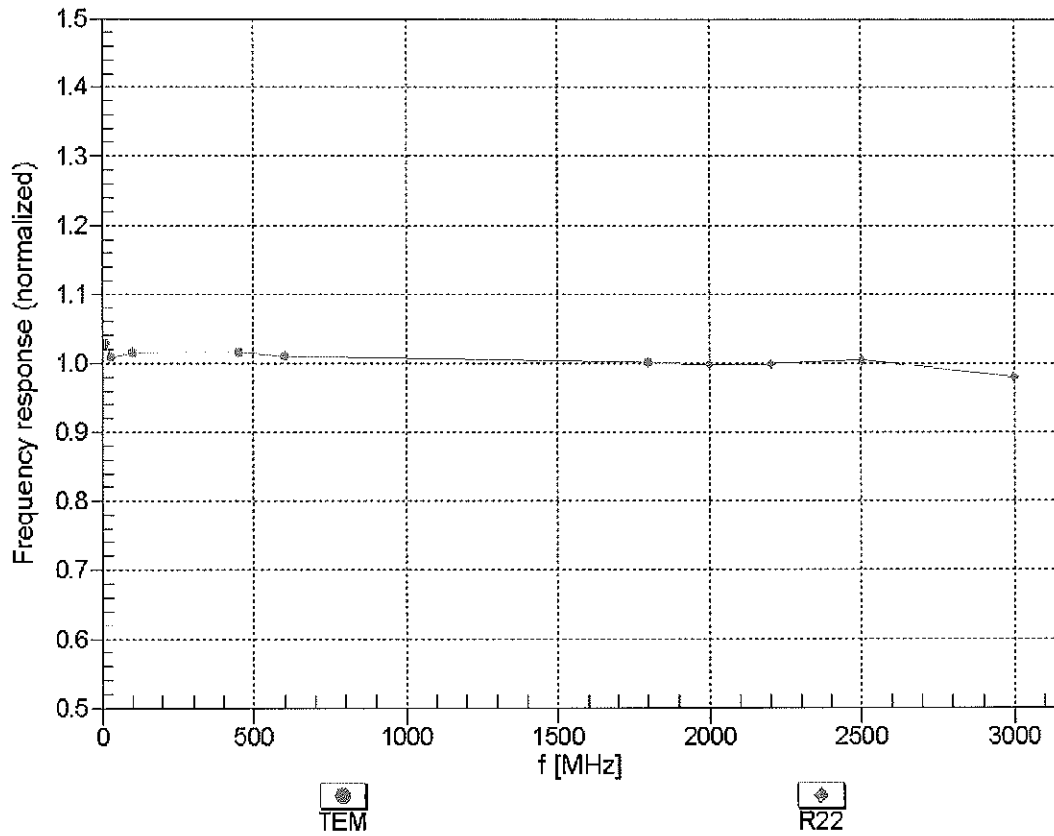

Uncertainty of Frequency Response of E-field: $\pm 6.3\%$ (k=2)

Receiving Pattern (ϕ), $\theta = 0^\circ$

f=600 MHz,TEM

f=1800 MHz,R22

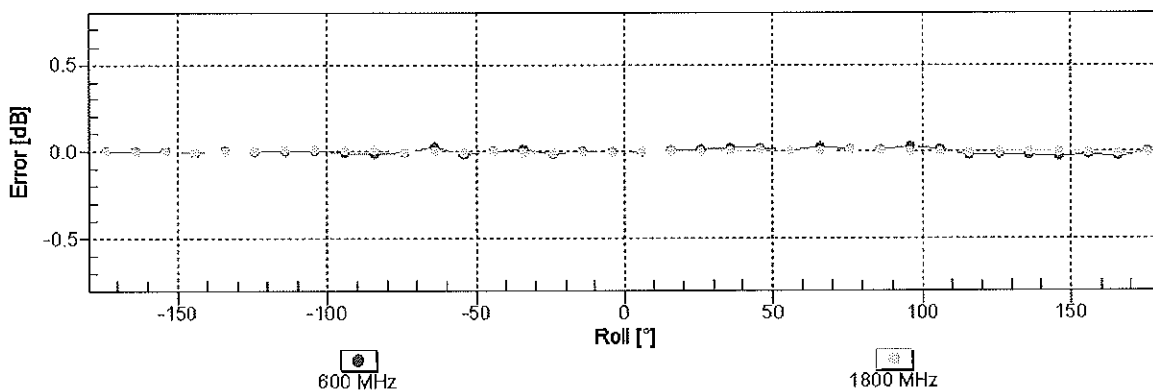
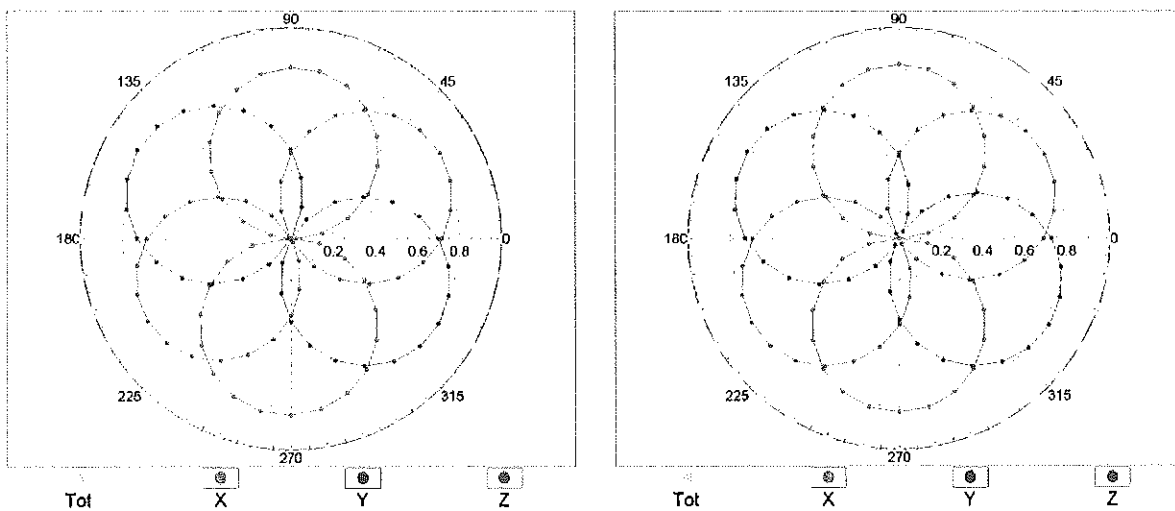

Uncertainty of Axial Isotropy Assessment: $\pm 0.5\%$ (k=2)

Dynamic Range $f(SAR_{head})$ (TEM cell , $f = 900$ MHz)

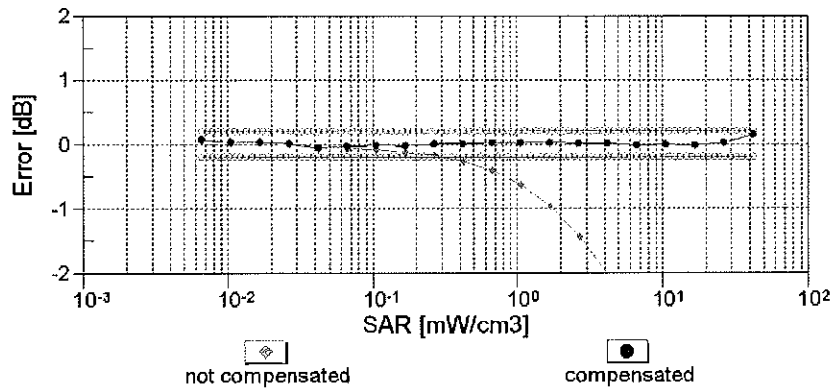
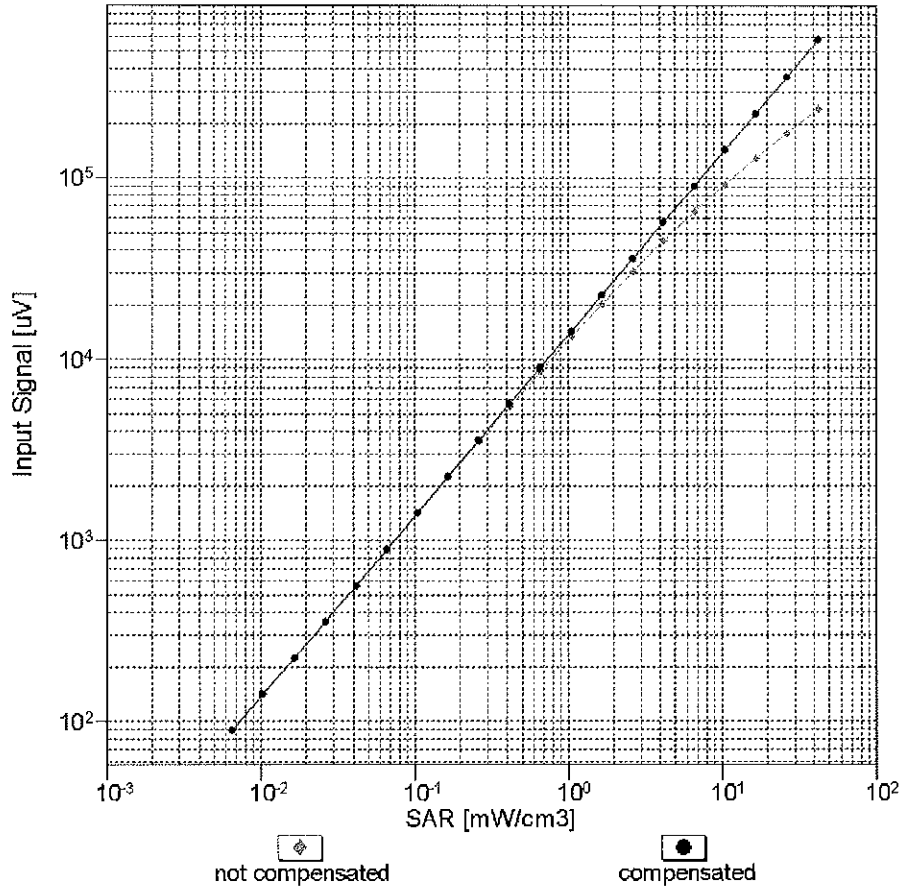

Uncertainty of Linearity Assessment: $\pm 0.6\%$ ($k=2$)

Conversion Factor Assessment

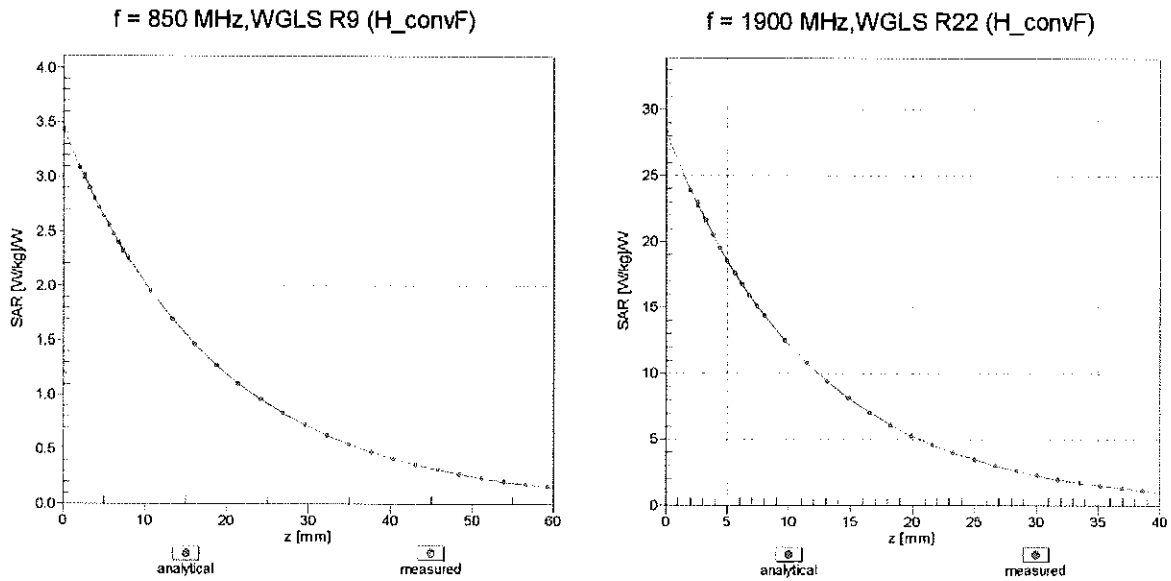

Deviation from Isotropy in Liquid Error (ϕ, θ), f = 900 MHz

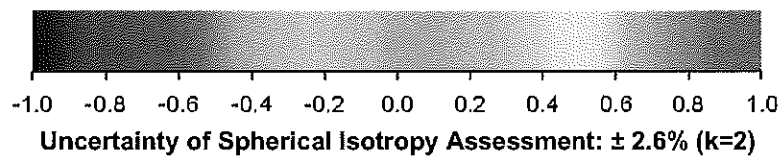
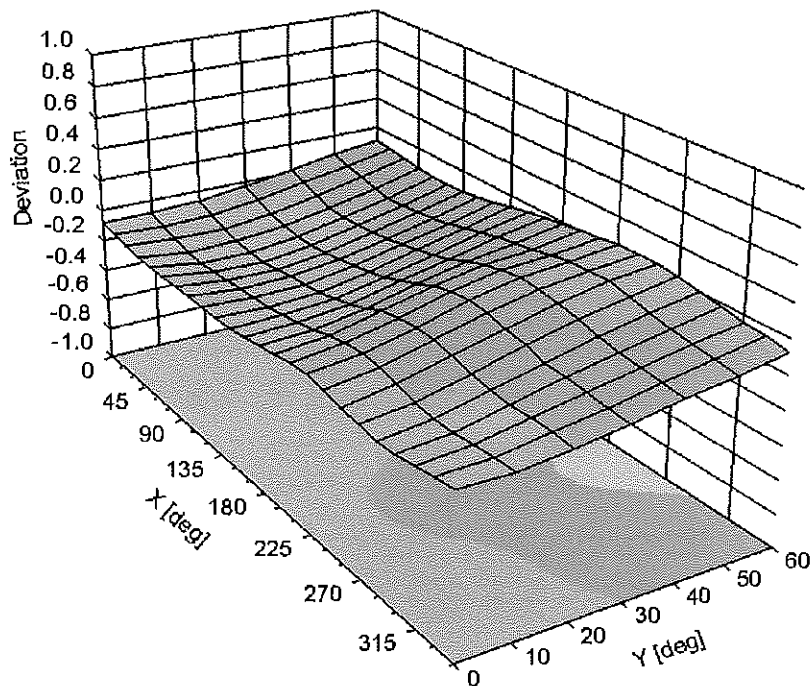

DASY/EASY - Parameters of Probe: ES3DV3 - SN:3319

Other Probe Parameters

Sensor Arrangement	Triangular
Connector Angle (°)	-104.1
Mechanical Surface Detection Mode	enabled
Optical Surface Detection Mode	disabled
Probe Overall Length	337 mm
Probe Body Diameter	10 mm
Tip Length	10 mm
Tip Diameter	4 mm
Probe Tip to Sensor X Calibration Point	2 mm
Probe Tip to Sensor Y Calibration Point	2 mm
Probe Tip to Sensor Z Calibration Point	2 mm
Recommended Measurement Distance from Surface	3 mm

Additional Conversion Factors for Dosimetric E-Field Probe

Type:	ES3DV3
Serial Number:	3319
Place of Assessment:	Zurich
Date of Assessment:	June 19, 2013
Probe Calibration Date:	April 29, 2013

Schmid & Partner Engineering AG hereby certifies that conversion factor(s) of this probe have been evaluated on the date indicated above. The assessment was performed using the FDTD numerical code SEMCAD of Schmid & Partner Engineering AG. The evaluation is coupled with measured conversion factors (probe calibration date indicated above). The uncertainty of the numerical assessment is based on the extrapolation from measured value at 835 MHz or at 1900 MHz.

Assessed by:

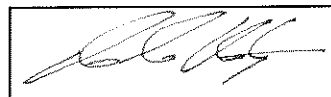

✓
KOK
6/25/13

Dosimetric E-Field Probe ES3DV3 SN:3319Conversion factor (\pm standard deviation)1750 \pm 50 MHz *ConvF* 5.59 \pm 7% $\epsilon_r = 40.1 \pm 5\%$
 $\sigma = 1.37 \pm 5\%$ mho/m
(head tissue)1750 \pm 50 MHz *ConvF* 5.22 \pm 7% $\epsilon_r = 53.4 \pm 5\%$
 $\sigma = 1.49 \pm 5\%$ mho/m
(body tissue)**Important Note:**

For numerically assessed probe conversion factors, parameters Alpha and Delta in the DASY software must have the following entries: Alpha = 0 and Delta = 1.

Please see also DASY Manual.

APPENDIX D: SAR TISSUE SPECIFICATIONS

Measurement Procedure for Tissue verification:



- 1) The network analyzer and probe system was configured and calibrated.
- 2) The probe was immersed in the tissue. The tissue was placed in a nonmetallic container. Trapped air bubbles beneath the flange were minimized by placing the probe at a slight angle.
- 3) The complex admittance with respect to the probe aperture was measured
- 4) The complex relative permittivity ϵ can be calculated from the below equation (Pournaropoulos and Misra):

$$Y = \frac{j2\omega\epsilon_r\epsilon_0}{[\ln(b/a)]^2} \int_a^b \int_a^b \int_0^\pi \frac{\cos\phi' \exp[-j\omega r(\mu_0\epsilon_r'\epsilon_0)^{1/2}]}{r} d\phi' d\rho' d\rho$$

where Y is the admittance of the probe in contact with the sample, the primed and unprimed coordinates refer to source and observation points, respectively, $r^2 = \rho^2 + \rho'^2 - 2\rho\rho' \cos\phi'$, ω is the angular frequency, and $j = \sqrt{-1}$.

**Table D-I
Composition of the Tissue Equivalent Matter**

Frequency (MHz)	835	835	1900	1900	2450	2450
Tissue	Head	Body	Head	Body	Head	Body
Ingredients (% by weight)						
Bactericide	0.1	0.1			See Next Page	
DGBE			44.92	29.44		26.7
HEC	1	1				
NaCl	1.45	0.94	0.18	0.39		0.1
Sucrose	57	44.9				
Water	40.45	53.06	54.9	70.17		73.2

FCC ID: ZNFL34C		SAR EVALUATION REPORT		Reviewed by: Quality Manager
Test Dates: 01/22/2014 - 01/27/2014	DUT Type: Portable Handset	APPENDIX D: Page 1 of 2		

2 Composition / Information on ingredients

The Item is composed of the following ingredients:

H2O	Water, 52 – 75%
C8H18O3	Diethylene glycol monobutyl ether (DGBE), 25 – 48% (CAS-No. 112-34-5, EC-No. 203-961-6, EC-index-No. 603-096-00-8) Relevant for safety; Refer to the respective Safety Data Sheet*.
NaCl	Sodium Chloride, <1.0%

Figure D-1
Composition of 2.4 GHz Head Tissue Equivalent Matter

Note: 2.4 GHz head liquid recipes are proprietary SPEAG. Since the composition is approximate to the actual liquids utilized, the manufacturer tissue-equivalent liquid data sheets are provided below.

Measurement Certificate / Material Test

Item Name	Head Tissue Simulating Liquid (HSL 2450)
Product No.	SL AAH 245 BA (Charge: 120112-4)
Manufacturer	SPEAG
Measurement Method	
TSL dielectric parameters measured using calibrated OCP probe (type DAK).	
Target Parameters	
Target parameters as defined in the IEEE 1528 and IEC 62209 compliance standards.	
Test Condition	
Ambient Condition 22°C; 30% humidity	
TSL Temperature 23°C	
Test Date 18-Jan-12	
Additional Information	
TSL Density 0.988 g/cm ³	
TSL Heat-capacity 3.680 kJ/(kg*K)	

Results

f [MHz]	Measured			Target		Diff.to Target [%]	
	HP-e'	HP-e''	sigma	eps	sigma	Δ-eps	Δ-sigma
1900	40.5	11.99	1.27	40.0	1.40	1.1	-9.5
1925	40.3	12.08	1.29	40.0	1.40	0.9	-7.6
1950	40.2	12.17	1.32	40.0	1.40	0.6	-5.7
1975	40.1	12.26	1.35	40.0	1.40	0.3	-3.8
2000	40.0	12.35	1.37	40.0	1.40	0.0	-1.9
2025	39.9	12.44	1.40	40.0	1.42	-0.1	-1.5
2050	39.9	12.53	1.43	39.9	1.44	-0.3	-1.1
2075	39.7	12.60	1.46	39.9	1.47	-0.4	-0.8
2100	39.6	12.68	1.48	39.8	1.49	-0.6	-0.5
2125	39.5	12.76	1.51	39.8	1.51	-0.7	-0.2
2150	39.4	12.84	1.54	39.7	1.53	-0.8	0.2
2175	39.3	12.93	1.56	39.7	1.56	-1.0	0.6
2200	39.2	13.02	1.59	39.6	1.58	-1.1	1.0
2225	39.1	13.09	1.62	39.6	1.60	-1.3	1.3
2250	39.0	13.17	1.65	39.6	1.62	-1.4	1.6
2275	38.9	13.25	1.68	39.5	1.64	-1.5	2.0
2300	38.8	13.33	1.71	39.5	1.67	-1.7	2.3
2325	38.7	13.40	1.73	39.4	1.69	-1.8	2.7
2350	38.6	13.48	1.76	39.4	1.71	-2.0	3.0
2375	38.5	13.56	1.79	39.3	1.73	-2.1	3.3
2400	38.4	13.63	1.82	39.3	1.76	-2.3	3.7
2425	38.3	13.71	1.85	39.2	1.78	-2.4	4.0
2450	38.2	13.78	1.88	39.2	1.80	-2.6	4.4
2475	38.1	13.85	1.91	39.2	1.83	-2.7	4.4
2500	38.0	13.93	1.94	39.1	1.85	-2.9	4.4
2525	37.9	13.99	1.97	39.1	1.88	-3.1	4.4
2550	37.8	14.06	1.99	39.1	1.91	-3.3	4.4
2575	37.7	14.13	2.02	39.0	1.94	-3.5	4.5
2600	37.6	14.20	2.05	39.0	1.96	-3.7	4.6
2625	37.5	14.28	2.08	39.0	1.99	-3.8	4.6
2650	37.4	14.32	2.11	38.9	2.02	-4.0	4.6
2675	37.3	14.39	2.14	38.9	2.05	-4.3	4.7
2700	37.1	14.46	2.17	38.9	2.07	-4.5	4.8

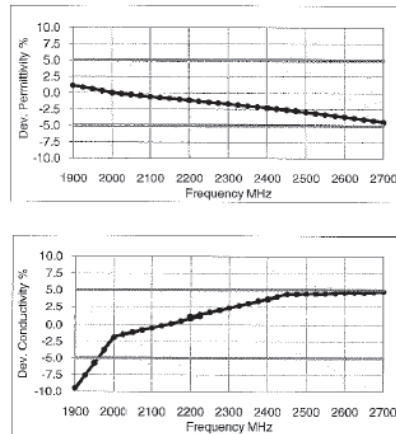



Figure D-2
2.4 GHz Head Tissue Equivalent Matter

FCC ID: ZNFL34C		SAR EVALUATION REPORT		Reviewed by: Quality Manager
Test Dates: 01/22/2014 - 01/27/2014	DUT Type: Portable Handset			APPENDIX D: Page 2 of 2

APPENDIX E: SAR SYSTEM VALIDATION



Per FCC KDB 865664 D02v01, SAR system validation status should be documented to confirm measurement accuracy. The SAR systems (including SAR probes, system components and software versions) used for this device were validated against its performance specifications prior to the SAR measurements. Reference dipoles were used with the required tissue- equivalent media for system validation, according to the procedures outlined in IEEE 1528-2003 and FCC KDB 865664 D01 v01. Since SAR probe calibrations are frequency dependent, each probe calibration point was validated at a frequency within the valid frequency range of the probe calibration point, using the system that normally operates with the probe for routine SAR measurements and according to the required tissue-equivalent media.

A tabulated summary of the system validation status including the validation date(s), measurement frequencies, SAR probes and tissue dielectric parameters has been included.

Table E-I
SAR System Validation Summary

SAR SYSTEM #	FREQ. [MHz]	DATE	PROBE SN	PROBE TYPE	PROBE CAL. POINT		COND.	PERM.	CW VALIDATION			MOD. VALIDATION		
							(σ)	(ϵ_r)	SENSI-TIVITY	PROBE LINEARITY	PROBE ISOTROPY	MOD. TYPE	DUTY FACTOR	PAR
B	835	11/5/2013	3288	ES3DV3	835	Head	0.882	41.40	PASS	PASS	PASS	GMSK	PASS	N/A
C	1900	8/13/2013	3263	ES3DV3	1900	Head	1.458	38.68	PASS	PASS	PASS	GMSK	PASS	N/A
G	2450	1/15/2014	3209	ES3DV3	2450	Head	1.794	38.12	PASS	PASS	PASS	OFDM	N/A	PASS
H	835	6/19/2013	3318	ES3DV3	835	Body	1.016	55.43	PASS	PASS	PASS	GMSK	PASS	N/A
K	835	12/19/2013	3333	ES3DV3	835	Body	1.006	53.18	PASS	PASS	PASS	GMSK	PASS	N/A
I	1900	7/1/2013	3319	ES3DV3	1900	Body	1.502	52.10	PASS	PASS	PASS	GMSK	PASS	N/A
C	2450	8/9/2013	3263	ES3DV3	2450	Body	1.970	51.89	PASS	PASS	PASS	OFDM	N/A	PASS

NOTE: While the probes have been calibrated for both a CW and modulated signals, all measurements were performed using communication systems calibrated for CW signals only. Modulations in the table above represent test configurations for which the measurement system has been validated per FCC KDB Publication 865664 D01v01 for scenarios when CW probe calibrations are used with other signal types. SAR systems were validated for modulated signals with a periodic duty cycle, such as GMSK, or with a high peak to average ratio (>5 dB), such as OFDM according to KDB 865664.

FCC ID: ZNFL34C	 PCTEST ENGINEERING LABORATORY, INC.	SAR EVALUATION REPORT	 LG	Reviewed by: Quality Manager
Test Dates: 01/22/2014 - 01/27/2014	DUT Type: Portable Handset			APPENDIX E: Page 1 of 1