

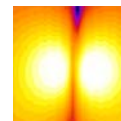

PCTEST

7185 Oakland Mills Road, Columbia, MD 21046 USA
Tel. 410.290.6652 / Fax 410.290.6654
http://www.pctest.com



HEARING AID COMPATIBILITY

Applicant Name:
LG Electronics U.S.A, Inc.
1000 Sylvan Avenue
Englewood Cliffs, NJ 07632
United States

Date of Testing:
03/16/2020 - 03/26/2020
Test Site/Location:
PCTEST, Columbia, MD, USA
Test Report Serial No.:
1M2003020032-03.ZNF
Date of Issue:
04/02/2020

FCC ID:	ZNFK400AM
APPLICANT:	LG ELECTRONICS U.S.A, INC.

Scope of Test: Audio Band Magnetic Testing (T-Coil)
Application Type: Certification
FCC Rule Part(s): CFR §20.19(b)
HAC Standard: ANSI C63.19-2011
 285076 D01 HAC Guidance v05
 285076 D02 T-Coil testing for CMRS IP v03

DUT Type: Portable Handset
Model: LM-K400AKR
Additional Model(s): LMK400AKR, K400AKR, LM-K400AM, LMK400AM, K400AM
Test Device Serial No.: Pre-Production Sample [S/N: 10575]

C63.19-2011 HAC Category:	T3 (SIGNAL TO NOISE CATEGORY)
----------------------------------	--------------------------------------

This wireless portable device has been shown to be hearing-aid compatible under the above rated category, specified in ANSI/IEEE Std. C63.19-2011 and has been tested in accordance with the specified measurement procedures. Test results reported herein relate only to the item(s) tested. Hearing-Aid Compatibility is based on the assumption that all production units will be designed electrically identical to the device tested in this report. North American Bands only.

I attest to the accuracy of data. All measurements reported herein were performed by me or were made under my supervision and are correct to the best of my knowledge and belief. I assume full responsibility for the completeness of these measurements and vouch for the qualifications of all persons taking them.



Randy Ortanez
President



FCC ID: ZNFK400AM		HAC (T-COIL) TEST REPORT		Approved by: Quality Manager
Filename: 1M2003020032-03.ZNF	Test Dates: 03/16/2020 - 03/26/2020	DUT Type: Portable Handset		Page 1 of 71

TABLE OF CONTENTS

1.	INTRODUCTION	3
2.	DUT DESCRIPTION.....	4
3.	ANSI C63.19-2011 PERFORMANCE CATEGORIES	5
4.	METHOD OF MEASUREMENT	7
5.	VOLTE TEST SYSTEM SETUP AND DUT CONFIGURATION	17
6.	VOWIFI TEST SYSTEM SETUP AND DUT CONFIGURATION	19
7.	OTT VOIP TEST SYSTEM AND DUT CONFIGURATION	22
8.	FCC 3G MEASUREMENTS	25
9.	T-COIL TEST SUMMARY	26
10.	MEASUREMENT UNCERTAINTY	34
11.	EQUIPMENT LIST.....	35
12.	TEST DATA.....	36
13.	CALIBRATION CERTIFICATES.....	56
14.	CONCLUSION.....	66
15.	REFERENCES	67
16.	TEST SETUP PHOTOGRAPHS	69

FCC ID: ZNFK400AM	 <small>Head to the point of service</small>	HAC (T-COIL) TEST REPORT		Approved by: Quality Manager
Filename: 1M2003020032-03.ZNF	Test Dates: 03/16/2020 - 03/26/2020	DUT Type: Portable Handset	Page 2 of 71	

1. INTRODUCTION

On July 10, 2003, the Federal Communications Commission (FCC) adopted new rules requiring wireless manufacturers and service providers to provide digital wireless phones that are compatible with hearing aids. The FCC has modified the exemption for wireless phones under the Hearing Aid Compatibility Act of 1998 (HAC Act) in WT Docket 01-309 RM-8658¹ to extend the benefits of wireless telecommunications to individuals with hearing disabilities. These benefits encompass business, social and emergency communications, which increase the value of the wireless network for everyone. An estimated more than 10% of the population in the United States show signs of hearing impairment and of that fraction, almost 80% use hearing aids. Approximately 500 million people worldwide and 30 million people in the United States suffer from hearing loss.

Compatibility Tests Involved:

The standard calls for wireless communications devices to be measured for:

- RF Electric-field emissions
- T-coil mode, magnetic-signal strength in the audio band
- T-coil mode, magnetic-signal frequency response through the audio band
- T-coil mode, magnetic-signal and noise articulation index

The hearing aid must be measured for:

- RF immunity in microphone mode
- RF immunity in T-coil mode

In the following tests and results, this report includes the evaluation for a wireless communications device.

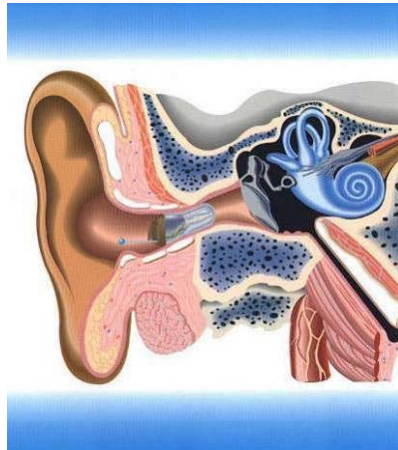



Figure 1-1 Hearing Aid *in-vitu*

¹ FCC Rule & Order, WT Docket 01-309 RM-8658

FCC ID: ZNFK400AM		HAC (T-COIL) TEST REPORT		Approved by: Quality Manager
Filename: 1M2003020032-03.ZNF	Test Dates: 03/16/2020 - 03/26/2020	DUT Type: Portable Handset		Page 3 of 71

2. DUT DESCRIPTION



FCC ID: ZNFK400AM
Applicant: LG Electronics U.S.A, Inc.
 1000 Sylvan Avenue
 Englewood Cliffs, NJ 07632
 United States
Model: LM-K400AKR
Additional Model(s): LMK400AKR, K400AKR, LM-K400AM, LMK400AM, K400AM
Serial Number: 10575
HW Version: Rev.1.0
SW Version: K400AM07c
Antenna: Internal Antenna
DUT Type: Portable Handset

Table 2-1
ZNFK400AM HAC Air Interfaces

Air-Interface	Band (MHz)	Type Transport	HAC Tested	Simultaneous But Not Tested	Name of Voice Service	Audio Codec Evaluated
GSM	850	VO	Yes	Yes: WIFI or BT	CMRS Voice ¹	EFR
	1900	VD	Yes	Yes: WIFI or BT	Google Duo ²	OPUS
	GPRS/EDGE					
UMTS	850	VD	Yes	Yes: WIFI or BT	CMRS Voice ¹	NB AMR
	1700					
	1900	VD	Yes	Yes: WIFI or BT	Google Duo ²	OPUS
	HSPA					
LTE (FDD)	700 (B12)	VD	Yes	Yes: WIFI or BT	VoLTE ¹ , Google Duo ²	VoLTE: NB AMR, WB AMR Google Duo: OPUS
	790 (B14)					
	850 (B5)					
	1700 (B66)					
	1900 (B2)					
	2300 (B30)					
WIFI	2450	VD	Yes	Yes: GSM, UMTS, or LTE	VoWIFI ² , Google Duo ²	VoWIFI: NB AMR, WB AMR Google Duo: OPUS
BT	2450	DT	No	Yes: GSM, UMTS, or LTE	N/A	N/A
Type Transport VO = Voice Only DT = Digital Data - Not intended for Voice Services VD = CMRS and/or IP Voice over Data Transport			Notes: 1. Reference level in accordance with 7.4.2.1 of ANSI C63.19-2011 and July 2012 C63 VoLTE Interpretation. 2. Reference level is -20dBm0 in accordance with FCC KDB 285076 D02			

I. LTE Band Selection

This device supports the following pair of LTE bands with similar frequencies: LTE B4 & B66. This pair of LTE bands has the same target power and shares the same transmission path. Since the supported frequency span for the smaller LTE band is completely covered by the larger LTE band, only the larger LTE band (LTE B66) was evaluated for hearing-aid compliance.

FCC ID: ZNFK400AM	PCTEST Proud to be part of LG	HAC (T-COIL) TEST REPORT	LG	Approved by: Quality Manager
Filename: 1M2003020032-03.ZNF	Test Dates: 03/16/2020 - 03/26/2020	DUT Type: Portable Handset	Page 4 of 71	

3. ANSI C63.19-2011 PERFORMANCE CATEGORIES

I. MAGNETIC COUPLING

Axial and Radial Field Intensity

All orientations of the magnetic field, in the axial and radial position along the measurement plane shall be ≥ -18 dB(A/m) at 1 kHz in a 1/3 octave band filter per §8.3.1.

Frequency Response

The frequency response of the axial component of the magnetic field shall follow the response curve specified in EIA RS-504-1983, over the frequency range 300 Hz – 3000 Hz per §8.3.2.

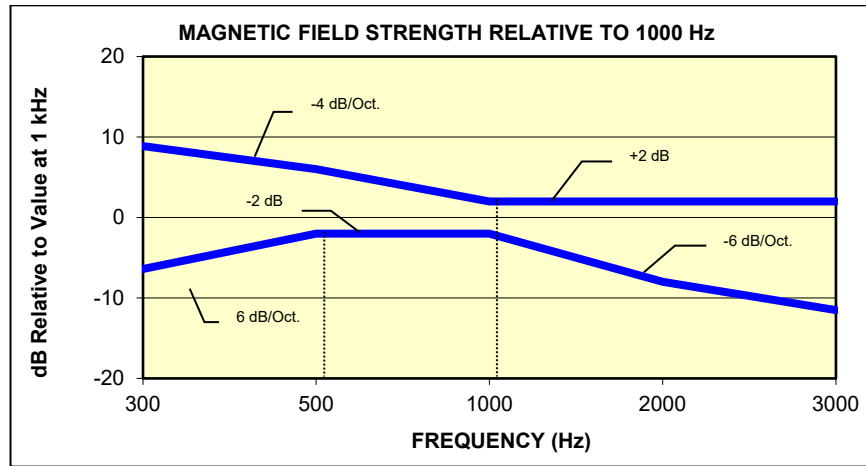

Figure 3-1
Magnetic field frequency response for Wireless Devices with an axial field ≤ -15 dB(A/m) at 1 kHz

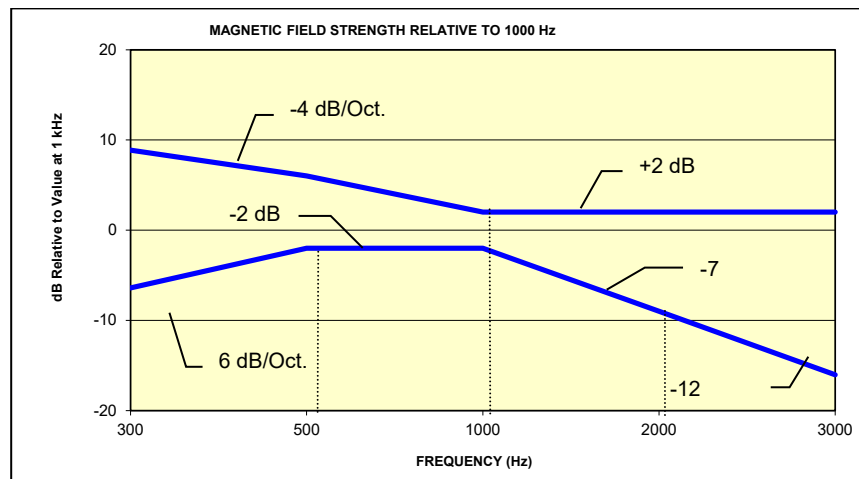





Figure 3-2
Magnetic Field frequency response for wireless devices with an axial field that exceeds -15 dB(A/m) at 1 kHz

FCC ID: ZNFK400AM	 PCTEST Proud to be part of 	HAC (T-COIL) TEST REPORT	 LG	Approved by: Quality Manager
Filename: 1M2003020032-03.ZNF	Test Dates: 03/16/2020 - 03/26/2020	DUT Type: Portable Handset		Page 5 of 71

Signal Quality



The table below provides the signal quality requirement for the intended audio magnetic signal from a wireless device. Only the RF immunity of the hearing aid is measured in T-coil mode. It is assumed that a hearing aid can have no immunity to an interference signal in the audio band, which is the intended reception band for this mode. The only criterion that can be measured is the RF immunity in T-coil mode. This is measured using the same procedure as the audio coupling mode at the same levels.

The signal quality of the axial and radial components of the magnetic field was used to determine the T-coil mode category.

Category	Telephone RF Parameters
	Wireless Device Signal Quality [(Signal + Noise)-to-noise ratio in dB]
T1	0 to 10 dB
T2	10 to 20 dB
T3	20 to 30 dB
T4	> 30 dB

Table 3-1
Magnetic Coupling Parameters

Note: The FCC limit for SNNR is 20dB and the test data margins will indicate a margin from the FCC limit for compliance.

FCC ID: ZNFK400AM	 PCTEST Head to toe part of device	HAC (T-COIL) TEST REPORT	 LG	Approved by: Quality Manager
Filename: 1M2003020032-03.ZNF	Test Dates: 03/16/2020 - 03/26/2020	DUT Type: Portable Handset		Page 6 of 71

4. METHOD OF MEASUREMENT

I. Test Setup

The equipment was connected as shown in an acoustic/RF hemi-anechoic chamber:

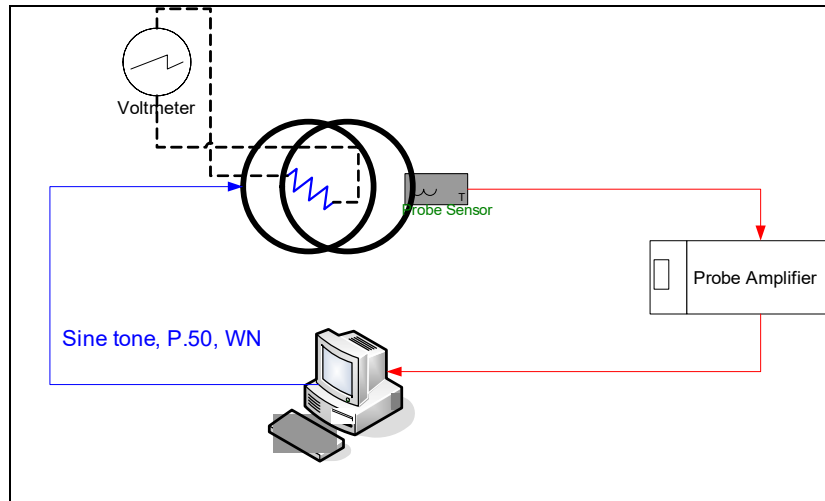

Figure 4-1
Validation Setup with Helmholtz Coil

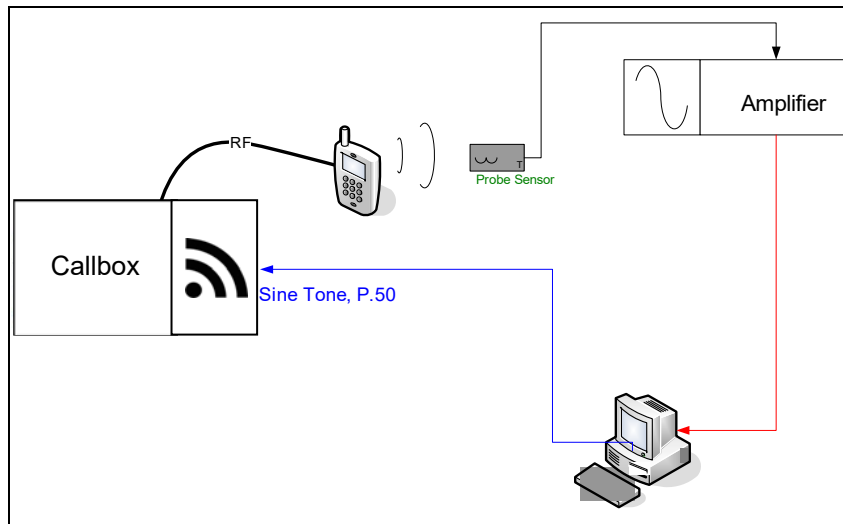





Figure 4-2
T-Coil Test Setup

FCC ID: ZNFK400AM	 PCTEST Proud to be part of 	HAC (T-COIL) TEST REPORT	 LG	Approved by: Quality Manager
Filename: 1M2003020032-03.ZNF	Test Dates: 03/16/2020 - 03/26/2020	DUT Type: Portable Handset		Page 7 of 71

© 2020 PCTEST

REV 3.5.M
3/2/2020

© 2020 PCTEST All rights reserved. Unless otherwise specified, no part of this report may be reproduced or utilized in any part, form or by any means, electronic or mechanical, including photocopying and microfilm, without permission in writing from PCTEST. If you have any questions about this international copyright or have an enquiry about obtaining additional rights to this report or assembly of contents thereof, please contact INFO@PCTEST.COM.

II. Scanning Mechanism

Manufacturer:	TEM
Accuracy:	± 0.83 cm/meter
Minimum Step Size:	0.1 mm
Maximum speed	6.1 cm/sec
Line Voltage:	115 VAC
Line Frequency:	60 Hz
Material Composite:	Delrin (Acetal)
Data Control:	Parallel Port
Dynamic Range (X-Y-Z):	45 x 31.75 x 47 cm
Dimensions:	36" x 25" x 38"
Operating Area:	36" x 49" x 55"
Reflections:	< -20 dB (in anechoic chamber)

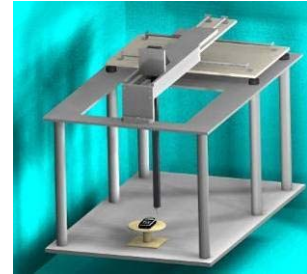

Figure 4-3
RF Near-Field Scanner

III. ITU-T P.50 Artificial Voice

Manufacturer:	ITU-T
Active Frequency Range:	100 Hz – 8 kHz
Stimulus Type:	Male and Female, no spaces
Single Sample Duration:	20.96 seconds
Activity Level:	100%

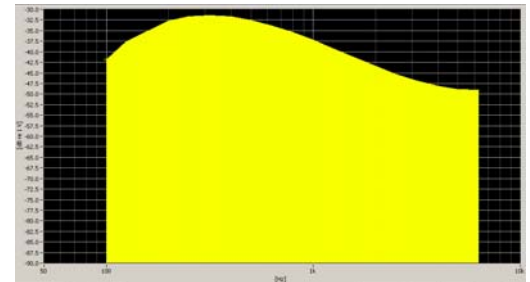

Figure 4-4
Spectral Characteristic of full P.50

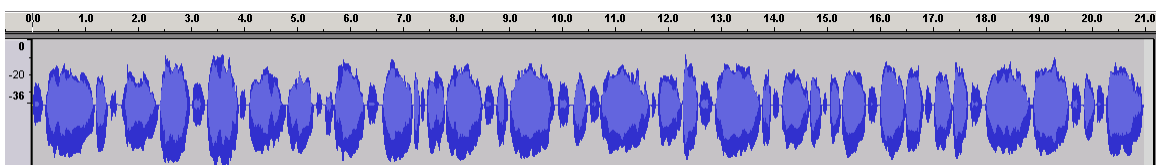



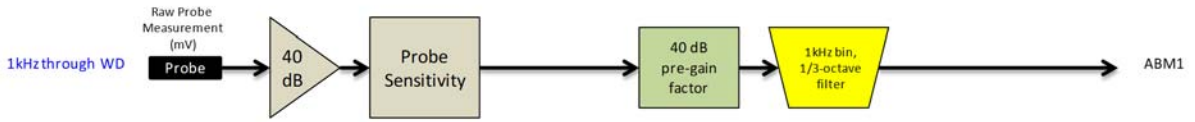

Figure 4-5
Temporal Characteristic of full P.50

FCC ID: ZNFK400AM	 PCTEST Proud to be part of 	HAC (T-COIL) TEST REPORT	 LG	Approved by: Quality Manager
Filename: 1M2003020032-03.ZNF	Test Dates: 03/16/2020 - 03/26/2020	DUT Type: Portable Handset		Page 8 of 71

ABM1 Measurement Block Diagram:



ABM2 Measurement Block Diagram:

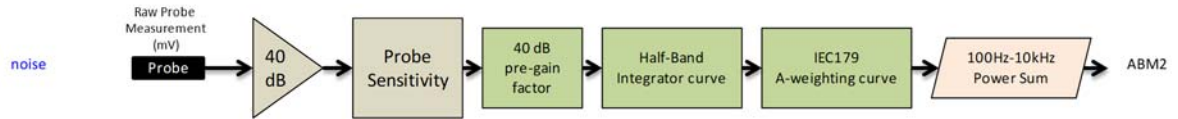

Figure 4-6 Magnetic Measurement Processing Steps

IV. Test Procedure

1. Ambient Noise Check per C63.19 §7.3.1
 - a. Ambient interference was monitored using a Real-Time Analyzer between 100-10,000 Hz with 1/3 octave filtering.
 - b. “A-weighting” and Half-Band Integration was applied to the measurements.
 - c. Since this measurement was measured in the same method as ABM2 measurements, this level was verified to be more than 10 dB below the lowest measurement signal (which is the highest ABM2 measurement for a T4 WD). Therefore the maximum noise level for a T4 WD with an ABM1 = -18 dBA/m is:

$$-18 - 30 - 10 = -58 \text{ dBA/m}$$
2. Measurement System Validation (See Figure 4-1)
 - a. The measurement system including the probe, pre-amplifier and acquisition system were validated as an entire system to ensure the reliability of test measurements.
 - b. ABM1 Validation
 The magnetic field at the center of the Helmholtz coil is given by the equation (per C63.19 Annex D.10.1):

$$H_c = \frac{NI}{r\sqrt{1.25^3}} = \frac{N\left(\frac{V}{R}\right)}{r\sqrt{1.25^3}}$$



Where H_c = magnetic field strength in amperes per meter
 N = number of turns per coil

For the Helmholtz Coil (SN: 925), $N=20$; $r=0.08\text{m}$; $R=10.2\Omega$ and using $V=18\text{mV}$:

$$H_{c,925} = \frac{20 \cdot \left(\frac{0.018}{10.2}\right)}{0.08 \cdot \sqrt{1.25^3}} = 0.316 \text{ A/m} \approx -10 \text{ dB(A/m)}$$

For the Helmholtz Coil (SN: SBI 1052), $N=20$; $r=0.13\text{m}$; $R=10.193\Omega$ and using $V=29\text{mV}$:

$$H_{c,SBI 1052} = \frac{20 \cdot \left(\frac{0.029}{10.193}\right)}{0.13 \cdot \sqrt{1.25^3}} = 0.316 \text{ A/m} \approx -10 \text{ dB(A/m)}$$

FCC ID: ZNFK400AM		HAC (T-COIL) TEST REPORT		Approved by: Quality Manager
Filename: 1M2003020032-03.ZNF	Test Dates: 03/16/2020 - 03/26/2020	DUT Type: Portable Handset		Page 9 of 71

Therefore a pure tone of 1kHz was applied into the coils such that 18mV was observed across the resistor in Helmholtz coil SN: 925 and 29mV was observed across the resistor in Helmholtz coil SN: SBI 1052. The voltmeter used for measurement was verified to be capable of measurements in the audio band range. This theoretically generates an expected field of -10 dB(A/m) in the center of the Helmholtz coil which was used to validate the probe measurement at -10dB(A/m). This was verified to be within ± 0.5 dB of the -10dB(A/m) value (see Page 32).

c. Frequency Response Validation

The frequency response through the Helmholtz Coil was verified to be within 0.5 dB relative to 1kHz, between 300 – 3000 Hz using the P.50 signal as shown below:

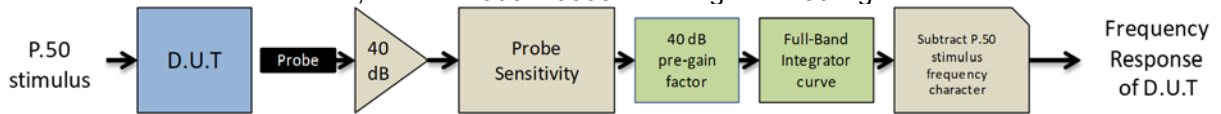

Figure 4-7 Frequency Response Validation

d. ABM2 Measurement Validation

WD noise measurements are filtered with A-weighting and Half-Band Integration over a frequency range of 100Hz – 10kHz to process ABM2 measurements. Below is the verification of the system processing A-weighting and Half-Band integration between system input to output within 0.5 dB of the theoretical result:

Table 4-1
ABM2 Frequency Response Validation

f (Hz)	HBI, A - Measured (dB re 1kHz)	HBI, A - Theoretical (dB re 1kHz)	dB Var.
100	-16.180	-16.170	-0.010
125	-13.257	-13.250	-0.007
160	-10.347	-10.340	-0.007
200	-8.017	-8.010	-0.007
250	-5.925	-5.920	-0.005
315	-4.045	-4.040	-0.005
400	-2.405	-2.400	-0.005
500	-1.212	-1.210	-0.002
630	-0.349	-0.350	0.001
800	0.071	0.070	0.001
1000	0.000	0.000	0.000
1250	-0.503	-0.500	-0.003
1600	-1.513	-1.510	-0.003
2000	-2.778	-2.780	0.002
2500	-4.316	-4.320	0.004
3150	-6.166	-6.170	0.004
4000	-8.322	-8.330	0.008
5000	-10.573	-10.590	0.017
6300	-13.178	-13.200	0.022
8000	-16.241	-16.270	0.029
10000	-19.495	-19.520	0.025

FCC ID: ZNFK400AM	PCTEST Head to the point of service	HAC (T-COIL) TEST REPORT	LG	Approved by: Quality Manager
Filename: 1M2003020032-03.ZNF	Test Dates: 03/16/2020 - 03/26/2020	DUT Type: Portable Handset		Page 10 of 71

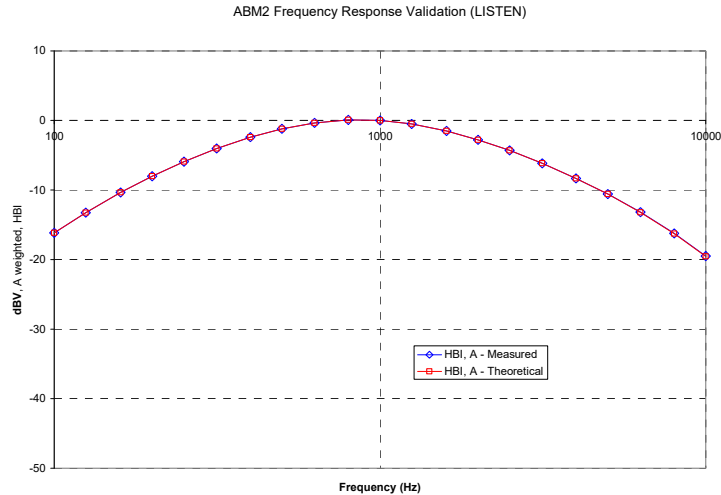

Figure 4-8
ABM2 Frequency Response Validation

The ABM2 result is a power sum from 100Hz to 10kHz with half-band integration and A-weighting. To verify the power sum measurement, a power sum over the full band was measured and verified to track with the source level (See Figure 4-9). Therefore the setup in this step was used to verify the power sum post-processing for ABM2 measurements. See below block diagram:

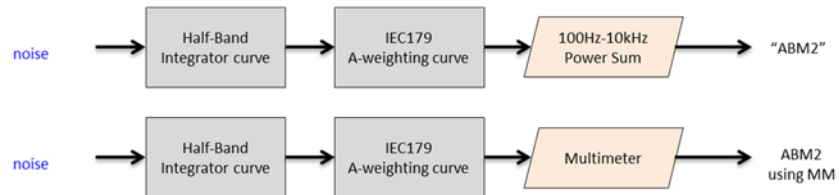

Figure 4-9
ABM2 Validation Block Diagram

The power summed output results for a known input were compared to the multi-meter results to verify any deviation in the post-processing implemented with the power-sum.

Table 4-2
ABM2 Power Sum Validation

WN Input (dBV)	Power Sum (dBV)	Multimeter-Full (dBV)	Dev (dB)
-60	-60.36	-60.2	0.16
-50	-50.19	-50.13	0.06
-40	-40.14	-40.03	0.11
-30	-30.13	-30.01	0.12
-20	-20.12	-20	0.12
-10	-10.14	-10	0.14

FCC ID: ZNFK400AM	PCTEST Proud to be part of	HAC (T-COIL) TEST REPORT	LG	Approved by: Quality Manager
Filename: 1M2003020032-03.ZNF	Test Dates: 03/16/2020 - 03/26/2020	DUT Type: Portable Handset		Page 11 of 71

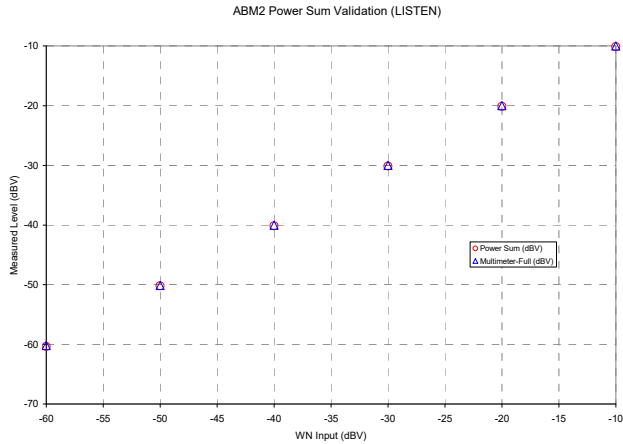

Figure 4-10
ABM2 Power Sum Validation

3. Measurement Test Setup

a. Fine scan above the WD (TEM)

- i. A multitone signal was applied to the handset such that the phone acoustic output was stable within 1dB over the probe settling time and with the acoustic output level at the C63.19 specified levels (below). The measurement step size was in 2 mm increments at a distance of 10 mm between the surface of the wireless device as shown below (note that in Figure 4-12, the grid is not to scale but merely a graphical representation of the coordinate system in use):

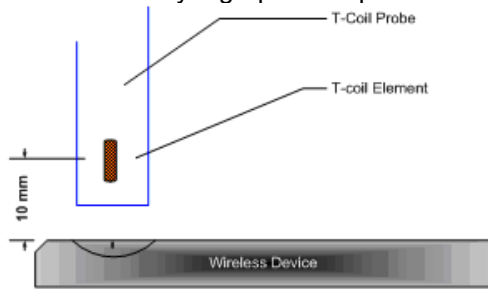

Figure 4-11
Measurement Distance

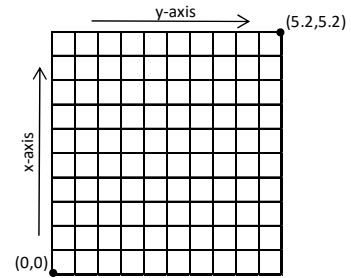



Figure 4-12
Measurement Grid

- ii. After scanning, the planar field maximum point was determined. The position of the probe was moved to this location to setup the test using the SoundCheck system.
 - iii. These steps were repeated for all T-coil orientations (axial and radial) per Figure 4-14 after a T-coil orientation was fully measured with the SoundCheck system.
- b. Speech Signal Setup to Base Station Simulator
- i. C63.19 Table 7-1 states audio reference input levels for various technologies:

Standard	Technology	Input Level (dBm0)
TIA/EIA/IS-2000	CDMA	-18
J-STD-007	GSM (217)	-16
T1/T1P1/3GPP	UMTS (WCDMA)	-16
iDEN™	TDMA (22 and 11 Hz)	-18

FCC ID: ZNFK400AM	PCTEST Proud to be part of	HAC (T-COIL) TEST REPORT	LG	Approved by: Quality Manager
Filename: 1M2003020032-03.ZNF	Test Dates: 03/16/2020 - 03/26/2020	DUT Type: Portable Handset		Page 12 of 71

- ii. See Section 5 and 6 for more information regarding CMW500 audio level settings for Voice Over LTE (VoLTE), and Voice Over WIFI (VoWIFI) testing.
 - iii. See Section 7 for more information regarding audio level settings for Over-The-Top (OTT) Voice Over IP (VoIP) Testing.
 - c. Real-Time Analyzer (RTA)
 - i. The Real-Time Analyzer was configured to analyze measurements using 1/3 Octave band weighted filtering.
 - d. WD Radio Configuration Selection
 - i. The device was chosen to be tested in the worst-case ABM2 condition (See Section 8 for more information regarding worst-case configurations for UMTS. LTE configuration information can be found in Section 5 and 7. WIFI configuration information can be found in Section 6 and 7.)
 - ii. Supported GSM vocoders were investigated for the worst-case ABM2 condition. GSM-EFR was deemed the worst-case condition for the GSM air interface.
- 4. Signal Quality Data Analysis
 - a. Narrow-band Magnetic Intensity
 - i. The standard specifies a 1kHz 1/3 octave band minimum field intensity for a sine tone. The ABM1 measurements were evaluated at 1kHz with 1/3 octave band filtering over an averaged period of 10 seconds.
 - b. Frequency Response
 - i. The appropriate frequency response curve was measured to curves in Figure 3-1 or Figure 3-2 between 300 – 3000 Hz using digital linear averaging (limit lines chosen according to measurement found in step 4a). A linear average over 3x the length of the artificial voice signal (3x sampling) was performed. A 10 second delay was configured in the measurement process of the stimulus to ensure handset vocoder latency effects and echo cancellation devices (if any) were appropriately stabilized during measurements.
 - ii. The appropriate post-processing was applied according to the system processing chain illustrated in Figure 4-7. All R10 frequencies were plotted with respect to 0dB at 1kHz value and aligned with respect to the EIA-504 mask.
 - iii. The margin is represented by the closest measured data point on the curve to the EIA-504 limit lines, in dB.
 - c. Signal Quality Index
 - i. Ensuring the WD was at maximum RF power, maximum volume, backlight off, display on, maximum contrast setting, keypad lights on (when possible) with no audio signal through the vocoder, the WD was measured over at least 100 Hz – 10,000 Hz, maximized over 5 seconds with a 50ms sample time for the ABM2 measurement (5 second time period is used in noise measurements under standards such as IEEE 269, etc.).
 - ii. After applying half-band integration and A-weighting to the result, a power sum was applied over each 1/3 octave bandwidth frequency for an ABM2 value.
 - iii. This result was subtracted from the ABM1 result in step a, to obtain the Signal Quality.

FCC ID: ZNFK400AM	 PCTEST <small>Head to the point of service</small>	HAC (T-COIL) TEST REPORT		Approved by: Quality Manager
Filename: 1M2003020032-03.ZNF	Test Dates: 03/16/2020 - 03/26/2020	DUT Type: Portable Handset	Page 13 of 71	

V. Test Setup

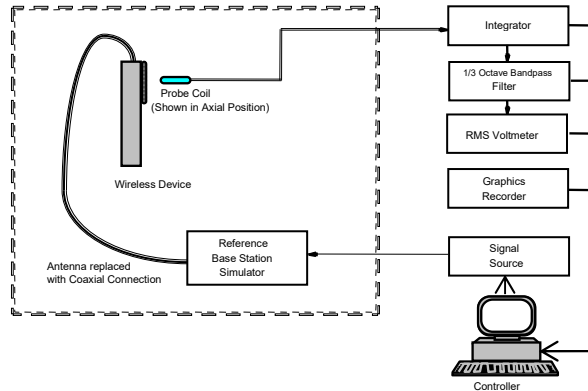

Figure 4-13
Audio Magnetic Field Test Setup



Environmental conditions such as temperature and relative humidity are monitored to ensure there are no impacts on system specifications. Proper voltage and power line frequency conditions are maintained with three phase power sources. Environmental noise and reflections are monitored through system checks.

VI. Deviation from C63.19 Test Procedure

Non-conducted RF connection due to inaccessible RF ports.

VII. Air Interface Technologies Tested

All air interfaces which support voice capabilities over a managed CMRS or pre-installed OTT VoIP applications were tested for T-coil unless otherwise noted. See Table 2-1 for more details regarding which modes were tested.

FCC ID: ZNFK400AM	 PCTEST Road to the part of the device	HAC (T-COIL) TEST REPORT	 LG	Approved by: Quality Manager
Filename: 1M2003020032-03.ZNF	Test Dates: 03/16/2020 - 03/26/2020	DUT Type: Portable Handset		Page 14 of 71

VIII. Wireless Device Channels and Frequencies

1. 2G/3G Modes

The frequencies listed in the table below are those that lie in the center of the bands used for cellular telephony. Low, middle and high channels were tested in each band for FCC compliance evaluation to ensure the maximum emission is captured across the entire band. Only middle channels were evaluated for data modes.

**Table 4-3
Center Channels and Frequencies**



Test frequencies & associated channels	
Channel	Frequency (MHz)
Cellular 850	
190 (GSM)	836.60
4183 (UMTS)	836.60
AWS 1750	
1412 (UMTS)	1730.40
PCS 1900	
661 (GSM)	1880
9400 (UMTS)	1880

2. 4G (LTE) Modes

The middle channel for every band and bandwidth combination was tested for each probe orientation. The band and bandwidth combination from each probe orientation resulting in the worst-case SNNR was additionally tested using low and high channels for that band and bandwidth combination. The middle channel and supported bandwidths from the worst-case band according to Table 7-5 was additionally evaluated with OTT VoIP for each probe orientation. See Tables 9-4 to 9-9 as well as 9-13 for LTE bandwidths and channels.

3. WIFI

The middle channel for each IEEE 802.11 standard was tested for each probe orientation. The 2.4GHz IEEE 802.11 standard from each probe orientation resulting in the worst-case SNNR was additionally tested using low and high channels. See Tables 9-10 as well as 9-14 for WIFI standards and channels.

FCC ID: ZNFK400AM	 PCTEST Head to toe part of device	HAC (T-COIL) TEST REPORT	 LG	Approved by: Quality Manager
Filename: 1M2003020032-03.ZNF	Test Dates: 03/16/2020 - 03/26/2020	DUT Type: Portable Handset		Page 15 of 71

IX. Test Flow

The flow diagram below was followed (From C63.19):

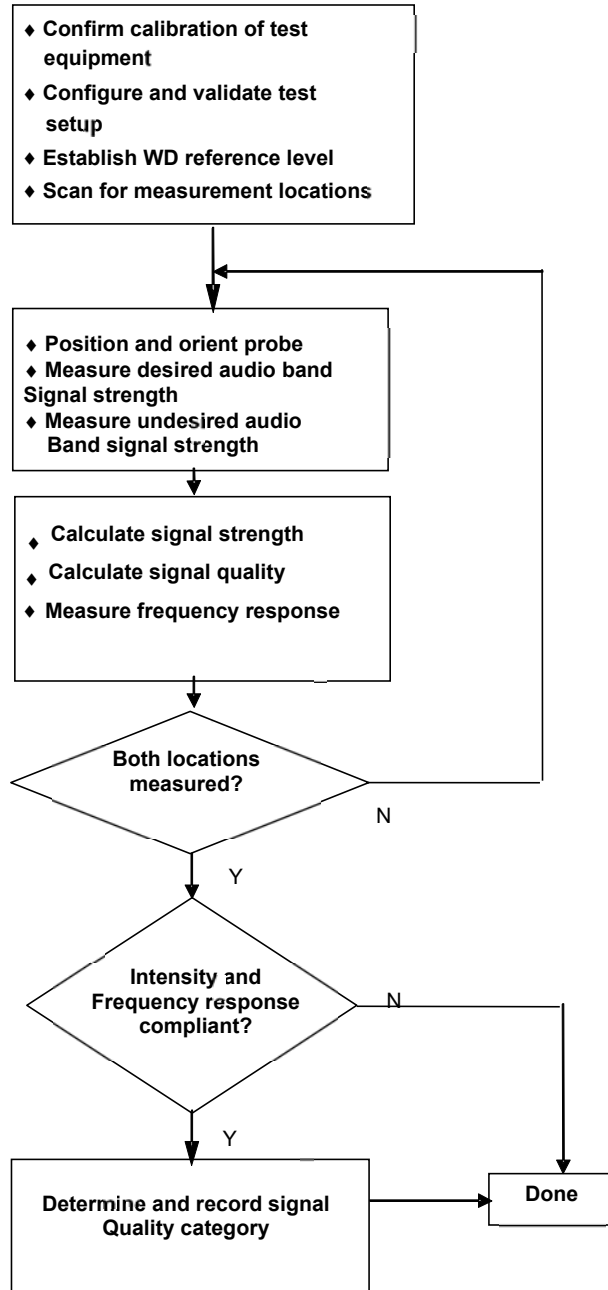





Figure 4-14
C63.19 T-Coil Signal Test Process

FCC ID: ZNFK400AM	 PCTEST Proud to be part of 	HAC (T-COIL) TEST REPORT	 LG	Approved by: Quality Manager
Filename: 1M2003020032-03.ZNF	Test Dates: 03/16/2020 - 03/26/2020	DUT Type: Portable Handset		Page 16 of 71

5. VOLTE TEST SYSTEM SETUP AND DUT CONFIGURATION

I. Test System Setup for VoLTE over IMS T-coil Testing

1. Equipment Setup

The general test setup used for VoLTE over IMS is shown below. The callbox used when performing VoLTE over IMS T-coil measurements is a CMW500. The Data Application Unit (DAU) of the CMW500 was used to simulate the IP Multimedia Subsystem (IMS) server.

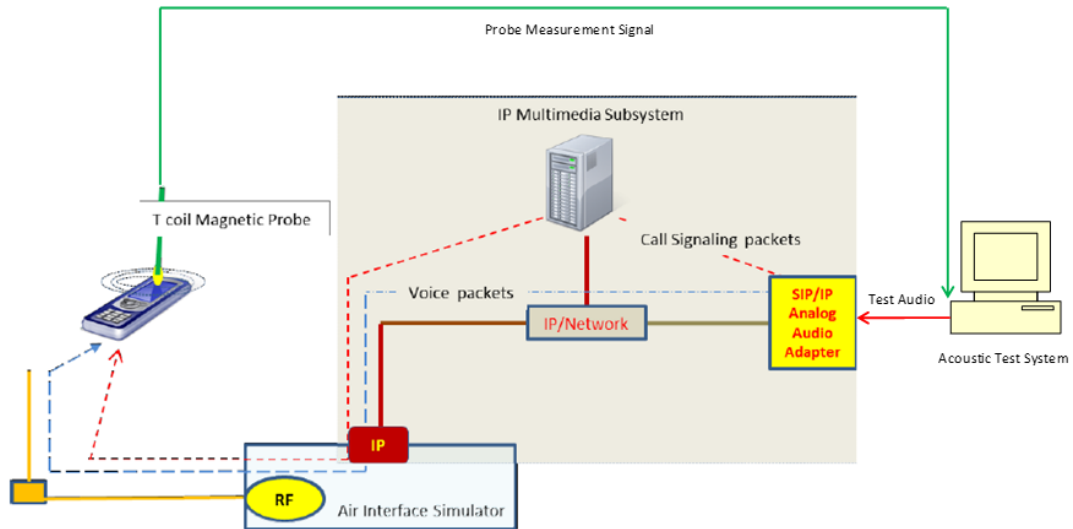



Figure 5-1
Test Setup for VoLTE over IMS T-Coil Measurements

2. Audio Level Settings

According to the July 2012 interpretations by the C63 Committee regarding the appropriate audio levels to be used for VoLTE over IMS T-coil testing, -16dBm0 shall be used for the normal speech input level*. The CMW500 base station simulator was manually configured to ensure that the settings for speech input and full scale levels resulted in the -16dBm0 speech input level to the DUT for the VoLTE over IMS connection.

* http://c63.org/documents/misc/posting/new_interpretations.htm

FCC ID: ZNFK400AM		HAC (T-COIL) TEST REPORT		Approved by: Quality Manager
Filename: 1M2003020032-03.ZNF	Test Dates: 03/16/2020 - 03/26/2020	DUT Type: Portable Handset		Page 17 of 71

© 2020 PCTEST

REV 3.5.M
3/2/2020

© 2020 PCTEST All rights reserved. Unless otherwise specified, no part of this report may be reproduced or utilized in any part, form or by any means, electronic or mechanical, including photocopying and microfilm, without permission in writing from PCTEST. If you have any questions about this international copyright or have an enquiry about obtaining additional rights to this report or assembly of contents thereof, please contact INFO@PCTEST.COM.

II. DUT Configuration for VoLTE over IMS T-coil Testing

1. Radio Configuration

An investigation was performed to determine the modulation and RB configuration to be used for testing. The effects of modulation and RB configuration were found to be independent of band and bandwidth; therefore, only one band and bandwidth were used for this investigation. 16QAM, 1RB, 0RB offset was used for the testing as the worst-case configuration for the handset. See below table for SNNR comparison between different radio configurations:

Table 5-1
VoLTE over IMS SNNR by Radio Configuration

Band	Frequency [MHz]	Channel	Bandwidth [MHz]	Modulation	RB Size	RB Offset	ABM1 [dB(A/m)]	ABM2 [dB(A/m)]	SNNR [dB]
30	2310.0	27710	10	QPSK	1	0	4.93	-38.55	43.48
30	2310.0	27710	10	QPSK	1	25	4.92	-35.85	40.77
30	2310.0	27710	10	QPSK	1	49	4.87	-36.88	41.75
30	2310.0	27710	10	QPSK	25	0	4.88	-38.80	43.68
30	2310.0	27710	10	QPSK	25	12	4.92	-39.04	43.96
30	2310.0	27710	10	QPSK	25	25	4.87	-37.48	42.35
30	2310.0	27710	10	QPSK	50	0	4.87	-37.24	42.11
30	2310.0	27710	10	16QAM	1	0	4.94	-30.52	35.46
30	2310.0	27710	10	16QAM	1	25	4.86	-31.91	36.77
30	2310.0	27710	10	16QAM	1	49	4.87	-32.09	36.96
30	2310.0	27710	10	16QAM	25	0	4.89	-37.53	42.42
30	2310.0	27710	10	16QAM	25	12	4.93	-37.10	42.03
30	2310.0	27710	10	16QAM	25	25	4.93	-37.28	42.21
30	2310.0	27710	10	16QAM	50	0	4.88	-37.25	42.13

2. Codec Configuration

An investigation was performed to determine the audio codec configuration to be used for testing. The effects of codec configuration were found to be independent of radio configuration; therefore, only one radio configuration was used for this investigation. The NB AMR 12.2kbps setting was used for the audio codec on the CMW500 for VoLTE over IMS T-coil testing. See below table for comparisons between different codecs and codec data rates:

Table 5-2
AMR Codec Investigation – VoLTE over IMS

Codec Setting:	WB AMR 23.85kbps	WB AMR 6.60kbps	NB AMR 12.2kbps	NB AMR 4.75kbps	Orientation	Band / BW	Channel
ABM1 (dBA/m)	11.85	12.12	4.82	4.87	Axial	Band 30 10MHz	27710
ABM2 (dBA/m)	-30.85	-30.67	-30.73	-31.07			
Frequency Response	Pass	Pass	Pass	Pass			
S+N/N (dB)	42.70	42.79	35.55	35.94			

- Mute on; Backlight off; Max Volume; Max Contrast
- TPC = "Max Power"

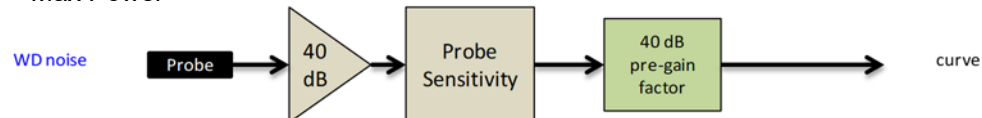

Figure 5-2
Audio Band Magnetic Curve Measurement Block Diagram

FCC ID: ZNFK400AM	PCTEST Proud to be part of	HAC (T-COIL) TEST REPORT	LG	Approved by: Quality Manager
Filename: 1M2003020032-03.ZNF	Test Dates: 03/16/2020 - 03/26/2020	DUT Type: Portable Handset		Page 18 of 71

6. VOWIFI TEST SYSTEM SETUP AND DUT CONFIGURATION

I. Test System Setup for VoWIFI over IMS T-coil Testing

1. Equipment Setup

The general test setup used for VoWIFI over IMS, or CMRS WIFI Calling, is shown below. The callbox used when performing VoWIFI over IMS T-coil measurements is a CMW500. The Data Application Unit (DAU) of the CMW500 was used to simulate the IP Multimedia Subsystem (IMS) server.

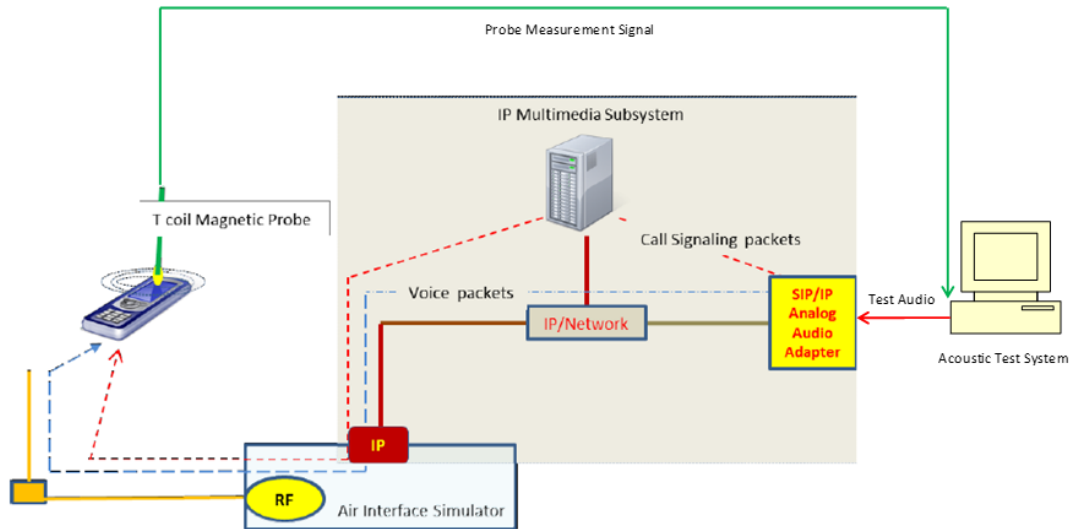



Figure 6-1
Test Setup for VoWIFI over IMS T-Coil Measurements

2. Audio Level Settings

According to KDB 285076 D02 released by the FCC OET regarding the appropriate audio levels to be used for VoWIFI over IMS T-Coil testing, -20dBm0 shall be used for the normal speech input level². The CMW500 base station simulator was manually configured to ensure that the settings for speech input and full scale levels resulted in the -20dBm0 speech input level to the DUT for the VoWIFI over IMS connection.

² FCC Office of Engineering and Technology KDB, "285076 D02 T-Coil Testing for CMRS IP v03," September 13, 2017

FCC ID: ZNFK400AM		HAC (T-COIL) TEST REPORT		Approved by: Quality Manager
Filename: 1M2003020032-03.ZNF	Test Dates: 03/16/2020 - 03/26/2020	DUT Type: Portable Handset		Page 19 of 71

II. DUT Configuration for VoWiFi over IMS T-coil Testing

1. Radio Configuration

An investigation was performed on all applicable data rates and modulations to determine the radio configuration to be used for testing. See tables below for SNNR comparison between radio configurations in each IEEE 802.11 standard:

Table 6-1
IEEE 802.11b SNNR by Radio Configuration



Mode	Channel	Modulation	Data Rate [Mbps]	ABM1 [dB(A/m)]	ABM2 [dB(A/m)]	SNNR [dB]
IEEE 802.11b	6	DSSS	1	2.18	-36.54	38.72
IEEE 802.11b	6	DSSS	2	2.19	-36.65	38.84
IEEE 802.11b	6	CCK	5.5	2.20	-36.97	39.17
IEEE 802.11b	6	CCK	11	2.20	-36.86	39.06

Table 6-2
IEEE 802.11g SNNR by Radio Configuration

Mode	Channel	Modulation	Data Rate [Mbps]	ABM1 [dB(A/m)]	ABM2 [dB(A/m)]	SNNR [dB]
IEEE 802.11g	6	BPSK	6	2.21	-40.06	42.27
IEEE 802.11g	6	BPSK	9	2.19	-39.86	42.05
IEEE 802.11g	6	QPSK	12	2.19	-40.80	42.99
IEEE 802.11g	6	QPSK	18	2.20	-40.90	43.10
IEEE 802.11g	6	16QAM	24	2.21	-41.42	43.63
IEEE 802.11g	6	16QAM	36	2.20	-41.17	43.37
IEEE 802.11g	6	64QAM	48	2.20	-41.63	43.83
IEEE 802.11g	6	64QAM	54	2.20	-42.09	44.29

Table 6-3
IEEE 802.11n SNNR by Radio Configuration

Mode	Channel	Modulation	MCS Index	ABM1 [dB(A/m)]	ABM2 [dB(A/m)]	SNNR [dB]
IEEE 802.11n	6	BPSK	0	2.19	-38.51	40.70
IEEE 802.11n	6	QPSK	1	2.19	-38.05	40.24
IEEE 802.11n	6	QPSK	2	2.19	-38.07	40.26
IEEE 802.11n	6	16QAM	3	2.04	-38.69	40.73
IEEE 802.11n	6	16QAM	4	2.35	-38.40	40.75
IEEE 802.11n	6	64QAM	5	2.18	-38.68	40.86
IEEE 802.11n	6	64QAM	6	2.22	-38.92	41.14
IEEE 802.11n	6	64QAM	7	2.20	-38.89	41.09

FCC ID: ZNFK400AM	 PCTEST Proud to be part of 	HAC (T-COIL) TEST REPORT		Approved by: Quality Manager
Filename: 1M2003020032-03.ZNF	Test Dates: 03/16/2020 - 03/26/2020	DUT Type: Portable Handset		Page 20 of 71

2. Codec Configuration

An investigation was performed to determine the audio codec configuration to be used for testing. The effects of codec configuration were found to be independent of radio configuration; therefore, only one radio configuration was used for this investigation. The NB AMR 12.2kbps setting was used for the audio codec on the CMW500 for VoWiFi over IMS T-coil testing. See below table for comparisons between different codecs and codec data rates:

Table 6-4
AMR Codec Investigation – VoWiFi over IMS

Codec Setting:	WB AMR 23.85kbps	WB AMR 6.60kbps	NB AMR 12.2kbps	NB AMR 4.75kbps	Orientation	Band	Standard	Channel
ABM1 (dBA/m)	11.90	11.76	2.18	2.18	Axial	2.4GHz	IEEE 802.11b	6
ABM2 (dBA/m)	-36.71	-36.53	-36.65	-36.70				
Frequency Response	Pass	Pass	Pass	Pass				
S+N/N (dB)	48.61	48.29	38.83	38.88				

- Mute on; Backlight off; Max Volume; Max Contrast

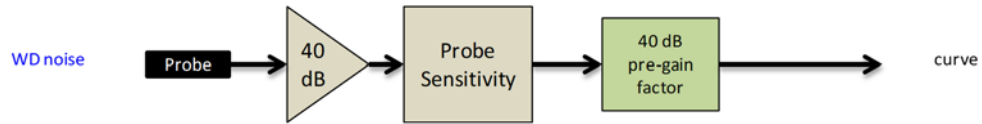



Figure 6-2
Audio Band Magnetic Curve Measurement Block Diagram

FCC ID: ZNFK400AM		HAC (T-COIL) TEST REPORT		Approved by: Quality Manager
Filename: 1M2003020032-03.ZNF	Test Dates: 03/16/2020 - 03/26/2020	DUT Type: Portable Handset		Page 21 of 71

7. OTT VOIP TEST SYSTEM AND DUT CONFIGURATION

I. Test System Setup for OTT VoIP T-Coil Testing

1. OTT VoIP Application

Google Duo is a pre-installed application on the DUT which allows for VoIP calls in a held-to-ear scenario. Duo uses the OPUS audio codec and supports a bitrate range of 6kb/s to 75kb/s. All air interfaces capable of a data connection were evaluated with Google Duo.

2. Equipment Setup

A CMW500 callbox was used to perform OTT VoIP T-coil measurements. The Data Application Unit (DAU) of the CMW500 was connected to the internet and allowed for an IP data connection on the DUT. An auxiliary VoIP unit was used to initiate an OTT VoIP call to the DUT. The auxiliary VoIP unit allowed for the configuration and monitoring of the OTT VoIP codec bitrate during a call. Both high and low bitrate settings were evaluated in to determine the worst-case configuration.

3. Audio Level Settings

According to KDB 285076 D02, the average speech level of -20dBm0 shall be used for protocols not specifically listed in Table 7.1 of ANSI C63.19-2011 or the ANSI C63.19-2011 VoLTE interpretation³. The auxiliary VoIP unit allowed for monitoring the signal input level to ensure that the settings for speech input and full scale levels resulted in the -20dBm0 speech input level to the DUT for the OTT VoIP call.



Note: The green highlighted text is approved by FCC under the TCB PAG Re-Use Policy 388624 D01 IV. D. for T-Coil Testing for WI-FI calling and Google Duo.

II. DUT Configuration for OTT VoIP T-Coil Testing

1. Codec Configuration

An investigation was performed for each applicable data mode to determine the audio codec configuration to be used for testing. The effects of codec configuration were found to be independent of radio configuration; therefore, only one radio configuration for each applicable data mode was used for these investigations. The 75kbps codec setting was used for the audio codec on the auxiliary VoIP unit for OTT VoIP T-Coil testing. See the following tables for comparisons between codec data rates on all applicable data modes:

³ FCC Office of Engineering and Technology KDB, "285076 D02 T-Coil Testing for CMRS IP v03," September 13, 2017

FCC ID: ZNFK400AM	 PCTEST Proud to be part of 	HAC (T-COIL) TEST REPORT		Approved by: Quality Manager
Filename: 1M2003020032-03.ZNF	Test Dates: 03/16/2020 - 03/26/2020	DUT Type: Portable Handset	Page 22 of 71	

**Table 7-1
Codec Investigation – OTT VoIP (EDGE)**

Codec Setting:	75kbps	6kbps	Orientation	Channel
ABM1 (dBA/m)	9.77	9.65	Axial	661
ABM2 (dBA/m)	-14.31	-14.49		
Frequency Response	Pass	Pass		
S+N/N (dB)	24.08	24.14		

**Table 7-2
Codec Investigation – OTT VoIP (HSPA)**

Codec Setting:	75kbps	6kbps	Orientation	Channel
ABM1 (dBA/m)	9.73	9.58	Axial	9400
ABM2 (dBA/m)	-38.54	-38.78		
Frequency Response	Pass	Pass		
S+N/N (dB)	48.27	48.36		

**Table 7-3
Codec Investigation – OTT VoIP (LTE)**

Codec Setting:	75kbps	6kbps	Orientation	Band / BW	Channel
ABM1 (dBA/m)	9.52	9.64	Axial	Band 30 10MHz	27710
ABM2 (dBA/m)	-31.41	-31.59			
Frequency Response	Pass	Pass			
S+N/N (dB)	40.93	41.23			

**Table 7-4
Codec Investigation – OTT VoIP (WIFI)**

Codec Setting:	75kbps	6kbps	Orientation	Band	Standard	Channel
ABM1 (dBA/m)	9.89	9.77	Axial	2.4GHz	IEEE 802.11b	6
ABM2 (dBA/m)	-33.77	-33.99				
Frequency Response	Pass	Pass				
S+N/N (dB)	43.66	43.76				

- Mute on; Backlight off; Max Volume; Max Contrast
- Radio Configurations can be found in Section 9.II.F

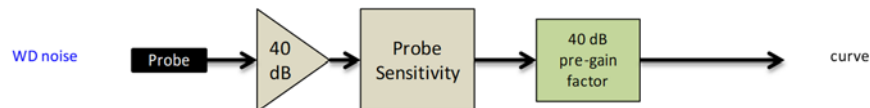

**Figure 7-1
Audio Band Magnetic Curve Measurement Block Diagram**



FCC ID: ZNFK400AM	PCTEST Proud to be part of LG	HAC (T-COIL) TEST REPORT	LG	Approved by: Quality Manager
Filename: 1M2003020032-03.ZNF	Test Dates: 03/16/2020 - 03/26/2020	DUT Type: Portable Handset		Page 23 of 71

2. Radio Configuration for OTT VoIP (LTE)

An investigation was performed to determine the worst-case LTE FDD band to be used for OTT VoIP testing. LTE FDD Band 2 was used for the testing as the worst-case configuration for the handset. See below table for SNNR comparison between different LTE bands:

Table 7-5
OTT VoIP (LTE FDD) SNNR by LTE Band

Band	Frequency [MHz]	Channel	Bandwidth [MHz]	Modulation	RB Size	RB Offset	ABM1 [dB(A/m)]	ABM2 [dB(A/m)]	SNNR [dB]
12	707.5	23095	10	16QAM	1	0	9.63	-31.95	41.58
14	793.0	23330	10	16QAM	1	0	9.61	-32.04	41.65
5	836.5	20525	10	16QAM	1	0	9.66	-30.04	39.70
66	1745.0	132322	20	16QAM	1	0	9.65	-29.43	39.08
2	1880.0	18900	20	16QAM	1	0	9.61	-29.15	38.76
30	2310.0	27710	10	16QAM	1	0	9.61	-31.06	40.67

FCC ID: ZNFK400AM	 PCTEST Road to the part of the future	HAC (T-COIL) TEST REPORT	 LG	Approved by: Quality Manager
Filename: 1M2003020032-03.ZNF	Test Dates: 03/16/2020 - 03/26/2020	DUT Type: Portable Handset		Page 24 of 71

8. FCC 3G MEASUREMENTS

I. UMTS Test Configurations

AMR at 12.2kbps, 13.6kbps SRB (thick, purple data curve) was used for the testing as the worst-case configuration for the handset. See below plot for ABM noise comparison between vocoder rates:

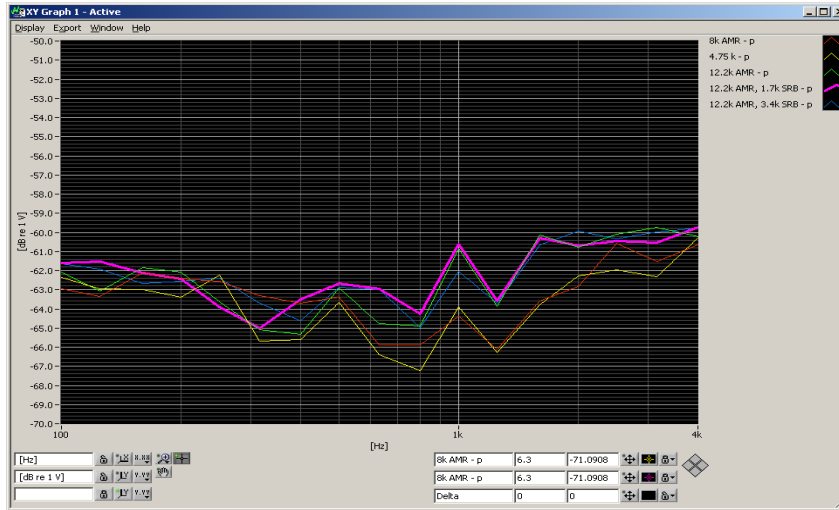

Figure 8-1
UMTS Audio Band Magnetic Noise

Table 8-1
Codec Investigation - UMTS

Codec Setting:	AMR 12.2kbps	AMR 7.95kbps	AMR 4.75kbps	Orientation	Channel
ABM1 (dBA/m)	5.73	5.76	5.48	Axial	9400
ABM2 (dBA/m)	-41.71	-43.35	-43.32		
Frequency Response	Pass	Pass	Pass		
S+N/N (dB)	47.44	49.11	48.80		

- Mute on; Backlight off; Max Volume; Max Contrast
- TPC="All 1s"

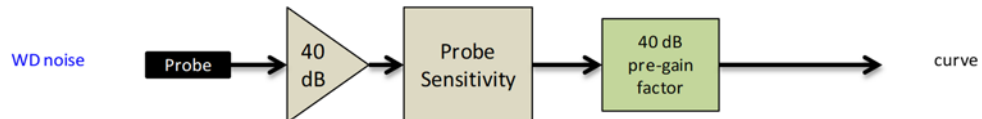



Figure 8-2
Audio Band Magnetic Curve Measurement Block Diagram

FCC ID: ZNFK400AM	PCTEST Proud to be part of LG	HAC (T-COIL) TEST REPORT	LG	Approved by: Quality Manager
Filename: 1M2003020032-03.ZNF	Test Dates: 03/16/2020 - 03/26/2020	DUT Type: Portable Handset		Page 25 of 71

9. T-COIL TEST SUMMARY

**Table 9-1
Consolidated Tabled Results**

		Freq. Response Margin		Magnetic Intensity Verdict		FCC SNNR Verdict		Margin from FCC Limit (dB)	C63.19-2011 Rating
		8.3.2		8.3.1		8.3.4			
C63.19 Section		Axial	Radial	Axial	Radial	Axial	Radial		
GSM	Cellular	PASS	NA	PASS	PASS	PASS	PASS	-5.81	T3
	PCS	PASS	NA	PASS	PASS	PASS	PASS		
EDGE (OTT VoIP)	Cellular	PASS	NA	PASS	PASS	PASS	PASS	-3.17	T3
	PCS	PASS	NA	PASS	PASS	PASS	PASS		
UMTS	Cellular	PASS	NA	PASS	PASS	PASS	PASS	-19.34	T4
	AWS	PASS	NA	PASS	PASS	PASS	PASS		
	PCS	PASS	NA	PASS	PASS	PASS	PASS		
HSPA (OTT VoIP)	Cellular	PASS	NA	PASS	PASS	PASS	PASS	-19.04	T4
	AWS	PASS	NA	PASS	PASS	PASS	PASS		
	PCS	PASS	NA	PASS	PASS	PASS	PASS		
LTE FDD	B12	PASS	NA	PASS	PASS	PASS	PASS	-9.97	T3
	B14	PASS	NA	PASS	PASS	PASS	PASS		
	B5	PASS	NA	PASS	PASS	PASS	PASS		
	B66	PASS	NA	PASS	PASS	PASS	PASS		
	B2	PASS	NA	PASS	PASS	PASS	PASS		
	B30	PASS	NA	PASS	PASS	PASS	PASS		
LTE FDD (OTT VoIP)	B2	PASS	NA	PASS	PASS	PASS	PASS	-12.91	T4
WLAN	IEEE 802.11b	PASS	NA	PASS	PASS	PASS	PASS	-8.41	T3
	IEEE 802.11g	PASS	NA	PASS	PASS	PASS	PASS		
	IEEE 802.11n	PASS	NA	PASS	PASS	PASS	PASS		
WLAN (OTT VoIP)	IEEE 802.11b	PASS	NA	PASS	PASS	PASS	PASS	-12.81	T4
	IEEE 802.11g	PASS	NA	PASS	PASS	PASS	PASS		
	IEEE 802.11n	PASS	NA	PASS	PASS	PASS	PASS		

FCC ID: ZNFK400AM	 PCTEST <small>Head to toe part of device</small>	HAC (T-COIL) TEST REPORT	 LG	Approved by: Quality Manager
Filename: 1M2003020032-03.ZNF	Test Dates: 03/16/2020 - 03/26/2020	DUT Type: Portable Handset		Page 26 of 71

I. Raw Handset Data

**Table 9-2
Raw Data Results for GSM**

Mode	Orientation	Channel	ABM1 [dB(A/m)]	ABM2 [dB(A/m)]	Ambient Noise [dB(A/m)]	Frequency Response Margin (dB)	S+N/N (dB)	FCC Limit (dB)	Margin from FCC Limit (dB)	C63.19-2011 Rating	Test Coordinates	
GSM850	Axial	128	17.49	-9.69	-60.56	1.55	27.18	20.00	-7.18	T3	2.0, 4.0	
		190	17.38	-11.37		1.52	28.75	20.00	-8.75	T3		
		251	17.45	-12.46		1.51	29.91	20.00	-9.91	T3		
	Radial	128	8.17	-17.64	-62.79	N/A	25.81	20.00	-5.81	T3		2.0, 3.2
		190	8.22	-19.30			27.52	20.00	-7.52	T3		
		251	8.22	-20.43			28.65	20.00	-8.65	T3		
GSM1900	Axial	512	17.47	-13.01	-60.56	1.53	30.48	20.00	-10.48	T4	2.0, 4.0	
		661	17.44	-12.56		1.48	30.00	20.00	-10.00	T4		
		810	17.27	-12.82		1.53	30.09	20.00	-10.09	T4		
	Radial	512	8.23	-21.17	-62.79	N/A	29.40	20.00	-9.40	T3		2.0, 3.2
		661	8.17	-20.64			28.81	20.00	-8.81	T3		
		810	8.30	-20.97			29.27	20.00	-9.27	T3		

**Table 9-3
Raw Data Results for UMTS**

Mode	Orientation	Channel	ABM1 [dB(A/m)]	ABM2 [dB(A/m)]	Ambient Noise [dB(A/m)]	Frequency Response Margin (dB)	S+N/N (dB)	FCC Limit (dB)	Margin from FCC Limit (dB)	C63.19-2011 Rating	Test Coordinates	
UMTS V	Axial	4132	5.64	-42.92	-63.16	1.39	48.56	20.00	-28.56	T4	2.0, 4.0	
		4183	5.65	-41.26		1.34	46.91	20.00	-26.91	T4		
		4233	5.66	-41.58		1.38	47.24	20.00	-27.24	T4		
	Radial	4132	-3.81	-45.68	-62.79	N/A	41.87	20.00	-21.87	T4		2.0, 3.2
		4183	-3.81	-45.57			41.76	20.00	-21.76	T4		
		4233	-3.83	-45.01			41.18	20.00	-21.18	T4		
UMTS IV	Axial	1312	5.67	-43.10	-63.16	1.38	48.77	20.00	-28.77	T4	2.0, 4.0	
		1412	5.66	-43.19		1.34	48.85	20.00	-28.85	T4		
		1513	5.65	-41.94		1.38	47.59	20.00	-27.59	T4		
	Radial	1312	-3.78	-45.22	-62.79	N/A	41.44	20.00	-21.44	T4		2.0, 3.2
		1412	-3.80	-45.14			41.34	20.00	-21.34	T4		
		1513	-3.79	-45.21			41.42	20.00	-21.42	T4		
UMTS II	Axial	9262	5.69	-41.31	-63.16	1.35	47.00	20.00	-27.00	T4	2.0, 4.0	
		9400	5.73	-41.23		1.36	46.96	20.00	-26.96	T4		
		9538	5.67	-41.71		1.36	47.38	20.00	-27.38	T4		
	Radial	9262	-3.78	-43.12	-62.79	N/A	39.34	20.00	-19.34	T4		2.0, 3.2
		9400	-3.80	-45.49			41.69	20.00	-21.69	T4		
		9538	-3.79	-43.46			39.67	20.00	-19.67	T4		

**Table 9-4
Raw Data Results for LTE B12**

Mode	Orientation	Bandwidth	Channel	ABM1 [dB(A/m)]	ABM2 [dB(A/m)]	Ambient Noise [dB(A/m)]	Frequency Response Margin (dB)	S+N/N (dB)	FCC Limit (dB)	Margin from FCC Limit (dB)	C63.19-2011 Rating	Test Coordinates	
LTE Band 12	Axial	10MHz	23095	5.05	-34.07	-63.16	1.33	39.12	20.00	-19.12	T4	2.0, 4.0	
		5MHz	23095	5.08	-32.83		1.35	37.91	20.00	-17.91	T4		
		3MHz	23095	5.09	-33.01		1.37	38.10	20.00	-18.10	T4		
		1.4MHz	23095	5.05	-33.15		1.37	38.20	20.00	-18.20	T4		
	Radial	10MHz	23095	-3.92	-36.65	-62.79	N/A	32.73	20.00	-12.73	T4		2.0, 3.2
		5MHz	23095	-3.97	-35.46			31.49	20.00	-11.49	T4		
		3MHz	23095	-3.98	-37.62			33.64	20.00	-13.64	T4		
		1.4MHz	23095	-3.88	-35.98			32.10	20.00	-12.10	T4		



FCC ID: ZNFK400AM	 PCTEST Proud to be part of	HAC (T-COIL) TEST REPORT	 LG	Approved by: Quality Manager
Filename: 1M2003020032-03.ZNF	Test Dates: 03/16/2020 - 03/26/2020	DUT Type: Portable Handset	Page 27 of 71	

Table 9-5
Raw Data Results for LTE B14

Mode	Orientation	Bandwidth	Channel	ABM1 [dB(A/m)]	ABM2 [dB(A/m)]	Ambient Noise [dB(A/m)]	Frequency Response Margin (dB)	S+N/N (dB)	FCC Limit (dB)	Margin from FCC Limit (dB)	C63.19-2011 Rating	Test Coordinates	
LTE Band 14	Axial	10MHz	23330	4.88	-33.92	-63.16	1.40	38.80	20.00	-18.80	T4	2.0, 4.0	
		5MHz	23330	5.03	-32.78		1.37	37.81	20.00	-17.81	T4		
	Radial	10MHz	23330	-3.96	-36.74	-62.79	N/A	32.78	20.00	-12.78	T4		2.0, 3.2
		5MHz	23330	-3.61	-37.06			33.45	20.00	-13.45	T4		

Table 9-6
Raw Data Results for LTE B5

Mode	Orientation	Bandwidth	Channel	ABM1 [dB(A/m)]	ABM2 [dB(A/m)]	Ambient Noise [dB(A/m)]	Frequency Response Margin (dB)	S+N/N (dB)	FCC Limit (dB)	Margin from FCC Limit (dB)	C63.19-2011 Rating	Test Coordinates
LTE Band 5	Axial	10MHz	20525	4.94	-32.36	-63.16	1.27	37.30	20.00	-17.30	T4	2.0, 4.0
		5MHz	20525	4.94	-33.18		1.29	38.12	20.00	-18.12	T4	
		3MHz	20525	4.94	-34.50		1.35	39.44	20.00	-19.44	T4	
		1.4MHz	20525	4.92	-34.70		1.36	39.62	20.00	-19.62	T4	
	Radial	10MHz	20525	-3.75	-36.44	-62.79	N/A	32.69	20.00	-12.69	T4	2.0, 3.2
		5MHz	20525	-4.03	-37.39			33.36	20.00	-13.36	T4	
		3MHz	20525	-3.99	-38.36			34.37	20.00	-14.37	T4	
		1.4MHz	20525	-3.94	-38.33			34.39	20.00	-14.39	T4	

Table 9-7
Raw Data Results for LTE B66

Mode	Orientation	Bandwidth	Channel	ABM1 [dB(A/m)]	ABM2 [dB(A/m)]	Ambient Noise [dB(A/m)]	Frequency Response Margin (dB)	S+N/N (dB)	FCC Limit (dB)	Margin from FCC Limit (dB)	C63.19-2011 Rating	Test Coordinates
LTE Band 66	Axial	20MHz	132322	4.90	-30.93	-63.16	1.36	35.83	20.00	-15.83	T4	2.0, 4.0
		15MHz	132322	4.93	-30.66		1.43	35.59	20.00	-15.59	T4	
		10MHz	132322	4.77	-30.63		1.39	35.40	20.00	-15.40	T4	
		5MHz	132647	4.69	-30.95		1.36	35.64	20.00	-15.64	T4	
		5MHz	132322	4.79	-29.16		1.40	33.95	20.00	-13.95	T4	
		5MHz	131997	4.73	-30.12		1.45	34.85	20.00	-14.85	T4	
		3MHz	132322	4.76	-30.21		1.42	34.97	20.00	-14.97	T4	
		1.4MHz	132322	4.70	-31.21		1.40	35.91	20.00	-15.91	T4	
	Radial	20MHz	132322	-4.04	-34.62	-62.79	N/A	30.58	20.00	-10.58	T4	2.0, 3.2
		15MHz	132322	-3.98	-34.92			30.94	20.00	-10.94	T4	
		10MHz	132322	-3.68	-34.23			30.55	20.00	-10.55	T4	
		5MHz	132647	-3.93	-35.64			31.71	20.00	-11.71	T4	
		5MHz	132322	-3.96	-33.93			29.97	20.00	-9.97	T3	
		5MHz	131997	-4.00	-35.42			31.42	20.00	-11.42	T4	
		3MHz	132322	-4.04	-34.49			30.45	20.00	-10.45	T4	
		1.4MHz	132322	-4.00	-34.73			30.73	20.00	-10.73	T4	

Table 9-8
Raw Data Results for LTE B2

Mode	Orientation	Bandwidth	Channel	ABM1 [dB(A/m)]	ABM2 [dB(A/m)]	Ambient Noise [dB(A/m)]	Frequency Response Margin (dB)	S+N/N (dB)	FCC Limit (dB)	Margin from FCC Limit (dB)	C63.19-2011 Rating	Test Coordinates
LTE Band 2	Axial	20MHz	18900	4.78	-30.48	-63.16	1.41	35.26	20.00	-15.26	T4	2.0, 4.0
		15MHz	18900	4.73	-31.59		1.37	36.32	20.00	-16.32	T4	
		10MHz	18900	4.73	-31.65		1.40	36.38	20.00	-16.38	T4	
		5MHz	18900	4.75	-30.18		1.40	34.93	20.00	-14.93	T4	
		3MHz	18900	4.74	-31.53		1.36	36.27	20.00	-16.27	T4	
		1.4MHz	18900	4.71	-31.40		1.44	36.11	20.00	-16.11	T4	
	Radial	20MHz	18900	-3.87	-36.00	-62.79	N/A	32.13	20.00	-12.13	T4	2.0, 3.2
		15MHz	18900	-3.97	-36.08			32.11	20.00	-12.11	T4	
		10MHz	18900	-3.84	-35.92			32.08	20.00	-12.08	T4	
		5MHz	18900	-4.03	-35.92			31.89	20.00	-11.89	T4	
		3MHz	18900	-4.01	-36.45			32.44	20.00	-12.44	T4	
		1.4MHz	18900	-4.01	-36.05			32.04	20.00	-12.04	T4	



FCC ID: ZNFK400AM	 PCTEST Proud to be part of 	HAC (T-COIL) TEST REPORT	 LG	Approved by: Quality Manager
Filename: 1M2003020032-03.ZNF	Test Dates: 03/16/2020 - 03/26/2020	DUT Type: Portable Handset	Page 28 of 71	

Table 9-9
Raw Data Results for LTE B30

Mode	Orientation	Bandwidth	Channel	ABM1 [dB(A/m)]	ABM2 [dB(A/m)]	Ambient Noise [dB(A/m)]	Frequency Response Margin (dB)	S+N/N (dB)	FCC Limit (dB)	Margin from FCC Limit (dB)	C63.19-2011 Rating	Test Coordinates
LTE Band 30	Axial	10MHz	27710	4.74	-30.57	-63.16	1.38	35.31	20.00	-15.31	T4	2.0, 4.0
		5MHz	27710	4.70	-31.40		1.41	36.10	20.00	-16.10	T4	
	Radial	10MHz	27710	-4.07	-36.61	-62.79	N/A	32.54	20.00	-12.54	T4	2.0, 3.2
		5MHz	27710	-3.93	-35.87			31.94	20.00	-11.94	T4	

Table 9-10
Raw Data Results for 2.4GHz WIFI

Mode	Orientation	Channel	ABM1 [dB(A/m)]	ABM2 [dB(A/m)]	Ambient Noise [dB(A/m)]	Frequency Response Margin (dB)	S+N/N (dB)	FCC Limit (dB)	Margin from FCC Limit (dB)	C63.19-2011 Rating	Test Coordinates
IEEE 802.11b	Axial	1	2.19	-37.16	-63.16	1.30	39.35	20.00	-19.35	T4	2.0, 4.0
		6	2.19	-36.49		1.35	38.68	20.00	-18.68	T4	
		11	2.17	-37.11		1.34	39.28	20.00	-19.28	T4	
	Radial	1	-8.00	-37.01	-62.79	N/A	29.01	20.00	-9.01	T3	2.0, 3.2
		6	-7.93	-37.67			29.74	20.00	-9.74	T3	
		11	-8.04	-36.45			28.41	20.00	-8.41	T3	
IEEE 802.11g	Axial	6	2.18	-39.88	-63.16	1.35	42.06	20.00	-22.06	T4	2.0, 4.0
	Radial	6	-7.96	-38.67	-62.79	N/A	30.71	20.00	-10.71	T4	2.0, 3.2
IEEE 802.11n	Axial	6	2.19	-37.92	-63.16	1.28	40.11	20.00	-20.11	T4	2.0, 4.0
	Radial	6	-8.00	-40.14	-62.79	N/A	32.14	20.00	-12.14	T4	2.0, 3.2

Table 9-11
Raw Data Results for EDGE (OTT VoIP)

Mode	Orientation	Channel	ABM1 [dB(A/m)]	ABM2 [dB(A/m)]	Ambient Noise [dB(A/m)]	Frequency Response Margin (dB)	S+N/N (dB)	FCC Limit (dB)	Margin from FCC Limit (dB)	C63.19-2011 Rating	Test Coordinates
EDGE850	Axial	190	9.75	-13.42	-63.16	1.99	23.17	20.00	-3.17	T3	2.0, 4.0
	Radial	190	-0.62	-24.21	-62.79	N/A	23.59	20.00	-3.59	T3	2.0, 3.2
EDGE1900	Axial	661	9.76	-14.02	-63.16	1.99	23.78	20.00	-3.78	T3	2.0, 4.0
	Radial	661	-0.62	-25.20	-62.79	N/A	24.58	20.00	-4.58	T3	2.0, 3.2

Table 9-12
Raw Data Results for HSPA (OTT VoIP)

Mode	Orientation	Channel	ABM1 [dB(A/m)]	ABM2 [dB(A/m)]	Ambient Noise [dB(A/m)]	Frequency Response Margin (dB)	S+N/N (dB)	FCC Limit (dB)	Margin from FCC Limit (dB)	C63.19-2011 Rating	Test Coordinates
HSPA V	Axial	4183	9.73	-38.63	-63.16	2.00	48.36	20.00	-28.36	T4	2.0, 4.0
	Radial	4183	-0.73	-42.11	-62.79	N/A	41.38	20.00	-21.38	T4	2.0, 3.2
HSPA IV	Axial	1412	9.62	-38.28	-63.16	2.00	47.90	20.00	-27.90	T4	2.0, 4.0
	Radial	1412	-0.66	-40.57	-62.79	N/A	39.91	20.00	-19.91	T4	2.0, 3.2
HSPA II	Axial	9400	9.74	-38.40	-63.16	2.00	48.14	20.00	-28.14	T4	2.0, 4.0
	Radial	9400	-0.69	-39.73	-62.79	N/A	39.04	20.00	-19.04	T4	2.0, 3.2



FCC ID: ZNFK400AM	 PCTEST Proud to be part of	HAC (T-COIL) TEST REPORT	 LG	Approved by: Quality Manager
Filename: 1M2003020032-03.ZNF	Test Dates: 03/16/2020 - 03/26/2020	DUT Type: Portable Handset		Page 29 of 71

Table 9-13
Raw Data Results for LTE FDD B2 (OTT VoIP)

Mode	Orientation	Bandwidth	Channel	ABM1 [dB(A/m)]	ABM2 [dB(A/m)]	Ambient Noise [dB(A/m)]	Frequency Response Margin (dB)	S+N/N (dB)	FCC Limit (dB)	Margin from FCC Limit (dB)	C63.19-2011 Rating	Test Coordinates
LTE Band 2	Axial	20MHz	19100	9.62	-29.78	-63.16	2.00	39.40	20.00	-19.40	T4	2.0, 4.0
		20MHz	18900	9.62	-28.82		1.82	38.44	20.00	-18.44	T4	
		20MHz	18700	9.60	-29.23		2.00	38.83	20.00	-18.83	T4	
		15MHz	18900	9.70	-29.63		2.00	39.33	20.00	-19.33	T4	
		10MHz	18900	9.57	-29.95		2.00	39.52	20.00	-19.52	T4	
		5MHz	18900	9.64	-29.28		2.00	38.92	20.00	-18.92	T4	
		3MHz	18900	9.59	-30.05		1.98	39.64	20.00	-19.64	T4	
	1.4MHz	18900	9.64	-29.79	1.94	39.43	20.00	-19.43	T4			
	Radial	20MHz	18900	-0.57	-35.40	-62.79	N/A	34.83	20.00	-14.83	T4	2.0, 3.2
		15MHz	18900	-0.62	-35.61			34.99	20.00	-14.99	T4	
		10MHz	18900	-0.60	-35.93			35.33	20.00	-15.33	T4	
		5MHz	19175	-0.67	-33.58			32.91	20.00	-12.91	T4	
		5MHz	18900	-0.65	-35.31			34.66	20.00	-14.66	T4	
		5MHz	18625	-0.68	-35.66			34.98	20.00	-14.98	T4	
3MHz		18900	-0.69	-35.70	35.01			20.00	-15.01	T4		
1.4MHz	18900	-0.63	-36.27	35.64	20.00	-15.64	T4					

Table 9-14
Raw Data Results for 2.4GHz WIFI (OTT VoIP)

Mode	Orientation	Channel	ABM1 [dB(A/m)]	ABM2 [dB(A/m)]	Ambient Noise [dB(A/m)]	Frequency Response Margin (dB)	S+N/N (dB)	FCC Limit (dB)	Margin from FCC Limit (dB)	C63.19-2011 Rating	Test Coordinates
IEEE 802.11b	Axial	1	9.87	-33.66	-63.16	2.00	43.53	20.00	-23.53	T4	2.0, 4.0
		6	9.90	-33.41		2.00	43.31	20.00	-23.31	T4	
		11	9.90	-33.90		2.00	43.80	20.00	-23.80	T4	
	Radial	1	-0.65	-35.20	-62.79	N/A	34.55	20.00	-14.55	T4	2.0, 3.2
		6	-0.64	-34.49			33.85	20.00	-13.85	T4	
		11	-0.59	-33.40			32.81	20.00	-12.81	T4	
IEEE 802.11g	Axial	6	9.88	-36.97	-63.16	2.00	46.85	20.00	-26.85	T4	2.0, 4.0
	Radial	6	-0.86	-35.36	-62.79	N/A	34.50	20.00	-14.50	T4	2.0, 3.2
IEEE 802.11n	Axial	6	9.90	-36.22	-63.16	2.00	46.12	20.00	-26.12	T4	2.0, 4.0
	Radial	6	-0.69	-37.07	-62.79	N/A	36.38	20.00	-16.38	T4	2.0, 3.2



II. Test Notes

A. General

1. Phone Condition: Mute on; Backlight off; Max Volume; Max Contrast
2. 'Radial' orientation refers to radial transverse.
3. Hearing Aid Mode (**Phone→Call settings→Additional settings→Hearing aids**) was set to ON for Frequency Response compliance
4. Speech Signal: ITU-T P.50 Artificial Voice
5. Bluetooth and WIFI were disabled while testing 2G/3G/4G modes.
6. Licensed data modes and Bluetooth were disabled while testing WIFI modes.
7. The Margin from FCC limit column indicates a margin from the FCC limit for compliance (T3).

B. GSM

1. Power Configuration: GSM850: PCL=5, GSM1900: PCL=0;
2. Vocoder Configuration: EFR (GSM);

FCC ID: ZNFK400AM		HAC (T-COIL) TEST REPORT		Approved by: Quality Manager
Filename: 1M2003020032-03.ZNF	Test Dates: 03/16/2020 - 03/26/2020	DUT Type: Portable Handset		Page 30 of 71

C. UMTS

1. Power Configuration: TPC= "All 1s";
2. Vocoder Configuration: AMR 12.2 kbps (UMTS);

D. LTE FDD



1. Power Configuration: TPC = "Max Power"
2. Radio Configuration: 16QAM, 1RB, 0RB offset
3. Vocoder Configuration: NB AMR 12.2kbps
4. The worst-case band and bandwidth combination for each probe orientation is additionally tested on the low and high channels for those combinations. LTE Band 66 at 5MHz is the worst-case for both the Axial and Radial probe orientations.

E. WIFI

1. Radio Configuration
 - a. IEEE 802.11b: DSSS, 1Mbps
 - b. IEEE 802.11g: BPSK, 9Mbps
 - c. IEEE 802.11n: QPSK, MCS 1
2. Vocoder Configuration: NB AMR 12.2kbps
3. The worst-case standard for 2.4GHz WIFI in each probe orientation is additionally tested on the low and high channels. IEEE 802.11b is the worst-case for both the Axial and Radial probe orientations.

F. OTT VoIP

1. Vocoder Configuration: 75kbps
2. EDGE Configuration
 - a. MCS Index: 7
 - b. Number of TX slots: 2
3. HSPA Configuration:
 - a. Release: 6
 - b. 3GPP 34.121 Subtest 1
4. LTE FDD Configuration:
 - a. Power Configuration: TPC = "Max Power"
 - b. Radio Configuration: 16QAM, 1RB, 0RB offset
 - c. LTE Band 2 was the worst-case band from Table 7-5 and was used to test both Axial and Radial probe orientations.
 - d. The worst-case band and bandwidth combination for each probe orientation is additionally tested on the low and high channels for those combinations. LTE Band 2 at 20MHz is the worst-case for the Axial probe orientation. LTE Band 2 at 5MHz bandwidth is the worst-case for the Radial probe orientation.
5. WIFI Configuration:
 - a. Radio Configuration
 - i. IEEE 802.11b: DSSS, 1Mbps
 - ii. IEEE 802.11g: BPSK, 9Mbps
 - iii. IEEE 802.11n: QPSK, MCS 1
 - b. The worst-case standard for 2.4GHz WIFI in each probe orientation is additionally tested on the low and high channels. IEEE 802.11b is the worst-case for both the Axial and Radial probe orientations.

FCC ID: ZNFK400AM	 PCTEST Head to the point of service	HAC (T-COIL) TEST REPORT		Approved by: Quality Manager
Filename: 1M2003020032-03.ZNF	Test Dates: 03/16/2020 - 03/26/2020	DUT Type: Portable Handset		Page 31 of 71

III. 1 kHz Vocoder Application Check

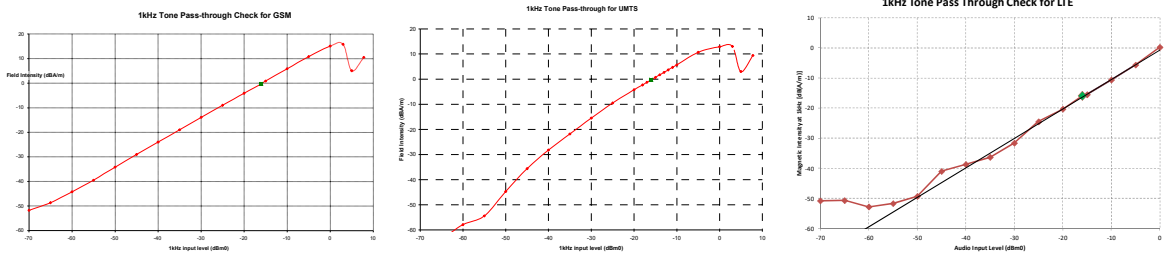

This model was verified to be within the linear region for ABM1 measurements at -16 dBm₀ for GSM, UMTS, and VoLTE over IMS. This measurement was taken in the axial configuration above the maximum location.

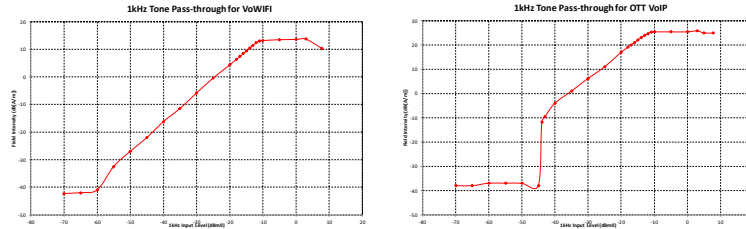

This model was verified to be within the linear region for ABM1 measurements at -20 dBm₀ for VoWiFi over IMS and OTT VoIP. This measurement was taken in the axial configuration above the maximum location.



IV. T-Coil Validation Test Results

Table 9-15
Helmholtz Coil Validation Table of Results – 03/16/2020

Item	Target	Result	Verdict
Axial			
Magnetic Intensity, -10 dBA/m	-10 ± 0.5 dB	-10.296	PASS
Environmental Noise	< -58 dBA/m	-63.16	PASS
Frequency Response, from limits	> 0 dB	0.80	PASS
Radial			
Magnetic Intensity, -10 dBA/m	-10 ± 0.5 dB	-10.347	PASS
Environmental Noise	< -58 dBA/m	-62.79	PASS
Frequency Response, from limits	> 0 dB	0.80	PASS

Table 9-16
Helmholtz Coil Validation Table of Results – 03/25/2020

Item	Target	Result	Verdict
Axial			
Magnetic Intensity, -10 dBA/m	-10 ± 0.5 dB	-9.908	PASS
Environmental Noise	< -58 dBA/m	-60.56	PASS
Frequency Response, from limits	> 0 dB	0.70	PASS

FCC ID: ZNFK400AM	 PCTEST Proud to be part of	HAC (T-COIL) TEST REPORT	 LG	Approved by: Quality Manager
Filename: 1M2003020032-03.ZNF	Test Dates: 03/16/2020 - 03/26/2020	DUT Type: Portable Handset		Page 32 of 71

V. ABM1 Magnetic Field Distribution Scan Overlays

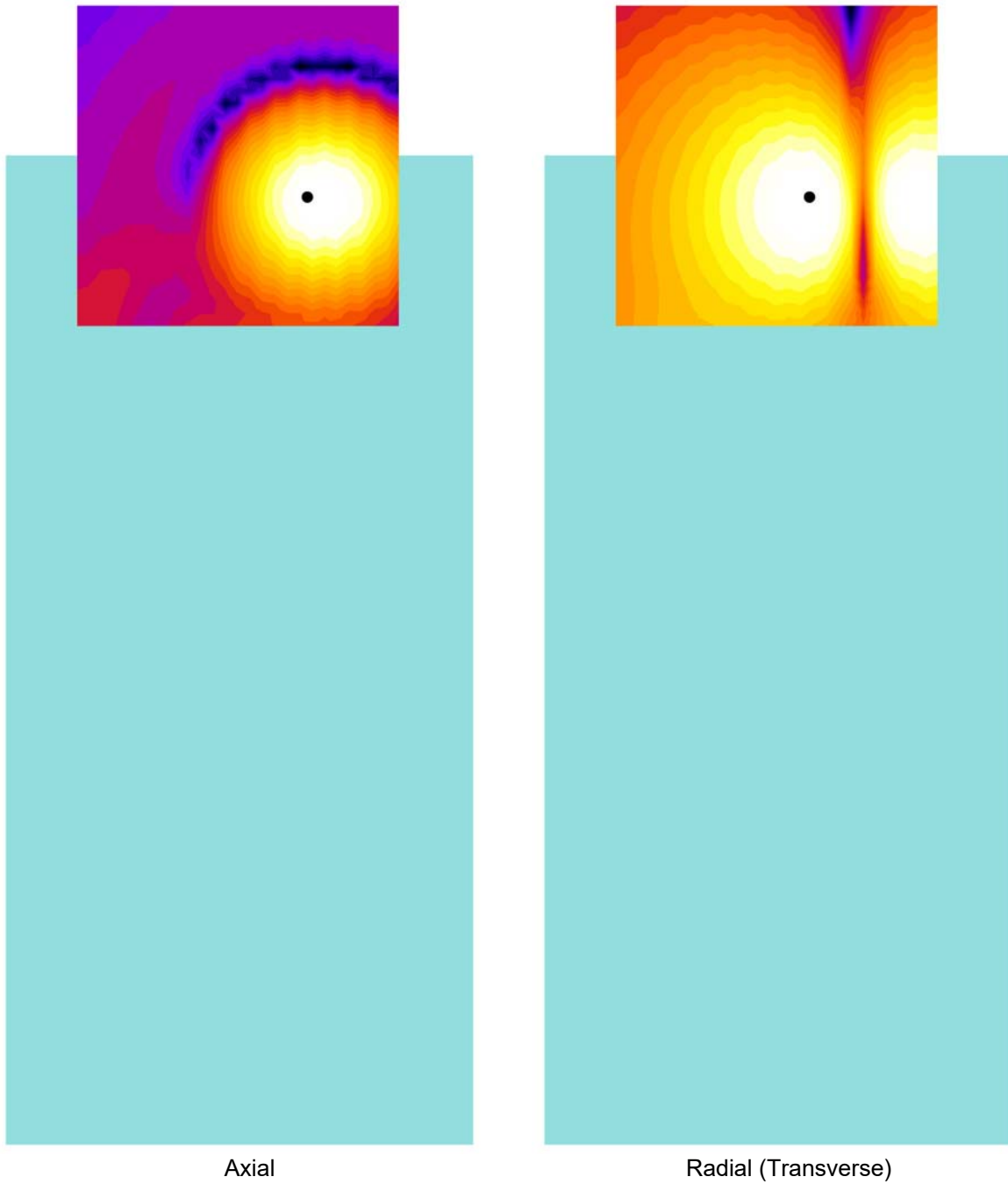



Figure 9-1
T-Coil Scan Overlay Magnetic Field Distributions

Notes:

1. Final measurement locations are indicated by a cursor on the contour plots.
2. See Test Setup Photographs for actual WD overlay.

FCC ID: ZNFK400AM		HAC (T-COIL) TEST REPORT	
Filename: 1M2003020032-03.ZNF	Test Dates: 03/16/2020 - 03/26/2020	DUT Type: Portable Handset	Approved by: Quality Manager

10. MEASUREMENT UNCERTAINTY



**Table 10-1
Uncertainty Estimation Table**

Contribution	Data +/- %	Data +/- dB	Data Type	Probability distribution	Divisor	Standard uncertainty	Standard Uncertainty (dB)
ABM Noise	7.0%	0.29	Std. Dev.	Normal k=1	1.00	7.0%	
RF Reflections	4.7%	0.20	Specification	Rectangular	1.73	2.7%	
Reference Signal Level	12.2%	0.50	Specification	Rectangular	1.73	7.0%	
Positioning Accuracy	10.0%	0.41	Uncertainty	Rectangular	1.73	5.8%	
Probe Coil Sensitivity	12.2%	0.50	Specification	Rectangular	1.73	7.0%	
Probe Linearity	2.4%	0.10	Std. Dev.	Normal k=1	1.00	2.4%	
Cable Loss	2.8%	0.12	Specification	Rectangular	1.73	1.6%	
Frequency Analyzer	5.0%	0.21	Specification	Rectangular	1.73	2.9%	
System Repeatability	5.0%	0.21	Std. Dev.	Normal k=1	1.00	5.0%	
WD Repeatability	9.0%	0.37	Std. Dev.	Normal k=1	1.00	9.0%	
Positioner Accuracy	1.0%	0.04	Specification	Rectangular	1.73	0.6%	
Combined standard uncertainty, u_c (k=1)						17.7%	0.71
Expanded uncertainty (k=2), 95% confidence level						35.3%	1.31

Notes:

1. Test equipments are calibrated according to techniques outlined in NIS81, NIS3003 and NIST Tech Note 1297.
2. All equipments have traceability according to NIST. Measurement Uncertainties are defined in further detail in NIS 81 and NIST Tech Note 1297 and UKAS M3003.



Measurement uncertainty reflects the quality and accuracy of a measured result as compared to the true value. Such statements are generally required when stating results of measurements so that it is clear to the intended audience that the results may differ when reproduced by different facilities. Measurement results vary due to the measurement uncertainty of the instrumentation, measurement technique, and test engineer. Most uncertainties are calculated using the tolerances of the instrumentation used in the measurement, the measurement setup variability, and the technique used in performing the test. While not generally included, the variability of the equipment under test also figures into the overall measurement uncertainty. Another component of the overall uncertainty is based on the variability of repeated measurements (so-called Type A uncertainty). This may mean that the Hearing Aid compatibility tests may have to be repeated by taking down the test setup and resetting it up so that there are a statistically significant number of repeat measurements to identify the measurement uncertainty. By combining the repeat measurement results with that of the instrumentation chain using the technique contained in NIS 81 and NIS 3003, the overall measurement uncertainty was estimated.

FCC ID: ZNFK400AM	 PCTEST Head to the point of delivery	HAC (T-COIL) TEST REPORT	 LG	Approved by: Quality Manager
Filename: 1M2003020032-03.ZNF	Test Dates: 03/16/2020 - 03/26/2020	DUT Type: Portable Handset		Page 34 of 71



11. EQUIPMENT LIST

**Table 11-1
Equipment List**

Manufacturer	Model	Description	Cal Date	Cal Interval	Cal Due	Serial Number
Control Company	4040	Therm./Clock/Humidity Monitor	6/29/2019	Biennial	6/29/2021	192291463
Dell	Latitude E6540	SoundCheck Acoustic Analyzer Laptop	4/24/2019	Biennial	4/24/2021	7BFNM32
Dell	Latitude E6540	SoundCheck Acoustic Analyzer Laptop	9/6/2018	Biennial	9/6/2020	2655082910
Listen	SoundConnect	Microphone Power Supply	4/22/2019	Biennial	4/22/2021	PS2612
Listen	SoundConnect	Microphone Power Supply	9/6/2018	Biennial	9/6/2020	0899-PS150
RME	Fireface UC	Soundcheck Acoustic Analyzer External Audio Interface	4/24/2019	Biennial	4/24/2021	23528889
RME	Fireface UC	Soundcheck Acoustic Analyzer External Audio Interface	9/6/2018	Biennial	9/6/2020	23792992
Rohde & Schwarz	CMW500	Radio Communication tester	8/14/2019	Annual	8/14/2020	140144
Rohde & Schwarz	CMW500	Wideband Radio Communication Tester	2/4/2020	Annual	2/4/2021	162125
Seekonk	NC-100	Torque Wrench (8" lb)	5/10/2018	Biennial	5/10/2020	21053
TEM	Axial T-Coil Probe	Axial T-Coil Probe	5/17/2019	Biennial	5/17/2021	TEM-1124
TEM	Axial T-Coil Probe	Axial T-Coil Probe	9/19/2018	Biennial	9/19/2020	TEM-1123
TEM		HAC Positioner	N/A		N/A	N/A
TEM		HAC System Controller with Software	N/A		N/A	N/A
TEM	C63.19	Helmholtz Coil	5/20/2019	Biennial	5/20/2021	925
TEM	Helmholtz Coil	Helmholtz Coil	10/10/2018	Biennial	10/10/2020	SBI 1052
TEM	Radial T-Coil Probe	Radial T-Coil Probe	5/17/2019	Biennial	5/17/2021	TEM-1130

FCC ID: ZNFK400AM	 <small>Head to toe part of device</small>	HAC (T-COIL) TEST REPORT		Approved by: Quality Manager
Filename: 1M2003020032-03.ZNF	Test Dates: 03/16/2020 - 03/26/2020	DUT Type: Portable Handset	Page 35 of 71	

12. TEST DATA

FCC ID: ZNFK400AM	 PCTEST <small>Head to toe part of</small>	HAC (T-COIL) TEST REPORT	 LG	Approved by: Quality Manager
Filename: 1M2003020032-03.ZNF	Test Dates: 03/16/2020 - 03/26/2020	DUT Type: Portable Handset	Page 36 of 71	

© 2020 PCTEST

REV 3.5.M
3/2/2020

© 2020 PCTEST All rights reserved. Unless otherwise specified, no part of this report may be reproduced or utilized in any part, form or by any means, electronic or mechanical, including photocopying and microfilm, without permission in writing from PCTEST. If you have any questions about this international copyright or have an enquiry about obtaining additional rights to this report or assembly of contents thereof, please contact INFO@PCTEST.COM.



PCTEST Hearing-Aid Compatibility Facility

DUT: HH Coil – SN: SBI 1052

Type: HH Coil
Serial: SBI 1052

Measurement Standard: ANSI C63.19-2011

Equipment:

- Probe: Axial T-Coil Probe – SN: TEM-1123; Calibrated: 09/19/2018
- Helmholtz Coil – SN: SBI 1052; Calibrated: 10/10/2018

Noise Spectrum

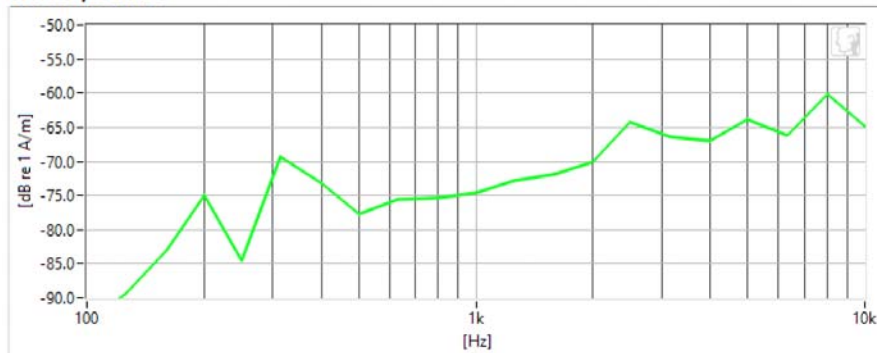

Frequency Response

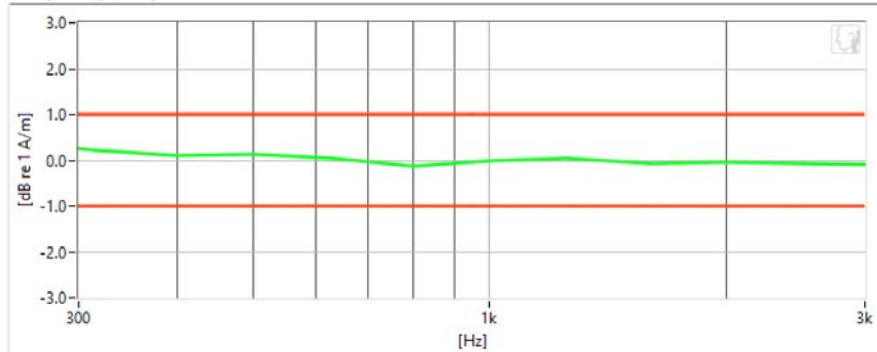

Results

Verification 1kHz Intensity	-9.908 dB	✓	Max/Min	-9.5/-10.5
Verification ABM2	-60.56 dB	✓	Maximum	-58.0
Frequency Response Margin	700m dB	✓	Tolerance curves	Aligned Data

PCTEST 2020

FCC ID: ZNFK400AM	PCTEST Proud to be part of element	HAC (T-COIL) TEST REPORT	LG	Approved by: Quality Manager
Filename: 1M2003020032-03.ZNF	Test Dates: 03/16/2020 - 03/26/2020	DUT Type: Portable Handset		Page 37 of 71



PCTEST Hearing-Aid Compatibility Facility

DUT: HH Coil – SN: 925

Type: HH Coil
Serial: 925

Measurement Standard: ANSI C63.19-2011

Equipment:

- Probe: Axial T-Coil Probe – SN: TEM-1124; Calibrated: 05/17/2019
- Helmholtz Coil – SN: 925; Calibrated: 05/20/2019

Noise Spectrum

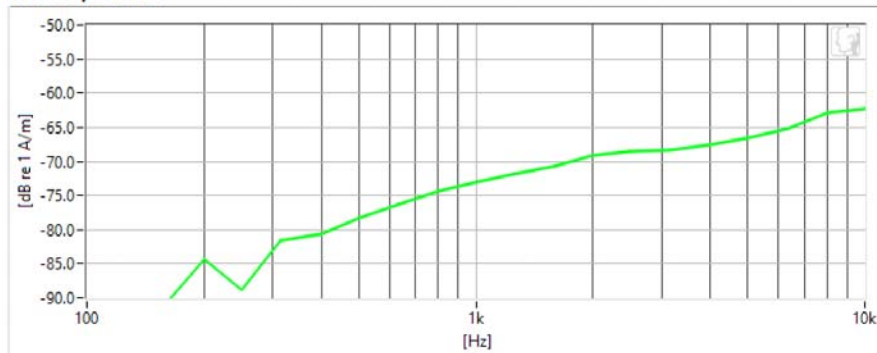

Frequency Response

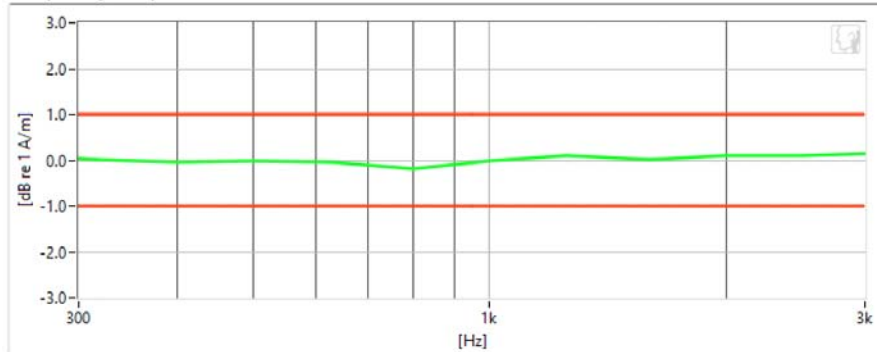

Results

Verification 1kHz Intensity	-10.296 dB	✓	Max/Min	-9.5/-10.5
Verification ABM2	-63.16 dB	✓	Maximum	-58.0
Frequency Response Margin	800m dB	✓	Tolerance curves	Aligned Data

PCTEST 2020

FCC ID: ZNFK400AM	PCTEST Proud to be part of element	HAC (T-COIL) TEST REPORT		Approved by: Quality Manager
Filename: 1M2003020032-03.ZNF	Test Dates: 03/16/2020 - 03/26/2020	DUT Type: Portable Handset		Page 38 of 71



PCTEST Hearing-Aid Compatibility Facility

DUT: HH Coil – SN: 925

Type: HH Coil
Serial: 925

Measurement Standard: ANSI C63.19-2011

Equipment:

- Probe: Radial T-Coil Probe – SN: TEM-1130; Calibrated: 05/17/2019
- Helmholtz Coil – SN: 925; Calibrated: 05/20/2019

Noise Spectrum

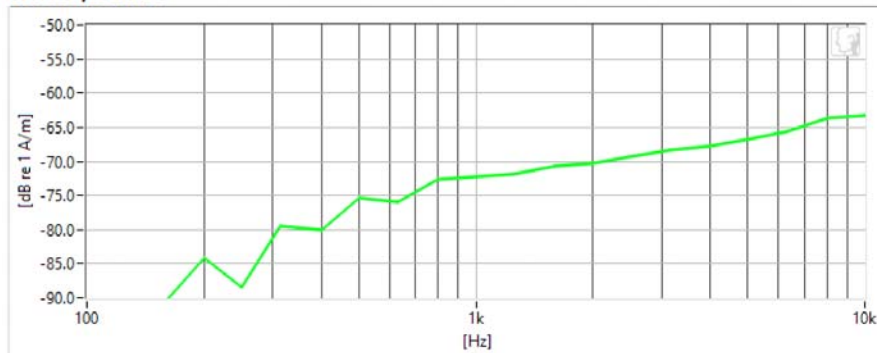

Frequency Response

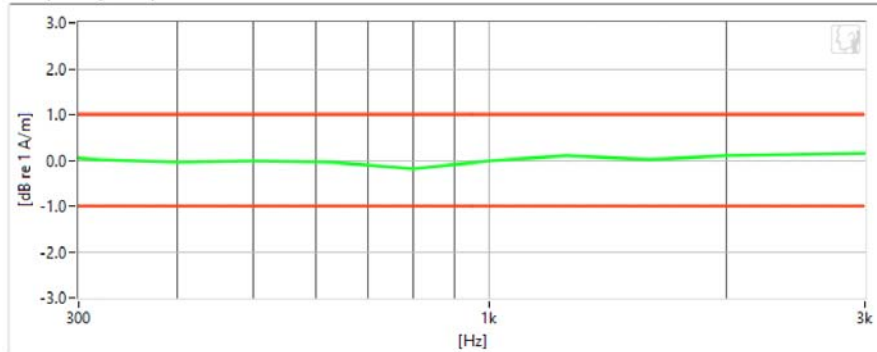

Results

Verification 1kHz Intensity	-10.347 dB	✓	Max/Min	-9.5/-10.5
Verification ABM2	-62.79 dB	✓	Maximum	-58.0
Frequency Response Margin	800m dB	✓	Tolerance curves	Aligned Data

PCTEST 2020

FCC ID: ZNFK400AM		HAC (T-COIL) TEST REPORT		Approved by: Quality Manager
Filename: 1M2003020032-03.ZNF	Test Dates: 03/16/2020 - 03/26/2020	DUT Type: Portable Handset		Page 39 of 71



PCTEST Hearing-Aid Compatibility Facility

DUT: ZNFK400AM

Type: Portable Handset
Serial: 10575

Measurement Standard: ANSI C63.19-2011

Equipment:

- Probe: Axial T-Coil Probe – SN: TEM-1123; Calibrated: 09/19/2018

Test Configuration:

- Mode: GSM850
- Channel: 128
- Speech Signal: ITU-T P.50 Artificial Voice

Noise Spectrum

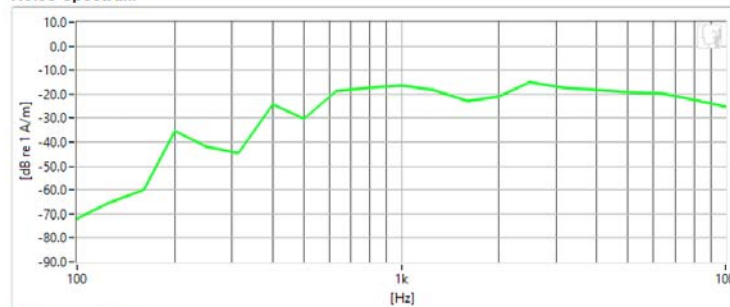

Frequency Response

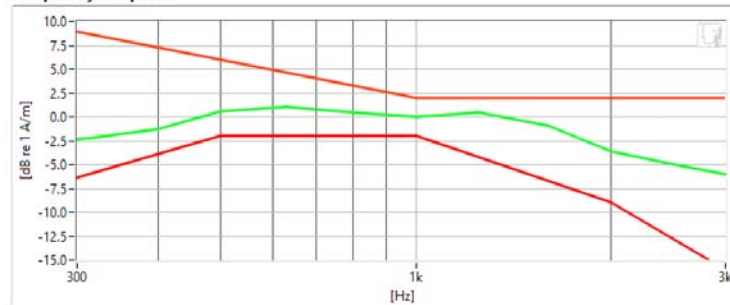

Results

ABM1	17.49 dB	✓	Minimum	-18.0
ABM2	-9.69 dB	✓	Maximum	0.0
SNNR	27.18 dB	✓	Minimum	20.0
Aligned Response - P.50	1.55 dB	✓	Tolerance curves	Aligned Data

PCTEST 2020

FCC ID: ZNFK400AM		HAC (T-COIL) TEST REPORT		Approved by: Quality Manager
Filename: 1M2003020032-03.ZNF	Test Dates: 03/16/2020 - 03/26/2020	DUT Type: Portable Handset		Page 40 of 71



PCTEST Hearing-Aid Compatibility Facility

DUT: ZNFK400AM

Type: Portable Handset
Serial: 10575

Measurement Standard: ANSI C63.19-2011

Equipment:

- Probe: Axial T-Coil Probe – SN: TEM-1123; Calibrated: 09/19/2018

Test Configuration:

- Mode: GSM1900
- Channel: 661
- Speech Signal: ITU-T P.50 Artificial Voice

Noise Spectrum

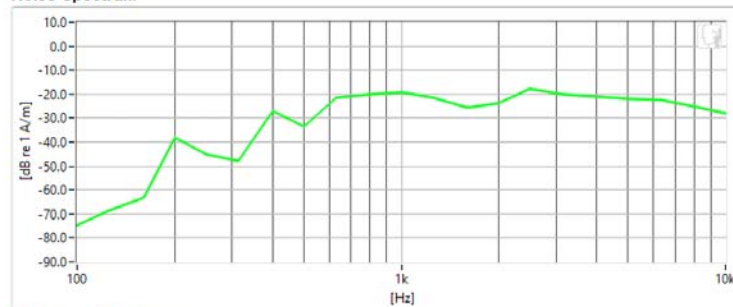

Frequency Response

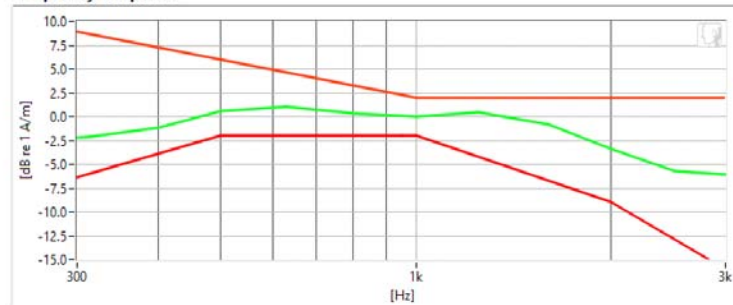

Results

ABM1	17.44 dB	✓	Minimum	-18.0
ABM2	-12.56 dB	✓	Maximum	0.0
SNNR	30 dB	✓	Minimum	20.0
Aligned Response - P.50	1.48 dB	✓	Tolerance curves	Aligned Data

PCTEST 2020

FCC ID: ZNFK400AM		HAC (T-COIL) TEST REPORT		Approved by: Quality Manager
Filename: 1M2003020032-03.ZNF	Test Dates: 03/16/2020 - 03/26/2020	DUT Type: Portable Handset		Page 41 of 71



PCTEST

 Proud to be part of 

PCTEST Hearing-Aid Compatibility Facility

DUT: ZNFK400AM
 Type: Portable Handset
 Serial: 10575

Measurement Standard: ANSI C63.19-2011

Equipment:

- Probe: Axial T-Coil Probe – SN: TEM-1124; Calibrated: 05/17/2019

Test Configuration:

- Mode: UMTS V
- Channel: 4183
- Speech Signal: ITU-T P.50 Artificial Voice

Noise Spectrum

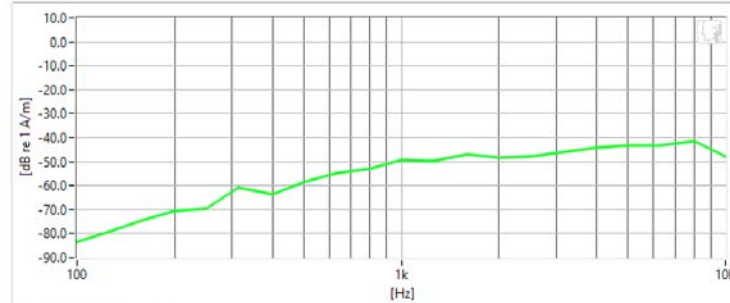

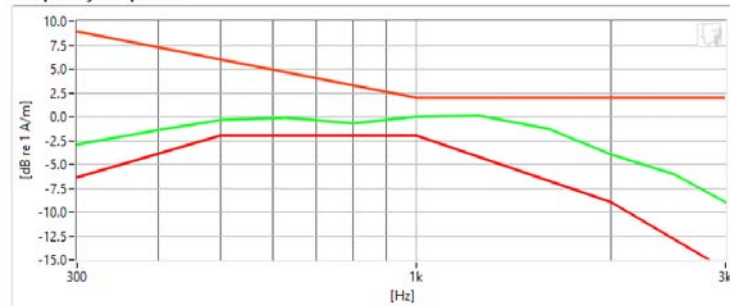

Frequency Response



Results

ABM1	5.65 dB	✓	Minimum	-18.0
ABM2	-41.27 dB	✓	Maximum	0.0
SNNR	46.91 dB	✓	Minimum	20.0
Aligned Response - P.50	1.34 dB	✓	Tolerance curves	Aligned Data

PCTEST 2020

FCC ID: ZNFK400AM		HAC (T-COIL) TEST REPORT		Approved by: Quality Manager
Filename: 1M2003020032-03.ZNF	Test Dates: 03/16/2020 - 03/26/2020	DUT Type: Portable Handset		Page 42 of 71



PCTEST Hearing-Aid Compatibility Facility

DUT: ZNFK400AM

Type: Portable Handset
Serial: 10575

Measurement Standard: ANSI C63.19-2011

Equipment:

- Probe: Axial T-Coil Probe – SN: TEM-1124; Calibrated: 05/17/2019

Test Configuration:

- Mode: UMTS IV
- Channel: 1513
- Speech Signal: ITU-T P.50 Artificial Voice

Noise Spectrum

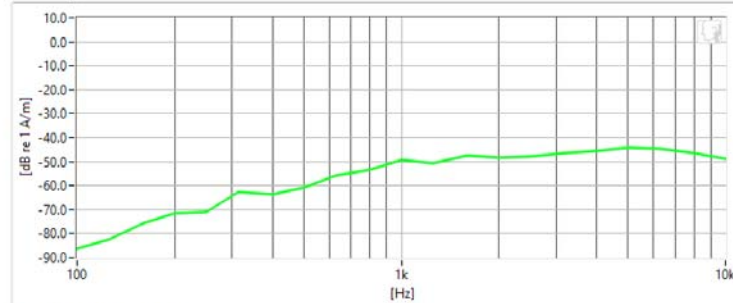

Frequency Response

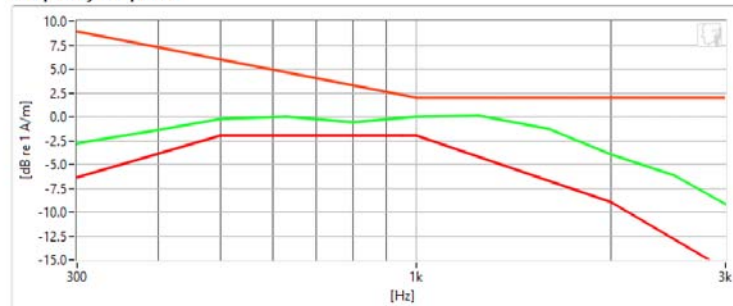

Results

ABM1	5.65 dB	✓	Minimum	-18.0
ABM2	-41.94 dB	✓	Maximum	0.0
SNNR	47.59 dB	✓	Minimum	20.0
Aligned Response - P.50	1.38 dB	✓	Tolerance curves	Aligned Data

PCTEST 2020

FCC ID: ZNFK400AM		HAC (T-COIL) TEST REPORT		Approved by: Quality Manager
Filename: 1M2003020032-03.ZNF	Test Dates: 03/16/2020 - 03/26/2020	DUT Type: Portable Handset		Page 43 of 71



PCTEST

 Proud to be part of 

PCTEST Hearing-Aid Compatibility Facility

DUT: ZNFK400AM

Type: Portable Handset
Serial: 10575

Measurement Standard: ANSI C63.19-2011

Equipment:

- Probe: Axial T-Coil Probe – SN: TEM-1124; Calibrated: 05/17/2019

Test Configuration:

- Mode: UMTS II
- Channel: 9400
- Speech Signal: ITU-T P.50 Artificial Voice

Noise Spectrum

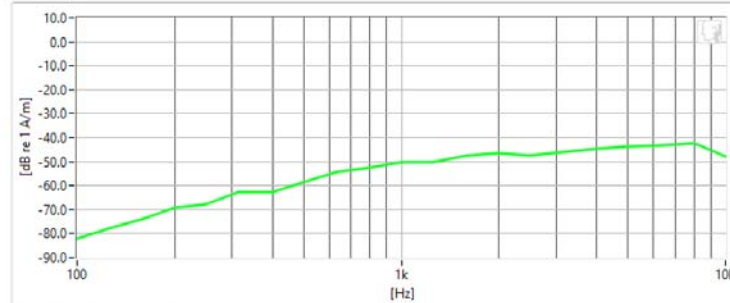

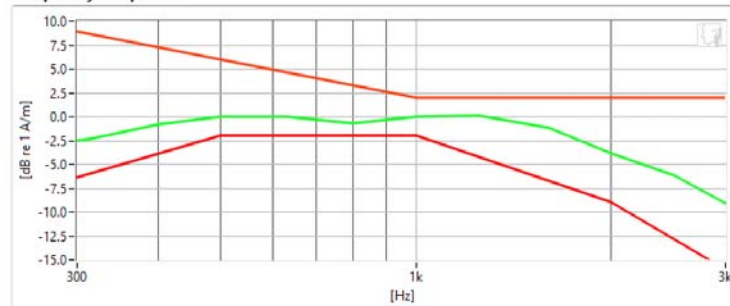

Frequency Response



Results

ABM1	5.73 dB	✓	Minimum	-18.0
ABM2	-41.24 dB	✓	Maximum	0
SNNR	46.96 dB	✓	Minimum	20
Aligned Response - P.50	1.36 dB	✓	Tolerance curves	Aligned Data

PCTEST 2020

FCC ID: ZNFK400AM		HAC (T-COIL) TEST REPORT		Approved by: Quality Manager
Filename: 1M2003020032-03.ZNF	Test Dates: 03/16/2020 - 03/26/2020	DUT Type: Portable Handset		Page 44 of 71



PCTEST

 Proud to be part of 

PCTEST Hearing-Aid Compatibility Facility

DUT: ZNFK400AM

Type: Portable Handset
Serial: 10575

Measurement Standard: ANSI C63.19-2011

Equipment:

- Probe: Axial T-Coil Probe – SN: TEM-1124; Calibrated: 05/17/2019

Test Configuration:

- Mode: LTE Band 66
- Bandwidth: 5MHz
- Channel: 132322
- Speech Signal: ITU-T P.50 Artificial Voice

Noise Spectrum

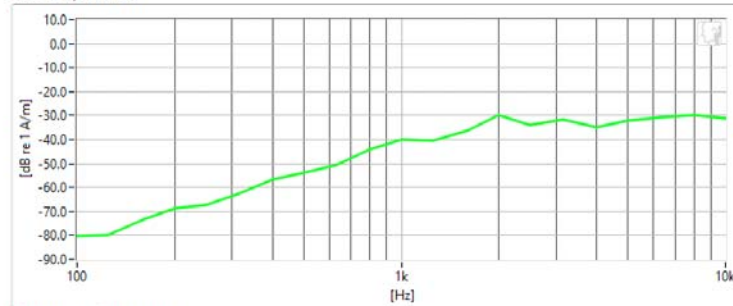

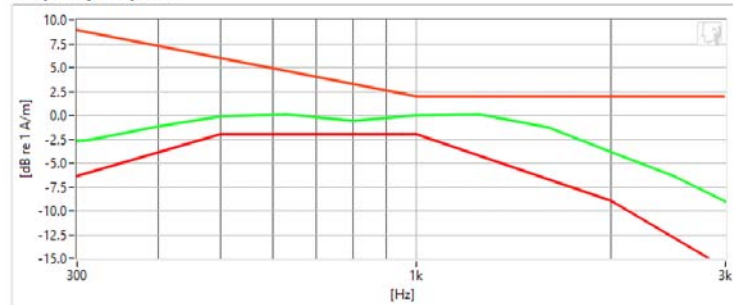

Frequency Response



Results

ABM1	4.79 dB	✓	Minimum	-18.0
ABM2	-29.16 dB	✓	Maximum	0.0
SNNR	33.95 dB	✓	Minimum	20.0
Aligned Response - P.50	1.4 dB	✓	Tolerance curves	Aligned Data

PCTEST 2020

FCC ID: ZNFK400AM		HAC (T-COIL) TEST REPORT		Approved by: Quality Manager
Filename: 1M2003020032-03.ZNF	Test Dates: 03/16/2020 - 03/26/2020	DUT Type: Portable Handset		Page 45 of 71



PCTEST

 Proud to be part of 

PCTEST Hearing-Aid Compatibility Facility

DUT: ZNFK400AM
 Type: Portable Handset
 Serial: 10575

Measurement Standard: ANSI C63.19-2011

Equipment:

- Probe: Axial T-Coil Probe – SN: TEM-1124; Calibrated: 05/17/2019

Test Configuration:

- Mode: 2.4GHz WIFI
- Standard: IEEE 802.11b
- Channel: 6
- Speech Signal: ITU-T P.50 Artificial Voice

Noise Spectrum

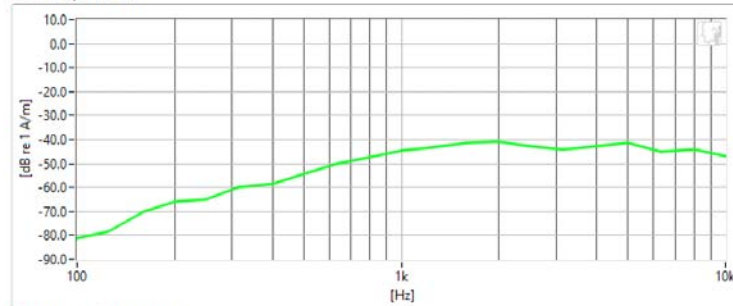

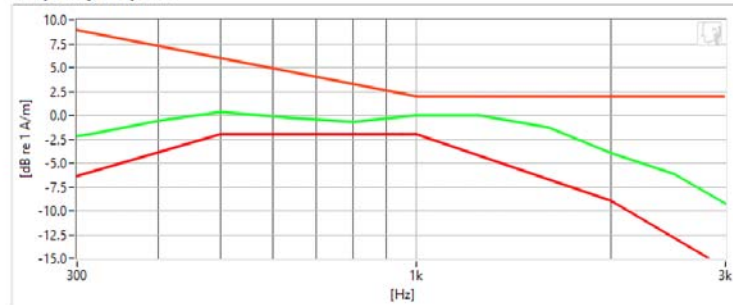

Frequency Response



Results

ABM1	2.19 dB	✓	Minimum	-18.0
ABM2	-36.49 dB	✓	Maximum	0.0
SNNR	38.68 dB	✓	Minimum	20.0
Aligned Response - P.50	1.35 dB	✓	Tolerance curves	Aligned Data

PCTEST 2020

FCC ID: ZNFK400AM		HAC (T-COIL) TEST REPORT		Approved by: Quality Manager
Filename: 1M2003020032-03.ZNF	Test Dates: 03/16/2020 - 03/26/2020	DUT Type: Portable Handset		Page 46 of 71



PCTEST

 Proud to be part of 

PCTEST Hearing-Aid Compatibility Facility

DUT: ZNFK400AM
 Type: Portable Handset
 Serial: 10575

Measurement Standard: ANSI C63.19-2011

Equipment:

- Probe: Axial T-Coil Probe – SN: TEM-1124; Calibrated: 05/17/2019

Test Configuration:

- VoIP Application: Google Duo
- Mode: EDGE850
- Channel: 190
- Speech Signal: ITU-T P.50 Artificial Voice

Noise Spectrum

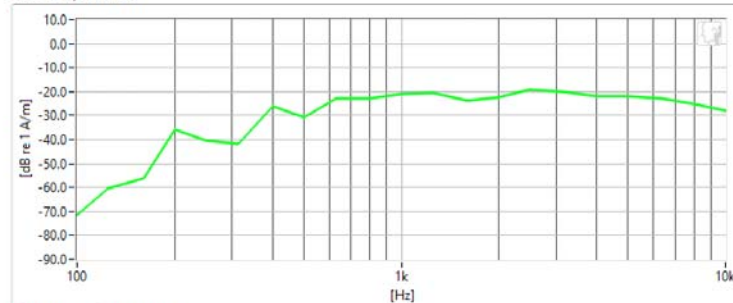

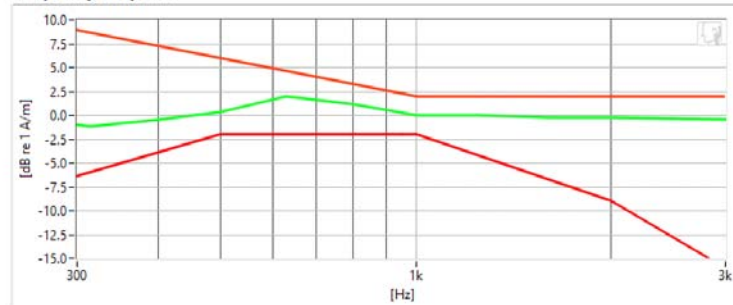

Frequency Response



Results

ABM1	9.75 dB	✓	Minimum	-18.0
ABM2	-13.42 dB	✓	Maximum	0.0
SNNR	23.17 dB	✓	Minimum	20.0
Aligned Response - P.50	1.99 dB	✓	Tolerance curves	Aligned Data

PCTEST 2020

FCC ID: ZNFK400AM		HAC (T-COIL) TEST REPORT		Approved by: Quality Manager
Filename: 1M2003020032-03.ZNF	Test Dates: 03/16/2020 - 03/26/2020	DUT Type: Portable Handset		Page 47 of 71



PCTEST Hearing-Aid Compatibility Facility

DUT: ZNFK400AM

Type: Portable Handset
Serial: 10575

Measurement Standard: ANSI C63.19-2011

Equipment:

- Probe: Radial T-Coil Probe – SN: TEM-1130; Calibrated: 05/17/2019

Test Configuration:

- Mode: GSM850
- Channel: 128

Noise Spectrum

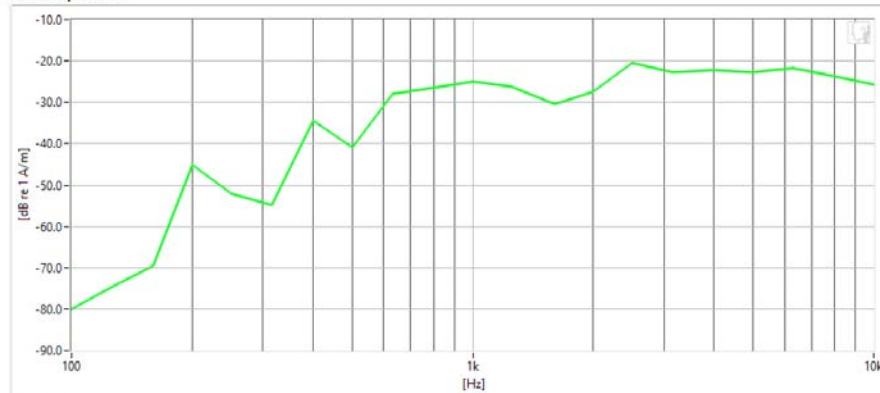

Results

ABM1	8.17 dB	✓	Minimum	-18.0
ABM2	-17.63 dB	✓	Maximum	0.0
SNNR	25.81 dB	✓	Minimum	20.0

PCTEST 2020

FCC ID: ZNFK400AM	PCTEST Proud to be part of element	HAC (T-COIL) TEST REPORT		Approved by: Quality Manager
Filename: 1M2003020032-03.ZNF	Test Dates: 03/16/2020 - 03/26/2020	DUT Type: Portable Handset	Page 48 of 71	



PCTEST Hearing-Aid Compatibility Facility

DUT: ZNFK400AM

Type: Portable Handset
Serial: 10575

Measurement Standard: ANSI C63.19-2011

Equipment:

- Probe: Radial T-Coil Probe – SN: TEM-1130; Calibrated: 05/17/2019

Test Configuration:

- Mode: GSM1900
- Channel: 661

Noise Spectrum

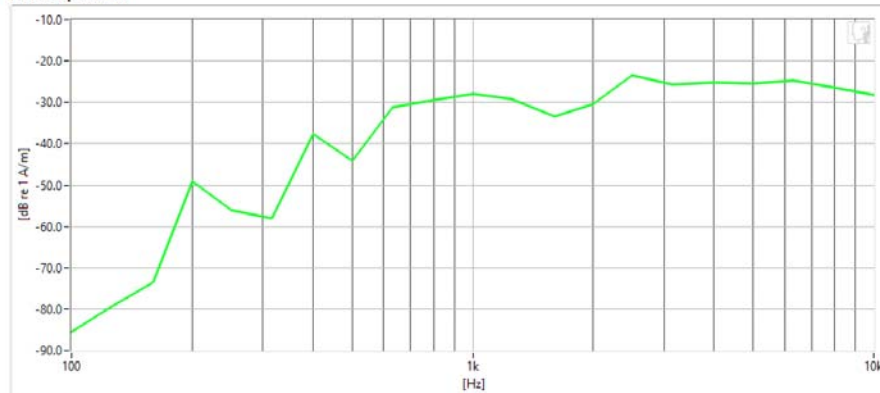

Results

ABM1	8.17 dB	✓	Minimum	-18.0
ABM2	-20.64 dB	✓	Maximum	0.0
SNNR	28.81 dB	✓	Minimum	20.0

PCTEST 2020

FCC ID: ZNFK400AM	PCTEST Proud to be part of element	HAC (T-COIL) TEST REPORT	LG	Approved by: Quality Manager
Filename: 1M2003020032-03.ZNF	Test Dates: 03/16/2020 - 03/26/2020	DUT Type: Portable Handset	Page 49 of 71	



PCTEST Hearing-Aid Compatibility Facility

DUT: ZNFK400AM

Type: Portable Handset
Serial: 10575

Measurement Standard: ANSI C63.19-2011

Equipment:

- Probe: Radial T-Coil Probe – SN: TEM-1130; Calibrated: 05/17/2019

Test Configuration:

- Mode: UMTS V
- Channel: 4233

Noise Spectrum

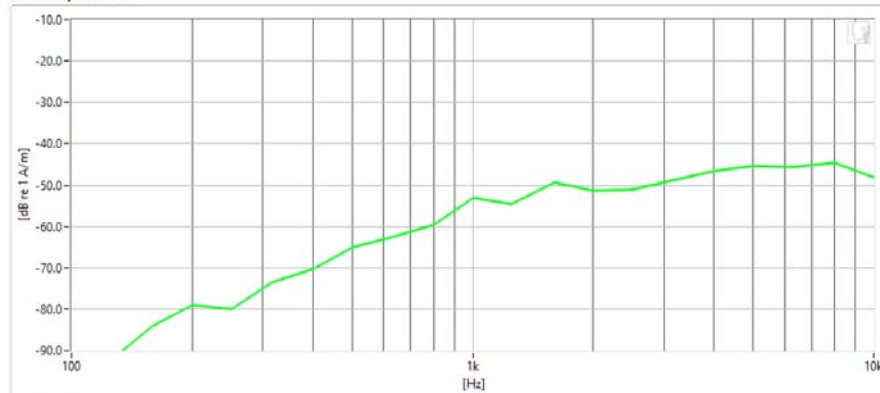

Results

ABM1	-3.83 dB	✓	Minimum	-18.0
ABM2	-45.01 dB	✓	Maximum	0.0
SNNR	41.18 dB	✓	Minimum	20.0

PCTEST 2020

FCC ID: ZNFK400AM	PCTEST Proud to be part of element	HAC (T-COIL) TEST REPORT	LG	Approved by: Quality Manager
Filename: 1M2003020032-03.ZNF	Test Dates: 03/16/2020 - 03/26/2020	DUT Type: Portable Handset	Page 50 of 71	

© 2020 PCTEST

REV 3.5.M
3/2/2020



PCTEST Hearing-Aid Compatibility Facility

DUT: ZNFK400AM

Type: Portable Handset
Serial: 10575

Measurement Standard: ANSI C63.19-2011

Equipment:

- Probe: Radial T-Coil Probe – SN: TEM-1130; Calibrated: 05/17/2019

Test Configuration:

- Mode: UMTS IV
- Channel: 1412

Noise Spectrum

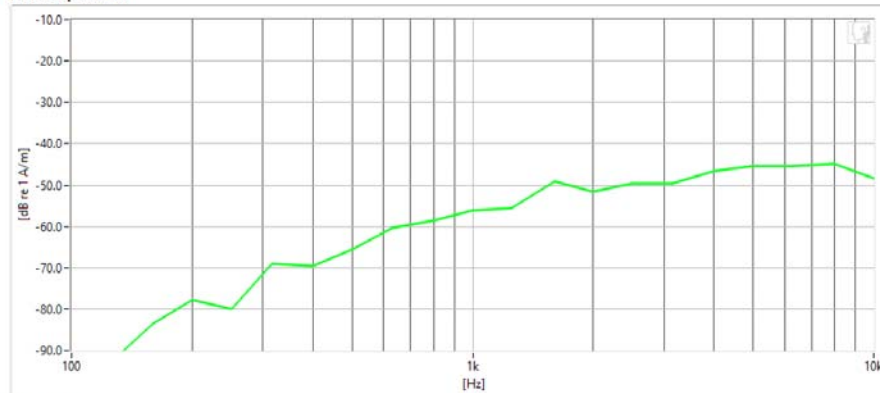

Results

ABM1	-3.8 dB	✓	Minimum	-18.0
ABM2	-45.13 dB	✓	Maximum	0.0
SNNR	41.34 dB	✓	Minimum	20.0

PCTEST 2020

FCC ID: ZNFK400AM		HAC (T-COIL) TEST REPORT		Approved by: Quality Manager
Filename: 1M2003020032-03.ZNF	Test Dates: 03/16/2020 - 03/26/2020	DUT Type: Portable Handset	Page 51 of 71	



PCTEST Hearing-Aid Compatibility Facility

DUT: ZNFK400AM

Type: Portable Handset
Serial: 10575

Measurement Standard: ANSI C63.19-2011

Equipment:

- Probe: Radial T-Coil Probe – SN: TEM-1130; Calibrated: 05/17/2019

Test Configuration:

- Mode: UMTS II
- Channel: 9262

Noise Spectrum

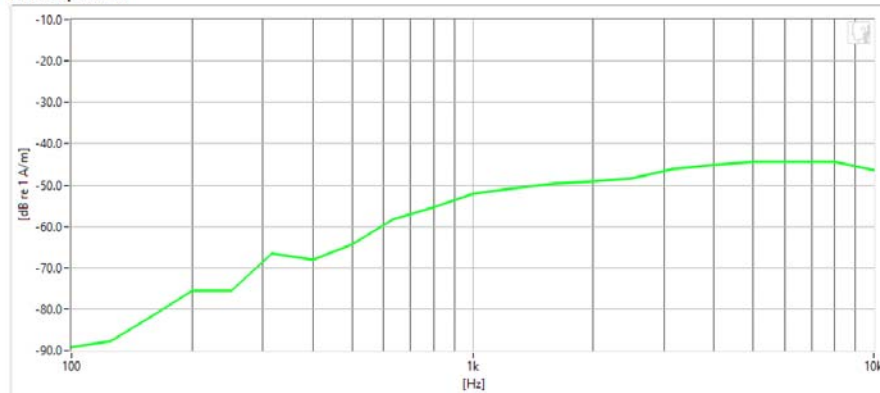

Results

ABM1	-3.78 dB	✓	Minimum	-18.0
ABM2	-43.12 dB	✓	Maximum	0.0
SNNR	39.34 dB	✓	Minimum	20.0

PCTEST 2020

FCC ID: ZNFK400AM	PCTEST Proud to be part of element	HAC (T-COIL) TEST REPORT	LG	Approved by: Quality Manager
Filename: 1M2003020032-03.ZNF	Test Dates: 03/16/2020 - 03/26/2020	DUT Type: Portable Handset	Page 52 of 71	



PCTEST Hearing-Aid Compatibility Facility

DUT: ZNFK400AM

Type: Portable Handset
Serial: 10575

Measurement Standard: ANSI C63.19-2011

Equipment:

- Probe: Radial T-Coil Probe – SN: TEM-1130; Calibrated: 05/17/2019

Test Configuration:

- Mode: LTE Band 66
- Bandwidth: 5MHz
- Channel: 132322

Noise Spectrum

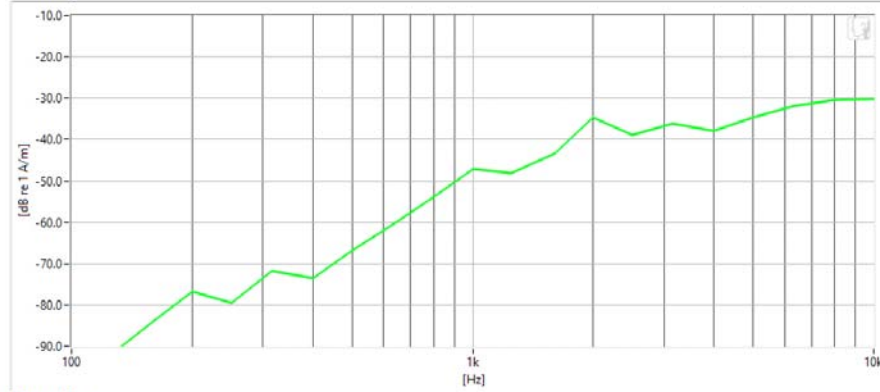

Results

ABM1	-3.96 dB	✓	Minimum	-18.0
ABM2	-33.93 dB	✓	Maximum	0.0
SNNR	29.97 dB	✓	Minimum	20.0

PCTEST 2020

FCC ID: ZNFK400AM		HAC (T-COIL) TEST REPORT		Approved by: Quality Manager
Filename: 1M2003020032-03.ZNF	Test Dates: 03/16/2020 - 03/26/2020	DUT Type: Portable Handset		Page 53 of 71



PCTEST Hearing-Aid Compatibility Facility

DUT: ZNFK400AM

Type: Portable Handset
Serial: 10575

Measurement Standard: ANSI C63.19-2011

Equipment:

- Probe: Radial T-Coil Probe – SN: TEM-1130; Calibrated: 05/17/2019

Test Configuration:

- Mode: 2.4GHz WFI
- Standard: IEEE 802.11b
- Channel: 11

Noise Spectrum

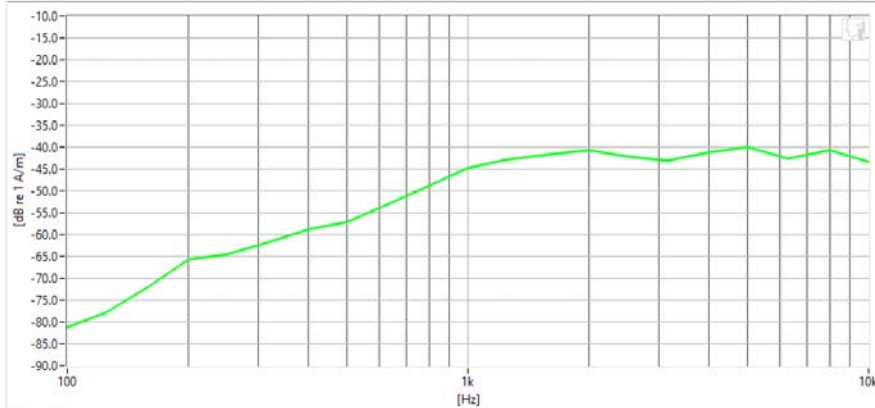

Results

ABM1	-8.04 dB	✓	Minimum	-18.0
ABM2	-36.44 dB	✓	Maximum	0.0
SNNR	28.41 dB	✓	Minimum	20.0

PCTEST 2020

FCC ID: ZNFK400AM		HAC (T-COIL) TEST REPORT		Approved by: Quality Manager
Filename: 1M2003020032-03.ZNF	Test Dates: 03/16/2020 - 03/26/2020	DUT Type: Portable Handset	Page 54 of 71	



PCTEST Hearing-Aid Compatibility Facility

DUT: ZNFK400AM

Type: Portable Handset
Serial: 10575

Measurement Standard: ANSI C63.19-2011

Equipment:

- Probe: Radial T-Coil Probe – SN: TEM-1130; Calibrated: 05/17/2019

Test Configuration:

- VoIP Application: Google Duo
- Mode: EDGE850
- Channel: 190

Noise Spectrum

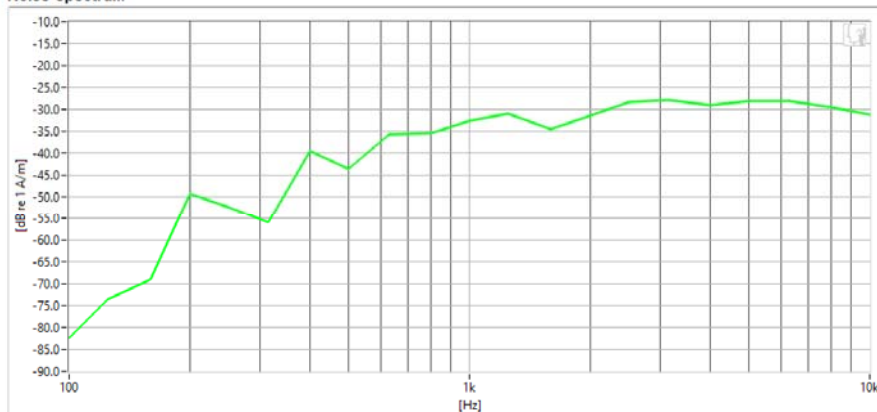



Results

ABM1	-620m dB	✓	Minimum	-18.0
ABM2	-24.21 dB	✓	Maximum	0.0
SNNR	23.59 dB	✓	Minimum	20.0

PCTEST 2020

FCC ID: ZNFK400AM		HAC (T-COIL) TEST REPORT		Approved by: Quality Manager
Filename: 1M2003020032-03.ZNF	Test Dates: 03/16/2020 - 03/26/2020	DUT Type: Portable Handset		Page 55 of 71

13. CALIBRATION CERTIFICATES

FCC ID: ZNFK400AM	 PCTEST <small>Head to toe part of</small>	HAC (T-COIL) TEST REPORT	 LG	Approved by: Quality Manager
Filename: 1M2003020032-03.ZNF	Test Dates: 03/16/2020 - 03/26/2020	DUT Type: Portable Handset	Page 56 of 71	

© 2020 PCTEST

REV 3.5.M
3/2/2020

© 2020 PCTEST All rights reserved. Unless otherwise specified, no part of this report may be reproduced or utilized in any part, form or by any means, electronic or mechanical, including photocopying and microfilm, without permission in writing from PCTEST. If you have any questions about this international copyright or have an enquiry about obtaining additional rights to this report or assembly of contents thereof, please contact INFO@PCTEST.COM.

West Caldwell Calibration Laboratories Inc.

Certificate of Calibration

for

AXIAL T COIL PROBE

Manufactured by: TEM CONSULTING
Model No: AXIAL T COIL PROBE
Serial No: TEM-1124
Calibration Recall No: 29973

Submitted By:

Customer: ANDREW HARWELL
Company: PCTEST ENGINEERING LAB
Address: 6660-B DOBBIN ROAD
COLUMBIA MD 21045

The subject instrument was calibrated to the indicated specification using standards traceable to the National Institute of Standards and Technology or to accepted values of natural physical constants. This document certifies that the instrument met the following specification upon its return to the submitter.

West Caldwell Calibration Laboratories Procedure No. AXIAL T C TEM C

Upon receipt for Calibration, the instrument was found to be:

Within (X)

tolerance of the indicated specification. See attached Report of Calibration.
The information supplied relates to the calibrated item listed above.

West Caldwell Calibration Laboratories' calibration control system meets the requirements, ISO 10012-1 MIL-STD-45662A, ANSI/NCSL Z540-1, IEC Guide 25, ISO 9001:2015 and ISO 17025.

Note: With this Certificate, Report of Calibration is included.

Approved by:

James Zhu

Calibration Date: 17-May-19

Certificate No: 29973 -1

Quality Manager
ISO/IEC 17025:2005

QA Doc. #1051 Rev. 2.0 10/1/01

Certificate Page 1 of 1



uncompromised calibration
1575 State Route 96, Victor, NY 14564, U.S.A.

**West Caldwell
Calibration
Laboratories, Inc.**



Calibration Lab. Cert. # 1533.01

JAH
6/4/2019

FCC ID: ZNFK400AM		HAC (T-COIL) TEST REPORT		Approved by: Quality Manager
Filename: 1M2003020032-03.ZNF	Test Dates: 03/16/2020 - 03/26/2020	DUT Type: Portable Handset		Page 57 of 71

© 2020 PCTEST

REV 3.5.M
3/2/2020

© 2020 PCTEST All rights reserved. Unless otherwise specified, no part of this report may be reproduced or utilized in any part, form or by any means, electronic or mechanical, including photocopying and microfilm, without permission in writing from PCTEST. If you have any questions about this international copyright or have an enquiry about obtaining additional rights to this report or assembly of contents thereof, please contact INFO@PCTEST.COM.



ISO/IEC 17025: 2005



Calibration Lab. Cert. # 1533.01

REPORT OF CALIBRATION

for

TEM Consulting LP Axial T Coil Probe
Company: PCTest Engineering Labs

Model No.: Axial T Coil Probe

Serial No.: TEM-1124
I. D. No.: XXXX

Calibration results:

Probe Sensitivity measured with Helmholtz Coil

Helmholtz Coil;
the number of turns on each coil; 10 No.
the radius of each coil, in meters; 0.204 m
the current in the coils, in amperes.; 0.09 A
Helmholtz Coil Constant; 7.09 A/m/V
Helmholtz Coil magnetic field; 5.96 A/m

Before & after data same: ...X...

Laboratory Environment:
Ambient Temperature: 20.7 °C
Ambient Humidity: 42.7 % RH
Ambient Pressure: 98.256 kPa
Calibration Date: 17-May-2019
Calibration Due: 17-May-2020
Report Number: 29973 -1
Control Number: 29973

Probe Sensitivity at 1000 Hz.
was -60.41 dBV/A/m
0.954 mV/A/m
Probe resistance 903 Ohms

The above listed instrument meets or exceeds the tested manufacturer's specifications.

This Calibration is traceable through NIST test numbers: 683/290345-18

The expanded uncertainty of calibration: 0.30dB at 95% confidence level with a coverage factor of k=2.

Graph represents Probes Frequency Response.

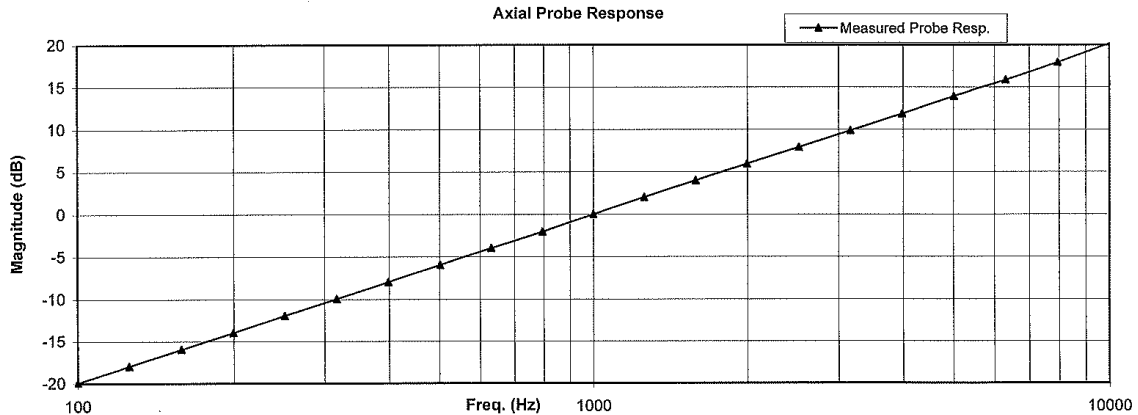

The above listed instrument was checked using calibration procedure documented in West Caldwell

Calibration Laboratories Inc. procedure :

Rev. 7.0 Jan. 24, 2014 Doc. # 1038 HCATEMC

Calibration was performed by West Caldwell Calibration Laboratories Inc. under Operating Procedures

intended to implement the requirements of ISO10012-1, IEC Guide 25, ANSI/NCSL Z540-1, (MIL-STD-45662A) and ISO 17025

Cal. Date: 17-May-2019

Measurements performed by: *James Zhu*

Calibrated on WCCL system type 9700

James Zhu

This document shall not be reproduced, except in full, without the written approval from West Caldwell Cal. Labs. Inc.

Rev. 7.0 Jan. 24, 2014 Doc. # 1038 HCATEMC

FCC ID: ZNFK400AM		HAC (T-COIL) TEST REPORT		Approved by: Quality Manager
Filename: 1M2003020032-03.ZNF	Test Dates: 03/16/2020 - 03/26/2020	DUT Type: Portable Handset		Page 58 of 71

HCATEMC_TEM-1124_May-17-2019

West Caldwell Calibration Laboratories Inc.

1575 State Route 96, Victor NY 14564
Tel. (585) 586-3900 FAX (585) 586-4327

Calibration Data Record

TEM Consulting LP Axial T Coil Probe
Company: PCTest Engineering Labs

for
Model No.: Axial T Coil Probe

Serial No.: TEM-1124

Test	Function	Tolerance	Measured values		
			Before	Out	Remarks
1.0	Probe Sensitivity at	1000 Hz. dBV/A/m	-60.41		
2.0	Probe Level Linearity	Ref. (0 dB)	dB		
			6	6.10	
			0	0.00	
			-6	-6.00	
			-12	-12.00	
3.0	Probe Frequency Response	Ref. (0 dB)	Hz		
			100	-19.9	
			126	-17.9	
			158	-16.0	
			200	-14.0	
			251	-12.0	
			316	-10.0	
			398	-8.0	
			501	-6.0	
			631	-3.9	
			794	-2.0	
			1000	0.0	
			1259	2.0	
			1585	4.0	
			1995	5.9	
			2512	7.9	
			3162	9.9	
3981	11.9				
5012	13.9				
6310	15.9				
7943	18.0				
10000	20.2				

Instruments used for calibration:				Date of Cal.	Traceability No.	Due Date
HP	34401A	S/N US360641	25-Jul-2018	,1010733	26-Jul-2019	
HP	34401A	S/N US361024	25-Jul-2018	,1010733	26-Jul-2019	
HP	33120A	S/N US360437	25-Jul-2018	,1010733	26-Jul-2019	
B&K	2133	S/N 1583254	25-Jul-2018	683/290345-18	26-Jul-2019	



Cal. Date: 17-May-2019

Tested by: James Zhu

Calibrated on WCCL system type 9700

This document shall not be reproduced, except in full, without the written approval from West Caldwell Cal. Labs. Inc.

Rev. 7.0 Jan. 24, 2014 Doc. # 1038 HCATEMC

FCC ID: ZNFK400AM		HAC (T-COIL) TEST REPORT		Approved by: Quality Manager
Filename: 1M2003020032-03.ZNF	Test Dates: 03/16/2020 - 03/26/2020	DUT Type: Portable Handset		Page 59 of 71

West Caldwell Calibration Laboratories Inc.

Certificate of Calibration

for

RADIAL T COIL PROBE

Manufactured by: TEM CONSULTING
Model No: RADIAL T COIL PROBE
Serial No: TEM-1130
Calibration Recall No: 29973

Submitted By:

Customer: ANDREW HARWELL
Company: PCTEST ENGINEERING LAB
Address: 6660-B DOBBIN ROAD
COLUMBIA MD 21045

The subject instrument was calibrated to the indicated specification using standards traceable to the National Institute of Standards and Technology or to accepted values of natural physical constants. This document certifies that the instrument met the following specification upon its return to the submitter.

West Caldwell Calibration Laboratories Procedure No. RADIAL T TEM C

Upon receipt for Calibration, the instrument was found to be:

Within (X)

tolerance of the indicated specification. See attached Report of Calibration.

The information supplied relates to the calibrated item listed above.

West Caldwell Calibration Laboratories' calibration control system meets the requirements, ISO 10012-1 MIL-STD-45662A, ANSI/NCSL Z540-1, IEC Guide 25, ISO 9001:2015 and ISO 17025.

Note: With this Certificate, Report of Calibration is Included.

Approved by:

James Zhu

Calibration Date: 17-May-19

Certificate No: 29973 -2

Quality Manager
ISO/IEC 17025:2005



QA Doc. #1051 Rev. 2.0 10/1/01

Certificate Page 1 of 1

West Caldwell Calibration Laboratories, Inc.
uncompromised calibration
1575 State Route 96, Victor, NY 14584, U.S.A.



Calibration Lab. Cert. # 1533.01

FCC ID: ZNFK400AM		HAC (T-COIL) TEST REPORT		Approved by: Quality Manager
Filename: 1M2003020032-03.ZNF	Test Dates: 03/16/2020 - 03/26/2020	DUT Type: Portable Handset		Page 60 of 71

© 2020 PCTEST

REV 3.5.M
3/2/2020

© 2020 PCTEST All rights reserved. Unless otherwise specified, no part of this report may be reproduced or utilized in any part, form or by any means, electronic or mechanical, including photocopying and microfilm, without permission in writing from PCTEST. If you have any questions about this international copyright or have an enquiry about obtaining additional rights to this report or assembly of contents thereof, please contact INFO@PCTEST.COM.



REPORT OF CALIBRATION

for

TEM Consulting LP Radial T Coil Probe
Company: PCTest Engineering Labs

Model No.: Radial T Coil Probe

Serial No.: TEM-1130
I. D. No.: XXXX

Calibration results:			
Probe Sensitivity measured with Helmholtz Coil			
<i>Helmholtz Coil;</i>			
the number of turns on each coil;	10	No.	Before & after data same: ...X...
the radius of each coil, in meters;	0.204	m	
the current in the coils, in amperes.;	0.08	A	
<i>Helmholtz Coil Constant;</i>	7.09	A/m/V	Laboratory Environment:
<i>Helmholtz Coil magnetic field;</i>	5.94	A/m	Ambient Temperature: 20.7 °C
			Ambient Humidity: 42.7 % RH
			Ambient Pressure: 98.256 kPa
			Calibration Date: 17-May-2019
			Calibration Due: 17-May-2020
			Report Number: 29973 -2
			Control Number: 29973
Probe Sensitivity at	1000	Hz.	
was	-60.37	dBV/A/m	
	0.958	mV/A/m	
Probe resistance	895	Ohms	

The above listed instrument meets or exceeds the tested manufacturer's specifications.
This Calibration is traceable through NIST test numbers: 683/290345-18
The expanded uncertainty of calibration: 0.30dB at 95% confidence level with a coverage factor of k=2.
Graph represents Probes Frequency Response.

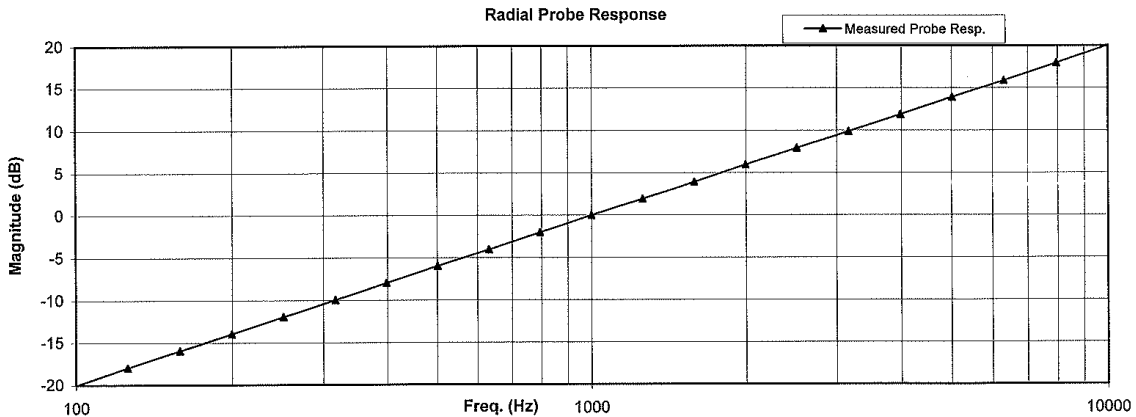

The above listed instrument was checked using calibration procedure documented in West Caldwell Calibration Laboratories Inc. procedure : Rev. 7.0 Jan. 24, 2014 Doc. # 1038 HCRTEMC
Calibration was performed by West Caldwell Calibration Laboratories Inc. under Operating Procedures intended to implement the requirements of ISO10012-1, IEC Guide 25, ANSI/NCSL Z540-1, (MIL-STD-45662A) and ISO 17025

Cal. Date: 17-May-2019
Calibrated on WCCL system type 9700

Measurements performed by:
James Zhu

This document shall not be reproduced, except in full, without the written approval from West Caldwell Cal. Labs. Inc.

Rev. 7.0 Jan. 24, 2014 Doc. # 1038 HCRTEMC

FCC ID: ZNFK400AM		HAC (T-COIL) TEST REPORT		Approved by: Quality Manager
Filename: 1M2003020032-03.ZNF	Test Dates: 03/16/2020 - 03/26/2020	DUT Type: Portable Handset		Page 61 of 71

HCRTEMC_TEM-1130_May-17-2019

West Caldwell Calibration Laboratories Inc.

1575 State Route 96, Victor NY 14564
Tel. (585) 586-3900 FAX (585) 586-4327

Calibration Data Record

TEM Consulting LP Radial T Coil Probe for Model No.: Radial T Coil Probe Serial No.: TEM-1130
Company: PCTest Engineering Labs

Test	Function	Tolerance	Measured values		
			Before	Out	Remarks
1.0	Probe Sensitivity at	1000 Hz. dBV/A/m	-60.37		
2.0	Probe Level Linearity	Ref. (0 dB)	6	6.00	
			0	0.00	
			-6	-6.10	
			-12	-12.10	
3.0	Probe Frequency Response	Ref. (0 dB)	100	-20.0	
			126	-17.9	
			158	-16.0	
			200	-14.0	
			251	-12.0	
			316	-10.0	
			398	-8.0	
			501	-6.0	
			631	-4.0	
			794	-2.0	
			1000	0.0	
			1259	1.9	
			1585	3.9	
			1995	5.9	
			2512	7.9	
			3162	9.9	
3981	11.9				
5012	13.9				
6310	15.9				
7943	18.0				
10000	20.1				



Instruments used for calibration:				Date of Cal.	Traceability No.	Due Date
HP	34401A	S/N US360641	25-Jul-2018	,1010733	26-Jul-2019	
HP	34401A	S/N US361024	25-Jul-2018	,1010733	26-Jul-2019	
HP	33120A	S/N US360437	25-Jul-2018	,1010733	26-Jul-2019	
B&K	2133	S/N 1583254	25-Jul-2018	683/290345-18	26-Jul-2019	

Cal. Date: 17-May-2019
Calibrated on WCCL system type 9700

Tested by: James Zhu

This document shall not be reproduced, except in full, without the written approval from West Caldwell Cal. Labs. Inc.

Rev. 7.0 Jan. 24, 2014 Doc. # 1038 HCRTEMC

FCC ID: ZNFK400AM		HAC (T-COIL) TEST REPORT		Approved by: Quality Manager
Filename: 1M2003020032-03.ZNF	Test Dates: 03/16/2020 - 03/26/2020	DUT Type: Portable Handset		Page 62 of 71

West Caldwell Calibration Laboratories Inc.

Certificate of Calibration

for

AXIAL T COIL PROBE

Manufactured by: TEM CONSULTING LP
 Model No: AXIAL T COIL PROBE
 Serial No: TEM-1123
 Calibration Recall No: 29156

Submitted By:

Customer: Andrew Harwell
 Company: PCTest Engineering Lab
 Address: 6660-B Dobbin Road
 Columbia MD 21045

The subject instrument was calibrated to the indicated specification using standards traceable to the National Institute of Standards and Technology or to accepted values of natural physical constants. This document certifies that the instrument met the following specification upon its return to the submitter.

West Caldwell Calibration Laboratories Procedure No. AXIAL T C TEM C

Upon receipt for Calibration, the instrument was found to be:

Within (X)

QA
12/4/2019

tolerance of the indicated specification. See attached Report of Calibration. The information supplied relates to the calibrated item listed above.

West Caldwell Calibration Laboratories' calibration control system meets the requirements, ISO 10012-1 MIL-STD-45662A, ANSI/NCSL Z540-1, IEC Guide 25, ISO 9001:2008 and ISO 17025.

Note: With this Certificate, Report of Calibration is included.

Approved by: *FC*

Calibration Date: 19-Sep-18

Felix Christopher (QA Mgr.)

Certificate No: 29156 -2

ISO/IEC 17025:2005



QA Doc. #1051 Rev. 2.0 10/1/01

Certificate Page 1 of 1

West Caldwell Calibration Laboratories, Inc.
 uncompromised calibration
 1575 State Route 96, Victor, NY 14564, U.S.A.



Calibration Lab. Cert. # 1533.01

FCC ID: ZNFK400AM	 PCTEST Head to the point of service	HAC (T-COIL) TEST REPORT	 LG	Approved by: Quality Manager
Filename: 1M2003020032-03.ZNF	Test Dates: 03/16/2020 - 03/26/2020	DUT Type: Portable Handset		Page 63 of 71



REPORT OF CALIBRATION

for

TEM Consulting LP Axial T Coil Probe
Company: PCTest Engineering Lab

Model No.: Axial T Coil Probe

Serial No.: TEM-1123
I. D. No.: XXXX

Calibration results:			
Probe Sensitivity measured with Helmholtz Coil		Before & after data same: ...X...	
<i>Helmholtz Coil;</i>			
the number of turns on each coil;	10	No.	
the radius of each coil, in meters;	0.204	m	
the current in the coils, in amperes.;	0.08	A	
<i>Helmholtz Coil Constant;</i>	7.09	A/m/V	
<i>Helmholtz Coil magnetic field;</i>	5.95	A/m	
Probe Sensitivity at	1000	Hz.	
was	-59.89	dBV/A/m	
	1.013	mV/A/m	
Probe resistance	903	Ohms	
Laboratory Environment:		Ambient Temperature: 22.7 °C	
		Ambient Humidity: 52.1 % RH	
		Ambient Pressure: 99.326 kPa	
		Calibration Date: 19-Sep-2018	
		Calibration Due:	
		Report Number: 29156 -2	
		Control Number: 29156	
The above listed instrument meets or exceeds the tested manufacturer's specifications.			
This Calibration is traceable through NIST test numbers: 683/284413-14			
The expanded uncertainty of calibration: 0.30dB at 95% confidence level with a coverage factor of k=2.			
Graph represents Probes Frequency Response.			

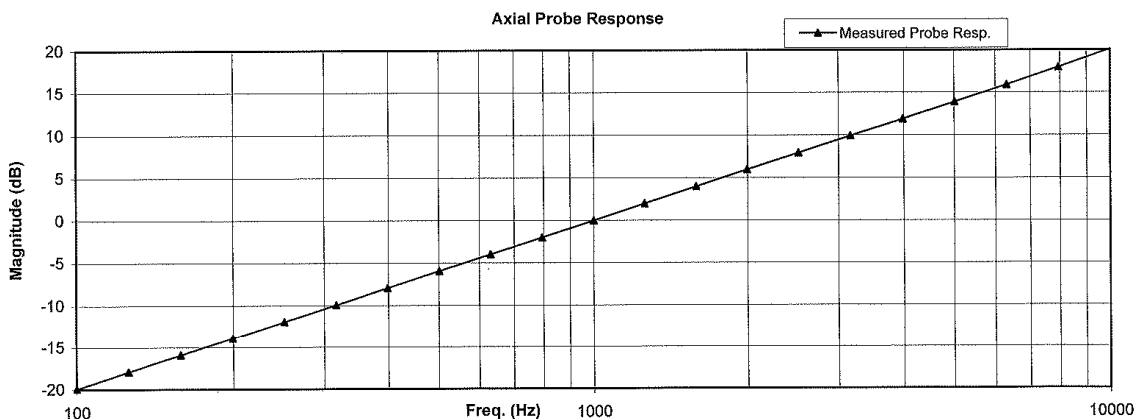

The above listed instrument was checked using calibration procedure documented in West Caldwell Calibration Laboratories Inc. procedure : Rev. 7.0 Jan. 24, 2014 Doc. # 1038 HCATEMC
Calibration was performed by West Caldwell Calibration Laboratories Inc. under Operating Procedures intended to implement the requirements of ISO10012-1, IEC Guide 25, ANSI/NCSL Z540-1, (MIL-STD-45662A) and ISO 9001:2008, ISO17025

Cal. Date: 19-Sep-2018
Calibrated on WCCL system type 9700

Measurements performed by: James Zhu

This document shall not be reproduced, except in full, without the written approval from West Caldwell Cal. Labs. Inc.

Rev. 7.0 Jan. 24, 2014 Doc. # 1038 HCATEMC

FCC ID: ZNFK400AM		HAC (T-COIL) TEST REPORT		Approved by: Quality Manager
Filename: 1M2003020032-03.ZNF	Test Dates: 03/16/2020 - 03/26/2020	DUT Type: Portable Handset		Page 64 of 71

HCATEMC_TEM-1123_Sep-19-2018

West Caldwell Calibration Laboratories Inc.

1575 State Route 96, Victor NY 14564
Tel. (585) 586-3900 FAX (585) 586-4327

Calibration Data Record

TEM Consulting LP Axial T Coil Probe for Model No.: Axial T Coil Probe Serial No.: TEM-1123
Company: PCTest Engineering Lab

Test	Function	Tolerance	Measured values		
			Before	Out	Remarks
1.0	Probe Sensitivity at	1000 Hz. dBV/A/m	-59.89		
2.0	Probe Level Linearity	Ref. (0 dB)	dB		
			6	6.03	
			0	0.00	
			-6	-6.03	
			-12	-12.05	
3.0	Probe Frequency Response	Ref. (0 dB)	Hz		
			100	-19.9	
			126	-17.9	
			158	-15.9	
			200	-13.9	
			251	-11.9	
			316	-9.9	
			398	-7.9	
			501	-6.0	
			631	-4.0	
			794	-2.0	
			1000	0.0	
			1259	2.0	
			1585	4.0	
			1995	5.9	
			2512	7.9	
			3162	9.9	
3981	11.9				
5012	13.9				
6310	15.9				
7943	18.0				
10000	20.1				



Instruments used for calibration:			Date of Cal.	Traceability No.	Due Date
HP	34401A	S/N US360641	25-Jul-2018	,287708	25-Jul-2019
HP	34401A	S/N US361024	25-Jul-2018	,287708	25-Jul-2019
HP	33120A	S/N US360437	25-Jul-2018	,287708	25-Jul-2019
B&K	2133	S/N 1583254	25-Jul-2018	683/284413-14	25-Jul-2019

Cal. Date: 19-Sep-2018
Calibrated on WCCL system type 9700

Tested by: James Zhu

This document shall not be reproduced, except in full, without the written approval from West Caldwell Cal. Labs. Inc.



Rev. 7.0 Jan. 24, 2014 Doc. # 1038 HCATEMC

FCC ID: ZNFK400AM		HAC (T-COIL) TEST REPORT		Approved by: Quality Manager
Filename: 1M2003020032-03.ZNF	Test Dates: 03/16/2020 - 03/26/2020	DUT Type: Portable Handset		Page 65 of 71

14. CONCLUSION

The measurements indicate that the wireless communications device complies with the HAC limits specified in accordance with the ANSI C63.19 Standard and FCC WT Docket No. 01-309 RM-8658. Precise laboratory measures were taken to assure repeatability of the tests. The tested device complies with the requirements in respect to all parameters specific to the test. The test results and statements relate only to the item(s) tested.

The measurement system and techniques presented in this evaluation are proposed in the ANSI standard as a means of best approximating wireless device compatibility with a hearing-aid. The literature is under continual re-construction.

FCC ID: ZNFK400AM	 PCTEST Head to the point of delivery	HAC (T-COIL) TEST REPORT	 LG	Approved by: Quality Manager
Filename: 1M2003020032-03.ZNF	Test Dates: 03/16/2020 - 03/26/2020	DUT Type: Portable Handset	Page 66 of 71	



© 2020 PCTEST

REV 3.5.M
3/2/2020



© 2020 PCTEST All rights reserved. Unless otherwise specified, no part of this report may be reproduced or utilized in any part, form or by any means, electronic or mechanical, including photocopying and microfilm, without permission in writing from PCTEST. If you have any questions about this international copyright or have an enquiry about obtaining additional rights to this report or assembly of contents thereof, please contact INFO@PCTEST.COM.

15. REFERENCES

1. ANSI C63.19-2011, American National Standard for Methods of Measurement of Compatibility between Wireless communication devices and Hearing Aids.", New York, NY, IEEE, May 2011
2. FCC Office of Engineering and Technology KDB, "285076 D01 HAC Guidance v05," September 13, 2017
3. FCC Office of Engineering and Technology KDB, "285076 D02 T-Coil Testing for CMRS IP v03," September 13, 2017
4. FCC Public Notice DA 06-1215, *Wireless Telecommunications Bureau and Office of Engineering and Technology Clarify Use of Revised Wireless Phone Hearing Aid Compatibility Standard*, June 6, 2006
5. FCC 3G Review Guidance, Laboratory Division OET FCC, May/June 2006
6. Berger, H. S., "Compatibility Between Hearing Aids and Wireless Devices," Electronic Industries Forum, Boston, MA, May, 1997
7. Berger, H. S., "Hearing Aid and Cellular Phone Compatibility: Working Toward Solutions," *Wireless Telephones and Hearing Aids: New Challenges for Audiology*, Gallaudet University, Washington, D.C., May, 1997 (To be reprinted in the American Journal of Audiology).
8. Berger, H. S., "Hearing Aid Compatibility with Wireless Communications Devices," IEEE International Symposium on Electromagnetic Compatibility, Austin, TX, August, 1997.
9. Bronaugh, E. L., "Simplifying EMI Immunity (Susceptibility) Tests in TEM Cells," in the 1990 IEEE International Symposium on Electromagnetic Compatibility Symposium Record, Washington, D.C., August 1990, pp. 488-491
10. Byrne, D. and Dillon, H., The National Acoustics Laboratory (NAL) New Procedure for Selecting the Gain and Frequency Response of a Hearing Aid, *Ear and Hearing* 7:257-265, 1986.
11. Crawford, M. L., "Measurement of Electromagnetic Radiation from Electronic Equipment using TEM Transmission Cells," U.S. Department of Commerce, National Bureau of Standards, NBSIR 73-306, Feb. 1973.
12. Crawford, M. L., and Workman, J. L., "Using a TEM Cell for EMC Measurements of Electronic Equipment," U.S. Department of Commerce, National Bureau of Standards. Technical Note 1013, July 1981.
13. EHIMA GSM Project, Development phase, Project Report (1st part) Revision A. Technical-Audiological Laboratory and Telecom Denmark, October 1993.
14. EHIMA GSM Project, Development phase, Part II Project Report. Technical-Audiological Laboratory and Telecom Denmark, June 1994.
15. EHIMA GSM Project Final Report, Hearing Aids and GSM Mobile Telephones: Interference Problems, Methods of Measurement and Levels of Immunity. Technical-Audiological Laboratory and Telecom Denmark, 1995.
16. HAMPIS Report, Comparison of Mobile phone electromagnetic near field with an upscaled electromagnetic far field, using hearing aid as reference, 21 October 1999.

FCC ID: ZNFK400AM	 PCTEST Proud to be part of	HAC (T-COIL) TEST REPORT	 LG	Approved by: Quality Manager
Filename: 1M2003020032-03.ZNF	Test Dates: 03/16/2020 - 03/26/2020	DUT Type: Portable Handset		Page 67 of 71

17. Hearing Aids/GSM, Report from OTWIDAM, Technical-Audiological Laboratory and Telecom Denmark, April 1993.
18. IEEE 100, The Authoritative Dictionary of IEEE Standards Terms, Seventh Edition.
19. Joyner, K. H., et. al., Interference to Hearing Aids by the New Digital Mobile Telephone System, Global System for Mobile (GSM) Communication Standard, National Acoustic Laboratory, Australian Hearing Series, Sydney 1993.
20. Joyner, K. H., et. al., Interference to Hearing Aids by the Digital Mobile Telephone System, Global System for Mobile Communications (GSM), NAL Report #131, National Acoustic Laboratory, Australian Hearing Series, Sydney, 1995.
21. Kecker, W. T., Crawford, M. L., and Wilson, W. A., "Construction of a Transverse Electromagnetic Cell", U.S. Department of Commerce, National Bureau of Standards, Technical Note 1011, Nov. 1978.
22. Konigstein, D., and Hansen, D., "A New Family of TEM Cells with enlarged bandwidth and Optimized working Volume," in the Proceedings of the 7th International Symposium on EMC, Zurich, Switzerland, March 1987; 50:9, pp. 127-132.
23. Kuk, F., and Hjorstgaard, N. K., "Factors affecting interference from digital cellular telephones," Hearing Journal, 1997; 50:9, pp 32-34.
24. Ma, M. A., and Kanda, M., "Electromagnetic Compatibility and Interference Metrology," U.S. Department of Commerce, National Bureau of Standards, Technical Note 1099, July 1986, pp. 17-43.
25. Ma, M. A., Sreenivashiah, I. , and Chang, D. C., "A Method of Determining the Emission and Susceptibility Levels of Electrically Small Objects Using a TEM Cell," U.S. Department of Commerce, National Bureau of Standards, Technial Note 1040, July 1981.
26. McCandless, G. A., and Lyregaard, P. E., Prescription of Gain/Output (POGO) for Hearing Aids, Hearing Instruments 1:16-21, 1983
27. Skopec, M., "Hearing Aid Electromagnetic Interference from Digital Wireless Telephones," IEEE Transactions on Rehabilitation Engineering, vol. 6, no. 2, pp. 235-239, June 1998.
28. Technical Report, GSM 05.90, GSM EMC Considerations, European Telecommunications Standards Institute, January 1993.
29. Victorian, T. A., "Digital Cellular Telephone Interference and Hearing Aid Compatibility—an Update," Hearing Journal 1998; 51:10, pp. 53-60
30. Wong, G. S. K., and Embleton, T. F. W., eds., AIP Handbook of Condenser Microphones: Theory, Calibration and Measurements, AIP Press.

FCC ID: ZNFK400AM	 PCTEST Head to the point of delivery	HAC (T-COIL) TEST REPORT	 LG	Approved by: Quality Manager
Filename: 1M2003020032-03.ZNF	Test Dates: 03/16/2020 - 03/26/2020	DUT Type: Portable Handset	Page 68 of 71	

© 2020 PCTEST

REV 3.5.M
3/2/2020

© 2020 PCTEST All rights reserved. Unless otherwise specified, no part of this report may be reproduced or utilized in any part, form or by any means, electronic or mechanical, including photocopying and microfilm, without permission in writing from PCTEST. If you have any questions about this international copyright or have an enquiry about obtaining additional rights to this report or assembly of contents thereof, please contact INFO@PCTEST.COM.