



Accredited by the Swiss Accreditation Service (SAS)
The Swiss Accreditation Service is one of the signatories to the EA
Multilateral Agreement for the recognition of calibration certificates

Accreditation No.: **SCS 108**

Client **PC Test**

Certificate No: **ES3-3209_Mar14**

CALIBRATION CERTIFICATE

Object **ES3DV3 - SN:3209**

Calibration procedure(s) **QA CAL-01.v9, QA CAL-23.v5, QA CAL-25.v6
Calibration procedure for dosimetric E-field probes**

*CCV
3/27/14*

Calibration date: **March 19, 2014**

This calibration certificate documents the traceability to national standards, which realize the physical units of measurements (SI).
The measurements and the uncertainties with confidence probability are given on the following pages and are part of the certificate.

All calibrations have been conducted in the closed laboratory facility: environment temperature (22 ± 3)°C and humidity < 70%.

Calibration Equipment used (M&TE critical for calibration)

| Primary Standards | ID | Cal Date (Certificate No.) | Scheduled Calibration |
|----------------------------|-----------------|-----------------------------------|------------------------|
| Power meter E4419B | GB41293874 | 04-Apr-13 (No. 217-01733) | Apr-14 |
| Power sensor E4412A | MY41498087 | 04-Apr-13 (No. 217-01733) | Apr-14 |
| Reference 3 dB Attenuator | SN: S5054 (3c) | 04-Apr-13 (No. 217-01737) | Apr-14 |
| Reference 20 dB Attenuator | SN: S5277 (20x) | 04-Apr-13 (No. 217-01735) | Apr-14 |
| Reference 30 dB Attenuator | SN: S5129 (30b) | 04-Apr-13 (No. 217-01738) | Apr-14 |
| Reference Probe ES3DV2 | SN: 3013 | 30-Dec-13 (No. ES3-3013_Dec13) | Dec-14 |
| DAE4 | SN: 660 | 13-Dec-13 (No. DAE4-660_Dec13) | Dec-14 |
| Secondary Standards | ID | Check Date (in house) | Scheduled Check |
| RF generator HP 8648C | US3642U01700 | 4-Aug-99 (in house check Apr-13) | In house check: Apr-16 |
| Network Analyzer HP 8753E | US37390585 | 18-Oct-01 (in house check Oct-13) | In house check: Oct-14 |

| | | | |
|---|--------------------------------|-----------------------------------|------------------------|
| Calibrated by: | Name Claudio Leubler | Function Laboratory Technician | Signature |
| Approved by: | Name Katja Pokovic | Function Technical Manager | Signature |
| | | | Issued: March 20, 2014 |
| This calibration certificate shall not be reproduced except in full without written approval of the laboratory. | | | |



Accredited by the Swiss Accreditation Service (SAS)

Accreditation No.: **SCS 108**

The Swiss Accreditation Service is one of the signatories to the EA
 Multilateral Agreement for the recognition of calibration certificates

Glossary:

| | |
|-----------------------|---|
| TSL | tissue simulating liquid |
| NORM _{x,y,z} | sensitivity in free space |
| ConvF | sensitivity in TSL / NORM _{x,y,z} |
| DCP | diode compression point |
| CF | crest factor (1/duty_cycle) of the RF signal |
| A, B, C, D | modulation dependent linearization parameters |
| Polarization φ | φ rotation around probe axis |
| Polarization θ | θ rotation around an axis that is in the plane normal to probe axis (at measurement center), i.e., θ = 0 is normal to probe axis |
| Connector Angle | information used in DASY system to align probe sensor X to the robot coordinate system |

Calibration is Performed According to the Following Standards:

- a) IEEE Std 1528-2013, "IEEE Recommended Practice for Determining the Peak Spatial-Averaged Specific Absorption Rate (SAR) in the Human Head from Wireless Communications Devices: Measurement Techniques", June 2013
- b) IEC 62209-1, "Procedure to measure the Specific Absorption Rate (SAR) for hand-held devices used in close proximity to the ear (frequency range of 300 MHz to 3 GHz)", February 2005

Methods Applied and Interpretation of Parameters:

- **NORM_{x,y,z}**: Assessed for E-field polarization θ = 0 (f ≤ 900 MHz in TEM-cell; f > 1800 MHz: R22 waveguide). NORM_{x,y,z} are only intermediate values, i.e., the uncertainties of NORM_{x,y,z} does not affect the E²-field uncertainty inside TSL (see below ConvF).
- **NORM(f)_{x,y,z} = NORM_{x,y,z} * frequency_response** (see Frequency Response Chart). This linearization is implemented in DASY4 software versions later than 4.2. The uncertainty of the frequency response is included in the stated uncertainty of ConvF.
- **DCP_{x,y,z}**: DCP are numerical linearization parameters assessed based on the data of power sweep with CW signal (no uncertainty required). DCP does not depend on frequency nor media.
- **PAR**: PAR is the Peak to Average Ratio that is not calibrated but determined based on the signal characteristics
- **A_{x,y,z}; B_{x,y,z}; C_{x,y,z}; D_{x,y,z}; VR_{x,y,z}; A, B, C, D** are numerical linearization parameters assessed based on the data of power sweep for specific modulation signal. The parameters do not depend on frequency nor media. VR is the maximum calibration range expressed in RMS voltage across the diode.
- **ConvF and Boundary Effect Parameters**: Assessed in flat phantom using E-field (or Temperature Transfer Standard for f ≤ 800 MHz) and inside waveguide using analytical field distributions based on power measurements for f > 800 MHz. The same setups are used for assessment of the parameters applied for boundary compensation (alpha, depth) of which typical uncertainty values are given. These parameters are used in DASY4 software to improve probe accuracy close to the boundary. The sensitivity in TSL corresponds to NORM_{x,y,z} * ConvF whereby the uncertainty corresponds to that given for ConvF. A frequency dependent ConvF is used in DASY version 4.4 and higher which allows extending the validity from ± 50 MHz to ± 100 MHz.
- **Spherical isotropy (3D deviation from isotropy)**: in a field of low gradients realized using a flat phantom exposed by a patch antenna.
- **Sensor Offset**: The sensor offset corresponds to the offset of virtual measurement center from the probe tip (on probe axis). No tolerance required.
- **Connector Angle**: The angle is assessed using the information gained by determining the NORM_x (no uncertainty required).

Probe ES3DV3

SN:3209

Manufactured: October 14, 2008
Calibrated: March 19, 2014

Calibrated for DASY/EASY Systems
(Note: non-compatible with DASY2 system!)

DASY/EASY - Parameters of Probe: ES3DV3 - SN:3209

Basic Calibration Parameters

| | Sensor X | Sensor Y | Sensor Z | Unc (k=2) |
|---|----------|----------|----------|--------------|
| Norm ($\mu\text{V}/(\text{V}/\text{m})^2$) ^A | 1.35 | 1.32 | 1.13 | $\pm 10.1\%$ |
| DCP (mV) ^B | 101.5 | 101.0 | 102.5 | |

Modulation Calibration Parameters

| UID | Communication System Name | | A dB | B dB $\sqrt{\mu\text{V}}$ | C | D dB | VR mV | Unc ^F (k=2) |
|---------------|--|---|---------|------------------------------|------|---------|----------|---------------------------|
| 0 | CW | X | 0.0 | 0.0 | 1.0 | 0.00 | 188.4 | $\pm 3.8\%$ |
| | | Y | 0.0 | 0.0 | 1.0 | | 180.7 | |
| | | Z | 0.0 | 0.0 | 1.0 | | 200.1 | |
| 10010- CAA | SAR Validation (Square, 100ms, 10ms) | X | 2.80 | 64.7 | 12.3 | 10.00 | 43.2 | $\pm 1.4\%$ |
| | | Y | 3.12 | 65.6 | 13.1 | | 41.9 | |
| | | Z | 2.67 | 64.0 | 11.7 | | 39.4 | |
| 10011- CAB | UMTS-FDD (WCDMA) | X | 3.39 | 67.7 | 19.0 | 2.91 | 149.2 | $\pm 0.5\%$ |
| | | Y | 3.38 | 67.7 | 19.0 | | 146.1 | |
| | | Z | 3.35 | 67.6 | 18.7 | | 136.1 | |
| 10012- CAA | IEEE 802.11b WiFi 2.4 GHz (DSSS, 1 Mbps) | X | 3.01 | 69.8 | 19.4 | 1.87 | 149.4 | $\pm 0.7\%$ |
| | | Y | 3.06 | 70.1 | 19.6 | | 147.1 | |
| | | Z | 2.98 | 69.7 | 19.2 | | 136.4 | |
| 10021- DAB | GSM-FDD (TDMA, GMSK) | X | 5.47 | 79.6 | 20.4 | 9.39 | 146.9 | $\pm 1.7\%$ |
| | | Y | 7.76 | 84.9 | 22.9 | | 134.2 | |
| | | Z | 4.34 | 75.3 | 18.5 | | 134.2 | |
| 10023- DAB | GPRS-FDD (TDMA, GMSK, TN 0) | X | 6.66 | 82.9 | 21.6 | 9.57 | 139.8 | $\pm 2.5\%$ |
| | | Y | 9.36 | 88.2 | 24.2 | | 131.5 | |
| | | Z | 4.67 | 76.1 | 18.8 | | 144.8 | |
| 10024- DAB | GPRS-FDD (TDMA, GMSK, TN 0-1) | X | 5.89 | 79.1 | 17.9 | 6.56 | 141.2 | $\pm 1.9\%$ |
| | | Y | 27.58 | 99.6 | 24.8 | | 145.8 | |
| | | Z | 5.42 | 77.8 | 17.4 | | 129.3 | |
| 10027- DAB | GPRS-FDD (TDMA, GMSK, TN 0-1-2) | X | 9.68 | 85.3 | 19.0 | 4.80 | 136.9 | $\pm 2.2\%$ |
| | | Y | 36.47 | 100.0 | 23.3 | | 139.2 | |
| | | Z | 31.63 | 96.5 | 21.4 | | 149.2 | |
| 10028- DAB | GPRS-FDD (TDMA, GMSK, TN 0-1-2-3) | X | 40.09 | 99.7 | 21.7 | 3.55 | 125.9 | $\pm 1.9\%$ |
| | | Y | 47.92 | 99.6 | 21.7 | | 127.6 | |
| | | Z | 61.98 | 99.9 | 20.8 | | 136.2 | |
| 10032- CAA | IEEE 802.15.1 Bluetooth (GFSK, DH5) | X | 99.32 | 95.7 | 16.5 | 1.16 | 145.1 | $\pm 1.7\%$ |
| | | Y | 55.30 | 99.5 | 19.3 | | 145.6 | |
| | | Z | 0.54 | 60.4 | 5.7 | | 132.7 | |
| 10039- CAB | CDMA2000 (1xRTT, RC1) | X | 4.77 | 67.1 | 19.2 | 4.57 | 145.6 | $\pm 0.9\%$ |
| | | Y | 4.85 | 67.5 | 19.5 | | 147.8 | |
| | | Z | 4.67 | 66.7 | 18.9 | | 133.4 | |

| | | | | | | | | |
|-----------|---|---|-------|------|------|------|-------|--------|
| 10081-CAB | CDMA2000 (1xRTT, RC3) | X | 3.93 | 66.4 | 18.8 | 3.97 | 140.9 | ±0.7 % |
| | | Y | 4.02 | 66.9 | 19.1 | | 146.0 | |
| | | Z | 3.86 | 66.1 | 18.5 | | 129.1 | |
| 10098-CAB | UMTS-FDD (HSUPA, Subtest 2) | X | 4.56 | 66.6 | 18.6 | 3.98 | 132.8 | ±0.7 % |
| | | Y | 4.58 | 66.7 | 18.7 | | 135.9 | |
| | | Z | 4.63 | 67.0 | 18.7 | | 143.0 | |
| 10100-CAB | LTE-FDD (SC-FDMA, 100% RB, 20 MHz, QPSK) | X | 6.42 | 67.5 | 19.8 | 5.67 | 139.3 | ±1.4 % |
| | | Y | 6.49 | 67.9 | 20.1 | | 143.0 | |
| | | Z | 6.18 | 66.7 | 19.3 | | 126.9 | |
| 10108-CAB | LTE-FDD (SC-FDMA, 100% RB, 10 MHz, QPSK) | X | 6.28 | 67.1 | 19.7 | 5.80 | 136.9 | ±1.4 % |
| | | Y | 6.35 | 67.5 | 20.0 | | 140.4 | |
| | | Z | 6.36 | 67.5 | 19.8 | | 147.1 | |
| 10110-CAB | LTE-FDD (SC-FDMA, 100% RB, 5 MHz, QPSK) | X | 5.94 | 66.5 | 19.4 | 5.75 | 134.0 | ±1.4 % |
| | | Y | 6.01 | 66.9 | 19.8 | | 136.4 | |
| | | Z | 5.99 | 66.8 | 19.5 | | 143.6 | |
| 10114-CAA | IEEE 802.11n (HT Greenfield, 13.5 Mbps, BPSK) | X | 10.02 | 68.5 | 21.1 | 8.10 | 127.2 | ±2.2 % |
| | | Y | 10.31 | 69.3 | 21.8 | | 130.2 | |
| | | Z | 10.12 | 68.8 | 21.2 | | 139.0 | |
| 10117-CAA | IEEE 802.11n (HT Mixed, 13.5 Mbps, BPSK) | X | 10.03 | 68.5 | 21.1 | 8.07 | 129.2 | ±2.2 % |
| | | Y | 10.31 | 69.3 | 21.7 | | 131.2 | |
| | | Z | 10.15 | 68.9 | 21.3 | | 141.0 | |
| 10151-CAB | LTE-TDD (SC-FDMA, 50% RB, 20 MHz, QPSK) | X | 8.54 | 72.4 | 24.8 | 9.28 | 139.6 | ±3.0 % |
| | | Y | 9.29 | 75.2 | 26.7 | | 144.1 | |
| | | Z | 8.55 | 72.5 | 24.7 | | 149.7 | |
| 10154-CAB | LTE-FDD (SC-FDMA, 50% RB, 10 MHz, QPSK) | X | 5.94 | 66.5 | 19.4 | 5.75 | 134.7 | ±1.4 % |
| | | Y | 6.00 | 66.9 | 19.7 | | 136.7 | |
| | | Z | 6.01 | 66.9 | 19.5 | | 143.3 | |
| 10160-CAB | LTE-FDD (SC-FDMA, 50% RB, 15 MHz, QPSK) | X | 6.40 | 67.1 | 19.7 | 5.82 | 139.9 | ±1.7 % |
| | | Y | 6.48 | 67.5 | 20.0 | | 142.9 | |
| | | Z | 6.43 | 67.3 | 19.7 | | 148.7 | |
| 10169-CAB | LTE-FDD (SC-FDMA, 1 RB, 20 MHz, QPSK) | X | 4.90 | 66.8 | 19.8 | 5.73 | 136.1 | ±1.4 % |
| | | Y | 5.03 | 67.2 | 20.2 | | 141.1 | |
| | | Z | 5.08 | 67.3 | 20.0 | | 148.1 | |
| 10172-CAB | LTE-TDD (SC-FDMA, 1 RB, 20 MHz, QPSK) | X | 6.56 | 72.5 | 25.2 | 9.21 | 125.7 | ±2.5 % |
| | | Y | 7.28 | 75.4 | 27.1 | | 128.8 | |
| | | Z | 6.78 | 73.0 | 25.2 | | 138.3 | |
| 10175-CAB | LTE-FDD (SC-FDMA, 1 RB, 10 MHz, QPSK) | X | 4.86 | 66.6 | 19.7 | 5.72 | 133.7 | ±1.4 % |
| | | Y | 4.97 | 66.9 | 20.0 | | 136.3 | |
| | | Z | 5.04 | 67.2 | 19.9 | | 145.7 | |
| 10181-CAB | LTE-FDD (SC-FDMA, 1 RB, 15 MHz, QPSK) | X | 4.88 | 66.7 | 19.7 | 5.72 | 133.3 | ±1.4 % |
| | | Y | 4.99 | 67.0 | 20.0 | | 136.5 | |
| | | Z | 5.06 | 67.3 | 19.9 | | 145.7 | |

| | | | | | | | | |
|-----------|--|---|-------|------|------|------|-------|--------|
| 10193-CAA | IEEE 802.11n (HT Greenfield, 6.5 Mbps, BPSK) | X | 10.05 | 69.2 | 21.7 | 8.09 | 146.7 | ±2.5 % |
| | | Y | 10.20 | 69.8 | 22.1 | | 146.9 | |
| | | Z | 9.76 | 68.5 | 21.1 | | 132.1 | |
| 10196-CAA | IEEE 802.11n (HT Mixed, 6.5 Mbps, BPSK) | X | 10.05 | 69.2 | 21.7 | 8.10 | 148.5 | ±2.2 % |
| | | Y | 10.21 | 69.9 | 22.2 | | 148.0 | |
| | | Z | 9.75 | 68.5 | 21.2 | | 133.6 | |
| 10219-CAA | IEEE 802.11n (HT Mixed, 7.2 Mbps, BPSK) | X | 9.96 | 69.2 | 21.6 | 8.03 | 148.9 | ±2.5 % |
| | | Y | 10.09 | 69.7 | 22.1 | | 147.4 | |
| | | Z | 9.67 | 68.5 | 21.1 | | 133.4 | |
| 10222-CAA | IEEE 802.11n (HT Mixed, 15 Mbps, BPSK) | X | 10.00 | 68.5 | 21.1 | 8.06 | 127.8 | ±2.2 % |
| | | Y | 10.21 | 69.1 | 21.6 | | 127.3 | |
| | | Z | 10.11 | 68.9 | 21.2 | | 140.4 | |
| 10225-CAB | UMTS-FDD (HSPA+) | X | 6.81 | 66.5 | 19.3 | 5.97 | 125.8 | ±1.4 % |
| | | Y | 7.07 | 67.5 | 19.9 | | 149.0 | |
| | | Z | 6.92 | 67.0 | 19.4 | | 136.8 | |
| 10237-CAB | LTE-TDD (SC-FDMA, 1 RB, 10 MHz, QPSK) | X | 6.62 | 72.8 | 25.3 | 9.21 | 128.5 | ±2.2 % |
| | | Y | 7.33 | 75.7 | 27.2 | | 129.5 | |
| | | Z | 6.87 | 73.4 | 25.5 | | 141.8 | |
| 10252-CAB | LTE-TDD (SC-FDMA, 50% RB, 10 MHz, QPSK) | X | 7.92 | 71.5 | 24.4 | 9.24 | 131.3 | ±3.0 % |
| | | Y | 8.35 | 73.3 | 25.7 | | 131.3 | |
| | | Z | 7.94 | 71.6 | 24.3 | | 140.2 | |
| 10267-CAB | LTE-TDD (SC-FDMA, 100% RB, 10 MHz, QPSK) | X | 8.52 | 72.3 | 24.8 | 9.30 | 138.8 | ±3.0 % |
| | | Y | 9.10 | 74.5 | 26.3 | | 139.5 | |
| | | Z | 8.53 | 72.3 | 24.6 | | 149.4 | |
| 10274-CAB | UMTS-FDD (HSUPA, Subtest 5, 3GPP Rel8.10) | X | 5.98 | 67.1 | 19.1 | 4.87 | 144.4 | ±0.9 % |
| | | Y | 5.99 | 67.3 | 19.2 | | 144.0 | |
| | | Z | 5.80 | 66.6 | 18.7 | | 131.0 | |
| 10275-CAB | UMTS-FDD (HSUPA, Subtest 5, 3GPP Rel8.4) | X | 4.51 | 67.2 | 19.0 | 3.96 | 148.6 | ±0.7 % |
| | | Y | 4.30 | 66.3 | 18.6 | | 127.3 | |
| | | Z | 4.40 | 66.9 | 18.7 | | 135.9 | |
| 10291-AAB | CDMA2000, RC3, SO55, Full Rate | X | 3.61 | 66.9 | 18.8 | 3.46 | 138.3 | ±0.7 % |
| | | Y | 3.67 | 67.2 | 19.0 | | 140.5 | |
| | | Z | 3.62 | 67.0 | 18.7 | | 128.8 | |
| 10292-AAB | CDMA2000, RC3, SO32, Full Rate | X | 3.59 | 67.1 | 18.9 | 3.39 | 141.5 | ±0.7 % |
| | | Y | 3.59 | 67.1 | 18.9 | | 142.0 | |
| | | Z | 3.59 | 67.2 | 18.8 | | 130.8 | |
| 10297-AAA | LTE-FDD (SC-FDMA, 50% RB, 20 MHz, QPSK) | X | 6.27 | 67.0 | 19.7 | 5.81 | 135.3 | ±1.7 % |
| | | Y | 6.31 | 67.3 | 19.9 | | 136.0 | |
| | | Z | 6.36 | 67.4 | 19.8 | | 147.2 | |
| 10311-AAA | LTE-FDD (SC-FDMA, 100% RB, 15 MHz, QPSK) | X | 6.91 | 67.9 | 20.2 | 6.06 | 141.9 | ±1.7 % |
| | | Y | 6.94 | 68.1 | 20.4 | | 142.7 | |
| | | Z | 6.68 | 67.1 | 19.7 | | 130.3 | |

| | | | | | | | | |
|-----------|---|---|------|------|------|------|-------|--------|
| 10315-AAA | IEEE 802.11b WiFi 2.4 GHz (DSSS, 1 Mbps, 96pc duty cycle) | X | 2.94 | 69.9 | 19.6 | 1.71 | 148.6 | ±0.5 % |
| | | Y | 2.81 | 68.8 | 19.0 | | 148.8 | |
| | | Z | 2.92 | 69.7 | 19.2 | | 138.1 | |
| 10403-AAB | CDMA2000 (1xEV-DO, Rev. 0) | X | 4.76 | 68.7 | 19.1 | 3.76 | 128.0 | ±0.5 % |
| | | Y | 4.71 | 68.2 | 18.9 | | 129.2 | |
| | | Z | 4.85 | 68.8 | 19.0 | | 141.9 | |
| 10404-AAB | CDMA2000 (1xEV-DO, Rev. A) | X | 4.64 | 68.5 | 19.0 | 3.77 | 126.3 | ±0.7 % |
| | | Y | 4.60 | 68.2 | 18.9 | | 127.9 | |
| | | Z | 4.74 | 68.8 | 19.0 | | 140.6 | |

The reported uncertainty of measurement is stated as the standard uncertainty of measurement multiplied by the coverage factor $k=2$, which for a normal distribution corresponds to a coverage probability of approximately 95%.

^A The uncertainties of NormX,Y,Z do not affect the E^2 -field uncertainty inside TSL (see Pages 8 and 9).

^B Numerical linearization parameter: uncertainty not required.

^E Uncertainty is determined using the max. deviation from linear response applying rectangular distribution and is expressed for the square of the field value.

DASY/EASY - Parameters of Probe: ES3DV3 - SN:3209

Calibration Parameter Determined in Head Tissue Simulating Media

| f (MHz) ^C | Relative Permittivity ^F | Conductivity (S/m) ^F | ConvF X | ConvF Y | ConvF Z | Alpha ^G | Depth ^G (mm) | Unct. (k=2) |
|----------------------|------------------------------------|---------------------------------|---------|---------|---------|--------------------|-------------------------|-------------|
| 750 | 41.9 | 0.89 | 6.43 | 6.43 | 6.43 | 0.29 | 2.01 | ± 12.0 % |
| 835 | 41.5 | 0.90 | 6.23 | 6.23 | 6.23 | 0.34 | 1.70 | ± 12.0 % |
| 1750 | 40.1 | 1.37 | 5.24 | 5.24 | 5.24 | 0.80 | 1.13 | ± 12.0 % |
| 1900 | 40.0 | 1.40 | 5.13 | 5.13 | 5.13 | 0.46 | 1.49 | ± 12.0 % |
| 2450 | 39.2 | 1.80 | 4.54 | 4.54 | 4.54 | 0.63 | 1.38 | ± 12.0 % |
| 2600 | 39.0 | 1.96 | 4.38 | 4.38 | 4.38 | 0.76 | 1.28 | ± 12.0 % |

^C Frequency validity of ± 100 MHz only applies for DASY v4.4 and higher (see Page 2), else it is restricted to ± 50 MHz. The uncertainty is the RSS of the ConvF uncertainty at calibration frequency and the uncertainty for the indicated frequency band.

^F At frequencies below 3 GHz, the validity of tissue parameters (ϵ and σ) can be relaxed to ± 10% if liquid compensation formula is applied to measured SAR values. At frequencies above 3 GHz, the validity of tissue parameters (ϵ and σ) is restricted to ± 5%. The uncertainty is the RSS of the ConvF uncertainty for indicated target tissue parameters.

^G Alpha/Depth are determined during calibration. SPEAG warrants that the remaining deviation due to the boundary effect after compensation is always less than ± 1% for frequencies below 3 GHz and below ± 2% for frequencies between 3-6 GHz at any distance larger than half the probe tip diameter from the boundary.

DASY/EASY - Parameters of Probe: ES3DV3 - SN:3209

Calibration Parameter Determined in Body Tissue Simulating Media

| f (MHz) ^C | Relative Permittivity ^F | Conductivity (S/m) ^F | ConvF X | ConvF Y | ConvF Z | Alpha ^G | Depth ^G (mm) | Unct. (k=2) |
|----------------------|------------------------------------|---------------------------------|---------|---------|---------|--------------------|-------------------------|-------------|
| 750 | 55.5 | 0.96 | 6.16 | 6.16 | 6.16 | 0.26 | 2.23 | ± 12.0 % |
| 835 | 55.2 | 0.97 | 6.14 | 6.14 | 6.14 | 0.80 | 1.13 | ± 12.0 % |
| 1750 | 53.4 | 1.49 | 4.85 | 4.85 | 4.85 | 0.59 | 1.42 | ± 12.0 % |
| 1900 | 53.3 | 1.52 | 4.68 | 4.68 | 4.68 | 0.52 | 1.59 | ± 12.0 % |
| 2450 | 52.7 | 1.95 | 4.20 | 4.20 | 4.20 | 0.73 | 1.08 | ± 12.0 % |
| 2600 | 52.5 | 2.16 | 4.04 | 4.04 | 4.04 | 0.80 | 1.00 | ± 12.0 % |

^C Frequency validity of ± 100 MHz only applies for DASY v4.4 and higher (see Page 2), else it is restricted to ± 50 MHz. The uncertainty is the RSS of the ConvF uncertainty at calibration frequency and the uncertainty for the indicated frequency band.

^F At frequencies below 3 GHz, the validity of tissue parameters (ϵ and σ) can be relaxed to ± 10% if liquid compensation formula is applied to measured SAR values. At frequencies above 3 GHz, the validity of tissue parameters (ϵ and σ) is restricted to ± 5%. The uncertainty is the RSS of the ConvF uncertainty for indicated target tissue parameters.

^G Alpha/Depth are determined during calibration. SPEAG warrants that the remaining deviation due to the boundary effect after compensation is always less than ± 1% for frequencies below 3 GHz and below ± 2% for frequencies between 3-6 GHz at any distance larger than half the probe tip diameter from the boundary.

Frequency Response of E-Field

(TEM-Cell:ifi110 EXX, Waveguide: R22)

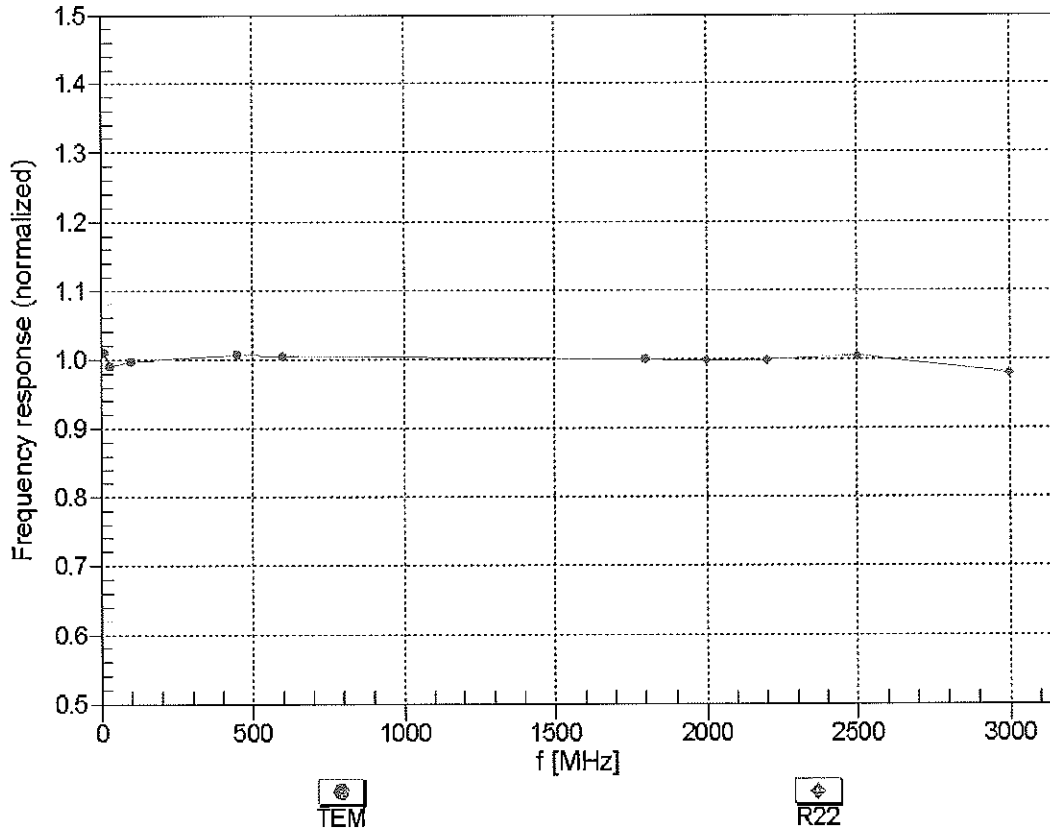

Uncertainty of Frequency Response of E-field: $\pm 6.3\%$ (k=2)

Receiving Pattern (ϕ), $\vartheta = 0^\circ$

f=600 MHz,TEM

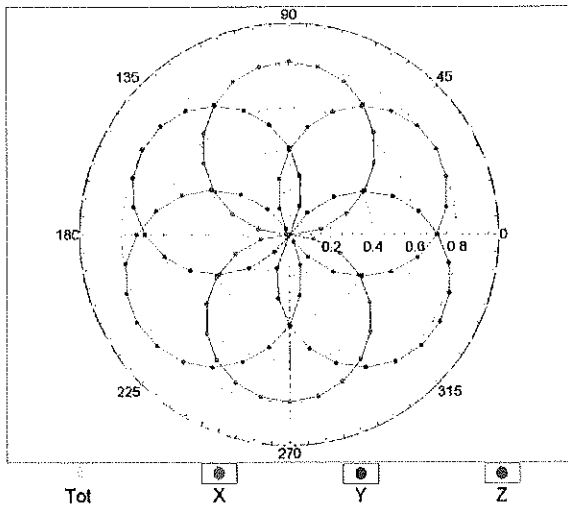

f=1800 MHz,R22

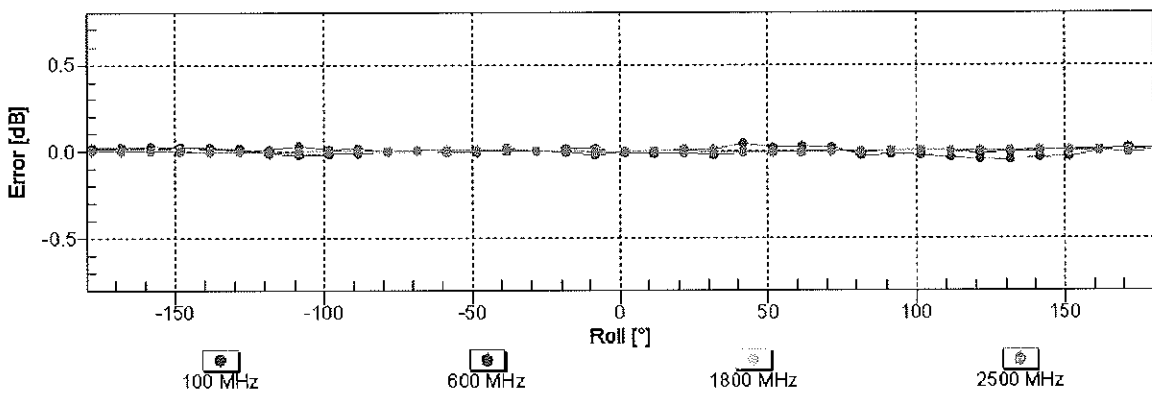
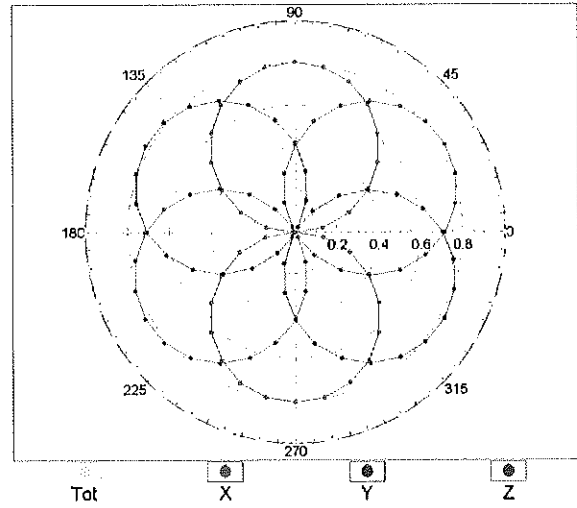

Uncertainty of Axial Isotropy Assessment: $\pm 0.5\%$ (k=2)

Dynamic Range $f(\text{SAR}_{\text{head}})$ (TEM cell , $f_{\text{eval}} = 1900 \text{ MHz}$)

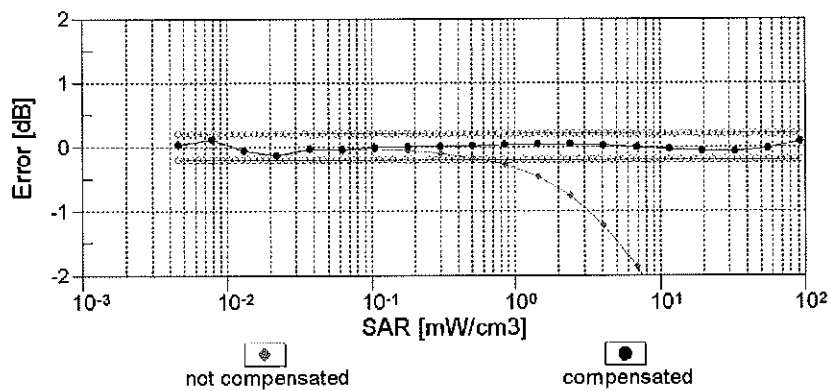
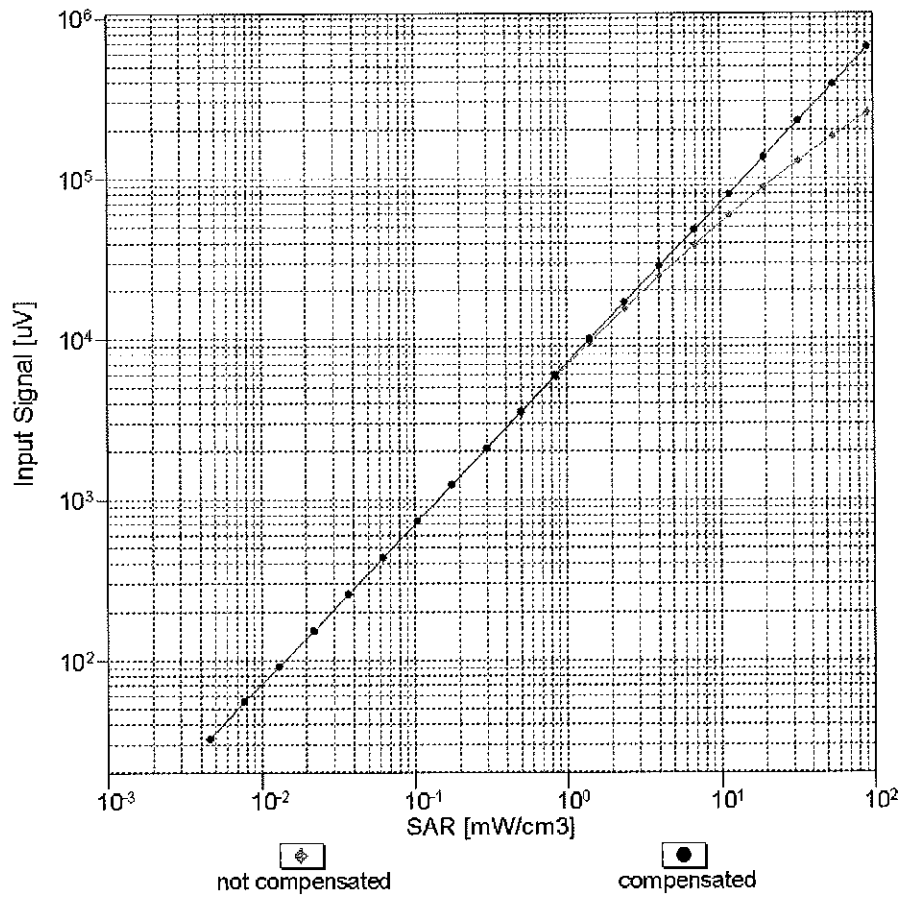

Uncertainty of Linearity Assessment: $\pm 0.6\%$ ($k=2$)

Conversion Factor Assessment

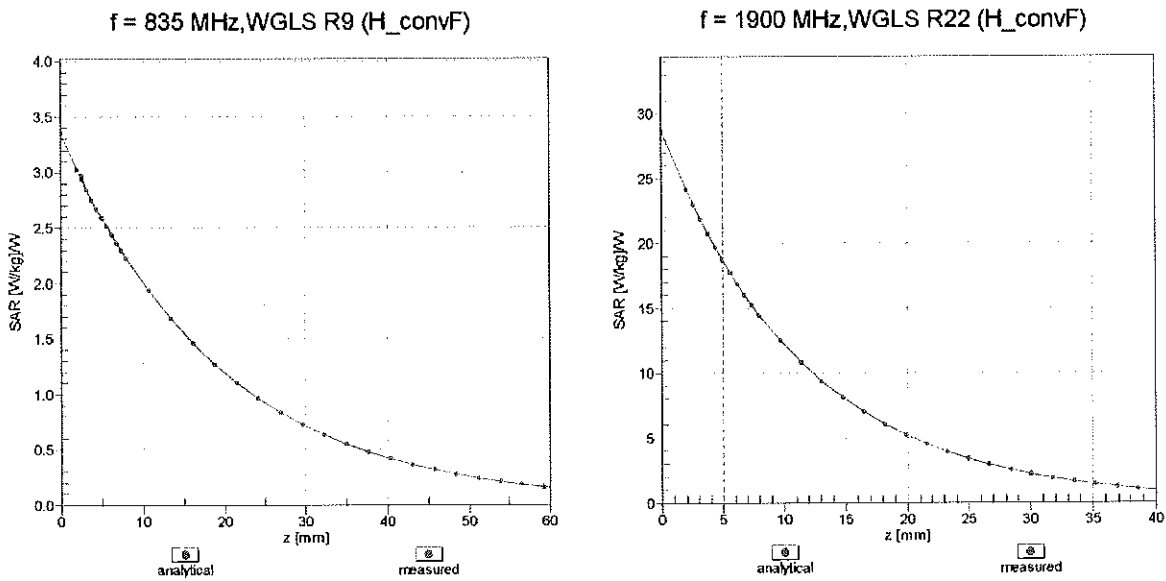

Deviation from Isotropy in Liquid Error (ϕ, θ), f = 900 MHz

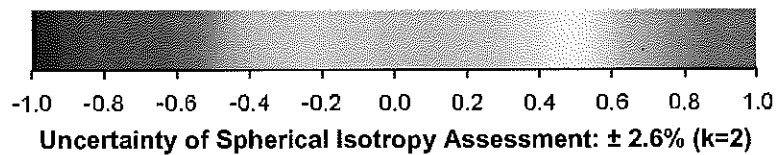
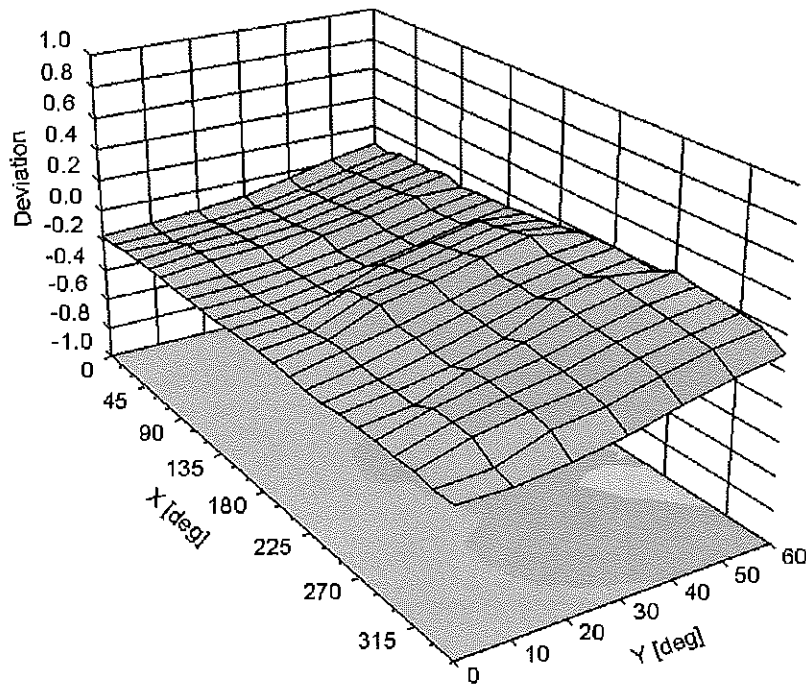

DASY/EASY - Parameters of Probe: ES3DV3 - SN:3209**Other Probe Parameters**

| | |
|---|------------|
| Sensor Arrangement | Triangular |
| Connector Angle (°) | -38.3 |
| Mechanical Surface Detection Mode | enabled |
| Optical Surface Detection Mode | disabled |
| Probe Overall Length | 337 mm |
| Probe Body Diameter | 10 mm |
| Tip Length | 10 mm |
| Tip Diameter | 4 mm |
| Probe Tip to Sensor X Calibration Point | 2 mm |
| Probe Tip to Sensor Y Calibration Point | 2 mm |
| Probe Tip to Sensor Z Calibration Point | 2 mm |
| Recommended Measurement Distance from Surface | 3 mm |

**Calibration Laboratory of
Schmid & Partner
Engineering AG**
Zeughausstrasse 43, 8004 Zurich, Switzerland



S Schweizerischer Kalibrierdienst
C Service suisse d'étalonnage
S Servizio svizzero di taratura
Swiss Calibration Service

Accredited by the Swiss Accreditation Service (SAS)
The Swiss Accreditation Service is one of the signatories to the EA
Multilateral Agreement for the recognition of calibration certificates

Accreditation No.: **SCS 108**

Client **PC Test**

Certificate No: **ES3-3022_Aug14/2**

CALIBRATION CERTIFICATE (Replacement of No: ES3-3022_Aug14)

Object **ES3DV2 - SN:3022**

Calibration procedure(s) **QA CAL-01.v9, QA CAL-12.v9, QA CAL-23.v5, QA CAL-25.v6
Calibration procedure for dosimetric E-field probes** CC
D/M/14

Calibration date: **August 19, 2014**

This calibration certificate documents the traceability to national standards, which realize the physical units of measurements (SI).
The measurements and the uncertainties with confidence probability are given on the following pages and are part of the certificate.

All calibrations have been conducted in the closed laboratory facility: environment temperature (22 ± 3)°C and humidity < 70%.

Calibration Equipment used (M&TE critical for calibration)

| Primary Standards | ID | Cal Date (Certificate No.) | Scheduled Calibration |
|----------------------------|-----------------|-----------------------------------|------------------------|
| Power meter E4419B | GB41293874 | 03-Apr-14 (No. 217-01911) | Apr-15 |
| Power sensor E4412A | MY41498087 | 03-Apr-14 (No. 217-01911) | Apr-15 |
| Reference 3 dB Attenuator | SN: S5054 (3c) | 03-Apr-14 (No. 217-01915) | Apr-15 |
| Reference 20 dB Attenuator | SN: S5277 (20x) | 03-Apr-14 (No. 217-01919) | Apr-15 |
| Reference 30 dB Attenuator | SN: S5129 (30b) | 03-Apr-14 (No. 217-01920) | Apr-15 |
| Reference Probe ES3DV2 | SN: 3013 | 30-Dec-13 (No. ES3-3013_Dec13) | Dec-14 |
| DAE4 | SN: 660 | 13-Dec-13 (No. DAE4-660_Dec13) | Dec-14 |
| Secondary Standards | ID | Check Date (in house) | Scheduled Check |
| RF generator HP 8648C | US3642U01700 | 4-Aug-99 (in house check Apr-13) | In house check: Apr-16 |
| Network Analyzer HP 8753E | US37390585 | 18-Oct-01 (in house check Oct-13) | In house check: Oct-14 |

| | | | |
|----------------|-------------------------------|--|---------------|
| Calibrated by: | Name Jeton Kastrali | Function Laboratory Technician | Signature |
| Approved by: | Name Katja Pokovic | Function Technical Manager | |

Issued: November 3, 2014

This calibration certificate shall not be reproduced except in full without written approval of the laboratory.



Accredited by the Swiss Accreditation Service (SAS)
The Swiss Accreditation Service is one of the signatories to the EA
Multilateral Agreement for the recognition of calibration certificates

Accreditation No.: **SCS 108**

Glossary:

| | |
|--------------------------|---|
| TSL | tissue simulating liquid |
| NORM _{x,y,z} | sensitivity in free space |
| ConvF | sensitivity in TSL / NORM _{x,y,z} |
| DCP | diode compression point |
| CF | crest factor (1/duty_cycle) of the RF signal |
| A, B, C, D | modulation dependent linearization parameters |
| Polarization φ | φ rotation around probe axis |
| Polarization ϑ | ϑ rotation around an axis that is in the plane normal to probe axis (at measurement center), i.e., $\vartheta = 0$ is normal to probe axis |
| Connector Angle | information used in DASY system to align probe sensor X to the robot coordinate system |

Calibration is Performed According to the Following Standards:

- IEEE Std 1528-2013, "IEEE Recommended Practice for Determining the Peak Spatial-Averaged Specific Absorption Rate (SAR) in the Human Head from Wireless Communications Devices: Measurement Techniques", June 2013
- IEC 62209-1, "Procedure to measure the Specific Absorption Rate (SAR) for hand-held devices used in close proximity to the ear (frequency range of 300 MHz to 3 GHz)", February 2005

Methods Applied and Interpretation of Parameters:

- NORM_{x,y,z}**: Assessed for E-field polarization $\vartheta = 0$ ($f \leq 900$ MHz in TEM-cell; $f > 1800$ MHz: R22 waveguide). NORM_{x,y,z} are only intermediate values, i.e., the uncertainties of NORM_{x,y,z} does not affect the E²-field uncertainty inside TSL (see below ConvF).
- NORM(f)_{x,y,z}** = NORM_{x,y,z} * frequency_response (see Frequency Response Chart). This linearization is implemented in DASY4 software versions later than 4.2. The uncertainty of the frequency response is included in the stated uncertainty of ConvF.
- DCP_{x,y,z}**: DCP are numerical linearization parameters assessed based on the data of power sweep with CW signal (no uncertainty required). DCP does not depend on frequency nor media.
- PAR**: PAR is the Peak to Average Ratio that is not calibrated but determined based on the signal characteristics
- A_{x,y,z}; B_{x,y,z}; C_{x,y,z}; D_{x,y,z}; VR_{x,y,z}; A, B, C, D** are numerical linearization parameters assessed based on the data of power sweep for specific modulation signal. The parameters do not depend on frequency nor media. VR is the maximum calibration range expressed in RMS voltage across the diode.
- ConvF and Boundary Effect Parameters**: Assessed in flat phantom using E-field (or Temperature Transfer Standard for $f \leq 800$ MHz) and inside waveguide using analytical field distributions based on power measurements for $f > 800$ MHz. The same setups are used for assessment of the parameters applied for boundary compensation (alpha, depth) of which typical uncertainty values are given. These parameters are used in DASY4 software to improve probe accuracy close to the boundary. The sensitivity in TSL corresponds to NORM_{x,y,z} * ConvF whereby the uncertainty corresponds to that given for ConvF. A frequency dependent ConvF is used in DASY version 4.4 and higher which allows extending the validity from ± 50 MHz to ± 100 MHz.
- Spherical isotropy (3D deviation from isotropy)**: in a field of low gradients realized using a flat phantom exposed by a patch antenna.
- Sensor Offset**: The sensor offset corresponds to the offset of virtual measurement center from the probe tip (on probe axis). No tolerance required.
- Connector Angle**: The angle is assessed using the information gained by determining the NORM_x (no uncertainty required).

Probe ES3DV2

SN:3022

Manufactured: April 15, 2003
Calibrated: August 19, 2014

Calibrated for DASY/EASY Systems
(Note: non-compatible with DASY2 system!)

DASY/EASY - Parameters of Probe: ES3DV2 - SN:3022

Basic Calibration Parameters

| | Sensor X | Sensor Y | Sensor Z | Unc (k=2) |
|---|----------|----------|----------|---------------|
| Norm ($\mu\text{V}/(\text{V}/\text{m})^2$) ^A | 1.00 | 1.04 | 0.96 | $\pm 10.1 \%$ |
| DCP (mV) ^B | 103.0 | 96.3 | 101.6 | |

Modulation Calibration Parameters

| UID | Communication System Name | | A dB | B dB $\sqrt{\mu\text{V}}$ | C | D dB | VR mV | Unc ^E (k=2) |
|---------------|---|---|---------|------------------------------|------|---------|----------|---------------------------|
| 0 | CW | X | 0.0 | 0.0 | 1.0 | 0.00 | 181.8 | $\pm 2.7 \%$ |
| | | Y | 0.0 | 0.0 | 1.0 | | 183.0 | |
| | | Z | 0.0 | 0.0 | 1.0 | | 192.3 | |
| 10010- CAA | SAR Validation (Square, 100ms, 10ms) | X | 2.51 | 63.1 | 12.7 | 10.00 | 42.6 | $\pm 1.9 \%$ |
| | | Y | 2.62 | 63.1 | 12.9 | | 42.7 | |
| | | Z | 3.12 | 65.7 | 13.6 | | 40.4 | |
| 10011- CAB | UMTS-FDD (WCDMA) | X | 3.33 | 67.8 | 19.2 | 2.91 | 145.9 | $\pm 0.9 \%$ |
| | | Y | 3.13 | 64.9 | 16.9 | | 147.4 | |
| | | Z | 3.20 | 66.4 | 18.2 | | 139.6 | |
| 10012- CAA | IEEE 802.11b WiFi 2.4 GHz (DSSS, 1 Mbps) | X | 3.05 | 70.1 | 19.8 | 1.87 | 147.2 | $\pm 0.9 \%$ |
| | | Y | 2.62 | 65.1 | 16.2 | | 147.4 | |
| | | Z | 2.85 | 68.2 | 18.4 | | 141.7 | |
| 10013- CAA | IEEE 802.11g WiFi 2.4 GHz (DSSS-OFDM, 6 Mbps) | X | 11.10 | 70.9 | 23.6 | 9.46 | 143.9 | $\pm 3.0 \%$ |
| | | Y | 11.04 | 70.2 | 22.9 | | 144.2 | |
| | | Z | 10.77 | 70.2 | 23.1 | | 134.7 | |
| 10021- DAB | GSM-FDD (TDMA, GMSK) | X | 19.66 | 99.7 | 28.6 | 9.39 | 126.0 | $\pm 1.9 \%$ |
| | | Y | 11.04 | 89.6 | 25.5 | | 138.9 | |
| | | Z | 10.45 | 88.8 | 24.9 | | 137.5 | |
| 10023- DAB | GPRS-FDD (TDMA, GMSK, TN 0) | X | 20.19 | 99.6 | 28.5 | 9.57 | 142.0 | $\pm 2.5 \%$ |
| | | Y | 10.53 | 88.4 | 25.0 | | 145.5 | |
| | | Z | 15.52 | 96.5 | 27.8 | | 147.6 | |
| 10024- DAB | GPRS-FDD (TDMA, GMSK, TN 0-1) | X | 31.93 | 99.6 | 25.2 | 6.56 | 149.5 | $\pm 1.9 \%$ |
| | | Y | 12.70 | 87.9 | 22.2 | | 148.0 | |
| | | Z | 27.00 | 99.8 | 25.7 | | 135.3 | |
| 10027- DAB | GPRS-FDD (TDMA, GMSK, TN 0-1-2) | X | 38.32 | 99.8 | 23.8 | 4.80 | 148.1 | $\pm 2.2 \%$ |
| | | Y | 9.80 | 83.2 | 19.3 | | 138.8 | |
| | | Z | 31.96 | 99.9 | 24.2 | | 128.9 | |
| 10028- DAB | GPRS-FDD (TDMA, GMSK, TN 0-1-2-3) | X | 40.03 | 99.5 | 22.8 | 3.55 | 130.5 | $\pm 2.2 \%$ |
| | | Y | 40.27 | 99.6 | 23.0 | | 148.1 | |
| | | Z | 43.09 | 99.7 | 22.5 | | 140.1 | |
| 10032- CAA | IEEE 802.15.1 Bluetooth (GFSK, DH5) | X | 38.93 | 99.4 | 20.4 | 1.16 | 146.7 | $\pm 1.9 \%$ |
| | | Y | 32.83 | 92.5 | 17.9 | | 139.2 | |
| | | Z | 31.94 | 99.5 | 20.8 | | 133.1 | |
| 10039- CAB | CDMA2000 (1xRTT, RC1) | X | 4.66 | 66.8 | 19.3 | 4.57 | 144.5 | $\pm 1.2 \%$ |
| | | Y | 4.56 | 65.3 | 17.9 | | 137.2 | |
| | | Z | 4.52 | 66.1 | 18.7 | | 131.7 | |

| | | | | | | | | |
|-----------|---|---|-------|------|------|------|-------|--------|
| 10081-CAB | CDMA2000 (1xRTT, RC3) | X | 3.82 | 66.0 | 18.7 | 3.97 | 140.3 | ±0.9 % |
| | | Y | 3.77 | 64.5 | 17.3 | | 133.6 | |
| | | Z | 3.79 | 65.7 | 18.4 | | 128.2 | |
| 10098-CAB | UMTS-FDD (HSUPA, Subtest 2) | X | 4.40 | 66.2 | 18.5 | 3.98 | 130.9 | ±1.2 % |
| | | Y | 4.39 | 65.0 | 17.4 | | 131.1 | |
| | | Z | 4.47 | 66.3 | 18.4 | | 140.0 | |
| 10100-CAB | LTE-FDD (SC-FDMA, 100% RB, 20 MHz, QPSK) | X | 6.30 | 67.3 | 19.8 | 5.67 | 137.4 | ±1.7 % |
| | | Y | 6.25 | 66.3 | 18.9 | | 135.9 | |
| | | Z | 6.36 | 67.4 | 19.7 | | 147.5 | |
| 10108-CAB | LTE-FDD (SC-FDMA, 100% RB, 10 MHz, QPSK) | X | 6.14 | 66.8 | 19.6 | 5.80 | 134.6 | ±1.7 % |
| | | Y | 6.17 | 66.1 | 18.9 | | 133.9 | |
| | | Z | 6.24 | 67.0 | 19.7 | | 144.5 | |
| 10110-CAB | LTE-FDD (SC-FDMA, 100% RB, 6 MHz, QPSK) | X | 5.82 | 66.3 | 19.4 | 5.75 | 131.2 | ±1.7 % |
| | | Y | 5.82 | 65.4 | 18.6 | | 130.3 | |
| | | Z | 5.91 | 66.5 | 19.4 | | 140.4 | |
| 10114-CAA | IEEE 802.11n (HT Greenfield, 13.5 Mbps, BPSK) | X | 10.00 | 68.5 | 21.2 | 8.10 | 124.3 | ±2.5 % |
| | | Y | 9.89 | 67.9 | 20.6 | | 124.0 | |
| | | Z | 10.05 | 68.6 | 21.2 | | 133.2 | |
| 10117-CAA | IEEE 802.11n (HT Mixed, 13.5 Mbps, BPSK) | X | 10.01 | 68.6 | 21.2 | 8.07 | 125.8 | ±2.5 % |
| | | Y | 9.91 | 67.9 | 20.7 | | 125.8 | |
| | | Z | 10.09 | 68.8 | 21.3 | | 134.7 | |
| 10151-CAB | LTE-TDD (SC-FDMA, 50% RB, 20 MHz, QPSK) | X | 9.69 | 75.5 | 26.4 | 9.28 | 144.7 | ±3.3 % |
| | | Y | 9.09 | 72.7 | 24.6 | | 143.2 | |
| | | Z | 8.54 | 72.0 | 24.5 | | 124.8 | |
| 10154-CAB | LTE-FDD (SC-FDMA, 50% RB, 10 MHz, QPSK) | X | 5.82 | 66.2 | 19.4 | 5.75 | 131.3 | ±1.9 % |
| | | Y | 6.06 | 66.3 | 19.1 | | 149.2 | |
| | | Z | 5.91 | 66.5 | 19.4 | | 140.7 | |
| 10160-CAB | LTE-FDD (SC-FDMA, 50% RB, 15 MHz, QPSK) | X | 6.27 | 66.9 | 19.7 | 5.82 | 136.5 | ±1.4 % |
| | | Y | 6.19 | 65.8 | 18.7 | | 128.4 | |
| | | Z | 6.33 | 67.0 | 19.6 | | 145.4 | |
| 10169-CAB | LTE-FDD (SC-FDMA, 1 RB, 20 MHz, QPSK) | X | 4.81 | 66.4 | 19.7 | 5.73 | 134.8 | ±1.7 % |
| | | Y | 4.92 | 66.1 | 19.1 | | 149.9 | |
| | | Z | 4.78 | 66.4 | 19.6 | | 141.2 | |
| 10172-CAB | LTE-TDD (SC-FDMA, 1 RB, 20 MHz, QPSK) | X | 7.83 | 76.6 | 27.2 | 9.21 | 131.4 | ±3.5 % |
| | | Y | 7.54 | 74.5 | 25.8 | | 147.8 | |
| | | Z | 7.71 | 76.7 | 27.4 | | 145.3 | |
| 10175-CAB | LTE-FDD (SC-FDMA, 1 RB, 10 MHz, QPSK) | X | 4.90 | 66.9 | 20.0 | 5.72 | 147.6 | ±1.4 % |
| | | Y | 4.90 | 66.0 | 19.1 | | 148.0 | |
| | | Z | 4.78 | 66.4 | 19.6 | | 141.6 | |
| 10181-CAB | LTE-FDD (SC-FDMA, 1 RB, 15 MHz, QPSK) | X | 4.90 | 66.9 | 20.0 | 5.72 | 148.1 | ±1.4 % |
| | | Y | 4.89 | 65.9 | 19.0 | | 146.9 | |
| | | Z | 4.80 | 66.5 | 19.7 | | 142.1 | |
| 10193-CAA | IEEE 802.11n (HT Greenfield, 6.5 Mbps, BPSK) | X | 9.80 | 68.7 | 21.4 | 8.09 | 135.1 | ±2.7 % |
| | | Y | 9.78 | 68.2 | 20.9 | | 135.5 | |
| | | Z | 9.70 | 68.5 | 21.2 | | 130.2 | |

| | | | | | | | | |
|-----------|---|---|-------|------|------|------|-------|--------|
| 10196-CAA | IEEE 802.11n (HT Mixed, 6.5 Mbps, BPSK) | X | 9.79 | 68.7 | 21.4 | 8.10 | 136.4 | ±2.7 % |
| | | Y | 9.81 | 68.3 | 20.9 | | 138.0 | |
| | | Z | 9.72 | 68.6 | 21.3 | | 132.8 | |
| 10219-CAA | IEEE 802.11n (HT Mixed, 7.2 Mbps, BPSK) | X | 9.68 | 68.6 | 21.3 | 8.03 | 136.0 | ±2.7 % |
| | | Y | 9.74 | 68.3 | 21.0 | | 137.4 | |
| | | Z | 9.62 | 68.5 | 21.2 | | 132.6 | |
| 10222-CAA | IEEE 802.11n (HT Mixed, 15 Mbps, BPSK) | X | 10.20 | 69.1 | 21.5 | 8.06 | 143.4 | ±2.5 % |
| | | Y | 9.91 | 60.0 | 20.7 | | 125.8 | |
| | | Z | 10.27 | 69.4 | 21.6 | | 148.4 | |
| 10225-CAB | UMTS-FDD (HSPA+) | X | 6.87 | 66.9 | 19.6 | 5.97 | 139.5 | ±1.9 % |
| | | Y | 7.04 | 66.9 | 19.3 | | 149.3 | |
| | | Z | 6.89 | 67.0 | 19.5 | | 143.5 | |
| 10237-CAB | LTE-TDD (SC-FDMA, 1 RB, 10 MHz, QPSK) | X | 7.66 | 75.9 | 26.9 | 9.21 | 126.1 | ±3.0 % |
| | | Y | 7.17 | 73.1 | 25.1 | | 132.1 | |
| | | Z | 7.18 | 74.6 | 26.3 | | 128.0 | |
| 10252-CAB | LTE-TDD (SC-FDMA, 50% RB, 10 MHz, QPSK) | X | 8.58 | 73.1 | 25.3 | 9.24 | 127.6 | ±3.3 % |
| | | Y | 8.22 | 71.0 | 23.7 | | 126.9 | |
| | | Z | 8.83 | 74.3 | 26.0 | | 149.8 | |
| 10267-CAB | LTE-TDD (SC-FDMA, 100% RB, 10 MHz, QPSK) | X | 9.69 | 75.5 | 26.5 | 9.30 | 143.8 | ±3.3 % |
| | | Y | 8.88 | 72.0 | 24.2 | | 135.2 | |
| | | Z | 8.83 | 72.9 | 25.1 | | 131.3 | |
| 10274-CAB | UMTS-FDD (HSUPA, Subtest 5, 3GPP Rel8.10) | X | 5.87 | 67.0 | 19.2 | 4.87 | 141.2 | ±1.4 % |
| | | Y | 5.77 | 65.8 | 18.1 | | 136.0 | |
| | | Z | 5.71 | 66.3 | 18.6 | | 132.7 | |
| 10275-CAB | UMTS-FDD (HSUPA, Subtest 5, 3GPP Rel8.4) | X | 4.44 | 67.2 | 19.2 | 3.96 | 147.3 | ±0.9 % |
| | | Y | 4.29 | 65.3 | 17.6 | | 139.2 | |
| | | Z | 4.31 | 66.3 | 18.5 | | 139.6 | |
| 10291-AAB | CDMA2000, RC3, SO55, Full Rate | X | 3.60 | 67.1 | 19.1 | 3.46 | 137.8 | ±0.7 % |
| | | Y | 3.44 | 64.8 | 17.2 | | 129.6 | |
| | | Z | 3.48 | 66.2 | 18.4 | | 130.5 | |
| 10292-AAB | CDMA2000, RC3, SO32, Full Rate | X | 3.50 | 66.9 | 18.9 | 3.39 | 139.5 | ±0.7 % |
| | | Y | 3.38 | 64.8 | 17.2 | | 132.0 | |
| | | Z | 3.48 | 66.5 | 18.5 | | 133.1 | |
| 10297-AAA | LTE-FDD (SC-FDMA, 50% RB, 20 MHz, QPSK) | X | 6.12 | 66.7 | 19.6 | 5.81 | 133.3 | ±1.9 % |
| | | Y | 6.35 | 66.7 | 19.3 | | 149.3 | |
| | | Z | 6.17 | 66.8 | 19.5 | | 132.7 | |
| 10311-AAA | LTE-FDD (SC-FDMA, 100% RB, 15 MHz, QPSK) | X | 6.72 | 67.4 | 20.0 | 6.06 | 138.7 | ±1.7 % |
| | | Y | 6.63 | 66.3 | 19.1 | | 131.4 | |
| | | Z | 6.72 | 67.3 | 19.9 | | 138.7 | |
| 10315-AAA | IEEE 802.11b WiFi 2.4 GHz (DSSS, 1 Mbps, 96pc duty cycle) | X | 2.90 | 69.9 | 19.8 | 1.71 | 146.4 | ±0.5 % |
| | | Y | 2.54 | 65.2 | 16.5 | | 139.3 | |
| | | Z | 2.75 | 68.1 | 18.5 | | 146.4 | |
| 10316-AAA | IEEE 802.11g WiFi 2.4 GHz (ERP-OFDM, 6 Mbps, 96pc duty cycle) | X | 10.12 | 69.3 | 21.9 | 8.36 | 142.9 | ±3.0 % |
| | | Y | 10.01 | 68.5 | 21.3 | | 135.2 | |
| | | Z | 10.11 | 69.3 | 21.9 | | 141.7 | |

| | | | | | | | | |
|-----------|---|---|-------|------|------|------|-------|--------|
| 10403-AAB | CDMA2000 (1xEV-DO, Rev. 0) | X | 4.59 | 68.2 | 19.0 | 3.76 | 126.7 | ±0.7 % |
| | | Y | 4.59 | 67.2 | 18.0 | | 142.4 | |
| | | Z | 4.64 | 68.5 | 19.0 | | 143.0 | |
| 10404-AAB | CDMA2000 (1xEV-DO, Rev. A) | X | 4.64 | 68.8 | 19.3 | 3.77 | 147.1 | ±0.9 % |
| | | Y | 4.47 | 67.1 | 17.9 | | 139.6 | |
| | | Z | 4.54 | 68.4 | 18.9 | | 147.2 | |
| 10415-AAA | IEEE 802.11b WiFi 2.4 GHz (DSSS, 1 Mbps, 99pc duty cycle) | X | 2.66 | 69.0 | 19.4 | 1.54 | 145.8 | ±0.5 % |
| | | Y | 2.40 | 64.8 | 16.2 | | 140.0 | |
| | | Z | 2.62 | 67.8 | 18.4 | | 147.2 | |
| 10416-AAA | IEEE 802.11g WiFi 2.4 GHz (ERP-OFDM, 6 Mbps, 99pc duty cycle) | X | 9.97 | 69.1 | 21.7 | 8.23 | 142.0 | ±3.0 % |
| | | Y | 10.08 | 68.9 | 21.4 | | 145.8 | |
| | | Z | 10.01 | 69.2 | 21.8 | | 143.3 | |

The reported uncertainty of measurement is stated as the standard uncertainty of measurement multiplied by the coverage factor $k=2$, which for a normal distribution corresponds to a coverage probability of approximately 95%.

[^] The uncertainties of Norm X, Y, Z do not affect the E^2 -field uncertainty inside TSL (see Pages 8 and 9).

[^] Numerical linearization parameter: uncertainty not required.

[^] Uncertainty is determined using the max. deviation from linear response applying rectangular distribution and is expressed for the square of the field value.

DASY/EASY - Parameters of Probe: ES3DV2 - SN:3022

Calibration Parameter Determined in Head Tissue Simulating Media

| f (MHz) ^c | Relative Permittivity ^F | Conductivity (S/m) ^F | ConvF X | ConvF Y | ConvF Z | Alpha ^G | Depth ^G (mm) | Unct. (k=2) |
|----------------------|------------------------------------|---------------------------------|---------|---------|---------|--------------------|-------------------------|-------------|
| 750 | 41.9 | 0.89 | 6.39 | 6.39 | 6.39 | 0.20 | 2.24 | ± 12.0 % |
| 835 | 41.5 | 0.90 | 6.18 | 6.18 | 6.18 | 0.23 | 1.98 | ± 12.0 % |
| 1750 | 40.1 | 1.37 | 5.04 | 5.04 | 5.04 | 0.51 | 1.35 | ± 12.0 % |
| 1900 | 40.0 | 1.40 | 4.85 | 4.85 | 4.85 | 0.38 | 1.66 | ± 12.0 % |
| 2450 | 39.2 | 1.80 | 4.31 | 4.31 | 4.31 | 0.66 | 1.28 | ± 12.0 % |
| 2600 | 39.0 | 1.96 | 4.13 | 4.13 | 4.13 | 0.76 | 1.28 | ± 12.0 % |

^c Frequency validity above 300 MHz of ± 100 MHz only applies for DASY v4.4 and higher (see Page 2), else it is restricted to ± 50 MHz. The uncertainty is the RSS of the ConvF uncertainty at calibration frequency and the uncertainty for the indicated frequency band. Frequency validity below 300 MHz is ± 10, 25, 40, 50 and 70 MHz for ConvF assessments at 30, 64, 128, 150 and 220 MHz respectively. Above 5 GHz frequency validity can be extended to ± 110 MHz.

^F At frequencies below 3 GHz, the validity of tissue parameters (ϵ and σ) can be relaxed to ± 10% if liquid compensation formula is applied to measured SAR values. At frequencies above 3 GHz, the validity of tissue parameters (ϵ and σ) is restricted to ± 5%. The uncertainty is the RSS of the ConvF uncertainty for indicated target tissue parameters.

^G Alpha/Depth are determined during calibration. SPEAG warrants that the remaining deviation due to the boundary effect after compensation is always less than ± 1% for frequencies below 3 GHz and below ± 2% for frequencies between 3-6 GHz at any distance larger than half the probe tip diameter from the boundary.

DASY/EASY - Parameters of Probe: ES3DV2 - SN:3022

Calibration Parameter Determined in Body Tissue Simulating Media

| f (MHz) ^c | Relative Permittivity ^f | Conductivity (S/m) ^f | ConvF X | ConvF Y | ConvF Z | Alpha ^g | Depth ^g (mm) | Unct. (k=2) |
|----------------------|------------------------------------|---------------------------------|---------|---------|---------|--------------------|-------------------------|-------------|
| 450 | 56.7 | 0.94 | 6.78 | 6.78 | 6.78 | 0.12 | 1.30 | ± 13.3 % |
| 600 | 56.1 | 0.95 | 6.72 | 6.72 | 6.72 | 0.05 | 1.20 | ± 13.3 % |
| 750 | 55.5 | 0.96 | 6.02 | 6.02 | 6.02 | 0.23 | 2.05 | ± 12.0 % |
| 835 | 55.2 | 0.97 | 5.98 | 5.98 | 5.98 | 0.29 | 1.85 | ± 12.0 % |
| 1750 | 53.4 | 1.49 | 4.70 | 4.70 | 4.70 | 0.66 | 1.25 | ± 12.0 % |
| 1900 | 53.3 | 1.52 | 4.49 | 4.49 | 4.49 | 0.33 | 2.02 | ± 12.0 % |
| 2450 | 52.7 | 1.95 | 4.05 | 4.05 | 4.05 | 0.80 | 1.01 | ± 12.0 % |
| 2600 | 52.5 | 2.16 | 3.94 | 3.94 | 3.94 | 0.68 | 1.03 | ± 12.0 % |

^c Frequency validity above 300 MHz of ± 100 MHz only applies for DASY v4.4 and higher (see Page 2), else it is restricted to ± 50 MHz. The uncertainty is the RSS of the ConvF uncertainty at calibration frequency and the uncertainty for the indicated frequency band. Frequency validity below 300 MHz is ± 10, 25, 40, 50 and 70 MHz for ConvF assessments at 30, 64, 128, 150 and 220 MHz respectively. Above 5 GHz frequency validity can be extended to ± 110 MHz.

^f At frequencies below 3 GHz, the validity of tissue parameters (ϵ and σ) can be relaxed to ± 10% if liquid compensation formula is applied to measured SAR values. At frequencies above 3 GHz, the validity of tissue parameters (ϵ and σ) is restricted to ± 5%. The uncertainty is the RSS of the ConvF uncertainty for indicated target tissue parameters.

^g Alpha/Depth are determined during calibration. SPEAG warrants that the remaining deviation due to the boundary effect after compensation is always less than ± 1% for frequencies below 3 GHz and below ± 2% for frequencies between 3-6 GHz at any distance larger than half the probe tip diameter from the boundary.

Frequency Response of E-Field (TEM-Cell:ifi110 EXX, Waveguide: R22)

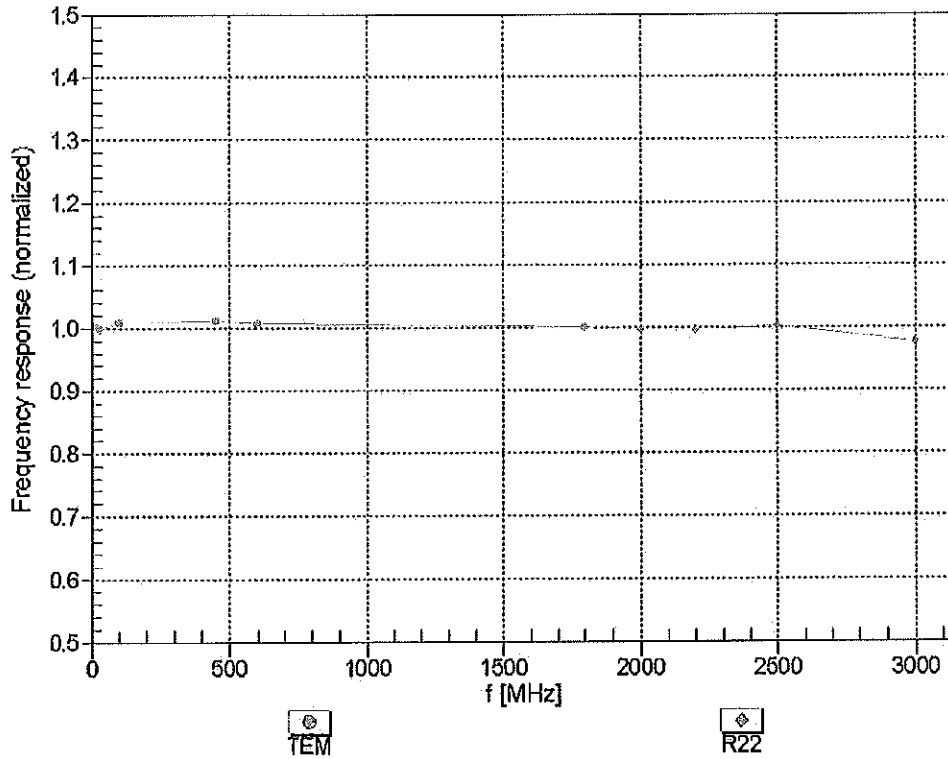

Uncertainty of Frequency Response of E-field: $\pm 6.3\%$ (k=2)

Receiving Pattern (ϕ), $\theta = 0^\circ$

f=600 MHz,TEM

f=1800 MHz,R22

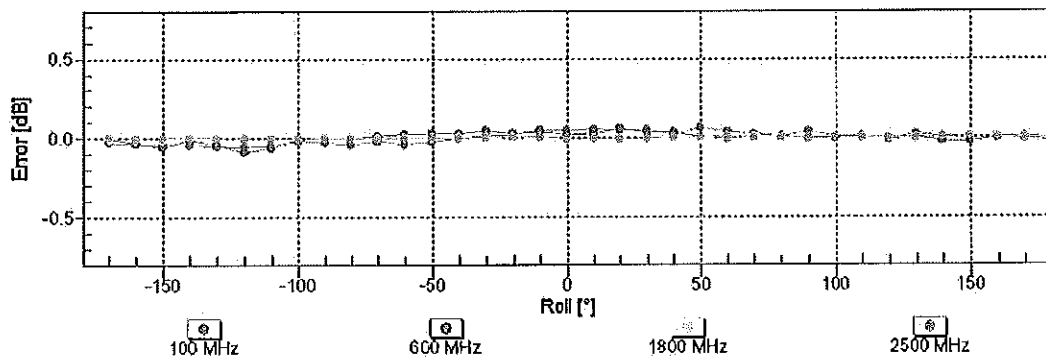
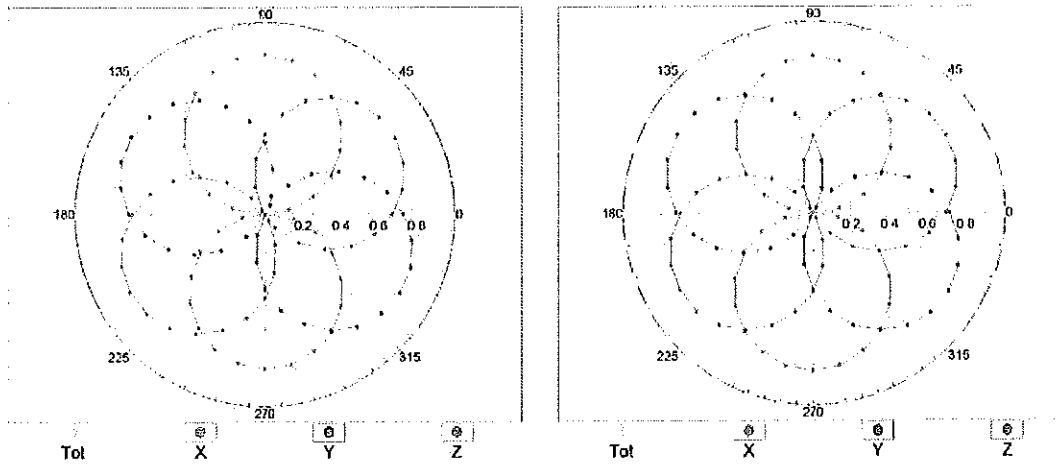

Uncertainty of Axial Isotropy Assessment: $\pm 0.5\%$ (k=2)

Dynamic Range $f(SAR_{head})$ (TEM cell, $f_{eval}=1900$ MHz)

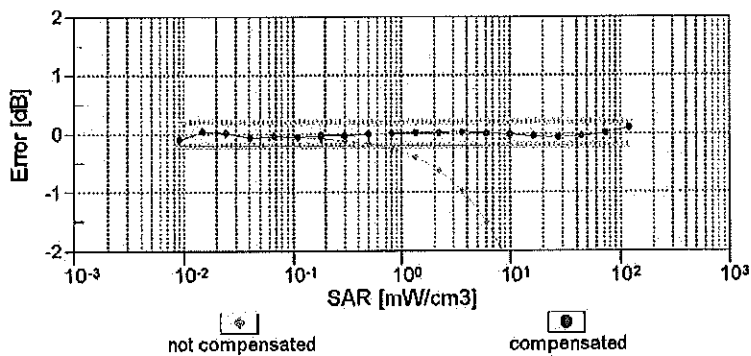
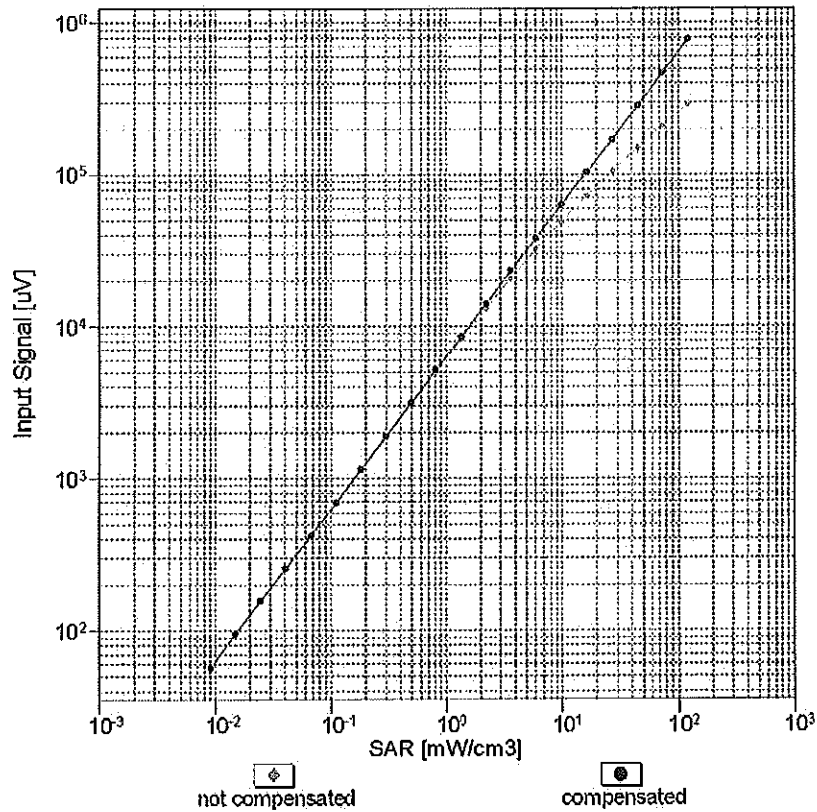

Uncertainty of Linearity Assessment: $\pm 0.6\%$ (k=2)

Conversion Factor Assessment

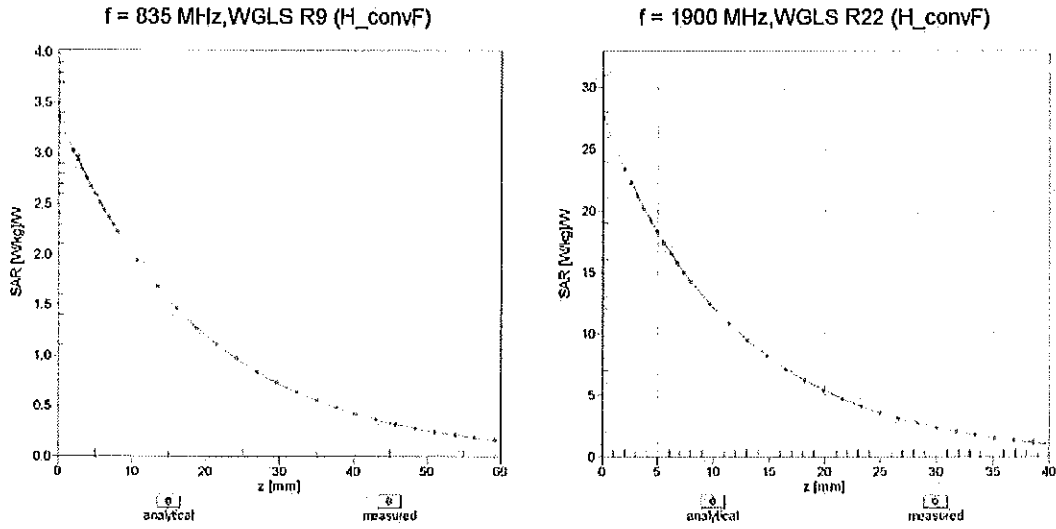

Deviation from Isotropy in Liquid Error (ϕ, θ), f = 900 MHz

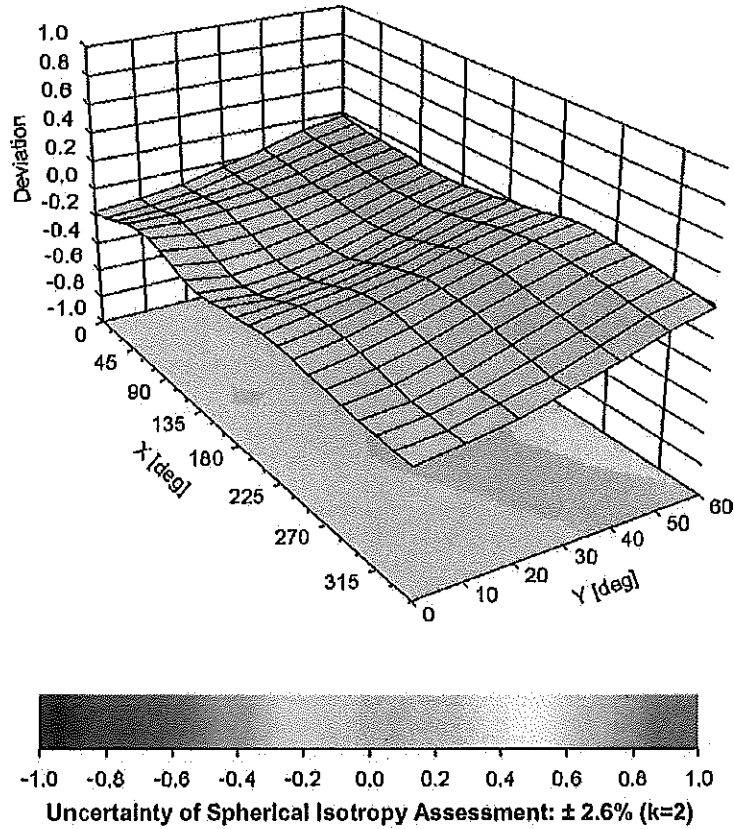

DASY/EASY - Parameters of Probe: ES3DV2 - SN:3022**Other Probe Parameters**

| | |
|---|------------|
| Sensor Arrangement | Triangular |
| Connector Angle (°) | -80,3 |
| Mechanical Surface Detection Mode | enabled |
| Optical Surface Detection Mode | disabled |
| Probe Overall Length | 337 mm |
| Probe Body Diameter | 10 mm |
| Tip Length | 10 mm |
| Tip Diameter | 4 mm |
| Probe Tip to Sensor X Calibration Point | 2 mm |
| Probe Tip to Sensor Y Calibration Point | 2 mm |
| Probe Tip to Sensor Z Calibration Point | 2 mm |
| Recommended Measurement Distance from Surface | 3 mm |



Accredited by the Swiss Accreditation Service (SAS)
The Swiss Accreditation Service is one of the signatories to the EA
Multilateral Agreement for the recognition of calibration certificates

Accreditation No.: **SCS 108**

Client **PC Test**

Certificate No: **ES3-3258_Feb14**

CALIBRATION CERTIFICATE

Object **ES3DV3 - SN:3258**

Calibration procedure(s) **QA CAL-01.v9, QA CAL-23.v5, QA CAL-25.v6
Calibration procedure for dosimetric E-field probes** *CCV 3/16/14*

Calibration date: **February 25, 2014**

This calibration certificate documents the traceability to national standards, which realize the physical units of measurements (SI).
The measurements and the uncertainties with confidence probability are given on the following pages and are part of the certificate.

All calibrations have been conducted in the closed laboratory facility: environment temperature (22 ± 3)°C and humidity < 70%.

Calibration Equipment used (M&TE critical for calibration)

| Primary Standards | ID | Cal Date (Certificate No.) | Scheduled Calibration |
|----------------------------|-----------------|-----------------------------------|------------------------|
| Power meter E4419B | GB41293874 | 04-Apr-13 (No. 217-01733) | Apr-14 |
| Power sensor E4412A | MY41498087 | 04-Apr-13 (No. 217-01733) | Apr-14 |
| Reference 3 dB Attenuator | SN: S5054 (3c) | 04-Apr-13 (No. 217-01737) | Apr-14 |
| Reference 20 dB Attenuator | SN: S5277 (20x) | 04-Apr-13 (No. 217-01735) | Apr-14 |
| Reference 30 dB Attenuator | SN: S5129 (30b) | 04-Apr-13 (No. 217-01738) | Apr-14 |
| Reference Probe ES3DV2 | SN: 3013 | 30-Dec-13 (No. ES3-3013_Dec13) | Dec-14 |
| DAE4 | SN: 660 | 13-Dec-13 (No. DAE4-660_Dec13) | Dec-14 |
| Secondary Standards | ID | Check Date (in house) | Scheduled Check |
| RF generator HP 8648C | US3642U01700 | 4-Aug-99 (in house check Apr-13) | In house check: Apr-16 |
| Network Analyzer HP 8753E | US37390585 | 18-Oct-01 (in house check Oct-13) | In house check: Oct-14 |

| | | | |
|----------------|-------------------------------|--|------------------------------------|
| Calibrated by: | Name Israe El-Naouq | Function Laboratory Technician | Signature <i>Israe El-Naouq</i> |
| Approved by: | Name Katja Pokovic | Function Technical Manager | Signature <i>Katja Pokovic</i> |

Issued: February 27, 2014

This calibration certificate shall not be reproduced except in full without written approval of the laboratory.

PCT# 80615



Accredited by the Swiss Accreditation Service (SAS)

Accreditation No.: **SCS 108**

The Swiss Accreditation Service is one of the signatories to the EA Multilateral Agreement for the recognition of calibration certificates

Glossary:

| | |
|--------------------------|--|
| TSL | tissue simulating liquid |
| NORM _{x,y,z} | sensitivity in free space |
| ConvF | sensitivity in TSL / NORM _{x,y,z} |
| DCP | diode compression point |
| CF | crest factor (1/duty_cycle) of the RF signal |
| A, B, C, D | modulation dependent linearization parameters |
| Polarization φ | φ rotation around probe axis |
| Polarization ϑ | ϑ rotation around an axis that is in the plane normal to probe axis (at measurement center), i.e., $\vartheta = 0$ is normal to probe axis |
| Connector Angle | information used in DASY system to align probe sensor X to the robot coordinate system |

Calibration is Performed According to the Following Standards:

- IEEE Std 1528-2013, "IEEE Recommended Practice for Determining the Peak Spatial-Averaged Specific Absorption Rate (SAR) in the Human Head from Wireless Communications Devices: Measurement Techniques", June 2013
- IEC 62209-1, "Procedure to measure the Specific Absorption Rate (SAR) for hand-held devices used in close proximity to the ear (frequency range of 300 MHz to 3 GHz)", February 2005

Methods Applied and Interpretation of Parameters:

- NORM_{x,y,z}**: Assessed for E-field polarization $\vartheta = 0$ ($f \leq 900$ MHz in TEM-cell; $f > 1800$ MHz: R22 waveguide). NORM_{x,y,z} are only intermediate values, i.e., the uncertainties of NORM_{x,y,z} does not affect the E²-field uncertainty inside TSL (see below ConvF).
- NORM(f)_{x,y,z}** = NORM_{x,y,z} * frequency_response (see Frequency Response Chart). This linearization is implemented in DASY4 software versions later than 4.2. The uncertainty of the frequency response is included in the stated uncertainty of ConvF.
- DCP_{x,y,z}**: DCP are numerical linearization parameters assessed based on the data of power sweep with CW signal (no uncertainty required). DCP does not depend on frequency nor media.
- PAR**: PAR is the Peak to Average Ratio that is not calibrated but determined based on the signal characteristics
- A_{x,y,z}; B_{x,y,z}; C_{x,y,z}; D_{x,y,z}; VR_{x,y,z}**: A, B, C, D are numerical linearization parameters assessed based on the data of power sweep for specific modulation signal. The parameters do not depend on frequency nor media. VR is the maximum calibration range expressed in RMS voltage across the diode.
- ConvF and Boundary Effect Parameters**: Assessed in flat phantom using E-field (or Temperature Transfer Standard for $f \leq 800$ MHz) and inside waveguide using analytical field distributions based on power measurements for $f > 800$ MHz. The same setups are used for assessment of the parameters applied for boundary compensation (alpha, depth) of which typical uncertainty values are given. These parameters are used in DASY4 software to improve probe accuracy close to the boundary. The sensitivity in TSL corresponds to NORM_{x,y,z} * ConvF whereby the uncertainty corresponds to that given for ConvF. A frequency dependent ConvF is used in DASY version 4.4 and higher which allows extending the validity from ± 50 MHz to ± 100 MHz.
- Spherical isotropy (3D deviation from isotropy)**: in a field of low gradients realized using a flat phantom exposed by a patch antenna.
- Sensor Offset**: The sensor offset corresponds to the offset of virtual measurement center from the probe tip (on probe axis). No tolerance required.
- Connector Angle**: The angle is assessed using the information gained by determining the NORM_x (no uncertainty required).

Probe ES3DV3

SN:3258

Manufactured: January 25, 2010
Calibrated: February 25, 2014

Calibrated for DASY/EASY Systems
(Note: non-compatible with DASY2 system!)

DASY/EASY - Parameters of Probe: ES3DV3 - SN:3258

Basic Calibration Parameters

| | Sensor X | Sensor Y | Sensor Z | Unc (k=2) |
|---------------------------------------|----------|----------|----------|-----------|
| Norm ($\mu V/(V/m)^2$) ^A | 1.29 | 1.19 | 1.23 | ± 10.1 % |
| DCP (mV) ^B | 104.5 | 107.0 | 103.0 | |

Modulation Calibration Parameters

| UID | Communication System Name | | A dB | B dB√μV | C | D dB | VR mV | Unc ^E (k=2) |
|-----------|--|---|---------|------------|------|---------|----------|---------------------------|
| 0 | CW | X | 0.0 | 0.0 | 1.0 | 0.00 | 222.4 | ±3.8 % |
| | | Y | 0.0 | 0.0 | 1.0 | | 202.2 | |
| | | Z | 0.0 | 0.0 | 1.0 | | 207.1 | |
| 10010-CAA | SAR Validation (Square, 100ms, 10ms) | X | 5.09 | 65.6 | 14.1 | 10.00 | 44.8 | ±1.9 % |
| | | Y | 1.68 | 57.4 | 9.3 | | 40.7 | |
| | | Z | 4.01 | 62.4 | 13.0 | | 51.1 | |
| 10011-CAB | UMTS-FDD (WCDMA) | X | 3.34 | 67.5 | 18.9 | 2.91 | 131.2 | ±0.5 % |
| | | Y | 3.43 | 67.9 | 18.7 | | 137.1 | |
| | | Z | 3.42 | 67.8 | 19.0 | | 146.0 | |
| 10012-CAA | IEEE 802.11b WiFi 2.4 GHz (DSSS, 1 Mbps) | X | 3.40 | 70.9 | 19.8 | 1.87 | 134.2 | ±0.7 % |
| | | Y | 3.19 | 70.2 | 19.2 | | 137.9 | |
| | | Z | 3.46 | 70.8 | 19.6 | | 149.6 | |
| 10021-DAB | GSM-FDD (TDMA, GMSK) | X | 30.24 | 99.7 | 28.7 | 9.39 | 131.2 | ±1.4 % |
| | | Y | 12.91 | 88.5 | 23.9 | | 147.5 | |
| | | Z | 30.37 | 99.5 | 28.9 | | 128.0 | |
| 10023-DAB | GPRS-FDD (TDMA, GMSK, TN 0) | X | 29.88 | 100.0 | 29.0 | 9.57 | 123.0 | ±1.9 % |
| | | Y | 16.02 | 92.5 | 25.4 | | 140.7 | |
| | | Z | 30.01 | 100.0 | 29.4 | | 125.8 | |
| 10024-DAB | GPRS-FDD (TDMA, GMSK, TN 0-1) | X | 44.57 | 99.7 | 25.9 | 6.56 | 119.6 | ±1.7 % |
| | | Y | 28.97 | 95.3 | 23.2 | | 127.6 | |
| | | Z | 43.72 | 99.8 | 26.3 | | 120.1 | |
| 10027-DAB | GPRS-FDD (TDMA, GMSK, TN 0-1-2) | X | 53.52 | 99.7 | 24.4 | 4.80 | 129.4 | ±2.2 % |
| | | Y | 54.55 | 99.9 | 22.9 | | 143.3 | |
| | | Z | 51.63 | 99.7 | 24.8 | | 127.5 | |
| 10028-DAB | GPRS-FDD (TDMA, GMSK, TN 0-1-2-3) | X | 58.93 | 99.8 | 23.4 | 3.55 | 133.4 | ±2.2 % |
| | | Y | 77.54 | 99.7 | 21.3 | | 125.3 | |
| | | Z | 56.64 | 99.8 | 23.8 | | 130.8 | |
| 10032-CAA | IEEE 802.15.1 Bluetooth (GFSK, DH5) | X | 47.03 | 99.5 | 21.3 | 1.16 | 136.3 | ±1.7 % |
| | | Y | 95.86 | 95.2 | 17.1 | | 138.2 | |
| | | Z | 39.68 | 100.0 | 22.2 | | 132.3 | |
| 10039-CAB | CDMA2000 (1xRTT, RC1) | X | 4.84 | 66.8 | 19.1 | 4.57 | 131.3 | ±0.9 % |
| | | Y | 4.75 | 67.0 | 18.9 | | 135.2 | |
| | | Z | 4.86 | 66.7 | 19.0 | | 127.2 | |

| | | | | | | | | |
|-----------|---|---|-------|------|------|------|-------|--------|
| 10081-CAB | CDMA2000 (1xRTT, RC3) | X | 4.06 | 66.8 | 19.0 | 3.97 | 148.4 | ±0.7 % |
| | | Y | 3.96 | 66.6 | 18.6 | | 134.7 | |
| | | Z | 4.13 | 66.9 | 19.1 | | 143.4 | |
| 10098-CAB | UMTS-FDD (HSUPA, Subtest 2) | X | 4.63 | 66.8 | 18.7 | 3.98 | 137.3 | ±0.7 % |
| | | Y | 4.75 | 67.5 | 18.8 | | 148.4 | |
| | | Z | 4.65 | 66.7 | 18.7 | | 133.2 | |
| 10100-CAB | LTE-FDD (SC-FDMA, 100% RB, 20 MHz, QPSK) | X | 6.66 | 68.5 | 20.3 | 5.67 | 144.0 | ±1.2 % |
| | | Y | 6.27 | 67.1 | 19.3 | | 130.6 | |
| | | Z | 6.62 | 68.2 | 20.1 | | 140.5 | |
| 10108-CAB | LTE-FDD (SC-FDMA, 100% RB, 10 MHz, QPSK) | X | 6.53 | 68.0 | 20.2 | 5.80 | 142.6 | ±1.4 % |
| | | Y | 6.17 | 66.8 | 19.3 | | 129.2 | |
| | | Z | 6.52 | 67.8 | 20.1 | | 139.0 | |
| 10110-CAB | LTE-FDD (SC-FDMA, 100% RB, 5 MHz, QPSK) | X | 6.19 | 67.3 | 19.9 | 5.75 | 137.9 | ±1.4 % |
| | | Y | 6.12 | 67.3 | 19.6 | | 149.5 | |
| | | Z | 6.19 | 67.1 | 19.8 | | 136.1 | |
| 10114-CAA | IEEE 802.11n (HT Greenfield, 13.5 Mbps, BPSK) | X | 10.49 | 69.5 | 21.7 | 8.10 | 132.4 | ±2.5 % |
| | | Y | 10.23 | 69.1 | 21.3 | | 144.3 | |
| | | Z | 10.45 | 69.3 | 21.6 | | 129.5 | |
| 10117-CAA | IEEE 802.11n (HT Mixed, 13.5 Mbps, BPSK) | X | 10.46 | 69.5 | 21.7 | 8.07 | 133.9 | ±2.5 % |
| | | Y | 10.26 | 69.2 | 21.3 | | 147.4 | |
| | | Z | 10.47 | 69.4 | 21.7 | | 130.5 | |
| 10151-CAB | LTE-TDD (SC-FDMA, 50% RB, 20 MHz, QPSK) | X | 11.61 | 77.4 | 26.8 | 9.28 | 118.8 | ±3.0 % |
| | | Y | 9.89 | 75.2 | 25.7 | | 144.9 | |
| | | Z | 12.01 | 77.8 | 26.9 | | 119.6 | |
| 10154-CAB | LTE-FDD (SC-FDMA, 50% RB, 10 MHz, QPSK) | X | 6.20 | 67.3 | 19.9 | 5.75 | 139.2 | ±1.2 % |
| | | Y | 5.86 | 66.2 | 19.0 | | 128.5 | |
| | | Z | 6.22 | 67.3 | 19.9 | | 136.3 | |
| 10160-CAB | LTE-FDD (SC-FDMA, 50% RB, 15 MHz, QPSK) | X | 6.63 | 67.8 | 20.1 | 5.82 | 144.1 | ±1.4 % |
| | | Y | 6.31 | 66.8 | 19.3 | | 133.1 | |
| | | Z | 6.66 | 67.7 | 20.0 | | 140.9 | |
| 10169-CAB | LTE-FDD (SC-FDMA, 1 RB, 20 MHz, QPSK) | X | 5.25 | 67.5 | 20.2 | 5.73 | 143.6 | ±1.2 % |
| | | Y | 4.92 | 66.7 | 19.5 | | 131.0 | |
| | | Z | 5.29 | 67.4 | 20.2 | | 140.7 | |
| 10172-CAB | LTE-TDD (SC-FDMA, 1 RB, 20 MHz, QPSK) | X | 13.49 | 87.5 | 31.6 | 9.21 | 139.0 | ±2.7 % |
| | | Y | 7.83 | 75.5 | 26.0 | | 124.9 | |
| | | Z | 13.47 | 86.5 | 31.1 | | 137.8 | |
| 10175-CAB | LTE-FDD (SC-FDMA, 1 RB, 10 MHz, QPSK) | X | 5.22 | 67.4 | 20.1 | 5.72 | 144.3 | ±1.4 % |
| | | Y | 5.08 | 67.5 | 19.9 | | 147.9 | |
| | | Z | 5.26 | 67.2 | 20.0 | | 139.6 | |
| 10181-CAB | LTE-FDD (SC-FDMA, 1 RB, 15 MHz, QPSK) | X | 5.24 | 67.5 | 20.1 | 5.72 | 144.5 | ±1.2 % |
| | | Y | 5.06 | 67.4 | 19.8 | | 147.0 | |
| | | Z | 5.29 | 67.3 | 20.1 | | 139.2 | |

| | | | | | | | | |
|-----------|--|---|-------|------|------|------|-------|--------|
| 10193-CAA | IEEE 802.11n (HT Greenfield, 6.5 Mbps, BPSK) | X | 10.12 | 69.1 | 21.6 | 8.09 | 128.8 | ±2.2 % |
| | | Y | 9.76 | 68.4 | 21.0 | | 132.8 | |
| | | Z | 10.08 | 68.9 | 21.5 | | 123.4 | |
| 10196-CAA | IEEE 802.11n (HT Mixed, 6.5 Mbps, BPSK) | X | 10.15 | 69.2 | 21.7 | 8.10 | 130.2 | ±2.2 % |
| | | Y | 9.77 | 68.5 | 21.0 | | 134.1 | |
| | | Z | 10.10 | 69.0 | 21.5 | | 124.0 | |
| 10219-CAA | IEEE 802.11n (HT Mixed, 7.2 Mbps, BPSK) | X | 10.02 | 69.0 | 21.5 | 8.03 | 128.7 | ±2.2 % |
| | | Y | 9.67 | 68.5 | 21.0 | | 133.3 | |
| | | Z | 10.02 | 68.9 | 21.5 | | 123.9 | |
| 10222-CAA | IEEE 802.11n (HT Mixed, 15 Mbps, BPSK) | X | 10.46 | 69.6 | 21.7 | 8.06 | 134.0 | ±2.2 % |
| | | Y | 10.09 | 68.8 | 21.1 | | 139.7 | |
| | | Z | 10.40 | 69.3 | 21.6 | | 128.7 | |
| 10225-CAB | UMTS-FDD (HSPA+) | X | 7.09 | 67.1 | 19.6 | 5.97 | 131.2 | ±1.4 % |
| | | Y | 6.98 | 67.2 | 19.4 | | 138.0 | |
| | | Z | 7.06 | 66.8 | 19.4 | | 127.2 | |
| 10237-CAB | LTE-TDD (SC-FDMA, 1 RB, 10 MHz, QPSK) | X | 13.63 | 87.8 | 31.7 | 9.21 | 141.6 | ±3.0 % |
| | | Y | 7.85 | 75.5 | 26.0 | | 126.5 | |
| | | Z | 13.99 | 87.7 | 31.6 | | 141.4 | |
| 10252-CAB | LTE-TDD (SC-FDMA, 50% RB, 10 MHz, QPSK) | X | 12.86 | 81.4 | 28.9 | 9.24 | 142.1 | ±3.0 % |
| | | Y | 8.91 | 73.4 | 24.8 | | 129.9 | |
| | | Z | 13.15 | 81.4 | 28.8 | | 142.0 | |
| 10267-CAB | LTE-TDD (SC-FDMA, 100% RB, 10 MHz, QPSK) | X | 11.63 | 77.5 | 26.8 | 9.30 | 118.7 | ±3.0 % |
| | | Y | 9.62 | 74.3 | 25.2 | | 138.4 | |
| | | Z | 11.96 | 77.7 | 26.9 | | 119.3 | |
| 10274-CAB | UMTS-FDD (HSUPA, Subtest 5, 3GPP Rel8.10) | X | 6.14 | 67.4 | 19.3 | 4.87 | 149.9 | ±0.9 % |
| | | Y | 5.90 | 66.9 | 18.7 | | 132.8 | |
| | | Z | 6.20 | 67.5 | 19.3 | | 146.6 | |
| 10275-CAB | UMTS-FDD (HSUPA, Subtest 5, 3GPP Rel8.4) | X | 4.45 | 66.9 | 18.9 | 3.96 | 130.1 | ±0.7 % |
| | | Y | 4.50 | 67.2 | 18.8 | | 137.9 | |
| | | Z | 4.64 | 67.6 | 19.3 | | 149.2 | |
| 10291-AAB | CDMA2000, RC3, SO55, Full Rate | X | 3.79 | 67.5 | 19.2 | 3.46 | 145.3 | ±0.7 % |
| | | Y | 3.74 | 67.5 | 18.9 | | 128.2 | |
| | | Z | 3.78 | 67.3 | 19.1 | | 139.1 | |
| 10292-AAB | CDMA2000, RC3, SO32, Full Rate | X | 3.77 | 67.8 | 19.3 | 3.39 | 147.0 | ±0.5 % |
| | | Y | 3.69 | 67.7 | 18.9 | | 130.1 | |
| | | Z | 3.73 | 67.3 | 19.0 | | 141.3 | |
| 10297-AAA | LTE-FDD (SC-FDMA, 50% RB, 20 MHz, QPSK) | X | 6.52 | 67.9 | 20.1 | 5.81 | 141.4 | ±1.4 % |
| | | Y | 6.41 | 67.6 | 19.7 | | 147.4 | |
| | | Z | 6.51 | 67.7 | 20.1 | | 135.4 | |
| 10311-AAA | LTE-FDD (SC-FDMA, 100% RB, 15 MHz, QPSK) | X | 7.17 | 68.7 | 20.7 | 6.06 | 147.7 | ±1.4 % |
| | | Y | 6.69 | 67.2 | 19.6 | | 128.6 | |
| | | Z | 7.12 | 68.4 | 20.5 | | 142.0 | |

| | | | | | | | | |
|-----------|---|---|------|------|------|------|-------|--------|
| 10315-AAA | IEEE 802.11b WiFi 2.4 GHz (DSSS, 1 Mbps, 96pc duty cycle) | X | 3.04 | 70.0 | 19.6 | 1.71 | 129.8 | ±0.5 % |
| | | Y | 3.25 | 71.3 | 19.7 | | 136.9 | |
| | | Z | 3.09 | 69.9 | 19.5 | | 148.7 | |
| 10403-AAB | CDMA2000 (1xEV-DO, Rev. 0) | X | 4.73 | 67.3 | 18.6 | 3.76 | 135.7 | ±0.5 % |
| | | Y | 4.93 | 69.1 | 19.0 | | 141.5 | |
| | | Z | 4.73 | 67.1 | 18.4 | | 132.7 | |
| 10404-AAB | CDMA2000 (1xEV-DO, Rev. A) | X | 4.67 | 67.5 | 18.6 | 3.77 | 134.0 | ±0.5 % |
| | | Y | 4.92 | 69.4 | 19.1 | | 139.8 | |
| | | Z | 4.65 | 67.1 | 18.5 | | 130.7 | |

The reported uncertainty of measurement is stated as the standard uncertainty of measurement multiplied by the coverage factor k=2, which for a normal distribution corresponds to a coverage probability of approximately 95%.

^A The uncertainties of NormX,Y,Z do not affect the E²-field uncertainty inside TSL (see Pages 8 and 9).
^B Numerical linearization parameter: uncertainty not required.
^E Uncertainty is determined using the max. deviation from linear response applying rectangular distribution and is expressed for the square of the field value.

DASY/EASY - Parameters of Probe: ES3DV3 - SN:3258

Calibration Parameter Determined in Head Tissue Simulating Media

| f (MHz) ^C | Relative Permittivity ^F | Conductivity (S/m) ^F | ConvF X | ConvF Y | ConvF Z | Alpha ^G | Depth ^G (mm) | Unct. (k=2) |
|----------------------|------------------------------------|---------------------------------|---------|---------|---------|--------------------|-------------------------|-------------|
| 750 | 41.9 | 0.89 | 6.53 | 6.53 | 6.53 | 0.40 | 1.60 | ± 12.0 % |
| 835 | 41.5 | 0.90 | 6.27 | 6.27 | 6.27 | 0.80 | 1.17 | ± 12.0 % |
| 1750 | 40.1 | 1.37 | 5.19 | 5.19 | 5.19 | 0.80 | 1.10 | ± 12.0 % |
| 1900 | 40.0 | 1.40 | 5.04 | 5.04 | 5.04 | 0.68 | 1.27 | ± 12.0 % |
| 2450 | 39.2 | 1.80 | 4.52 | 4.52 | 4.52 | 0.78 | 1.23 | ± 12.0 % |
| 2600 | 39.0 | 1.96 | 4.34 | 4.34 | 4.34 | 0.76 | 1.33 | ± 12.0 % |

^C Frequency validity of ± 100 MHz only applies for DASY v4.4 and higher (see Page 2), else it is restricted to ± 50 MHz. The uncertainty is the RSS of the ConvF uncertainty at calibration frequency and the uncertainty for the indicated frequency band.

^F At frequencies below 3 GHz, the validity of tissue parameters (ϵ and σ) can be relaxed to ± 10% if liquid compensation formula is applied to measured SAR values. At frequencies above 3 GHz, the validity of tissue parameters (ϵ and σ) is restricted to ± 5%. The uncertainty is the RSS of the ConvF uncertainty for indicated target tissue parameters.

^G Alpha/Depth are determined during calibration. SPEAG warrants that the remaining deviation due to the boundary effect after compensation is always less than ± 1% for frequencies below 3 GHz and below ± 2% for frequencies between 3-6 GHz at any distance larger than half the probe tip diameter from the boundary.

DASY/EASY - Parameters of Probe: ES3DV3 - SN:3258

Calibration Parameter Determined in Body Tissue Simulating Media

| f (MHz) ^c | Relative Permittivity ^F | Conductivity (S/m) ^F | ConvF X | ConvF Y | ConvF Z | Alpha ^G | Depth ^G (mm) | Unct. (k=2) |
|----------------------|------------------------------------|---------------------------------|---------|---------|---------|--------------------|-------------------------|-------------|
| 750 | 55.5 | 0.96 | 6.15 | 6.15 | 6.15 | 0.61 | 1.32 | ± 12.0 % |
| 835 | 55.2 | 0.97 | 6.11 | 6.11 | 6.11 | 0.80 | 1.15 | ± 12.0 % |
| 1750 | 53.4 | 1.49 | 4.83 | 4.83 | 4.83 | 0.47 | 1.74 | ± 12.0 % |
| 1900 | 53.3 | 1.52 | 4.61 | 4.61 | 4.61 | 0.55 | 1.59 | ± 12.0 % |
| 2450 | 52.7 | 1.95 | 4.14 | 4.14 | 4.14 | 0.80 | 1.11 | ± 12.0 % |
| 2600 | 52.5 | 2.16 | 3.91 | 3.91 | 3.91 | 0.80 | 1.00 | ± 12.0 % |

^c Frequency validity of ± 100 MHz only applies for DASY v4.4 and higher (see Page 2), else it is restricted to ± 50 MHz. The uncertainty is the RSS of the ConvF uncertainty at calibration frequency and the uncertainty for the indicated frequency band.

^F At frequencies below 3 GHz, the validity of tissue parameters (ϵ and σ) can be relaxed to ± 10% if liquid compensation formula is applied to measured SAR values. At frequencies above 3 GHz, the validity of tissue parameters (ϵ and σ) is restricted to ± 5%. The uncertainty is the RSS of the ConvF uncertainty for indicated target tissue parameters.

^G Alpha/Depth are determined during calibration. SPEAG warrants that the remaining deviation due to the boundary effect after compensation is always less than ± 1% for frequencies below 3 GHz and below ± 2% for frequencies between 3-6 GHz at any distance larger than half the probe tip diameter from the boundary.

Frequency Response of E-Field (TEM-Cell: ifi110 EXX, Waveguide: R22)

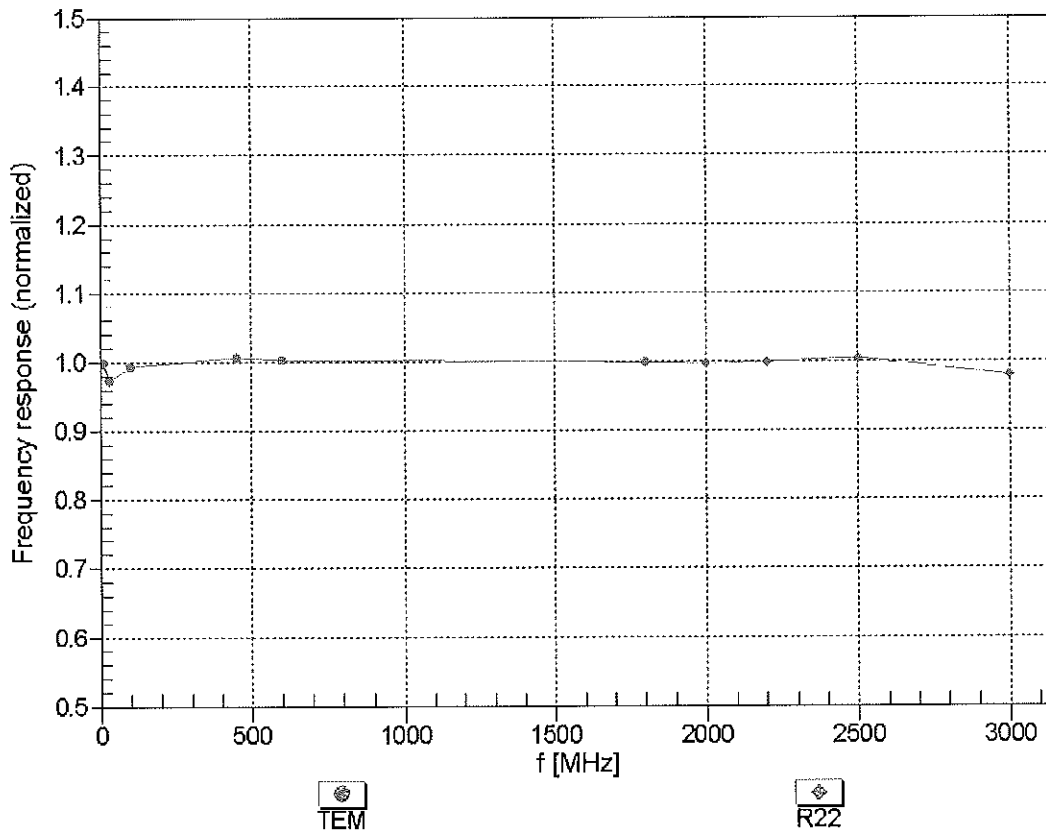

Uncertainty of Frequency Response of E-field: $\pm 6.3\%$ (k=2)

Receiving Pattern (ϕ), $\theta = 0^\circ$

f=600 MHz,TEM

f=1800 MHz,R22

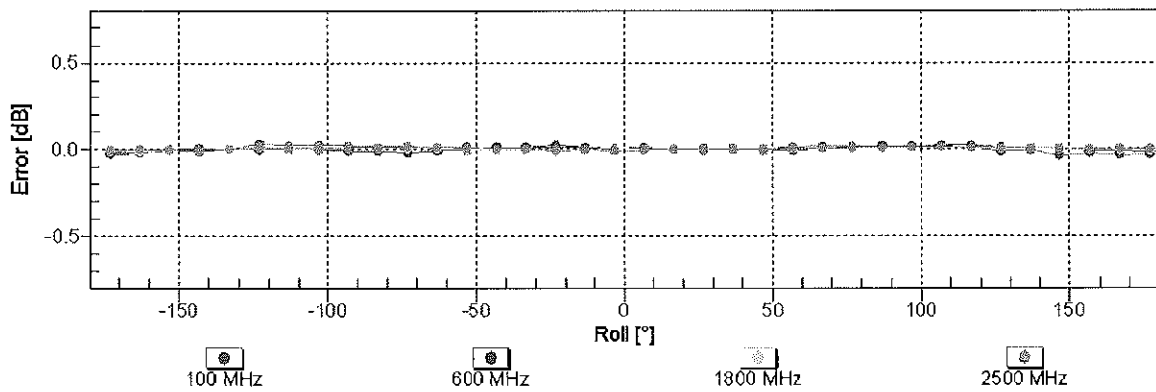
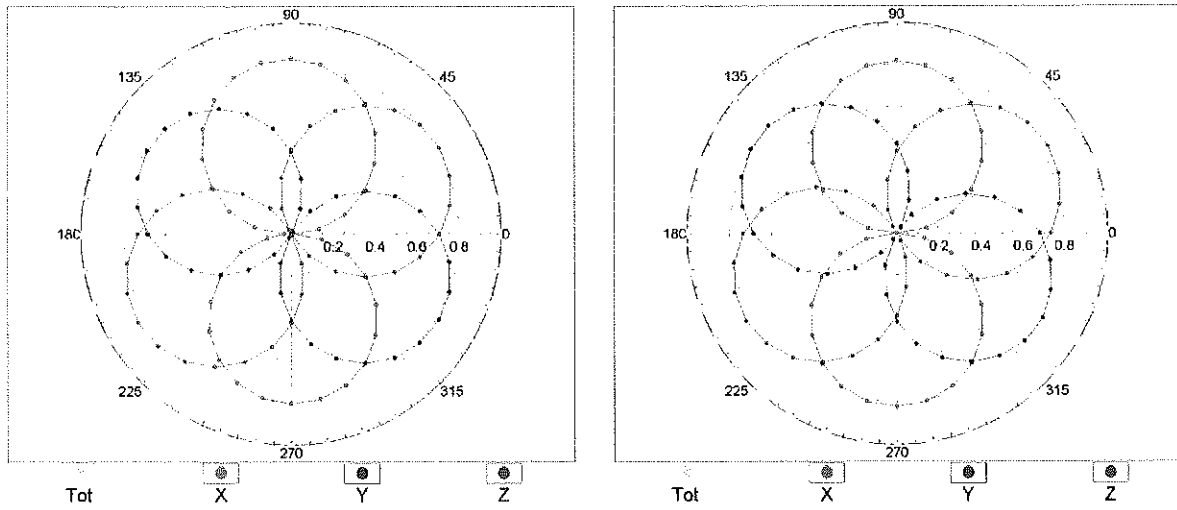

Uncertainty of Axial Isotropy Assessment: $\pm 0.5\%$ ($k=2$)

Dynamic Range f(SAR_{head}) (TEM cell , f_{eval}= 1900 MHz)

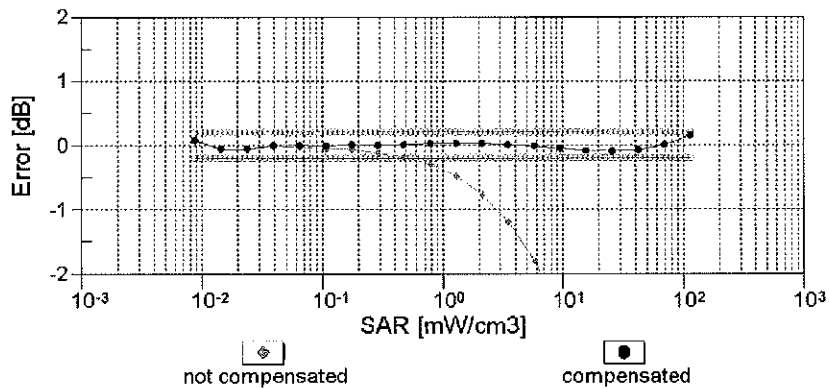
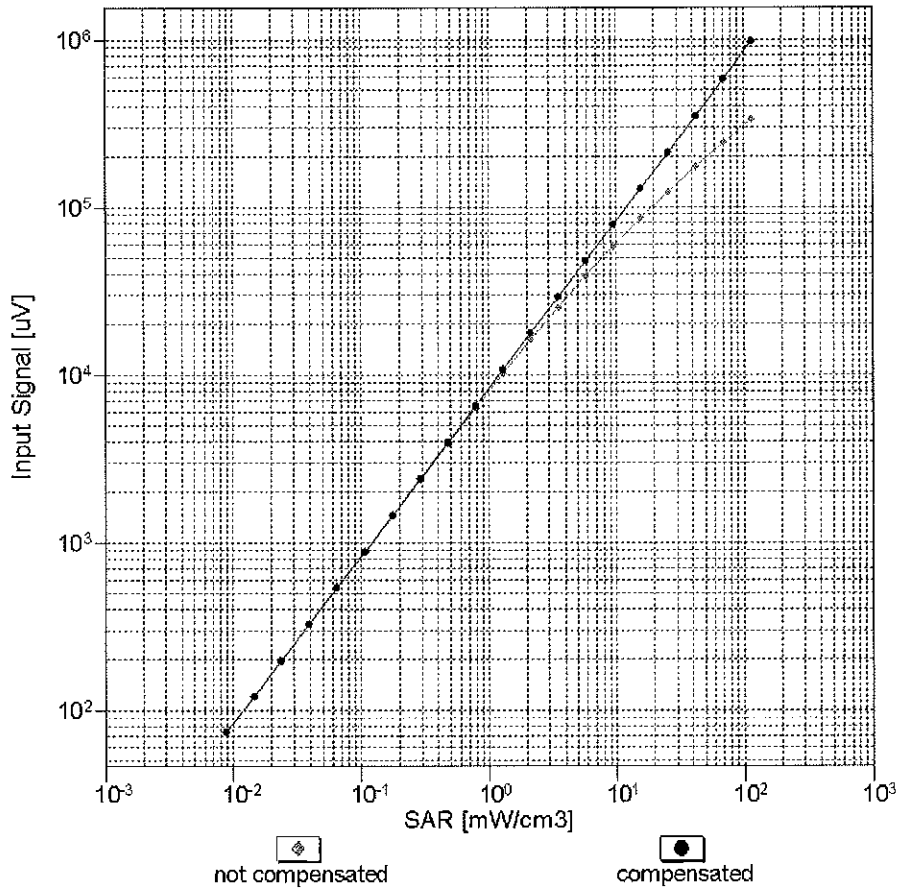

Uncertainty of Linearity Assessment: ± 0.6% (k=2)

Conversion Factor Assessment

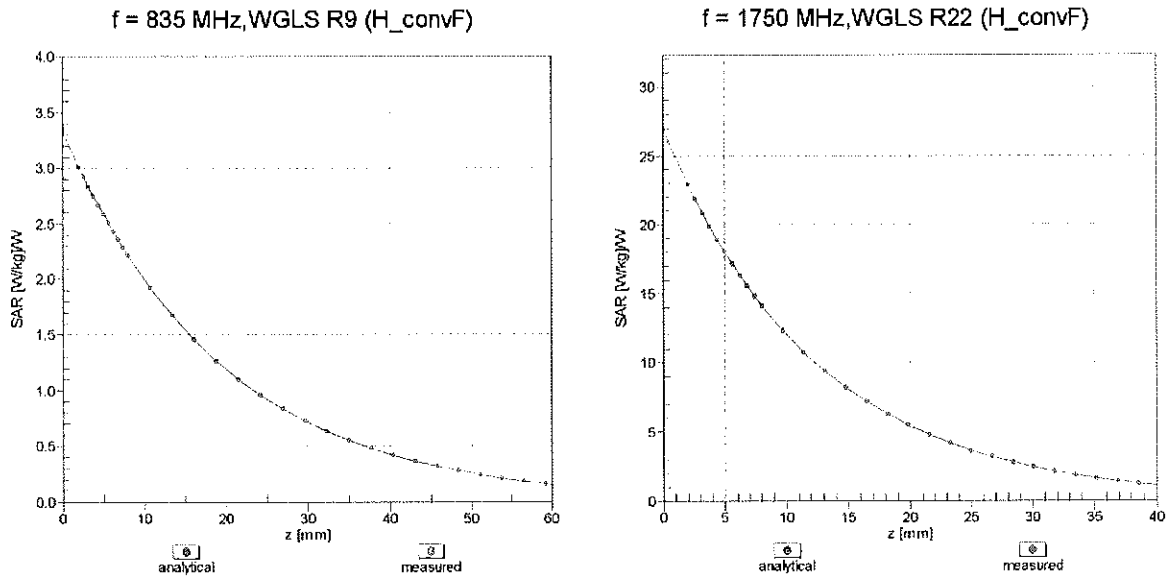

Deviation from Isotropy in Liquid Error (ϕ, ϑ), f = 900 MHz

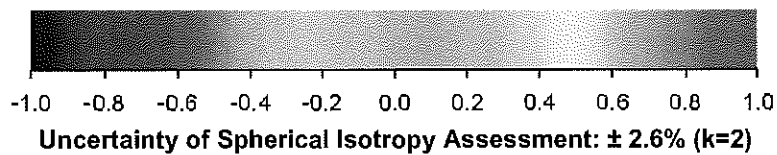
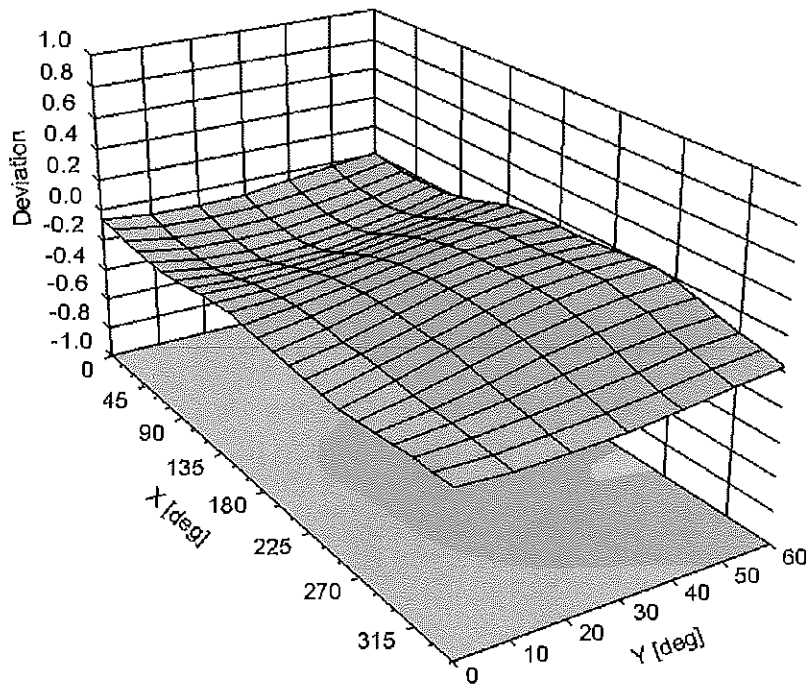

DASY/EASY - Parameters of Probe: ES3DV3 - SN:3258

Other Probe Parameters

| | |
|---|------------|
| Sensor Arrangement | Triangular |
| Connector Angle (°) | -123.1 |
| Mechanical Surface Detection Mode | enabled |
| Optical Surface Detection Mode | disabled |
| Probe Overall Length | 337 mm |
| Probe Body Diameter | 10 mm |
| Tip Length | 10 mm |
| Tip Diameter | 4 mm |
| Probe Tip to Sensor X Calibration Point | 2 mm |
| Probe Tip to Sensor Y Calibration Point | 2 mm |
| Probe Tip to Sensor Z Calibration Point | 2 mm |
| Recommended Measurement Distance from Surface | 3 mm |

Calibration Laboratory of
Schmid & Partner
Engineering AG
Zeughausstrasse 43, 8004 Zurich, Switzerland



S Schweizerischer Kalibrierdienst
S Service suisse d'étalonnage
C Servizio svizzero di taratura
S Swiss Calibration Service

Accredited by the Swiss Accreditation Service (SAS)
The Swiss Accreditation Service is one of the signatories to the EA
Multilateral Agreement for the recognition of calibration certificates

Accreditation No.: **SCS 108**

Client **PC Test**

Certificate No: **ES3-3334_Dec14**

CALIBRATION CERTIFICATE

Object **ES3DV3 - SN:3334**

Calibration procedure(s) **QA CAL-01.v9, QA CAL-23.v5, QA CAL-25.v6**
Calibration procedure for dosimetric E-field probes

CC
12/31/14

Calibration date: **December 16, 2014**

This calibration certificate documents the traceability to national standards, which realize the physical units of measurements (SI).
The measurements and the uncertainties with confidence probability are given on the following pages and are part of the certificate.

All calibrations have been conducted in the closed laboratory facility: environment temperature (22 ± 3)°C and humidity < 70%.

Calibration Equipment used (M&TE critical for calibration)

| Primary Standards | ID | Cal Date (Certificate No.) | Scheduled Calibration |
|----------------------------|-----------------|-----------------------------------|------------------------|
| Power meter E4419B | GB41293874 | 03-Apr-14 (No. 217-01911) | Apr-15 |
| Power sensor E4412A | MY41498087 | 03-Apr-14 (No. 217-01911) | Apr-15 |
| Reference 3 dB Attenuator | SN: S5054 (3c) | 03-Apr-14 (No. 217-01915) | Apr-15 |
| Reference 20 dB Attenuator | SN: S5277 (20x) | 03-Apr-14 (No. 217-01919) | Apr-15 |
| Reference 30 dB Attenuator | SN: S5129 (30b) | 03-Apr-14 (No. 217-01920) | Apr-15 |
| Reference Probe ES3DV2 | SN: 3013 | 30-Dec-13 (No. ES3-3013_Dec13) | Dec-14 |
| DAE4 | SN: 789 | 30-Apr-14 (No. DAE4-789_Apr14) | Apr-15 |
| Secondary Standards | ID | Check Date (in house) | Scheduled Check |
| RF generator HP 8648C | US3642U01700 | 4-Aug-99 (in house check Apr-13) | In house check: Apr-16 |
| Network Analyzer HP 8753E | US37390585 | 18-Oct-01 (in house check Oct-14) | In house check: Oct-15 |

| | Name | Function | Signature |
|---|---------------|-----------------------|---------------------------|
| Calibrated by: | Leif Klysner | Laboratory Technician | |
| Approved by: | Katja Pokovic | Technical Manager | |
| | | | Issued: December 16, 2014 |
| This calibration certificate shall not be reproduced except in full without written approval of the laboratory. | | | |



Accredited by the Swiss Accreditation Service (SAS)
The Swiss Accreditation Service is one of the signatories to the EA
Multilateral Agreement for the recognition of calibration certificates

Accreditation No.: **SCS 108**

Glossary:

| | |
|--------------------------|---|
| TSL | tissue simulating liquid |
| NORM _{x,y,z} | sensitivity in free space |
| ConvF | sensitivity in TSL / NORM _{x,y,z} |
| DCP | diode compression point |
| CF | crest factor (1/duty_cycle) of the RF signal |
| A, B, C, D | modulation dependent linearization parameters |
| Polarization ϕ | ϕ rotation around probe axis |
| Polarization ϑ | ϑ rotation around an axis that is in the plane normal to probe axis (at measurement center), i.e., $\vartheta = 0$ is normal to probe axis |
| Connector Angle | Information used in DASY system to align probe sensor X to the robot coordinate system |

Calibration is Performed According to the Following Standards:

- a) IEEE Std 1528-2013, "IEEE Recommended Practice for Determining the Peak Spatial-Averaged Specific Absorption Rate (SAR) in the Human Head from Wireless Communications Devices: Measurement Techniques", June 2013
- b) IEC 62209-1, "Procedure to measure the Specific Absorption Rate (SAR) for hand-held devices used in close proximity to the ear (frequency range of 300 MHz to 3 GHz)", February 2005

Methods Applied and Interpretation of Parameters:

- **NORM_{x,y,z}:** Assessed for E-field polarization $\vartheta = 0$ ($f \leq 900$ MHz in TEM-cell; $f > 1800$ MHz: R22 waveguide). NORM_{x,y,z} are only intermediate values, i.e., the uncertainties of NORM_{x,y,z} does not affect the E²-field uncertainty inside TSL (see below ConvF).
- **NORM(f)_{x,y,z} = NORM_{x,y,z} * frequency_response** (see Frequency Response Chart). This linearization is implemented in DASY4 software versions later than 4.2. The uncertainty of the frequency response is included in the stated uncertainty of ConvF.
- **DCP_{x,y,z}:** DCP are numerical linearization parameters assessed based on the data of power sweep with CW signal (no uncertainty required). DCP does not depend on frequency nor media.
- **PAR:** PAR is the Peak to Average Ratio that is not calibrated but determined based on the signal characteristics
- **A_{x,y,z}; B_{x,y,z}; C_{x,y,z}; D_{x,y,z}; VR_{x,y,z}:** A, B, C, D are numerical linearization parameters assessed based on the data of power sweep for specific modulation signal. The parameters do not depend on frequency nor media. VR is the maximum calibration range expressed in RMS voltage across the diode.
- **ConvF and Boundary Effect Parameters:** Assessed in flat phantom using E-field (or Temperature Transfer Standard for $f \leq 800$ MHz) and inside waveguide using analytical field distributions based on power measurements for $f > 800$ MHz. The same setups are used for assessment of the parameters applied for boundary compensation (alpha, depth) of which typical uncertainty values are given. These parameters are used in DASY4 software to improve probe accuracy close to the boundary. The sensitivity in TSL corresponds to NORM_{x,y,z} * ConvF whereby the uncertainty corresponds to that given for ConvF. A frequency dependent ConvF is used in DASY version 4.4 and higher which allows extending the validity from ± 50 MHz to ± 100 MHz.
- **Spherical Isotropy (3D deviation from isotropy):** in a field of low gradients realized using a flat phantom exposed by a patch antenna.
- **Sensor Offset:** The sensor offset corresponds to the offset of virtual measurement center from the probe tip (on probe axis). No tolerance required.
- **Connector Angle:** The angle is assessed using the information gained by determining the NORM_x (no uncertainty required).

Probe ES3DV3

SN:3334

| | |
|---------------|-------------------|
| Manufactured: | January 24, 2012 |
| Repaired: | December 9, 2014 |
| Calibrated: | December 16, 2014 |

Calibrated for DASY/EASY Systems
(Note: non-compatible with DASY2 system!)

DASY/EASY - Parameters of Probe: ES3DV3 - SN:3334

Basic Calibration Parameters

| | Sensor X | Sensor Y | Sensor Z | Unc (k=2) |
|---|----------|----------|----------|---------------|
| Norm ($\mu\text{V}/(\text{V}/\text{m})^2$) ^A | 1.04 | 1.05 | 1.01 | $\pm 10.1 \%$ |
| DCP (mV) ^B | 106.5 | 105.0 | 105.6 | |

Modulation Calibration Parameters

| UID | Communication System Name | | A dB | B dB $\sqrt{\mu\text{V}}$ | C | D dB | VR mV | Unc ^F (k=2) |
|-----------|---|---|---------|------------------------------|------|---------|----------|---------------------------|
| 0 | CW | X | 0.0 | 0.0 | 1.0 | 0.00 | 188.0 | $\pm 3.0 \%$ |
| | | Y | 0.0 | 0.0 | 1.0 | | 183.2 | |
| | | Z | 0.0 | 0.0 | 1.0 | | 181.8 | |
| 10010-CAA | SAR Validation (Square, 100ms, 10ms) | X | 4.61 | 67.2 | 13.7 | 10.00 | 38.4 | $\pm 1.4 \%$ |
| | | Y | 20.36 | 82.7 | 18.7 | | 38.0 | |
| | | Z | 17.55 | 80.3 | 17.6 | | 37.0 | |
| 10011-CAB | UMTS-FDD (WCDMA) | X | 3.56 | 68.4 | 19.1 | 2.91 | 148.4 | $\pm 0.7 \%$ |
| | | Y | 3.44 | 68.1 | 19.2 | | 146.9 | |
| | | Z | 3.52 | 68.3 | 19.1 | | 144.7 | |
| 10012-CAB | IEEE 802.11b WIFI 2.4 GHz (DSSS, 1 Mbps) | X | 3.54 | 71.9 | 20.0 | 1.87 | 148.0 | $\pm 0.7 \%$ |
| | | Y | 3.51 | 72.2 | 20.5 | | 148.9 | |
| | | Z | 3.80 | 73.3 | 20.6 | | 144.6 | |
| 10013-CAB | IEEE 802.11g WIFI 2.4 GHz (DSSS-OFDM, 6 Mbps) | X | 11.39 | 71.1 | 23.3 | 9.46 | 149.8 | $\pm 3.8 \%$ |
| | | Y | 11.54 | 71.8 | 24.0 | | 149.5 | |
| | | Z | 11.11 | 70.5 | 23.0 | | 141.6 | |
| 10021-DAB | GSM-FDD (TDMA, GMSK) | X | 15.29 | 91.3 | 25.0 | 9.39 | 131.9 | $\pm 1.7 \%$ |
| | | Y | 24.16 | 100.0 | 28.4 | | 142.8 | |
| | | Z | 13.05 | 89.2 | 24.5 | | 126.5 | |
| 10023-DAB | GPRS-FDD (TDMA, GMSK, TN 0) | X | 16.07 | 91.7 | 25.1 | 9.57 | 144.0 | $\pm 2.2 \%$ |
| | | Y | 19.00 | 95.3 | 26.8 | | 136.4 | |
| | | Z | 13.93 | 89.8 | 24.6 | | 141.0 | |
| 10024-DAB | GPRS-FDD (TDMA, GMSK, TN 0-1) | X | 19.98 | 91.0 | 22.4 | 6.56 | 134.2 | $\pm 1.9 \%$ |
| | | Y | 34.78 | 99.7 | 25.5 | | 145.0 | |
| | | Z | 29.89 | 96.8 | 24.1 | | 129.8 | |
| 10027-DAB | GPRS-FDD (TDMA, GMSK, TN 0-1-2) | X | 56.30 | 99.7 | 22.8 | 4.80 | 125.2 | $\pm 1.9 \%$ |
| | | Y | 41.16 | 99.6 | 23.9 | | 131.2 | |
| | | Z | 50.78 | 99.8 | 23.1 | | 147.6 | |
| 10028-DAB | GPRS-FDD (TDMA, GMSK, TN 0-1-2-3) | X | 49.35 | 99.7 | 22.5 | 3.55 | 133.2 | $\pm 2.2 \%$ |
| | | Y | 46.49 | 99.6 | 22.9 | | 139.2 | |
| | | Z | 58.21 | 99.7 | 22.0 | | 129.4 | |
| 10032-CAA | IEEE 802.15.1 Bluetooth (GFSK, DH5) | X | 56.54 | 100.0 | 20.2 | 1.16 | 128.0 | $\pm 1.7 \%$ |
| | | Y | 20.03 | 99.3 | 22.4 | | 130.3 | |
| | | Z | 84.01 | 100.0 | 19.4 | | 141.0 | |
| 10100-CAB | LTE-FDD (SC-FDMA, 100% RB, 20 MHz, QPSK) | X | 6.44 | 67.6 | 19.6 | 5.67 | 138.5 | $\pm 1.4 \%$ |
| | | Y | 6.50 | 67.9 | 20.0 | | 142.1 | |
| | | Z | 6.31 | 67.2 | 19.4 | | 129.4 | |

| | | | | | | | | |
|-----------|--|---|-------|------|------|------|-------|--------|
| 10103-CAB | LTE-TDD (SC-FDMA, 100% RB, 20 MHz, QPSK) | X | 9.77 | 73.6 | 24.6 | 9.29 | 129.6 | ±3.3 % |
| | | Y | 10.52 | 76.0 | 26.3 | | 132.1 | |
| | | Z | 10.21 | 75.0 | 25.4 | | 147.7 | |
| 10108-CAC | LTE-FDD (SC-FDMA, 100% RB, 10 MHz, QPSK) | X | 6.36 | 67.2 | 19.6 | 5.80 | 136.8 | ±1.4 % |
| | | Y | 6.31 | 67.3 | 19.8 | | 137.2 | |
| | | Z | 6.20 | 66.7 | 19.3 | | 128.8 | |
| 10117-CAB | IEEE 802.11n (HT Mixed, 13.5 Mbps, BPSK) | X | 9.96 | 68.3 | 20.8 | 8.07 | 126.5 | ±2.5 % |
| | | Y | 10.12 | 68.8 | 21.3 | | 126.6 | |
| | | Z | 10.22 | 69.0 | 21.2 | | 143.7 | |
| 10151-CAB | LTE-TDD (SC-FDMA, 50% RB, 20 MHz, QPSK) | X | 9.29 | 73.0 | 24.4 | 9.28 | 125.3 | ±3.3 % |
| | | Y | 9.65 | 74.5 | 25.6 | | 124.4 | |
| | | Z | 9.65 | 74.3 | 25.2 | | 141.1 | |
| 10154-CAC | LTE-FDD (SC-FDMA, 50% RB, 10 MHz, QPSK) | X | 6.03 | 66.7 | 19.3 | 5.75 | 132.7 | ±1.4 % |
| | | Y | 5.97 | 66.7 | 19.5 | | 132.7 | |
| | | Z | 6.17 | 67.3 | 19.7 | | 148.3 | |
| 10160-CAB | LTE-FDD (SC-FDMA, 50% RB, 15 MHz, QPSK) | X | 6.47 | 67.2 | 19.5 | 5.82 | 138.1 | ±1.4 % |
| | | Y | 6.44 | 67.3 | 19.8 | | 138.2 | |
| | | Z | 6.27 | 66.6 | 19.2 | | 126.8 | |
| 10169-CAB | LTE-FDD (SC-FDMA, 1 RB, 20 MHz, QPSK) | X | 5.03 | 66.9 | 19.6 | 5.73 | 137.2 | ±1.2 % |
| | | Y | 4.97 | 67.0 | 19.9 | | 135.7 | |
| | | Z | 4.91 | 66.5 | 19.5 | | 127.1 | |
| 10172-CAB | LTE-TDD (SC-FDMA, 1 RB, 20 MHz, QPSK) | X | 8.53 | 77.4 | 26.9 | 9.21 | 142.4 | ±2.7 % |
| | | Y | 9.59 | 81.3 | 29.3 | | 142.3 | |
| | | Z | 7.78 | 75.0 | 25.7 | | 126.7 | |
| 10175-CAC | LTE-FDD (SC-FDMA, 1 RB, 10 MHz, QPSK) | X | 5.02 | 67.0 | 19.7 | 5.72 | 131.8 | ±1.2 % |
| | | Y | 4.98 | 67.0 | 19.9 | | 136.1 | |
| | | Z | 4.95 | 66.8 | 19.6 | | 128.1 | |
| 10181-CAB | LTE-FDD (SC-FDMA, 1 RB, 15 MHz, QPSK) | X | 4.99 | 66.8 | 19.6 | 5.72 | 131.2 | ±1.2 % |
| | | Y | 4.99 | 67.1 | 20.0 | | 136.2 | |
| | | Z | 4.92 | 66.6 | 19.5 | | 127.9 | |
| 10196-CAB | IEEE 802.11n (HT Mixed, 6.5 Mbps, BPSK) | X | 9.98 | 68.8 | 21.2 | 8.10 | 141.7 | ±2.5 % |
| | | Y | 10.14 | 69.5 | 21.8 | | 147.2 | |
| | | Z | 9.85 | 68.6 | 21.1 | | 137.5 | |
| 10225-CAB | UMTS-FDD (HSPA+) | X | 7.17 | 67.5 | 19.6 | 5.97 | 146.0 | ±1.4 % |
| | | Y | 7.13 | 67.7 | 19.9 | | 149.9 | |
| | | Z | 7.12 | 67.5 | 19.6 | | 142.9 | |
| 10237-CAB | LTE-TDD (SC-FDMA, 1 RB, 10 MHz, QPSK) | X | 8.29 | 76.6 | 26.5 | 9.21 | 136.1 | ±2.7 % |
| | | Y | 9.60 | 81.4 | 29.3 | | 142.3 | |
| | | Z | 7.98 | 75.8 | 26.1 | | 132.9 | |
| 10252-CAB | LTE-TDD (SC-FDMA, 50% RB, 10 MHz, QPSK) | X | 9.27 | 74.1 | 25.1 | 9.24 | 139.1 | ±3.3 % |
| | | Y | 10.25 | 77.5 | 27.4 | | 146.3 | |
| | | Z | 9.07 | 73.7 | 25.0 | | 135.8 | |
| 10267-CAB | LTE-TDD (SC-FDMA, 100% RB, 10 MHz, QPSK) | X | 9.95 | 74.9 | 25.4 | 9.30 | 147.0 | ±3.3 % |
| | | Y | 9.80 | 75.0 | 25.9 | | 125.9 | |
| | | Z | 9.74 | 74.6 | 25.4 | | 143.8 | |

| | | | | | | | | |
|-----------|---|---|-------|------|------|------|-------|--------|
| 10275-CAB | UMTS-FDD (HSUPA, Sublest 5, 3GPP Rel8.4) | X | 4.63 | 67.6 | 19.0 | 3.96 | 147.5 | ±0.7 % |
| | | Y | 4.41 | 66.9 | 18.9 | | 129.5 | |
| | | Z | 4.61 | 67.6 | 19.1 | | 148.1 | |
| 10291-AAB | CDMA2000, RC3, SO55, Full Rate | X | 3.83 | 67.7 | 19.0 | 3.46 | 133.7 | ±0.7 % |
| | | Y | 3.71 | 67.4 | 19.0 | | 139.0 | |
| | | Z | 3.86 | 68.1 | 19.2 | | 133.7 | |
| 10292-AAB | CDMA2000, RC3, SO32, Full Rate | X | 3.85 | 68.2 | 19.2 | 3.39 | 136.7 | ±0.5 % |
| | | Y | 3.67 | 67.5 | 19.1 | | 141.3 | |
| | | Z | 3.75 | 67.8 | 19.0 | | 136.2 | |
| 10297-AAA | LTE-FDD (SC-FDMA, 50% RB, 20 MHz, QPSK) | X | 6.31 | 67.1 | 19.5 | 5.81 | 130.6 | ±1.4 % |
| | | Y | 6.32 | 67.3 | 19.8 | | 135.1 | |
| | | Z | 6.24 | 66.9 | 19.4 | | 129.2 | |
| 10311-AAA | LTE-FDD (SC-FDMA, 100% RB, 15 MHz, QPSK) | X | 6.85 | 67.5 | 19.8 | 6.06 | 135.1 | ±1.4 % |
| | | Y | 6.90 | 67.9 | 20.2 | | 141.5 | |
| | | Z | 6.82 | 67.5 | 19.8 | | 135.1 | |
| 10403-AAB | CDMA2000 (1xEV-DO, Rev. 0) | X | 5.04 | 69.1 | 19.1 | 3.76 | 126.0 | ±0.5 % |
| | | Y | 4.90 | 69.0 | 19.3 | | 129.6 | |
| | | Z | 5.11 | 69.7 | 19.4 | | 125.8 | |
| 10404-AAB | CDMA2000 (1xEV-DO, Rev. A) | X | 5.05 | 69.6 | 19.4 | 3.77 | 147.1 | ±0.7 % |
| | | Y | 4.84 | 69.2 | 19.5 | | 127.8 | |
| | | Z | 5.15 | 70.1 | 19.6 | | 143.3 | |
| 10415-AAA | IEEE 802.11b WIFI 2.4 GHz (DSSS, 1 Mbps, 99pc duty cycle) | X | 3.13 | 71.2 | 19.9 | 1.54 | 144.5 | ±0.5 % |
| | | Y | 2.93 | 70.4 | 19.9 | | 149.8 | |
| | | Z | 3.18 | 71.6 | 20.1 | | 141.4 | |
| 10416-AAA | IEEE 802.11g WIFI 2.4 GHz (ERP-OFDM, 6 Mbps, 99pc duty cycle) | X | 10.11 | 69.0 | 21.4 | 8.23 | 144.3 | ±2.5 % |
| | | Y | 10.21 | 69.6 | 21.9 | | 148.3 | |
| | | Z | 9.99 | 68.9 | 21.3 | | 141.1 | |

The reported uncertainty of measurement is stated as the standard uncertainty of measurement multiplied by the coverage factor $k=2$, which for a normal distribution corresponds to a coverage probability of approximately 95%.

^A The uncertainties of NormX,Y,Z do not affect the E^2 -field uncertainty inside TSL. (see Pages 7 and 8).

^B Numerical linearization parameter: uncertainty not required.

^E Uncertainty is determined using the max. deviation from linear response applying rectangular distribution and is expressed for the square of the field value.

DASY/EASY - Parameters of Probe: ES3DV3 - SN:3334

Calibration Parameter Determined in Head Tissue Simulating Media

| f (MHz) ^c | Relative Permittivity ^f | Conductivity (S/m) ^f | ConvF X | ConvF Y | ConvF Z | Alpha ^g | Depth ^g (mm) | Unct. (k=2) |
|----------------------|------------------------------------|---------------------------------|---------|---------|---------|--------------------|-------------------------|-------------|
| 750 | 41.9 | 0.89 | 6.51 | 6.51 | 6.51 | 0.80 | 1.17 | ± 12.0 % |
| 835 | 41.5 | 0.90 | 6.25 | 6.25 | 6.25 | 0.38 | 1.58 | ± 12.0 % |
| 1750 | 40.1 | 1.37 | 5.21 | 5.21 | 5.21 | 0.43 | 1.63 | ± 12.0 % |
| 1900 | 40.0 | 1.40 | 5.03 | 5.03 | 5.03 | 0.53 | 1.45 | ± 12.0 % |
| 2450 | 39.2 | 1.80 | 4.51 | 4.51 | 4.51 | 0.80 | 1.26 | ± 12.0 % |
| 2600 | 39.0 | 1.96 | 4.31 | 4.31 | 4.31 | 0.79 | 1.27 | ± 12.0 % |

^c Frequency validity above 300 MHz of ± 100 MHz only applies for DASY v4.4 and higher (see Page 2), else it is restricted to ± 50 MHz. The uncertainty is the RSS of the ConvF uncertainty at calibration frequency and the uncertainty for the indicated frequency band. Frequency validity below 300 MHz is ± 10, 25, 40, 50 and 70 MHz for ConvF assessments at 30, 64, 128, 150 and 220 MHz respectively. Above 5 GHz frequency validity can be extended to ± 110 MHz.

^f At frequencies below 3 GHz, the validity of tissue parameters (ϵ and σ) can be relaxed to ± 10% if liquid compensation formula is applied to measured SAR values. At frequencies above 3 GHz, the validity of tissue parameters (ϵ and σ) is restricted to ± 5%. The uncertainty is the RSS of the ConvF uncertainty for indicated target tissue parameters.

^g Alpha/Depth are determined during calibration. SPEAG warrants that the remaining deviation due to the boundary effect after compensation is always less than ± 1% for frequencies below 3 GHz and below ± 2% for frequencies between 3-6 GHz at any distance larger than half the probe tip diameter from the boundary.

DASY/EASY - Parameters of Probe: ES3DV3 - SN:3334

Calibration Parameter Determined in Body Tissue Simulating Media

| f (MHz) ^c | Relative Permittivity ^f | Conductivity (S/m) ^f | ConvF X | ConvF Y | ConvF Z | Alpha ^g | Depth ^d (mm) | Unct. (k=2) |
|----------------------|------------------------------------|---------------------------------|---------|---------|---------|--------------------|-------------------------|-------------|
| 750 | 55.5 | 0.96 | 6.09 | 6.09 | 6.09 | 0.49 | 1.47 | ± 12.0 % |
| 835 | 55.2 | 0.97 | 6.14 | 6.14 | 6.14 | 0.69 | 1.27 | ± 12.0 % |
| 1750 | 53.4 | 1.49 | 4.94 | 4.94 | 4.94 | 0.80 | 1.24 | ± 12.0 % |
| 1900 | 53.3 | 1.52 | 4.73 | 4.73 | 4.73 | 0.62 | 1.44 | ± 12.0 % |
| 2450 | 52.7 | 1.95 | 4.28 | 4.28 | 4.28 | 0.80 | 1.13 | ± 12.0 % |
| 2600 | 52.5 | 2.16 | 4.16 | 4.16 | 4.16 | 0.75 | 1.25 | ± 12.0 % |

^c Frequency validity above 300 MHz of ± 100 MHz only applies for DASY v4.4 and higher (see Page 2), else it is restricted to ± 50 MHz. The uncertainty is the RSS of the ConvF uncertainty at calibration frequency and the uncertainty for the indicated frequency band. Frequency validity below 300 MHz is ± 10, 25, 40, 50 and 70 MHz for ConvF assessments at 30, 64, 128, 150 and 220 MHz respectively. Above 5 GHz frequency validity can be extended to ± 110 MHz.

^f At frequencies below 3 GHz, the validity of tissue parameters (ϵ and σ) can be relaxed to ± 10% if liquid compensation formula is applied to measured SAR values. At frequencies above 3 GHz, the validity of tissue parameters (ϵ and σ) is restricted to ± 5%. The uncertainty is the RSS of the ConvF uncertainty for indicated target tissue parameters.

^g Alpha/Depth are determined during calibration. SPEAG warrants that the remaining deviation due to the boundary effect after compensation is always less than ± 1% for frequencies below 3 GHz and below ± 2% for frequencies between 3-6 GHz at any distance larger than half the probe tip diameter from the boundary.

Frequency Response of E-Field (TEM-Cell:ifi110 EXX, Waveguide: R22)

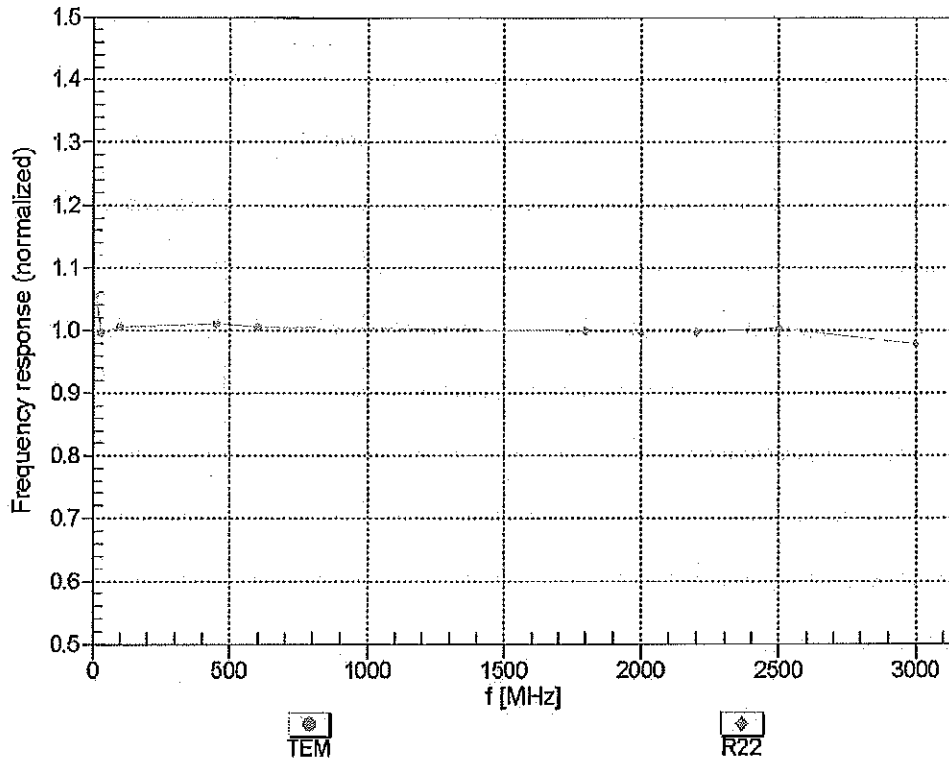

Uncertainty of Frequency Response of E-field: $\pm 6.3\%$ ($k=2$)

Receiving Pattern (ϕ), $\theta = 0^\circ$

f=600 MHz,TEM

f=1800 MHz,R22

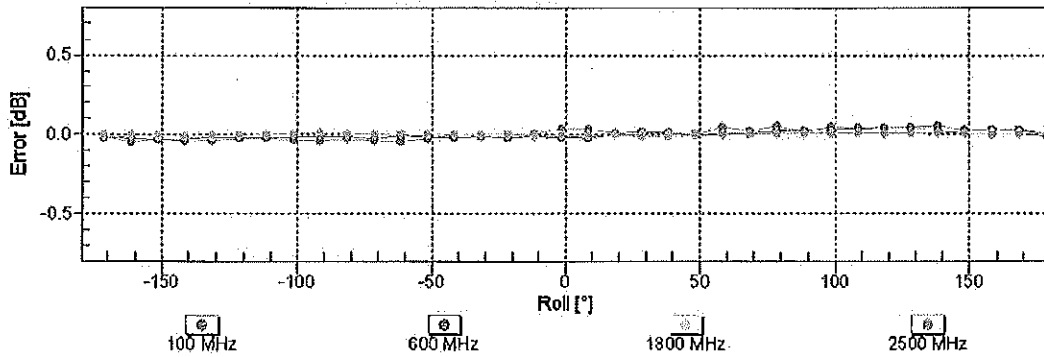
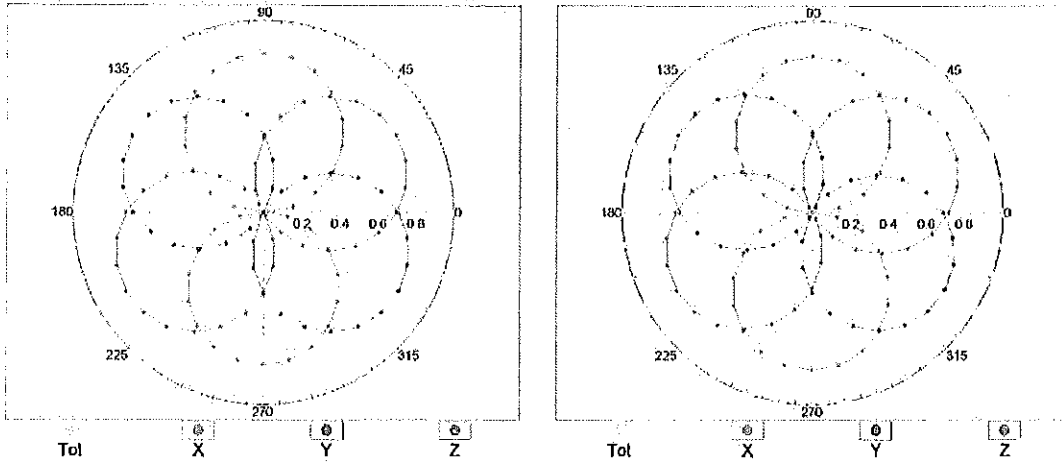

Uncertainty of Axial Isotropy Assessment: $\pm 0.5\%$ ($k=2$)

Dynamic Range f(SAR_{head}) (TEM cell , f_{eval}= 1900 MHz)

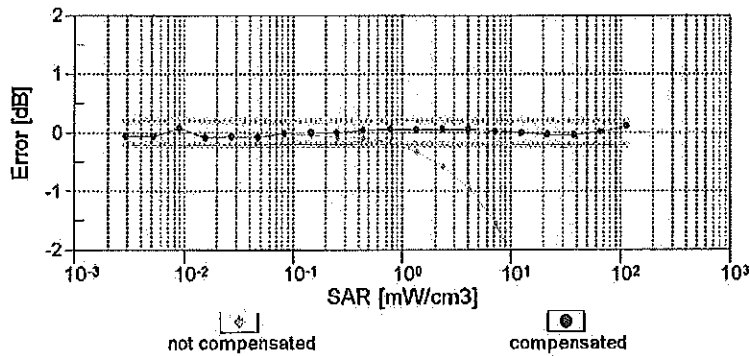
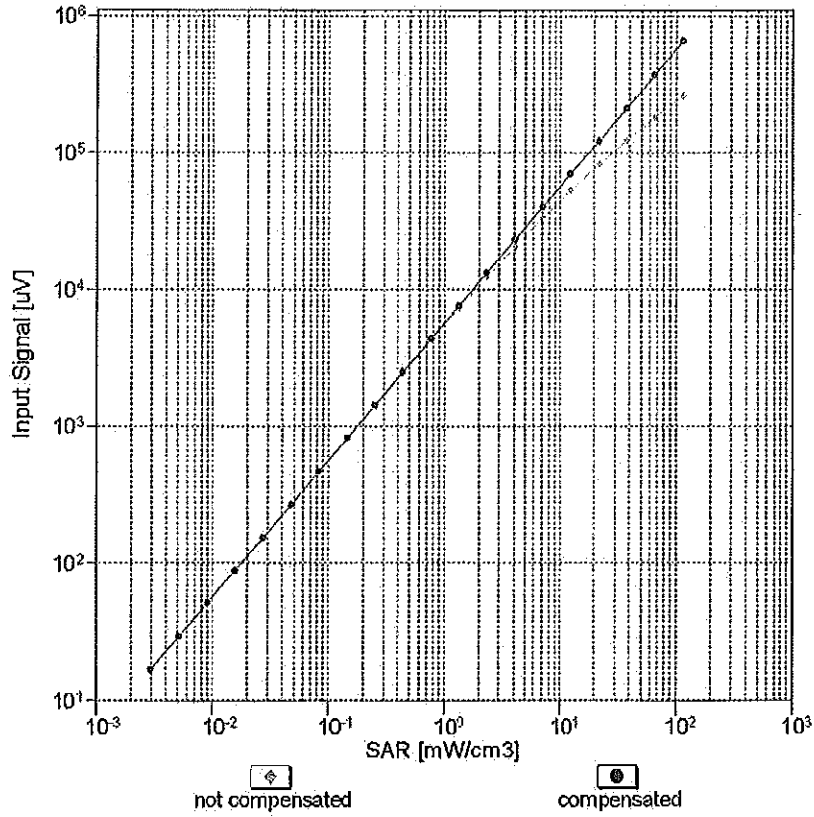

Uncertainty of Linearity Assessment: ± 0.6% (k=2)

Conversion Factor Assessment

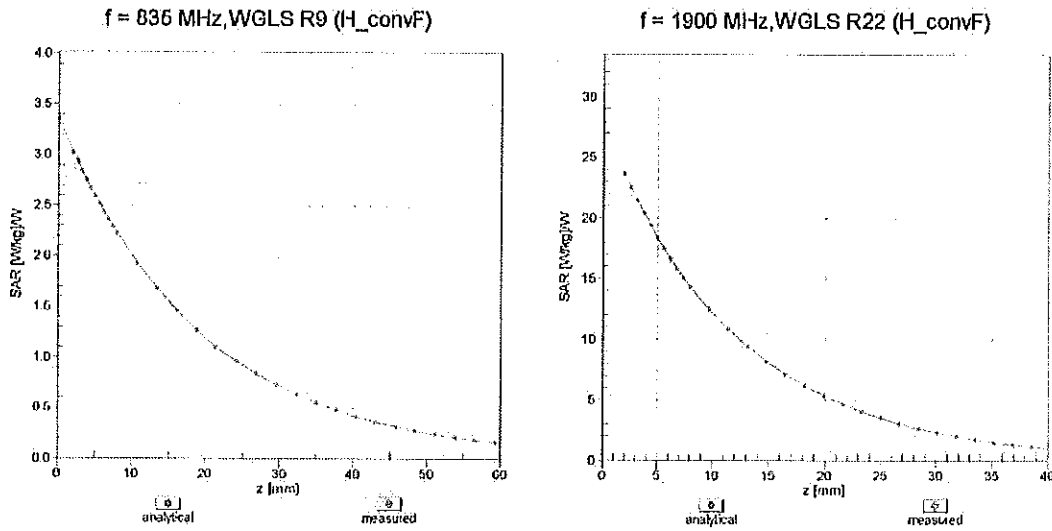

Deviation from Isotropy in Liquid Error (ϕ, θ), f = 900 MHz

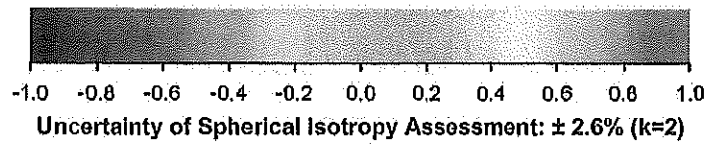
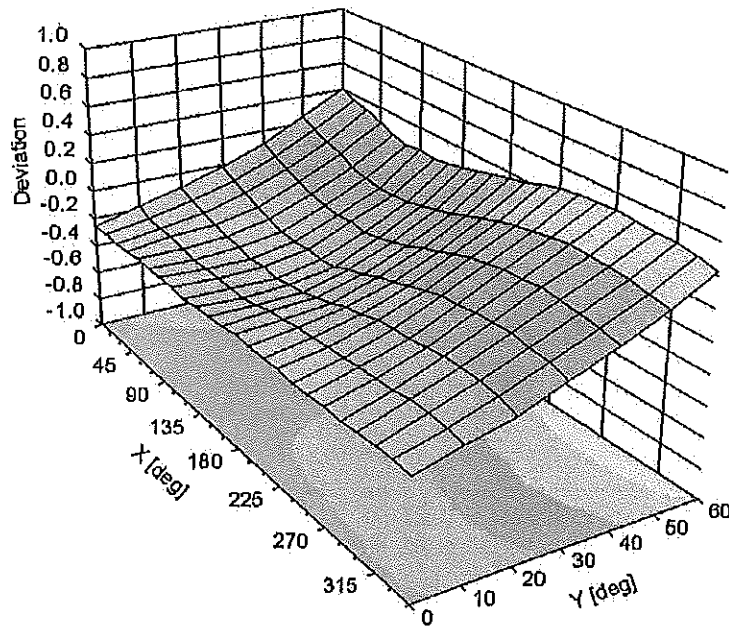

Uncertainty of Spherical Isotropy Assessment: $\pm 2.6\%$ (k=2)

DASY/EASY - Parameters of Probe: ES3DV3 - SN:3334**Other Probe Parameters**

| | |
|---|------------|
| Sensor Arrangement | Triangular |
| Connector Angle (°) | 18.5 |
| Mechanical Surface Detection Mode | enabled |
| Optical Surface Detection Mode | disabled |
| Probe Overall Length | 337 mm |
| Probe Body Diameter | 10 mm |
| Tip Length | 10 mm |
| Tip Diameter | 4 mm |
| Probe Tip to Sensor X Calibration Point | 2 mm |
| Probe Tip to Sensor Y Calibration Point | 2 mm |
| Probe Tip to Sensor Z Calibration Point | 2 mm |
| Recommended Measurement Distance from Surface | 3 mm |



Accredited by the Swiss Accreditation Service (SAS)
The Swiss Accreditation Service is one of the signatories to the EA
Multilateral Agreement for the recognition of calibration certificates

Accreditation No.: **SCS 108**

Client **PC Test**

Certificate No: **EX3-3920_Dec14**

CALIBRATION CERTIFICATE

Object **EX3DV4 - SN:3920**

Calibration procedure(s) **QA CAL-01.v9, QA CAL-14.v4, QA CAL-23.v5, QA CAL-25.v6
Calibration procedure for dosimetric E-field probes**

CC
RIS/19

Calibration date: **December 12, 2014**

This calibration certificate documents the traceability to national standards, which realize the physical units of measurements (SI).
The measurements and the uncertainties with confidence probability are given on the following pages and are part of the certificate.

All calibrations have been conducted in the closed laboratory facility: environment temperature (22 ± 3)°C and humidity < 70%.

Calibration Equipment used (M&TE critical for calibration)

| Primary Standards | ID | Cal Date (Certificate No.) | Scheduled Calibration |
|----------------------------|-----------------|-----------------------------------|------------------------|
| Power meter E4419B | GB41293874 | 03-Apr-14 (No. 217-01911) | Apr-15 |
| Power sensor E4412A | MY41498087 | 03-Apr-14 (No. 217-01911) | Apr-15 |
| Reference 3 dB Attenuator | SN: S5054 (3c) | 03-Apr-14 (No. 217-01915) | Apr-15 |
| Reference 20 dB Attenuator | SN: S5277 (20x) | 03-Apr-14 (No. 217-01919) | Apr-15 |
| Reference 30 dB Attenuator | SN: S5129 (30b) | 03-Apr-14 (No. 217-01920) | Apr-15 |
| Reference Probe ES3DV2 | SN: 3013 | 30-Dec-13 (No. ES3-3013_Dec13) | Dec-14 |
| DAE4 | SN: 660 | 13-Dec-13 (No. DAE4-660_Dec13) | Dec-14 |
| Secondary Standards | ID | Check Date (in house) | Scheduled Check |
| RF generator HP 8648C | US3642U01700 | 4-Aug-99 (in house check Apr-13) | In house check: Apr-16 |
| Network Analyzer HP 8753E | US37390585 | 18-Oct-01 (in house check Oct-14) | In house check: Oct-15 |

| | | | |
|---|-------------------------------|--|---------------------------|
| Calibrated by: | Name Israe El-Naoug | Function Laboratory Technician | Signature |
| Approved by: | Name Katja Pokovic | Function Technical Manager | Signature |
| | | | Issued: December 13, 2014 |
| This calibration certificate shall not be reproduced except in full without written approval of the laboratory. | | | |



Accredited by the Swiss Accreditation Service (SAS)

Accreditation No.: **SCS 108**

The Swiss Accreditation Service is one of the signatories to the EA
Multilateral Agreement for the recognition of calibration certificates

Glossary:

| | |
|--------------------------|---|
| TSL | tissue simulating liquid |
| NORM _{x,y,z} | sensitivity in free space |
| ConvF | sensitivity in TSL / NORM _{x,y,z} |
| DCP | diode compression point |
| CF | crest factor (1/duty_cycle) of the RF signal |
| A, B, C, D | modulation dependent linearization parameters |
| Polarization φ | φ rotation around probe axis |
| Polarization ϑ | ϑ rotation around an axis that is in the plane normal to probe axis (at measurement center), i.e., $\vartheta = 0$ is normal to probe axis |
| Connector Angle | information used in DASY system to align probe sensor X to the robot coordinate system |

Calibration is Performed According to the Following Standards:

- IEEE Std 1528-2013, "IEEE Recommended Practice for Determining the Peak Spatial-Averaged Specific Absorption Rate (SAR) in the Human Head from Wireless Communications Devices: Measurement Techniques", June 2013
- IEC 62209-1, "Procedure to measure the Specific Absorption Rate (SAR) for hand-held devices used in close proximity to the ear (frequency range of 300 MHz to 3 GHz)", February 2005

Methods Applied and Interpretation of Parameters:

- NORM_{x,y,z}**: Assessed for E-field polarization $\vartheta = 0$ ($f \leq 900$ MHz in TEM-cell; $f > 1800$ MHz: R22 waveguide). NORM_{x,y,z} are only intermediate values, i.e., the uncertainties of NORM_{x,y,z} does not affect the E²-field uncertainty inside TSL (see below ConvF).
- NORM(f)_{x,y,z}** = NORM_{x,y,z} * frequency_response (see Frequency Response Chart). This linearization is implemented in DASY4 software versions later than 4.2. The uncertainty of the frequency response is included in the stated uncertainty of ConvF.
- DCP_{x,y,z}**: DCP are numerical linearization parameters assessed based on the data of power sweep with CW signal (no uncertainty required). DCP does not depend on frequency nor media.
- PAR**: PAR is the Peak to Average Ratio that is not calibrated but determined based on the signal characteristics
- A_{x,y,z}; B_{x,y,z}; C_{x,y,z}; D_{x,y,z}; VR_{x,y,z}; A, B, C, D** are numerical linearization parameters assessed based on the data of power sweep for specific modulation signal. The parameters do not depend on frequency nor media. VR is the maximum calibration range expressed in RMS voltage across the diode.
- ConvF and Boundary Effect Parameters**: Assessed in flat phantom using E-field (or Temperature Transfer Standard for $f \leq 800$ MHz) and inside waveguide using analytical field distributions based on power measurements for $f > 800$ MHz. The same setups are used for assessment of the parameters applied for boundary compensation (alpha, depth) of which typical uncertainty values are given. These parameters are used in DASY4 software to improve probe accuracy close to the boundary. The sensitivity in TSL corresponds to NORM_{x,y,z} * ConvF whereby the uncertainty corresponds to that given for ConvF. A frequency dependent ConvF is used in DASY version 4.4 and higher which allows extending the validity from ± 50 MHz to ± 100 MHz.
- Spherical isotropy (3D deviation from isotropy)**: in a field of low gradients realized using a flat phantom exposed by a patch antenna.
- Sensor Offset**: The sensor offset corresponds to the offset of virtual measurement center from the probe tip (on probe axis). No tolerance required.
- Connector Angle**: The angle is assessed using the information gained by determining the NORM_x (no uncertainty required).

Probe EX3DV4

SN:3920

Manufactured: December 18, 2012
Calibrated: December 12, 2014

Calibrated for DASY/EASY Systems
(Note: non-compatible with DASY2 system!)

DASY/EASY - Parameters of Probe: EX3DV4 - SN:3920

Basic Calibration Parameters

| | Sensor X | Sensor Y | Sensor Z | Unc (k=2) |
|---|----------|----------|----------|--------------|
| Norm ($\mu\text{V}/(\text{V}/\text{m})^2$) ^A | 0.35 | 0.50 | 0.50 | $\pm 10.1\%$ |
| DCP (mV) ^B | 104.2 | 98.5 | 97.7 | |

Modulation Calibration Parameters

| UID | Communication System Name | | A dB | B dB $\sqrt{\mu\text{V}}$ | C | D dB | VR mV | Unc ^E (k=2) |
|---------------|---|---|---------|------------------------------|------|---------|----------|---------------------------|
| 0 | CW | X | 0.0 | 0.0 | 1.0 | 0.00 | 131.7 | $\pm 3.5\%$ |
| | | Y | 0.0 | 0.0 | 1.0 | | 140.3 | |
| | | Z | 0.0 | 0.0 | 1.0 | | 136.8 | |
| 10010- CAA | SAR Validation (Square, 100ms, 10ms) | X | 0.94 | 56.5 | 8.3 | 10.00 | 38.1 | $\pm 0.7\%$ |
| | | Y | 2.14 | 63.7 | 12.2 | | 41.6 | |
| | | Z | 3.89 | 70.9 | 15.1 | | 40.9 | |
| 10012- CAB | IEEE 802.11b WiFi 2.4 GHz (DSSS, 1 Mbps) | X | 2.91 | 68.2 | 18.0 | 1.87 | 142.7 | $\pm 0.7\%$ |
| | | Y | 2.48 | 64.3 | 15.8 | | 132.6 | |
| | | Z | 2.61 | 65.8 | 16.8 | | 129.2 | |
| 10013- CAB | IEEE 802.11g WiFi 2.4 GHz (DSSS-OFDM, 6 Mbps) | X | 10.41 | 69.4 | 22.2 | 9.46 | 149.3 | $\pm 3.5\%$ |
| | | Y | 10.78 | 69.4 | 22.2 | | 146.4 | |
| | | Z | 10.76 | 69.7 | 22.6 | | 141.9 | |
| 10032- CAA | IEEE 802.15.1 Bluetooth (GFSK, DH5) | X | 0.29 | 58.3 | 5.2 | 1.16 | 136.2 | $\pm 0.7\%$ |
| | | Y | 0.52 | 61.5 | 7.4 | | 149.5 | |
| | | Z | 0.99 | 66.7 | 9.6 | | 146.5 | |
| 10062- CAB | IEEE 802.11a/h WiFi 5 GHz (OFDM, 6 Mbps) | X | 9.78 | 68.2 | 21.1 | 8.68 | 126.2 | $\pm 3.3\%$ |
| | | Y | 10.40 | 68.9 | 21.4 | | 145.8 | |
| | | Z | 10.43 | 69.3 | 21.9 | | 146.6 | |
| 10103- CAB | LTE-TDD (SC-FDMA, 100% RB, 20 MHz, QPSK) | X | 7.49 | 68.0 | 21.7 | 9.29 | 145.0 | $\pm 2.2\%$ |
| | | Y | 7.76 | 68.0 | 21.7 | | 137.3 | |
| | | Z | 8.12 | 69.7 | 22.9 | | 139.5 | |
| 10117- CAB | IEEE 802.11n (HT Mixed, 13.5 Mbps, BPSK) | X | 10.08 | 68.6 | 20.8 | 8.07 | 140.7 | $\pm 3.0\%$ |
| | | Y | 10.01 | 67.8 | 20.3 | | 129.1 | |
| | | Z | 10.13 | 68.3 | 20.8 | | 130.9 | |
| 10151- CAB | LTE-TDD (SC-FDMA, 50% RB, 20 MHz, QPSK) | X | 7.12 | 67.7 | 21.7 | 9.28 | 140.0 | $\pm 2.2\%$ |
| | | Y | 7.42 | 67.6 | 21.5 | | 133.0 | |
| | | Z | 7.70 | 69.2 | 22.8 | | 135.2 | |
| 10172- CAB | LTE-TDD (SC-FDMA, 1 RB, 20 MHz, QPSK) | X | 5.55 | 68.8 | 22.5 | 9.21 | 129.9 | $\pm 2.7\%$ |
| | | Y | 6.01 | 69.1 | 22.6 | | 144.5 | |
| | | Z | 6.16 | 70.6 | 23.9 | | 146.7 | |
| 10196- CAB | IEEE 802.11n (HT Mixed, 6.5 Mbps, BPSK) | X | 9.56 | 68.2 | 20.7 | 8.10 | 132.3 | $\pm 3.0\%$ |
| | | Y | 10.09 | 68.7 | 20.9 | | 149.9 | |
| | | Z | 10.08 | 69.0 | 21.3 | | 147.9 | |
| 10237- CAB | LTE-TDD (SC-FDMA, 1 RB, 10 MHz, QPSK) | X | 5.60 | 69.2 | 22.8 | 9.21 | 133.6 | $\pm 2.7\%$ |
| | | Y | 6.05 | 69.3 | 22.7 | | 145.6 | |
| | | Z | 6.15 | 70.5 | 23.9 | | 147.8 | |

| | | | | | | | | |
|-----------|---|---|-------|------|------|------|-------|--------|
| 10252-CAB | LTE-TDD (SC-FDMA, 50% RB, 10 MHz, QPSK) | X | 6.68 | 67.3 | 21.6 | 9.24 | 133.4 | ±2.7 % |
| | | Y | 7.19 | 68.0 | 21.9 | | 147.8 | |
| | | Z | 7.38 | 69.3 | 23.0 | | 147.7 | |
| 10267-CAB | LTE-TDD (SC-FDMA, 100% RB, 10 MHz, QPSK) | X | 7.14 | 67.7 | 21.8 | 9.30 | 139.9 | ±2.2 % |
| | | Y | 7.44 | 67.6 | 21.5 | | 133.0 | |
| | | Z | 7.68 | 69.1 | 22.7 | | 131.5 | |
| 10317-AAB | IEEE 802.11a WiFi 5 GHz (OFDM, 6 Mbps, 96pc duty cycle) | X | 9.72 | 68.3 | 21.0 | 8.36 | 132.1 | ±3.3 % |
| | | Y | 10.25 | 68.8 | 21.2 | | 148.1 | |
| | | Z | 10.27 | 69.2 | 21.6 | | 148.7 | |
| 10400-AAB | IEEE 802.11ac WiFi (20MHz, 64-QAM, 99pc duty cycle) | X | 9.78 | 68.3 | 20.9 | 8.37 | 131.9 | ±3.3 % |
| | | Y | 9.97 | 67.9 | 20.7 | | 125.1 | |
| | | Z | 10.36 | 69.3 | 21.7 | | 148.4 | |
| 10401-AAB | IEEE 802.11ac WiFi (40MHz, 64-QAM, 99pc duty cycle) | X | 10.63 | 68.9 | 21.2 | 8.60 | 142.5 | ±3.0 % |
| | | Y | 10.72 | 68.6 | 21.0 | | 133.5 | |
| | | Z | 10.74 | 68.8 | 21.4 | | 133.0 | |
| 10402-AAB | IEEE 802.11ac WiFi (80MHz, 64-QAM, 99pc duty cycle) | X | 10.89 | 69.3 | 21.2 | 8.53 | 145.0 | ±3.3 % |
| | | Y | 10.70 | 68.4 | 20.8 | | 133.2 | |
| | | Z | 10.95 | 69.2 | 21.4 | | 134.0 | |
| 10415-AAA | IEEE 802.11b WiFi 2.4 GHz (DSSS, 1 Mbps, 99pc duty cycle) | X | 2.84 | 68.2 | 17.9 | 1.54 | 141.1 | ±0.5 % |
| | | Y | 2.39 | 64.2 | 15.6 | | 130.2 | |
| | | Z | 2.63 | 66.6 | 17.2 | | 128.6 | |
| 10416-AAA | IEEE 802.11g WiFi 2.4 GHz (ERP-OFDM, 6 Mbps, 99pc duty cycle) | X | 9.67 | 68.3 | 20.9 | 8.23 | 131.6 | ±3.3 % |
| | | Y | 10.14 | 68.6 | 21.0 | | 147.9 | |
| | | Z | 10.17 | 69.1 | 21.5 | | 148.5 | |
| 10417-AAA | IEEE 802.11a/h WiFi 5 GHz (OFDM, 6 Mbps, 99pc duty cycle) | X | 9.67 | 68.3 | 20.9 | 8.23 | 133.0 | ±3.3 % |
| | | Y | 9.78 | 67.7 | 20.5 | | 124.4 | |
| | | Z | 10.21 | 69.1 | 21.5 | | 149.4 | |

The reported uncertainty of measurement is stated as the standard uncertainty of measurement multiplied by the coverage factor $k=2$, which for a normal distribution corresponds to a coverage probability of approximately 95%.

^A The uncertainties of NormX,Y,Z do not affect the E^2 -field uncertainty inside TSL (see Pages 6 and 7).

^B Numerical linearization parameter: uncertainty not required.

^E Uncertainty is determined using the max. deviation from linear response applying rectangular distribution and is expressed for the square of the field value.

DASY/EASY - Parameters of Probe: EX3DV4 - SN:3920

Calibration Parameter Determined in Head Tissue Simulating Media

| f (MHz) ^C | Relative Permittivity ^F | Conductivity (S/m) ^F | ConvF X | ConvF Y | ConvF Z | Alpha ^G | Depth ^G (mm) | Unct. (k=2) |
|----------------------|------------------------------------|---------------------------------|---------|---------|---------|--------------------|-------------------------|-------------|
| 2450 | 39.2 | 1.80 | 7.12 | 7.12 | 7.12 | 0.62 | 0.65 | ± 12.0 % |
| 2600 | 39.0 | 1.96 | 6.85 | 6.85 | 6.85 | 0.36 | 0.86 | ± 12.0 % |
| 5200 | 36.0 | 4.66 | 4.87 | 4.87 | 4.87 | 0.35 | 1.80 | ± 13.1 % |
| 5300 | 35.9 | 4.76 | 4.69 | 4.69 | 4.69 | 0.35 | 1.80 | ± 13.1 % |
| 5500 | 35.6 | 4.96 | 4.44 | 4.44 | 4.44 | 0.40 | 1.80 | ± 13.1 % |
| 5600 | 35.5 | 5.07 | 4.35 | 4.35 | 4.35 | 0.40 | 1.80 | ± 13.1 % |
| 5800 | 35.3 | 5.27 | 4.27 | 4.27 | 4.27 | 0.40 | 1.80 | ± 13.1 % |

^C Frequency validity above 300 MHz of ± 100 MHz only applies for DASY v4.4 and higher (see Page 2), else it is restricted to ± 50 MHz. The uncertainty is the RSS of the ConvF uncertainty at calibration frequency and the uncertainty for the indicated frequency band. Frequency validity below 300 MHz is ± 10, 25, 40, 50 and 70 MHz for ConvF assessments at 30, 64, 128, 150 and 220 MHz respectively. Above 5 GHz frequency validity can be extended to ± 110 MHz.

^F At frequencies below 3 GHz, the validity of tissue parameters (ϵ and σ) can be relaxed to ± 10% if liquid compensation formula is applied to measured SAR values. At frequencies above 3 GHz, the validity of tissue parameters (ϵ and σ) is restricted to ± 5%. The uncertainty is the RSS of the ConvF uncertainty for indicated target tissue parameters.

^G Alpha/Depth are determined during calibration. SPEAG warrants that the remaining deviation due to the boundary effect after compensation is always less than ± 1% for frequencies below 3 GHz and below ± 2% for frequencies between 3-6 GHz at any distance larger than half the probe tip diameter from the boundary.

DASY/EASY - Parameters of Probe: EX3DV4 - SN:3920

Calibration Parameter Determined in Body Tissue Simulating Media

| f (MHz) ^C | Relative Permittivity ^F | Conductivity (S/m) ^F | ConvF X | ConvF Y | ConvF Z | Alpha ^G | Depth ^G (mm) | Unct. (k=2) |
|----------------------|------------------------------------|---------------------------------|---------|---------|---------|--------------------|-------------------------|-------------|
| 2450 | 52.7 | 1.95 | 7.02 | 7.02 | 7.02 | 0.80 | 0.50 | ± 12.0 % |
| 2600 | 52.5 | 2.16 | 6.78 | 6.78 | 6.78 | 0.80 | 0.50 | ± 12.0 % |
| 5200 | 49.0 | 5.30 | 4.33 | 4.33 | 4.33 | 0.45 | 1.90 | ± 13.1 % |
| 5300 | 48.9 | 5.42 | 4.16 | 4.16 | 4.16 | 0.45 | 1.90 | ± 13.1 % |
| 5500 | 48.6 | 5.65 | 3.79 | 3.79 | 3.79 | 0.50 | 1.90 | ± 13.1 % |
| 5600 | 48.5 | 5.77 | 3.66 | 3.66 | 3.66 | 0.50 | 1.90 | ± 13.1 % |
| 5800 | 48.2 | 6.00 | 3.93 | 3.93 | 3.93 | 0.50 | 1.90 | ± 13.1 % |

^C Frequency validity above 300 MHz of ± 100 MHz only applies for DASY v4.4 and higher (see Page 2), else it is restricted to ± 50 MHz. The uncertainty is the RSS of the ConvF uncertainty at calibration frequency and the uncertainty for the indicated frequency band. Frequency validity below 300 MHz is ± 10, 25, 40, 50 and 70 MHz for ConvF assessments at 30, 64, 128, 150 and 220 MHz respectively. Above 5 GHz frequency validity can be extended to ± 110 MHz.

^F At frequencies below 3 GHz, the validity of tissue parameters (ϵ and σ) can be relaxed to ± 10% if liquid compensation formula is applied to measured SAR values. At frequencies above 3 GHz, the validity of tissue parameters (ϵ and σ) is restricted to ± 5%. The uncertainty is the RSS of the ConvF uncertainty for indicated target tissue parameters.

^G Alpha/Depth are determined during calibration. SPEAG warrants that the remaining deviation due to the boundary effect after compensation is always less than ± 1% for frequencies below 3 GHz and below ± 2% for frequencies between 3-6 GHz at any distance larger than half the probe tip diameter from the boundary.

Frequency Response of E-Field

(TEM-Cell:ifi110 EXX, Waveguide: R22)

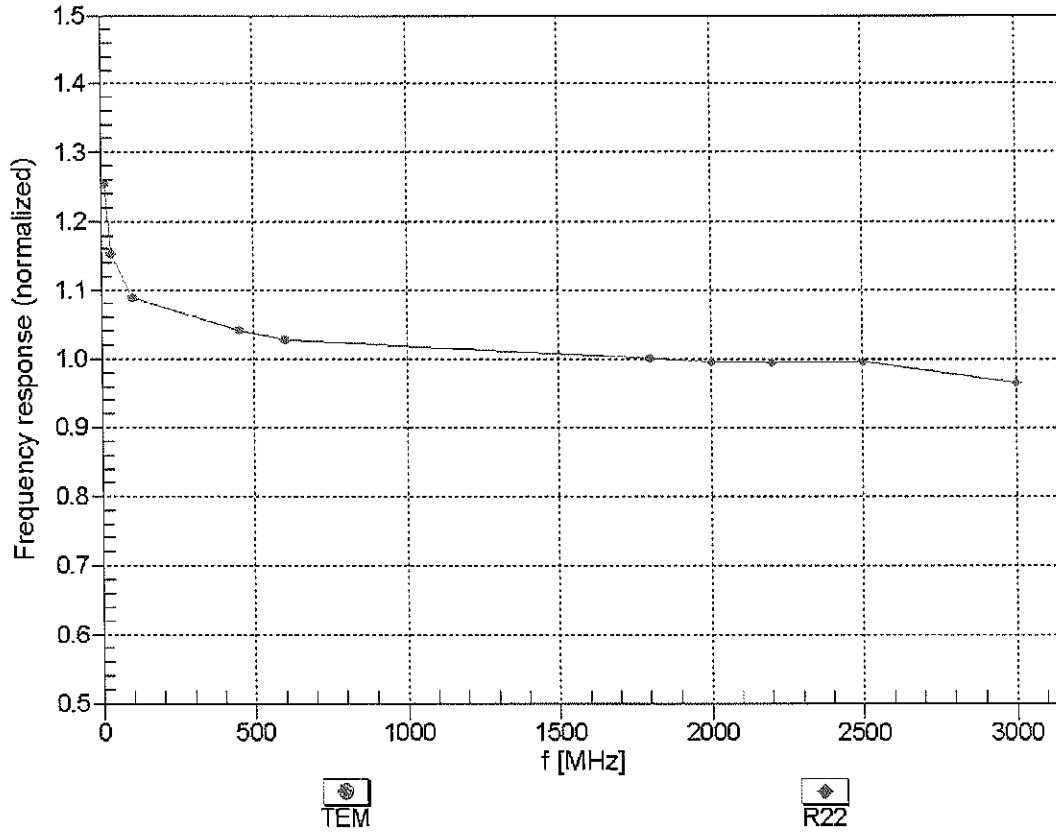

Uncertainty of Frequency Response of E-field: $\pm 6.3\%$ (k=2)

Receiving Pattern (ϕ), $\vartheta = 0^\circ$

f=600 MHz,TEM

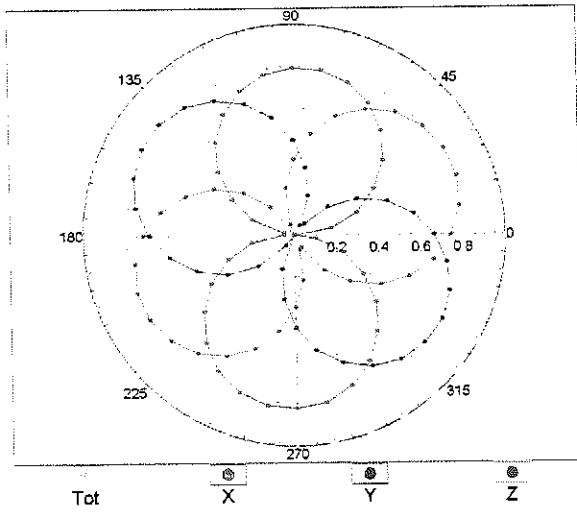

f=1800 MHz,R22

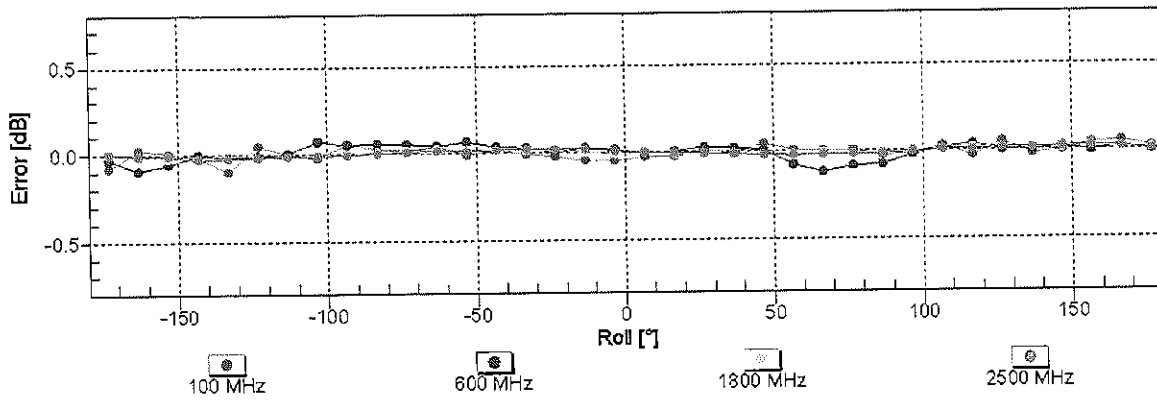
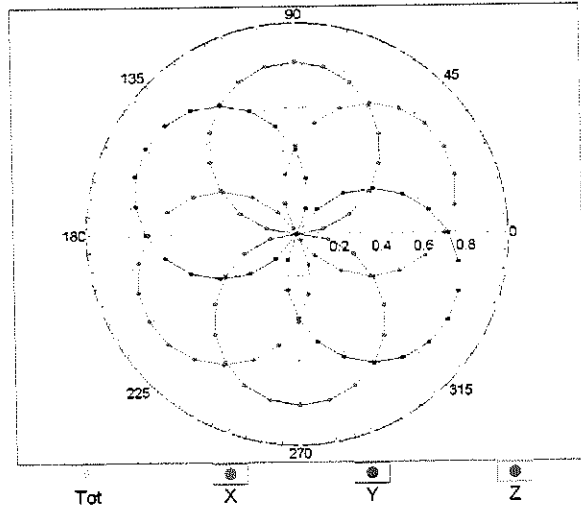

Uncertainty of Axial Isotropy Assessment: $\pm 0.5\%$ (k=2)

Dynamic Range f(SAR_{head})

(TEM cell , f_{eval}= 1900 MHz)

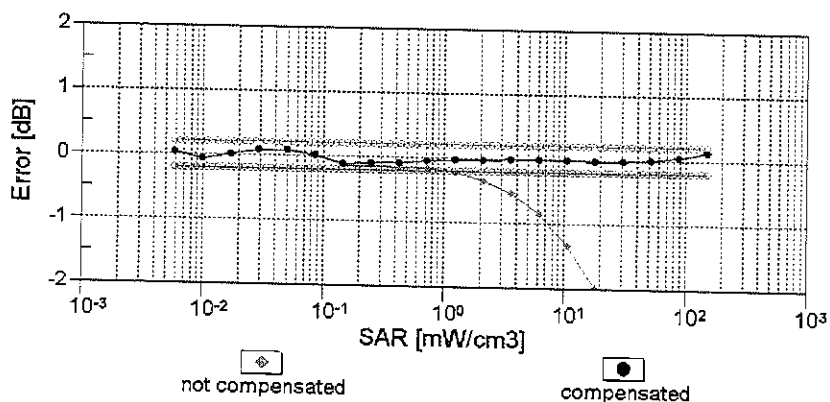
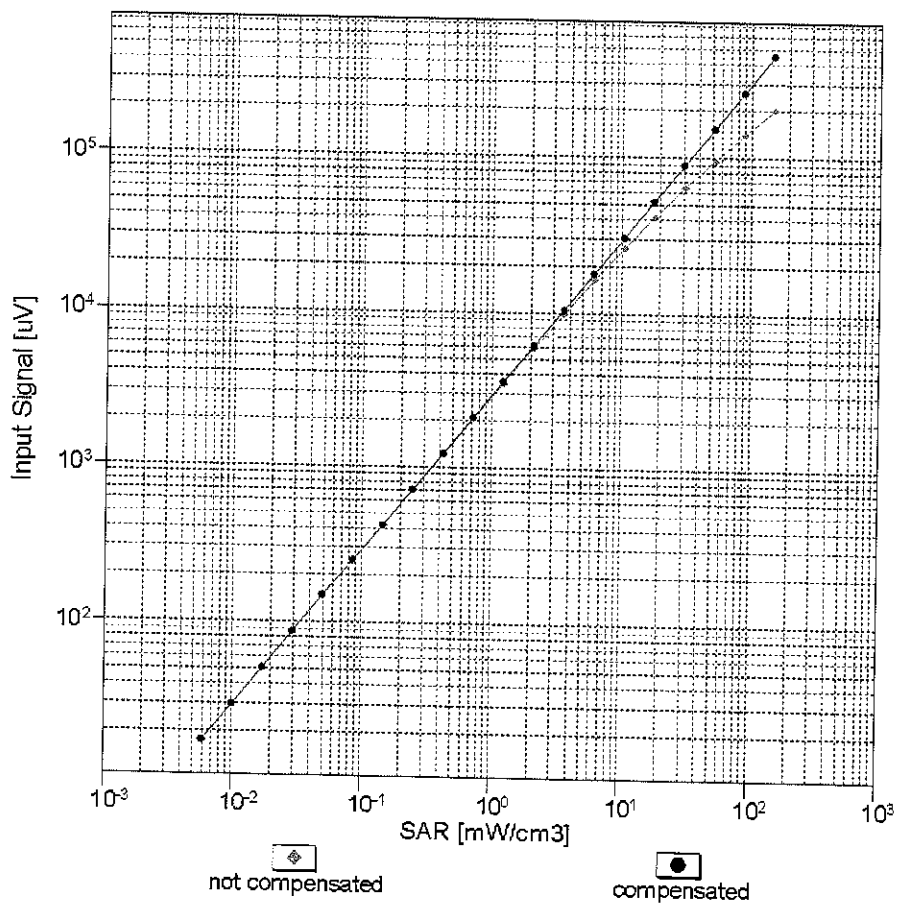

Uncertainty of Linearity Assessment: ± 0.6% (k=2)

Conversion Factor Assessment

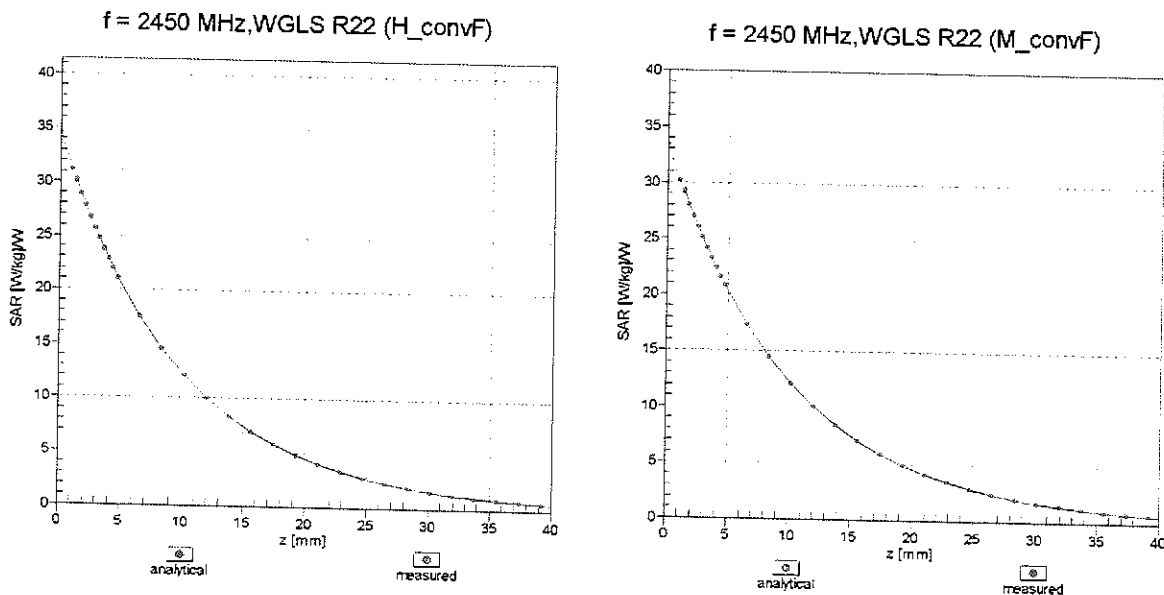

Deviation from Isotropy in Liquid

Error (ϕ, θ), f = 900 MHz

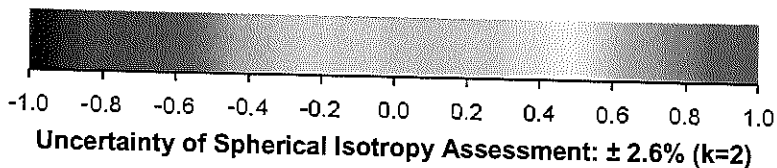
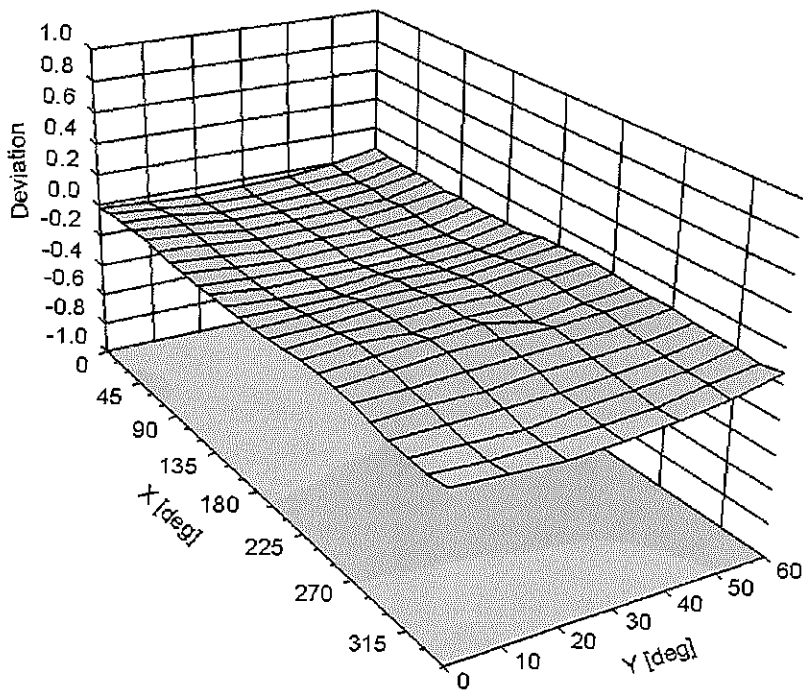

DASY/EASY - Parameters of Probe: EX3DV4 - SN:3920

Other Probe Parameters

| | |
|---|------------|
| Sensor Arrangement | Triangular |
| Connector Angle (°) | -23.3 |
| Mechanical Surface Detection Mode | enabled |
| Optical Surface Detection Mode | disabled |
| Probe Overall Length | 337 mm |
| Probe Body Diameter | 10 mm |
| Tip Length | 9 mm |
| Tip Diameter | 2.5 mm |
| Probe Tip to Sensor X Calibration Point | 1 mm |
| Probe Tip to Sensor Y Calibration Point | 1 mm |
| Probe Tip to Sensor Z Calibration Point | 1 mm |
| Recommended Measurement Distance from Surface | 1.4 mm |

**Calibration Laboratory of
Schmid & Partner
Engineering AG**
Zeughausstrasse 43, 8004 Zurich, Switzerland



S Schweizerischer Kalibrierdienst
S Service suisse d'étalonnage
C Servizio svizzero di taratura
S Swiss Calibration Service

Accredited by the Swiss Accreditation Service (SAS)
The Swiss Accreditation Service is one of the signatories to the EA
Multilateral Agreement for the recognition of calibration certificates

Accreditation No.: **SCS 108**

Client **PC Test**

Certificate No: **ES3-3288_Sep14/2**

CALIBRATION CERTIFICATE (Replacement of No:ES3-3288_Sep14)

Object **ES3DV3 - SN:3288**

Calibration procedure(s) **QA CAL-01.v9, QA CAL-23.v5, QA CAL-25.v6
Calibration procedure for dosimetric E-field probes** CC
11/12/14

Calibration date: **September 24, 2014**

This calibration certificate documents the traceability to national standards, which realize the physical units of measurements (SI).
The measurements and the uncertainties with confidence probability are given on the following pages and are part of the certificate.

All calibrations have been conducted in the closed laboratory facility: environment temperature (22 ± 3)°C and humidity < 70%.

Calibration Equipment used (M&TE critical for calibration)

| Primary Standards | ID | Cal Date (Certificate No.) | Scheduled Calibration |
|----------------------------|-----------------|-----------------------------------|------------------------|
| Power meter E4419B | GB41293874 | 03-Apr-14 (No. 217-01911) | Apr-15 |
| Power sensor E4412A | MY41498087 | 03-Apr-14 (No. 217-01911) | Apr-15 |
| Reference 3 dB Attenuator | SN: S5054 (3c) | 03-Apr-14 (No. 217-01915) | Apr-15 |
| Reference 20 dB Attenuator | SN: S5277 (20x) | 03-Apr-14 (No. 217-01919) | Apr-15 |
| Reference 30 dB Attenuator | SN: S5129 (30b) | 03-Apr-14 (No. 217-01920) | Apr-15 |
| Reference Probe ES3DV2 | SN: 3013 | 30-Dec-13 (No. ES3-3013_Dec13) | Dec-14 |
| DAE4 | SN: 660 | 13-Dec-13 (No. DAE4-660_Dec13) | Dec-14 |
| Secondary Standards | ID | Check Date (in house) | Scheduled Check |
| RF generator HP 8648C | US3642U01700 | 4-Aug-99 (in house check Apr-13) | In house check: Apr-16 |
| Network Analyzer HP 8753E | US37390585 | 18-Oct-01 (in house check Oct-13) | In house check: Oct-14 |

| | Name | Function | Signature |
|----------------|---------------|-----------------------|-----------|
| Calibrated by: | Leif Klysner | Laboratory Technician | |
| Approved by: | Katja Pokovic | Technical Manager | |

Issued: November 3, 2014

This calibration certificate shall not be reproduced except in full without written approval of the laboratory.



Accredited by the Swiss Accreditation Service (SAS)
The Swiss Accreditation Service is one of the signatories to the EA
Multilateral Agreement for the recognition of calibration certificates

Accreditation No.: **SCS 108**

Glossary:

| | |
|--------------------------|---|
| TSL | tissue simulating liquid |
| NORM _{x,y,z} | sensitivity in free space |
| ConvF | sensitivity in TSL / NORM _{x,y,z} |
| DCP | diode compression point |
| CF | crest factor (1/duty_cycle) of the RF signal |
| A, B, C, D | modulation dependent linearization parameters |
| Polarization ϕ | ϕ rotation around probe axis |
| Polarization ϑ | ϑ rotation around an axis that is in the plane normal to probe axis (at measurement center), i.e., $\vartheta = 0$ is normal to probe axis |
| Connector Angle | information used in DASY system to align probe sensor X to the robot coordinate system |

Calibration is Performed According to the Following Standards:

- a) IEEE Std 1528-2013, "IEEE Recommended Practice for Determining the Peak Spatial-Averaged Specific Absorption Rate (SAR) in the Human Head from Wireless Communications Devices: Measurement Techniques", June 2013
- b) IEC 62209-1, "Procedure to measure the Specific Absorption Rate (SAR) for hand-held devices used in close proximity to the ear (frequency range of 300 MHz to 3 GHz)", February 2005

Methods Applied and Interpretation of Parameters:

- *NORM_{x,y,z}*: Assessed for E-field polarization $\vartheta = 0$ ($f \leq 900$ MHz in TEM-cell; $f > 1800$ MHz: R22 waveguide). *NORM_{x,y,z}* are only intermediate values, i.e., the uncertainties of *NORM_{x,y,z}* does not affect the E^2 -field uncertainty inside TSL (see below *ConvF*).
- *NORM(f)_{x,y,z}* = *NORM_{x,y,z}* * *frequency_response* (see Frequency Response Chart). This linearization is implemented in DASY4 software versions later than 4.2. The uncertainty of the frequency response is included in the stated uncertainty of *ConvF*.
- *DCP_{x,y,z}*: DCP are numerical linearization parameters assessed based on the data of power sweep with CW signal (no uncertainty required). DCP does not depend on frequency nor media.
- *PAR*: PAR is the Peak to Average Ratio that is not calibrated but determined based on the signal characteristics
- *A_{x,y,z}*; *B_{x,y,z}*; *C_{x,y,z}*; *D_{x,y,z}*; *VR_{x,y,z}*; *A*, *B*, *C*, *D* are numerical linearization parameters assessed based on the data of power sweep for specific modulation signal. The parameters do not depend on frequency nor media. *VR* is the maximum calibration range expressed in RMS voltage across the diode.
- *ConvF and Boundary Effect Parameters*: Assessed in flat phantom using E-field (or Temperature Transfer Standard for $f \leq 800$ MHz) and inside waveguide using analytical field distributions based on power measurements for $f > 800$ MHz. The same setups are used for assessment of the parameters applied for boundary compensation (alpha, depth) of which typical uncertainty values are given. These parameters are used in DASY4 software to improve probe accuracy close to the boundary. The sensitivity in TSL corresponds to *NORM_{x,y,z}* * *ConvF* whereby the uncertainty corresponds to that given for *ConvF*. A frequency dependent *ConvF* is used in DASY version 4.4 and higher which allows extending the validity from ± 50 MHz to ± 100 MHz.
- *Spherical isotropy (3D deviation from isotropy)*: in a field of low gradients realized using a flat phantom exposed by a patch antenna.
- *Sensor Offset*: The sensor offset corresponds to the offset of virtual measurement center from the probe tip (on probe axis). No tolerance required.
- *Connector Angle*: The angle is assessed using the information gained by determining the *NORM_x* (no uncertainty required).

Probe ES3DV3

SN:3288

| | |
|---------------|--------------------|
| Manufactured: | July 6, 2010 |
| Repaired: | September 18, 2014 |
| Calibrated: | September 24, 2014 |

Calibrated for DASY/EASY Systems
(Note: non-compatible with DASY2 system!)

DASY/EASY - Parameters of Probe: ES3DV3 - SN:3288

Basic Calibration Parameters

| | Sensor X | Sensor Y | Sensor Z | Unc (k=2) |
|---|----------|----------|----------|---------------|
| Norm ($\mu\text{V}/(\text{V}/\text{m})^2$) ^A | 1.05 | 1.16 | 0.92 | $\pm 10.1 \%$ |
| DCP (mV) ^B | 105.1 | 104.6 | 106.7 | |

Modulation Calibration Parameters

| UID | Communication System Name | | A dB | B dB $\sqrt{\mu\text{V}}$ | C | D dB | VR mV | Unc ^E (k=2) |
|---------------|---|---|---------|------------------------------|------|---------|----------|---------------------------|
| 0 | CW | X | 0.0 | 0.0 | 1.0 | 0.00 | 195.8 | $\pm 3.5 \%$ |
| | | Y | 0.0 | 0.0 | 1.0 | | 175.9 | |
| | | Z | 0.0 | 0.0 | 1.0 | | 177.1 | |
| 10010- CAA | SAR Validation (Square, 100ms, 10ms) | X | 2.71 | 61.9 | 11.4 | 10.00 | 40.3 | $\pm 2.2 \%$ |
| | | Y | 2.37 | 60.2 | 11.2 | | 42.6 | |
| | | Z | 1.54 | 56.6 | 8.9 | | 41.2 | |
| 10011- CAB | UMTS-FDD (WCDMA) | X | 3.29 | 67.1 | 18.4 | 2.91 | 133.8 | $\pm 0.5 \%$ |
| | | Y | 3.43 | 67.9 | 18.9 | | 139.5 | |
| | | Z | 3.45 | 68.1 | 18.9 | | 141.3 | |
| 10012- CAA | IEEE 802.11b WiFi 2.4 GHz (DSSS, 1 Mbps) | X | 2.99 | 68.9 | 18.6 | 1.87 | 135.1 | $\pm 0.7 \%$ |
| | | Y | 3.59 | 72.4 | 20.4 | | 140.7 | |
| | | Z | 3.54 | 72.4 | 20.3 | | 143.0 | |
| 10013- CAA | IEEE 802.11g WiFi 2.4 GHz (DSSS-OFDM, 6 Mbps) | X | 11.15 | 70.8 | 23.3 | 9.46 | 132.3 | $\pm 3.5 \%$ |
| | | Y | 11.29 | 70.8 | 23.2 | | 141.1 | |
| | | Z | 11.07 | 70.7 | 23.2 | | 139.2 | |
| 10021- DAB | GSM-FDD (TDMA, GMSK) | X | 14.71 | 90.5 | 24.5 | 9.39 | 149.0 | $\pm 1.9 \%$ |
| | | Y | 16.40 | 92.8 | 26.0 | | 131.3 | |
| | | Z | 11.34 | 87.2 | 23.6 | | 126.1 | |
| 10023- DAB | GPRS-FDD (TDMA, GMSK, TN 0) | X | 15.91 | 92.2 | 25.3 | 9.57 | 138.9 | $\pm 2.5 \%$ |
| | | Y | 21.25 | 96.9 | 27.2 | | 142.0 | |
| | | Z | 11.68 | 87.2 | 23.5 | | 145.9 | |
| 10024- DAB | GPRS-FDD (TDMA, GMSK, TN 0-1) | X | 38.62 | 99.8 | 24.7 | 6.56 | 123.8 | $\pm 2.2 \%$ |
| | | Y | 36.71 | 99.7 | 25.2 | | 128.1 | |
| | | Z | 36.56 | 99.4 | 24.5 | | 129.5 | |
| 10027- DAB | GPRS-FDD (TDMA, GMSK, TN 0-1-2) | X | 56.60 | 99.6 | 22.6 | 4.80 | 138.8 | $\pm 1.9 \%$ |
| | | Y | 46.94 | 99.9 | 23.7 | | 149.9 | |
| | | Z | 51.17 | 99.8 | 22.9 | | 144.9 | |
| 10028- DAB | GPRS-FDD (TDMA, GMSK, TN 0-1-2-3) | X | 70.88 | 100.0 | 21.6 | 3.55 | 147.5 | $\pm 1.9 \%$ |
| | | Y | 52.58 | 99.8 | 22.6 | | 129.4 | |
| | | Z | 76.98 | 99.8 | 21.2 | | 128.7 | |
| 10032- CAA | IEEE 802.15.1 Bluetooth (GFSK, DH5) | X | 98.89 | 99.5 | 18.9 | 1.16 | 135.8 | $\pm 1.4 \%$ |
| | | Y | 78.39 | 99.6 | 19.5 | | 141.7 | |
| | | Z | 95.21 | 95.5 | 17.1 | | 143.4 | |
| 10039- CAB | CDMA2000 (1xRTT, RC1) | X | 4.72 | 66.7 | 18.9 | 4.57 | 133.7 | $\pm 0.9 \%$ |
| | | Y | 4.85 | 67.1 | 19.1 | | 137.7 | |
| | | Z | 4.81 | 67.4 | 19.2 | | 141.9 | |

| | | | | | | | | |
|-----------|---|---|-------|------|------|------|-------|--------|
| 10081-CAB | CDMA2000 (1xRTT, RC3) | X | 3.91 | 66.3 | 18.6 | 3.97 | 129.5 | ±0.7 % |
| | | Y | 4.00 | 66.6 | 18.7 | | 133.7 | |
| | | Z | 3.99 | 66.8 | 18.8 | | 137.5 | |
| 10098-CAB | UMTS-FDD (HSUPA, Subtest 2) | X | 4.63 | 66.9 | 18.7 | 3.98 | 141.4 | ±0.7 % |
| | | Y | 4.78 | 67.5 | 19.0 | | 147.7 | |
| | | Z | 4.57 | 66.8 | 18.6 | | 127.8 | |
| 10100-CAB | LTE-FDD (SC-FDMA, 100% RB, 20 MHz, QPSK) | X | 6.59 | 68.2 | 20.1 | 5.67 | 149.2 | ±1.4 % |
| | | Y | 6.36 | 67.3 | 19.6 | | 130.7 | |
| | | Z | 6.36 | 67.5 | 19.6 | | 133.6 | |
| 10108-CAB | LTE-FDD (SC-FDMA, 100% RB, 10 MHz, QPSK) | X | 6.44 | 67.8 | 20.0 | 5.80 | 146.6 | ±1.4 % |
| | | Y | 6.23 | 66.8 | 19.4 | | 128.8 | |
| | | Z | 6.24 | 67.1 | 19.6 | | 131.4 | |
| 10110-CAB | LTE-FDD (SC-FDMA, 100% RB, 5 MHz, QPSK) | X | 6.08 | 67.1 | 19.6 | 5.75 | 143.2 | ±1.4 % |
| | | Y | 6.20 | 67.4 | 19.8 | | 148.0 | |
| | | Z | 5.92 | 66.6 | 19.3 | | 128.5 | |
| 10114-CAA | IEEE 802.11n (HT Greenfield, 13.5 Mbps, BPSK) | X | 10.32 | 69.3 | 21.5 | 8.10 | 137.0 | ±2.2 % |
| | | Y | 10.31 | 69.1 | 21.4 | | 143.5 | |
| | | Z | 10.37 | 69.5 | 21.6 | | 146.1 | |
| 10117-CAA | IEEE 802.11n (HT Mixed, 13.5 Mbps, BPSK) | X | 10.35 | 69.4 | 21.6 | 8.07 | 138.3 | ±2.2 % |
| | | Y | 10.36 | 69.3 | 21.4 | | 146.4 | |
| | | Z | 10.42 | 69.6 | 21.6 | | 149.0 | |
| 10151-CAB | LTE-TDD (SC-FDMA, 50% RB, 20 MHz, QPSK) | X | 9.95 | 75.7 | 26.2 | 9.28 | 134.9 | ±3.3 % |
| | | Y | 10.37 | 76.0 | 26.1 | | 146.6 | |
| | | Z | 9.77 | 75.4 | 26.0 | | 142.5 | |
| 10154-CAB | LTE-FDD (SC-FDMA, 50% RB, 10 MHz, QPSK) | X | 6.12 | 67.2 | 19.7 | 5.75 | 144.9 | ±1.4 % |
| | | Y | 6.21 | 67.4 | 19.8 | | 148.8 | |
| | | Z | 5.91 | 66.5 | 19.3 | | 128.7 | |
| 10160-CAB | LTE-FDD (SC-FDMA, 50% RB, 15 MHz, QPSK) | X | 6.28 | 66.7 | 19.4 | 5.82 | 125.5 | ±1.2 % |
| | | Y | 6.37 | 66.8 | 19.4 | | 129.7 | |
| | | Z | 6.36 | 67.1 | 19.6 | | 132.9 | |
| 10169-CAB | LTE-FDD (SC-FDMA, 1 RB, 20 MHz, QPSK) | X | 5.08 | 67.6 | 20.2 | 5.73 | 147.0 | ±1.2 % |
| | | Y | 4.95 | 66.6 | 19.6 | | 128.6 | |
| | | Z | 4.91 | 66.9 | 19.8 | | 131.2 | |
| 10172-CAB | LTE-TDD (SC-FDMA, 1 RB, 20 MHz, QPSK) | X | 8.18 | 77.2 | 27.2 | 9.21 | 123.4 | ±2.7 % |
| | | Y | 8.37 | 76.6 | 26.6 | | 129.5 | |
| | | Z | 7.97 | 76.7 | 26.9 | | 128.7 | |
| 10175-CAB | LTE-FDD (SC-FDMA, 1 RB, 10 MHz, QPSK) | X | 5.05 | 67.4 | 20.1 | 5.72 | 146.2 | ±1.4 % |
| | | Y | 5.10 | 67.3 | 20.0 | | 142.8 | |
| | | Z | 4.87 | 66.7 | 19.6 | | 129.6 | |
| 10181-CAB | LTE-FDD (SC-FDMA, 1 RB, 15 MHz, QPSK) | X | 5.04 | 67.4 | 20.0 | 5.72 | 145.5 | ±1.2 % |
| | | Y | 5.12 | 67.4 | 20.0 | | 143.4 | |
| | | Z | 4.87 | 66.7 | 19.6 | | 129.9 | |
| 10193-CAA | IEEE 802.11n (HT Greenfield, 6.5 Mbps, BPSK) | X | 9.92 | 68.9 | 21.4 | 8.09 | 131.0 | ±2.2 % |
| | | Y | 9.84 | 68.5 | 21.1 | | 130.0 | |
| | | Z | 9.94 | 69.0 | 21.4 | | 138.6 | |

| | | | | | | | | |
|-----------|---|---|-------|------|------|------|-------|--------|
| 10196-CAA | IEEE 802.11n (HT Mixed, 6.5 Mbps, BPSK) | X | 9.90 | 68.9 | 21.4 | 8.10 | 130.8 | ±2.2 % |
| | | Y | 9.81 | 68.4 | 21.0 | | 131.4 | |
| | | Z | 9.95 | 69.1 | 21.5 | | 140.5 | |
| 10219-CAA | IEEE 802.11n (HT Mixed, 7.2 Mbps, BPSK) | X | 9.81 | 68.8 | 21.3 | 8.03 | 130.0 | ±2.2 % |
| | | Y | 9.89 | 68.9 | 21.3 | | 138.1 | |
| | | Z | 9.89 | 69.1 | 21.5 | | 140.5 | |
| 10222-CAA | IEEE 802.11n (HT Mixed, 15 Mbps, BPSK) | X | 10.25 | 69.2 | 21.4 | 8.06 | 137.1 | ±2.2 % |
| | | Y | 10.30 | 69.2 | 21.4 | | 144.4 | |
| | | Z | 10.38 | 69.6 | 21.6 | | 148.4 | |
| 10225-CAB | UMTS-FDD (HSPA+) | X | 6.90 | 66.8 | 19.3 | 5.97 | 132.8 | ±1.4 % |
| | | Y | 7.09 | 67.3 | 19.6 | | 142.0 | |
| | | Z | 7.04 | 67.4 | 19.6 | | 143.5 | |
| 10237-CAB | LTE-TDD (SC-FDMA, 1 RB, 10 MHz, QPSK) | X | 9.61 | 81.9 | 29.6 | 9.21 | 149.3 | ±2.7 % |
| | | Y | 8.66 | 77.6 | 27.1 | | 133.7 | |
| | | Z | 8.20 | 77.5 | 27.3 | | 132.2 | |
| 10252-CAB | LTE-TDD (SC-FDMA, 50% RB, 10 MHz, QPSK) | X | 9.16 | 74.5 | 25.8 | 9.24 | 126.3 | ±3.0 % |
| | | Y | 9.62 | 75.0 | 25.8 | | 137.4 | |
| | | Z | 9.16 | 74.8 | 25.9 | | 135.2 | |
| 10267-CAB | LTE-TDD (SC-FDMA, 100% RB, 10 MHz, QPSK) | X | 9.97 | 75.7 | 26.3 | 9.30 | 133.7 | ±3.3 % |
| | | Y | 10.38 | 75.9 | 26.1 | | 146.1 | |
| | | Z | 9.91 | 75.7 | 26.3 | | 143.8 | |
| 10274-CAB | UMTS-FDD (HSUPA, Subtest 5, 3GPP Rel8.10) | X | 5.86 | 66.6 | 18.7 | 4.87 | 129.9 | ±0.9 % |
| | | Y | 6.01 | 67.1 | 19.0 | | 135.7 | |
| | | Z | 5.95 | 67.1 | 19.0 | | 139.4 | |
| 10275-CAB | UMTS-FDD (HSUPA, Subtest 5, 3GPP Rel8.4) | X | 4.40 | 66.7 | 18.6 | 3.96 | 136.4 | ±0.7 % |
| | | Y | 4.55 | 67.3 | 19.0 | | 138.3 | |
| | | Z | 4.56 | 67.6 | 19.1 | | 144.3 | |
| 10291-AAB | CDMA2000, RC3, SO55, Full Rate | X | 3.64 | 66.9 | 18.7 | 3.46 | 127.4 | ±0.5 % |
| | | Y | 3.77 | 67.6 | 19.1 | | 130.2 | |
| | | Z | 3.72 | 67.5 | 19.0 | | 134.4 | |
| 10292-AAB | CDMA2000, RC3, SO32, Full Rate | X | 3.58 | 67.0 | 18.7 | 3.39 | 128.4 | ±0.5 % |
| | | Y | 3.73 | 67.7 | 19.1 | | 132.7 | |
| | | Z | 3.69 | 67.8 | 19.1 | | 136.1 | |
| 10297-AAA | LTE-FDD (SC-FDMA, 50% RB, 20 MHz, QPSK) | X | 6.43 | 67.7 | 19.9 | 5.81 | 145.5 | ±1.4 % |
| | | Y | 6.49 | 67.7 | 19.9 | | 149.5 | |
| | | Z | 6.23 | 67.0 | 19.6 | | 129.5 | |
| 10311-AAA | LTE-FDD (SC-FDMA, 100% RB, 15 MHz, QPSK) | X | 6.74 | 67.3 | 19.8 | 6.06 | 126.7 | ±1.4 % |
| | | Y | 6.83 | 67.5 | 19.8 | | 132.9 | |
| | | Z | 6.81 | 67.6 | 19.9 | | 135.8 | |
| 10315-AAA | IEEE 802.11b WiFi 2.4 GHz (DSSS, 1 Mbps, 96pc duty cycle) | X | 3.00 | 69.9 | 19.4 | 1.71 | 133.9 | ±0.5 % |
| | | Y | 3.30 | 71.5 | 20.1 | | 141.0 | |
| | | Z | 3.22 | 71.4 | 20.0 | | 142.9 | |
| 10316-AAA | IEEE 802.11g WiFi 2.4 GHz (ERP-OFDM, 6 Mbps, 96pc duty cycle) | X | 10.17 | 69.2 | 21.8 | 8.36 | 130.5 | ±2.5 % |
| | | Y | 10.20 | 69.1 | 21.6 | | 138.4 | |
| | | Z | 10.20 | 69.4 | 21.8 | | 140.7 | |

| | | | | | | | | |
|-----------|---|---|-------|------|------|------|-------|--------|
| 10403-AAB | CDMA2000 (1xEV-DO, Rev. 0) | X | 4.75 | 68.3 | 18.8 | 3.76 | 138.5 | ±0.7 % |
| | | Y | 5.00 | 69.1 | 19.2 | | 146.7 | |
| | | Z | 4.92 | 69.2 | 19.1 | | 148.5 | |
| 10404-AAB | CDMA2000 (1xEV-DO, Rev. A) | X | 4.73 | 68.6 | 18.9 | 3.77 | 136.3 | ±0.7 % |
| | | Y | 4.97 | 69.4 | 19.4 | | 143.7 | |
| | | Z | 4.91 | 69.6 | 19.3 | | 146.0 | |
| 10415-AAA | IEEE 802.11b WiFi 2.4 GHz (DSSS, 1 Mbps, 99pc duty cycle) | X | 2.65 | 68.1 | 18.5 | 1.54 | 135.2 | ±0.5 % |
| | | Y | 3.05 | 70.8 | 19.9 | | 140.7 | |
| | | Z | 2.87 | 69.8 | 19.3 | | 144.8 | |
| 10416-AAA | IEEE 802.11g WiFi 2.4 GHz (ERP-OFDM, 6 Mbps, 99pc duty cycle) | X | 10.00 | 69.0 | 21.5 | 8.23 | 130.8 | ±2.2 % |
| | | Y | 10.06 | 68.9 | 21.4 | | 138.6 | |
| | | Z | 10.08 | 69.3 | 21.7 | | 141.6 | |

The reported uncertainty of measurement is stated as the standard uncertainty of measurement multiplied by the coverage factor $k=2$, which for a normal distribution corresponds to a coverage probability of approximately 95%.

^A The uncertainties of NormX,Y,Z do not affect the E^2 -field uncertainty inside TSL (see Pages 8 and 9).

^B Numerical linearization parameter: uncertainty not required.

^E Uncertainty is determined using the max. deviation from linear response applying rectangular distribution and is expressed for the square of the field value.

DASY/EASY - Parameters of Probe: ES3DV3 - SN:3288

Calibration Parameter Determined in Head Tissue Simulating Media

| f (MHz) ^C | Relative Permittivity ^F | Conductivity (S/m) ^F | ConvF X | ConvF Y | ConvF Z | Alpha ^G | Depth ^G (mm) | Unct. (k=2) |
|----------------------|------------------------------------|---------------------------------|---------|---------|---------|--------------------|-------------------------|-------------|
| 750 | 41.9 | 0.89 | 6.81 | 6.81 | 6.81 | 0.37 | 1.70 | ± 12.0 % |
| 835 | 41.5 | 0.90 | 6.51 | 6.51 | 6.51 | 0.45 | 1.52 | ± 12.0 % |
| 1750 | 40.1 | 1.37 | 5.38 | 5.38 | 5.38 | 0.44 | 1.58 | ± 12.0 % |
| 1900 | 40.0 | 1.40 | 5.17 | 5.17 | 5.17 | 0.80 | 1.18 | ± 12.0 % |
| 2450 | 39.2 | 1.80 | 4.56 | 4.56 | 4.56 | 0.80 | 1.21 | ± 12.0 % |
| 2600 | 39.0 | 1.96 | 4.44 | 4.44 | 4.44 | 0.80 | 1.22 | ± 12.0 % |

^C Frequency validity above 300 MHz of ± 100 MHz only applies for DASY v4.4 and higher (see Page 2), else it is restricted to ± 50 MHz. The uncertainty is the RSS of the ConvF uncertainty at calibration frequency and the uncertainty for the indicated frequency band. Frequency validity below 300 MHz is ± 10, 25, 40, 50 and 70 MHz for ConvF assessments at 30, 64, 128, 150 and 220 MHz respectively. Above 5 GHz frequency validity can be extended to ± 110 MHz.

^F At frequencies below 3 GHz, the validity of tissue parameters (ϵ and σ) can be relaxed to ± 10% if liquid compensation formula is applied to measured SAR values. At frequencies above 3 GHz, the validity of tissue parameters (ϵ and σ) is restricted to ± 5%. The uncertainty is the RSS of the ConvF uncertainty for indicated target tissue parameters.

^G Alpha/Depth are determined during calibration. SPEAG warrants that the remaining deviation due to the boundary effect after compensation is always less than ± 1% for frequencies below 3 GHz and below ± 2% for frequencies between 3-6 GHz at any distance larger than half the probe tip diameter from the boundary.

DASY/EASY - Parameters of Probe: ES3DV3 - SN:3288

Calibration Parameter Determined in Body Tissue Simulating Media

| f (MHz) ^C | Relative Permittivity ^F | Conductivity (S/m) ^F | ConvF X | ConvF Y | ConvF Z | Alpha ^G | Depth ^G (mm) | Unct. (k=2) |
|----------------------|------------------------------------|---------------------------------|---------|---------|---------|--------------------|-------------------------|-------------|
| 750 | 55.5 | 0.96 | 6.38 | 6.38 | 6.38 | 0.31 | 1.89 | ± 12.0 % |
| 835 | 55.2 | 0.97 | 6.32 | 6.32 | 6.32 | 0.55 | 1.39 | ± 12.0 % |
| 1750 | 53.4 | 1.49 | 5.03 | 5.03 | 5.03 | 0.57 | 1.44 | ± 12.0 % |
| 1900 | 53.3 | 1.52 | 4.82 | 4.82 | 4.82 | 0.51 | 1.54 | ± 12.0 % |
| 2450 | 52.7 | 1.95 | 4.36 | 4.36 | 4.36 | 0.71 | 1.07 | ± 12.0 % |
| 2600 | 52.5 | 2.16 | 4.22 | 4.22 | 4.22 | 0.80 | 1.07 | ± 12.0 % |

^C Frequency validity above 300 MHz of ± 100 MHz only applies for DASY v4.4 and higher (see Page 2), else it is restricted to ± 50 MHz. The uncertainty is the RSS of the ConvF uncertainty at calibration frequency and the uncertainty for the indicated frequency band. Frequency validity below 300 MHz is ± 10, 25, 40, 50 and 70 MHz for ConvF assessments at 30, 64, 128, 150 and 220 MHz respectively. Above 5 GHz frequency validity can be extended to ± 110 MHz.

^F At frequencies below 3 GHz, the validity of tissue parameters (ϵ and σ) can be relaxed to ± 10% if liquid compensation formula is applied to measured SAR values. At frequencies above 3 GHz, the validity of tissue parameters (ϵ and σ) is restricted to ± 5%. The uncertainty is the RSS of the ConvF uncertainty for indicated target tissue parameters.

^G Alpha/Depth are determined during calibration. SPEAG warrants that the remaining deviation due to the boundary effect after compensation is always less than ± 1% for frequencies below 3 GHz and below ± 2% for frequencies between 3-6 GHz at any distance larger than half the probe tip diameter from the boundary.

Frequency Response of E-Field

(TEM-Cell:ifi1110 EXX, Waveguide: R22)

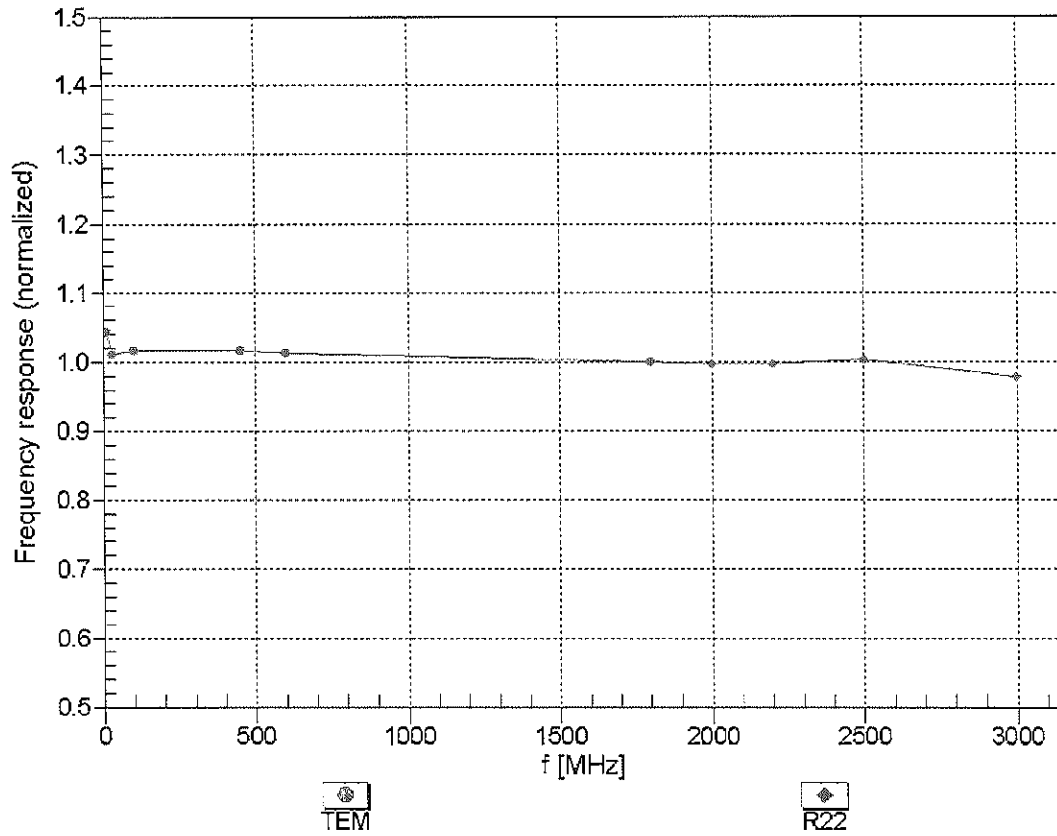

Uncertainty of Frequency Response of E-field: $\pm 6.3\%$ (k=2)

Receiving Pattern (ϕ), $\vartheta = 0^\circ$

f=600 MHz,TEM

f=1800 MHz,R22

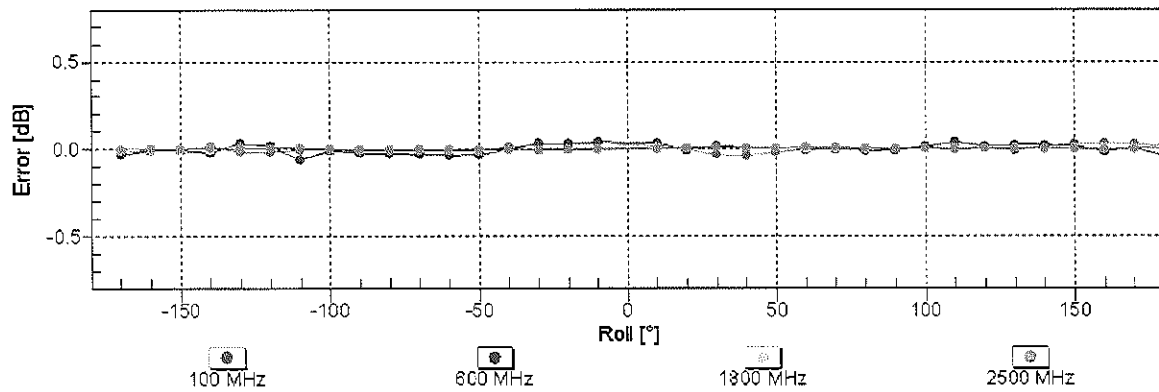
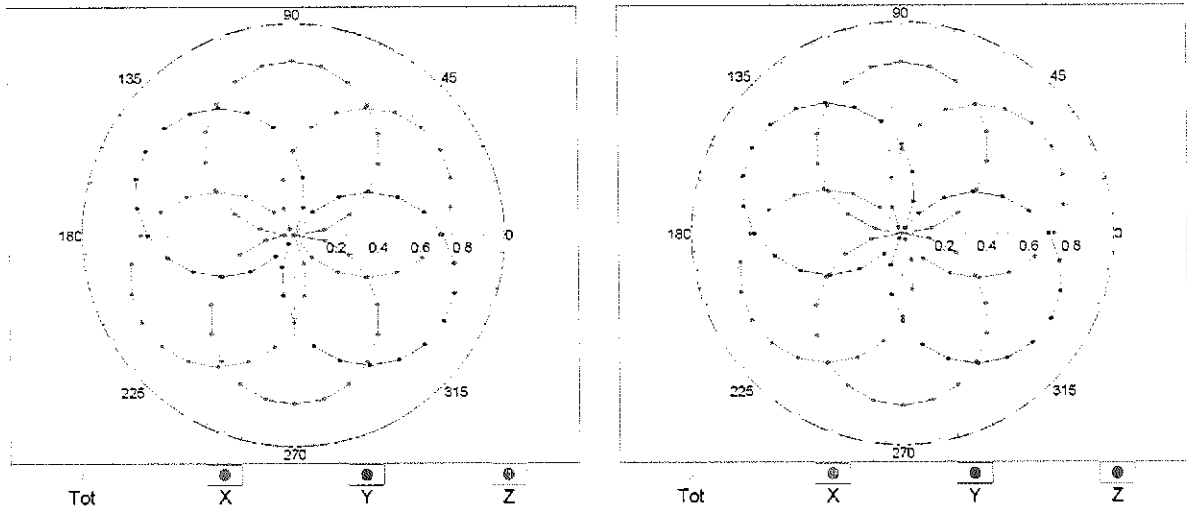

Uncertainty of Axial Isotropy Assessment: $\pm 0.5\%$ (k=2)

Dynamic Range $f(\text{SAR}_{\text{head}})$ (TEM cell , $f_{\text{eval}}= 1900 \text{ MHz}$)

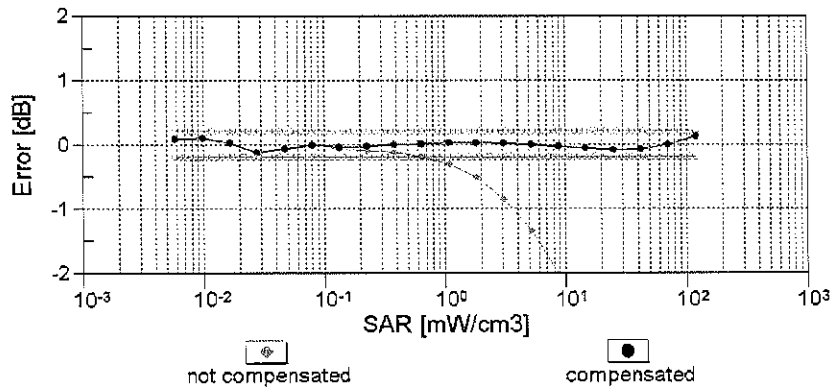
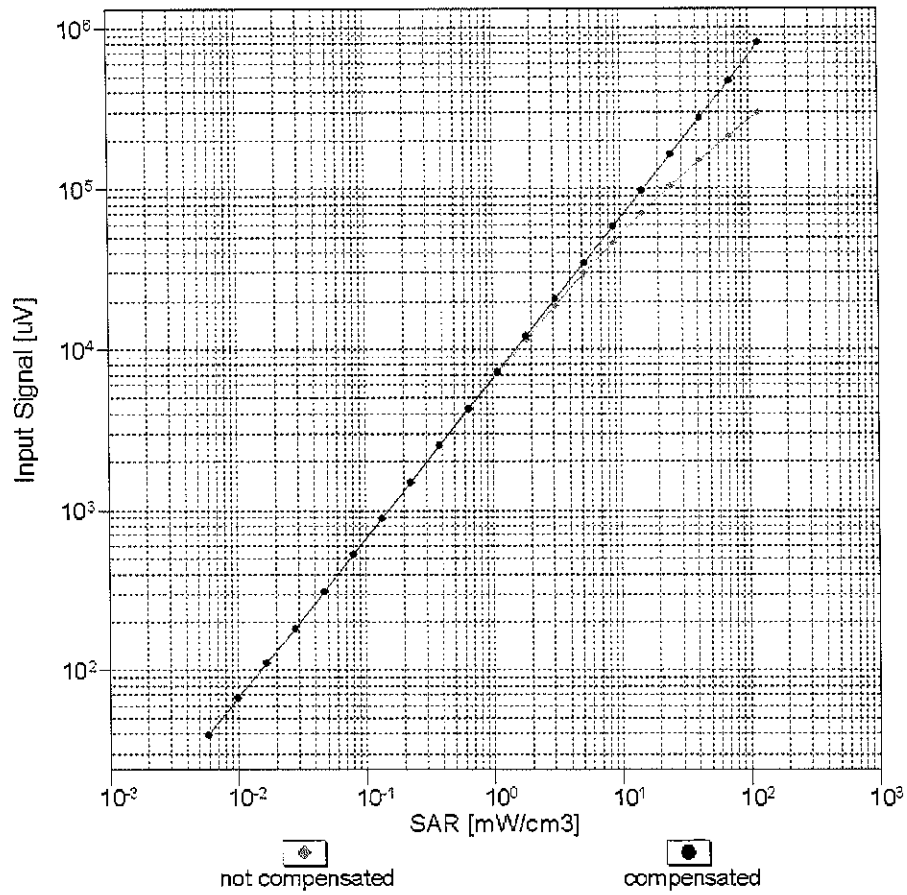

Uncertainty of Linearity Assessment: $\pm 0.6\%$ ($k=2$)

Conversion Factor Assessment

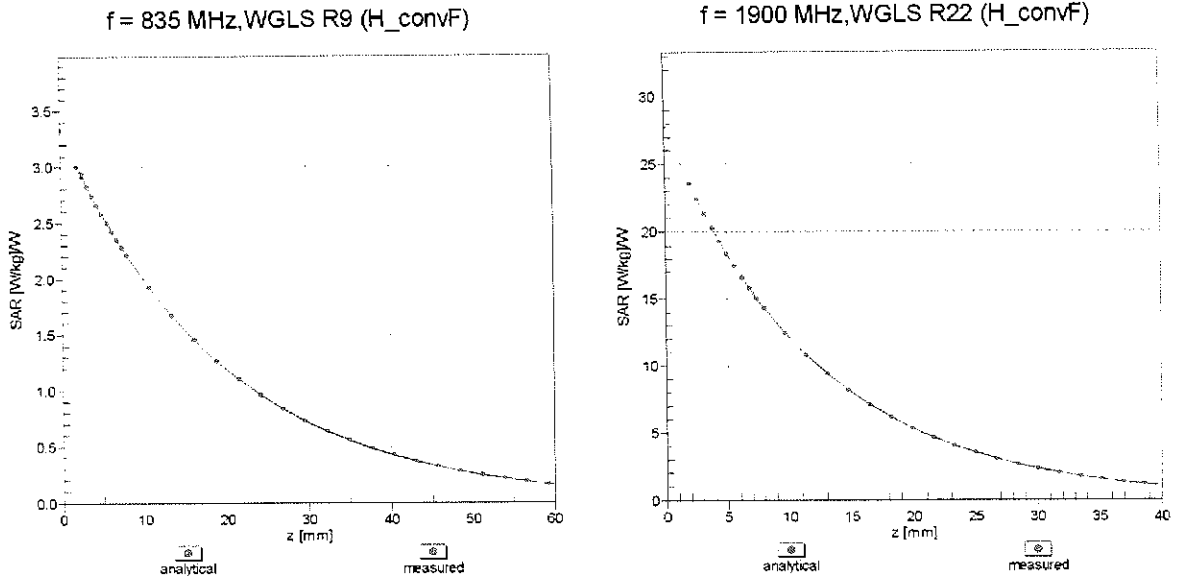

Deviation from Isotropy in Liquid

Error (ϕ, θ), f = 900 MHz

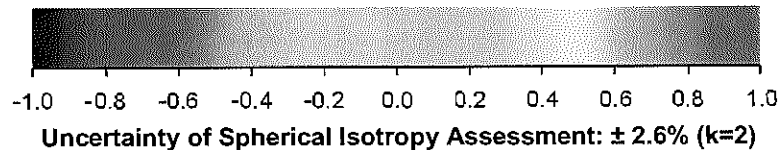
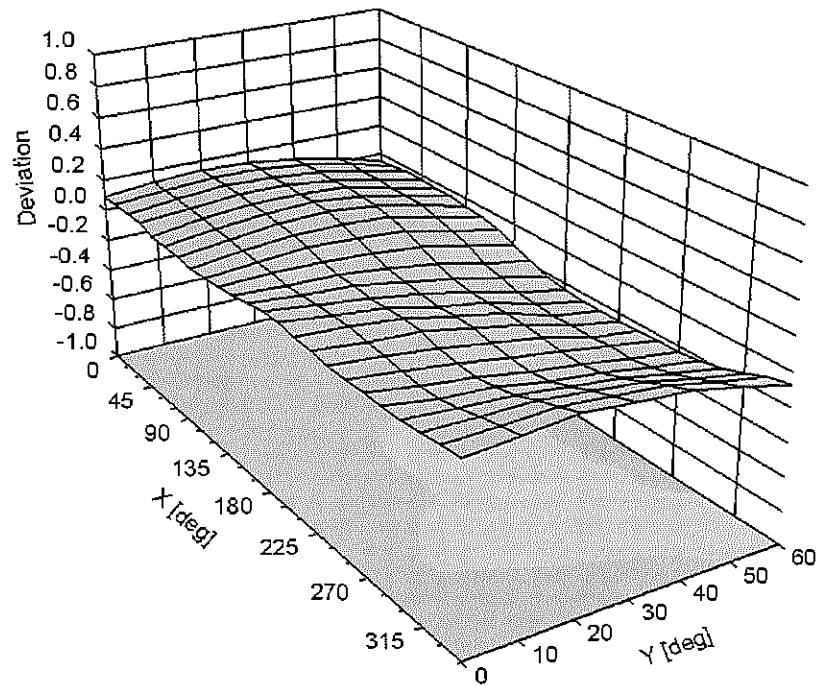

DASY/EASY - Parameters of Probe: ES3DV3 - SN:3288

Other Probe Parameters

| | |
|---|------------|
| Sensor Arrangement | Triangular |
| Connector Angle (°) | -110 |
| Mechanical Surface Detection Mode | enabled |
| Optical Surface Detection Mode | disabled |
| Probe Overall Length | 337 mm |
| Probe Body Diameter | 10 mm |
| Tip Length | 10 mm |
| Tip Diameter | 4 mm |
| Probe Tip to Sensor X Calibration Point | 2 mm |
| Probe Tip to Sensor Y Calibration Point | 2 mm |
| Probe Tip to Sensor Z Calibration Point | 2 mm |
| Recommended Measurement Distance from Surface | 3 mm |



Accredited by the Swiss Accreditation Service (SAS)
The Swiss Accreditation Service is one of the signatories to the EA
Multilateral Agreement for the recognition of calibration certificates

Accreditation No.: **SCS 108**

Client **PC Test**

Certificate No: **ES3-3263_May14**

CALIBRATION CERTIFICATE

Object **ES3DV3 - SN:3263**

Calibration procedure(s) **QA CAL-01.v9, QA CAL-23.v5, QA CAL-25.v6
Calibration procedure for dosimetric E-field probes**

OCV
7/17/14

Calibration date: **May 15, 2014**

This calibration certificate documents the traceability to national standards, which realize the physical units of measurements (SI).
The measurements and the uncertainties with confidence probability are given on the following pages and are part of the certificate.

All calibrations have been conducted in the closed laboratory facility: environment temperature (22 ± 3)°C and humidity < 70%.

Calibration Equipment used (M&TE critical for calibration)

| Primary Standards | ID | Cal Date (Certificate No.) | Scheduled Calibration |
|----------------------------|-----------------|-----------------------------------|------------------------|
| Power meter E4419B | GB41293874 | 03-Apr-14 (No. 217-01911) | Apr-15 |
| Power sensor E4412A | MY41498087 | 03-Apr-14 (No. 217-01911) | Apr-15 |
| Reference 3 dB Attenuator | SN: S5054 (3c) | 03-Apr-14 (No. 217-01915) | Apr-15 |
| Reference 20 dB Attenuator | SN: S5277 (20x) | 03-Apr-14 (No. 217-01919) | Apr-15 |
| Reference 30 dB Attenuator | SN: S5129 (30b) | 03-Apr-14 (No. 217-01920) | Apr-15 |
| Reference Probe ES3DV2 | SN: 3013 | 30-Dec-13 (No. ES3-3013_Dec13) | Dec-14 |
| DAE4 | SN: 660 | 13-Dec-13 (No. DAE4-660_Dec13) | Dec-14 |
| Secondary Standards | ID | Check Date (in house) | Scheduled Check |
| RF generator HP 8648C | US3642U01700 | 4-Aug-99 (in house check Apr-13) | In house check: Apr-16 |
| Network Analyzer HP 8753E | US37390585 | 18-Oct-01 (in house check Oct-13) | In house check: Oct-14 |

| | Name | Function | Signature |
|----------------|----------------|-----------------------|----------------------|
| Calibrated by: | Jeton Kastrati | Laboratory Technician | |
| Approved by: | Katja Pokovic | Technical Manager | |
| | | | Issued: May 15, 2014 |

This calibration certificate shall not be reproduced except in full without written approval of the laboratory.



Accredited by the Swiss Accreditation Service (SAS)
The Swiss Accreditation Service is one of the signatories to the EA
Multilateral Agreement for the recognition of calibration certificates

Accreditation No.: **SCS 108**

Glossary:

| | |
|--------------------------|---|
| TSL | tissue simulating liquid |
| NORM _{x,y,z} | sensitivity in free space |
| ConvF | sensitivity in TSL / NORM _{x,y,z} |
| DCP | diode compression point |
| CF | crest factor (1/duty_cycle) of the RF signal |
| A, B, C, D | modulation dependent linearization parameters |
| Polarization φ | φ rotation around probe axis |
| Polarization ϑ | ϑ rotation around an axis that is in the plane normal to probe axis (at measurement center), i.e., $\vartheta = 0$ is normal to probe axis |
| Connector Angle | information used in DASY system to align probe sensor X to the robot coordinate system |

Calibration is Performed According to the Following Standards:

- IEEE Std 1528-2013, "IEEE Recommended Practice for Determining the Peak Spatial-Averaged Specific Absorption Rate (SAR) in the Human Head from Wireless Communications Devices: Measurement Techniques", June 2013
- IEC 62209-1, "Procedure to measure the Specific Absorption Rate (SAR) for hand-held devices used in close proximity to the ear (frequency range of 300 MHz to 3 GHz)", February 2005

Methods Applied and Interpretation of Parameters:

- NORM_{x,y,z}**: Assessed for E-field polarization $\vartheta = 0$ ($f \leq 900$ MHz in TEM-cell; $f > 1800$ MHz: R22 waveguide). NORM_{x,y,z} are only intermediate values, i.e., the uncertainties of NORM_{x,y,z} does not affect the E²-field uncertainty inside TSL (see below *ConvF*).
- NORM(*f*)_{x,y,z} = NORM_{x,y,z} * frequency_response** (see Frequency Response Chart). This linearization is implemented in DASY4 software versions later than 4.2. The uncertainty of the frequency response is included in the stated uncertainty of *ConvF*.
- DCP_{x,y,z}**: DCP are numerical linearization parameters assessed based on the data of power sweep with CW signal (no uncertainty required). DCP does not depend on frequency nor media.
- PAR**: PAR is the Peak to Average Ratio that is not calibrated but determined based on the signal characteristics
- A_{x,y,z}; B_{x,y,z}; C_{x,y,z}; D_{x,y,z}; VR_{x,y,z}**: A, B, C, D are numerical linearization parameters assessed based on the data of power sweep for specific modulation signal. The parameters do not depend on frequency nor media. VR is the maximum calibration range expressed in RMS voltage across the diode.
- ConvF and Boundary Effect Parameters**: Assessed in flat phantom using E-field (or Temperature Transfer Standard for $f \leq 800$ MHz) and inside waveguide using analytical field distributions based on power measurements for $f > 800$ MHz. The same setups are used for assessment of the parameters applied for boundary compensation (alpha, depth) of which typical uncertainty values are given. These parameters are used in DASY4 software to improve probe accuracy close to the boundary. The sensitivity in TSL corresponds to NORM_{x,y,z} * ConvF whereby the uncertainty corresponds to that given for ConvF. A frequency dependent ConvF is used in DASY version 4.4 and higher which allows extending the validity from ± 50 MHz to ± 100 MHz.
- Spherical isotropy (3D deviation from isotropy)**: in a field of low gradients realized using a flat phantom exposed by a patch antenna.
- Sensor Offset**: The sensor offset corresponds to the offset of virtual measurement center from the probe tip (on probe axis). No tolerance required.
- Connector Angle**: The angle is assessed using the information gained by determining the NORM_x (no uncertainty required).

Probe ES3DV3

SN:3263

Manufactured: January 25, 2010
Calibrated: May 15, 2014

Calibrated for DASYS/EASY Systems
(Note: non-compatible with DASYS2 system!)

DASY/EASY - Parameters of Probe: ES3DV3 - SN:3263

Basic Calibration Parameters

| | Sensor X | Sensor Y | Sensor Z | Unc (k=2) |
|---|----------|----------|----------|--------------|
| Norm ($\mu\text{V}/(\text{V}/\text{m})^2$) ^A | 1.21 | 1.24 | 1.13 | $\pm 10.1\%$ |
| DCP (mV) ^B | 103.8 | 102.3 | 104.7 | |

Modulation Calibration Parameters

| UID | Communication System Name | | A dB | B dB $\sqrt{\mu\text{V}}$ | C | D dB | VR mV | Unc ^E (k=2) |
|---------------|---|---|---------|------------------------------|------|---------|----------|---------------------------|
| 0 | CW | X | 0.0 | 0.0 | 1.0 | 0.00 | 156.3 | $\pm 3.5\%$ |
| | | Y | 0.0 | 0.0 | 1.0 | | 203.1 | |
| | | Z | 0.0 | 0.0 | 1.0 | | 197.2 | |
| 10010- CAA | SAR Validation (Square, 100ms, 10ms) | X | 2.33 | 59.4 | 10.8 | 10.00 | 46.4 | $\pm 1.4\%$ |
| | | Y | 4.39 | 63.4 | 13.6 | | 50.8 | |
| | | Z | 1.35 | 55.5 | 7.8 | | 39.6 | |
| 10011- CAB | UMTS-FDD (WCDMA) | X | 3.49 | 68.2 | 19.1 | 2.91 | 126.7 | $\pm 0.7\%$ |
| | | Y | 3.28 | 66.9 | 18.5 | | 120.7 | |
| | | Z | 2.74 | 63.1 | 15.1 | | 113.5 | |
| 10012- CAA | IEEE 802.11b WiFi 2.4 GHz (DSSS, 1 Mbps) | X | 3.51 | 72.0 | 20.3 | 1.87 | 127.9 | $\pm 0.7\%$ |
| | | Y | 3.21 | 69.4 | 18.8 | | 124.1 | |
| | | Z | 1.93 | 60.6 | 12.6 | | 113.3 | |
| 10013- CAA | IEEE 802.11g WiFi 2.4 GHz (DSSS-OFDM, 6 Mbps) | X | 11.30 | 70.8 | 23.3 | 9.46 | 125.2 | $\pm 2.5\%$ |
| | | Y | 12.42 | 72.7 | 24.4 | | 129.4 | |
| | | Z | 10.03 | 67.8 | 21.1 | | 105.5 | |
| 10021- DAB | GSM-FDD (TDMA, GMSK) | X | 24.45 | 99.1 | 27.6 | 9.39 | 141.4 | $\pm 1.4\%$ |
| | | Y | 29.93 | 99.5 | 29.0 | | 124.5 | |
| | | Z | 4.53 | 73.0 | 18.1 | | 111.6 | |
| 10023- DAB | GPRS-FDD (TDMA, GMSK, TN 0) | X | 25.10 | 99.7 | 27.9 | 9.57 | 134.2 | $\pm 1.9\%$ |
| | | Y | 24.85 | 96.1 | 28.0 | | 120.2 | |
| | | Z | 5.99 | 76.5 | 19.1 | | 142.5 | |
| 10024- DAB | GPRS-FDD (TDMA, GMSK, TN 0-1) | X | 24.34 | 93.0 | 23.0 | 6.56 | 117.1 | $\pm 1.4\%$ |
| | | Y | 26.49 | 92.6 | 24.2 | | 148.7 | |
| | | Z | 4.00 | 69.6 | 13.8 | | 136.6 | |
| 10027- DAB | GPRS-FDD (TDMA, GMSK, TN 0-1-2) | X | 51.24 | 99.9 | 23.5 | 4.80 | 131.1 | $\pm 1.9\%$ |
| | | Y | 56.83 | 99.5 | 24.3 | | 101.8 | |
| | | Z | 1.70 | 61.4 | 9.1 | | 107.7 | |
| 10028- DAB | GPRS-FDD (TDMA, GMSK, TN 0-1-2-3) | X | 60.12 | 99.6 | 22.2 | 3.55 | 138.7 | $\pm 1.9\%$ |
| | | Y | 64.73 | 99.9 | 23.4 | | 105.5 | |
| | | Z | 1.13 | 58.4 | 6.0 | | 116.0 | |
| 10032- CAA | IEEE 802.15.1 Bluetooth (GFSK, DH5) | X | 77.27 | 99.6 | 19.6 | 1.16 | 149.5 | $\pm 2.5\%$ |
| | | Y | 60.44 | 99.7 | 21.0 | | 109.4 | |
| | | Z | 0.34 | 55.9 | 2.9 | | 131.4 | |
| 10039- CAB | CDMA2000 (1xRTT, RC1) | X | 4.79 | 66.8 | 19.0 | 4.57 | 124.5 | $\pm 0.9\%$ |
| | | Y | 4.85 | 66.4 | 18.8 | | 125.6 | |
| | | Z | 4.06 | 63.4 | 16.1 | | 108.1 | |

| | | | | | | | | |
|-----------|---|---|-------|------|------|------|-------|--------|
| 10081-CAB | CDMA2000 (1xRTT, RC3) | X | 3.93 | 66.1 | 18.5 | 3.97 | 119.8 | ±0.7 % |
| | | Y | 3.90 | 65.5 | 18.2 | | 120.1 | |
| | | Z | 3.29 | 62.4 | 15.3 | | 108.5 | |
| 10098-CAB | UMTS-FDD (HSUPA, Subtest 2) | X | 4.68 | 66.9 | 18.7 | 3.98 | 131.2 | ±0.7 % |
| | | Y | 4.64 | 66.6 | 18.6 | | 130.5 | |
| | | Z | 4.15 | 64.5 | 16.5 | | 118.8 | |
| 10100-CAB | LTE-FDD (SC-FDMA, 100% RB, 20 MHz, QPSK) | X | 6.61 | 68.1 | 20.0 | 5.67 | 137.5 | ±1.7 % |
| | | Y | 6.70 | 68.4 | 20.2 | | 137.7 | |
| | | Z | 5.90 | 65.6 | 17.9 | | 124.0 | |
| 10108-CAB | LTE-FDD (SC-FDMA, 100% RB, 10 MHz, QPSK) | X | 6.44 | 67.5 | 19.8 | 5.80 | 135.1 | ±1.7 % |
| | | Y | 6.60 | 68.0 | 20.1 | | 135.4 | |
| | | Z | 5.75 | 64.9 | 17.6 | | 121.8 | |
| 10110-CAB | LTE-FDD (SC-FDMA, 100% RB, 5 MHz, QPSK) | X | 6.14 | 67.1 | 19.7 | 5.75 | 131.6 | ±1.2 % |
| | | Y | 6.28 | 67.4 | 19.9 | | 132.7 | |
| | | Z | 5.62 | 65.5 | 18.2 | | 118.4 | |
| 10114-CAA | IEEE 802.11n (HT Greenfield, 13.5 Mbps, BPSK) | X | 10.18 | 68.8 | 21.2 | 8.10 | 124.3 | ±1.9 % |
| | | Y | 10.60 | 69.7 | 21.8 | | 126.2 | |
| | | Z | 9.38 | 67.0 | 19.8 | | 108.4 | |
| 10117-CAA | IEEE 802.11n (HT Mixed, 13.5 Mbps, BPSK) | X | 10.23 | 68.9 | 21.3 | 8.07 | 125.0 | ±1.9 % |
| | | Y | 10.56 | 69.6 | 21.7 | | 127.1 | |
| | | Z | 9.37 | 67.1 | 19.8 | | 109.1 | |
| 10151-CAB | LTE-TDD (SC-FDMA, 50% RB, 20 MHz, QPSK) | X | 10.23 | 75.7 | 26.0 | 9.28 | 125.0 | ±2.7 % |
| | | Y | 14.60 | 83.3 | 29.5 | | 147.3 | |
| | | Z | 8.05 | 69.7 | 22.3 | | 106.3 | |
| 10154-CAB | LTE-FDD (SC-FDMA, 50% RB, 10 MHz, QPSK) | X | 6.12 | 67.0 | 19.6 | 5.75 | 131.6 | ±1.4 % |
| | | Y | 6.28 | 67.4 | 19.9 | | 132.4 | |
| | | Z | 5.49 | 64.7 | 17.4 | | 117.9 | |
| 10160-CAB | LTE-FDD (SC-FDMA, 50% RB, 15 MHz, QPSK) | X | 6.57 | 67.5 | 19.8 | 5.82 | 136.0 | ±1.4 % |
| | | Y | 6.71 | 67.9 | 20.1 | | 137.1 | |
| | | Z | 5.89 | 65.2 | 17.8 | | 122.4 | |
| 10169-CAB | LTE-FDD (SC-FDMA, 1 RB, 20 MHz, QPSK) | X | 4.82 | 66.0 | 19.3 | 5.73 | 113.5 | ±1.4 % |
| | | Y | 5.12 | 66.3 | 19.4 | | 116.6 | |
| | | Z | 4.75 | 65.9 | 18.3 | | 142.7 | |
| 10172-CAB | LTE-TDD (SC-FDMA, 1 RB, 20 MHz, QPSK) | X | 9.53 | 80.6 | 28.6 | 9.21 | 136.5 | ±2.2 % |
| | | Y | 11.32 | 81.6 | 28.8 | | 109.2 | |
| | | Z | 6.84 | 72.0 | 23.8 | | 117.3 | |
| 10175-CAB | LTE-FDD (SC-FDMA, 1 RB, 10 MHz, QPSK) | X | 4.86 | 66.2 | 19.4 | 5.72 | 112.9 | ±1.2 % |
| | | Y | 5.10 | 66.2 | 19.4 | | 115.9 | |
| | | Z | 4.55 | 64.9 | 17.8 | | 137.7 | |
| 10181-CAB | LTE-FDD (SC-FDMA, 1 RB, 15 MHz, QPSK) | X | 4.81 | 66.0 | 19.2 | 5.72 | 111.6 | ±1.2 % |
| | | Y | 5.13 | 66.4 | 19.5 | | 116.1 | |
| | | Z | 4.70 | 65.7 | 18.3 | | 137.1 | |
| 10193-CAA | IEEE 802.11n (HT Greenfield, 6.5 Mbps, BPSK) | X | 9.80 | 68.3 | 21.0 | 8.09 | 117.2 | ±2.2 % |
| | | Y | 10.23 | 69.1 | 21.6 | | 121.5 | |
| | | Z | 9.85 | 68.9 | 20.8 | | 148.4 | |

| | | | | | | | | |
|-----------|---|---|-------|------|------|------|-------|--------|
| 10196-CAA | IEEE 802.11n (HT Mixed, 6.5 Mbps, BPSK) | X | 9.81 | 68.4 | 21.1 | 8.10 | 117.7 | ±2.2 % |
| | | Y | 10.23 | 69.2 | 21.6 | | 121.7 | |
| | | Z | 9.87 | 69.0 | 20.9 | | 149.9 | |
| 10219-CAA | IEEE 802.11n (HT Mixed, 7.2 Mbps, BPSK) | X | 9.71 | 68.3 | 21.0 | 8.03 | 117.8 | ±2.2 % |
| | | Y | 10.12 | 69.1 | 21.6 | | 121.0 | |
| | | Z | 8.90 | 66.6 | 19.6 | | 104.1 | |
| 10222-CAA | IEEE 802.11n (HT Mixed, 15 Mbps, BPSK) | X | 10.14 | 68.7 | 21.2 | 8.06 | 122.3 | ±1.9 % |
| | | Y | 10.52 | 69.5 | 21.7 | | 125.4 | |
| | | Z | 9.28 | 66.8 | 19.6 | | 108.5 | |
| 10225-CAB | UMTS-FDD (HSPA+) | X | 7.25 | 67.8 | 19.9 | 5.97 | 146.3 | ±1.7 % |
| | | Y | 7.32 | 67.5 | 19.8 | | 149.3 | |
| | | Z | 6.52 | 65.7 | 18.0 | | 130.7 | |
| 10237-CAB | LTE-TDD (SC-FDMA, 1 RB, 10 MHz, QPSK) | X | 9.55 | 80.7 | 28.7 | 9.21 | 137.2 | ±2.5 % |
| | | Y | 11.34 | 81.7 | 28.9 | | 109.9 | |
| | | Z | 6.98 | 72.5 | 24.0 | | 119.5 | |
| 10252-CAB | LTE-TDD (SC-FDMA, 50% RB, 10 MHz, QPSK) | X | 9.26 | 74.1 | 25.3 | 9.24 | 115.6 | ±3.3 % |
| | | Y | 13.72 | 82.5 | 29.3 | | 137.9 | |
| | | Z | 8.83 | 73.3 | 24.4 | | 144.1 | |
| 10267-CAB | LTE-TDD (SC-FDMA, 100% RB, 10 MHz, QPSK) | X | 10.06 | 75.2 | 25.8 | 9.30 | 122.9 | ±2.7 % |
| | | Y | 14.69 | 83.4 | 29.6 | | 147.6 | |
| | | Z | 8.02 | 69.6 | 22.3 | | 103.4 | |
| 10274-CAB | UMTS-FDD (HSUPA, Subtest 5, 3GPP Rel8.10) | X | 6.08 | 67.2 | 19.0 | 4.87 | 140.2 | ±1.2 % |
| | | Y | 6.23 | 67.5 | 19.2 | | 143.5 | |
| | | Z | 5.52 | 65.4 | 17.4 | | 125.1 | |
| 10275-CAB | UMTS-FDD (HSUPA, Subtest 5, 3GPP Rel8.4) | X | 4.44 | 66.7 | 18.7 | 3.96 | 122.1 | ±0.7 % |
| | | Y | 4.39 | 66.3 | 18.5 | | 124.4 | |
| | | Z | 3.83 | 63.7 | 16.0 | | 114.0 | |
| 10291-AAB | CDMA2000, RC3, SO55, Full Rate | X | 3.64 | 66.7 | 18.6 | 3.46 | 115.7 | ±0.7 % |
| | | Y | 3.60 | 66.0 | 18.2 | | 118.0 | |
| | | Z | 3.17 | 64.2 | 16.3 | | 108.4 | |
| 10292-AAB | CDMA2000, RC3, SO32, Full Rate | X | 3.62 | 67.0 | 18.8 | 3.39 | 116.9 | ±0.9 % |
| | | Y | 3.54 | 66.1 | 18.2 | | 119.1 | |
| | | Z | 3.24 | 64.2 | 15.8 | | 145.6 | |
| 10297-AAA | LTE-FDD (SC-FDMA, 50% RB, 20 MHz, QPSK) | X | 6.43 | 67.5 | 19.8 | 5.81 | 132.0 | ±1.4 % |
| | | Y | 6.60 | 68.0 | 20.1 | | 134.9 | |
| | | Z | 5.81 | 65.4 | 18.0 | | 115.0 | |
| 10311-AAA | LTE-FDD (SC-FDMA, 100% RB, 15 MHz, QPSK) | X | 7.04 | 68.1 | 20.2 | 6.06 | 137.5 | ±1.4 % |
| | | Y | 7.19 | 68.6 | 20.5 | | 140.3 | |
| | | Z | 6.26 | 65.7 | 18.2 | | 119.6 | |
| 10315-AAA | IEEE 802.11b WiFi 2.4 GHz (DSSS, 1 Mbps, 96pc duty cycle) | X | 3.05 | 70.0 | 19.4 | 1.71 | 121.7 | ±0.7 % |
| | | Y | 2.91 | 68.7 | 18.7 | | 123.4 | |
| | | Z | 1.83 | 60.2 | 12.3 | | 108.4 | |
| 10316-AAA | IEEE 802.11g WiFi 2.4 GHz (ERP-OFDM, 6 Mbps, 96pc duty cycle) | X | 10.05 | 68.7 | 21.4 | 8.36 | 117.3 | ±1.9 % |
| | | Y | 10.57 | 69.7 | 22.0 | | 122.8 | |
| | | Z | 9.11 | 66.5 | 19.7 | | 103.1 | |

| | | | | | | | | |
|-----------|---|---|-------|------|------|------|-------|--------|
| 10403-AAB | CDMA2000 (1xEV-DO, Rev. 0) | X | 4.81 | 68.3 | 18.8 | 3.76 | 125.8 | ±0.7 % |
| | | Y | 4.65 | 66.5 | 18.1 | | 130.8 | |
| | | Z | 3.98 | 64.7 | 16.0 | | 114.7 | |
| 10404-AAB | CDMA2000 (1xEV-DO, Rev. A) | X | 4.91 | 69.1 | 19.2 | 3.77 | 123.3 | ±0.7 % |
| | | Y | 4.60 | 66.6 | 18.1 | | 128.5 | |
| | | Z | 3.73 | 64.0 | 15.4 | | 112.0 | |
| 10415-AAA | IEEE 802.11b WiFi 2.4 GHz (DSSS, 1 Mbps, 99pc duty cycle) | X | 2.78 | 69.0 | 19.0 | 1.54 | 121.9 | ±0.7 % |
| | | Y | 2.46 | 66.8 | 17.9 | | 122.5 | |
| | | Z | 1.83 | 60.9 | 13.0 | | 112.4 | |
| 10416-AAA | IEEE 802.11g WiFi 2.4 GHz (ERP-OFDM, 6 Mbps, 99pc duty cycle) | X | 9.88 | 68.4 | 21.2 | 8.23 | 116.6 | ±1.7 % |
| | | Y | 10.29 | 69.2 | 21.7 | | 121.5 | |
| | | Z | 9.25 | 67.3 | 20.2 | | 103.4 | |

The reported uncertainty of measurement is stated as the standard uncertainty of measurement multiplied by the coverage factor $k=2$, which for a normal distribution corresponds to a coverage probability of approximately 95%.

^A The uncertainties of NormX,Y,Z do not affect the E^2 -field uncertainty inside TSL (see Pages 8 and 9).

^B Numerical linearization parameter: uncertainty not required.

^E Uncertainty is determined using the max. deviation from linear response applying rectangular distribution and is expressed for the square of the field value.

DASY/EASY - Parameters of Probe: ES3DV3 - SN:3263

Calibration Parameter Determined in Head Tissue Simulating Media

| f (MHz) ^C | Relative Permittivity ^F | Conductivity (S/m) ^F | ConvF X | ConvF Y | ConvF Z | Alpha ^G | Depth ^G (mm) | Unct. (k=2) |
|----------------------|------------------------------------|---------------------------------|---------|---------|---------|--------------------|-------------------------|-------------|
| 750 | 41.9 | 0.89 | 6.42 | 6.42 | 6.42 | 0.72 | 1.18 | ± 12.0 % |
| 835 | 41.5 | 0.90 | 6.23 | 6.23 | 6.23 | 0.27 | 2.02 | ± 12.0 % |
| 1750 | 40.1 | 1.37 | 5.41 | 5.41 | 5.41 | 0.74 | 1.23 | ± 12.0 % |
| 1900 | 40.0 | 1.40 | 5.08 | 5.08 | 5.08 | 0.80 | 1.16 | ± 12.0 % |
| 2450 | 39.2 | 1.80 | 4.47 | 4.47 | 4.47 | 0.80 | 1.22 | ± 12.0 % |
| 2600 | 39.0 | 1.96 | 4.33 | 4.33 | 4.33 | 0.66 | 1.41 | ± 12.0 % |

^C Frequency validity of ± 100 MHz only applies for DASY v4.4 and higher (see Page 2), else it is restricted to ± 50 MHz. The uncertainty is the RSS of the ConvF uncertainty at calibration frequency and the uncertainty for the indicated frequency band.

^F At frequencies below 3 GHz, the validity of tissue parameters (ϵ and σ) can be relaxed to ± 10% if liquid compensation formula is applied to measured SAR values. At frequencies above 3 GHz, the validity of tissue parameters (ϵ and σ) is restricted to ± 5%. The uncertainty is the RSS of the ConvF uncertainty for indicated target tissue parameters.

^G Alpha/Depth are determined during calibration. SPEAG warrants that the remaining deviation due to the boundary effect after compensation is always less than ± 1% for frequencies below 3 GHz and below ± 2% for frequencies between 3-6 GHz at any distance larger than half the probe tip diameter from the boundary.

DASY/EASY - Parameters of Probe: ES3DV3 - SN:3263

Calibration Parameter Determined in Body Tissue Simulating Media

| f (MHz) ^C | Relative Permittivity ^F | Conductivity (S/m) ^F | ConvF X | ConvF Y | ConvF Z | Alpha ^G | Depth (mm) ^G | Unct. (k=2) |
|----------------------|------------------------------------|---------------------------------|---------|---------|---------|--------------------|-------------------------|-------------|
| 750 | 55.5 | 0.96 | 6.19 | 6.19 | 6.19 | 0.52 | 1.41 | ± 12.0 % |
| 835 | 55.2 | 0.97 | 6.16 | 6.16 | 6.16 | 0.68 | 1.28 | ± 12.0 % |
| 1750 | 53.4 | 1.49 | 4.98 | 4.98 | 4.98 | 0.38 | 1.91 | ± 12.0 % |
| 1900 | 53.3 | 1.52 | 4.78 | 4.78 | 4.78 | 0.66 | 1.35 | ± 12.0 % |
| 2450 | 52.7 | 1.95 | 4.27 | 4.27 | 4.27 | 0.72 | 1.13 | ± 12.0 % |
| 2600 | 52.5 | 2.16 | 4.11 | 4.11 | 4.11 | 0.74 | 1.07 | ± 12.0 % |

^C Frequency validity of ± 100 MHz only applies for DASY v4.4 and higher (see Page 2), else it is restricted to ± 50 MHz. The uncertainty is the RSS of the ConvF uncertainty at calibration frequency and the uncertainty for the indicated frequency band.

^F At frequencies below 3 GHz, the validity of tissue parameters (ϵ and σ) can be relaxed to ± 10% if liquid compensation formula is applied to measured SAR values. At frequencies above 3 GHz, the validity of tissue parameters (ϵ and σ) is restricted to ± 5%. The uncertainty is the RSS of the ConvF uncertainty for indicated target tissue parameters.

^G Alpha/Depth are determined during calibration. SPEAG warrants that the remaining deviation due to the boundary effect after compensation is always less than ± 1% for frequencies below 3 GHz and below ± 2% for frequencies between 3-6 GHz at any distance larger than half the probe tip diameter from the boundary.

Frequency Response of E-Field (TEM-Cell:ifi110 EXX, Waveguide: R22)

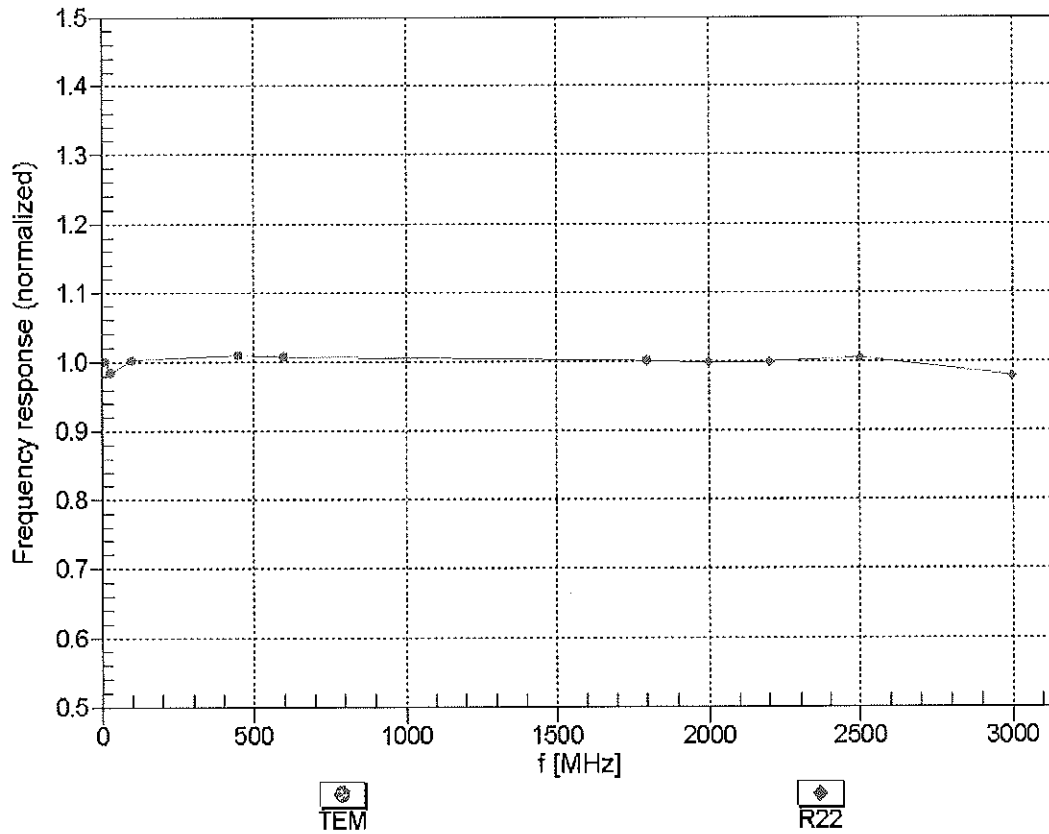

Uncertainty of Frequency Response of E-field: $\pm 6.3\%$ (k=2)

Receiving Pattern (ϕ), $\theta = 0^\circ$

f=600 MHz,TEM

f=1800 MHz,R22

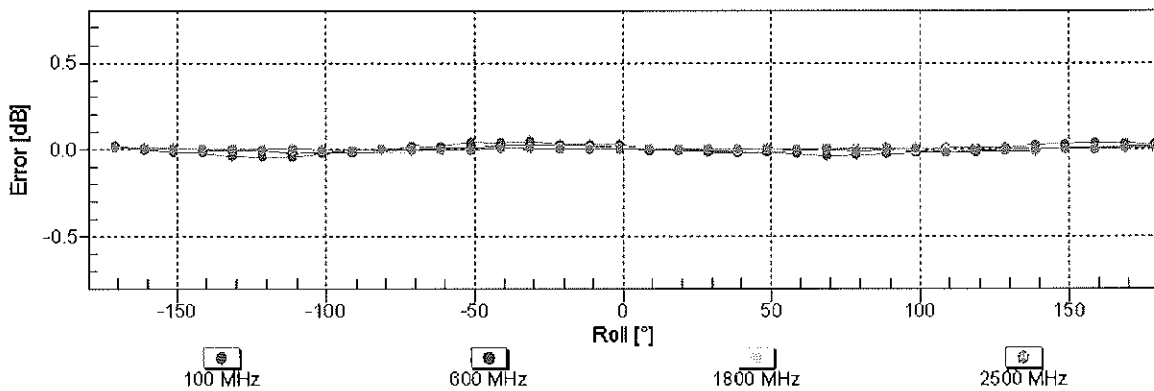
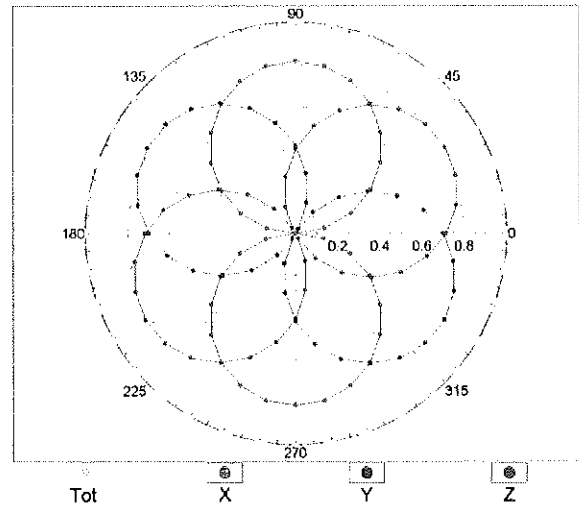
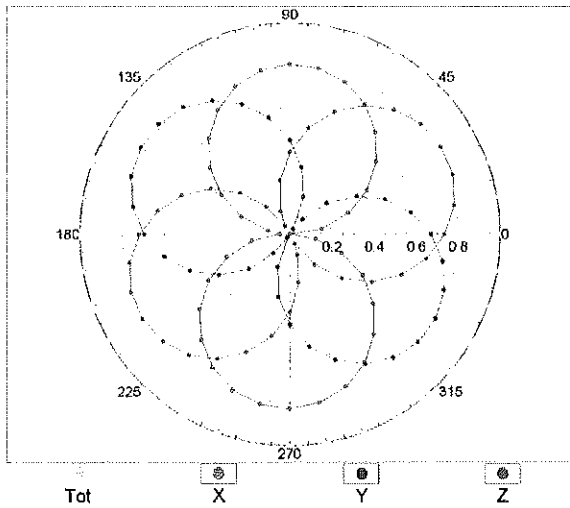

Uncertainty of Axial Isotropy Assessment: $\pm 0.5\%$ (k=2)

Dynamic Range $f(\text{SAR}_{\text{head}})$ (TEM cell , $f_{\text{eval}}=1900 \text{ MHz}$)

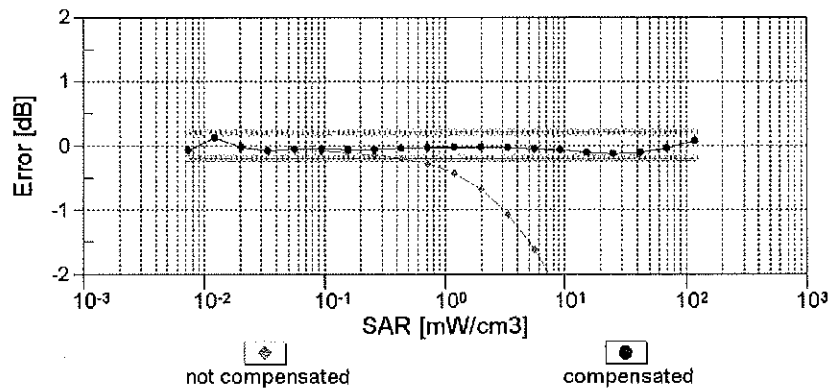
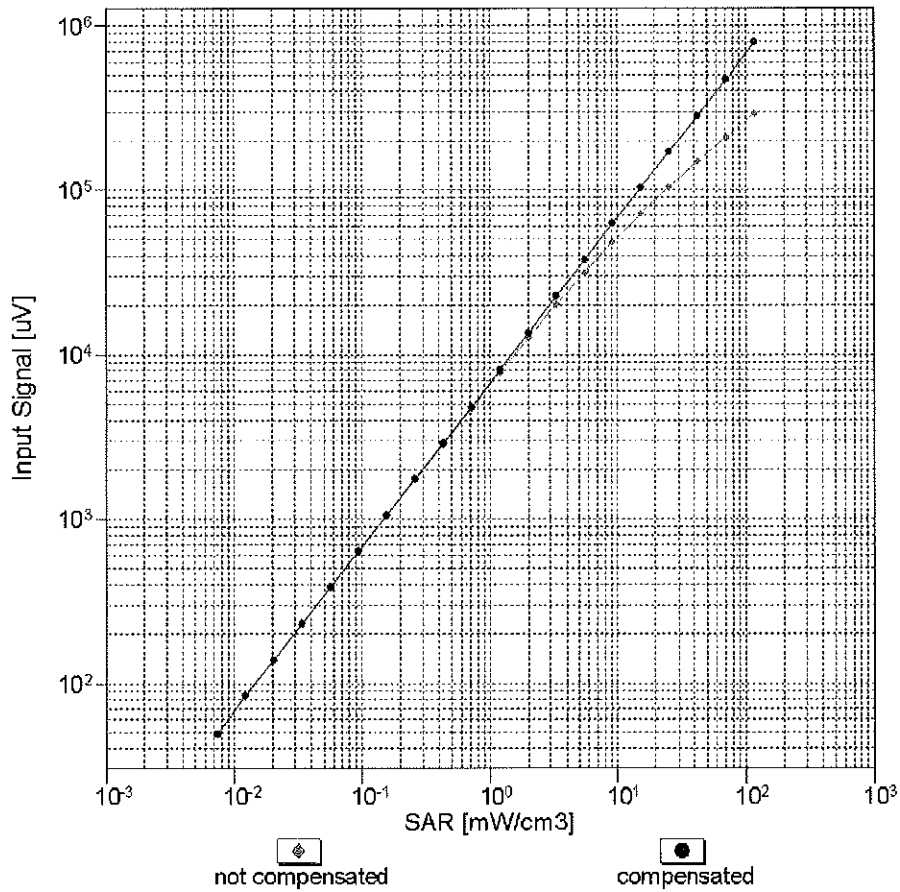

Uncertainty of Linearity Assessment: $\pm 0.6\%$ ($k=2$)

Conversion Factor Assessment

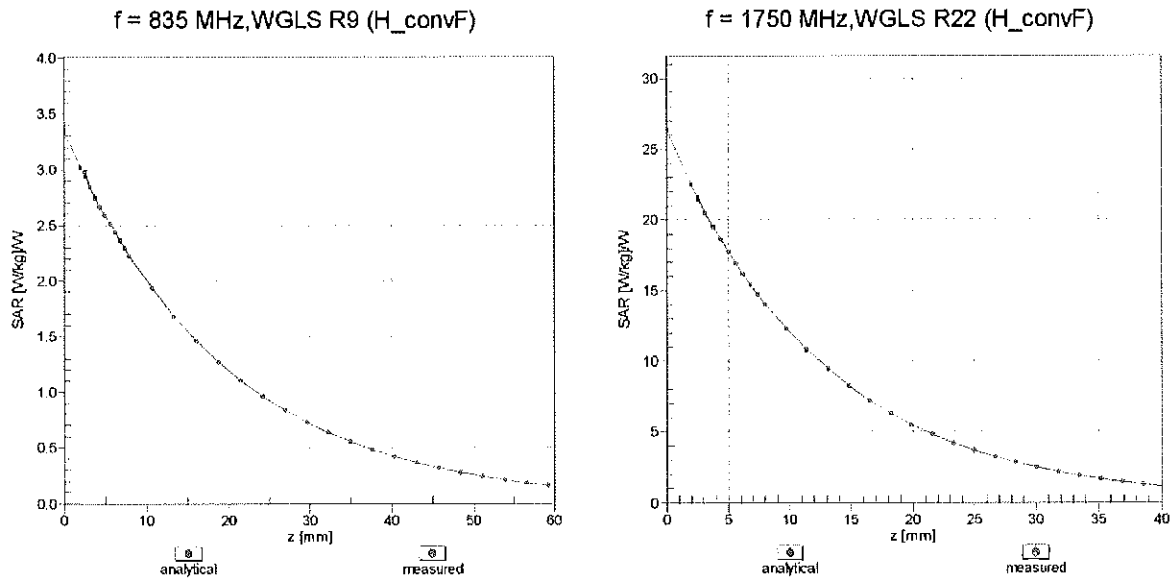

Deviation from Isotropy in Liquid Error (ϕ, ϑ), f = 900 MHz

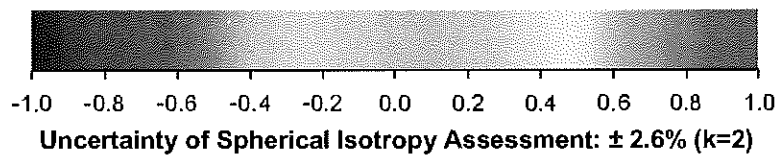
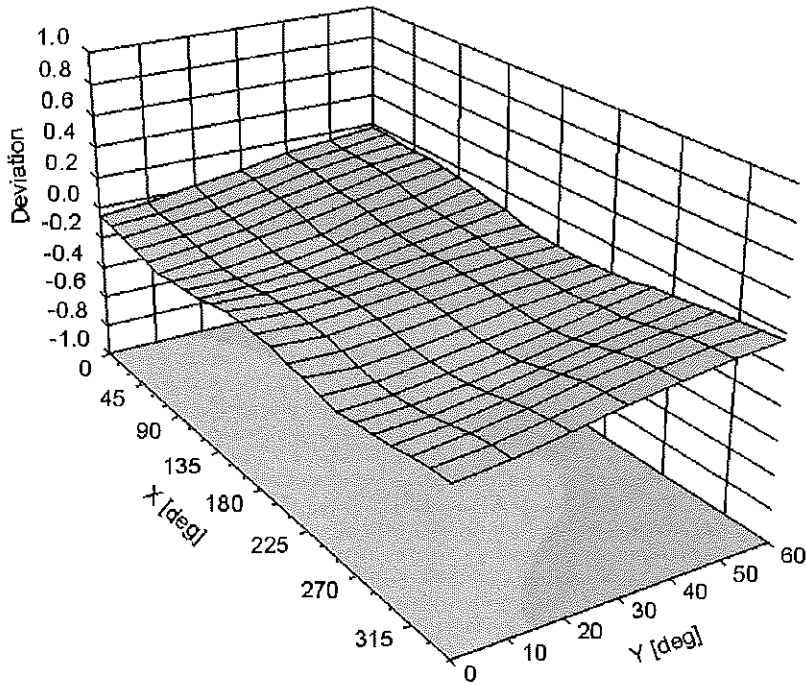

DASY/EASY - Parameters of Probe: ES3DV3 - SN:3263

Other Probe Parameters

| | |
|---|------------|
| Sensor Arrangement | Triangular |
| Connector Angle (°) | -111.2 |
| Mechanical Surface Detection Mode | enabled |
| Optical Surface Detection Mode | disabled |
| Probe Overall Length | 337 mm |
| Probe Body Diameter | 10 mm |
| Tip Length | 10 mm |
| Tip Diameter | 4 mm |
| Probe Tip to Sensor X Calibration Point | 2 mm |
| Probe Tip to Sensor Y Calibration Point | 2 mm |
| Probe Tip to Sensor Z Calibration Point | 2 mm |
| Recommended Measurement Distance from Surface | 3 mm |

APPENDIX D: SAR TISSUE SPECIFICATIONS

Measurement Procedure for Tissue verification:



- 1) The network analyzer and probe system was configured and calibrated.
- 2) The probe was immersed in the tissue. The tissue was placed in a nonmetallic container. Trapped air bubbles beneath the flange were minimized by placing the probe at a slight angle.
- 3) The complex admittance with respect to the probe aperture was measured
- 4) The complex relative permittivity ϵ can be calculated from the below equation (Pournaropoulos and Misra):

$$Y = \frac{j2\omega\epsilon_r\epsilon_0}{[\ln(b/a)]^2} \int_a^b \int_a^b \int_0^\pi \cos\phi' \frac{\exp[-j\omega r(\mu_0\epsilon_r'\epsilon_0)^{1/2}]}{r} d\phi' d\rho' d\rho$$

where Y is the admittance of the probe in contact with the sample, the primed and unprimed coordinates refer to source and observation points, respectively, $r^2 = \rho^2 + \rho'^2 - 2\rho\rho' \cos\phi'$, ω is the angular frequency, and $j = \sqrt{-1}$.

**Table D-I
Composition of the Tissue Equivalent Matter**

| Frequency (MHz) | 750 | 750 | 835 | 835 | 1750 | 1750 | 1900 | 1900 | 2450 | 2450 | 5200-5800 | 5200-5800 |
|---------------------------|--------------|------------|-------|-------|------|------|-------|-------|------------|------|------------|-----------|
| Tissue | Head | Body | Head | Body | Head | Body | Head | Body | Head | Body | Head | Body |
| Ingredients (% by weight) | | | | | | | | | | | | |
| Bactericide | See page 2-3 | See page 2 | 0.1 | 0.1 | | | | | See page 4 | 26.7 | See page 5 | |
| DGBE | | | | | 47 | 31 | 44.92 | 29.44 | | | | |
| HFC | | | 1 | 1 | | | | | | | | |
| NaCl | | | 1.45 | 0.94 | 0.4 | 0.2 | 0.18 | 0.39 | | | | |
| Sucrose | | | 57 | 44.9 | | | | | | | | |
| Polysorbate (Tween) 80 | | | | | | | | | | | | |
| Water | | | 40.45 | 53.06 | 52.6 | 68.8 | 54.9 | 70.17 | | 73.2 | | 80 |

| | | | | |
|------------------------------------|---|-----------------------|---|---------------------------------|
| FCC ID: ZNFH950 |  | SAR EVALUATION REPORT |  | Reviewed by: Quality Manager |
| Test Dates: 01/12/15 - 01/22/15 | DUT Type: Portable Handset | | | APPENDIX D: Page 1 of 5 |

2 Composition / Information on ingredients

The Item is composed of the following ingredients:

| | |
|------------------------|---|
| H ₂ O | Water, 35 – 58% |
| Sucrose | Sugar, white, refined, 40 – 60% |
| NaCl | Sodium Chloride, 0 – 6% |
| Hydroxyethyl-cellulose | Medium Viscosity (CAS# 9004-62-0), <0.3% |
| Preventol-D7 | Preservative: aqueous preparation, (CAS# 55965-84-9), containing 5-chloro-2-methyl-3(2H)-isothiazolone and 2-methyl-3(2H)-isothiazolone, 0.1 – 0.7% |

Relevant for safety; Refer to the respective Safety Data Sheet*.

Figure D-1

Composition of 750 MHz Head and Body Tissue Equivalent Matter

Note: 750MHz liquid recipes are proprietary SPEAG. Since the composition is approximate to the actual liquids utilized, the manufacturer tissue-equivalent liquid data sheets are provided below.

Measurement Certificate / Material Test

| | |
|--------------|--|
| Item Name | Body Tissue Simulating Liquid (MSL750V2) |
| Product No. | SL AAM 075 AA (Charge: 130313-1) |
| Manufacturer | SPEAG |

Measurement Method

TSL dielectric parameters measured using calibrated OCP probe.

Setup Validation

Validation results were within $\pm 2.5\%$ towards the target values of Methanol.

Target Parameters

Target parameters as defined in the IEEE 1528 and IEC 62209 compliance standards.

Test Condition

Ambient Environment temperature (22 ± 3)°C and humidity < 70%.
 TSL Temperature 22°C
 Test Date 13-Mar-13
 Operator IEN

Additional Information

TSL Density 1.212 g/cm³
 TSL Heat-capacity 3.006 kJ/(kg*K)

| f [MHz] | Measured | | | Target | | Diff.to Target [%] | |
|------------|-------------|--------------|-------------|-------------|-------------|--------------------|-------------|
| | HP-e' | HP-e'' | sigma | eps | sigma | Δ-eps | Δ-sigma |
| 600 | 57.5 | 24.64 | 0.82 | 56.1 | 0.95 | 2.5 | -13.6 |
| 625 | 57.2 | 24.31 | 0.84 | 56.0 | 0.95 | 2.1 | -11.4 |
| 650 | 57.0 | 23.99 | 0.87 | 55.9 | 0.96 | 1.8 | -9.2 |
| 675 | 56.7 | 23.69 | 0.89 | 55.8 | 0.96 | 1.5 | -7.1 |
| 700 | 56.4 | 23.39 | 0.91 | 55.7 | 0.96 | 1.2 | -5.1 |
| 725 | 56.2 | 23.18 | 0.93 | 55.6 | 0.96 | 1.0 | -2.8 |
| 750 | 55.9 | 22.97 | 0.96 | 55.5 | 0.96 | 0.7 | -0.5 |
| 775 | 55.7 | 22.78 | 0.98 | 55.4 | 0.97 | 0.4 | 1.7 |
| 800 | 55.4 | 22.60 | 1.01 | 55.3 | 0.97 | 0.1 | 4.0 |
| 825 | 55.2 | 22.44 | 1.03 | 55.2 | 0.98 | -0.2 | 5.3 |
| 850 | 55.0 | 22.38 | 1.04 | 55.2 | 0.98 | -0.3 | 5.9 |
| 875 | 54.9 | 22.28 | 1.05 | 55.2 | 0.99 | -0.4 | 6.6 |
| 900 | 54.7 | 22.16 | 1.08 | 55.1 | 1.02 | -0.7 | 5.8 |
| 925 | 54.5 | 22.03 | 1.10 | 55.0 | 1.05 | -1.0 | 5.1 |
| 950 | 54.2 | 21.93 | 1.13 | 55.0 | 1.06 | -1.3 | 6.2 |
| 975 | 54.0 | 21.82 | 1.15 | 54.9 | 1.08 | -1.7 | 7.2 |
| 1000 | 53.8 | 21.74 | 1.18 | 54.9 | 1.09 | -2.0 | 8.5 |
| | 53.6 | 21.66 | 1.21 | 54.8 | 1.10 | -2.3 | 9.7 |

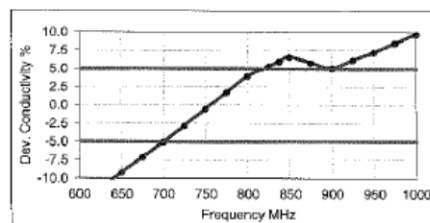
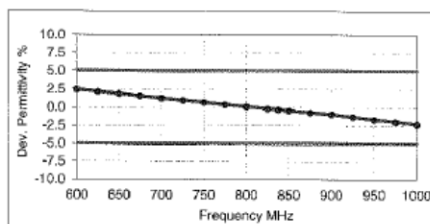



Figure D-2

750MHz Body Tissue Equivalent Matter

| | | | | |
|------------------------------------|---|-----------------------|---|---------------------------------|
| FCC ID: ZNFH950 |  | SAR EVALUATION REPORT |  | Reviewed by: Quality Manager |
| Test Dates: 01/12/15 - 01/22/15 | DUT Type: Portable Handset | | | APPENDIX D: Page 2 of 5 |

Measurement Certificate / Material Test

| | |
|--------------|--|
| Item Name | Head Tissue Simulating Liquid (HSL750V2) |
| Product No. | SL AAH 075 AA (Charge: 130312-4) |
| Manufacturer | SPEAG |

Measurement Method

TSL dielectric parameters measured using calibrated OCP probe.

Setup Validation

Validation results were within $\pm 2.5\%$ towards the target values of Methanol.

Target Parameters

Target parameters as defined in the IEEE 1528 and IEC 62209 compliance standards.

Test Condition

| | |
|-----------------|---|
| Ambient | Environment temperatur (22 ± 3)°C and humidity < 70%. |
| TSL Temperature | 22°C |
| Test Date | 13-Mar-13 |
| Operator | IEN |

Additional Information

| | |
|-------------------|-------------------------|
| TSL Density | 1.284 g/cm ³ |
| TSL Heat-capacity | 2.701 kJ/(kg*K) |

| f [MHz] | Measured | | | Target | | Diff. to Target [%] | |
|------------|-------------|--------------|-------------|-------------|-------------|---------------------|-----------------|
| | HP-e' | HP-e'' | sigma | eps | sigma | Δ -eps | Δ -sigma |
| 600 | 44.6 | 23.25 | 0.78 | 42.7 | 0.88 | 4.3 | -12.0 |
| 625 | 44.2 | 23.00 | 0.80 | 42.6 | 0.88 | 3.8 | -9.5 |
| 650 | 43.8 | 22.76 | 0.82 | 42.5 | 0.89 | 3.2 | -7.1 |
| 675 | 43.4 | 22.50 | 0.84 | 42.3 | 0.89 | 2.6 | -4.9 |
| 700 | 43.1 | 22.24 | 0.87 | 42.2 | 0.89 | 2.1 | -2.6 |
| 725 | 42.7 | 22.06 | 0.89 | 42.1 | 0.89 | 1.6 | -0.2 |
| 750 | 42.4 | 21.88 | 0.91 | 41.9 | 0.89 | 1.1 | 2.2 |
| 775 | 42.1 | 21.72 | 0.94 | 41.8 | 0.90 | 0.6 | 4.6 |
| 800 | 41.7 | 21.55 | 0.96 | 41.7 | 0.90 | 0.1 | 6.9 |
| 825 | 41.4 | 21.40 | 0.98 | 41.6 | 0.91 | -0.4 | 8.3 |
| 838 | 41.3 | 21.32 | 0.99 | 41.5 | 0.91 | -0.6 | 9.0 |
| 850 | 41.1 | 21.24 | 1.00 | 41.5 | 0.92 | -0.9 | 9.6 |
| 875 | 40.8 | 21.11 | 1.03 | 41.5 | 0.94 | -1.6 | 9.0 |
| 900 | 40.6 | 20.99 | 1.05 | 41.5 | 0.97 | -2.3 | 8.3 |
| 925 | 40.3 | 20.87 | 1.07 | 41.5 | 0.98 | -2.9 | 9.4 |
| 950 | 40.0 | 20.76 | 1.10 | 41.4 | 0.99 | -3.5 | 10.3 |
| 975 | 39.7 | 20.66 | 1.12 | 41.4 | 1.00 | -4.0 | 11.5 |
| 1000 | 39.5 | 20.57 | 1.14 | 41.3 | 1.01 | -4.5 | 12.7 |

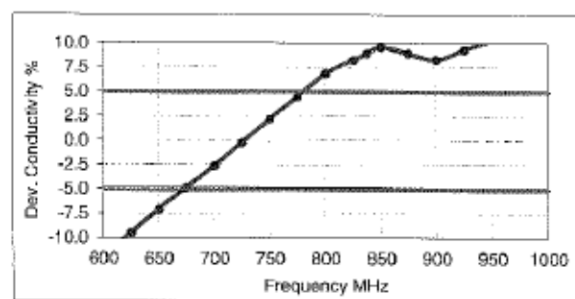
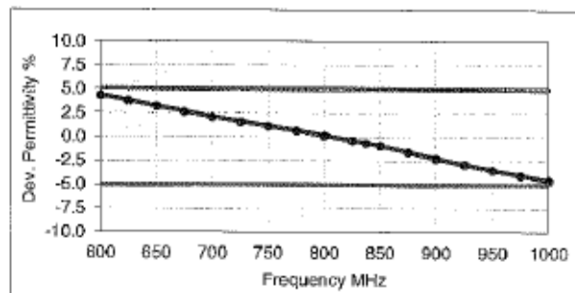



Figure D-3
750MHz Head Tissue Equivalent Matter

| | | | | |
|------------------------------------|---|-----------------------|---|---------------------------------|
| FCC ID: ZNFH950 |  | SAR EVALUATION REPORT |  | Reviewed by: Quality Manager |
| Test Dates: 01/12/15 - 01/22/15 | DUT Type: Portable Handset | | | APPENDIX D: Page 3 of 5 |

2 Composition / Information on ingredients

The Item is composed of the following ingredients:

| | |
|---------|---|
| H2O | Water, 52 – 75% |
| C8H18O3 | Diethylene glycol monobutyl ether (DGBE), 25 – 48% (CAS-No. 112-34-5, EC-No. 203-961-6, EC-index-No. 603-096-00-8) Relevant for safety; Refer to the respective Safety Data Sheet*. |
| NaCl | Sodium Chloride, <1.0% |

Figure D-4

Composition of 2.4 GHz Head Tissue Equivalent Matter

Note: 2.4 GHz head liquid recipes are proprietary SPEAG. Since the composition is approximate to the actual liquids utilized, the manufacturer tissue-equivalent liquid data sheets are provided below.

Measurement Certificate / Material Test

| | |
|--------------|---|
| Item Name | Head Tissue Simulating Liquid (HSL2450V2) |
| Product No. | SL AAH 245 BA (Charge: 130212-2) |
| Manufacturer | SPEAG |

Measurement Method

TSL dielectric parameters measured using calibrated OCP probe.

Setup Validation

Validation results were within $\pm 2.5\%$ towards the target values of Methanol.

Target Parameters

Target parameters as defined in the IEEE 1528 and IEC 62209 compliance standards.

Test Condition

| | |
|-----------------|---|
| Ambient | Environment temperatur (22 ± 3)°C and humidity < 70%. |
| TSL Temperature | 23°C |
| Test Date | 13-Feb-13 |
| Operator | DI |

Additional Information

| | |
|-------------------|-------------------------|
| TSL Density | 0.988 g/cm ³ |
| TSL Heat-capacity | 3.680 kJ/(kg*K) |

| f (MHz) | Measured | | | Target | | Diff. to Target [%] | |
|---------|----------|--------|-------|--------|-------|---------------------|---------|
| | HP-ε' | HP-ε'' | sigma | eps | sigma | Δ-eps | Δ-sigma |
| 1900 | 40.4 | 11.94 | 1.26 | 40.0 | 1.40 | 1.0 | -9.9 |
| 1925 | 40.3 | 12.02 | 1.29 | 40.0 | 1.40 | 0.7 | -8.0 |
| 1950 | 40.2 | 12.11 | 1.31 | 40.0 | 1.40 | 0.5 | -6.2 |
| 1975 | 40.1 | 12.20 | 1.34 | 40.0 | 1.40 | 0.2 | -4.2 |
| 2000 | 40.0 | 12.29 | 1.37 | 40.0 | 1.40 | -0.1 | -2.3 |
| 2025 | 39.9 | 12.39 | 1.40 | 40.0 | 1.42 | -0.2 | -1.9 |
| 2050 | 39.8 | 12.49 | 1.42 | 39.9 | 1.44 | -0.4 | -1.4 |
| 2075 | 39.6 | 12.57 | 1.45 | 39.9 | 1.47 | -0.6 | -1.1 |
| 2100 | 39.5 | 12.65 | 1.48 | 39.8 | 1.49 | -0.7 | -0.7 |
| 2125 | 39.4 | 12.74 | 1.51 | 39.8 | 1.51 | -0.9 | -0.4 |
| 2150 | 39.3 | 12.82 | 1.53 | 39.7 | 1.53 | -1.0 | 0.0 |
| 2175 | 39.2 | 12.89 | 1.56 | 39.7 | 1.56 | -1.2 | 0.3 |
| 2200 | 39.1 | 12.97 | 1.59 | 39.6 | 1.58 | -1.3 | 0.6 |
| 2225 | 39.0 | 13.04 | 1.61 | 39.6 | 1.60 | -1.5 | 0.9 |
| 2250 | 38.9 | 13.11 | 1.64 | 39.6 | 1.62 | -1.7 | 1.2 |
| 2275 | 38.8 | 13.20 | 1.67 | 39.5 | 1.64 | -1.8 | 1.6 |
| 2300 | 38.7 | 13.28 | 1.70 | 39.5 | 1.67 | -2.0 | 2.0 |
| 2325 | 38.6 | 13.35 | 1.73 | 39.4 | 1.69 | -2.1 | 2.3 |
| 2350 | 38.5 | 13.42 | 1.75 | 39.4 | 1.71 | -2.3 | 2.6 |
| 2375 | 38.4 | 13.50 | 1.78 | 39.3 | 1.73 | -2.4 | 2.9 |
| 2400 | 38.3 | 13.58 | 1.81 | 39.3 | 1.76 | -2.6 | 3.3 |
| 2425 | 38.2 | 13.65 | 1.84 | 39.2 | 1.78 | -2.7 | 3.6 |
| 2450 | 38.1 | 13.73 | 1.87 | 39.2 | 1.80 | -2.9 | 4.0 |
| 2475 | 38.0 | 13.79 | 1.90 | 39.2 | 1.83 | -3.1 | 3.9 |
| 2500 | 37.9 | 13.85 | 1.93 | 39.1 | 1.85 | -3.3 | 3.9 |
| 2525 | 37.8 | 13.94 | 1.96 | 39.1 | 1.88 | -3.4 | 4.0 |
| 2550 | 37.7 | 14.02 | 1.99 | 39.1 | 1.91 | -3.6 | 4.2 |
| 2575 | 37.6 | 14.09 | 2.02 | 39.0 | 1.94 | -3.8 | 4.3 |
| 2600 | 37.5 | 14.17 | 2.05 | 39.0 | 1.96 | -4.0 | 4.4 |
| 2625 | 37.4 | 14.23 | 2.08 | 39.0 | 1.99 | -4.2 | 4.4 |
| 2650 | 37.3 | 14.29 | 2.11 | 38.9 | 2.02 | -4.3 | 4.4 |
| 2675 | 37.1 | 14.36 | 2.14 | 38.9 | 2.05 | -4.5 | 4.5 |
| 2700 | 37.0 | 14.43 | 2.17 | 38.9 | 2.07 | -4.8 | 4.6 |

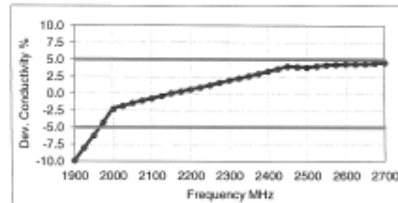
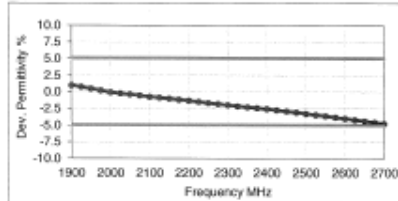



Figure D-5

2.4 GHz Head Tissue Equivalent Matter

| | | | | |
|------------------------------------|---|-----------------------|---|---------------------------------|
| FCC ID: ZNFH950 |  | SAR EVALUATION REPORT |  | Reviewed by: Quality Manager |
| Test Dates: 01/12/15 - 01/22/15 | DUT Type: Portable Handset | | | APPENDIX D: Page 4 of 5 |

2 Composition / Information on ingredients

The Item is composed of the following ingredients:

| | |
|-------------|----------|
| Water | 50 – 65% |
| Mineral oil | 10 – 30% |
| Emulsifiers | 8 – 25% |
| Sodium salt | 0 – 1.5% |

Figure D-6

Composition of 5 GHz Head Tissue Equivalent Matter

Note: 5GHz head liquid recipes are proprietary SPEAG. Since the composition is approximate to the actual liquids utilized, the manufacturer tissue-equivalent liquid data sheets are provided below.

Measurement Certificate / Material Test

| | |
|--------------|---|
| Item Name | Head Tissue Simulating Liquid (HBBL3500-5800V5) |
| Product No. | SL AAH 502 AC (Charge: 130903-1) |
| Manufacturer | SPEAG |

Measurement Method

TSL dielectric parameters measured using calibrated OCP probe.

Setup Validation

Validation results were within $\pm 2.5\%$ towards the target values of Methanol.

Target Parameters

Target parameters as defined in the IEEE 1528 and IEC 62209 compliance standards.

Test Condition

| | |
|-----------------|---|
| Ambient | Environment temperatur (22 ± 3)°C and humidity < 70%. |
| TSL Temperature | 22°C |
| Test Date | 4-Sep-13 |
| Operator | IEN |

Additional Information

| | |
|-------------------|-------------------------|
| TSL Density | 0.985 g/cm ³ |
| TSL Heat-capacity | 3.383 kJ/(kg·K) |

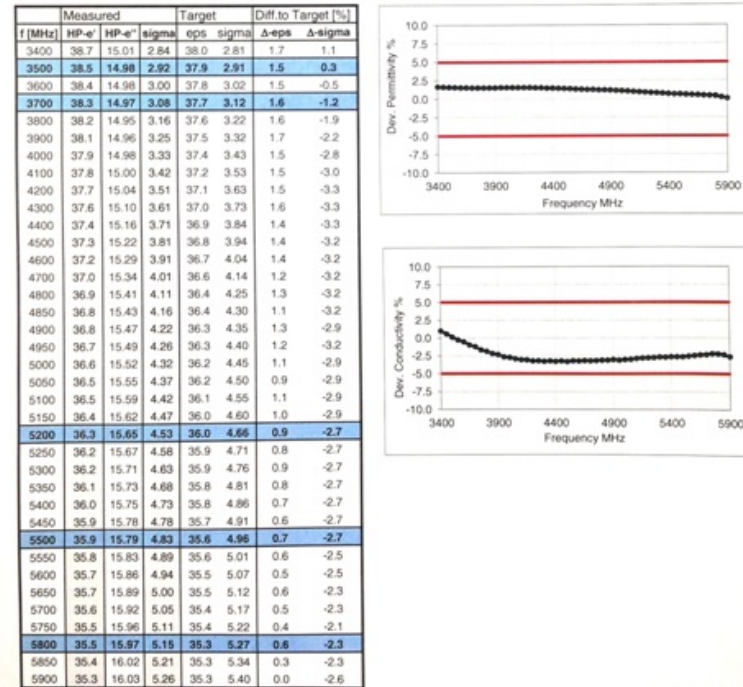

Figure D-7

5GHz Head Tissue Equivalent Matter

| | | | | |
|------------------------------------|--|-----------------------|----|---------------------------------|
| FCC ID: ZNFH950 | PCTEST ENGINEERING LABORATORY, INC. | SAR EVALUATION REPORT | LG | Reviewed by: Quality Manager |
| Test Dates: 01/12/15 - 01/22/15 | DUT Type: Portable Handset | | | APPENDIX D: Page 5 of 5 |

APPENDIX E: SAR SYSTEM VALIDATION



Per FCC KDB 865664 D02v01, SAR system validation status should be documented to confirm measurement accuracy. The SAR systems (including SAR probes, system components and software versions) used for this device were validated against its performance specifications prior to the SAR measurements. Reference dipoles were used with the required tissue- equivalent media for system validation, according to the procedures outlined in FCC KDB 865664 D01 v01 and IEEE 1528-2013. Since SAR probe calibrations are frequency dependent, each probe calibration point was validated at a frequency within the valid frequency range of the probe calibration point, using the system that normally operates with the probe for routine SAR measurements and according to the required tissue-equivalent media.

A tabulated summary of the system validation status including the validation date(s), measurement frequencies, SAR probes and tissue dielectric parameters has been included.

Table E-I
SAR System Validation Summary

| SAR SYSTEM # | FREQ. [MHz] | DATE | PROBE SN | PROBE TYPE | PROBE CAL. POINT | | COND. | PERM. | CW VALIDATION | | | MOD. VALIDATION | | |
|--------------|-------------|------------|----------|------------|------------------|------|--------------|------------------|---------------|-----------------|----------------|-----------------|-------------|------|
| | | | | | | | (σ) | (ϵ_r) | SENSI-TIVITY | PROBE LINEARITY | PROBE ISOTROPY | MOD. TYPE | DUTY FACTOR | PAR |
| K | 750 | 10/10/2014 | 3288 | ES3DV3 | 750 | Head | 0.889 | 40.21 | PASS | PASS | PASS | N/A | N/A | N/A |
| J | 835 | 9/30/2014 | 3022 | ES3DV2 | 835 | Head | 0.911 | 41.35 | PASS | PASS | PASS | GMSK | PASS | N/A |
| I | 1750 | 7/2/2014 | 3209 | ES3DV3 | 1750 | Head | 1.329 | 40.35 | PASS | PASS | PASS | N/A | N/A | N/A |
| G | 1900 | 6/27/2014 | 3258 | ES3DV3 | 1900 | Head | 1.400 | 39.22 | PASS | PASS | PASS | GMSK | PASS | N/A |
| B | 2450 | 1/6/2015 | 3334 | ES3DV3 | 2450 | Head | 1.835 | 40.79 | PASS | PASS | PASS | OFDM/TDD | PASS | PASS |
| I | 2600 | 7/9/2014 | 3209 | ES3DV3 | 2600 | Head | 1.982 | 38.41 | PASS | PASS | PASS | TDD | PASS | PASS |
| H | 5200 | 1/18/2015 | 3920 | EX3DV4 | 5200 | Head | 4.609 | 36.48 | PASS | PASS | PASS | OFDM | N/A | PASS |
| H | 5300 | 1/18/2015 | 3920 | EX3DV4 | 5300 | Head | 4.647 | 35.22 | PASS | PASS | PASS | OFDM | N/A | PASS |
| H | 5500 | 1/18/2015 | 3920 | EX3DV4 | 5500 | Head | 4.853 | 34.92 | PASS | PASS | PASS | OFDM | N/A | PASS |
| H | 5600 | 1/18/2015 | 3920 | EX3DV4 | 5600 | Head | 4.960 | 34.73 | PASS | PASS | PASS | OFDM | N/A | PASS |
| H | 5800 | 1/18/2015 | 3920 | EX3DV4 | 5800 | Head | 5.137 | 34.49 | PASS | PASS | PASS | OFDM | N/A | PASS |
| I | 750 | 6/30/2014 | 3209 | ES3DV3 | 750 | Body | 0.966 | 54.09 | PASS | PASS | PASS | N/A | N/A | N/A |
| K | 835 | 10/13/2014 | 3288 | ES3DV3 | 835 | Body | 0.998 | 52.95 | PASS | PASS | PASS | GMSK | PASS | N/A |
| D | 1750 | 8/7/2014 | 3263 | ES3DV3 | 1750 | Body | 1.438 | 52.96 | PASS | PASS | PASS | N/A | N/A | N/A |
| J | 1900 | 9/4/2014 | 3022 | ES3DV2 | 1900 | Body | 1.555 | 52.66 | PASS | PASS | PASS | GMSK | PASS | N/A |
| B | 2450 | 1/5/2015 | 3334 | ES3DV3 | 2450 | Body | 2.044 | 50.90 | PASS | PASS | PASS | OFDM/TDD | PASS | PASS |
| I | 2600 | 7/14/2014 | 3209 | ES3DV3 | 2600 | Body | 2.133 | 50.50 | PASS | PASS | PASS | TDD | PASS | PASS |
| H | 5200 | 12/30/2014 | 3920 | EX3DV4 | 5200 | Body | 5.387 | 47.95 | PASS | PASS | PASS | OFDM | N/A | PASS |
| H | 5300 | 12/30/2014 | 3920 | EX3DV4 | 5300 | Body | 5.523 | 47.80 | PASS | PASS | PASS | OFDM | N/A | PASS |
| H | 5500 | 12/30/2014 | 3920 | EX3DV4 | 5500 | Body | 5.800 | 47.43 | PASS | PASS | PASS | OFDM | N/A | PASS |
| H | 5600 | 12/30/2014 | 3920 | EX3DV4 | 5600 | Body | 5.932 | 47.26 | PASS | PASS | PASS | OFDM | N/A | PASS |
| H | 5800 | 12/30/2014 | 3920 | EX3DV4 | 5800 | Body | 6.191 | 46.98 | PASS | PASS | PASS | OFDM | N/A | PASS |

NOTE: While the probes have been calibrated for both CW and modulated signals, all measurements were performed using communication systems calibrated for CW signals only. Modulations in the table above represent test configurations for which the measurement system has been validated per FCC KDB Publication 865664 D01v01 for scenarios when CW probe calibrations are used with other signal types. SAR systems were validated for modulated signals with a periodic duty cycle, such as GMSK, or with a high peak to average ratio (>5 dB), such as OFDM according to KDB 865664.

| | | | | |
|------------------------------------|---|-----------------------|---|---------------------------------|
| FCC ID: ZNFH950 |  | SAR EVALUATION REPORT |  | Reviewed by: Quality Manager |
| Test Dates: 01/12/15 - 01/22/15 | DUT Type: Portable Handset | | | APPENDIX E: Page 1 of 1 |