



SAR EVALUATION REPORT

Applicant Name:
 LG Electronics MobileComm U.S.A., Inc.
 1000 Sylvan Avenue
 Englewood Cliffs, NJ 07632
 United States

Date of Testing:
 04/02/18 - 04/15/18
Test Site/Location:
 PCTEST Lab, Columbia, MD, USA
Document Serial No.:
 1M1804030062-01-R2.ZNF

FCC ID: ZNFG710VM

APPLICANT: LG ELECTRONICS MOBILECOMM U.S.A., INC.

DUT Type: Portable Handset
Application Type: Class II Permissive Change
FCC Rule Part(s): CFR §2.1093
Model: LM-G710VM
Additional Model(s): LMG710VM, G710VM, LG-G710PM, LGG710PM, G710PM, LM-G710VMP, LMG710VMP, G710VMP, LM-G710ULM, LMG710ULM, G710ULM
Permissive Change(s): See FCC Change Document

Equipment Class	Band & Mode	Tx Frequency	SAR			
			1g Head (W/kg)	1g Body-Worn (W/kg)	1g Hotspot (W/kg)	10g Phablet (W/kg)
PCE	CDMA/EVDO BC10 (\$90S)	817.90 - 823.10 MHz	0.26	0.44	0.45	N/A
PCE	CDMA/EVDO BC0 (\$22H)	824.70 - 848.31 MHz	0.27	0.52	0.51	N/A
PCE	PCS CDMA/EVDO	1851.25 - 1908.75 MHz	0.13	0.36	1.01	2.37
PCE	GSM/GPRS/EDGE 850	824.20 - 848.80 MHz	0.15	0.34	0.34	N/A
PCE	GSM/GPRS/EDGE 1900	1850.20 - 1909.80 MHz	< 0.1	0.31	0.67	N/A
PCE	UMTS 850	826.40 - 846.60 MHz	0.20	0.41	0.41	N/A
PCE	UMTS 1750	1712.4 - 1752.6 MHz	0.15	0.51	0.93	2.48
PCE	UMTS 1900	1852.4 - 1907.6 MHz	0.13	0.59	1.28	2.86
PCE	LTE Band 12	899.7 - 715.3 MHz	0.17	0.52	0.52	N/A
PCE	LTE Band 17	706.5 - 713.5 MHz	N/A	N/A	N/A	N/A
PCE	LTE Band 13	779.5 - 784.5 MHz	0.21	0.59	0.59	N/A
PCE	LTE Band 5 (Cell)	824.7 - 848.3 MHz	0.20	0.40	0.40	N/A
PCE	LTE Band 26 (Cell)	814.7 - 848.3 MHz	0.21	0.42	0.42	N/A
PCE	LTE Band 66 (AWS)	1710.7 - 1779.3 MHz	0.17	0.47	0.89	2.17
PCE	LTE Band 4 (AWS)	1710.7 - 1754.3 MHz	N/A	N/A	N/A	N/A
PCE	LTE Band 25 (PCS)	1850.7 - 1914.3 MHz	0.10	0.37	1.00	3.20
PCE	LTE Band 2 (PCS)	1850.7 - 1909.3 MHz	N/A	N/A	N/A	N/A
PCE	LTE Band 41	2498.5 - 2687.5 MHz	< 0.1	0.60	0.93	N/A
DTS	2.4 GHz WLAN	2412 - 2462 MHz	0.51	0.50	0.50	N/A
Nil	U-NII-1	5180 - 5240 MHz	N/A	N/A	0.73	N/A
Nil	U-NII-2A	5260 - 5320 MHz	0.62	1.04	N/A	2.57
Nil	U-NII-2C	5500 - 5720 MHz	0.49	0.82	N/A	2.39
Nil	U-NII-3	5745 - 5825 MHz	0.55	0.81	0.81	N/A
DSS/DTS	Bluetooth	2402 - 2480 MHz	0.12	< 0.1	< 0.1	N/A
Simultaneous SAR per KDB 990783 D01v01r03:			0.94	1.59	1.59	3.93

Note: This revised Test Report (S/N: 1M1804030062-01-R2.ZNF) supersedes and replaces the previously issued test report on the same subject device for the same type of testing as indicated. Please discard or destroy the previously issued test report(s) and dispose of it accordingly.

This wireless portable device has been shown to be capable of compliance for localized specific absorption rate (SAR) for uncontrolled environment/general population exposure limits specified in ANSI/IEEE C95.1-1992 and has been tested in accordance with the measurement procedures specified in Section 1.8 of this report; for North American frequency bands only.

I attest to the accuracy of data. All measurements reported herein were performed by me or were made under my supervision and are correct to the best of my knowledge and belief. I assume full responsibility for the completeness of these measurements and vouch for the qualifications of all persons taking them. Test results reported herein relate only to the item(s) tested.

Randy Ortanez
 President





The SAR Tick is an initiative of the Mobile & Wireless Forum (MWF). While a product may be considered eligible, use of the SAR Tick logo requires an agreement with the MWF. Further details can be obtained by emailing: sartick@mwfi.info.

FCC ID ZNFG710VM	PCTEST ENGINEERING LABORATORY, INC.	SAR EVALUATION REPORT	LG	Approved by: Quality Manager
Document S/N: 1M1804030062-01-R2.ZNF	Test Dates: 04/02/18 - 04/15/18	DUT Type: Portable Handset	Page 1 of 126	

TABLE OF CONTENTS

1	DEVICE UNDER TEST	3
2	LTE INFORMATION	15
3	INTRODUCTION	16
4	DOSIMETRIC ASSESSMENT	17
5	DEFINITION OF REFERENCE POINTS	18
6	TEST CONFIGURATION POSITIONS	19
7	RF EXPOSURE LIMITS	23
8	FCC MEASUREMENT PROCEDURES.....	24
9	RF CONDUCTED POWERS.....	32
10	SYSTEM VERIFICATION.....	70
11	SAR DATA SUMMARY	74
12	FCC MULTI-TX AND ANTENNA SAR CONSIDERATIONS.....	98
13	SAR MEASUREMENT VARIABILITY	117
14	ADDITIONAL TESTING PER FCC GUIDANCE	119
15	EQUIPMENT LIST.....	122
16	MEASUREMENT UNCERTAINTIES.....	123
17	CONCLUSION.....	124
18	REFERENCES	125
APPENDIX A: SAR TEST PLOTS		
APPENDIX B: SAR DIPOLE VERIFICATION PLOTS		
APPENDIX C: PROBE AND DIPOLE CALIBRATION CERTIFICATES		
APPENDIX D: SAR TISSUE SPECIFICATIONS		
APPENDIX E: SAR SYSTEM VALIDATION		
APPENDIX F: DUT ANTENNA DIAGRAM & SAR TEST SETUP PHOTOGRAPHS		
APPENDIX G: POWER REDUCTION VERIFICATION		
APPENDIX H: DOWNLINK LTE CA RF CONDUCTED POWERS		

FCC ID ZNFG710VM	 PCTEST <small>ENGINEERING LABORATORY, INC.</small>	SAR EVALUATION REPORT		Approved by: Quality Manager
Document S/N: 1M1804030062-01-R2.ZNF	Test Dates: 04/02/18 - 04/15/18	DUT Type: Portable Handset	Page 2 of 126	



1 DEVICE UNDER TEST

1.1 Device Overview

Band & Mode	Operating Modes	Tx Frequency
CDMA/EVDO BC10 (§90S)	Voice/Data	817.90 - 823.10 MHz
CDMA/EVDO BC0 (§22H)	Voice/Data	824.70 - 848.31 MHz
PCS CDMA/EVDO	Voice/Data	1851.25 - 1908.75 MHz
GSM/GPRS/EDGE 850	Voice/Data	824.20 - 848.80 MHz
GSM/GPRS/EDGE 1900	Voice/Data	1850.20 - 1909.80 MHz
UMTS 850	Voice/Data	826.40 - 846.60 MHz
UMTS 1750	Voice/Data	1712.4 - 1752.6 MHz
UMTS 1900	Voice/Data	1852.4 - 1907.6 MHz
LTE Band 12	Voice/Data	699.7 - 715.3 MHz
LTE Band 17	Voice/Data	706.5 - 713.5 MHz
LTE Band 13	Voice/Data	779.5 - 784.5 MHz
LTE Band 26 (Cell)	Voice/Data	814.7 - 848.3 MHz
LTE Band 5 (Cell)	Voice/Data	824.7 - 848.3 MHz
LTE Band 66 (AWS)	Voice/Data	1710.7 - 1779.3 MHz
LTE Band 4 (AWS)	Voice/Data	1710.7 - 1754.3 MHz
LTE Band 25 (PCS)	Voice/Data	1850.7 - 1914.3 MHz
LTE Band 2 (PCS)	Voice/Data	1850.7 - 1909.3 MHz
LTE Band 41	Voice/Data	2498.5 - 2687.5 MHz
2.4 GHz WLAN	Voice/Data	2412 - 2462 MHz
U-NII-1	Voice/Data	5180 - 5240 MHz
U-NII-2A	Voice/Data	5260 - 5320 MHz
U-NII-2C	Voice/Data	5500 - 5720 MHz
U-NII-3	Voice/Data	5745 - 5825 MHz
Bluetooth	Data	2402 - 2480 MHz
NFC	Data	13.56 MHz
WMC	Data	500 Hz - 4 kHz

1.2 Power Reduction for SAR

This device uses a power reduction mechanism for SAR compliance. The power reduction mechanism is activated when the device is used in close proximity to the user's body. FCC KDB Publication 616217 D04v01r02 Section 6 was used as a guideline for selecting SAR test distances for this device. Detailed descriptions of the power reduction mechanism are included in the operational description.

FCC ID ZNFG710VM	 PCTEST ENGINEERING LABORATORY, INC.	SAR EVALUATION REPORT	 LG	Approved by: Quality Manager
Document S/N: 1M1804030062-01-R2.ZNF	Test Dates: 04/02/18 - 04/15/18	DUT Type: Portable Handset	Page 3 of 126	

This device uses an independent fixed level power reduction mechanism for WLAN operations during voice or VoIP held to ear scenarios. Per FCC Guidance, the held-to-ear exposure conditions were evaluated at reduced power according to the head SAR positions described in IEEE 1528-2013. Detailed descriptions of the power reduction mechanism are included in the operational description.



1.3 Nominal and Maximum Output Power Specifications

This device operates using the following maximum and nominal output power specifications. SAR values were scaled to the maximum allowed power to determine compliance per KDB Publication 447498 D01v06.

1.3.1 Maximum PCE Power



Mode / Band		Voice (dBm)	Burst Average GMSK (dBm)		Burst Average 8-PSK (dBm)	
		1 TX Slot	1 TX Slots	2 TX Slots	1 TX Slots	2 TX Slots
GSM/GPRS/EDGE 850	Maximum	31.7	31.7	31.7	27.7	27.7
	Nominal	31.2	31.2	31.2	27.2	27.2
GSM/GPRS/EDGE 1900	Maximum	30.7	30.7	29.7	26.7	26.7
	Nominal	30.2	30.2	29.2	26.2	26.2

Mode / Band		Modulated Average (dBm)		
		3GPP WCDMA	3GPP HSDPA	3GPP HSUPA
UMTS Band 5 (850 MHz)	Maximum	25.5	25.5	25.5
	Nominal	25.0	25.0	25.0
UMTS Band 4 (1750 MHz)	Maximum	25.2	25.2	25.2
	Nominal	24.7	24.7	24.7
UMTS Band 2 (1900 MHz)	Maximum	25.5	25.5	25.5
	Nominal	25.0	25.0	25.0

FCC ID ZNFG710VM	 PCTEST ENGINEERING LABORATORY, INC.	SAR EVALUATION REPORT	 LG	Approved by: Quality Manager
Document S/N: 1M1804030062-01-R2.ZNF	Test Dates: 04/02/18 - 04/15/18	DUT Type: Portable Handset	Page 4 of 126	

Mode / Band		Modulated Average (dBm)
CDMA/EVDO BC10 (§90S)	Maximum	25.5
	Nominal	25.0
CDMA/EVDO BC0 (§22H)	Maximum	25.5
	Nominal	25.0
PCS CDMA/EVDO	Maximum	25.2
	Nominal	24.7

Mode / Band		Modulated Average (dBm)
LTE Band 12	Maximum	25.5
	Nominal	25.0
LTE Band 17	Maximum	25.5
	Nominal	25.0
LTE Band 13	Maximum	25.5
	Nominal	25.0
LTE Band 5 (Cell)	Maximum	25.5
	Nominal	25.0
LTE Band 26 (Cell)	Maximum	25.5
	Nominal	25.0
LTE Band 66 (AWS)	Maximum	25.2
	Nominal	24.7
LTE Band 4 (AWS)	Maximum	25.2
	Nominal	24.7
LTE Band 25 (PCS)	Maximum	25.5
	Nominal	25.0
LTE Band 2 (PCS)	Maximum	25.5
	Nominal	25.0
LTE Band 41 PC3	Maximum	25.2
	Nominal	24.7
LTE Band 41 PC2	Maximum	27.7
	Nominal	27.2



FCC ID ZNFG710VM	 PCTEST ENGINEERING LABORATORY, INC.	SAR EVALUATION REPORT	 LG	Approved by: Quality Manager
Document S/N: 1M1804030062-01-R2.ZNF	Test Dates: 04/02/18 - 04/15/18	DUT Type: Portable Handset		Page 5 of 126

1.3.1 Reduced PCE Power

Mode / Band		Modulated Average (dBm)		
		3GPP WCDMA	3GPP HSDPA	3GPP HSUPA
UMTS Band 4 (1750 MHz)	Maximum	24.2	24.2	24.2
	Nominal	23.7	23.7	23.7
UMTS Band 2 (1900 MHz)	Maximum	24.5	24.5	24.5
	Nominal	24.0	24.0	24.0

Mode / Band		Modulated Average (dBm)
PCS CDMA/EVDO	Maximum	24.2
	Nominal	23.7

Mode / Band		Modulated Average (dBm)
LTE Band 66 (AWS)	Maximum	24.2
	Nominal	23.7
LTE Band 4 (AWS)	Maximum	24.2
	Nominal	23.7
LTE Band 25 (PCS)	Maximum	24.5
	Nominal	24.0
LTE Band 2 (PCS)	Maximum	24.5
	Nominal	24.0



FCC ID ZNFG710VM	 PCTEST ENGINEERING LABORATORY, INC.	SAR EVALUATION REPORT	 LG	Approved by: Quality Manager
Document S/N: 1M1804030062-01-R2.ZNF	Test Dates: 04/02/18 - 04/15/18	DUT Type: Portable Handset		Page 6 of 126

1.3.2

Maximum Bluetooth and SISO and MIMO WLAN Power

Mode / Band		Modulated Average - Single Tx Chain (dBm)
Bluetooth	Maximum	12.0
	Nominal	11.0
Bluetooth LE	Maximum	5.5
	Nominal	4.5



Mode / Band		Modulated Average - Single Tx Chain (dBm)		
		Ch. 1-2	Ch. 3-9	Ch. 10-11
IEEE 802.11b (2.4 GHz)	Maximum	21.0		
	Nominal	20.0		
IEEE 802.11g (2.4 GHz)	Maximum	18.5	20.5	18.5
	Nominal	17.5	19.5	17.5
IEEE 802.11n (2.4 GHz)	Maximum	18.0	19.5	18.0
	Nominal	17.0	18.5	17.0
IEE 802.11ac (2.4 GHz)	Maximum	18.0	19.5	18.0
	Nominal	17.0	18.5	17.0

FCC ID ZNFG710VM	 PCTEST ENGINEERING LABORATORY, INC.	SAR EVALUATION REPORT		Approved by: Quality Manager
Document S/N: 1M1804030062-01-R2.ZNF	Test Dates: 04/02/18 - 04/15/18	DUT Type: Portable Handset		Page 7 of 126

Mode / Band		Modulated Average (dBm) - MIMO		
		Ch. 1-2	Ch. 3-9	Ch. 10-11
IEEE 802.11b (2.4 GHz)	Maximum	24.0		
	Nominal	23.0		
IEEE 802.11g (2.4 GHz)	Maximum	21.5	23.5	21.5
	Nominal	20.5	22.5	20.5
IEEE 802.11n (2.4 GHz)	Maximum	21.0	22.5	21.0
	Nominal	20.0	21.5	20.0
IEEE 802.11ac (2.4 GHz)	Maximum	21.0	22.5	21.0
	Nominal	20.0	21.5	20.0

Mode / Band		Modulated Average - Single Tx Chain (dBm)						
		20 MHz Bandwidth		40 MHz Bandwidth			80 MHz Bandwidth	
		Ch. 36, 44-52, 60-153, 165	Ch. 40, 56, 157-161	Ch. 38	Ch. 46-54, 110-159	Ch. 62-102	Ch. 58	Ch. 42, 106-155
IEEE 802.11a (5 GHz)	Maximum	17.0	18.0					
	Nominal	16.0	17.0					
IEEE 802.11n (5 GHz)	Maximum	17.0	18.0	13.0	16.0	12.5		
	Nominal	16.0	17.0	12.0	15.0	11.5		
IEEE 802.11ac (5 GHz)	Maximum	17.0	18.0	13.0	16.0	12.5	10.5	13.5
	Nominal	16.0	17.0	12.0	15.0	11.5	9.5	12.5

Mode / Band		Modulated Average - MIMO (dBm)						
		20 MHz Bandwidth		40 MHz Bandwidth			80 MHz Bandwidth	
		Ch. 36, 44-52, 60-153, 165	Ch. 40, 56, 157-161	Ch. 38	Ch. 46-54, 110-159	Ch. 62-102	Ch. 58	Ch. 42, 106-155
IEEE 802.11a (5 GHz)	Maximum	20.0	21.0					
	Nominal	19.0	20.0					
IEEE 802.11n (5 GHz)	Maximum	20.0	21.0	16.0	19.0	15.5		
	Nominal	19.0	20.0	15.0	18.0	14.5		
IEEE 802.11ac (5 GHz)	Maximum	20.0	21.0	16.0	19.0	15.5	13.5	16.5
	Nominal	19.0	20.0	15.0	18.0	14.5	12.5	15.5



FCC ID ZNFG710VM	 PCTEST ENGINEERING LABORATORY, INC.	SAR EVALUATION REPORT	 LG	Approved by: Quality Manager
Document S/N: 1M1804030062-01-R2.ZNF	Test Dates: 04/02/18 - 04/15/18	DUT Type: Portable Handset		Page 8 of 126

1.3.1 Reduced SISO WLAN Power/Output Power during Simultaneous Scenarios with 2.4 GHz WLAN and 5 GHz WLAN

Mode / Band		Modulated Average - Single Tx Chain (dBm)
IEEE 802.11b (2.4 GHz)	Maximum	18.0
	Nominal	17.0
IEEE 802.11g (2.4 GHz)	Maximum	18.0
	Nominal	17.0
IEEE 802.11n (2.4 GHz)	Maximum	18.0
	Nominal	17.0
IEEE 802.11ac (2.4 GHz)	Maximum	18.0
	Nominal	17.0

1.3.2 Reduced MIMO WLAN Power

Mode / Band		Modulated Average (dBm) - MIMO
IEEE 802.11b (2.4 GHz)	Maximum	21.0
	Nominal	20.0
IEEE 802.11g (2.4 GHz)	Maximum	21.0
	Nominal	20.0
IEEE 802.11n (2.4 GHz)	Maximum	21.0
	Nominal	20.0
IEEE 802.11ac (2.4 GHz)	Maximum	21.0
	Nominal	20.0



FCC ID ZNFG710VM	 PCTEST ENGINEERING LABORATORY, INC.	SAR EVALUATION REPORT	 LG	Approved by: Quality Manager
Document S/N: 1M1804030062-01-R2.ZNF	Test Dates: 04/02/18 - 04/15/18	DUT Type: Portable Handset		Page 9 of 126

1.3.3

Output Power during Simultaneous Scenarios with 2.4 GHz WLAN and 5 GHz WLAN

Mode / Band		Antenna 1 - Modulated Average Single Tx Chain (dBm)
IEEE 802.11b (2.4 GHz)	Maximum	18.0
	Nominal	17.0
IEEE 802.11g (2.4 GHz)	Maximum	18.0
	Nominal	17.0
IEEE 802.11n (2.4 GHz)	Maximum	18.0
	Nominal	17.0
IEEE 802.11ac (2.4 GHz)	Maximum	18.0
	Nominal	17.0

Mode / Band		Antenna 2 - Modulated Average - Single Tx Chain (dBm)					
		20 MHz Bandwidth		40 MHz Bandwidth		80 MHz Bandwidth	
		Ch. 36-165	Ch. 38	Ch. 46-54, 110-159	Ch. 62-102	Ch. 58	Ch. 42, 106-155
IEEE 802.11a (5 GHz)	Maximum	15.0					
	Nominal	14.0					
IEEE 802.11n (5 GHz)	Maximum	15.0	13.0	15.0	12.5		
	Nominal	14.0	12.0	14.0	11.5		
IEEE 802.11ac (5 GHz)	Maximum	15.0	13.0	15.0	12.5	10.5	13.5
	Nominal	14.0	12.0	14.0	11.5	9.5	12.5

FCC ID ZNFG710VM	 PCTEST ENGINEERING LABORATORY, INC.	SAR EVALUATION REPORT		Approved by: Quality Manager
Document S/N: 1M1804030062-01-R2-ZNF	Test Dates: 04/02/18 - 04/15/18	DUT Type: Portable Handset	Page 10 of 126	

1.4 DUT Antenna Locations

The overall dimensions of this device are > 9 x 5 cm. A diagram showing the location of the device antennas can be found in Appendix F. Since the diagonal dimension of this device is > 160 mm and <200 mm, it is considered a “phablet.”

**Table 1-1
Device Edges/Sides for SAR Testing**

Mode	Back	Front	Top	Bottom	Right	Left
EVDO BC10 (§90S)	Yes	Yes	No	Yes	Yes	Yes
EVDO BC0 (§22H)	Yes	Yes	No	Yes	Yes	Yes
PCS EVDO	Yes	Yes	No	Yes	No	Yes
GPRS 850	Yes	Yes	No	Yes	Yes	Yes
GPRS 1900	Yes	Yes	No	Yes	No	Yes
UMTS 850	Yes	Yes	No	Yes	Yes	Yes
UMTS 1750	Yes	Yes	No	Yes	No	Yes
UMTS 1900	Yes	Yes	No	Yes	No	Yes
LTE Band 12	Yes	Yes	No	Yes	Yes	Yes
LTE Band 13	Yes	Yes	No	Yes	Yes	Yes
LTE Band 5 (Cell)	Yes	Yes	No	Yes	Yes	Yes
LTE Band 26 (Cell)	Yes	Yes	No	Yes	Yes	Yes
LTE Band 66 (AWS)	Yes	Yes	No	Yes	No	Yes
LTE Band 25 (PCS)	Yes	Yes	No	Yes	No	Yes
LTE Band 41	Yes	Yes	No	Yes	Yes	Yes
2.4 GHz WLAN Ant 1	Yes	Yes	Yes	No	No	Yes
2.4 GHz WLAN Ant 2	Yes	Yes	Yes	No	No	Yes
5 GHz WLAN Ant 1	Yes	Yes	Yes	No	No	Yes
5 GHz WLAN Ant 2	Yes	Yes	Yes	No	No	Yes
Bluetooth	Yes	Yes	Yes	No	No	Yes

Note: Particular DUT edges were not required to be evaluated for wireless router SAR or phablet SAR if the edges were greater than 2.5 cm from the transmitting antenna according to FCC KDB Publication 941225 D06v02r01 Section III and FCC KDB Publication 648474 D04v01r03. The distances between the transmit antennas and the edges of the device are included in the filing. When wireless router mode is enabled U-NII-2A and U-NII-2C operations are disabled.



1.5 Near Field Communications (NFC) Antenna

This DUT has NFC operations. The NFC antenna is integrated into the device for this model. Therefore, all SAR tests were performed with the device which already incorporates the NFC antenna. A diagram showing the location of the NFC antenna can be found in Appendix F.

1.6 Simultaneous Transmission Capabilities

According to FCC KDB Publication 447498 D01v06, transmitters are considered to be transmitting simultaneously when there is overlapping transmission, with the exception of transmissions during network hand-offs with maximum hand-off duration less than 30 seconds.



This device contains multiple transmitters that may operate simultaneously, and therefore requires a simultaneous transmission analysis according to FCC KDB Publication 447498 D01v06 4.3.2 procedures.

FCC ID ZNFG710VM	 PCTEST ENGINEERING LABORATORY, INC.	SAR EVALUATION REPORT	 LG	Approved by: Quality Manager
Document S/N: 1M1804030062-01-R2.ZNF	Test Dates: 04/02/18 - 04/15/18	DUT Type: Portable Handset	Page 11 of 126	

**Table 1-2
Simultaneous Transmission Scenarios**

No.	Capable Transmit Configuration	Head	Body-Worn Accessory	Wireless Router	Phablet	Notes
1	1x CDMA voice + 2.4 GHz WI-FI	Yes	Yes	N/A	Yes	
2	1x CDMA voice + 5 GHz WI-FI	Yes	Yes	N/A	Yes	
3	1x CDMA voice + 2.4 GHz Bluetooth	Yes^	Yes	N/A	Yes	^ Bluetooth Tethering is considered
4	1x CDMA voice + 2.4 GHz WI-FI MIMO	Yes	Yes	N/A	Yes	
5	1x CDMA voice + 5 GHz WI-FI MIMO	Yes	Yes	N/A	Yes	
6	1x CDMA voice + 2.4 GHz WI-FI Ant 1 + 5 GHz WI-FI Ant 2	Yes	Yes	N/A	Yes	
7	GSM voice + 2.4 GHz WI-FI	Yes	Yes	N/A	Yes	
8	GSM voice + 5 GHz WI-FI	Yes	Yes	N/A	Yes	
9	GSM voice + 2.4 GHz Bluetooth	Yes^	Yes	N/A	Yes	^ Bluetooth Tethering is considered
10	GSM voice + 2.4 GHz WI-FI MIMO	Yes	Yes	N/A	Yes	
11	GSM voice + 5 GHz WI-FI MIMO	Yes	Yes	N/A	Yes	
12	GSM voice + 2.4 GHz WI-FI Ant 1 + 5 GHz WI-FI Ant 2	Yes	Yes	N/A	Yes	
13	UMTS + 2.4 GHz WI-FI	Yes	Yes	Yes	Yes	
14	UMTS + 5 GHz WI-FI	Yes	Yes	Yes	Yes	
15	UMTS + 2.4 GHz Bluetooth	Yes^	Yes	Yes^	Yes	^ Bluetooth Tethering is considered
16	UMTS + 2.4 GHz WI-FI MIMO	Yes	Yes	Yes	Yes	
17	UMTS + 5 GHz WI-FI MIMO	Yes	Yes	Yes	Yes	
18	UMTS + 2.4 GHz WI-FI Ant 1 + 5 GHz WI-FI Ant 2	Yes	Yes	Yes	Yes	
19	LTE + 2.4 GHz WI-FI	Yes	Yes	Yes	Yes	
20	LTE + 5 GHz WI-FI	Yes	Yes	Yes	Yes	
21	LTE + 2.4 GHz Bluetooth	Yes^	Yes	Yes^	Yes	^ Bluetooth Tethering is considered
22	LTE + 2.4 GHz WI-FI MIMO	Yes	Yes	Yes	Yes	
23	LTE + 5 GHz WI-FI MIMO	Yes	Yes	Yes	Yes	
24	LTE + 2.4 GHz WI-FI Ant 1 + 5 GHz WI-FI Ant 2	Yes	Yes	Yes	Yes	
25	CDMA/EVDO data + 2.4 GHz WI-FI	Yes*	Yes*	Yes	Yes	* Pre-installed VOIP applications are considered
26	CDMA/EVDO data + 5 GHz WI-FI	Yes*	Yes*	Yes	Yes	* Pre-installed VOIP applications are considered
27	CDMA/EVDO data + 2.4 GHz Bluetooth	Yes^*	Yes*	Yes^	Yes	* Pre-installed VOIP applications are considered ^ Bluetooth Tethering is considered
28	CDMA/EVDO data + 2.4 GHz WI-FI MIMO	Yes*	Yes*	Yes	Yes	* Pre-installed VOIP applications are considered
29	CDMA/EVDO data + 5 GHz WI-FI MIMO	Yes*	Yes*	Yes	Yes	* Pre-installed VOIP applications are considered
30	CDMA/EVDO data + 2.4 GHz WI-FI Ant 1 + 5 GHz WI-FI Ant 2	Yes*	Yes*	Yes	Yes	* Pre-installed VOIP applications are considered
31	GPRS/EDGE + 2.4 GHz WI-FI	Yes*	Yes*	Yes	Yes	* Pre-installed VOIP applications are considered
32	GPRS/EDGE + 5 GHz WI-FI	Yes*	Yes*	Yes	Yes	* Pre-installed VOIP applications are considered
33	GPRS/EDGE + 2.4 GHz Bluetooth	Yes^*	Yes*	Yes^	Yes	* Pre-installed VOIP applications are considered ^ Bluetooth Tethering is considered
34	GPRS/EDGE + 2.4 GHz WI-FI MIMO	Yes*	Yes*	Yes	Yes	* Pre-installed VOIP applications are considered
35	GPRS/EDGE + 5 GHz WI-FI MIMO	Yes*	Yes*	Yes	Yes	* Pre-installed VOIP applications are considered
36	GPRS/EDGE + 2.4 GHz WI-FI Ant 1 + 5 GHz WI-FI Ant 2	Yes*	Yes*	Yes	Yes	* Pre-installed VOIP applications are considered

- Bluetooth cannot transmit simultaneously with WLAN.
- All licensed modes share the same antenna path and cannot transmit simultaneously.
- When the user utilizes multiple services in UMTS 3G mode it uses multi-Radio Access Bearer or multi-RAB. The power control is based on a physical control channel (Dedicated Physical Control Channel [DPCCH]) and power control will be adjusted to meet the needs of both services. Therefore, the UMTS+WLAN scenario also represents the UMTS Voice/DATA + WLAN Hotspot scenario.
- Per the manufacturer, WIFI Direct is expected to be used in conjunction with a held-to-ear or body-worn accessory voice call. Therefore, the simultaneous transmission scenarios involving WIFI are listed in the above table.
- 5 GHz Wireless Router is only supported for the U-NII-1 and U-NII-3 by S/W, therefore U-NII2A and U-NII2C were not evaluated for wireless router conditions.
- This device supports 2x2 MIMO Tx for WLAN. 802.11a/g/n/ac modes support CDD, 802.11b mode supports TDD operations only, and 802.11n/ac modes additionally support SDM. Each WLAN antenna can transmit independently or together when operating with MIMO.
- This device supports BT Tethering.
- This device supports VOLTE.
- This device supports VOWIFI.

FCC ID ZNFG710VM	 PCTEST ENGINEERING LABORATORY, INC.	SAR EVALUATION REPORT		Approved by: Quality Manager
Document S/N: 1M1804030062-01-R2.ZNF	Test Dates: 04/02/18 - 04/15/18	DUT Type: Portable Handset	Page 12 of 126	

1.7 Miscellaneous SAR Test Considerations

(A) WIFI/BT

Since Wireless Router operations are not allowed by the chipset firmware using U-NII-2A & U-NII-2C WIFI, only 2.4 GHz, U-NII-1 and U-NII-3 WIFI Hotspot SAR tests and combinations are considered for SAR with respect to Wireless Router configurations according to FCC KDB 941225 D06v02r01.

Since U-NII-1 and U-NII-2A bands have the same maximum output power and the highest reported SAR for U-NII-2A is less than 1.2 W/kg, SAR is not required for U-NII-1 band according to FCC KDB Publication 248227 D01v02r02.

This device supports IEEE 802.11ac with the following features:

- a) Up to 80 MHz Bandwidth only
- b) No aggregate channel configurations
- c) 2 Tx antenna output
- d) 256 QAM is supported
- e) TDWR and Band gap channels are supported

Per FCC KDB Publication 648474 D04v01r03, this device is considered a "phablet" since the diagonal dimension is greater than 160mm and less than 200mm. Phablet SAR tests are required when wireless router mode does not apply or if wireless router 1g SAR > 1.2 W/kg. Because wireless router operations are not supported for U-NII-2A & U-NII-2C WLAN, phablet SAR tests were performed. Phablet SAR was not evaluated for Bluetooth, 2.4 GHz, U-NII-1, and U-NII-3 WLAN operations since wireless router 1g SAR was <1.2 W/kg.

(B) Licensed Transmitter(s)

GSM/GPRS/EDGE DTM is not supported for US bands. Therefore, the GSM Voice modes in this report do not transmit simultaneously with GPRS/EDGE Data.



This device is only capable of QPSK HSUPA in the uplink. Therefore, no additional SAR tests are required beyond that described for devices with HSUPA in KDB 941225 D01v03r01.

LTE SAR for the higher modulations and lower bandwidths were not tested since the maximum average output power of all required channels and configurations was not more than 0.5 dB higher than the highest bandwidth; and the reported LTE SAR for the highest bandwidth was less than 1.45 W/kg for all configurations according to FCC KDB 941225 D05v02r04.

CDMA 1X Advanced technology was not required for SAR since the maximum allowed output powers for 1x Advanced was not more than 0.25 dB higher than the maximum powers for 1x and the measured SAR in any 1x mode exposure conditions was not greater than 1.2 W/kg per FCC KDB Publication 941225 D01v03r01.

This device supports LTE Carrier Aggregation (CA) in the downlink. All uplink communications are identical to Release 8 specifications. Per FCC KDB Publication 941225 D05A v01r02, SAR for downlink only LTE CA operations was not needed since the maximum average output power in downlink only LTE CA mode was not >0.25 dB higher than the maximum output power when downlink carrier aggregation was inactive. Downlink LTE CA conducted powers are included in Appendix H.

This device supports 64QAM on the uplink for LTE Operations. Conducted powers for 64QAM configurations were measured per Section 5.1 of FCC KDB Publication 941225 D05v02r05. SAR was not required for 64QAM since the highest maximum output power for 64 QAM is $\leq \frac{1}{2}$ dB higher than the same

FCC ID ZNFG710VM	 PCTEST ENGINEERING LABORATORY, INC.	SAR EVALUATION REPORT	 LG	Approved by: Quality Manager
Document S/N: 1M1804030062-01-R2.ZNF	Test Dates: 04/02/18 - 04/15/18	DUT Type: Portable Handset		Page 13 of 126

configuration in QPSK and the reported SAR for the QPSK configuration is ≤ 1.45 W/kg, per Section 5.2.4 of FCC KDB Publication 941225 D05v02r05.

Per FCC KDB Publication 648474 D04v01r03, this device is considered a "phablet" since the diagonal dimension is greater than 160mm and less than 200mm. Therefore, phablet SAR tests are required when wireless router mode does not apply or if wireless router 1g SAR > 1.2 W/kg.

This device supports downlink 4x4 MIMO operations for some LTE Bands. Per May 2017 TCB Workshop Guidance, SAR for downlink 4x4 MIMO was not needed since the maximum average output power in 4x4 downlink MIMO mode was not > 0.25 dB higher than the maximum output power with downlink 4x4 MIMO inactive.

This device supports LTE capabilities with overlapping transmission frequency ranges. When the supported frequency range of an LTE Band falls completely within an LTE band with a larger transmission frequency range, both LTE bands have the same target power (or the band with the larger transmission frequency range has a higher target power), and both LTE bands share the same transmission path and signal characteristics, SAR was only assessed for the band with the larger transmission frequency range.

This device supports both Power Class 2 (PC2) and Power Class 3 (PC3) for LTE Band 41. Per May 2017 TCB Workshop Notes, SAR tests were performed with Power Class 3 (given the specific UL/DL limitations for Power Class 2). Additionally, SAR testing for the power class condition was evaluated for the highest configuration in Power Class 3 for each test configuration to confirm the results were scalable linearly (See Section 14.1).

This device supports LTE Carrier Aggregation (CA) in the uplink for LTE Band 41 and LTE Band 5 with two component carriers in the uplink. SAR Measurements and conducted powers were evaluated per 2017 Fall TCB Workshop Notes.



Additional SAR tests for phablet SAR were evaluated per KDB 616217 Section 6 (See Section 6.9 for more information)

1.8 Guidance Applied

- IEEE 1528-2013
- FCC KDB Publication 941225 D01v03r01, D05v02r04, D05Av01r02, D06v02r01 (2G/3G/4G and Hotspot)
- FCC KDB Publication 248227 D01v02r02 (SAR Considerations for 802.11 Devices)
- FCC KDB Publication 447498 D01v06 (General SAR Guidance)
- FCC KDB Publication 865664 D01v01r04, D02v01r02 (SAR Measurements up to 6 GHz)
- FCC KDB Publication 648474 D04v01r03 (Phablet Procedures)
- FCC KDB Publication 616217 D04v01r02 (Proximity Sensor)
- October 2013 TCB Workshop Notes (GPRS Testing Considerations)
- May 2017 TCB Workshop Notes (LTE 4x4 Downlink MIMO, LTE Band 41 Power Class 2/3)
- Fall 2017 TCB Workshop Notes (LTE Carrier Aggregation)

1.9 Device Serial Numbers



Several samples with identical hardware were used to support SAR testing. The manufacturer has confirmed that the device(s) tested have the same physical, mechanical and thermal characteristics and are within operational tolerances expected for production units. The serial numbers used for each test are indicated alongside the results in Section 11.

FCC ID ZNFG710VM	 PCTEST ENGINEERING LABORATORY, INC.	SAR EVALUATION REPORT	 LG	Approved by: Quality Manager
Document S/N: 1M1804030062-01-R2.ZNF	Test Dates: 04/02/18 - 04/15/18	DUT Type: Portable Handset	Page 14 of 126	

2

LTE INFORMATION

LTE Information					
FCC ID	ZNFG710VM				
Form Factor	Portable Handset				
Frequency Range of each LTE transmission band	LTE Band 12 (699.7 - 715.3 MHz)				
	LTE Band 17 (706.5 - 713.5 MHz)				
	LTE Band 13 (779.5 - 784.5 MHz)				
	LTE Band 5 (Cell) (824.7 - 848.3 MHz)				
	LTE Band 26 (Cell) (814.7 - 848.3 MHz)				
	LTE Band 66 (AWS) (1710.7 - 1779.3 MHz)				
	LTE Band 4 (AWS) (1710.7 - 1754.3 MHz)				
	LTE Band 25 (PCS) (1850.7 - 1914.3 MHz)				
	LTE Band 2 (PCS) (1850.7 - 1909.3 MHz)				
	LTE Band 41 (2498.5 - 2687.5 MHz)				
Channel Bandwidths	LTE Band 12: 1.4 MHz, 3 MHz, 5 MHz, 10 MHz				
	LTE Band 17: 5 MHz, 10 MHz				
	LTE Band 13: 5 MHz, 10 MHz				
	LTE Band 5 (Cell): 1.4 MHz, 3 MHz, 5 MHz, 10 MHz				
	LTE Band 26 (Cell): 1.4 MHz, 3 MHz, 5 MHz, 10 MHz, 15 MHz				
	LTE Band 66 (AWS): 1.4 MHz, 3 MHz, 5 MHz, 10 MHz, 15 MHz, 20 MHz				
	LTE Band 4 (AWS): 1.4 MHz, 3 MHz, 5 MHz, 10 MHz, 15 MHz, 20 MHz				
	LTE Band 25 (PCS): 1.4 MHz, 3 MHz, 5 MHz, 10 MHz, 15 MHz, 20 MHz				
	LTE Band 2 (PCS): 1.4 MHz, 3 MHz, 5 MHz, 10 MHz, 15 MHz, 20 MHz				
	LTE Band 41: 5 MHz, 10 MHz, 15 MHz, 20 MHz				
Channel Numbers and Frequencies (MHz)	Low	Low-Mid	Mid	Mid-High	High
LTE Band 12: 1.4 MHz	699.7 (23017)		707.5 (23095)		715.3 (23173)
LTE Band 12: 3 MHz	700.5 (23025)		707.5 (23095)		714.5 (23165)
LTE Band 12: 5 MHz	701.5 (23035)		707.5 (23095)		713.5 (23155)
LTE Band 12: 10 MHz	704 (23060)		707.5 (23095)		711 (23130)
LTE Band 17: 5 MHz	706.5 (23755)		710 (23790)		713.5 (23825)
LTE Band 17: 10 MHz	709 (23780)		710 (23790)		711 (23800)
LTE Band 13: 5 MHz	779.5 (23205)		782 (23230)		784.5 (23255)
LTE Band 13: 10 MHz	N/A		782 (23230)		N/A
LTE Band 5 (Cell): 1.4 MHz	824.7 (20407)		836.5 (20525)		848.3 (20643)
LTE Band 5 (Cell): 3 MHz	825.5 (20415)		836.5 (20525)		847.5 (20635)
LTE Band 5 (Cell): 5 MHz	826.5 (20425)		836.5 (20525)		846.5 (20625)
LTE Band 5 (Cell): 10 MHz	829 (20450)		836.5 (20525)		844 (20600)
LTE Band 26 (Cell): 1.4 MHz	814.7 (26697)		831.5 (26865)		848.3 (27033)
LTE Band 26 (Cell): 3 MHz	815.5 (26705)		831.5 (26865)		847.5 (27025)
LTE Band 26 (Cell): 5 MHz	816.5 (26715)		831.5 (26865)		846.5 (27015)
LTE Band 26 (Cell): 10 MHz	819 (26740)		831.5 (26865)		844 (26990)
LTE Band 26 (Cell): 15 MHz	821.5 (26765)		831.5 (26865)		841.5 (26965)
LTE Band 66 (AWS): 1.4 MHz	1710.7 (131979)		1745 (132322)		1779.3 (132665)
LTE Band 66 (AWS): 3 MHz	1711.5 (131987)		1745 (132322)		1778.5 (132657)
LTE Band 66 (AWS): 5 MHz	1712.5 (131997)		1745 (132322)		1777.5 (132647)
LTE Band 66 (AWS): 10 MHz	1715 (132022)		1745 (132322)		1775 (132622)
LTE Band 66 (AWS): 15 MHz	1717.5 (132047)		1745 (132322)		1772.5 (132597)
LTE Band 66 (AWS): 20 MHz	1720 (132072)		1745 (132322)		1770 (132572)
LTE Band 4 (AWS): 1.4 MHz	1710.7 (19957)		1732.5 (20175)		1754.3 (20393)
LTE Band 4 (AWS): 3 MHz	1711.5 (19965)		1732.5 (20175)		1753.5 (20385)
LTE Band 4 (AWS): 5 MHz	1712.5 (19975)		1732.5 (20175)		1752.5 (20375)
LTE Band 4 (AWS): 10 MHz	1715 (20000)		1732.5 (20175)		1750 (20350)
LTE Band 4 (AWS): 15 MHz	1717.5 (20025)		1732.5 (20175)		1747.5 (20325)
LTE Band 4 (AWS): 20 MHz	1720 (20050)		1732.5 (20175)		1745 (20300)
LTE Band 25 (PCS): 1.4 MHz	1850.7 (26047)		1882.5 (26365)		1914.3 (26683)
LTE Band 25 (PCS): 3 MHz	1851.5 (26055)		1882.5 (26365)		1913.5 (26675)
LTE Band 25 (PCS): 5 MHz	1852.5 (26065)		1882.5 (26365)		1912.5 (26665)
LTE Band 25 (PCS): 10 MHz	1855 (26090)		1882.5 (26365)		1910 (26640)
LTE Band 25 (PCS): 15 MHz	1857.5 (26115)		1882.5 (26365)		1907.5 (26615)
LTE Band 25 (PCS): 20 MHz	1860 (26140)		1882.5 (26365)		1905 (26590)
LTE Band 2 (PCS): 1.4 MHz	1850.7 (18607)		1880 (18900)		1909.3 (19193)
LTE Band 2 (PCS): 3 MHz	1851.5 (18615)		1880 (18900)		1908.5 (19185)
LTE Band 2 (PCS): 5 MHz	1852.5 (18625)		1880 (18900)		1907.5 (19175)
LTE Band 2 (PCS): 10 MHz	1855 (18650)		1880 (18900)		1905 (19150)
LTE Band 2 (PCS): 15 MHz	1857.5 (18675)		1880 (18900)		1902.5 (19125)
LTE Band 2 (PCS): 20 MHz	1860 (18700)		1880 (18900)		1900 (19100)
LTE Band 41: 5 MHz	2506 (39750)	2549.5 (40185)	2593 (40620)	2636.5 (41055)	2680 (41490)
LTE Band 41: 10 MHz	2506 (39750)	2549.5 (40185)	2593 (40620)	2636.5 (41055)	2680 (41490)
LTE Band 41: 15 MHz	2506 (39750)	2549.5 (40185)	2593 (40620)	2636.5 (41055)	2680 (41490)
LTE Band 41: 20 MHz	2506 (39750)	2549.5 (40185)	2593 (40620)	2636.5 (41055)	2680 (41490)
UE Category	DL UE Cat 18 (QPSK, 16 QAM, 64 QAM), UL UE Cat 13 (QPSK, 16 QAM, 64 QAM)				
Modulations Supported in UL	QPSK, 16QAM, 64QAM				
LTE MPR Permanently implemented per 3GPP TS 36.101 section 6.2.3-6.2.5? (manufacturer attestation to be provided)	YES				
A-MPR (Additional MPR) disabled for SAR Testing?	YES				
LTE Carrier Aggregation Possible Combinations	The technical description includes all the possible carrier aggregation combinations				
LTE Additional Information	This device does not support full CA features on 3GPP Release 12. It supports uplink carrier aggregation for LTE CA_41C with a maximum of two 20MHz component carriers and LTE CA_5B with a maximum of two 10MHz component carriers. All other uplink communications are identical to the Release 8 Specifications. Uplink communications are done on the PCC unless otherwise specified. The following LTE Release 12 Features are not supported: Relay, HetNet, Enhanced MIMO, eICIC, MDH, eMBMS, Cross-Carrier Scheduling, Enhanced SC-FDMA.				

FCC ID ZNFG710VM		SAR EVALUATION REPORT		Approved by: Quality Manager
Document S/N: 1M1804030062-01-R2.ZNF	Test Dates: 04/02/18 - 04/15/18	DUT Type: Portable Handset	Page 15 of 126	

3 INTRODUCTION

The FCC and Innovation, Science, and Economic Development Canada have adopted the guidelines for evaluating the environmental effects of radio frequency (RF) radiation in ET Docket 93-62 on Aug. 6, 1996 and Health Canada Safety Code 6 to protect the public and workers from the potential hazards of RF emissions due to FCC-regulated portable devices. [1]

The safety limits used for the environmental evaluation measurements are based on the criteria published by the American National Standards Institute (ANSI) for localized specific absorption rate (SAR) in IEEE/ANSI C95.1-1992 Standard for Safety Levels with Respect to Human Exposure to Radio Frequency Electromagnetic Fields, 3 kHz to 300 GHz [3] and Health Canada RF Exposure Guidelines Safety Code 6 [22]. The measurement procedure described in IEEE/ANSI C95.3-2002 Recommended Practice for the Measurement of Potentially Hazardous Electromagnetic Fields - RF and Microwave [4] is used for guidance in measuring the Specific Absorption Rate (SAR) due to the RF radiation exposure from the Equipment Under Test (EUT). These criteria for SAR evaluation are similar to those recommended by the International Committee for Non-Ionizing Radiation Protection (ICNIRP) in Biological Effects and Exposure Criteria for Radiofrequency Electromagnetic Fields,” Report No. Vol 74. SAR is a measure of the rate of energy absorption due to exposure to an RF transmitting source. SAR values have been related to threshold levels for potential biological hazards.

3.1 SAR Definition

Specific Absorption Rate is defined as the time derivative (rate) of the incremental energy (dU) absorbed by (dissipated in) an incremental mass (dm) contained in a volume element (dV) of a given density (ρ). It is also defined as the rate of RF energy absorption per unit mass at a point in an absorbing body (see Equation 3-1).

**Equation 3-1
SAR Mathematical Equation**

$$SAR = \frac{d}{dt} \left(\frac{dU}{dm} \right) = \frac{d}{dt} \left(\frac{dU}{\rho dv} \right)$$



SAR is expressed in units of Watts per Kilogram (W/kg).

$$SAR = \frac{\sigma \cdot E^2}{\rho}$$

where:

- σ = conductivity of the tissue-simulating material (S/m)
- ρ = mass density of the tissue-simulating material (kg/m³)
- E = Total RMS electric field strength (V/m)

NOTE: The primary factors that control rate of energy absorption were found to be the wavelength of the incident field in relation to the dimensions and geometry of the irradiated organism, the orientation of the organism in relation to the polarity of field vectors, the presence of reflecting surfaces, and whether conductive contact is made by the organism with a ground plane.[6]

FCC ID ZNFG710VM	 PCTEST ENGINEERING LABORATORY, INC.	SAR EVALUATION REPORT	 LG	Approved by: Quality Manager
Document S/N: 1M1804030062-01-R2.ZNF	Test Dates: 04/02/18 - 04/15/18	DUT Type: Portable Handset	Page 16 of 126	

4 DOSIMETRIC ASSESSMENT

4.1 Measurement Procedure

The evaluation was performed using the following procedure compliant to FCC KDB Publication 865664 D01v01r04 and IEEE 1528-2013:

1. The SAR distribution at the exposed side of the head or body was measured at a distance no greater than 5.0 mm from the inner surface of the shell. The area covered the entire dimension of the device-head and body interface and the horizontal grid resolution was determined per FCC KDB Publication 865664 D01v01r04 (See Table 4-1) and IEEE 1528-2013.
2. The point SAR measurement was taken at the maximum SAR region determined from Step 1 to enable the monitoring of SAR fluctuations/drifts during the 1g/10g cube evaluation. SAR at this fixed point was measured and used as a reference value.
3. Based on the area scan data, the peak of the region with maximum SAR was determined by spline interpolation. Around this point, a volume was assessed according to the measurement resolution and volume size requirements of FCC KDB Publication 865664 D01v01r04 (See Table 4-1) and IEEE 1528-2013. On the basis of this data set, the spatial peak SAR value was evaluated with the following procedure (see references or the DASY manual online for more details):
 - a. SAR values at the inner surface of the phantom are extrapolated from the measured values along the line away from the surface with spacing no greater than that in Table 4-1. The extrapolation was based on a least-squares algorithm. A polynomial of the fourth order was calculated through the points in the z-axis (normal to the phantom shell).
 - b. After the maximum interpolated values were calculated between the points in the cube, the SAR was averaged over the spatial volume (1g or 10g) using a 3D-Spline interpolation algorithm. The 3D-spline is composed of three one-dimensional splines with the “Not a knot” condition (in x, y, and z directions). The volume was then integrated with the trapezoidal algorithm. One thousand points (10 x 10 x 10) were obtained through interpolation, in order to calculate the averaged SAR.
 - c. All neighboring volumes were evaluated until no neighboring volume with a higher average value was found.
4. The SAR reference value, at the same location as step 2, was re-measured after the zoom scan was complete to calculate the SAR drift. If the drift deviated by more than 5%, the SAR test and drift measurements were repeated.

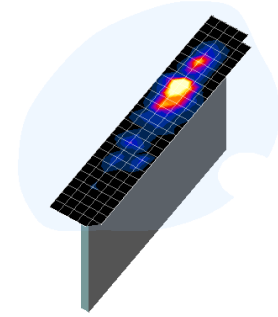

Figure 4-1
Sample SAR Area Scan

Table 4-1
Area and Zoom Scan Resolutions per FCC KDB Publication 865664 D01v01r04*

Frequency	Maximum Area Scan Resolution (mm) ($\Delta x_{\text{area}}, \Delta y_{\text{area}}$)	Maximum Zoom Scan Resolution (mm) ($\Delta x_{\text{zoom}}, \Delta y_{\text{zoom}}$)	Maximum Zoom Scan Spatial Resolution (mm)			Minimum Zoom Scan Volume (mm) (x,y,z)
			Uniform Grid	Graded Grid		
			$\Delta z_{\text{zoom}}(n)$	$\Delta z_{\text{zoom}}(1)^*$	$\Delta z_{\text{zoom}}(n>1)^*$	
≤ 2 GHz	≤ 15	≤ 8	≤ 5	≤ 4	≤ 1.5* $\Delta z_{\text{zoom}}(n-1)$	≥ 30
2-3 GHz	≤ 12	≤ 5	≤ 5	≤ 4	≤ 1.5* $\Delta z_{\text{zoom}}(n-1)$	≥ 30
3-4 GHz	≤ 12	≤ 5	≤ 4	≤ 3	≤ 1.5* $\Delta z_{\text{zoom}}(n-1)$	≥ 28
4-5 GHz	≤ 10	≤ 4	≤ 3	≤ 2.5	≤ 1.5* $\Delta z_{\text{zoom}}(n-1)$	≥ 25
5-6 GHz	≤ 10	≤ 4	≤ 2	≤ 2	≤ 1.5* $\Delta z_{\text{zoom}}(n-1)$	≥ 22

*Also compliant to IEEE 1528-2013 Table 6

FCC ID ZNFG710VM	PCTEST ENGINEERING LABORATORY, INC.	SAR EVALUATION REPORT	LG	Approved by: Quality Manager
Document S/N: 1M1804030062-01-R2.ZNF	Test Dates: 04/02/18 - 04/15/18	DUT Type: Portable Handset		Page 17 of 126

5 DEFINITION OF REFERENCE POINTS

5.1 EAR REFERENCE POINT

Figure 5-2 shows the front, back and side views of the SAM Twin Phantom. The point “M” is the reference point for the center of the mouth, “LE” is the left ear reference point (ERP), and “RE” is the right ERP. The ERP is 15mm posterior to the entrance to the ear canal (EEC) along the B-M line (Back-Mouth), as shown in Figure 5-1. The plane passing through the two ear canals and M is defined as the Reference Plane. The line N-F (Neck-Front), also called the Reference Pivoting Line, is not perpendicular to the reference plane (see Figure 5-1). Line B-M is perpendicular to the N-F line. Both N-F and B-M lines are marked on the external phantom shell to facilitate handset positioning [5].

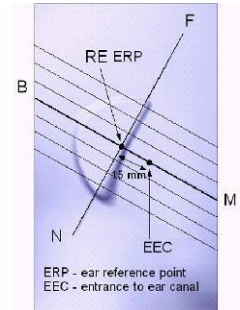

Figure 5-1
Close-Up Side view of ERP

5.2 HANDSET REFERENCE POINTS

Two imaginary lines on the handset were established: the vertical centerline and the horizontal line. The test device was placed in a normal operating position with the acoustic output located along the “vertical centerline” on the front of the device aligned to the “ear reference point” (See Figure 5-3). The acoustic output was then located at the same level as the center of the ear reference point. The test device was positioned so that the “vertical centerline” was bisecting the front surface of the handset at its top and bottom edges, positioning the “ear reference point” on the outer surface of the both the left and right head phantoms on the ear reference point.



Figure 5-2
Front, back and side view of SAM Twin Phantom

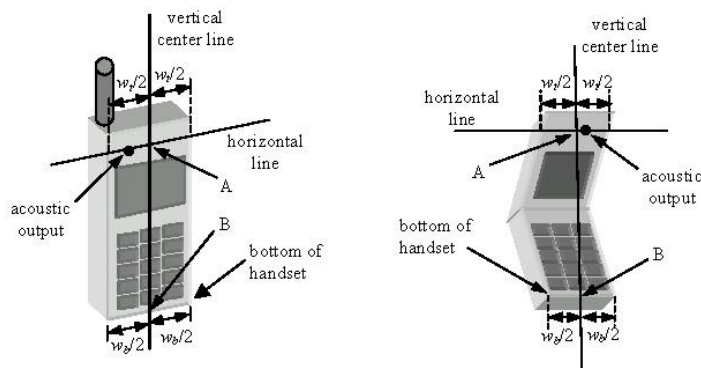



Figure 5-3
Handset Vertical Center & Horizontal Line Reference Points

FCC ID ZNFG710VM	 PCTEST ENGINEERING LABORATORY, INC.	SAR EVALUATION REPORT	 LG	Approved by: Quality Manager
Document S/N: 1M1804030062-01-R2.ZNF	Test Dates: 04/02/18 - 04/15/18	DUT Type: Portable Handset		Page 18 of 126

6 TEST CONFIGURATION POSITIONS

6.1 Device Holder

The device holder is made out of low-loss POM material having the following dielectric parameters: relative permittivity $\epsilon = 3$ and loss tangent $\delta = 0.02$.

6.2 Positioning for Cheek

1. The test device was positioned with the device close to the surface of the phantom such that point A is on the (virtual) extension of the line passing through points RE and LE on the phantom (see Figure 6-1), such that the plane defined by the vertical center line and the horizontal line of the phone is approximately parallel to the sagittal plane of the phantom.

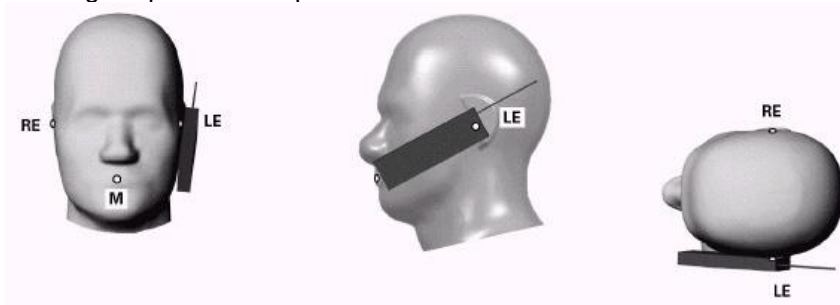



Figure 6-1 Front, Side and Top View of Cheek Position

2. The handset was translated towards the phantom along the line passing through RE & LE until the handset touches the pinna.
3. While maintaining the handset in this plane, the handset was rotated around the LE-RE line until the vertical centerline was in the reference plane.
4. The phone was then rotated around the vertical centerline until the phone (horizontal line) was symmetrical with respect to the line NF.
5. While maintaining the vertical centerline in the reference plane, keeping point A on the line passing through RE and LE, and maintaining the device contact with the ear, the device was rotated about the NF line until any point on the handset made contact with a phantom point below the ear (cheek) (See Figure 6-2).

6.3 Positioning for Ear / 15° Tilt

With the test device aligned in the “Cheek Position”:

1. While maintaining the orientation of the phone, the phone was retracted parallel to the reference plane far enough to enable a rotation of the phone by 15 degrees.
2. The phone was then rotated around the horizontal line by 15 degrees.
3. While maintaining the orientation of the phone, the phone was moved parallel to the reference plane until any part of the handset touched the head. (In this position, point A was located on the line RE-LE). The tilted position is obtained when the contact is on the pinna. If the contact was at any location other than the pinna, the angle of the phone would then be reduced. In this situation, the tilted position was obtained when any part of the phone was in contact of the ear as well as a second part of the phone was in contact with the head (see Figure 6-2).

FCC ID ZNFG710VM	 PCTEST ENGINEERING LABORATORY, INC.	SAR EVALUATION REPORT	 LG	Approved by: Quality Manager
Document S/N: 1M1804030062-01-R2.ZNF	Test Dates: 04/02/18 - 04/15/18	DUT Type: Portable Handset		Page 19 of 126

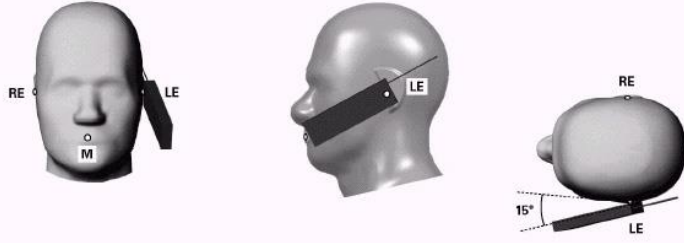

Figure 6-2 Front, Side and Top View of Ear/15° Tilt Position

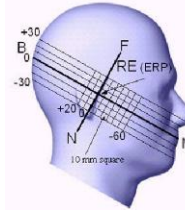

Figure 6-3 Side view w/ relevant markings

6.4 SAR Evaluations near the Mouth/Jaw Regions of the SAM Phantom

Antennas located near the bottom of a phone may require SAR measurements around the mouth and jaw regions of the SAM head phantom. This typically applies to clam-shell style phones that are generally longer in the unfolded normal use positions or to certain older style long rectangular phones. Per IEEE 1528-2013, a rotated SAM phantom is necessary to allow probe access to such regions. Both SAM heads of the TwinSAM-Chin20 are rotated 20 degrees around the NF line. Each head can be removed from the table for emptying and cleaning.

Under these circumstances, the following procedures apply, adopted from the FCC guidance on SAR handsets document FCC KDB Publication 648474 D04v01r03. The SAR required in these regions of SAM should be measured using a flat phantom. The phone should be positioned with a separation distance of 4 mm between the ear reference point (ERP) and the outer surface of the flat phantom shell. While maintaining this distance at the ERP location, the low (bottom) edge of the phone should be lowered from the phantom to establish the same separation distance between the peak SAR location identified by the truncated partial SAR distribution measured with the SAM phantom. The distance from the peak SAR location to the phone is determined by the straight line passing perpendicularly through the phantom surface. When it is not feasible to maintain 4 mm separation at the ERP while also establishing the required separation at the peak SAR location, the top edge of the phone will be allowed to touch the phantom with a separation < 4 mm at the ERP. The phone should not be tilted to the left or right while placed in this inclined position to the flat phantom.

6.5 Body-Worn Accessory Configurations

Body-worn operating configurations are tested with the belt-clips and holsters attached to the device and positioned against a flat phantom in a normal use configuration (see Figure 6-4). Per FCC KDB Publication 648474 D04v01r03, Body-worn accessory exposure is typically related to voice mode operations when handsets are carried in body-worn accessories. The body-worn accessory procedures in FCC KDB Publication 447498 D01v06 should be used to test for body-worn accessory SAR compliance, without a headset connected to it. This enables the test results for such configuration to be compatible with that required for hotspot mode when the body-worn accessory test separation distance is greater than or equal to that required for hotspot mode, when applicable. When the reported SAR for a body-worn accessory, measured without a headset connected to the handset, is > 1.2 W/kg, the highest reported SAR configuration for that wireless mode and frequency band should be repeated for that body-worn accessory with a headset attached to the handset.

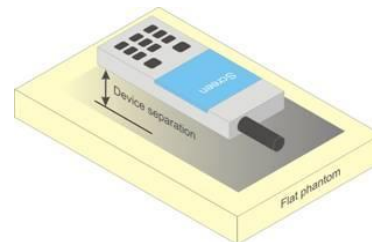

Figure 6-4 Sample Body-Worn Diagram

Accessories for Body-worn operation configurations are divided into two categories: those that do not contain metallic components and those that do contain metallic components. When multiple accessories that do not

FCC ID ZNFG710VM	PCTEST ENGINEERING LABORATORY, INC.	SAR EVALUATION REPORT	LG	Approved by: Quality Manager
Document S/N: 1M1804030062-01-R2.ZNF	Test Dates: 04/02/18 - 04/15/18	DUT Type: Portable Handset		Page 20 of 126

contain metallic components are supplied with the device, the device is tested with only the accessory that dictates the closest spacing to the body. Then multiple accessories that contain metallic components are tested with the device with each accessory. If multiple accessories share an identical metallic component (i.e. the same metallic belt-clip used with different holsters with no other metallic components) only the accessory that dictates the closest spacing to the body is tested.

Body-worn accessories may not always be supplied or available as options for some devices intended to be authorized for body-worn use. In this case, a test configuration with a separation distance between the back of the device and the flat phantom is used. Test position spacing was documented. Transmitters that are designed to operate in front of a person’s face, as in push-to-talk configurations, are tested for SAR compliance with the front of the device positioned to face the flat phantom in head fluid. For devices that are carried next to the body such as a shoulder, waist or chest-worn transmitters, SAR compliance is tested with the accessories, including headsets and microphones, attached to the device and positioned against a flat phantom in a normal use configuration.

6.6 Extremity Exposure Configurations

Devices that are designed or intended for use on extremities or mainly operated in extremity only exposure conditions; i.e., hands, wrists, feet and ankles, may require extremity SAR evaluation. When the device also operates in close proximity to the user’s body, SAR compliance for the body is also required. The 1g body and 10g extremity SAR Exclusion Thresholds found in KDB Publication 447498 D01v06 should be applied to determine SAR test requirements.

Per KDB Publication 447498 D01v06, Cell phones (handsets) are not normally designed to be used on extremities or operated in extremity only exposure conditions. The maximum output power levels of handsets generally do not require extremity SAR testing to show compliance. Therefore, extremity SAR was not evaluated for this device.



6.7 Wireless Router Configurations

Some battery-operated handsets have the capability to transmit and receive user data through simultaneous transmission of WIFI simultaneously with a separate licensed transmitter. The FCC has provided guidance in FCC KDB Publication 941225 D06v02r01 where SAR test considerations for handsets (L x W ≥ 9 cm x 5 cm) are based on a composite test separation distance of 10 mm from the front, back and edges of the device containing transmitting antennas within 2.5 cm of their edges, determined from general mixed use conditions for this type of devices. Since the hotspot SAR results may overlap with the body-worn accessory SAR requirements, the more conservative configurations can be considered, thus excluding some body-worn accessory SAR tests.

When the user enables the personal wireless router functions for the handset, actual operations include simultaneous transmission of both the WIFI transmitter and another licensed transmitter. Both transmitters often do not transmit at the same transmitting frequency and thus cannot be evaluated for SAR under actual use conditions due to the limitations of the SAR assessment probes. Therefore, SAR must be evaluated for each frequency transmission and mode separately and spatially summed with the WIFI transmitter according to FCC KDB Publication 447498 D01v06 procedures. The “Portable Hotspot” feature on the handset was NOT activated during SAR assessments, to ensure the SAR measurements were evaluated for a single transmission frequency RF signal at a time.

6.8 Phablet Configurations

For smart phones with a display diagonal dimension > 150 mm or an overall diagonal dimension > 160 mm that provide similar mobile web access and multimedia support found in mini-tablets or UMPC mini-tablets that

FCC ID ZNFG710VM	 PCTEST ENGINEERING LABORATORY, INC.	SAR EVALUATION REPORT	 LG	Approved by: Quality Manager
Document S/N: 1M1804030062-01-R2.ZNF	Test Dates: 04/02/18 - 04/15/18	DUT Type: Portable Handset	Page 21 of 126	



support voice calls next to the ear, the phablets procedures outlined in KDB Publication 648474 D04v01r03 should be applied to evaluate SAR compliance. A device marketed as phablets, regardless of form factors and operating characteristics must be tested as a phablet to determine SAR compliance. In addition to the normally required head and body-worn accessory SAR test procedures required for handsets, the UMPC mini-tablet procedures must also be applied to test the SAR of all surfaces and edges with an antenna ≤ 25 mm from that surface or edge, in direct contact with the phantom, for 10g SAR. The UMPC mini-tablet 1g SAR at 5 mm is not required. When hotspot mode applies, 10g SAR is required only for the surfaces and edges with hotspot mode 1g SAR > 1.2 W/kg.

6.9 Additional Test Positions due to Proximity Considerations

This device uses a sensor to reduce voice and data powers in extremity (hand-held) use conditions.

When the sensor detects a user is touching the device on or near to the antenna the device reduces the maximum allowed output power. However, the proximity sensor is not active when the device is moved beyond the sensor triggering distance and the maximum output power is no longer limited. Therefore, an additional exposure condition is needed in the vicinity of the triggering distance to ensure SAR is compliant when the device is allowed to operate at a non-reduced output power level.

The proximity sensor is designed to support sufficient detection range and sensitivity to cover regions of the sensors in all applicable directions since the proximity sensor entirely covers the antenna. FCC KDB Publication 616217 D04v01r02 Section 6 was used as a guideline for selecting SAR test distances for this device at these additional test positions. Sensor triggering distance summary data is included in Appendix G.

FCC ID ZNFG710VM	 PCTEST ENGINEERING LABORATORY, INC.	SAR EVALUATION REPORT	 LG	Approved by: Quality Manager
Document S/N: 1M1804030062-01-R2.ZNF	Test Dates: 04/02/18 - 04/15/18	DUT Type: Portable Handset	Page 22 of 126	

7 RF EXPOSURE LIMITS

7.1 Uncontrolled Environment

UNCONTROLLED ENVIRONMENTS are defined as locations where there is the exposure of individuals who have no knowledge or control of their exposure. The general population/uncontrolled exposure limits are applicable to situations in which the general public may be exposed or in which persons who are exposed as a consequence of their employment may not be made fully aware of the potential for exposure or cannot exercise control over their exposure. Members of the general public would come under this category when exposure is not employment-related; for example, in the case of a wireless transmitter that exposes persons in its vicinity.



7.2 Controlled Environment

CONTROLLED ENVIRONMENTS are defined as locations where there is exposure that may be incurred by persons who are aware of the potential for exposure, (i.e. as a result of employment or occupation). In general, occupational/controlled exposure limits are applicable to situations in which persons are exposed as a consequence of their employment, who have been made fully aware of the potential for exposure and can exercise control over their exposure. This exposure category is also applicable when the exposure is of a transient nature due to incidental passage through a location where the exposure levels may be higher than the general population/uncontrolled limits, but the exposed person is fully aware of the potential for exposure and can exercise control over his or her exposure by leaving the area or by some other appropriate means.

**Table 7-1
SAR Human Exposure Specified in ANSI/IEEE C95.1-1992 and Health Canada Safety Code 6**

HUMAN EXPOSURE LIMITS		
	UNCONTROLLED ENVIRONMENT <i>General Population</i> (W/kg) or (mW/g)	CONTROLLED ENVIRONMENT <i>Occupational</i> (W/kg) or (mW/g)
Peak Spatial Average SAR Head	1.6	8.0
Whole Body SAR	0.08	0.4
Peak Spatial Average SAR Hands, Feet, Ankle, Wrists, etc.	4.0	20

1. The Spatial Peak value of the SAR averaged over any 1 gram of tissue (defined as a tissue volume in the shape of a cube) and over the appropriate averaging time.
2. The Spatial Average value of the SAR averaged over the whole body.
3. The Spatial Peak value of the SAR averaged over any 10 grams of tissue (defined as a tissue volume in the shape of a cube) and over the appropriate averaging time.

FCC ID ZNFG710VM	 PCTEST ENGINEERING LABORATORY, INC.	SAR EVALUATION REPORT	 LG	Approved by: Quality Manager
Document S/N: 1M1804030062-01-R2.ZNF	Test Dates: 04/02/18 - 04/15/18	DUT Type: Portable Handset	Page 23 of 126	

8 FCC MEASUREMENT PROCEDURES

Power measurements for licensed transmitters are performed using a base station simulator under digital average power.

8.1 Measured and Reported SAR

Per FCC KDB Publication 447498 D01v06, when SAR is not measured at the maximum power level allowed for production units, the results must be scaled to the maximum tune-up tolerance limit according to the power applied to the individual channels tested to determine compliance. For simultaneous transmission, the measured aggregate SAR must be scaled according to the sum of the differences between the maximum tune-up tolerance and actual power used to test each transmitter. When SAR is measured at or scaled to the maximum tune-up tolerance limit, the results are referred to as **reported** SAR. The highest **reported** SAR results are identified on the grant of equipment authorization according to procedures in KDB 690783 D01v01r03.

8.2 3G SAR Test Reduction Procedure

In FCC KDB Publication 941225 D01v03r01, certain transmission modes within a frequency band and wireless mode evaluated for SAR are defined as primary modes. The equivalent modes considered for SAR test reduction are denoted as secondary modes. When the maximum output power including tune-up tolerance specified for production units in a secondary mode is ≤ 0.25 dB higher than the primary mode or when the highest reported SAR of the primary mode, scaled by the ratio of specified maximum output power and tune-up tolerance of secondary to primary mode, is ≤ 1.2 W/kg, SAR measurements are not required for the secondary mode. These criteria are referred to as the 3G SAR test reduction procedure. When the 3G SAR test reduction procedure is not satisfied, SAR measurements are additionally required for the secondary mode.

8.3 Procedures Used to Establish RF Signal for SAR

The following procedures are according to FCC KDB Publication 941225 D01v03r01 “3G SAR Measurement Procedures.”



The device is placed into a simulated call using a base station simulator in a RF shielded chamber. Establishing connections in this manner ensure a consistent means for testing SAR and are recommended for evaluating SAR [4]. Devices under test are evaluated prior to testing, with a fully charged battery and were configured to operate at maximum output power. In order to verify that the device is tested throughout the SAR test at maximum output power, the SAR measurement system measures a “point SAR” at an arbitrary reference point at the start and end of the 1 gram SAR evaluation, to assess for any power drifts during the evaluation. If the power drift deviates by more than 5%, the SAR test and drift measurements are repeated.

8.4 SAR Measurement Conditions for CDMA2000

The following procedures were performed according to FCC KDB Publication 941225 D01v03r01 “3G SAR Measurement Procedures.”

8.4.1 Output Power Verification

See 3GPP2 C.S0011/TIA-98-E as recommended by FCC KDB Publication 941225 D01v03r01 “3G SAR Measurement Procedures.” Maximum output power is verified on the High, Middle and Low channels according to procedures in section 4.4.5.2 of 3GPP2 C.S0011/TIA-98-E. SO55 tests were measured with power control bits in the “All Up” condition.

FCC ID ZNFG710VM	 PCTEST ENGINEERING LABORATORY, INC.	SAR EVALUATION REPORT	 LG	Approved by: Quality Manager
Document S/N: 1M1804030062-01-R2.ZNF	Test Dates: 04/02/18 - 04/15/18	DUT Type: Portable Handset		Page 24 of 126

1. If the mobile station (MS) supports Reverse TCH RC 1 and Forward TCH RC 1, set up a call using Fundamental Channel Test Mode 1 (RC=1/1) with 9600 bps data rate only.
2. Under RC1, C.S0011 Table 4.4.5.2-1, Table 8-1 parameters were applied.
3. If the MS supports the RC 3 Reverse FCH, RC3 Reverse SCH₀ and demodulation of RC 3,4, or 5, set up a call using Supplemental Channel Test Mode 3 (RC 3/3) with 9600 bps Fundamental Channel and 9600 bps SCH₀ data rate.
4. Under RC3, C.S0011 Table 4.4.5.2-2, Table 8-2 was applied.

Table 8-1
Parameters for Max. Power for RC1

Parameter	Units	Value
$\frac{I_{or}}{I_{or}}$	dBm/1.23 MHz	-104
$\frac{Pilot E_c}{I_{or}}$	dB	-7
$\frac{Traffic E_c}{I_{or}}$	dB	-7.4

Table 8-2
Parameters for Max. Power for RC3

Parameter	Units	Value
$\frac{I_{or}}{I_{or}}$	dBm/1.23 MHz	-86
$\frac{Pilot E_c}{I_{or}}$	dB	-7
$\frac{Traffic E_c}{I_{or}}$	dB	-7.4

5. FCHs were configured at full rate for maximum SAR with “All Up” power control bits.

8.4.2 Head SAR Measurements

SAR for next to the ear head exposure is measured in RC3 with the handset configured to transmit at fullrate in SO55. The 3G SAR test reduction procedure is applied to RC1 with RC3 as the primary mode; otherwise, SAR is required for the channel with maximum measured output in RC1 using the head exposure configuration that results in the highest reported SAR in RC3.

Head SAR is additionally evaluated using EVDO Rev. A to support compliance for VoIP operations. See Section 8.4.5 for EVDO Rev. A configuration parameters.

8.4.3 Body-worn SAR Measurements



SAR for body-worn exposure configurations is measured in RC3 with the DUT configured to transmit at full rate on FCH with all other code channels disabled using TDSO / SO32. The 3G SAR test reduction procedure is applied to the multiple code channel configuration (FCH+SCH_n), with FCH only as the primary mode. Otherwise, SAR is required for multiple code channel configuration (FCH + SCH_n), with FCH at full rate and SCH₀ enabled at 9600 bps, using the highest reported SAR configuration for FCH only. When multiple code channels are enabled, the transmitter output can shift by more than 0.5 dB and may lead to higher SAR drifts and SCH dropouts.

The 3G SAR test reduction procedure is applied to body-worn accessory SAR in RC1 with RC3 as the primary mode. Otherwise, SAR is required for RC1, with SO55 and full rate, using the highest reported SAR configuration for body-worn accessory exposure in RC3.

8.4.4 Body-worn SAR Measurements for EVDO Devices

For handsets with EVDO capabilities, the 3G SAR test reduction procedure is applied to EVDO Rev. 0 with 1x RTT RC3 as the primary mode to determine body-worn accessory test requirements. Otherwise, body-worn accessory SAR is required for Rev. 0, at 153.6 kbps, using the highest reported SAR configuration for body-worn accessory exposure in RC3.

The 3G SAR test reduction procedure is applied to Rev. A, with Rev. 0 as the primary mode to determine body-worn accessory SAR test requirements. When SAR is not required for Rev. 0, the 3G SAR test reduction is applied with 1x RTT RC3 as the primary mode.

FCC ID ZNFG710VM	 PCTEST ENGINEERING LABORATORY, INC.	SAR EVALUATION REPORT	 LG	Approved by: Quality Manager
Document S/N: 1M1804030062-01-R2.ZNF	Test Dates: 04/02/18 - 04/15/18	DUT Type: Portable Handset		Page 25 of 126

When SAR is required for EVDO Rev. A, SAR is measured with a Reverse Data Channel payload size of 4096 bits and a Termination Target of 16 slots defined for Subtype 2 Physical Layer configurations, using the highest reported SAR configuration for body-worn accessory exposure in Rev. 0 or 1x RTT RC3, as appropriate.

8.4.5 Body SAR Measurements for EVDO Hotspot

Hotspot Body SAR is measured using Subtype 0/1 Physical Layer configurations for Rev. 0. The 3G SAR test reduction procedure is applied to Rev. A, Subtype 2 Physical layer configuration, with Rev. 0 as the primary mode; otherwise, SAR is measured for Rev. A using the highest reported SAR configuration for body-worn accessory exposure in Rev. 0. The AT is tested with a Reverse Data Channel rate of 153.6 kbps in Subtype 0/1 Physical Layer configurations; and a Reverse Data Channel payload size of 4096 bits and Termination Target of 16 slots in Subtype 2 Physical Layer configurations.

For EVDO data devices that also support 1x RTT voice and/or data operations, the 3G SAR test reduction procedure is applied to 1x RTT RC3 and RC1 with EVDO Rev. 0 and Rev. A as the respective primary modes. Otherwise, the 'Body-Worn Accessory SAR' procedures in the '3GPP2 CDMA 2000 1x Handsets' section are applied.

8.4.6 CDMA2000 1x Advanced

This device additionally supports 1x Advanced. Conducted powers are measured using SO75 with RC8 on the uplink and RC11 on the downlink per FCC KDB Publication 941225 D01v03r01. Smart blanking is disabled for all measurements. The EUT is configured with forward power control Mode 000 and reverse power control at 400 bps. Conducted powers are measured on an Agilent 8960 Series 10 Wireless Communications Test Set, Model E5515C using the CDMA2000 1x Advanced application, Option E1962B-410.

The 3G SAR test reduction procedure is applied to the 1x-Advanced transmission mode with 1x RTT RC3 as the primary mode. When SAR measurement is required, the 1x-Advanced power measurement configurations are used. The 1x Advanced SAR procedures are applied separately to head, body-worn accessory and other exposure conditions.



8.5 SAR Measurement Conditions for UMTS

8.5.1 Output Power Verification

Maximum output power is verified on the High, Middle and Low channels according to the general descriptions in section 5.2 of 3GPP TS 34.121, using the appropriate RMC with TPC (transmit power control) set to all "1s" or applying the required inner loop power control procedures to maintain maximum output power while HSUPA is active. Results for all applicable physical channel configurations (DPCCH, DPDCHn and spreading codes, HS-DPCCH etc) are tabulated in this test report. All configurations that are not supported by the DUT or cannot be measured due to technical or equipment limitations are identified.

8.5.2 Head SAR Measurements

SAR for next to the ear head exposure is measured using a 12.2 kbps RMC with TPC bits configured to all "1s". The 3G SAR test reduction procedure is applied to AMR configurations with 12.2 kbps RMC as the

FCC ID ZNFG710VM	 PCTEST ENGINEERING LABORATORY, INC.	SAR EVALUATION REPORT	 LG	Approved by: Quality Manager
Document S/N: 1M1804030062-01-R2.ZNF	Test Dates: 04/02/18 - 04/15/18	DUT Type: Portable Handset	Page 26 of 126	

primary mode. Otherwise, SAR is measured for 12.2 kbps AMR in 3.4 kbps SRB (signaling radio bearer) using the highest reported SAR configuration in 12.2 kbps RMC for head exposure.

8.5.3 Body SAR Measurements

SAR for body exposure configurations is measured using the 12.2 kbps RMC with the TPC bits all “1s”. The 3G SAR test reduction procedure is applied to other spreading codes and multiple DPDCH_n configurations supported by the handset with 12.2 kbps RMC as the primary mode. Otherwise, SAR is measured using an applicable RMC configuration with the corresponding spreading code or DPDCH_n, for the highest reported SAR configuration in 12.2 kbps RMC.

8.5.4 SAR Measurements with Rel 5 HSDPA

The 3G SAR test reduction procedure is applied to HSDPA body configurations with 12.2 kbps RMC as the primary mode. Otherwise, Body SAR for HSDPA is measured using an FRC with H-Set 1 in Sub-test 1 and a 12.2 kbps RMC configured in Test Loop Mode 1, for the highest reported SAR configuration in 12.2 kbps RMC without HSDPA. Handsets with both HSDPA and HSUPA are tested according to Release 6 HSPA test procedures.

8.5.5 SAR Measurements with Rel 6 HSUPA

The 3G SAR test reduction procedure is applied to HSPA (HSUPA/HSDPA with RMC) body configurations with 12.2 kbps RMC as the primary mode. Otherwise, Body SAR for HSPA is measured with E-DCH Sub-test 5, using H-Set 1 and QPSK for FRC and a 12.2 kbps RMC configured in Test Loop Mode 1 and power control algorithm 2, according to the highest reported body SAR configuration in 12.2 kbps RMC without HSPA.

When VOIP applies to head exposure, the 3G SAR test reduction procedure is applied with 12.2 kbps RMC as the primary mode; otherwise, the same HSPA configuration used for body SAR measurements are applied to head exposure testing.

8.6 SAR Measurement Conditions for LTE



LTE modes are tested according to FCC KDB 941225 D05v02r04 publication. Establishing connections with base station simulators ensure a consistent means for testing SAR and are recommended for evaluating SAR [4]. The R&S CMW500 or Anritsu MT8820C simulators are used for LTE output power measurements and SAR testing. Closed loop power control was used so the UE transmits with maximum output power during SAR testing. SAR tests were performed with the same number of RB and RB offsets transmitting on all TTI frames (maximum TTI).

8.6.1 Spectrum Plots for RB Configurations

A properly configured base station simulator was used for SAR tests and power measurements. Therefore, spectrum plots for RB configurations were not required to be included in this report.

8.6.2 MPR

MPR is permanently implemented for this device by the manufacturer. The specific manufacturer target MPR is indicated alongside the SAR results. MPR is enabled for this device, according to 3GPP TS36.101 Section 6.2.3 – 6.2.5 under Table 6.2.3-1.

FCC ID ZNFG710VM	 PCTEST ENGINEERING LABORATORY, INC.	SAR EVALUATION REPORT	 LG	Approved by: Quality Manager
Document S/N: 1M1804030062-01-R2.ZNF	Test Dates: 04/02/18 - 04/15/18	DUT Type: Portable Handset	Page 27 of 126	

8.6.3 A-MPR

A-MPR (Additional MPR) has been disabled for all SAR tests by setting NS=01 on the base station simulator.

8.6.4 Required RB Size and RB Offsets for SAR Testing

According to FCC KDB 941225 D05v02r04:



- a. Per Section 5.2.1, SAR is required for QPSK 1 RB Allocation for the largest bandwidth
 - i. The required channel and offset combination with the highest maximum output power is required for SAR.
 - ii. When the reported SAR is ≤ 0.8 W/kg, testing of the remaining RB offset configurations and required test channels is not required. Otherwise, SAR is required for the remaining required test channels using the RB offset configuration with highest output power for that channel.
 - iii. When the reported SAR for a required test channel is > 1.45 W/kg, SAR is required for all RB offset configurations for that channel.
- b. Per Section 5.2.2, SAR is required for 50% RB allocation using the largest bandwidth following the same procedures outlined in Section 5.2.1.
- c. Per Section 5.2.3, QPSK SAR is not required for the 100% allocation when the highest maximum output power for the 100% allocation is less than the highest maximum output power of the 1 RB and 50% RB allocations and the reported SAR for the 1 RB and 50% RB allocations is < 0.8 W/kg.
- d. Per Section 5.2.4 and 5.3, SAR tests for higher order modulations and lower bandwidths configurations are not required when the conducted power of the required test configurations determined by Sections 5.2.1 through 5.2.3 is less than or equal to $\frac{1}{2}$ dB higher than the equivalent configuration using QPSK modulation and when the QPSK SAR for those configurations is < 1.45 W/kg.
- e. Per FCC KDB Publication 447498 D01v06, when the reported LTE Band 41 SAR measured at the highest output power channel in a given a test configuration was > 0.6 W/kg for 1g evaluations, testing at the other channels was required for such test configurations.

8.6.5 TDD

LTE TDD testing is performed using the SAR test guidance provided in FCC KDB 941225 D05v02r04. TDD is tested at the highest duty factor using UL-DL configuration 0 with special subframe configuration 6 and applying the FDD LTE procedures in KDB 941225 D05v02r04. SAR testing is performed using the extended cyclic prefix listed in 3GPP TS 36.211 Section 4.

8.6.6 Downlink Only Carrier Aggregation

Conducted power measurements with LTE Carrier Aggregation (CA) (downlink only) active are made in accordance to KDB Publication 941225 D05Av01r02. The RRC connection is only handled by one cell, the primary component carrier (PCC) for downlink and uplink communications. After making a data connection to the PCC, the UE device adds secondary component carrier(s) (SCC) on the downlink only. All uplink communications and acknowledgements remain identical to specifications when downlink carrier aggregation is inactive on the PCC. For every supported combination of downlink only carrier aggregation, additional conducted output powers are measured with the downlink carrier aggregation active for the configuration with highest measured maximum conducted power with downlink carrier aggregation inactive measured among the channel bandwidth, modulation, and RB combinations in each frequency band. Per FCC KDB Publication 941225 D05Av01r02, no SAR measurements are required for carrier aggregation configurations when the average output power with downlink only carrier aggregation

FCC ID ZNFG710VM	 PCTEST ENGINEERING LABORATORY, INC.	SAR EVALUATION REPORT	 LG	Approved by: Quality Manager
Document S/N: 1M1804030062-01-R2.ZNF	Test Dates: 04/02/18 - 04/15/18	DUT Type: Portable Handset	Page 28 of 126	

active is not more than 0.25 dB higher than the average output power with downlink only carrier aggregation inactive.

8.7 SAR Testing with 802.11 Transmitters

The normal network operating configurations of 802.11 transmitters are not suitable for SAR measurements. Unpredictable fluctuations in network traffic and antenna diversity conditions can introduce undesirable variations in SAR results. The SAR for these devices should be measured using chipset based test mode software to ensure the results are consistent and reliable. See KDB Publication 248227 D01v02r02 for more details.

8.7.1 General Device Setup

Chipset based test mode software is hardware dependent and generally varies among manufacturers. The device operating parameters established in test mode for SAR measurements must be identical to those programmed in production units, including output power levels, amplifier gain settings and other RF performance tuning parameters.

A periodic duty factor is required for current generation SAR systems to measure SAR. When 802.11 frame gaps are accounted for in the transmission, a maximum transmission duty factor of 92 - 96% is typically achievable in most test mode configurations. A minimum transmission duty factor of 85% is required to avoid certain hardware and device implementation issues related to wide range SAR scaling. The reported SAR is scaled to 100% transmission duty factor to determine compliance at the maximum tune-up tolerance limit.

8.7.2 U-NII-1 and U-NII-2A



For devices that operate in both U-NII-1 and U-NII-2A bands, when the same maximum output power is specified for both bands, SAR measurement using OFDM SAR test procedures is not required for U-NII-1 unless the highest reported SAR for U-NII-2A is > 1.2 W/kg. When different maximum output powers are specified for the bands, SAR measurement for the U-NII band with the lower maximum output power is not required unless the highest reported SAR for the U-NII band with the higher maximum output power, adjusted by the ratio of lower to higher specified maximum output power for the two bands, is > 1.2 W/kg. When 10g SAR measurement is considered, a factor of 2.5 is applied to the thresholds above.

8.7.3 U-NII-2C and U-NII-3

The frequency range covered by U-NII-2C and U-NII-3 is 380 MHz (5.47 – 5.85 GHz), which requires a minimum of at least two SAR probe calibration frequency points to support SAR measurements. When Terminal Doppler Weather Radar (TDWR) restriction applies, the channels at 5.60 – 5.65 GHz in U-NII-2C band must be disabled with acceptable mechanisms and documented in the equipment certification. Unless band gap channels are permanently disabled, SAR must be considered for these channels. Each band is tested independently according to the normally required OFDM SAR measurement and probe calibration frequency points requirements.

8.7.4 Initial Test Position Procedure

For exposure conditions with multiple test positions, such as handset operating next to the ear, devices with hotspot mode or UMPC mini-tablet, procedures for initial test position can be applied. Using the transmission mode determined by the DSSS procedure or initial test configuration, area scans are measured for all positions in an exposure condition. The test position with the highest extrapolated (peak) SAR is used as the initial test position. When reported SAR for the initial test position is ≤ 0.4 W/kg, no additional testing for the remaining test positions is required. Otherwise, SAR is evaluated at the subsequent highest peak SAR

FCC ID ZNFG710VM	 PCTEST ENGINEERING LABORATORY, INC.	SAR EVALUATION REPORT	 LG	Approved by: Quality Manager
Document S/N: 1M1804030062-01-R2.ZNF	Test Dates: 04/02/18 - 04/15/18	DUT Type: Portable Handset	Page 29 of 126	

positions until the reported SAR result is ≤ 0.8 W/kg or all test positions are measured. When 10g SAR measurement is considered, a factor of 2.5 is applied to the thresholds above.

8.7.5 2.4 GHz SAR Test Requirements

SAR is measured for 2.4 GHz 802.11b DSSS using either the fixed test position or, when applicable, the initial test position procedure. SAR test reduction is determined according to the following:

- 1) When the reported SAR of the highest measured maximum output power channel for the exposure configuration is ≤ 0.8 W/kg, no further SAR testing is required for 802.11b DSSS in that exposure configuration.
- 2) When the reported SAR is > 0.8 W/kg, SAR is required for that position using the next highest measured output power channel. When any reported SAR is > 1.2 W/kg, SAR is required for the third channel; i.e., all channels require testing.

2.4 GHz 802.11 g/n OFDM are additionally evaluated for SAR if the highest reported SAR for 802.11b, adjusted by the ratio of the OFDM to DSSS specified maximum output power, is > 1.2 W/kg. When SAR is required for OFDM modes in 2.4 GHz band, the Initial Test Configuration Procedures should be followed. When 10g SAR measurement is considered, a factor of 2.5 is applied to the thresholds above.



8.7.6 OFDM Transmission Mode and SAR Test Channel Selection

When the same maximum output power was specified for multiple OFDM transmission mode configurations in a frequency band or aggregated band, SAR is measured using the configuration with the largest channel bandwidth, lowest order modulation and lowest data rate. When the maximum output power of a channel is the same for equivalent OFDM configurations; for example, 802.11a, 802.11n and 802.11ac or 802.11g and 802.11n with the same channel bandwidth, modulation and data rate etc., the lower order 802.11 mode i.e., 802.11a, then 802.11n and 802.11ac or 802.11g then 802.11n, is used for SAR measurement. When the maximum output power are the same for multiple test channels, either according to the default or additional power measurement requirements, SAR is measured using the channel closest to the middle of the frequency band or aggregated band. When there are multiple channels with the same maximum output power, SAR is measured using the higher number channel.

8.7.7 Initial Test Configuration Procedure

For OFDM, an initial test configuration is determined for each frequency band and aggregated band, according to the transmission mode with the highest maximum output power specified for SAR measurements. When the same maximum output power is specified for multiple OFDM transmission mode configurations in a frequency band or aggregated band, SAR is measured using the configuration(s) with the largest channel bandwidth, lowest order modulation, lowest data rate and lowest order IEEE 802.11 mode. The channel of the transmission mode with the highest average RF output conducted power will be the initial test configuration.

When the reported SAR is ≤ 0.8 W/kg, no additional measurements on other test channels are required. Otherwise, SAR is evaluated using the subsequent highest average RF output channel until the reported SAR result is ≤ 1.2 W/kg or all channels are measured. When there are multiple untested channels having the same subsequent highest average RF output power, the channel with higher frequency from the lowest 802.11 mode is considered for SAR measurements (See Section 8.7.6). When 10g SAR measurement is considered, a factor of 2.5 is applied to the thresholds above.



FCC ID ZNFG710VM	 PCTEST ENGINEERING LABORATORY, INC.	SAR EVALUATION REPORT	 LG	Approved by: Quality Manager
Document S/N: 1M1804030062-01-R2.ZNF	Test Dates: 04/02/18 - 04/15/18	DUT Type: Portable Handset	Page 30 of 126	

8.7.8 Subsequent Test Configuration Procedures

For OFDM configurations in each frequency band and aggregated band, SAR is evaluated for initial test configuration using the fixed test position or the initial test position procedure. When the highest reported SAR (for the initial test configuration), adjusted by the ratio of the specified maximum output power of the subsequent test configuration to initial test configuration, is ≤ 1.2 W/kg, no additional SAR tests for the subsequent test configurations are required. When 10g SAR measurement is considered, a factor of 2.5 is applied to the thresholds above.

8.7.9 MIMO SAR considerations

Per KDB Publication 248227 D01v02r02, the simultaneous SAR provisions in KDB Publication 447498 D01v06 should be applied to determine simultaneous transmission SAR test exclusion for WIFI MIMO. If the sum of 1g single transmission chain SAR measurements is < 1.6 W/kg, no additional SAR measurements for MIMO are required. Alternatively, SAR for MIMO can be measured with all antennas transmitting simultaneously at the specified maximum output power of MIMO operation. When 10g SAR measurement is considered, a factor of 2.5 is applied to the thresholds above.

FCC ID ZNFG710VM	 PCTEST ENGINEERING LABORATORY, INC.	SAR EVALUATION REPORT	 LG	Approved by: Quality Manager
Document S/N: 1M1804030062-01-R2.ZNF	Test Dates: 04/02/18 - 04/15/18	DUT Type: Portable Handset	Page 31 of 126	

9 RF CONDUCTED POWERS

9.1 CDMA Conducted Powers

**Table 9-1
Maximum Conducted Power**

Band	Channel	Rule Part	Frequency	SO55 [dBm]	SO55 [dBm]	SO75 [dBm]	TDSO SO32 [dBm]	TDSO SO32 [dBm]	1x EvDO Rev. 0 [dBm]	1x EvDO Rev. A [dBm]
	F-RC		MHz	RC1	RC3	RC11	FCH+SCH	FCH	(RTAP)	(RETAP)
Cellular	564	90S	820.1	25.22	25.22	25.34	25.31	25.30	25.13	25.20
Cellular	1013	22H	824.7	25.31	25.26	25.20	25.30	25.26	25.30	25.24
	384	22H	836.52	25.16	25.25	25.33	25.31	25.25	25.16	25.20
	777	22H	848.31	25.20	25.23	25.13	25.21	25.19	25.25	25.22
PCS	25	24E	1851.25	25.10	25.06	25.11	25.06	25.19	25.13	25.09
	600	24E	1880	25.13	25.20	25.15	25.13	25.19	25.10	25.11
	1175	24E	1908.75	25.10	25.09	25.07	25.06	25.08	25.14	25.14

**Table 9-2
Reduced Conducted Powers**

Band	Channel	Rule Part	Frequency	SO55 [dBm]	SO55 [dBm]	SO75 [dBm]	TDSO SO32 [dBm]	TDSO SO32 [dBm]	1x EvDO Rev. 0 [dBm]	1x EvDO Rev. A [dBm]
	F-RC		MHz	RC1	RC3	RC11	FCH+SCH	FCH	(RTAP)	(RETAP)
PCS	25	24E	1851.25	24.06	24.15	24.10	24.06	24.07	24.10	24.13
	600	24E	1880	24.12	24.03	24.16	24.14	24.18	24.19	24.16
	1175	24E	1908.75	24.11	24.05	24.13	24.15	24.17	24.13	24.15

Note: RC1 is only applicable for IS-95 compatibility. For FCC Rule Part 90S, Per FCC KDB Publication 447498 D01v06 4.1.g), only one channel is required since the device operates within the transmission range of 817.90 – 823.10 MHz.

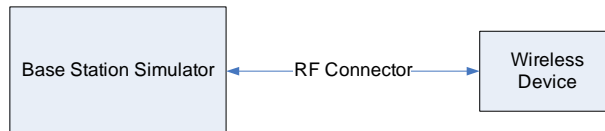

**Figure 9-1
Power Measurement Setup**

FCC ID ZNFG710VM	PCTEST ENGINEERING LABORATORY, INC.	SAR EVALUATION REPORT	LG	Approved by: Quality Manager
Document S/N: 1M1804030062-01-R2.ZNF	Test Dates: 04/02/18 - 04/15/18	DUT Type: Portable Handset	Page 32 of 126	



9.2 GSM Conducted Powers

**Table 9-3
Maximum Conducted Power**

Maximum Burst-Averaged Output Power						
Band	Channel	Voice	GPRS/EDGE Data (GMSK)		EDGE Data (8-PSK)	
		GSM [dBm] CS (1 Slot)	GPRS [dBm] 1 Tx Slot	GPRS [dBm] 2 Tx Slot	EDGE [dBm] 1 Tx Slot	EDGE [dBm] 2 Tx Slot
GSM 850	128	31.54	31.42	31.23	27.33	27.30
	190	31.50	31.49	31.29	27.32	27.23
	251	31.51	31.45	31.30	27.25	27.25
GSM 1900	512	30.59	30.60	29.38	26.44	26.34
	661	30.61	30.60	29.41	26.41	26.29
	810	30.51	30.55	29.39	26.31	26.30

Calculated Maximum Frame-Averaged Output Power						
Band	Channel	Voice	GPRS/EDGE Data (GMSK)		EDGE Data (8-PSK)	
		GSM [dBm] CS (1 Slot)	GPRS [dBm] 1 Tx Slot	GPRS [dBm] 2 Tx Slot	EDGE [dBm] 1 Tx Slot	EDGE [dBm] 2 Tx Slot
GSM 850	128	22.51	22.39	25.21	18.30	21.28
	190	22.47	22.46	25.27	18.29	21.21
	251	22.48	22.42	25.28	18.22	21.23
GSM 1900	512	21.56	21.57	23.36	17.41	20.32
	661	21.58	21.57	23.39	17.38	20.27
	810	21.48	21.52	23.37	17.28	20.28

GSM 850	Frame Avg. Targets:	22.17	22.17	25.18	18.17	21.18
GSM 1900		21.17	21.17	23.18	17.17	20.18

FCC ID ZNFG710VM	 PCTEST ENGINEERING LABORATORY, INC.	SAR EVALUATION REPORT	 LG	Approved by: Quality Manager
Document S/N: 1M1804030062-01-R2.ZNF	Test Dates: 04/02/18 - 04/15/18	DUT Type: Portable Handset		Page 33 of 126



Note:

1. Both burst-averaged and calculated frame-averaged powers are included. Frame-averaged power was calculated from the measured burst-averaged power by converting the slot powers into linear units and calculating the energy over 8 timeslots.
2. GPRS/EDGE (GMSK) output powers were measured with coding scheme setting of 1 (CS1) on the base station simulator. CS1 was configured to measure GPRS output power measurements and SAR to ensure GMSK modulation in the signal. Our Investigation has shown that CS1 - CS4 settings do not have any impact on the output levels or modulation in the GPRS modes.
3. EDGE (8-PSK) output powers were measured with MCS7 on the base station simulator. MCS7 coding scheme was used to measure the output powers for EDGE since investigation has shown that choosing MCS7 coding scheme will ensure 8-PSK modulation. It has been shown that MCS levels that produce 8PSK modulation do not have an impact on output power.

GSM Class: B
GPRS Multislot class: 10 (Max 2 Tx uplink slots)
EDGE Multislot class: 10 (Max 2 Tx uplink slots)
DTM Multislot Class: N/A



Figure 9-2
Power Measurement Setup

FCC ID ZNFG710VM	 PCTEST ENGINEERING LABORATORY, INC.	SAR EVALUATION REPORT	 LG	Approved by: Quality Manager
Document S/N: 1M1804030062-01-R2.ZNF	Test Dates: 04/02/18 - 04/15/18	DUT Type: Portable Handset		Page 34 of 126

9.3 UMTS Conducted Powers

**Table 9-4
Maximum Conducted Power**

3GPP Release Version	Mode	3GPP 34.121 Subtest	Cellular Band [dBm]			AWS Band [dBm]			PCS Band [dBm]			3GPP MPR [dB]
			4132	4183	4233	1312	1412	1513	9262	9400	9538	
99	WCDMA	12.2 kbps RMC	25.35	25.31	25.29	24.99	24.96	25.03	25.19	25.21	25.35	-
99		12.2 kbps AMR	25.25	25.30	25.34	25.00	24.65	24.99	25.13	25.20	25.29	-
6	HSDPA	Subtest 1	25.12	25.15	25.12	24.95	24.92	24.95	25.08	25.00	25.08	0
6		Subtest 2	25.14	25.15	25.13	24.96	24.94	24.95	25.07	25.01	25.06	0
6		Subtest 3	24.62	24.70	24.65	24.38	24.35	24.40	24.50	24.42	24.50	0.5
6		Subtest 4	24.65	24.67	24.66	24.42	24.40	24.40	24.48	24.40	24.50	0.5
6	HSUPA	Subtest 1	25.14	25.12	25.15	24.90	24.87	24.90	25.04	24.96	25.05	0
6		Subtest 2	23.18	23.20	23.20	22.95	22.98	22.95	23.10	23.01	23.10	2
6		Subtest 3	24.15	24.16	24.20	23.97	24.00	24.00	24.10	24.02	24.10	1
6		Subtest 4	23.17	23.20	23.14	23.00	22.97	22.95	23.10	23.00	23.10	2
6		Subtest 5	25.14	25.14	25.16	24.95	24.94	24.96	25.06	25.00	25.06	0

**Table 9-5
Reduced Conducted Power**

3GPP Release Version	Mode	3GPP 34.121 Subtest	AWS Band [dBm]			PCS Band [dBm]			3GPP MPR [dB]
			1312	1412	1513	9262	9400	9538	
99	WCDMA	12.2 kbps RMC	23.95	23.90	23.88	24.13	24.11	24.16	-
99		12.2 kbps AMR	24.02	23.68	24.09	24.12	24.19	24.22	-
6	HSDPA	Subtest 1	23.95	23.88	23.99	24.02	24.07	24.01	0
6		Subtest 2	24.06	23.88	23.89	24.05	24.06	24.07	0
6		Subtest 3	23.47	23.42	23.39	23.48	23.37	23.46	0.5
6		Subtest 4	23.35	23.49	23.48	23.47	23.43	23.47	0.5
6	HSUPA	Subtest 1	23.89	23.78	23.82	24.06	24.01	23.97	0
6		Subtest 2	21.95	21.92	22.04	22.09	21.90	22.11	2
6		Subtest 3	23.04	22.93	22.93	23.03	22.96	23.04	1
6		Subtest 4	21.99	21.97	21.90	22.18	22.05	22.06	2
6		Subtest 5	23.91	24.03	23.91	24.16	23.91	24.03	0

This device does not support DC-HSDPA.

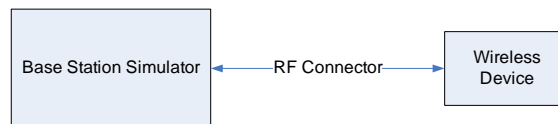

**Figure 9-3
Power Measurement Setup**

FCC ID ZNFG710VM	PCTEST ENGINEERING LABORATORY, INC.	SAR EVALUATION REPORT	LG	Approved by: Quality Manager
Document S/N: 1M1804030062-01-R2.ZNF	Test Dates: 04/02/18 - 04/15/18	DUT Type: Portable Handset	Page 35 of 126	



9.4 LTE Conducted Powers

9.4.1 LTE Band 12

Table 9-6
LTE Band 12 Conducted Powers - 10 MHz Bandwidth

LTE Band 12 10 MHz Bandwidth					
Modulation	RB Size	RB Offset	Mid Channel	MPR Allowed per 3GPP [dB]	MPR [dB]
			23095 (707.5 MHz)		
			Conducted Power [dBm]		
QPSK	1	0	25.10	0	0
	1	25	25.03		0
	1	49	24.96		0
	25	0	23.94	0-1	1
	25	12	23.97		1
	25	25	24.07		1
	50	0	23.96		1
16QAM	1	0	24.00	0-1	1
	1	25	23.89		1
	1	49	23.93		1
	25	0	23.04	0-2	2
	25	12	23.02		2
	25	25	23.09		2
	50	0	23.05		2
64QAM	1	0	23.00	0-2	2
	1	25	23.01		2
	1	49	23.13		2
	25	0	22.02	0-3	3
	25	12	22.07		3
	25	25	21.97		3
	50	0	21.92		3

Note: LTE Band 12 at 10 MHz bandwidth does not support three non-overlapping channels. Per KDB Publication 941225 D05v02, when a device supports overlapping channel assignment in a channel bandwidth configuration, the middle channel of the group of overlapping channels should be selected for testing.

FCC ID ZNFG710VM	 PCTEST ENGINEERING LABORATORY, INC.	SAR EVALUATION REPORT	 LG	Approved by: Quality Manager
Document S/N: 1M1804030062-01-R2.ZNF	Test Dates: 04/02/18 - 04/15/18	DUT Type: Portable Handset		Page 36 of 126

**Table 9-7
LTE Band 12 Conducted Powers - 5 MHz Bandwidth**

LTE Band 12 5 MHz Bandwidth							
Modulation	RB Size	RB Offset	Low Channel	Mid Channel	High Channel	MPR Allowed per 3GPP [dB]	MPR [dB]
			23035 (701.5 MHz)	23095 (707.5 MHz)	23155 (713.5 MHz)		
			Conducted Power [dBm]				
QPSK	1	0	24.85	24.96	25.03	0	0
	1	12	24.88	24.92	25.03		0
	1	24	25.09	24.97	24.96		0
	12	0	23.92	23.87	24.06	0-1	1
	12	6	23.98	23.97	23.99		1
	12	13	24.04	23.95	24.04		1
16QAM	25	0	23.97	23.91	24.09	0-1	1
	1	0	24.24	24.20	24.25		1
	1	12	24.30	24.30	24.36		1
	1	24	24.28	24.20	24.34	0-2	1
	12	0	23.04	22.95	23.03		2
	12	6	23.10	23.05	23.07		2
64QAM	12	13	23.09	23.00	23.09	0-2	2
	25	0	23.03	22.96	23.15		2
	1	0	23.22	23.13	23.13		0-2
	1	12	23.22	23.27	23.22	2	
	1	24	23.25	23.08	23.24	2	
	64QAM	12	0	21.96	21.84	21.99	0-3
12		6	22.01	22.02	22.06	3	
12		13	21.95	21.91	22.04	3	
25		0	21.99	21.94	22.11	3	

**Table 9-8
LTE Band 12 Conducted Powers - 3 MHz Bandwidth**

LTE Band 12 3 MHz Bandwidth								
Modulation	RB Size	RB Offset	Low Channel	Mid Channel	High Channel	MPR Allowed per 3GPP [dB]	MPR [dB]	
			23025 (700.5 MHz)	23095 (707.5 MHz)	23165 (714.5 MHz)			
			Conducted Power [dBm]					
QPSK	1	0	24.66	25.01	24.94	0	0	
	1	7	24.88	25.01	24.94		0	
	1	14	24.77	24.89	25.02		0	
	8	0	23.82	23.89	24.06	0-1	1	
	8	4	23.87	23.97	24.01		1	
	8	7	23.92	23.93	23.99		1	
16QAM	15	0	23.83	23.93	24.01	0-1	1	
	1	0	24.11	24.20	24.29		0-1	1
	1	7	24.23	24.29	24.44			1
	1	14	24.20	24.17	24.47	0-2		1
	8	0	22.90	22.86	23.08		2	
	8	4	23.01	22.96	23.03		2	
64QAM	8	7	22.99	22.90	22.98	0-2	2	
	15	0	22.92	22.93	23.03		2	
	1	0	23.05	23.07	23.24		0-2	2
	1	7	23.18	23.22	23.34	2		
	1	14	23.12	23.10	23.41	2		
	64QAM	8	0	21.77	21.78	22.05	0-3	3
8		4	21.88	21.90	21.98	3		
8		7	21.94	21.78	21.94	3		
15		0	21.81	21.83	22.00	3		





FCC ID ZNFG710VM	 PCTEST ENGINEERING LABORATORY, INC.	SAR EVALUATION REPORT	 LG	Approved by: Quality Manager
Document S/N: 1M1804030062-01-R2.ZNF	Test Dates: 04/02/18 - 04/15/18	DUT Type: Portable Handset		Page 37 of 126

Table 9-9
LTE Band 12 Conducted Powers -1.4 MHz Bandwidth

LTE Band 12 1.4 MHz Bandwidth							
Modulation	RB Size	RB Offset	Low Channel	Mid Channel	High Channel	MPR Allowed per 3GPP [dB]	MPR [dB]
			23017 (699.7 MHz)	23095 (707.5 MHz)	23173 (715.3 MHz)		
			Conducted Power [dBm]				
QPSK	1	0	25.05	25.20	25.30	0	0
	1	2	25.12	25.29	25.34		0
	1	5	25.05	25.27	25.32		0
	3	0	25.15	25.30	25.40		0
	3	2	25.12	25.38	25.40		0
	3	3	25.18	25.40	25.37		0
	6	0	24.15	24.29	24.34	0-1	1
16QAM	1	0	24.45	24.28	24.31	0-1	1
	1	2	24.46	24.29	24.18		1
	1	5	24.45	24.32	24.23		1
	3	0	24.39	24.38	24.18		1
	3	2	24.36	24.44	24.10		1
	3	3	24.34	24.45	24.11		1
	6	0	23.14	23.25	23.25	0-2	2
64QAM	1	0	23.36	23.27	23.24	0-2	2
	1	2	23.42	23.26	23.12		2
	1	5	23.45	23.32	23.12		2
	3	0	23.26	23.25	23.10		2
	3	2	23.27	23.42	23.09		2
	3	3	23.25	23.41	22.99		2
	6	0	22.03	22.17	22.19	0-3	3



FCC ID ZNFG710VM	 PCTEST ENGINEERING LABORATORY, INC.	SAR EVALUATION REPORT		Approved by: Quality Manager
Document S/N: 1M1804030062-01-R2.ZNF	Test Dates: 04/02/18 - 04/15/18	DUT Type: Portable Handset	Page 38 of 126	

9.4.2

LTE Band 13

Table 9-10
 LTE Band 13 Conducted Powers - 10 MHz Bandwidth



LTE Band 13 10 MHz Bandwidth					
Modulation	RB Size	RB Offset	Mid Channel	MPR Allowed per 3GPP [dB]	MPR [dB]
			23230 (782.0 MHz)		
			Conducted Power [dBm]		
QPSK	1	0	25.06	0	0
	1	25	25.07		0
	1	49	25.04		0
	25	0	23.94	0-1	1
	25	12	24.01		1
	25	25	23.97		1
	50	0	23.92		1
16QAM	1	0	23.96	0-1	1
	1	25	24.10		1
	1	49	24.05		1
	25	0	22.99	0-2	2
	25	12	23.04		2
	25	25	23.02		2
	50	0	22.91		2
64QAM	1	0	23.00	0-2	2
	1	25	23.01		2
	1	49	23.13		2
	25	0	22.06	0-3	3
	25	12	22.07		3
	25	25	21.98		3
	50	0	22.09		3

FCC ID ZNFG710VM	 PCTEST ENGINEERING LABORATORY, INC.	SAR EVALUATION REPORT	 LG	Approved by: Quality Manager
Document S/N: 1M1804030062-01-R2.ZNF	Test Dates: 04/02/18 - 04/15/18	DUT Type: Portable Handset		Page 39 of 126

**Table 9-11
LTE Band 13 Conducted Powers - 5 MHz Bandwidth**

LTE Band 13 5 MHz Bandwidth					
Modulation	RB Size	RB Offset	Mid Channel	MPR Allowed per 3GPP [dB]	MPR [dB]
			23230 (782.0 MHz)		
			Conducted Power [dBm]		
QPSK	1	0	25.29	0	0
	1	12	25.39		0
	1	24	24.99		0
	12	0	24.24	0-1	1
	12	6	24.46		1
	12	13	24.32		1
	25	0	24.30		1
16QAM	1	0	24.39	0-1	1
	1	12	24.31		1
	1	24	24.30		1
	12	0	23.25	0-2	2
	12	6	23.33		2
	12	13	23.37		2
	25	0	23.36		2
64QAM	1	0	23.22	0-2	2
	1	12	23.06		2
	1	24	23.15		2
	12	0	22.13	0-3	3
	12	6	22.06		3
	12	13	22.22		3
	25	0	22.21		3

Note: LTE Band 13 at 5 MHz bandwidth does not support three non-overlapping channels. Per KDB Publication 941225 D05v02, when a device supports overlapping channel assignment in a channel bandwidth configuration, the middle channel of the group of overlapping channels should be selected for testing.

FCC ID ZNFG710VM	 PCTEST ENGINEERING LABORATORY, INC.	SAR EVALUATION REPORT	 LG	Approved by: Quality Manager
Document S/N: 1M1804030062-01-R2.ZNF	Test Dates: 04/02/18 - 04/15/18	DUT Type: Portable Handset		Page 40 of 126

9.4.3

LTE Band 26 (Cell)

Table 9-12
 LTE Band 26 (Cell) Conducted Powers - 15 MHz Bandwidth

LTE Band 26 (Cell) 15 MHz Bandwidth					
Modulation	RB Size	RB Offset	Mid Channel	MPR Allowed per 3GPP [dB]	MPR [dB]
			26865 (831.5 MHz)		
			Conducted Power [dBm]		
QPSK	1	0	24.99	0	0
	1	36	25.06		0
	1	74	24.99		0
	36	0	23.99	0-1	1
	36	18	24.02		1
	36	37	24.12		1
	75	0	24.11		1
16QAM	1	0	24.00	0-1	1
	1	36	24.01		1
	1	74	24.02		1
	36	0	22.99	0-2	2
	36	18	22.92		2
	36	37	22.88		2
	75	0	23.01		2
64QAM	1	0	23.00	0-2	2
	1	36	22.96		2
	1	74	23.12		2
	36	0	21.98	0-3	3
	36	18	22.06		3
	36	37	21.98		3
	75	0	22.03		3

Note: LTE Band 26 (Cell) at 15 MHz bandwidth does not support three non-overlapping channels. Per KDB Publication 941225 D05v02, when a device supports overlapping channel assignment in a channel bandwidth configuration, the middle channel of the group of overlapping channels should be selected for testing.



FCC ID ZNFG710VM	 PCTEST ENGINEERING LABORATORY, INC.	SAR EVALUATION REPORT	 LG	Approved by: Quality Manager
Document S/N: 1M1804030062-01-R2.ZNF	Test Dates: 04/02/18 - 04/15/18	DUT Type: Portable Handset		Page 41 of 126

Table 9-13
LTE Band 26 (Cell) Conducted Powers - 10 MHz Bandwidth

LTE Band 26 (Cell) 10 MHz Bandwidth							
Modulation	RB Size	RB Offset	Low Channel	Mid Channel	High Channel	MPR Allowed per 3GPP [dB]	MPR [dB]
			26740 (819.0 MHz)	26865 (831.5 MHz)	26990 (844.0 MHz)		
			Conducted Power [dBm]				
QPSK	1	0	24.97	25.17	25.06	0	0
	1	25	24.93	25.22	25.16		0
	1	49	24.85	24.87	24.80		0
	25	0	24.16	24.26	24.33	0-1	1
	25	12	23.99	24.09	24.26		1
	25	25	24.08	24.08	24.27		1
16QAM	1	0	24.42	24.46	24.46	0-1	1
	1	25	24.21	24.36	24.44		1
	1	49	24.27	24.43	24.00		1
	25	0	23.10	23.22	23.28	0-2	2
	25	12	23.13	23.29	23.35		2
	25	25	23.02	23.16	23.27		2
64QAM	1	0	23.36	23.40	23.42	0-2	2
	1	25	23.19	23.32	23.31		2
	1	49	23.14	23.32	22.86		2
	25	0	22.07	22.22	22.16	0-3	3
	25	12	22.05	22.16	22.22		3
	25	25	21.90	22.13	22.23		3
	50	0	22.01	22.22	22.17		3

Table 9-14
LTE Band 26 (Cell) Conducted Powers - 5 MHz Bandwidth

LTE Band 26 (Cell) 5 MHz Bandwidth							
Modulation	RB Size	RB Offset	Low Channel	Mid Channel	High Channel	MPR Allowed per 3GPP [dB]	MPR [dB]
			26715 (816.5 MHz)	26865 (831.5 MHz)	27015 (846.5 MHz)		
			Conducted Power [dBm]				
QPSK	1	0	25.10	25.17	25.01	0	0
	1	12	25.21	25.22	25.00		0
	1	24	25.00	25.06	24.76		0
	12	0	24.30	24.29	24.25	0-1	1
	12	6	24.25	24.23	24.20		1
	12	13	24.21	24.17	23.97		1
16QAM	25	0	24.07	24.13	24.13		1
	1	0	24.45	24.43	24.44	0-1	1
	1	12	24.36	24.43	24.35		1
	1	24	24.46	24.36	23.89		1
	12	0	23.29	23.24	23.31	0-2	2
	12	6	23.32	23.27	23.38		2
12	13	23.16	23.08	23.09	2		
64QAM	25	0	23.28	23.23	23.27		2
	1	0	23.41	23.42	23.34	0-2	2
	1	12	23.31	23.29	23.34		2
	1	24	23.38	23.22	22.76		2
	12	0	22.17	22.20	22.30	0-3	3
	12	6	22.27	22.13	22.32		3
12	13	22.05	22.01	21.96	3		
	25	0	22.15	22.09	22.18		3





FCC ID ZNFG710VM	 PCTEST ENGINEERING LABORATORY, INC.	SAR EVALUATION REPORT	 LG	Approved by: Quality Manager
Document S/N: 1M1804030062-01-R2.ZNF	Test Dates: 04/02/18 - 04/15/18	DUT Type: Portable Handset		Page 42 of 126

Table 9-15
LTE Band 26 (Cell) Conducted Powers - 3 MHz Bandwidth

LTE Band 26 (Cell) 3 MHz Bandwidth							
Modulation	RB Size	RB Offset	Low Channel	Mid Channel	High Channel	MPR Allowed per 3GPP [dB]	MPR [dB]
			26705 (815.5 MHz)	26865 (831.5 MHz)	27025 (847.5 MHz)		
			Conducted Power [dBm]				
QPSK	1	0	24.99	25.17	25.03	0	0
	1	7	25.16	25.29	24.91		0
	1	14	24.99	25.01	24.82		0
	8	0	24.26	24.29	24.10	0-1	1
	8	4	24.22	24.20	23.93		1
	8	7	24.21	24.15	23.85		1
16QAM	15	0	24.17	24.19	23.99	0-1	1
	1	0	24.41	24.33	24.50		1
	1	7	24.47	24.39	24.32		1
	1	14	24.35	24.34	23.92	0-2	1
	8	0	23.28	23.15	23.05		2
	8	4	23.33	23.27	23.03		2
64QAM	8	7	23.22	23.08	22.84	0-2	2
	15	0	23.26	23.26	23.04		2
	1	0	23.40	23.29	23.36		0-2
	1	7	23.44	23.32	23.23	2	
	1	14	23.33	23.22	22.80	2	
	64QAM	8	0	22.24	22.03	21.98	0-3
8		4	22.25	22.15	21.95	3	
8		7	22.14	22.08	21.84	3	
15		0	22.14	22.15	21.94	0-3	3
8		0	22.24	22.03	21.98		3
8		4	22.25	22.15	21.95		3

Table 9-16
LTE Band 26 (Cell) Conducted Powers -1.4 MHz Bandwidth

LTE Band 26 (Cell) 1.4 MHz Bandwidth							
Modulation	RB Size	RB Offset	Low Channel	Mid Channel	High Channel	MPR Allowed per 3GPP [dB]	MPR [dB]
			26697 (814.7 MHz)	26865 (831.5 MHz)	27033 (848.3 MHz)		
			Conducted Power [dBm]				
QPSK	1	0	24.98	25.03	24.87	0	0
	1	2	25.09	25.16	24.85		0
	1	5	24.97	24.91	24.53		0
	3	0	25.07	25.16	24.85	0-1	0
	3	2	25.06	25.13	24.70		0
	3	3	25.05	25.16	24.69		0
16QAM	6	0	23.98	24.08	23.86	0-1	1
	1	0	24.24	24.43	24.37		1
	1	2	24.29	24.40	24.27		1
	1	5	24.25	24.38	24.05	0-1	1
	3	0	24.22	24.12	23.91		1
	3	2	24.30	24.26	23.92		1
64QAM	3	3	24.16	24.13	23.75	0-2	1
	6	0	23.05	23.15	22.96		2
	1	0	23.15	23.42	23.28		0-2
	1	2	23.20	23.28	23.22	2	
	1	5	23.20	23.37	23.05	2	
	64QAM	3	0	23.11	22.98	22.84	0-2
3		2	23.20	23.12	22.82	2	
3		3	23.12	23.04	22.73	2	
6		0	22.02	22.13	21.93	0-3	3
3		0	23.11	22.98	22.84		2
3		2	23.20	23.12	22.82		2

FCC ID ZNFG710VM	 PCTEST ENGINEERING LABORATORY, INC.	SAR EVALUATION REPORT	 LG	Approved by: Quality Manager
Document S/N: 1M1804030062-01-R2.ZNF	Test Dates: 04/02/18 - 04/15/18	DUT Type: Portable Handset		Page 43 of 126



9.4.1

LTE Band 5 (Cell)

Table 9-17
 LTE Band 5 (Cell) Conducted Powers - 10 MHz Bandwidth

LTE Band 5 (Cell) 10 MHz Bandwidth					
Modulation	RB Size	RB Offset	Mid Channel	MPR Allowed per 3GPP [dB]	MPR [dB]
			20525 (836.5 MHz)		
			Conducted Power [dBm]		
QPSK	1	0	25.34	0	0
	1	25	24.93		0
	1	49	25.19		0
	25	0	24.28	0-1	1
	25	12	24.17		1
	25	25	24.15		1
	50	0	24.26		1
16QAM	1	0	24.11	0-1	1
	1	25	24.33		1
	1	49	24.20		1
	25	0	23.27	0-2	2
	25	12	23.11		2
	25	25	23.18		2
	50	0	23.19		2
64QAM	1	0	23.03	0-2	2
	1	25	23.23		2
	1	49	23.10		2
	25	0	22.25	0-3	3
	25	12	22.09		3
	25	25	22.06		3
	50	0	22.16		3

Note: LTE Band 5 (Cell) at 10 MHz bandwidth does not support three non-overlapping channels. Per KDB Publication 941225 D05v02, when a device supports overlapping channel assignment in a channel bandwidth configuration, the middle channel of the group of overlapping channels should be selected for testing.

FCC ID ZNFG710VM	 PCTEST ENGINEERING LABORATORY, INC.	SAR EVALUATION REPORT	 LG	Approved by: Quality Manager
Document S/N: 1M1804030062-01-R2.ZNF	Test Dates: 04/02/18 - 04/15/18	DUT Type: Portable Handset		Page 44 of 126

**Table 9-18
LTE Band 5 (Cell) Conducted Powers - 5 MHz Bandwidth**

LTE Band 5 (Cell) 5 MHz Bandwidth							
Modulation	RB Size	RB Offset	Low Channel	Mid Channel	High Channel	MPR Allowed per 3GPP [dB]	MPR [dB]
			20425 (826.5 MHz)	20525 (836.5 MHz)	20625 (846.5 MHz)		
			Conducted Power [dBm]				
QPSK	1	0	25.24	25.27	25.09	0	0
	1	12	25.18	25.09	24.97		0
	1	24	25.21	25.14	25.10		0
	12	0	24.25	24.16	24.10	0-1	1
	12	6	24.28	24.13	24.21		1
	12	13	24.18	24.12	24.25		1
	25	0	24.25	24.08	24.17		1
16QAM	1	0	24.15	24.21	24.15	0-1	1
	1	12	24.09	24.37	23.89		1
	1	24	24.15	24.22	24.05		1
	12	0	23.31	23.20	23.30	0-2	2
	12	6	23.34	23.15	23.24		2
	12	13	23.27	23.16	23.35		2
	25	0	23.22	23.12	23.20		2
64QAM	1	0	23.03	23.07	23.03	0-2	2
	1	12	23.09	23.26	22.87		2
	1	24	23.02	23.11	22.96		2
	12	0	22.17	22.10	22.29	0-3	3
	12	6	22.32	22.02	22.12		3
	12	13	22.19	22.11	22.35		3
	25	0	22.16	22.11	22.12		3

**Table 9-19
LTE Band 5 (Cell) Conducted Powers - 3 MHz Bandwidth**

LTE Band 5 (Cell) 3 MHz Bandwidth							
Modulation	RB Size	RB Offset	Low Channel	Mid Channel	High Channel	MPR Allowed per 3GPP [dB]	MPR [dB]
			20415 (825.5 MHz)	20525 (836.5 MHz)	20635 (847.5 MHz)		
			Conducted Power [dBm]				
QPSK	1	0	25.01	25.12	25.15	0	0
	1	7	25.07	25.13	25.10		0
	1	14	25.01	25.07	25.10		0
	8	0	24.16	24.13	24.06	0-1	1
	8	4	24.22	24.13	24.22		1
	8	7	24.09	24.07	24.16		1
	15	0	24.22	24.15	24.20		1
16QAM	1	0	24.05	24.05	24.25	0-1	1
	1	7	24.29	24.19	24.19		1
	1	14	23.85	23.75	24.15		1
	8	0	23.27	23.19	23.09	0-2	2
	8	4	23.26	23.09	23.21		2
	8	7	23.21	23.10	23.20		2
	15	0	23.19	23.07	23.09		2
64QAM	1	0	23.05	23.03	23.21	0-2	2
	1	7	23.18	23.08	23.10		2
	1	14	22.81	22.64	23.11		2
	8	0	22.23	22.16	21.95	0-3	3
	8	4	22.15	22.03	22.11		3
	8	7	22.09	22.02	22.11		3
	15	0	22.14	22.00	22.02		3





FCC ID ZNFG710VM	 PCTEST ENGINEERING LABORATORY, INC.	SAR EVALUATION REPORT	 LG	Approved by: Quality Manager
Document S/N: 1M1804030062-01-R2.ZNF	Test Dates: 04/02/18 - 04/15/18	DUT Type: Portable Handset		Page 45 of 126

Table 9-20
LTE Band 5 (Cell) Conducted Powers -1.4 MHz Bandwidth

LTE Band 5 (Cell) 1.4 MHz Bandwidth							
Modulation	RB Size	RB Offset	Low Channel	Mid Channel	High Channel	MPR Allowed per 3GPP [dB]	MPR [dB]
			20407 (824.7 MHz)	20525 (836.5 MHz)	20643 (848.3 MHz)		
			Conducted Power [dBm]				
QPSK	1	0	25.01	24.98	25.04	0	0
	1	2	25.06	25.02	25.06		0
	1	5	25.00	25.05	25.05		0
	3	0	25.21	24.98	25.10		0
	3	2	25.22	25.06	25.25		0
	3	3	25.10	24.97	25.16		0
	6	0	24.17	24.06	24.09	0-1	1
16QAM	1	0	24.28	24.30	24.15	0-1	1
	1	2	24.21	24.09	24.19		1
	1	5	24.27	24.31	24.25		1
	3	0	24.38	24.15	24.19		1
	3	2	24.30	24.16	24.17		1
	3	3	24.26	24.13	24.15		1
	6	0	23.10	23.18	23.01	0-2	2
64QAM	1	0	23.23	23.18	23.09	0-2	2
	1	2	23.19	23.05	23.14		2
	1	5	23.24	23.19	23.23		2
	3	0	23.29	23.15	23.11		2
	3	2	23.27	23.08	23.07		2
	3	3	23.13	23.01	23.13		2
	6	0	22.08	22.07	21.97	0-3	3

FCC ID ZNFG710VM	 PCTEST <small>ENGINEERING LABORATORY, INC.</small>	SAR EVALUATION REPORT		Approved by: Quality Manager
Document S/N: 1M1804030062-01-R2.ZNF	Test Dates: 04/02/18 - 04/15/18	DUT Type: Portable Handset		Page 46 of 126

9.4.2 LTE Band 66 (AWS)

**Table 9-21
LTE Band 66 (AWS) Maximum Conducted Powers - 20 MHz Bandwidth**

LTE Band 66 (AWS) 20 MHz Bandwidth							
Modulation	RB Size	RB Offset	Low Channel	Mid Channel	High Channel	MPR Allowed per 3GPP [dB]	MPR [dB]
			132072 (1720.0 MHz)	132322 (1745.0 MHz)	132572 (1770.0 MHz)		
			Conducted Power [dBm]				
QPSK	1	0	25.07	25.11	24.96	0	0
	1	50	25.15	25.09	25.06		0
	1	99	25.20	25.19	25.09		0
	50	0	23.98	23.97	24.03	0-1	1
	50	25	24.04	23.97	23.96		1
	50	50	24.10	24.07	23.89		1
	100	0	24.00	24.03	23.90		1
16QAM	1	0	24.03	23.93	24.04	0-1	1
	1	50	24.04	23.95	23.96		1
	1	99	23.96	23.93	23.95		1
	50	0	23.01	23.13	22.96	0-2	2
	50	25	22.95	23.00	23.00		2
	50	50	23.20	22.90	23.10		2
	100	0	23.16	22.95	22.98		2
64QAM	1	0	22.93	22.91	23.07	0-2	2
	1	50	23.13	22.96	23.07		2
	1	99	23.19	23.02	23.18		2
	50	0	22.05	22.17	22.07	0-3	3
	50	25	22.05	22.01	21.97		3
	50	50	22.19	21.93	21.88		3
	100	0	22.03	22.03	22.09		3

**Table 9-22
LTE Band 66 (AWS) Maximum Conducted Powers - 15 MHz Bandwidth**

LTE Band 66 (AWS) 15 MHz Bandwidth							
Modulation	RB Size	RB Offset	Low Channel	Mid Channel	High Channel	MPR Allowed per 3GPP [dB]	MPR [dB]
			132047 (1717.5 MHz)	132322 (1745.0 MHz)	132597 (1772.5 MHz)		
			Conducted Power [dBm]				
QPSK	1	0	25.11	24.76	24.94	0	0
	1	36	24.80	24.52	24.57		0
	1	74	25.01	24.92	24.88		0
	36	0	23.85	23.73	23.96	0-1	1
	36	18	23.50	23.71	23.86		1
	36	37	24.09	23.95	23.98		1
	75	0	23.88	23.95	23.91		1
16QAM	1	0	24.00	23.57	23.76	0-1	1
	1	36	23.66	23.32	23.66		1
	1	74	23.76	23.69	23.84		1
	36	0	22.25	22.75	22.83	0-2	2
	36	18	22.51	22.74	22.93		2
	36	37	23.11	22.95	22.87		2
	75	0	22.72	22.95	22.96		2
64QAM	1	0	22.94	22.52	22.70	0-2	2
	1	36	22.58	22.22	22.61		2
	1	74	22.63	22.64	22.76		2
	36	0	21.19	21.67	21.72	0-3	3
	36	18	21.45	21.66	21.87		3
	36	37	22.00	21.85	21.81		3
	75	0	21.66	21.84	21.93		3

FCC ID ZNFG710VM	PCTEST <small>ENGINEERING LABORATORY, INC.</small>	SAR EVALUATION REPORT	LG	Approved by: Quality Manager
Document S/N: 1M1804030062-01-R2.ZNF	Test Dates: 04/02/18 - 04/15/18	DUT Type: Portable Handset	Page 47 of 126	

Table 9-23
LTE Band 66 (AWS) Maximum Conducted Powers - 10 MHz Bandwidth

LTE Band 66 (AWS) 10 MHz Bandwidth							
Modulation	RB Size	RB Offset	Low Channel	Mid Channel	High Channel	MPR Allowed per 3GPP [dB]	MPR [dB]
			132022 (1715.0 MHz)	132322 (1745.0 MHz)	132622 (1775.0 MHz)		
			Conducted Power [dBm]				
QPSK	1	0	24.99	24.80	24.88	0	0
	1	25	25.01	24.90	25.18		0
	1	49	25.00	25.17	25.18		0
	25	0	23.42	23.87	24.10	0-1	1
	25	12	23.68	23.98	24.15		1
	25	25	23.76	24.17	24.10		1
16QAM	50	0	23.60	23.97	24.10	0-1	1
	1	0	23.48	23.61	24.10		1
	1	25	23.50	23.79	23.95		1
	1	49	23.70	23.91	24.07	0-2	1
	25	0	22.33	23.03	23.12		2
	25	12	22.47	23.12	23.14		2
64QAM	25	25	22.87	23.10	23.15	0-2	2
	50	0	22.87	23.07	22.98		2
	1	0	22.39	22.58	23.07		0-2
	1	25	22.45	22.76	22.85	2	
	1	49	22.56	22.82	23.00	2	
	64QAM	25	0	21.21	22.00	22.00	0-3
25		12	21.45	22.01	22.01	3	
25		25	21.73	22.03	22.03	3	
50		0	21.83	22.06	21.84	0-3	3

Table 9-24
LTE Band 66 (AWS) Maximum Conducted Powers - 5 MHz Bandwidth

LTE Band 66 (AWS) 5 MHz Bandwidth								
Modulation	RB Size	RB Offset	Low Channel	Mid Channel	High Channel	MPR Allowed per 3GPP [dB]	MPR [dB]	
			131997 (1712.5 MHz)	132322 (1745.0 MHz)	132647 (1777.5 MHz)			
			Conducted Power [dBm]					
QPSK	1	0	24.80	24.83	25.09	0	0	
	1	12	25.03	24.71	24.99		0	
	1	24	24.80	24.84	25.17		0	
	12	0	23.59	24.02	24.11	0-1	1	
	12	6	23.69	23.90	24.12		1	
	12	13	23.81	23.97	24.10		1	
16QAM	25	0	23.62	24.00	23.99	0-1	1	
	1	0	23.58	24.19	23.98		0-1	1
	1	12	23.73	24.09	24.10			1
	1	24	23.75	24.02	23.93	0-2		1
	12	0	22.70	23.06	23.11		2	
	12	6	22.80	23.10	23.09		2	
64QAM	12	13	22.73	23.17	23.10	0-2	2	
	25	0	22.72	22.90	23.10		2	
	1	0	22.44	23.14	22.88		0-2	2
	1	12	22.73	23.03	23.00	2		
	1	24	22.73	22.89	22.89	2		
	64QAM	12	0	21.69	21.98	22.01	0-3	3
12		6	21.76	21.97	22.03	3		
12		13	21.69	22.04	21.98	3		
25		0	21.63	21.79	22.03	3		



FCC ID ZNFG710VM	 PCTEST ENGINEERING LABORATORY, INC.	SAR EVALUATION REPORT	 LG	Approved by: Quality Manager
Document S/N: 1M1804030062-01-R2.ZNF	Test Dates: 04/02/18 - 04/15/18	DUT Type: Portable Handset	Page 48 of 126	

Table 9-25
LTE Band 66 (AWS) Maximum Conducted Powers - 3 MHz Bandwidth

LTE Band 66 (AWS) 3 MHz Bandwidth							
Modulation	RB Size	RB Offset	Low Channel	Mid Channel	High Channel	MPR Allowed per 3GPP [dB]	MPR [dB]
			131987 (1711.5 MHz)	132322 (1745.0 MHz)	132657 (1778.5 MHz)		
			Conducted Power [dBm]				
QPSK	1	0	24.81	24.88	24.79	0	0
	1	7	24.82	24.99	24.91		0
	1	14	24.74	24.71	24.90		0
	8	0	24.06	23.94	23.78	0-1	1
	8	4	23.80	23.97	23.85		1
	8	7	23.82	23.79	24.00		1
	15	0	23.90	23.85	23.92	1	
16QAM	1	0	24.10	24.13	24.07	0-1	1
	1	7	24.18	24.10	23.91		1
	1	14	24.09	24.04	24.04		1
	8	0	22.90	22.89	22.97	0-2	2
	8	4	22.98	22.72	23.02		2
	8	7	23.01	22.88	22.86		2
	15	0	22.79	22.92	22.85	2	
64QAM	1	0	23.06	23.00	23.02	0-2	2
	1	7	23.07	23.08	22.90		2
	1	14	23.07	23.03	22.98		2
	8	0	21.76	21.84	21.88	0-3	3
	8	4	21.96	21.67	21.93		3
	8	7	21.97	21.83	21.77		3
	15	0	21.77	21.91	21.78	3	

Table 9-26
LTE Band 66 (AWS) Maximum Conducted Powers -1.4 MHz Bandwidth

LTE Band 66 (AWS) 1.4 MHz Bandwidth							
Modulation	RB Size	RB Offset	Low Channel	Mid Channel	High Channel	MPR Allowed per 3GPP [dB]	MPR [dB]
			131979 (1710.7 MHz)	132322 (1745.0 MHz)	132665 (1779.3 MHz)		
			Conducted Power [dBm]				
QPSK	1	0	24.75	24.73	24.85	0	0
	1	2	24.87	24.77	24.78		0
	1	5	24.90	24.81	24.91		0
	3	0	24.79	24.68	24.87	0-1	0
	3	2	24.81	24.73	24.80		0
	3	3	24.68	24.85	24.75		0
	6	0	23.86	23.66	23.89	1	
16QAM	1	0	24.09	24.13	23.84	0-1	1
	1	2	24.03	24.09	24.11		1
	1	5	23.96	23.90	24.01		1
	3	0	23.91	23.74	23.88	0-2	1
	3	2	23.83	23.92	23.98		1
	3	3	23.85	23.68	23.97		1
	6	0	22.80	22.78	22.68	2	
64QAM	1	0	22.97	23.07	22.81	0-2	2
	1	2	22.97	23.07	23.05		2
	1	5	22.88	22.88	22.88		2
	3	0	22.84	22.67	22.79	0-3	2
	3	2	22.78	22.88	22.87		2
	3	3	22.80	22.55	22.89		2
	6	0	21.72	21.74	21.67	3	



FCC ID ZNFG710VM	 PCTEST ENGINEERING LABORATORY, INC.	SAR EVALUATION REPORT	 LG	Approved by: Quality Manager
Document S/N: 1M1804030062-01-R2.ZNF	Test Dates: 04/02/18 - 04/15/18	DUT Type: Portable Handset		Page 49 of 126

Table 9-27
LTE Band 66 (AWS) Reduced Conducted Powers - 20 MHz Bandwidth

LTE Band 66 (AWS) 20 MHz Bandwidth							
Modulation	RB Size	RB Offset	Low Channel	Mid Channel	High Channel	MPR Allowed per 3GPP [dB]	MPR [dB]
			132072 (1720.0 MHz)	132322 (1745.0 MHz)	132572 (1770.0 MHz)		
			Conducted Power [dBm]				
QPSK	1	0	24.12	24.15	23.95	0	0
	1	50	23.72	23.77	24.13		0
	1	99	23.73	24.06	24.10		0
	50	0	24.08	24.16	23.76	0-1	0
	50	25	23.80	23.74	23.89		0
	50	50	23.93	24.15	23.80		0
	100	0	23.95	23.97	23.85		0
16QAM	1	0	23.75	24.00	24.16	0-1	0
	1	50	23.97	23.88	24.02		0
	1	99	23.81	23.94	23.72		0
	50	0	22.82	23.10	22.78	0-2	1
	50	25	23.15	22.73	22.79		1
	50	50	23.06	22.88	22.72		1
	100	0	22.99	23.02	22.96		1
64QAM	1	0	23.00	22.72	22.92	0-2	1
	1	50	22.74	23.15	22.97		1
	1	99	23.11	23.07	23.15		1
	50	0	21.79	22.16	21.94	0-3	2
	50	25	21.73	21.71	21.99		2
	50	50	22.03	21.94	21.72		2
	100	0	21.75	21.78	22.13		2

Table 9-28
LTE Band 66 (AWS) Reduced Conducted Powers - 15 MHz Bandwidth

LTE Band 66 (AWS) 15 MHz Bandwidth							
Modulation	RB Size	RB Offset	Low Channel	Mid Channel	High Channel	MPR Allowed per 3GPP [dB]	MPR [dB]
			132047 (1717.5 MHz)	132322 (1745.0 MHz)	132597 (1772.5 MHz)		
			Conducted Power [dBm]				
QPSK	1	0	23.92	24.03	24.09	0	0
	1	36	23.92	24.15	24.09		0
	1	74	23.89	23.91	23.92		0
	36	0	24.15	24.07	24.13	0-1	0
	36	18	24.14	24.06	23.94		0
	36	37	23.91	23.87	24.00		0
	75	0	24.07	24.03	24.13		0
16QAM	1	0	23.89	23.96	23.91	0-1	0
	1	36	24.14	24.00	24.19		0
	1	74	24.08	24.04	24.02		0
	36	0	23.17	23.12	23.16	0-2	1
	36	18	23.19	23.16	22.88		1
	36	37	23.10	23.12	23.04		1
	75	0	23.11	23.06	23.03		1
64QAM	1	0	23.20	23.12	22.98	0-2	1
	1	36	23.05	22.99	23.08		1
	1	74	23.14	23.10	23.06		1
	36	0	21.97	22.17	21.90	0-3	2
	36	18	21.93	22.13	22.20		2
	36	37	22.18	22.12	21.88		2
	75	0	22.10	22.15	21.96		2



FCC ID ZNFG710VM	 PCTEST ENGINEERING LABORATORY, INC.	SAR EVALUATION REPORT	 LG	Approved by: Quality Manager
Document S/N: 1M1804030062-01-R2.ZNF	Test Dates: 04/02/18 - 04/15/18	DUT Type: Portable Handset		Page 50 of 126

Table 9-29
LTE Band 66 (AWS) Reduced Conducted Powers - 10 MHz Bandwidth

LTE Band 66 (AWS) 10 MHz Bandwidth							
Modulation	RB Size	RB Offset	Low Channel	Mid Channel	High Channel	MPR Allowed per 3GPP [dB]	MPR [dB]
			132022 (1715.0 MHz)	132322 (1745.0 MHz)	132622 (1775.0 MHz)		
			Conducted Power [dBm]				
QPSK	1	0	23.91	23.94	24.14	0	0
	1	25	23.92	24.05	24.10		0
	1	49	24.18	24.07	24.14		0
	25	0	24.14	23.88	24.17	0-1	0
	25	12	24.20	24.09	24.12		0
	25	25	24.18	24.05	23.87		0
	50	0	24.06	24.18	24.17		0
16QAM	1	0	24.11	24.09	23.99	0-1	0
	1	25	24.16	23.90	24.16		0
	1	49	24.02	24.00	23.94		0
	25	0	23.09	23.15	22.88	0-2	1
	25	12	22.92	23.19	23.01		1
	25	25	23.10	22.88	23.08		1
	50	0	22.92	22.96	22.98		1
64QAM	1	0	23.19	22.98	22.96	0-2	1
	1	25	23.14	23.04	23.19		1
	1	49	23.04	23.08	22.99		1
	25	0	22.16	21.87	22.08	0-3	2
	25	12	21.90	21.92	21.98		2
	25	25	21.93	22.01	22.04		2
	50	0	22.06	22.14	22.01		2

Table 9-30
LTE Band 66 (AWS) Reduced Conducted Powers - 5 MHz Bandwidth

LTE Band 66 (AWS) 5 MHz Bandwidth							
Modulation	RB Size	RB Offset	Low Channel	Mid Channel	High Channel	MPR Allowed per 3GPP [dB]	MPR [dB]
			131997 (1712.5 MHz)	132322 (1745.0 MHz)	132647 (1777.5 MHz)		
			Conducted Power [dBm]				
QPSK	1	0	23.93	24.09	24.19	0	0
	1	12	24.17	24.01	23.99		0
	1	24	23.93	23.88	24.15		0
	12	0	23.99	24.00	23.95	0-1	0
	12	6	24.17	24.16	24.16		0
	12	13	23.98	24.08	24.02		0
	25	0	24.09	23.98	23.88		0
16QAM	1	0	23.87	24.12	24.00	0-1	0
	1	12	24.05	24.18	24.19		0
	1	24	23.97	24.16	23.95		0
	12	0	22.99	22.93	23.11	0-2	1
	12	6	23.06	23.15	23.01		1
	12	13	22.99	23.12	22.90		1
	25	0	23.19	23.06	22.88		1
64QAM	1	0	22.91	22.92	23.19	0-2	1
	1	12	22.96	23.03	23.02		1
	1	24	22.96	23.10	22.92		1
	12	0	21.95	21.88	22.14	0-3	2
	12	6	21.91	22.16	21.99		2
	12	13	22.06	21.98	21.93		2
	25	0	22.12	22.05	21.89		2





FCC ID ZNFG710VM	 PCTEST ENGINEERING LABORATORY, INC.	SAR EVALUATION REPORT	 LG	Approved by: Quality Manager
Document S/N: 1M1804030062-01-R2.ZNF	Test Dates: 04/02/18 - 04/15/18	DUT Type: Portable Handset	Page 51 of 126	

Table 9-31
LTE Band 66 (AWS) Reduced Conducted Powers - 3 MHz Bandwidth

LTE Band 66 (AWS) 3 MHz Bandwidth							
Modulation	RB Size	RB Offset	Low Channel	Mid Channel	High Channel	MPR Allowed per 3GPP [dB]	MPR [dB]
			131987 (1711.5 MHz)	132322 (1745.0 MHz)	132657 (1778.5 MHz)		
			Conducted Power [dBm]				
QPSK	1	0	23.99	24.16	24.03	0	0
	1	7	23.90	24.03	24.15		0
	1	14	23.91	24.04	23.90		0
	8	0	23.99	23.87	24.07	0-1	0
	8	4	23.97	23.99	23.98		0
	8	7	24.10	23.99	23.89		0
	15	0	24.10	24.08	23.87		0
16QAM	1	0	23.94	24.10	23.92	0-1	0
	1	7	24.02	24.16	24.16		0
	1	14	24.19	23.96	23.91		0
	8	0	22.91	23.00	22.93	0-2	1
	8	4	23.17	22.98	22.97		1
	8	7	22.98	22.99	22.90		1
	15	0	23.19	22.94	23.00		1
64QAM	1	0	22.92	22.90	22.99	0-2	1
	1	7	22.89	23.16	23.19		1
	1	14	22.99	23.09	23.14		1
	8	0	22.16	21.88	21.90	0-3	2
	8	4	22.05	21.92	22.04		2
	8	7	22.16	21.98	21.89		2
	15	0	21.98	22.12	21.89		2

Table 9-32
LTE Band 66 (AWS) Reduced Conducted Powers -1.4 MHz Bandwidth

LTE Band 66 (AWS) 1.4 MHz Bandwidth							
Modulation	RB Size	RB Offset	Low Channel	Mid Channel	High Channel	MPR Allowed per 3GPP [dB]	MPR [dB]
			131979 (1710.7 MHz)	132322 (1745.0 MHz)	132665 (1779.3 MHz)		
			Conducted Power [dBm]				
QPSK	1	0	24.05	23.94	24.09	0	0
	1	2	24.05	24.15	24.04		0
	1	5	23.89	23.88	24.13		0
	3	0	24.17	24.13	23.95	0-1	0
	3	2	23.91	24.17	24.19		0
	3	3	23.98	23.94	24.10		0
	6	0	23.99	24.16	24.10		0
16QAM	1	0	24.05	24.14	24.08	0-1	0
	1	2	24.13	24.16	23.87		0
	1	5	23.99	24.13	23.95		0
	3	0	24.13	23.94	24.08	0-2	0
	3	2	24.15	24.11	23.94		0
	3	3	23.96	23.93	24.02		0
	6	0	22.95	23.07	22.89		1
64QAM	1	0	23.09	23.01	23.00	0-2	1
	1	2	23.08	23.17	23.08		1
	1	5	23.01	23.04	23.08		1
	3	0	22.99	23.19	22.88	0-3	1
	3	2	23.13	23.03	23.05		1
	3	3	22.96	23.18	23.10		1
	6	0	22.02	21.90	22.07		2

FCC ID ZNFG710VM	 PCTEST ENGINEERING LABORATORY, INC.	SAR EVALUATION REPORT	 LG	Approved by: Quality Manager
Document S/N: 1M1804030062-01-R2.ZNF	Test Dates: 04/02/18 - 04/15/18	DUT Type: Portable Handset	Page 52 of 126	

9.4.3

LTE Band 25 (PCS)

Table 9-33
LTE Band 25 (PCS) Maximum Conducted Powers - 20 MHz Bandwidth

LTE Band 25 (PCS) 20 MHz Bandwidth								
Modulation	RB Size	RB Offset	Low Channel	Mid Channel	High Channel	MPR Allowed per 3GPP [dB]	MPR [dB]	
			26140 (1860.0 MHz)	26365 (1882.5 MHz)	26590 (1905.0 MHz)			
			Conducted Power [dBm]					
QPSK	1	0	25.00	25.12	25.14	0	0	
	1	50	25.11	25.13	25.24		0	
	1	99	25.33	25.18	25.08		0	
	50	0	24.26	24.25	23.95	0-1	1	
	50	25	24.00	24.19	24.22		1	
	50	50	24.04	24.13	24.13		1	
16QAM	100	0	24.06	24.16	24.22	0-1	1	
	1	0	24.15	24.05	24.13		0-1	1
	1	50	24.16	24.27	24.16			1
	1	99	23.92	24.31	24.14	0-2		1
	50	0	23.18	23.06	23.24		2	
	50	25	23.15	23.28	23.20		2	
64QAM	50	50	23.14	23.10	23.18	0-2	2	
	100	0	23.01	23.07	23.11		2	
	1	0	23.30	23.16	23.17		0-2	2
	1	50	23.02	23.12	23.22	2		
	1	99	23.30	23.15	23.13	0-3		2
	50	0	22.32	22.24	21.89		3	
50	25	22.06	22.33	22.10	3			
64QAM	50	50	22.21	22.23	22.29	0-3	3	
	100	0	22.02	22.22	22.24		3	

Table 9-34
LTE Band 25 (PCS) Maximum Conducted Powers - 15 MHz Bandwidth

LTE Band 25 (PCS) 15 MHz Bandwidth								
Modulation	RB Size	RB Offset	Low Channel	Mid Channel	High Channel	MPR Allowed per 3GPP [dB]	MPR [dB]	
			26115 (1857.5 MHz)	26365 (1882.5 MHz)	26615 (1907.5 MHz)			
			Conducted Power [dBm]					
QPSK	1	0	25.17	25.32	24.98	0	0	
	1	36	24.84	24.93	24.68		0	
	1	74	25.03	24.96	24.91		0	
	36	0	23.94	24.27	23.74	0-1	1	
	36	18	23.81	24.10	24.01		1	
	36	37	23.85	24.13	24.09		1	
16QAM	75	0	23.80	24.14	23.86	0-1	1	
	1	0	24.33	24.31	24.24		0-1	1
	1	36	23.97	24.25	23.84			1
	1	74	24.26	24.41	23.88	0-2		1
	36	0	23.05	23.29	22.78		2	
	36	18	22.94	23.23	23.10		2	
64QAM	36	37	22.84	23.13	23.30	0-2	2	
	75	0	22.96	23.27	22.99		2	
	1	0	23.19	23.28	23.17		0-2	2
	1	36	22.93	23.14	22.78	2		
	1	74	23.18	23.31	22.79	0-3		2
	36	0	21.94	22.18	21.65		3	
36	18	21.87	22.17	22.08	3			
64QAM	36	37	21.71	22.09	22.18	0-3	3	
	75	0	21.87	22.15	21.92		3	



FCC ID ZNFG710VM	 PCTEST ENGINEERING LABORATORY, INC.	SAR EVALUATION REPORT	 LG	Approved by: Quality Manager
Document S/N: 1M1804030062-01-R2.ZNF	Test Dates: 04/02/18 - 04/15/18	DUT Type: Portable Handset	Page 53 of 126	

Table 9-35
LTE Band 25 (PCS) Maximum Conducted Powers - 10 MHz Bandwidth

LTE Band 25 (PCS) 10 MHz Bandwidth							
Modulation	RB Size	RB Offset	Low Channel	Mid Channel	High Channel	MPR Allowed per 3GPP [dB]	MPR [dB]
			26090 (1855.0 MHz)	26365 (1882.5 MHz)	26640 (1910.0 MHz)		
			Conducted Power [dBm]				
QPSK	1	0	25.39	25.34	24.81	0	0
	1	25	25.15	25.16	25.22		0
	1	49	24.95	25.06	24.99		0
	25	0	24.34	24.31	24.04	0-1	1
	25	12	24.07	24.15	24.35		1
	25	25	24.00	24.17	24.16		1
16QAM	1	0	24.31	24.50	23.78	0-1	1
	1	25	24.08	24.23	24.22		1
	1	49	23.91	24.26	23.80		1
	25	0	23.26	23.30	23.01	0-2	2
	25	12	23.14	23.31	23.41		2
	25	25	22.97	23.19	23.28		2
64QAM	1	0	23.28	23.47	22.65	0-2	2
	1	25	23.05	23.17	23.20		2
	1	49	22.87	23.13	22.74		2
	25	0	22.20	22.23	21.95	0-3	3
	25	12	22.01	22.26	22.35		3
	25	25	21.84	22.18	22.26		3
	50	0	21.99	22.16	22.08		3

Table 9-36
LTE Band 25 (PCS) Maximum Conducted Powers - 5 MHz Bandwidth

LTE Band 25 (PCS) 5 MHz Bandwidth							
Modulation	RB Size	RB Offset	Low Channel	Mid Channel	High Channel	MPR Allowed per 3GPP [dB]	MPR [dB]
			26065 (1852.5 MHz)	26365 (1882.5 MHz)	26665 (1912.5 MHz)		
			Conducted Power [dBm]				
QPSK	1	0	25.32	25.23	25.44	0	0
	1	12	25.33	25.40	25.16		0
	1	24	25.39	25.31	24.87		0
	12	0	24.48	24.42	24.44	0-1	1
	12	6	24.47	24.42	24.11		1
	12	13	24.32	24.33	23.87		1
16QAM	1	0	24.36	24.35	24.39	0-1	1
	1	12	24.31	24.35	24.12		1
	1	24	24.35	24.45	23.90		1
	12	0	23.38	23.50	23.22	0-2	2
	12	6	23.31	23.44	23.21		2
	12	13	23.39	23.35	23.19		2
64QAM	1	0	23.39	23.49	23.22	0-2	2
	1	12	23.26	23.32	23.05		2
	1	24	23.28	23.29	23.01		2
	12	0	23.22	23.38	22.90	0-3	3
	12	6	22.31	22.39	22.20		3
	12	13	22.27	22.31	22.10		3
	25	0	22.35	22.23	22.14		3
	25	0	22.30	22.35	22.18		3



FCC ID ZNFG710VM	 PCTEST ENGINEERING LABORATORY, INC.	SAR EVALUATION REPORT	 LG	Approved by: Quality Manager
Document S/N: 1M1804030062-01-R2.ZNF	Test Dates: 04/02/18 - 04/15/18	DUT Type: Portable Handset		Page 54 of 126

Table 9-37
LTE Band 25 (PCS) Maximum Conducted Powers - 3 MHz Bandwidth

LTE Band 25 (PCS) 3 MHz Bandwidth							
Modulation	RB Size	RB Offset	Low Channel	Mid Channel	High Channel	MPR Allowed per 3GPP [dB]	MPR [dB]
			26055 (1851.5 MHz)	26365 (1882.5 MHz)	26675 (1913.5 MHz)		
			Conducted Power [dBm]				
QPSK	1	0	25.18	25.20	25.19	0	0
	1	7	25.22	25.21	24.61		0
	1	14	25.07	25.00	24.85		0
	8	0	24.28	24.23	24.18	0-1	1
	8	4	24.26	24.10	23.76		1
	8	7	24.23	24.11	23.52		1
	15	0	24.22	24.32	23.82		1
16QAM	1	0	24.34	24.34	24.22	0-1	1
	1	7	24.49	24.32	24.02		1
	1	14	24.32	24.45	23.80		1
	8	0	23.30	23.17	23.19	0-2	2
	8	4	23.45	23.21	22.98		2
	8	7	23.25	23.20	22.64		2
	15	0	23.33	23.29	23.06		2
64QAM	1	0	23.30	23.24	23.16	0-2	2
	1	7	23.43	23.29	22.90		2
	1	14	23.21	23.33	22.77		2
	8	0	22.20	22.13	22.13	0-3	3
	8	4	22.33	22.12	21.91		3
	8	7	22.18	22.18	21.60		3
	15	0	22.20	22.29	21.94		3

Table 9-38
LTE Band 25 (PCS) Maximum Conducted Powers -1.4 MHz Bandwidth

LTE Band 25 (PCS) 1.4 MHz Bandwidth							
Modulation	RB Size	RB Offset	Low Channel	Mid Channel	High Channel	MPR Allowed per 3GPP [dB]	MPR [dB]
			26047 (1850.7 MHz)	26365 (1882.5 MHz)	26683 (1914.3 MHz)		
			Conducted Power [dBm]				
QPSK	1	0	25.12	25.07	25.40	0	0
	1	2	25.21	25.15	25.34		0
	1	5	25.04	25.04	24.88		0
	3	0	25.32	25.15	25.38		0
	3	2	25.22	25.10	25.06		0
	3	3	25.27	25.09	25.13		0
	6	0	24.21	24.08	24.28	0-1	1
16QAM	1	0	24.44	24.31	24.31	0-1	1
	1	2	24.43	24.30	24.40		1
	1	5	24.36	24.26	24.29		1
	3	0	24.41	24.08	24.41		1
	3	2	24.46	24.18	24.45		1
	3	3	24.34	24.06	24.16		1
	6	0	23.21	23.36	23.34	0-2	2
64QAM	1	0	23.31	23.23	23.18	0-2	2
	1	2	23.40	23.25	23.26		2
	1	5	23.25	23.12	23.24		2
	3	0	23.28	22.97	23.33		2
	3	2	23.36	23.05	23.39		2
	3	3	23.27	23.05	23.05		2
	6	0	22.14	22.27	22.20	0-3	3



FCC ID ZNFG710VM	 PCTEST ENGINEERING LABORATORY, INC.	SAR EVALUATION REPORT	 LG	Approved by: Quality Manager
Document S/N: 1M1804030062-01-R2.ZNF	Test Dates: 04/02/18 - 04/15/18	DUT Type: Portable Handset		Page 55 of 126

Table 9-39
LTE Band 25 (PCS) Reduced Conducted Powers - 20 MHz Bandwidth

LTE Band 25 (PCS) 20 MHz Bandwidth							
Modulation	RB Size	RB Offset	Low Channel	Mid Channel	High Channel	MPR Allowed per 3GPP [dB]	MPR [dB]
			26140 (1860.0 MHz)	26365 (1882.5 MHz)	26590 (1905.0 MHz)		
			Conducted Power [dBm]				
QPSK	1	0	24.16	24.36	24.46	0	0
	1	50	24.12	24.24	24.13		0
	1	99	24.04	24.27	24.20		0
	50	0	24.20	24.01	24.16	0-1	0
	50	25	24.10	24.30	24.31		0
	50	50	24.03	24.04	24.17		0
	100	0	24.27	24.29	24.25		0
16QAM	1	0	24.23	24.18	24.42	0-1	0
	1	50	24.10	24.04	24.26		0
	1	99	24.13	24.11	24.19		0
	50	0	23.04	23.26	23.08	0-2	1
	50	25	23.25	23.25	23.07		1
	50	50	23.38	23.44	23.19		1
	100	0	23.10	23.25	23.12		1
64QAM	1	0	23.12	23.14	23.07	0-2	1
	1	50	23.36	23.35	23.33		1
	1	99	23.15	23.15	23.22		1
	50	0	22.20	22.30	22.14	0-3	2
	50	25	22.20	22.26	22.37		2
	50	50	22.39	22.00	22.17		2
	100	0	22.23	22.05	22.11		2

Table 9-40
LTE Band 25 (PCS) Reduced Conducted Powers - 15 MHz Bandwidth

LTE Band 25 (PCS) 15 MHz Bandwidth							
Modulation	RB Size	RB Offset	Low Channel	Mid Channel	High Channel	MPR Allowed per 3GPP [dB]	MPR [dB]
			26115 (1857.5 MHz)	26365 (1882.5 MHz)	26615 (1907.5 MHz)		
			Conducted Power [dBm]				
QPSK	1	0	24.13	24.35	24.19	0	0
	1	36	24.04	24.49	24.05		0
	1	74	24.21	24.24	24.11		0
	36	0	24.47	24.34	24.09	0-1	0
	36	18	24.35	24.23	24.41		0
	36	37	24.24	24.22	24.10		0
	75	0	24.20	24.03	24.34		0
16QAM	1	0	24.13	24.16	24.02	0-1	0
	1	36	24.21	24.11	24.22		0
	1	74	24.31	24.49	24.36		0
	36	0	23.03	23.32	23.14	0-2	1
	36	18	23.31	23.07	23.09		1
	36	37	23.03	23.22	23.36		1
	75	0	23.19	23.30	23.00		1
64QAM	1	0	23.41	23.43	23.49	0-2	1
	1	36	23.30	23.26	23.35		1
	1	74	23.24	23.00	23.40		1
	36	0	22.20	22.11	22.04	0-3	2
	36	18	22.46	22.09	22.22		2
	36	37	22.44	22.08	22.17		2
	75	0	22.36	22.44	22.42		2



FCC ID ZNFG710VM	 PCTEST ENGINEERING LABORATORY, INC.	SAR EVALUATION REPORT		Approved by: Quality Manager
Document S/N: 1M1804030062-01-R2.ZNF	Test Dates: 04/02/18 - 04/15/18	DUT Type: Portable Handset	Page 56 of 126	

Table 9-41
LTE Band 25 (PCS) Reduced Conducted Powers - 10 MHz Bandwidth

LTE Band 25 (PCS) 10 MHz Bandwidth							
Modulation	RB Size	RB Offset	Low Channel	Mid Channel	High Channel	MPR Allowed per 3GPP [dB]	MPR [dB]
			26090 (1855.0 MHz)	26365 (1882.5 MHz)	26640 (1910.0 MHz)		
			Conducted Power [dBm]				
QPSK	1	0	24.15	24.17	24.44	0	0
	1	25	24.23	24.04	24.44		0
	1	49	24.22	24.05	24.25		0
	25	0	24.10	24.26	24.01	0-1	0
	25	12	24.47	24.33	24.27		0
	25	25	24.41	24.47	24.22		0
16QAM	50	0	24.12	24.23	24.31	0-1	0
	1	0	24.34	24.33	24.20		0
	1	25	24.36	24.50	24.16		0
	1	49	24.37	24.13	24.46	0-2	0
	25	0	23.49	23.28	23.23		1
	25	12	23.26	23.33	23.15		1
64QAM	25	25	23.42	23.21	23.02	0-2	1
	50	0	23.05	23.41	23.13		1
	1	0	23.09	23.38	23.08		0-3
	1	25	23.07	23.00	23.25	1	
	1	49	23.06	23.15	23.39	1	
	25	0	22.28	22.23	22.26	0-3	2
25	12	22.38	22.08	22.33	2		
25	25	22.16	22.36	22.28	2		
50	0	22.04	22.22	22.24		2	

Table 9-42
LTE Band 25 (PCS) Reduced Conducted Powers - 5 MHz Bandwidth

LTE Band 25 (PCS) 5 MHz Bandwidth							
Modulation	RB Size	RB Offset	Low Channel	Mid Channel	High Channel	MPR Allowed per 3GPP [dB]	MPR [dB]
			26065 (1852.5 MHz)	26365 (1882.5 MHz)	26665 (1912.5 MHz)		
			Conducted Power [dBm]				
QPSK	1	0	24.42	24.07	24.43	0	0
	1	12	24.22	24.46	24.34		0
	1	24	24.21	24.42	24.49		0
	12	0	24.35	24.31	24.16	0-1	0
	12	6	24.07	24.20	24.29		0
	12	13	24.43	24.22	24.27		0
16QAM	25	0	24.13	24.41	24.04	0-1	0
	1	0	24.15	24.19	24.07		0
	1	12	24.20	24.40	24.18		0
	1	24	24.17	24.48	24.21	0-2	0
	12	0	23.40	23.10	23.08		1
	12	6	23.14	23.09	23.09		1
64QAM	12	13	23.45	23.21	23.31	0-2	1
	25	0	23.15	23.39	23.28		1
	1	0	23.49	23.11	23.00		0-3
	1	12	23.40	23.20	23.40	1	
	1	24	23.30	23.21	23.23	1	
	12	0	22.07	22.33	22.34	0-3	2
12	6	22.12	22.35	22.47	2		
12	13	22.21	22.30	22.18	2		
25	0	22.33	22.43	22.01		2	





FCC ID ZNFG710VM	 PCTEST ENGINEERING LABORATORY, INC.	SAR EVALUATION REPORT	 LG	Approved by: Quality Manager
Document S/N: 1M1804030062-01-R2.ZNF	Test Dates: 04/02/18 - 04/15/18	DUT Type: Portable Handset		Page 57 of 126

Table 9-43
LTE Band 25 (PCS) Reduced Conducted Powers - 3 MHz Bandwidth

LTE Band 25 (PCS) 3 MHz Bandwidth							
Modulation	RB Size	RB Offset	Low Channel	Mid Channel	High Channel	MPR Allowed per 3GPP [dB]	MPR [dB]
			26055 (1851.5 MHz)	26365 (1882.5 MHz)	26675 (1913.5 MHz)		
			Conducted Power [dBm]				
QPSK	1	0	24.44	24.16	24.14	0	0
	1	7	24.43	24.08	24.08		0
	1	14	24.25	24.48	24.17		0
	8	0	24.24	24.34	24.13	0-1	0
	8	4	24.00	24.02	24.17		0
	8	7	24.17	24.16	24.49		0
	15	0	24.06	24.04	24.18		0
16QAM	1	0	24.37	24.39	24.45	0-1	0
	1	7	24.21	24.42	24.35		0
	1	14	24.17	24.41	24.04		0
	8	0	23.39	23.09	23.25	0-2	1
	8	4	23.33	23.45	23.34		1
	8	7	23.49	23.38	23.06		1
	15	0	23.16	23.30	23.41		1
64QAM	1	0	23.18	23.14	23.45	0-2	1
	1	7	23.21	23.19	23.21		1
	1	14	23.16	23.07	23.47		1
	8	0	22.14	22.37	22.48	0-3	2
	8	4	22.11	22.04	22.38		2
	8	7	22.48	22.25	22.11		2
	15	0	22.27	22.09	22.41		2

Table 9-44
LTE Band 25 (PCS) Reduced Conducted Powers -1.4 MHz Bandwidth

LTE Band 25 (PCS) 1.4 MHz Bandwidth							
Modulation	RB Size	RB Offset	Low Channel	Mid Channel	High Channel	MPR Allowed per 3GPP [dB]	MPR [dB]
			26047 (1850.7 MHz)	26365 (1882.5 MHz)	26683 (1914.3 MHz)		
			Conducted Power [dBm]				
QPSK	1	0	24.12	24.23	24.27	0	0
	1	2	24.45	24.25	24.20		0
	1	5	24.45	24.47	24.27		0
	3	0	24.32	24.45	24.42	0-1	0
	3	2	24.04	24.38	24.35		0
	3	3	24.14	24.43	24.20		0
	6	0	24.12	24.17	24.17		0
16QAM	1	0	24.03	24.11	24.44	0-1	0
	1	2	24.13	24.04	24.48		0
	1	5	24.04	24.38	24.39		0
	3	0	24.43	24.07	24.20	0-2	0
	3	2	24.35	24.35	24.40		0
	3	3	24.28	24.22	24.25		0
	6	0	23.26	23.13	23.11		1
64QAM	1	0	23.29	23.34	23.45	0-2	1
	1	2	23.33	23.37	23.31		1
	1	5	23.07	23.20	23.24		1
	3	0	23.04	23.45	23.17	0-3	1
	3	2	23.41	23.08	23.06		1
	3	3	23.43	23.36	23.19		1
	6	0	22.47	22.24	22.10		2

FCC ID ZNFG710VM	 PCTEST ENGINEERING LABORATORY, INC.	SAR EVALUATION REPORT		Approved by: Quality Manager
Document S/N: 1M1804030062-01-R2.ZNF	Test Dates: 04/02/18 - 04/15/18	DUT Type: Portable Handset	Page 58 of 126	

9.4.4

LTE Band 41

Table 9-45
LTE Band 41 Power Class 3 Conducted Powers - 20 MHz Bandwidth

LTE Band 41 20 MHz Bandwidth									
Modulation	RB Size	RB Offset	Low Channel	Low-Mid Channel	Mid Channel	Mid-High Channel	High Channel	MPR Allowed per 3GPP [dB]	MPR [dB]
			39750 (2506.0 MHz)	40185 (2549.5 MHz)	40620 (2593.0 MHz)	41055 (2636.5 MHz)	41490 (2680.0 MHz)		
			Conducted Power [dBm]						
QPSK	1	0	24.97	24.87	24.90	25.09	25.03	0	0
	1	50	24.87	25.00	25.08	25.08	24.98		0
	1	99	25.08	24.87	25.01	24.95	24.95		0
	50	0	23.90	23.86	23.96	23.96	24.00	0-1	1
	50	25	24.06	23.93	23.92	23.92	23.93		1
	50	50	24.00	23.91	24.07	24.09	24.00		1
16QAM	100	0	24.06	23.88	23.97	23.95	24.08	0-1	1
	1	0	23.99	23.95	23.92	23.92	23.90		1
	1	50	24.04	24.08	24.09	23.90	24.03		1
	1	99	24.02	24.01	23.95	23.86	23.96	0-2	1
	50	0	23.03	23.06	23.04	22.97	22.95		2
	50	25	22.86	22.91	22.91	22.89	22.87		2
64QAM	50	50	23.03	22.92	23.03	23.08	22.90	0-2	2
	100	0	22.98	22.89	22.88	23.08	23.07		2
	1	0	23.01	22.99	23.06	22.87	22.99		2
	1	50	23.10	22.93	23.05	22.94	23.07	0-3	2
	1	99	23.05	23.08	22.97	23.09	22.97		2
	50	0	22.00	22.01	21.92	21.97	21.90		3
50	25	21.92	21.97	22.00	21.99	22.08	3		
50	50	22.09	22.07	21.91	21.88	22.01	3		
100	0	21.91	22.00	21.99	21.90	21.86	3		

Table 9-46
LTE Band 41 Power Class 3 Conducted Powers - 15 MHz Bandwidth

LTE Band 41 15 MHz Bandwidth									
Modulation	RB Size	RB Offset	Low Channel	Low-Mid Channel	Mid Channel	Mid-High Channel	High Channel	MPR Allowed per 3GPP [dB]	MPR [dB]
			39750 (2506.0 MHz)	40185 (2549.5 MHz)	40620 (2593.0 MHz)	41055 (2636.5 MHz)	41490 (2680.0 MHz)		
			Conducted Power [dBm]						
QPSK	1	0	25.13	25.10	25.11	25.08	24.98	0	0
	1	36	25.04	24.92	25.07	25.04	24.84		0
	1	74	24.96	24.99	24.98	24.94	24.83		0
	36	0	24.09	24.09	24.09	24.03	23.93	0-1	1
	36	18	24.06	24.00	24.03	24.08	23.83		1
	36	37	24.05	24.06	23.97	24.00	23.95		1
16QAM	75	0	24.03	24.01	24.03	23.99	23.87	0-1	1
	1	0	24.10	24.11	24.18	24.06	23.96		1
	1	36	23.91	24.02	24.09	24.00	23.88		1
	1	74	23.85	23.93	24.10	23.88	23.85	0-2	1
	36	0	23.12	23.01	23.03	23.07	22.92		2
	36	18	23.02	23.04	23.00	23.05	22.92		2
64QAM	36	37	22.95	22.98	23.02	22.93	22.84	0-2	2
	75	0	23.10	22.98	23.05	23.05	22.84		2
	1	0	22.97	23.07	23.11	22.95	22.84		2
	1	36	22.80	22.95	23.04	22.93	22.86	0-2	2
	1	74	22.82	22.89	23.05	22.75	22.75		2
	36	0	21.99	21.97	22.03	21.99	21.80		0-3
36	18	21.98	21.95	21.86	22.02	21.87	3		
36	37	21.89	21.91	21.96	21.84	21.76	3		
75	0	22.02	21.89	21.98	22.01	21.77	3		



FCC ID ZNFG710VM	 PCTEST ENGINEERING LABORATORY, INC.	SAR EVALUATION REPORT	 LG	Approved by: Quality Manager
Document S/N: 1M1804030062-01-R2.ZNF	Test Dates: 04/02/18 - 04/15/18	DUT Type: Portable Handset	Page 59 of 126	

Table 9-47
LTE Band 41 Power Class 3 Conducted Powers - 10 MHz Bandwidth

LTE Band 41 10 MHz Bandwidth									
Modulation	RB Size	RB Offset	Low Channel	Low-Mid Channel	Mid Channel	Mid-High Channel	High Channel	MPR Allowed per 3GPP [dB]	MPR [dB]
			39750 (2506.0 MHz)	40185 (2549.5 MHz)	40620 (2593.0 MHz)	41055 (2636.5 MHz)	41490 (2680.0 MHz)		
			Conducted Power [dBm]						
QPSK	1	0	25.10	24.97	25.12	25.13	25.09	0	0
	1	25	24.93	24.98	25.04	24.99	24.88		0
	1	49	24.94	24.94	25.04	24.95	24.85		0
	25	0	24.06	24.00	23.99	24.09	23.98	0-1	1
	25	12	24.09	24.08	23.97	24.03	23.94		1
	25	25	23.98	23.99	24.03	23.98	24.02		1
50	0	24.08	23.97	24.03	24.07	23.99	1		
16QAM	1	0	24.04	24.10	24.09	24.02	24.09	0-1	1
	1	25	23.91	24.02	24.15	23.92	23.84		1
	1	49	23.96	23.93	24.12	23.90	23.87		1
	25	0	23.07	23.04	23.01	23.06	23.05	0-2	2
	25	12	23.03	22.98	23.01	23.00	22.87		2
	25	25	23.03	22.97	22.99	23.01	22.95		2
50	0	23.04	23.03	23.00	23.02	23.06	2		
64QAM	1	0	22.92	23.04	22.99	22.99	23.04	0-2	2
	1	25	22.87	22.92	23.03	22.79	22.83		2
	1	49	22.87	22.85	23.00	22.88	22.75		2
	25	0	22.00	21.94	22.00	21.95	21.95	0-3	3
	25	12	21.90	21.91	21.87	21.96	21.87		3
	25	25	22.00	21.90	21.92	21.87	21.85		3
50	0	21.97	21.98	21.99	22.00	21.96	3		

Table 9-48
LTE Band 41 Power Class 3 Conducted Powers - 5 MHz Bandwidth

LTE Band 41 5 MHz Bandwidth									
Modulation	RB Size	RB Offset	Low Channel	Low-Mid Channel	Mid Channel	Mid-High Channel	High Channel	MPR Allowed per 3GPP [dB]	MPR [dB]
			39750 (2506.0 MHz)	40185 (2549.5 MHz)	40620 (2593.0 MHz)	41055 (2636.5 MHz)	41490 (2680.0 MHz)		
			Conducted Power [dBm]						
QPSK	1	0	24.99	25.02	24.81	25.05	24.87	0	0
	1	12	24.91	24.94	24.85	25.06	24.84		0
	1	24	24.95	24.89	24.81	25.02	24.80		0
	12	0	24.03	24.00	23.98	24.07	23.89	0-1	1
	12	6	24.04	24.08	24.07	24.01	23.88		1
	12	13	24.08	23.96	23.98	24.03	23.81		1
25	0	24.00	24.05	23.99	24.04	23.85	1		
16QAM	1	0	23.90	23.92	24.11	23.96	23.81	0-1	1
	1	12	23.95	23.85	24.16	24.01	23.73		1
	1	24	23.85	23.94	24.10	23.93	23.78		1
	12	0	22.99	23.02	23.11	23.01	22.81	0-2	2
	12	6	23.10	22.99	23.09	23.05	22.80		2
	12	13	23.02	22.97	22.98	22.98	22.82		2
25	0	22.97	22.98	23.01	22.97	22.85	2		
64QAM	1	0	22.88	22.80	22.99	22.93	22.80	0-2	2
	1	12	22.90	22.78	23.07	22.98	22.67		2
	1	24	22.80	22.85	23.06	22.83	22.75		2
	12	0	21.94	21.94	22.02	21.98	21.77	0-3	3
	12	6	22.03	21.97	21.98	22.04	21.72		3
	12	13	21.91	21.95	21.86	21.93	21.79		3
25	0	21.91	21.86	22.00	21.89	21.75	3		





FCC ID ZNFG710VM	 PCTEST ENGINEERING LABORATORY, INC.	SAR EVALUATION REPORT	 LG	Approved by: Quality Manager
Document S/N: 1M1804030062-01-R2.ZNF	Test Dates: 04/02/18 - 04/15/18	DUT Type: Portable Handset	Page 60 of 126	

Table 9-49
LTE Band 41 Power Class 2 Conducted Powers - 20 MHz Bandwidth

LTE Band 41 20 MHz Bandwidth										
Modulation	RB Size	RB Offset	Low Channel	Low-Mid Channel	Mid Channel	Mid-High Channel	High Channel	MPR Allowed per 3GPP [dB]	MPR [dB]	
			39750 (2506.0 MHz)	40185 (2549.5 MHz)	40620 (2593.0 MHz)	41055 (2636.5 MHz)	41490 (2680.0 MHz)			
			Conducted Power [dBm]							
QPSK	1	0	27.37	27.47	27.49	27.46	27.25	0	0	
	1	50	27.23	27.48	27.40	27.60	27.32		0	
	1	99	27.51	27.59	27.44	27.32	27.36		0	
	16QAM	50	0	26.41	26.23	26.43	26.50	26.49	0-1	1
		50	25	26.35	26.49	26.51	26.52	26.46		1
		50	50	26.44	26.32	26.27	26.34	26.19		1
		100	0	26.44	26.47	26.46	26.38	26.30		1
1		0	26.35	26.53	26.47	26.31	26.32	0-1		1
1	50	26.37	26.51	26.39	26.56	26.54	1			
1	99	26.39	26.34	26.45	26.45	26.30	1			
64QAM	50	0	25.32	25.54	25.46	25.41	25.39	0-2	2	
	50	25	25.46	25.34	25.25	25.24	25.46		2	
	50	50	25.56	25.49	25.25	25.20	25.49		2	
	100	0	25.46	25.23	25.18	25.29	25.28		2	
	64QAM	1	0	25.28	25.24	25.46	25.48	25.49	0-2	2
		1	50	25.25	25.60	25.31	25.55	25.45		2
		1	99	25.38	25.23	25.29	25.43	25.50		2
		64QAM	50	0	24.33	24.33	24.29	24.21	24.57	0-3
50			25	24.37	24.45	24.33	24.31	24.31	3	
50			50	24.48	24.33	24.33	24.37	24.60	3	
100			0	24.51	24.41	24.33	24.48	24.48	3	

Table 9-50
LTE Band 41 Power Class 2 Conducted Powers - 15 MHz Bandwidth

LTE Band 41 15 MHz Bandwidth										
Modulation	RB Size	RB Offset	Low Channel	Low-Mid Channel	Mid Channel	Mid-High Channel	High Channel	MPR Allowed per 3GPP [dB]	MPR [dB]	
			39750 (2506.0 MHz)	40185 (2549.5 MHz)	40620 (2593.0 MHz)	41055 (2636.5 MHz)	41490 (2680.0 MHz)			
			Conducted Power [dBm]							
QPSK	1	0	27.31	27.25	27.12	27.29	27.24	0	0	
	1	36	27.14	27.31	27.36	27.08	27.17		0	
	1	74	27.11	27.19	27.25	26.95	27.06		0	
	16QAM	36	0	26.33	26.30	26.29	26.34	26.20	0-1	1
		36	18	26.29	26.30	26.34	26.28	26.14		1
		36	37	26.29	26.17	26.27	26.24	26.08		1
		75	0	26.26	26.28	26.20	26.23	26.12		1
16QAM	1	0	26.30	26.21	26.27	26.52	26.28	0-1	1	
	1	36	26.28	26.31	26.20	26.43	26.16		1	
	1	74	26.38	26.11	26.22	26.24	26.24		1	
	64QAM	36	0	25.29	25.35	25.38	25.35	25.18	0-2	2
		36	18	25.32	25.24	25.34	25.40	25.14		2
		36	37	25.23	25.24	25.22	25.27	25.14		2
64QAM	75	0	25.25	25.28	25.30	25.26	25.14	0-2	2	
	1	0	25.28	25.08	25.26	25.48	25.23		2	
	1	36	25.17	25.20	25.19	25.34	25.10		2	
	64QAM	1	74	25.25	25.01	25.12	25.13	25.13	0-3	2
		36	0	24.28	24.31	24.34	24.33	24.13		3
		36	18	24.19	24.22	24.23	24.30	24.02		3
		36	37	24.22	24.20	24.12	24.21	24.05		3
75	0	24.19	24.25	24.21	24.18	24.10	3			



FCC ID ZNFG710VM	 PCTEST ENGINEERING LABORATORY, INC.	SAR EVALUATION REPORT	 LG	Approved by: Quality Manager
Document S/N: 1M1804030062-01-R2.ZNF	Test Dates: 04/02/18 - 04/15/18	DUT Type: Portable Handset	Page 61 of 126	

**Table 9-51
LTE Band 41 Power Class 2 Conducted Powers - 10 MHz Bandwidth**

LTE Band 41 10 MHz Bandwidth									
Modulation	RB Size	RB Offset	Low Channel	Low-Mid Channel	Mid Channel	Mid-High Channel	High Channel	MPR Allowed per 3GPP [dB]	MPR [dB]
			39750 (2506.0 MHz)	40185 (2549.5 MHz)	40620 (2593.0 MHz)	41055 (2636.5 MHz)	41490 (2680.0 MHz)		
			Conducted Power [dBm]						
QPSK	1	0	27.22	27.23	27.37	27.02	26.99	0	0
	1	25	27.19	27.31	27.33	27.02	27.15		0
	1	49	27.15	27.34	27.17	26.91	27.24		0
	25	0	26.27	26.29	26.31	26.17	26.32	0-1	1
	25	12	26.34	26.27	26.26	26.26	26.16		1
	25	25	26.29	26.24	26.21	26.15	26.32		1
50	0	26.26	26.29	26.28	26.12	26.34	1		
16QAM	1	0	26.38	26.08	26.21	26.35	26.18	0-1	1
	1	25	26.24	26.08	26.32	26.30	26.18		1
	1	49	26.13	26.01	26.16	26.17	26.24		1
	25	0	25.37	25.26	25.36	25.26	25.32	0-2	2
	25	12	25.31	25.30	25.32	25.27	25.20		2
	25	25	25.24	25.24	25.31	25.15	25.28		2
50	0	25.32	25.26	25.29	25.24	25.29	2		
64QAM	1	0	25.29	25.06	25.10	25.33	25.08	0-2	2
	1	25	25.22	24.97	25.30	25.20	25.15		2
	1	49	25.09	24.89	25.14	25.06	25.20		2
	25	0	24.34	24.17	24.28	24.15	24.18	0-3	3
	25	12	24.22	24.20	24.19	24.17	24.12		3
	25	25	24.15	24.22	24.20	24.10	24.16		3
50	0	24.21	24.24	24.22	24.18	24.19	3		

**Table 9-52
LTE Band 41 Power Class 2 Conducted Powers - 5 MHz Bandwidth**

LTE Band 41 5 MHz Bandwidth									
Modulation	RB Size	RB Offset	Low Channel	Low-Mid Channel	Mid Channel	Mid-High Channel	High Channel	MPR Allowed per 3GPP [dB]	MPR [dB]
			39750 (2506.0 MHz)	40185 (2549.5 MHz)	40620 (2593.0 MHz)	41055 (2636.5 MHz)	41490 (2680.0 MHz)		
			Conducted Power [dBm]						
QPSK	1	0	27.35	27.31	27.09	27.19	27.14	0	0
	1	12	27.38	27.35	27.22	27.12	27.22		0
	1	24	27.13	27.27	27.24	27.01	27.12		0
	12	0	26.36	26.29	26.30	26.32	26.16	0-1	1
	12	6	26.38	26.39	26.30	26.33	26.19		1
	12	13	26.26	26.30	26.31	26.25	26.12		1
25	0	26.36	26.27	26.29	26.29	26.14	1		
16QAM	1	0	26.16	26.27	26.21	26.44	26.26	0-1	1
	1	12	26.23	26.21	26.27	26.36	26.29		1
	1	24	26.16	26.15	26.24	26.36	26.16		1
	12	0	25.22	25.35	25.20	25.37	25.18	0-2	2
	12	6	25.34	25.36	25.21	25.36	25.18		2
	12	13	25.40	25.26	25.20	25.38	25.13		2
25	0	25.33	25.39	25.27	25.32	25.23	2		
64QAM	1	0	25.03	25.21	25.18	25.31	25.18	0-2	2
	1	12	25.15	25.21	25.17	25.29	25.15		2
	1	24	25.16	25.05	25.19	25.30	25.07		2
	12	0	24.08	24.33	24.06	24.36	24.04	0-3	3
	12	6	24.20	24.24	24.10	24.33	24.10		3
	12	13	24.37	24.22	24.16	24.30	24.03		3
25	0	24.20	24.30	24.25	24.31	24.15	3		

FCC ID ZNFG710VM	 PCTEST ENGINEERING LABORATORY, INC.	SAR EVALUATION REPORT	 LG	Approved by: Quality Manager
Document S/N: 1M1804030062-01-R2.ZNF	Test Dates: 04/02/18 - 04/15/18	DUT Type: Portable Handset	Page 62 of 126	

9.4.5 LTE Uplink Carrier Aggregation Conducted Powers

Table 9-53
LTE Band 5 Uplink Carrier Aggregation Conducted Powers

Combination	PCC								SCC								Power			
	PCC Band	PCC Bandwidth [MHz]	PCC UL Channel	PCC UL Frequency [MHz]	PCC DL Channel	PCC DL Frequency [MHz]	Modulation	PCC UL# RB	PCC UL RB Offset	SCC Band	SCC Bandwidth [MHz]	SCC UL Channel	SCC UL Frequency [MHz]	SCC DL Channel	SCC DL Frequency [MHz]	Modulation	SCC UL# RB	SCC UL RB Offset	LTE Tx.Power with UL CA Enabled (dBm)	LTE Single Carrier Tx Power (dBm)
CA_5B	LTE B5	10	20525	836.5	2525	881.5	QPSK	1	0	LTE B5	5	20453	829.3	2453	874.3	QPSK	1	24	25.10	25.34

Table 9-54
LTE Band 41 Uplink Carrier Aggregation Conducted Powers

Combination	PCC						SCC						Power			
	PCC Band	PCC Bandwidth [MHz]	PCC (UL/DL) Channel	PCC (UL/DL) Frequency [MHz]	Modulation	PCC UL# RB	PCC UL RB Offset	SCC Band	SCC Bandwidth [MHz]	SCC (UL/DL) Channel	SCC (UL/DL) Frequency [MHz]	Modulation	SCC UL# RB	SCC UL RB Offset	LTE Tx.Power with UL CA Enabled (dBm)	LTE Single Carrier Tx Power (dBm)
CA_41C	LTE B41	20	39750	2506.0	QPSK	1	99	LTE B41	20	39948	2525.8	QPSK	1	0	25.12	25.08
CA_41C	LTE B41	20	41055	2636.5	QPSK	1	0	LTE B41	20	40857	2616.7	QPSK	1	99	25.13	25.09

Notes:

1. This device supports uplink carrier aggregation for LTE CA_41C with a maximum of two 20 MHz component carriers and LTE CA_5B with a maximum of two 10 MHz component carriers. For intraband contiguous carrier aggregation scenarios, 3GPP 36.101 Table 6.2.2A-1 specifies that the aggregate maximum allowed output power is equivalent to the single carrier scenario. 3GPP 36.101 6.2.3A allows for several dB of MPR to be applied when non-contiguous RB allocation is implemented. The conducted powers and MPR settings in this device are permanently implemented per the above 3GPP requirements.
2. Per FCC Guidance, the output power with uplink CA active was measured for the configuration with the highest reported SAR with single carrier for each exposure condition. The power was measured with wideband signal integration over both component carriers.
3. Uplink carrier aggregation is only possible when the device is operating with Power Class 3 for LTE Band 41.



Figure 9-4
Power Measurement Setup

FCC ID ZNFG710VM	PCTEST ENGINEERING LABORATORY, INC.	SAR EVALUATION REPORT	LG	Approved by: Quality Manager
Document S/N: 1M1804030062-01-R2.ZNF	Test Dates: 04/02/18 - 04/15/18	DUT Type: Portable Handset	Page 63 of 126	

9.5 WLAN Conducted Powers

Table 9-55
2.4 GHz WLAN Maximum Average RF Power – Ant 1

2.4GHz Conducted Power [dBm]					
Freq [MHz]	Channel	IEEE Transmission Mode			
		802.11b	802.11g	802.11n	802.11ac
2412	1	20.81	18.40	17.61	17.60
2437	6	20.69	20.04	19.08	19.05
2462	11	20.72	18.21	17.57	17.62

Table 9-56
2.4 GHz WLAN Maximum Average RF Power – Ant 2



2.4GHz Conducted Power [dBm]					
Freq [MHz]	Channel	IEEE Transmission Mode			
		802.11b	802.11g	802.11n	802.11ac
2412	1	20.96	18.26	17.57	17.58
2437	6	20.99	19.85	18.93	18.89
2462	11	20.98	18.28	17.51	17.50

Table 9-57
2.4 GHz WLAN Ant 1 Reduced Average RF Power/Output Power During Simultaneous Conditions with 2.4 GHz and 5 GHz WLAN

2.4GHz Conducted Power [dBm]					
Freq [MHz]	Channel	IEEE Transmission Mode			
		802.11b	802.11g	802.11n	802.11ac
2412	1	17.58	17.24	17.02	17.09
2437	6	17.42	17.02	17.21	17.14
2462	11	17.27	17.01	17.09	17.03

Table 9-58
2.4 GHz WLAN Ant 2 Reduced Average RF Power/Output Power During Simultaneous Conditions with 2.4 GHz and 5 GHz WLAN

2.4GHz Conducted Power [dBm]					
Freq [MHz]	Channel	IEEE Transmission Mode			
		802.11b	802.11g	802.11n	802.11ac
2412	1	17.48	17.15	17.15	17.27
2437	6	17.26	17.03	17.09	17.07
2462	11	17.31	17.01	17.29	17.12

FCC ID ZNFG710VM	 PCTEST ENGINEERING LABORATORY, INC.	SAR EVALUATION REPORT	 LG	Approved by: Quality Manager
Document S/N: 1M1804030062-01-R2.ZNF	Test Dates: 04/02/18 - 04/15/18	DUT Type: Portable Handset		Page 64 of 126

**Table 9-59
5 GHz WLAN Maximum Average RF Power – Ant 1**

5GHz (20MHz) Conducted Power [dBm]				
Freq [MHz]	Channel	IEEE Transmission Mode		
		802.11a	802.11n	802.11ac
5180	36	16.64	16.42	16.56
5200	40	17.52	17.40	17.38
5220	44	16.44	16.17	16.23
5240	48	16.55	16.38	16.47
5260	52	16.52	16.31	16.36
5280	56	17.56	17.34	17.35
5300	60	16.71	16.46	16.53
5320	64	16.71	16.57	16.66
5500	100	16.32	16.11	16.05
5600	120	16.56	16.46	16.43
5620	124	16.40	16.30	16.34
5720	144	16.45	16.33	16.33
5745	149	16.45	16.43	16.36
5785	157	17.46	17.38	17.38
5805	161	17.47	17.57	17.50
5825	165	16.77	16.68	16.59



FCC ID ZNFG710VM	 PCTEST ENGINEERING LABORATORY, INC.	SAR EVALUATION REPORT	 LG	Approved by: Quality Manager
Document S/N: 1M1804030062-01-R2.ZNF	Test Dates: 04/02/18 - 04/15/18	DUT Type: Portable Handset		Page 65 of 126

Table 9-60
5 GHz WLAN Maximum Average RF Power – Ant 2

5GHz (20MHz) Conducted Power [dBm]				
Freq [MHz]	Channel	IEEE Transmission Mode		
		802.11a	802.11n	802.11ac
5180	36	16.32	16.42	16.39
5200	40	17.27	17.25	17.29
5220	44	16.47	16.49	16.45
5240	48	16.50	16.50	16.50
5260	52	16.51	16.56	16.58
5280	56	17.50	17.51	17.47
5300	60	16.41	16.40	16.41
5320	64	16.41	16.33	16.38
5500	100	16.66	16.25	16.32
5600	120	16.67	16.20	16.23
5620	124	16.68	16.51	16.36
5720	144	16.63	16.27	16.34
5745	149	16.43	16.14	16.33
5785	157	17.50	17.28	17.32
5805	161	17.33	17.02	17.07
5825	165	16.55	16.24	16.32

Table 9-61
5 GHz WLAN Maximum Average RF Power – MIMO

5GHz (20MHz) 802.11n Conducted Power [dBm]				
Freq [MHz]	Channel	ANT1	ANT2	MIMO
5180	36	16.42	16.42	19.43
5200	40	17.40	17.25	20.34
5220	44	16.17	16.49	19.34
5240	48	16.38	16.50	19.45
5260	52	16.31	16.56	19.45
5280	56	17.34	17.51	20.44
5300	60	16.46	16.40	19.44
5320	64	16.57	16.33	19.46
5500	100	16.11	16.25	19.19
5600	120	16.46	16.20	19.34
5620	124	16.30	16.51	19.42
5720	144	16.33	16.27	19.31
5745	149	16.43	16.14	19.30
5785	157	17.38	17.28	20.34
5805	161	17.57	17.02	20.31
5825	165	16.68	16.24	19.48



FCC ID ZNFG710VM	 PCTEST ENGINEERING LABORATORY, INC.	SAR EVALUATION REPORT		Approved by: Quality Manager
Document S/N: 1M1804030062-01-R2.ZNF	Test Dates: 04/02/18 - 04/15/18	DUT Type: Portable Handset		Page 66 of 126

Table 9-62
5 GHz WLAN Ant 2 Output Powers During Simultaneous Conditions with 2.4 GHz and 5 GHz WLAN

5GHz (40MHz) Conducted Power [dBm]			
Freq [MHz]	Channel	IEEE Transmission Mode	
		802.11n	802.11ac
		Average	Average
5190	38	12.37	12.34
5230	46	14.50	14.49
5270	54	14.48	14.51
5310	62	11.86	11.86
5510	102	12.11	11.93
5590	118	14.41	14.45
5630	126	14.43	14.46
5710	142	14.51	14.47
5755	151	14.51	14.44
5795	159	14.48	14.53

Justification for test configurations for WLAN per KDB Publication 248227 D01v02r02:

- Power measurements were performed for the transmission mode configuration with the highest maximum output power specified for production units.
- For transmission modes with the same maximum output power specification, powers were measured for the largest channel bandwidth, lowest order modulation and lowest data rate.
- For transmission modes with identical maximum specified output power, channel bandwidth, modulation and data rates, power measurements were required for all identical configurations.
- For each transmission mode configuration, powers were measured for the highest and lowest channels; and at the mid-band channel(s) when there were at least 3 channels supported. For configurations with multiple mid-band channels, due to an even number of channels, both channels were measured.
- The bolded data rate and channel above were tested for SAR.

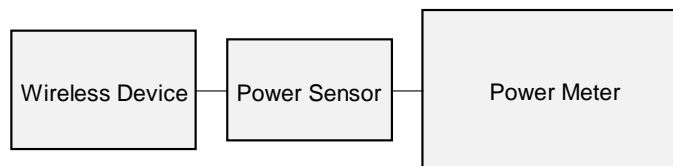



Figure 9-5
Power Measurement Setup



FCC ID ZNFG710VM	 PCTEST <small>ENGINEERING LABORATORY, INC.</small>	SAR EVALUATION REPORT		Approved by: Quality Manager
Document S/N: 1M1804030062-01-R2.ZNF	Test Dates: 04/02/18 - 04/15/18	DUT Type: Portable Handset		Page 67 of 126

9.6 Bluetooth Conducted Powers

Table 9-63
Bluetooth Average RF Power

Frequency [MHz]	Data Rate [Mbps]	Channel No.	Avg Conducted Power	
			[dBm]	[mW]
2402	1.0	0	11.81	15.163
2441	1.0	39	11.67	14.693
2480	1.0	78	11.56	14.327
2402	2.0	0	11.14	13.009
2441	2.0	39	11.04	12.696
2480	2.0	78	10.93	12.393
2402	3.0	0	11.20	13.180
2441	3.0	39	11.10	12.895
2480	3.0	78	10.99	12.551

Note: The bolded data rates and channel above were tested for SAR.

FCC ID ZNFG710VM	 PCTEST ENGINEERING LABORATORY, INC.	SAR EVALUATION REPORT	 LG	Approved by: Quality Manager
Document S/N: 1M1804030062-01-R2.ZNF	Test Dates: 04/02/18 - 04/15/18	DUT Type: Portable Handset		Page 68 of 126

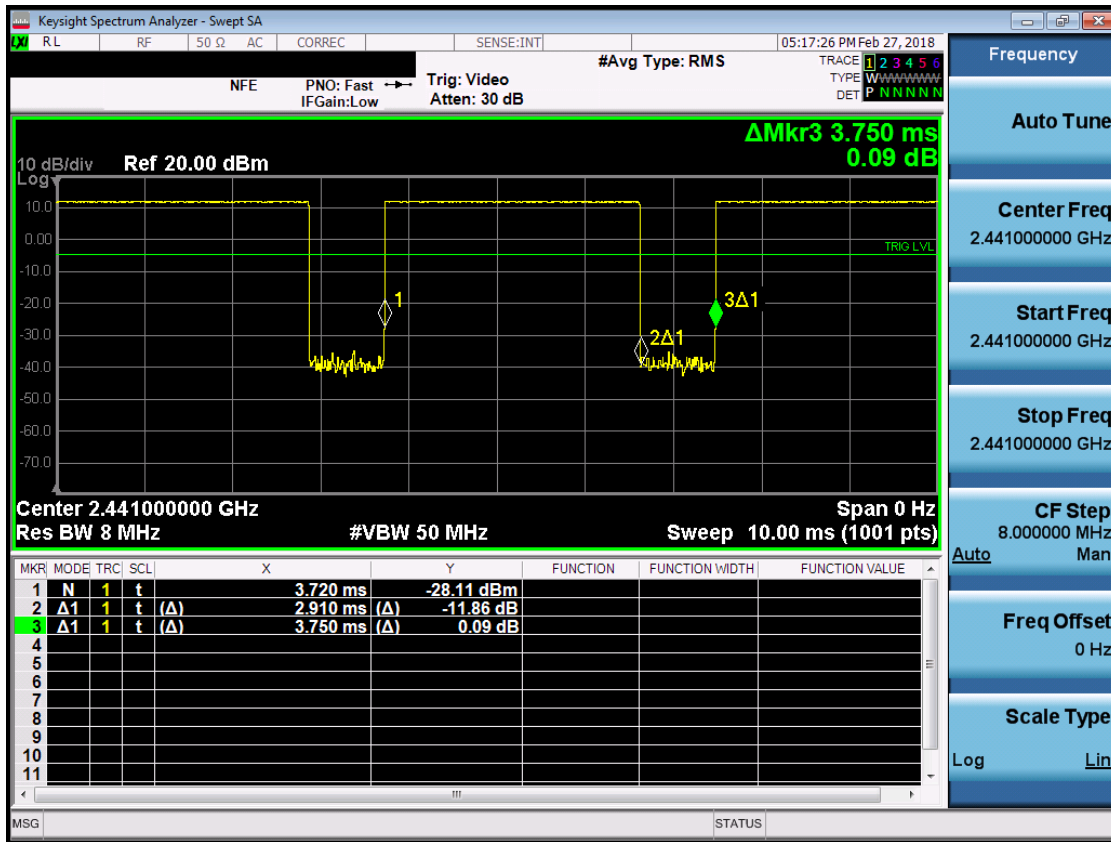

Figure 9-6
Bluetooth Transmission Plot

Equation 9-1
Bluetooth Duty Cycle Calculation

$$Duty\ Cycle = \frac{Pulse\ Width}{Period} * 100\% = \frac{2.910ms}{3.75ms} * 100\% = 77.6\%$$

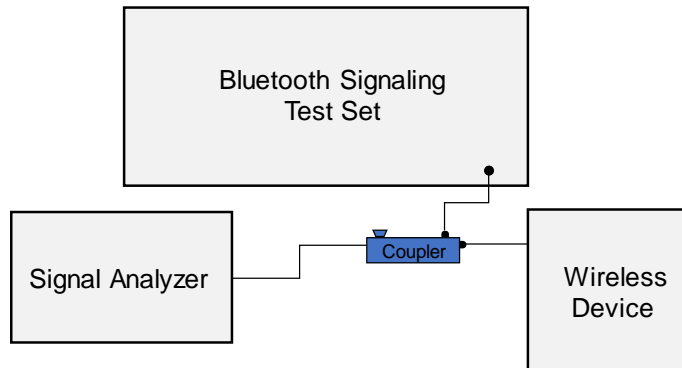

Figure 9-7
Power Measurement Setup



FCC ID ZNFG710VM	PCTEST ENGINEERING LABORATORY, INC.	SAR EVALUATION REPORT	LG	Approved by: Quality Manager
Document S/N: 1M1804030062-01-R2.ZNF	Test Dates: 04/02/18 - 04/15/18	DUT Type: Portable Handset		Page 69 of 126

10 SYSTEM VERIFICATION

10.1 Tissue Verification

**Table 10-1
Measured Head Tissue Properties**



Calibrated for Tests Performed on:	Tissue Type	Tissue Temp During Calibration (°C)	Measured Frequency (MHz)	Measured Conductivity, σ (S/m)	Measured Dielectric Constant, ϵ	TARGET Conductivity, σ (S/m)	TARGET Dielectric Constant, ϵ	% dev σ	% dev ϵ
4/12/2018	750H	21.7	700	0.887	41.260	0.889	42.201	-0.22%	-2.23%
			710	0.890	41.238	0.890	42.149	0.00%	-2.16%
			740	0.901	41.117	0.893	41.994	0.90%	-2.09%
			755	0.906	41.076	0.894	41.916	1.34%	-2.00%
			770	0.913	41.049	0.895	41.838	2.01%	-1.89%
			785	0.917	40.952	0.896	41.760	2.34%	-1.93%
4/9/2018	835H	20.7	820	0.903	43.022	0.899	41.578	0.44%	3.47%
			835	0.918	42.828	0.900	41.500	2.00%	3.20%
			850	0.934	42.627	0.916	41.500	1.97%	2.72%
4/7/2018	1750H	21.4	1710	1.360	39.763	1.348	40.142	0.89%	-0.94%
			1750	1.403	39.580	1.371	40.079	2.33%	-1.25%
			1790	1.445	39.373	1.394	40.016	3.66%	-1.61%
4/13/2018	1900H	21.7	1850	1.403	38.131	1.400	40.000	0.21%	-4.67%
			1880	1.422	38.103	1.400	40.000	1.57%	-4.74%
			1910	1.441	38.070	1.400	40.000	2.93%	-4.83%
4/9/2018	2450H	22.8	2400	1.786	39.784	1.756	39.289	1.71%	1.26%
			2450	1.843	39.600	1.800	39.200	2.39%	1.02%
			2500	1.900	39.399	1.855	39.136	2.43%	0.67%
4/15/2018	2600H	22.5	2500	1.915	40.256	1.855	39.136	3.23%	2.86%
			2550	1.974	40.073	1.909	39.073	3.40%	2.56%
			2600	2.030	39.891	1.964	39.009	3.36%	2.26%
			2650	2.089	39.706	2.018	38.945	3.52%	1.95%
04/09/2018	5200H-5800H	21.6	5240	4.609	37.163	4.696	35.940	-1.85%	3.40%
			5260	4.618	37.249	4.717	35.917	-2.10%	3.71%
			5280	4.630	37.162	4.737	35.894	-2.26%	3.53%
			5300	4.653	37.187	4.758	35.871	-2.21%	3.67%
			5320	4.674	37.163	4.778	35.849	-2.18%	3.67%
			5500	4.851	36.900	4.963	35.643	-2.26%	3.53%
			5520	4.879	36.871	4.983	35.620	-2.09%	3.51%
			5540	4.912	36.870	5.004	35.597	-1.84%	3.58%
			5560	4.941	36.822	5.024	35.574	-1.65%	3.51%
			5580	4.947	36.721	5.045	35.551	-1.94%	3.29%
			5600	4.981	36.743	5.065	35.529	-1.66%	3.42%
			5620	5.009	36.646	5.086	35.506	-1.51%	3.21%
			5640	5.018	36.644	5.106	35.483	-1.72%	3.27%
			5660	5.043	36.675	5.127	35.460	-1.64%	3.43%
			5680	5.061	36.683	5.147	35.437	-1.67%	3.52%
			5700	5.053	36.656	5.168	35.414	-2.23%	3.51%
			5745	5.136	36.462	5.214	35.363	-1.50%	3.11%
			5765	5.144	36.508	5.234	35.340	-1.72%	3.31%
			5785	5.153	36.469	5.255	35.317	-1.94%	3.26%
			5800	5.186	36.434	5.270	35.300	-1.59%	3.21%
5805	5.227	36.456	5.275	35.294	-0.91%	3.29%			
5825	5.206	36.507	5.296	35.271	-1.70%	3.50%			

FCC ID ZNFG710VM	 PCTEST ENGINEERING LABORATORY, INC.	SAR EVALUATION REPORT	 LG	Approved by: Quality Manager
Document S/N: 1M1804030062-01-R2.ZNF	Test Dates: 04/02/18 - 04/15/18	DUT Type: Portable Handset		Page 70 of 126

**Table 10-2
Measured Body Tissue Properties**

Calibrated for Tests Performed on:	Tissue Type	Tissue Temp During Calibration (°C)	Measured Frequency (MHz)	Measured Conductivity, σ (S/m)	Measured Dielectric Constant, ϵ	TARGET Conductivity, σ (S/m)	TARGET Dielectric Constant, ϵ	% dev σ	% dev ϵ
4/9/2018	750B	21.5	700	0.932	54.200	0.959	55.726	-2.82%	-2.74%
			710	0.936	54.171	0.960	55.687	-2.50%	-2.72%
			740	0.947	54.101	0.963	55.570	-1.66%	-2.64%
			755	0.954	54.062	0.964	55.512	-1.04%	-2.61%
			770	0.960	54.023	0.965	55.453	-0.52%	-2.58%
			785	0.965	53.991	0.966	55.395	-0.10%	-2.53%
4/6/2018	835B	22.0	820	0.960	54.422	0.969	55.258	-0.93%	-1.51%
			835	0.975	54.294	0.970	55.200	0.52%	-1.64%
			850	0.989	54.174	0.988	55.154	0.10%	-1.78%
4/11/2018	835B	22.3	820	0.950	53.692	0.969	55.258	-1.96%	-2.83%
			835	0.965	53.572	0.970	55.200	-0.52%	-2.95%
			850	0.980	53.449	0.988	55.154	-0.81%	-3.09%
4/5/2018	1750B	21.5	1710	1.454	52.032	1.463	53.537	-0.62%	-2.81%
			1750	1.499	51.867	1.488	53.432	0.74%	-2.93%
			1790	1.543	51.715	1.514	53.326	1.92%	-3.02%
4/10/2018	1750B	21.9	1710	1.448	52.780	1.463	53.537	-1.03%	-1.41%
			1750	1.495	52.635	1.488	53.432	0.47%	-1.49%
			1790	1.540	52.490	1.514	53.326	1.72%	-1.57%
4/5/2018	1900B	21.7	1850	1.520	53.877	1.520	53.300	0.00%	1.08%
			1880	1.553	53.793	1.520	53.300	2.17%	0.92%
			1910	1.587	53.695	1.520	53.300	4.41%	0.74%
4/6/2018	2450B	22.3	2400	1.966	51.673	1.902	52.767	3.36%	-2.07%
			2450	2.027	51.515	1.950	52.700	3.95%	-2.25%
			2500	2.088	51.344	2.021	52.636	3.32%	-2.45%
4/9/2018	2450B-2600B	22.0	2400	1.978	50.898	1.902	52.767	4.00%	-3.54%
			2450	2.038	50.739	1.950	52.700	4.51%	-3.72%
			2500	2.098	50.584	2.021	52.636	3.81%	-3.90%
			2550	2.157	50.438	2.092	52.573	3.11%	-4.06%
			2600	2.218	50.276	2.163	52.509	2.54%	-4.25%
			2650	2.279	50.117	2.234	52.445	2.01%	-4.44%
			2700	2.338	49.952	2.305	52.382	1.43%	-4.64%
			5180	5.388	47.313	5.276	49.041	2.12%	-3.52%
5200	5.424	47.284	5.299	49.014	2.36%	-3.53%			
5220	5.450	47.232	5.323	48.987	2.39%	-3.58%			
5240	5.478	47.205	5.346	48.960	2.47%	-3.58%			
5260	5.499	47.203	5.369	48.933	2.42%	-3.54%			
5745	6.153	46.367	5.936	48.275	3.66%	-3.95%			
5765	6.182	46.318	5.959	48.248	3.74%	-4.00%			
5785	6.203	46.287	5.982	48.220	3.69%	-4.01%			
5800	6.226	46.272	6.000	48.200	3.77%	-4.00%			
5805	6.234	46.255	6.006	48.193	3.80%	-4.02%			
5825	6.268	46.222	6.029	48.166	3.96%	-4.04%			
04/14/2018	5200B-5800B	21.8	5240	5.503	47.675	5.346	48.960	2.94%	-2.62%
			5260	5.529	47.610	5.369	48.933	2.98%	-2.70%
			5280	5.543	47.605	5.393	48.906	2.78%	-2.66%
			5300	5.586	47.541	5.416	48.879	3.14%	-2.74%
			5320	5.607	47.544	5.439	48.851	3.09%	-2.68%
			5500	5.844	47.219	5.650	48.607	3.43%	-2.86%
			5520	5.864	47.217	5.673	48.580	3.37%	-2.81%
			5540	5.888	47.135	5.696	48.553	3.37%	-2.92%
			5560	5.931	47.103	5.720	48.526	3.69%	-2.93%
			5580	5.962	47.063	5.743	48.499	3.81%	-2.96%
			5600	5.980	47.052	5.766	48.471	3.71%	-2.93%
			5620	5.985	46.990	5.790	48.444	3.37%	-3.00%
			5640	6.035	46.960	5.813	48.417	3.82%	-3.01%
			5660	6.066	46.907	5.837	48.390	3.92%	-3.06%
			5680	6.106	46.871	5.860	48.363	4.20%	-3.09%
			5700	6.128	46.867	5.883	48.336	4.16%	-3.04%
			5745	6.185	46.822	5.936	48.275	4.19%	-3.01%
			5765	6.212	46.785	5.959	48.248	4.25%	-3.03%
			5785	6.244	46.767	5.982	48.220	4.38%	-3.01%
			5800	6.269	46.714	6.000	48.200	4.48%	-3.08%
5805	6.274	46.705	6.006	48.193	4.46%	-3.09%			
5825	6.302	46.681	6.029	48.166	4.53%	-3.08%			

The above measured tissue parameters were used in the DASY software. The DASY software was used to perform interpolation to determine the dielectric parameters at the SAR test device frequencies (per KDB Publication 865664 D01v01r04 and IEEE 1528-2013 6.6.1.2). The tissue parameters listed in the SAR test plots may slightly differ from the table above due to significant digit rounding in the software.



FCC ID ZNFG710VM		SAR EVALUATION REPORT		Approved by: Quality Manager
Document S/N: 1M1804030062-01-R2.ZNF	Test Dates: 04/02/18 - 04/15/18	DUT Type: Portable Handset		Page 71 of 126

10.2 Test System Verification

Prior to SAR assessment, the system is verified to $\pm 10\%$ of the SAR measurement on the reference dipole at the time of calibration by the calibration facility. Full system validation status and result summary can be found in Appendix E.

Table 10-3
System Verification Results – 1g

System Verification TARGET & MEASURED												
SAR System #	Tissue Frequency (MHz)	Tissue Type	Date:	Amb. Temp (°C)	Liquid Temp (°C)	Input Power (W)	Source SN	Probe SN	Measured SAR _{1g} (W/kg)	1 W Target SAR _{1g} (W/kg)	1 W Normalized SAR _{1g} (W/kg)	Deviation _{1g} (%)
J	750	HEAD	04/12/2018	22.7	21.7	0.200	1003	3914	1.720	8.280	8.600	3.86%
E	835	HEAD	04/09/2018	21.5	20.7	0.200	4d132	3213	1.990	9.360	9.950	6.30%
H	1750	HEAD	04/07/2018	20.3	21.4	0.100	1148	7410	3.720	36.400	37.200	2.20%
J	1900	HEAD	04/13/2018	21.9	21.7	0.100	5d148	3914	4.350	40.100	43.500	8.48%
G	2450	HEAD	04/09/2018	22.4	22.8	0.100	797	3332	5.490	52.700	54.900	4.17%
G	2600	HEAD	04/15/2018	22.8	23.1	0.100	1126	3332	5.530	56.400	55.300	-1.95%
H	5250	HEAD	04/09/2018	21.9	21.6	0.050	1191	3589	3.680	78.900	73.600	-6.72%
H	5600	HEAD	04/09/2018	21.9	21.6	0.050	1191	3589	3.910	83.600	78.200	-6.46%
H	5750	HEAD	04/09/2018	21.9	21.6	0.050	1191	3589	3.910	79.100	78.200	-1.14%
I	750	BODY	04/09/2018	22.6	21.5	0.200	1003	3287	1.760	8.580	8.800	2.56%
E	835	BODY	04/06/2018	24.2	22.0	0.200	4d132	3213	1.960	9.710	9.800	0.93%
E	835	BODY	04/11/2018	22.7	22.3	0.200	4d132	3213	1.940	9.710	9.700	-0.10%
I	1750	BODY	04/05/2018	22.6	21.2	0.100	1148	3287	3.930	37.000	39.300	6.22%
I	1750	BODY	04/10/2018	22.8	21.4	0.100	1148	3287	3.820	37.000	38.200	3.24%
J	1900	BODY	04/05/2018	21.9	21.7	0.100	5d148	3914	4.180	39.600	41.800	5.56%
K	2450	BODY	04/06/2018	22.8	21.7	0.100	797	3319	5.020	51.100	50.200	-1.76%
K	2450	BODY	04/09/2018	23.4	22.0	0.100	797	3319	5.150	51.100	51.500	0.78%
K	2600	BODY	04/09/2018	23.4	22.0	0.100	1126	3319	5.560	54.300	55.600	2.39%
D	5250	BODY	04/02/2018	22.5	20.6	0.050	1237	7308	3.600	76.900	72.000	-6.37%
D	5250	BODY	04/14/2018	22.3	21.8	0.050	1237	7308	3.750	76.900	75.000	-2.47%
D	5600	BODY	04/14/2018	22.3	21.8	0.050	1237	7308	3.940	78.500	78.800	0.38%
D	5750	BODY	04/02/2018	22.5	20.6	0.050	1237	7308	3.600	77.100	72.000	-6.61%
D	5750	BODY	04/14/2018	22.3	21.8	0.050	1237	7308	3.670	77.100	73.400	-4.80%

FCC ID ZNFG710VM	 PCTEST ENGINEERING LABORATORY, INC.	SAR EVALUATION REPORT	 LG	Approved by: Quality Manager
Document S/N: 1M1804030062-01-R2.ZNF	Test Dates: 04/02/18 - 04/15/18	DUT Type: Portable Handset	Page 72 of 126	

**Table 10-4
System Verification Results – 10g**

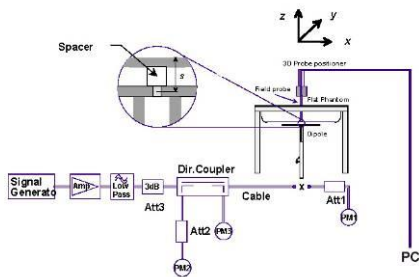

System Verification TARGET & MEASURED												
SAR System #	Tissue Frequency (MHz)	Tissue Type	Date:	Amb. Temp (°C)	Liquid Temp (°C)	Input Power (W)	Source SN	Probe SN	Measured SAR _{10g} (W/kg)	1 W Target SAR _{10g} (W/kg)	1 W Normalized SAR _{10g} (W/kg)	Deviation _{10g} (%)
I	1750	BODY	04/05/2018	22.6	21.2	0.100	1148	3287	2.100	19.800	21.000	6.06%
I	1750	BODY	04/10/2018	22.8	21.4	0.100	1148	3287	2.030	19.800	20.300	2.53%
J	1900	BODY	04/05/2018	21.9	21.7	0.100	5d148	3914	2.160	20.900	21.600	3.35%
D	5250	BODY	04/14/2018	22.3	21.8	0.050	1237	7308	1.050	21.500	21.000	-2.33%
D	5600	BODY	04/14/2018	22.3	21.8	0.050	1237	7308	1.090	22.100	21.800	-1.36%



**Figure 10-1
System Verification Setup Diagram**



**Figure 10-2
System Verification Setup Photo**

FCC ID ZNFG710VM	 PCTEST <small>ENGINEERING LABORATORY, INC.</small>	SAR EVALUATION REPORT		Approved by: Quality Manager
Document S/N: 1M1804030062-01-R2.ZNF	Test Dates: 04/02/18 - 04/15/18	DUT Type: Portable Handset		Page 73 of 126

11 SAR DATA SUMMARY



11.1 Standalone Head SAR Data

**Table 11-1
CDMA BC10 (§90S) Head SAR**

MEASUREMENT RESULTS														
FREQUENCY		Mode/Band	Service	Maximum Allowed Power [dBm]	Conducted Power [dBm]	Power Drift [dB]	Side	Test Position	Device Serial Number	Duty Cycle	SAR (1g)	Scaling Factor	Reported SAR (1g)	Plot #
MHz	Ch.										(W/kg)		(W/kg)	
820.10	564	CDMA BC10 (§90S)	RC3 / SO55	25.5	25.22	0.04	Right	Cheek	12256	1:1	0.191	1.067	0.204	
820.10	564	CDMA BC10 (§90S)	RC3 / SO55	25.5	25.22	-0.03	Right	Tilt	12256	1:1	0.091	1.067	0.097	
820.10	564	CDMA BC10 (§90S)	RC3 / SO55	25.5	25.22	0.05	Left	Cheek	12256	1:1	0.137	1.067	0.146	
820.10	564	CDMA BC10 (§90S)	RC3 / SO55	25.5	25.22	0.04	Left	Tilt	12256	1:1	0.088	1.067	0.094	
820.10	564	CDMA BC10 (§90S)	EVDO Rev. A	25.5	25.20	-0.07	Right	Cheek	12256	1:1	0.245	1.072	0.263	A1
820.10	564	CDMA BC10 (§90S)	EVDO Rev. A	25.5	25.20	0.09	Right	Tilt	12256	1:1	0.106	1.072	0.114	
820.10	564	CDMA BC10 (§90S)	EVDO Rev. A	25.5	25.20	-0.02	Left	Cheek	12256	1:1	0.135	1.072	0.145	
820.10	564	CDMA BC10 (§90S)	EVDO Rev. A	25.5	25.20	0.06	Left	Tilt	12256	1:1	0.065	1.072	0.070	
ANSI / IEEE C95.1 1992 - SAFETY LIMIT Spatial Peak Uncontrolled Exposure/General Population							Head 1.6 W/kg (mW/g) averaged over 1 gram							

**Table 11-2
CDMA BC0 (§22H) Head SAR**

MEASUREMENT RESULTS														
FREQUENCY		Mode/Band	Service	Maximum Allowed Power [dBm]	Conducted Power [dBm]	Power Drift [dB]	Side	Test Position	Device Serial Number	Duty Cycle	SAR (1g)	Scaling Factor	Reported SAR (1g)	Plot #
MHz	Ch.										(W/kg)		(W/kg)	
836.52	384	CDMA BC0 (§22H)	RC3 / SO55	25.5	25.25	-0.06	Right	Cheek	12256	1:1	0.209	1.059	0.221	
836.52	384	CDMA BC0 (§22H)	RC3 / SO55	25.5	25.25	-0.12	Right	Tilt	12256	1:1	0.089	1.059	0.094	
836.52	384	CDMA BC0 (§22H)	RC3 / SO55	25.5	25.25	0.08	Left	Cheek	12256	1:1	0.131	1.059	0.139	
836.52	384	CDMA BC0 (§22H)	RC3 / SO55	25.5	25.25	0.06	Left	Tilt	12256	1:1	0.090	1.059	0.095	
836.52	384	CDMA BC0 (§22H)	EVDO Rev. A	25.5	25.20	0.00	Right	Cheek	12256	1:1	0.253	1.072	0.271	A2
836.52	384	CDMA BC0 (§22H)	EVDO Rev. A	25.5	25.20	0.06	Right	Tilt	12256	1:1	0.120	1.072	0.129	
836.52	384	CDMA BC0 (§22H)	EVDO Rev. A	25.5	25.20	0.09	Left	Cheek	12256	1:1	0.136	1.072	0.146	
836.52	384	CDMA BC0 (§22H)	EVDO Rev. A	25.5	25.20	0.13	Left	Tilt	12256	1:1	0.069	1.072	0.074	
ANSI / IEEE C95.1 1992 - SAFETY LIMIT Spatial Peak Uncontrolled Exposure/General Population							Head 1.6 W/kg (mW/g) averaged over 1 gram							



FCC ID ZNFG710VM	 PCTEST ENGINEERING LABORATORY, INC.	SAR EVALUATION REPORT	 LG	Approved by: Quality Manager
Document S/N: 1M1804030062-01-R2.ZNF	Test Dates: 04/02/18 - 04/15/18	DUT Type: Portable Handset	Page 74 of 126	

**Table 11-3
PCS CDMA Head SAR**

MEASUREMENT RESULTS														
FREQUENCY		Mode/Band	Service	Maximum Allowed Power [dBm]	Conducted Power [dBm]	Power Drift [dB]	Side	Test Position	Device Serial Number	Duty Cycle	SAR (1g)	Scaling Factor	Reported SAR (1g)	Plot #
MHz	Ch.										(W/kg)		(W/kg)	
1880.00	600	PCS CDMA	RC3 / SO55	25.2	25.20	-0.07	Right	Cheek	12256	1:1	0.111	1.000	0.111	
1880.00	600	PCS CDMA	RC3 / SO55	25.2	25.20	0.02	Right	Tilt	12256	1:1	0.107	1.000	0.107	
1880.00	600	PCS CDMA	RC3 / SO55	25.2	25.20	0.16	Left	Cheek	12256	1:1	0.128	1.000	0.128	A3
1880.00	600	PCS CDMA	RC3 / SO55	25.2	25.20	-0.14	Left	Tilt	12256	1:1	0.070	1.000	0.070	
1880.00	600	PCS CDMA	EVDO Rev. A	25.5	25.11	-0.04	Right	Cheek	12256	1:1	0.106	1.094	0.116	
1880.00	600	PCS CDMA	EVDO Rev. A	25.5	25.11	-0.04	Right	Tilt	12256	1:1	0.087	1.094	0.095	
1880.00	600	PCS CDMA	EVDO Rev. A	25.5	25.11	-0.16	Left	Cheek	12256	1:1	0.121	1.094	0.132	
1880.00	600	PCS CDMA	EVDO Rev. A	25.5	25.11	-0.03	Left	Tilt	12256	1:1	0.076	1.094	0.083	
ANSI / IEEE C95.1 1992 - SAFETY LIMIT Spatial Peak Uncontrolled Exposure/General Population							Head 1.6 W/kg (mW/g) averaged over 1 gram							

**Table 11-4
GSM 850 Head SAR**

MEASUREMENT RESULTS															
FREQUENCY		Mode/Band	Service	Maximum Allowed Power [dBm]	Conducted Power [dBm]	Power Drift [dB]	Side	Test Position	Device Serial Number	# of Time Slots	Duty Cycle	SAR (1g)	Scaling Factor	Reported SAR (1g)	Plot #
MHz	Ch.											(W/kg)		(W/kg)	
836.60	190	GSM 850	GSM	31.7	31.50	-0.01	Right	Cheek	12256	1	1:8.3	0.082	1.047	0.086	
836.60	190	GSM 850	GSM	31.7	31.50	-0.04	Right	Tilt	12256	1	1:8.3	0.035	1.047	0.037	
836.60	190	GSM 850	GSM	31.7	31.50	0.11	Left	Cheek	12256	1	1:8.3	0.055	1.047	0.058	
836.60	190	GSM 850	GSM	31.7	31.50	0.14	Left	Tilt	12256	1	1:8.3	0.032	1.047	0.034	
836.60	190	GSM 850	GPRS	31.7	31.29	0.14	Right	Cheek	12256	2	1:4.15	0.137	1.099	0.151	A4
836.60	190	GSM 850	GPRS	31.7	31.29	-0.19	Right	Tilt	12256	2	1:4.15	0.062	1.099	0.068	
836.60	190	GSM 850	GPRS	31.7	31.29	-0.03	Left	Cheek	12256	2	1:4.15	0.091	1.099	0.100	
836.60	190	GSM 850	GPRS	31.7	31.29	-0.15	Left	Tilt	12256	2	1:4.15	0.063	1.099	0.069	
ANSI / IEEE C95.1 1992 - SAFETY LIMIT Spatial Peak Uncontrolled Exposure/General Population							Head 1.6 W/kg (mW/g) averaged over 1 gram								

FCC ID ZNFG710VM	 PCTEST ENGINEERING LABORATORY, INC.	SAR EVALUATION REPORT	 LG	Approved by: Quality Manager
Document S/N: 1M1804030062-01-R2.ZNF	Test Dates: 04/02/18 - 04/15/18	DUT Type: Portable Handset		Page 75 of 126

**Table 11-5
GSM 1900 Head SAR**



MEASUREMENT RESULTS															
FREQUENCY		Mode/Band	Service	Maximum Allowed Power [dBm]	Conducted Power [dBm]	Power Drift [dB]	Side	Test Position	Device Serial Number	# of Time Slots	Duty Cycle	SAR (1g)	Scaling Factor	Reported SAR (1g)	Plot #
MHz	Ch.											(W/kg)		(W/kg)	
1880.00	661	GSM 1900	GSM	30.7	30.61	0.10	Right	Cheek	12256	1	1:8.3	0.036	1.021	0.037	
1880.00	661	GSM 1900	GSM	30.7	30.61	0.13	Right	Tilt	12256	1	1:8.3	0.032	1.021	0.033	
1880.00	661	GSM 1900	GSM	30.7	30.61	-0.17	Left	Cheek	12256	1	1:8.3	0.044	1.021	0.045	
1880.00	661	GSM 1900	GSM	30.7	30.61	-0.19	Left	Tilt	12256	1	1:8.3	0.018	1.021	0.018	
1880.00	661	GSM 1900	GPRS	29.7	29.41	0.17	Right	Cheek	12256	2	1:4.15	0.066	1.069	0.071	
1880.00	661	GSM 1900	GPRS	29.7	29.41	-0.07	Right	Tilt	12256	2	1:4.15	0.050	1.069	0.053	
1880.00	661	GSM 1900	GPRS	29.7	29.41	0.09	Left	Cheek	12256	2	1:4.15	0.073	1.069	0.078	A5
1880.00	661	GSM 1900	GPRS	29.7	29.41	0.00	Left	Tilt	12256	2	1:4.15	0.041	1.069	0.044	
ANSI / IEEE C95.1 1992 - SAFETY LIMIT Spatial Peak Uncontrolled Exposure/General Population							Head 1.6 W/kg (mW/g) averaged over 1 gram								

**Table 11-6
UMTS 850 Head SAR**

MEASUREMENT RESULTS														
FREQUENCY		Mode/Band	Service	Maximum Allowed Power [dBm]	Conducted Power [dBm]	Power Drift [dB]	Side	Test Position	Device Serial Number	Duty Cycle	SAR (1g)	Scaling Factor	Reported SAR (1g)	Plot #
MHz	Ch.										(W/kg)		(W/kg)	
836.60	4183	UMTS 850	RMC	25.5	25.31	-0.03	Right	Cheek	12280	1:1	0.191	1.045	0.200	A6
836.60	4183	UMTS 850	RMC	25.5	25.31	0.08	Right	Tilt	12280	1:1	0.086	1.045	0.090	
836.60	4183	UMTS 850	RMC	25.5	25.31	0.04	Left	Cheek	12280	1:1	0.134	1.045	0.140	
836.60	4183	UMTS 850	RMC	25.5	25.31	0.03	Left	Tilt	12280	1:1	0.080	1.045	0.084	
ANSI / IEEE C95.1 1992 - SAFETY LIMIT Spatial Peak Uncontrolled Exposure/General Population							Head 1.6 W/kg (mW/g) averaged over 1 gram							

**Table 11-7
UMTS 1750 Head SAR**

MEASUREMENT RESULTS														
FREQUENCY		Mode/Band	Service	Maximum Allowed Power [dBm]	Conducted Power [dBm]	Power Drift [dB]	Side	Test Position	Device Serial Number	Duty Cycle	SAR (1g)	Scaling Factor	Reported SAR (1g)	Plot #
MHz	Ch.										(W/kg)		(W/kg)	
1732.40	1412	UMTS 1750	RMC	25.2	24.96	0.01	Right	Cheek	12280	1:1	0.111	1.057	0.117	
1732.40	1412	UMTS 1750	RMC	25.2	24.96	0.01	Right	Tilt	12280	1:1	0.143	1.057	0.151	A7
1732.40	1412	UMTS 1750	RMC	25.2	24.96	0.10	Left	Cheek	12280	1:1	0.116	1.057	0.123	
1732.40	1412	UMTS 1750	RMC	25.2	24.96	0.12	Left	Tilt	12280	1:1	0.073	1.057	0.077	
ANSI / IEEE C95.1 1992 - SAFETY LIMIT Spatial Peak Uncontrolled Exposure/General Population							Head 1.6 W/kg (mW/g) averaged over 1 gram							

FCC ID ZNFG710VM	 PCTEST ENGINEERING LABORATORY, INC.	SAR EVALUATION REPORT		Approved by: Quality Manager
Document S/N: 1M1804030062-01-R2.ZNF	Test Dates: 04/02/18 - 04/15/18	DUT Type: Portable Handset	Page 76 of 126	

**Table 11-8
UMTS 1900 Head SAR**



MEASUREMENT RESULTS														
FREQUENCY		Mode/Band	Service	Maximum Allowed Power [dBm]	Conducted Power [dBm]	Power Drift [dB]	Side	Test Position	Device Serial Number	Duty Cycle	SAR (1g)	Scaling Factor	Reported SAR (1g)	Plot #
MHz	Ch.										(W/kg)		(W/kg)	
1880.00	9400	UMTS 1900	RMC	25.5	25.21	-0.16	Right	Cheek	12256	1:1	0.084	1.069	0.090	
1880.00	9400	UMTS 1900	RMC	25.5	25.21	-0.02	Right	Tilt	12256	1:1	0.122	1.069	0.130	A8
1880.00	9400	UMTS 1900	RMC	25.5	25.21	-0.07	Left	Cheek	12256	1:1	0.121	1.069	0.129	
1880.00	9400	UMTS 1900	RMC	25.5	25.21	0.15	Left	Tilt	12256	1:1	0.073	1.069	0.078	
ANSI / IEEE C95.1 1992 - SAFETY LIMIT Spatial Peak Uncontrolled Exposure/General Population							Head 1.6 W/kg (mW/g) averaged over 1 gram							

**Table 11-9
LTE Band 12 Head SAR**

MEASUREMENT RESULTS																			
FREQUENCY		Mode	Bandwidth [MHz]	Maximum Allowed Power [dBm]	Conducted Power [dBm]	Power Drift [dB]	MPR [dB]	Side	Test Position	Modulation	RB Size	RB Offset	Device Serial Number	Duty Cycle	SAR (1g)	Scaling Factor	Reported SAR (1g)	Plot #	
MHz	Ch.														(W/kg)		(W/kg)		
707.50	23095	Mid	LTE Band 12	10	25.5	25.10	0.02	0	Right	Cheek	QPSK	1	0	12256	1:1	0.157	1.096	0.172	A9
707.50	23095	Mid	LTE Band 12	10	24.5	24.07	0.05	1	Right	Cheek	QPSK	25	25	12256	1:1	0.113	1.104	0.125	
707.50	23095	Mid	LTE Band 12	10	25.5	25.10	0.18	0	Right	Tilt	QPSK	1	0	12256	1:1	0.056	1.096	0.061	
707.50	23095	Mid	LTE Band 12	10	24.5	24.07	0.12	1	Right	Tilt	QPSK	25	25	12256	1:1	0.040	1.104	0.044	
707.50	23095	Mid	LTE Band 12	10	25.5	25.10	0.11	0	Left	Cheek	QPSK	1	0	12256	1:1	0.124	1.096	0.136	
707.50	23095	Mid	LTE Band 12	10	24.5	24.07	0.07	1	Left	Cheek	QPSK	25	25	12256	1:1	0.085	1.104	0.094	
707.50	23095	Mid	LTE Band 12	10	25.5	25.10	0.16	0	Left	Tilt	QPSK	1	0	12256	1:1	0.061	1.096	0.067	
707.50	23095	Mid	LTE Band 12	10	24.5	24.07	0.21	1	Left	Tilt	QPSK	25	25	12256	1:1	0.044	1.104	0.049	
ANSI / IEEE C95.1 1992 - SAFETY LIMIT Spatial Peak Uncontrolled Exposure/General Population							Head 1.6 W/kg (mW/g) averaged over 1 gram												

**Table 11-10
LTE Band 13 Head SAR**

MEASUREMENT RESULTS																			
FREQUENCY		Mode	Bandwidth [MHz]	Maximum Allowed Power [dBm]	Conducted Power [dBm]	Power Drift [dB]	MPR [dB]	Side	Test Position	Modulation	RB Size	RB Offset	Device Serial Number	Duty Cycle	SAR (1g)	Scaling Factor	Reported SAR (1g)	Plot #	
MHz	Ch.														(W/kg)		(W/kg)		
782.00	23230	Mid	LTE Band 13	10	25.5	25.07	0.12	0	Right	Cheek	QPSK	1	25	12256	1:1	0.190	1.104	0.210	A10
782.00	23230	Mid	LTE Band 13	10	24.5	24.01	0.06	1	Right	Cheek	QPSK	25	12	12256	1:1	0.133	1.119	0.149	
782.00	23230	Mid	LTE Band 13	10	25.5	25.07	0.12	0	Right	Tilt	QPSK	1	25	12256	1:1	0.080	1.104	0.088	
782.00	23230	Mid	LTE Band 13	10	24.5	24.01	0.17	1	Right	Tilt	QPSK	25	12	12256	1:1	0.062	1.119	0.069	
782.00	23230	Mid	LTE Band 13	10	25.5	25.07	0.11	0	Left	Cheek	QPSK	1	25	12256	1:1	0.146	1.104	0.161	
782.00	23230	Mid	LTE Band 13	10	24.5	24.01	0.21	1	Left	Cheek	QPSK	25	12	12256	1:1	0.095	1.119	0.106	
782.00	23230	Mid	LTE Band 13	10	25.5	25.07	0.16	0	Left	Tilt	QPSK	1	25	12256	1:1	0.082	1.104	0.091	
782.00	23230	Mid	LTE Band 13	10	24.5	24.01	0.20	1	Left	Tilt	QPSK	25	12	12256	1:1	0.054	1.119	0.060	
ANSI / IEEE C95.1 1992 - SAFETY LIMIT Spatial Peak Uncontrolled Exposure/General Population							Head 1.6 W/kg (mW/g) averaged over 1 gram												

FCC ID ZNFG710VM	 PCTEST ENGINEERING LABORATORY, INC.	SAR EVALUATION REPORT		Approved by: Quality Manager
Document S/N: 1M1804030062-01-R2.ZNF	Test Dates: 04/02/18 - 04/15/18	DUT Type: Portable Handset		Page 77 of 126

**Table 11-11
LTE Band 5 (Cell) Head SAR**



MEASUREMENT RESULTS																					
1 CC Uplink 2 CC Uplink	Component Carrier	FREQUENCY		Mode	Bandwidth [MHz]	Maximum Allowed Power [dBm]	Conducted Power [dBm]	Power Drift [dB]	MPR [dB]	Side	Test Position	Modulation	RB Size	RB Offset	Device Serial Number	Duty Cycle	SAR (1g)	Scaling Factor	Reported SAR (1g)	Plot #	
		MHz	Ch.														(W/kg)		(W/kg)		
1 CC Uplink	N/A	836.50	20525	Mid	LTE Band 5 (Cell)	10	25.5	25.34	0.20	0	Right	Cheek	QPSK	1	0	12256	1:1	0.191	1.038	0.198	A11
2 CC Uplink	PCC	836.50	20525	Mid	LTE Band 5 (Cell)	10	25.5	25.10	-0.03	0	Right	Cheek	QPSK	1	0	12256	1:1	0.172	1.096	0.189	
	SCC	829.30	20453	Mid		5															
1 CC Uplink	N/A	836.50	20525	Mid	LTE Band 5 (Cell)	10	24.5	24.28	0.02	1	Right	Cheek	QPSK	25	0	12256	1:1	0.131	1.052	0.138	
1 CC Uplink	N/A	836.50	20525	Mid	LTE Band 5 (Cell)	10	25.5	25.34	0.03	0	Right	Tilt	QPSK	1	0	12256	1:1	0.079	1.038	0.082	
1 CC Uplink	N/A	836.50	20525	Mid	LTE Band 5 (Cell)	10	24.5	24.28	0.03	1	Right	Tilt	QPSK	25	0	12256	1:1	0.053	1.052	0.056	
1 CC Uplink	N/A	836.50	20525	Mid	LTE Band 5 (Cell)	10	25.5	25.34	0.05	0	Left	Cheek	QPSK	1	0	12256	1:1	0.131	1.038	0.136	
1 CC Uplink	N/A	836.50	20525	Mid	LTE Band 5 (Cell)	10	24.5	24.28	0.02	1	Left	Cheek	QPSK	25	0	12256	1:1	0.100	1.052	0.105	
1 CC Uplink	N/A	836.50	20525	Mid	LTE Band 5 (Cell)	10	25.5	25.34	-0.10	0	Left	Tilt	QPSK	1	0	12256	1:1	0.072	1.038	0.075	
1 CC Uplink	N/A	836.50	20525	Mid	LTE Band 5 (Cell)	10	24.5	24.28	-0.03	1	Left	Tilt	QPSK	25	0	12256	1:1	0.046	1.052	0.048	
ANSI / IEEE C95.1 1992 - SAFETY LIMIT Spatial Peak Uncontrolled Exposure/General Population										Head 1.6 W/kg (mW/g) averaged over 1 gram											

**Table 11-12
LTE Band 26 (Cell) Head SAR**

MEASUREMENT RESULTS																			
FREQUENCY		Mode	Bandwidth [MHz]	Maximum Allowed Power [dBm]	Conducted Power [dBm]	Power Drift [dB]	MPR [dB]	Side	Test Position	Modulation	RB Size	RB Offset	Device Serial Number	Duty Cycle	SAR (1g)	Scaling Factor	Reported SAR (1g)	Plot #	
MHz	Ch.														(W/kg)		(W/kg)		
831.50	26865	Mid	LTE Band 26 (Cell)	15	25.5	25.06	0.08	0	Right	Cheek	QPSK	1	36	12256	1:1	0.193	1.107	0.214	A12
831.50	26865	Mid	LTE Band 26 (Cell)	15	24.5	24.12	0.01	1	Right	Cheek	QPSK	36	37	12256	1:1	0.127	1.091	0.139	
831.50	26865	Mid	LTE Band 26 (Cell)	15	25.5	25.06	0.02	0	Right	Tilt	QPSK	1	36	12256	1:1	0.079	1.107	0.087	
831.50	26865	Mid	LTE Band 26 (Cell)	15	24.5	24.12	0.09	1	Right	Tilt	QPSK	36	37	12256	1:1	0.053	1.091	0.058	
831.50	26865	Mid	LTE Band 26 (Cell)	15	25.5	25.06	0.03	0	Left	Cheek	QPSK	1	36	12256	1:1	0.135	1.107	0.149	
831.50	26865	Mid	LTE Band 26 (Cell)	15	24.5	24.12	0.08	1	Left	Cheek	QPSK	36	37	12256	1:1	0.093	1.091	0.101	
831.50	26865	Mid	LTE Band 26 (Cell)	15	25.5	25.06	0.17	0	Left	Tilt	QPSK	1	36	12256	1:1	0.068	1.107	0.075	
831.50	26865	Mid	LTE Band 26 (Cell)	15	24.5	24.12	0.11	1	Left	Tilt	QPSK	36	37	12256	1:1	0.047	1.091	0.051	
ANSI / IEEE C95.1 1992 - SAFETY LIMIT Spatial Peak Uncontrolled Exposure/General Population										Head 1.6 W/kg (mW/g) averaged over 1 gram									

**Table 11-13
LTE Band 66 (AWS) Head SAR**

MEASUREMENT RESULTS																			
FREQUENCY		Mode	Bandwidth [MHz]	Maximum Allowed Power [dBm]	Conducted Power [dBm]	Power Drift [dB]	MPR [dB]	Side	Test Position	Modulation	RB Size	RB Offset	Device Serial Number	Duty Cycle	SAR (1g)	Scaling Factor	Reported SAR (1g)	Plot #	
MHz	Ch.														(W/kg)		(W/kg)		
1720.00	132072	Low	LTE Band 66 (AWS)	20	25.2	25.20	0.09	0	Right	Cheek	QPSK	1	99	12280	1:1	0.115	1.000	0.115	
1720.00	132072	Low	LTE Band 66 (AWS)	20	24.2	24.10	0.06	1	Right	Cheek	QPSK	50	50	12280	1:1	0.085	1.023	0.087	
1720.00	132072	Low	LTE Band 66 (AWS)	20	25.2	25.20	0.08	0	Right	Tilt	QPSK	1	99	12280	1:1	0.159	1.000	0.159	
1720.00	132072	Low	LTE Band 66 (AWS)	20	24.2	24.10	0.04	1	Right	Tilt	QPSK	50	50	12280	1:1	0.118	1.023	0.121	
1720.00	132072	Low	LTE Band 66 (AWS)	20	25.2	25.20	0.03	0	Left	Cheek	QPSK	1	99	12280	1:1	0.114	1.000	0.114	
1720.00	132072	Low	LTE Band 66 (AWS)	20	24.2	24.10	0.10	1	Left	Cheek	QPSK	50	50	12280	1:1	0.079	1.023	0.081	
1720.00	132072	Low	LTE Band 66 (AWS)	20	25.2	25.20	0.03	0	Left	Tilt	QPSK	1	99	12280	1:1	0.174	1.000	0.174	A13
1720.00	132072	Low	LTE Band 66 (AWS)	20	24.2	24.10	0.06	1	Left	Tilt	QPSK	50	50	12280	1:1	0.117	1.023	0.120	
ANSI / IEEE C95.1 1992 - SAFETY LIMIT Spatial Peak Uncontrolled Exposure/General Population										Head 1.6 W/kg (mW/g) averaged over 1 gram									

FCC ID ZNFG710VM	 PCTEST ENGINEERING LABORATORY, INC.	SAR EVALUATION REPORT	 LG	Approved by: Quality Manager
Document S/N: 1M1804030062-01-R2.ZNF	Test Dates: 04/02/18 - 04/15/18	DUT Type: Portable Handset	Page 78 of 126	

**Table 11-14
LTE Band 25 (PCS) Head SAR**



MEASUREMENT RESULTS																			
FREQUENCY		Mode	Bandwidth [MHz]	Maximum Allowed Power [dBm]	Conducted Power [dBm]	Power Drift [dB]	MPR [dB]	Side	Test Position	Modulation	RB Size	RB Offset	Device Serial Number	Duty Cycle	SAR (1g)	Scaling Factor	Reported SAR (1g)	Plot #	
MHz	Ch.														(W/kg)		(W/kg)		
1860.00	26140	Low	LTE Band 25 (PCS)	20	25.5	25.33	-0.11	0	Right	Cheek	QPSK	1	99	12280	1:1	0.092	1.040	0.096	
1860.00	26140	Low	LTE Band 25 (PCS)	20	24.5	24.26	-0.11	1	Right	Cheek	QPSK	50	0	12280	1:1	0.070	1.057	0.074	
1860.00	26140	Low	LTE Band 25 (PCS)	20	25.5	25.33	0.08	0	Right	Tilt	QPSK	1	99	12280	1:1	0.079	1.040	0.082	
1860.00	26140	Low	LTE Band 25 (PCS)	20	24.5	24.26	0.10	1	Right	Tilt	QPSK	50	0	12280	1:1	0.060	1.057	0.063	
1860.00	26140	Low	LTE Band 25 (PCS)	20	25.5	25.33	0.00	0	Left	Cheek	QPSK	1	99	12280	1:1	0.096	1.040	0.100	A14
1860.00	26140	Low	LTE Band 25 (PCS)	20	24.5	24.26	0.05	1	Left	Cheek	QPSK	50	0	12280	1:1	0.079	1.057	0.084	
1860.00	26140	Low	LTE Band 25 (PCS)	20	25.5	25.33	0.01	0	Left	Tilt	QPSK	1	99	12280	1:1	0.079	1.040	0.082	
1860.00	26140	Low	LTE Band 25 (PCS)	20	24.5	24.26	-0.09	1	Left	Tilt	QPSK	50	0	12280	1:1	0.073	1.057	0.077	
ANSI / IEEE C95.1 1992 - SAFETY LIMIT Spatial Peak Uncontrolled Exposure/General Population										Head 1.6 W/kg (mW/g) averaged over 1 gram									

**Table 11-15
LTE Band 41 Head SAR**

MEASUREMENT RESULTS																					
1 CC Uplink 2 CC Uplink	Component Carrier	FREQUENCY		Mode	Bandwidth [MHz]	Maximum Allowed Power [dBm]	Conducted Power [dBm]	Power Drift [dB]	MPR [dB]	Side	Test Position	Modulation	RB Size	RB Offset	Device Serial Number	Duty Cycle	SAR (1g)	Scaling Factor	Reported SAR (1g)	Plot #	
		MHz	Ch.														(W/kg)		(W/kg)		
1 CC Uplink - Power Class 3	N/A	2636.50	41055	Mid-High	LTE Band 41	20	25.2	25.09	0.16	0	Right	Cheek	QPSK	1	0	12298	1:1.58	0.038	1.026	0.039	
1 CC Uplink - Power Class 3	N/A	2636.50	41055	Mid-High	LTE Band 41	20	24.2	24.09	0.19	1	Right	Cheek	QPSK	50	50	12298	1:1.58	0.026	1.026	0.027	
1 CC Uplink - Power Class 3	N/A	2636.50	41055	Mid-High	LTE Band 41	20	25.2	25.09	0.12	0	Right	Tilt	QPSK	1	0	12298	1:1.58	0.024	1.026	0.025	
1 CC Uplink - Power Class 3	N/A	2636.50	41055	Mid-High	LTE Band 41	20	24.2	24.09	0.13	1	Right	Tilt	QPSK	50	50	12298	1:1.58	0.015	1.026	0.015	
1 CC Uplink - Power Class 3	N/A	2636.50	41055	Mid-High	LTE Band 41	20	25.2	25.09	0.03	0	Left	Cheek	QPSK	1	0	12298	1:1.58	0.038	1.026	0.039	
1 CC Uplink - Power Class 3	N/A	2636.50	41055	Mid-High	LTE Band 41	20	24.2	24.09	0.18	1	Left	Cheek	QPSK	50	50	12298	1:1.58	0.031	1.026	0.032	
1 CC Uplink - Power Class 2	N/A	2636.50	41055	Mid-High	LTE Band 41	20	27.7	27.46	0.15	0	Left	Cheek	QPSK	1	0	12298	1:2.31	0.041	1.057	0.043	A15
2 CC Uplink - Power Class 3	PCC	2636.50	41055	Mid-High	LTE Band 41	20	25.2	25.13	0.16	0	Left	Cheek	QPSK	1	0	12298	1:1.58	0.040	1.016	0.041	
2 CC Uplink - Power Class 3	SCC	2616.70	40857	Mid-High									QPSK	1	99						
1 CC Uplink - Power Class 3	N/A	2636.50	41055	Mid-High	LTE Band 41	20	25.2	25.09	-0.16	0	Left	Tilt	QPSK	1	0	12298	1:1.58	0.036	1.026	0.037	
1 CC Uplink - Power Class 3	N/A	2636.50	41055	Mid-High	LTE Band 41	20	24.2	24.09	0.14	1	Left	Tilt	QPSK	50	50	12298	1:1.58	0.026	1.026	0.027	
ANSI / IEEE C95.1 1992 - SAFETY LIMIT Spatial Peak Uncontrolled Exposure/General Population										Head 1.6 W/kg (mW/g) averaged over 1 gram											

**Table 11-16
DTS Head SAR**

MEASUREMENT RESULTS																			
FREQUENCY		Mode	Service	Bandwidth [MHz]	Maximum Allowed Power [dBm]	Conducted Power [dBm]	Power Drift [dB]	Side	Test Position	Antenna Config.	Device Serial Number	Data Rate (Mbps)	Duty Cycle (%)	Peak SAR of Area Scan	SAR (1g)	Scaling Factor (Power)	Scaling Factor (Duty Cycle)	Reported SAR (1g)	Plot #
MHz	Ch.													(W/kg)	(W/kg)			(W/kg)	
2412	1	802.11b	DSSS	22	18.0	17.58	0.14	Right	Cheek	1	12371	1	99.5	0.484	0.464	1.102	1.005	0.514	A16
2412	1	802.11b	DSSS	22	18.0	17.58	0.09	Right	Tilt	1	12371	1	99.5	0.564	0.436	1.102	1.005	0.483	
2412	1	802.11b	DSSS	22	18.0	17.58	0.06	Left	Cheek	1	12371	1	99.5	0.367	-	1.102	1.005	-	
2412	1	802.11b	DSSS	22	18.0	17.58	0.09	Left	Tilt	1	12371	1	99.5	0.460	-	1.102	1.005	-	
2412	1	802.11b	DSSS	22	18.0	17.48	0.15	Right	Cheek	2	12371	1	99.2	0.142	0.102	1.127	1.008	0.116	
2412	1	802.11b	DSSS	22	18.0	17.48	0.10	Right	Tilt	2	12371	1	99.2	0.045	-	1.127	1.008	-	
2412	1	802.11b	DSSS	22	18.0	17.48	0.11	Left	Cheek	2	12371	1	99.2	0.054	-	1.127	1.008	-	
2412	1	802.11b	DSSS	22	18.0	17.48	0.19	Left	Tilt	2	12371	1	99.2	0.009	-	1.127	1.008	-	
ANSI / IEEE C95.1 1992 - SAFETY LIMIT Spatial Peak Uncontrolled Exposure/General Population										Head 1.6 W/kg (mW/g) averaged over 1 gram									



FCC ID ZNFG710VM		SAR EVALUATION REPORT		Approved by: Quality Manager
Document S/N: 1M1804030062-01-R2.ZNF	Test Dates: 04/02/18 - 04/15/18	DUT Type: Portable Handset	Page 79 of 126	

**Table 11-17
NII Head SAR**

MEASUREMENT RESULTS																			
FREQUENCY		Mode	Service	Bandwidth [MHz]	Maximum Allowed Power [dBm]	Conducted Power [dBm]	Power Drift [dB]	Side	Test Position	Antenna Config.	Device Serial Number	Data Rate (Mbps)	Duty Cycle (%)	Peak SAR of Area Scan	SAR (1g)	Scaling Factor (Power)	Scaling Factor (Duty Cycle)	Reported SAR (1g)	Plot #
MHz	Ch.													W/kg	(W/kg)			(W/kg)	
5260	52	802.11a	OFDM	20	17.0	16.52	0.16	Right	Cheek	1	12249	6	98.5	0.706	0.369	1.117	1.015	0.418	
5280	56	802.11a	OFDM	20	18.0	17.56	-0.03	Right	Cheek	1	12249	6	98.5	1.332	0.553	1.107	1.015	0.621	A17
5320	64	802.11a	OFDM	20	17.0	16.71	0.16	Right	Cheek	1	12249	6	98.5	0.755	0.380	1.069	1.015	0.412	
5280	56	802.11a	OFDM	20	18.0	17.56	0.16	Right	Tilt	1	12249	6	98.5	0.839	0.345	1.107	1.015	0.388	
5280	56	802.11a	OFDM	20	18.0	17.56	0.16	Left	Cheek	1	12249	6	98.5	0.266	-	1.107	1.015	-	
5280	56	802.11a	OFDM	20	18.0	17.56	0.03	Left	Tilt	1	12249	6	98.5	0.244	-	1.107	1.015	-	
5280	56	802.11a	OFDM	20	18.0	17.50	0.13	Right	Cheek	2	12249	6	98.8	0.070	-	1.122	1.012	-	
5280	56	802.11a	OFDM	20	18.0	17.50	0.17	Right	Tilt	2	12249	6	98.8	0.035	-	1.122	1.012	-	
5280	56	802.11a	OFDM	20	18.0	17.50	0.10	Left	Cheek	2	12249	6	98.8	0.074	0.023	1.122	1.012	0.026	
5280	56	802.11a	OFDM	20	18.0	17.50	0.16	Left	Tilt	2	12249	6	98.8	0.043	-	1.122	1.012	-	
5600	120	802.11a	OFDM	20	17.0	16.56	0.18	Right	Cheek	1	12249	6	98.5	1.011	0.439	1.107	1.015	0.493	
5600	120	802.11a	OFDM	20	17.0	16.56	0.11	Right	Tilt	1	12249	6	98.5	0.796	0.305	1.107	1.015	0.343	
5600	120	802.11a	OFDM	20	17.0	16.56	0.12	Left	Cheek	1	12249	6	98.5	0.275	-	1.107	1.015	-	
5600	120	802.11a	OFDM	20	17.0	16.56	-0.15	Left	Tilt	1	12249	6	98.5	0.329	-	1.107	1.015	-	
5620	124	802.11a	OFDM	20	17.0	16.68	0.14	Right	Cheek	2	12249	6	98.8	0.064	-	1.076	1.012	-	
5620	124	802.11a	OFDM	20	17.0	16.68	0.16	Right	Tilt	2	12249	6	98.8	0.028	-	1.076	1.012	-	
5620	124	802.11a	OFDM	20	17.0	16.68	0.17	Left	Cheek	2	12249	6	98.8	0.096	0.025	1.076	1.012	0.027	
5620	124	802.11a	OFDM	20	17.0	16.68	-0.13	Left	Tilt	2	12249	6	98.8	0.032	-	1.076	1.012	-	
5805	161	802.11a	OFDM	20	18.0	17.47	0.18	Right	Cheek	1	12249	6	98.5	1.062	0.480	1.130	1.015	0.551	
5805	161	802.11a	OFDM	20	18.0	17.47	0.19	Right	Tilt	1	12249	6	98.5	0.707	0.311	1.130	1.015	0.357	
5805	161	802.11a	OFDM	20	18.0	17.47	-0.12	Left	Cheek	1	12249	6	98.5	0.337	-	1.130	1.015	-	
5805	161	802.11a	OFDM	20	18.0	17.47	0.15	Left	Tilt	1	12249	6	98.5	0.381	-	1.130	1.015	-	
5785	157	802.11a	OFDM	20	18.0	17.50	0.07	Right	Cheek	2	12249	6	98.8	0.176	0.046	1.122	1.012	0.052	
5785	157	802.11a	OFDM	20	18.0	17.50	0.06	Right	Tilt	2	12249	6	98.8	0.037	-	1.122	1.012	-	
5785	157	802.11a	OFDM	20	18.0	17.50	0.04	Left	Cheek	2	12249	6	98.8	0.141	-	1.122	1.012	-	
5785	157	802.11a	OFDM	20	18.0	17.50	0.17	Left	Tilt	2	12249	6	98.8	0.045	-	1.122	1.012	-	
ANSI / IEEE C95.1 1992 - SAFETY LIMIT												Head							
Spatial Peak												1.6 W/kg (mW/g)							
Uncontrolled Exposure/General Population												averaged over 1 gram							

**Table 11-18
DSS Head SAR**

MEASUREMENT RESULTS																	
FREQUENCY		Mode	Service	Maximum Allowed Power [dBm]	Conducted Power [dBm]	Power Drift [dB]	Side	Test Position	Device Serial Number	Data Rate (Mbps)	Duty Cycle %	SAR (1g)	Scaling Factor (Cond Power)	Scaling Factor (Duty Cycle)	Reported SAR (1g)	Plot #	
MHz	Ch.											(W/kg)		(W/kg)			
2402.00	0	Bluetooth	FHSS	12.0	11.81	0.17	Right	Cheek	12371	1	77.6	0.089	1.045	1.289	0.120		
2402.00	0	Bluetooth	FHSS	12.0	11.81	0.15	Right	Tilt	12371	1	77.6	0.087	1.045	1.289	0.117		
2402.00	0	Bluetooth	FHSS	12.0	11.81	0.01	Left	Cheek	12371	1	77.6	0.064	1.045	1.289	0.086		
2402.00	0	Bluetooth	FHSS	12.0	11.81	0.12	Left	Tilt	12371	1	77.6	0.091	1.045	1.289	0.123	A18	
ANSI / IEEE C95.1 1992 - SAFETY LIMIT												Head					
Spatial Peak												1.6 W/kg (mW/g)					
Uncontrolled Exposure/General Population												averaged over 1 gram					

FCC ID ZNFG710VM	 PCTEST ENGINEERING LABORATORY, INC.	SAR EVALUATION REPORT	 LG	Approved by: Quality Manager
Document S/N: 1M1804030062-01-R2.ZNF	Test Dates: 04/02/18 - 04/15/18	DUT Type: Portable Handset		Page 80 of 126



11.2 Standalone Body-Worn SAR Data

**Table 11-19
GSM/UMTS/CDMA Body-Worn SAR Data**

MEASUREMENT RESULTS															
FREQUENCY		Mode	Service	Maximum Allowed Power [dBm]	Conducted Power [dBm]	Power Drift [dB]	Spacing	Device Serial Number	# of Time Slots	Duty Cycle	Side	SAR (1g)	Scaling Factor	Reported SAR (1g)	Plot #
MHz	Ch.											(W/kg)		(W/kg)	
820.10	564	CDMA BC10 (§90S)	TDSO / SO32	25.5	25.30	0.00	10 mm	12280	N/A	1:1	back	0.424	1.047	0.444	A19
836.52	384	CDMA BC0 (§22H)	TDSO / SO32	25.5	25.25	0.05	10 mm	12280	N/A	1:1	back	0.492	1.059	0.521	A21
1880.00	600	PCS CDMA	TDSO / SO32	25.2	25.19	0.10	10 mm	12280	N/A	1:1	back	0.357	1.002	0.358	A23
836.60	190	GSM 850	GSM	31.7	31.50	-0.02	10 mm	12298	1	1:8.3	back	0.185	1.047	0.194	
836.60	190	GSM 850	GPRS	31.7	31.29	-0.04	10 mm	12298	2	1:4.15	back	0.306	1.099	0.336	A25
1880.00	661	GSM 1900	GSM	30.7	30.61	0.12	10 mm	12272	1	1:8.3	back	0.189	1.021	0.193	
1880.00	661	GSM 1900	GPRS	29.7	29.41	-0.09	10 mm	12272	2	1:4.15	back	0.288	1.069	0.308	A26
836.60	4183	UMTS 850	RMC	25.5	25.31	-0.03	10 mm	12256	N/A	1:1	back	0.391	1.045	0.409	A28
1732.40	1412	UMTS 1750	RMC	25.2	24.96	0.04	10 mm	12256	N/A	1:1	back	0.482	1.057	0.509	A29
1880.00	9400	UMTS 1900	RMC	25.5	25.21	-0.05	10 mm	12272	N/A	1:1	back	0.552	1.069	0.590	A31
ANSI / IEEE C95.1 1992 - SAFETY LIMIT Spatial Peak Uncontrolled Exposure/General Population							Body 1.6 W/kg (mW/g) averaged over 1 gram								

**Table 11-20
LTE FDD Body-Worn SAR**

MEASUREMENT RESULTS																			
FREQUENCY		Mode	Bandwidth [MHz]	Maximum Allowed Power [dBm]	Conducted Power [dBm]	Power Drift [dB]	MPR [dB]	Device Serial Number	Modulation	RB Size	RB Offset	Spacing	Side	Duty Cycle	SAR (1g)	Scaling Factor	Reported SAR (1g)	Plot #	
MHz	Ch.														(W/kg)		(W/kg)		
707.50	23095	Mid	LTE Band 12	10	25.5	25.10	0.00	0	12249	QPSK	1	0	10 mm	back	1:1	0.471	1.096	0.516	A33
707.50	23095	Mid	LTE Band 12	10	24.5	24.07	0.01	1	12249	QPSK	25	25	10 mm	back	1:1	0.332	1.104	0.367	
782.00	23230	Mid	LTE Band 13	10	25.5	25.07	0.01	0	12249	QPSK	1	25	10 mm	back	1:1	0.533	1.104	0.588	A34
782.00	23230	Mid	LTE Band 13	10	24.5	24.01	-0.01	1	12249	QPSK	25	12	10 mm	back	1:1	0.373	1.119	0.417	
831.50	26865	Mid	LTE Band 26 (Cell)	15	25.5	25.06	0.00	0	12256	QPSK	1	36	10 mm	back	1:1	0.383	1.107	0.424	A36
831.50	26865	Mid	LTE Band 26 (Cell)	15	24.5	24.12	0.04	1	12256	QPSK	36	37	10 mm	back	1:1	0.262	1.091	0.286	
1720.00	132072	Low	LTE Band 66 (AWS)	20	25.2	25.20	0.00	0	12280	QPSK	1	99	10 mm	back	1:1	0.473	1.000	0.473	A37
1720.00	132072	Low	LTE Band 66 (AWS)	20	24.2	24.10	-0.01	1	12280	QPSK	50	50	10 mm	back	1:1	0.339	1.023	0.347	
1860.00	26140	Low	LTE Band 25 (PCS)	20	25.5	25.33	0.10	0	12249	QPSK	1	99	10 mm	back	1:1	0.358	1.040	0.372	A39
1860.00	26140	Low	LTE Band 25 (PCS)	20	24.5	24.26	0.01	1	12249	QPSK	50	0	10 mm	back	1:1	0.280	1.057	0.296	
ANSI / IEEE C95.1 1992 - SAFETY LIMIT Spatial Peak Uncontrolled Exposure/General Population							Body 1.6 W/kg (mW/g) averaged over 1 gram												

FCC ID ZNFG710VM	 PCTEST ENGINEERING LABORATORY, INC.	SAR EVALUATION REPORT		Approved by: Quality Manager
Document S/N: 1M1804030062-01-R2.ZNF	Test Dates: 04/02/18 - 04/15/18	DUT Type: Portable Handset		Page 81 of 126

**Table 11-21
LTE FDD Band 5 Body-Worn SAR**

MEASUREMENT RESULTS																			Plot #		
1 CC Uplink 2 CC Uplink	Component Carrier	FREQUENCY		Mode	Bandwidth [MHz]	Maximum Allowed Power [dBm]	Conducted Power [dBm]	Power Drift [dB]	MPR [dB]	Device Serial Number	Modulation	RB Size	RB Offset	Spacing	Side	Duty Cycle	SAR (1g)	Scaling Factor		Reported SAR (1g)	
		MHz	Ch.														(W/kg)			(W/kg)	
1 CC Uplink	N/A	836.50	20525	Mid	LTE Band 5 (Cell)	10	25.5	25.34	-0.01	0	12256	QPSK	1	0	10 mm	back	1:1	0.385	1.038	0.400	A35
2 CC Uplink	PCC	836.50	20525	Mid	LTE Band 5 (Cell)	10	25.5	25.10	-0.12	0	12256	QPSK	1	0	10 mm	back	1:1	0.351	1.096	0.385	
	SCC	829.30	20453	High	LTE Band 5 (Cell)	5						QPSK	1	24	10 mm	back	1:1				
1 CC Uplink	N/A	836.50	20525	Mid	LTE Band 5 (Cell)	10	24.5	24.28	-0.02	1	12256	QPSK	25	0	10 mm	back	1:1	0.263	1.052	0.277	
ANSI / IEEE C95.1 1992 - SAFETY LIMIT Spatial Peak											Body 1.6 W/kg (mW/g) averaged over 1 gram										
Uncontrolled Exposure/General Population																					

**Table 11-22
LTE TDD Body-Worn SAR**

MEASUREMENT RESULTS																			Plot #		
1 CC Uplink 2 CC Uplink	Component Carrier	FREQUENCY		Mode	Bandwidth [MHz]	Maximum Allowed Power [dBm]	Conducted Power [dBm]	Power Drift [dB]	MPR [dB]	Device Serial Number	Modulation	RB Size	RB Offset	Spacing	Side	Duty Cycle	SAR (1g)	Scaling Factor		Reported SAR (1g)	
		MHz	Ch.														(W/kg)			(W/kg)	
1 CC Uplink - Power Class 3	N/A	2636.50	41055	Mid-High	LTE Band 41	20	25.2	25.09	-0.01	0	12272	QPSK	1	0	10 mm	back	1:1.58	0.491	1.026	0.504	
1 CC Uplink - Power Class 3	N/A	2636.50	41055	Mid-High	LTE Band 41	20	24.2	24.09	0.05	1	12272	QPSK	50	50	10 mm	back	1:1.58	0.353	1.026	0.362	
1 CC Uplink - Power Class 2	N/A	2636.50	41055	Mid-High	LTE Band 41	20	27.7	27.46	-0.07	0	12272	QPSK	1	0	10 mm	back	1:2.31	0.566	1.057	0.598	A41
2 CC Uplink - Power Class 3	PCC	2636.50	41055	Mid-High	LTE Band 41	20	25.2	25.13	-0.04	0	12272	QPSK	1	0	10 mm	back	1:1.58	0.505	1.016	0.513	
2 CC Uplink - Power Class 3	SCC	2616.70	40857	Mid-High								QPSK	1	99							
ANSI / IEEE C95.1 1992 - SAFETY LIMIT Spatial Peak											Body 1.6 W/kg (mW/g) averaged over 1 gram										
Uncontrolled Exposure/General Population																					



**Table 11-23
DTS SISO Body-Worn SAR**

MEASUREMENT RESULTS																			Plot #
FREQUENCY		Mode	Service	Bandwidth [MHz]	Maximum Allowed Power [dBm]	Conducted Power [dBm]	Power Drift [dB]	Spacing	Antenna Config.	Device Serial Number	Data Rate (Mbps)	Side	Duty Cycle (%)	Peak SAR of Area Scan	SAR (1g)	Scaling Factor (Power)	Scaling Factor (Duty Cycle)	Reported SAR (1g)	
MHz	Ch.													(W/kg)	(W/kg)			(W/kg)	
2412	1	802.11b	DSSS	22	21.0	20.81	-0.07	10 mm	1	12371	1	back	99.5	0.410	0.381	1.045	1.005	0.400	
2437	6	802.11b	DSSS	22	21.0	20.99	0.04	10 mm	2	12371	1	back	99.2	0.455	0.491	1.002	1.008	0.496	A43
ANSI / IEEE C95.1 1992 - SAFETY LIMIT Spatial Peak											Body 1.6 W/kg (mW/g) averaged over 1 gram								
Uncontrolled Exposure/General Population																			

**Table 11-24
DTS Body-Worn SAR for Conditions with 2.4 GHz Ant 1 and 5 GHz Ant 2 WLAN**

MEASUREMENT RESULTS																			Plot #
FREQUENCY		Mode	Service	Bandwidth [MHz]	Maximum Allowed Power [dBm]	Conducted Power [dBm]	Power Drift [dB]	Spacing	Antenna Config.	Device Serial Number	Data Rate (Mbps)	Side	Duty Cycle (%)	Peak SAR of Area Scan	SAR (1g)	Scaling Factor (Power)	Scaling Factor (Duty Cycle)	Reported SAR (1g)	
MHz	Ch.													(W/kg)	(W/kg)			(W/kg)	
2412	1	802.11b	DSSS	22	18.0	17.58	-0.03	10 mm	1	12371	1	back	99.5	0.204	0.185	1.102	1.005	0.205	
ANSI / IEEE C95.1 1992 - SAFETY LIMIT Spatial Peak											Body 1.6 W/kg (mW/g) averaged over 1 gram								
Uncontrolled Exposure/General Population																			

DTS was additionally evaluated at the maximum allowed output power during operations with simultaneous 2.4 GHz Ant 1 and 5 GHz Ant 2 WLAN. 5 GHz Ant 2 WIFI was not transmitting during the above evaluations.

FCC ID ZNFG710VM	 PCTEST ENGINEERING LABORATORY, INC.	SAR EVALUATION REPORT	 LG	Approved by: Quality Manager
Document S/N: 1M1804030062-01-R2.ZNF	Test Dates: 04/02/18 - 04/15/18	DUT Type: Portable Handset		Page 82 of 126

**Table 11-25
NII SISO Body-Worn SAR**



MEASUREMENT RESULTS																			
FREQUENCY		Mode	Service	Bandwidth [MHz]	Maximum Allowed Power [dBm]	Conducted Power [dBm]	Power Drift [dB]	Spacing	Antenna Config.	Device Serial Number	Data Rate (Mbps)	Side	Duty Cycle (%)	Peak SAR of Area Scan	SAR (1g)	Scaling Factor (Power)	Scaling Factor (Duty Cycle)	Reported SAR (1g)	Plot #
MHz	Ch.													W/kg	(W/kg)	(W/kg)	(W/kg)		
5280	56	802.11a	OFDM	20	18.0	17.56	0.14	10 mm	1	12298	6	back	98.5	0.331	0.164	1.107	1.015	0.184	
5260	52	802.11a	OFDM	20	17.0	16.51	-0.04	10 mm	2	12298	6	back	98.8	1.438	0.624	1.119	1.012	0.707	
5280	56	802.11a	OFDM	20	18.0	17.50	0.01	10 mm	2	12298	6	back	98.8	2.068	0.917	1.122	1.012	1.041	
5320	64	802.11a	OFDM	20	17.0	16.41	0.03	10 mm	2	12298	6	back	98.8	1.978	0.735	1.146	1.012	0.852	
5600	120	802.11a	OFDM	20	17.0	16.56	-0.12	10 mm	1	12298	6	back	98.5	0.122	0.045	1.107	1.015	0.051	
5600	120	802.11a	OFDM	20	17.0	16.67	0.03	10 mm	2	12298	6	back	98.8	1.628	0.741	1.079	1.012	0.809	
5620	124	802.11a	OFDM	20	17.0	16.68	0.07	10 mm	2	12298	6	back	98.8	1.722	0.753	1.076	1.012	0.820	
5805	161	802.11a	OFDM	20	18.0	17.47	0.18	10 mm	1	12298	6	back	98.5	0.153	0.057	1.130	1.015	0.065	
5785	157	802.11a	OFDM	20	18.0	17.50	0.03	10 mm	2	12298	6	back	98.8	1.621	0.717	1.122	1.012	0.814	
5805	161	802.11a	OFDM	20	18.0	17.33	0.03	10 mm	2	12298	6	back	98.8	1.615	0.685	1.167	1.012	0.809	
ANSI / IEEE C95.1 1992 - SAFETY LIMIT Spatial Peak Uncontrolled Exposure/General Population										Body 1.6 W/kg (mW/g) averaged over 1 gram									

**Table 11-26
NII MIMO Body-Worn SAR**

MEASUREMENT RESULTS																					
FREQUENCY		Mode	Service	Bandwidth [MHz]	Maximum Allowed Power (Ant 1) [dBm]	Conducted Power (Ant 1) [dBm]	Maximum Allowed Power (Ant 2) [dBm]	Conducted Power (Ant 2) [dBm]	Power Drift [dB]	Spacing	Antenna Config.	Device Serial Number	Data Rate (Mbps)	Side	Duty Cycle (%)	Peak SAR of Area Scan	SAR (1g)	Scaling Factor (Power)	Scaling Factor (Duty Cycle)	Reported SAR (1g)	Plot #
MHz	Ch.															W/kg	(W/kg)	(W/kg)	(W/kg)		
5260	52	802.11n	OFDM	20	17.0	16.31	17.0	16.56	0.13	10 mm	MIMO	12272	13	back	98.6	1.603	0.708	1.172	1.014	0.841	
5280	56	802.11n	OFDM	20	18.0	17.34	18.0	17.51	0.12	10 mm	MIMO	12272	13	back	98.6	2.673	0.854	1.164	1.014	1.126	
5320	64	802.11n	OFDM	20	17.0	16.57	17.0	16.33	0.05	10 mm	MIMO	12272	13	back	98.6	1.790	0.810	1.167	1.014	0.959	
5600	120	802.11n	OFDM	20	17.0	16.46	17.0	16.20	0.08	10 mm	MIMO	12272	13	back	98.6	1.971	0.901	1.202	1.014	1.098	
5620	124	802.11n	OFDM	20	17.0	16.30	17.0	16.51	0.08	10 mm	MIMO	12272	13	back	98.6	2.013	0.838	1.175	1.014	0.998	
5785	157	802.11n	OFDM	20	18.0	17.38	18.0	17.28	0.16	10 mm	MIMO	12298	13	back	98.6	1.778	0.763	1.180	1.014	0.913	
5805	161	802.11n	OFDM	20	18.0	17.57	18.0	17.02	0.03	10 mm	MIMO	12298	13	back	98.6	1.766	0.741	1.253	1.014	0.941	
5280	56	802.11n	OFDM	20	18.0	17.34	18.0	17.51	-0.02	10 mm	MIMO	12272	13	back	98.6	2.332	0.963	1.164	1.014	1.137	A44
5600	120	802.11n	OFDM	20	17.0	16.46	17.0	16.20	0.08	10 mm	MIMO	12272	13	back	98.6	1.886	0.828	1.202	1.014	1.009	
ANSI / IEEE C95.1 1992 - SAFETY LIMIT Spatial Peak Uncontrolled Exposure/General Population										Body 1.6 W/kg (mW/g) averaged over 1 gram											

Note:

- Blue entry represents variability measurement.
- To achieve the 5GHz WLAN 20.0 dBm (Ch. 52, 64, 120, 124) and 21 dBm (Ch. 56, 157, 161) maximum allowed MIMO power shown in the documentation, each antenna transmits at a maximum allowed power of 17.0 dBm (Ch. 52, 64, 120, 124) and 18.0 dBm (Ch. 56, 157, 161).

FCC ID ZNFG710VM	 PCTEST ENGINEERING LABORATORY, INC.	SAR EVALUATION REPORT		Approved by: Quality Manager
Document S/N: 1M1804030062-01-R2.ZNF	Test Dates: 04/02/18 - 04/15/18	DUT Type: Portable Handset		Page 83 of 126



**Table 11-27
NII Body-Worn SAR for Conditions with 2.4 GHz Ant 1 and 5 GHz Ant 2 WLAN**

MEASUREMENT RESULTS																			
FREQUENCY		Mode	Service	Bandwidth [MHz]	Maximum Allowed Power [dBm]	Conducted Power [dBm]	Power Drift [dB]	Spacing	Antenna Config.	Device Serial Number	Data Rate (Mbps)	Side	Duty Cycle (%)	Peak SAR of Area Scan	SAR (1g)	Scaling Factor (Power)	Scaling Factor (Duty Cycle)	Reported SAR (1g)	Plot #
MHz	Ch.													(W/kg)	(W/kg)	(W/kg)			
5270	54	802.11n	OFDM	40	15.0	14.48	0.04	10 mm	2	12298	13.5	back	97.9	1.057	0.436	1.127	1.021	0.502	
5710	142	802.11n	OFDM	40	15.0	14.51	-0.02	10 mm	2	12298	13.5	back	97.9	0.963	0.383	1.119	1.021	0.438	
5755	151	802.11n	OFDM	40	15.0	14.51	-0.13	10 mm	2	12298	13.5	back	97.9	0.960	0.378	1.119	1.021	0.432	
ANSI / IEEE C95.1 1992 - SAFETY LIMIT Spatial Peak Uncontrolled Exposure/General Population								Body 1.6 W/kg (mW/g) averaged over 1 gram											

NII was additionally evaluated at the maximum allowed output power during operations with simultaneous 2.4 GHz Ant 1 and 5 GHz Ant 2 WLAN. 2.4 GHz Ant 1 WIFI was not transmitting during the above evaluations.

**Table 11-28
DSS Body-Worn SAR**

MEASUREMENT RESULTS																
FREQUENCY		Mode	Service	Maximum Allowed Power [dBm]	Conducted Power [dBm]	Power Drift [dB]	Spacing	Device Serial Number	Data Rate (Mbps)	Side	Duty Cycle	SAR (1g)	Scaling Factor (Cond Power)	Scaling Factor (Duty Cycle)	Reported SAR (1g)	Plot #
MHz	Ch.											(W/kg)	(W/kg)	(W/kg)		
2402	0	Bluetooth	FHSS	12.0	11.81	0.15	10 mm	12371	1	back	77.6	0.015	1.045	1.289	0.020	A46
ANSI / IEEE C95.1 1992 - SAFETY LIMIT Spatial Peak Uncontrolled Exposure/General Population								Body 1.6 W/kg (mW/g) averaged over 1 gram								



FCC ID ZNFG710VM	 PCTEST ENGINEERING LABORATORY, INC.	SAR EVALUATION REPORT		Approved by: Quality Manager
Document S/N: 1M1804030062-01-R2.ZNF	Test Dates: 04/02/18 - 04/15/18	DUT Type: Portable Handset	Page 84 of 126	

11.3 Standalone Hotspot SAR Data

**Table 11-29
GPRS/UMTS/CDMA Hotspot SAR Data**

MEASUREMENT RESULTS															
FREQUENCY		Mode	Service	Maximum Allowed Power [dBm]	Conducted Power [dBm]	Power Drift [dB]	Spacing	Device Serial Number	# of GPRS Slots	Duty Cycle	Side	SAR (1g)	Scaling Factor	Reported SAR (1g)	Plot #
MHz	Ch.											(W/kg)		(W/kg)	
820.10	564	CDMA BC10 (§90S)	EVDO Rev. 0	25.5	25.13	0.03	10 mm	12280	N/A	1:1	back	0.409	1.089	0.445	A20
820.10	564	CDMA BC10 (§90S)	EVDO Rev. 0	25.5	25.13	-0.02	10 mm	12280	N/A	1:1	front	0.313	1.089	0.341	
820.10	564	CDMA BC10 (§90S)	EVDO Rev. 0	25.5	25.13	-0.16	10 mm	12280	N/A	1:1	bottom	0.246	1.089	0.268	
820.10	564	CDMA BC10 (§90S)	EVDO Rev. 0	25.5	25.13	0.03	10 mm	12280	N/A	1:1	right	0.219	1.089	0.238	
820.10	564	CDMA BC10 (§90S)	EVDO Rev. 0	25.5	25.13	-0.05	10 mm	12280	N/A	1:1	left	0.086	1.089	0.094	
836.52	384	CDMA BC0 (§22H)	EVDO Rev. 0	25.5	25.16	0.03	10 mm	12280	N/A	1:1	back	0.467	1.081	0.505	A22
836.52	384	CDMA BC0 (§22H)	EVDO Rev. 0	25.5	25.16	0.08	10 mm	12280	N/A	1:1	front	0.372	1.081	0.402	
836.52	384	CDMA BC0 (§22H)	EVDO Rev. 0	25.5	25.16	-0.01	10 mm	12280	N/A	1:1	bottom	0.279	1.081	0.302	
836.52	384	CDMA BC0 (§22H)	EVDO Rev. 0	25.5	25.16	-0.01	10 mm	12280	N/A	1:1	right	0.275	1.081	0.297	
836.52	384	CDMA BC0 (§22H)	EVDO Rev. 0	25.5	25.16	-0.17	10 mm	12280	N/A	1:1	left	0.136	1.081	0.147	
1880.00	600	PCS CDMA	EVDO Rev. 0	25.2	25.10	0.16	10 mm	12280	N/A	1:1	back	0.407	1.023	0.416	
1880.00	600	PCS CDMA	EVDO Rev. 0	25.2	25.10	0.15	10 mm	12280	N/A	1:1	front	0.328	1.023	0.336	
1851.25	25	PCS CDMA	EVDO Rev. 0	25.2	25.13	-0.01	10 mm	12280	N/A	1:1	bottom	0.914	1.016	0.929	
1880.00	600	PCS CDMA	EVDO Rev. 0	25.2	25.10	0.16	10 mm	12280	N/A	1:1	bottom	0.883	1.023	0.903	
1908.75	1175	PCS CDMA	EVDO Rev. 0	25.2	25.14	-0.01	10 mm	12280	N/A	1:1	bottom	0.996	1.014	1.010	A24
1880.00	600	PCS CDMA	EVDO Rev. 0	25.2	25.10	-0.02	10 mm	12280	N/A	1:1	left	0.249	1.023	0.255	
836.60	190	GSM 850	GPRS	31.7	31.29	-0.04	10 mm	12298	2	1:4.15	back	0.306	1.099	0.336	A25
836.60	190	GSM 850	GPRS	31.7	31.29	0.05	10 mm	12298	2	1:4.15	front	0.270	1.099	0.297	
836.60	190	GSM 850	GPRS	31.7	31.29	-0.02	10 mm	12298	2	1:4.15	bottom	0.213	1.099	0.234	
836.60	190	GSM 850	GPRS	31.7	31.29	0.02	10 mm	12298	2	1:4.15	right	0.204	1.099	0.224	
836.60	190	GSM 850	GPRS	31.7	31.29	-0.14	10 mm	12298	2	1:4.15	left	0.097	1.099	0.107	
1880.00	661	GSM 1900	GPRS	29.7	29.41	-0.09	10 mm	12272	2	1:4.15	back	0.288	1.069	0.308	
1880.00	661	GSM 1900	GPRS	29.7	29.41	0.02	10 mm	12272	2	1:4.15	front	0.219	1.069	0.234	
1850.20	512	GSM 1900	GPRS	29.7	29.38	0.19	10 mm	12272	2	1:4.15	bottom	0.485	1.076	0.522	
1880.00	661	GSM 1900	GPRS	29.7	29.41	0.06	10 mm	12272	2	1:4.15	bottom	0.581	1.069	0.621	
1909.80	810	GSM 1900	GPRS	29.7	29.39	0.01	10 mm	12272	2	1:4.15	bottom	0.627	1.074	0.673	A27
1880.00	661	GSM 1900	GPRS	29.7	29.41	-0.06	10 mm	12272	2	1:4.15	left	0.151	1.069	0.161	
836.60	4183	UMTS 850	RMC	25.5	25.31	-0.03	10 mm	12256	N/A	1:1	back	0.391	1.045	0.409	A28
836.60	4183	UMTS 850	RMC	25.5	25.31	0.16	10 mm	12256	N/A	1:1	front	0.379	1.045	0.396	
836.60	4183	UMTS 850	RMC	25.5	25.31	0.02	10 mm	12256	N/A	1:1	bottom	0.278	1.045	0.291	
836.60	4183	UMTS 850	RMC	25.5	25.31	0.00	10 mm	12256	N/A	1:1	right	0.280	1.045	0.293	
836.60	4183	UMTS 850	RMC	25.5	25.31	0.01	10 mm	12256	N/A	1:1	left	0.135	1.045	0.141	
1732.40	1412	UMTS 1750	RMC	25.2	24.96	0.04	10 mm	12256	N/A	1:1	back	0.482	1.057	0.509	
1732.40	1412	UMTS 1750	RMC	25.2	24.96	0.02	10 mm	12256	N/A	1:1	front	0.410	1.057	0.433	
1712.40	1312	UMTS 1750	RMC	25.2	24.99	0.05	10 mm	12256	N/A	1:1	bottom	0.615	1.050	0.646	
1732.40	1412	UMTS 1750	RMC	25.2	24.96	0.00	10 mm	12256	N/A	1:1	bottom	0.750	1.057	0.793	
1752.60	1513	UMTS 1750	RMC	25.2	25.03	-0.02	10 mm	12256	N/A	1:1	bottom	0.891	1.040	0.927	A30
1732.40	1412	UMTS 1750	RMC	25.2	24.96	-0.02	10 mm	12256	N/A	1:1	left	0.300	1.057	0.317	
1752.60	1513	UMTS 1750	RMC	25.2	25.03	-0.02	10 mm	12256	N/A	1:1	bottom	0.890	1.040	0.926	
1880.00	9400	UMTS 1900	RMC	25.5	25.21	-0.05	10 mm	12272	N/A	1:1	back	0.552	1.069	0.590	
1880.00	9400	UMTS 1900	RMC	25.5	25.21	-0.05	10 mm	12272	N/A	1:1	front	0.486	1.069	0.520	
1852.40	9262	UMTS 1900	RMC	25.5	25.19	-0.01	10 mm	12272	N/A	1:1	bottom	1.140	1.074	1.224	
1880.00	9400	UMTS 1900	RMC	25.5	25.21	-0.03	10 mm	12272	N/A	1:1	bottom	1.100	1.069	1.176	
1907.60	9538	UMTS 1900	RMC	25.5	25.35	-0.12	10 mm	12272	N/A	1:1	bottom	1.240	1.035	1.283	A32
1880.00	9400	UMTS 1900	RMC	25.5	25.21	-0.04	10 mm	12272	N/A	1:1	left	0.293	1.069	0.313	
1907.60	9538	UMTS 1900	RMC	25.5	25.35	0.11	10 mm	12272	N/A	1:1	bottom	1.210	1.035	1.252	
ANSI / IEEE C95.1 1992 - SAFETY LIMIT Spatial Peak Uncontrolled Exposure/General Population							Body 1.6 W/kg (mW/g) averaged over 1 gram								

Note: Blue entry represents variability measurement.



FCC ID ZNFG710VM	 PCTEST ENGINEERING LABORATORY, INC.	SAR EVALUATION REPORT	 LG	Approved by: Quality Manager
Document S/N: 1M1804030062-01-R2.ZNF	Test Dates: 04/02/18 - 04/15/18	DUT Type: Portable Handset		Page 85 of 126

**Table 11-30
LTE Band 12 Hotspot SAR**

MEASUREMENT RESULTS																		
FREQUENCY		Mode	Bandwidth [MHz]	Maximum Allowed Power [dBm]	Conducted Power [dBm]	Power Drift [dB]	MPR [dB]	Device Serial Number	Modulation	RB Size	RB Offset	Spacing	Side	Duty Cycle	SAR (1g)	Scaling Factor	Reported SAR	Plot #
MHz	Ch.														(W/kg)		(W/kg)	
707.50	23095	Mid	LTE Band 12	10	25.5	25.10	0.00	0	12249	QPSK	1	0	10 mm	back	1:1	1.096	0.516	A33
707.50	23095	Mid	LTE Band 12	10	24.5	24.07	0.01	1	12249	QPSK	25	25	10 mm	back	1:1	1.104	0.367	
707.50	23095	Mid	LTE Band 12	10	25.5	25.10	0.05	0	12249	QPSK	1	0	10 mm	front	1:1	1.096	0.391	
707.50	23095	Mid	LTE Band 12	10	24.5	24.07	0.03	1	12249	QPSK	25	25	10 mm	front	1:1	1.104	0.278	
707.50	23095	Mid	LTE Band 12	10	25.5	25.10	-0.03	0	12249	QPSK	1	0	10 mm	bottom	1:1	1.096	0.273	
707.50	23095	Mid	LTE Band 12	10	24.5	24.07	-0.03	1	12249	QPSK	25	25	10 mm	bottom	1:1	1.104	0.191	
707.50	23095	Mid	LTE Band 12	10	25.5	25.10	-0.03	0	12249	QPSK	1	0	10 mm	right	1:1	1.096	0.309	
707.50	23095	Mid	LTE Band 12	10	24.5	24.07	0.01	1	12249	QPSK	25	25	10 mm	right	1:1	1.104	0.189	
707.50	23095	Mid	LTE Band 12	10	25.5	25.10	-0.01	0	12249	QPSK	1	0	10 mm	left	1:1	1.096	0.163	
707.50	23095	Mid	LTE Band 12	10	24.5	24.07	0.03	1	12249	QPSK	25	25	10 mm	left	1:1	1.104	0.096	
ANSI / IEEE C95.1 1992 - SAFETY LIMIT Spatial Peak Uncontrolled Exposure/General Population									Body 1.6 W/kg (mW/g) averaged over 1 gram									

**Table 11-31
LTE Band 13 Hotspot SAR**

MEASUREMENT RESULTS																		
FREQUENCY		Mode	Bandwidth [MHz]	Maximum Allowed Power [dBm]	Conducted Power [dBm]	Power Drift [dB]	MPR [dB]	Device Serial Number	Modulation	RB Size	RB Offset	Spacing	Side	Duty Cycle	SAR (1g)	Scaling Factor	Reported SAR	Plot #
MHz	Ch.														(W/kg)		(W/kg)	
782.00	23230	Mid	LTE Band 13	10	25.5	25.07	0.01	0	12249	QPSK	1	25	10 mm	back	1:1	1.104	0.588	A34
782.00	23230	Mid	LTE Band 13	10	24.5	24.01	-0.01	1	12249	QPSK	25	12	10 mm	back	1:1	1.119	0.417	
782.00	23230	Mid	LTE Band 13	10	25.5	25.07	-0.01	0	12249	QPSK	1	25	10 mm	front	1:1	1.104	0.479	
782.00	23230	Mid	LTE Band 13	10	24.5	24.01	-0.02	1	12249	QPSK	25	12	10 mm	front	1:1	1.119	0.341	
782.00	23230	Mid	LTE Band 13	10	25.5	25.07	-0.01	0	12249	QPSK	1	25	10 mm	bottom	1:1	1.104	0.302	
782.00	23230	Mid	LTE Band 13	10	24.5	24.01	-0.01	1	12249	QPSK	25	12	10 mm	bottom	1:1	1.119	0.214	
782.00	23230	Mid	LTE Band 13	10	25.5	25.07	-0.02	0	12249	QPSK	1	25	10 mm	right	1:1	1.104	0.376	
782.00	23230	Mid	LTE Band 13	10	24.5	24.01	0.02	1	12249	QPSK	25	12	10 mm	right	1:1	1.119	0.266	
782.00	23230	Mid	LTE Band 13	10	25.5	25.07	-0.03	0	12249	QPSK	1	25	10 mm	left	1:1	1.104	0.185	
782.00	23230	Mid	LTE Band 13	10	24.5	24.01	0.01	1	12249	QPSK	25	12	10 mm	left	1:1	1.119	0.131	
ANSI / IEEE C95.1 1992 - SAFETY LIMIT Spatial Peak Uncontrolled Exposure/General Population									Body 1.6 W/kg (mW/g) averaged over 1 gram									



FCC ID ZNFG710VM	 PCTEST ENGINEERING LABORATORY, INC.	SAR EVALUATION REPORT	 LG	Approved by: Quality Manager
Document S/N: 1M1804030062-01-R2.ZNF	Test Dates: 04/02/18 - 04/15/18	DUT Type: Portable Handset	Page 86 of 126	

**Table 11-32
LTE Band 5 (Cell) Hotspot SAR**

MEASUREMENT RESULTS																					
1 CC Uplink 2 CC Uplink	Component Carrier	FREQUENCY		Mode	Bandwidth [MHz]	Maximum Allowed Power [dBm]	Conducted Power [dBm]	Power Drift [dB]	MPR [dB]	Device Serial Number	Modulation	RB Size	RB Offset	Spacing	Side	Duty Cycle	SAR (1g)	Scaling Factor	Reported SAR (1g)	Plot #	
		MHz	Ch.														(W/kg)		(W/kg)		
1 CC Uplink	N/A	836.50	20525	Mid	LTE Band 5 (Cell)	10	25.5	25.34	-0.01	0	12256	QPSK	1	0	10 mm	back	1:1	0.385	1.038	0.400	A35
2 CC Uplink	PCC	836.50	20525	Mid	LTE Band 5 (Cell)	10	25.5	25.10	-0.12	0	12256	QPSK	1	0	10 mm	back	1:1	0.351	1.096	0.385	
	SCC	829.30	20453	Mid	LTE Band 5 (Cell)	5						QPSK	1	24							
1 CC Uplink	N/A	836.50	20525	Mid	LTE Band 5 (Cell)	10	24.5	24.28	-0.02	1	12256	QPSK	25	0	10 mm	back	1:1	0.263	1.052	0.277	
1 CC Uplink	N/A	836.50	20525	Mid	LTE Band 5 (Cell)	10	25.5	25.34	0.04	0	12256	QPSK	1	0	10 mm	front	1:1	0.349	1.038	0.362	
1 CC Uplink	N/A	836.50	20525	Mid	LTE Band 5 (Cell)	10	24.5	24.28	0.04	1	12256	QPSK	25	0	10 mm	front	1:1	0.244	1.052	0.257	
1 CC Uplink	N/A	836.50	20525	Mid	LTE Band 5 (Cell)	10	25.5	25.34	-0.10	0	12256	QPSK	1	0	10 mm	bottom	1:1	0.249	1.038	0.258	
1 CC Uplink	N/A	836.50	20525	Mid	LTE Band 5 (Cell)	10	24.5	24.28	-0.05	1	12256	QPSK	25	0	10 mm	bottom	1:1	0.169	1.052	0.178	
1 CC Uplink	N/A	836.50	20525	Mid	LTE Band 5 (Cell)	10	25.5	25.34	0.00	0	12256	QPSK	1	0	10 mm	right	1:1	0.209	1.038	0.217	
1 CC Uplink	N/A	836.50	20525	Mid	LTE Band 5 (Cell)	10	24.5	24.28	-0.01	1	12256	QPSK	25	0	10 mm	right	1:1	0.154	1.052	0.162	
1 CC Uplink	N/A	836.50	20525	Mid	LTE Band 5 (Cell)	10	25.5	25.34	-0.04	0	12256	QPSK	1	0	10 mm	left	1:1	0.103	1.038	0.107	
1 CC Uplink	N/A	836.50	20525	Mid	LTE Band 5 (Cell)	10	24.5	24.28	-0.01	1	12256	QPSK	25	0	10 mm	left	1:1	0.076	1.052	0.080	
ANSI / IEEE C95.1 1992 - SAFETY LIMIT Spatial Peak Uncontrolled Exposure/General Population										Body 1.6 W/kg (mW/g) averaged over 1 gram											

**Table 11-33
LTE Band 26 (Cell) Hotspot SAR**

MEASUREMENT RESULTS																			
FREQUENCY		Mode	Bandwidth [MHz]	Maximum Allowed Power [dBm]	Conducted Power [dBm]	Power Drift [dB]	MPR [dB]	Device Serial Number	Modulation	RB Size	RB Offset	Spacing	Side	Duty Cycle	SAR (1g)	Scaling Factor	Reported SAR (1g)	Plot #	
MHz	Ch.														(W/kg)		(W/kg)		
831.50	26865	Mid	LTE Band 26 (Cell)	15	25.5	25.06	0.00	0	12256	QPSK	1	36	10 mm	back	1:1	0.383	1.107	0.424	A36
831.50	26865	Mid	LTE Band 26 (Cell)	15	24.5	24.12	0.04	1	12256	QPSK	36	37	10 mm	back	1:1	0.262	1.091	0.286	
831.50	26865	Mid	LTE Band 26 (Cell)	15	25.5	25.06	0.11	0	12256	QPSK	1	36	10 mm	front	1:1	0.312	1.107	0.345	
831.50	26865	Mid	LTE Band 26 (Cell)	15	24.5	24.12	0.05	1	12256	QPSK	36	37	10 mm	front	1:1	0.235	1.091	0.256	
831.50	26865	Mid	LTE Band 26 (Cell)	15	25.5	25.06	-0.08	0	12256	QPSK	1	36	10 mm	bottom	1:1	0.243	1.107	0.269	
831.50	26865	Mid	LTE Band 26 (Cell)	15	24.5	24.12	-0.09	1	12256	QPSK	36	37	10 mm	bottom	1:1	0.164	1.091	0.179	
831.50	26865	Mid	LTE Band 26 (Cell)	15	25.5	25.06	0.01	0	12256	QPSK	1	36	10 mm	right	1:1	0.203	1.107	0.225	
831.50	26865	Mid	LTE Band 26 (Cell)	15	24.5	24.12	-0.01	1	12256	QPSK	36	37	10 mm	right	1:1	0.152	1.091	0.166	
831.50	26865	Mid	LTE Band 26 (Cell)	15	25.5	25.06	-0.04	0	12256	QPSK	1	36	10 mm	left	1:1	0.095	1.107	0.105	
831.50	26865	Mid	LTE Band 26 (Cell)	15	24.5	24.12	-0.15	1	12256	QPSK	36	37	10 mm	left	1:1	0.075	1.091	0.082	
ANSI / IEEE C95.1 1992 - SAFETY LIMIT Spatial Peak Uncontrolled Exposure/General Population										Body 1.6 W/kg (mW/g) averaged over 1 gram									



FCC ID ZNFG710VM	 PCTEST ENGINEERING LABORATORY, INC.	SAR EVALUATION REPORT	 LG	Approved by: Quality Manager
Document S/N: 1M1804030062-01-R2.ZNF	Test Dates: 04/02/18 - 04/15/18	DUT Type: Portable Handset	Page 87 of 126	

**Table 11-34
LTE Band 66 (AWS) Hotspot SAR**

MEASUREMENT RESULTS																			
FREQUENCY		Mode	Bandwidth [MHz]	Maximum Allowed Power [dBm]	Conducted Power [dBm]	Power Drift [dB]	MPR [dB]	Device Serial Number	Modulation	RB Size	RB Offset	Spacing	Side	Duty Cycle	SAR (1g)	Scaling Factor	Reported SAR (1g)	Plot #	
MHz	Ch.														(W/kg)		(W/kg)		
1720.00	132072	Low	LTE Band 66 (AWS)	20	25.2	25.20	0.00	0	12280	QPSK	1	99	10 mm	back	1:1	0.473	1.000	0.473	
1720.00	132072	Low	LTE Band 66 (AWS)	20	24.2	24.10	-0.01	1	12280	QPSK	50	50	10 mm	back	1:1	0.339	1.023	0.347	
1720.00	132072	Low	LTE Band 66 (AWS)	20	25.2	25.20	0.03	0	12280	QPSK	1	99	10 mm	front	1:1	0.415	1.000	0.415	
1720.00	132072	Low	LTE Band 66 (AWS)	20	24.2	24.10	-0.02	1	12280	QPSK	50	50	10 mm	front	1:1	0.301	1.023	0.308	
1720.00	132072	Low	LTE Band 66 (AWS)	20	25.2	25.20	-0.01	0	12280	QPSK	1	99	10 mm	bottom	1:1	0.717	1.000	0.717	
1745.00	132322	Mid	LTE Band 66 (AWS)	20	25.2	25.19	0.05	0	12280	QPSK	1	99	10 mm	bottom	1:1	0.747	1.002	0.748	
1770.00	132572	High	LTE Band 66 (AWS)	20	25.2	25.09	-0.04	0	12280	QPSK	1	99	10 mm	bottom	1:1	0.869	1.026	0.892	A38
1720.00	132072	Low	LTE Band 66 (AWS)	20	24.2	24.10	0.00	1	12280	QPSK	50	50	10 mm	bottom	1:1	0.498	1.023	0.509	
1745.00	132322	Mid	LTE Band 66 (AWS)	20	24.2	24.03	0.04	1	12280	QPSK	100	0	10 mm	bottom	1:1	0.537	1.040	0.558	
1720.00	132072	Low	LTE Band 66 (AWS)	20	25.2	25.20	0.00	0	12280	QPSK	1	99	10 mm	left	1:1	0.315	1.000	0.315	
1720.00	132072	Low	LTE Band 66 (AWS)	20	24.2	24.10	0.01	1	12280	QPSK	50	50	10 mm	left	1:1	0.226	1.023	0.231	
ANSI / IEEE C95.1 1992 - SAFETY LIMIT Spatial Peak Uncontrolled Exposure/General Population								Body 1.6 W/kg (mW/g) averaged over 1 gram											

**Table 11-35
LTE Band 25 (PCS) Hotspot SAR**



MEASUREMENT RESULTS																			
FREQUENCY		Mode	Bandwidth [MHz]	Maximum Allowed Power [dBm]	Conducted Power [dBm]	Power Drift [dB]	MPR [dB]	Device Serial Number	Modulation	RB Size	RB Offset	Spacing	Side	Duty Cycle	SAR (1g)	Scaling Factor	Reported SAR (1g)	Plot #	
MHz	Ch.														(W/kg)		(W/kg)		
1860.00	26140	Low	LTE Band 25 (PCS)	20	25.5	25.33	0.10	0	12249	QPSK	1	99	10 mm	back	1:1	0.358	1.040	0.372	
1860.00	26140	Low	LTE Band 25 (PCS)	20	24.5	24.26	0.01	1	12249	QPSK	50	0	10 mm	back	1:1	0.280	1.057	0.296	
1860.00	26140	Low	LTE Band 25 (PCS)	20	25.5	25.33	0.13	0	12249	QPSK	1	99	10 mm	front	1:1	0.314	1.040	0.327	
1860.00	26140	Low	LTE Band 25 (PCS)	20	24.5	24.26	0.19	1	12249	QPSK	50	0	10 mm	front	1:1	0.245	1.057	0.259	
1860.00	26140	Low	LTE Band 25 (PCS)	20	25.5	25.33	0.16	0	12249	QPSK	1	99	10 mm	bottom	1:1	0.817	1.040	0.850	
1882.50	26365	Mid	LTE Band 25 (PCS)	20	25.5	25.18	0.15	0	12249	QPSK	1	99	10 mm	bottom	1:1	0.871	1.076	0.937	
1905.00	26590	High	LTE Band 25 (PCS)	20	25.5	25.24	0.18	0	12249	QPSK	1	50	10 mm	bottom	1:1	0.939	1.062	0.997	A40
1860.00	26140	Low	LTE Band 25 (PCS)	20	24.5	24.26	0.18	1	12249	QPSK	50	0	10 mm	bottom	1:1	0.648	1.057	0.685	
1905.00	26590	High	LTE Band 25 (PCS)	20	24.5	24.22	0.19	1	12249	QPSK	100	0	10 mm	bottom	1:1	0.708	1.067	0.755	
1860.00	26140	Low	LTE Band 25 (PCS)	20	25.5	25.33	0.03	0	12249	QPSK	1	99	10 mm	left	1:1	0.235	1.040	0.244	
1860.00	26140	Low	LTE Band 25 (PCS)	20	24.5	24.26	0.06	1	12249	QPSK	50	0	10 mm	left	1:1	0.194	1.057	0.205	
ANSI / IEEE C95.1 1992 - SAFETY LIMIT Spatial Peak Uncontrolled Exposure/General Population								Body 1.6 W/kg (mW/g) averaged over 1 gram											

FCC ID ZNFG710VM	 PCTEST ENGINEERING LABORATORY, INC.	SAR EVALUATION REPORT		Approved by: Quality Manager
Document S/N: 1M1804030062-01-R2.ZNF	Test Dates: 04/02/18 - 04/15/18	DUT Type: Portable Handset		Page 88 of 126

**Table 11-36
LTE Band 41 Hotspot SAR**



MEASUREMENT RESULTS																					
1 CC Uplink 2 CC Uplink	Component Carrier	FREQUENCY		Mode	Bandwidth [MHz]	Maximum Allowed Power [dBm]	Conducted Power [dBm]	Power Drift [dB]	MPR [dB]	Device Serial Number	Modulation	RB Size	RB Offset	Spacing	Side	Duty Cycle	SAR (1g)	Scaling Factor	Reported SAR	Plot #	
		MHz	Ch.														(W/kg)		(W/kg)		
1 CC Uplink - Power Class 3	N/A	2636.50	41055	Mid-High	LTE Band 41	20	25.2	25.09	-0.01	0	12272	QPSK	1	0	10 mm	back	1:1.58	0.491	1.026	0.504	
1 CC Uplink - Power Class 3	N/A	2636.50	41055	Mid-High	LTE Band 41	20	24.2	24.09	0.05	1	12272	QPSK	50	50	10 mm	back	1:1.58	0.353	1.026	0.362	
1 CC Uplink - Power Class 3	N/A	2636.50	41055	Mid-High	LTE Band 41	20	25.2	25.09	0.06	0	12272	QPSK	1	0	10 mm	front	1:1.58	0.176	1.026	0.181	
1 CC Uplink - Power Class 3	N/A	2636.50	41055	Mid-High	LTE Band 41	20	24.2	24.09	0.21	1	12272	QPSK	50	50	10 mm	front	1:1.58	0.135	1.026	0.139	
1 CC Uplink - Power Class 3	N/A	2506.00	39750	Low	LTE Band 41	20	25.2	25.08	0.08	0	12272	QPSK	1	99	10 mm	bottom	1:1.58	0.751	1.028	0.772	
1 CC Uplink - Power Class 3	N/A	2549.50	40185	Low-Mid	LTE Band 41	20	25.2	25.00	-0.10	0	12272	QPSK	1	50	10 mm	bottom	1:1.58	0.616	1.047	0.645	
1 CC Uplink - Power Class 3	N/A	2593.00	40620	Mid	LTE Band 41	20	25.2	25.08	-0.11	0	12272	QPSK	1	50	10 mm	bottom	1:1.58	0.440	1.028	0.452	
1 CC Uplink - Power Class 3	N/A	2636.50	41055	Mid-High	LTE Band 41	20	25.2	25.09	-0.04	0	12272	QPSK	1	0	10 mm	bottom	1:1.58	0.697	1.026	0.715	
1 CC Uplink - Power Class 3	N/A	2680.00	41490	High	LTE Band 41	20	25.2	25.03	-0.13	0	12272	QPSK	1	0	10 mm	bottom	1:1.58	0.480	1.040	0.499	
1 CC Uplink - Power Class 3	N/A	2636.50	41055	Mid-High	LTE Band 41	20	24.2	24.09	0.00	1	12272	QPSK	50	50	10 mm	bottom	1:1.58	0.542	1.026	0.556	
1 CC Uplink - Power Class 3	N/A	2680.00	41490	High	LTE Band 41	20	24.2	24.08	-0.08	1	12272	QPSK	100	0	10 mm	bottom	1:1.58	0.356	1.028	0.366	
1 CC Uplink - Power Class 2	N/A	2506.00	39750	Low	LTE Band 41	20	27.7	27.51	0.19	0	12272	QPSK	1	99	10 mm	bottom	1:2.31	0.889	1.045	0.929	A42
2 CC Uplink - Power Class 3	PCC	2506.00	39750	Low	LTE Band 41	20	25.2	25.12	0.12	0	12272	QPSK	1	99	10 mm	bottom	1:1.58	0.756	1.019	0.770	
2 CC Uplink - Power Class 3	SCC	2525.80	39948	Low		QPSK						1	0								
1 CC Uplink - Power Class 3	N/A	2636.50	41055	Mid-High	LTE Band 41	20	25.2	25.09	0.14	0	12272	QPSK	1	0	10 mm	right	1:1.58	0.040	1.026	0.041	
1 CC Uplink - Power Class 3	N/A	2636.50	41055	Mid-High	LTE Band 41	20	24.2	24.09	0.20	1	12272	QPSK	50	50	10 mm	right	1:1.58	0.029	1.026	0.030	
1 CC Uplink - Power Class 3	N/A	2636.50	41055	Mid-High	LTE Band 41	20	25.2	25.09	-0.01	0	12272	QPSK	1	0	10 mm	left	1:1.58	0.045	1.026	0.046	
1 CC Uplink - Power Class 3	N/A	2636.50	41055	Mid-High	LTE Band 41	20	24.2	24.09	0.20	1	12272	QPSK	50	50	10 mm	left	1:1.58	0.031	1.026	0.032	
1 CC Uplink - Power Class 2	N/A	2506.00	39750	Low	LTE Band 41	20	27.7	27.51	0.17	0	12272	QPSK	1	99	10 mm	bottom	1:2.31	0.886	1.045	0.926	
ANSI / IEEE C95.1 1992 - SAFETY LIMIT										Body											
Spatial Peak										1.6 W/kg (mW/g)											
Uncontrolled Exposure/General Population										averaged over 1 gram											

Note: Blue entry represents variability measurement.

FCC ID ZNFG710VM	 PCTEST <small>ENGINEERING LABORATORY, INC.</small>	SAR EVALUATION REPORT		Approved by: Quality Manager
Document S/N: 1M1804030062-01-R2.ZNF	Test Dates: 04/02/18 - 04/15/18	DUT Type: Portable Handset		Page 89 of 126

**Table 11-37
WLAN Hotspot SAR**

MEASUREMENT RESULTS																			
FREQUENCY		Mode	Service	Bandwidth [MHz]	Maximum Allowed Power [dBm]	Conducted Power [dBm]	Power Drift [dB]	Spacing	Antenna Config.	Device Serial Number	Data Rate (Mbps)	Side	Duty Cycle (%)	Peak SAR of Area Scan	SAR (1g)	Scaling Factor (Power)	Scaling Factor (Duty Cycle)	Reported SAR (1g)	Plot #
MHz	Ch.													W/kg	(W/kg)			(W/kg)	
2412	1	802.11b	DSSS	22	21.0	20.81	-0.07	10 mm	1	12371	1	back	99.5	0.410	0.381	1.045	1.005	0.400	
2412	1	802.11b	DSSS	22	21.0	20.81	0.11	10 mm	1	12371	1	front	99.5	0.240	-	1.045	1.005	-	
2412	1	802.11b	DSSS	22	21.0	20.81	0.01	10 mm	1	12371	1	top	99.5	0.495	0.351	1.045	1.005	0.369	
2412	1	802.11b	DSSS	22	21.0	20.81	0.13	10 mm	1	12371	1	left	99.5	0.086	-	1.045	1.005	-	
2437	6	802.11b	DSSS	22	21.0	20.99	0.04	10 mm	2	12371	1	back	99.2	0.455	0.491	1.002	1.008	0.496	A43
2437	6	802.11b	DSSS	22	21.0	20.99	0.16	10 mm	2	12371	1	front	99.2	0.047	-	1.002	1.008	-	
2437	6	802.11b	DSSS	22	21.0	20.99	0.15	10 mm	2	12371	1	top	99.2	0.033	-	1.002	1.008	-	
2437	6	802.11b	DSSS	22	21.0	20.99	0.17	10 mm	2	12371	1	left	99.2	0.213	0.165	1.002	1.008	0.167	
5200	40	802.11a	OFDM	20	18.0	17.52	0.13	10 mm	1	12298	6	back	98.5	0.378	0.155	1.117	1.015	0.176	
5200	40	802.11a	OFDM	20	18.0	17.52	0.00	10 mm	1	12298	6	front	98.5	0.072	-	1.117	1.015	-	
5200	40	802.11a	OFDM	20	18.0	17.52	0.19	10 mm	1	12298	6	top	98.5	0.078	-	1.117	1.015	-	
5200	40	802.11a	OFDM	20	18.0	17.52	0.10	10 mm	1	12298	6	left	98.5	0.059	-	1.117	1.015	-	
5200	40	802.11a	OFDM	20	18.0	17.27	0.04	10 mm	2	12298	6	back	98.8	1.515	0.607	1.183	1.012	0.727	
5200	40	802.11a	OFDM	20	18.0	17.27	0.00	10 mm	2	12298	6	front	98.8	0.021	-	1.183	1.012	-	
5200	40	802.11a	OFDM	20	18.0	17.27	-0.19	10 mm	2	12298	6	top	98.8	0.097	-	1.183	1.012	-	
5200	40	802.11a	OFDM	20	18.0	17.27	0.18	10 mm	2	12298	6	left	98.8	0.371	0.167	1.183	1.012	0.200	
5805	161	802.11a	OFDM	20	18.0	17.47	0.18	10 mm	1	12298	6	back	98.5	0.153	0.057	1.130	1.015	0.065	
5805	161	802.11a	OFDM	20	18.0	17.47	0.00	10 mm	1	12298	6	front	98.5	0.064	-	1.130	1.015	-	
5805	161	802.11a	OFDM	20	18.0	17.47	-0.10	10 mm	1	12298	6	top	98.5	0.061	-	1.130	1.015	-	
5805	161	802.11a	OFDM	20	18.0	17.47	0.00	10 mm	1	12298	6	left	98.5	0.041	-	1.130	1.015	-	
5745	149	802.11a	OFDM	20	17.0	16.43	0.08	10 mm	2	12298	6	back	98.8	1.514	0.635	1.140	1.012	0.733	
5785	157	802.11a	OFDM	20	18.0	17.50	0.03	10 mm	2	12298	6	back	98.8	1.621	0.717	1.122	1.012	0.814	A45
5805	161	802.11a	OFDM	20	18.0	17.33	0.03	10 mm	2	12298	6	back	98.8	1.615	0.685	1.167	1.012	0.809	
5785	157	802.11a	OFDM	20	18.0	17.50	0.00	10 mm	2	12298	6	front	98.8	0.036	-	1.122	1.012	-	
5785	157	802.11a	OFDM	20	18.0	17.50	-0.13	10 mm	2	12298	6	top	98.8	0.076	-	1.122	1.012	-	
5785	157	802.11a	OFDM	20	18.0	17.50	0.13	10 mm	2	12298	6	left	98.8	0.477	0.174	1.122	1.012	0.198	
ANSI / IEEE C95.1 1992 - SAFETY LIMIT								Body											
Spatial Peak								1.6 W/kg (mW/g)											
Uncontrolled Exposure/General Population								averaged over 1 gram											

FCC ID ZNFG710VM	 PCTEST ENGINEERING LABORATORY, INC.	SAR EVALUATION REPORT	 LG	Approved by: Quality Manager
Document S/N: 1M1804030062-01-R2.ZNF	Test Dates: 04/02/18 - 04/15/18	DUT Type: Portable Handset	Page 90 of 126	



**Table 11-38
WLAN Hotspot SAR for Conditions with 2.4 GHz Ant 1 and 5 GHz WLAN Ant 2**

MEASUREMENT RESULTS																			
FREQUENCY		Mode	Service	Bandwidth [MHz]	Maximum Allowed Power [dBm]	Conducted Power [dBm]	Power Drift [dB]	Spacing	Antenna Config.	Device Serial Number	Data Rate (Mbps)	Side	Duty Cycle (%)	Peak SAR of Area Scan	SAR (1g)	Scaling Factor (Power)	Scaling Factor (Duty Cycle)	Reported SAR (1g)	Plot #
MHz	Ch.													W/kg	(W/kg)			(W/kg)	
2412	1	802.11b	DSSS	22	18.0	17.58	-0.03	10 mm	1	12371	1	back	99.5	0.204	0.185	1.102	1.005	0.205	
2412	1	802.11b	DSSS	22	18.0	17.58	0.13	10 mm	1	12371	1	front	99.5	0.127	-	1.102	1.005	-	
2412	1	802.11b	DSSS	22	18.0	17.58	0.11	10 mm	1	12371	1	top	99.5	0.255	0.211	1.102	1.005	0.234	
2412	1	802.11b	DSSS	22	18.0	17.58	0.10	10 mm	1	12371	1	left	99.5	0.046	-	1.102	1.005	-	
5230	46	802.11n	OFDM	40	15.0	14.50	0.15	10 mm	2	12298	13.5	back	97.9	0.885	0.372	1.122	1.021	0.426	
5230	46	802.11n	OFDM	40	15.0	14.50	0.19	10 mm	2	12298	13.5	front	97.9	0.015	-	1.122	1.021	-	
5230	46	802.11n	OFDM	40	15.0	14.50	0.17	10 mm	2	12298	13.5	top	97.9	0.069	-	1.122	1.021	-	
5230	46	802.11n	OFDM	40	15.0	14.50	-0.10	10 mm	2	12298	13.5	left	97.9	0.221	0.089	1.122	1.021	0.102	
5755	151	802.11n	OFDM	40	15.0	14.51	-0.13	10 mm	2	12298	13.5	back	97.9	0.960	0.378	1.119	1.021	0.432	
5755	151	802.11n	OFDM	40	15.0	14.51	0.10	10 mm	2	11298	13.5	front	97.9	0.022	-	1.119	1.021	-	
5755	151	802.11n	OFDM	40	15.0	14.51	0.10	10 mm	2	11298	13.5	top	97.9	0.065	-	1.119	1.021	-	
5755	151	802.11n	OFDM	40	15.0	14.51	-0.15	10 mm	2	11298	13.5	left	97.9	0.226	0.085	1.119	1.021	0.097	
ANSI / IEEE C95.1 1992 - SAFETY LIMIT Spatial Peak Uncontrolled Exposure/General Population								Body 1.6 W/kg (mW/g) averaged over 1 gram											

DTS and NII were additionally evaluated at the maximum allowed output power during operations with Simultaneous 2.4 GHz Ant 1 and 5 GHz Ant 2 WLAN. 2.4 GHz Ant 1 WIFI was not transmitting during the NII evaluations, and 5 GHz Ant 2 WIFI was not transmitting during the DTS evaluations.

**Table 11-39
DSS Hotspot SAR**

MEASUREMENT RESULTS																
FREQUENCY		Mode	Service	Maximum Allowed Power [dBm]	Conducted Power [dBm]	Power Drift [dB]	Spacing	Device Serial Number	Data Rate (Mbps)	Side	Duty Cycle (%)	SAR (1g)	Scaling Factor (Cond Power)	Scaling Factor (Duty Cycle)	Reported SAR (1g)	Plot #
MHz	Ch.											(W/kg)			(W/kg)	
2402	0	Bluetooth	FHSS	12.0	11.81	0.15	10 mm	12371	1	back	77.6	0.015	1.045	1.289	0.020	
2402	0	Bluetooth	FHSS	12.0	11.81	0.13	10 mm	12371	1	front	77.6	0.009	1.045	1.289	0.012	
2402	0	Bluetooth	FHSS	12.0	11.81	-0.07	10 mm	12371	1	top	77.6	0.018	1.045	1.289	0.024	A47
2402	0	Bluetooth	FHSS	12.0	11.81	0.14	10 mm	12371	1	left	77.6	0.008	1.045	1.289	0.011	
ANSI / IEEE C95.1 1992 - SAFETY LIMIT Spatial Peak Uncontrolled Exposure/General Population								Body 1.6 W/kg (mW/g) averaged over 1 gram								



FCC ID ZNFG710VM	 PCTEST ENGINEERING LABORATORY, INC.	SAR EVALUATION REPORT	 LG	Approved by: Quality Manager
Document S/N: 1M1804030062-01-R2.ZNF	Test Dates: 04/02/18 - 04/15/18	DUT Type: Portable Handset		Page 91 of 126

11.4 Standalone Phablet SAR Data

**Table 11-40
UMTS/CDMA Phablet SAR Data**

MEASUREMENT RESULTS														
FREQUENCY		Mode	Service	Maximum Allowed Power [dBm]	Conducted Power [dBm]	Power Drift [dB]	Spacing	Device Serial Number	Duty Cycle	Side	SAR (10g)	Scaling Factor	Reported SAR (10g)	Plot #
MHz	Ch.										(W/kg)		(W/kg)	
1880.00	600	PCS CDMA	EVDO Rev. 0	25.2	25.10	0.05	5 mm	12280	1:1	back	0.604	1.023	0.618	
1880.00	600	PCS CDMA	EVDO Rev. 0	25.2	25.10	-0.02	2 mm	12280	1:1	front	0.892	1.023	0.913	
1880.00	600	PCS CDMA	EVDO Rev. 0	25.2	25.10	-0.05	6 mm	12280	1:1	bottom	0.917	1.023	0.938	
1880.00	600	PCS CDMA	EVDO Rev. 0	25.2	25.10	0.01	0 mm	12280	1:1	left	0.795	1.023	0.813	
1880.00	600	PCS CDMA	EVDO Rev. 0	24.2	24.19	0.16	0 mm	12280	1:1	back	1.100	1.002	1.102	
1880.00	600	PCS CDMA	EVDO Rev. 0	24.2	24.19	0.15	0 mm	12280	1:1	front	1.010	1.002	1.012	
1851.25	25	PCS CDMA	EVDO Rev. 0	24.2	24.10	-0.12	0 mm	12280	1:1	bottom	2.120	1.023	2.169	
1880.00	600	PCS CDMA	EVDO Rev. 0	24.2	24.19	-0.01	0 mm	12280	1:1	bottom	2.270	1.002	2.275	
1908.75	1175	PCS CDMA	EVDO Rev. 0	24.2	24.13	-0.05	0 mm	12280	1:1	bottom	2.330	1.016	2.367	A48
1732.40	1412	UMTS 1750	RMC	25.2	24.96	-0.01	5 mm	12280	1:1	back	0.592	1.057	0.626	
1732.40	1412	UMTS 1750	RMC	25.2	24.96	0.04	2 mm	12280	1:1	front	1.460	1.057	1.543	
1732.40	1412	UMTS 1750	RMC	25.2	24.96	0.01	6 mm	12280	1:1	bottom	0.800	1.057	0.846	
1732.40	1412	UMTS 1750	RMC	25.2	24.96	0.00	0 mm	12280	1:1	left	0.751	1.057	0.794	
1732.40	1412	UMTS 1750	RMC	24.2	23.90	0.03	0 mm	12256	1:1	back	1.250	1.072	1.340	
1732.40	1412	UMTS 1750	RMC	24.2	23.90	0.02	0 mm	12256	1:1	front	1.290	1.072	1.383	
1712.40	1312	UMTS 1750	RMC	24.2	23.95	0.02	0 mm	12256	1:1	bottom	2.110	1.059	2.234	
1732.40	1412	UMTS 1750	RMC	24.2	23.90	0.02	0 mm	12256	1:1	bottom	2.220	1.072	2.380	
1752.60	1513	UMTS 1750	RMC	24.2	23.88	0.00	0 mm	12256	1:1	bottom	2.300	1.076	2.475	A49
1752.60	1513	UMTS 1750	RMC	24.2	23.88	-0.03	0 mm	12256	1:1	bottom	2.170	1.076	2.335	
1880.00	9400	UMTS 1900	RMC	25.5	25.21	-0.14	5 mm	12272	1:1	back	0.590	1.069	0.631	
1880.00	9400	UMTS 1900	RMC	25.5	25.21	-0.01	2 mm	12272	1:1	front	1.200	1.069	1.283	
1880.00	9400	UMTS 1900	RMC	25.5	25.21	-0.06	6 mm	12272	1:1	bottom	1.100	1.069	1.176	
1880.00	9400	UMTS 1900	RMC	25.5	25.21	0.00	0 mm	12272	1:1	left	0.863	1.069	0.923	
1880.00	9400	UMTS 1900	RMC	24.5	24.11	-0.05	0 mm	12272	1:1	back	1.250	1.094	1.368	
1880.00	9400	UMTS 1900	RMC	24.5	24.11	-0.12	0 mm	12272	1:1	front	1.350	1.094	1.477	
1852.40	9262	UMTS 1900	RMC	24.5	24.13	0.14	0 mm	12272	1:1	bottom	2.300	1.089	2.505	
1880.00	9400	UMTS 1900	RMC	24.5	24.11	-0.17	0 mm	12272	1:1	bottom	2.610	1.094	2.855	A50
1907.60	9538	UMTS 1900	RMC	24.5	24.16	-0.13	0 mm	12272	1:1	bottom	2.590	1.081	2.800	
ANSI / IEEE C95.1 1992 - SAFETY LIMIT Spatial Peak Uncontrolled Exposure/General Population							Phablet 4.0 W/kg (mW/g) averaged over 10 grams							



Note: Blue entry represents variability measurement.

FCC ID ZNFG710VM	 PCTEST ENGINEERING LABORATORY, INC.	SAR EVALUATION REPORT	 LG	Approved by: Quality Manager
Document S/N: 1M1804030062-01-R2.ZNF	Test Dates: 04/02/18 - 04/15/18	DUT Type: Portable Handset	Page 92 of 126	

**Table 11-41
LTE Phablet SAR**

MEASUREMENT RESULTS																			
FREQUENCY		Mode	Bandwidth [MHz]	Maximum Allowed Power [dBm]	Conducted Power [dBm]	Power Drift [dB]	MPR [dB]	Device Serial Number	Modulation	RB Size	RB Offset	Spacing	Side	Duty Cycle	SAR (10g)	Scaling Factor	Reported SAR	Plot #	
MHz	Ch.														(W/kg)		(W/kg)		
1720.00	132072	Low	LTE Band 66 (AWS)	20	25.2	25.20	0.03	0	12280	QPSK	1	99	5 mm	back	1:1	0.471	1.000	0.471	
1720.00	132072	Low	LTE Band 66 (AWS)	20	24.2	24.10	-0.02	1	12280	QPSK	50	50	5 mm	back	1:1	0.356	1.023	0.364	
1720.00	132072	Low	LTE Band 66 (AWS)	20	25.2	25.20	0.00	0	12280	QPSK	1	99	2 mm	front	1:1	0.821	1.000	0.821	
1720.00	132072	Low	LTE Band 66 (AWS)	20	24.2	24.10	-0.05	1	12280	QPSK	50	50	2 mm	front	1:1	0.616	1.023	0.630	
1720.00	132072	Low	LTE Band 66 (AWS)	20	25.2	25.20	-0.01	0	12280	QPSK	1	99	6 mm	bottom	1:1	0.851	1.000	0.851	
1720.00	132072	Low	LTE Band 66 (AWS)	20	24.2	24.10	0.00	1	12280	QPSK	50	50	6 mm	bottom	1:1	0.598	1.023	0.612	
1720.00	132072	Low	LTE Band 66 (AWS)	20	25.2	25.20	-0.01	0	12280	QPSK	1	99	0 mm	left	1:1	0.720	1.000	0.720	
1720.00	132072	Low	LTE Band 66 (AWS)	20	24.2	24.10	0.00	1	12280	QPSK	50	50	0 mm	left	1:1	0.515	1.023	0.527	
1745.00	132322	Mid	LTE Band 66 (AWS)	20	24.2	24.15	-0.04	0	12280	QPSK	1	0	0 mm	back	1:1	1.340	1.012	1.356	
1745.00	132322	Mid	LTE Band 66 (AWS)	20	24.2	24.16	0.00	0	12280	QPSK	50	0	0 mm	back	1:1	1.260	1.009	1.271	
1745.00	132322	Mid	LTE Band 66 (AWS)	20	24.2	24.15	0.05	0	12280	QPSK	1	0	0 mm	front	1:1	1.370	1.012	1.386	
1745.00	132322	Mid	LTE Band 66 (AWS)	20	24.2	24.16	0.05	0	12280	QPSK	50	0	0 mm	front	1:1	1.230	1.009	1.241	
1720.00	132072	Low	LTE Band 66 (AWS)	20	24.2	24.12	0.03	0	12280	QPSK	1	0	0 mm	bottom	1:1	1.950	1.019	1.987	
1745.00	132322	Mid	LTE Band 66 (AWS)	20	24.2	24.15	0.02	0	12280	QPSK	1	0	0 mm	bottom	1:1	2.140	1.012	2.166	A51
1770.00	132572	High	LTE Band 66 (AWS)	20	24.2	24.13	0.12	0	12280	QPSK	1	50	0 mm	bottom	1:1	2.130	1.016	2.164	
1745.00	132322	Mid	LTE Band 66 (AWS)	20	24.2	24.16	-0.03	0	12280	QPSK	50	0	0 mm	bottom	1:1	1.970	1.009	1.988	
1745.00	132322	Mid	LTE Band 66 (AWS)	20	24.2	23.97	-0.03	0	12280	QPSK	100	0	0 mm	bottom	1:1	1.970	1.054	2.076	
1860.00	26140	Low	LTE Band 25 (PCS)	20	25.5	25.33	-0.01	0	12249	QPSK	1	99	5 mm	back	1:1	0.698	1.040	0.726	
1860.00	26140	Low	LTE Band 25 (PCS)	20	24.5	24.26	-0.08	1	12249	QPSK	50	0	5 mm	back	1:1	0.480	1.057	0.507	
1860.00	26140	Low	LTE Band 25 (PCS)	20	25.5	25.33	-0.12	0	12249	QPSK	1	99	2 mm	front	1:1	1.010	1.040	1.050	
1860.00	26140	Low	LTE Band 25 (PCS)	20	24.5	24.26	-0.01	1	12249	QPSK	50	0	2 mm	front	1:1	0.747	1.057	0.790	
1860.00	26140	Low	LTE Band 25 (PCS)	20	25.5	25.33	-0.01	0	12249	QPSK	1	99	6 mm	bottom	1:1	0.988	1.040	1.028	
1860.00	26140	Low	LTE Band 25 (PCS)	20	24.5	24.26	0.01	1	12249	QPSK	50	0	6 mm	bottom	1:1	0.796	1.057	0.841	
1860.00	26140	Low	LTE Band 25 (PCS)	20	25.5	25.33	-0.03	0	12249	QPSK	1	99	0 mm	left	1:1	0.749	1.040	0.779	
1860.00	26140	Low	LTE Band 25 (PCS)	20	24.5	24.26	-0.01	1	12249	QPSK	50	0	0 mm	left	1:1	0.634	1.057	0.670	
1905.00	26590	High	LTE Band 25 (PCS)	20	24.5	24.46	0.00	0	12249	QPSK	1	0	0 mm	back	1:1	1.430	1.009	1.443	
1905.00	26590	High	LTE Band 25 (PCS)	20	24.5	24.31	0.09	0	12249	QPSK	50	25	0 mm	back	1:1	1.340	1.045	1.400	
1905.00	26590	High	LTE Band 25 (PCS)	20	24.5	24.46	0.11	0	12249	QPSK	1	0	0 mm	front	1:1	1.520	1.009	1.534	
1905.00	26590	High	LTE Band 25 (PCS)	20	24.5	24.31	-0.12	0	12249	QPSK	50	25	0 mm	front	1:1	1.430	1.045	1.494	
1860.00	26140	Low	LTE Band 25 (PCS)	20	24.5	24.16	-0.20	0	12249	QPSK	1	0	0 mm	bottom	1:1	2.720	1.081	2.940	
1882.50	26365	Mid	LTE Band 25 (PCS)	20	24.5	24.36	0.09	0	12249	QPSK	1	0	0 mm	bottom	1:1	2.780	1.033	2.872	
1905.00	26590	High	LTE Band 25 (PCS)	20	24.5	24.46	-0.15	0	12249	QPSK	1	0	0 mm	bottom	1:1	3.170	1.009	3.199	A52
1860.00	26140	Low	LTE Band 25 (PCS)	20	24.5	24.20	-0.11	0	12249	QPSK	50	0	0 mm	bottom	1:1	2.560	1.072	2.744	
1882.50	26365	Mid	LTE Band 25 (PCS)	20	24.5	24.30	-0.16	0	12249	QPSK	50	25	0 mm	bottom	1:1	2.600	1.047	2.722	
1905.00	26590	High	LTE Band 25 (PCS)	20	24.5	24.31	0.09	0	12249	QPSK	50	25	0 mm	bottom	1:1	2.910	1.045	3.041	
1882.50	26365	Mid	LTE Band 25 (PCS)	20	24.5	24.29	-0.21	0	12249	QPSK	100	0	0 mm	bottom	1:1	2.610	1.050	2.741	
1905.00	26590	High	LTE Band 25 (PCS)	20	24.5	24.46	-0.18	0	12249	QPSK	1	0	0 mm	bottom	1:1	3.140	1.009	3.168	
ANSI / IEEE C95.1 1992 - SAFETY LIMIT										Phablet									
Spatial Peak										4.0 W/kg (mW/g)									
Uncontrolled Exposure/General Population										averaged over 10 grams									

Note: Blue entry represents variability measurement.

FCC ID ZNFG710VM		SAR EVALUATION REPORT		Approved by: Quality Manager
Document S/N: 1M1804030062-01-R2.ZNF	Test Dates: 04/02/18 - 04/15/18	DUT Type: Portable Handset	Page 93 of 126	

**Table 11-42
WLAN Phablet SAR**



MEASUREMENT RESULTS																			
FREQUENCY		Mode	Service	Bandwidth [MHz]	Maximum Allowed Power [dBm]	Conducted Power [dBm]	Power Drift [dB]	Spacing	Antenna Config.	Device Serial Number	Data Rate (Mbps)	Side	Duty Cycle (%)	Peak SAR of Area Scan [W/kg]	SAR (10g) [W/kg]	Scaling Factor (Power)	Scaling Factor (Duty Cycle)	Reported SAR (10g) [W/kg]	Plot #
MHz	Ch.																		
5280	56	802.11a	OFDM	20	18.0	17.56	0.12	0 mm	1	12298	6	back	98.5	6.572	0.399	1.107	1.015	0.448	
5280	56	802.11a	OFDM	20	18.0	17.56	0.10	0 mm	1	12298	6	front	98.5	3.382	-	1.107	1.015	-	
5280	56	802.11a	OFDM	20	18.0	17.56	-0.17	0 mm	1	12298	6	top	98.5	1.070	-	1.107	1.015	-	
5280	56	802.11a	OFDM	20	18.0	17.56	0.00	0 mm	1	12298	6	left	98.5	0.307	-	1.107	1.015	-	
5260	52	802.11a	OFDM	20	17.0	16.51	0.07	0 mm	2	12298	6	back	98.8	37.460	1.700	1.119	1.012	1.925	
5280	56	802.11a	OFDM	20	18.0	17.50	-0.02	0 mm	2	12298	6	back	98.8	57.612	2.260	1.122	1.012	2.566	
5320	64	802.11a	OFDM	20	17.0	16.41	0.14	0 mm	2	12298	6	back	98.8	34.208	1.950	1.146	1.012	2.262	
5280	56	802.11a	OFDM	20	18.0	17.50	0.00	0 mm	2	12298	6	front	98.8	0.161	0.017	1.122	1.012	0.019	
5280	56	802.11a	OFDM	20	18.0	17.50	0.19	0 mm	2	12298	6	top	98.8	0.291	-	1.122	1.012	-	
5280	56	802.11a	OFDM	20	18.0	17.50	0.00	0 mm	2	12298	6	left	98.8	4.341	0.432	1.122	1.012	0.491	
5600	120	802.11a	OFDM	20	17.0	16.56	0.18	0 mm	1	12298	6	back	98.5	5.441	0.234	1.107	1.015	0.263	
5600	120	802.11a	OFDM	20	17.0	16.56	0.14	0 mm	1	12298	6	front	98.5	4.008	-	1.107	1.015	-	
5600	120	802.11a	OFDM	20	17.0	16.56	0.10	0 mm	1	12298	6	top	98.5	0.575	-	1.107	1.015	-	
5600	120	802.11a	OFDM	20	17.0	16.56	0.10	0 mm	1	12298	6	left	98.5	0.252	-	1.107	1.015	-	
5600	120	802.11a	OFDM	20	17.0	16.67	0.15	0 mm	2	12298	6	back	98.8	40.611	2.190	1.079	1.012	2.391	
5620	124	802.11a	OFDM	20	17.0	16.68	0.16	0 mm	2	12298	6	back	98.8	29.108	2.140	1.076	1.012	2.330	
5620	124	802.11a	OFDM	20	17.0	16.68	0.14	0 mm	2	12298	6	front	98.8	0.467	0.041	1.076	1.012	0.045	
5620	124	802.11a	OFDM	20	17.0	16.68	0.18	0 mm	2	12298	6	top	98.8	0.300	-	1.076	1.012	-	
5620	124	802.11a	OFDM	20	17.0	16.68	0.10	0 mm	2	12298	6	left	98.8	3.286	0.363	1.076	1.012	0.395	
ANSI / IEEE C95.1 1992 - SAFETY LIMIT Spatial Peak Uncontrolled Exposure/General Population									Phablet 4.0 W/kg (mW/g) averaged over 10 grams										

**Table 11-43
WLAN MIMO Phablet SAR**

MEASUREMENT RESULTS																					
FREQUENCY		Mode	Service	Bandwidth [MHz]	Maximum Allowed Power (Ant 1) [dBm]	Conducted Power (Ant 1) [dBm]	Maximum Allowed Power (Ant 2) [dBm]	Conducted Power (Ant 2) [dBm]	Power Drift [dB]	Spacing	Antenna Config.	Device Serial Number	Data Rate (Mbps)	Side	Duty Cycle (%)	Peak SAR of Area Scan [W/kg]	SAR (10g) [W/kg]	Scaling Factor (Power)	Scaling Factor (Duty Cycle)	Reported SAR (10g) [W/kg]	Plot #
MHz	Ch.																				
5260	52	802.11n	OFDM	20	17.0	16.31	17.0	16.56	0.10	0 mm	MIMO	12272	13	back	98.6	30.447	1.710	1.172	1.014	2.032	
5280	56	802.11n	OFDM	20	18.0	17.34	18.0	17.51	0.00	0 mm	MIMO	12272	13	back	98.6	48.313	2.390	1.164	1.014	2.821	A53
5320	64	802.11n	OFDM	20	17.0	16.57	17.0	16.33	0.18	0 mm	MIMO	12272	13	back	98.6	30.636	2.010	1.167	1.014	2.379	
5280	56	802.11n	OFDM	20	18.0	17.34	18.0	17.51	0.16	0 mm	MIMO	12272	13	front	98.6	2.369	0.299	1.164	1.014	0.353	
5280	56	802.11n	OFDM	20	18.0	17.34	18.0	17.51	0.11	0 mm	MIMO	12272	13	top	98.6	0.738	-	1.164	1.014	-	
5280	56	802.11n	OFDM	20	18.0	17.34	18.0	17.51	0.00	0 mm	MIMO	12272	13	left	98.6	4.080	0.464	1.164	1.014	0.548	
5600	120	802.11n	OFDM	20	17.0	16.46	17.0	16.20	0.16	0 mm	MIMO	12272	13	back	98.6	43.898	2.220	1.202	1.014	2.706	
5620	124	802.11n	OFDM	20	17.0	16.30	17.0	16.51	0.15	0 mm	MIMO	12272	13	back	98.6	38.379	2.180	1.175	1.014	2.597	
5620	124	802.11n	OFDM	20	17.0	16.30	17.0	16.51	0.10	0 mm	MIMO	12272	13	front	98.6	3.165	0.234	1.175	1.014	0.279	
5620	124	802.11n	OFDM	20	17.0	16.30	17.0	16.51	0.10	0 mm	MIMO	12272	13	top	98.6	0.498	-	1.175	1.014	-	
5620	124	802.11n	OFDM	20	17.0	16.30	17.0	16.51	0.10	0 mm	MIMO	12272	13	left	98.6	3.515	0.417	1.175	1.014	0.497	
5280	56	802.11n	OFDM	20	18.0	17.34	18.0	17.51	0.11	0 mm	MIMO	12272	13	back	98.6	38.931	2.220	1.164	1.014	2.620	
5600	120	802.11n	OFDM	20	17.0	16.46	17.0	16.20	0.15	0 mm	MIMO	12272	13	back	98.6	33.172	2.210	1.202	1.014	2.694	
ANSI / IEEE C95.1 1992 - SAFETY LIMIT Spatial Peak Uncontrolled Exposure/General Population									Phablet 4.0 W/kg (mW/g) averaged over 10 grams												

Note:

- Blue entry represents variability measurement.
- To achieve the 5GHz WLAN 20.0 dBm (Ch. 52, 64, 120,124) and 21 dBm (Ch. 56) maximum allowed MIMO power shown in the documentation, each antenna transmits at a maximum allowed power of 17.0 dBm (Ch. 52, 64, 120,124) and 18.0 dBm (Ch. 56).

FCC ID ZNFG710VM	 PCTEST ENGINEERING LABORATORY, INC.	SAR EVALUATION REPORT	 LG	Approved by: Quality Manager
Document S/N: 1M1804030062-01-R2.ZNF	Test Dates: 04/02/18 - 04/15/18	DUT Type: Portable Handset	Page 94 of 126	



11.5 SAR Test Notes

General Notes:

1. The test data reported are the worst-case SAR values according to test procedures specified in IEEE 1528-2013, FCC KDB Publication 616217 D04v01r02, and FCC KDB Publication 447498 D01v06.
2. Batteries are fully charged at the beginning of the SAR measurements.
3. Liquid tissue depth was at least 15.0 cm for all frequencies.
4. The manufacturer has confirmed that the device(s) tested have the same physical, mechanical and thermal characteristics and are within operational tolerances expected for production units.
5. SAR results were scaled to the maximum allowed power to demonstrate compliance per FCC KDB Publication 447498 D01v06.
6. Device was tested using a fixed spacing for body-worn accessory testing. A separation distance of 10 mm was considered because the manufacturer has determined that there will be body-worn accessories available in the marketplace for users to support this separation distance.
7. Per FCC KDB Publication 648474 D04v01r03, body-worn SAR was evaluated without a headset connected to the device. Since the standalone reported body-worn SAR was ≤ 1.2 W/kg, no additional body-worn SAR evaluations using a headset cable were required.
8. Per FCC KDB 865664 D01v01r04, variability SAR tests were performed when the measured SAR results for a frequency band were greater than or equal to 0.8 W/kg. Repeated SAR measurements are highlighted in the tables above for clarity. Please see Section 13 for variability analysis.
9. During SAR Testing for the Wireless Router conditions per FCC KDB Publication 941225 D06v02r01, the actual Portable Hotspot operation (with actual simultaneous transmission of a transmitter with WIFI) was not activated (See Section 6.7 for more details).
10. Per FCC KDB Publication 648474 D04v01r03, this device is considered a "phablet" since the diagonal dimension is > 160 mm and < 200 mm. Therefore, phablet SAR tests are required when wireless router mode does not apply or if wireless router 1g SAR > 1.2 W/kg.
11. This device utilizes power reduction for some wireless modes and technologies, as outlined in Section 1.3. The maximum output power allowed for each transmitter and exposure condition was evaluated for SAR compliance based on expected use conditions and simultaneous transmission scenarios.
12. Unless otherwise noted, when 10g SAR measurement is considered, a factor of 2.5 is applied to the thresholds below.
13. Additional SAR tests for phablet SAR were evaluated per KDB 616217 Section 6 (See Section 6.9 for more information).

GSM Test Notes:

1. Body-Worn accessory testing is typically associated with voice operations. Therefore, GSM voice was evaluated for body-worn SAR.
2. Justification for reduced test configurations per KDB Publication 941225 D01v03r01 and October 2013 TCB Workshop Notes: The source-based frame-averaged output power was evaluated for all GPRS/EDGE slot configurations. The configuration with the highest target frame averaged output power was evaluated for hotspot SAR. When the maximum frame-averaged powers are equivalent across two or more slots (within 0.25 dB), the configuration with the most number of time slots was tested.
3. Per FCC KDB Publication 447498 D01v06, if the reported (scaled) SAR measured at the middle channel or highest output power channel for each test configuration is ≤ 0.8 W/kg for 1g evaluations then testing at the other channels is not required for such test configuration(s). When the maximum output power variation across the required test channels is $> \frac{1}{2}$ dB, instead of the middle channel, the highest output power channel was used.
4. GPRS was additionally evaluated for head and body-worn exposure conditions to address possible VoIP scenarios.

FCC ID ZNFG710VM	 PCTEST ENGINEERING LABORATORY, INC.	SAR EVALUATION REPORT	 LG	Approved by: Quality Manager
Document S/N: 1M1804030062-01-R2.ZNF	Test Dates: 04/02/18 - 04/15/18	DUT Type: Portable Handset	Page 95 of 126	

CDMA Notes:



1. Head SAR for CDMA2000 mode was tested under RC3/SO55 per FCC KDB Publication 941225 D01v03r01.
2. Body-Worn SAR was tested with 1x RTT with TDSO / SO32 FCH Only. EVDO Rev0 and RevA and TDSO / SO32 FCH+SCH SAR tests were not required per the 3G SAR Test Reduction Procedure in FCC KDB Publication 941225 D01v03r01.
3. CDMA Wireless Router SAR is measured using Subtype 0/1 Physical Layer configurations for Rev. 0 according to KDB 941225 D01v03r01 procedures for data devices. Wireless Router SAR tests for Subtype 2 of Rev.A and 1x RTT configurations were not required per the 3G SAR Test Reduction Policy in KDB Publication 941225 D01v03r01.
4. Head SAR was additionally evaluated using EVDO Rev. A to determine compliance for VoIP operations.
5. Per FCC KDB Publication 447498 D01v06, if the reported (scaled) SAR measured at the middle channel or highest output power channel for each test configuration is ≤ 0.8 W/kg for 1g evaluations then testing at the other channels is not required for such test configuration(s). When the maximum output power variation across the required test channels is $> \frac{1}{2}$ dB, instead of the middle channel, the highest output power channel was used.
6. CDMA 1X Advanced technology was not required for SAR since the maximum allowed output powers for 1X Advanced was not more than 0.25 dB higher than the maximum powers for 1X.

UMTS Notes:

1. UMTS mode in was tested under RMC 12.2 kbps with HSPA Inactive per KDB Publication 941225 D01v03r01. AMR and HSPA SAR was not required per the 3G Test Reduction Procedure in KDB Publication 941225 D01v03r01.
2. Per FCC KDB Publication 447498 D01v06, if the reported (scaled) SAR measured at the middle channel or highest output power channel for each test configuration is ≤ 0.8 W/kg for 1g evaluations then testing at the other channels is not required for such test configuration(s). When the maximum output power variation across the required test channels is $> \frac{1}{2}$ dB, instead of the middle channel, the highest output power channel was used.

LTE Notes:

1. LTE Considerations: LTE test configurations are determined according to SAR Evaluation Considerations for LTE Devices in FCC KDB Publication 941225 D05v02r04. The general test procedures used for testing can be found in Section 8.6.4.
2. MPR is permanently implemented for this device by the manufacturer. The specific manufacturer target MPR is indicated alongside the SAR results. MPR is enabled for this device, according to 3GPP TS36.101 Section 6.2.3 – 6.2.5 under Table 6.2.3-1.
3. A-MPR was disabled for all SAR tests by setting NS=01 and MCC=001 on the base station simulator. SAR tests were performed with the same number of RB and RB offsets transmitting on all TTI frames (maximum TTI).
4. Per FCC KDB Publication 447498 D01v06, when the reported LTE Band 41 SAR measured at the highest output power channel in a given a test configuration was > 0.6 W/kg for 1g evaluations, testing at the other channels was required for such test configurations.
5. TDD LTE was tested per the guidance provided in FCC KDB Publication 941225 D05v02r04. Testing was performed using UL-DL configuration 0 with 6 UL subframes and 2 S subframes using extended cyclic prefix only and special subframe configuration 6. SAR tests were performed at maximum output power and worst-case transmission duty factor in extended cyclic prefix. Per 3GPP 36.211 Section 4, the duty factor for special subframe configuration 6 using extended cyclic prefix is 0.633.
6. Per KDB Publication 941225 D05Av01r02, SAR for downlink only LTE CA operations was not needed since the maximum average output power in LTE CA mode was not >0.25 dB higher than the maximum output power when downlink carrier aggregation was inactive.
7. This device supports Power Class 2 and Power Class 3 operations for LTE Band 41. The highest available duty cycle for Power Class 2 operations is 43.3 % using UL-DL configuration 1. Per FCC Guidance, all SAR tests were performed using Power Class 3. SAR with power class 2 at the available

FCC ID ZNFG710VM	 PCTEST ENGINEERING LABORATORY, INC.	SAR EVALUATION REPORT	 LG	Approved by: Quality Manager
Document S/N: 1M1804030062-01-R2.ZNF	Test Dates: 04/02/18 - 04/15/18	DUT Type: Portable Handset	Page 96 of 126	

duty factor was additionally performed for the power class 3 configuration with the highest SAR configuration for each exposure conditions. Please see Section 14 for linearity results.



- For LTE Band 41 and LTE Band 5, per Fall TCB Workshop Notes, SAR was first measured with only a single carrier active in the uplink (carrier aggregation not active). For each exposure condition, the uplink CA scenario with two component carriers was additionally tested for the configuration with the highest SAR when carrier aggregation was not active. The SCC was configured with the closest available contiguous channel. The two component carriers were configured so the resource blocks are physically allocated side by side to achieve the maximum output power.

WLAN Notes:

- For held-to-ear, hotspot, and phablet operations, the initial test position procedures were applied. The test position with the highest extrapolated peak SAR will be used as the initial test position. When reported SAR for the initial test position is ≤ 0.4 W/kg for 1g evaluations, no additional testing for the remaining test positions was required. Otherwise, SAR is evaluated at the subsequent highest peak SAR positions until the reported SAR result is ≤ 0.8 W/kg or all test positions are measured.
- Justification for test configurations for WLAN per KDB Publication 248227 D01v02r02 for 2.4 GHz WIFI single transmission chain operations, the highest measured maximum output power channel for DSSS was selected for SAR measurement. SAR for OFDM modes (2.4 GHz 802.11g/n) was not required due to the maximum allowed powers and the highest reported DSSS SAR. See Section 8.7.5 for more information.
- Justification for test configurations for WLAN per KDB Publication 248227 D01v02r02 for 5 GHz WIFI single transmission chain operations, the initial test configuration was selected according to the transmission mode with the highest maximum allowed powers. Other transmission modes were not investigated since the highest reported SAR for initial test configuration adjusted by the ratio of maximum output powers is less than 1.2 W/kg for 1g evaluations. See Section 8.7.6 for more information.
- Per KDB Publication 248227 D01v02r02, SAR for MIMO was evaluated by following the simultaneous SAR provisions from KDB Publication 447498 D01v06 by either evaluating the sum of the 1g SAR values of each antenna transmitting independently or making a SAR measurement with both antennas transmitting simultaneously. Please see Section 12 for complete analysis.
- When the maximum reported 1g averaged SAR is ≤ 0.8 W/kg, SAR testing on additional channels was not required. Otherwise, SAR for the next highest output power channel was required until the reported SAR result was ≤ 1.20 W/kg for 1g evaluations or all test channels were measured.
- The device was configured to transmit continuously at the required data rate, channel bandwidth and signal modulation, using the highest transmission duty factor supported by the test mode tools. The reported SAR was scaled to the 100% transmission duty factor to determine compliance. Procedures used to measure the duty factor are identical to that in the associated EMC test reports.
- When 10-g SAR measurement is considered, a factor of 2.5 is applied to the thresholds above.

Bluetooth Notes

- Bluetooth SAR was measured with the device connected to a call box with hopping disabled with DH5 operation and Tx Tests test mode type. Per October 2016 TCB Workshop Notes, the reported SAR was scaled to the 100% transmission duty factor to determine compliance. See Section 9.6 for the time domain plot and calculation for the duty factor of the device.

FCC ID ZNFG710VM	 PCTEST ENGINEERING LABORATORY, INC.	SAR EVALUATION REPORT		Approved by: Quality Manager
Document S/N: 1M1804030062-01-R2.ZNF	Test Dates: 04/02/18 - 04/15/18	DUT Type: Portable Handset		Page 97 of 126

12 FCC MULTI-TX AND ANTENNA SAR CONSIDERATIONS

12.1 Introduction

The following procedures adopted from FCC KDB Publication 447498 D01v06 are applicable to devices with built-in unlicensed transmitters such as 802.11 and Bluetooth devices which may simultaneously transmit with the licensed transmitter.

12.2 Simultaneous Transmission Procedures

This device contains transmitters that may operate simultaneously. Therefore, simultaneous transmission analysis is required. Per FCC KDB Publication 447498 D01v06 4.3.2 and IEEE 1528-2013 Section 6.3.4.1.2, simultaneous transmission SAR test exclusion may be applied when the sum of the 1g SAR for all the simultaneous transmitting antennas in a specific a physical test configuration is ≤ 1.6 W/kg. The different test positions in an exposure condition may be considered collectively to determine SAR test exclusion according to the sum of 1g or 10g SAR.

12.3 Head SAR Simultaneous Transmission Analysis

Table 12-1
Simultaneous Transmission Scenario with 2.4 GHz WLAN (Held to Ear)

Exposure Condition	Mode	2G/3G/4G SAR (W/kg)	2.4 GHz WLAN Ant 1 SAR (W/kg)	2.4 GHz WLAN Ant 2 SAR (W/kg)	Σ SAR (W/kg)		
		1	2	3	1+2	1+3	1+2+3
Head SAR	CDMA/EVDO BC10 (§90S)	0.263	0.514	0.116	0.777	0.379	0.893
	CDMA/EVDO BC0 (§22H)	0.271	0.514	0.116	0.785	0.387	0.901
	PCS CDMA/EVDO	0.132	0.514	0.116	0.646	0.248	0.762
	GSM/GPRS 850	0.151	0.514	0.116	0.665	0.267	0.781
	GSM/GPRS 1900	0.078	0.514	0.116	0.592	0.194	0.708
	UMTS 850	0.200	0.514	0.116	0.714	0.316	0.830
	UMTS 1750	0.151	0.514	0.116	0.665	0.267	0.781
	UMTS 1900	0.130	0.514	0.116	0.644	0.246	0.760
	LTE Band 12	0.172	0.514	0.116	0.686	0.288	0.802
	LTE Band 13	0.210	0.514	0.116	0.724	0.326	0.840
	LTE Band 5 (Cell)	0.198	0.514	0.116	0.712	0.314	0.828
	LTE Band 26 (Cell)	0.214	0.514	0.116	0.728	0.330	0.844
	LTE Band 66 (AWS)	0.174	0.514	0.116	0.688	0.290	0.804
	LTE Band 25 (PCS)	0.100	0.514	0.116	0.614	0.216	0.730
LTE Band 41	0.043	0.514	0.116	0.557	0.159	0.673	



FCC ID ZNFG710VM	 PCTEST ENGINEERING LABORATORY, INC.	SAR EVALUATION REPORT		Approved by: Quality Manager
Document S/N: 1M1804030062-01-R2.ZNF	Test Dates: 04/02/18 - 04/15/18	DUT Type: Portable Handset	Page 98 of 126	

Table 12-2
Simultaneous Transmission Scenario with 5 GHz WLAN (Held to Ear)

Exposure Condition	Mode	2G/3G/4G SAR (W/kg)	5 GHz WLAN Ant 1 SAR (W/kg)	5 GHz WLAN Ant 2 SAR (W/kg)	Σ SAR (W/kg)		
		1	2	3	1+2	1+3	1+2+3
Head SAR	CDMA/EVDO BC10 (§90S)	0.263	0.621	0.052	0.884	0.315	0.936
	CDMA/EVDO BC0 (§22H)	0.271	0.621	0.052	0.892	0.323	0.944
	PCS CDMA/EVDO	0.132	0.621	0.052	0.753	0.184	0.805
	GSM/GPRS 850	0.151	0.621	0.052	0.772	0.203	0.824
	GSM/GPRS 1900	0.078	0.621	0.052	0.699	0.130	0.751
	UMTS 850	0.200	0.621	0.052	0.821	0.252	0.873
	UMTS 1750	0.151	0.621	0.052	0.772	0.203	0.824
	UMTS 1900	0.130	0.621	0.052	0.751	0.182	0.803
	LTE Band 12	0.172	0.621	0.052	0.793	0.224	0.845
	LTE Band 13	0.210	0.621	0.052	0.831	0.262	0.883
	LTE Band 5 (Cell)	0.198	0.621	0.052	0.819	0.250	0.871
	LTE Band 26 (Cell)	0.214	0.621	0.052	0.835	0.266	0.887
	LTE Band 66 (AWS)	0.174	0.621	0.052	0.795	0.226	0.847
	LTE Band 25 (PCS)	0.100	0.621	0.052	0.721	0.152	0.773
	LTE Band 41	0.043	0.621	0.052	0.664	0.095	0.716

Table 12-3
Simultaneous Transmission Scenario with 2.4 GHz Ant 1 and 5 GHz Ant 2 WLAN (Held to Ear)

Exposure Condition	Mode	2G/3G/4G SAR (W/kg)	2.4 GHz WLAN Ant 1 SAR (W/kg)	5 GHz WLAN Ant 2 SAR (W/kg)	Σ SAR (W/kg)
		1	2	3	1+2+3
Head SAR	CDMA/EVDO BC10 (§90S)	0.263	0.514	0.052	0.829
	CDMA/EVDO BC0 (§22H)	0.271	0.514	0.052	0.837
	PCS CDMA/EVDO	0.132	0.514	0.052	0.698
	GSM/GPRS 850	0.151	0.514	0.052	0.717
	GSM/GPRS 1900	0.078	0.514	0.052	0.644
	UMTS 850	0.200	0.514	0.052	0.766
	UMTS 1750	0.151	0.514	0.052	0.717
	UMTS 1900	0.130	0.514	0.052	0.696
	LTE Band 12	0.172	0.514	0.052	0.738
	LTE Band 13	0.210	0.514	0.052	0.776
	LTE Band 5 (Cell)	0.198	0.514	0.052	0.764
	LTE Band 26 (Cell)	0.214	0.514	0.052	0.780
	LTE Band 66 (AWS)	0.174	0.514	0.052	0.740
	LTE Band 25 (PCS)	0.100	0.514	0.052	0.666
	LTE Band 41	0.043	0.514	0.052	0.609





FCC ID ZNFG710VM	 PCTEST <small>ENGINEERING LABORATORY, INC.</small>	SAR EVALUATION REPORT		Approved by: Quality Manager
Document S/N: 1M1804030062-01-R2.ZNF	Test Dates: 04/02/18 - 04/15/18	DUT Type: Portable Handset		Page 99 of 126

Table 12-4
Simultaneous Transmission Scenario with Bluetooth (Held to Ear)

Mode	2G/3G/4G SAR (W/kg)	Bluetooth SAR (W/kg)	Σ SAR (W/kg)
	1	2	1+2
CDMA/EVDO BC10 (§90S)	0.263	0.123	0.386
CDMA/EVDO BC0 (§22H)	0.271	0.123	0.394
PCS CDMA/EVDO	0.132	0.123	0.255
GSM/GPRS 850	0.151	0.123	0.274
GSM/GPRS 1900	0.078	0.123	0.201
UMTS 850	0.200	0.123	0.323
UMTS 1750	0.151	0.123	0.274
UMTS 1900	0.130	0.123	0.253
LTE Band 12	0.172	0.123	0.295
LTE Band 13	0.210	0.123	0.333
LTE Band 5 (Cell)	0.198	0.123	0.321
LTE Band 26 (Cell)	0.214	0.123	0.337
LTE Band 66 (AWS)	0.174	0.123	0.297
LTE Band 25 (PCS)	0.100	0.123	0.223
LTE Band 41	0.043	0.123	0.166

FCC ID ZNFG710VM	 PCTEST ENGINEERING LABORATORY, INC.	SAR EVALUATION REPORT	 LG	Approved by: Quality Manager
Document S/N: 1M1804030062-01-R2.ZNF	Test Dates: 04/02/18 - 04/15/18	DUT Type: Portable Handset		Page 100 of 126



12.4 Body-Worn Simultaneous Transmission Analysis

Table 12-5
Simultaneous Transmission Scenario with 2.4 GHz WLAN (Body-Worn at 1.0 cm)

Exposure Condition	Mode	2G/3G/4G SAR (W/kg)	2.4 GHz WLAN Ant 1 SAR (W/kg)	2.4 GHz WLAN Ant 2 SAR (W/kg)	Σ SAR (W/kg)		
		1	2	3	1+2	1+3	1+2+3
Body-Worn	CDMA BC10 (§90S)	0.444	0.400	0.496	0.844	0.940	1.340
	CDMA BC0 (§22H)	0.521	0.400	0.496	0.921	1.017	1.417
	PCS CDMA	0.358	0.400	0.496	0.758	0.854	1.254
	GSM/GPRS 850	0.336	0.400	0.496	0.736	0.832	1.232
	GSM/GPRS 1900	0.308	0.400	0.496	0.708	0.804	1.204
	UMTS 850	0.409	0.400	0.496	0.809	0.905	1.305
	UMTS 1750	0.509	0.400	0.496	0.909	1.005	1.405
	UMTS 1900	0.590	0.400	0.496	0.990	1.086	1.486
	LTE Band 12	0.516	0.400	0.496	0.916	1.012	1.412
	LTE Band 13	0.588	0.400	0.496	0.988	1.084	1.484
	LTE Band 5 (Cell)	0.400	0.400	0.496	0.800	0.896	1.296
	LTE Band 26 (Cell)	0.424	0.400	0.496	0.824	0.920	1.320
	LTE Band 66 (AWS)	0.473	0.400	0.496	0.873	0.969	1.369
	LTE Band 25 (PCS)	0.372	0.400	0.496	0.772	0.868	1.268
LTE Band 41	0.598	0.400	0.496	0.998	1.094	1.494	

Table 12-6
Simultaneous Transmission Scenario with 5 GHz WLAN (Body-Worn at 1.0 cm)

Exposure Condition	Mode	2G/3G/4G SAR (W/kg)	5 GHz WLAN Ant 1 SAR (W/kg)	Σ SAR (W/kg)
		1	2	1+2
Body-Worn	CDMA BC10 (§90S)	0.444	0.184	0.628
	CDMA BC0 (§22H)	0.521	0.184	0.705
	PCS CDMA	0.358	0.184	0.542
	GSM/GPRS 850	0.336	0.184	0.520
	GSM/GPRS 1900	0.308	0.184	0.492
	UMTS 850	0.409	0.184	0.593
	UMTS 1750	0.509	0.184	0.693
	UMTS 1900	0.590	0.184	0.774
	LTE Band 12	0.516	0.184	0.700
	LTE Band 13	0.588	0.184	0.772
	LTE Band 5 (Cell)	0.400	0.184	0.584
	LTE Band 26 (Cell)	0.424	0.184	0.608
	LTE Band 66 (AWS)	0.473	0.184	0.657
	LTE Band 25 (PCS)	0.372	0.184	0.556
LTE Band 41	0.598	0.184	0.782	

FCC ID ZNFG710VM	 PCTEST ENGINEERING LABORATORY, INC.	SAR EVALUATION REPORT		Approved by: Quality Manager
Document S/N: 1M1804030062-01-R2.ZNF	Test Dates: 04/02/18 - 04/15/18	DUT Type: Portable Handset	Page 101 of 126	

Exposure Condition	Mode	2G/3G/4G SAR (W/kg)	5 GHz WLAN Ant 2 SAR (W/kg)	Σ SAR (W/kg)	SPLSR
		1	2		
Body-Worn	CDMA BC10 (§90S)	0.444	1.041	1.485	N/A
	CDMA BC0 (§22H)	0.521	1.041	1.562	N/A
	PCS CDMA	0.358	1.041	1.399	N/A
	GSM/GPRS 850	0.336	1.041	1.377	N/A
	GSM/GPRS 1900	0.308	1.041	1.349	N/A
	UMTS 850	0.409	1.041	1.450	N/A
	UMTS 1750	0.509	1.041	1.550	N/A
	UMTS 1900	0.590	1.041	See Note 1	0.02
	LTE Band 12	0.516	1.041	1.557	N/A
	LTE Band 13	0.588	1.041	See Note 1	0.02
	LTE Band 5 (Cell)	0.400	1.041	1.441	N/A
	LTE Band 26 (Cell)	0.424	1.041	1.465	N/A
	LTE Band 66 (AWS)	0.473	1.041	1.514	N/A
	LTE Band 25 (PCS)	0.372	1.041	1.413	N/A
LTE Band 41	0.598	1.041	See Note 1	0.02	

Exposure Condition	Mode	2G/3G/4G SAR (W/kg)	5 GHz WLAN MIMO SAR (W/kg)	Σ SAR (W/kg)	SPLSR
		1	2		
Body-Worn	CDMA BC10 (§90S)	0.444	1.137	1.581	N/A
	CDMA BC0 (§22H)	0.521	1.137	See Note 1	0.02
	PCS CDMA	0.358	1.137	1.495	N/A
	GSM/GPRS 850	0.336	1.137	1.473	N/A
	GSM/GPRS 1900	0.308	1.137	1.445	N/A
	UMTS 850	0.409	1.137	1.546	N/A
	UMTS 1750	0.509	1.137	See Note 1	0.02
	UMTS 1900	0.590	1.137	See Note 1	0.02
	LTE Band 12	0.516	1.137	See Note 1	0.02
	LTE Band 13	0.588	1.137	See Note 1	0.02
	LTE Band 5 (Cell)	0.400	1.137	1.537	N/A
	LTE Band 26 (Cell)	0.424	1.137	1.561	N/A
	LTE Band 66 (AWS)	0.473	1.137	See Note 1	0.02
	LTE Band 25 (PCS)	0.372	1.137	1.509	N/A
LTE Band 41	0.598	1.137	See Note 1	0.02	





FCC ID ZNFG710VM	 PCTEST ENGINEERING LABORATORY, INC.	SAR EVALUATION REPORT		Approved by: Quality Manager
Document S/N: 1M1804030062-01-R2.ZNF	Test Dates: 04/02/18 - 04/15/18	DUT Type: Portable Handset	Page 102 of 126	

Table 12-7

Simultaneous Transmission Scenario with 2.4 GHz Ant 1 and 5 GHz Ant 2 WLAN (Body-Worn at 1.0 cm)



Exposure Condition	Mode	2G/3G/4G SAR (W/kg)	2.4 GHz WLAN Ant 1 at 17 dBm SAR (W/kg)	5 GHz WLAN Ant 2 at 14 dBm SAR (W/kg)	Σ SAR (W/kg)
		1	2	3	1+2+3
Body-Worn	CDMA BC10 (§90S)	0.444	0.205	0.502	1.151
	CDMA BC0 (§22H)	0.521	0.205	0.502	1.228
	PCS CDMA	0.358	0.205	0.502	1.065
	GSM/GPRS 850	0.336	0.205	0.502	1.043
	GSM/GPRS 1900	0.308	0.205	0.502	1.015
	UMTS 850	0.409	0.205	0.502	1.116
	UMTS 1750	0.509	0.205	0.502	1.216
	UMTS 1900	0.590	0.205	0.502	1.297
	LTE Band 12	0.516	0.205	0.502	1.223
	LTE Band 13	0.588	0.205	0.502	1.295
	LTE Band 5 (Cell)	0.400	0.205	0.502	1.107
	LTE Band 26 (Cell)	0.424	0.205	0.502	1.131
	LTE Band 66 (AWS)	0.473	0.205	0.502	1.180
	LTE Band 25 (PCS)	0.372	0.205	0.502	1.079
	LTE Band 41	0.598	0.205	0.502	1.305

FCC ID ZNFG710VM	 PCTEST ENGINEERING LABORATORY, INC.	SAR EVALUATION REPORT		Approved by: Quality Manager
Document S/N: 1M1804030062-01-R2.ZNF	Test Dates: 04/02/18 - 04/15/18	DUT Type: Portable Handset		Page 103 of 126

**Table 12-8
Simultaneous Transmission Scenario with Bluetooth (Body-Worn at 1.0 cm)**

Exposure Condition	Mode	2G/3G/4G SAR (W/kg)	Bluetooth SAR (W/kg)	Σ SAR (W/kg)
		1	2	1+2
Body-Worn	CDMA BC10 (§90S)	0.444	0.020	0.464
	CDMA BC0 (§22H)	0.521	0.020	0.541
	PCS CDMA	0.358	0.020	0.378
	GSM/GPRS 850	0.336	0.020	0.356
	GSM/GPRS 1900	0.308	0.020	0.328
	UMTS 850	0.409	0.020	0.429
	UMTS 1750	0.509	0.020	0.529
	UMTS 1900	0.590	0.020	0.610
	LTE Band 12	0.516	0.020	0.536
	LTE Band 13	0.588	0.020	0.608
	LTE Band 5 (Cell)	0.400	0.020	0.420
	LTE Band 26 (Cell)	0.424	0.020	0.444
	LTE Band 66 (AWS)	0.473	0.020	0.493
	LTE Band 25 (PCS)	0.372	0.020	0.392
LTE Band 41	0.598	0.020	0.618	

Note 1: No evaluation was performed to determine the aggregate 1g SAR for these configurations as the SPLS ratio between the antenna pairs was not greater than 0.04 per FCC KDB 447498 D01v06. See Section 12.7 for detailed SPLS ratio analysis.

FCC ID ZNFG710VM	 PCTEST <small>ENGINEERING LABORATORY, INC.</small>	SAR EVALUATION REPORT		Approved by: Quality Manager
Document S/N: 1M1804030062-01-R2.ZNF	Test Dates: 04/02/18 - 04/15/18	DUT Type: Portable Handset	Page 104 of 126	

12.5 Hotspot SAR Simultaneous Transmission Analysis

Per FCC KDB Publication 941225 D06v02r01, the devices edges with antennas more than 2.5 cm from edge are not required to be evaluated for SAR (“-“).

(*) For test positions that were not required to be evaluated for WLAN SAR per FCC KDB publication 248227, the worst case WLAN SAR result for applicable exposure conditions was used for simultaneous transmission analysis.

Table 12-9
Simultaneous Transmission Scenario with 2.4 GHz WLAN (Hotspot at 1.0 cm)

Exposure Condition	Mode	2G/3G/4G SAR (W/kg)	2.4 GHz WLAN Ant 1 SAR (W/kg)	2.4 GHz WLAN Ant 2 SAR (W/kg)	Σ SAR (W/kg)										
		1	2	3	1+2	1+3	1+2+3								
Hotspot SAR	EVDO BC10 (§90S)	0.445	0.400	0.496	0.845	0.941	1.341								
	EVDO BC0 (§22H)	0.505	0.400	0.496	0.905	1.001	1.401								
	PCS EVDO	1.010	0.400	0.496	1.410	1.506	See Table Below								
	GPRS 850	0.336	0.400	0.496	0.736	0.832	1.232								
	GPRS 1900	0.673	0.400	0.496	1.073	1.169	1.569								
	UMTS 850	0.409	0.400	0.496	0.809	0.905	1.305								
	UMTS 1750	0.927	0.400	0.496	1.327	1.423	See Table Below								
	UMTS 1900	1.283	0.400	0.496	See Table Below	See Table Below	See Table Below								
	LTE Band 12	0.516	0.400	0.496	0.916	1.012	1.412								
	LTE Band 13	0.588	0.400	0.496	0.988	1.084	1.484								
	LTE Band 5 (Cell)	0.400	0.400	0.496	0.800	0.896	1.296								
	LTE Band 26 (Cell)	0.424	0.400	0.496	0.824	0.920	1.320								
	LTE Band 66 (AWS)	0.892	0.400	0.496	1.292	1.388	See Table Below								
LTE Band 25 (PCS)	0.997	0.400	0.496	1.397	1.493	See Table Below									
LTE Band 41	0.929	0.400	0.496	1.329	1.425	See Table Below									
Simult Tx	Configuration	PCS EVDO SAR (W/kg)	2.4 GHz WLAN Ant 1 SAR (W/kg)	2.4 GHz WLAN Ant 2 SAR (W/kg)	Σ SAR (W/kg)			Simult Tx	Configuration	UMTS 1750 SAR (W/kg)	2.4 GHz WLAN Ant 1 SAR (W/kg)	2.4 GHz WLAN Ant 2 SAR (W/kg)	Σ SAR (W/kg)		
		1	2	3	1+2	1+3	1+2+3			1	2	3	1+2	1+3	1+2+3
Hotspot SAR	Back	0.416	0.400	0.496	0.816	0.912	1.312	Hotspot SAR	Back	0.509	0.400	0.496	0.909	1.005	1.405
	Front	0.336	0.400*	0.496*	0.736	0.832	1.232		Front	0.433	0.400*	0.496*	0.833	0.929	1.329
	Top	-	0.369	0.496*	0.369	0.496	0.865		Top	-	0.369	0.496*	0.369	0.496	0.865
	Bottom	1.010	-	-	1.010	1.010	1.010		Bottom	0.927	-	-	0.927	0.927	0.927
	Right	-	-	-	0.000	0.000	0.000		Right	-	-	-	0.000	0.000	0.000
	Left	0.255	0.400*	0.167	0.655	0.422	0.822		Left	0.317	0.400*	0.167	0.717	0.484	0.884
Simult Tx	Configuration	UMTS 1900 SAR (W/kg)	2.4 GHz WLAN Ant 1 SAR (W/kg)	2.4 GHz WLAN Ant 2 SAR (W/kg)	Σ SAR (W/kg)			Simult Tx	Configuration	LTE Band 66 (AWS) SAR (W/kg)	2.4 GHz WLAN Ant 1 SAR (W/kg)	2.4 GHz WLAN Ant 2 SAR (W/kg)	Σ SAR (W/kg)		
		1	2	3	1+2	1+3	1+2+3			1	2	3	1+2	1+3	1+2+3
Hotspot SAR	Back	0.590	0.400	0.496	0.990	1.086	1.486	Hotspot SAR	Back	0.473	0.400	0.496	0.873	0.969	1.369
	Front	0.520	0.400*	0.496*	0.920	1.016	1.416		Front	0.415	0.400*	0.496*	0.815	0.911	1.311
	Top	-	0.369	0.496*	0.369	0.496	0.865		Top	-	0.369	0.496*	0.369	0.496	0.865
	Bottom	1.283	-	-	1.283	1.283	1.283		Bottom	0.892	-	-	0.892	0.892	0.892
	Right	-	-	-	0.000	0.000	0.000		Right	-	-	-	0.000	0.000	0.000
	Left	0.313	0.400*	0.167	0.713	0.480	0.880		Left	0.315	0.400*	0.167	0.715	0.482	0.882
Simult Tx	Configuration	LTE Band 25 (PCS) SAR (W/kg)	2.4 GHz WLAN Ant 1 SAR (W/kg)	2.4 GHz WLAN Ant 2 SAR (W/kg)	Σ SAR (W/kg)			Simult Tx	Configuration	LTE Band 41 SAR (W/kg)	2.4 GHz WLAN Ant 1 SAR (W/kg)	2.4 GHz WLAN Ant 2 SAR (W/kg)	Σ SAR (W/kg)		
		1	2	3	1+2	1+3	1+2+3			1	2	3	1+2	1+3	1+2+3
Hotspot SAR	Back	0.372	0.400	0.496	0.772	0.868	1.268	Hotspot SAR	Back	0.504	0.400	0.496	0.904	1.000	1.400
	Front	0.327	0.400*	0.496*	0.727	0.823	1.223		Front	0.181	0.400*	0.496*	0.581	0.677	1.077
	Top	-	0.369	0.496*	0.369	0.496	0.865		Top	-	0.369	0.496*	0.369	0.496	0.865
	Bottom	0.997	-	-	0.997	0.997	0.997		Bottom	0.929	-	-	0.929	0.929	0.929
	Right	-	-	-	0.000	0.000	0.000		Right	0.041	-	-	0.041	0.041	0.041
	Left	0.244	0.400*	0.167	0.644	0.411	0.811		Left	0.046	0.400*	0.167	0.446	0.213	0.613



FCC ID ZNFG710VM	 PCTEST ENGINEERING LABORATORY, INC.	SAR EVALUATION REPORT			Approved by: Quality Manager
Document S/N: 1M1804030062-01-R2.ZNF	Test Dates: 04/02/18 - 04/15/18	DUT Type: Portable Handset		Page 105 of 126	

Table 12-10
Simultaneous Transmission Scenario with 5 GHz WLAN (Hotspot at 1.0 cm)

Exposure Condition	Mode	2G/3G/4G SAR (W/kg)	5 GHz WLAN Ant 1 SAR (W/kg)	5 GHz WLAN Ant 2 SAR (W/kg)	Σ SAR (W/kg)		
		1	2	3	1+2	1+3	1+2+3
Hotspot SAR	EVDO BC10 (§90S)	0.445	0.176	0.814	0.621	1.259	1.435
	EVDO BC0 (§22H)	0.505	0.176	0.814	0.681	1.319	1.495
	PCS EVDO	1.010	0.176	0.814	1.186	See Table Below	See Table Below
	GPRS 850	0.336	0.176	0.814	0.512	1.150	1.326
	GPRS 1900	0.673	0.176	0.814	0.849	1.487	See Table Below
	UMTS 850	0.409	0.176	0.814	0.585	1.223	1.399
	UMTS 1750	0.927	0.176	0.814	1.103	See Table Below	See Table Below
	UMTS 1900	1.283	0.176	0.814	1.459	See Table Below	See Table Below
	LTE Band 12	0.516	0.176	0.814	0.692	1.330	1.506
	LTE Band 13	0.588	0.176	0.814	0.764	1.402	1.578
	LTE Band 5 (Cell)	0.400	0.176	0.814	0.576	1.214	1.390
	LTE Band 26 (Cell)	0.424	0.176	0.814	0.600	1.238	1.414
	LTE Band 66 (AWS)	0.892	0.176	0.814	1.068	See Table Below	See Table Below
	LTE Band 25 (PCS)	0.997	0.176	0.814	1.173	See Table Below	See Table Below
LTE Band 41	0.929	0.176	0.814	1.105	See Table Below	See Table Below	

Simult Tx	Configuration	PCS EVDO SAR (W/kg)	5 GHz WLAN Ant 1 SAR (W/kg)	5 GHz WLAN Ant 2 SAR (W/kg)	Σ SAR (W/kg)			Simult Tx	Configuration	GPRS 1900 SAR (W/kg)	5 GHz WLAN Ant 1 SAR (W/kg)	5 GHz WLAN Ant 2 SAR (W/kg)	Σ SAR (W/kg)		
		1	2	3	1+2	1+3	1+2+3			1	2	3	1+2	1+3	1+2+3
Hotspot SAR	Back	0.416	0.176	0.814	0.592	1.230	1.406	Hotspot SAR	Back	0.308	0.176	0.814	0.484	1.122	1.298
	Front	0.336	0.176*	0.814*	0.512	1.150	1.326		Front	0.234	0.176*	0.814*	0.410	1.048	1.224
	Top	-	0.176*	0.814*	0.176	0.814	0.990		Top	-	0.176*	0.814*	0.176	0.814	0.990
	Bottom	1.010	-	-	1.010	1.010	1.010		Bottom	0.673	-	-	0.673	0.673	0.673
	Right	-	-	-	0.000	0.000	0.000		Right	-	-	-	0.000	0.000	0.000
	Left	0.255	0.176*	0.200	0.431	0.455	0.631		Left	0.161	0.176*	0.200	0.337	0.361	0.537

Simult Tx	Configuration	UMTS 1750 SAR (W/kg)	5 GHz WLAN Ant 1 SAR (W/kg)	5 GHz WLAN Ant 2 SAR (W/kg)	Σ SAR (W/kg)			Simult Tx	Configuration	UMTS 1900 SAR (W/kg)	5 GHz WLAN Ant 1 SAR (W/kg)	5 GHz WLAN Ant 2 SAR (W/kg)	Σ SAR (W/kg)		
		1	2	3	1+2	1+3	1+2+3			1	2	3	1+2	1+3	1+2+3
Hotspot SAR	Back	0.509	0.176	0.814	0.685	1.323	1.499	Hotspot SAR	Back	0.590	0.176	0.814	0.766	1.404	1.580
	Front	0.433	0.176*	0.814*	0.609	1.247	1.423		Front	0.520	0.176*	0.814*	0.696	1.334	1.510
	Top	-	0.176*	0.814*	0.176	0.814	0.990		Top	-	0.176*	0.814*	0.176	0.814	0.990
	Bottom	0.927	-	-	0.927	0.927	0.927		Bottom	1.283	-	-	1.283	1.283	1.283
	Right	-	-	-	0.000	0.000	0.000		Right	-	-	-	0.000	0.000	0.000
	Left	0.317	0.176*	0.200	0.493	0.517	0.693		Left	0.313	0.176*	0.200	0.489	0.513	0.689

Simult Tx	Configuration	LTE Band 66 (AWS) SAR (W/kg)	5 GHz WLAN Ant 1 SAR (W/kg)	5 GHz WLAN Ant 2 SAR (W/kg)	Σ SAR (W/kg)			Simult Tx	Configuration	LTE Band 25 (PCS) SAR (W/kg)	5 GHz WLAN Ant 1 SAR (W/kg)	5 GHz WLAN Ant 2 SAR (W/kg)	Σ SAR (W/kg)		
		1	2	3	1+2	1+3	1+2+3			1	2	3	1+2	1+3	1+2+3
Hotspot SAR	Back	0.473	0.176	0.814	0.649	1.287	1.463	Hotspot SAR	Back	0.372	0.176	0.814	0.548	1.186	1.362
	Front	0.415	0.176*	0.814*	0.591	1.229	1.405		Front	0.327	0.176*	0.814*	0.503	1.141	1.317
	Top	-	0.176*	0.814*	0.176	0.814	0.990		Top	-	0.176*	0.814*	0.176	0.814	0.990
	Bottom	0.892	-	-	0.892	0.892	0.892		Bottom	0.997	-	-	0.997	0.997	0.997
	Right	-	-	-	0.000	0.000	0.000		Right	-	-	-	0.000	0.000	0.000
	Left	0.315	0.176*	0.200	0.491	0.515	0.691		Left	0.244	0.176*	0.200	0.420	0.444	0.620

Simult Tx	Configuration	LTE Band 41 SAR (W/kg)	5 GHz WLAN Ant 1 SAR (W/kg)	5 GHz WLAN Ant 2 SAR (W/kg)	Σ SAR (W/kg)		
		1	2	3	1+2	1+3	1+2+3
Hotspot SAR	Back	0.504	0.176	0.814	0.680	1.318	1.494
	Front	0.181	0.176*	0.814*	0.357	0.995	1.171
	Top	-	0.176*	0.814*	0.176	0.814	0.990
	Bottom	0.929	-	-	0.929	0.929	0.929
	Right	0.041	-	-	0.041	0.041	0.041
	Left	0.046	0.176*	0.200	0.222	0.246	0.422



FCC ID ZNFG710VM	 PCTEST ENGINEERING LABORATORY, INC.	SAR EVALUATION REPORT	 LG	Approved by: Quality Manager
Document S/N: 1M1804030062-01-R2.ZNF	Test Dates: 04/02/18 - 04/15/18	DUT Type: Portable Handset	Page 106 of 126	

Table 12-11
Simultaneous Transmission Scenario with 2.4 GHz Ant 1 and 5 GHz Ant 2 WLAN (Hotspot at 1.0 cm)

Exposure Condition	Mode	2G/3G/4G SAR (W/kg)	2.4 GHz WLAN Ant 1 at 17 dBm SAR (W/kg)	5 GHz WLAN Ant 2 at 14 dBm SAR (W/kg)	Σ SAR (W/kg)		
		1	2	3	1+2	1+3	1+2+3
Hotspot SAR	EVDO BC10 (§90S)	0.445	0.234	0.432	0.679	0.877	1.111
	EVDO BC0 (§22H)	0.505	0.234	0.432	0.739	0.937	1.171
	PCS EVDO	1.010	0.234	0.432	1.244	1.442	See Table Below
	GPRS 850	0.336	0.234	0.432	0.570	0.768	1.002
	GPRS 1900	0.673	0.234	0.432	0.907	1.105	1.339
	UMTS 850	0.409	0.234	0.432	0.643	0.841	1.075
	UMTS 1750	0.927	0.234	0.432	1.161	1.359	1.593
	UMTS 1900	1.283	0.234	0.432	1.517	See Table Below	See Table Below
	LTE Band 12	0.516	0.234	0.432	0.750	0.948	1.182
	LTE Band 13	0.588	0.234	0.432	0.822	1.020	1.254
	LTE Band 5 (Cell)	0.400	0.234	0.432	0.634	0.832	1.066
	LTE Band 26 (Cell)	0.424	0.234	0.432	0.658	0.856	1.090
	LTE Band 66 (AWS)	0.892	0.234	0.432	1.126	1.324	1.558
	LTE Band 25 (PCS)	0.997	0.234	0.432	1.231	1.429	See Table Below
LTE Band 41	0.929	0.234	0.432	1.163	1.361	See Table Below	

Simult Tx	Configuration	PCS EVDO SAR (W/kg)	2.4 GHz WLAN Ant 1 at 17 dBm SAR (W/kg)	5 GHz WLAN Ant 2 at 14 dBm SAR (W/kg)	Σ SAR (W/kg)			Simult Tx	Configuration	UMTS 1900 SAR (W/kg)	2.4 GHz WLAN Ant 1 at 17 dBm SAR (W/kg)	5 GHz WLAN Ant 2 at 14 dBm SAR (W/kg)	Σ SAR (W/kg)		
		1	2	3	1+2	1+3	1+2+3			1	2	3	1+2	1+3	1+2+3
Hotspot SAR	Back	0.416	0.205	0.432	0.621	0.848	1.053	Hotspot SAR	Back	0.590	0.205	0.432	0.795	1.022	1.227
	Front	0.336	0.234*	0.432*	0.570	0.768	1.002		Front	0.520	0.234*	0.432*	0.754	0.952	1.186
	Top	-	0.234	0.432*	0.234	0.432	0.666		Top	-	0.234	0.432*	0.234	0.432	0.666
	Bottom	1.010	-	-	1.010	1.010	1.010		Bottom	1.283	-	-	1.283	1.283	1.283
	Right	-	-	-	0.000	0.000	0.000		Right	-	-	-	0.000	0.000	0.000
	Left	0.255	0.234*	0.102	0.489	0.357	0.591		Left	0.313	0.234*	0.102	0.547	0.415	0.649

Simult Tx	Configuration	LTE Band 25 (PCS) SAR (W/kg)	2.4 GHz WLAN Ant 1 at 17 dBm SAR (W/kg)	5 GHz WLAN Ant 2 at 14 dBm SAR (W/kg)	Σ SAR (W/kg)			Simult Tx	Configuration	LTE Band 41 SAR (W/kg)	2.4 GHz WLAN Ant 1 at 17 dBm SAR (W/kg)	5 GHz WLAN Ant 2 at 14 dBm SAR (W/kg)	Σ SAR (W/kg)		
		1	2	3	1+2	1+3	1+2+3			1	2	3	1+2	1+3	1+2+3
Hotspot SAR	Back	0.372	0.205	0.432	0.577	0.804	1.009	Hotspot SAR	Back	0.504	0.205	0.432	0.709	0.936	1.141
	Front	0.327	0.234*	0.432*	0.561	0.759	0.993		Front	0.181	0.234*	0.432*	0.415	0.613	0.847
	Top	-	0.234	0.432*	0.234	0.432	0.666		Top	-	0.234	0.432*	0.234	0.432	0.666
	Bottom	0.997	-	-	0.997	0.997	0.997		Bottom	0.929	-	-	0.929	0.929	0.929
	Right	-	-	-	0.000	0.000	0.000		Right	0.041	-	-	0.041	0.041	0.041
	Left	0.244	0.234*	0.102	0.478	0.346	0.580		Left	0.046	0.234*	0.102	0.280	0.148	0.382





FCC ID ZNFG710VM	 PCTEST ENGINEERING LABORATORY, INC.	SAR EVALUATION REPORT		Approved by: Quality Manager
Document S/N: 1M1804030062-01-R2.ZNF	Test Dates: 04/02/18 - 04/15/18	DUT Type: Portable Handset		Page 107 of 126

Table 12-12
Simultaneous Transmission Scenario with Bluetooth (Hotspot at 1.0 cm)

Exposure Condition	Mode	2G/3G/4G SAR (W/kg)	Bluetooth SAR (W/kg)	Σ SAR (W/kg)
		1	2	1+2
Hotspot SAR	EVDO BC10 (§90S)	0.445	0.024	0.469
	EVDO BC0 (§22H)	0.505	0.024	0.529
	PCS EVDO	1.010	0.024	1.034
	GPRS 850	0.336	0.024	0.360
	GPRS 1900	0.673	0.024	0.697
	UMTS 850	0.409	0.024	0.433
	UMTS 1750	0.927	0.024	0.951
	UMTS 1900	1.283	0.024	1.307
	LTE Band 12	0.516	0.024	0.540
	LTE Band 13	0.588	0.024	0.612
	LTE Band 5 (Cell)	0.400	0.024	0.424
	LTE Band 26 (Cell)	0.424	0.024	0.448
	LTE Band 66 (AWS)	0.892	0.024	0.916
	LTE Band 25 (PCS)	0.997	0.024	1.021
	LTE Band 41	0.929	0.024	0.953

FCC ID ZNFG710VM	 PCTEST <small>ENGINEERING LABORATORY, INC.</small>	SAR EVALUATION REPORT		Approved by: Quality Manager
Document S/N: 1M1804030062-01-R2.ZNF	Test Dates: 04/02/18 - 04/15/18	DUT Type: Portable Handset	Page 108 of 126	

12.6 Phablet Simultaneous Transmission Analysis

Per FCC KDB Publication 941225 D06v02r01, the devices edges with antennas more than 2.5 cm from edge are not required to be evaluated for SAR (“-”).

(*) For test positions that were not required to be evaluated for WLAN SAR per FCC KDB publication 248227, the worst case WLAN SAR result for applicable exposure conditions was used for simultaneous transmission analysis.



For Phablet SAR summation the highest reported SAR across all test distances was used as the most conservative evaluation for simultaneous transmission analysis for each device edge.

Per FCC KDB Publication 648474 D04 Handset SAR, Phablet SAR tests were not required if wireless router 1g SAR (scaled to the maximum output power, including tolerance) < 1.2 W/kg. Therefore, no further analysis beyond the tables included in this section was required to determine that possible simultaneous transmission scenarios would not exceed the SAR limit.

Table 12-13
Simultaneous Transmission Scenario with 5 GHz WLAN (Phablet)



Exposure Condition	Mode	2G/3G/4G SAR (W/kg)	5 GHz WLAN Ant 1 SAR (W/kg)	5 GHz WLAN Ant 2 SAR (W/kg)	Σ SAR (W/kg)	
		1	2	3	1+2	1+3
Phablet SAR	PCS EVDO	2.367	0.448	2.566	2.815	See Table Below
	UMTS 1750	2.475	0.448	2.566	2.923	See Table Below
	UMTS 1900	2.855	0.448	2.566	3.303	See Table Below
	LTE Band 66 (AWS)	2.166	0.448	2.566	2.614	See Table Below
	LTE Band 25 (PCS)	3.199	0.448	2.566	3.647	See Table Below

Simult Tx	Configuration	PCS EVDO SAR (W/kg)	5 GHz WLAN Ant 2 SAR (W/kg)	Σ SAR (W/kg)	Simult Tx	Configuration	UMTS 1750 SAR (W/kg)	5 GHz WLAN Ant 2 SAR (W/kg)	Σ SAR (W/kg)
		1	2	1+2			1	2	1+2
Phablet SAR	Back	1.102	2.566	3.668	Phablet SAR	Back	1.340	2.566	3.906
	Front	1.012	0.045	1.057		Front	1.543	0.045	1.588
	Top	-	2.566*	2.566		Top	-	2.566*	2.566
	Bottom	2.367	-	2.367		Bottom	2.475	-	2.475
	Right	-	-	0.000		Right	-	-	0.000
	Left	0.813	0.491	1.304		Left	0.794	0.491	1.285

FCC ID ZNFG710VM	 PCTEST ENGINEERING LABORATORY, INC.	SAR EVALUATION REPORT		Approved by: Quality Manager
Document S/N: 1M1804030062-01-R2.ZNF	Test Dates: 04/02/18 - 04/15/18	DUT Type: Portable Handset	Page 109 of 126	

Simult Tx	Configuration	UMTS 1900 SAR (W/kg)	5 GHz WLAN Ant 2 SAR (W/kg)	Σ SAR (W/kg)	Simult Tx	Configuration	LTE Band 66 (AWS) SAR (W/kg)	5 GHz WLAN Ant 2 SAR (W/kg)	Σ SAR (W/kg)
		1	2	1+2			1	2	1+2
Phablet SAR	Back	1.368	2.566	3.934	Phablet SAR	Back	1.356	2.566	3.922
	Front	1.477	0.045	1.522		Front	1.386	0.045	1.431
	Top	-	2.566*	2.566		Top	-	2.566*	2.566
	Bottom	2.855	-	2.855		Bottom	2.166	-	2.166
	Right	-	-	0.000		Right	-	-	0.000
	Left	0.923	0.491	1.414		Left	0.720	0.491	1.211

Simult Tx	Configuration	LTE Band 25 (PCS) SAR (W/kg)	5 GHz WLAN Ant 2 SAR (W/kg)	Σ SAR (W/kg)	SPLSR
		1	2	1+2	1+2
Phablet SAR	Back	1.443	2.566	See Note 1	0.07
	Front	1.534	0.045	1.579	N/A
	Top	-	2.566*	2.566	N/A
	Bottom	3.199	-	3.199	N/A
	Right	-	-	0.000	N/A
	Left	0.779	0.491	1.270	N/A



FCC ID ZNFG710VM	 PCTEST ENGINEERING LABORATORY, INC.	SAR EVALUATION REPORT		Approved by: Quality Manager
Document S/N: 1M1804030062-01-R2.ZNF	Test Dates: 04/02/18 - 04/15/18	DUT Type: Portable Handset	Page 110 of 126	

Exposure Condition	Mode	2G/3G/4G SAR (W/kg)	5 GHz WLAN MIMO SAR (W/kg)	Σ SAR (W/kg)
		1	2	1+2
Phablet SAR	PCS EVDO	2.367	2.821	See Table Below
	UMTS 1750	2.475	2.821	See Table Below
	UMTS 1900	2.855	2.821	See Table Below
	LTE Band 66 (AWS)	2.166	2.821	See Table Below
	LTE Band 25 (PCS)	3.199	2.821	See Table Below

Simult Tx	Configuration	PCS EVDO SAR (W/kg)	5 GHz WLAN MIMO SAR (W/kg)	Σ SAR (W/kg)
		1	2	1+2
Phablet SAR	Back	1.102	2.821	3.923
	Front	1.012	0.353	1.365
	Top	-	2.821*	2.821
	Bottom	2.367	-	2.367
	Right	-	-	0.000
	Left	0.813	0.548	1.361

Simult Tx	Configuration	UMTS 1750 SAR (W/kg)	5 GHz WLAN MIMO SAR (W/kg)	Σ SAR (W/kg)	SPLSR	Simult Tx	Configuration	UMTS 1900 SAR (W/kg)	5 GHz WLAN MIMO SAR (W/kg)	Σ SAR (W/kg)	SPLSR
		1	2	1+2	1+2			1	2	1+2	1+2
Phablet SAR	Back	1.340	2.821	See Note 1	0.07	Phablet SAR	Back	1.368	2.821	See Note 1	0.07
	Front	1.543	0.353	1.896	N/A		Front	1.477	0.353	1.830	N/A
	Top	-	2.821*	2.821	N/A		Top	-	2.821*	2.821	N/A
	Bottom	2.475	-	2.475	N/A		Bottom	2.855	-	2.855	N/A
	Right	-	-	0.000	N/A		Right	-	-	0.000	N/A
	Left	0.794	0.548	1.342	N/A		Left	0.923	0.548	1.471	N/A
Simult Tx	Configuration	LTE Band 66 (AWS) SAR (W/kg)	5 GHz WLAN MIMO SAR (W/kg)	Σ SAR (W/kg)	SPLSR	Simult Tx	Configuration	LTE Band 25 (PCS) SAR (W/kg)	5 GHz WLAN MIMO SAR (W/kg)	Σ SAR (W/kg)	SPLSR
		1	2	1+2	1+2			1	2	1+2	1+2
Phablet SAR	Back	1.356	2.821	See Note 1	0.07	Phablet SAR	Back	1.443	2.821	See Note 1	0.07
	Front	1.386	0.353	1.739	N/A		Front	1.534	0.353	1.887	N/A
	Top	-	2.821*	2.821	N/A		Top	-	2.821*	2.821	N/A
	Bottom	2.166	-	2.166	N/A		Bottom	3.199	-	3.199	N/A
	Right	-	-	0.000	N/A		Right	-	-	0.000	N/A
	Left	0.720	0.548	1.268	N/A		Left	0.779	0.548	1.327	N/A

Note 1: No evaluation was performed to determine the aggregate 10g SAR for these configurations as the SPLSR ratio between the antenna pairs was not greater than 0.10 per FCC KDB 447498 D01v06. See Section 12.7 for detailed SPLS ratio analysis.

FCC ID ZNFG710VM	 PCTEST ENGINEERING LABORATORY, INC.	SAR EVALUATION REPORT	 LG	Approved by: Quality Manager
Document S/N: 1M1804030062-01-R2.ZNF	Test Dates: 04/02/18 - 04/15/18	DUT Type: Portable Handset	Page 111 of 126	

12.7 SPLSR Evaluation and Analysis

Per FCC KDB Publication 447498 D01v06, when the sum of the standalone transmitters is more than 1.6 W/kg for 1g, the SAR sum to peak locations can be analyzed to determine SAR distribution overlaps. When the SAR peak to location ratio (shown below) for each pair of antennas is ≤ 0.04 for 1g and ≤ 0.10 , simultaneous SAR evaluation is not required. The distance between the transmitters was calculated using the following formula.

$$\text{Distance}_{\text{Tx1-Tx2}} = R_i = \sqrt{(x_1 - x_2)^2 + (y_1 - y_2)^2}$$

$$\text{SPLS Ratio} = \frac{(SAR_1 + SAR_2)^{1.5}}{R_i}$$

12.7.1 Body-Worn Back Side SPLSR Evaluation and Analysis

Table 12-14
Peak SAR Locations for Body-Worn Back Side

Mode/Band	x (mm)	y (mm)	Reported SAR (W/kg)
5 GHz WLAN Ant 2	12.00	53.00	1.041
5 GHz WLAN MIMO	11.00	51.00	1.137
CDMA BC0	-5.00	-72.00	0.521
UMTS 1750	-15.50	-78.50	0.509
UMTS 1900	-25.00	-73.50	0.590
LTE Band 12	-11.50	-72.00	0.516
LTE Band 13	-11.50	-72.00	0.588
LTE Band 66	-7.50	-80.00	0.473
LTE Band 41	-16.70	-67.20	0.598

Table 12-15
Body-Worn Back Side SAR to Peak Location Separation Ratio Calculations

Antenna Pair		Standalone SAR (W/kg)		Standalone SAR Sum (W/kg)	Peak SAR Separation Distance (mm)	SPLS Ratio	Plot Number
Ant "a"	Ant "b"	a	b	a+b	D _{a-b}	(a+b) ^{1.5} /D _{a-b}	
5 GHz WLAN Ant 2	UMTS 1900	1.041	0.590	1.631	131.80	0.02	1
5 GHz WLAN Ant 2	LTE Band 13	1.041	0.588	1.629	127.19	0.02	2
5 GHz WLAN Ant 2	LTE Band 41	1.041	0.598	1.639	123.58	0.02	3
5 GHz WLAN MIMO	CDMA BC0	1.137	0.521	1.658	124.04	0.02	4
5 GHz WLAN MIMO	UMTS 1750	1.137	0.509	1.646	132.18	0.02	5
5 GHz WLAN MIMO	UMTS 1900	1.137	0.590	1.727	129.60	0.02	6
5 GHz WLAN MIMO	LTE Band 12	1.137	0.516	1.653	125.04	0.02	7
5 GHz WLAN MIMO	LTE Band 13	1.137	0.588	1.725	125.04	0.02	8
5 GHz WLAN MIMO	LTE Band 66	1.137	0.473	1.610	132.30	0.02	9
5 GHz WLAN MIMO	LTE Band 41	1.137	0.598	1.735	121.40	0.02	10





FCC ID ZNFG710VM	 PCTEST ENGINEERING LABORATORY, INC.	SAR EVALUATION REPORT		Approved by: Quality Manager
Document S/N: 1M1804030062-01-R2.ZNF	Test Dates: 04/02/18 - 04/15/18	DUT Type: Portable Handset	Page 112 of 126	

Table 12-16
Body-Worn Back Side SAR to Peak Location Separation Ratio Plots



FCC ID ZNFG710VM	PCTEST ENGINEERING LABORATORY, INC.	SAR EVALUATION REPORT	LG	Approved by: Quality Manager
Document S/N: 1M1804030062-01-R2.ZNF	Test Dates: 04/02/18 - 04/15/18	DUT Type: Portable Handset		Page 113 of 126

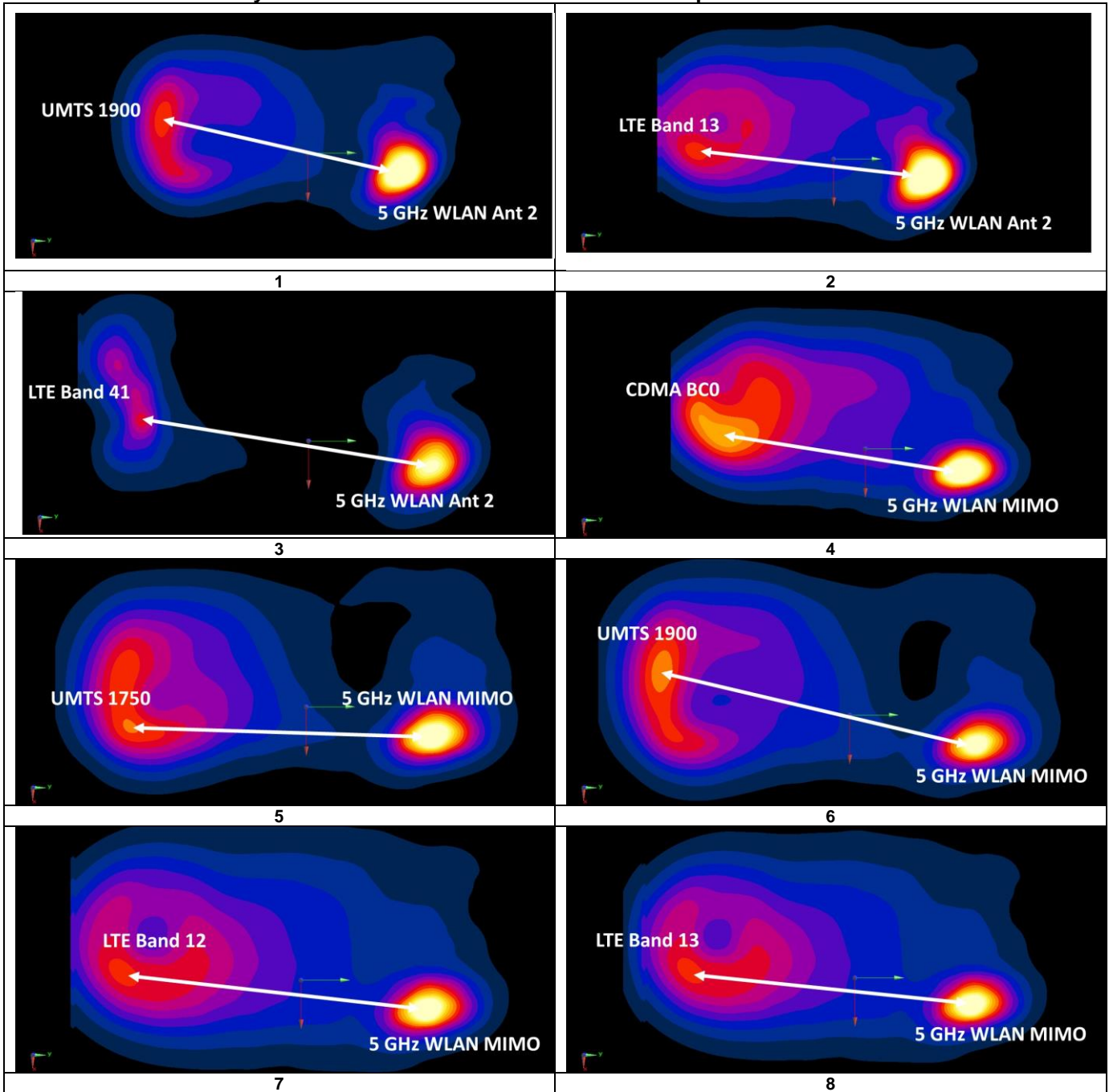
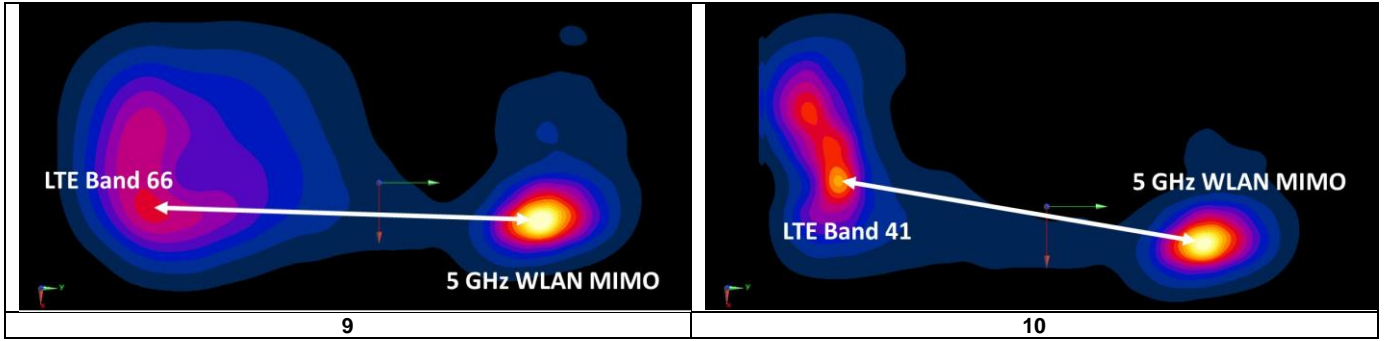

FCC ID ZNFG710VM	 PCTEST <small>ENGINEERING LABORATORY, INC.</small>	SAR EVALUATION REPORT		Approved by: Quality Manager
Document S/N: 1M1804030062-01-R2.ZNF	Test Dates: 04/02/18 - 04/15/18	DUT Type: Portable Handset		Page 114 of 126



12.7.2 Phablet Back Side SPLSR Evaluation and Analysis

Table 12-17
Peak SAR Locations for Phablet Back Side

Mode/Band	x (mm)	y (mm)	Reported SAR (W/kg)
5 GHz WLAN Ant 2	13.00	50.00	2.566
5 GHz WLAN MIMO	12.00	50.00	2.821
UMTS 1750	-9.00	-78.50	1.340
UMTS 1900	-10.00	-72.00	1.368
LTE Band 66 (AWS)	-10.50	-78.50	1.356
LTE Band 25 (PCS)	-7.00	-70.50	1.443

Table 12-18
Phablet Back Side SAR to Peak Location Separation Ratio Calculations

Antenna Pair		Standalone SAR (W/kg)		Standalone SAR Sum (W/kg)	Peak SAR Separation Distance (mm)	SPLSR Ratio	Plot Number
Ant "a"	Ant "b"	a	b	a+b	D _{a-b}	$(a+b)^{1.5}/D_{a-b}$	
5 GHz WLAN Ant 2	LTE Band 25 (PCS)	2.566	1.443	4.009	122.15	0.07	1
5 GHz WLAN MIMO	UMTS 1750	2.821	1.340	4.161	130.20	0.07	2
5 GHz WLAN MIMO	UMTS 1900	2.821	1.368	4.189	123.97	0.07	3
5 GHz WLAN MIMO	LTE Band 66 (AWS)	2.821	1.356	4.177	130.45	0.07	4
5 GHz WLAN MIMO	LTE Band 25 (PCS)	2.821	1.443	4.264	121.99	0.07	5

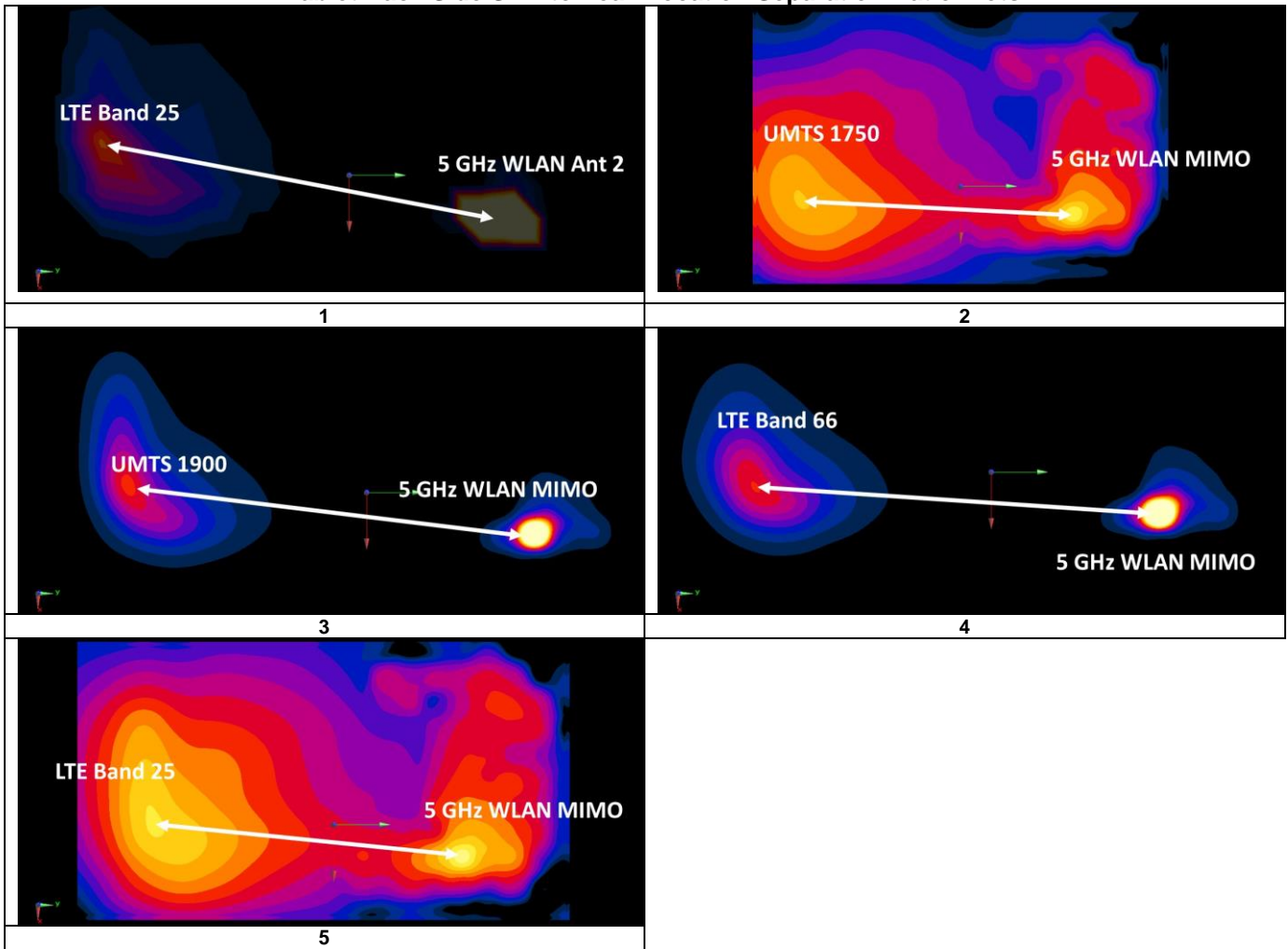

FCC ID ZNFG710VM	 PCTEST ENGINEERING LABORATORY, INC.	SAR EVALUATION REPORT		Approved by: Quality Manager
Document S/N: 1M1804030062-01-R2.ZNF	Test Dates: 04/02/18 - 04/15/18	DUT Type: Portable Handset		Page 115 of 126

**Table 12-19
Phablet Back Side SAR to Peak Location Separation Ratio Plots**



12.8 Simultaneous Transmission Conclusion

The above numerical summed SAR results and SPLSR analysis are sufficient to determine that simultaneous transmission cases will not exceed the SAR limit and therefore no measured volumetric simultaneous SAR summation is required per FCC KDB Publication 447498 D01v06 and IEEE 1528- 2013 Section 6.3.4.1.

FCC ID ZNFG710VM	 PCTEST <small>ENGINEERING LABORATORY, INC.</small>	SAR EVALUATION REPORT		Approved by: Quality Manager
Document S/N: 1M1804030062-01-R2.ZNF	Test Dates: 04/02/18 - 04/15/18	DUT Type: Portable Handset	Page 116 of 126	

13 SAR MEASUREMENT VARIABILITY

13.1 Measurement Variability



Per FCC KDB Publication 865664 D01v01r04, SAR measurement variability was assessed for each frequency band, which was determined by the SAR probe calibration point and tissue-equivalent medium used for the device measurements. When both head and body tissue-equivalent media were required for SAR measurements in a frequency band, the variability measurement procedures were applied to the tissue medium with the highest measured SAR, using the highest measured SAR configuration for that tissue-equivalent medium. These additional measurements were repeated after the completion of all measurements requiring the same head or body tissue-equivalent medium in a frequency band. The test device was returned to ambient conditions (normal room temperature) with the battery fully charged before it was re-mounted on the device holder for the repeated measurement(s) to minimize any unexpected variations in the repeated results.

SAR Measurement Variability was assessed using the following procedures for each frequency band:

- 1) When the original highest measured SAR is ≥ 0.80 W/kg, the measurement was repeated once.
- 2) A second repeated measurement was performed only if the ratio of largest to smallest SAR for the original and first repeated measurements was > 1.20 or when the original or repeated measurement was ≥ 1.45 W/kg (~ 10% from the 1g SAR limit).
- 3) A third repeated measurement was performed only if the original, first or second repeated measurement was ≥ 1.5 W/kg and the ratio of largest to smallest SAR for the original, first and second repeated measurements is > 1.20 .
- 4) Repeated measurements are not required when the original highest measured SAR is < 0.80 W/kg
- 5) When 10g SAR measurement is considered, a factor of 2.5 is applied to the thresholds above.

**Table 13-1
Body SAR Measurement Variability Results**

BODY VARIABILITY RESULTS														
Band	FREQUENCY		Mode	Service	Data Rate (Mbps)	Side	Spacing	Measured SAR (1g)	1st Repeated SAR (1g)	Ratio	2nd Repeated SAR (1g)	Ratio	3rd Repeated SAR (1g)	Ratio
	MHz	Ch.						(W/kg)	(W/kg)		(W/kg)		(W/kg)	
1750	1752.60	1513	UMTS 1750	RMC	N/A	bottom	10 mm	0.891	0.890	1.00	N/A	N/A	N/A	N/A
1900	1907.60	9538	UMTS 1900	RMC	N/A	bottom	10 mm	1.240	1.210	1.02	N/A	N/A	N/A	N/A
2450	2506.00	39750	LTE Band 41 PC2, 20 MHz Bandwidth	QPSK, 1 RB, 99 RB Offset	N/A	bottom	10 mm	0.889	0.886	1.00	N/A	N/A	N/A	N/A
5250	5280.00	56	802.11n, 20 MHz Bandwidth	OFDM, MIMO	13	back	10 mm	0.954	0.963	1.01	N/A	N/A	N/A	N/A
5600	5600.00	120	802.11n, 20 MHz Bandwidth	OFDM, MIMO	13	back	10 mm	0.901	0.828	1.09	N/A	N/A	N/A	N/A
ANSI / IEEE C95.1 1992 - SAFETY LIMIT Spatial Peak Uncontrolled Exposure/General Population							Body 1.6 W/kg (mW/g) averaged over 1 gram							



FCC ID ZNFG710VM	 PCTEST ENGINEERING LABORATORY, INC.	SAR EVALUATION REPORT	 LG	Approved by: Quality Manager
Document S/N: 1M1804030062-01-R2.ZNF	Test Dates: 04/02/18 - 04/15/18	DUT Type: Portable Handset	Page 117 of 126	

**Table 13-2
Phablet SAR Measurement Variability Results**

PHABLET VARIABILITY RESULTS														
Band	FREQUENCY		Mode	Service	Data Rate (Mbps)	Side	Spacing	Measured SAR (10g)	1st Repeated SAR (10g)	Ratio	2nd Repeated SAR (10g)	Ratio	3rd Repeated SAR (10g)	Ratio
	MHz	Ch.						(W/kg)	(W/kg)		(W/kg)		(W/kg)	
1750	1752.60	1513	UMTS 1750	RMC	N/A	bottom	0 mm	2.300	2.170	1.06	N/A	N/A	N/A	N/A
1900	1905.00	26590	LTE Band 25 (PCS), 20 MHz Bandwidth	QPSK, 1 RB, 0 RB Offset	N/A	bottom	0 mm	3.170	3.140	1.01	N/A	N/A	N/A	N/A
5250	5280.00	56	802.11n, 20 MHz Bandwidth	OFDM, MIMO	13	back	0 mm	2.390	2.220	1.08	N/A	N/A	N/A	N/A
5600	5600.00	120	802.11n, 20 MHz Bandwidth	OFDM, MIMO	13	back	0 mm	2.220	2.210	1.00	N/A	N/A	N/A	N/A
ANSI / IEEE C95.1 1992 - SAFETY LIMIT Spatial Peak Uncontrolled Exposure/General Population							Phablet 4.0 W/kg (mW/g) averaged over 10 grams							

13.2 Measurement Uncertainty

The measured SAR was <1.5 W/kg for 1g and <3.75 W/kg for 10g for all frequency bands. Therefore, per KDB Publication 865664 D01v01r04, the extended measurement uncertainty analysis per IEEE 1528-2013 was not required.

FCC ID ZNFG710VM	 PCTEST ENGINEERING LABORATORY, INC.	SAR EVALUATION REPORT	 LG	Approved by: Quality Manager
Document S/N: 1M1804030062-01-R2.ZNF	Test Dates: 04/02/18 - 04/15/18	DUT Type: Portable Handset	Page 118 of 126	

14 ADDITIONAL TESTING PER FCC GUIDANCE

14.1 LTE Band 41 Power Class 2 and Power Class 3 Linearity

This device supports Power Class 2 and Power Class 3 operations for LTE Band 41. The highest available duty cycle for Power Class 2 operations is 43.3 % using UL-DL configuration 1. Per May 2017 TCB Workshop Notes based on the device behavior, all SAR tests were performed using Power Class 3. SAR with Power Class 2 at the highest power and available duty factor was additionally performed for the Power Class 3 configuration with the highest SAR for each exposure condition. The linearity between the Power Class 2 and Power Class 3 SAR results and the respective frame averaged powers was calculated to determine that the results were linear. Per May 2017 TCB Workshop, no additional SAR measurements were required since the linearity between power classes as < 10% and all reported SAR values were < 1.4 W/kg for 1g and < 3.5 W/kg for 10g.

LTE Band 41 SAR testing with power class 2 at the highest power and available duty factor was additionally performed for the power class 3 configuration with the highest SAR for each exposure condition.

**Table 14-1
LTE Band 41 Head Linearity Data**

	LTE Band 41 PC3	LTE Band 41 PC2
Maximum Allowed Output Power (dBm)	25.2	27.7
Measured Output Power (dBm)	25.09	27.46
Measured SAR (W/kg)	0.038	0.041
Measured Power (mW)	322.85	557.19
Duty Cycle	63.3%	43.3%
Frame Averaged Output Power (mW)	204.36	241.26
% deviation from expected linearity		-8.62%

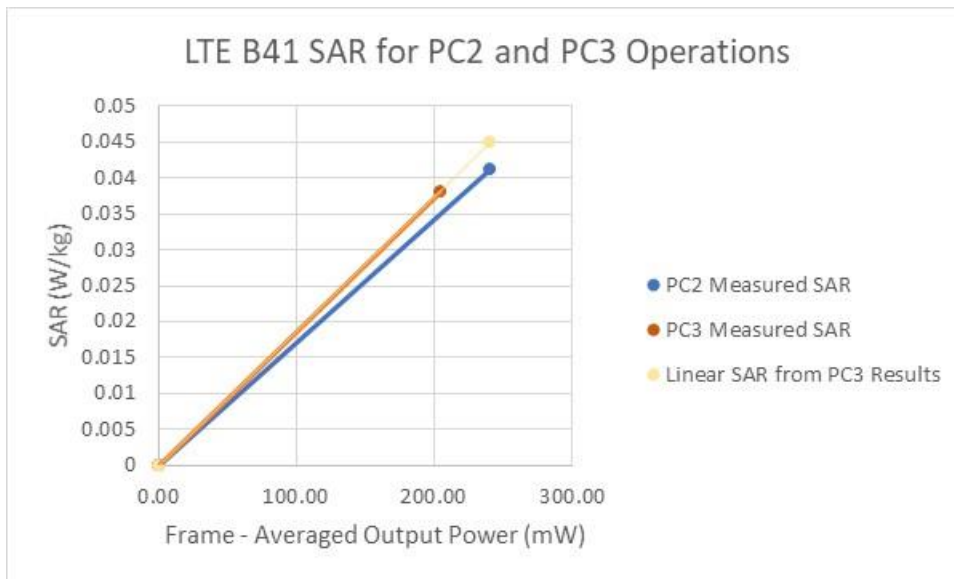
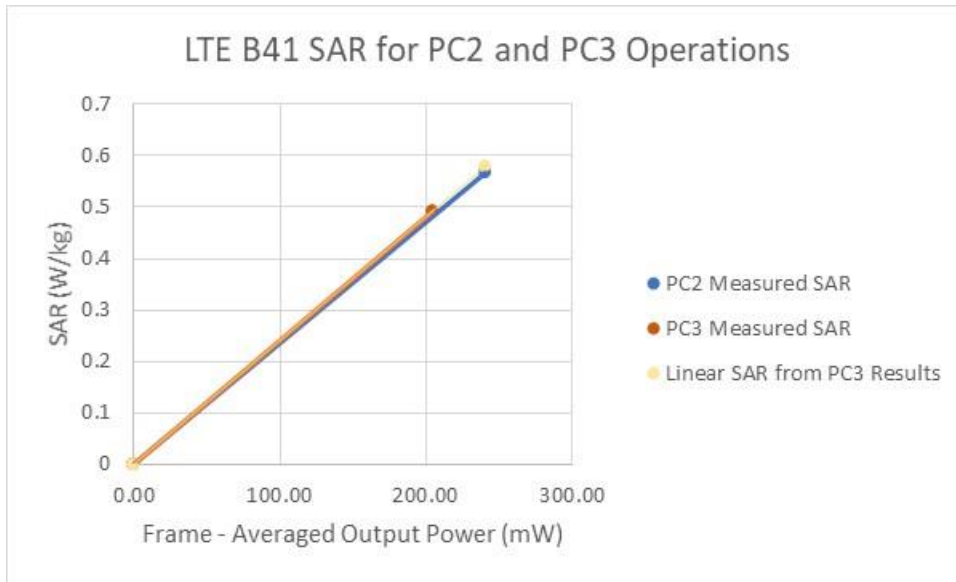

**Figure 14-1
LTE Band 41 Head Linearity**



FCC ID ZNFG710VM	PCTEST ENGINEERING LABORATORY, INC.	SAR EVALUATION REPORT	LG	Approved by: Quality Manager
Document S/N: 1M1804030062-01-R2.ZNF	Test Dates: 04/02/18 - 04/15/18	DUT Type: Portable Handset		Page 119 of 126

**Table 14-2
LTE Band 41 Body-Worn Linearity Data**

	LTE Band 41 PC3	LTE Band 41 PC2
Maximum Allowed Output Power (dBm)	25.2	27.7
Measured Output Power (dBm)	25.09	27.46
Measured SAR (W/kg)	0.491	0.566
Measured Power (mW)	322.85	557.19
Duty Cycle	63.3%	43.3%
Frame Averaged Output Power (mW)	204.36	241.26
% deviation from expected linearity		-2.35%

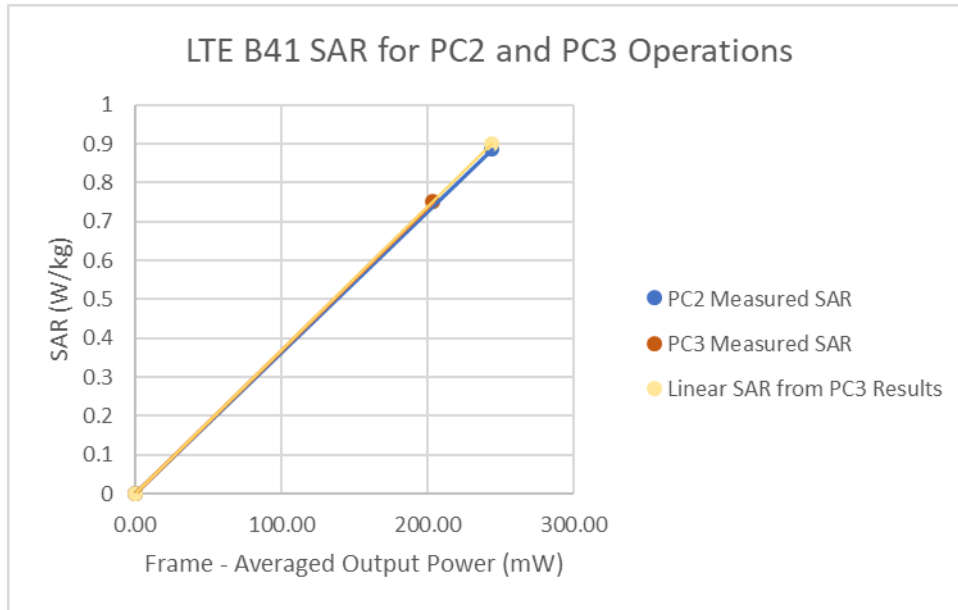

**Figure 14-2
LTE Band 41 Body-Worn Linearity**



FCC ID ZNFG710VM	 PCTEST <small>ENGINEERING LABORATORY, INC.</small>	SAR EVALUATION REPORT		Approved by: Quality Manager
Document S/N: 1M1804030062-01-R2.ZNF	Test Dates: 04/02/18 - 04/15/18	DUT Type: Portable Handset	Page 120 of 126	

**Table 14-3
LTE Band 41 Hotspot Linearity Data**

	LTE Band 41 PC3	LTE Band 41 PC2
Maximum Allowed Output Power (dBm)	25.2	27.7
Measured Output Power (dBm)	25.08	27.51
Measured SAR (W/kg)	0.751	0.886
Measured Power (mW)	322.11	563.64
Duty Cycle	63.3%	43.3%
Frame Averaged Output Power (mW)	203.89	244.06
% deviation from expected linearity		-1.44%





**Figure 14-3
LTE Band 41 Hotspot Linearity**

FCC ID ZNFG710VM	 PCTEST <small>ENGINEERING LABORATORY, INC.</small>	SAR EVALUATION REPORT		Approved by: Quality Manager
Document S/N: 1M1804030062-01-R2.ZNF	Test Dates: 04/02/18 - 04/15/18	DUT Type: Portable Handset	Page 121 of 126	

15 EQUIPMENT LIST



Manufacturer	Model	Description	Cal Date	Cal Interval	Cal Due	Serial Number
Agilent	8594A	(9kHz-2.9GHz) Spectrum Analyzer	N/A	N/A	N/A	3051A00187
Agilent	E5515C	8960 Series 10 Wireless Communications Test Set	11/15/2017	Annual	11/15/2018	GB42230325
Agilent	E4438C	ESG Vector Signal Generator	3/21/2017	Biennial	3/21/2019	MY45090700
Agilent	N9020A	MXA Signal Analyzer	1/24/2018	Annual	1/24/2019	US46470561
Agilent	N5182A	MXG Vector Signal Generator	11/1/2017	Annual	11/1/2018	MY47420603
Agilent	8753ES	S-Parameter Network Analyzer	9/14/2017	Annual	9/14/2018	US39170118
Agilent	8753ES	S-Parameter Vector Network Analyzer	8/17/2017	Annual	8/17/2018	MY40003841
Agilent	E5515C	Wireless Communications Test Set	5/31/2017	Annual	5/31/2018	GB43304278
Agilent	E5515C	Wireless Communications Test Set	1/24/2018	Annual	1/24/2019	GB44400860
Agilent	N4010A	Wireless Connectivity Test Set	N/A	N/A	N/A	GB46170464
Agilent	N4010A	Wireless Connectivity Test Set	N/A	N/A	N/A	GB44450273
Amplifier Research	1551G6	Amplifier	CBT	N/A	CBT	433971
Amplifier Research	1551G6	Amplifier	CBT	N/A	CBT	433972
Anritsu	ML2496A	Power Meter	4/20/2017	Annual	4/20/2018	1306009
Anritsu	ML2495A	Power Meter	10/22/2017	Annual	10/22/2018	941001
Anritsu	ML2495A	Power Meter	11/28/2017	Annual	11/28/2018	1039008
Anritsu	MA2411B	Pulse Power Sensor	3/2/2018	Annual	3/2/2019	1207364
Anritsu	MA2411B	Pulse Power Sensor	3/2/2018	Annual	3/2/2019	1339018
Anritsu	MT8820C	Radio Communication Analyzer	5/23/2017	Annual	5/23/2018	6201240328
Anritsu	MT8821C	Radio Communication Analyzer	7/25/2017	Annual	7/25/2018	6201664756
Anritsu	MT8821C	Radio Communication Analyzer	11/17/2017	Annual	11/17/2018	6201381794
Anritsu	MA24106A	USB Power Sensor	6/7/2017	Annual	6/7/2018	1231538
Anritsu	MA24106A	USB Power Sensor	6/7/2017	Annual	6/7/2018	1231535
COMTECH	AR85729-5/5759B	Solid State Amplifier	CBT	N/A	CBT	MBW1A00-1002
Control Company	4040	Therm./ Clock/ Humidity Monitor	1/8/2018	Annual	1/8/2019	160473909
Control Company	4352	Ultra Long Stem Thermometer	1/8/2018	Annual	1/8/2019	160580897
Keysight	772D	Dual Directional Coupler	CBT	N/A	CBT	MY52180215
MCL	BW-N6W5+	6dB Attenuator	CBT	N/A	CBT	1139
Mini Circuits	PWR-4GHS	USB Power Sensor	1/20/2018	Annual	1/20/2019	11710030063
Mini Circuits	PWR-4GHS	USB Power Sensor	1/22/2018	Annual	1/22/2019	11710030062
MiniCircuits	SLP-2400+	Low Pass Filter	CBT	N/A	CBT	R8979500903
MiniCircuits	VLF-6000+	Low Pass Filter	CBT	N/A	CBT	N/A
Mini-Circuits	BW-N20W5+	DC to 18 GHz Precision Fixed 20 dB Attenuator	CBT	N/A	CBT	N/A
Mini-Circuits	NLP-1200+	Low Pass Filter DC to 1000 MHz	CBT	N/A	CBT	N/A
Mini-Circuits	NLP-2950+	Low Pass Filter DC to 2700 MHz	CBT	N/A	CBT	N/A
Mini-Circuits	BW-N20W5	Power Attenuator	CBT	N/A	CBT	1226
Narda	4014C-6	4 - 8 GHz SMA 6 dB Directional Coupler	CBT	N/A	CBT	N/A
Narda	4772-3	Attenuator (3dB)	CBT	N/A	CBT	9406
Pasternack	PE2208-6	Bidirectional Coupler	CBT	N/A	CBT	N/A
Pasternack	PE2209-10	Bidirectional Coupler	CBT	N/A	CBT	N/A
Pasternack	PE5011-1	Torque Wrench	7/19/2017	Biennial	7/19/2019	N/A
Rohde & Schwarz	CMW500	Radio Communication Tester	5/4/2017	Annual	5/4/2018	112347
Rohde & Schwarz	CMW500	Radio Communication Tester	5/4/2017	Annual	5/4/2018	101699
Rohde & Schwarz	CMW500	Wideband Radio Communication Tester	7/20/2017	Annual	7/20/2018	132885
Rohde & Schwarz	CMW500	Wideband Radio Communication Tester	1/19/2018	Annual	1/19/2019	164948
Seekonk	NC-100	Torque Wrench (8" lb)	8/30/2016	Biennial	8/30/2018	N/A
SPEAG	D1750V2	1750 MHz SAR Dipole	5/9/2017	Annual	5/9/2018	1148
SPEAG	D1900V2	1900 MHz SAR Dipole	2/7/2018	Annual	2/7/2019	5d148
SPEAG	D2450V2	2450 MHz SAR Dipole	9/11/2017	Annual	9/11/2018	797
SPEAG	D2600V2	2600 MHz SAR Dipole	7/10/2017	Annual	7/10/2018	1126
SPEAG	D5GHzV2	5 GHz SAR Dipole	8/15/2017	Annual	8/15/2018	1237
SPEAG	D5GHzV2	5 GHz SAR Dipole	9/21/2016	Biennial	9/21/2018	1191
SPEAG	D750V3	750 MHz SAR Dipole	1/15/2018	Annual	1/15/2019	1003
SPEAG	D835V2	835 MHz SAR Dipole	1/15/2018	Annual	1/15/2019	4d132
SPEAG	DAE4	Dasy Data Acquisition Electronics	6/14/2017	Annual	6/14/2018	1334
SPEAG	DAE4	Dasy Data Acquisition Electronics	6/21/2017	Annual	6/21/2018	1333
SPEAG	DAE4	Dasy Data Acquisition Electronics	7/13/2017	Annual	7/13/2018	1322
SPEAG	DAE4	Dasy Data Acquisition Electronics	8/9/2017	Annual	8/9/2018	1323
SPEAG	DAE4	Dasy Data Acquisition Electronics	2/9/2018	Annual	2/9/2019	1272
SPEAG	DAE4	Dasy Data Acquisition Electronics	2/15/2018	Annual	2/15/2019	665
SPEAG	DAE4	Dasy Data Acquisition Electronics	3/7/2018	Annual	3/7/2019	1368
SPEAG	DAK-3.5	Dielectric Assessment Kit	9/12/2017	Annual	9/12/2018	1091
SPEAG	EX3DV4	SAR Probe	7/17/2017	Annual	7/17/2018	7410
SPEAG	ES3DV3	SAR Probe	8/14/2017	Annual	8/14/2018	3332
SPEAG	EX3DV4	SAR Probe	8/16/2017	Annual	8/16/2018	7308
SPEAG	ES3DV3	SAR Probe	9/18/2017	Annual	9/18/2018	3287
SPEAG	EX3DV4	SAR Probe	1/16/2018	Annual	1/16/2019	3589
SPEAG	ES3DV3	SAR Probe	2/13/2018	Annual	2/13/2019	3213
SPEAG	EX3DV4	SAR Probe	2/14/2018	Annual	2/14/2019	3914
SPEAG	ES3DV3	SAR Probe	3/13/2018	Annual	3/13/2019	3319

Note: CBT (Calibrated Before Testing). Prior to testing, the measurement paths containing a cable, amplifier, attenuator, coupler or filter were connected to a calibrated source (i.e. a signal generator) to determine the losses of the measurement path. The power meter offset was then adjusted to compensate for the measurement system losses. This level offset is stored within the power meter before measurements are made. This calibration verification procedure applies to the system verification and output power measurements. The calibrated reading is then taken directly from the power meter after compensation of the losses for all final power measurements.

FCC ID ZNFG710VM	 PCTEST ENGINEERING LABORATORY, INC.	SAR EVALUATION REPORT	 LG	Approved by: Quality Manager
Document S/N: 1M1804030062-01-R2.ZNF	Test Dates: 04/02/18 - 04/15/18	DUT Type: Portable Handset	Page 122 of 126	

16 MEASUREMENT UNCERTAINTIES

a	c	d	e= f(d,k)	f	g	h = c x f/e	i = c x g/e	k
Uncertainty Component	Tol. (± %)	Prob. Dist.	Div.	c _i 1gm	c _i 10 gms	1gm u _i (± %)	10gms u _i (± %)	v _i
Measurement System								
Probe Calibration	6.55	N	1	1.0	1.0	6.6	6.6	∞
Axial Isotropy	0.25	N	1	0.7	0.7	0.2	0.2	∞
Hemishperical Isotropy	1.3	N	1	0.7	0.7	0.9	0.9	∞
Boundary Effect	2.0	R	1.73	1.0	1.0	1.2	1.2	∞
Linearity	0.3	N	1	1.0	1.0	0.3	0.3	∞
System Detection Limits	0.25	R	1.73	1.0	1.0	0.1	0.1	∞
Readout Electronics	0.3	N	1	1.0	1.0	0.3	0.3	∞
Response Time	0.8	R	1.73	1.0	1.0	0.5	0.5	∞
Integration Time	2.6	R	1.73	1.0	1.0	1.5	1.5	∞
RF Ambient Conditions - Noise	3.0	R	1.73	1.0	1.0	1.7	1.7	∞
RF Ambient Conditions - Reflections	3.0	R	1.73	1.0	1.0	1.7	1.7	∞
Probe Positioner Mechanical Tolerance	0.4	R	1.73	1.0	1.0	0.2	0.2	∞
Probe Positioning w/ respect to Phantom	6.7	R	1.73	1.0	1.0	3.9	3.9	∞
Extrapolation, Interpolation & Integration algorithms for Max. SAR Evaluation	4.0	R	1.73	1.0	1.0	2.3	2.3	∞
Test Sample Related								
Test Sample Positioning	2.7	N	1	1.0	1.0	2.7	2.7	35
Device Holder Uncertainty	1.67	N	1	1.0	1.0	1.7	1.7	5
Output Power Variation - SAR drift measurement	5.0	R	1.73	1.0	1.0	2.9	2.9	∞
SAR Scaling	0.0	R	1.73	1.0	1.0	0.0	0.0	∞
Phantom & Tissue Parameters								
Phantom Uncertainty (Shape & Thickness tolerances)	7.6	R	1.73	1.0	1.0	4.4	4.4	∞
Liquid Conductivity - measurement uncertainty	4.2	N	1	0.78	0.71	3.3	3.0	10
Liquid Permittivity - measurement uncertainty	4.1	N	1	0.23	0.26	1.0	1.1	10
Liquid Conductivity - Temperature Uncertainty	3.4	R	1.73	0.78	0.71	1.5	1.4	∞
Liquid Permittivity - Temperature Uncertainty	0.6	R	1.73	0.23	0.26	0.1	0.1	∞
Liquid Conductivity - deviation from target values	5.0	R	1.73	0.64	0.43	1.8	1.2	∞
Liquid Permittivity - deviation from target values	5.0	R	1.73	0.60	0.49	1.7	1.4	∞
Combined Standard Uncertainty (k=1)	RSS					11.5	11.3	60
Expanded Uncertainty (95% CONFIDENCE LEVEL)	k=2					23.0	22.6	



FCC ID ZNFG710VM	 PCTEST ENGINEERING LABORATORY, INC.	SAR EVALUATION REPORT		Approved by: Quality Manager
Document S/N: 1M1804030062-01-R2.ZNF	Test Dates: 04/02/18 - 04/15/18	DUT Type: Portable Handset		Page 123 of 126

17 CONCLUSION

17.1 Measurement Conclusion



The SAR evaluation indicates that the EUT complies with the RF radiation exposure limits of the FCC and Innovation, Science, and Economic Development Canada, with respect to all parameters subject to this test. These measurements were taken to simulate the RF effects of RF exposure under worst-case conditions. Precise laboratory measures were taken to assure repeatability of the tests. The results and statements relate only to the item(s) tested.

Please note that the absorption and distribution of electromagnetic energy in the body are very complex phenomena that depend on the mass, shape, and size of the body, the orientation of the body with respect to the field vectors, and the electrical properties of both the body and the environment. Other variables that may play a substantial role in possible biological effects are those that characterize the environment (e.g. ambient temperature, air velocity, relative humidity, and body insulation) and those that characterize the individual (e.g. age, gender, activity level, debilitation, or disease). Because various factors may interact with one another to vary the specific biological outcome of an exposure to electromagnetic fields, any protection guide should consider maximal amplification of biological effects as a result of field-body interactions, environmental conditions, and physiological variables. [3]



FCC ID ZNFG710VM	 PCTEST ENGINEERING LABORATORY, INC.	SAR EVALUATION REPORT	 LG	Approved by: Quality Manager
Document S/N: 1M1804030062-01-R2.ZNF	Test Dates: 04/02/18 - 04/15/18	DUT Type: Portable Handset		Page 124 of 126

18 REFERENCES

- [1] Federal Communications Commission, ET Docket 93-62, Guidelines for Evaluating the Environmental Effects of Radiofrequency Radiation, Aug. 1996.
- [2] ANSI/IEEE C95.1-2005, American National Standard safety levels with respect to human exposure to radio frequency electromagnetic fields, 3kHz to 300GHz, New York: IEEE, 2006.
- [3] ANSI/IEEE C95.1-1992, American National Standard safety levels with respect to human exposure to radio frequency electromagnetic fields, 3kHz to 300GHz, New York: IEEE, Sept. 1992.
- [4] ANSI/IEEE C95.3-2002, IEEE Recommended Practice for the Measurement of Potentially Hazardous Electromagnetic Fields - RF and Microwave, New York: IEEE, December 2002.
- [5] IEEE Standards Coordinating Committee 39 –Standards Coordinating Committee 34 – IEEE Std. 1528-2013, IEEE Recommended Practice for Determining the Peak Spatial-Average Specific Absorption Rate (SAR) in the Human Head from Wireless Communications Devices: Measurement Techniques.
- [6] NCRP, National Council on Radiation Protection and Measurements, Biological Effects and Exposure Criteria for RadioFrequency Electromagnetic Fields, NCRP Report No. 86, 1986. Reprinted Feb. 1995.
- [7] T. Schmid, O. Egger, N. Kuster, Automated E-field scanning system for dosimetric assessments, IEEE Transaction on Microwave Theory and Techniques, vol. 44, Jan. 1996, pp. 105-113.
- [8] K. Pokovic, T. Schmid, N. Kuster, Robust setup for precise calibration of E-field probes in tissue simulating liquids at mobile communications frequencies, ICECOM97, Oct. 1997, pp. 1 -124.
- [9] K. Pokovic, T. Schmid, and N. Kuster, E-field Probe with improved isotropy in brain simulating liquids, Proceedings of the ELMAR, Zadar, Croatia, June 23-25, 1996, pp. 172-175.
- [10] Schmid & Partner Engineering AG, Application Note: Data Storage and Evaluation, June 1998, p2.
- [11] V. Hombach, K. Meier, M. Burkhardt, E. Kuhn, N. Kuster, The Dependence of EM Energy Absorption upon Human Modeling at 900 MHz, IEEE Transaction on Microwave Theory and Techniques, vol. 44 no. 10, Oct. 1996, pp. 1865-1873.
- [12] N. Kuster and Q. Balzano, Energy absorption mechanism by biological bodies in the near field of dipole antennas above 300MHz, IEEE Transaction on Vehicular Technology, vol. 41, no. 1, Feb. 1992, pp. 17-23.
- [13] G. Hartsgrrove, A. Kraszewski, A. Surowiec, Simulated Biological Materials for Electromagnetic Radiation Absorption Studies, University of Ottawa, Bioelectromagnetics, Canada: 1987, pp. 29-36.
- [14] Q. Balzano, O. Garay, T. Manning Jr., Electromagnetic Energy Exposure of Simulated Users of Portable Cellular Telephones, IEEE Transactions on Vehicular Technology, vol. 44, no.3, Aug. 1995.
- [15] W. Gander, Computermathematick, Birkhaeuser, Basel, 1992.
- [16] W.H. Press, S.A. Teukolsky, W.T. Vetterling, and B.P. Flannery, Numerical Recipes in C, The Art of Scientific Computing, Second edition, Cambridge University Press, 1992.
- [17] N. Kuster, R. Kastle, T. Schmid, Dosimetric evaluation of mobile communications equipment with known precision, IEEE Transaction on Communications, vol. E80-B, no. 5, May 1997, pp. 645-652.

FCC ID ZNFG710VM	 PCTEST ENGINEERING LABORATORY, INC.	SAR EVALUATION REPORT	 LG	Approved by: Quality Manager
Document S/N: 1M1804030062-01-R2.ZNF	Test Dates: 04/02/18 - 04/15/18	DUT Type: Portable Handset	Page 125 of 126	

- [18] CENELEC CLC/SC111B, European Prestandard (prENV 50166-2), Human Exposure to Electromagnetic Fields High-frequency: 10kHz-300GHz, Jan. 1995.
- [19] Prof. Dr. Niels Kuster, ETH, Eidgenössische Technische Hochschule Zürich, Dosimetric Evaluation of the Cellular Phone.
- [20] IEC 62209-1, Measurement procedure for the assessment of specific absorption rate of human exposure to radio frequency fields from hand-held and body-mounted wireless communication devices - Part 1: Devices used next to the ear (Frequency range of 300 MHz to 6 GHz), July 2016.
- [21] Innovation, Science, Economic Development Canada RSS-102 Radio Frequency Exposure Compliance of Radiocommunication Apparatus (All Frequency Bands) Issue 5, March 2015.
- [22] Health Canada Safety Code 6 Limits of Human Exposure to Radio Frequency Electromagnetic Fields in the Frequency Range from 3 kHz – 300 GHz, 2015
- [23] FCC SAR Test Procedures for 2G-3G Devices, Mobile Hotspot and UMPC Devices KDB Publications 941225, D01-D07
- [24] SAR Measurement Guidance for IEEE 802.11 Transmitters, KDB Publication 248227 D01
- [25] FCC SAR Considerations for Handsets with Multiple Transmitters and Antennas, KDB Publications 648474 D03-D04
- [26] FCC SAR Evaluation Considerations for Laptop, Notebook, Netbook and Tablet Computers, FCC KDB Publication 616217 D04
- [27] FCC SAR Measurement and Reporting Requirements for 100MHz – 6 GHz, KDB Publications 865664 D01-D02
- [28] FCC General RF Exposure Guidance and SAR Procedures for Dongles, KDB Publication 447498, D01-D02
- [29] Anexo à Resolução No. 533, de 10 de Setembro de 2009.
- [30] IEC 62209-2, Human exposure to radio frequency fields from hand-held and body-mounted wireless communication devices - Human models, instrumentation, and procedures - Part 2: Procedure to determine the specific absorption rate (SAR) for wireless communication devices used in close proximity to the human body (frequency range of 30 MHz to 6 GHz), Mar. 2010.

FCC ID ZNFG710VM	 PCTEST ENGINEERING LABORATORY, INC.	SAR EVALUATION REPORT	 LG	Approved by: Quality Manager
Document S/N: 1M1804030062-01-R2.ZNF	Test Dates: 04/02/18 - 04/15/18	DUT Type: Portable Handset	Page 126 of 126	

APPENDIX A: SAR TEST DATA

PCTEST ENGINEERING LABORATORY, INC.

DUT: ZNFG710VM; Type: Portable Handset; Serial: 12256

Communication System: UID 0, Cellular CDMA; Frequency: 820.1 MHz; Duty Cycle: 1:1
Medium: 835 Head Medium parameters used (interpolated):
 $f = 820.1 \text{ MHz}$; $\sigma = 0.903 \text{ S/m}$; $\epsilon_r = 43.021$; $\rho = 1000 \text{ kg/m}^3$
Phantom section: Right Section

Test Date: 04-09-2018; Ambient Temp: 21.5°C; Tissue Temp: 20.7°C

Probe: ES3DV3 - SN3213; ConvF(6.42, 6.42, 6.42); Calibrated: 2/13/2018;
Sensor-Surface: 3mm (Mechanical Surface Detection)
Electronics: DAE4 Sn1272; Calibrated: 2/9/2018
Phantom: SAM 5.0 front; Type: QD000P40CD; Serial: 1648
Measurement SW: DASY52, Version 52.10; SEMCAD X Version 14.6.10 (7417)

Mode: Cell. EVDO Rev. A, Rule Part 90S, Right Head, Cheek, Mid.ch

Area Scan (9x15x1): Measurement grid: $dx=15\text{mm}$, $dy=15\text{mm}$

Zoom Scan (6x5x7)/Cube 0: Measurement grid: $dx=8\text{mm}$, $dy=8\text{mm}$, $dz=5\text{mm}$

Reference Value = 16.95 V/m; Power Drift = -0.07 dB

Peak SAR (extrapolated) = 0.316 W/kg

SAR(1 g) = 0.245 W/kg

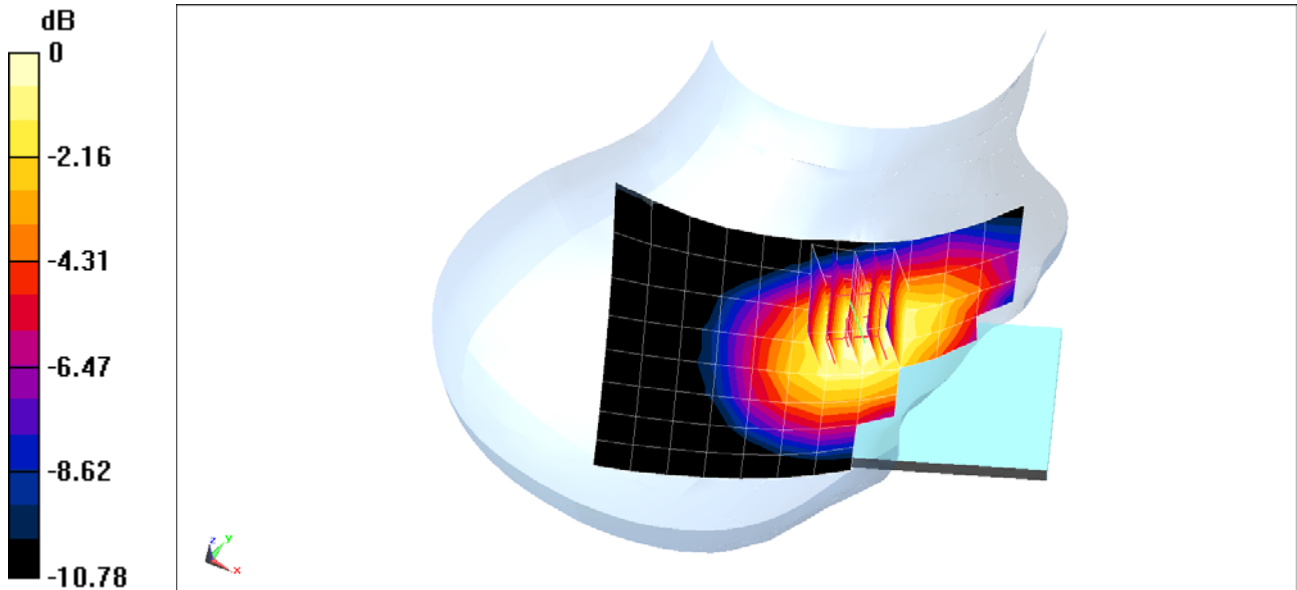

0 dB = 0.265 W/kg = -5.77 dBW/kg

PCTEST ENGINEERING LABORATORY, INC.

DUT: ZNFG710VM; Type: Portable Handset; Serial: 12256

Communication System: UID 0, CDMA; Frequency: 836.52 MHz; Duty Cycle: 1:1
Medium: 835 Head Medium parameters used (interpolated):
 $f = 836.52$ MHz; $\sigma = 0.92$ S/m; $\epsilon_r = 42.808$; $\rho = 1000$ kg/m³
Phantom section: Right Section

Test Date: 04-09-2018; Ambient Temp: 21.5°C; Tissue Temp: 20.7°C

Probe: ES3DV3 - SN3213; ConvF(6.42, 6.42, 6.42); Calibrated: 2/13/2018;
Sensor-Surface: 3mm (Mechanical Surface Detection)
Electronics: DAE4 Sn1272; Calibrated: 2/9/2018
Phantom: SAM 5.0 front; Type: QD000P40CD; Serial: 1648
Measurement SW: DASY52, Version 52.10; SEMCAD X Version 14.6.10 (7417)

Mode: Cell. EVDO Rev. A, Rule Part 22H, Right Head, Cheek, Mid.ch

Area Scan (9x15x1): Measurement grid: dx=15mm, dy=15mm

Zoom Scan (6x5x7)/Cube 0: Measurement grid: dx=8mm, dy=8mm, dz=5mm

Reference Value = 17.03 V/m; Power Drift = 0.00 dB

Peak SAR (extrapolated) = 0.328 W/kg

SAR(1 g) = 0.253 W/kg

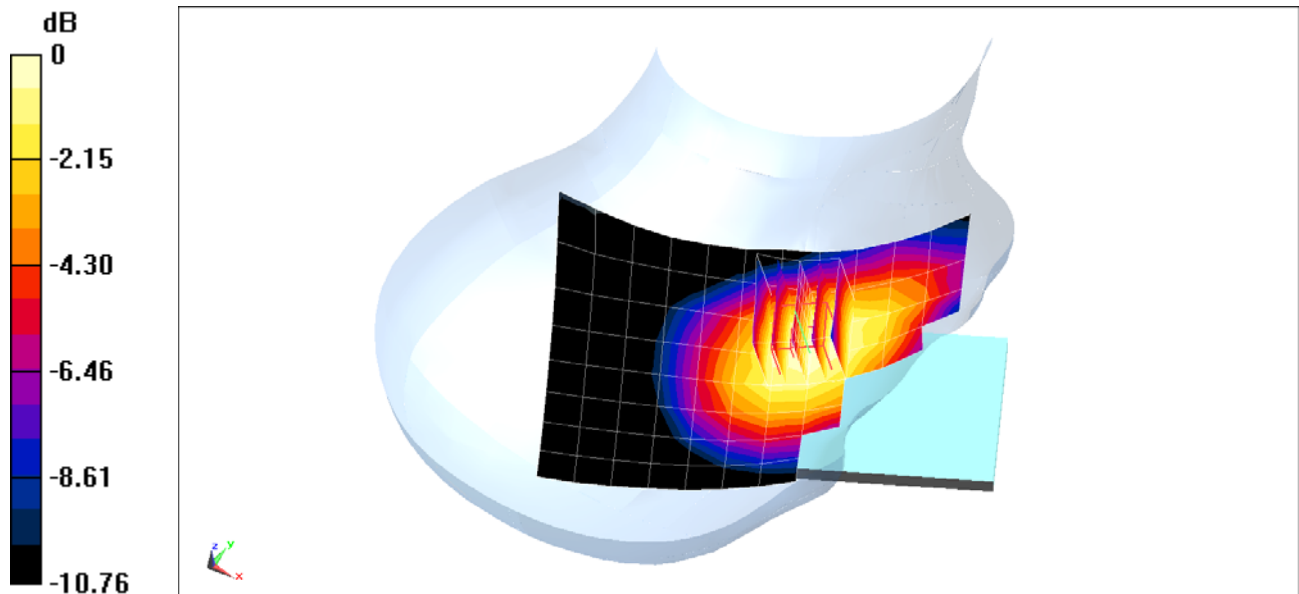

0 dB = 0.275 W/kg = -5.61 dBW/kg

PCTEST ENGINEERING LABORATORY, INC.

DUT: ZNFG710VM; Type: Portable Handset; Serial: 12256

Communication System: UID 0, PCS CDMA; Frequency: 1880 MHz; Duty Cycle: 1:1
Medium: 1900 Head Medium parameters used:
 $f = 1880 \text{ MHz}$; $\sigma = 1.422 \text{ S/m}$; $\epsilon_r = 38.103$; $\rho = 1000 \text{ kg/m}^3$
Phantom section: Left Section

Test Date: 04-13-2018; Ambient Temp: 21.9°C; Tissue Temp: 21.7°C

Probe: EX3DV4 - SN3914; ConvF(7.98, 7.98, 7.98); Calibrated: 2/14/2018;
Sensor-Surface: 1.4mm (Mechanical Surface Detection)
Electronics: DAE4 Sn665; Calibrated: 2/15/2018
Phantom: Twin-SAM V5.0 left; Type: QD 000 P40 CD; Serial: 1692
Measurement SW: DASY52, Version 52.10; SEMCAD X Version 14.6.10 (7417)

Mode: PCS CDMA, Left Head, Cheek, Mid.ch

Area Scan (9x15x1): Measurement grid: dx=15mm, dy=15mm

Zoom Scan (5x5x7)/Cube 0: Measurement grid: dx=8mm, dy=8mm, dz=5mm

Reference Value = 9.912 V/m; Power Drift = 0.16 dB

Peak SAR (extrapolated) = 0.219 W/kg

SAR(1 g) = 0.128 W/kg

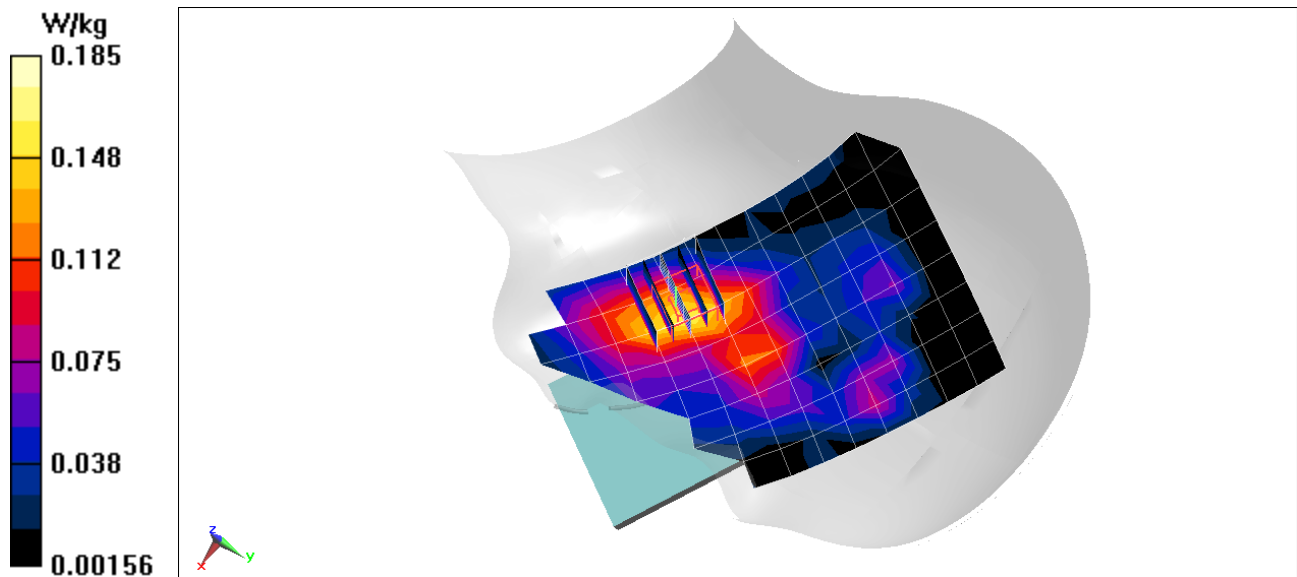

PCTEST ENGINEERING LABORATORY, INC.

DUT: ZNFG710VM; Type: Portable Handset; Serial: 12256

Communication System: UID 0, GSM GPRS; 2 Tx slots; Frequency: 836.6 MHz; Duty Cycle: 1:4.15
Medium: 835 Head Medium parameters used (interpolated):
 $f = 836.6 \text{ MHz}$; $\sigma = 0.92 \text{ S/m}$; $\epsilon_r = 42.807$; $\rho = 1000 \text{ kg/m}^3$
Phantom section: Right Section

Test Date: 04-09-2018; Ambient Temp: 21.5°C; Tissue Temp: 20.7°C

Probe: ES3DV3 - SN3213; ConvF(6.42, 6.42, 6.42); Calibrated: 2/13/2018;
Sensor-Surface: 3mm (Mechanical Surface Detection)
Electronics: DAE4 Sn1272; Calibrated: 2/9/2018
Phantom: SAM 5.0 front; Type: QD000P40CD; Serial: 1648
Measurement SW: DASY52, Version 52.10; SEMCAD X Version 14.6.10 (7417)

Mode: GPRS 850, Right Head, Cheek, Mid.ch, 2 Tx slots

Area Scan (9x15x1): Measurement grid: $dx=15\text{mm}$, $dy=15\text{mm}$
Zoom Scan (5x5x7)/Cube 0: Measurement grid: $dx=8\text{mm}$, $dy=8\text{mm}$, $dz=5\text{mm}$
Reference Value = 12.41 V/m; Power Drift = 0.14 dB
Peak SAR (extrapolated) = 0.175 W/kg
SAR(1 g) = 0.137 W/kg

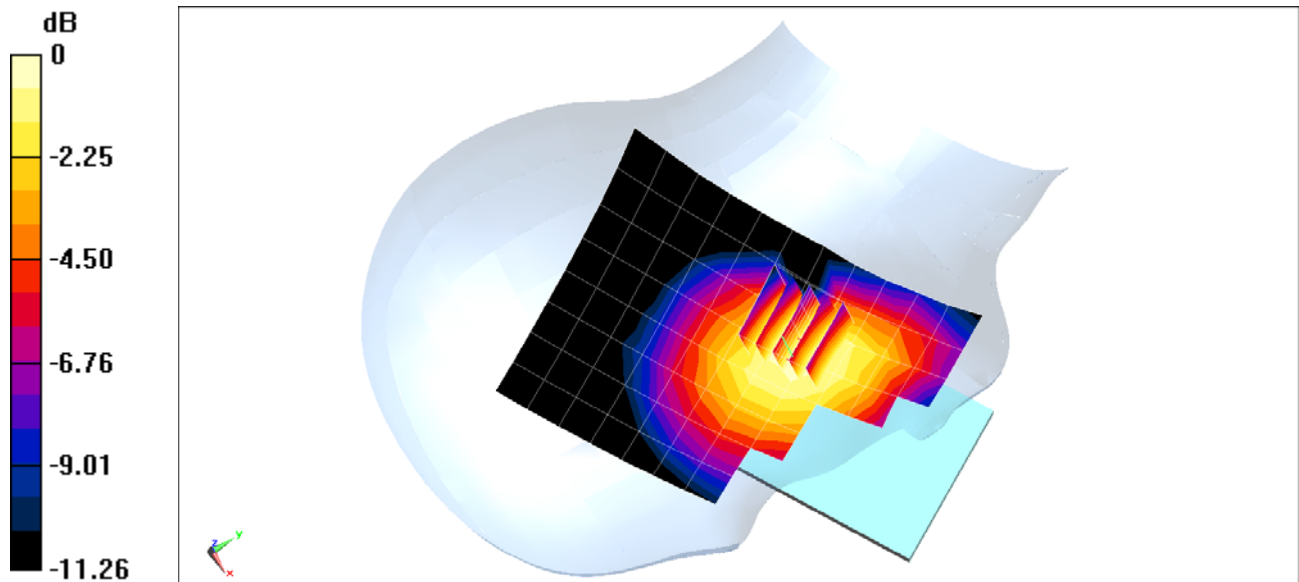

0 dB = 0.150 W/kg = -8.24 dBW/kg

PCTEST ENGINEERING LABORATORY, INC.

DUT: ZNFG710VM; Type: Portable Handset; Serial: 12256

Communication System: UID 0, GSM GPRS; 2 Tx slots; Frequency: 1880 MHz; Duty Cycle: 1:4.15

Medium: 1900 Head Medium parameters used:

$f = 1880 \text{ MHz}$; $\sigma = 1.422 \text{ S/m}$; $\epsilon_r = 38.103$; $\rho = 1000 \text{ kg/m}^3$

Phantom section: Left Section

Test Date: 04-13-2018; Ambient Temp: 21.9°C; Tissue Temp: 21.7°C

Probe: EX3DV4 - SN3914; ConvF(7.98, 7.98, 7.98); Calibrated: 2/14/2018;

Sensor-Surface: 1.4mm (Mechanical Surface Detection)

Electronics: DAE4 Sn665; Calibrated: 2/15/2018

Phantom: Twin-SAM V5.0 left; Type: QD 000 P40 CD; Serial: 1692

Measurement SW: DASY52, Version 52.10; SEMCAD X Version 14.6.10 (7417)

Mode: GPRS 1900, Left Head, Cheek, Mid.ch, 2 Tx slots

Area Scan (9x15x1): Measurement grid: dx=15mm, dy=15mm

Zoom Scan (5x5x7)/Cube 0: Measurement grid: dx=8mm, dy=8mm, dz=5mm

Reference Value = 7.408 V/m; Power Drift = 0.09 dB

Peak SAR (extrapolated) = 0.126 W/kg

SAR(1 g) = 0.073 W/kg

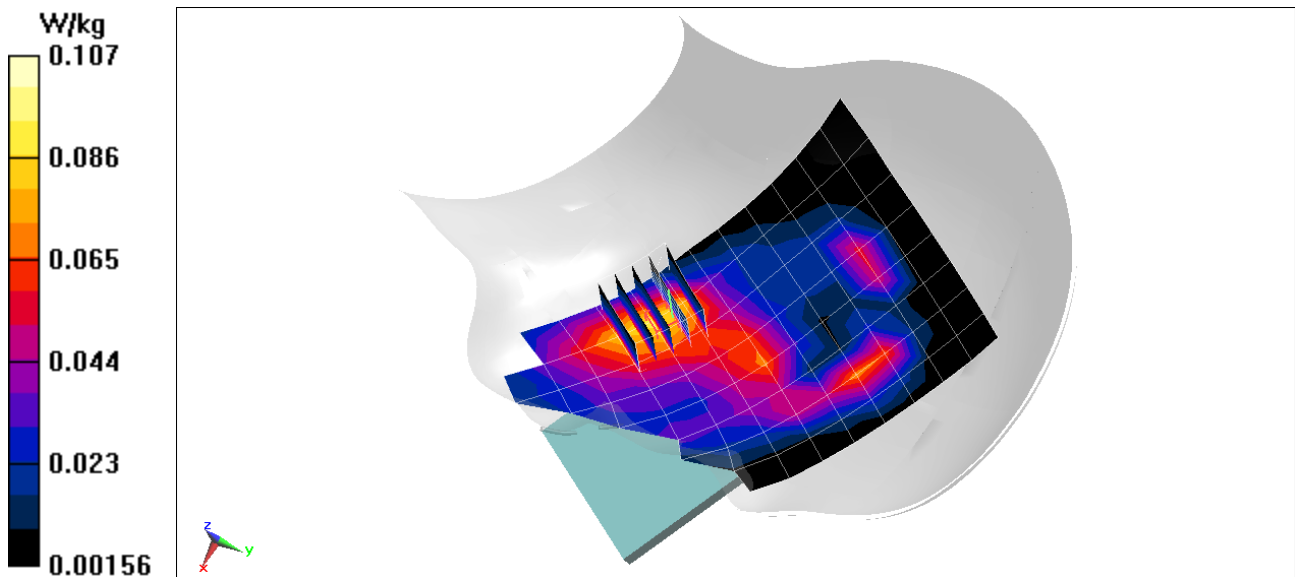

PCTEST ENGINEERING LABORATORY, INC.

DUT: ZNFG710VM; Type: Portable Handset; Serial: 12280

Communication System: UID 0, UMTS; Frequency: 836.6 MHz; Duty Cycle: 1:1
Medium: 835 Head Medium parameters used (interpolated):
 $f = 836.6 \text{ MHz}$; $\sigma = 0.92 \text{ S/m}$; $\epsilon_r = 42.807$; $\rho = 1000 \text{ kg/m}^3$
Phantom section: Right Section

Test Date: 04-09-2018; Ambient Temp: 21.5°C; Tissue Temp: 20.7°C

Probe: ES3DV3 - SN3213; ConvF(6.42, 6.42, 6.42); Calibrated: 2/13/2018;
Sensor-Surface: 3mm (Mechanical Surface Detection)
Electronics: DAE4 Sn1272; Calibrated: 2/9/2018
Phantom: SAM 5.0 front; Type: QD000P40CD; Serial: 1648
Measurement SW: DASY52, Version 52.10; SEMCAD X Version 14.6.10 (7417)

Mode: UMTS 850, Right Head, Cheek, Mid.ch

Area Scan (9x15x1): Measurement grid: dx=15mm, dy=15mm

Zoom Scan (6x5x7)/Cube 0: Measurement grid: dx=8mm, dy=8mm, dz=5mm

Reference Value = 14.81 V/m; Power Drift = -0.03 dB

Peak SAR (extrapolated) = 0.249 W/kg

SAR(1 g) = 0.191 W/kg

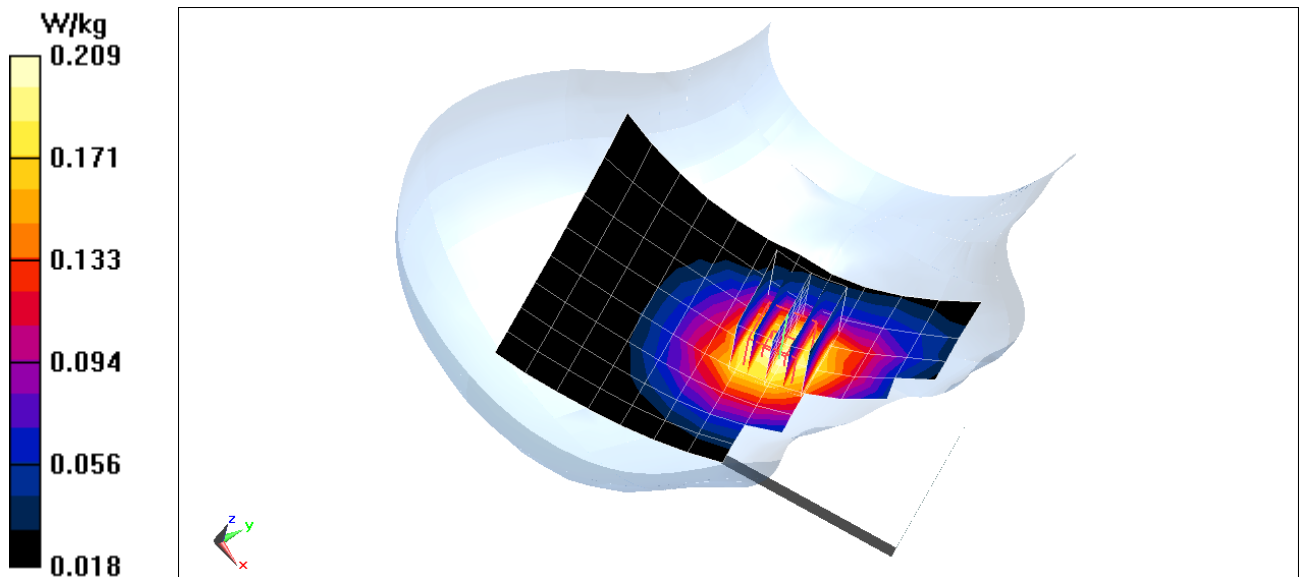

PCTEST ENGINEERING LABORATORY, INC.

DUT: ZNFG710VM; Type: Portable Handset; Serial: 12280

Communication System: UID 0, UMTS; Frequency: 1732.4 MHz; Duty Cycle: 1:1
Medium: 1750 Head Medium parameters used (interpolated):
 $f = 1732.4 \text{ MHz}$; $\sigma = 1.384 \text{ S/m}$; $\epsilon_r = 39.661$; $\rho = 1000 \text{ kg/m}^3$
Phantom section: Right Section

Test Date: 04-07-2018; Ambient Temp: 20.3°C; Tissue Temp: 21.4°C

Probe: EX3DV4 - SN7410; ConvF(8.66, 8.66, 8.66); Calibrated: 7/17/2017;
Sensor-Surface: 1.4mm (Mechanical Surface Detection)
Electronics: DAE4 Sn1322; Calibrated: 7/13/2017

Phantom: SAM with CRP v5.0 (Right); Type: QD000P40CD; Serial: TP:1759
Measurement SW: DASY52, Version 52.10; SEMCAD X Version 14.6.10 (7417)

Mode: UMTS 1750, Right Head, Tilt, Mid.ch

Area Scan (9x15x1): Measurement grid: dx=15mm, dy=15mm

Zoom Scan (5x5x7)/Cube 0: Measurement grid: dx=8mm, dy=8mm, dz=5mm

Reference Value = 11.01 V/m; Power Drift = 0.01 dB

Peak SAR (extrapolated) = 0.269 W/kg

SAR(1 g) = 0.143 W/kg

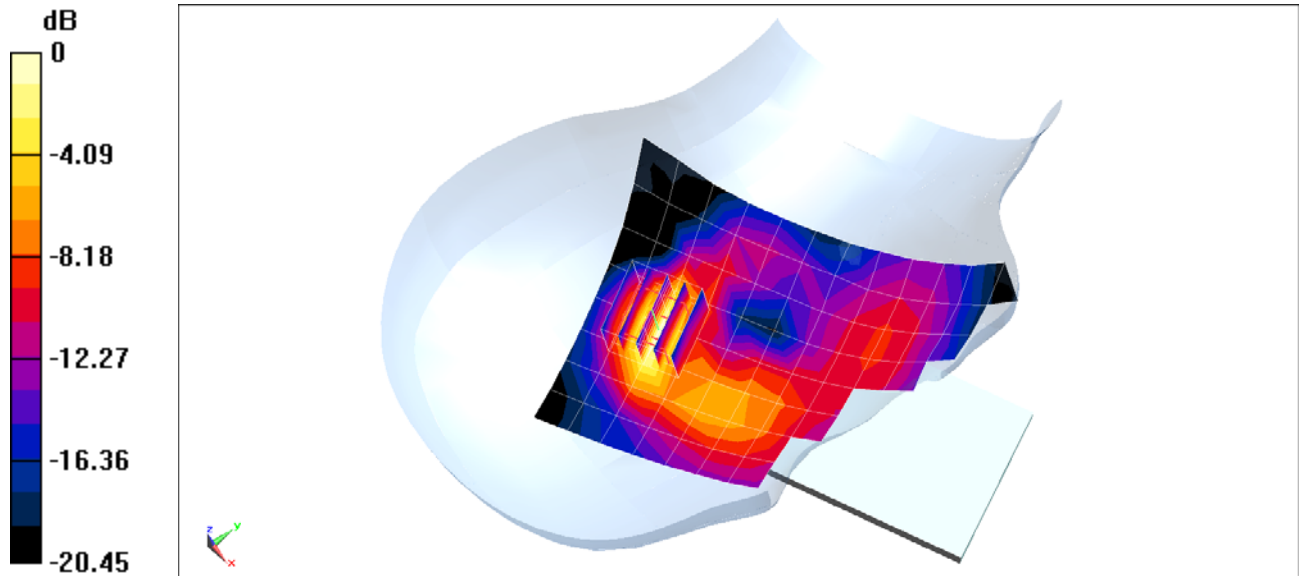

0 dB = 0.230 W/kg = -6.38 dBW/kg

PCTEST ENGINEERING LABORATORY, INC.

DUT: ZNFG710VM; Type: Portable Handset; Serial: 12256

Communication System: UID 0, UMTS; Frequency: 1880 MHz; Duty Cycle: 1:1
Medium: 1900 Head Medium parameters used:
 $f = 1880 \text{ MHz}$; $\sigma = 1.422 \text{ S/m}$; $\epsilon_r = 38.103$; $\rho = 1000 \text{ kg/m}^3$
Phantom section: Right Section

Test Date: 04-13-2018; Ambient Temp: 21.9°C; Tissue Temp: 21.7°C

Probe: EX3DV4 - SN3914; ConvF(7.98, 7.98, 7.98); Calibrated: 2/14/2018;
Sensor-Surface: 1.4mm (Mechanical Surface Detection)
Electronics: DAE4 Sn665; Calibrated: 2/15/2018
Phantom: Twin-SAM V5.0 left; Type: QD 000 P40 CD; Serial: 1692
Measurement SW: DASY52, Version 52.10; SEMCAD X Version 14.6.10 (7417)

Mode: UMTS 1900, Right Head, Tilt, Mid.ch

Area Scan (9x15x1): Measurement grid: $dx=15\text{mm}$, $dy=15\text{mm}$
Zoom Scan (6x5x7)/Cube 0: Measurement grid: $dx=8\text{mm}$, $dy=8\text{mm}$, $dz=5\text{mm}$
Reference Value = 8.557 V/m; Power Drift = -0.02 dB
Peak SAR (extrapolated) = 0.230 W/kg
SAR(1 g) = 0.122 W/kg

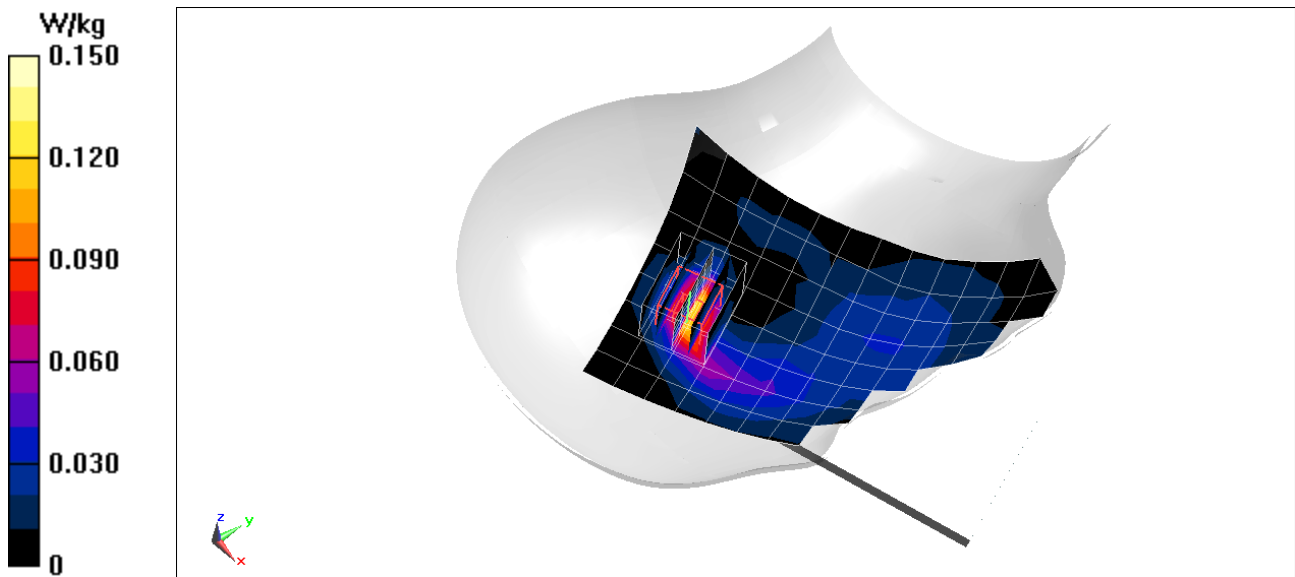

PCTEST ENGINEERING LABORATORY, INC.

DUT: ZNFG710VM; Type: Portable Handset; Serial: 12256

Communication System: UID 0, LTE Band 12; Frequency: 707.5 MHz; Duty Cycle: 1:1
Medium: 750 Head Medium parameters used (interpolated):
 $f = 707.5$ MHz; $\sigma = 0.889$ S/m; $\epsilon_r = 41.243$; $\rho = 1000$ kg/m³
Phantom section: Right Section

Test Date: 04-12-2018; Ambient Temp: 22.7°C; Tissue Temp: 21.7°C

Probe: EX3DV4 - SN3914; ConvF(10.18, 10.18, 10.18); Calibrated: 2/14/2018;
Sensor-Surface: 1.4mm (Mechanical Surface Detection)
Electronics: DAE4 Sn665; Calibrated: 2/15/2018
Phantom: Twin-SAM V5.0 left; Type: QD 000 P40 CD; Serial: 1692
Measurement SW: DASY52, Version 52.10; SEMCAD X Version 14.6.10 (7417)

Mode: LTE Band 12, Right Head, Cheek, Mid.ch
10 MHz Bandwidth, QPSK, 1 RB, 0 RB Offset

Area Scan (9x14x1): Measurement grid: dx=15mm, dy=15mm
Zoom Scan (5x5x7)/Cube 0: Measurement grid: dx=8mm, dy=8mm, dz=5mm
Reference Value = 13.67 V/m; Power Drift = 0.02 dB
Peak SAR (extrapolated) = 0.196 W/kg
SAR(1 g) = 0.157 W/kg

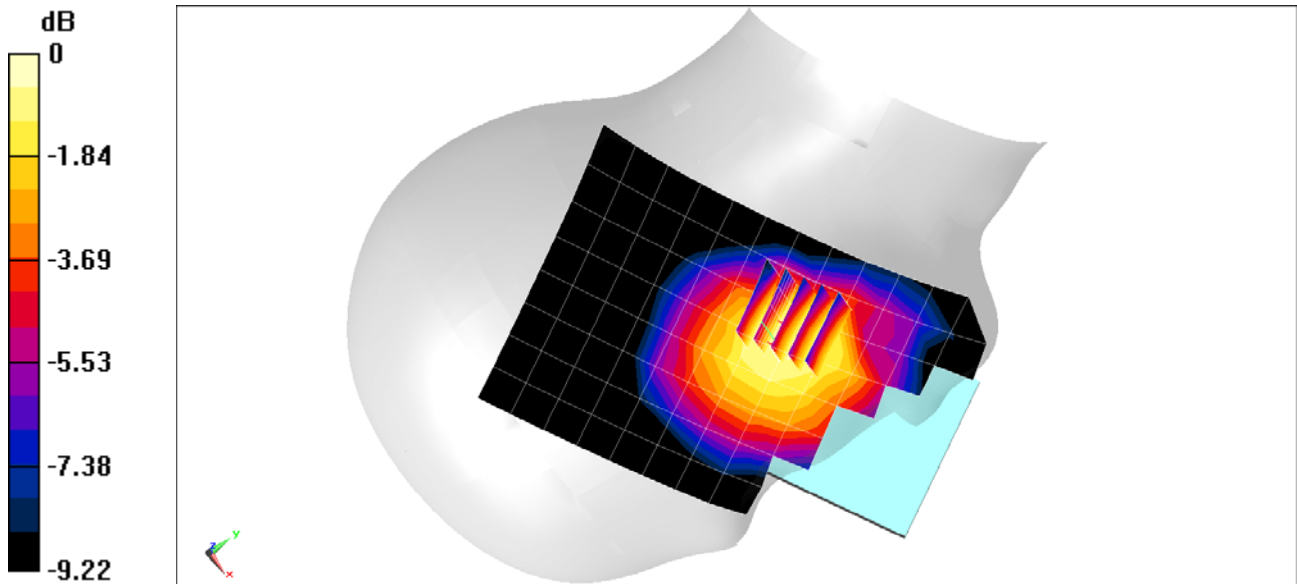

0 dB = 0.183 W/kg = -7.38 dBW/kg

PCTEST ENGINEERING LABORATORY, INC.

DUT: ZNFG710VM; Type: Portable Handset; Serial: 12256

Communication System: UID 0, LTE Band 13; Frequency: 782 MHz; Duty Cycle: 1:1
Medium: 750 Head Medium parameters used (interpolated):
 $f = 782 \text{ MHz}$; $\sigma = 0.916 \text{ S/m}$; $\epsilon_r = 40.971$; $\rho = 1000 \text{ kg/m}^3$
Phantom section: Right Section

Test Date: 04-12-2018; Ambient Temp: 22.7°C; Tissue Temp: 21.7°C

Probe: EX3DV4 - SN3914; ConvF(10.18, 10.18, 10.18); Calibrated: 2/14/2018;
Sensor-Surface: 1.4mm (Mechanical Surface Detection)
Electronics: DAE4 Sn665; Calibrated: 2/15/2018
Phantom: Twin-SAM V5.0 left; Type: QD 000 P40 CD; Serial: 1692
Measurement SW: DASY52, Version 52.10; SEMCAD X Version 14.6.10 (7417)

Mode: LTE Band 13, Right Head, Cheek, Mid.ch
10 MHz Bandwidth, QPSK, 1 RB, 25 RB Offset

Area Scan (9x14x1): Measurement grid: $dx=15\text{mm}$, $dy=15\text{mm}$
Zoom Scan (5x5x7)/Cube 0: Measurement grid: $dx=8\text{mm}$, $dy=8\text{mm}$, $dz=5\text{mm}$
Reference Value = 14.90 V/m; Power Drift = 0.12 dB
Peak SAR (extrapolated) = 0.240 W/kg
SAR(1 g) = 0.190 W/kg

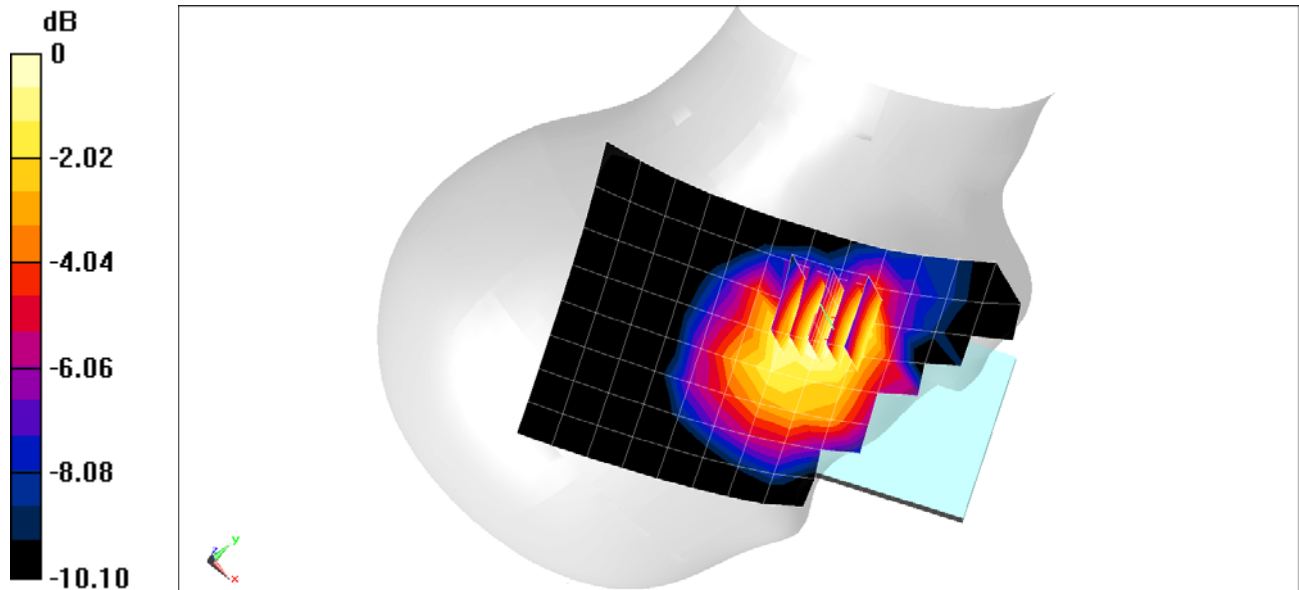

0 dB = 0.220 W/kg = -6.58 dBW/kg

PCTEST ENGINEERING LABORATORY, INC.

DUT: ZNFG710VM; Type: Portable Handset; Serial: 12256

Communication System: UID 0, LTE Band 5 (Cell.); Frequency: 836.5 MHz; Duty Cycle: 1:1
Medium: 835 Head Medium parameters used (interpolated):
 $f = 836.5 \text{ MHz}$; $\sigma = 0.92 \text{ S/m}$; $\epsilon_r = 42.808$; $\rho = 1000 \text{ kg/m}^3$
Phantom section: Right Section

Test Date: 04-09-2018; Ambient Temp: 21.5°C; Tissue Temp: 20.7°C

Probe: ES3DV3 - SN3213; ConvF(6.42, 6.42, 6.42); Calibrated: 2/13/2018;
Sensor-Surface: 3mm (Mechanical Surface Detection)
Electronics: DAE4 Sn1272; Calibrated: 2/9/2018
Phantom: SAM 5.0 front; Type: QD000P40CD; Serial: 1648
Measurement SW: DASY52, Version 52.10; SEMCAD X Version 14.6.10 (7417)

Mode: LTE Band 5 (Cell.), Right Head, Cheek, Mid.ch
10 MHz Bandwidth, QPSK, 1 RB, 0 RB Offset

Area Scan (9x15x1): Measurement grid: $dx=15\text{mm}$, $dy=15\text{mm}$
Zoom Scan (5x5x7)/Cube 0: Measurement grid: $dx=8\text{mm}$, $dy=8\text{mm}$, $dz=5\text{mm}$
Reference Value = 15.31 V/m; Power Drift = 0.20 dB
Peak SAR (extrapolated) = 0.253 W/kg
SAR(1 g) = 0.191 W/kg

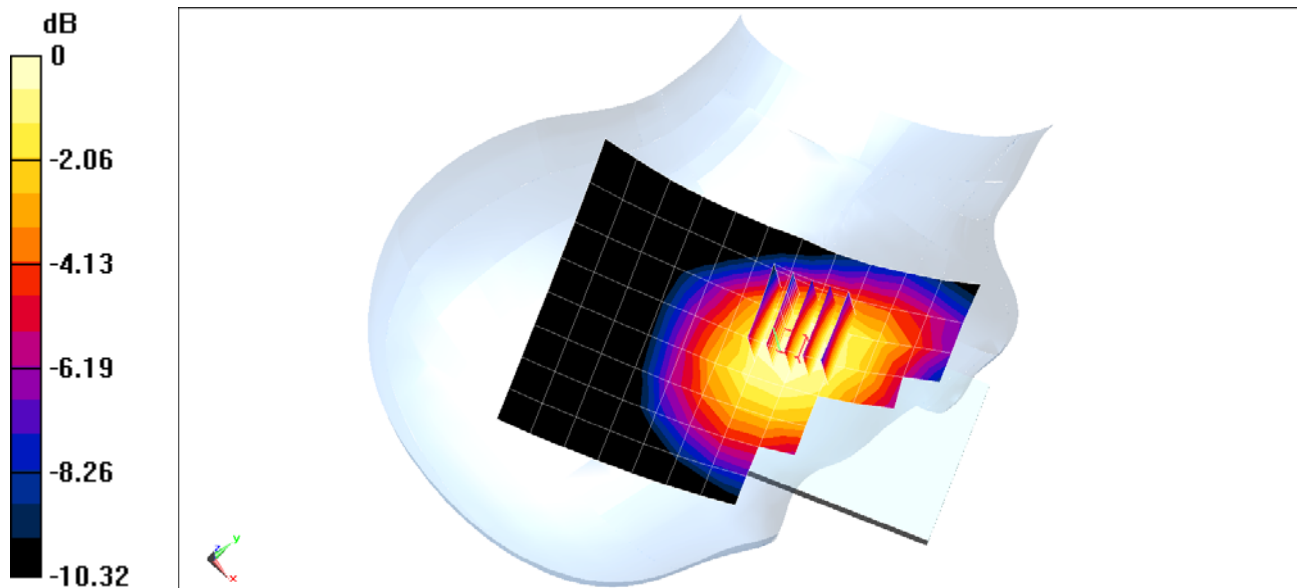

0 dB = 0.212 W/kg = -6.74 dBW/kg

PCTEST ENGINEERING LABORATORY, INC.

DUT: ZNFG710VM; Type: Portable Handset; Serial: 12256

Communication System: UID 0, LTE Band 26; Frequency: 831.5 MHz; Duty Cycle: 1:1
Medium: 835 Head Medium parameters used (interpolated):
 $f = 831.5 \text{ MHz}$; $\sigma = 0.915 \text{ S/m}$; $\epsilon_r = 42.873$; $\rho = 1000 \text{ kg/m}^3$
Phantom section: Right Section

Test Date: 04-09-2018; Ambient Temp: 21.5°C; Tissue Temp: 20.7°C

Probe: ES3DV3 - SN3213; ConvF(6.42, 6.42, 6.42); Calibrated: 2/13/2018;
Sensor-Surface: 3mm (Mechanical Surface Detection)
Electronics: DAE4 Sn1272; Calibrated: 2/9/2018
Phantom: SAM 5.0 front; Type: QD000P40CD; Serial: 1648
Measurement SW: DASY52, Version 52.10; SEMCAD X Version 14.6.10 (7417)

**Mode: LTE Band 26 (Cell.), Right Head, Cheek, Mid.ch,
15 MHz Bandwidth, QPSK, 1 RB, 36 RB Offset**

Area Scan (9x15x1): Measurement grid: $dx=15\text{mm}$, $dy=15\text{mm}$
Zoom Scan (5x5x7)/Cube 0: Measurement grid: $dx=8\text{mm}$, $dy=8\text{mm}$, $dz=5\text{mm}$
Reference Value = 15.48 V/m; Power Drift = 0.08 dB
Peak SAR (extrapolated) = 0.252 W/kg
SAR(1 g) = 0.193 W/kg

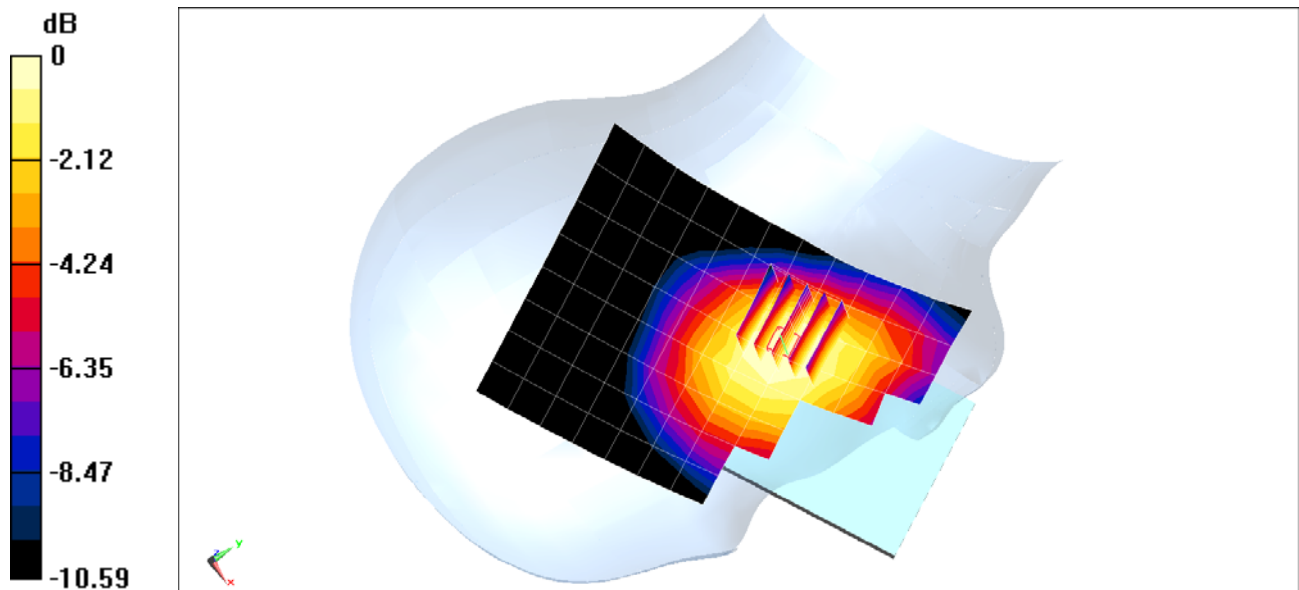

0 dB = 0.209 W/kg = -6.80 dBW/kg

PCTEST ENGINEERING LABORATORY, INC.

DUT: ZNFG710VM; Type: Portable Handset; Serial: 12280

Communication System: UID 0, LTE Band 66 (AWS); Frequency: 1720 MHz; Duty Cycle: 1:1
Medium: 1750 Head Medium parameters used (interpolated):
 $f = 1720 \text{ MHz}$; $\sigma = 1.371 \text{ S/m}$; $\epsilon_r = 39.717$; $\rho = 1000 \text{ kg/m}^3$
Phantom section: Left Section

Test Date: 04-07-2018; Ambient Temp: 20.3°C; Tissue Temp: 21.4°C

Probe: EX3DV4 - SN7410; ConvF(8.66, 8.66, 8.66); Calibrated: 7/17/2017;

Sensor-Surface: 1.4mm (Mechanical Surface Detection)

Electronics: DAE4 Sn1322; Calibrated: 7/13/2017

Phantom: SAM with CRP v5.0 (Right); Type: QD000P40CD; Serial: TP:1759

Measurement SW: DASY52, Version 52.10; SEMCAD X Version 14.6.10 (7417)

Mode: LTE Band 66 (AWS), Left Head, Tilt, Low.ch
20 MHz Bandwidth, QPSK, 1 RB, 99 RB Offset

Area Scan (9x15x1): Measurement grid: $dx=15\text{mm}$, $dy=15\text{mm}$

Zoom Scan (5x5x7)/Cube 0: Measurement grid: $dx=8\text{mm}$, $dy=8\text{mm}$, $dz=5\text{mm}$

Reference Value = 12.93 V/m; Power Drift = 0.03 dB

Peak SAR (extrapolated) = 0.322 W/kg

SAR(1 g) = 0.174 W/kg

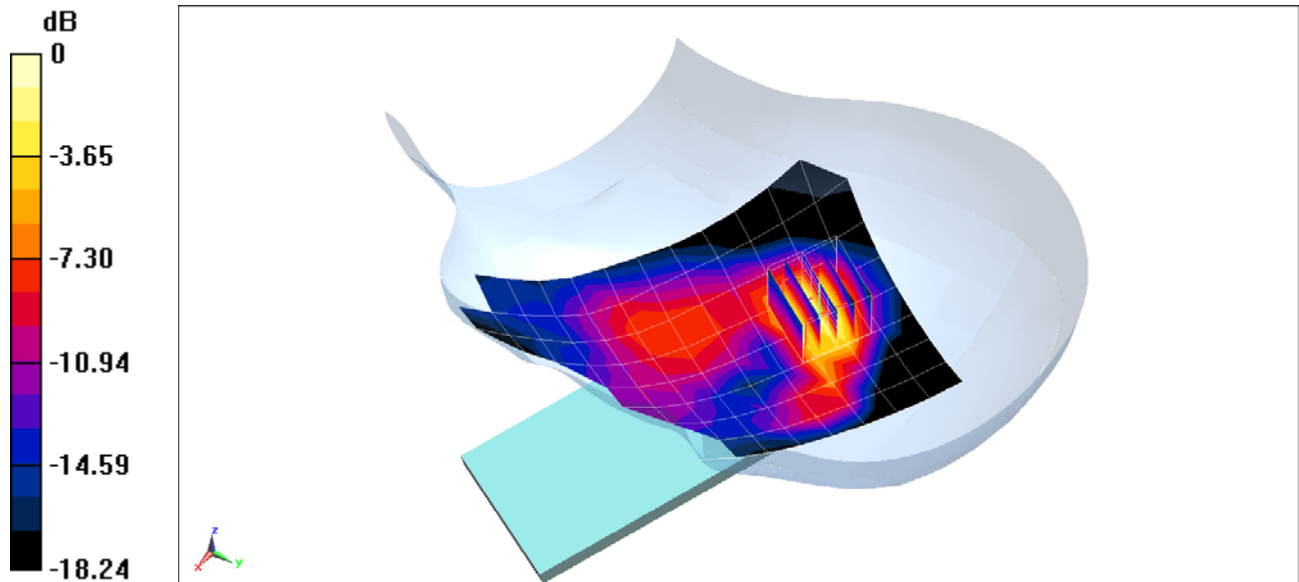

0 dB = 0.274 W/kg = -5.62 dBW/kg

PCTEST ENGINEERING LABORATORY, INC.

DUT: ZNFG710VM; Type: Portable Handset; Serial: 12280

Communication System: UID 0, LTE Band 25 (PCS); Frequency: 1860 MHz; Duty Cycle: 1:1
Medium: 1900 Head Medium parameters used (interpolated):
 $f = 1860 \text{ MHz}$; $\sigma = 1.409 \text{ S/m}$; $\epsilon_r = 38.122$; $\rho = 1000 \text{ kg/m}^3$
Phantom section: Left Section

Test Date: 04-13-2018; Ambient Temp: 21.9°C; Tissue Temp: 21.7°C

Probe: EX3DV4 - SN3914; ConvF(7.98, 7.98, 7.98); Calibrated: 2/14/2018;

Sensor-Surface: 1.4mm (Mechanical Surface Detection)

Electronics: DAE4 Sn665; Calibrated: 2/15/2018

Phantom: Twin-SAM V5.0 left; Type: QD 000 P40 CD; Serial: 1692

Measurement SW: DASY52, Version 52.10; SEMCAD X Version 14.6.10 (7417)

**Mode: LTE Band 25 (PCS), Left Head, Cheek, Low.ch,
20 MHz Bandwidth, QPSK, 1 RB, 99 RB Offset**

Mode: Area Scan (9x14x1): Measurement grid: $dx=15\text{mm}$, $dy=15\text{mm}$

Zoom Scan (5x5x7)/Cube 0: Measurement grid: $dx=8\text{mm}$, $dy=8\text{mm}$, $dz=5\text{mm}$

Reference Value = 8.976 V/m; Power Drift = 0.00 dB

Peak SAR (extrapolated) = 0.164 W/kg

SAR(1 g) = 0.096 W/kg

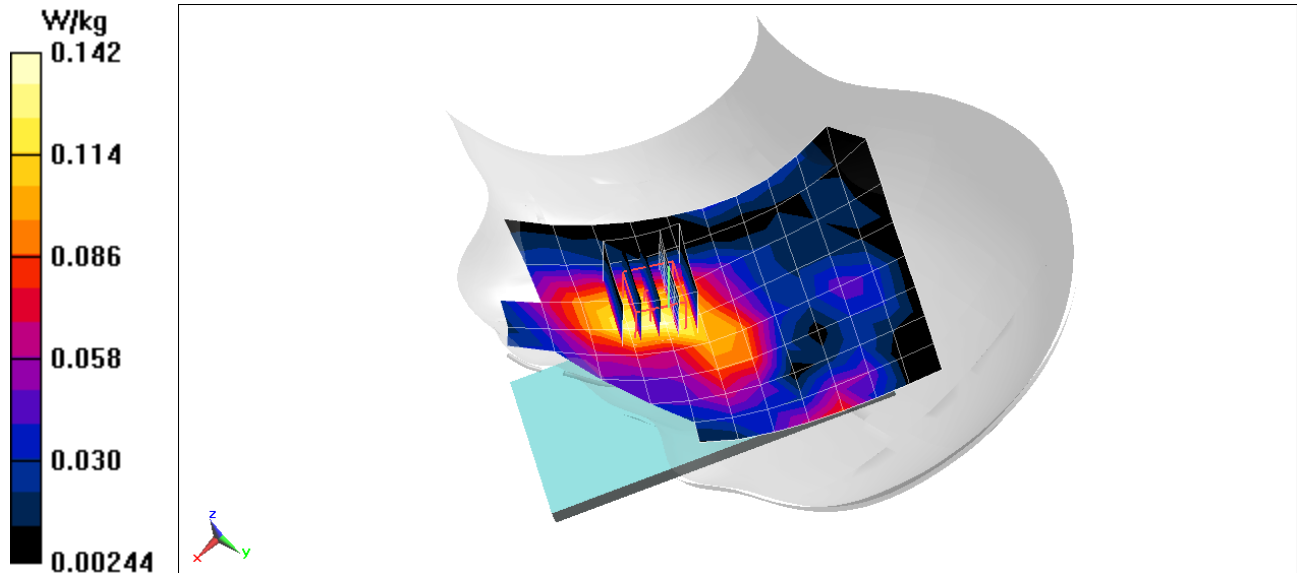

PCTEST ENGINEERING LABORATORY, INC.

DUT: ZNFG710VM; Type: Portable Handset; Serial: 12298

Communication System: UID 0, LTE Band 41 (Class 2); Frequency: 2636.5 MHz; Duty Cycle: 1:2.31
Medium: 2600 Head Medium parameters used (interpolated):
 $f = 2636.5$ MHz; $\sigma = 2.073$ S/m; $\epsilon_r = 39.756$; $\rho = 1000$ kg/m³
Phantom section: Left Section

Test Date: 04-15-2018; Ambient Temp: 22.8°C; Tissue Temp: 23.1°C

Probe: ES3DV3 - SN3332; ConvF(4.56, 4.56, 4.56); Calibrated: 8/14/2017;
Sensor-Surface: 3mm (Mechanical Surface Detection)
Electronics: DAE4 Sn1323; Calibrated: 8/9/2017
Phantom: SAM Front; Type: SAM; Serial: 1686
Measurement SW: DASY52, Version 52.10; SEMCAD X Version 14.6.10 (7417)

**Mode: LTE Band 41 PC2, Left Head, Cheek, Mid-High.ch, QPSK,
20 MHz Bandwidth, 1 RB, 0 RB Offset**

Area Scan (10x17x1): Measurement grid: dx=12mm, dy=12mm
Zoom Scan (9x8x7)/Cube 0: Measurement grid: dx=5mm, dy=5mm, dz=5mm
Reference Value = 5.101 V/m; Power Drift = 0.15 dB
Peak SAR (extrapolated) = 0.0790 W/kg
SAR(1 g) = 0.041 W/kg

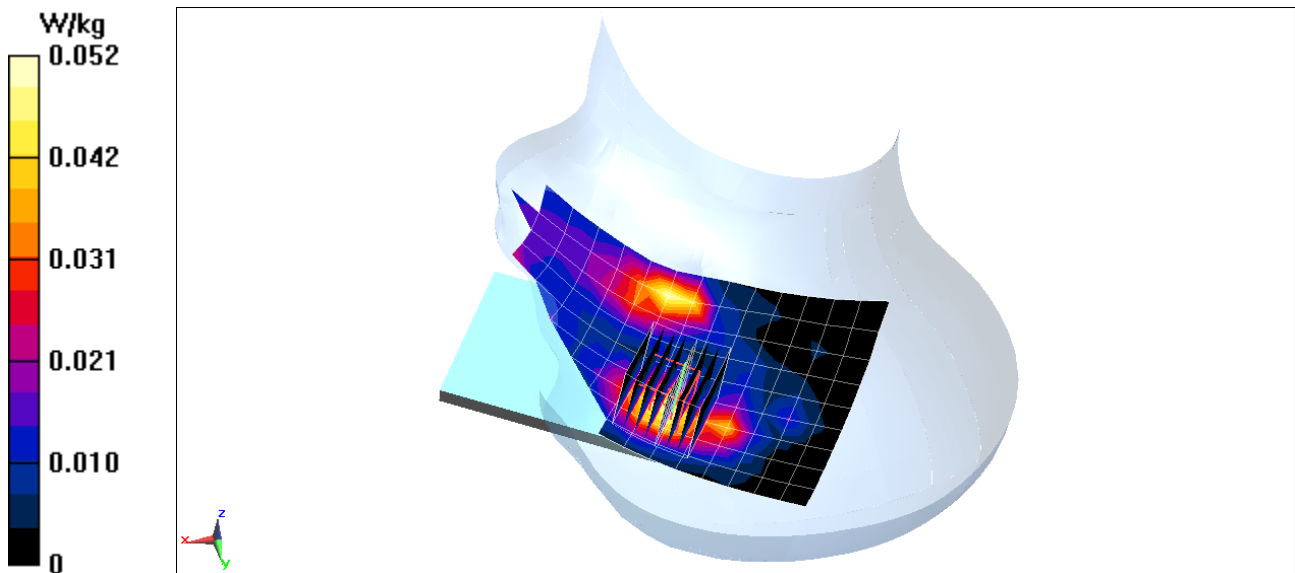

PCTEST ENGINEERING LABORATORY, INC.

DUT: ZNFG710VM; Type: Portable Handset; Serial: 12371

Communication System: UID 0, _IEEE 802.11b; Frequency: 2412 MHz; Duty Cycle: 1:1
Medium: 2450 Head Medium parameters used (interpolated):
f = 2412 MHz; $\sigma = 1.8$ S/m; $\epsilon_r = 39.74$; $\rho = 1000$ kg/m³
Phantom section: Right Section

Test Date: 04-09-2018; Ambient Temp: 22.4°C; Tissue Temp: 22.8°C

Probe: ES3DV3 - SN3332; ConvF(4.68, 4.68, 4.68); Calibrated: 8/14/2017;
Sensor-Surface: 3mm (Mechanical Surface Detection)
Electronics: DAE4 Sn1323; Calibrated: 8/9/2017
Phantom: SAM Front; Type: SAM; Serial: 1686
Measurement SW: DASY52, Version 52.10; SEMCAD X Version 14.6.10 (7417)

Mode: IEEE 802.11b, 22 MHz Bandwidth, Right Head, Cheek, Ch 1, 1 Mbps, Antenna 1

Area Scan (11x18x1): Measurement grid: dx=12mm, dy=12mm
Zoom Scan (9x7x7)/Cube 0: Measurement grid: dx=5mm, dy=5mm, dz=5mm
Reference Value = 13.79 V/m; Power Drift = 0.14 dB
Peak SAR (extrapolated) = 1.07 W/kg
SAR(1 g) = 0.464 W/kg

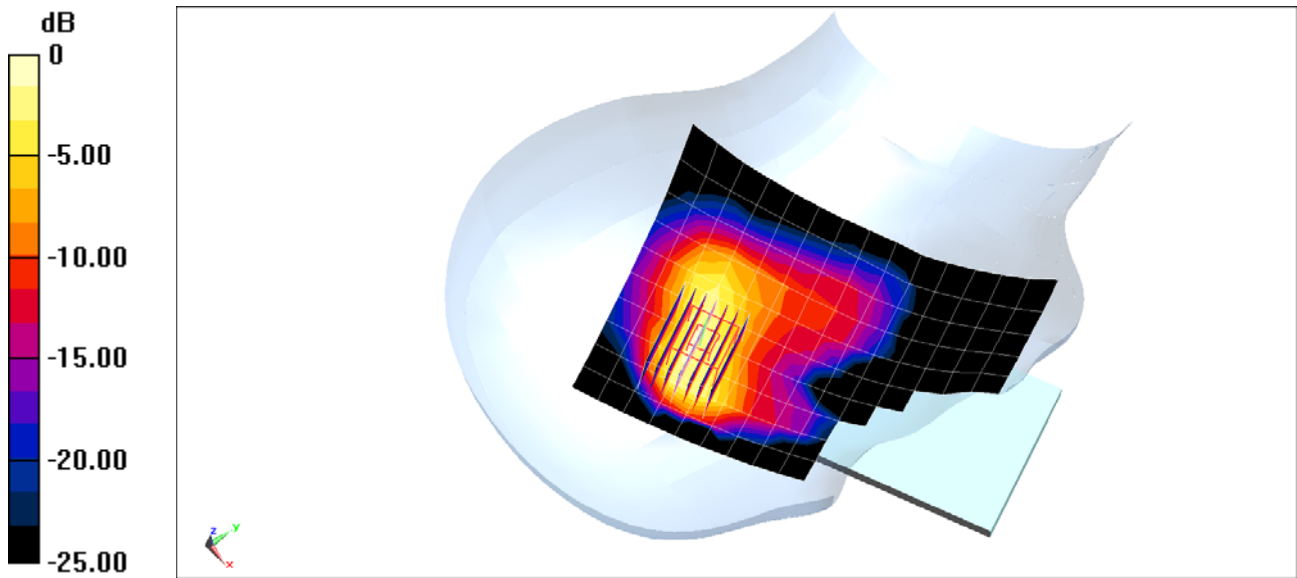

0 dB = 0.604 W/kg = -2.19 dBW/kg

PCTEST ENGINEERING LABORATORY, INC.

DUT: ZNFG710VM; Type: Portable Handset; Serial: 12249

Communication System: UID 0, 802.11a 5.2-5.8 GHz Band; Frequency: 5280 MHz; Duty Cycle: 1:1

Medium: 5GHz Head Medium parameters used:

$f = 5280 \text{ MHz}$; $\sigma = 4.63 \text{ S/m}$; $\epsilon_r = 37.162$; $\rho = 1000 \text{ kg/m}^3$

Phantom section: Right Section

Test Date: 04-09-2018; Ambient Temp: 21.9°C; Tissue Temp: 21.6°C

Probe: EX3DV4 - SN3589; ConvF(4.69, 4.69, 4.69); Calibrated: 1/16/2018;

Sensor-Surface: 1.4mm (Mechanical Surface Detection)

Electronics: DAE4 Sn1322; Calibrated: 7/13/2017

Phantom: SAM with CRP v5.0 (Right); Type: QD000P40CD; Serial: TP:1759

Measurement SW: DASY52, Version 52.10;SEMCAD X Version 14.6.10 (7417)

**Mode: IEEE 802.11a, U-NII-2A, 20 MHz Bandwidth, Right Head, Cheek,
Ch 56, 6 Mbps, Antenna 1**

Area Scan (13x21x1): Measurement grid: dx=10mm, dy=10mm

Zoom Scan (8x8x7)/Cube 0: Measurement grid: dx=4mm, dy=4mm, dz=1.4mm; Graded Ratio: 1.4

Reference Value = 5.462 V/m; Power Drift = -0.03 dB

Peak SAR (extrapolated) = 2.40 W/kg

SAR(1 g) = 0.553 W/kg

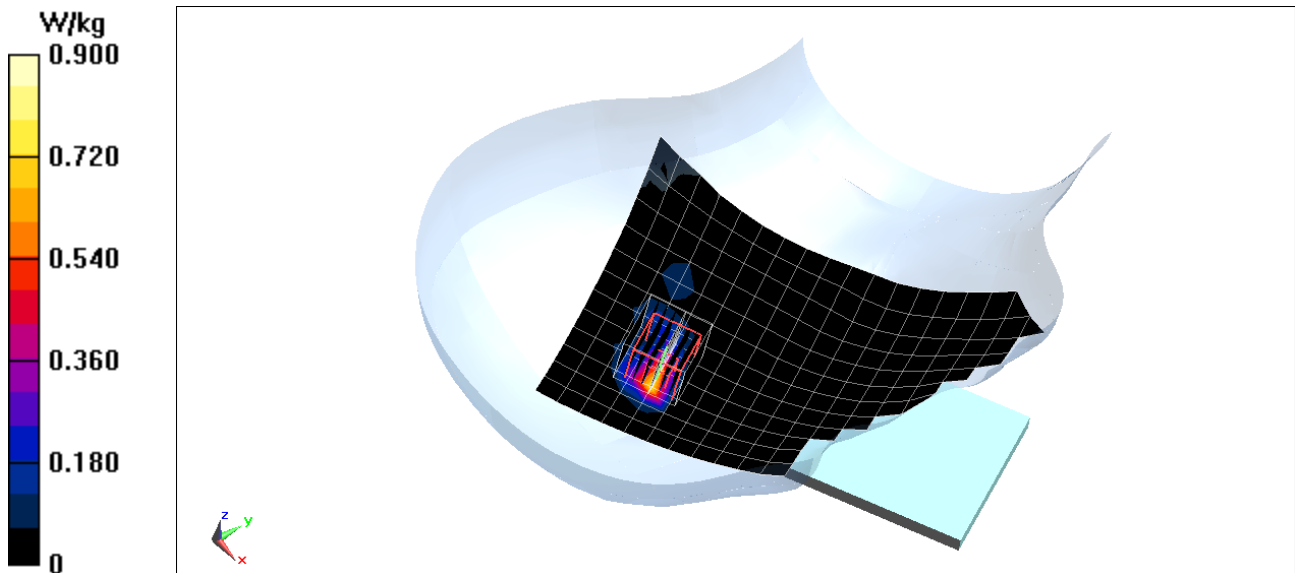

PCTEST ENGINEERING LABORATORY, INC.

DUT: ZNFG710VM; Type: Portable Handset; Serial: 12371

Communication System: UID 0, Bluetooth; Frequency: 2402 MHz; Duty Cycle: 1:1.289

Medium: 2450 Head Medium parameters used (interpolated):

$f = 2402$ MHz; $\sigma = 1.788$ S/m; $\epsilon_r = 39.777$; $\rho = 1000$ kg/m³

Phantom section: Left Section

Test Date: 04-09-2018; Ambient Temp: 22.4°C; Tissue Temp: 22.8°C

Probe: ES3DV3 - SN3332; ConvF(4.68, 4.68, 4.68); Calibrated: 8/14/2017;

Sensor-Surface: 3mm (Mechanical Surface Detection)

Electronics: DAE4 Sn1323; Calibrated: 8/9/2017

Phantom: SAM Front; Type: SAM; Serial: 1686

Measurement SW: DASY52, Version 52.10; SEMCAD X Version 14.6.10 (7417)

Mode: Bluetooth, Left Head, Tilt, Ch 0, 1 Mbps

Area Scan (11x19x1): Measurement grid: dx=12mm, dy=12mm

Zoom Scan (7x7x7)/Cube 0: Measurement grid: dx=5mm, dy=5mm, dz=5mm

Reference Value = 7.793 V/m; Power Drift = 0.12 dB

Peak SAR (extrapolated) = 0.198 W/kg

SAR(1 g) = 0.091 W/kg

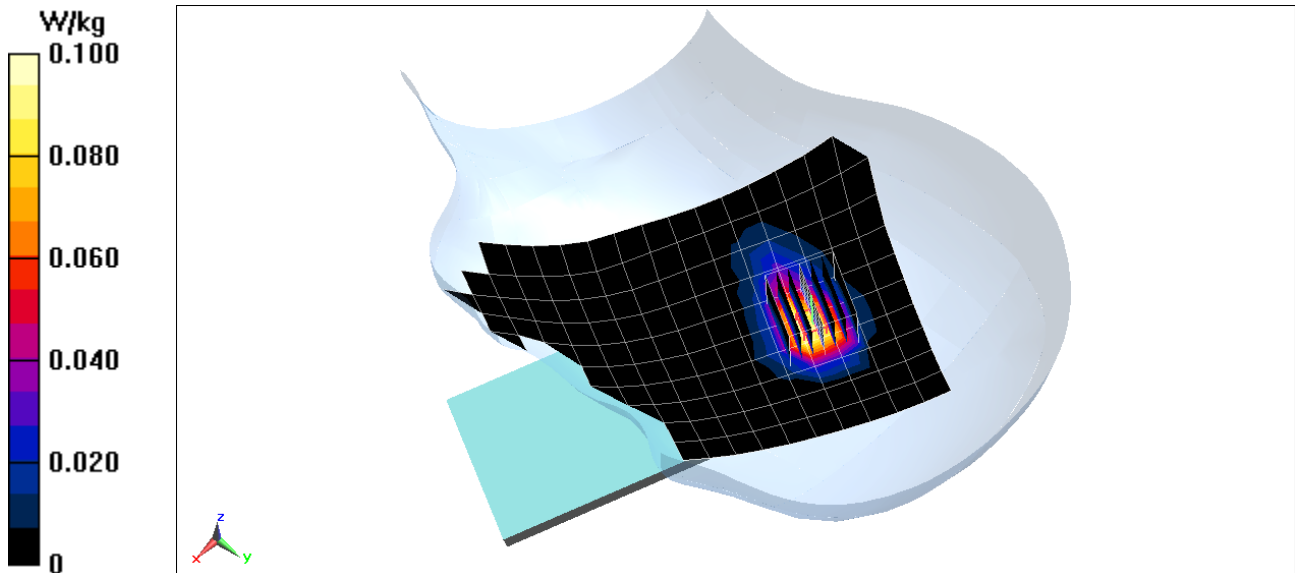

PCTEST ENGINEERING LABORATORY, INC.

DUT: ZNFG710VM; Type: Portable Handset; Serial: 12280

Communication System: UID 0, CDMA; Frequency: 820.1 MHz; Duty Cycle: 1:1
Medium: 835 Body Medium parameters used (interpolated):
 $f = 820.1 \text{ MHz}$; $\sigma = 0.95 \text{ S/m}$; $\epsilon_r = 53.691$; $\rho = 1000 \text{ kg/m}^3$
Phantom section: Flat Section; Space: 1.0 cm

Test Date: 04-11-2018; Ambient Temp: 22.7°C; Tissue Temp: 22.3°C

Probe: ES3DV3 - SN3213; ConvF(6.2, 6.2, 6.2); Calibrated: 2/13/2018;
Sensor-Surface: 3mm (Mechanical Surface Detection)

Electronics: DAE4 Sn1272; Calibrated: 2/9/2018

Phantom: SAM V5.0 Right; Type: QD000P40CD; Serial: 1647

Measurement SW: DASY52, Version 52.10; SEMCAD X Version 14.6.10 (7417)

Mode: Cell. CDMA BC10, Rule Part 90S, Body SAR, Back side, Mid.ch

Area Scan (9x15x1): Measurement grid: dx=15mm, dy=15mm

Zoom Scan (5x5x7)/Cube 0: Measurement grid: dx=8mm, dy=8mm, dz=5mm

Reference Value = 22.20 V/m; Power Drift = 0.00 dB

Peak SAR (extrapolated) = 0.757 W/kg

SAR(1 g) = 0.424 W/kg

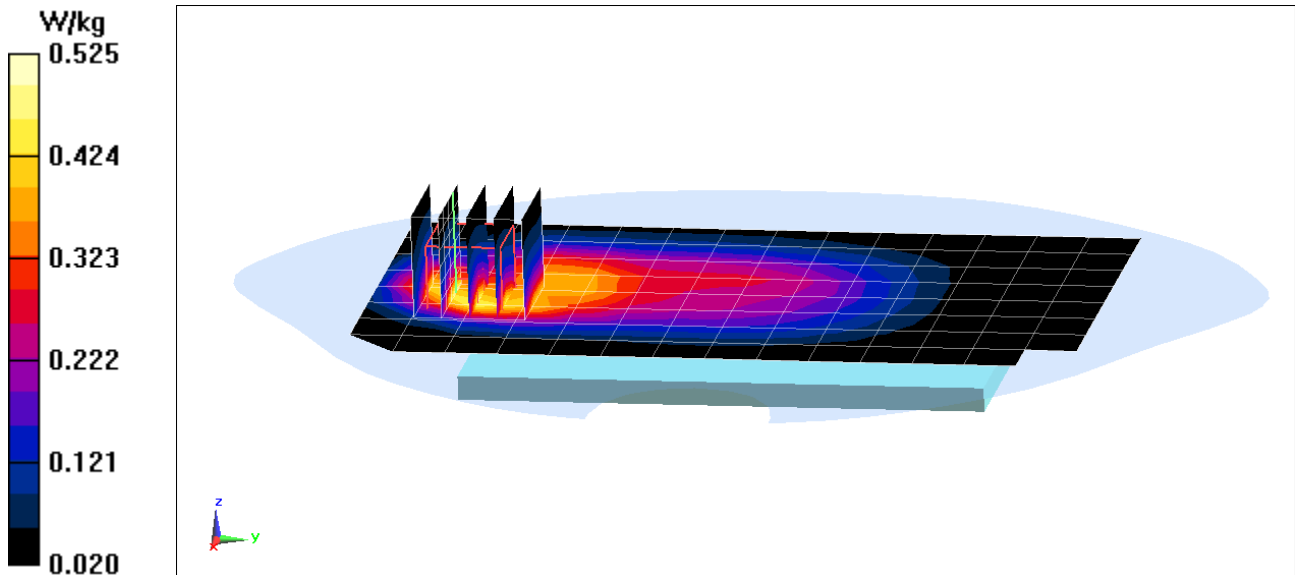

PCTEST ENGINEERING LABORATORY, INC.

DUT: ZNFG710VM; Type: Portable Handset; Serial: 12280

Communication System: UID 0, CDMA; Frequency: 820.1 MHz; Duty Cycle: 1:1
Medium: 835 Body Medium parameters used (interpolated):
 $f = 820.1 \text{ MHz}$; $\sigma = 0.95 \text{ S/m}$; $\epsilon_r = 53.691$; $\rho = 1000 \text{ kg/m}^3$
Phantom section: Flat Section; Space: 1.0 cm

Test Date: 04-11-2018; Ambient Temp: 22.7°C; Tissue Temp: 22.3°C

Probe: ES3DV3 - SN3213; ConvF(6.2, 6.2, 6.2); Calibrated: 2/13/2018;
Sensor-Surface: 3mm (Mechanical Surface Detection)

Electronics: DAE4 Sn1272; Calibrated: 2/9/2018

Phantom: SAM V5.0 Right; Type: QD000P40CD; Serial: 1647

Measurement SW: DASY52, Version 52.10; SEMCAD X Version 14.6.10 (7417)

Mode: Cell. EVDO BC10, Rule Part 90S, Body SAR, Back side, Mid.ch

Area Scan (9x15x1): Measurement grid: $dx=15\text{mm}$, $dy=15\text{mm}$

Zoom Scan (5x5x7)/Cube 0: Measurement grid: $dx=8\text{mm}$, $dy=8\text{mm}$, $dz=5\text{mm}$

Reference Value = 21.91 V/m; Power Drift = 0.03 dB

Peak SAR (extrapolated) = 0.719 W/kg

SAR(1 g) = 0.409 W/kg

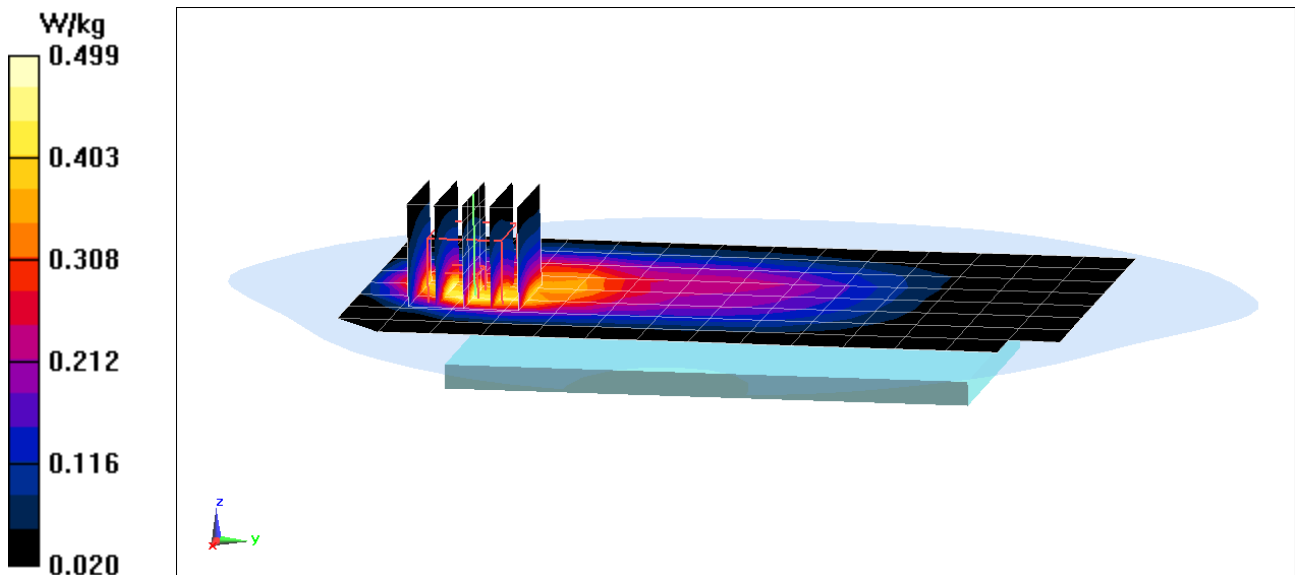

PCTEST ENGINEERING LABORATORY, INC.

DUT: ZNFG710VM; Type: Portable Handset; Serial: 12280

Communication System: UID 0, CDMA; Frequency: 836.52 MHz; Duty Cycle: 1:1
Medium: 835 Body Medium parameters used (interpolated):
 $f = 836.52 \text{ MHz}$; $\sigma = 0.967 \text{ S/m}$; $\epsilon_r = 53.56$; $\rho = 1000 \text{ kg/m}^3$
Phantom section: Flat Section; Space: 1.0 cm

Test Date: 04-11-2018; Ambient Temp: 22.7°C; Tissue Temp: 22.3°C

Probe: ES3DV3 - SN3213; ConvF(6.2, 6.2, 6.2); Calibrated: 2/13/2018;
Sensor-Surface: 3mm (Mechanical Surface Detection)

Electronics: DAE4 Sn1272; Calibrated: 2/9/2018

Phantom: SAM V5.0 Right; Type: QD000P40CD; Serial: 1647

Measurement SW: DASY52, Version 52.10; SEMCAD X Version 14.6.10 (7417)

Mode: Cell. CDMA, Rule Part 22H, Body SAR, Back side, Mid.ch

Area Scan (9x15x1): Measurement grid: dx=15mm, dy=15mm

Zoom Scan (5x5x7)/Cube 0: Measurement grid: dx=8mm, dy=8mm, dz=5mm

Reference Value = 23.80 V/m; Power Drift = 0.05 dB

Peak SAR (extrapolated) = 0.868 W/kg

SAR(1 g) = 0.492 W/kg

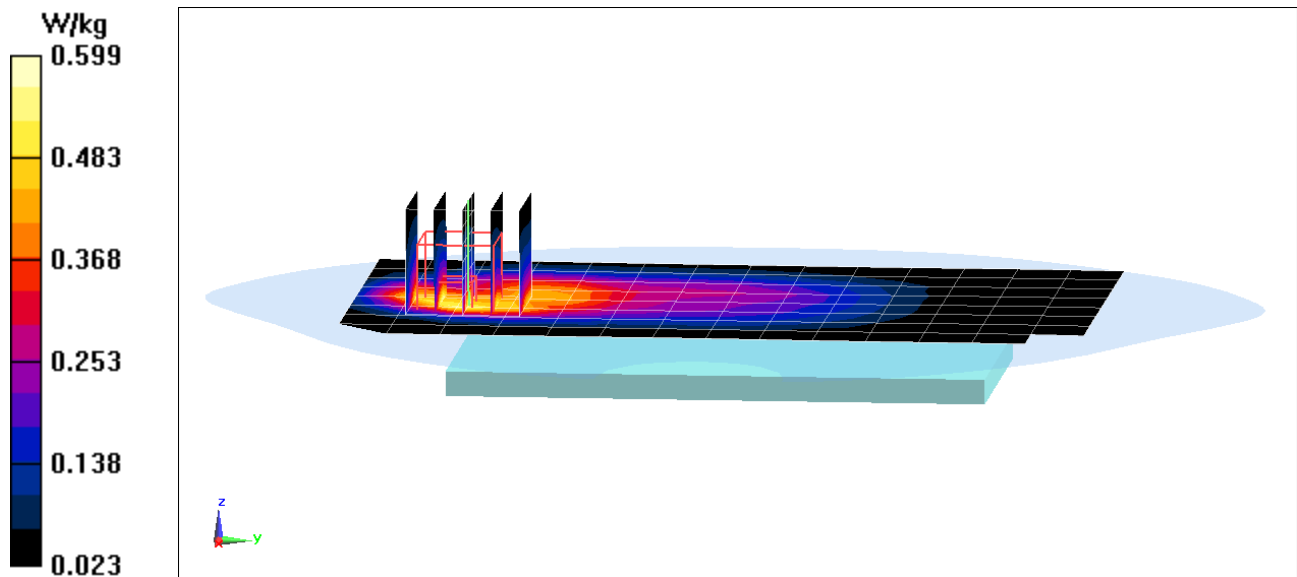

PCTEST ENGINEERING LABORATORY, INC.

DUT: ZNFG710VM; Type: Portable Handset; Serial: 12280

Communication System: UID 0, CDMA; Frequency: 836.52 MHz; Duty Cycle: 1:1
Medium: 835 Body Medium parameters used (interpolated):
 $f = 836.52 \text{ MHz}$; $\sigma = 0.967 \text{ S/m}$; $\epsilon_r = 53.56$; $\rho = 1000 \text{ kg/m}^3$
Phantom section: Flat Section; Space: 1.0 cm

Test Date: 04-11-2018; Ambient Temp: 22.7°C; Tissue Temp: 22.3°C

Probe: ES3DV3 - SN3213; ConvF(6.2, 6.2, 6.2); Calibrated: 2/13/2018;
Sensor-Surface: 3mm (Mechanical Surface Detection)

Electronics: DAE4 Sn1272; Calibrated: 2/9/2018

Phantom: SAM V5.0 Right; Type: QD000P40CD; Serial: 1647

Measurement SW: DASY52, Version 52.10; SEMCAD X Version 14.6.10 (7417)

Mode: Cell. EVDO, Rule Part 22H, Body SAR, Back side, Mid.ch

Area Scan (9x15x1): Measurement grid: $dx=15\text{mm}$, $dy=15\text{mm}$

Zoom Scan (5x5x7)/Cube 0: Measurement grid: $dx=8\text{mm}$, $dy=8\text{mm}$, $dz=5\text{mm}$

Reference Value = 23.18 V/m; Power Drift = 0.03 dB

Peak SAR (extrapolated) = 0.812 W/kg

SAR(1 g) = 0.467 W/kg

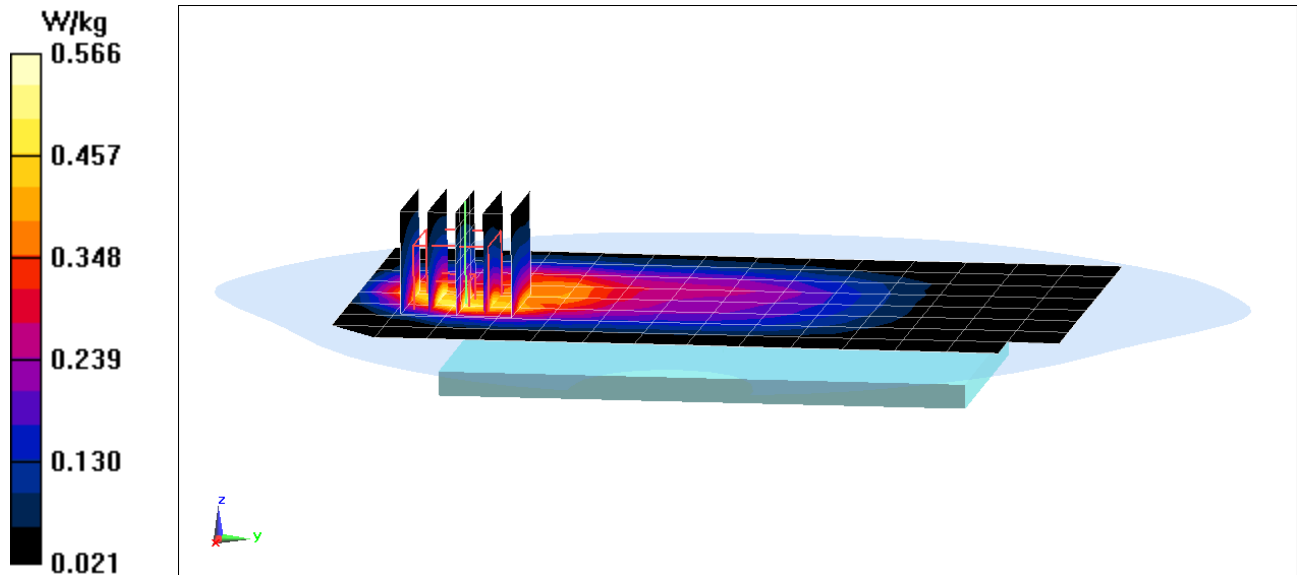

PCTEST ENGINEERING LABORATORY, INC.

DUT: ZNFG710VM; Type: Portable Handset; Serial: 12280

Communication System: UID 0, CDMA; Frequency: 1880 MHz; Duty Cycle: 1:1
Medium: 1900 Body Medium parameters used:
 $f = 1880 \text{ MHz}$; $\sigma = 1.553 \text{ S/m}$; $\epsilon_r = 53.793$; $\rho = 1000 \text{ kg/m}^3$
Phantom section: Flat Section; Space: 1.0 cm

Test Date: 04-05-2018; Ambient Temp: 21.9°C; Tissue Temp: 21.7°C

Probe: EX3DV4 - SN3914; ConvF(7.62, 7.62, 7.62); Calibrated: 2/14/2018;
Sensor-Surface: 1.4mm (Mechanical Surface Detection)
Electronics: DAE4 Sn665; Calibrated: 2/15/2018
Phantom: Twin-SAM V5.0 Right; Type: QD 000 P40 CD; Serial: 1800
Measurement SW: DASY52, Version 52.10; SEMCAD X Version 14.6.10 (7417)

Mode: PCS CDMA, Body SAR, Back side, Mid.ch

Area Scan (9x14x1): Measurement grid: dx=15mm, dy=15mm
Zoom Scan (5x6x7)/Cube 0: Measurement grid: dx=8mm, dy=8mm, dz=5mm
Reference Value = 15.86 V/m; Power Drift = 0.10 dB
Peak SAR (extrapolated) = 0.628 W/kg
SAR(1 g) = 0.357 W/kg

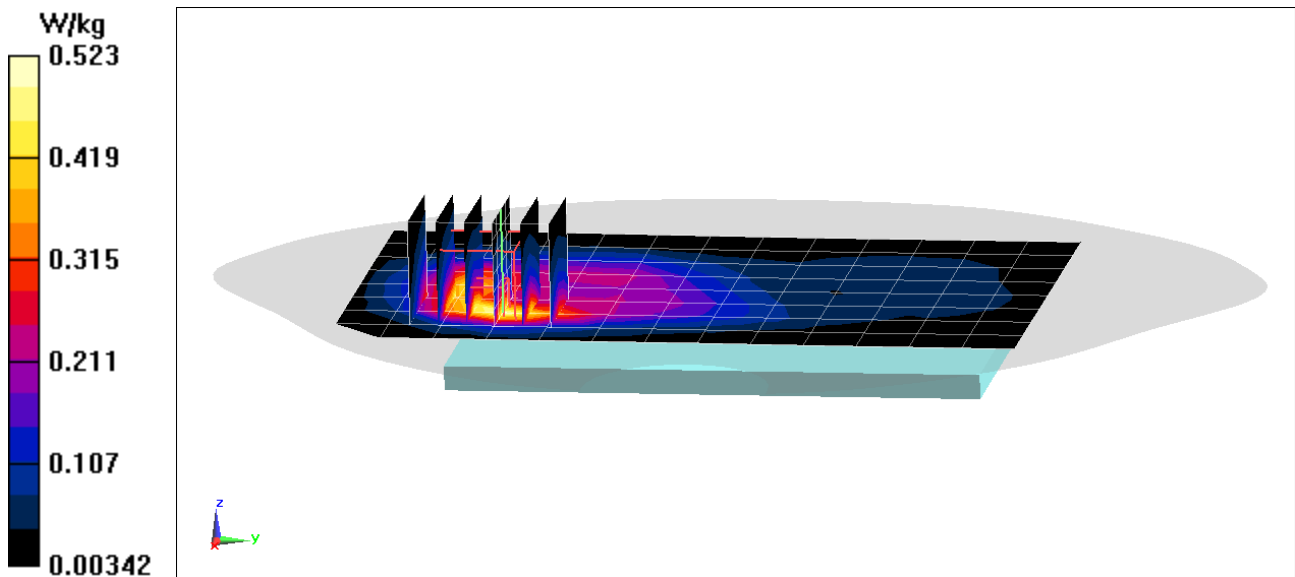

PCTEST ENGINEERING LABORATORY, INC.

DUT: ZNFG710VM; Type: Portable Handset; Serial: 12280

Communication System: UID 0, CDMA; Frequency: 1908.75 MHz; Duty Cycle: 1:1
Medium: 1900 Body Medium parameters used (interpolated):
 $f = 1908.75 \text{ MHz}$; $\sigma = 1.586 \text{ S/m}$; $\epsilon_r = 53.699$; $\rho = 1000 \text{ kg/m}^3$
Phantom section: Flat Section; Space: 1.0 cm

Test Date: 04-05-2018; Ambient Temp: 21.9°C; Tissue Temp: 21.7°C

Probe: EX3DV4 - SN3914; ConvF(7.62, 7.62, 7.62); Calibrated: 2/14/2018;
Sensor-Surface: 1.4mm (Mechanical Surface Detection)

Electronics: DAE4 Sn665; Calibrated: 2/15/2018

Phantom: Twin-SAM V5.0 Right; Type: QD 000 P40 CD; Serial: 1800

Measurement SW: DASY52, Version 52.10; SEMCAD X Version 14.6.10 (7417)

Mode: PCS EVDO, Body SAR, Bottom Edge, High.ch

Area Scan (10x8x1): Measurement grid: dx=5mm, dy=15mm

Zoom Scan (5x5x7)/Cube 0: Measurement grid: dx=8mm, dy=8mm, dz=5mm

Reference Value = 26.42 V/m; Power Drift = -0.01 dB

Peak SAR (extrapolated) = 1.75 W/kg

SAR(1 g) = 0.996 W/kg

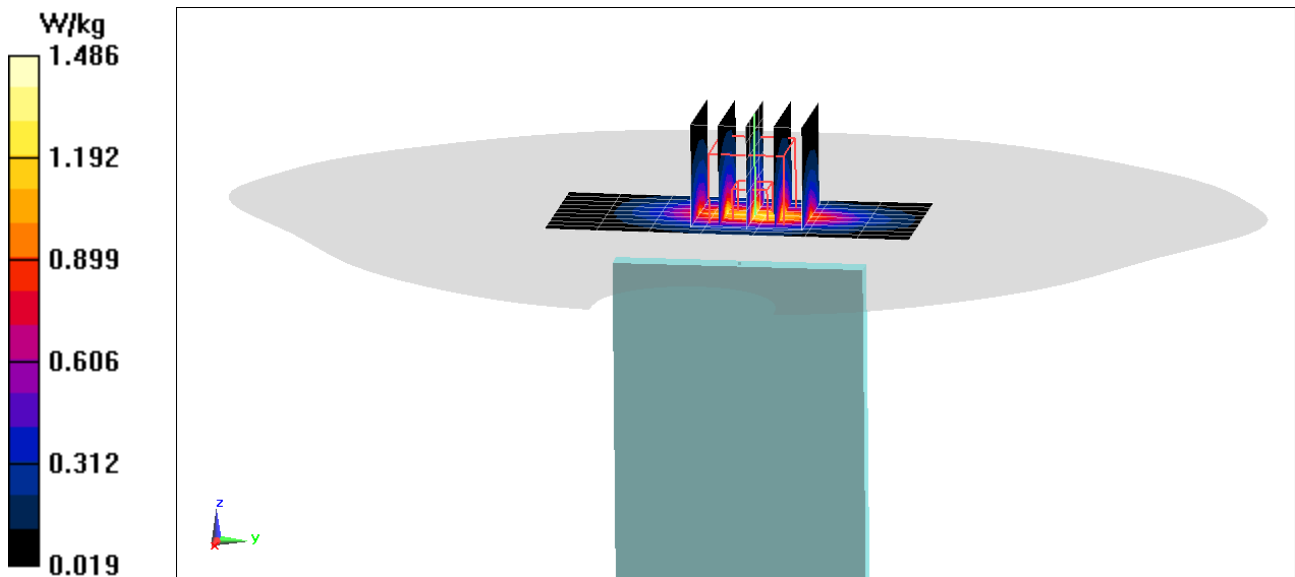

PCTEST ENGINEERING LABORATORY, INC.

DUT: ZNFG710VM; Type: Portable Handset; Serial: 12298

Communication System: UID 0, GSM GPRS; 2 Tx slots; Frequency: 836.6 MHz; Duty Cycle: 1:4.15
Medium: 835 Body Medium parameters used (interpolated):
 $f = 836.6 \text{ MHz}$; $\sigma = 0.976 \text{ S/m}$; $\epsilon_r = 54.281$; $\rho = 1000 \text{ kg/m}^3$
Phantom section: Flat Section; Space: 1.0 cm

Test Date: 04-06-2018; Ambient Temp: 24.2°C; Tissue Temp: 22.0°C

Probe: ES3DV3 - SN3213; ConvF(6.2, 6.2, 6.2); Calibrated: 2/13/2018;
Sensor-Surface: 3mm (Mechanical Surface Detection)
Electronics: DAE4 Sn1272; Calibrated: 2/9/2018

Phantom: SAM V5.0 Right; Type: QD000P40CD; Serial: 1647
Measurement SW: DASY52, Version 52.10; SEMCAD X Version 14.6.10 (7417)

Mode: GPRS 850, Body SAR, Back side, Mid.ch, 2 Tx Slots

Area Scan (9x15x1): Measurement grid: dx=15mm, dy=15mm

Zoom Scan (6x6x7)/Cube 0: Measurement grid: dx=8mm, dy=8mm, dz=5mm

Reference Value = 18.80 V/m; Power Drift = -0.04 dB

Peak SAR (extrapolated) = 0.529 W/kg

SAR(1 g) = 0.306 W/kg

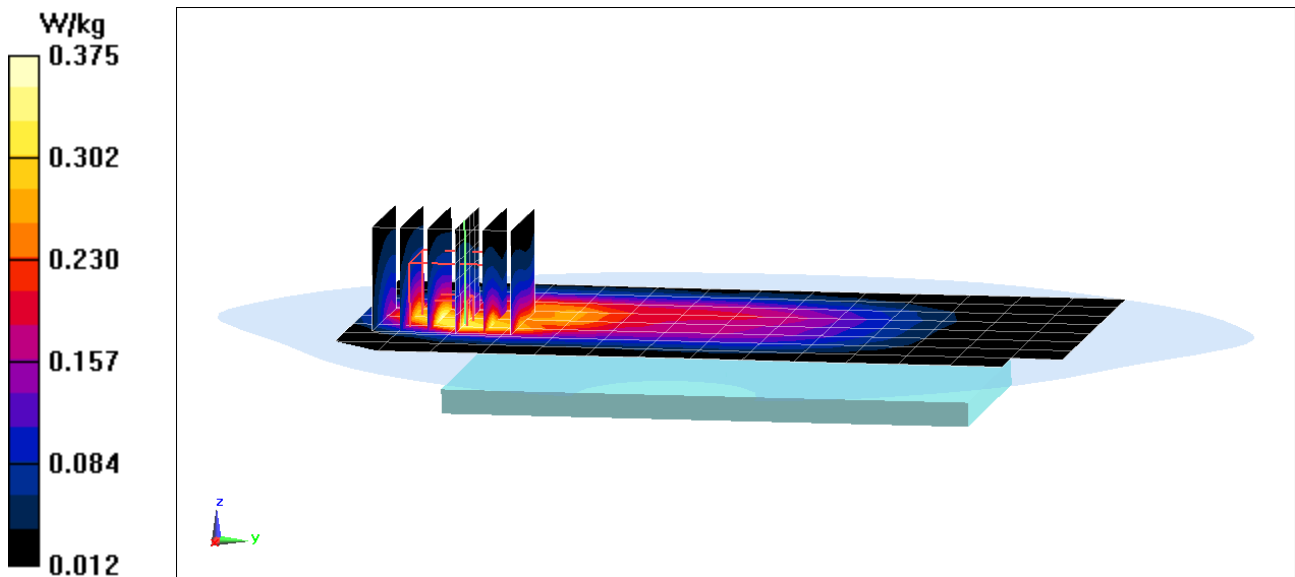

PCTEST ENGINEERING LABORATORY, INC.

DUT: ZNFG710VM; Type: Portable Handset; Serial: 12272

Communication System: UID 0, GSM GPRS; 2 Tx slots; Frequency: 1880 MHz; Duty Cycle: 1:4.15

Medium: 1900 Body Medium parameters used:

$f = 1880 \text{ MHz}$; $\sigma = 1.553 \text{ S/m}$; $\epsilon_r = 53.793$; $\rho = 1000 \text{ kg/m}^3$

Phantom section: Flat Section; Space: 1.0 cm

Test Date: 04-05-2018; Ambient Temp: 21.9°C; Tissue Temp: 21.7°C

Probe: EX3DV4 - SN3914; ConvF(7.62, 7.62, 7.62); Calibrated: 2/14/2018;

Sensor-Surface: 1.4mm (Mechanical Surface Detection)

Electronics: DAE4 Sn665; Calibrated: 2/15/2018

Phantom: Twin-SAM V5.0 Right; Type: QD 000 P40 CD; Serial: 1800

Measurement SW: DASY52, Version 52.10; SEMCAD X Version 14.6.10 (7417)

Mode: GPRS 1900, Body SAR, Back side, Mid.ch, 2 Tx Slots

Area Scan (9x14x1): Measurement grid: dx=15mm, dy=15mm

Zoom Scan (5x5x7)/Cube 0: Measurement grid: dx=8mm, dy=8mm, dz=5mm

Reference Value = 14.04 V/m; Power Drift = -0.09 dB

Peak SAR (extrapolated) = 0.481 W/kg

SAR(1 g) = 0.288 W/kg

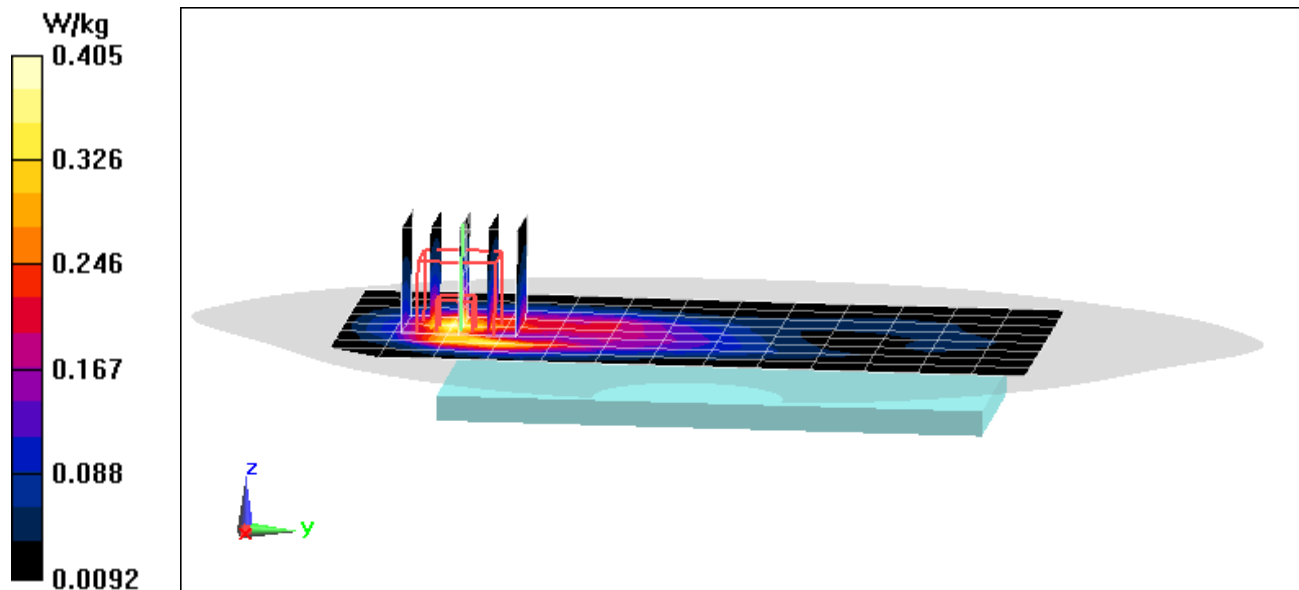

PCTEST ENGINEERING LABORATORY, INC.

DUT: ZNFG710VM; Type: Portable Handset; Serial: 12272

Communication System: UID 0, GSM GPRS; 2 Tx slots; Frequency: 1909.8 MHz; Duty Cycle: 1:4.15

Medium: 1900 Body Medium parameters used:

$f = 1910$ MHz; $\sigma = 1.587$ S/m; $\epsilon_r = 53.695$; $\rho = 1000$ kg/m³

Phantom section: Flat Section; Space: 1.0 cm

Test Date: 04-05-2018; Ambient Temp: 21.9°C; Tissue Temp: 21.7°C

Probe: EX3DV4 - SN3914; ConvF(7.62, 7.62, 7.62); Calibrated: 2/14/2018;

Sensor-Surface: 1.4mm (Mechanical Surface Detection)

Electronics: DAE4 Sn665; Calibrated: 2/15/2018

Phantom: Twin-SAM V5.0 Right; Type: QD 000 P40 CD; Serial: 1800

Measurement SW: DASY52, Version 52.10; SEMCAD X Version 14.6.10 (7417)

Mode: GPRS 1900, Body SAR, Bottom Edge, High.ch, 2 Tx Slots

Area Scan (10x7x1): Measurement grid: dx=5mm, dy=15mm

Zoom Scan (5x5x7)/Cube 0: Measurement grid: dx=8mm, dy=8mm, dz=5mm

Reference Value = 22.09 V/m; Power Drift = 0.01 dB

Peak SAR (extrapolated) = 1.08 W/kg

SAR(1 g) = 0.627 W/kg

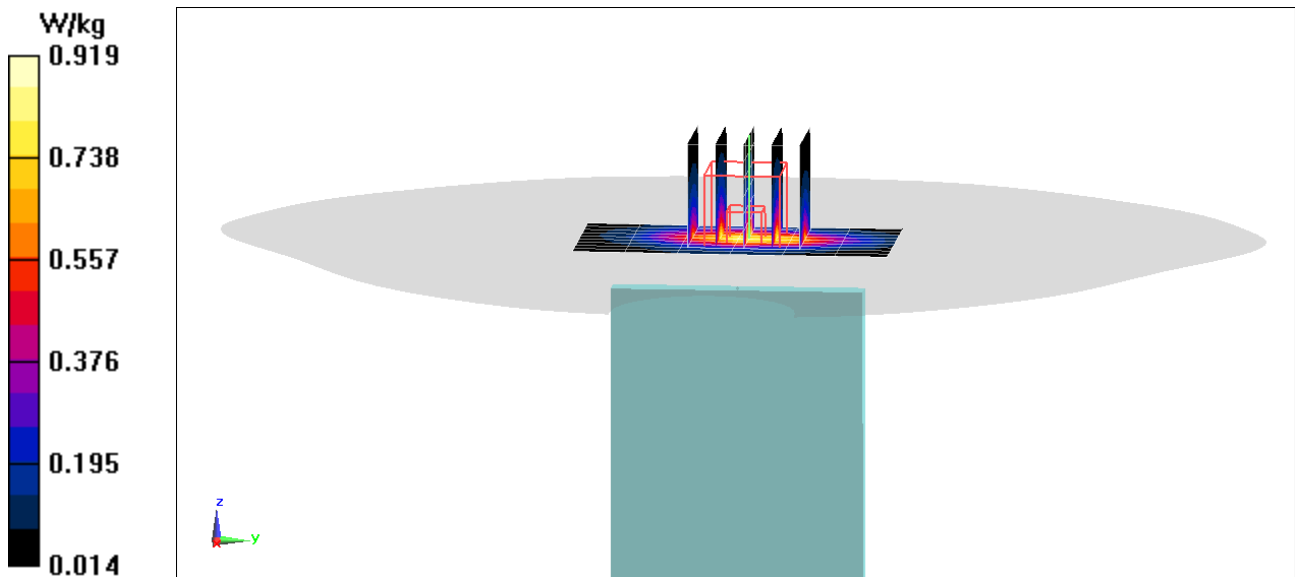

PCTEST ENGINEERING LABORATORY, INC.

DUT: ZNFG710VM; Type: Portable Handset; Serial: 12256

Communication System: UID 0, UMTS; Frequency: 836.6 MHz; Duty Cycle: 1:1
Medium: 835 Body Medium parameters used (interpolated):
 $f = 836.6 \text{ MHz}$; $\sigma = 0.976 \text{ S/m}$; $\epsilon_r = 54.281$; $\rho = 1000 \text{ kg/m}^3$
Phantom section: Flat Section; Space: 1.0 cm

Test Date: 04-06-2018; Ambient Temp: 24.2°C; Tissue Temp: 22.0°C

Probe: ES3DV3 - SN3213; ConvF(6.2, 6.2, 6.2); Calibrated: 2/13/2018;
Sensor-Surface: 3mm (Mechanical Surface Detection)
Electronics: DAE4 Sn1272; Calibrated: 2/9/2018
Phantom: SAM V5.0 Right; Type: QD000P40CD; Serial: 1647
Measurement SW: DASY52, Version 52.10; SEMCAD X Version 14.6.10 (7417)

Mode: UMTS 850, Body SAR, Back side, Mid.ch

Area Scan (9x15x1): Measurement grid: dx=15mm, dy=15mm
Zoom Scan (6x6x7)/Cube 0: Measurement grid: dx=8mm, dy=8mm, dz=5mm
Reference Value = 21.02 V/m; Power Drift = -0.03 dB
Peak SAR (extrapolated) = 0.675 W/kg
SAR(1 g) = 0.391 W/kg

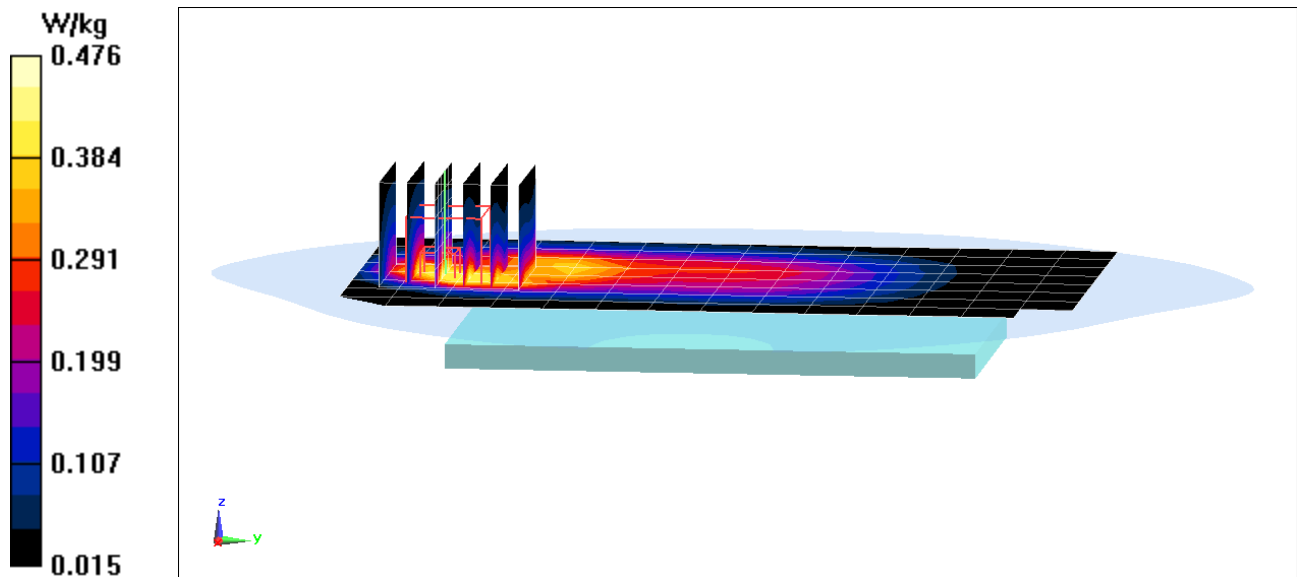

PCTEST ENGINEERING LABORATORY, INC.

DUT: ZNFG710VM; Type: Portable Handset; Serial: 12256

Communication System: UID 0, UMTS; Frequency: 1732.4 MHz; Duty Cycle: 1:1
Medium: 1750 Body Medium parameters used (interpolated):
 $f = 1732.4 \text{ MHz}$; $\sigma = 1.474 \text{ S/m}$; $\epsilon_r = 52.699$; $\rho = 1000 \text{ kg/m}^3$
Phantom section: Flat Section; Space: 1.0 cm

Test Date: 04-10-2018; Ambient Temp: 22.8°C; Tissue Temp: 21.4°C

Probe: ES3DV3 - SN3287; ConvF(5.19, 5.19, 5.19); Calibrated: 9/18/2017;
Sensor-Surface: 3mm (Mechanical Surface Detection)
Electronics: DAE4 Sn1333; Calibrated: 6/21/2017
Phantom: Twin-SAM V4.0; Type: QD 000 P40 CC; Serial: 1167
Measurement SW: DASY52, Version 52.10; SEMCAD X Version 14.6.10 (7417)

Mode: UMTS 1750, Body SAR, Back side, Mid.ch

Area Scan (9x15x1): Measurement grid: dx=15mm, dy=15mm
Zoom Scan (8x6x7)/Cube 0: Measurement grid: dx=8mm, dy=8mm, dz=5mm
Reference Value = 18.21 V/m; Power Drift = 0.04 dB
Peak SAR (extrapolated) = 0.758 W/kg
SAR(1 g) = 0.482 W/kg

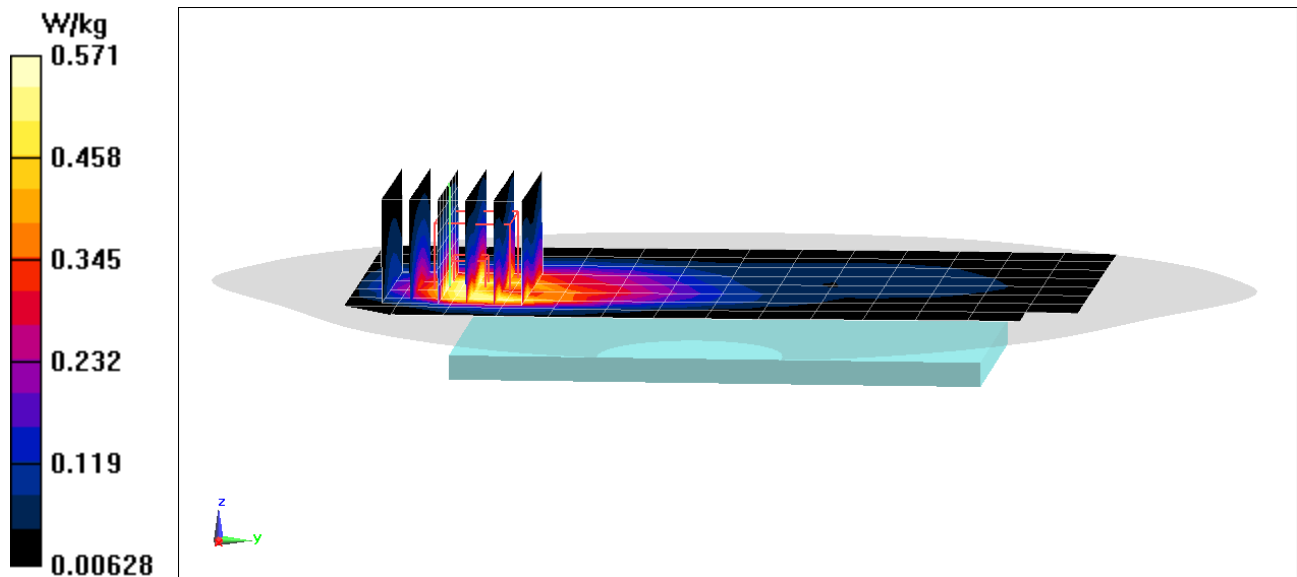

PCTEST ENGINEERING LABORATORY, INC.

DUT: ZNFG710VM; Type: Portable Handset; Serial: 12256

Communication System: UID 0, UMTS; Frequency: 1752.6 MHz; Duty Cycle: 1:1
Medium: 1750 Body Medium parameters used (interpolated):
 $f = 1752.6 \text{ MHz}$; $\sigma = 1.498 \text{ S/m}$; $\epsilon_r = 52.626$; $\rho = 1000 \text{ kg/m}^3$
Phantom section: Flat Section; Space: 1.0 cm

Test Date: 04-10-2018; Ambient Temp: 22.8°C; Tissue Temp: 21.4°C

Probe: ES3DV3 - SN3287; ConvF(5.19, 5.19, 5.19); Calibrated: 9/18/2017;
Sensor-Surface: 3mm (Mechanical Surface Detection)
Electronics: DAE4 Sn1333; Calibrated: 6/21/2017
Phantom: Twin-SAM V4.0; Type: QD 000 P40 CC; Serial: 1167
Measurement SW: DASY52, Version 52.10; SEMCAD X Version 14.6.10 (7417)

Mode: UMTS 1750, Body SAR, Bottom Edge, High.ch

Area Scan (10x7x1): Measurement grid: dx=5mm, dy=15mm
Zoom Scan (5x6x7)/Cube 0: Measurement grid: dx=8mm, dy=8mm, dz=5mm
Reference Value = 26.13 V/m; Power Drift = -0.02 dB
Peak SAR (extrapolated) = 1.51 W/kg
SAR(1 g) = 0.891 W/kg

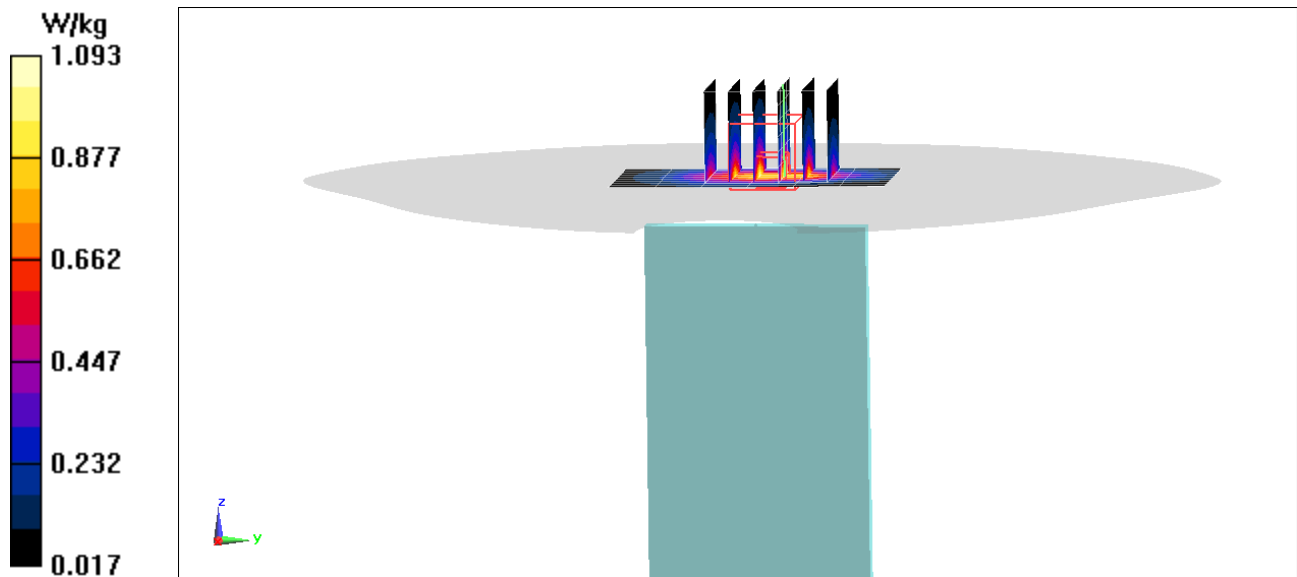

PCTEST ENGINEERING LABORATORY, INC.

DUT: ZNFG710VM; Type: Portable Handset; Serial: 12272

Communication System: UID 0, UMTS; Frequency: 1880 MHz; Duty Cycle: 1:1
Medium: 1900 Body Medium parameters used:
 $f = 1880 \text{ MHz}$; $\sigma = 1.553 \text{ S/m}$; $\epsilon_r = 53.793$; $\rho = 1000 \text{ kg/m}^3$
Phantom section: Flat Section; Space: 1.0 cm

Test Date: 04-05-2018; Ambient Temp: 21.9°C; Tissue Temp: 21.7°C

Probe: EX3DV4 - SN3914; ConvF(7.62, 7.62, 7.62); Calibrated: 2/14/2018;
Sensor-Surface: 1.4mm (Mechanical Surface Detection)
Electronics: DAE4 Sn665; Calibrated: 2/15/2018
Phantom: Twin-SAM V5.0 Right; Type: QD 000 P40 CD; Serial: 1800
Measurement SW: DASY52, Version 52.10; SEMCAD X Version 14.6.10 (7417)

Mode: UMTS 1900, Body SAR, Back side, Mid.ch

Area Scan (9x14x1): Measurement grid: dx=15mm, dy=15mm

Zoom Scan (5x5x7)/Cube 0: Measurement grid: dx=8mm, dy=8mm, dz=5mm

Reference Value = 19.36 V/m; Power Drift = -0.05 dB

Peak SAR (extrapolated) = 0.923 W/kg

SAR(1 g) = 0.552 W/kg

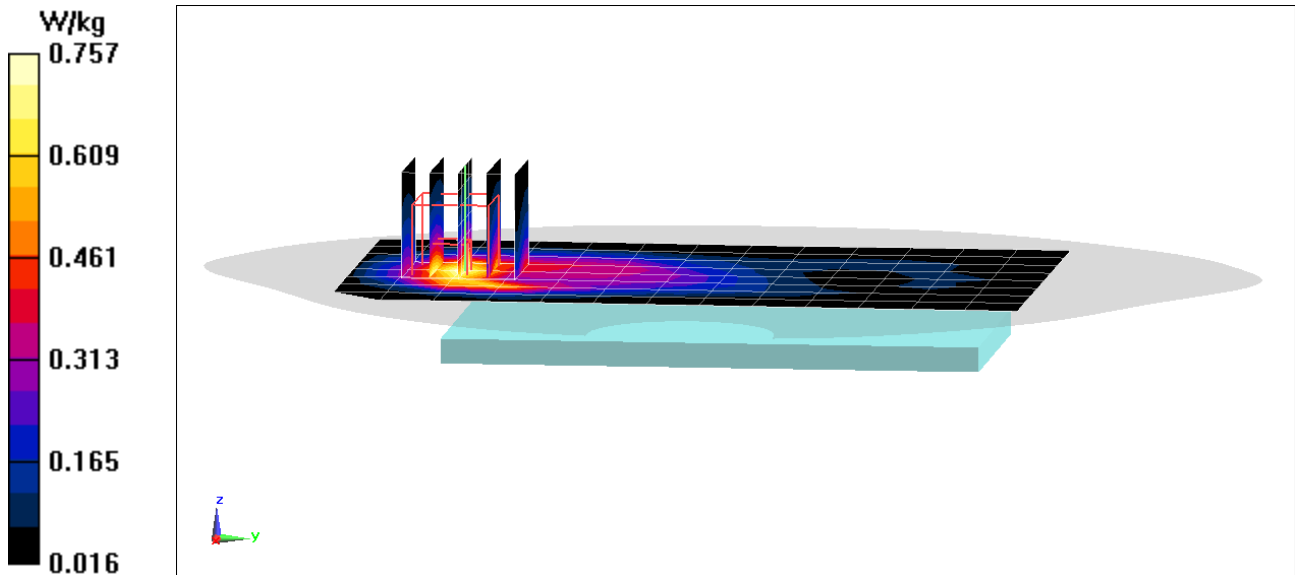

PCTEST ENGINEERING LABORATORY, INC.

DUT: ZNFG710VM; Type: Portable Handset; Serial: 12272

Communication System: UID 0, UMTS; Frequency: 1907.6 MHz; Duty Cycle: 1:1
Medium: 1900 Body parameters used (interpolated):
 $f = 1907.6$ MHz; $\sigma = 1.584$ S/m; $\epsilon_r = 53.703$; $\rho = 1000$ kg/m³
Phantom section: Flat Section; Space: 1.0 cm

Test Date: 04-05-2018; Ambient Temp: 21.9°C; Tissue Temp: 21.7°C

Probe: EX3DV4 - SN3914; ConvF(7.62, 7.62, 7.62); Calibrated: 2/14/2018;
Sensor-Surface: 1.4mm (Mechanical Surface Detection)

Electronics: DAE4 Sn665; Calibrated: 2/15/2018

Phantom: Twin-SAM V5.0 Right; Type: QD 000 P40 CD; Serial: 1800

Measurement SW: DASY52, Version 52.10; SEMCAD X Version 14.6.10 (7417)

Mode: UMTS 1900, Body SAR, Bottom Edge, High.ch

Area Scan (10x8x1): Measurement grid: dx=5mm, dy=15mm

Zoom Scan (5x5x7)/Cube 0: Measurement grid: dx=8mm, dy=8mm, dz=5mm

Reference Value = 29.21 V/m; Power Drift = -0.12 dB

Peak SAR (extrapolated) = 2.19 W/kg

SAR(1 g) = 1.24 W/kg

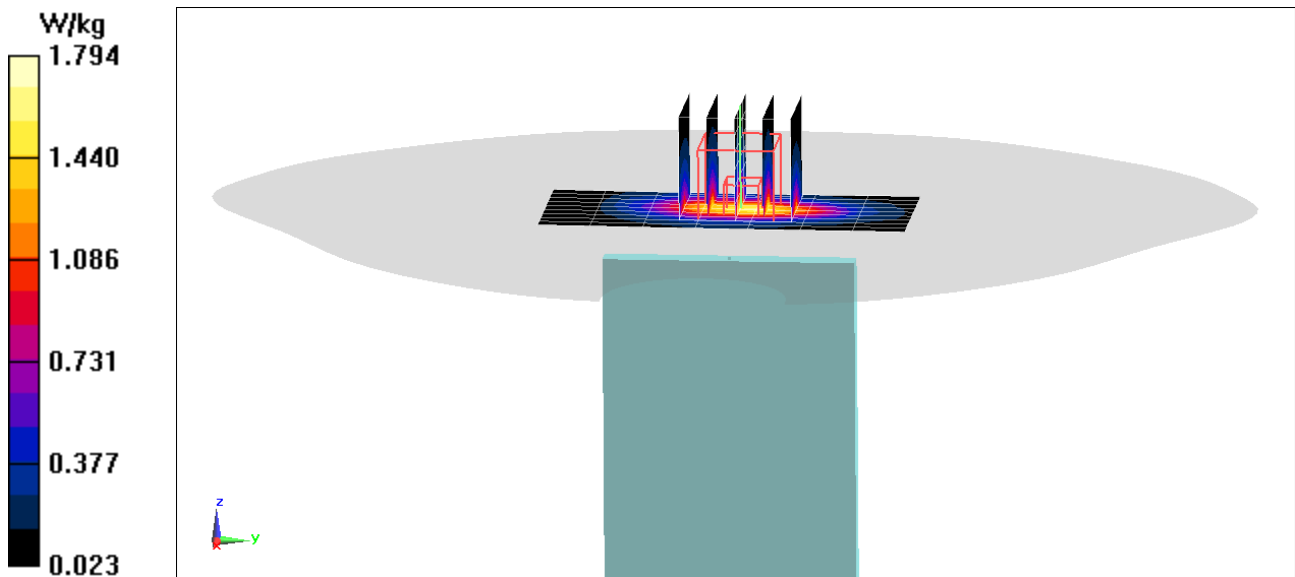

PCTEST ENGINEERING LABORATORY, INC.

DUT: ZNFG710VM; Type: Portable Handset; Serial: 12249

Communication System: UID 0, LTE Band 12; Frequency: 707.5 MHz; Duty Cycle: 1:1
Medium: 750 Body Medium parameters used (interpolated):
 $f = 707.5$ MHz; $\sigma = 0.935$ S/m; $\epsilon_r = 54.178$; $\rho = 1000$ kg/m³
Phantom section: Flat Section; Space: 1.0 cm

Test Date: 04-09-2018; Ambient Temp: 22.6°C; Tissue Temp: 21.5°C

Probe: ES3DV3 - SN3287; ConvF(6.71, 6.71, 6.71); Calibrated: 9/18/2017;
Sensor-Surface: 3mm (Mechanical Surface Detection)
Electronics: DAE4 Sn1333; Calibrated: 6/21/2017
Phantom: Twin-SAM V5.0; Type: QD 000 P40 CD; Serial: 1692
Measurement SW: DASY52, Version 52.10; SEMCAD X Version 14.6.10 (7417)

**Mode: LTE Band 12, Body SAR, Back side, Mid.ch,
10 MHz Bandwidth, QPSK, 1 RB, 0 RB Offset**

Area Scan (9x13x1): Measurement grid: dx=15mm, dy=15mm
Zoom Scan (7x9x7)/Cube 0: Measurement grid: dx=8mm, dy=8mm, dz=5mm
Reference Value = 23.75 V/m; Power Drift = 0.00 dB
Peak SAR (extrapolated) = 0.849 W/kg
SAR(1 g) = 0.471 W/kg

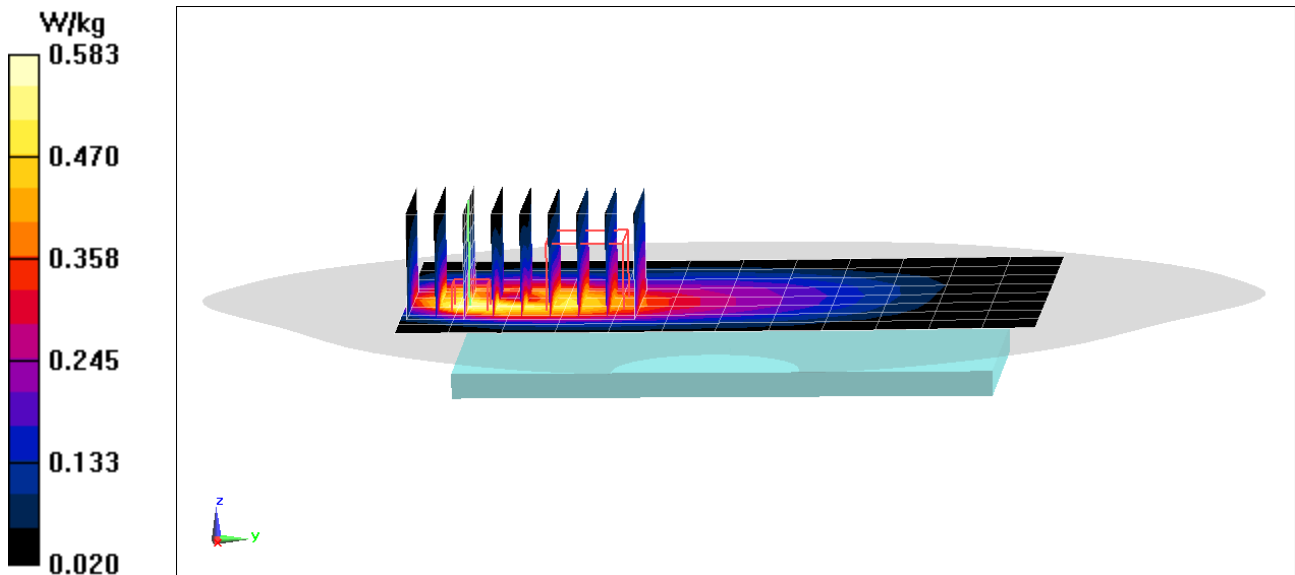

PCTEST ENGINEERING LABORATORY, INC.

DUT: ZNFG710VM; Type: Portable Handset; Serial: 12249

Communication System: UID 0, LTE Band 13; Frequency: 782 MHz; Duty Cycle: 1:1

Medium: 750 Body Medium parameters used (interpolated):

$f = 782 \text{ MHz}$; $\sigma = 0.964 \text{ S/m}$; $\epsilon_r = 53.997$; $\rho = 1000 \text{ kg/m}^3$

Phantom section: Flat Section; Space: 1.0 cm

Test Date: 04-09-2018; Ambient Temp: 22.6°C; Tissue Temp: 21.5°C

Probe: ES3DV3 - SN3287; ConvF(6.71, 6.71, 6.71); Calibrated: 9/18/2017;

Sensor-Surface: 3mm (Mechanical Surface Detection)

Electronics: DAE4 Sn1333; Calibrated: 6/21/2017

Phantom: Twin-SAM V5.0; Type: QD 000 P40 CD; Serial: 1692

Measurement SW: DASY52, Version 52.10; SEMCAD X Version 14.6.10 (7417)

**Mode: LTE Band 13, Body SAR, Back side, Mid.ch,
10 MHz Bandwidth, QPSK, 1 RB, 25 RB Offset**

Area Scan (9x13x1): Measurement grid: dx=15mm, dy=15mm

Zoom Scan (5x5x7)/Cube 0: Measurement grid: dx=8mm, dy=8mm, dz=5mm

Reference Value = 24.87 V/m; Power Drift = 0.01 dB

Peak SAR (extrapolated) = 0.957 W/kg

SAR(1 g) = 0.533 W/kg

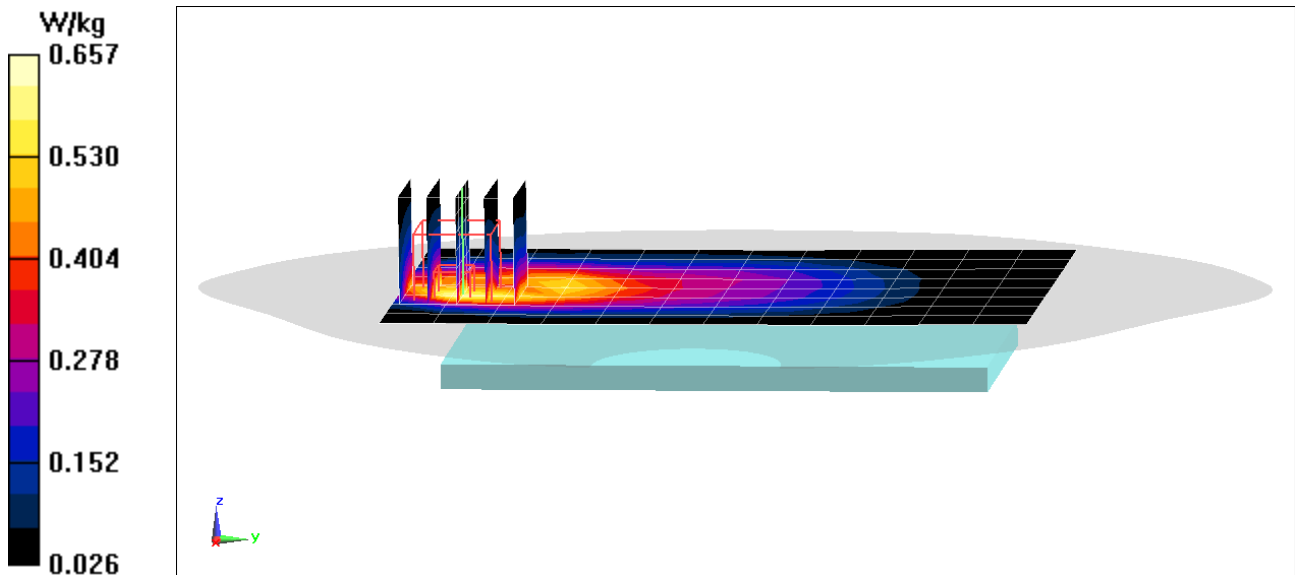

PCTEST ENGINEERING LABORATORY, INC.

DUT: ZNFG710VM; Type: Portable Handset; Serial: 12256

Communication System: UID 0, LTE Band 5; Frequency: 836.5 MHz; Duty Cycle: 1:1
Medium: 835 Body Medium parameters used (interpolated):
 $f = 836.5 \text{ MHz}$; $\sigma = 0.967 \text{ S/m}$; $\epsilon_r = 53.56$; $\rho = 1000 \text{ kg/m}^3$
Phantom section: Flat Section; Space: 1.0 cm

Test Date: 04-11-2018; Ambient Temp: 22.7°C; Tissue Temp: 22.3°C

Probe: ES3DV3 - SN3213; ConvF(6.2, 6.2, 6.2); Calibrated: 2/13/2018;
Sensor-Surface: 3mm (Mechanical Surface Detection)

Electronics: DAE4 Sn1272; Calibrated: 2/9/2018

Phantom: SAM V5.0 Right; Type: QD000P40CD; Serial: 1647

Measurement SW: DASY52, Version 52.10; SEMCAD X Version 14.6.10 (7417)

**Mode: LTE Band 5 (Cell.), Body SAR, Back side, Mid.ch,
10 MHz Bandwidth, QPSK, 1 RB, 0 RB Offset**

Area Scan (9x15x1): Measurement grid: dx=15mm, dy=15mm

Zoom Scan (5x5x7)/Cube 0: Measurement grid: dx=8mm, dy=8mm, dz=5mm

Reference Value = 21.11 V/m; Power Drift = -0.01 dB

Peak SAR (extrapolated) = 0.666 W/kg

SAR(1 g) = 0.385 W/kg

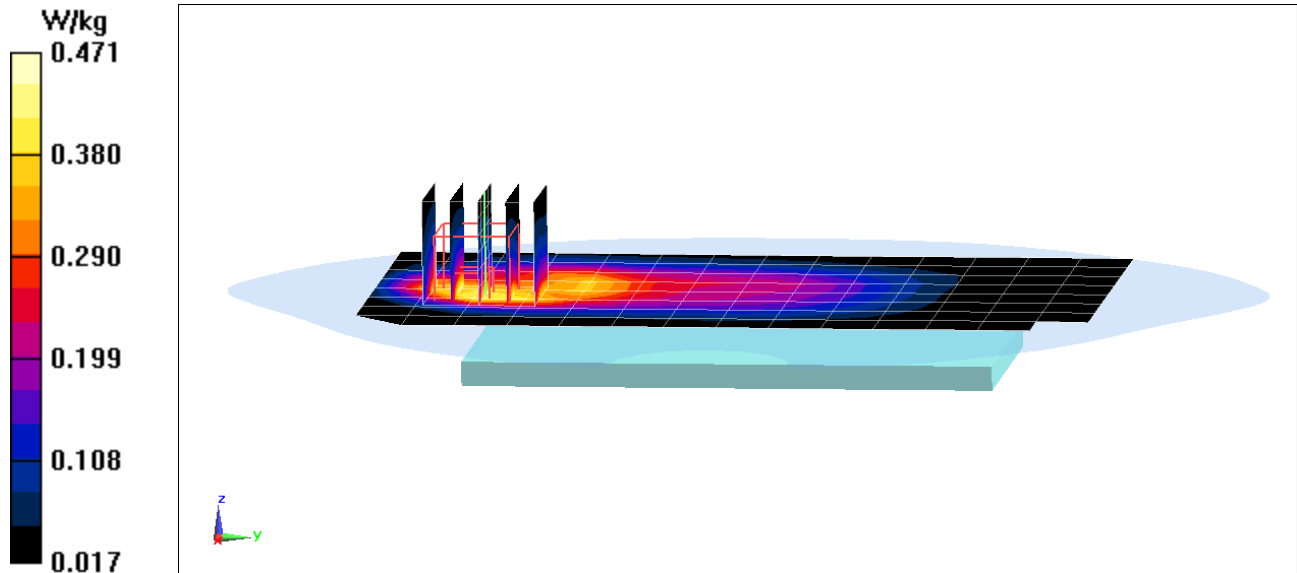

PCTEST ENGINEERING LABORATORY, INC.

DUT: ZNFG710VM; Type: Portable Handset; Serial: 12256

Communication System: UID 0, LTE Band 26; Frequency: 831.5 MHz; Duty Cycle: 1:1

Medium: 835 Body Medium parameters used (interpolated):

$f = 831.5 \text{ MHz}$; $\sigma = 0.961 \text{ S/m}$; $\epsilon_r = 53.6$; $\rho = 1000 \text{ kg/m}^3$

Phantom section: Flat Section; Space: 1.0 cm

Test Date: 04-11-2018; Ambient Temp: 22.7°C; Tissue Temp: 22.3°C

Probe: ES3DV3 - SN3213; ConvF(6.2, 6.2, 6.2); Calibrated: 2/13/2018;

Sensor-Surface: 3mm (Mechanical Surface Detection)

Electronics: DAE4 Sn1272; Calibrated: 2/9/2018

Phantom: SAM V5.0 Right; Type: QD000P40CD; Serial: 1647

Measurement SW: DASY52, Version 52.10; SEMCAD X Version 14.6.10 (7417)

**Mode: LTE Band 26 (Cell.), Body SAR, Back side, Mid.ch,
15 MHz Bandwidth, QPSK, 1 RB, 36 RB Offset**

Area Scan (9x15x1): Measurement grid: dx=15mm, dy=15mm

Zoom Scan (5x5x7)/Cube 0: Measurement grid: dx=8mm, dy=8mm, dz=5mm

Reference Value = 21.08 V/m; Power Drift = 0.00 dB

Peak SAR (extrapolated) = 0.664 W/kg

SAR(1 g) = 0.383 W/kg

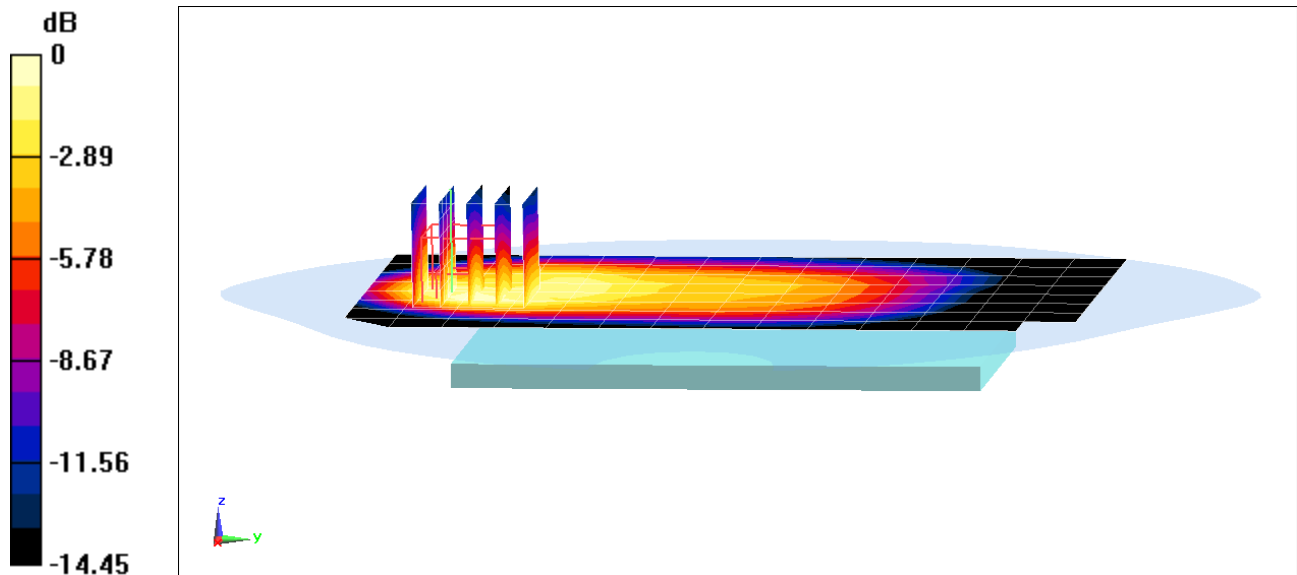

0 dB = 0.471 W/kg = -3.27 dBW/kg

PCTEST ENGINEERING LABORATORY, INC.

DUT: ZNFG710VM; Type: Portable Handset; Serial: 12280

Communication System: UID 0, LTE Band 66 (AWS); Frequency: 1720 MHz; Duty Cycle: 1:1
Medium: 1750 Body Medium parameters used (interpolated):
 $f = 1720 \text{ MHz}$; $\sigma = 1.465 \text{ S/m}$; $\epsilon_r = 51.991$; $\rho = 1000 \text{ kg/m}^3$
Phantom section: Flat Section; Space: 1.0 cm

Test Date: 04-05-2018; Ambient Temp: 22.6°C; Tissue Temp: 21.2°C

Probe: ES3DV3 - SN3287; ConvF(5.19, 5.19, 5.19); Calibrated: 9/18/2017;
Sensor-Surface: 3mm (Mechanical Surface Detection)
Electronics: DAE4 Sn1333; Calibrated: 6/21/2017
Phantom: Twin-SAM V4.0; Type: QD 000 P40 CC; Serial: 1167
Measurement SW: DASY52, Version 52.10; SEMCAD X Version 14.6.10 (7417)

**Mode: LTE Band 66 (AWS), Body SAR, Back side, Low.ch,
20 MHz Bandwidth, QPSK, 1 RB, 99 RB Offset**

Area Scan (9x15x1): Measurement grid: dx=15mm, dy=15mm
Zoom Scan (8x6x7)/Cube 0: Measurement grid: dx=8mm, dy=8mm, dz=5mm
Reference Value = 17.65 V/m; Power Drift = 0.00 dB
Peak SAR (extrapolated) = 0.756 W/kg
SAR(1 g) = 0.473 W/kg

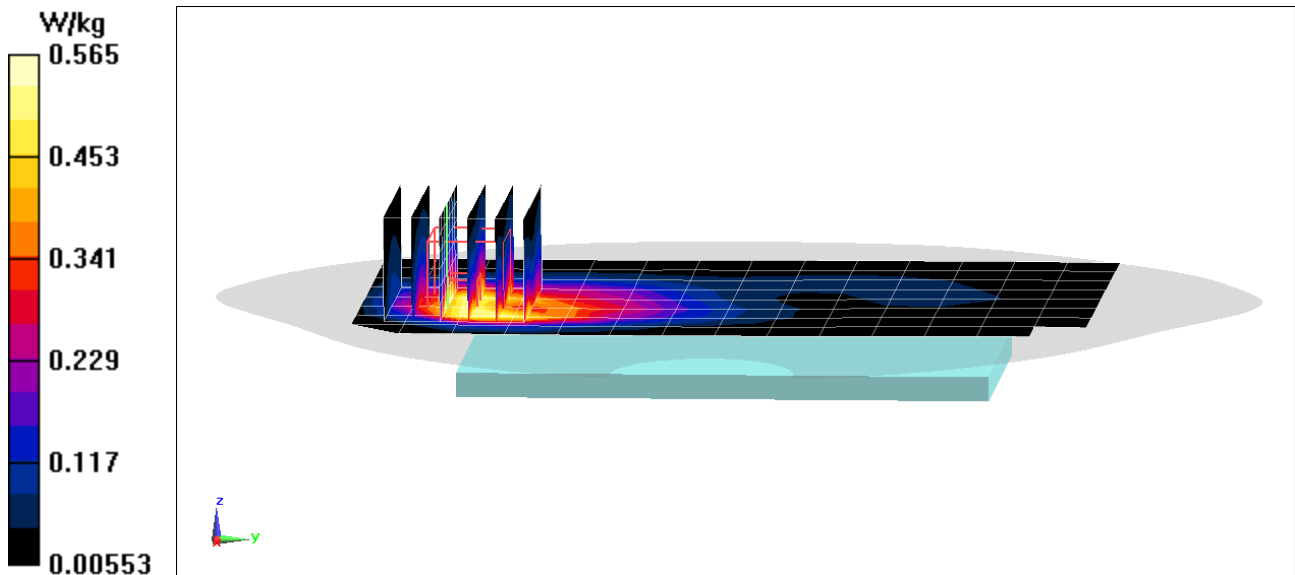

PCTEST ENGINEERING LABORATORY, INC.

DUT: ZNFG710VM; Type: Portable Handset; Serial: 12280

Communication System: UID 0, _LTE Band 66 (AWS); Frequency: 1770 MHz; Duty Cycle: 1:1
Medium: 1750 Body Medium parameters used (interpolated):
 $f = 1770 \text{ MHz}$; $\sigma = 1.521 \text{ S/m}$; $\epsilon_r = 51.791$; $\rho = 1000 \text{ kg/m}^3$
Phantom section: Flat Section; Space: 1.0 cm

Test Date: 04-05-2018; Ambient Temp: 22.6°C; Tissue Temp: 21.2°C

Probe: ES3DV3 - SN3287; ConvF(5.19, 5.19, 5.19); Calibrated: 9/18/2017;
Sensor-Surface: 3mm (Mechanical Surface Detection)
Electronics: DAE4 Sn1333; Calibrated: 6/21/2017
Phantom: Twin-SAM V4.0; Type: QD 000 P40 CC; Serial: 1167
Measurement SW: DASY52, Version 52.10; SEMCAD X Version 14.6.10 (7417)

**Mode: LTE Band 66 (AWS), Body SAR, Bottom Edge, High.ch,
20 MHz Bandwidth, QPSK, 1 RB, 99 RB Offset**

Area Scan (11x7x1): Measurement grid: dx=5mm, dy=15mm
Zoom Scan (5x5x7)/Cube 0: Measurement grid: dx=8mm, dy=8mm, dz=5mm
Reference Value = 25.74 V/m; Power Drift = -0.04 dB
Peak SAR (extrapolated) = 1.45 W/kg
SAR(1 g) = 0.869 W/kg

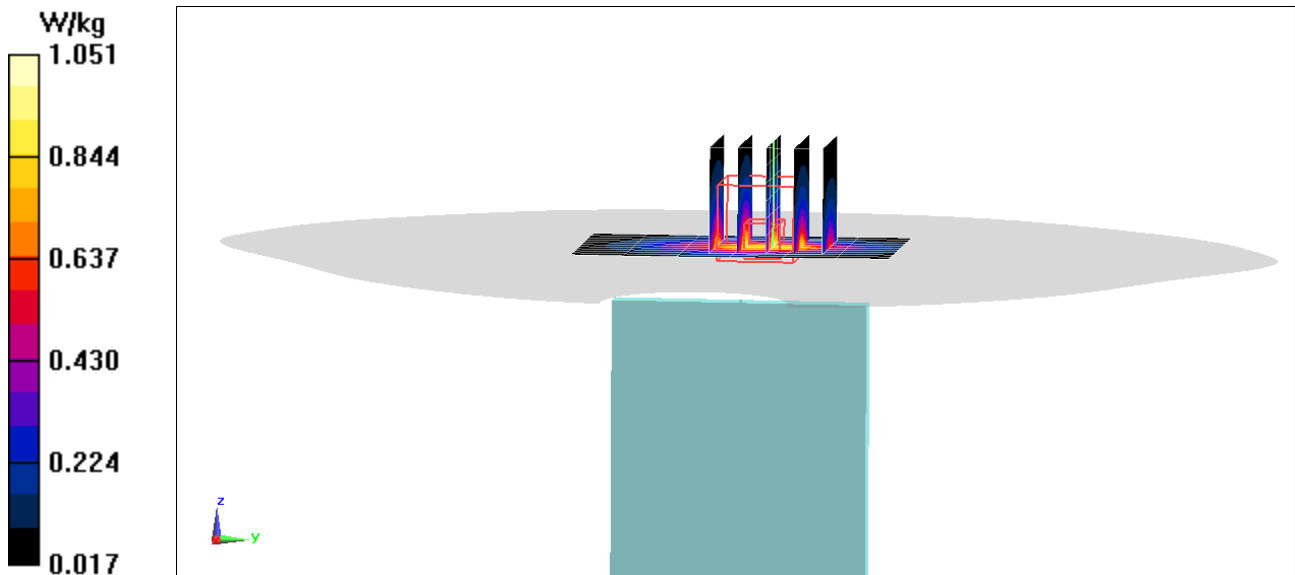

PCTEST ENGINEERING LABORATORY, INC.

DUT: ZNFG710VM; Type: Portable Handset; Serial: 12249

Communication System: UID 0, LTE Band 25 (PCS); Frequency: 1860 MHz; Duty Cycle: 1:1
Medium: 1900 Body Medium parameters used (interpolated):
 $f = 1860 \text{ MHz}$; $\sigma = 1.531 \text{ S/m}$; $\epsilon_r = 53.849$; $\rho = 1000 \text{ kg/m}^3$
Phantom section: Flat Section; Space: 1.0 cm

Test Date: 04-05-2018; Ambient Temp: 21.9°C; Tissue Temp: 21.7°C

Probe: EX3DV4 - SN3914; ConvF(7.62, 7.62, 7.62); Calibrated: 2/14/2018;
Sensor-Surface: 1.4mm (Mechanical Surface Detection)

Electronics: DAE4 Sn665; Calibrated: 2/15/2018

Phantom: Twin-SAM V5.0 Right; Type: QD 000 P40 CD; Serial: 1800

Measurement SW: DASY52, Version 52.10; SEMCAD X Version 14.6.10 (7417)

**Mode: LTE Band 25 (PCS), Body SAR, Back side, Low.ch,
20 MHz Bandwidth, QPSK, 1 RB, 99 RB Offset**

Area Scan (8x13x1): Measurement grid: dx=15mm, dy=15mm

Zoom Scan (5x5x7)/Cube 0: Measurement grid: dx=8mm, dy=8mm, dz=5mm

Reference Value = 16.13 V/m; Power Drift = 0.10 dB

Peak SAR (extrapolated) = 0.647 W/kg

SAR(1 g) = 0.358 W/kg

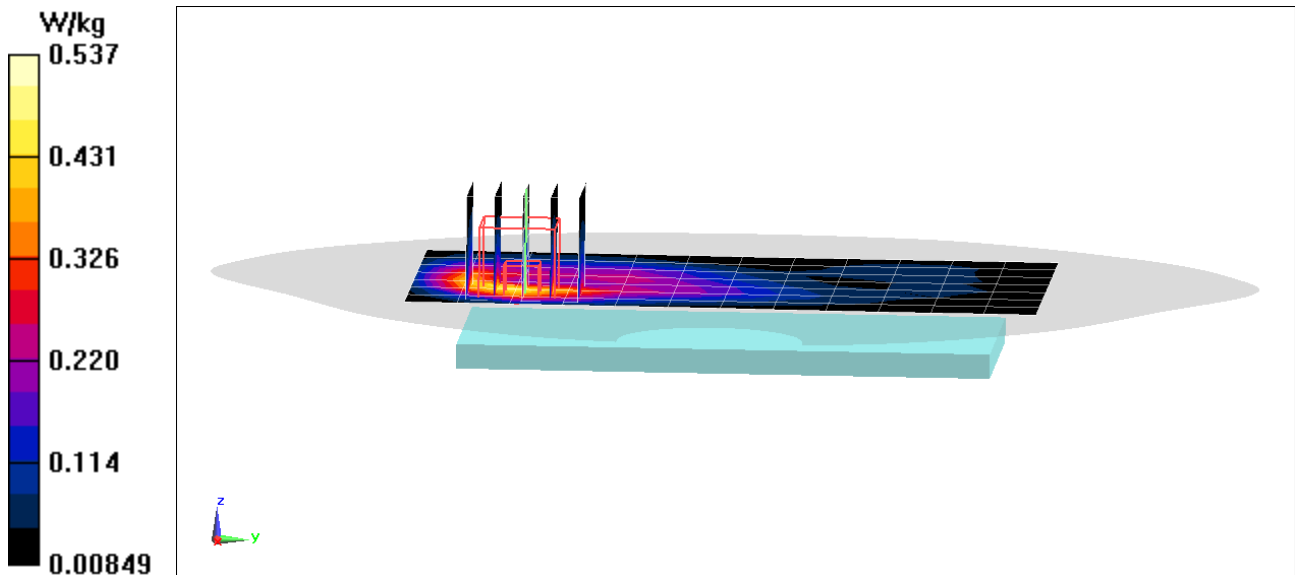

PCTEST ENGINEERING LABORATORY, INC.

DUT: ZNFG710VM; Type: Portable Handset; Serial: 12249

Communication System: UID 0, LTE Band 25 (PCS); Frequency: 1905 MHz; Duty Cycle: 1:1
Medium: 1900 Body Medium parameters used (interpolated):
 $f = 1905 \text{ MHz}$; $\sigma = 1.581 \text{ S/m}$; $\epsilon_r = 53.711$; $\rho = 1000 \text{ kg/m}^3$
Phantom section: Flat Section; Space: 1.0 cm

Test Date: 04-05-2018; Ambient Temp: 21.9°C; Tissue Temp: 21.7°C

Probe: EX3DV4 - SN3914; ConvF(7.62, 7.62, 7.62); Calibrated: 2/14/2018;
Sensor-Surface: 1.4mm (Mechanical Surface Detection)

Electronics: DAE4 Sn665; Calibrated: 2/15/2018

Phantom: Twin-SAM V5.0 Right; Type: QD 000 P40 CD; Serial: 1800

Measurement SW: DASY52, Version 52.10; SEMCAD X Version 14.6.10 (7417)

**Mode: LTE Band 25 (PCS), Body SAR, Bottom Edge, High.ch,
20 MHz Bandwidth, QPSK, 1 RB, 50 RB Offset**

Area Scan (9x9x1): Measurement grid: dx=5mm, dy=15mm

Zoom Scan (5x6x7)/Cube 0: Measurement grid: dx=8mm, dy=8mm, dz=5mm

Reference Value = 25.50 V/m; Power Drift = 0.18 dB

Peak SAR (extrapolated) = 1.61 W/kg

SAR(1 g) = 0.939 W/kg

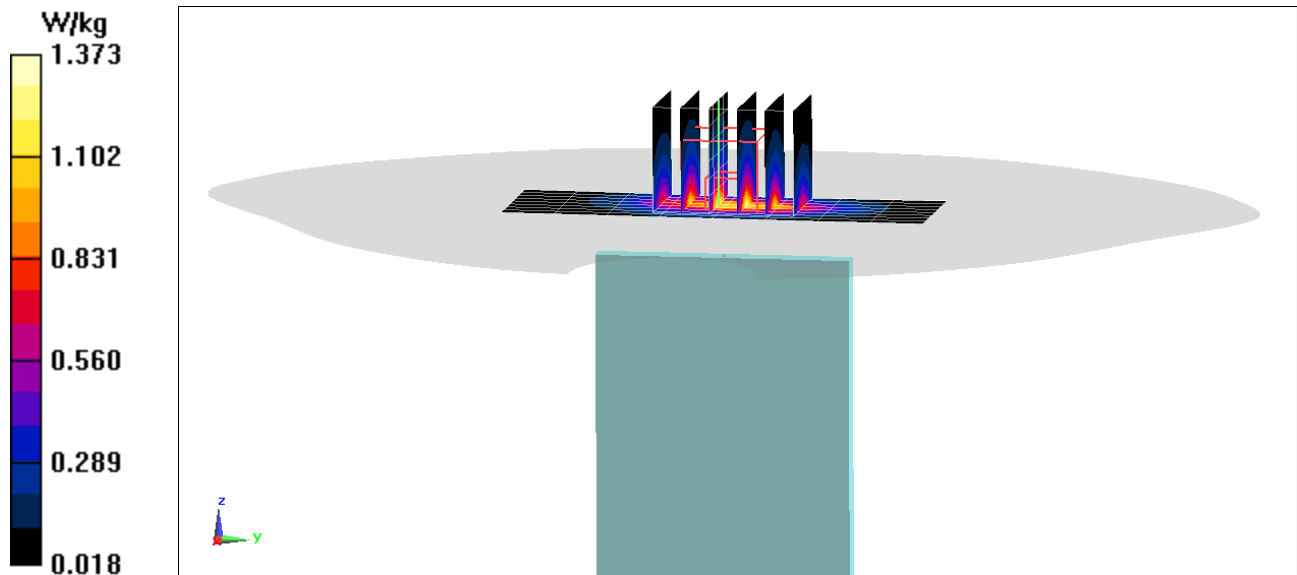

PCTEST ENGINEERING LABORATORY, INC.

DUT: ZNFG710VM; Type: Portable Handset; Serial: 12272

Communication System: UID 0, LTE Band 41 (Class 2); Frequency: 2636.5 MHz; Duty Cycle: 1:2.31
Medium: 2600 Body Medium parameters used (interpolated):
 $f = 2636.5 \text{ MHz}$; $\sigma = 2.263 \text{ S/m}$; $\epsilon_r = 50.16$; $\rho = 1000 \text{ kg/m}^3$
Phantom section: Flat Section; Space: 1.0 cm

Test Date: 04-09-2018; Ambient Temp: 23.4°C; Tissue Temp: 22.0°C

Probe: ES3DV3 - SN3319; ConvF(4.33, 4.33, 4.33); Calibrated: 3/13/2018;
Sensor-Surface: 3mm (Mechanical Surface Detection)
Electronics: DAE4 Sn1368; Calibrated: 3/7/2018

Phantom: Right Twin-SAM V5.0; Type: QD 000 P40 CD; Serial: 1797
Measurement SW: DASY52, Version 52.10; SEMCAD X Version 14.6.10 (7417)

**Mode: LTE Band 41 PC2, Body SAR, Back side, Mid-High.ch,
20 MHz Bandwidth, QPSK, 1 RB, 0 RB Offset**

Area Scan (10x16x1): Measurement grid: dx=12mm, dy=12mm

Zoom Scan (8x7x7)/Cube 0: Measurement grid: dx=5mm, dy=5mm, dz=5mm

Reference Value = 18.41 V/m; Power Drift = -0.07 dB

Peak SAR (extrapolated) = 1.29 W/kg

SAR(1 g) = 0.566 W/kg

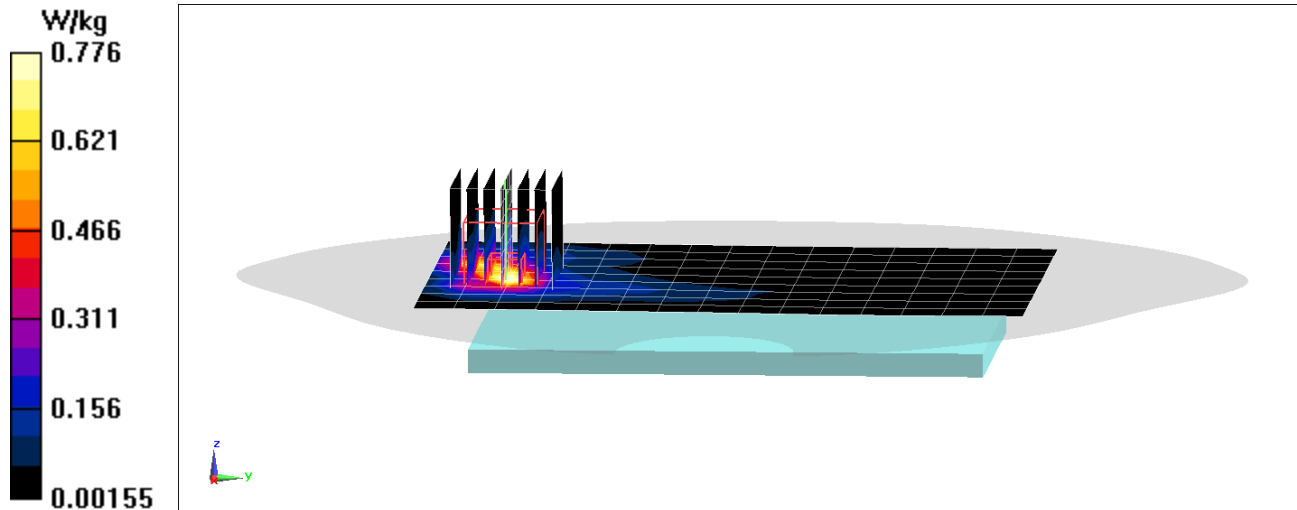

PCTEST ENGINEERING LABORATORY, INC.

DUT: ZNFG710VM; Type: Portable Handset; Serial: 12272

Communication System: UID 0, LTE Band 41 (Class 2); Frequency: 2506 MHz; Duty Cycle: 1:2.31
Medium: 2450 Body Medium parameters used (interpolated):
 $f = 2506 \text{ MHz}$; $\sigma = 2.105 \text{ S/m}$; $\epsilon_r = 50.566$; $\rho = 1000 \text{ kg/m}^3$
Phantom section: Flat Section; Space: 1.0 cm

Test Date: 04-09-2018; Ambient Temp: 23.4°C; Tissue Temp: 22.0°C

Probe: ES3DV3 - SN3319; ConvF(4.51, 4.51, 4.51); Calibrated: 3/13/2018;
Sensor-Surface: 3mm (Mechanical Surface Detection)
Electronics: DAE4 Sn1368; Calibrated: 3/7/2018
Phantom: Right Twin-SAM V5.0; Type: QD 000 P40 CD; Serial: 1797
Measurement SW: DASY52, Version 52.10; SEMCAD X Version 14.6.10 (7417)

**Mode: LTE Band 41 PC2, Body SAR, Bottom Edge, Low.ch,
20 MHz Bandwidth, QPSK, 1 RB, 99 RB Offset**

Area Scan (10x9x1): Measurement grid: dx=5mm, dy=12mm
Zoom Scan (8x8x7)/Cube 0: Measurement grid: dx=5mm, dy=5mm, dz=5mm
Reference Value = 20.89 V/m; Power Drift = 0.19 dB
Peak SAR (extrapolated) = 1.82 W/kg
SAR(1 g) = 0.889 W/kg

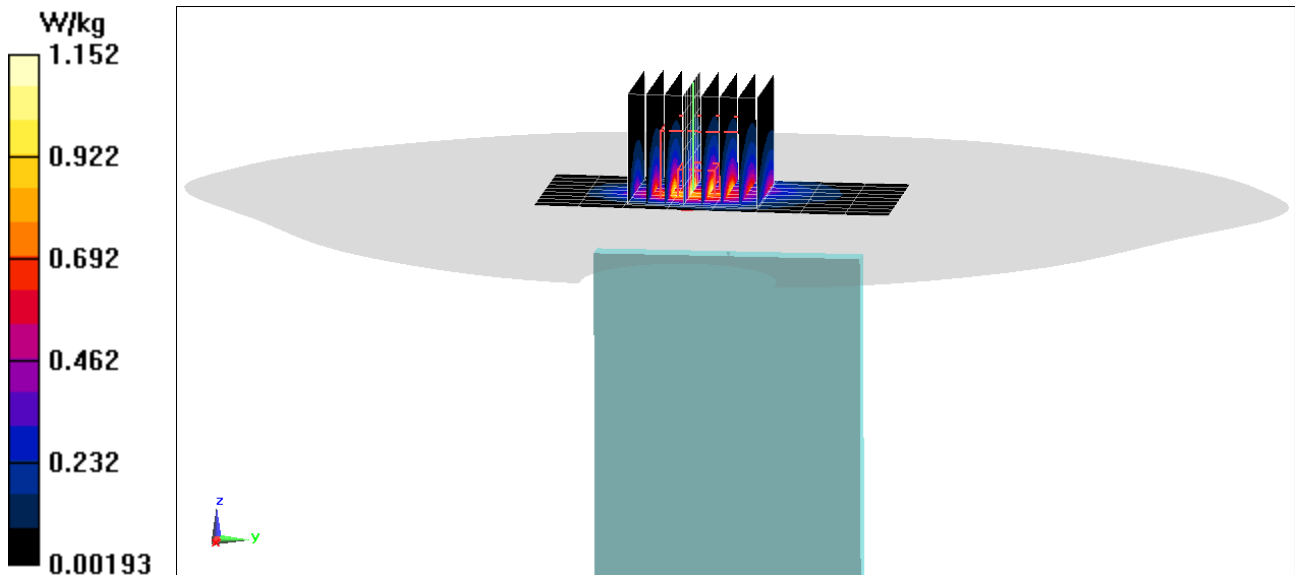

PCTEST ENGINEERING LABORATORY, INC.

DUT: ZNFG710VM; Type: Portable Handset; Serial: 12371

Communication System: UID 0, _IEEE 802.11b; Frequency: 2437 MHz; Duty Cycle: 1:1
Medium: 2450 Body Medium parameters used (interpolated):
 $f = 2437 \text{ MHz}$; $\sigma = 2.022 \text{ S/m}$; $\epsilon_r = 50.78$; $\rho = 1000 \text{ kg/m}^3$
Phantom section: Flat Section; Space: 1.0 cm

Test Date: 04-09-2018; Ambient Temp: 23.4°C; Tissue Temp: 22.0°C

Probe: ES3DV3 - SN3319; ConvF(4.51, 4.51, 4.51); Calibrated: 3/13/2018;
Sensor-Surface: 3mm (Mechanical Surface Detection)
Electronics: DAE4 Sn1368; Calibrated: 3/7/2018
Phantom: Right Twin-SAM V5.0; Type: QD 000 P40 CD; Serial: 1797
Measurement SW: DASY52, Version 52.10; SEMCAD X Version 14.6.10 (7417)

Mode: IEEE 802.11b, 22 MHz Bandwidth, Body SAR, Ch 6, 1 Mbps, Back Side, Antenna 2

Area Scan (11x17x1): Measurement grid: dx=12mm, dy=12mm
Zoom Scan (7x7x7)/Cube 0: Measurement grid: dx=5mm, dy=5mm, dz=5mm
Reference Value = 17.22 V/m; Power Drift = 0.04 dB
Peak SAR (extrapolated) = 1.09 W/kg
SAR(1 g) = 0.491 W/kg

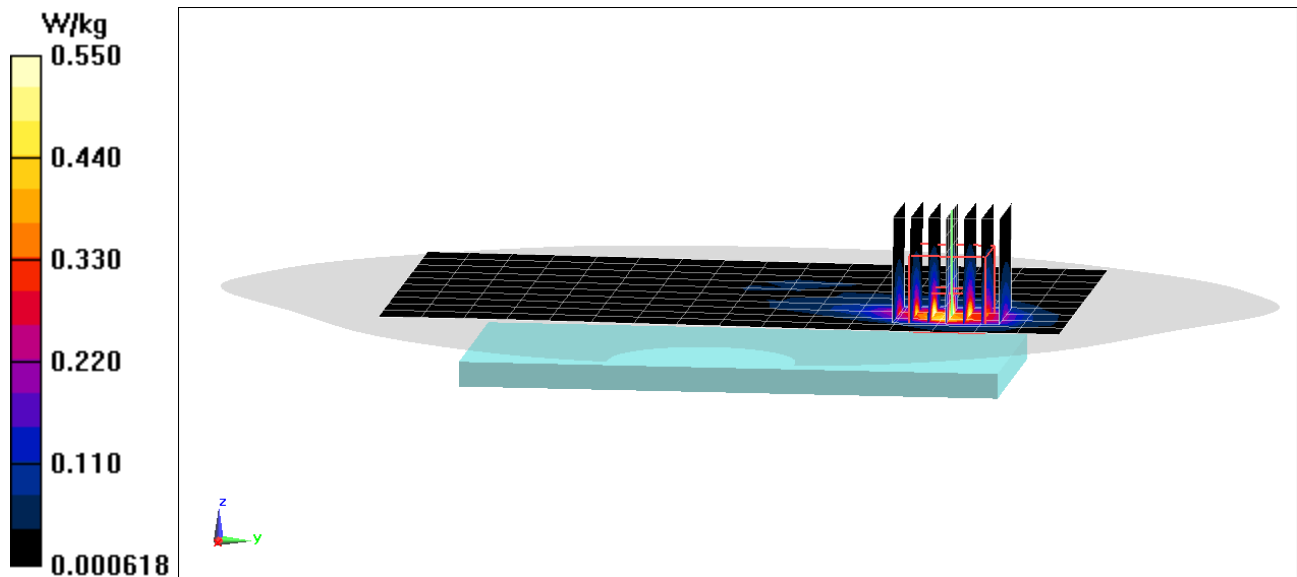

PCTEST ENGINEERING LABORATORY, INC.

DUT: ZNFG710VM; Type: Portable Handset; Serial: 12272

Communication System: UID 0, 802.11n 5.2-5.8 GHz Band; Frequency: 5280 MHz; Duty Cycle: 1:1

Medium: 5 GHz Body Medium parameters used:

$f = 5280 \text{ MHz}$; $\sigma = 5.543 \text{ S/m}$; $\epsilon_r = 47.605$; $\rho = 1000 \text{ kg/m}^3$

Phantom section: Flat Section; Space: 1.0 cm

Test Date: 04-14-2018; Ambient Temp: 22.3°C; Tissue Temp: 21.8°C

Probe: EX3DV4 - SN7308; ConvF(4.84, 4.84, 4.84); Calibrated: 8/16/2017;

Sensor-Surface: 1.4mm (Mechanical Surface Detection)

Electronics: DAE4 Sn1334; Calibrated: 6/14/2017

Phantom: SAM with CRP v5.0 Front; Type: QD000P40CD; Serial: 1646

Measurement SW: DASY52, Version 52.10; SEMCAD X Version 14.6.10 (7417)

**Mode: IEEE 802.11n, UNII-2A, 20 MHz Bandwidth, Body SAR,
Ch 56, 13.0 Mbps, Back Side, MIMO**

Area Scan (13x21x1): Measurement grid: dx=10mm, dy=10mm

Zoom Scan (7x7x7)/Cube 0: Measurement grid: dx=4mm, dy=4mm, dz=1.4mm; Graded Ratio: 1.4

Reference Value = 14.36 V/m; Power Drift = -0.02 dB

Peak SAR (extrapolated) = 4.11 W/kg

SAR(1 g) = 0.963 W/kg

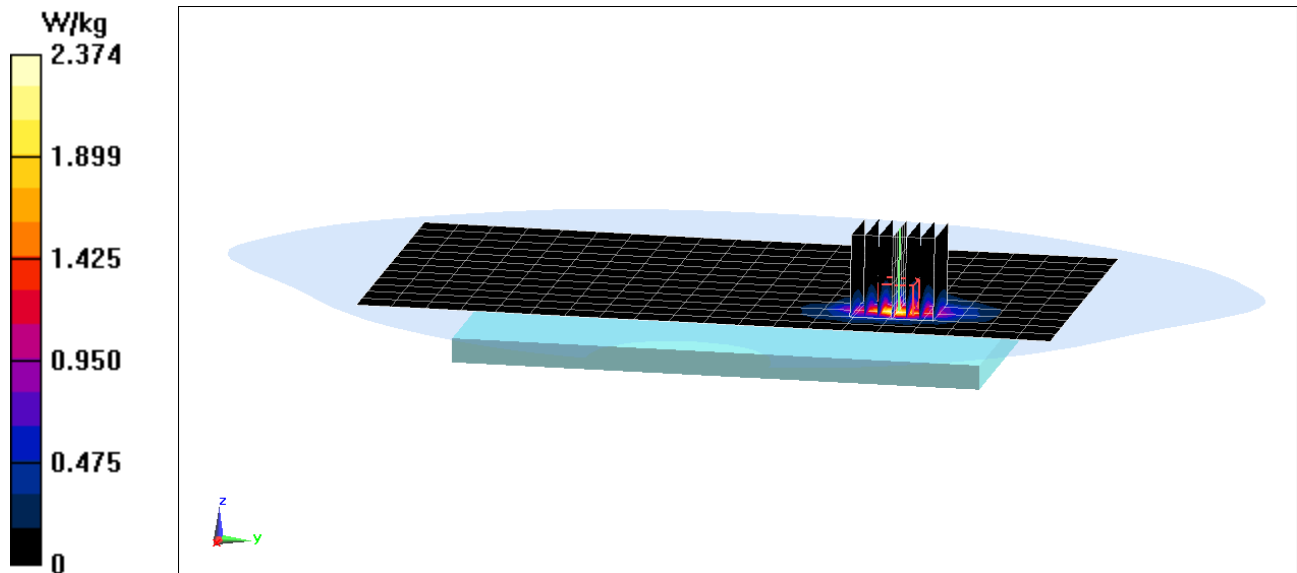

PCTEST ENGINEERING LABORATORY, INC.

DUT: ZNFG710VM; Type: Portable Handset; Serial: 12298

Communication System: UID 0, 802.11a 5.2-5.8 GHz Band; Frequency: 5785 MHz; Duty Cycle: 1:1

Medium: 5 GHz Body Medium parameters used:

$f = 5785 \text{ MHz}$; $\sigma = 6.203 \text{ S/m}$; $\epsilon_r = 46.287$; $\rho = 1000 \text{ kg/m}^3$

Phantom section: Flat Section; Space: 1.0 cm

Test Date: 04-02-2018; Ambient Temp: 22.5°C; Tissue Temp: 20.6°C

Probe: EX3DV4 - SN7308; ConvF(4.5, 4.5, 4.5); Calibrated: 8/16/2017;

Sensor-Surface: 1.4mm (Mechanical Surface Detection)

Electronics: DAE4 Sn1334; Calibrated: 6/14/2017

Phantom: SAM with CRP v5.0 Front; Type: QD000P40CD; Serial: 1646

Measurement SW: DASY52, Version 52.10; SEMCAD X Version 14.6.10 (7417)

**Mode: IEEE 802.11a, UNII-3, 20 MHz Bandwidth, Body SAR, Ch 157,
6 Mbps, Back Side, Antenna 2**

Area Scan (13x11x1): Measurement grid: dx=10mm, dy=10mm

Zoom Scan (7x7x7)/Cube 0: Measurement grid: dx=4mm, dy=4mm, dz=1.4mm; Graded Ratio: 1.4

Reference Value = 11.49 V/m; Power Drift = 0.03 dB

Peak SAR (extrapolated) = 3.45 W/kg

SAR(1 g) = 0.717 W/kg

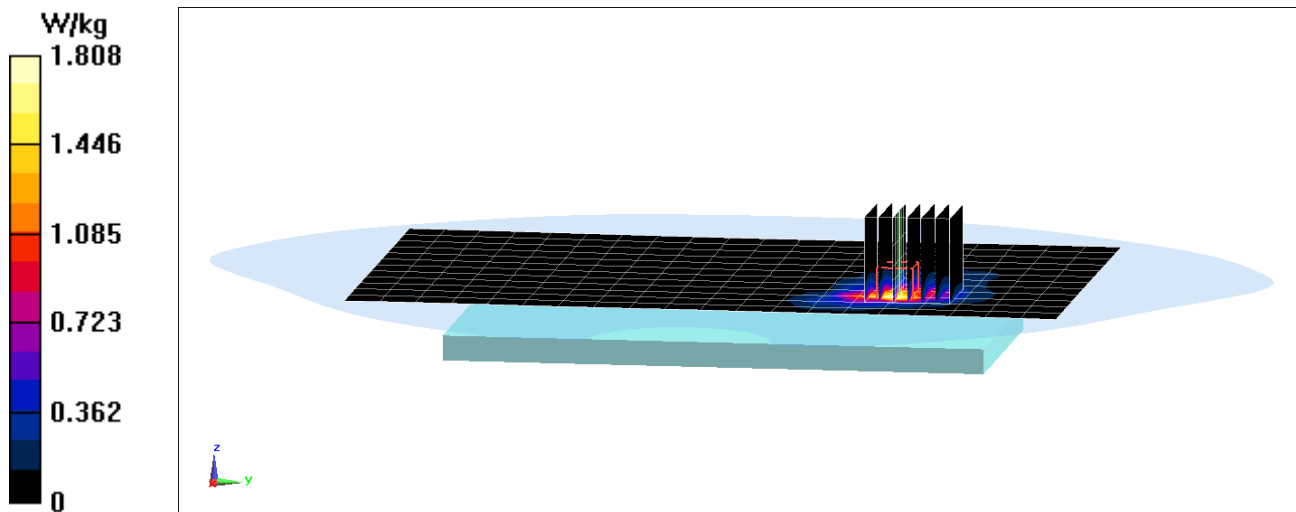

PCTEST ENGINEERING LABORATORY, INC.

DUT: ZNFG710VM; Type: Portable Handset; Serial: 12371

Communication System: UID 0, Bluetooth; Frequency: 2402 MHz; Duty Cycle: 1:1.289

Medium: 2450 Body Medium parameters used (interpolated):

$f = 2402 \text{ MHz}$; $\sigma = 1.968 \text{ S/m}$; $\epsilon_r = 51.667$; $\rho = 1000 \text{ kg/m}^3$

Phantom section: Flat Section; Space: 1.0 cm

Test Date: 04-06-2018; Ambient Temp: 22.8°C; Tissue Temp: 21.7°C

Probe: ES3DV3 - SN3319; ConvF(4.51, 4.51, 4.51); Calibrated: 3/13/2018;

Sensor-Surface: 3mm (Mechanical Surface Detection)

Electronics: DAE4 Sn1368; Calibrated: 3/7/2018

Phantom: Right Twin-SAM V5.0; Type: QD 000 P40 CD; Serial: 1797

Measurement SW: DASY52, Version 52.10; SEMCAD X Version 14.6.10 (7417)

Mode: Bluetooth, Body SAR, Ch 0, 1 Mbps, Back Side

Area Scan (11x17x1): Measurement grid: dx=12mm, dy=12mm

Zoom Scan (7x7x7)/Cube 0: Measurement grid: dx=5mm, dy=5mm, dz=5mm

Reference Value = 2.908 V/m; Power Drift = 0.15 dB

Peak SAR (extrapolated) = 0.0310 W/kg

SAR(1 g) = 0.015 W/kg

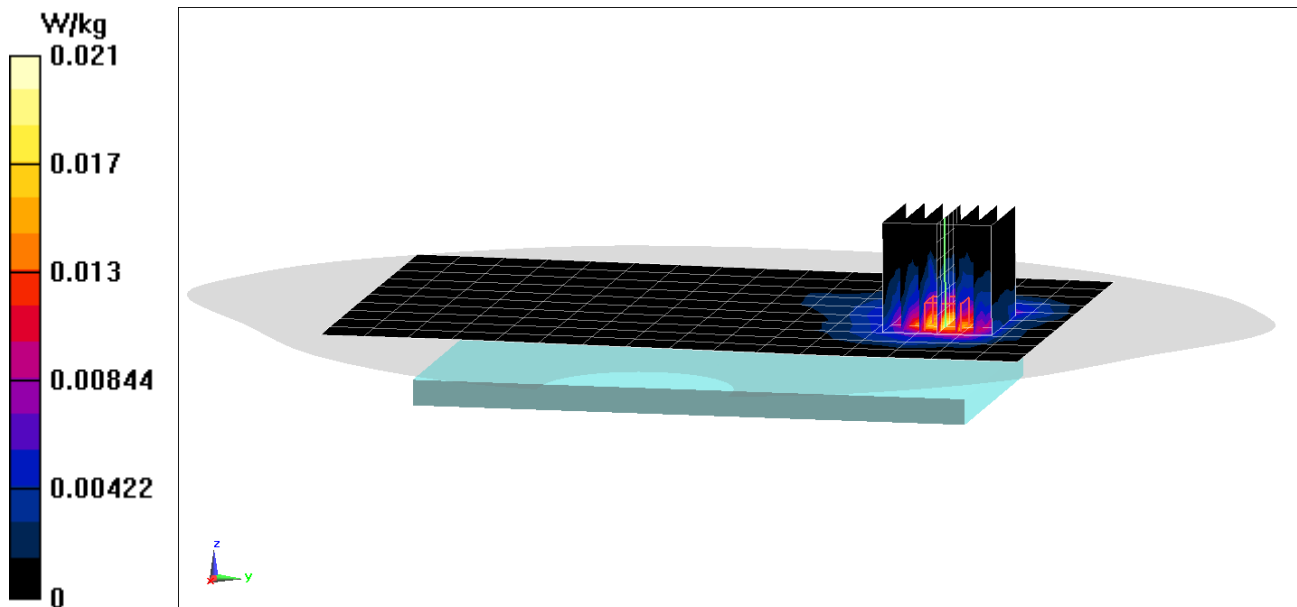

PCTEST ENGINEERING LABORATORY, INC.

DUT: ZNFG710VM; Type: Portable Handset; Serial: 12371

Communication System: UID 0, Bluetooth; Frequency: 2402 MHz; Duty Cycle: 1:1.289

Medium: 2450 Body Medium parameters used (interpolated):

$f = 2402 \text{ MHz}$; $\sigma = 1.968 \text{ S/m}$; $\epsilon_r = 51.667$; $\rho = 1000 \text{ kg/m}^3$

Phantom section: Flat Section; Space: 1.0 cm

Test Date: 04-06-2018; Ambient Temp: 22.8°C; Tissue Temp: 21.7°C

Probe: ES3DV3 - SN3319; ConvF(4.51, 4.51, 4.51); Calibrated: 3/13/2018;

Sensor-Surface: 3mm (Mechanical Surface Detection)

Electronics: DAE4 Sn1368; Calibrated: 3/7/2018

Phantom: Right Twin-SAM V5.0; Type: QD 000 P40 CD; Serial: 1797

Measurement SW: DASY52, Version 52.10; SEMCAD X Version 14.6.10 (7417)

Mode: Bluetooth, Body SAR, Ch 0, 1 Mbps, Top Edge

Area Scan (11x17x1): Measurement grid: dx=12mm, dy=12mm

Zoom Scan (7x7x7)/Cube 0: Measurement grid: dx=5mm, dy=5mm, dz=5mm

Reference Value = 3.300 V/m; Power Drift = -0.07 dB

Peak SAR (extrapolated) = 0.0430 W/kg

SAR(1 g) = 0.018 W/kg

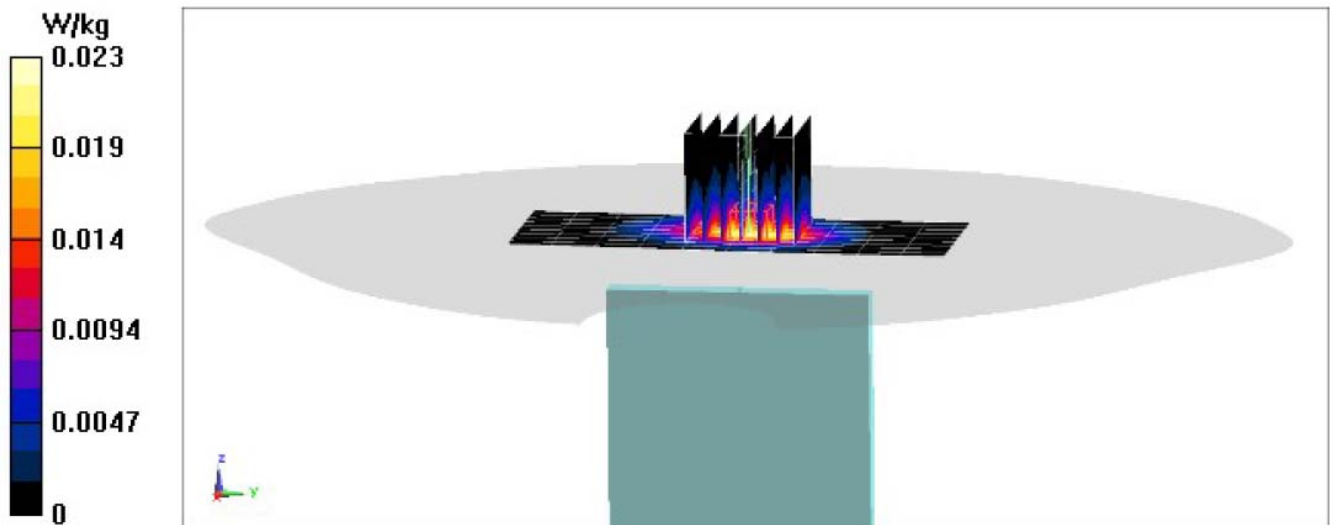

PCTEST ENGINEERING LABORATORY, INC.

DUT: ZNFG710VM; Type: Portable Handset; Serial: 12280

Communication System: UID 0, CDMA; Frequency: 1908.75 MHz; Duty Cycle: 1:1
Medium: 1900 Body Medium parameters used (interpolated):
 $f = 1908.75 \text{ MHz}$; $\sigma = 1.586 \text{ S/m}$; $\epsilon_r = 53.699$; $\rho = 1000 \text{ kg/m}^3$
Phantom section: Flat Section; Space: 0.0 cm

Test Date: 04-05-2018; Ambient Temp: 21.9°C; Tissue Temp: 21.7°C

Probe: EX3DV4 - SN3914; ConvF(7.62, 7.62, 7.62); Calibrated: 2/14/2018;
Sensor-Surface: 1.4mm (Mechanical Surface Detection)

Electronics: DAE4 Sn665; Calibrated: 2/15/2018

Phantom: Twin-SAM V5.0 Right; Type: QD 000 P40 CD; Serial: 1800

Measurement SW: DASY52, Version 52.10; SEMCAD X Version 14.6.10 (7417)

Mode: PCS EVDO, Phablet SAR, Bottom Edge, High.ch

Area Scan (10x8x1): Measurement grid: dx=5mm, dy=15mm

Zoom Scan (5x7x7)/Cube 0: Measurement grid: dx=8mm, dy=8mm, dz=5mm

Reference Value = 58.09 V/m; Power Drift = -0.05 dB

Peak SAR (extrapolated) = 11.6 W/kg

SAR(10 g) = 2.33 W/kg

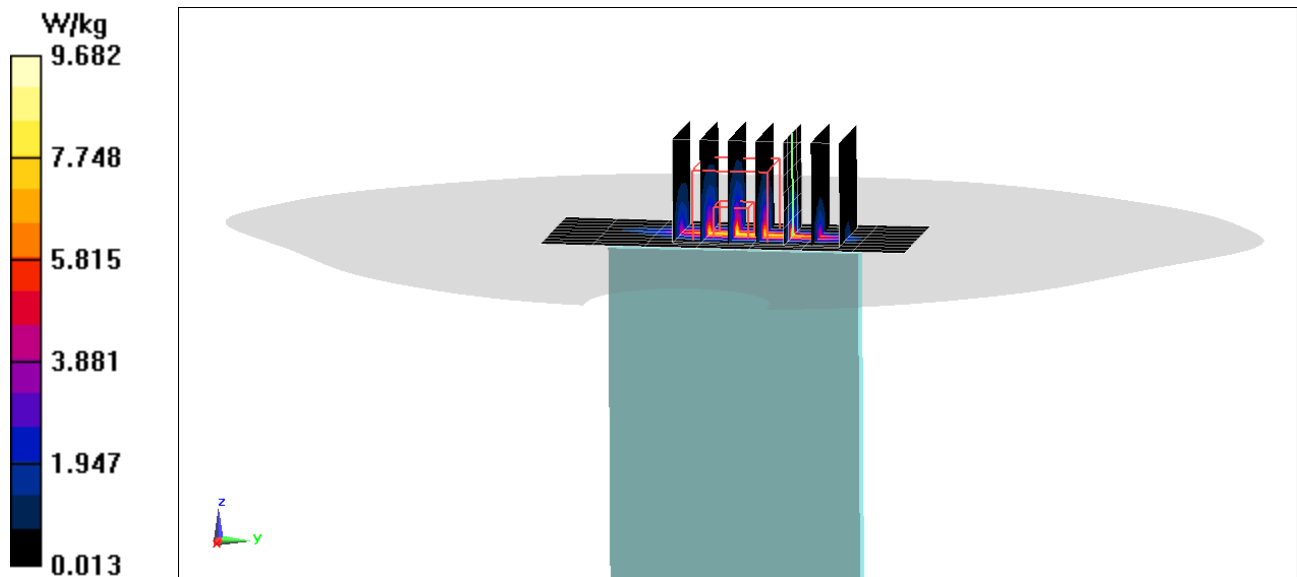

PCTEST ENGINEERING LABORATORY, INC.

DUT: ZNFG710VM; Type: Portable Handset; Serial: 12256

Communication System: UID 0, UMTS; Frequency: 1752.6 MHz; Duty Cycle: 1:1
Medium: 1750 Body Medium parameters used (interpolated):
 $f = 1752.6$ MHz; $\sigma = 1.498$ S/m; $\epsilon_r = 52.626$; $\rho = 1000$ kg/m³
Phantom section: Flat Section; Space: 0.0 cm

Test Date: 04-10-2018; Ambient Temp: 22.8°C; Tissue Temp: 21.4°C

Probe: ES3DV3 - SN3287; ConvF(5.19, 5.19, 5.19); Calibrated: 9/18/2017;
Sensor-Surface: 3mm (Mechanical Surface Detection)
Electronics: DAE4 Sn1333; Calibrated: 6/21/2017
Phantom: Twin-SAM V4.0; Type: QD 000 P40 CC; Serial: 1167
Measurement SW: DASY52, Version 52.10; SEMCAD X Version 14.6.10 (7417)

Mode: UMTS 1750, Phablet SAR, Bottom Edge, High.ch

Area Scan (10x9x1): Measurement grid: dx=5mm, dy=15mm
Zoom Scan (5x6x7)/Cube 0: Measurement grid: dx=8mm, dy=8mm, dz=5mm
Reference Value = 63.39 V/m; Power Drift = 0.00 dB
Peak SAR (extrapolated) = 11.2 W/kg
SAR(10 g) = 2.30 W/kg

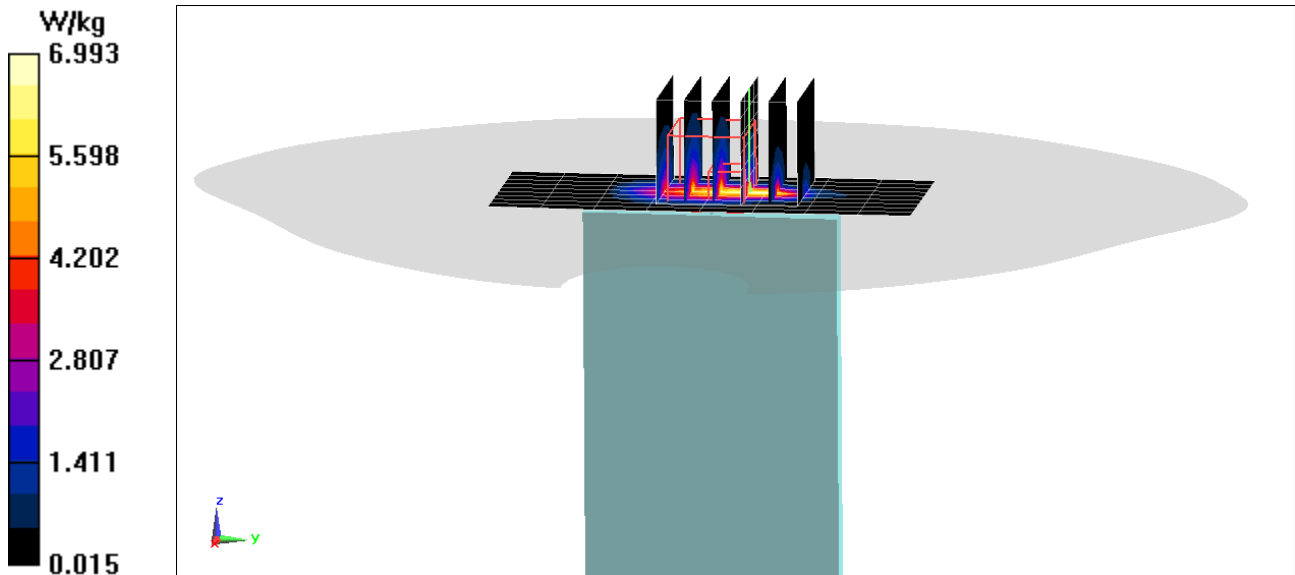

PCTEST ENGINEERING LABORATORY, INC.

DUT: ZNFG710VM; Type: Portable Handset; Serial: 12272

Communication System: UID 0, UMTS; Frequency: 1880 MHz; Duty Cycle: 1:1
Medium: 1900 Body Medium parameters used:
 $f = 1880 \text{ MHz}$; $\sigma = 1.553 \text{ S/m}$; $\epsilon_r = 53.793$; $\rho = 1000 \text{ kg/m}^3$
Phantom section: Flat Section; Space: 0.0 cm

Test Date: 04-05-2018; Ambient Temp: 21.9°C; Tissue Temp: 21.7°C

Probe: EX3DV4 - SN3914; ConvF(7.62, 7.62, 7.62); Calibrated: 2/14/2018;
Sensor-Surface: 1.4mm (Mechanical Surface Detection)
Electronics: DAE4 Sn665; Calibrated: 2/15/2018
Phantom: Twin-SAM V5.0 Right; Type: QD 000 P40 CD; Serial: 1800
Measurement SW: DASY52, Version 52.10; SEMCAD X Version 14.6.10 (7417)

Mode: UMTS 1900, Phablet SAR, Bottom Edge, Mid.ch

Area Scan (11x9x1): Measurement grid: dx=5mm, dy=15mm
Zoom Scan (5x5x7)/Cube 0: Measurement grid: dx=8mm, dy=8mm, dz=5mm
Reference Value = 68.29 V/m; Power Drift = -0.17 dB
Peak SAR (extrapolated) = 13.0 W/kg
SAR(10 g) = 2.61 W/kg

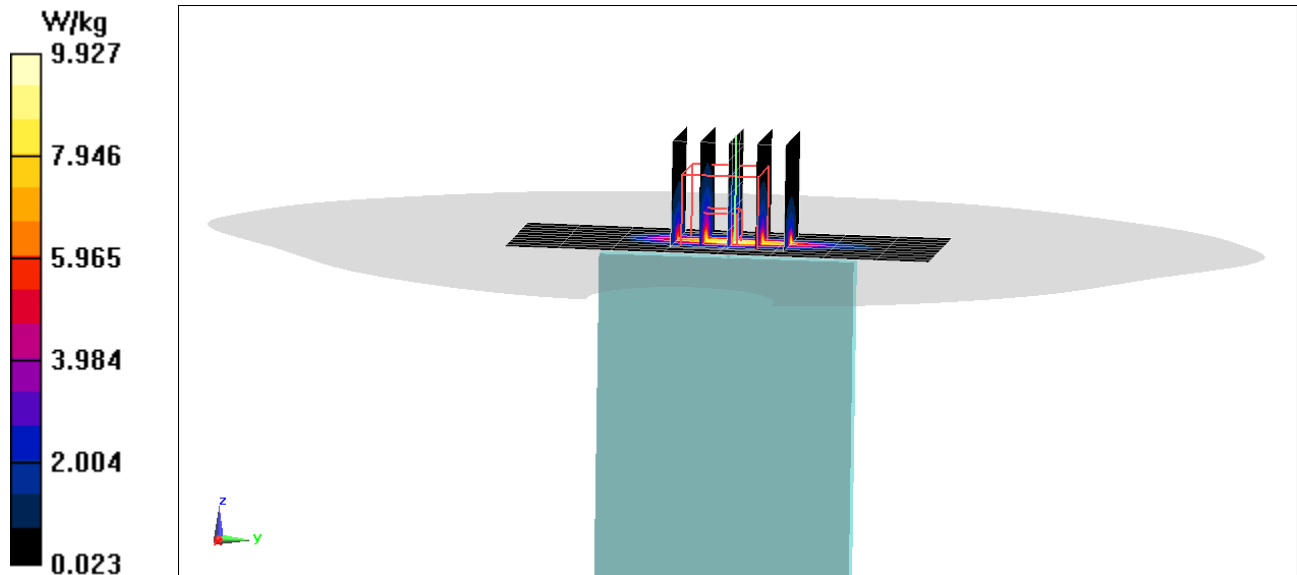

PCTEST ENGINEERING LABORATORY, INC.

DUT: ZNFG710VM; Type: Portable Handset; Serial: 12280

Communication System: UID 0, _LTE Band 66 (AWS); Frequency: 1745 MHz; Duty Cycle: 1:1
Medium: 1750 Body Medium parameters used (interpolated):
 $f = 1745 \text{ MHz}$; $\sigma = 1.493 \text{ S/m}$; $\epsilon_r = 51.888$; $\rho = 1000 \text{ kg/m}^3$
Phantom section: Flat Section; Space: 0.0 cm

Test Date: 04-05-2018; Ambient Temp: 22.6°C; Tissue Temp: 21.2°C

Probe: ES3DV3 - SN3287; ConvF(5.19, 5.19, 5.19); Calibrated: 9/18/2017;
Sensor-Surface: 3mm (Mechanical Surface Detection)
Electronics: DAE4 Sn1333; Calibrated: 6/21/2017
Phantom: Twin-SAM V4.0; Type: QD 000 P40 CC; Serial: 1167
Measurement SW: DASY52, Version 52.10; SEMCAD X Version 14.6.10 (7417)

**Mode: LTE Band 66 (AWS), Phablet SAR, Bottom Edge, Mid.ch,
20 MHz Bandwidth, QPSK, 1 RB, 0 RB Offset**

Area Scan (11x7x1): Measurement grid: $dx=5\text{mm}$, $dy=15\text{mm}$
Zoom Scan (5x6x7)/Cube 0: Measurement grid: $dx=8\text{mm}$, $dy=8\text{mm}$, $dz=5\text{mm}$
Reference Value = 59.57 V/m; Power Drift = 0.02 dB
Peak SAR (extrapolated) = 9.60 W/kg
SAR(10 g) = 2.14 W/kg

