



## SAR EVALUATION REPORT

**Applicant Name:**  
 LG Electronics MobileComm U.S.A., Inc.  
 1000 Sylvan Avenue  
 Englewood Cliffs, NJ 07632  
 United States

**Date of Testing:**  
 04/03/18 - 04/16/18  
**Test Site/Location:**  
 PCTEST Lab, Columbia, MD, USA  
**Document Serial No.:**  
 1M1804030060-01-R1.ZNF

**FCC ID:** ZNFG710TM  
**APPLICANT:** LG ELECTRONICS MOBILECOMM U.S.A., INC.

**DUT Type:** Portable Handset  
**Application Type:** Class II Permissive Change  
**FCC Rule Part(s):** CFR §2.1093  
**Model:** LM-G710TM  
**Additional Model(s):** LMG710TM, G710TM, LM-G710AWM, LMG710AWM, G710AWM, LM-G710RM, LMG710RM, G710RM  
**Permissive Change(s):** See FCC Change Document

Equipment Class	Band & Mode	Tx Frequency	SAR			
			1g Head (W/kg)	1g Body-Worn (W/kg)	1g Hotspot (W/kg)	10g Phablet (W/kg)
PCE	GSMGPRS/EDGE 850	824.20 - 848.80 MHz	0.14	0.35	0.35	N/A
PCE	GSMGPRS/EDGE 1900	1850.20 - 1909.80 MHz	< 0.1	0.29	0.74	N/A
PCE	UMTS 850	826.40 - 846.60 MHz	0.20	0.44	0.44	N/A
PCE	UMTS 1750	1712.4 - 1752.6 MHz	0.20	0.52	0.83	2.79
PCE	UMTS 1900	1852.4 - 1907.6 MHz	0.15	0.51	1.08	2.38
PCE	LTE Band 71	665.5 - 695.5 MHz	0.12	0.42	0.42	N/A
PCE	LTE Band 12	699.7 - 715.3 MHz	0.20	0.53	0.53	N/A
PCE	LTE Band 17	706.5 - 713.5 MHz	N/A	N/A	N/A	N/A
PCE	LTE Band 13	779.5 - 784.5 MHz	0.22	0.49	0.49	N/A
PCE	LTE Band 5 (Cell)	824.7 - 848.3 MHz	0.21	0.38	0.38	N/A
PCE	LTE Band 66 (AWS)	1710.7 - 1779.3 MHz	0.21	0.62	1.07	2.61
PCE	LTE Band 4 (AWS)	1710.7 - 1754.3 MHz	N/A	N/A	N/A	N/A
PCE	LTE Band 25 (PCS)	1850.7 - 1914.3 MHz	0.16	0.31	0.92	3.09
PCE	LTE Band 2 (PCS)	1850.7 - 1909.3 MHz	N/A	N/A	N/A	N/A
PCE	LTE Band 30	2307.5 - 2312.5 MHz	< 0.1	0.31	0.31	N/A
PCE	LTE Band 7	2502.5 - 2567.5 MHz	< 0.1	1.30	1.30	2.61
PCE	LTE Band 41	2498.5 - 2687.5 MHz	< 0.1	0.71	0.88	N/A
DTS	2.4 GHz WLAN	2412 - 2462 MHz	0.35	0.39	0.40	N/A
NI	U-NII-1	5180 - 5240 MHz	N/A	N/A	0.67	N/A
NI	U-NII-2A	5260 - 5320 MHz	0.47	0.90	N/A	1.75
NI	U-NII-2C	5500 - 5720 MHz	0.42	0.77	N/A	2.42
NI	U-NII-3	5745 - 5825 MHz	0.48	0.87	0.87	N/A
DSS/DTS	Bluetooth	2402 - 2480 MHz	0.13	< 0.1	< 0.1	N/A
<b>Simultaneous SAR per KDB 690783 D01v01r03:</b>			0.79	1.58	1.59	3.96

Note: This revised Test Report (S/N: 1M1804030060-01-R1.ZNF) supersedes and replaces the previously issued test report on the same subject device for the same type of testing as indicated. Please discard or destroy the previously issued test report(s) and dispose of it accordingly. This wireless portable device has been shown to be capable of compliance for localized specific absorption rate (SAR) for uncontrolled environment/general population exposure limits specified in ANSI/IEEE C95.1-1992 and has been tested in accordance with the measurement procedures specified in Section 1.8 of this report; for North American frequency bands only.

I attest to the accuracy of data. All measurements reported herein were performed by me or were made under my supervision and are correct to the best of my knowledge and belief. I assume full responsibility for the completeness of these measurements and vouch for the qualifications of all persons taking them. Test results reported herein relate only to the item(s) tested.

Randy Ortanez  
 President





The SAR Tick is an initiative of the Mobile & Wireless Forum (MWF). While a product may be considered eligible, use of the SAR Tick logo requires an agreement with the MWF. Further details can be obtained by emailing: sar tick@mwfai.info.

<b>FCC ID:</b> ZNFG710TM		<b>SAR EVALUATION REPORT</b>		<b>Approved by:</b> Quality Manager
<b>Document S/N:</b> 1M1804030060-01-R1.ZNF	<b>Test Dates:</b> 04/03/18 - 04/16/18	<b>DUT Type:</b> Portable Handset		Page 1 of 131

# T A B L E O F C O N T E N T S

1	DEVICE UNDER TEST .....	3
2	LTE INFORMATION .....	15
3	INTRODUCTION .....	16
4	DOSIMETRIC ASSESSMENT .....	17
5	DEFINITION OF REFERENCE POINTS.....	18
6	TEST CONFIGURATION POSITIONS.....	19
7	RF EXPOSURE LIMITS .....	23
8	FCC MEASUREMENT PROCEDURES.....	24
9	RF CONDUCTED POWERS.....	30
10	SYSTEM VERIFICATION.....	74
11	SAR DATA SUMMARY .....	78
12	FCC MULTI-TX AND ANTENNA SAR CONSIDERATIONS.....	102
13	SAR MEASUREMENT VARIABILITY .....	125
14	EQUIPMENT LIST.....	127
15	MEASUREMENT UNCERTAINTIES.....	128
16	CONCLUSION.....	129
17	REFERENCES .....	130
APPENDIX A:	SAR TEST PLOTS	
APPENDIX B:	SAR DIPOLE VERIFICATION PLOTS	
APPENDIX C:	PROBE AND DIPOLE CALIBRATION CERTIFICATES	
APPENDIX D:	SAR TISSUE SPECIFICATIONS	
APPENDIX E:	SAR SYSTEM VALIDATION	
APPENDIX F:	DUT ANTENNA DIAGRAM & SAR TEST SETUP PHOTOGRAPHS	
APPENDIX G:	POWER REDUCTION VERIFICATION	
APPENDIX H:	DOWNLINK LTE CA RF CONDUCTED POWERS	

FCC ID: ZNFG710TM	 <b>SAR EVALUATION REPORT</b>		<b>Approved by:</b> Quality Manager
<b>Document S/N:</b> 1M1804030060-01-R1.ZNF	<b>Test Dates:</b> 04/03/18 - 04/16/18	<b>DUT Type:</b> Portable Handset	Page 2 of 131

# 1 DEVICE UNDER TEST



## 1.1 Device Overview

Band & Mode	Operating Modes	Tx Frequency
GSM/GPRS/EDGE 850	Voice/Data	824.20 - 848.80 MHz
GSM/GPRS/EDGE 1900	Voice/Data	1850.20 - 1909.80 MHz
UMTS 850	Voice/Data	826.40 - 846.60 MHz
UMTS 1750	Voice/Data	1712.4 - 1752.6 MHz
UMTS 1900	Voice/Data	1852.4 - 1907.6 MHz
LTE Band 71	Voice/Data	665.5 - 695.5 MHz
LTE Band 12	Voice/Data	699.7 - 715.3 MHz
LTE Band 17	Voice/Data	706.5 - 713.5 MHz
LTE Band 13	Voice/Data	779.5 - 784.5 MHz
LTE Band 5 (Cell)	Voice/Data	824.7 - 848.3 MHz
LTE Band 66 (AWS)	Voice/Data	1710.7 - 1779.3 MHz
LTE Band 4 (AWS)	Voice/Data	1710.7 - 1754.3 MHz
LTE Band 25 (PCS)	Voice/Data	1850.7 - 1914.3 MHz
LTE Band 2 (PCS)	Voice/Data	1850.7 - 1909.3 MHz
LTE Band 30	Voice/Data	2307.5 - 2312.5 MHz
LTE Band 7	Voice/Data	2502.5 - 2567.5 MHz
LTE Band 41	Voice/Data	2498.5 - 2687.5 MHz
2.4 GHz WLAN	Voice/Data	2412 - 2462 MHz
U-NII-1	Voice/Data	5180 - 5240 MHz
U-NII-2A	Voice/Data	5260 - 5320 MHz
U-NII-2C	Voice/Data	5500 - 5720 MHz
U-NII-3	Voice/Data	5745 - 5825 MHz
Bluetooth	Data	2402 - 2480 MHz
NFC	Data	13.56 MHz
WMC	Data	500 Hz - 4 kHz

## 1.2 Power Reduction for SAR

This device uses a power reduction mechanism for SAR compliance. The power reduction mechanism is activated when the device is being used in close proximity to the user's hand. FCC KDB Publication 616217 D04v01r02 Section 6 was used as a guideline for selecting SAR test distances for this device when being used in phablet use conditions. Detailed descriptions of the power reduction mechanism are included in the operational description.

This device uses an independent fixed level power reduction mechanism for WLAN operations during voice or VoIP held to ear scenarios. Per FCC Guidance, the held-to-ear exposure conditions were evaluated at reduced power according to the head SAR positions described in IEEE 1528-2013. Detailed descriptions of the power reduction mechanism are included in the operational description.

FCC ID: ZNFG710TM		SAR EVALUATION REPORT		Approved by: Quality Manager
Document S/N: 1M1804030060-01-R1.ZNF	Test Dates: 04/03/18 - 04/16/18	DUT Type: Portable Handset	Page 3 of 131	



### 1.3 Nominal and Maximum Output Power Specifications

This device operates using the following maximum and nominal output power specifications. SAR values were scaled to the maximum allowed power to determine compliance per KDB Publication 447498 D01v06.



#### 1.3.1 Maximum PCE Output Power

Mode / Band		Voice (dBm)	Burst Average GMSK (dBm)				Burst Average 8-PSK (dBm)			
		1 TX Slot	1 TX Slots	2 TX Slots	3 TX Slots	4 TX Slots	1 TX Slots	2 TX Slots	3 TX Slots	4 TX Slots
GSM/GPRS/EDGE 850	Maximum	31.7	31.7	31.7	30.2	28.7	27.7	27.7	26.7	26.7
	Nominal	31.2	31.2	31.2	29.7	28.2	27.2	27.2	26.2	26.2
GSM/GPRS/EDGE 1900	Maximum	30.7	30.7	29.7	27.2	25.7	26.7	26.7	25.7	25.7
	Nominal	30.2	30.2	29.2	26.7	25.2	26.2	26.2	25.2	25.2

Mode / Band		Modulated Average (dBm)			
		3GPP WCDMA	3GPP HSDPA	3GPP HSUPA	3GPP DC-HSDPA
UMTS Band 5 (850 MHz)	Maximum	25.5	25.5	25.5	25.5
	Nominal	25.0	25.0	25.0	25.0
UMTS Band 4 (1750 MHz)	Maximum	25.2	25.2	25.2	25.2
	Nominal	24.7	24.7	24.7	24.7
UMTS Band 2 (1900 MHz)	Maximum	25.5	25.5	25.5	25.5
	Nominal	25.0	25.0	25.0	25.0

FCC ID: ZNFG710TM	 <b>PCTEST</b> ENGINEERING LABORATORY, INC.	SAR EVALUATION REPORT	 <b>LG</b>	Approved by: Quality Manager
Document S/N: 1M1804030060-01-R1.ZNF	Test Dates: 04/03/18 - 04/16/18	DUT Type: Portable Handset		Page 4 of 131



Mode / Band		Modulated Average (dBm)
LTE Band 71	Maximum	25.5
	Nominal	25.0
LTE Band 12	Maximum	25.5
	Nominal	25.0
LTE Band 17	Maximum	25.5
	Nominal	25.0
LTE Band 13	Maximum	25.5
	Nominal	25.0
LTE Band 5 (Cell)	Maximum	25.5
	Nominal	25.0
LTE Band 66 (AWS)	Maximum	25.2
	Nominal	24.7
LTE Band 4 (AWS)	Maximum	25.2
	Nominal	24.7
LTE Band 25 (PCS)	Maximum	25.5
	Nominal	25.0
LTE Band 2 (PCS)	Maximum	25.5
	Nominal	25.0
LTE Band 30	Maximum	25.5
	Nominal	25.0
LTE Band 7	Maximum	25.5
	Nominal	25.0
LTE Band 41	Maximum	25.2
	Nominal	24.7

FCC ID: ZNFG710TM	 <b>PCTEST</b> ENGINEERING LABORATORY, INC.	<b>SAR EVALUATION REPORT</b>	 <b>LG</b>	Approved by: Quality Manager
Document S/N: 1M1804030060-01-R1.ZNF	Test Dates: 04/03/18 - 04/16/18	DUT Type: Portable Handset		Page 5 of 131

### 1.3.2 Reduced PCE Output Power

Mode / Band		Modulated Average (dBm)			
		3GPP WCDMA	3GPP HSDPA	3GPP HSUPA	3GPP DC-HSDPA
UMTS Band 4 (1750 MHz)	Maximum	<b>24.2</b>	<b>24.2</b>	<b>24.2</b>	<b>24.2</b>
	Nominal	<b>23.7</b>	<b>23.7</b>	<b>23.7</b>	<b>23.7</b>
UMTS Band 2 (1900 MHz)	Maximum	<b>24.5</b>	<b>24.5</b>	<b>24.5</b>	<b>24.5</b>
	Nominal	<b>24.0</b>	<b>24.0</b>	<b>24.0</b>	<b>24.0</b>

Mode / Band		Modulated Average (dBm)
LTE Band 66 (AWS)	Maximum	<b>24.2</b>
	Nominal	<b>23.7</b>
LTE Band 4 (AWS)	Maximum	<b>24.2</b>
	Nominal	<b>23.7</b>
LTE Band 25 (PCS)	Maximum	<b>24.5</b>
	Nominal	<b>24.0</b>
LTE Band 2 (PCS)	Maximum	<b>24.5</b>
	Nominal	<b>24.0</b>

FCC ID: ZNFG710TM	 <b>PCTEST</b> ENGINEERING LABORATORY, INC.	SAR EVALUATION REPORT	 <b>LG</b>	Approved by: Quality Manager
Document S/N: 1M1804030060-01-R1.ZNF	Test Dates: 04/03/18 - 04/16/18	DUT Type: Portable Handset	Page 6 of 131	



### 1.3.3

### Maximum WLAN and Bluetooth Output Power

Mode / Band		Modulated Average - Single Tx Chain (dBm)		
		Ch. 1-2	Ch. 3-9	Ch. 10-11
IEEE 802.11b (2.4 GHz)	Maximum	<b>21.0</b>	<b>21.0</b>	<b>21.0</b>
	Nominal	<b>20.0</b>	<b>20.0</b>	<b>20.0</b>
IEEE 802.11g (2.4 GHz)	Maximum	<b>18.5</b>	<b>20.5</b>	<b>18.5</b>
	Nominal	<b>17.5</b>	<b>19.5</b>	<b>17.5</b>
IEEE 802.11n (2.4 GHz)	Maximum	<b>18.0</b>	<b>19.5</b>	<b>18.0</b>
	Nominal	<b>17.0</b>	<b>18.5</b>	<b>17.0</b>
IEEE 802.11ac (2.4 GHz)	Maximum	<b>18.0</b>	<b>19.5</b>	<b>18.0</b>
	Nominal	<b>17.0</b>	<b>18.5</b>	<b>17.0</b>



Mode / Band		Modulated Average - MIMO (dBm)		
		Ch. 1-2	Ch. 3-9	Ch. 10-11
IEEE 802.11b (2.4 GHz)	Maximum	<b>24.0</b>	<b>24.0</b>	<b>24.0</b>
	Nominal	<b>23.0</b>	<b>23.0</b>	<b>23.0</b>
IEEE 802.11g (2.4 GHz)	Maximum	<b>21.5</b>	<b>23.5</b>	<b>21.5</b>
	Nominal	<b>20.5</b>	<b>22.5</b>	<b>20.5</b>
IEEE 802.11n (2.4 GHz)	Maximum	<b>21.0</b>	<b>22.5</b>	<b>21.0</b>
	Nominal	<b>20.0</b>	<b>21.5</b>	<b>20.0</b>
IEEE 802.11ac (2.4 GHz)	Maximum	<b>21.0</b>	<b>22.5</b>	<b>21.0</b>
	Nominal	<b>20.0</b>	<b>21.5</b>	<b>20.0</b>

Mode / Band		Modulated Average - Single Tx Chain (dBm)						
		20 MHz Bandwidth		40 MHz Bandwidth			80 MHz Bandwidth	
		Ch. 36, 44-52, 60-153, 165	Ch. 40, 56, 157, 161	Ch. 38	Ch. 62-102	Ch. 46-54, 110-159	Ch. 42, 106-155	Ch. 58
IEEE 802.11a (5 GHz)	Maximum	<b>17.0</b>	<b>18.0</b>					
	Nominal	<b>16.0</b>	<b>17.0</b>					
IEEE 802.11n (5 GHz)	Maximum	<b>17.0</b>	<b>18.0</b>	<b>13.0</b>	<b>12.5</b>	<b>16.0</b>		
	Nominal	<b>16.0</b>	<b>17.0</b>	<b>12.0</b>	<b>11.5</b>	<b>15.0</b>		
IEEE 802.11ac (5 GHz)	Maximum	<b>17.0</b>	<b>18.0</b>	<b>13.0</b>	<b>12.5</b>	<b>16.0</b>	<b>13.5</b>	<b>10.5</b>
	Nominal	<b>16.0</b>	<b>17.0</b>	<b>12.0</b>	<b>11.5</b>	<b>15.0</b>	<b>12.5</b>	<b>9.5</b>

<b>FCC ID:</b> ZNFG710TM	 <b>PCTEST</b> ENGINEERING LABORATORY, INC.	<b>SAR EVALUATION REPORT</b>	 <b>LG</b>	<b>Approved by:</b> Quality Manager
<b>Document S/N:</b> 1M1804030060-01-R1.ZNF	<b>Test Dates:</b> 04/03/18 - 04/16/18	<b>DUT Type:</b> Portable Handset		Page 7 of 131

Mode / Band		Modulated Average - MIMO (dBm)						
		20 MHz Bandwidth		40 MHz Bandwidth			80 MHz Bandwidth	
		Ch. 36, 44-52, 60-153, 165	Ch. 40, 56, 157, 161	Ch. 38	Ch. 62-102	Ch. 46-54, 110-159	Ch. 42, 106-155	Ch. 58
IEEE 802.11a (5 GHz)	Maximum	20.0	21.0					
	Nominal	19.0	20.0					
IEEE 802.11n (5 GHz)	Maximum	20.0	21.0	16.0	15.5	19.0		
	Nominal	19.0	20.0	15.0	14.5	18.0		
IEEE 802.11ac (5 GHz)	Maximum	20.0	21.0	16.0	15.5	19.0	16.5	13.5
	Nominal	19.0	20.0	15.0	14.5	18.0	15.5	12.5

Mode / Band		Modulated Average - Single Tx Chain (dBm)
Bluetooth	Maximum	12.0
	Nominal	11.0
Bluetooth LE	Maximum	5.5
	Nominal	4.5

FCC ID: ZNFG710TM	 PCTEST ENGINEERING LABORATORY, INC.	SAR EVALUATION REPORT	 LG	Approved by: Quality Manager
Document S/N: 1M1804030060-01-R1.ZNF	Test Dates: 04/03/18 - 04/16/18	DUT Type: Portable Handset		Page 8 of 131





**1.3.4**

**Reduced WLAN Output Power (Held-to-Ear)**

Mode / Band		Modulated Average - Single Tx Chain (dBm)
IEEE 802.11b (2.4 GHz)	Maximum	<b>18.0</b>
	Nominal	<b>17.0</b>
IEEE 802.11g (2.4 GHz)	Maximum	<b>18.0</b>
	Nominal	<b>17.0</b>
IEEE 802.11n (2.4 GHz)	Maximum	<b>18.0</b>
	Nominal	<b>17.0</b>
IEEE 802.11ac (2.4 GHz)	Maximum	<b>18.0</b>
	Nominal	<b>17.0</b>

Mode / Band		Modulated Average - MIMO (dBm)
IEEE 802.11b (2.4 GHz)	Maximum	<b>21.0</b>
	Nominal	<b>20.0</b>
IEEE 802.11g (2.4 GHz)	Maximum	<b>21.0</b>
	Nominal	<b>20.0</b>
IEEE 802.11n (2.4 GHz)	Maximum	<b>21.0</b>
	Nominal	<b>20.0</b>
IEEE 802.11ac (2.4 GHz)	Maximum	<b>21.0</b>
	Nominal	<b>20.0</b>



FCC ID: ZNFG710TM	 <b>PCTEST</b> ENGINEERING LABORATORY, INC.	<b>SAR EVALUATION REPORT</b>	 <b>LG</b>	Approved by: Quality Manager
Document S/N: 1M1804030060-01-R1.ZNF	Test Dates: 04/03/18 - 04/16/18	DUT Type: Portable Handset		Page 9 of 131

### 1.3.5

### Output Power during Scenarios with 2.4 GHz WLAN Ant 1 and 5 GHz WLAN Ant 2

Mode / Band		Modulated Average - Single Tx Chain, Antenna 1 (dBm)
IEEE 802.11b (2.4 GHz)	Maximum	<b>18.0</b>
	Nominal	<b>17.0</b>
IEEE 802.11g (2.4 GHz)	Maximum	<b>18.0</b>
	Nominal	<b>17.0</b>
IEEE 802.11n (2.4 GHz)	Maximum	<b>18.0</b>
	Nominal	<b>17.0</b>
IEEE 802.11ac (2.4 GHz)	Maximum	<b>18.0</b>
	Nominal	<b>17.0</b>

Mode / Band		Modulated Average - Single Tx Chain, Antenna 2 (dBm)						
		20 MHz Bandwidth		40 MHz Bandwidth			80 MHz Bandwidth	
		Ch. 36-165		Ch. 38	Ch. 62-102	Ch. 46-54, 110-159	Ch. 58	Ch. 42, 106-155
IEEE 802.11a (5 GHz)	Maximum	<b>15.0</b>						
	Nominal	<b>14.0</b>						
IEEE 802.11n (5 GHz)	Maximum	<b>15.0</b>	<b>13.0</b>	<b>12.5</b>	<b>15.0</b>			
	Nominal	<b>14.0</b>	<b>12.0</b>	<b>11.5</b>	<b>14.0</b>			
IEEE 802.11ac (5 GHz)	Maximum	<b>15.0</b>	<b>13.0</b>	<b>12.5</b>	<b>15.0</b>	<b>10.5</b>	<b>13.5</b>	
	Nominal	<b>14.0</b>	<b>12.0</b>	<b>11.5</b>	<b>14.0</b>	<b>9.5</b>	<b>12.5</b>	

FCC ID: ZNFG710TM	 <b>PCTEST</b> ENGINEERING LABORATORY, INC.	<b>SAR EVALUATION REPORT</b>		Approved by: Quality Manager
Document S/N: 1M1804030060-01-R1.ZNF	Test Dates: 04/03/18 - 04/16/18	DUT Type: Portable Handset		Page 10 of 131

## 1.4 DUT Antenna Locations

The overall dimensions of this device are > 9 x 5 cm. A diagram showing the location of the device antennas can be found in Appendix F. Since the diagonal dimension of this device is > 160 mm and <200 mm, it is considered a “phablet.”

**Table 1-1  
Device Edges/Sides for SAR Testing**

Mode	Back	Front	Top	Bottom	Right	Left
GPRS 850	Yes	Yes	No	Yes	Yes	Yes
GPRS 1900	Yes	Yes	No	Yes	No	Yes
UMTS 850	Yes	Yes	No	Yes	Yes	Yes
UMTS 1750	Yes	Yes	No	Yes	No	Yes
UMTS 1900	Yes	Yes	No	Yes	No	Yes
LTE Band 71	Yes	Yes	No	Yes	Yes	Yes
LTE Band 12	Yes	Yes	No	Yes	Yes	Yes
LTE Band 13	Yes	Yes	No	Yes	Yes	Yes
LTE Band 5 (Cell)	Yes	Yes	No	Yes	Yes	Yes
LTE Band 66 (AWS)	Yes	Yes	No	Yes	No	Yes
LTE Band 25 (PCS)	Yes	Yes	No	Yes	No	Yes
LTE Band 30	Yes	Yes	No	Yes	Yes	Yes
LTE Band 7	Yes	Yes	No	Yes	Yes	Yes
LTE Band 41	Yes	Yes	No	Yes	Yes	Yes
2.4 GHz WLAN Ant 1	Yes	Yes	Yes	No	No	Yes
2.4 GHz WLAN Ant 2	Yes	Yes	Yes	No	No	Yes
5 GHz WLAN Ant 1	Yes	Yes	Yes	No	No	Yes
5 GHz WLAN Ant 2	Yes	Yes	Yes	No	No	Yes
Bluetooth	Yes	Yes	Yes	No	No	Yes

Note: Particular DUT edges were not required to be evaluated for wireless router SAR or phablet SAR if the edges were greater than 2.5 cm from the transmitting antenna according to FCC KDB Publication 941225 D06v02r01 Section III and FCC KDB Publication 648474 D04v01r03. The distances between the transmit antennas and the edges of the device are included in the filing.



## 1.5 Near Field Communications (NFC) Antenna

This DUT has NFC operations. The NFC antenna is integrated into the device for this model. Therefore, all SAR tests were performed with the device which already incorporates the NFC antenna. A diagram showing the location of the NFC antenna can be found in Appendix F.

## 1.6 Simultaneous Transmission Capabilities

According to FCC KDB Publication 447498 D01v06, transmitters are considered to be transmitting simultaneously when there is overlapping transmission, with the exception of transmissions during network hand-offs with maximum hand-off duration less than 30 seconds.



This device contains multiple transmitters that may operate simultaneously, and therefore requires a simultaneous transmission analysis according to FCC KDB Publication 447498 D01v06 4.3.2 procedures.

FCC ID: ZNFG710TM	 PCTEST ENGINEERING LABORATORY, INC.	SAR EVALUATION REPORT	 LG	Approved by: Quality Manager
Document S/N: 1M1804030060-01-R1.ZNF	Test Dates: 04/03/18 - 04/16/18	DUT Type: Portable Handset	Page 11 of 131	

**Table 1-2  
Simultaneous Transmission Scenarios**

No.	Capable Transmit Configuration	Head	Body-Worn Accessory	Wireless Router	Phablet	Notes
1	GSM voice + 2.4 GHz Wi-Fi	Yes	Yes	N/A	Yes	
2	GSM voice + 5 GHz Wi-Fi	Yes	Yes	N/A	Yes	
3	GSM voice + 2.4 GHz Bluetooth	Yes^	Yes	N/A	Yes	^Bluetooth Tethering is considered
4	GSM voice + 2.4 GHz Wi-Fi MIMO	Yes	Yes	N/A	Yes	
5	GSM voice + 5 GHz Wi-Fi MIMO	Yes	Yes	N/A	Yes	
6	GSM voice + 2.4 GHz Wi-Fi Ant 1 + 5 GHz Wi-Fi Ant 2	Yes	Yes	N/A	Yes	
7	UMTS + 2.4 GHz Wi-Fi	Yes	Yes	Yes	Yes	
8	UMTS + 5 GHz Wi-Fi	Yes	Yes	Yes	Yes	
9	UMTS + 2.4 GHz Bluetooth	Yes^	Yes	Yes^	Yes	^Bluetooth Tethering is considered
10	UMTS + 2.4 GHz Wi-Fi MIMO	Yes	Yes	Yes	Yes	
11	UMTS + 5 GHz Wi-Fi MIMO	Yes	Yes	Yes	Yes	
12	UMTS + 2.4 GHz Wi-Fi Ant 1 + 5 GHz Wi-Fi Ant 2	Yes	Yes	Yes	Yes	
13	LTE + 2.4 GHz Wi-Fi	Yes	Yes	Yes	Yes	
14	LTE + 5 GHz Wi-Fi	Yes	Yes	Yes	Yes	
15	LTE + 2.4 GHz Bluetooth	Yes^	Yes	Yes^	Yes	^Bluetooth Tethering is considered
16	LTE + 2.4 GHz Wi-Fi MIMO	Yes	Yes	Yes	Yes	
17	LTE + 5 GHz Wi-Fi MIMO	Yes	Yes	Yes	Yes	
18	LTE + 2.4 GHz Wi-Fi Ant 1 + 5 GHz Wi-Fi Ant 2	Yes	Yes	Yes	Yes	
19	GPRS/EDGE + 2.4 GHz Wi-Fi	Yes*	Yes*	Yes	Yes	* Pre-installed VOIP applications are considered
20	GPRS/EDGE + 5 GHz Wi-Fi	Yes*	Yes*	Yes	Yes	* Pre-installed VOIP applications are considered
21	GPRS/EDGE + 2.4 GHz Bluetooth	Yes*^	Yes*	Yes^	Yes	* Pre-installed VOIP applications are considered ^Bluetooth Tethering is considered
22	GPRS/EDGE + 2.4 GHz Wi-Fi MIMO	Yes*	Yes*	Yes	Yes	* Pre-installed VOIP applications are considered
23	GPRS/EDGE + 5 GHz Wi-Fi MIMO	Yes*	Yes*	Yes	Yes	* Pre-installed VOIP applications are considered
24	GPRS/EDGE + 2.4 GHz Wi-Fi Ant 1 + 5 GHz Wi-Fi Ant 2	Yes*	Yes*	Yes	Yes	* Pre-installed VOIP applications are considered

1. All licensed modes share the same antenna path and cannot transmit simultaneously.
2. When the user utilizes multiple services in UMTS 3G mode it uses multi-Radio Access Bearer or multi-RAB. The power control is based on a physical control channel (Dedicated Physical Control Channel [DPCCH]) and power control will be adjusted to meet the needs of both services. Therefore, the UMTS+WLAN scenario also represents the UMTS Voice/DATA + WLAN Hotspot scenario.
3. Per the manufacturer, WIFI Direct is expected to be used in conjunction with a held-to-ear or body-worn accessory voice call. Simultaneous transmission scenarios involving WIFI direct are that listed in the above table.
4. 5 GHz Wireless Router is only supported for the U-NII-1 and U-NII-3 by S/W, therefore U-NII2A and U-NII2C were not evaluated for wireless router conditions.
5. This device supports 2x2 MIMO Tx for WLAN. 802.11a/g/n/ac modes support CDD and 802.11n/ac modes additionally support SDM. 802.11b mode supports TDD operations only. Each WLAN antenna can transmit independently or together when operating with MIMO.
6. This device supports VoLTE.
7. This device supports VoWIFI.
8. This device supports Bluetooth tethering.

FCC ID: ZNFG710TM		<b>SAR EVALUATION REPORT</b>		<b>Approved by:</b> Quality Manager
<b>Document S/N:</b> 1M1804030060-01-R1.ZNF	<b>Test Dates:</b> 04/03/18 - 04/16/18	<b>DUT Type:</b> Portable Handset	Page 12 of 131	

## 1.7 Miscellaneous SAR Test Considerations

### (A) WIFI/BT

Since U-NII-1 and U-NII-2A bands have the same maximum output power and the highest reported SAR for U-NII-2A is less than 1.2 W/kg, SAR is not required for U-NII-1 band according to FCC KDB Publication 248227 D01v02r02.

Since Wireless Router operations are not allowed by the chipset firmware using U-NII-2A & U-NII-2C WIFI, only 2.4 GHz, U-NII-1, and U-NII-3 WIFI Hotspot SAR tests and combinations are considered for SAR with respect to Wireless Router configurations according to FCC KDB 941225 D06v02r01.

This device supports IEEE 802.11ac with the following features:

- a) Up to 80 MHz Bandwidth only
- b) No aggregate channel configurations
- c) 2 Tx antenna output
- d) 256 QAM is supported
- e) TDWR and Band gap channels are supported

Per FCC KDB Publication 648474 D04v01r03, this device is considered a "phablet" since the diagonal dimension is greater than 160mm and less than 200mm. Phablet SAR tests are required when wireless router mode does not apply or if wireless router 1g SAR > 1.2 W/kg. Because wireless router operations are not supported for U-NII-2A & U-NII-2C WLAN, phablet SAR tests were performed. Phablet SAR was not evaluated for Bluetooth, 2.4 GHz, U-NII-1, and U-NII-3 WLAN operations since wireless router 1g SAR was < 1.2 W/kg.

### (B) Licensed Transmitter(s)

GSM/GPRS/EDGE DTM is not supported for US bands. Therefore, the GSM Voice modes in this report do not transmit simultaneously with GPRS/EDGE Data.



This device is only capable of QPSK HSUPA in the uplink. Therefore, no additional SAR tests are required beyond that described for devices with HSUPA in KDB 941225 D01v03r01.

LTE SAR for the higher modulations and lower bandwidths were not tested since the maximum average output power of all required channels and configurations was not more than 0.5 dB higher than the highest bandwidth; and the reported LTE SAR for the highest bandwidth was less than 1.45 W/kg for all configurations according to FCC KDB 941225 D05v02r04.

This device supports 64QAM on the uplink and 256QAM on the downlink for LTE Operations. Conducted powers for 64QAM uplink configurations were measured per Section 5.1 of FCC KDB Publication 941225 D05v02r05. SAR was not required for 64QAM since the highest maximum output power for 64 QAM is  $\leq \frac{1}{2}$  dB higher than the same configuration in QPSK and the reported SAR for the QPSK configuration is  $\leq 1.45$  W/kg, per Section 5.2.4 of FCC KDB Publication 941225 D05v02r05.

This device supports LTE Carrier Aggregation (CA) in the downlink. All uplink communications are identical to Release 8 specifications. Per FCC KDB Publication 941225 D05A v01r02, SAR for downlink only LTE CA operations was not needed since the maximum average output power in downlink only LTE CA mode was not >0.25 dB higher than the maximum output power when downlink carrier aggregation was inactive.

Per FCC KDB Publication 648474 D04v01r03, this device is considered a "phablet" since the diagonal dimension is greater than 160mm and less than 200mm. Therefore, phablet SAR tests are required when wireless router mode does not apply or if wireless router 1g SAR > 1.2 W/kg.

FCC ID: ZNFG710TM	 <b>SAR EVALUATION REPORT</b> 		Approved by: Quality Manager
Document S/N: 1M1804030060-01-R1.ZNF	Test Dates: 04/03/18 - 04/16/18	DUT Type: Portable Handset	Page 13 of 131

This device supports downlink 4x4 MIMO operations for some LTE Bands. Per May 2017 TCB Workshop Guidance, SAR for downlink 4x4 MIMO was not needed since the maximum average output power in 4x4 downlink MIMO mode was not > 0.25 dB higher than the maximum output power with downlink 4x4 MIMO inactive.



This device supports LTE capabilities with overlapping transmission frequency ranges. When the supported frequency range of an LTE Band falls completely within an LTE band with a larger transmission frequency range, both LTE bands have the same target power (or the band with the larger transmission frequency range has a higher target power), and both LTE bands share the same transmission path and signal characteristics, SAR was only assessed for the band with the larger transmission frequency range.

## 1.8 Guidance Applied

- IEEE 1528-2013
- FCC KDB Publication 941225 D01v03r01, D05v02r04, D05Av01r02, D06v02r01 (2G/3G/4G and Hotspot)
- FCC KDB Publication 248227 D01v02r02 (SAR Considerations for 802.11 Devices)
- FCC KDB Publication 447498 D01v06 (General SAR Guidance)
- FCC KDB Publication 865664 D01v01r04, D02v01r02 (SAR Measurements up to 6 GHz)
- FCC KDB Publication 648474 D04v01r03 (Phablet Procedures)
- FCC KDB Publication 616217 D04v01r02 (Proximity Sensor)
- October 2013 TCB Workshop Notes (GPRS Testing Considerations)
- May 2017 TCB Workshop Notes (LTE 4x4 Downlink MIMO)
- Fall 2017 TCB Workshop Notes (LTE Carrier Aggregation)

## 1.9 Device Serial Numbers



Several samples with identical hardware were used to support SAR testing. The manufacturer has confirmed that the device(s) tested have the same physical, mechanical and thermal characteristics and are within operational tolerances expected for production units. The serial numbers used for each test are indicated alongside the results in Section 11.

FCC ID: ZNFG710TM	 <b>SAR EVALUATION REPORT</b> 		<b>Approved by:</b> Quality Manager
<b>Document S/N:</b> 1M1804030060-01-R1.ZNF	<b>Test Dates:</b> 04/03/18 - 04/16/18	<b>DUT Type:</b> Portable Handset	Page 14 of 131

# 2

# LTE INFORMATION

LTE Information					
FCC ID	ZNFG710TM				
Form Factor	Portable Handset				
Frequency Range of each LTE transmission band	LTE Band 71 (665.5 - 695.5 MHz)				
	LTE Band 12 (699.7 - 715.3 MHz)				
	LTE Band 17 (706.5 - 713.5 MHz)				
	LTE Band 13 (779.5 - 784.5 MHz)				
	LTE Band 5 (Cell) (824.7 - 848.3 MHz)				
	LTE Band 66 (AWS) (1710.7 - 1779.3 MHz)				
	LTE Band 4 (AWS) (1710.7 - 1754.3 MHz)				
	LTE Band 25 (PCS) (1850.7 - 1914.3 MHz)				
	LTE Band 2 (PCS) (1850.7 - 1909.3 MHz)				
	LTE Band 30 (2307.5 - 2312.5 MHz)				
	LTE Band 7 (2502.5 - 2567.5 MHz)				
	LTE Band 41 (2498.5 - 2687.5 MHz)				
	Channel Bandwidths	LTE Band 71: 5 MHz, 10 MHz, 15 MHz, 20 MHz			
		LTE Band 12: 1.4 MHz, 3 MHz, 5 MHz, 10 MHz			
LTE Band 17: 5 MHz, 10 MHz					
LTE Band 13: 5 MHz, 10 MHz					
LTE Band 5 (Cell): 1.4 MHz, 3 MHz, 5 MHz, 10 MHz					
LTE Band 66 (AWS): 1.4 MHz, 3 MHz, 5 MHz, 10 MHz, 15 MHz, 20 MHz					
LTE Band 4 (AWS): 1.4 MHz, 3 MHz, 5 MHz, 10 MHz, 15 MHz, 20 MHz					
LTE Band 25 (PCS): 1.4 MHz, 3 MHz, 5 MHz, 10 MHz, 15 MHz, 20 MHz					
LTE Band 2 (PCS): 1.4 MHz, 3 MHz, 5 MHz, 10 MHz, 15 MHz, 20 MHz					
LTE Band 30: 5 MHz, 10 MHz					
LTE Band 7: 5 MHz, 10 MHz, 15 MHz, 20 MHz					
LTE Band 41: 5 MHz, 10 MHz, 15 MHz, 20 MHz					
Channel Numbers and Frequencies (MHz)		Low	Low-Mid	Mid	Mid-High
					High
LTE Band 71: 5 MHz	665.5 (133147)		680.5 (133297)	695.5 (133447)	
LTE Band 71: 10 MHz	668 (133172)		680.5 (133297)	693 (133422)	
LTE Band 71: 15 MHz	670.5 (133197)		680.5 (133297)	690.5 (133397)	
LTE Band 71: 20 MHz	673 (133222)		680.5 (133297)	688 (133372)	
LTE Band 12: 1.4 MHz	699.7 (23017)		707.5 (23095)	715.3 (23173)	
LTE Band 12: 3 MHz	700.5 (23025)		707.5 (23095)	714.5 (23165)	
LTE Band 12: 5 MHz	701.5 (23035)		707.5 (23095)	713.5 (23155)	
LTE Band 12: 10 MHz	704 (23060)		707.5 (23095)	711 (23130)	
LTE Band 17: 5 MHz	706.5 (23755)		710 (23790)	713.5 (23825)	
LTE Band 17: 10 MHz	709 (23780)		710 (23790)	711 (23800)	
LTE Band 13: 5 MHz	779.5 (23205)		782 (23230)	784.5 (23255)	
LTE Band 13: 10 MHz	N/A		782 (23230)	N/A	
LTE Band 5 (Cell): 1.4 MHz	824.7 (20407)		836.5 (20525)	848.3 (20643)	
LTE Band 5 (Cell): 3 MHz	825.5 (20415)		836.5 (20525)	847.5 (20635)	
LTE Band 5 (Cell): 5 MHz	826.5 (20425)		836.5 (20525)	846.5 (20625)	
LTE Band 5 (Cell): 10 MHz	829 (20450)		836.5 (20525)	844 (20600)	
LTE Band 66 (AWS): 1.4 MHz	1710.7 (131979)		1745 (132322)	1779.3 (132665)	
LTE Band 66 (AWS): 3 MHz	1711.5 (131987)		1745 (132322)	1778.5 (132657)	
LTE Band 66 (AWS): 5 MHz	1712.5 (131997)		1745 (132322)	1777.5 (132647)	
LTE Band 66 (AWS): 10 MHz	1715 (132022)		1745 (132322)	1775 (132622)	
LTE Band 66 (AWS): 15 MHz	1717.5 (132047)		1745 (132322)	1772.5 (132597)	
LTE Band 66 (AWS): 20 MHz	1720 (132072)		1745 (132322)	1770 (132572)	
LTE Band 4 (AWS): 1.4 MHz	1710.7 (19957)		1732.5 (20175)	1754.3 (20393)	
LTE Band 4 (AWS): 3 MHz	1711.5 (19965)		1732.5 (20175)	1753.5 (20385)	
LTE Band 4 (AWS): 5 MHz	1712.5 (19975)		1732.5 (20175)	1752.5 (20375)	
LTE Band 4 (AWS): 10 MHz	1715 (20000)		1732.5 (20175)	1750 (20350)	
LTE Band 4 (AWS): 15 MHz	1717.5 (20025)		1732.5 (20175)	1747.5 (20325)	
LTE Band 4 (AWS): 20 MHz	1720 (20050)		1732.5 (20175)	1745 (20300)	
LTE Band 25 (PCS): 1.4 MHz	1850.7 (26047)		1882.5 (26365)	1914.3 (26683)	
LTE Band 25 (PCS): 3 MHz	1851.5 (26055)		1882.5 (26365)	1913.5 (26675)	
LTE Band 25 (PCS): 5 MHz	1852.5 (26065)		1882.5 (26365)	1912.5 (26665)	
LTE Band 25 (PCS): 10 MHz	1855 (26090)		1882.5 (26365)	1910 (26640)	
LTE Band 25 (PCS): 15 MHz	1857.5 (26115)		1882.5 (26365)	1907.5 (26615)	
LTE Band 25 (PCS): 20 MHz	1860 (26140)		1882.5 (26365)	1905 (26590)	
LTE Band 2 (PCS): 1.4 MHz	1850.7 (18607)		1880 (18900)	1909.3 (19193)	
LTE Band 2 (PCS): 3 MHz	1851.5 (18615)		1880 (18900)	1908.5 (19185)	
LTE Band 2 (PCS): 5 MHz	1852.5 (18625)		1880 (18900)	1907.5 (19175)	
LTE Band 2 (PCS): 10 MHz	1855 (18650)		1880 (18900)	1905 (19150)	
LTE Band 2 (PCS): 15 MHz	1857.5 (18675)		1880 (18900)	1902.5 (19125)	
LTE Band 2 (PCS): 20 MHz	1860 (18700)		1880 (18900)	1900 (19100)	
LTE Band 30: 5 MHz	2307.5 (27685)		2310 (27710)	2312.5 (27735)	
LTE Band 30: 10 MHz	N/A		2310 (27710)	N/A	
LTE Band 7: 5 MHz	2502.5 (20775)		2535 (21100)	2567.5 (21425)	
LTE Band 7: 10 MHz	2505 (20800)		2535 (21100)	2565 (21400)	
LTE Band 7: 15 MHz	2507.5 (20825)		2535 (21100)	2562.5 (21375)	
LTE Band 7: 20 MHz	2510 (20850)		2535 (21100)	2560 (21350)	
LTE Band 41: 5 MHz	2506 (39750)	2549.5 (40185)	2593 (40620)	2636.5 (41055)	
LTE Band 41: 10 MHz	2506 (39750)	2549.5 (40185)	2593 (40620)	2636.5 (41055)	
LTE Band 41: 15 MHz	2506 (39750)	2549.5 (40185)	2593 (40620)	2636.5 (41055)	
LTE Band 41: 20 MHz	2506 (39750)	2549.5 (40185)	2593 (40620)	2636.5 (41055)	
UE Category	DL UE Cat 18 (QPSK, 16QAM, 64QAM, 256QAM), UL UE Cat 5 (QPSK, 16QAM, 64QAM)				
Modulations Supported in UL	QPSK, 16QAM, 64QAM				
LTE MPR Permanently implemented per 3GPP TS 36.101 section 6.2.3-6.2.5? (manufacturer attestation to be provided)	YES				
A-MPR (Additional MPR) disabled for SAR Testing?	YES				
LTE Carrier Aggregation Possible Combinations	The technical description includes all the possible carrier aggregation combinations				
LTE Additional Information	This device does not support full CA features on 3G Release 12. It supports carrier aggregation, downlink MIMO, and LAA features shown in Appendix H. All other uplink communications are identical to the Release 8 Specifications. Uplink communications are done on the PCC unless otherwise specified. The following LTE Release 12 features are not supported: Relay, HetNet, Enhanced eCIC, MDH, eMBMS, Cross-carrier scheduling, Enhanced SC-FDMA.				

FCC ID: ZNFG710TM		SAR EVALUATION REPORT		Approved by: Quality Manager
Document S/N: 1M1804030060-01-R1.ZNF	Test Dates: 04/03/18 - 04/16/18	DUT Type: Portable Handset		Page 15 of 131

### 3 INTRODUCTION

The FCC and Innovation, Science, and Economic Development Canada have adopted the guidelines for evaluating the environmental effects of radio frequency (RF) radiation in ET Docket 93-62 on Aug. 6, 1996 and Health Canada Safety Code 6 to protect the public and workers from the potential hazards of RF emissions due to FCC-regulated portable devices. [1]

The safety limits used for the environmental evaluation measurements are based on the criteria published by the American National Standards Institute (ANSI) for localized specific absorption rate (SAR) in IEEE/ANSI C95.1-1992 Standard for Safety Levels with Respect to Human Exposure to Radio Frequency Electromagnetic Fields, 3 kHz to 300 GHz [3] and Health Canada RF Exposure Guidelines Safety Code 6 [22]. The measurement procedure described in IEEE/ANSI C95.3-2002 Recommended Practice for the Measurement of Potentially Hazardous Electromagnetic Fields - RF and Microwave [4] is used for guidance in measuring the Specific Absorption Rate (SAR) due to the RF radiation exposure from the Equipment Under Test (EUT). These criteria for SAR evaluation are similar to those recommended by the International Committee for Non-Ionizing Radiation Protection (ICNIRP) in Biological Effects and Exposure Criteria for Radiofrequency Electromagnetic Fields,” Report No. Vol 74. SAR is a measure of the rate of energy absorption due to exposure to an RF transmitting source. SAR values have been related to threshold levels for potential biological hazards.

#### 3.1 SAR Definition

Specific Absorption Rate is defined as the time derivative (rate) of the incremental energy (dU) absorbed by (dissipated in) an incremental mass (dm) contained in a volume element (dV) of a given density (ρ). It is also defined as the rate of RF energy absorption per unit mass at a point in an absorbing body (see Equation 3-1).

**Equation 3-1  
SAR Mathematical Equation**

$$SAR = \frac{d}{dt} \left( \frac{dU}{dm} \right) = \frac{d}{dt} \left( \frac{dU}{\rho dv} \right)$$



SAR is expressed in units of Watts per Kilogram (W/kg).

$$SAR = \frac{\sigma \cdot E^2}{\rho}$$

where:

- σ = conductivity of the tissue-simulating material (S/m)
- ρ = mass density of the tissue-simulating material (kg/m<sup>3</sup>)
- E = Total RMS electric field strength (V/m)

NOTE: The primary factors that control rate of energy absorption were found to be the wavelength of the incident field in relation to the dimensions and geometry of the irradiated organism, the orientation of the organism in relation to the polarity of field vectors, the presence of reflecting surfaces, and whether conductive contact is made by the organism with a ground plane.[6]

FCC ID: ZNFG710TM	 <b>PCTEST</b> ENGINEERING LABORATORY, INC.	SAR EVALUATION REPORT	 LG	Approved by: Quality Manager
Document S/N: 1M1804030060-01-R1.ZNF	Test Dates: 04/03/18 - 04/16/18	DUT Type: Portable Handset	Page 16 of 131	



# 4 DOSIMETRIC ASSESSMENT

## 4.1 Measurement Procedure

The evaluation was performed using the following procedure compliant to FCC KDB Publication 865664 D01v01r04 and IEEE 1528-2013:

1. The SAR distribution at the exposed side of the head or body was measured at a distance no greater than 5.0 mm from the inner surface of the shell. The area covered the entire dimension of the device-head and body interface and the horizontal grid resolution was determined per FCC KDB Publication 865664 D01v01r04 (See Table 4-1) and IEEE 1528-2013.
2. The point SAR measurement was taken at the maximum SAR region determined from Step 1 to enable the monitoring of SAR fluctuations/drifts during the 1g/10g cube evaluation. SAR at this fixed point was measured and used as a reference value.
3. Based on the area scan data, the peak of the region with maximum SAR was determined by spline interpolation. Around this point, a volume was assessed according to the measurement resolution and volume size requirements of FCC KDB Publication 865664 D01v01r04 (See Table 4-1) and IEEE 1528-2013. On the basis of this data set, the spatial peak SAR value was evaluated with the following procedure (see references or the DASY manual online for more details):
  - a. SAR values at the inner surface of the phantom are extrapolated from the measured values along the line away from the surface with spacing no greater than that in Table 4-1. The extrapolation was based on a least-squares algorithm. A polynomial of the fourth order was calculated through the points in the z-axis (normal to the phantom shell).
  - b. After the maximum interpolated values were calculated between the points in the cube, the SAR was averaged over the spatial volume (1g or 10g) using a 3D-Spline interpolation algorithm. The 3D-spline is composed of three one-dimensional splines with the “Not a knot” condition (in x, y, and z directions). The volume was then integrated with the trapezoidal algorithm. One thousand points (10 x 10 x 10) were obtained through interpolation, in order to calculate the averaged SAR.
  - c. All neighboring volumes were evaluated until no neighboring volume with a higher average value was found.
4. The SAR reference value, at the same location as step 2, was re-measured after the zoom scan was complete to calculate the SAR drift. If the drift deviated by more than 5%, the SAR test and drift measurements were repeated.

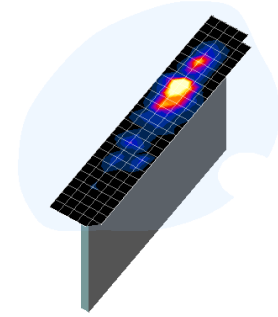



**Figure 4-1**  
Sample SAR Area Scan

**Table 4-1**  
Area and Zoom Scan Resolutions per FCC KDB Publication 865664 D01v01r04\*

Frequency	Maximum Area Scan Resolution (mm) ( $\Delta x_{\text{area}}, \Delta y_{\text{area}}$ )	Maximum Zoom Scan Resolution (mm) ( $\Delta x_{\text{zoom}}, \Delta y_{\text{zoom}}$ )	Maximum Zoom Scan Spatial Resolution (mm)			Minimum Zoom Scan Volume (mm) (x,y,z)
			Uniform Grid		Graded Grid	
			$\Delta z_{\text{zoom}}(n)$	$\Delta z_{\text{zoom}}(1)^*$		
≤ 2 GHz	≤ 15	≤ 8	≤ 5	≤ 4	≤ 1.5* $\Delta z_{\text{zoom}}(n-1)$	≥ 30
2-3 GHz	≤ 12	≤ 5	≤ 5	≤ 4	≤ 1.5* $\Delta z_{\text{zoom}}(n-1)$	≥ 30
3-4 GHz	≤ 12	≤ 5	≤ 4	≤ 3	≤ 1.5* $\Delta z_{\text{zoom}}(n-1)$	≥ 28
4-5 GHz	≤ 10	≤ 4	≤ 3	≤ 2.5	≤ 1.5* $\Delta z_{\text{zoom}}(n-1)$	≥ 25
5-6 GHz	≤ 10	≤ 4	≤ 2	≤ 2	≤ 1.5* $\Delta z_{\text{zoom}}(n-1)$	≥ 22

\*Also compliant to IEEE 1528-2013 Table 6

FCC ID: ZNFG710TM	 <b>SAR EVALUATION REPORT</b> 		Approved by: Quality Manager
Document S/N: 1M1804030060-01-R1.ZNF	Test Dates: 04/03/18 - 04/16/18	DUT Type: Portable Handset	Page 17 of 131

# 5 DEFINITION OF REFERENCE POINTS

## 5.1 EAR REFERENCE POINT

Figure 5-2 shows the front, back and side views of the SAM Twin Phantom. The point “M” is the reference point for the center of the mouth, “LE” is the left ear reference point (ERP), and “RE” is the right ERP. The ERP is 15mm posterior to the entrance to the ear canal (EEC) along the B-M line (Back-Mouth), as shown in Figure 5-1. The plane passing through the two ear canals and M is defined as the Reference Plane. The line N-F (Neck-Front), also called the Reference Pivoting Line, is not perpendicular to the reference plane (see Figure 5-1). Line B-M is perpendicular to the N-F line. Both N-F and B-M lines are marked on the external phantom shell to facilitate handset positioning [5].

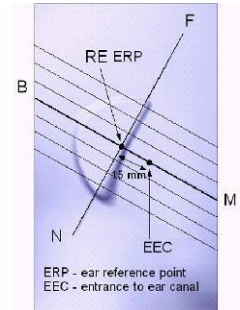

**Figure 5-1**  
Close-Up Side view of ERP

## 5.2 HANDSET REFERENCE POINTS



Two imaginary lines on the handset were established: the vertical centerline and the horizontal line. The test device was placed in a normal operating position with the acoustic output located along the “vertical centerline” on the front of the device aligned to the “ear reference point” (See Figure 5-3). The acoustic output was then located at the same level as the center of the ear reference point. The test device was positioned so that the “vertical centerline” was bisecting the front surface of the handset at its top and bottom edges, positioning the “ear reference point” on the outer surface of the both the left and right head phantoms on the ear reference point.

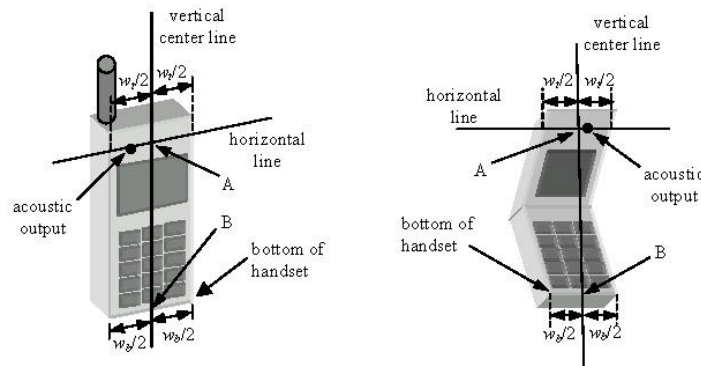

**Figure 5-2**  
Front, back and side view of SAM Twin Phantom



**Figure 5-3**  
Handset Vertical Center & Horizontal Line Reference Points

FCC ID: ZNFG710TM	 PCTEST ENGINEERING LABORATORY, INC.	SAR EVALUATION REPORT	 LG	Approved by: Quality Manager
Document S/N: 1M1804030060-01-R1.ZNF	Test Dates: 04/03/18 - 04/16/18	DUT Type: Portable Handset		Page 18 of 131

## 6 TEST CONFIGURATION POSITIONS

### 6.1 Device Holder

The device holder is made out of low-loss POM material having the following dielectric parameters: relative permittivity  $\epsilon = 3$  and loss tangent  $\delta = 0.02$ .

### 6.2 Positioning for Cheek

1. The test device was positioned with the device close to the surface of the phantom such that point A is on the (virtual) extension of the line passing through points RE and LE on the phantom (see Figure 6-1), such that the plane defined by the vertical center line and the horizontal line of the phone is approximately parallel to the sagittal plane of the phantom.

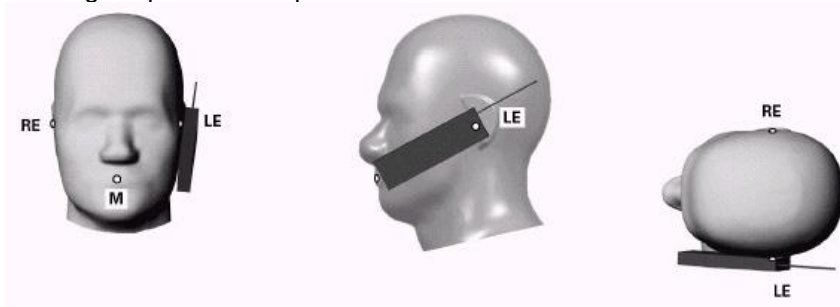



Figure 6-1 Front, Side and Top View of Cheek Position

2. The handset was translated towards the phantom along the line passing through RE & LE until the handset touches the pinna.
3. While maintaining the handset in this plane, the handset was rotated around the LE-RE line until the vertical centerline was in the reference plane.
4. The phone was then rotated around the vertical centerline until the phone (horizontal line) was symmetrical with respect to the line NF.
5. While maintaining the vertical centerline in the reference plane, keeping point A on the line passing through RE and LE, and maintaining the device contact with the ear, the device was rotated about the NF line until any point on the handset made contact with a phantom point below the ear (cheek) (See Figure 6-2).

### 6.3 Positioning for Ear / 15° Tilt

With the test device aligned in the “Cheek Position”:

1. While maintaining the orientation of the phone, the phone was retracted parallel to the reference plane far enough to enable a rotation of the phone by 15 degrees.
2. The phone was then rotated around the horizontal line by 15 degrees.
3. While maintaining the orientation of the phone, the phone was moved parallel to the reference plane until any part of the handset touched the head. (In this position, point A was located on the line RE-LE). The tilted position is obtained when the contact is on the pinna. If the contact was at any location other than the pinna, the angle of the phone would then be reduced. In this situation, the tilted position was obtained when any part of the phone was in contact of the ear as well as a second part of the phone was in contact with the head (see Figure 6-2).

FCC ID: ZNFG710TM	 PCTEST ENGINEERING LABORATORY, INC.	SAR EVALUATION REPORT	 LG	Approved by: Quality Manager
Document S/N: 1M1804030060-01-R1.ZNF	Test Dates: 04/03/18 - 04/16/18	DUT Type: Portable Handset		Page 19 of 131

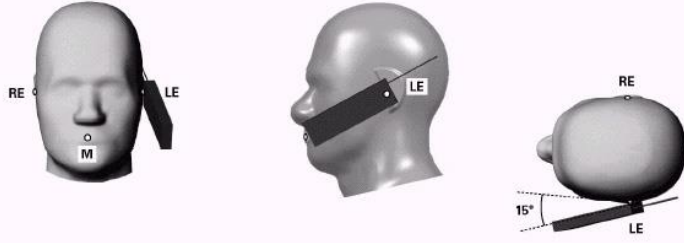

**Figure 6-2 Front, Side and Top View of Ear/15° Tilt Position**

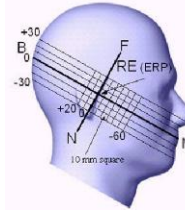

**Figure 6-3 Side view w/ relevant markings**

### 6.4 SAR Evaluations near the Mouth/Jaw Regions of the SAM Phantom

Antennas located near the bottom of a phone may require SAR measurements around the mouth and jaw regions of the SAM head phantom. This typically applies to clam-shell style phones that are generally longer in the unfolded normal use positions or to certain older style long rectangular phones. Per IEEE 1528-2013, a rotated SAM phantom is necessary to allow probe access to such regions. Both SAM heads of the TwinSAM-Chin20 are rotated 20 degrees around the NF line. Each head can be removed from the table for emptying and cleaning.

Under these circumstances, the following procedures apply, adopted from the FCC guidance on SAR handsets document FCC KDB Publication 648474 D04v01r03. The SAR required in these regions of SAM should be measured using a flat phantom. The phone should be positioned with a separation distance of 4 mm between the ear reference point (ERP) and the outer surface of the flat phantom shell. While maintaining this distance at the ERP location, the low (bottom) edge of the phone should be lowered from the phantom to establish the same separation distance between the peak SAR location identified by the truncated partial SAR distribution measured with the SAM phantom. The distance from the peak SAR location to the phone is determined by the straight line passing perpendicularly through the phantom surface. When it is not feasible to maintain 4 mm separation at the ERP while also establishing the required separation at the peak SAR location, the top edge of the phone will be allowed to touch the phantom with a separation < 4 mm at the ERP. The phone should not be tilted to the left or right while placed in this inclined position to the flat phantom.

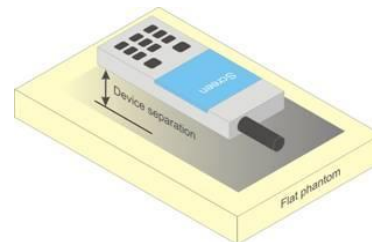

### 6.5 Body-Worn Accessory Configurations

Body-worn operating configurations are tested with the belt-clips and holsters attached to the device and positioned against a flat phantom in a normal use configuration (see Figure 6-4). Per FCC KDB Publication 648474 D04v01r03, Body-worn accessory exposure is typically related to voice mode operations when handsets are carried in body-worn accessories. The body-worn accessory procedures in FCC KDB Publication 447498 D01v06 should be used to test for body-worn accessory SAR compliance, without a headset connected to it. This enables the test results for such configuration to be compatible with that required for hotspot mode when the body-worn accessory test separation distance is greater than or equal to that required for hotspot mode, when applicable. When the reported SAR for a body-worn accessory, measured without a headset connected to the handset, is > 1.2 W/kg, the highest reported SAR configuration for that wireless mode and frequency band should be repeated for that body-worn accessory with a headset attached to the handset.



**Figure 6-4 Sample Body-Worn Diagram**

Accessories for Body-worn operation configurations are divided into two categories: those that do not contain metallic components and those that do contain metallic components. When multiple accessories that do not

FCC ID: ZNFG710TM	 PCTEST ENGINEERING LABORATORY, INC.	SAR EVALUATION REPORT	 LG	Approved by: Quality Manager
Document S/N: 1M1804030060-01-R1.ZNF	Test Dates: 04/03/18 - 04/16/18	DUT Type: Portable Handset		Page 20 of 131

contain metallic components are supplied with the device, the device is tested with only the accessory that dictates the closest spacing to the body. Then multiple accessories that contain metallic components are tested with the device with each accessory. If multiple accessories share an identical metallic component (i.e. the same metallic belt-clip used with different holsters with no other metallic components) only the accessory that dictates the closest spacing to the body is tested.

Body-worn accessories may not always be supplied or available as options for some devices intended to be authorized for body-worn use. In this case, a test configuration with a separation distance between the back of the device and the flat phantom is used. Test position spacing was documented. Transmitters that are designed to operate in front of a person’s face, as in push-to-talk configurations, are tested for SAR compliance with the front of the device positioned to face the flat phantom in head fluid. For devices that are carried next to the body such as a shoulder, waist or chest-worn transmitters, SAR compliance is tested with the accessories, including headsets and microphones, attached to the device and positioned against a flat phantom in a normal use configuration.

### 6.6 Extremity Exposure Configurations



Devices that are designed or intended for use on extremities or mainly operated in extremity only exposure conditions; i.e., hands, wrists, feet and ankles, may require extremity SAR evaluation. When the device also operates in close proximity to the user’s body, SAR compliance for the body is also required. The 1g body and 10g extremity SAR Exclusion Thresholds found in KDB Publication 447498 D01v06 should be applied to determine SAR test requirements.

Per KDB Publication 447498 D01v06, Cell phones (handsets) are not normally designed to be used on extremities or operated in extremity only exposure conditions. The maximum output power levels of handsets generally do not require extremity SAR testing to show compliance. Therefore, extremity SAR was not evaluated for this device.

### 6.7 Wireless Router Configurations

Some battery-operated handsets have the capability to transmit and receive user data through simultaneous transmission of WIFI simultaneously with a separate licensed transmitter. The FCC has provided guidance in FCC KDB Publication 941225 D06v02r01 where SAR test considerations for handsets (L x W ≥ 9 cm x 5 cm) are based on a composite test separation distance of 10 mm from the front, back and edges of the device containing transmitting antennas within 2.5 cm of their edges, determined from general mixed use conditions for this type of devices. Since the hotspot SAR results may overlap with the body-worn accessory SAR requirements, the more conservative configurations can be considered, thus excluding some body-worn accessory SAR tests.

When the user enables the personal wireless router functions for the handset, actual operations include simultaneous transmission of both the WIFI transmitter and another licensed transmitter. Both transmitters often do not transmit at the same transmitting frequency and thus cannot be evaluated for SAR under actual use conditions due to the limitations of the SAR assessment probes. Therefore, SAR must be evaluated for each frequency transmission and mode separately and spatially summed with the WIFI transmitter according to FCC KDB Publication 447498 D01v06 procedures. The “Portable Hotspot” feature on the handset was NOT activated during SAR assessments, to ensure the SAR measurements were evaluated for a single transmission frequency RF signal at a time.

FCC ID: ZNFG710TM	 <b>SAR EVALUATION REPORT</b> 		<b>Approved by:</b> Quality Manager
<b>Document S/N:</b> 1M1804030060-01-R1.ZNF	<b>Test Dates:</b> 04/03/18 - 04/16/18	<b>DUT Type:</b> Portable Handset	Page 21 of 131

## 6.8 Phablet Configurations



For smart phones with a display diagonal dimension > 150 mm or an overall diagonal dimension > 160 mm that provide similar mobile web access and multimedia support found in mini-tablets or UMPC mini-tablets that support voice calls next to the ear, the phablets procedures outlined in KDB Publication 648474 D04v01r03 should be applied to evaluate SAR compliance. A device marketed as phablets, regardless of form factors and operating characteristics must be tested as a phablet to determine SAR compliance. In addition to the normally required head and body-worn accessory SAR test procedures required for handsets, the UMPC mini-tablet procedures must also be applied to test the SAR of all surfaces and edges with an antenna  $\leq 25$  mm from that surface or edge, in direct contact with the phantom, for 10g SAR. The UMPC mini-tablet 1g SAR at 5 mm is not required. When hotspot mode applies, 10g SAR is required only for the surfaces and edges with hotspot mode 1g SAR > 1.2 W/kg.

## 6.9 Additional Test Positions due to Proximity Conditions

This device uses a sensor to reduce voice and data powers in extremity (hand-held) use conditions.

When the sensor detects a user is touching the device on or near to the antenna the device reduces the maximum allowed output power. However, the proximity sensor is not active when the device is moved beyond the sensor triggering distance and the maximum output power is no longer limited. Therefore, an additional exposure condition is needed in the vicinity of the triggering distance to ensure SAR is compliant when the device is allowed to operate at a non-reduced output power level.

The proximity sensor is designed to support sufficient detection range and sensitivity to cover regions of the sensors in all applicable directions since the proximity sensor entirely covers the antenna. FCC KDB Publication 616217 D04v01r02 Section 6 was used as a guideline for selecting SAR test distances for this device at these additional test positions. Sensor triggering distance summary data is included in Appendix G.

FCC ID: ZNFG710TM	 <b>SAR EVALUATION REPORT</b> 		<b>Approved by:</b> Quality Manager
<b>Document S/N:</b> 1M1804030060-01-R1.ZNF	<b>Test Dates:</b> 04/03/18 - 04/16/18	<b>DUT Type:</b> Portable Handset	Page 22 of 131

# 7 RF EXPOSURE LIMITS

## 7.1 Uncontrolled Environment

UNCONTROLLED ENVIRONMENTS are defined as locations where there is the exposure of individuals who have no knowledge or control of their exposure. The general population/uncontrolled exposure limits are applicable to situations in which the general public may be exposed or in which persons who are exposed as a consequence of their employment may not be made fully aware of the potential for exposure or cannot exercise control over their exposure. Members of the general public would come under this category when exposure is not employment-related; for example, in the case of a wireless transmitter that exposes persons in its vicinity.



## 7.2 Controlled Environment

CONTROLLED ENVIRONMENTS are defined as locations where there is exposure that may be incurred by persons who are aware of the potential for exposure, (i.e. as a result of employment or occupation). In general, occupational/controlled exposure limits are applicable to situations in which persons are exposed as a consequence of their employment, who have been made fully aware of the potential for exposure and can exercise control over their exposure. This exposure category is also applicable when the exposure is of a transient nature due to incidental passage through a location where the exposure levels may be higher than the general population/uncontrolled limits, but the exposed person is fully aware of the potential for exposure and can exercise control over his or her exposure by leaving the area or by some other appropriate means.

**Table 7-1  
SAR Human Exposure Specified in ANSI/IEEE C95.1-1992 and Health Canada Safety Code 6**

HUMAN EXPOSURE LIMITS		
	UNCONTROLLED ENVIRONMENT <i>General Population</i> (W/kg) or (mW/g)	CONTROLLED ENVIRONMENT <i>Occupational</i> (W/kg) or (mW/g)
<b>Peak Spatial Average SAR</b> Head	1.6	8.0
<b>Whole Body SAR</b>	0.08	0.4
<b>Peak Spatial Average SAR</b> Hands, Feet, Ankle, Wrists, etc.	4.0	20

1. The Spatial Peak value of the SAR averaged over any 1 gram of tissue (defined as a tissue volume in the shape of a cube) and over the appropriate averaging time.
2. The Spatial Average value of the SAR averaged over the whole body.
3. The Spatial Peak value of the SAR averaged over any 10 grams of tissue (defined as a tissue volume in the shape of a cube) and over the appropriate averaging time.

FCC ID: ZNFG710TM	 PCTEST ENGINEERING LABORATORY, INC.	SAR EVALUATION REPORT	 LG	Approved by: Quality Manager
Document S/N: 1M1804030060-01-R1.ZNF	Test Dates: 04/03/18 - 04/16/18	DUT Type: Portable Handset		Page 23 of 131

## 8 FCC MEASUREMENT PROCEDURES

Power measurements for licensed transmitters are performed using a base station simulator under digital average power.

### 8.1 Measured and Reported SAR

Per FCC KDB Publication 447498 D01v06, when SAR is not measured at the maximum power level allowed for production units, the results must be scaled to the maximum tune-up tolerance limit according to the power applied to the individual channels tested to determine compliance. For simultaneous transmission, the measured aggregate SAR must be scaled according to the sum of the differences between the maximum tune-up tolerance and actual power used to test each transmitter. When SAR is measured at or scaled to the maximum tune-up tolerance limit, the results are referred to as *reported* SAR. The highest *reported* SAR results are identified on the grant of equipment authorization according to procedures in KDB 690783 D01v01r03.

### 8.2 3G SAR Test Reduction Procedure

In FCC KDB Publication 941225 D01v03r01, certain transmission modes within a frequency band and wireless mode evaluated for SAR are defined as primary modes. The equivalent modes considered for SAR test reduction are denoted as secondary modes. When the maximum output power including tune-up tolerance specified for production units in a secondary mode is  $\leq 0.25$  dB higher than the primary mode or when the highest reported SAR of the primary mode, scaled by the ratio of specified maximum output power and tune-up tolerance of secondary to primary mode, is  $\leq 1.2$  W/kg, SAR measurements are not required for the secondary mode. These criteria are referred to as the 3G SAR test reduction procedure. When the 3G SAR test reduction procedure is not satisfied, SAR measurements are additionally required for the secondary mode.

### 8.3 Procedures Used to Establish RF Signal for SAR



The following procedures are according to FCC KDB Publication 941225 D01v03r01 “3G SAR Measurement Procedures.”

The device is placed into a simulated call using a base station simulator in a RF shielded chamber. Establishing connections in this manner ensure a consistent means for testing SAR and are recommended for evaluating SAR [4]. Devices under test are evaluated prior to testing, with a fully charged battery and were configured to operate at maximum output power. In order to verify that the device is tested throughout the SAR test at maximum output power, the SAR measurement system measures a “point SAR” at an arbitrary reference point at the start and end of the 1 gram SAR evaluation, to assess for any power drifts during the evaluation. If the power drift deviates by more than 5%, the SAR test and drift measurements are repeated.

### 8.4 SAR Measurement Conditions for UMTS

#### 8.4.1 Output Power Verification

Maximum output power is verified on the High, Middle and Low channels according to the general descriptions in section 5.2 of 3GPP TS 34.121, using the appropriate RMC with TPC (transmit power control) set to all “1s” or applying the required inner loop power control procedures to maintain maximum output power while HSUPA is active. Results for all applicable physical channel configurations (DPCCH, DPDCHn and spreading codes, HS-DPCCH etc) are tabulated in this test report. All configurations that are not supported by the DUT or cannot be measured due to technical or equipment limitations are identified.

FCC ID: ZNFG710TM	 PCTEST ENGINEERING LABORATORY, INC.	SAR EVALUATION REPORT	 LG	Approved by: Quality Manager
Document S/N: 1M1804030060-01-R1.ZNF	Test Dates: 04/03/18 - 04/16/18	DUT Type: Portable Handset		Page 24 of 131



## 8.4.2 Head SAR Measurements

SAR for next to the ear head exposure is measured using a 12.2 kbps RMC with TPC bits configured to all “1’s”. The 3G SAR test reduction procedure is applied to AMR configurations with 12.2 kbps RMC as the primary mode. Otherwise, SAR is measured for 12.2 kbps AMR in 3.4 kbps SRB (signaling radio bearer) using the highest reported SAR configuration in 12.2 kbps RMC for head exposure.

## 8.4.3 Body SAR Measurements

SAR for body exposure configurations is measured using the 12.2 kbps RMC with the TPC bits all “1s”. The 3G SAR test reduction procedure is applied to other spreading codes and multiple DPDCH<sub>n</sub> configurations supported by the handset with 12.2 kbps RMC as the primary mode. Otherwise, SAR is measured using an applicable RMC configuration with the corresponding spreading code or DPDCH<sub>n</sub>, for the highest reported SAR configuration in 12.2 kbps RMC.

## 8.4.4 SAR Measurements with Rel 5 HSDPA

The 3G SAR test reduction procedure is applied to HSDPA body configurations with 12.2 kbps RMC as the primary mode. Otherwise, Body SAR for HSDPA is measured using an FRC with H-Set 1 in Sub-test 1 and a 12.2 kbps RMC configured in Test Loop Mode 1, for the highest reported SAR configuration in 12.2 kbps RMC without HSDPA. Handsets with both HSDPA and HSUPA are tested according to Release 6 HSPA test procedures.

## 8.4.5 SAR Measurements with Rel 6 HSUPA

The 3G SAR test reduction procedure is applied to HSPA (HSUPA/HSDPA with RMC) body configurations with 12.2 kbps RMC as the primary mode. Otherwise, Body SAR for HSPA is measured with E-DCH Sub-test 5, using H-Set 1 and QPSK for FRC and a 12.2 kbps RMC configured in Test Loop Mode 1 and power control algorithm 2, according to the highest reported body SAR configuration in 12.2 kbps RMC without HSPA.



When VOIP applies to head exposure, the 3G SAR test reduction procedure is applied with 12.2 kbps RMC as the primary mode; otherwise, the same HSPA configuration used for body SAR measurements are applied to head exposure testing.

## 8.4.6 SAR Measurement Conditions for DC-HSDPA

SAR is required for Rel. 8 DC-HSDPA when SAR is required for Rel. 5 HSDPA; otherwise, the 3G SAR test reduction procedure is applied to DC-HSDPA with 12.2 kbps RMC as the primary mode. Power is measured for DC-HSDPA according to the H-Set 12, FRC configuration in Table C.8.1.12 of 3GPP TS 34.121-1 to determine SAR test reduction. A primary and a secondary serving HS-DSCH Cell are required to perform the power measurement and for the results to be acceptable.

## 8.5 SAR Measurement Conditions for LTE

LTE modes are tested according to FCC KDB 941225 D05v02r04 publication. Establishing connections with base station simulators ensure a consistent means for testing SAR and are recommended for evaluating SAR [4]. The R&S CMW500 or Anritsu MT8820C simulators are used for LTE output power measurements and SAR testing. Closed loop power control was used so the UE transmits with maximum output power during SAR testing. SAR tests were performed with the same number of RB and RB offsets transmitting on all TTI frames (maximum TTI).

FCC ID: ZNFG710TM	 <b>PCTEST</b> ENGINEERING LABORATORY, INC.	<b>SAR EVALUATION REPORT</b>		<b>Approved by:</b> Quality Manager
<b>Document S/N:</b> 1M1804030060-01-R1.ZNF	<b>Test Dates:</b> 04/03/18 - 04/16/18	<b>DUT Type:</b> Portable Handset	Page 25 of 131	

### 8.5.1 Spectrum Plots for RB Configurations

A properly configured base station simulator was used for SAR tests and power measurements. Therefore, spectrum plots for RB configurations were not required to be included in this report.

### 8.5.2 MPR

MPR is permanently implemented for this device by the manufacturer. The specific manufacturer target MPR is indicated alongside the SAR results. MPR is enabled for this device, according to 3GPP TS36.101 Section 6.2.3 – 6.2.5 under Table 6.2.3-1.

### 8.5.3 A-MPR

A-MPR (Additional MPR) has been disabled for all SAR tests by setting NS=01 on the base station simulator.

### 8.5.4 Required RB Size and RB Offsets for SAR Testing

According to FCC KDB 941225 D05v02r04:



- a. Per Section 5.2.1, SAR is required for QPSK 1 RB Allocation for the largest bandwidth
  - i. The required channel and offset combination with the highest maximum output power is required for SAR.
  - ii. When the reported SAR is  $\leq 0.8$  W/kg, testing of the remaining RB offset configurations and required test channels is not required. Otherwise, SAR is required for the remaining required test channels using the RB offset configuration with highest output power for that channel.
  - iii. When the reported SAR for a required test channel is  $> 1.45$  W/kg, SAR is required for all RB offset configurations for that channel.
- b. Per Section 5.2.2, SAR is required for 50% RB allocation using the largest bandwidth following the same procedures outlined in Section 5.2.1.
- c. Per Section 5.2.3, QPSK SAR is not required for the 100% allocation when the highest maximum output power for the 100% allocation is less than the highest maximum output power of the 1 RB and 50% RB allocations and the reported SAR for the 1 RB and 50% RB allocations is  $< 0.8$  W/kg.
- d. Per Section 5.2.4 and 5.3, SAR tests for higher order modulations and lower bandwidths configurations are not required when the conducted power of the required test configurations determined by Sections 5.2.1 through 5.2.3 is less than or equal to  $\frac{1}{2}$  dB higher than the equivalent configuration using QPSK modulation and when the QPSK SAR for those configurations is  $< 1.45$  W/kg.

### 8.5.5 TDD

LTE TDD testing is performed using the SAR test guidance provided in FCC KDB 941225 D05v02r04. TDD is tested at the highest duty factor using UL-DL configuration 0 with special subframe configuration 6 and applying the FDD LTE procedures in KDB 941225 D05v02r04. SAR testing is performed using the extended cyclic prefix listed in 3GPP TS 36.211 Section 4.

### 8.5.6 Downlink Only Carrier Aggregation

Conducted power measurements with LTE Carrier Aggregation (CA) (downlink only) active are made in accordance to KDB Publication 941225 D05Av01r02. The RRC connection is only handled by one cell, the primary component carrier (PCC) for downlink and uplink communications. After making a data connection to the PCC, the UE device adds secondary component carrier(s) (SCC) on the downlink only. All uplink communications and acknowledgements remain identical to specifications when downlink

FCC ID: ZNFG710TM	 PCTEST ENGINEERING LABORATORY, INC.	SAR EVALUATION REPORT	 LG	Approved by: Quality Manager
Document S/N: 1M1804030060-01-R1.ZNF	Test Dates: 04/03/18 - 04/16/18	DUT Type: Portable Handset	Page 26 of 131	

carrier aggregation is inactive on the PCC. For every supported combination of downlink only carrier aggregation, additional conducted output powers are measured with the downlink carrier aggregation active for the configuration with highest measured maximum conducted power with downlink carrier aggregation inactive measured among the channel bandwidth, modulation, and RB combinations in each frequency band. Per FCC KDB Publication 941225 D05Av01r02, no SAR measurements are required for carrier aggregation configurations when the average output power with downlink only carrier aggregation active is not more than 0.25 dB higher than the average output power with downlink only carrier aggregation inactive.

## 8.6 SAR Testing with 802.11 Transmitters

The normal network operating configurations of 802.11 transmitters are not suitable for SAR measurements. Unpredictable fluctuations in network traffic and antenna diversity conditions can introduce undesirable variations in SAR results. The SAR for these devices should be measured using chipset based test mode software to ensure the results are consistent and reliable. See KDB Publication 248227 D01v02r02 for more details.

### 8.6.1 General Device Setup

Chipset based test mode software is hardware dependent and generally varies among manufacturers. The device operating parameters established in test mode for SAR measurements must be identical to those programmed in production units, including output power levels, amplifier gain settings and other RF performance tuning parameters.



A periodic duty factor is required for current generation SAR systems to measure SAR. When 802.11 frame gaps are accounted for in the transmission, a maximum transmission duty factor of 92 - 96% is typically achievable in most test mode configurations. A minimum transmission duty factor of 85% is required to avoid certain hardware and device implementation issues related to wide range SAR scaling. The reported SAR is scaled to 100% transmission duty factor to determine compliance at the maximum tune-up tolerance limit.

### 8.6.2 U-NII-1 and U-NII-2A

For devices that operate in both U-NII-1 and U-NII-2A bands, when the same maximum output power is specified for both bands, SAR measurement using OFDM SAR test procedures is not required for U-NII-1 unless the highest reported SAR for U-NII-2A is > 1.2 W/kg. When different maximum output powers are specified for the bands, SAR measurement for the U-NII band with the lower maximum output power is not required unless the highest reported SAR for the U-NII band with the higher maximum output power, adjusted by the ratio of lower to higher specified maximum output power for the two bands, is > 1.2 W/kg. When 10g SAR measurement is considered, a factor of 2.5 is applied to the thresholds above.

### 8.6.3 U-NII-2C and U-NII-3

The frequency range covered by U-NII-2C and U-NII-3 is 380 MHz (5.47 – 5.85 GHz), which requires a minimum of at least two SAR probe calibration frequency points to support SAR measurements. When Terminal Doppler Weather Radar (TDWR) restriction applies, the channels at 5.60 – 5.65 GHz in U-NII-2C band must be disabled with acceptable mechanisms and documented in the equipment certification. Unless band gap channels are permanently disabled, SAR must be considered for these channels. Each band is tested independently according to the normally required OFDM SAR measurement and probe calibration frequency points requirements.

FCC ID: ZNFG710TM	 <b>SAR EVALUATION REPORT</b> 		<b>Approved by:</b> Quality Manager
<b>Document S/N:</b> 1M1804030060-01-R1.ZNF	<b>Test Dates:</b> 04/03/18 - 04/16/18	<b>DUT Type:</b> Portable Handset	Page 27 of 131

### 8.6.4 Initial Test Position Procedure

For exposure conditions with multiple test positions, such as handset operating next to the ear, devices with hotspot mode or UMPC mini-tablet, procedures for initial test position can be applied. Using the transmission mode determined by the DSSS procedure or initial test configuration, area scans are measured for all positions in an exposure condition. The test position with the highest extrapolated (peak) SAR is used as the initial test position. When reported SAR for the initial test position is  $\leq 0.4$  W/kg, no additional testing for the remaining test positions is required. Otherwise, SAR is evaluated at the subsequent highest peak SAR positions until the reported SAR result is  $\leq 0.8$  W/kg or all test positions are measured. When 10g SAR measurement is considered, a factor of 2.5 is applied to the thresholds above.

### 8.6.5 2.4 GHz SAR Test Requirements

SAR is measured for 2.4 GHz 802.11b DSSS using either the fixed test position or, when applicable, the initial test position procedure. SAR test reduction is determined according to the following:

- 1) When the reported SAR of the highest measured maximum output power channel for the exposure configuration is  $\leq 0.8$  W/kg, no further SAR testing is required for 802.11b DSSS in that exposure configuration.
- 2) When the reported SAR is  $> 0.8$  W/kg, SAR is required for that position using the next highest measured output power channel. When any reported SAR is  $> 1.2$  W/kg, SAR is required for the third channel; i.e., all channels require testing.

2.4 GHz 802.11 g/n OFDM are additionally evaluated for SAR if the highest reported SAR for 802.11b, adjusted by the ratio of the OFDM to DSSS specified maximum output power, is  $> 1.2$  W/kg. When SAR is required for OFDM modes in 2.4 GHz band, the Initial Test Configuration Procedures should be followed. When 10g SAR measurement is considered, a factor of 2.5 is applied to the thresholds above.



### 8.6.6 OFDM Transmission Mode and SAR Test Channel Selection

When the same maximum output power was specified for multiple OFDM transmission mode configurations in a frequency band or aggregated band, SAR is measured using the configuration with the largest channel bandwidth, lowest order modulation and lowest data rate. When the maximum output power of a channel is the same for equivalent OFDM configurations; for example, 802.11a, 802.11n and 802.11ac or 802.11g and 802.11n with the same channel bandwidth, modulation and data rate etc., the lower order 802.11 mode i.e., 802.11a, then 802.11n and 802.11ac or 802.11g then 802.11n, is used for SAR measurement. When the maximum output power are the same for multiple test channels, either according to the default or additional power measurement requirements, SAR is measured using the channel closest to the middle of the frequency band or aggregated band. When there are multiple channels with the same maximum output power, SAR is measured using the higher number channel.

### 8.6.7 Initial Test Configuration Procedure

For OFDM, an initial test configuration is determined for each frequency band and aggregated band, according to the transmission mode with the highest maximum output power specified for SAR measurements. When the same maximum output power is specified for multiple OFDM transmission mode configurations in a frequency band or aggregated band, SAR is measured using the configuration(s) with the largest channel bandwidth, lowest order modulation, lowest data rate and lowest order IEEE 802.11 mode. The channel of the transmission mode with the highest average RF output conducted power will be the initial test configuration.

When the reported SAR is  $\leq 0.8$  W/kg, no additional measurements on other test channels are required. Otherwise, SAR is evaluated using the subsequent highest average RF output channel until the reported SAR

FCC ID: ZNFG710TM	 <b>PCTEST</b> ENGINEERING LABORATORY, INC.	<b>SAR EVALUATION REPORT</b>		<b>Approved by:</b> Quality Manager
<b>Document S/N:</b> 1M1804030060-01-R1.ZNF	<b>Test Dates:</b> 04/03/18 - 04/16/18	<b>DUT Type:</b> Portable Handset	Page 28 of 131	



result is  $\leq 1.2$  W/kg or all channels are measured. When there are multiple untested channels having the same subsequent highest average RF output power, the channel with higher frequency from the lowest 802.11 mode is considered for SAR measurements (See Section 8.6.6). When 10g SAR measurement is considered, a factor of 2.5 is applied to the thresholds above.

### 8.6.8 Subsequent Test Configuration Procedures

For OFDM configurations in each frequency band and aggregated band, SAR is evaluated for initial test configuration using the fixed test position or the initial test position procedure. When the highest reported SAR (for the initial test configuration), adjusted by the ratio of the specified maximum output power of the subsequent test configuration to initial test configuration, is  $\leq 1.2$  W/kg, no additional SAR tests for the subsequent test configurations are required. When 10g SAR measurement is considered, a factor of 2.5 is applied to the thresholds above.

### 8.6.9 MIMO SAR considerations

Per KDB Publication 248227 D01v02r02, the simultaneous SAR provisions in KDB Publication 447498 D01v06 should be applied to determine simultaneous transmission SAR test exclusion for WIFI MIMO. If the sum of 1g single transmission chain SAR measurements is  $<1.6$  W/kg, no additional SAR measurements for MIMO are required. Alternatively, SAR for MIMO can be measured with all antennas transmitting simultaneously at the specified maximum output power of MIMO operation. When 10g SAR measurement is considered, a factor of 2.5 is applied to the thresholds above.



FCC ID: ZNFG710TM	 <b>SAR EVALUATION REPORT</b> 		<b>Approved by:</b> Quality Manager
<b>Document S/N:</b> 1M1804030060-01-R1.ZNF	<b>Test Dates:</b> 04/03/18 - 04/16/18	<b>DUT Type:</b> Portable Handset	Page 29 of 131

# 9 RF CONDUCTED POWERS

## 9.1 GSM Conducted Powers

Table 9-1  
Maximum Conducted Power

Maximum Burst-Averaged Output Power										
		Voice	GPRS/EDGE Data (GMSK)				EDGE Data (8-PSK)			
Band	Channel	GSM [dBm] CS (1 Slot)	GPRS [dBm] 1 Tx Slot	GPRS [dBm] 2 Tx Slot	GPRS [dBm] 3 Tx Slot	GPRS [dBm] 4 Tx Slot	EDGE [dBm] 1 Tx Slot	EDGE [dBm] 2 Tx Slot	EDGE [dBm] 3 Tx Slot	EDGE [dBm] 4 Tx Slot
GSM 850	128	31.23	31.22	31.20	<b>30.14</b>	28.64	26.98	26.78	26.35	26.20
	190	31.30	31.23	31.23	<b>30.20</b>	28.45	27.00	26.75	26.36	25.24
	251	31.31	31.20	31.21	<b>30.10</b>	28.40	26.99	26.81	26.32	26.20
GSM 1900	512	30.28	30.31	<b>29.20</b>	27.10	25.70	25.90	26.20	25.50	25.41
	661	30.53	30.56	<b>29.21</b>	26.92	25.41	26.12	26.12	25.51	25.30
	810	30.22	30.35	<b>29.15</b>	27.14	25.66	26.21	25.81	25.60	25.33
Calculated Maximum Frame-Averaged Output Power										
		Voice	GPRS/EDGE Data (GMSK)				EDGE Data (8-PSK)			
Band	Channel	GSM [dBm] CS (1 Slot)	GPRS [dBm] 1 Tx Slot	GPRS [dBm] 2 Tx Slot	GPRS [dBm] 3 Tx Slot	GPRS [dBm] 4 Tx Slot	EDGE [dBm] 1 Tx Slot	EDGE [dBm] 2 Tx Slot	EDGE [dBm] 3 Tx Slot	EDGE [dBm] 4 Tx Slot
GSM 850	128	22.20	22.19	25.18	<b>25.88</b>	25.63	17.95	20.76	22.09	23.19
	190	22.27	22.20	25.21	<b>25.94</b>	25.44	17.97	20.73	22.10	22.23
	251	22.28	22.17	25.19	<b>25.84</b>	25.39	17.96	20.79	22.06	23.19
GSM 1900	512	21.25	21.28	<b>23.18</b>	22.84	22.69	16.87	20.18	21.24	22.40
	661	21.50	21.53	<b>23.19</b>	22.66	22.40	17.09	20.10	21.25	22.29
	810	21.19	21.32	<b>23.13</b>	22.88	22.65	17.18	19.79	21.34	22.32
GSM 850	Frame	22.17	22.17	25.18	<b>25.44</b>	25.19	18.17	21.18	21.94	23.19
GSM 1900	Avg.Targets:	21.17	21.17	<b>23.18</b>	22.44	22.19	17.17	20.18	20.94	22.19



FCC ID: ZNFG710TM		SAR EVALUATION REPORT		Approved by: Quality Manager
Document S/N: 1M1804030060-01-R1.ZNF	Test Dates: 04/03/18 - 04/16/18	DUT Type: Portable Handset		Page 30 of 131

Note:

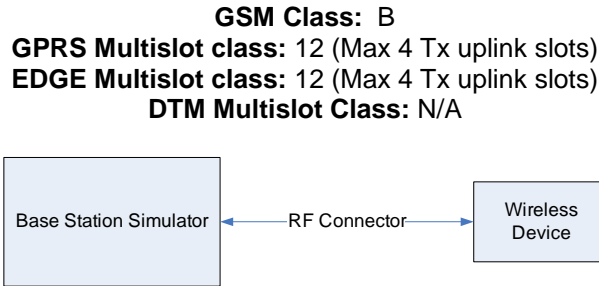
1. Both burst-averaged and calculated frame-averaged powers are included. Frame-averaged power was calculated from the measured burst-averaged power by converting the slot powers into linear units and calculating the energy over 8 timeslots.
2. GPRS/EDGE (GMSK) output powers were measured with coding scheme setting of 1 (CS1) on the base station simulator. CS1 was configured to measure GPRS output power measurements and SAR to ensure GMSK modulation in the signal. Our Investigation has shown that CS1 - CS4 settings do not have any impact on the output levels or modulation in the GPRS modes.
3. EDGE (8-PSK) output powers were measured with MCS7 on the base station simulator. MCS7 coding scheme was used to measure the output powers for EDGE since investigation has shown that choosing MCS7 coding scheme will ensure 8-PSK modulation. It has been shown that MCS levels that produce 8PSK modulation do not have an impact on output power.



**Figure 9-1**  
**Power Measurement Setup**

FCC ID: ZNFG710TM	 <b>SAR EVALUATION REPORT</b> 		<b>Approved by:</b> Quality Manager
<b>Document S/N:</b> 1M1804030060-01-R1.ZNF	<b>Test Dates:</b> 04/03/18 - 04/16/18	<b>DUT Type:</b> Portable Handset	Page 31 of 131



## 9.2 UMTS Conducted Powers

**Table 9-2**  
**Maximum Conducted Power**

3GPP Release Version	Mode	3GPP 34.121 Subtest	Cellular Band [dBm]			AWS Band [dBm]			PCS Band [dBm]			3GPP MPR [dB]
			4132	4183	4233	1312	1412	1513	9262	9400	9538	
99	WCDMA	12.2 kbps RMC	25.06	25.03	25.03	25.10	25.16	25.14	25.48	25.47	25.44	-
99		12.2 kbps AMR	25.00	25.00	25.01	25.08	25.10	25.06	25.48	25.41	25.41	-
6	HSDPA	Subtest 1	24.96	25.08	24.97	25.00	25.05	25.05	25.30	25.32	25.36	0
6		Subtest 2	25.03	25.07	25.11	24.98	25.03	25.00	25.28	25.32	25.30	0
6		Subtest 3	24.56	24.58	24.59	24.50	24.55	24.52	24.80	24.80	24.79	0.5
6		Subtest 4	24.55	24.57	24.57	24.51	24.51	24.53	24.81	24.82	24.85	0.5
6	HSUPA	Subtest 1	25.00	25.03	25.03	24.95	24.99	24.95	25.25	25.32	25.25	0
6		Subtest 2	23.02	23.04	23.10	22.98	23.10	22.95	23.27	23.33	23.32	2
6		Subtest 3	23.93	24.04	24.02	23.95	24.06	23.96	24.25	24.31	24.25	1
6		Subtest 4	22.97	23.04	23.03	22.95	23.05	22.95	23.30	23.35	23.25	2
6		Subtest 5	25.01	25.03	25.01	24.95	24.98	25.01	25.23	25.29	25.29	0
8	DC-HSDPA	Subtest 1	25.13	24.97	25.20	24.96	25.09	25.03	25.22	25.32	25.37	0
8		Subtest 2	25.03	25.01	25.04	24.86	25.06	25.11	25.30	25.19	25.37	0
8		Subtest 3	24.50	24.55	24.52	24.50	24.59	24.59	24.85	24.75	24.72	0.5
8		Subtest 4	24.49	24.56	24.60	24.56	24.43	24.55	24.85	24.93	24.88	0.5

**Table 9-3**  
**Reduced Conducted Power**

3GPP Release Version	Mode	3GPP 34.121 Subtest	AWS Band [dBm]			PCS Band [dBm]			3GPP MPR [dB]
			1312	1412	1513	9262	9400	9538	
99	WCDMA	12.2 kbps RMC	24.19	24.19	24.18	24.29	24.37	24.35	-
99		12.2 kbps AMR	24.16	24.13	24.18	24.29	24.30	24.33	-
6	HSDPA	Subtest 1	23.82	23.87	23.85	24.02	24.17	24.16	0
6		Subtest 2	23.87	23.95	23.94	24.10	24.17	24.02	0
6		Subtest 3	23.37	23.48	23.50	23.73	23.72	23.61	0.5
6		Subtest 4	23.39	23.40	23.40	23.57	23.70	23.57	0.5
6	HSUPA	Subtest 1	23.88	23.87	23.86	24.12	24.20	24.06	0
6		Subtest 2	21.89	21.90	21.93	22.15	22.21	22.10	2
6		Subtest 3	22.98	22.94	22.90	23.14	23.19	23.16	1
6		Subtest 4	21.95	21.97	21.92	22.10	22.23	22.08	2
6		Subtest 5	23.99	23.87	23.93	24.19	24.16	24.00	0
8	DC-HSDPA	Subtest 1	23.91	23.88	23.93	24.04	24.09	24.12	0
8		Subtest 2	23.96	23.84	23.96	24.25	24.26	23.99	0
8		Subtest 3	23.40	23.34	23.51	23.66	23.70	23.53	0.5
8		Subtest 4	23.34	23.38	23.36	23.51	23.71	23.67	0.5

FCC ID: ZNFG710TM	 PCTEST ENGINEERING LABORATORY, INC.	SAR EVALUATION REPORT		Approved by: Quality Manager
Document S/N: 1M1804030060-01-R1.ZNF	Test Dates: 04/03/18 - 04/16/18	DUT Type: Portable Handset		Page 32 of 131





DC-HSDPA considerations

- 3GPP Specification 34.121-1 Release 8 Ver 8.10.0 was used for DC-HSDPA guidance
- H-Set 12 (QPSK) was confirmed to be used during DC-HSDPA measurements
- The DUT supports UE category 24 for HSDPA



**Figure 9-2**  
**Power Measurement Setup**

FCC ID: ZNFG710TM	 <b>SAR EVALUATION REPORT</b> 		<b>Approved by:</b> Quality Manager
Document S/N: 1M1804030060-01-R1.ZNF	Test Dates: 04/03/18 - 04/16/18	DUT Type: Portable Handset	Page 33 of 131



### 9.3 LTE Conducted Powers

#### 9.3.1 LTE Band 71

Table 9-4  
LTE Band 71 Conducted Powers - 20 MHz Bandwidth

LTE Band 71 20 MHz Bandwidth					
Modulation	RB Size	RB Offset	Mid Channel	MPR Allowed per 3GPP [dB]	MPR [dB]
			133297 (680.5 MHz)		
			Conducted Power [dBm]		
QPSK	1	0	25.09	0	0
	1	50	25.06		0
	1	99	<b>25.15</b>		0
	50	0	<b>24.19</b>	0-1	1
	50	25	24.09		1
	50	50	24.13		1
	100	0	24.06		1
16QAM	1	0	24.13	0-1	1
	1	50	23.99		1
	1	99	24.09		1
	50	0	23.08	0-2	2
	50	25	23.03		2
	50	50	23.13		2
	100	0	23.09		2
64QAM	1	0	23.00	0-2	2
	1	50	22.96		2
	1	99	23.08		2
	50	0	22.05	0-3	3
	50	25	22.08		3
	50	50	22.16		3
	100	0	22.00		3



Note: LTE Band 71 at 20 MHz bandwidth does not support three non-overlapping channels. Per KDB Publication 941225 D05v02, when a device supports overlapping channel assignment in a channel bandwidth configuration, the middle channel of the group of overlapping channels should be selected for testing.

FCC ID: ZNFG710TM	 PCTEST ENGINEERING LABORATORY, INC.	SAR EVALUATION REPORT	 LG	Approved by: Quality Manager
Document S/N: 1M1804030060-01-R1.ZNF	Test Dates: 04/03/18 - 04/16/18	DUT Type: Portable Handset		Page 34 of 131

**Table 9-5  
LTE Band 71 Conducted Powers - 15 MHz Bandwidth**

LTE Band 71 15 MHz Bandwidth					
Modulation	RB Size	RB Offset	Mid Channel	MPR Allowed per 3GPP [dB]	MPR [dB]
			133297 (680.5 MHz)		
			Conducted Power [dBm]		
QPSK	1	0	25.35	0	0
	1	36	25.11		0
	1	74	25.30		0
	36	0	24.32	0-1	1
	36	18	24.30		1
	36	37	24.29		1
	75	0	24.26		1
16QAM	1	0	24.16	0-1	1
	1	36	23.91		1
	1	74	24.28		1
	36	0	23.34	0-2	2
	36	18	23.33		2
	36	37	23.26		2
	75	0	23.27		2
64QAM	1	0	22.98	0-2	2
	1	36	22.91		2
	1	74	23.12		2
	36	0	22.29	0-3	3
	36	18	22.29		3
	36	37	22.21		3
	75	0	22.17		3

Note: LTE Band 71 at 15 MHz bandwidth does not support three non-overlapping channels. Per KDB Publication 941225 D05v02, when a device supports overlapping channel assignment in a channel bandwidth configuration, the middle channel of the group of overlapping channels should be selected for testing.



FCC ID: ZNFG710TM		SAR EVALUATION REPORT		Approved by: Quality Manager
Document S/N: 1M1804030060-01-R1.ZNF	Test Dates: 04/03/18 - 04/16/18	DUT Type: Portable Handset		Page 35 of 131

**Table 9-6  
LTE Band 71 Conducted Powers - 10 MHz Bandwidth**

LTE Band 71 10 MHz Bandwidth							
Modulation	RB Size	RB Offset	Low Channel	Mid Channel	High Channel	MPR Allowed per 3GPP [dB]	MPR [dB]
			133172 (668.0 MHz)	133297 (680.5 MHz)	133422 (693.0 MHz)		
			Conducted Power [dBm]				
QPSK	1	0	25.04	25.12	24.72	0	0
	1	25	25.32	25.17	25.13		0
	1	49	25.03	25.48	25.08		0
	25	0	24.36	24.19	24.22	0-1	1
	25	12	24.29	24.25	24.10		1
	25	25	24.29	24.38	24.00		1
16QAM	50	0	24.31	24.29	24.10	0-1	1
	1	0	24.30	23.88	24.05		1
	1	25	24.29	24.00	23.85		1
	1	49	24.19	24.23	24.05	0-2	1
	25	0	23.37	23.30	23.07		2
	25	12	23.10	23.33	23.04		2
64QAM	25	25	23.16	23.42	22.99	0-2	2
	50	0	23.17	23.34	22.95		2
	1	0	23.13	22.72	22.87		0-2
	1	25	23.23	22.93	22.84	2	
	1	49	23.11	23.05	23.01	2	
	64QAM	25	0	22.27	22.18	21.96	0-3
25		12	22.03	22.18	21.85	3	
25		25	22.07	22.39	21.91	3	
50		0	22.15	22.20	21.80	3	

**Table 9-7  
LTE Band 71 Conducted Powers - 5 MHz Bandwidth**

LTE Band 71 5 MHz Bandwidth							
Modulation	RB Size	RB Offset	Low Channel	Mid Channel	High Channel	MPR Allowed per 3GPP [dB]	MPR [dB]
			133147 (665.5 MHz)	133297 (680.5 MHz)	133447 (695.5 MHz)		
			Conducted Power [dBm]				
QPSK	1	0	25.21	25.04	25.19	0	0
	1	12	25.29	25.03	25.19		0
	1	24	25.30	25.11	25.22		0
	12	0	24.30	24.23	24.14	0-1	1
	12	6	24.25	24.22	24.07		1
	12	13	24.31	24.24	24.05		1
16QAM	25	0	24.23	24.21	24.18	0-1	1
	1	0	24.14	24.11	24.17		1
	1	12	24.23	24.16	24.19		1
	1	24	24.36	24.13	23.83	0-2	1
	12	0	23.26	23.19	23.05		2
	12	6	23.30	23.37	23.04		2
64QAM	12	13	23.34	23.38	23.12	0-2	2
	25	0	23.28	23.22	23.16		2
	1	0	23.06	22.97	23.14		0-2
	1	12	23.17	23.02	23.09	2	
	1	24	23.27	23.11	22.80	0-3	
	12	0	22.06	22.15	22.05		3
12	6	22.23	22.30	21.89	3		
64QAM	12	13	22.24	22.31	22.10	0-3	3
	25	0	22.24	22.21	22.10		3

FCC ID: ZNFG710TM	 <b>PCTEST</b> ENGINEERING LABORATORY, INC.	<b>SAR EVALUATION REPORT</b>	 <b>LG</b>	Approved by: Quality Manager
Document S/N: 1M1804030060-01-R1.ZNF	Test Dates: 04/03/18 - 04/16/18	DUT Type: Portable Handset	Page 36 of 131	



9.3.2

LTE Band 12

Table 9-8  
LTE Band 12 Conducted Powers - 10 MHz Bandwidth

LTE Band 12 10 MHz Bandwidth					
Modulation	RB Size	RB Offset	Mid Channel	MPR Allowed per 3GPP [dB]	MPR [dB]
			23095 (707.5 MHz)		
			Conducted Power [dBm]		
QPSK	1	0	25.14	0	0
	1	25	25.03		0
	1	49	<b>25.17</b>		0
	25	0	<b>24.20</b>	0-1	1
	25	12	24.15		1
	25	25	24.13		1
	50	0	24.02		1
16QAM	1	0	24.16	0-1	1
	1	25	24.16		1
	1	49	24.04		1
	25	0	22.98	0-2	2
	25	12	22.97		2
	25	25	23.06		2
	50	0	22.97		2
64QAM	1	0	23.09	0-2	2
	1	25	23.16		2
	1	49	23.03		2
	25	0	22.20	0-3	3
	25	12	21.99		3
	25	25	22.09		3
	50	0	22.18		3

Note: LTE Band 12 at 10 MHz bandwidth does not support three non-overlapping channels. Per KDB Publication 941225 D05v02, when a device supports overlapping channel assignment in a channel bandwidth configuration, the middle channel of the group of overlapping channels should be selected for testing.



FCC ID: ZNFG710TM	 PCTEST ENGINEERING LABORATORY, INC.	SAR EVALUATION REPORT	 LG	Approved by: Quality Manager
Document S/N: 1M1804030060-01-R1.ZNF	Test Dates: 04/03/18 - 04/16/18	DUT Type: Portable Handset		Page 37 of 131

**Table 9-9  
LTE Band 12 Conducted Powers - 5 MHz Bandwidth**

LTE Band 12 5 MHz Bandwidth								
Modulation	RB Size	RB Offset	Low Channel	Mid Channel	High Channel	MPR Allowed per 3GPP [dB]	MPR [dB]	
			23035 (701.5 MHz)	23095 (707.5 MHz)	23155 (713.5 MHz)			
			Conducted Power [dBm]					
QPSK	1	0	25.37	25.11	25.36	0	0	
	1	12	25.10	25.13	25.20		0	
	1	24	25.11	25.10	24.87		0	
	16QAM	12	0	24.23	24.17	24.33	0-1	1
		12	6	24.24	24.17	24.30		1
		12	13	24.28	24.22	24.28		1
		25	0	24.34	24.17	24.31		1
64QAM	1	0	24.48	24.40	24.12	0-1	1	
	1	12	24.19	24.44	24.47		1	
	1	24	24.29	24.40	24.28		1	
	16QAM	12	0	23.47	23.25	23.34	0-2	2
		12	6	23.42	23.26	23.35		2
		12	13	23.13	23.19	23.33		2
		25	0	23.20	23.20	23.36		2
64QAM	1	0	23.36	23.35	23.05	0-2	2	
	1	12	23.04	23.28	23.31		2	
	1	24	23.13	23.21	23.20		2	
	16QAM	12	0	22.30	22.10	22.20	0-3	3
		12	6	22.26	22.19	22.30		3
		12	13	22.11	22.15	22.14		3
		25	0	22.09	22.13	22.21		3



**Table 9-10  
LTE Band 12 Conducted Powers - 3 MHz Bandwidth**

LTE Band 12 3 MHz Bandwidth								
Modulation	RB Size	RB Offset	Low Channel	Mid Channel	High Channel	MPR Allowed per 3GPP [dB]	MPR [dB]	
			23025 (700.5 MHz)	23095 (707.5 MHz)	23165 (714.5 MHz)			
			Conducted Power [dBm]					
QPSK	1	0	25.22	24.96	25.24	0	0	
	1	7	25.21	25.11	25.34		0	
	1	14	25.15	25.00	24.78		0	
	16QAM	8	0	24.20	24.18	24.27	0-1	1
		8	4	24.20	24.15	24.28		1
		8	7	24.22	24.16	24.24		1
		15	0	24.18	24.17	24.28		1
64QAM	1	0	24.11	24.28	24.31	0-1	1	
	1	7	24.34	24.46	24.20		1	
	1	14	24.43	24.33	24.20		1	
	16QAM	8	0	23.29	23.21	23.28	0-2	2
		8	4	23.25	23.24	23.27		2
		8	7	23.20	23.22	23.24		2
64QAM	15	0	23.25	23.15	23.32	0-2	2	
	1	0	22.92	23.11	23.22		0-2	2
	1	7	23.24	23.33	23.02			2
	16QAM	1	14	23.35	23.30	23.12		0-3
		8	0	22.26	22.17	22.10	3	
		8	4	22.10	22.14	22.24	3	
		8	7	22.18	22.15	22.16	3	
15	0	22.14	22.12	22.23	3			

FCC ID: ZNFG710TM	 <b>PCTEST</b> ENGINEERING LABORATORY, INC.	<b>SAR EVALUATION REPORT</b>	 <b>LG</b>	<b>Approved by:</b> Quality Manager
<b>Document S/N:</b> 1M1804030060-01-R1.ZNF	<b>Test Dates:</b> 04/03/18 - 04/16/18	<b>DUT Type:</b> Portable Handset	Page 38 of 131	

**Table 9-11**  
**LTE Band 12 Conducted Powers -1.4 MHz Bandwidth**

LTE Band 12 1.4 MHz Bandwidth							
Modulation	RB Size	RB Offset	Low Channel	Mid Channel	High Channel	MPR Allowed per 3GPP [dB]	MPR [dB]
			23017 (699.7 MHz)	23095 (707.5 MHz)	23173 (715.3 MHz)		
			Conducted Power [dBm]				
QPSK	1	0	25.17	25.06	25.05	0	0
	1	2	25.10	25.06	25.13		0
	1	5	25.08	25.03	24.74		0
	3	0	25.24	25.08	25.07		0
	3	2	25.18	25.10	24.89		0
	3	3	25.17	25.03	24.80		0
	6	0	24.10	24.10	24.18	0-1	1
16QAM	1	0	24.44	24.31	24.40	0-1	1
	1	2	24.46	24.36	24.44		1
	1	5	24.37	24.28	24.12		1
	3	0	24.14	24.24	24.26		1
	3	2	24.13	24.23	24.21		1
	3	3	24.10	24.16	24.02		1
	6	0	23.04	23.08	23.40	0-2	2
64QAM	1	0	23.36	23.15	23.37	0-2	2
	1	2	23.46	23.25	23.25		2
	1	5	23.35	23.15	23.11		2
	3	0	23.10	23.20	23.17		2
	3	2	23.03	23.17	23.07		2
	3	3	22.96	23.03	22.84		2
	6	0	21.88	21.91	22.23	0-3	3



FCC ID: ZNFG710TM		SAR EVALUATION REPORT		Approved by: Quality Manager
Document S/N: 1M1804030060-01-R1.ZNF	Test Dates: 04/03/18 - 04/16/18	DUT Type: Portable Handset		Page 39 of 131

9.3.3

LTE Band 13

Table 9-12  
LTE Band 13 Conducted Powers - 10 MHz Bandwidth

LTE Band 13 10 MHz Bandwidth					
Modulation	RB Size	RB Offset	Mid Channel	MPR Allowed per 3GPP [dB]	MPR [dB]
			23230 (782.0 MHz)		
			Conducted Power [dBm]		
QPSK	1	0	24.87	0	0
	1	25	<b>25.19</b>		0
	1	49	25.00		0
	25	0	24.09	0-1	1
	25	12	<b>24.18</b>		1
	25	25	24.03		1
	50	0	24.08		1
16QAM	1	0	24.00	0-1	1
	1	25	24.05		1
	1	49	23.91		1
	25	0	23.01	0-2	2
	25	12	22.95		2
	25	25	22.90		2
	50	0	23.15		2
64QAM	1	0	22.89	0-2	2
	1	25	23.14		2
	1	49	22.94		2
	25	0	21.92	0-3	3
	25	12	21.87		3
	25	25	22.09		3
	50	0	21.87		3



FCC ID: ZNFG710TM	 PCTEST ENGINEERING LABORATORY, INC.	SAR EVALUATION REPORT	 LG	Approved by: Quality Manager
Document S/N: 1M1804030060-01-R1.ZNF	Test Dates: 04/03/18 - 04/16/18	DUT Type: Portable Handset		Page 40 of 131



**Table 9-13  
LTE Band 13 Conducted Powers - 5 MHz Bandwidth**

LTE Band 13 5 MHz Bandwidth					
Modulation	RB Size	RB Offset	Mid Channel	MPR Allowed per 3GPP [dB]	MPR [dB]
			23230 (782.0 MHz)		
			Conducted Power [dBm]		
QPSK	1	0	25.38	0	0
	1	12	25.17		0
	1	24	24.94		0
	12	0	24.46	0-1	1
	12	6	24.36		1
	12	13	24.21		1
	25	0	24.24		1
16QAM	1	0	24.42	0-1	1
	1	12	24.38		1
	1	24	24.27		1
	12	0	23.44	0-2	2
	12	6	23.41		2
	12	13	23.33		2
	25	0	23.36		2
64QAM	1	0	23.20	0-2	2
	1	12	23.16		2
	1	24	23.05		2
	12	0	22.06	0-3	3
	12	6	22.15		3
	12	13	22.06		3
	25	0	22.06		3

Note: LTE Band 13 at 5 MHz bandwidth does not support three non-overlapping channels. Per KDB Publication 941225 D05v02, when a device supports overlapping channel assignment in a channel bandwidth configuration, the middle channel of the group of overlapping channels should be selected for testing.

FCC ID: ZNFG710TM		SAR EVALUATION REPORT		Approved by: Quality Manager
Document S/N: 1M1804030060-01-R1.ZNF	Test Dates: 04/03/18 - 04/16/18	DUT Type: Portable Handset		Page 41 of 131



9.3.4

LTE Band 5 (Cell)

Table 9-14  
 LTE Band 5 (Cell) Conducted Powers - 10 MHz Bandwidth

LTE Band 5 (Cell) 10 MHz Bandwidth					
Modulation	RB Size	RB Offset	Mid Channel	MPR Allowed per 3GPP [dB]	MPR [dB]
			20525 (836.5 MHz)		
			Conducted Power [dBm]		
QPSK	1	0	24.98	0	0
	1	25	25.09		0
	1	49	<b>25.16</b>		0
	25	0	<b>24.18</b>	0-1	1
	25	12	23.99		1
	25	25	24.02		1
	50	0	24.17		1
16QAM	1	0	24.10	0-1	1
	1	25	24.00		1
	1	49	24.20		1
	25	0	23.09	0-2	2
	25	12	23.17		2
	25	25	23.24		2
	50	0	23.13		2
64QAM	1	0	23.07	0-2	2
	1	25	23.09		2
	1	49	23.00		2
	25	0	22.29	0-3	3
	25	12	22.08		3
	25	25	22.01		3
	50	0	22.11		3

Note: LTE Band 5 (Cell) at 10 MHz bandwidth does not support three non-overlapping channels. Per KDB Publication 941225 D05v02, when a device supports overlapping channel assignment in a channel bandwidth configuration, the middle channel of the group of overlapping channels should be selected for testing.



FCC ID: ZNFG710TM			SAR EVALUATION REPORT		Approved by: Quality Manager
Document S/N: 1M1804030060-01-R1.ZNF	Test Dates: 04/03/18 - 04/16/18	DUT Type: Portable Handset		Page 42 of 131	

**Table 9-15  
LTE Band 5 (Cell) Conducted Powers - 5 MHz Bandwidth**

LTE Band 5 (Cell) 5 MHz Bandwidth							
Modulation	RB Size	RB Offset	Low Channel	Mid Channel	High Channel	MPR Allowed per 3GPP [dB]	MPR [dB]
			20425 (826.5 MHz)	20525 (836.5 MHz)	20625 (846.5 MHz)		
			Conducted Power [dBm]				
QPSK	1	0	25.34	25.37	25.29	0	0
	1	12	25.32	25.34	25.06		0
	1	24	25.39	25.37	24.88		0
	12	0	24.32	24.31	24.41	0-1	1
	12	6	24.34	24.38	24.37		1
	12	13	24.32	24.36	24.26		1
16QAM	25	0	24.27	24.46	24.35	0-1	1
	1	0	24.27	24.14	24.30		1
	1	12	24.36	24.43	24.36		1
	1	24	24.34	24.46	24.39	0-2	1
	12	0	23.43	23.28	23.28		2
	12	6	23.41	23.41	23.39		2
64QAM	12	13	23.33	23.43	23.44	0-2	2
	25	0	23.36	23.38	23.44		2
	1	0	23.16	22.97	23.28		0-3
	1	12	23.24	23.25	23.19	2	
	1	24	23.27	23.34	23.39	2	
	12	0	22.43	22.21	22.24	0-3	3
12	6	22.34	22.33	22.29	3		
12	13	22.19	22.31	22.26	3		
	25	0	22.31	22.34	22.42		3



**Table 9-16  
LTE Band 5 (Cell) Conducted Powers - 3 MHz Bandwidth**

LTE Band 5 (Cell) 3 MHz Bandwidth								
Modulation	RB Size	RB Offset	Low Channel	Mid Channel	High Channel	MPR Allowed per 3GPP [dB]	MPR [dB]	
			20415 (825.5 MHz)	20525 (836.5 MHz)	20635 (847.5 MHz)			
			Conducted Power [dBm]					
QPSK	1	0	25.38	25.21	25.18	0	0	
	1	7	25.32	25.39	25.30		0	
	1	14	25.25	25.23	25.06		0	
	8	0	24.38	24.29	24.36	0-1	1	
	8	4	24.35	24.46	24.38		1	
	8	7	24.33	24.33	24.32		1	
16QAM	15	0	24.38	24.38	24.26	0-1	1	
	1	0	24.30	24.49	24.34		0-1	1
	1	7	24.41	24.31	24.40			1
	1	14	24.37	24.41	24.33	0-2		1
	8	0	23.31	23.41	23.37		2	
	8	4	23.35	23.29	23.43		2	
64QAM	8	7	23.36	23.46	23.28	0-2	2	
	15	0	23.28	23.44	23.40		2	
	1	0	23.24	23.32	23.30		0-2	2
	1	7	23.25	23.12	23.32	0-3		2
	1	14	23.20	23.30	23.31			2
	8	0	22.15	22.24	22.36		0-3	3
8	4	22.23	22.25	22.37	3			
8	7	22.18	22.33	22.18	3			
	15	0	22.20	22.40	22.27		3	

FCC ID: ZNFG710TM	 <b>PCTEST</b> ENGINEERING LABORATORY, INC.	<b>SAR EVALUATION REPORT</b>	 <b>LG</b>	<b>Approved by:</b> Quality Manager
<b>Document S/N:</b> 1M1804030060-01-R1.ZNF	<b>Test Dates:</b> 04/03/18 - 04/16/18	<b>DUT Type:</b> Portable Handset	Page 43 of 131	

**Table 9-17**  
**LTE Band 5 (Cell) Conducted Powers -1.4 MHz Bandwidth**

LTE Band 5 (Cell) 1.4 MHz Bandwidth							
Modulation	RB Size	RB Offset	Low Channel	Mid Channel	High Channel	MPR Allowed per 3GPP [dB]	MPR [dB]
			20407 (824.7 MHz)	20525 (836.5 MHz)	20643 (848.3 MHz)		
			Conducted Power [dBm]				
QPSK	1	0	25.19	25.25	25.17	0	0
	1	2	25.28	25.32	25.04		0
	1	5	25.16	25.27	24.90		0
	3	0	25.23	25.26	25.10		0
	3	2	25.32	25.30	25.03		0
	3	3	25.20	25.29	24.99		0
	6	0	24.25	24.28	24.21	0-1	1
16QAM	1	0	24.43	24.36	24.32	0-1	1
	1	2	24.24	24.48	24.38		1
	1	5	24.45	24.23	24.46		1
	3	0	24.41	24.38	24.18		1
	3	2	24.38	24.45	24.19		1
	3	3	24.37	24.33	24.17		1
	6	0	23.27	23.44	23.16	0-2	2
64QAM	1	0	23.36	23.32	23.23	0-2	2
	1	2	23.17	23.46	23.31		2
	1	5	23.39	23.20	23.29		2
	3	0	23.40	23.19	23.10		2
	3	2	23.28	23.30	23.01		2
	3	3	23.22	23.33	23.08		2
	6	0	22.26	22.29	22.12	0-3	3



FCC ID: ZNFG710TM		SAR EVALUATION REPORT		Approved by: Quality Manager
Document S/N: 1M1804030060-01-R1.ZNF	Test Dates: 04/03/18 - 04/16/18	DUT Type: Portable Handset		Page 44 of 131

9.3.5

LTE Band 66 (AWS)

Table 9-18  
 LTE Band 66 (AWS) Maximum Conducted Powers - 20 MHz Bandwidth

LTE Band 66 (AWS) 20 MHz Bandwidth							
Modulation	RB Size	RB Offset	Low Channel	Mid Channel	High Channel	MPR Allowed per 3GPP [dB]	MPR [dB]
			132072 (1720.0 MHz)	132322 (1745.0 MHz)	132572 (1770.0 MHz)		
			Conducted Power [dBm]				
QPSK	1	0	25.20	25.05	25.13	0	0
	1	50	25.15	25.00	25.11		0
	1	99	24.98	24.89	25.14		0
	50	0	23.98	23.99	24.06	0-1	1
	50	25	24.20	24.17	23.98		1
	50	50	24.04	24.16	24.03		1
	100	0	24.16	24.06	24.01		1
16QAM	1	0	24.15	23.98	24.17	0-1	1
	1	50	24.01	23.88	23.91		1
	1	99	24.05	24.06	24.02		1
	50	0	23.16	22.98	22.93	0-2	2
	50	25	22.99	23.07	23.16		2
	50	50	23.11	23.20	23.18		2
	100	0	22.93	22.97	23.19		2
64QAM	1	0	23.18	23.01	23.10	0-2	2
	1	50	23.18	23.09	23.07		2
	1	99	22.95	23.17	22.99		2
	50	0	21.97	22.13	21.95	0-3	3
	50	25	21.97	22.02	22.12		3
	50	50	22.03	22.20	22.12		3
	100	0	22.00	22.20	22.15		3



FCC ID: ZNFG710TM	 PCTEST ENGINEERING LABORATORY, INC.	SAR EVALUATION REPORT	 LG	Approved by: Quality Manager
Document S/N: 1M1804030060-01-R1.ZNF	Test Dates: 04/03/18 - 04/16/18	DUT Type: Portable Handset		Page 45 of 131

**Table 9-19**  
**LTE Band 66 (AWS) Maximum Conducted Powers - 15 MHz Bandwidth**

LTE Band 66 (AWS) 15 MHz Bandwidth							
Modulation	RB Size	RB Offset	Low Channel	Mid Channel	High Channel	MPR Allowed per 3GPP [dB]	MPR [dB]
			132047 (1717.5 MHz)	132322 (1745.0 MHz)	132597 (1772.5 MHz)		
			Conducted Power [dBm]				
QPSK	1	0	25.11	25.01	25.12	0	0
	1	36	24.72	24.74	24.82		0
	1	74	24.98	25.10	25.10		0
	36	0	23.96	23.98	24.14	0-1	1
	36	18	23.82	23.93	24.11		1
	36	37	24.13	24.13	24.20		1
	75	0	24.00	24.20	24.09		1
16QAM	1	0	23.81	23.79	24.01	0-1	1
	1	36	23.44	23.50	23.88		1
	1	74	23.84	23.94	24.02		1
	36	0	22.95	22.97	23.08	0-2	2
	36	18	22.88	22.92	23.15		2
	36	37	23.15	23.20	23.05		2
	75	0	23.04	23.17	22.91		2
64QAM	1	0	22.77	22.79	22.83	0-2	2
	1	36	22.29	22.44	22.80		2
	1	74	22.80	22.75	22.82		2
	36	0	21.76	21.80	22.06	0-3	3
	36	18	21.84	21.80	22.12		3
	36	37	22.00	22.09	21.87		3
	75	0	21.88	22.00	21.75		3

**Table 9-20**  
**LTE Band 66 (AWS) Maximum Conducted Powers - 10 MHz Bandwidth**

LTE Band 66 (AWS) 10 MHz Bandwidth							
Modulation	RB Size	RB Offset	Low Channel	Mid Channel	High Channel	MPR Allowed per 3GPP [dB]	MPR [dB]
			132022 (1715.0 MHz)	132322 (1745.0 MHz)	132622 (1775.0 MHz)		
			Conducted Power [dBm]				
QPSK	1	0	25.00	25.01	25.02	0	0
	1	25	25.03	25.13	25.06		0
	1	49	25.13	25.00	25.10		0
	25	0	23.53	24.08	24.20	0-1	1
	25	12	23.64	24.00	24.10		1
	25	25	23.90	24.03	24.05		1
	50	0	23.71	24.18	24.06		1
16QAM	1	0	23.80	23.84	24.03	0-1	1
	1	25	23.64	23.93	24.18		1
	1	49	24.00	24.12	24.00		1
	25	0	22.80	23.16	23.01	0-2	2
	25	12	22.90	23.05	23.20		2
	25	25	22.98	23.05	23.03		2
	50	0	22.78	23.04	23.10		2
64QAM	1	0	22.71	22.66	23.03	0-2	2
	1	25	22.48	22.92	23.03		2
	1	49	23.00	22.94	22.84		2
	25	0	21.64	21.98	21.93	0-3	3
	25	12	21.77	21.94	22.14		3
	25	25	21.86	21.94	21.87		3
	50	0	21.72	22.00	22.01		3



FCC ID: ZNFG710TM	 <b>PCTEST</b> ENGINEERING LABORATORY, INC.	<b>SAR EVALUATION REPORT</b>	 <b>LG</b>	<b>Approved by:</b> Quality Manager
<b>Document S/N:</b> 1M1804030060-01-R1.ZNF	<b>Test Dates:</b> 04/03/18 - 04/16/18	<b>DUT Type:</b> Portable Handset	Page 46 of 131	

**Table 9-21**  
**LTE Band 66 (AWS) Maximum Conducted Powers - 5 MHz Bandwidth**

LTE Band 66 (AWS) 5 MHz Bandwidth								
Modulation	RB Size	RB Offset	Low Channel	Mid Channel	High Channel	MPR Allowed per 3GPP [dB]	MPR [dB]	
			131997 (1712.5 MHz)	132322 (1745.0 MHz)	132647 (1777.5 MHz)			
			Conducted Power [dBm]					
QPSK	1	0	24.96	24.67	25.00	0	0	
	1	12	25.00	24.62	25.19		0	
	1	24	24.89	24.77	25.18		0	
	QPSK	12	0	23.75	23.86	24.17	0-1	1
		12	6	23.87	23.81	24.07		1
		12	13	23.90	23.90	24.01		1
		25	0	23.78	23.84	24.11		1
16QAM	1	0	23.76	24.10	24.17	0-1	1	
	1	12	23.82	24.12	24.15		1	
	1	24	23.91	24.16	23.86		1	
	16QAM	12	0	22.88	22.97	23.05	0-2	2
		12	6	22.89	23.03	23.00		2
		12	13	22.89	23.01	23.15		2
		25	0	22.90	22.81	23.16		2
64QAM	1	0	22.72	23.03	23.09	0-2	2	
	1	12	22.66	22.94	23.00		2	
	1	24	22.89	23.15	22.76		2	
	64QAM	12	0	21.76	21.95	21.91	0-3	3
		12	6	21.79	21.99	21.97		3
		12	13	21.76	21.92	22.13		3
		25	0	21.79	21.78	21.96		3



**Table 9-22**  
**LTE Band 66 (AWS) Maximum Conducted Powers - 3 MHz Bandwidth**

LTE Band 66 (AWS) 3 MHz Bandwidth								
Modulation	RB Size	RB Offset	Low Channel	Mid Channel	High Channel	MPR Allowed per 3GPP [dB]	MPR [dB]	
			131987 (1711.5 MHz)	132322 (1745.0 MHz)	132657 (1778.5 MHz)			
			Conducted Power [dBm]					
QPSK	1	0	24.65	24.81	24.70	0	0	
	1	7	24.73	24.83	24.84		0	
	1	14	24.67	24.62	24.74		0	
	QPSK	8	0	23.90	23.87	23.69	0-1	1
		8	4	23.71	23.81	23.78		1
		8	7	23.75	23.70	23.84		1
		15	0	23.74	23.78	23.83		1
16QAM	1	0	24.01	23.97	24.00	0-1	1	
	1	7	24.11	24.01	23.75		1	
	1	14	23.93	23.97	23.95		1	
	16QAM	8	0	22.81	22.73	22.90	0-2	2
		8	4	22.91	22.63	22.86		2
		8	7	22.85	22.81	22.77		2
		15	0	22.70	22.76	22.78		2
64QAM	1	0	22.88	22.94	22.95	0-2	2	
	1	7	22.95	22.92	22.59		2	
	1	14	22.82	22.80	22.79		2	
	64QAM	8	0	21.63	21.60	21.82	0-3	3
		8	4	21.77	21.56	21.75		3
		8	7	21.83	21.75	21.72		3
		15	0	21.54	21.66	21.76		3

FCC ID: ZNFG710TM	 <b>PCTEST</b> ENGINEERING LABORATORY, INC.	<b>SAR EVALUATION REPORT</b>	 <b>LG</b>	<b>Approved by:</b> Quality Manager
<b>Document S/N:</b> 1M1804030060-01-R1.ZNF	<b>Test Dates:</b> 04/03/18 - 04/16/18	<b>DUT Type:</b> Portable Handset	Page 47 of 131	

**Table 9-23**  
**LTE Band 66 (AWS) Maximum Conducted Powers -1.4 MHz Bandwidth**

LTE Band 66 (AWS) 1.4 MHz Bandwidth							
Modulation	RB Size	RB Offset	Low Channel	Mid Channel	High Channel	MPR Allowed per 3GPP [dB]	MPR [dB]
			131979 (1710.7 MHz)	132322 (1745.0 MHz)	132665 (1779.3 MHz)		
			Conducted Power [dBm]				
QPSK	1	0	24.99	24.95	25.00	0	0
	1	2	25.02	25.01	25.00		0
	1	5	25.12	24.96	25.15		0
	3	0	25.03	24.90	25.02		0
	3	2	24.96	24.97	25.02		0
	3	3	24.90	25.00	24.99		0
	6	0	24.10	23.88	24.04		0-1
16QAM	1	0	24.15	24.16	24.06	0-1	1
	1	2	24.13	24.14	24.00		1
	1	5	24.20	24.12	24.16		1
	3	0	24.06	23.98	24.10		1
	3	2	24.05	24.07	24.00		1
	3	3	24.09	23.90	24.12		1
	6	0	22.95	23.02	22.90		0-2
64QAM	1	0	23.05	23.06	23.02	0-2	2
	1	2	23.10	23.03	22.80		2
	1	5	23.19	23.02	23.10		2
	3	0	23.00	22.91	23.04		2
	3	2	22.87	22.95	22.85		2
	3	3	23.08	22.71	22.97		2
	6	0	21.89	21.84	21.85		0-3

FCC ID: ZNFG710TM		SAR EVALUATION REPORT		Approved by: Quality Manager
Document S/N: 1M1804030060-01-R1.ZNF	Test Dates: 04/03/18 - 04/16/18	DUT Type: Portable Handset		Page 48 of 131





**Table 9-24**  
**LTE Band 66 (AWS) Reduced Conducted Powers - 20 MHz Bandwidth**

LTE Band 66 (AWS) 20 MHz Bandwidth							
Modulation	RB Size	RB Offset	Low Channel	Mid Channel	High Channel	MPR Allowed per 3GPP [dB]	MPR [dB]
			132072 (1720.0 MHz)	132322 (1745.0 MHz)	132572 (1770.0 MHz)		
			Conducted Power [dBm]				
QPSK	1	0	24.07	24.13	24.11	0	0
	1	50	23.96	23.92	24.14		0
	1	99	23.90	24.06	23.92		0
	50	0	24.11	23.99	23.91	0-1	0
	50	25	23.87	24.08	24.16		0
	50	50	24.12	24.11	24.02		0
	100	0	24.06	24.04	23.96		0
16QAM	1	0	24.10	23.96	24.09	0-1	0
	1	50	24.20	23.96	23.87		0
	1	99	24.17	23.97	24.08		0
	50	0	22.89	22.92	22.96	0-2	1
	50	25	23.10	22.93	23.13		1
	50	50	23.02	23.19	22.97		1
	100	0	23.05	23.17	23.11		1
64QAM	1	0	22.93	23.00	22.92	0-2	1
	1	50	22.89	22.95	22.99		1
	1	99	23.04	23.08	23.19		1
	50	0	22.10	21.89	22.11	0-3	2
	50	25	22.14	21.94	22.15		2
	50	50	22.01	22.18	22.16		2
	100	0	22.05	21.91	22.08		2

**Table 9-25**  
**LTE Band 66 (AWS) Reduced Conducted Powers - 15 MHz Bandwidth**

LTE Band 66 (AWS) 15 MHz Bandwidth							
Modulation	RB Size	RB Offset	Low Channel	Mid Channel	High Channel	MPR Allowed per 3GPP [dB]	MPR [dB]
			132047 (1717.5 MHz)	132322 (1745.0 MHz)	132597 (1772.5 MHz)		
			Conducted Power [dBm]				
QPSK	1	0	23.92	23.82	23.82	0	0
	1	36	23.91	23.77	24.07		0
	1	74	23.77	23.97	24.10		0
	36	0	23.73	24.09	24.07	0-1	0
	36	18	23.74	23.96	23.95		0
	36	37	24.01	23.76	24.10		0
	75	0	24.10	24.07	23.97		0
16QAM	1	0	23.99	23.89	23.96	0-1	0
	1	36	24.14	24.02	23.94		0
	1	74	23.99	24.15	23.82		0
	36	0	22.78	23.01	22.86	0-2	1
	36	18	23.11	23.04	23.02		1
	36	37	23.02	23.12	23.06		1
	75	0	23.12	22.78	22.98		1
64QAM	1	0	23.08	22.99	23.18	0-2	1
	1	36	22.74	22.77	23.04		1
	1	74	23.00	23.09	22.99		1
	36	0	21.70	21.97	21.71	0-3	2
	36	18	21.89	21.81	21.97		2
	36	37	22.10	21.92	21.94		2
	75	0	21.90	21.72	21.88		2



FCC ID: ZNFG710TM	 <b>PCTEST</b> ENGINEERING LABORATORY, INC.	<b>SAR EVALUATION REPORT</b>	 <b>LG</b>	Approved by: Quality Manager
Document S/N: 1M1804030060-01-R1.ZNF	Test Dates: 04/03/18 - 04/16/18	DUT Type: Portable Handset		Page 49 of 131

**Table 9-26**  
**LTE Band 66 (AWS) Reduced Conducted Powers - 10 MHz Bandwidth**

LTE Band 66 (AWS) 10 MHz Bandwidth							
Modulation	RB Size	RB Offset	Low Channel	Mid Channel	High Channel	MPR Allowed per 3GPP [dB]	MPR [dB]
			132022 (1715.0 MHz)	132322 (1745.0 MHz)	132622 (1775.0 MHz)		
			Conducted Power [dBm]				
QPSK	1	0	23.98	24.18	23.78	0	0
	1	25	23.94	23.87	23.80		0
	1	49	24.11	23.78	24.07		0
	25	0	23.85	23.88	23.78	0-1	0
	25	12	23.96	24.10	23.94		0
	25	25	24.00	24.11	23.82		0
	50	0	23.73	23.86	24.01		0
16QAM	1	0	24.06	24.07	23.95	0-1	0
	1	25	23.92	23.74	24.08		0
	1	49	23.95	23.79	24.11		0
	25	0	23.08	23.17	23.08	0-2	1
	25	12	23.11	22.86	22.93		1
	25	25	22.91	22.98	23.19		1
	50	0	22.71	22.93	22.76		1
64QAM	1	0	22.85	23.20	22.78	0-2	1
	1	25	22.72	23.15	22.74		1
	1	49	22.87	22.87	23.06		1
	25	0	21.99	21.84	21.76	0-3	2
	25	12	21.77	22.14	22.12		2
	25	25	21.84	22.08	22.16		2
	50	0	21.76	21.84	21.79		2

**Table 9-27**  
**LTE Band 66 (AWS) Reduced Conducted Powers - 5 MHz Bandwidth**

LTE Band 66 (AWS) 5 MHz Bandwidth							
Modulation	RB Size	RB Offset	Low Channel	Mid Channel	High Channel	MPR Allowed per 3GPP [dB]	MPR [dB]
			131997 (1712.5 MHz)	132322 (1745.0 MHz)	132647 (1777.5 MHz)		
			Conducted Power [dBm]				
QPSK	1	0	23.81	24.18	24.14	0	0
	1	12	24.13	24.16	23.84		0
	1	24	23.76	24.06	24.02		0
	12	0	24.00	23.86	23.99	0-1	0
	12	6	23.78	23.73	24.05		0
	12	13	23.89	23.88	23.84		0
	25	0	24.05	24.14	23.89		0
16QAM	1	0	24.14	23.84	23.85	0-1	0
	1	12	23.74	23.73	23.77		0
	1	24	23.96	24.14	24.03		0
	12	0	23.09	22.99	23.05	0-2	1
	12	6	23.10	22.91	22.76		1
	12	13	23.12	22.93	22.90		1
	25	0	22.84	23.09	22.88		1
64QAM	1	0	22.75	23.07	22.76	0-2	1
	1	12	22.92	23.10	22.78		1
	1	24	22.80	22.96	23.11		1
	12	0	21.91	21.80	21.89	0-3	2
	12	6	21.95	21.85	21.89		2
	12	13	21.77	22.08	22.19		2
	25	0	22.14	21.87	22.08		2



FCC ID: ZNFG710TM	 <b>PCTEST</b> ENGINEERING LABORATORY, INC.	<b>SAR EVALUATION REPORT</b>	 <b>LG</b>	<b>Approved by:</b> Quality Manager
<b>Document S/N:</b> 1M1804030060-01-R1.ZNF	<b>Test Dates:</b> 04/03/18 - 04/16/18	<b>DUT Type:</b> Portable Handset	Page 50 of 131	

**Table 9-28**  
**LTE Band 66 (AWS) Reduced Conducted Powers - 3 MHz Bandwidth**

LTE Band 66 (AWS) 3 MHz Bandwidth							
Modulation	RB Size	RB Offset	Low Channel	Mid Channel	High Channel	MPR Allowed per 3GPP [dB]	MPR [dB]
			131987 (1711.5 MHz)	132322 (1745.0 MHz)	132657 (1778.5 MHz)		
			Conducted Power [dBm]				
QPSK	1	0	23.72	24.20	24.02	0	0
	1	7	24.17	24.11	23.75		0
	1	14	23.80	23.92	23.94		0
	8	0	24.13	23.73	24.08	0-1	0
	8	4	23.78	23.84	23.94		0
	8	7	23.95	23.90	23.82		0
16QAM	15	0	24.19	23.78	23.71	0-1	0
	1	0	23.96	24.04	23.99		0
	1	7	23.73	23.96	23.75		0
	1	14	24.15	23.75	24.11	0-2	0
	8	0	22.99	23.19	22.94		1
	8	4	23.08	22.74	23.02		1
64QAM	8	7	23.13	22.97	23.05	0-2	1
	15	0	22.89	22.71	22.82		1
	1	0	23.19	22.72	22.92		0-3
	1	7	22.76	22.91	23.05	1	
	1	14	22.88	22.91	22.88	1	
	8	0	22.07	22.08	21.72	2	
	8	4	22.07	21.81	21.87	0-3	2
8	7	21.75	22.02	22.07	2		
15	0	21.75	21.97	22.19		2	

**Table 9-29**  
**LTE Band 66 (AWS) Reduced Conducted Powers – 1.4 MHz Bandwidth**

LTE Band 66 (AWS) 1.4 MHz Bandwidth								
Modulation	RB Size	RB Offset	Low Channel	Mid Channel	High Channel	MPR Allowed per 3GPP [dB]	MPR [dB]	
			131979 (1710.7 MHz)	132322 (1745.0 MHz)	132665 (1779.3 MHz)			
			Conducted Power [dBm]					
QPSK	1	0	24.15	23.91	24.16	0	0	
	1	2	23.85	24.19	23.77		0	
	1	5	23.91	23.99	23.77		0	
	3	0	23.79	23.70	24.03	0-1	0	
	3	2	23.72	23.71	24.16		0	
	3	3	23.87	23.83	24.15		0	
	6	0	23.82	23.90	23.73		0	
16QAM	1	0	24.08	23.87	23.97	0-1	0	
	1	2	23.93	23.75	23.87		0	
	1	5	24.02	23.96	24.17		0	
	3	0	23.99	24.12	23.89	0-2	0	
	3	2	24.16	23.99	24.10		0	
	3	3	23.89	24.04	23.98		0	
64QAM	6	0	23.04	22.93	22.88	0-2	1	
	1	0	23.13	22.71	22.79		0-2	1
	1	2	22.91	22.85	22.87			1
	1	5	23.02	22.82	23.06	1		
	3	0	22.84	23.17	23.08	1		
	3	2	23.08	22.76	22.78	1		
	3	3	23.12	22.91	23.03	0-3		1
6	0	21.88	22.12	22.05	2			



FCC ID: ZNFG710TM	 <b>PCTEST</b> ENGINEERING LABORATORY, INC.	<b>SAR EVALUATION REPORT</b>	 <b>LG</b>	Approved by: Quality Manager
Document S/N: 1M1804030060-01-R1.ZNF	Test Dates: 04/03/18 - 04/16/18	DUT Type: Portable Handset		Page 51 of 131

9.3.6

LTE Band 25 (PCS)

Table 9-30  
 LTE Band 25 (PCS) Maximum Conducted Powers - 20 MHz Bandwidth

LTE Band 25 (PCS) 20 MHz Bandwidth								
Modulation	RB Size	RB Offset	Low Channel	Mid Channel	High Channel	MPR Allowed per 3GPP [dB]	MPR [dB]	
			26140 (1860.0 MHz)	26365 (1882.5 MHz)	26590 (1905.0 MHz)			
			Conducted Power [dBm]					
QPSK	1	0	25.26	25.08	25.11	0	0	
	1	50	25.29	25.14	25.09		0	
	1	99	25.22	25.14	25.32		0	
	50	0	24.14	24.10	24.10	0-1	1	
	50	25	24.16	24.23	24.28		1	
	50	50	24.31	24.36	24.27		1	
16QAM	100	0	24.19	24.34	24.08	0-1	1	
	1	0	24.34	24.16	24.21		0-1	1
	1	50	24.17	24.13	24.29			1
	1	99	24.15	24.12	24.36	0-2		1
	50	0	23.09	23.18	23.26		2	
	50	25	23.36	23.29	23.07		2	
64QAM	50	50	23.31	23.24	23.12	0-2	2	
	100	0	23.25	23.15	23.31		2	
	1	0	23.27	23.38	23.34		0-2	2
	1	50	23.25	23.35	23.27	2		
	1	99	23.14	23.33	23.38	0-3		2
	50	0	22.19	22.32	22.18		3	
50	25	22.32	22.25	22.24	3			
64QAM	50	50	22.10	22.12	22.13	0-3	3	
	100	0	22.27	22.36	22.15		3	



FCC ID: ZNFG710TM	 PCTEST ENGINEERING LABORATORY, INC.	SAR EVALUATION REPORT	 LG	Approved by: Quality Manager
Document S/N: 1M1804030060-01-R1.ZNF	Test Dates: 04/03/18 - 04/16/18	DUT Type: Portable Handset		Page 52 of 131

**Table 9-31  
LTE Band 25 (PCS) Maximum Conducted Powers - 15 MHz Bandwidth**

LTE Band 25 (PCS) 15 MHz Bandwidth							
Modulation	RB Size	RB Offset	Low Channel	Mid Channel	High Channel	MPR Allowed per 3GPP [dB]	MPR [dB]
			26115 (1857.5 MHz)	26365 (1882.5 MHz)	26615 (1907.5 MHz)		
			Conducted Power [dBm]				
QPSK	1	0	25.30	25.24	25.44	0	0
	1	36	24.96	24.81	25.42		0
	1	74	25.07	24.94	25.05		0
	36	0	24.17	24.26	24.41	0-1	1
	36	18	23.97	24.07	24.50		1
	36	37	23.82	23.94	24.35		1
	75	0	23.99	24.03	24.42		1
16QAM	1	0	24.34	24.47	24.35	0-1	1
	1	36	24.31	24.09	24.42		1
	1	74	24.47	24.25	24.32		1
	36	0	23.19	23.21	23.45	0-2	2
	36	18	23.18	22.96	23.34		2
	36	37	23.06	22.86	23.30		2
	75	0	23.14	23.07	23.22		2
64QAM	1	0	23.25	23.45	23.20	0-2	2
	1	36	23.27	22.90	23.28		2
	1	74	23.27	23.11	23.21		2
	36	0	22.00	22.02	22.25	0-3	3
	36	18	22.00	21.96	22.27		3
	36	37	22.02	21.81	22.12		3
	75	0	21.98	22.04	22.06		3

**Table 9-32  
LTE Band 25 (PCS) Maximum Conducted Powers - 10 MHz Bandwidth**

LTE Band 25 (PCS) 10 MHz Bandwidth							
Modulation	RB Size	RB Offset	Low Channel	Mid Channel	High Channel	MPR Allowed per 3GPP [dB]	MPR [dB]
			26090 (1855.0 MHz)	26365 (1882.5 MHz)	26640 (1910.0 MHz)		
			Conducted Power [dBm]				
QPSK	1	0	25.45	25.15	25.38	0	0
	1	25	25.17	24.82	25.45		0
	1	49	25.08	25.01	25.02		0
	25	0	24.26	24.11	24.45	0-1	1
	25	12	24.24	23.96	24.31		1
	25	25	24.20	23.89	24.47		1
	50	0	24.23	23.91	24.47		1
16QAM	1	0	24.40	24.38	24.31	0-1	1
	1	25	24.39	24.20	24.37		1
	1	49	24.35	24.31	24.41		1
	25	0	23.20	23.18	23.46	0-2	2
	25	12	23.13	23.19	23.46		2
	25	25	23.19	22.92	23.37		2
	50	0	23.26	23.11	23.46		2
64QAM	1	0	23.31	23.20	23.28	0-2	2
	1	25	23.32	23.06	23.25		2
	1	49	23.28	23.20	23.34		2
	25	0	22.05	22.03	22.43	0-3	3
	25	12	22.11	22.00	22.27		3
	25	25	22.09	21.92	22.26		3
	50	0	22.19	22.01	22.32		3



FCC ID: ZNFG710TM	 <b>PCTEST</b> ENGINEERING LABORATORY, INC.	<b>SAR EVALUATION REPORT</b>	 <b>LG</b>	<b>Approved by:</b> Quality Manager
<b>Document S/N:</b> 1M1804030060-01-R1.ZNF	<b>Test Dates:</b> 04/03/18 - 04/16/18	<b>DUT Type:</b> Portable Handset	Page 53 of 131	

**Table 9-33**  
**LTE Band 25 (PCS) Maximum Conducted Powers - 5 MHz Bandwidth**

LTE Band 25 (PCS) 5 MHz Bandwidth							
Modulation	RB Size	RB Offset	Low Channel	Mid Channel	High Channel	MPR Allowed per 3GPP [dB]	MPR [dB]
			26065 (1852.5 MHz)	26365 (1882.5 MHz)	26665 (1912.5 MHz)		
			Conducted Power [dBm]				
QPSK	1	0	25.10	25.04	25.46	0	0
	1	12	25.05	24.85	25.42		0
	1	24	25.06	24.87	25.00		0
	12	0	24.19	24.08	24.49	0-1	1
	12	6	24.18	23.97	24.31		1
	12	13	24.20	23.91	24.28		1
	25	0	24.15	23.99	24.49		1
16QAM	1	0	24.45	24.32	24.40	0-1	1
	1	12	24.48	24.32	24.35		1
	1	24	24.48	24.25	24.30		1
	12	0	23.25	23.15	23.47	0-2	2
	12	6	23.35	23.05	23.41		2
	12	13	23.30	23.00	23.39		2
	25	0	23.22	22.93	23.45		2
64QAM	1	0	23.41	23.29	23.32	0-2	2
	1	12	23.38	23.30	23.26		2
	1	24	23.43	23.19	23.21		2
	12	0	22.08	22.00	22.34	0-3	3
	12	6	22.26	22.04	22.35		3
	12	13	22.11	21.81	22.26		3
	25	0	22.14	21.85	22.29		3



**Table 9-34**  
**LTE Band 25 (PCS) Maximum Conducted Powers - 3 MHz Bandwidth**

LTE Band 25 (PCS) 3 MHz Bandwidth							
Modulation	RB Size	RB Offset	Low Channel	Mid Channel	High Channel	MPR Allowed per 3GPP [dB]	MPR [dB]
			26055 (1851.5 MHz)	26365 (1882.5 MHz)	26675 (1913.5 MHz)		
			Conducted Power [dBm]				
QPSK	1	0	25.17	24.92	25.45	0	0
	1	7	25.22	24.94	25.18		0
	1	14	25.12	24.76	24.95		0
	8	0	24.20	23.99	24.30	0-1	1
	8	4	24.18	24.00	24.28		1
	8	7	24.17	23.91	24.21		1
	15	0	24.21	23.99	24.21		1
16QAM	1	0	24.33	24.25	24.34	0-1	1
	1	7	24.47	24.32	24.31		1
	1	14	24.48	24.15	24.24		1
	8	0	23.10	23.12	23.33	0-2	2
	8	4	23.13	23.03	23.34		2
	8	7	23.23	22.99	23.18		2
	15	0	23.15	23.00	23.32		2
64QAM	1	0	23.29	23.09	23.15	0-2	2
	1	7	23.40	23.18	23.20		2
	1	14	23.40	23.05	23.08		2
	8	0	22.00	22.10	22.20	0-3	3
	8	4	22.11	21.99	22.26		3
	8	7	22.08	21.98	22.16		3
	15	0	22.10	21.90	22.19		3

FCC ID: ZNFG710TM	 <b>PCTEST</b> ENGINEERING LABORATORY, INC.	<b>SAR EVALUATION REPORT</b>	 <b>LG</b>	Approved by: Quality Manager
Document S/N: 1M1804030060-01-R1.ZNF	Test Dates: 04/03/18 - 04/16/18	DUT Type: Portable Handset		Page 54 of 131

**Table 9-35**  
**LTE Band 25 (PCS) Maximum Conducted Powers -1.4 MHz Bandwidth**

LTE Band 25 (PCS) 1.4 MHz Bandwidth							
Modulation	RB Size	RB Offset	Low Channel	Mid Channel	High Channel	MPR Allowed per 3GPP [dB]	MPR [dB]
			26047 (1850.7 MHz)	26365 (1882.5 MHz)	26683 (1914.3 MHz)		
			Conducted Power [dBm]				
QPSK	1	0	25.06	24.95	25.02	0	0
	1	2	25.14	25.04	24.95		0
	1	5	25.05	24.98	24.89		0
	3	0	25.09	24.92	24.94		0
	3	2	25.18	24.99	24.90		0
	3	3	25.06	24.95	24.89		0
	6	0	24.08	23.93	24.08		0-1
16QAM	1	0	24.31	24.23	24.26	0-1	1
	1	2	24.36	24.37	24.32		1
	1	5	24.49	24.19	24.23		1
	3	0	24.14	24.11	24.04		1
	3	2	24.16	24.18	24.17		1
	3	3	24.15	23.98	24.12		1
	6	0	23.10	22.88	23.22		0-2
64QAM	1	0	23.16	23.13	23.11	0-2	2
	1	2	23.27	23.33	23.28		2
	1	5	23.41	23.18	23.20		2
	3	0	23.06	23.03	22.95		2
	3	2	22.98	23.15	23.09		2
	3	3	23.08	22.83	22.95		2
	6	0	22.02	21.71	22.07		0-3



FCC ID: ZNFG710TM		SAR EVALUATION REPORT		Approved by: Quality Manager
Document S/N: 1M1804030060-01-R1.ZNF	Test Dates: 04/03/18 - 04/16/18	DUT Type: Portable Handset		Page 55 of 131

**Table 9-36**  
**LTE Band 25 (PCS) Reduced Conducted Powers - 20 MHz Bandwidth**

LTE Band 25 (PCS) 20 MHz Bandwidth							
Modulation	RB Size	RB Offset	Low Channel	Mid Channel	High Channel	MPR Allowed per 3GPP [dB]	MPR [dB]
			26140 (1860.0 MHz)	26365 (1882.5 MHz)	26590 (1905.0 MHz)		
			Conducted Power [dBm]				
QPSK	1	0	24.16	24.16	24.18	0	0
	1	50	24.34	24.39	24.12		0
	1	99	24.41	24.27	24.10		0
	50	0	24.06	24.11	24.09	0-1	0
	50	25	24.14	24.05	24.24		0
	50	50	24.40	24.28	24.45		0
	100	0	24.31	24.31	24.40		0
16QAM	1	0	24.30	24.29	24.14	0-1	0
	1	50	24.46	24.19	24.39		0
	1	99	24.41	24.03	24.23		0
	50	0	23.04	23.36	23.19	0-2	1
	50	25	23.37	23.14	23.46		1
	50	50	23.50	23.11	23.32		1
	100	0	23.46	23.18	23.39		1
64QAM	1	0	23.11	23.04	23.12	0-2	1
	1	50	23.47	23.23	23.07		1
	1	99	23.12	23.05	23.39		1
	50	0	22.09	22.04	22.01	0-3	2
	50	25	22.40	22.35	22.35		2
	50	50	22.23	22.48	22.18		2
	100	0	22.26	22.28	22.33		2

**Table 9-37**  
**LTE Band 25 (PCS) Reduced Conducted Powers - 15 MHz Bandwidth**

LTE Band 25 (PCS) 15 MHz Bandwidth							
Modulation	RB Size	RB Offset	Low Channel	Mid Channel	High Channel	MPR Allowed per 3GPP [dB]	MPR [dB]
			26115 (1857.5 MHz)	26365 (1882.5 MHz)	26615 (1907.5 MHz)		
			Conducted Power [dBm]				
QPSK	1	0	24.25	24.16	24.46	0	0
	1	36	24.28	24.32	24.43		0
	1	74	24.43	24.48	24.48		0
	36	0	24.44	24.23	24.19	0-1	0
	36	18	24.22	24.11	24.27		0
	36	37	24.47	24.10	24.21		0
	75	0	24.47	24.45	24.07		0
16QAM	1	0	24.34	24.41	24.42	0-1	0
	1	36	24.26	24.23	24.06		0
	1	74	24.07	24.47	24.44		0
	36	0	23.05	23.05	23.47	0-2	1
	36	18	23.48	23.20	23.14		1
	36	37	23.13	23.29	23.11		1
	75	0	23.24	23.39	23.03		1
64QAM	1	0	23.11	23.33	23.13	0-2	1
	1	36	23.20	23.40	23.31		1
	1	74	23.04	23.20	23.16		1
	36	0	22.37	22.24	22.45	0-3	2
	36	18	22.18	22.48	22.24		2
	36	37	22.16	22.09	22.46		2
	75	0	22.50	22.47	22.40		2

FCC ID: ZNFG710TM		SAR EVALUATION REPORT		Approved by: Quality Manager
Document S/N: 1M1804030060-01-R1.ZNF	Test Dates: 04/03/18 - 04/16/18	DUT Type: Portable Handset		Page 56 of 131





**Table 9-38  
LTE Band 25 (PCS) Reduced Conducted Powers - 10 MHz Bandwidth**

LTE Band 25 (PCS) 10 MHz Bandwidth							
Modulation	RB Size	RB Offset	Low Channel	Mid Channel	High Channel	MPR Allowed per 3GPP [dB]	MPR [dB]
			26090 (1855.0 MHz)	26365 (1882.5 MHz)	26640 (1910.0 MHz)		
			Conducted Power [dBm]				
QPSK	1	0	24.49	24.28	24.06	0	0
	1	25	24.13	24.19	24.19		0
	1	49	24.26	24.18	24.11		0
	25	0	24.17	24.11	24.14	0-1	0
	25	12	24.42	24.01	24.29		0
	25	25	24.26	24.33	24.50		0
16QAM	50	0	24.41	24.38	24.16	0-1	0
	1	0	24.38	24.12	24.14		0
	1	25	24.32	24.12	24.40		0
	1	49	24.28	24.36	24.31	0-2	0
	25	0	23.49	23.12	23.12		1
	25	12	23.25	23.07	23.11		1
64QAM	25	25	23.46	23.44	23.32	0-2	1
	50	0	23.29	23.13	23.28		1
	1	0	23.49	23.05	23.34		0-3
	1	25	23.23	23.27	23.31	1	
	1	49	23.01	23.18	23.38	1	
	25	0	22.12	22.44	22.27	0-3	2
25	12	22.25	22.48	22.42	2		
25	25	22.05	22.19	22.21	2		
	50	0	22.22	22.27	22.33		2

**Table 9-39  
LTE Band 25 (PCS) Reduced Conducted Powers - 5 MHz Bandwidth**

LTE Band 25 (PCS) 5 MHz Bandwidth							
Modulation	RB Size	RB Offset	Low Channel	Mid Channel	High Channel	MPR Allowed per 3GPP [dB]	MPR [dB]
			26065 (1852.5 MHz)	26365 (1882.5 MHz)	26665 (1912.5 MHz)		
			Conducted Power [dBm]				
QPSK	1	0	24.13	24.05	24.45	0	0
	1	12	24.40	24.36	24.19		0
	1	24	24.09	24.29	24.40		0
	12	0	24.09	24.29	24.27	0-1	0
	12	6	24.44	24.22	24.22		0
	12	13	24.01	24.40	24.09		0
16QAM	25	0	24.29	24.01	24.19	0-1	0
	1	0	24.18	24.25	24.24		0
	1	12	24.05	24.16	24.42		0
	1	24	24.49	24.49	24.18	0-2	0
	12	0	23.04	23.44	23.44		1
	12	6	23.36	23.02	23.29		1
64QAM	12	13	23.18	23.18	23.41	0-2	1
	25	0	23.26	23.08	23.48		1
	1	0	23.07	23.18	23.16		0-3
	1	12	23.21	23.08	23.23	1	
	1	24	23.09	23.00	23.17	1	
	12	0	22.11	22.18	22.01	0-3	2
12	6	22.04	22.37	22.46	2		
12	13	22.25	22.42	22.46	2		
	25	0	22.42	22.30	22.40		2



FCC ID: ZNFG710TM	 <b>PCTEST</b> ENGINEERING LABORATORY, INC.	<b>SAR EVALUATION REPORT</b>	 <b>LG</b>	Approved by: Quality Manager
Document S/N: 1M1804030060-01-R1.ZNF	Test Dates: 04/03/18 - 04/16/18	DUT Type: Portable Handset		Page 57 of 131

**Table 9-40**  
**LTE Band 25 (PCS) Reduced Conducted Powers - 3 MHz Bandwidth**

LTE Band 25 (PCS) 3 MHz Bandwidth							
Modulation	RB Size	RB Offset	Low Channel	Mid Channel	High Channel	MPR Allowed per 3GPP [dB]	MPR [dB]
			26055 (1851.5 MHz)	26365 (1882.5 MHz)	26675 (1913.5 MHz)		
			Conducted Power [dBm]				
QPSK	1	0	24.43	24.40	24.44	0	0
	1	7	24.27	24.30	24.18		0
	1	14	24.36	24.02	24.09		0
	8	0	24.10	24.08	24.06	0-1	0
	8	4	24.40	24.13	24.28		0
	8	7	24.43	24.21	24.41		0
	15	0	24.22	24.05	24.09		0
16QAM	1	0	24.07	24.46	24.12	0-1	0
	1	7	24.10	24.43	24.08		0
	1	14	24.32	24.36	24.08		0
	8	0	23.31	23.43	23.21	0-2	1
	8	4	23.43	23.42	23.37		1
	8	7	23.25	23.11	23.12		1
	15	0	23.35	23.28	23.06		1
64QAM	1	0	23.35	23.24	23.02	0-2	1
	1	7	23.45	23.42	23.31		1
	1	14	23.23	23.19	23.45		1
	8	0	22.05	22.19	22.39	0-3	2
	8	4	22.21	22.24	22.22		2
	8	7	22.32	22.09	22.27		2
	15	0	22.38	22.37	22.29		2

**Table 9-41**  
**LTE Band 25 (PCS) Reduced Conducted Powers -1.4 MHz Bandwidth**

LTE Band 25 (PCS) 1.4 MHz Bandwidth							
Modulation	RB Size	RB Offset	Low Channel	Mid Channel	High Channel	MPR Allowed per 3GPP [dB]	MPR [dB]
			26047 (1850.7 MHz)	26365 (1882.5 MHz)	26683 (1914.3 MHz)		
			Conducted Power [dBm]				
QPSK	1	0	24.16	24.16	24.34	0	0
	1	2	24.21	24.09	24.24		0
	1	5	24.28	24.35	24.12		0
	3	0	24.35	24.06	24.09		0
	3	2	24.31	24.07	24.01		0
	3	3	24.01	24.22	24.00		0
	6	0	24.08	24.07	24.15	0-1	0
16QAM	1	0	24.38	24.14	24.16	0-1	0
	1	2	24.14	24.14	24.17		0
	1	5	24.28	24.45	24.47		0
	3	0	24.02	24.10	24.30		0
	3	2	24.06	24.15	24.02		0
	3	3	24.10	24.30	24.12		0
	6	0	23.05	23.22	23.30	0-2	1
64QAM	1	0	23.44	23.12	23.30	0-2	1
	1	2	23.07	23.09	23.09		1
	1	5	23.00	23.10	23.02		1
	3	0	23.05	23.28	23.36		1
	3	2	23.10	23.25	23.23		1
	3	3	23.10	23.21	23.15		1
	6	0	22.47	22.20	22.30	0-3	2



FCC ID: ZNFG710TM	 <b>PCTEST</b> <small>ENGINEERING LABORATORY, INC.</small>	<b>SAR EVALUATION REPORT</b>	 <b>LG</b>	<b>Approved by:</b> Quality Manager
<b>Document S/N:</b> 1M1804030060-01-R1.ZNF	<b>Test Dates:</b> 04/03/18 - 04/16/18	<b>DUT Type:</b> Portable Handset	Page 58 of 131	

9.3.7

LTE Band 30

Table 9-42  
 LTE Band 30 Conducted Powers - 10 MHz Bandwidth



LTE Band 30 10 MHz Bandwidth					
Modulation	RB Size	RB Offset	Mid Channel	MPR Allowed per 3GPP [dB]	MPR [dB]
			27710 (2310.0 MHz)		
			Conducted Power [dBm]		
QPSK	1	0	25.06	0	0
	1	25	<b>25.25</b>		0
	1	49	25.08		0
	25	0	23.90	0-1	1
	25	12	<b>24.10</b>		1
	25	25	23.99		1
	50	0	23.81		1
16QAM	1	0	24.13	0-1	1
	1	25	23.85		1
	1	49	24.06		1
	25	0	22.85	0-2	2
	25	12	23.07		2
	25	25	23.04		2
	50	0	22.86		2
64QAM	1	0	23.23	0-2	2
	1	25	22.92		2
	1	49	23.05		2
	25	0	21.90	0-3	3
	25	12	22.23		3
	25	25	21.92		3
	50	0	22.06		3

FCC ID: ZNFG710TM	 PCTEST ENGINEERING LABORATORY, INC.	SAR EVALUATION REPORT	 LG	Approved by: Quality Manager
Document S/N: 1M1804030060-01-R1.ZNF	Test Dates: 04/03/18 - 04/16/18	DUT Type: Portable Handset		Page 59 of 131

**Table 9-43  
LTE Band 30 Conducted Powers - 5 MHz Bandwidth**

LTE Band 30 5 MHz Bandwidth					
Modulation	RB Size	RB Offset	Mid Channel	MPR Allowed per 3GPP [dB]	MPR [dB]
			27710 (2310.0 MHz)		
			Conducted Power [dBm]		
QPSK	1	0	25.01	0	0
	1	12	25.00		0
	1	24	24.92		0
	12	0	24.11	0-1	1
	12	6	24.13		1
	12	13	24.02		1
	25	0	24.08		1
16QAM	1	0	24.44	0-1	1
	1	12	24.28		1
	1	24	24.41		1
	12	0	23.28	0-2	2
	12	6	23.20		2
	12	13	23.21		2
	25	0	23.11		2
64QAM	1	0	23.06	0-2	2
	1	12	23.05		2
	1	24	23.00		2
	12	0	22.06	0-3	3
	12	6	22.24		3
	12	13	22.05		3
	25	0	22.16		3

Note: LTE Band 30 at 5 MHz bandwidth does not support three non-overlapping channels. Per KDB Publication 941225 D05v02, when a device supports overlapping channel assignment in a channel bandwidth configuration, the middle channel of the group of overlapping channels should be selected for testing.



FCC ID: ZNFG710TM		SAR EVALUATION REPORT		Approved by: Quality Manager
Document S/N: 1M1804030060-01-R1.ZNF	Test Dates: 04/03/18 - 04/16/18	DUT Type: Portable Handset		Page 60 of 131

9.3.8

LTE Band 7

**Table 9-44**  
**LTE Band 7 Conducted Powers - 20 MHz Bandwidth**

LTE Band 7 20 MHz Bandwidth								
Modulation	RB Size	RB Offset	Low Channel	Mid Channel	High Channel	MPR Allowed per 3GPP [dB]	MPR [dB]	
			20850 (2510.0 MHz)	21100 (2535.0 MHz)	21350 (2560.0 MHz)			
			Conducted Power [dBm]					
QPSK	1	0	24.93	25.01	25.07	0	0	
	1	50	24.89	25.20	25.31		0	
	1	99	25.03	25.00	25.20		0	
	50	0	24.11	24.27	23.89	0-1	1	
	50	25	24.29	23.82	23.81		1	
	50	50	24.09	23.87	24.05		1	
16QAM	100	0	23.98	23.92	24.05	0-1	1	
	1	0	24.18	24.28	23.83		0-1	1
	1	50	24.21	24.01	24.20			1
	1	99	24.18	24.29	23.91	0-2		1
	50	0	22.90	23.05	23.20		2	
	50	25	23.16	23.03	23.14		2	
64QAM	50	50	22.91	23.08	23.09	0-2	2	
	100	0	22.91	22.94	23.27		2	
	1	0	22.88	22.92	22.97		0-2	2
	1	50	23.01	23.23	23.30	2		
	1	99	22.98	23.11	22.95	0-3		2
	50	0	22.21	21.98	22.21		3	
50	25	22.13	22.23	22.10	3			
50	50	22.24	22.23	22.28	3			
100	0	22.01	22.15	22.17	3			



FCC ID: ZNFG710TM	 PCTEST ENGINEERING LABORATORY, INC.	SAR EVALUATION REPORT	 LG	Approved by: Quality Manager
Document S/N: 1M1804030060-01-R1.ZNF	Test Dates: 04/03/18 - 04/16/18	DUT Type: Portable Handset	Page 61 of 131	

**Table 9-45**  
**LTE Band 7 Conducted Powers - 15 MHz Bandwidth**

LTE Band 7 15 MHz Bandwidth							
Modulation	RB Size	RB Offset	Low Channel	Mid Channel	High Channel	MPR Allowed per 3GPP [dB]	MPR [dB]
			20825 (2507.5 MHz)	21100 (2535.0 MHz)	21375 (2562.5 MHz)		
			Conducted Power [dBm]				
QPSK	1	0	25.31	25.14	24.87	0	0
	1	36	25.22	25.15	24.90		0
	1	74	25.25	25.05	24.91		0
	36	0	24.24	24.14	23.99	0-1	1
	36	18	24.23	24.19	24.03		1
	36	37	24.26	24.06	23.98		1
	75	0	24.25	24.13	23.94		1
16QAM	1	0	24.41	24.38	24.32	0-1	1
	1	36	24.43	24.35	24.31		1
	1	74	24.34	24.38	24.24		1
	36	0	23.26	23.21	23.13	0-2	2
	36	18	23.34	23.17	23.15		2
	36	37	23.32	23.15	23.07		2
	75	0	23.21	23.20	23.01		2
64QAM	1	0	23.40	23.36	23.12	0-2	2
	1	36	23.32	23.30	23.15		2
	1	74	23.28	23.24	23.23		2
	36	0	22.14	22.11	22.03	0-3	3
	36	18	22.15	22.03	22.12		3
	36	37	22.25	22.14	22.01		3
	75	0	22.18	22.09	21.98		3



**Table 9-46**  
**LTE Band 7 Conducted Powers - 10 MHz Bandwidth**

LTE Band 7 10 MHz Bandwidth							
Modulation	RB Size	RB Offset	Low Channel	Mid Channel	High Channel	MPR Allowed per 3GPP [dB]	MPR [dB]
			20800 (2505.0 MHz)	21100 (2535.0 MHz)	21400 (2565.0 MHz)		
			Conducted Power [dBm]				
QPSK	1	0	25.20	25.20	25.07	0	0
	1	25	25.22	25.11	25.02		0
	1	49	25.16	25.08	24.91		0
	25	0	24.21	24.13	24.06	0-1	1
	25	12	24.31	24.17	24.09		1
	25	25	24.27	24.13	23.99		1
	50	0	24.22	24.18	24.04		1
16QAM	1	0	24.42	24.42	24.40	0-1	1
	1	25	24.36	24.48	24.33		1
	1	49	24.36	24.38	24.41		1
	25	0	23.35	23.12	23.12	0-2	2
	25	12	23.31	23.23	23.04		2
	25	25	23.24	23.17	23.08		2
	50	0	23.31	23.18	23.09		2
64QAM	1	0	23.38	23.40	23.34	0-2	2
	1	25	23.21	23.36	23.17		2
	1	49	23.16	23.37	23.34		2
	25	0	22.33	22.00	22.10	0-3	3
	25	12	22.12	22.04	21.90		3
	25	25	22.07	22.03	22.02		3
	50	0	22.21	22.17	22.08		3

FCC ID: ZNFG710TM		SAR EVALUATION REPORT		Approved by: Quality Manager
Document S/N: 1M1804030060-01-R1.ZNF	Test Dates: 04/03/18 - 04/16/18	DUT Type: Portable Handset		Page 62 of 131

**Table 9-47**  
**LTE Band 7 Conducted Powers - 5 MHz Bandwidth**

LTE Band 7 5 MHz Bandwidth							
Modulation	RB Size	RB Offset	Low Channel	Mid Channel	High Channel	MPR Allowed per 3GPP [dB]	MPR [dB]
			20775 (2502.5 MHz)	21100 (2535.0 MHz)	21425 (2567.5 MHz)		
			Conducted Power [dBm]				
QPSK	1	0	25.42	25.20	25.16	0	0
	1	12	25.33	25.05	24.99		0
	1	24	25.17	24.97	25.00		0
	12	0	24.32	24.08	24.06	0-1	1
	12	6	24.31	24.20	24.01		1
	12	13	24.15	24.11	24.00		1
	25	0	24.27	24.13	24.03		1
16QAM	1	0	24.10	24.41	24.40	0-1	1
	1	12	24.40	24.39	24.29		1
	1	24	24.34	24.30	24.26		1
	12	0	23.35	23.14	23.02	0-2	2
	12	6	23.29	23.21	23.05		2
	12	13	23.29	23.06	23.01		2
	25	0	23.28	23.19	23.02		2
64QAM	1	0	22.93	23.40	23.34	0-2	2
	1	12	23.31	23.25	23.25		2
	1	24	23.25	23.28	23.18		2
	12	0	22.17	22.02	21.93	0-3	3
	12	6	22.21	22.13	21.89		3
	12	13	22.10	21.96	21.92		3
	25	0	22.19	22.03	21.94		3

FCC ID: ZNFG710TM		SAR EVALUATION REPORT		Approved by: Quality Manager
Document S/N: 1M1804030060-01-R1.ZNF	Test Dates: 04/03/18 - 04/16/18	DUT Type: Portable Handset		Page 63 of 131

9.3.9



LTE Band 41

**Table 9-48**  
**LTE Band 41 Conducted Powers - 20 MHz Bandwidth**

LTE Band 41 20 MHz Bandwidth									
Modulation	RB Size	RB Offset	Low Channel	Low-Mid Channel	Mid Channel	Mid-High Channel	High Channel	MPR Allowed per 3GPP [dB]	MPR [dB]
			39750 (2506.0 MHz)	40185 (2549.5 MHz)	40620 (2593.0 MHz)	41055 (2636.5 MHz)	41490 (2680.0 MHz)		
			Conducted Power [dBm]						
QPSK	1	0	24.76	24.88	24.82	25.02	24.74	0	0
	1	50	<b>25.20</b>	25.11	24.75	24.75	24.80		0
	1	99	24.94	24.92	24.80	25.02	24.87		0
	50	0	24.10	23.84	23.97	23.76	23.93	0-1	1
	50	25	23.77	23.94	23.71	23.85	<b>24.19</b>		1
	50	50	23.97	23.89	23.79	23.86	23.74		1
16QAM	100	0	23.97	23.92	24.11	23.91	23.87	0-1	1
	1	0	23.82	24.02	23.91	23.87	24.03		1
	1	50	23.92	23.94	23.95	23.85	23.75		1
	1	99	23.75	24.20	23.72	23.78	23.78	0-2	1
	50	0	23.05	22.88	23.08	23.10	22.98		2
	50	25	23.00	22.79	22.98	22.97	22.86		2
64QAM	50	50	23.07	22.72	23.03	23.08	22.94	0-2	2
	100	0	22.75	23.04	22.75	22.85	23.05		2
	1	0	23.15	23.19	23.13	23.20	23.03		2
	1	50	23.07	23.01	23.06	22.86	23.12	0-3	2
	1	99	23.14	23.10	22.82	22.81	23.00		2
	50	0	21.98	22.09	21.96	22.05	21.71		3
50	25	22.06	22.02	21.80	22.12	21.80	0-3	3	
50	50	21.94	22.09	21.72	22.05	22.12		3	
100	0	21.79	21.96	21.81	22.13	22.10	3		

**Table 9-49**  
**LTE Band 41 Conducted Powers - 15 MHz Bandwidth**

LTE Band 41 15 MHz Bandwidth									
Modulation	RB Size	RB Offset	Low Channel	Low-Mid Channel	Mid Channel	Mid-High Channel	High Channel	MPR Allowed per 3GPP [dB]	MPR [dB]
			39750 (2506.0 MHz)	40185 (2549.5 MHz)	40620 (2593.0 MHz)	41055 (2636.5 MHz)	41490 (2680.0 MHz)		
			Conducted Power [dBm]						
QPSK	1	0	25.10	25.04	25.14	25.05	24.92	0	0
	1	36	24.95	24.89	25.01	24.95	24.81		0
	1	74	24.90	24.90	24.95	24.88	24.74		0
	36	0	24.06	24.03	24.00	24.00	23.87	0-1	1
	36	18	23.97	23.97	23.97	23.99	23.80		1
	36	37	23.99	23.97	23.94	23.94	23.86		1
16QAM	75	0	24.00	23.95	23.94	23.96	23.81	0-1	1
	1	0	24.01	24.08	24.19	23.97	23.93		1
	1	36	23.85	23.93	24.06	23.94	23.79		1
	1	74	23.82	23.87	24.01	23.85	23.79	0-2	1
	36	0	23.03	22.98	22.97	22.98	22.89		2
	36	18	22.96	22.95	22.97	22.99	22.83		2
64QAM	36	37	22.92	22.92	22.93	22.90	22.78	0-2	2
	75	0	23.01	22.95	22.99	22.96	22.81		2
	1	0	22.98	22.91	23.11	22.94	22.77		2
	1	36	22.65	22.87	22.92	22.76	22.78	0-2	2
	1	74	22.63	22.72	22.94	22.85	22.75		2
	36	0	21.87	21.88	21.87	21.85	21.78		0-3
36	18	21.81	21.76	21.93	21.84	21.76	3		
36	37	21.81	21.80	21.82	21.90	21.58	3		
75	0	21.97	21.95	21.95	21.90	21.73	3		

FCC ID: ZNFG710TM	 PCTEST ENGINEERING LABORATORY, INC.	SAR EVALUATION REPORT	 LG	Approved by: Quality Manager
Document S/N: 1M1804030060-01-R1.ZNF	Test Dates: 04/03/18 - 04/16/18	DUT Type: Portable Handset	Page 64 of 131	





**Table 9-50**  
**LTE Band 41 Conducted Powers - 10 MHz Bandwidth**

LTE Band 41 10 MHz Bandwidth											
Modulation	RB Size	RB Offset	Low Channel	Low-Mid Channel	Mid Channel	Mid-High Channel	High Channel	MPR Allowed per 3GPP [dB]	MPR [dB]		
			39750 (2506.0 MHz)	40185 (2549.5 MHz)	40620 (2593.0 MHz)	41055 (2636.5 MHz)	41490 (2680.0 MHz)				
			Conducted Power [dBm]								
QPSK	1	0	25.03	24.96	25.08	25.06	25.00	0	0		
	1	25	24.89	24.91	25.03	24.95	24.81		0		
	1	49	24.93	24.90	24.97	24.94	25.00		0		
	QPSK	25	0	23.99	23.99	23.95	24.02	23.97	0-1	1	
		25	12	24.05	24.01	23.96	23.99	23.87		1	
		25	25	23.97	23.95	23.96	23.97	23.98		1	
		50	0	24.01	23.96	23.99	24.00	23.98		1	
16QAM		1	0	24.00	24.03	24.18	23.98	24.00		0-1	1
		1	25	23.90	23.98	24.08	23.91	23.80			1
	1	49	23.89	23.92	24.08	23.83	24.10	1			
	16QAM	25	0	23.03	22.97	23.00	23.02	22.98	0-2	2	
		25	12	23.02	22.94	22.94	22.99	22.83		2	
		25	25	22.96	22.96	22.95	22.94	22.94		2	
50		0	23.00	22.96	22.99	22.98	22.99	2			
64QAM	1	0	22.86	22.92	23.07	22.96	22.89	0-2	2		
	1	25	22.70	22.84	22.89	22.82	22.74		2		
	1	49	22.84	22.80	22.98	22.68	23.09		2		
	64QAM	25	0	21.93	21.85	21.90	21.93	21.80	0-3	3	
		25	12	22.00	21.81	21.87	21.97	21.71		3	
		25	25	21.78	21.90	21.86	21.75	21.87		3	
		50	0	21.80	21.96	21.94	21.83	21.94		3	

**Table 9-51**  
**LTE Band 41 Conducted Powers - 5 MHz Bandwidth**

LTE Band 41 5 MHz Bandwidth										
Modulation	RB Size	RB Offset	Low Channel	Low-Mid Channel	Mid Channel	Mid-High Channel	High Channel	MPR Allowed per 3GPP [dB]	MPR [dB]	
			39750 (2506.0 MHz)	40185 (2549.5 MHz)	40620 (2593.0 MHz)	41055 (2636.5 MHz)	41490 (2680.0 MHz)			
			Conducted Power [dBm]							
QPSK	1	0	24.95	24.95	24.80	25.01	24.80	0	0	
	1	12	24.90	24.90	24.78	25.05	24.80		0	
	1	24	24.88	24.88	24.77	24.95	24.79		0	
	QPSK	12	0	23.99	23.93	23.97	24.03	23.82	0-1	1
		12	6	24.03	24.04	24.00	24.00	23.84		1
		12	13	24.01	23.95	23.94	23.96	23.80		1
		25	0	23.96	23.98	23.98	24.00	23.78		1
16QAM	1	0	23.89	23.88	24.04	23.95	23.77	0-1	1	
	1	12	23.88	23.84	24.12	23.94	23.72		1	
	1	24	23.81	23.87	24.09	23.89	23.71		1	
	16QAM	12	0	22.98	22.98	23.04	23.00	22.77	0-2	2
		12	6	23.03	22.98	23.05	22.98	22.79		2
		12	13	22.98	22.90	22.97	22.94	22.75		2
64QAM	25	0	22.96	22.94	22.94	22.96	22.81	0-2	2	
	1	0	22.78	22.86	22.97	22.92	22.60		2	
	1	12	22.81	22.71	23.07	22.78	22.64		2	
	64QAM	1	24	22.78	22.71	22.96	22.75	22.65	0-3	2
		12	0	21.79	21.87	21.95	21.86	21.73		3
		12	6	21.89	21.84	22.04	21.84	21.66		3
		12	13	21.86	21.75	21.89	21.90	21.71		3
25		0	21.87	21.94	21.84	21.84	21.63	3		

FCC ID: ZNFG710TM	 <b>PCTEST</b> ENGINEERING LABORATORY, INC.	<b>SAR EVALUATION REPORT</b>	 <b>LG</b>	Approved by: Quality Manager
Document S/N: 1M1804030060-01-R1_ZNF	Test Dates: 04/03/18 - 04/16/18	DUT Type: Portable Handset	Page 65 of 131	

## 9.4 WLAN Conducted Powers

**Table 9-52**  
**2.4 GHz WLAN Maximum Average RF Power – Ant 1**



2.4GHz Conducted Power [dBm]			
Freq [MHz]	Channel	IEEE Transmission Mode	
		802.11b	802.11g
		Average	Average
2412	1	20.84	18.14
2437	6	<b>20.84</b>	19.88
2462	11	20.76	17.98

**Table 9-53**  
**2.4 GHz WLAN Maximum Average RF Power – Ant 2**

2.4GHz Conducted Power [dBm]			
Freq [MHz]	Channel	IEEE Transmission Mode	
		802.11b	802.11g
		Average	Average
2412	1	20.75	17.96
2437	6	20.67	20.48
2462	11	<b>20.78</b>	18.37

**Table 9-54**  
**2.4 GHz WLAN Maximum Average RF Power – MIMO**

2.4GHz 802.11g Conducted Power [dBm]				
Freq [MHz]	Channel	ANT1	ANT2	MIMO
2422	3	19.83	19.67	22.76
2437	6	<b>19.88</b>	<b>20.48</b>	<b>23.20</b>
2452	9	19.86	19.82	22.85



FCC ID: ZNFG710TM		SAR EVALUATION REPORT		Approved by: Quality Manager
Document S/N: 1M1804030060-01-R1.ZNF	Test Dates: 04/03/18 - 04/16/18	DUT Type: Portable Handset		Page 66 of 131

**Table 9-55  
5 GHz WLAN Maximum Average RF Power – Ant 1**

5GHz (20MHz) Conducted Power [dBm]				
Freq [MHz]	Channel	IEEE Transmission Mode		
		802.11a	802.11n	802.11ac
		Average	Average	Average
5180	36	16.92	16.60	16.72
5200	40	<b>17.76</b>	17.43	17.48
5220	44	16.56	16.15	16.35
5240	48	16.67	16.54	16.43
5260	52	16.45	16.37	16.28
5280	56	<b>17.67</b>	17.42	17.52
5300	60	16.78	16.57	16.71
5320	64	16.85	16.41	16.43
5500	100	16.67	16.38	16.43
5600	120	<b>16.76</b>	16.34	16.43
5620	124	16.49	16.28	16.34
5720	144	16.68	16.67	16.39
5745	149	16.25	16.04	16.08
5785	157	<b>17.42</b>	17.24	17.27
5805	161	17.40	17.23	17.30
5825	165	16.65	16.28	16.52



**Table 9-56  
5 GHz WLAN Maximum Average RF Power – Ant 2**

5GHz (20MHz) Conducted Power [dBm]				
Freq [MHz]	Channel	IEEE Transmission Mode		
		802.11a	802.11n	802.11ac
		Average	Average	Average
5180	36	16.86	16.40	16.52
5200	40	<b>17.73</b>	17.42	17.47
5220	44	16.70	16.43	16.63
5240	48	16.75	16.35	16.24
5260	52	16.57	16.52	16.43
5280	56	<b>17.67</b>	17.52	17.62
5300	60	16.64	16.54	16.68
5320	64	16.69	16.21	16.23
5500	100	16.78	16.60	16.65
5600	120	16.59	16.29	16.38
5620	124	16.64	16.39	16.45
5720	144	<b>16.87</b>	16.87	16.59
5745	149	16.61	16.37	16.43
5785	157	<b>17.57</b>	17.36	17.39
5805	161	17.46	17.28	17.29
5825	165	16.67	16.11	16.35

FCC ID: ZNFG710TM		SAR EVALUATION REPORT		Approved by: Quality Manager
Document S/N: 1M1804030060-01-R1.ZNF	Test Dates: 04/03/18 - 04/16/18	DUT Type: Portable Handset		Page 67 of 131

**Table 9-57  
5 GHz WLAN Maximum Average RF Power – MIMO**

5GHz (20MHz) 802.11n Conducted Power [dBm]				
Freq [MHz]	Channel	ANT1	ANT2	MIMO
5180	36	16.60	16.40	19.51
5200	40	<b>17.43</b>	<b>17.42</b>	<b>20.44</b>
5220	44	16.15	16.43	19.30
5240	48	16.54	16.35	19.46
5260	52	16.37	16.52	19.46
5280	56	<b>17.42</b>	<b>17.52</b>	<b>20.48</b>
5300	60	16.57	16.54	19.57
5320	64	16.41	16.21	19.32
5500	100	16.38	16.60	19.50
5600	120	16.34	16.29	19.33
5620	124	16.28	16.39	19.35
5720	144	<b>16.67</b>	<b>16.87</b>	<b>19.78</b>
5745	149	16.04	16.37	19.22
5785	157	<b>17.24</b>	<b>17.36</b>	<b>20.31</b>
5805	161	17.23	17.28	20.27
5825	165	16.28	16.11	19.21

FCC ID: ZNFG710TM		SAR EVALUATION REPORT		Approved by: Quality Manager
Document S/N: 1M1804030060-01-R1.ZNF	Test Dates: 04/03/18 - 04/16/18	DUT Type: Portable Handset		Page 68 of 131

**Table 9-58**  
**2.4 GHz WLAN Reduced Average RF Power – Ant 1 (Held-to-ear and During Conditions with 2.4 GHz Ant1 and 5 GHz WLAN Ant2)**



2.4GHz Conducted Power [dBm]					
Freq [MHz]	Channel	IEEE Transmission Mode			
		802.11b	802.11g	802.11n	802.11ac
		Average	Average	Average	Average
2412	1	<b>17.96</b>	17.64	17.39	17.26
2437	6	17.80	17.48	17.25	17.26
2462	11	17.70	17.32	17.14	17.12

**Table 9-59**  
**2.4 GHz WLAN Reduced Average RF Power – Ant 2 (Held-to-ear)**

2.4GHz Conducted Power [dBm]					
Freq [MHz]	Channel	IEEE Transmission Mode			
		802.11b	802.11g	802.11n	802.11ac
		Average	Average	Average	Average
2412	1	<b>17.83</b>	17.43	17.19	17.22
2437	6	17.57	17.30	17.05	17.07
2462	11	17.73	17.38	17.14	17.16

**Table 9-60**  
**5 GHz WLAN Output Powers During Conditions with 2.4 GHz Ant1 and 5 GHz WLAN Ant2**

5GHz (40MHz) Conducted Power [dBm]			
Freq [MHz]	Channel	IEEE Transmission Mode	
		802.11n	802.11ac
		Average	Average
5190	38	12.39	12.39
5230	46	<b>14.53</b>	14.51
5270	54	<b>14.55</b>	14.56
5310	62	<b>11.87</b>	11.92
5510	102	12.09	12.02
5550	110	14.51	14.51
5590	118	14.59	14.55
5630	126	14.61	14.59
5710	142	<b>14.62</b>	14.60
5755	151	14.42	14.39
5795	159	<b>14.51</b>	14.49



FCC ID: ZNFG710TM		SAR EVALUATION REPORT		Approved by: Quality Manager
Document S/N: 1M1804030060-01-R1.ZNF	Test Dates: 04/03/18 - 04/16/18	DUT Type: Portable Handset		Page 69 of 131

Justification for test configurations for WLAN per KDB Publication 248227 D01v02r02:

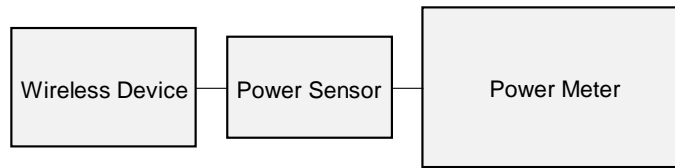
- Power measurements were performed for the transmission mode configuration with the highest maximum output power specified for production units.
- For transmission modes with the same maximum output power specification, powers were measured for the largest channel bandwidth, lowest order modulation and lowest data rate.
- For transmission modes with identical maximum specified output power, channel bandwidth, modulation and data rates, power measurements were required for all identical configurations.
- For each transmission mode configuration, powers were measured for the highest and lowest channels; and at the mid-band channel(s) when there were at least 3 channels supported. For configurations with multiple mid-band channels, due to an even number of channels, both channels were measured.
- The bolded data rate and channel above were tested for SAR.



**Figure 9-3**  
Power Measurement Setup



FCC ID: ZNFG710TM	 <b>SAR EVALUATION REPORT</b> 		<b>Approved by:</b> Quality Manager
Document S/N: 1M1804030060-01-R1.ZNF	Test Dates: 04/03/18 - 04/16/18	DUT Type: Portable Handset	Page 70 of 131

## 9.5 Bluetooth Conducted Powers

Table 9-61  
Bluetooth Average RF Power



Frequency [MHz]	Data Rate [Mbps]	Channel No.	Avg Conducted Power	
			[dBm]	[mW]
2402	1.0	0	<b>11.97</b>	15.745
2441	1.0	39	11.94	15.645
2480	1.0	78	11.64	14.596
2402	2.0	0	<b>11.33</b>	13.576
2441	2.0	39	11.48	14.060
2480	2.0	78	11.00	12.597
2402	3.0	0	<b>11.40</b>	13.790
2441	3.0	39	11.53	14.237
2480	3.0	78	11.07	12.800

Note: The bolded data rates and channel above were tested for SAR.

FCC ID: ZNFG710TM	 <b>PCTEST</b> ENGINEERING LABORATORY, INC.	SAR EVALUATION REPORT	 <b>LG</b>	Approved by: Quality Manager
Document S/N: 1M1804030060-01-R1.ZNF	Test Dates: 04/03/18 - 04/16/18	DUT Type: Portable Handset		Page 71 of 131

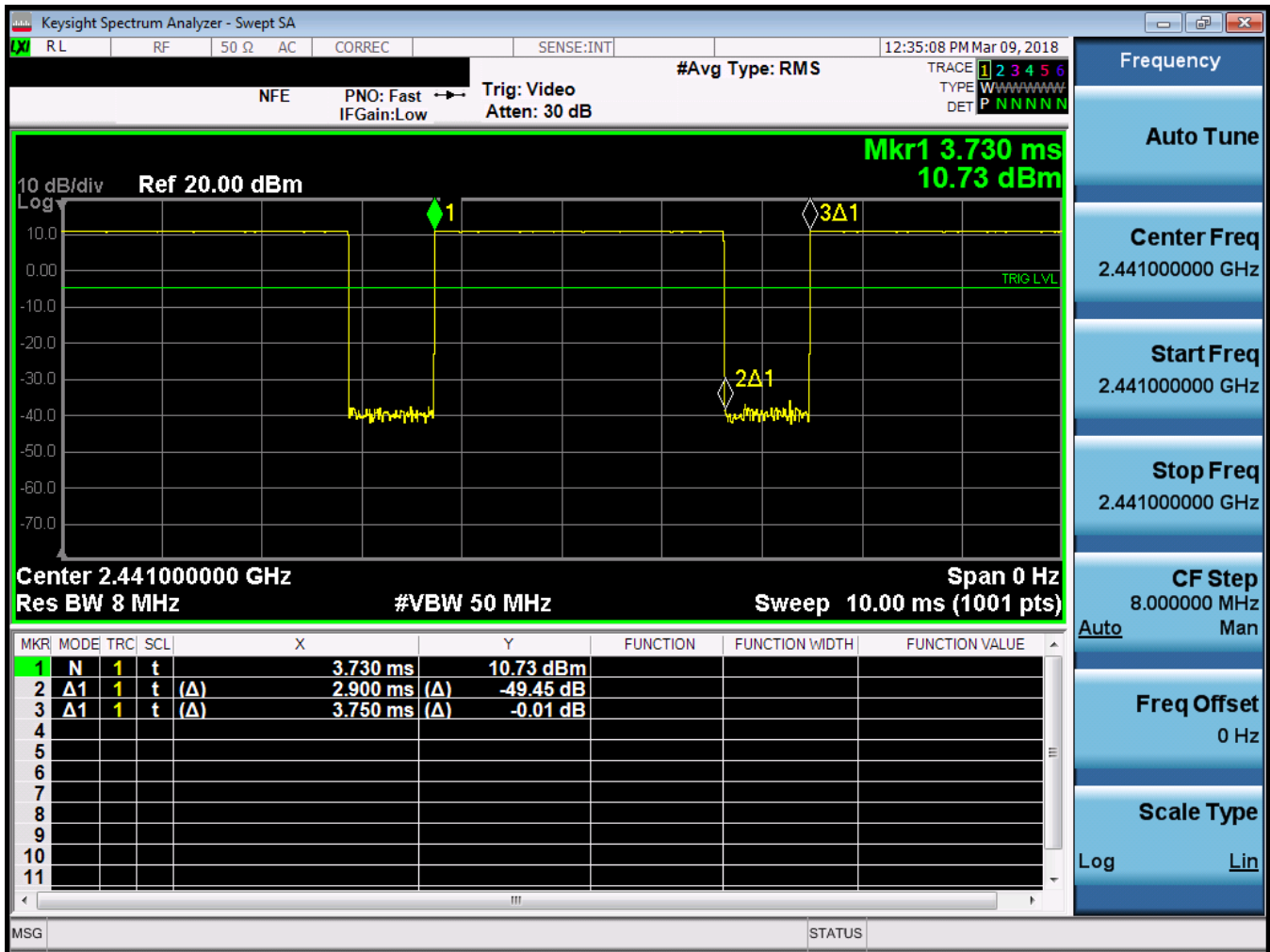
**Figure 9-4**  
Bluetooth Transmission Plot



FCC ID: ZNFG710TM	 <b>PCTEST</b> <small>ENGINEERING LABORATORY, INC.</small>	SAR EVALUATION REPORT		Approved by: Quality Manager
Document S/N: 1M1804030060-01-R1.ZNF	Test Dates: 04/03/18 - 04/16/18	DUT Type: Portable Handset		Page 72 of 131



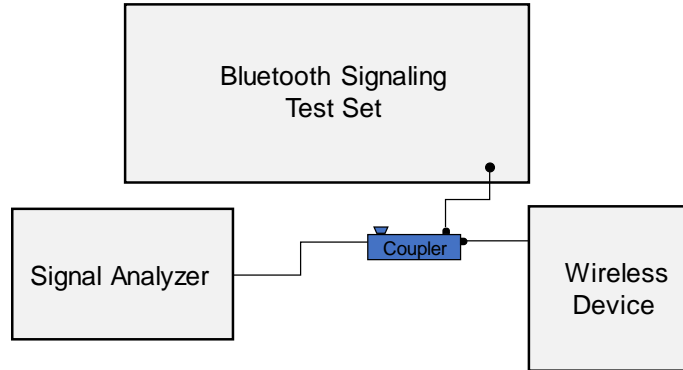

**Equation 9-1**  
**Bluetooth Duty Cycle Calculation**

$$Duty\ Cycle = \frac{Pulse\ Width}{Period} * 100\% = \frac{2.90\ ms}{3.75\ ms} * 100\% = 77.3\%$$



**Figure 9-5**  
**Power Measurement Setup**



FCC ID: ZNFG710TM		SAR EVALUATION REPORT		Approved by: Quality Manager
Document S/N: 1M1804030060-01-R1.ZNF	Test Dates: 04/03/18 - 04/16/18	DUT Type: Portable Handset		Page 73 of 131

# 10 SYSTEM VERIFICATION

## 10.1 Tissue Verification

**Table 10-1  
Measured Head Tissue Properties**



Calibrated for Tests Performed on:	Tissue Type	Tissue Temp During Calibration (°C)	Measured Frequency (MHz)	Measured Conductivity, $\sigma$ (S/m)	Measured Dielectric Constant, $\epsilon$	TARGET Conductivity, $\sigma$ (S/m)	TARGET Dielectric Constant, $\epsilon$	% dev $\sigma$	% dev $\epsilon$
4/12/2018	750H	21.7	680	0.881	41.272	0.888	42.305	-0.79%	-2.44%
			695	0.885	41.266	0.889	42.227	-0.45%	-2.28%
			700	0.887	41.260	0.889	42.201	-0.22%	-2.23%
			710	0.890	41.238	0.890	42.149	0.00%	-2.16%
			740	0.901	41.117	0.893	41.994	0.90%	-2.09%
			755	0.906	41.076	0.894	41.916	1.34%	-2.00%
			770	0.913	41.049	0.895	41.838	2.01%	-1.89%
			785	0.917	40.952	0.896	41.760	2.34%	-1.93%
4/9/2018	835H	20.7	820	0.903	43.022	0.899	41.578	0.44%	3.47%
			835	0.918	42.828	0.900	41.500	2.00%	3.20%
			850	0.934	42.627	0.916	41.500	1.97%	2.72%
4/7/2018	1750H	21.4	1710	1.360	39.763	1.348	40.142	0.89%	-0.94%
			1750	1.403	39.580	1.371	40.079	2.33%	-1.25%
			1790	1.445	39.373	1.394	40.016	3.66%	-1.61%
4/13/2018	1900H	21.7	1850	1.403	38.131	1.400	40.000	0.21%	-4.67%
			1880	1.422	38.103	1.400	40.000	1.57%	-4.74%
			1910	1.441	38.070	1.400	40.000	2.93%	-4.83%
4/11/2018	2300H	22.7	2300	1.683	39.982	1.670	39.500	0.78%	1.22%
			2310	1.693	39.967	1.679	39.480	0.83%	1.23%
			2320	1.707	39.908	1.687	39.460	1.19%	1.14%
4/6/2018	2450H	23.5	2400	1.781	39.270	1.756	39.289	1.42%	-0.05%
			2450	1.834	39.087	1.800	39.200	1.89%	-0.29%
			2500	1.893	38.883	1.855	39.136	2.05%	-0.65%
4/11/2018	2450H-2600H	22.7	2450	1.847	39.419	1.800	39.200	2.61%	0.56%
			2500	1.902	39.216	1.855	39.136	2.53%	0.20%
			2550	1.957	39.032	1.909	39.073	2.51%	-0.10%
			2600	2.018	38.849	1.964	39.009	2.75%	-0.41%
			2650	2.074	38.656	2.018	38.945	2.78%	-0.74%
			2700	2.132	38.486	2.073	38.882	2.85%	-1.02%
04/09/2018	5200H-5800H	21.6	5240	4.609	37.163	4.696	35.940	-1.85%	3.40%
			5260	4.618	37.249	4.717	35.917	-2.10%	3.71%
			5280	4.630	37.162	4.737	35.894	-2.26%	3.53%
			5600	4.981	36.743	5.065	35.529	-1.66%	3.42%
			5700	5.053	36.656	5.168	35.414	-2.23%	3.51%
			5745	5.136	36.462	5.214	35.363	-1.50%	3.11%
			5765	5.144	36.508	5.234	35.340	-1.72%	3.31%
			5785	5.153	36.469	5.255	35.317	-1.94%	3.26%

FCC ID: ZNFG710TM		SAR EVALUATION REPORT		Approved by: Quality Manager
Document S/N: 1M1804030060-01-R1.ZNF	Test Dates: 04/03/18 - 04/16/18	DUT Type: Portable Handset		Page 74 of 131

**Table 10-2  
Measured Body Tissue Properties**

Calibrated for Tests Performed on:	Tissue Type	Tissue Temp During Calibration (°C)	Measured Frequency (MHz)	Measured Conductivity, $\sigma$ (S/m)	Measured Dielectric Constant, $\epsilon$	TARGET Conductivity, $\sigma$ (S/m)	TARGET Dielectric Constant, $\epsilon$	% dev $\sigma$	% dev $\epsilon$
4/3/2018	750B	21.7	740	0.984	53.066	0.963	55.570	2.18%	-4.51%
			755	0.990	53.033	0.964	55.512	2.70%	-4.47%
			770	0.997	52.996	0.965	55.453	3.32%	-4.43%
			785	1.003	52.946	0.966	55.395	3.83%	-4.42%
4/9/2018	750B	21.5	680	0.926	54.264	0.958	55.804	-3.34%	-2.76%
			695	0.931	54.209	0.959	55.745	-2.92%	-2.76%
			700	0.932	54.200	0.959	55.726	-2.82%	-2.74%
			710	0.936	54.171	0.960	55.687	-2.50%	-2.72%
			740	0.947	54.101	0.963	55.570	-1.66%	-2.64%
			755	0.954	54.062	0.964	55.512	-1.04%	-2.61%
			820	0.960	54.422	0.969	55.258	-0.93%	-1.51%
4/6/2018	835B	22.0	835	0.975	54.294	0.970	55.200	0.52%	-1.64%
			850	0.989	54.174	0.988	55.154	0.10%	-1.78%
			1710	1.454	52.032	1.463	53.537	-0.62%	-2.81%
4/5/2018	1750B	21.5	1750	1.499	51.867	1.488	53.432	0.74%	-2.93%
			1790	1.543	51.715	1.514	53.326	1.92%	-3.02%
			1710	1.466	51.639	1.463	53.537	0.21%	-3.55%
4/12/2018	1750B	20.9	1750	1.513	51.512	1.488	53.432	1.68%	-3.59%
			1790	1.558	51.355	1.514	53.326	2.91%	-3.70%
			1850	1.520	53.877	1.520	53.300	0.00%	1.08%
4/5/2018	1900B	21.7	1880	1.553	53.793	1.520	53.300	2.17%	0.92%
			1910	1.587	53.695	1.520	53.300	4.41%	0.74%
			1850	1.504	54.036	1.520	53.300	-1.05%	1.38%
4/15/2018	1900B	22.4	1880	1.540	53.934	1.520	53.300	1.32%	1.19%
			1910	1.577	53.811	1.520	53.300	3.75%	0.96%
			2300	1.876	51.612	1.809	52.900	3.70%	-2.43%
4/15/2018	2300B	20.9	2310	1.887	51.577	1.816	52.887	3.91%	-2.48%
			2320	1.899	51.544	1.826	52.873	4.00%	-2.51%
			2450	2.038	50.739	1.950	52.700	4.51%	-3.72%
4/9/2018	2450B-2600B	22.0	2500	2.098	50.584	2.021	52.636	3.81%	-3.90%
			2550	2.157	50.438	2.092	52.573	3.11%	-4.06%
			2600	2.218	50.276	2.163	52.509	2.54%	-4.25%
			2650	2.279	50.117	2.234	52.445	2.01%	-4.44%
			2700	2.338	49.952	2.305	52.382	1.43%	-4.64%
4/12/2018	2450B-2600B	22.6	2450	2.025	50.788	1.950	52.700	3.85%	-3.63%
			2500	2.087	50.684	2.021	52.636	3.27%	-3.71%
			2550	2.153	50.567	2.092	52.573	2.92%	-3.82%
			2600	2.213	50.451	2.163	52.509	2.31%	-3.92%
4/16/2018	2450B-2600B	23.0	2400	1.902	52.317	1.902	52.767	0.00%	-0.85%
			2450	1.964	52.143	1.950	52.700	0.72%	-1.06%
			2500	2.037	51.950	2.021	52.636	0.79%	-1.30%
			2550	2.101	51.789	2.092	52.573	0.43%	-1.49%
			2600	2.166	51.570	2.163	52.509	0.14%	-1.79%
04/14/2018	5200B-5800B	21.8	5200	5.439	47.725	5.299	49.014	2.64%	-2.63%
			5220	5.480	47.678	5.323	48.987	2.95%	-2.67%
			5240	5.503	47.675	5.346	48.960	2.94%	-2.62%
			5260	5.529	47.610	5.369	48.933	2.98%	-2.70%
			5280	5.543	47.605	5.393	48.906	2.78%	-2.66%
			5300	5.586	47.541	5.416	48.879	3.14%	-2.74%
			5320	5.607	47.544	5.439	48.851	3.09%	-2.68%
			5500	5.844	47.219	5.650	48.607	3.43%	-2.86%
			5600	5.980	47.052	5.766	48.471	3.71%	-2.93%
			5620	5.985	46.990	5.790	48.444	3.37%	-3.00%
			5700	6.128	46.867	5.883	48.336	4.16%	-3.04%
			5745	6.185	46.822	5.936	48.275	4.19%	-3.01%
			5765	6.212	46.785	5.959	48.248	4.25%	-3.03%
			5785	6.244	46.767	5.982	48.220	4.38%	-3.01%
			5800	6.269	46.714	6.000	48.200	4.48%	-3.08%
			5805	6.274	46.705	6.006	48.193	4.46%	-3.09%
			5825	6.302	46.681	6.029	48.166	4.53%	-3.08%

The above measured tissue parameters were used in the DASY software. The DASY software was used to perform interpolation to determine the dielectric parameters at the SAR test device frequencies (per KDB Publication 865664 D01v01r04 and IEEE 1528-2013 6.6.1.2). The tissue parameters listed in the SAR test plots may slightly differ from the table above due to significant digit rounding in the software.



FCC ID: ZNFG710TM		SAR EVALUATION REPORT		Approved by: Quality Manager
Document S/N: 1M1804030060-01-R1.ZNF	Test Dates: 04/03/18 - 04/16/18	DUT Type: Portable Handset		Page 75 of 131

## 10.2 Test System Verification

Prior to SAR assessment, the system is verified to  $\pm 10\%$  of the SAR measurement on the reference dipole at the time of calibration by the calibration facility. Full system validation status and result summary can be found in Appendix E.

**Table 10-3  
System Verification Results – 1g**

System Verification TARGET & MEASURED												
SAR System #	Tissue Frequency (MHz)	Tissue Type	Date:	Amb. Temp (°C)	Liquid Temp (°C)	Input Power (W)	Source SN	Probe SN	Measured SAR <sub>1g</sub> (W/kg)	1 W Target SAR <sub>1g</sub> (W/kg)	1 W Normalized SAR <sub>1g</sub> (W/kg)	Deviation <sub>1g</sub> (%)
J	750	HEAD	04/12/2018	22.7	21.7	0.200	1003	3914	1.720	8.280	8.600	3.86%
E	835	HEAD	04/09/2018	21.5	20.7	0.200	4d132	3213	1.990	9.360	9.950	6.30%
H	1750	HEAD	04/07/2018	20.3	21.4	0.100	1148	7410	3.720	36.400	37.200	2.20%
J	1900	HEAD	04/13/2018	21.9	21.7	0.100	5d148	3914	4.350	40.100	43.500	8.48%
G	2300	HEAD	04/11/2018	22.1	21.9	0.100	1073	3332	4.950	48.600	49.500	1.85%
G	2450	HEAD	04/06/2018	22.0	21.7	0.100	797	3332	5.450	52.700	54.500	3.42%
G	2450	HEAD	04/11/2018	22.1	21.9	0.100	797	3332	5.130	52.700	51.300	-2.66%
G	2600	HEAD	04/11/2018	22.1	21.9	0.100	1126	3332	5.760	56.400	57.600	2.13%
H	5250	HEAD	04/09/2018	21.9	21.6	0.050	1191	3589	3.680	78.900	73.600	-6.72%
H	5600	HEAD	04/09/2018	21.9	21.6	0.050	1191	3589	3.910	83.600	78.200	-6.46%
H	5750	HEAD	04/09/2018	21.9	21.6	0.050	1191	3589	3.910	79.100	78.200	-1.14%
I	750	BODY	04/03/2018	22.0	20.9	0.200	1054	3287	1.750	8.610	8.750	1.63%
I	750	BODY	04/09/2018	22.6	21.5	0.200	1003	3287	1.760	8.580	8.800	2.56%
E	835	BODY	04/06/2018	24.2	22.0	0.200	4d132	3213	1.960	9.710	9.800	0.93%
I	1750	BODY	04/05/2018	22.6	21.2	0.100	1148	3287	3.930	37.000	39.300	6.22%
I	1750	BODY	04/12/2018	23.0	20.8	0.100	1148	3287	3.910	37.000	39.100	5.68%
J	1900	BODY	04/05/2018	21.9	21.7	0.100	5d148	3914	4.180	39.600	41.800	5.56%
J	1900	BODY	04/15/2018	22.5	22.4	0.100	5d148	3914	4.140	39.600	41.400	4.55%
K	2300	BODY	04/15/2018	22.0	20.9	0.100	1073	3319	5.030	48.100	50.300	4.57%
K	2450	BODY	04/09/2018	23.4	22.0	0.100	797	3319	5.150	51.100	51.500	0.78%
K	2450	BODY	04/12/2018	24.0	22.6	0.100	797	3319	5.000	51.100	50.000	-2.15%
H	2450	BODY	04/16/2018	22.6	23.0	0.100	797	7410	5.020	51.100	50.200	-1.76%
K	2600	BODY	04/09/2018	23.4	22.0	0.100	1126	3319	5.560	54.300	55.600	2.39%
K	2600	BODY	04/12/2018	24.0	22.6	0.100	1126	3319	5.480	54.300	54.800	0.92%
D	5250	BODY	04/14/2018	22.3	21.8	0.050	1237	7308	3.750	76.900	75.000	-2.47%
D	5600	BODY	04/14/2018	22.3	21.8	0.050	1237	7308	3.940	78.500	78.800	0.38%
D	5750	BODY	04/14/2018	22.3	21.8	0.050	1237	7308	3.670	77.100	73.400	-4.80%

FCC ID: ZNFG710TM		SAR EVALUATION REPORT		Approved by: Quality Manager
Document S/N: 1M1804030060-01-R1.ZNF	Test Dates: 04/03/18 - 04/16/18	DUT Type: Portable Handset		Page 76 of 131

**Table 10-4  
System Verification Results – 10g**

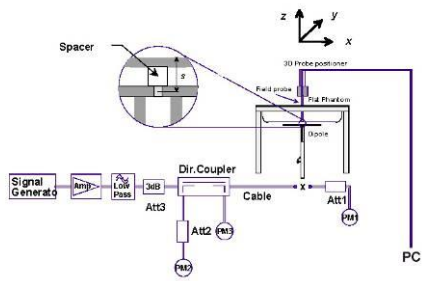

System Verification TARGET & MEASURED												
SAR System #	Tissue Frequency (MHz)	Tissue Type	Date:	Amb. Temp (°C)	Liquid Temp (°C)	Input Power (W)	Source SN	Probe SN	Measured SAR <sub>10g</sub> (W/kg)	1 W Target SAR <sub>10g</sub> (W/kg)	1 W Normalized SAR <sub>10g</sub> (W/kg)	Deviation <sub>10g</sub> (%)
I	1750	BODY	04/05/2018	22.6	21.2	0.100	1148	3287	2.100	19.800	21.000	6.06%
I	1750	BODY	04/12/2018	23.0	20.8	0.100	1148	3287	2.070	19.800	20.700	4.55%
J	1900	BODY	04/05/2018	21.9	21.7	0.100	5d148	3914	2.160	20.900	21.600	3.35%
H	2450	BODY	04/16/2018	22.6	23.0	0.100	797	7410	2.290	24.200	22.900	-5.37%
H	2600	BODY	04/16/2018	22.6	23.0	0.100	1126	7410	2.300	24.400	23.000	-5.74%
D	5250	BODY	04/14/2018	22.3	21.8	0.050	1237	7308	1.050	21.500	21.000	-2.33%
D	5600	BODY	04/14/2018	22.3	21.8	0.050	1237	7308	1.090	22.100	21.800	-1.36%
D	5750	BODY	04/14/2018	22.3	21.8	0.050	1237	7308	1.020	21.400	20.400	-4.67%



**Figure 10-1  
System Verification Setup Diagram**



**Figure 10-2  
System Verification Setup Photo**

FCC ID: ZNFG710TM		SAR EVALUATION REPORT		Approved by: Quality Manager
Document S/N: 1M1804030060-01-R1.ZNF	Test Dates: 04/03/18 - 04/16/18	DUT Type: Portable Handset	Page 77 of 131	

# 11 SAR DATA SUMMARY



## 11.1 Standalone Head SAR Data

**Table 11-1  
GSM 850 Head SAR**

MEASUREMENT RESULTS															
FREQUENCY		Mode/Band	Service	Maximum Allowed Power [dBm]	Conducted Power [dBm]	Power Drift [dB]	Side	Test Position	Device Serial Number	# of Time Slots	Duty Cycle	SAR (1g)	Scaling Factor	Reported SAR (1g)	Plot #
MHz	Ch.											(W/kg)		(W/kg)	
836.60	190	GSM 850	GSM	31.7	31.30	0.05	Right	Cheek	09670	1	1:8.3	0.043	1.096	0.047	
836.60	190	GSM 850	GSM	31.7	31.30	0.09	Right	Tilt	09670	1	1:8.3	0.018	1.096	0.020	
836.60	190	GSM 850	GSM	31.7	31.30	0.11	Left	Cheek	09670	1	1:8.3	0.030	1.096	0.033	
836.60	190	GSM 850	GSM	31.7	31.30	0.17	Left	Tilt	09670	1	1:8.3	0.018	1.096	0.020	
836.60	190	GSM 850	GPRS	30.2	30.20	0.20	Right	Cheek	09670	3	1:2.76	0.138	1.000	0.138	A1
836.60	190	GSM 850	GPRS	30.2	30.20	0.05	Right	Tilt	09670	3	1:2.76	0.064	1.000	0.064	
836.60	190	GSM 850	GPRS	30.2	30.20	0.01	Left	Cheek	09670	3	1:2.76	0.090	1.000	0.090	
836.60	190	GSM 850	GPRS	30.2	30.20	0.00	Left	Tilt	09670	3	1:2.76	0.052	1.000	0.052	
ANSI / IEEE C95.1 1992 - SAFETY LIMIT Spatial Peak Uncontrolled Exposure/General Population							Head 1.6 W/kg (mW/g) averaged over 1 gram								

**Table 11-2  
GSM 1900 Head SAR**

MEASUREMENT RESULTS															
FREQUENCY		Mode/Band	Service	Maximum Allowed Power [dBm]	Conducted Power [dBm]	Power Drift [dB]	Side	Test Position	Device Serial Number	# of Time Slots	Duty Cycle	SAR (1g)	Scaling Factor	Reported SAR (1g)	Plot #
MHz	Ch.											(W/kg)		(W/kg)	
1880.00	661	GSM 1900	GSM	30.7	30.53	0.16	Right	Cheek	09688	1	1:8.3	0.033	1.040	0.034	
1880.00	661	GSM 1900	GSM	30.7	30.53	-0.16	Right	Tilt	09688	1	1:8.3	0.034	1.040	0.035	
1880.00	661	GSM 1900	GSM	30.7	30.53	0.02	Left	Cheek	09688	1	1:8.3	0.035	1.040	0.036	
1880.00	661	GSM 1900	GSM	30.7	30.53	-0.10	Left	Tilt	09688	1	1:8.3	0.025	1.040	0.026	
1880.00	661	GSM 1900	GPRS	29.7	29.21	0.10	Right	Cheek	09688	2	1:4.15	0.055	1.119	0.062	
1880.00	661	GSM 1900	GPRS	29.7	29.21	0.02	Right	Tilt	09688	2	1:4.15	0.050	1.119	0.056	
1880.00	661	GSM 1900	GPRS	29.7	29.21	-0.07	Left	Cheek	09688	2	1:4.15	0.059	1.119	0.066	A2
1880.00	661	GSM 1900	GPRS	29.7	29.21	0.14	Left	Tilt	09688	2	1:4.15	0.042	1.119	0.047	
ANSI / IEEE C95.1 1992 - SAFETY LIMIT Spatial Peak Uncontrolled Exposure/General Population							Head 1.6 W/kg (mW/g) averaged over 1 gram								

FCC ID: ZNFG710TM		SAR EVALUATION REPORT		Approved by: Quality Manager
Document S/N: 1M1804030060-01-R1.ZNF	Test Dates: 04/03/18 - 04/16/18	DUT Type: Portable Handset		Page 78 of 131

**Table 11-3  
UMTS 850 Head SAR**



MEASUREMENT RESULTS														
FREQUENCY		Mode/Band	Service	Maximum Allowed Power [dBm]	Conducted Power [dBm]	Power Drift [dB]	Side	Test Position	Device Serial Number	Duty Cycle	SAR (1g)	Scaling Factor	Reported SAR (1g)	Plot #
MHz	Ch.										(W/kg)		(W/kg)	
836.60	4183	UMTS 850	RMC	25.5	25.03	-0.01	Right	Cheek	09670	1:1	0.177	1.114	0.197	A3
836.60	4183	UMTS 850	RMC	25.5	25.03	0.00	Right	Tilt	09670	1:1	0.080	1.114	0.089	
836.60	4183	UMTS 850	RMC	25.5	25.03	-0.01	Left	Cheek	09670	1:1	0.137	1.114	0.153	
836.60	4183	UMTS 850	RMC	25.5	25.03	0.01	Left	Tilt	09670	1:1	0.079	1.114	0.088	
ANSI / IEEE C95.1 1992 - SAFETY LIMIT Spatial Peak Uncontrolled Exposure/General Population							Head 1.6 W/kg (mW/g) averaged over 1 gram							

**Table 11-4  
UMTS 1750 Head SAR**

MEASUREMENT RESULTS														
FREQUENCY		Mode/Band	Service	Maximum Allowed Power [dBm]	Conducted Power [dBm]	Power Drift [dB]	Side	Test Position	Device Serial Number	Duty Cycle	SAR (1g)	Scaling Factor	Reported SAR (1g)	Plot #
MHz	Ch.										(W/kg)		(W/kg)	
1732.40	1412	UMTS 1750	RMC	25.2	25.16	0.04	Right	Cheek	09654	1:1	0.116	1.009	0.117	
1732.40	1412	UMTS 1750	RMC	25.2	25.16	0.02	Right	Tilt	09654	1:1	0.156	1.009	0.157	
1732.40	1412	UMTS 1750	RMC	25.2	25.16	0.02	Left	Cheek	09654	1:1	0.132	1.009	0.133	
1732.40	1412	UMTS 1750	RMC	25.2	25.16	-0.15	Left	Tilt	09654	1:1	0.201	1.009	0.203	A4
ANSI / IEEE C95.1 1992 - SAFETY LIMIT Spatial Peak Uncontrolled Exposure/General Population							Head 1.6 W/kg (mW/g) averaged over 1 gram							

**Table 11-5  
UMTS 1900 Head SAR**

MEASUREMENT RESULTS														
FREQUENCY		Mode/Band	Service	Maximum Allowed Power [dBm]	Conducted Power [dBm]	Power Drift [dB]	Side	Test Position	Device Serial Number	Duty Cycle	SAR (1g)	Scaling Factor	Reported SAR (1g)	Plot #
MHz	Ch.										(W/kg)		(W/kg)	
1880.00	9400	UMTS 1900	RMC	25.5	25.47	0.00	Right	Cheek	09688	1:1	0.114	1.007	0.115	
1880.00	9400	UMTS 1900	RMC	25.5	25.47	0.12	Right	Tilt	09688	1:1	0.133	1.007	0.134	
1880.00	9400	UMTS 1900	RMC	25.5	25.47	-0.01	Left	Cheek	09688	1:1	0.144	1.007	0.145	A5
1880.00	9400	UMTS 1900	RMC	25.5	25.47	0.09	Left	Tilt	09688	1:1	0.127	1.007	0.128	
ANSI / IEEE C95.1 1992 - SAFETY LIMIT Spatial Peak Uncontrolled Exposure/General Population							Head 1.6 W/kg (mW/g) averaged over 1 gram							

FCC ID: ZNFG710TM	 <b>PCTEST</b> ENGINEERING LABORATORY, INC.	<b>SAR EVALUATION REPORT</b>	 <b>LG</b>	<b>Approved by:</b> Quality Manager
<b>Document S/N:</b> 1M1804030060-01-R1.ZNF	<b>Test Dates:</b> 04/03/18 - 04/16/18	<b>DUT Type:</b> Portable Handset	Page 79 of 131	

**Table 11-6  
LTE Band 71 Head SAR**



MEASUREMENT RESULTS																			
FREQUENCY		Mode	Bandwidth [MHz]	Maximum Allowed Power [dBm]	Conducted Power [dBm]	Power Drift [dB]	MPR [dB]	Side	Test Position	Modulation	RB Size	RB Offset	Device Serial Number	Duty Cycle	SAR (1g)	Scaling Factor	Reported SAR (1g)	Plot #	
MHz	Ch.														(W/kg)		(W/kg)		
680.50	133297	Mid	LTE Band 71	20	25.5	25.15	0.19	0	Right	Cheek	QPSK	1	99	09654	1:1	0.106	1.084	0.115	A6
680.50	133297	Mid	LTE Band 71	20	24.5	24.19	0.12	1	Right	Cheek	QPSK	50	0	09654	1:1	0.090	1.074	0.097	
680.50	133297	Mid	LTE Band 71	20	25.5	25.15	0.10	0	Right	Tilt	QPSK	1	99	09654	1:1	0.047	1.084	0.051	
680.50	133297	Mid	LTE Band 71	20	24.5	24.19	0.10	1	Right	Tilt	QPSK	50	0	09654	1:1	0.033	1.074	0.035	
680.50	133297	Mid	LTE Band 71	20	25.5	25.15	0.15	0	Left	Cheek	QPSK	1	99	09654	1:1	0.099	1.084	0.107	
680.50	133297	Mid	LTE Band 71	20	24.5	24.19	0.06	1	Left	Cheek	QPSK	50	0	09654	1:1	0.078	1.074	0.084	
680.50	133297	Mid	LTE Band 71	20	25.5	25.15	0.21	0	Left	Tilt	QPSK	1	99	09654	1:1	0.068	1.084	0.074	
680.50	133297	Mid	LTE Band 71	20	24.5	24.19	0.11	1	Left	Tilt	QPSK	50	0	09654	1:1	0.049	1.074	0.053	
ANSI / IEEE C95.1 1992 - SAFETY LIMIT Spatial Peak Uncontrolled Exposure/General Population										Head 1.6 W/kg (mW/g) averaged over 1 gram									

**Table 11-7  
LTE Band 12 Head SAR**

MEASUREMENT RESULTS																			
FREQUENCY		Mode	Bandwidth [MHz]	Maximum Allowed Power [dBm]	Conducted Power [dBm]	Power Drift [dB]	MPR [dB]	Side	Test Position	Modulation	RB Size	RB Offset	Device Serial Number	Duty Cycle	SAR (1g)	Scaling Factor	Reported SAR (1g)	Plot #	
MHz	Ch.														(W/kg)		(W/kg)		
707.50	23095	Mid	LTE Band 12	10	25.5	25.17	0.18	0	Right	Cheek	QPSK	1	49	09654	1:1	0.187	1.079	0.202	A7
707.50	23095	Mid	LTE Band 12	10	24.5	24.20	0.13	1	Right	Cheek	QPSK	25	0	09654	1:1	0.128	1.072	0.137	
707.50	23095	Mid	LTE Band 12	10	25.5	25.17	-0.03	0	Right	Tilt	QPSK	1	49	09654	1:1	0.065	1.079	0.070	
707.50	23095	Mid	LTE Band 12	10	24.5	24.20	-0.17	1	Right	Tilt	QPSK	25	0	09654	1:1	0.046	1.072	0.049	
707.50	23095	Mid	LTE Band 12	10	25.5	25.17	0.10	0	Left	Cheek	QPSK	1	49	09654	1:1	0.149	1.079	0.161	
707.50	23095	Mid	LTE Band 12	10	24.5	24.20	0.17	1	Left	Cheek	QPSK	25	0	09654	1:1	0.100	1.072	0.107	
707.50	23095	Mid	LTE Band 12	10	25.5	25.17	0.05	0	Left	Tilt	QPSK	1	49	09654	1:1	0.097	1.079	0.105	
707.50	23095	Mid	LTE Band 12	10	24.5	24.20	-0.01	1	Left	Tilt	QPSK	25	0	09654	1:1	0.066	1.072	0.071	
ANSI / IEEE C95.1 1992 - SAFETY LIMIT Spatial Peak Uncontrolled Exposure/General Population										Head 1.6 W/kg (mW/g) averaged over 1 gram									

**Table 11-8  
LTE Band 13 Head SAR**

MEASUREMENT RESULTS																			
FREQUENCY		Mode	Bandwidth [MHz]	Maximum Allowed Power [dBm]	Conducted Power [dBm]	Power Drift [dB]	MPR [dB]	Side	Test Position	Modulation	RB Size	RB Offset	Device Serial Number	Duty Cycle	SAR (1g)	Scaling Factor	Reported SAR (1g)	Plot #	
MHz	Ch.														(W/kg)		(W/kg)		
782.00	23230	Mid	LTE Band 13	10	25.5	25.19	0.14	0	Right	Cheek	QPSK	1	25	09654	1:1	0.208	1.074	0.223	A8
782.00	23230	Mid	LTE Band 13	10	24.5	24.18	0.05	1	Right	Cheek	QPSK	25	12	09654	1:1	0.146	1.076	0.157	
782.00	23230	Mid	LTE Band 13	10	25.5	25.19	0.08	0	Right	Tilt	QPSK	1	25	09654	1:1	0.097	1.074	0.104	
782.00	23230	Mid	LTE Band 13	10	24.5	24.18	0.06	1	Right	Tilt	QPSK	25	12	09654	1:1	0.068	1.076	0.073	
782.00	23230	Mid	LTE Band 13	10	25.5	25.19	-0.03	0	Left	Cheek	QPSK	1	25	09654	1:1	0.153	1.074	0.164	
782.00	23230	Mid	LTE Band 13	10	24.5	24.18	0.08	1	Left	Cheek	QPSK	25	12	09654	1:1	0.100	1.076	0.108	
782.00	23230	Mid	LTE Band 13	10	25.5	25.19	0.05	0	Left	Tilt	QPSK	1	25	09654	1:1	0.109	1.074	0.117	
782.00	23230	Mid	LTE Band 13	10	24.5	24.18	0.02	1	Left	Tilt	QPSK	25	12	09654	1:1	0.073	1.076	0.079	
ANSI / IEEE C95.1 1992 - SAFETY LIMIT Spatial Peak Uncontrolled Exposure/General Population										Head 1.6 W/kg (mW/g) averaged over 1 gram									

FCC ID: ZNFG710TM		<b>SAR EVALUATION REPORT</b>		Approved by: Quality Manager
Document S/N: 1M1804030060-01-R1.ZNF	Test Dates: 04/03/18 - 04/16/18	DUT Type: Portable Handset		Page 80 of 131



**Table 11-9  
LTE Band 5 (Cell) Head SAR**



MEASUREMENT RESULTS																			
FREQUENCY		Mode	Bandwidth [MHz]	Maximum Allowed Power [dBm]	Conducted Power [dBm]	Power Drift [dB]	MPR [dB]	Side	Test Position	Modulation	RB Size	RB Offset	Device Serial Number	Duty Cycle	SAR (1g)	Scaling Factor	Reported SAR (1g)	Plot #	
MHz	Ch.														(W/kg)		(W/kg)		
836.50	20525	Mid	LTE Band 5 (Cell)	10	25.5	25.16	-0.06	0	Right	Cheek	QPSK	1	49	09670	1:1	0.195	1.081	0.211	A9
836.50	20525	Mid	LTE Band 5 (Cell)	10	24.5	24.18	0.05	1	Right	Cheek	QPSK	25	0	09670	1:1	0.135	1.076	0.145	
836.50	20525	Mid	LTE Band 5 (Cell)	10	25.5	25.16	-0.10	0	Right	Tilt	QPSK	1	49	09670	1:1	0.070	1.081	0.076	
836.50	20525	Mid	LTE Band 5 (Cell)	10	24.5	24.18	0.04	1	Right	Tilt	QPSK	25	0	09670	1:1	0.055	1.076	0.059	
836.50	20525	Mid	LTE Band 5 (Cell)	10	25.5	25.16	0.07	0	Left	Cheek	QPSK	1	49	09670	1:1	0.135	1.081	0.146	
836.50	20525	Mid	LTE Band 5 (Cell)	10	24.5	24.18	0.10	1	Left	Cheek	QPSK	25	0	09670	1:1	0.097	1.076	0.104	
836.50	20525	Mid	LTE Band 5 (Cell)	10	25.5	25.16	-0.02	0	Left	Tilt	QPSK	1	49	09670	1:1	0.070	1.081	0.076	
836.50	20525	Mid	LTE Band 5 (Cell)	10	24.5	24.18	-0.18	1	Left	Tilt	QPSK	25	0	09670	1:1	0.050	1.076	0.054	
ANSI / IEEE C95.1 1992 - SAFETY LIMIT Spatial Peak Uncontrolled Exposure/General Population										Head 1.6 W/kg (mW/g) averaged over 1 gram									

**Table 11-10  
LTE Band 66 (AWS) Head SAR**

MEASUREMENT RESULTS																			
FREQUENCY		Mode	Bandwidth [MHz]	Maximum Allowed Power [dBm]	Conducted Power [dBm]	Power Drift [dB]	MPR [dB]	Side	Test Position	Modulation	RB Size	RB Offset	Device Serial Number	Duty Cycle	SAR (1g)	Scaling Factor	Reported SAR (1g)	Plot #	
MHz	Ch.														(W/kg)		(W/kg)		
1720.00	132072	Low	LTE Band 66 (AWS)	20	25.2	25.20	0.02	0	Right	Cheek	QPSK	1	0	09654	1:1	0.134	1.000	0.134	
1720.00	132072	Low	LTE Band 66 (AWS)	20	24.2	24.20	0.06	1	Right	Cheek	QPSK	50	25	09654	1:1	0.100	1.000	0.100	
1720.00	132072	Low	LTE Band 66 (AWS)	20	25.2	25.20	0.07	0	Right	Tilt	QPSK	1	0	09654	1:1	0.188	1.000	0.188	
1720.00	132072	Low	LTE Band 66 (AWS)	20	24.2	24.20	0.04	1	Right	Tilt	QPSK	50	25	09654	1:1	0.140	1.000	0.140	
1720.00	132072	Low	LTE Band 66 (AWS)	20	25.2	25.20	-0.03	0	Left	Cheek	QPSK	1	0	09654	1:1	0.137	1.000	0.137	
1720.00	132072	Low	LTE Band 66 (AWS)	20	24.2	24.20	0.05	1	Left	Cheek	QPSK	50	25	09654	1:1	0.090	1.000	0.090	
1720.00	132072	Low	LTE Band 66 (AWS)	20	25.2	25.20	-0.01	0	Left	Tilt	QPSK	1	0	09654	1:1	0.206	1.000	0.206	A10
1720.00	132072	Low	LTE Band 66 (AWS)	20	24.2	24.20	0.02	1	Left	Tilt	QPSK	50	25	09654	1:1	0.136	1.000	0.136	
ANSI / IEEE C95.1 1992 - SAFETY LIMIT Spatial Peak Uncontrolled Exposure/General Population										Head 1.6 W/kg (mW/g) averaged over 1 gram									

**Table 11-11  
LTE Band 25 (PCS) Head SAR**

MEASUREMENT RESULTS																			
FREQUENCY		Mode	Bandwidth [MHz]	Maximum Allowed Power [dBm]	Conducted Power [dBm]	Power Drift [dB]	MPR [dB]	Side	Test Position	Modulation	RB Size	RB Offset	Device Serial Number	Duty Cycle	SAR (1g)	Scaling Factor	Reported SAR (1g)	Plot #	
MHz	Ch.														(W/kg)		(W/kg)		
1905.00	26590	High	LTE Band 25 (PCS)	20	25.5	25.32	0.18	0	Right	Cheek	QPSK	1	99	09688	1:1	0.118	1.042	0.123	
1882.50	26365	Mid	LTE Band 25 (PCS)	20	24.5	24.36	0.20	1	Right	Cheek	QPSK	50	50	09688	1:1	0.067	1.033	0.069	
1905.00	26590	High	LTE Band 25 (PCS)	20	25.5	25.32	0.04	0	Right	Tilt	QPSK	1	99	09688	1:1	0.094	1.042	0.098	
1882.50	26365	Mid	LTE Band 25 (PCS)	20	24.5	24.36	-0.02	1	Right	Tilt	QPSK	50	50	09688	1:1	0.064	1.033	0.066	
1905.00	26590	High	LTE Band 25 (PCS)	20	25.5	25.32	0.10	0	Left	Cheek	QPSK	1	99	09688	1:1	0.152	1.042	0.158	A11
1882.50	26365	Mid	LTE Band 25 (PCS)	20	24.5	24.36	-0.01	1	Left	Cheek	QPSK	50	50	09688	1:1	0.097	1.033	0.100	
1905.00	26590	High	LTE Band 25 (PCS)	20	25.5	25.32	-0.02	0	Left	Tilt	QPSK	1	99	09688	1:1	0.070	1.042	0.073	
1882.50	26365	Mid	LTE Band 25 (PCS)	20	24.5	24.36	0.00	1	Left	Tilt	QPSK	50	50	09688	1:1	0.063	1.033	0.065	
ANSI / IEEE C95.1 1992 - SAFETY LIMIT Spatial Peak Uncontrolled Exposure/General Population										Head 1.6 W/kg (mW/g) averaged over 1 gram									

FCC ID: ZNFG710TM		<b>SAR EVALUATION REPORT</b>		Approved by: Quality Manager
Document S/N: 1M1804030060-01-R1.ZNF	Test Dates: 04/03/18 - 04/16/18	DUT Type: Portable Handset		Page 81 of 131

**Table 11-12  
LTE Band 30 Head SAR**



MEASUREMENT RESULTS																			
FREQUENCY		Mode	Bandwidth [MHz]	Maximum Allowed Power [dBm]	Conducted Power [dBm]	Power Drift [dB]	MPR [dB]	Side	Test Position	Modulation	RB Size	RB Offset	Device Serial Number	Duty Cycle	SAR (1g)	Scaling Factor	Reported SAR (1g)	Plot #	
MHz	Ch.														(W/kg)		(W/kg)		
2310.00	27710	Mid	LTE Band 30	10	25.5	25.25	0.09	0	Right	Cheek	QPSK	1	25	09704	1:1	0.012	1.059	0.013	
2310.00	27710	Mid	LTE Band 30	10	24.5	24.10	0.12	1	Right	Cheek	QPSK	25	12	09704	1:1	0.011	1.096	0.012	
2310.00	27710	Mid	LTE Band 30	10	25.5	25.25	0.13	0	Right	Tilt	QPSK	1	25	09704	1:1	0.008	1.059	0.008	
2310.00	27710	Mid	LTE Band 30	10	24.5	24.10	0.18	1	Right	Tilt	QPSK	25	12	09704	1:1	0.007	1.096	0.008	
2310.00	27710	Mid	LTE Band 30	10	25.5	25.25	0.18	0	Left	Cheek	QPSK	1	25	09704	1:1	0.020	1.059	0.021	A12
2310.00	27710	Mid	LTE Band 30	10	24.5	24.10	0.12	1	Left	Cheek	QPSK	25	12	09704	1:1	0.016	1.096	0.018	
2310.00	27710	Mid	LTE Band 30	10	25.5	25.25	0.13	0	Left	Tilt	QPSK	1	25	09704	1:1	0.012	1.059	0.013	
2310.00	27710	Mid	LTE Band 30	10	24.5	24.10	0.16	1	Left	Tilt	QPSK	25	12	09704	1:1	0.010	1.096	0.011	
ANSI / IEEE C95.1 1992 - SAFETY LIMIT Spatial Peak Uncontrolled Exposure/General Population											Head 1.6 W/kg (mW/g) averaged over 1 gram								

**Table 11-13  
LTE Band 7 Head SAR**

MEASUREMENT RESULTS																			
FREQUENCY		Mode	Bandwidth [MHz]	Maximum Allowed Power [dBm]	Conducted Power [dBm]	Power Drift [dB]	MPR [dB]	Side	Test Position	Modulation	RB Size	RB Offset	Device Serial Number	Duty Cycle	SAR (1g)	Scaling Factor	Reported SAR (1g)	Plot #	
MHz	Ch.														(W/kg)		(W/kg)		
2560.00	21350	High	LTE Band 7	20	25.5	25.31	0.20	0	Right	Cheek	QPSK	1	50	09704	1:1	0.035	1.045	0.037	
2510.00	20850	Low	LTE Band 7	20	24.5	24.29	0.01	1	Right	Cheek	QPSK	50	25	09704	1:1	0.030	1.050	0.032	
2560.00	21350	High	LTE Band 7	20	25.5	25.31	0.20	0	Right	Tilt	QPSK	1	50	09704	1:1	0.029	1.045	0.030	
2510.00	20850	Low	LTE Band 7	20	24.5	24.29	-0.04	1	Right	Tilt	QPSK	50	25	09704	1:1	0.021	1.050	0.022	
2560.00	21350	High	LTE Band 7	20	25.5	25.31	0.15	0	Left	Cheek	QPSK	1	50	09704	1:1	0.036	1.045	0.038	
2510.00	20850	Low	LTE Band 7	20	24.5	24.29	0.18	1	Left	Cheek	QPSK	50	25	09704	1:1	0.030	1.050	0.032	
2560.00	21350	High	LTE Band 7	20	25.5	25.31	0.13	0	Left	Tilt	QPSK	1	50	09704	1:1	0.051	1.045	0.053	A13
2510.00	20850	Low	LTE Band 7	20	24.5	24.29	0.14	1	Left	Tilt	QPSK	50	25	09704	1:1	0.031	1.050	0.033	
ANSI / IEEE C95.1 1992 - SAFETY LIMIT Spatial Peak Uncontrolled Exposure/General Population											Head 1.6 W/kg (mW/g) averaged over 1 gram								

**Table 11-14  
LTE Band 41 Head SAR**

MEASUREMENT RESULTS																			
FREQUENCY		Mode	Bandwidth [MHz]	Maximum Allowed Power [dBm]	Conducted Power [dBm]	Power Drift [dB]	MPR [dB]	Side	Test Position	Modulation	RB Size	RB Offset	Device Serial Number	Duty Cycle	SAR (1g)	Scaling Factor	Reported SAR (1g)	Plot #	
MHz	Ch.														(W/kg)		(W/kg)		
2506.00	39750	Low	LTE Band 41	20	25.2	25.20	0.19	0	Right	Cheek	QPSK	1	50	09704	1:1.58	0.028	1.000	0.028	A14
2680.00	41490	High	LTE Band 41	20	24.2	24.19	0.17	1	Right	Cheek	QPSK	50	25	09704	1:1.58	0.005	1.002	0.005	
2506.00	39750	Low	LTE Band 41	20	25.2	25.20	0.19	0	Right	Tilt	QPSK	1	50	09704	1:1.58	0.019	1.000	0.019	
2680.00	41490	High	LTE Band 41	20	24.2	24.19	0.13	1	Right	Tilt	QPSK	50	25	09704	1:1.58	0.015	1.002	0.015	
2506.00	39750	Low	LTE Band 41	20	25.2	25.20	0.20	0	Left	Cheek	QPSK	1	50	09704	1:1.58	0.024	1.000	0.024	
2680.00	41490	High	LTE Band 41	20	24.2	24.19	0.12	1	Left	Cheek	QPSK	50	25	09704	1:1.58	0.008	1.002	0.008	
2506.00	39750	Low	LTE Band 41	20	25.2	25.20	0.12	0	Left	Tilt	QPSK	1	50	09704	1:1.58	0.021	1.000	0.021	
2680.00	41490	High	LTE Band 41	20	24.2	24.19	0.15	1	Left	Tilt	QPSK	50	25	09704	1:1.58	0.007	1.002	0.007	
ANSI / IEEE C95.1 1992 - SAFETY LIMIT Spatial Peak Uncontrolled Exposure/General Population											Head 1.6 W/kg (mW/g) averaged over 1 gram								



FCC ID: ZNFG710TM		SAR EVALUATION REPORT		Approved by: Quality Manager
Document S/N: 1M1804030060-01-R1.ZNF	Test Dates: 04/03/18 - 04/16/18	DUT Type: Portable Handset		Page 82 of 131

**Table 11-15  
DTS Head SAR**

MEASUREMENT RESULTS																			
FREQUENCY		Mode	Service	Bandwidth [MHz]	Maximum Allowed Power [dBm]	Conducted Power [dBm]	Power Drift [dB]	Side	Test Position	Antenna Config.	Device Serial Number	Data Rate (Mbps)	Duty Cycle (%)	Peak SAR of Area Scan	SAR (1g)	Scaling Factor (Power)	Scaling Factor (Duty Cycle)	Reported SAR (1g)	Plot #
MHz	Ch.													W/kg	(W/kg)			(W/kg)	
2412	1	802.11b	DSSS	22	18.0	17.96	0.18	Right	Cheek	1	09779	1	99.2	0.417	-	1.009	1.008	-	
2412	1	802.11b	DSSS	22	18.0	17.96	-0.09	Right	Tilt	1	09779	1	99.2	0.438	-	1.009	1.008	-	
2412	1	802.11b	DSSS	22	18.0	17.96	-0.14	Left	Cheek	1	09779	1	99.2	0.305	-	1.009	1.008	-	
2412	1	802.11b	DSSS	22	18.0	17.96	0.12	Left	Tilt	1	09779	1	99.2	0.467	0.348	1.009	1.008	0.354	A15
2412	1	802.11b	DSSS	22	18.0	17.83	0.13	Right	Cheek	2	09779	1	99.3	0.097	0.071	1.040	1.007	0.074	
2412	1	802.11b	DSSS	22	18.0	17.83	0.05	Right	Tilt	2	09779	1	99.3	0.036	-	1.040	1.007	-	
2412	1	802.11b	DSSS	22	18.0	17.83	0.12	Left	Cheek	2	09779	1	99.3	0.034	-	1.040	1.007	-	
2412	1	802.11b	DSSS	22	18.0	17.83	0.20	Left	Tilt	2	09779	1	99.3	0.014	-	1.040	1.007	-	
ANSI / IEEE C95.1 1992 - SAFETY LIMIT Spatial Peak Uncontrolled Exposure/General Population										Head 1.6 W/kg (mW/g) averaged over 1 gram									



**Table 11-16  
NII Head SAR**

MEASUREMENT RESULTS																			
FREQUENCY		Mode	Service	Bandwidth [MHz]	Maximum Allowed Power [dBm]	Conducted Power [dBm]	Power Drift [dB]	Side	Test Position	Antenna Config.	Device Serial Number	Data Rate (Mbps)	Duty Cycle (%)	Peak SAR of Area Scan	SAR (1g)	Scaling Factor (Power)	Scaling Factor (Duty Cycle)	Reported SAR (1g)	Plot #
MHz	Ch.													W/kg	(W/kg)			(W/kg)	
5280	56	802.11a	OFDM	20	18.0	17.67	0.19	Right	Cheek	1	09688	6	98.3	0.880	0.432	1.079	1.017	0.474	A16
5280	56	802.11a	OFDM	20	18.0	17.67	0.17	Right	Tilt	1	09688	6	98.3	0.642	0.299	1.079	1.017	0.328	
5280	56	802.11a	OFDM	20	18.0	17.67	0.20	Left	Cheek	1	09688	6	98.3	0.215	-	1.079	1.017	-	
5280	56	802.11a	OFDM	20	18.0	17.67	-0.17	Left	Tilt	1	09688	6	98.3	0.250	-	1.079	1.017	-	
5280	56	802.11a	OFDM	20	18.0	17.67	0.19	Right	Cheek	2	09688	6	98.3	0.071	0.033	1.079	1.017	0.036	
5280	56	802.11a	OFDM	20	18.0	17.67	0.18	Right	Tilt	2	09688	6	98.3	0.055	-	1.079	1.017	-	
5280	56	802.11a	OFDM	20	18.0	17.67	0.00	Left	Cheek	2	09688	6	98.3	0.068	-	1.079	1.017	-	
5280	56	802.11a	OFDM	20	18.0	17.67	0.00	Left	Tilt	2	09688	6	98.3	0.051	-	1.079	1.017	-	
5600	120	802.11a	OFDM	20	17.0	16.76	0.14	Right	Cheek	1	09688	6	98.3	0.791	0.393	1.057	1.017	0.422	
5600	120	802.11a	OFDM	20	17.0	16.76	0.14	Right	Tilt	1	09688	6	98.3	0.674	0.330	1.057	1.017	0.355	
5600	120	802.11a	OFDM	20	17.0	16.76	0.18	Left	Cheek	1	09688	6	98.3	0.270	-	1.057	1.017	-	
5600	120	802.11a	OFDM	20	17.0	16.76	-0.10	Left	Tilt	1	09688	6	98.3	0.338	-	1.057	1.017	-	
5720	144	802.11a	OFDM	20	17.0	16.87	0.16	Right	Cheek	2	09688	6	98.3	0.143	0.042	1.030	1.017	0.044	
5720	144	802.11a	OFDM	20	17.0	16.87	0.11	Right	Tilt	2	09688	6	98.3	0.023	-	1.030	1.017	-	
5720	144	802.11a	OFDM	20	17.0	16.87	0.08	Left	Cheek	2	09688	6	98.3	0.137	-	1.030	1.017	-	
5720	144	802.11a	OFDM	20	17.0	16.87	0.17	Left	Tilt	2	09688	6	98.3	0.025	-	1.030	1.017	-	
5785	157	802.11a	OFDM	20	18.0	17.42	0.09	Right	Cheek	1	09688	6	98.3	0.979	0.411	1.143	1.017	0.478	
5785	157	802.11a	OFDM	20	18.0	17.42	0.16	Right	Tilt	1	09688	6	98.3	0.864	0.346	1.143	1.017	0.402	
5785	157	802.11a	OFDM	20	18.0	17.42	-0.14	Left	Cheek	1	09688	6	98.3	0.293	-	1.143	1.017	-	
5785	157	802.11a	OFDM	20	18.0	17.42	-0.12	Left	Tilt	1	09688	6	98.3	0.281	-	1.143	1.017	-	
5785	157	802.11a	OFDM	20	18.0	17.57	0.06	Right	Cheek	2	09688	6	98.3	0.239	0.076	1.104	1.017	0.085	
5785	157	802.11a	OFDM	20	18.0	17.57	0.20	Right	Tilt	2	09688	6	98.3	0.035	-	1.104	1.017	-	
5785	157	802.11a	OFDM	20	18.0	17.57	-0.13	Left	Cheek	2	09688	6	98.3	0.162	-	1.104	1.017	-	
5785	157	802.11a	OFDM	20	18.0	17.57	0.19	Left	Tilt	2	09688	6	98.3	0.045	-	1.104	1.017	-	
ANSI / IEEE C95.1 1992 - SAFETY LIMIT Spatial Peak Uncontrolled Exposure/General Population										Head 1.6 W/kg (mW/g) averaged over 1 gram									

FCC ID: ZNFG710TM		SAR EVALUATION REPORT		Approved by: Quality Manager
Document S/N: 1M1804030060-01-R1.ZNF	Test Dates: 04/03/18 - 04/16/18	DUT Type: Portable Handset		Page 83 of 131

**Table 11-17  
DSS Head SAR**

MEASUREMENT RESULTS																
FREQUENCY		Mode	Service	Maximum Allowed Power [dBm]	Conducted Power [dBm]	Power Drift [dB]	Side	Test Position	Device Serial Number	Data Rate (Mbps)	Duty Cycle %	SAR (1g)	Scaling Factor (Cond Power)	Scaling Factor (Duty Cycle)	Reported SAR (1g)	Plot #
MHz	Ch.											(W/kg)			(W/kg)	
2402.00	0	Bluetooth	FHSS	12.0	11.97	0.08	Right	Cheek	09787	1	77.3	0.099	1.007	1.294	0.129	A17
2402.00	0	Bluetooth	FHSS	12.0	11.97	0.14	Right	Tilt	09787	1	77.3	0.088	1.007	1.294	0.115	
2402.00	0	Bluetooth	FHSS	12.0	11.97	0.20	Left	Cheek	09787	1	77.3	0.067	1.007	1.294	0.087	
2402.00	0	Bluetooth	FHSS	12.0	11.97	0.19	Left	Tilt	09787	1	77.3	0.083	1.007	1.294	0.108	
ANSI / IEEE C95.1 1992 - SAFETY LIMIT Spatial Peak Uncontrolled Exposure/General Population							Head 1.6 W/kg (mW/g) averaged over 1 gram									

FCC ID: ZNFG710TM		SAR EVALUATION REPORT		Approved by: Quality Manager
Document S/N: 1M1804030060-01-R1.ZNF	Test Dates: 04/03/18 - 04/16/18	DUT Type: Portable Handset		Page 84 of 131

## 11.2 Standalone Body-Worn SAR Data



**Table 11-18  
GSM/UMTS Body-Worn SAR Data**

MEASUREMENT RESULTS															
FREQUENCY		Mode	Service	Maximum Allowed Power [dBm]	Conducted Power [dBm]	Power Drift [dB]	Spacing	Device Serial Number	# of Time Slots	Duty Cycle	Side	SAR (1g)	Scaling Factor	Reported SAR (1g)	Plot #
MHz	Ch.											(W/kg)		(W/kg)	
836.60	190	GSM 850	GSM	31.7	31.30	-0.13	10 mm	09662	1	1:8.3	back	0.119	1.096	0.130	
836.60	190	GSM 850	GPRS	30.2	30.20	-0.18	10 mm	09662	3	1:2.76	back	0.350	1.000	0.350	A18
1880.00	661	GSM 1900	GSM	30.7	30.53	-0.06	10 mm	09670	1	1:8.3	back	0.159	1.040	0.165	
1880.00	661	GSM 1900	GPRS	29.7	29.21	-0.16	10 mm	09670	2	1:4.15	back	0.260	1.119	0.291	A19
836.60	4183	UMTS 850	RMC	25.5	25.03	0.02	10 mm	09662	N/A	1:1	back	0.399	1.114	0.444	A21
1732.40	1412	UMTS 1750	RMC	25.2	25.16	-0.01	10 mm	09654	N/A	1:1	back	0.517	1.009	0.522	A22
1880.00	9400	UMTS 1900	RMC	25.5	25.47	-0.02	10 mm	09670	N/A	1:1	back	0.501	1.007	0.505	A24
ANSI / IEEE C95.1 1992 - SAFETY LIMIT Spatial Peak Uncontrolled Exposure/General Population							Body 1.6 W/kg (mW/g) averaged over 1 gram								

**Table 11-19  
LTE Body-Worn SAR**

MEASUREMENT RESULTS																				
FREQUENCY		Mode	Bandwidth [MHz]	Accessory	Maximum Allowed Power [dBm]	Conducted Power [dBm]	Power Drift [dB]	MPR [dB]	Device Serial Number	Modulation	RB Size	RB Offset	Spacing	Side	Duty Cycle	SAR (1g)	Scaling Factor	Reported SAR (1g)	Plot #	
MHz	Ch.															(W/kg)		(W/kg)		
680.50	133297	Mid	LTE Band 71	20	N/A	25.5	25.15	-0.04	0	09662	QPSK	1	99	10 mm	back	1:1	0.383	1.084	0.415	A26
680.50	133297	Mid	LTE Band 71	20	N/A	24.5	24.19	0.01	1	09662	QPSK	50	0	10 mm	back	1:1	0.265	1.074	0.285	
707.50	23095	Mid	LTE Band 12	10	N/A	25.5	25.17	-0.07	0	09662	QPSK	1	49	10 mm	back	1:1	0.491	1.079	0.530	A27
707.50	23095	Mid	LTE Band 12	10	N/A	24.5	24.20	0.01	1	09662	QPSK	25	0	10 mm	back	1:1	0.312	1.072	0.334	
782.00	23230	Mid	LTE Band 13	10	N/A	25.5	25.19	-0.02	0	09696	QPSK	1	25	10 mm	back	1:1	0.459	1.074	0.493	A28
782.00	23230	Mid	LTE Band 13	10	N/A	24.5	24.18	-0.01	1	09696	QPSK	25	12	10 mm	back	1:1	0.317	1.076	0.341	
836.50	20525	Mid	LTE Band 5 (Cell)	10	N/A	25.5	25.16	0.03	0	09662	QPSK	1	49	10 mm	back	1:1	0.350	1.081	0.378	A29
836.50	20525	Mid	LTE Band 5 (Cell)	10	N/A	24.5	24.18	-0.02	1	09662	QPSK	25	0	10 mm	back	1:1	0.241	1.076	0.259	
1720.00	132072	Low	LTE Band 66 (AWS)	20	N/A	25.2	25.20	0.00	0	09696	QPSK	1	0	10 mm	back	1:1	0.618	1.000	0.618	A30
1720.00	132072	Low	LTE Band 66 (AWS)	20	N/A	24.2	24.20	-0.06	1	09696	QPSK	50	25	10 mm	back	1:1	0.454	1.000	0.454	
1905.00	26590	High	LTE Band 25 (PCS)	20	N/A	25.5	25.32	-0.19	0	09670	QPSK	1	99	10 mm	back	1:1	0.294	1.042	0.306	A32
1882.50	26365	Mid	LTE Band 25 (PCS)	20	N/A	24.5	24.36	0.03	1	09670	QPSK	50	50	10 mm	back	1:1	0.197	1.033	0.204	
2310.00	27710	Mid	LTE Band 30	10	N/A	25.5	25.25	0.06	0	09670	QPSK	1	25	10 mm	back	1:1	0.290	1.059	0.307	A34
2310.00	27710	Mid	LTE Band 30	10	N/A	24.5	24.10	0.03	1	09670	QPSK	25	12	10 mm	back	1:1	0.244	1.096	0.267	
2510.00	20850	Low	LTE Band 7	20	N/A	25.5	25.03	0.11	0	09670	QPSK	1	99	10 mm	back	1:1	1.150	1.114	1.281	
2535.00	21100	Mid	LTE Band 7	20	N/A	25.5	25.20	-0.14	0	09670	QPSK	1	50	10 mm	back	1:1	1.210	1.072	1.297	A35
2535.00	21100	Mid	LTE Band 7	20	Headphones	25.5	25.20	0.00	0	09670	QPSK	1	50	10 mm	back	1:1	1.180	1.072	1.265	
2560.00	21350	High	LTE Band 7	20	N/A	25.5	25.31	-0.07	0	09670	QPSK	1	50	10 mm	back	1:1	0.993	1.045	1.038	
2510.00	20850	Low	LTE Band 7	20	N/A	24.5	24.29	-0.08	1	09670	QPSK	50	25	10 mm	back	1:1	0.860	1.050	0.903	
2535.00	21100	Mid	LTE Band 7	20	N/A	24.5	24.27	0.08	1	09670	QPSK	50	0	10 mm	back	1:1	0.911	1.054	0.960	
2560.00	21350	High	LTE Band 7	20	N/A	24.5	24.05	-0.11	1	09670	QPSK	50	50	10 mm	back	1:1	0.770	1.109	0.854	
2560.00	21350	High	LTE Band 7	20	N/A	24.5	24.05	0.03	1	09670	QPSK	100	0	10 mm	back	1:1	0.787	1.109	0.873	
2510.00	20850	Low	LTE Band 7	20	N/A	25.5	25.03	-0.02	0	09670	QPSK	1	99	10 mm	back	1:1	1.070	1.114	1.192	
2535.00	21100	Mid	LTE Band 7	20	N/A	25.5	25.20	-0.14	0	09670	QPSK	1	50	10 mm	back	1:1	1.200	1.072	1.286	
2506.00	39750	Low	LTE Band 41	20	N/A	25.2	25.20	-0.04	0	09654	QPSK	1	50	10 mm	back	1:1.58	0.700	1.000	0.700	A36
2549.50	40185	Low-Mid	LTE Band 41	20	N/A	25.2	25.11	-0.14	0	09654	QPSK	1	50	10 mm	back	1:1.58	0.699	1.021	0.714	
2593.00	40620	Mid	LTE Band 41	20	N/A	25.2	24.82	-0.01	0	09654	QPSK	1	0	10 mm	back	1:1.58	0.601	1.091	0.656	
2636.50	41055	Mid-High	LTE Band 41	20	N/A	25.2	25.02	0.10	0	09654	QPSK	1	0	10 mm	back	1:1.58	0.577	1.042	0.601	
2680.00	41490	High	LTE Band 41	20	N/A	25.2	24.87	-0.12	0	09654	QPSK	1	99	10 mm	back	1:1.58	0.435	1.079	0.469	
2680.00	41490	High	LTE Band 41	20	N/A	24.2	24.19	0.08	1	09654	QPSK	50	25	10 mm	back	1:1.58	0.392	1.002	0.393	
2593.00	40620	Mid	LTE Band 41	20	N/A	24.2	24.11	-0.13	1	09654	QPSK	100	0	10 mm	back	1:1.58	0.460	1.021	0.470	
ANSI / IEEE C95.1 1992 - SAFETY LIMIT Spatial Peak Uncontrolled Exposure/General Population							Body 1.6 W/kg (mW/g) averaged over 1 gram													

**Note: Blue entry represents variability measurement.**

FCC ID: ZNFG710TM		SAR EVALUATION REPORT		Approved by: Quality Manager
Document S/N: 1M1804030060-01-R1.ZNF	Test Dates: 04/03/18 - 04/16/18	DUT Type: Portable Handset	Page 85 of 131	

**Table 11-20  
DTS SISO Body-Worn SAR**

MEASUREMENT RESULTS																			
FREQUENCY		Mode	Service	Bandwidth [MHz]	Maximum Allowed Power [dBm]	Conducted Power [dBm]	Power Drift [dB]	Spacing	Antenna Config.	Device Serial Number	Data Rate (Mbps)	Side	Duty Cycle (%)	Peak SAR of Area Scan	SAR (1g)	Scaling Factor (Power)	Scaling Factor (Duty Cycle)	Reported SAR (1g)	Plot #
MHz	Ch.													W/kg	(W/kg)			(W/kg)	
2437	6	802.11b	DSSS	22	21.0	20.84	0.21	10 mm	1	09688	1	back	99.2	0.456	0.376	1.038	1.008	0.393	
2462	11	802.11b	DSSS	22	21.0	20.78	0.13	10 mm	2	09688	1	back	99.3	0.420	0.363	1.052	1.007	0.385	
ANSI / IEEE C95.1 1992 - SAFETY LIMIT Spatial Peak Uncontrolled Exposure/General Population													Body 1.6 W/kg (mW/g) averaged over 1 gram						

**Table 11-21  
DTS MIMO Body-Worn SAR**

MEASUREMENT RESULTS																					
FREQUENCY		Mode	Service	Bandwidth [MHz]	Maximum Allowed Power (Ant 1) [dBm]	Conducted Power (Ant 1) [dBm]	Maximum Allowed Power (Ant 2) [dBm]	Conducted Power (Ant 2) [dBm]	Power Drift [dB]	Spacing	Antenna Config.	Device Serial Number	Data Rate (Mbps)	Side	Duty Cycle (%)	Peak SAR of Area Scan	SAR (1g)	Scaling Factor (Power)	Scaling Factor (Duty Cycle)	Reported SAR (1g)	Plot #
MHz	Ch.															W/kg	(W/kg)			(W/kg)	
2437	6	802.11g	OFDM	20	20.5	19.88	20.5	20.48	0.04	10 mm	MIMO	09688	6	back	98.5	0.590	0.404	1.153	1.015	0.473	A38
ANSI / IEEE C95.1 1992 - SAFETY LIMIT Spatial Peak Uncontrolled Exposure/General Population													Body 1.6 W/kg (mW/g) averaged over 1 gram								

To achieve the 23.5 dBm maximum allowed MIMO power shown in the documentation, each antenna transmits at a maximum allowed power of 20.5 dBm.



**Table 11-22  
DTS Body-Worn SAR for Conditions with 2.4 GHz Ant 1 and 5 GHz Ant 2 WLAN**

MEASUREMENT RESULTS																			
FREQUENCY		Mode	Service	Bandwidth [MHz]	Maximum Allowed Power [dBm]	Conducted Power [dBm]	Power Drift [dB]	Spacing	Antenna Config.	Device Serial Number	Data Rate (Mbps)	Side	Duty Cycle (%)	Peak SAR of Area Scan	SAR (1g)	Scaling Factor (Power)	Scaling Factor (Duty Cycle)	Reported SAR (1g)	Plot #
MHz	Ch.													W/kg	(W/kg)			(W/kg)	
2412	1	802.11b	DSSS	22	18.0	17.96	-0.05	10 mm	1	09704	1	back	99.2	0.257	0.226	1.009	1.008	0.230	
ANSI / IEEE C95.1 1992 - SAFETY LIMIT Spatial Peak Uncontrolled Exposure/General Population													Body 1.6 W/kg (mW/g) averaged over 1 gram						

DTS was additionally evaluated at the maximum allowed output power during operations with simultaneous 2.4 GHz Ant 1 and 5 GHz Ant 2 WLAN. 5 GHz Ant 2 WIFI was not transmitting during the above evaluations.

**Table 11-23  
NII SISO Body-Worn SAR**

MEASUREMENT RESULTS																			
FREQUENCY		Mode	Service	Bandwidth [MHz]	Maximum Allowed Power [dBm]	Conducted Power [dBm]	Power Drift [dB]	Spacing	Antenna Config.	Device Serial Number	Data Rate (Mbps)	Side	Duty Cycle (%)	Peak SAR of Area Scan	SAR (1g)	Scaling Factor (Power)	Scaling Factor (Duty Cycle)	Reported SAR (1g)	Plot #
MHz	Ch.													W/kg	(W/kg)			(W/kg)	
5280	56	802.11a	OFDM	20	18.0	17.67	-0.05	10 mm	1	09662	6	back	98.3	0.376	0.162	1.079	1.017	0.178	
5260	52	802.11a	OFDM	20	17.0	16.57	-0.08	10 mm	2	09662	6	back	98.3	1.463	0.593	1.104	1.017	0.666	
5280	56	802.11a	OFDM	20	18.0	17.67	-0.13	10 mm	2	09662	6	back	98.3	1.593	0.818	1.079	1.017	0.898	
5320	64	802.11a	OFDM	20	17.0	16.69	0.00	10 mm	2	09662	6	back	98.3	1.618	0.774	1.074	1.017	0.845	
5600	120	802.11a	OFDM	20	17.0	16.76	0.12	10 mm	1	09662	6	back	98.3	0.078	0.034	1.057	1.017	0.037	
5720	144	802.11a	OFDM	20	17.0	16.87	0.04	10 mm	2	09662	6	back	98.3	1.899	0.738	1.030	1.017	0.773	
5785	157	802.11a	OFDM	20	18.0	17.42	0.10	10 mm	1	09662	6	back	98.3	0.117	0.039	1.143	1.017	0.045	
5785	157	802.11a	OFDM	20	18.0	17.57	0.04	10 mm	2	09662	6	back	98.3	1.808	0.769	1.104	1.017	0.863	
5805	161	802.11a	OFDM	20	18.0	17.46	0.05	10 mm	2	09662	6	back	98.3	1.896	0.753	1.132	1.017	0.867	
5825	165	802.11a	OFDM	20	17.0	16.67	-0.10	10 mm	2	09662	6	back	98.3	1.400	0.549	1.079	1.017	0.602	
ANSI / IEEE C95.1 1992 - SAFETY LIMIT Spatial Peak Uncontrolled Exposure/General Population													Body 1.6 W/kg (mW/g) averaged over 1 gram						

FCC ID: ZNFG710TM		<b>SAR EVALUATION REPORT</b>		Approved by: Quality Manager
Document S/N: 1M1804030060-01-R1.ZNF	Test Dates: 04/03/18 - 04/16/18	DUT Type: Portable Handset		Page 86 of 131

**Table 11-24  
NII MIMO Body-Worn SAR**

MEASUREMENT RESULTS																					
FREQUENCY		Mode	Service	Bandwidth [MHz]	Maximum Allowed Power (Ant 1) [dBm]	Conducted Power (Ant 1) [dBm]	Maximum Allowed Power (Ant 2) [dBm]	Conducted Power (Ant 2) [dBm]	Power Drift [dB]	Spacing	Antenna Config.	Device Serial Number	Data Rate (Mbps)	Side	Duty Cycle (%)	Peak SAR of Area Scan	SAR (1g)	Scaling Factor (Power)	Scaling Factor (Duty Cycle)	Reported SAR (1g)	Plot #
MHz	Ch.															(W/kg)	(W/kg)	(W/kg)	(W/kg)		
5280	56	802.11n	OFDM	20	18.0	17.42	18.0	17.52	-0.02	10 mm	MIMO	09662	13	back	98.3	2.117	0.921	1.143	1.017	1.071	
5300	80	802.11n	OFDM	20	17.0	16.57	17.0	16.54	-0.03	10 mm	MIMO	09662	13	back	98.3	1.881	0.791	1.112	1.017	0.895	
5500	100	802.11n	OFDM	20	17.0	16.38	17.0	16.60	0.10	10 mm	MIMO	09662	13	back	98.3	2.226	0.991	1.153	1.017	1.162	A39
5620	124	802.11n	OFDM	20	17.0	16.28	17.0	16.39	-0.18	10 mm	MIMO	09662	13	back	98.3	2.105	0.912	1.180	1.017	1.094	
5720	144	802.11n	OFDM	20	17.0	16.67	17.0	16.87	0.06	10 mm	MIMO	09662	13	back	98.3	1.734	0.808	1.079	1.017	0.887	
5785	157	802.11n	OFDM	20	18.0	17.24	18.0	17.36	0.08	10 mm	MIMO	09662	13	back	98.3	2.056	0.825	1.191	1.017	0.999	
5805	161	802.11n	OFDM	20	18.0	17.23	18.0	17.28	0.04	10 mm	MIMO	09662	13	back	98.3	1.874	0.764	1.194	1.017	0.928	
5280	56	802.11n	OFDM	20	18.0	17.42	18.0	17.52	-0.06	10 mm	MIMO	09662	13	back	98.3	1.937	0.850	1.143	1.017	0.988	
5500	100	802.11n	OFDM	20	17.0	16.38	17.0	16.60	0.19	10 mm	MIMO	09662	13	back	98.3	2.161	0.960	1.153	1.017	1.126	
5785	157	802.11n	OFDM	20	18.0	17.24	18.0	17.36	0.10	10 mm	MIMO	09662	13	back	98.3	1.829	0.817	1.191	1.017	0.990	
ANSI / IEEE C95.1 1992 - SAFETY LIMIT											Body										
Spatial Peak											1.6 W/kg (mW/g)										
Uncontrolled Exposure/General Population											averaged over 1 gram										

Notes:

- Blue entries represent variability measurements.
- To achieve the 20.0 dBm (Ch. 60, 100, 124, 144) and 21.0 dBm (Ch. 56, 157, 161) maximum allowed MIMO power shown in the documentation, each antenna transmits at a maximum allowed power of 17.0 dBm (Ch. 60, 100, 124, 144) and 18.0 dBm (Ch. 56, 157, 161).



**Table 11-25  
NII Body-Worn SAR for Conditions with 2.4 GHz Ant 1 and 5 GHz Ant 2 WLAN**

MEASUREMENT RESULTS																			
FREQUENCY		Mode	Service	Bandwidth [MHz]	Maximum Allowed Power [dBm]	Conducted Power [dBm]	Power Drift [dB]	Spacing	Antenna Config.	Device Serial Number	Data Rate (Mbps)	Side	Duty Cycle (%)	Peak SAR of Area Scan	SAR (1g)	Scaling Factor (Power)	Scaling Factor (Duty Cycle)	Reported SAR (1g)	Plot #
MHz	Ch.													(W/kg)	(W/kg)	(W/kg)	(W/kg)		
5270	54	802.11n	OFDM	40	15.0	14.55	0.11	10 mm	2	09704	13.5	back	97.4	0.863	0.331	1.109	1.027	0.377	
5710	142	802.11n	OFDM	40	15.0	14.62	-0.12	10 mm	2	09704	13.5	back	97.4	1.326	0.510	1.091	1.027	0.571	
5795	159	802.11n	OFDM	40	15.0	14.51	-0.17	10 mm	2	09704	13.5	back	97.4	0.838	0.369	1.119	1.027	0.424	
ANSI / IEEE C95.1 1992 - SAFETY LIMIT											Body								
Spatial Peak											1.6 W/kg (mW/g)								
Uncontrolled Exposure/General Population											averaged over 1 gram								

NII was additionally evaluated at the maximum allowed output power during operations with simultaneous 2.4 GHz Ant 1 and 5 GHz Ant 2 WLAN. 2.4 GHz Ant1 WIFI was not transmitting during the above evaluations.

**Table 11-26  
DSS Body-Worn SAR**

MEASUREMENT RESULTS																
FREQUENCY		Mode	Service	Maximum Allowed Power [dBm]	Conducted Power [dBm]	Power Drift [dB]	Spacing	Device Serial Number	Data Rate (Mbps)	Side	Duty Cycle (%)	SAR (1g)	Scaling Factor (Cond Power)	Scaling Factor (Duty Cycle)	Reported SAR (1g)	Plot #
MHz	Ch.											(W/kg)	(W/kg)	(W/kg)		
2402	0	Bluetooth	FHSS	12.0	11.97	-0.06	10 mm	09688	1	back	77.3	0.031	1.007	1.294	0.040	A41
ANSI / IEEE C95.1 1992 - SAFETY LIMIT											Body					
Spatial Peak											1.6 W/kg (mW/g)					
Uncontrolled Exposure/General Population											averaged over 1 gram					



FCC ID: ZNFG710TM		<b>SAR EVALUATION REPORT</b>		Approved by: Quality Manager
Document S/N: 1M1804030060-01-R1.ZNF	Test Dates: 04/03/18 - 04/16/18	DUT Type: Portable Handset		Page 87 of 131

# 11.3 Standalone Hotspot SAR Data

**Table 11-27  
GPRS/UMTS Hotspot SAR Data**

MEASUREMENT RESULTS															
FREQUENCY		Mode	Service	Maximum Allowed Power [dBm]	Conducted Power [dBm]	Power Drift [dB]	Spacing	Device Serial Number	# of GPRS Slots	Duty Cycle	Side	SAR (1g)	Scaling Factor	Reported SAR (1g)	Plot #
MHz	Ch.											(W/kg)		(W/kg)	
836.60	190	GSM 850	GPRS	30.2	30.20	-0.18	10 mm	09662	3	1:2.76	back	0.350	1.000	0.350	A18
836.60	190	GSM 850	GPRS	30.2	30.20	-0.01	10 mm	09662	3	1:2.76	front	0.325	1.000	0.325	
836.60	190	GSM 850	GPRS	30.2	30.20	-0.01	10 mm	09662	3	1:2.76	bottom	0.198	1.000	0.198	
836.60	190	GSM 850	GPRS	30.2	30.20	0.02	10 mm	09662	3	1:2.76	right	0.251	1.000	0.251	
836.60	190	GSM 850	GPRS	30.2	30.20	-0.10	10 mm	09662	3	1:2.76	left	0.057	1.000	0.057	
1880.00	661	GSM 1900	GPRS	29.7	29.21	-0.16	10 mm	09670	2	1:4.15	back	0.260	1.119	0.291	
1880.00	661	GSM 1900	GPRS	29.7	29.21	-0.05	10 mm	09670	2	1:4.15	front	0.220	1.119	0.246	
1850.20	512	GSM 1900	GPRS	29.7	29.20	-0.05	10 mm	09670	2	1:4.15	bottom	0.551	1.122	0.618	
1880.00	661	GSM 1900	GPRS	29.7	29.21	0.01	10 mm	09670	2	1:4.15	bottom	0.555	1.119	0.621	
1909.80	810	GSM 1900	GPRS	29.7	29.15	0.04	10 mm	09670	2	1:4.15	bottom	0.648	1.135	0.735	A20
1880.00	661	GSM 1900	GPRS	29.7	29.21	-0.09	10 mm	09670	2	1:4.15	left	0.150	1.119	0.168	
836.60	4183	UMTS 850	RMC	25.5	25.03	0.02	10 mm	09662	N/A	1:1	back	0.399	1.114	0.444	A21
836.60	4183	UMTS 850	RMC	25.5	25.03	-0.01	10 mm	09662	N/A	1:1	front	0.357	1.114	0.398	
836.60	4183	UMTS 850	RMC	25.5	25.03	-0.01	10 mm	09662	N/A	1:1	bottom	0.276	1.114	0.307	
836.60	4183	UMTS 850	RMC	25.5	25.03	-0.03	10 mm	09662	N/A	1:1	right	0.280	1.114	0.312	
836.60	4183	UMTS 850	RMC	25.5	25.03	0.03	10 mm	09662	N/A	1:1	left	0.132	1.114	0.147	
1732.40	1412	UMTS 1750	RMC	25.2	25.16	-0.01	10 mm	09654	N/A	1:1	back	0.517	1.009	0.522	
1732.40	1412	UMTS 1750	RMC	25.2	25.16	-0.01	10 mm	09654	N/A	1:1	front	0.411	1.009	0.415	
1712.40	1312	UMTS 1750	RMC	25.2	25.10	-0.02	10 mm	09654	N/A	1:1	bottom	0.625	1.023	0.639	
1732.40	1412	UMTS 1750	RMC	25.2	25.16	-0.03	10 mm	09654	N/A	1:1	bottom	0.718	1.009	0.724	
1752.60	1513	UMTS 1750	RMC	25.2	25.14	-0.03	10 mm	09654	N/A	1:1	bottom	0.816	1.014	0.827	A23
1732.40	1412	UMTS 1750	RMC	25.2	25.16	0.00	10 mm	09654	N/A	1:1	left	0.303	1.009	0.306	
1880.00	9400	UMTS 1900	RMC	25.5	25.47	-0.02	10 mm	09670	N/A	1:1	back	0.501	1.007	0.505	
1880.00	9400	UMTS 1900	RMC	25.5	25.47	-0.06	10 mm	09670	N/A	1:1	front	0.419	1.007	0.422	
1852.40	9262	UMTS 1900	RMC	25.5	25.48	-0.02	10 mm	09670	N/A	1:1	bottom	0.968	1.005	0.973	
1880.00	9400	UMTS 1900	RMC	25.5	25.47	-0.08	10 mm	09670	N/A	1:1	bottom	0.965	1.007	0.972	
1907.60	9538	UMTS 1900	RMC	25.5	25.44	-0.07	10 mm	09670	N/A	1:1	bottom	1.060	1.014	1.075	A25
1880.00	9400	UMTS 1900	RMC	25.5	25.47	0.04	10 mm	09670	N/A	1:1	left	0.254	1.007	0.256	
1907.60	9538	UMTS 1900	RMC	25.5	25.44	-0.11	10 mm	09670	N/A	1:1	bottom	1.050	1.014	1.065	
ANSI / IEEE C95.1 1992 - SAFETY LIMIT Spatial Peak Uncontrolled Exposure/General Population							Body 1.6 W/kg (mW/g) averaged over 1 gram								

**Note: Blue entry represents variability measurement.**

FCC ID: ZNFG710TM		SAR EVALUATION REPORT		Approved by: Quality Manager
Document S/N: 1M1804030060-01-R1.ZNF	Test Dates: 04/03/18 - 04/16/18	DUT Type: Portable Handset	Page 88 of 131	



**Table 11-28  
LTE Band 71 Hotspot SAR**



MEASUREMENT RESULTS																			
FREQUENCY		Mode	Bandwidth [MHz]	Maximum Allowed Power [dBm]	Conducted Power [dBm]	Power Drift [dB]	MPR [dB]	Device Serial Number	Modulation	RB Size	RB Offset	Spacing	Side	Duty Cycle	SAR (1g)	Scaling Factor	Reported SAR (1g)	Plot #	
MHz	Ch.														(W/kg)		(W/kg)		
680.50	133297	Mid	LTE Band 71	20	25.5	25.15	-0.04	0	09662	QPSK	1	99	10 mm	back	1:1	0.383	1.084	0.415	A26
680.50	133297	Mid	LTE Band 71	20	24.5	24.19	0.01	1	09662	QPSK	50	0	10 mm	back	1:1	0.265	1.074	0.285	
680.50	133297	Mid	LTE Band 71	20	25.5	25.15	0.04	0	09662	QPSK	1	99	10 mm	front	1:1	0.317	1.084	0.344	
680.50	133297	Mid	LTE Band 71	20	24.5	24.19	0.02	1	09662	QPSK	50	0	10 mm	front	1:1	0.216	1.074	0.232	
680.50	133297	Mid	LTE Band 71	20	25.5	25.15	-0.05	0	09662	QPSK	1	99	10 mm	bottom	1:1	0.213	1.084	0.231	
680.50	133297	Mid	LTE Band 71	20	24.5	24.19	-0.04	1	09662	QPSK	50	0	10 mm	bottom	1:1	0.139	1.074	0.149	
680.50	133297	Mid	LTE Band 71	20	25.5	25.15	-0.02	0	09662	QPSK	1	99	10 mm	right	1:1	0.147	1.084	0.159	
680.50	133297	Mid	LTE Band 71	20	24.5	24.19	0.00	1	09662	QPSK	50	0	10 mm	right	1:1	0.128	1.074	0.137	
680.50	133297	Mid	LTE Band 71	20	25.5	25.15	0.00	0	09662	QPSK	1	99	10 mm	left	1:1	0.093	1.084	0.101	
680.50	133297	Mid	LTE Band 71	20	24.5	24.19	0.03	1	09662	QPSK	50	0	10 mm	left	1:1	0.068	1.074	0.073	
ANSI / IEEE C95.1 1992 - SAFETY LIMIT Spatial Peak Uncontrolled Exposure/General Population								Body 1.6 W/kg (mW/g) averaged over 1 gram											

**Table 11-29  
LTE Band 12 Hotspot SAR**

MEASUREMENT RESULTS																			
FREQUENCY		Mode	Bandwidth [MHz]	Maximum Allowed Power [dBm]	Conducted Power [dBm]	Power Drift [dB]	MPR [dB]	Device Serial Number	Modulation	RB Size	RB Offset	Spacing	Side	Duty Cycle	SAR (1g)	Scaling Factor	Reported SAR (1g)	Plot #	
MHz	Ch.														(W/kg)		(W/kg)		
707.50	23095	Mid	LTE Band 12	10	25.5	25.17	-0.07	0	09662	QPSK	1	49	10 mm	back	1:1	0.491	1.079	0.530	A27
707.50	23095	Mid	LTE Band 12	10	24.5	24.20	0.01	1	09662	QPSK	25	0	10 mm	back	1:1	0.312	1.072	0.334	
707.50	23095	Mid	LTE Band 12	10	25.5	25.17	-0.02	0	09662	QPSK	1	49	10 mm	front	1:1	0.413	1.079	0.446	
707.50	23095	Mid	LTE Band 12	10	24.5	24.20	-0.04	1	09662	QPSK	25	0	10 mm	front	1:1	0.264	1.072	0.283	
707.50	23095	Mid	LTE Band 12	10	25.5	25.17	0.00	0	09662	QPSK	1	49	10 mm	bottom	1:1	0.252	1.079	0.272	
707.50	23095	Mid	LTE Band 12	10	24.5	24.20	-0.01	1	09662	QPSK	25	0	10 mm	bottom	1:1	0.160	1.072	0.172	
707.50	23095	Mid	LTE Band 12	10	25.5	25.17	0.00	0	09662	QPSK	1	49	10 mm	right	1:1	0.264	1.079	0.285	
707.50	23095	Mid	LTE Band 12	10	24.5	24.20	-0.01	1	09662	QPSK	25	0	10 mm	right	1:1	0.199	1.072	0.213	
707.50	23095	Mid	LTE Band 12	10	25.5	25.17	-0.03	0	09662	QPSK	1	49	10 mm	left	1:1	0.124	1.079	0.134	
707.50	23095	Mid	LTE Band 12	10	24.5	24.20	-0.02	1	09662	QPSK	25	0	10 mm	left	1:1	0.093	1.072	0.100	
ANSI / IEEE C95.1 1992 - SAFETY LIMIT Spatial Peak Uncontrolled Exposure/General Population								Body 1.6 W/kg (mW/g) averaged over 1 gram											

**Table 11-30  
LTE Band 13 Hotspot SAR**

MEASUREMENT RESULTS																			
FREQUENCY		Mode	Bandwidth [MHz]	Maximum Allowed Power [dBm]	Conducted Power [dBm]	Power Drift [dB]	MPR [dB]	Device Serial Number	Modulation	RB Size	RB Offset	Spacing	Side	Duty Cycle	SAR (1g)	Scaling Factor	Reported SAR (1g)	Plot #	
MHz	Ch.														(W/kg)		(W/kg)		
782.00	23230	Mid	LTE Band 13	10	25.5	25.19	-0.02	0	09696	QPSK	1	25	10 mm	back	1:1	0.459	1.074	0.493	A28
782.00	23230	Mid	LTE Band 13	10	24.5	24.18	-0.01	1	09696	QPSK	25	12	10 mm	back	1:1	0.317	1.076	0.341	
782.00	23230	Mid	LTE Band 13	10	25.5	25.19	0.03	0	09696	QPSK	1	25	10 mm	front	1:1	0.459	1.074	0.493	
782.00	23230	Mid	LTE Band 13	10	24.5	24.18	0.03	1	09696	QPSK	25	12	10 mm	front	1:1	0.319	1.076	0.343	
782.00	23230	Mid	LTE Band 13	10	25.5	25.19	0.02	0	09696	QPSK	1	25	10 mm	bottom	1:1	0.292	1.074	0.314	
782.00	23230	Mid	LTE Band 13	10	24.5	24.18	0.01	1	09696	QPSK	25	12	10 mm	bottom	1:1	0.201	1.076	0.216	
782.00	23230	Mid	LTE Band 13	10	25.5	25.19	-0.03	0	09696	QPSK	1	25	10 mm	right	1:1	0.311	1.074	0.334	
782.00	23230	Mid	LTE Band 13	10	24.5	24.18	0.03	1	09696	QPSK	25	12	10 mm	right	1:1	0.224	1.076	0.241	
782.00	23230	Mid	LTE Band 13	10	25.5	25.19	-0.03	0	09696	QPSK	1	25	10 mm	left	1:1	0.164	1.074	0.176	
782.00	23230	Mid	LTE Band 13	10	24.5	24.18	-0.02	1	09696	QPSK	25	12	10 mm	left	1:1	0.114	1.076	0.123	
ANSI / IEEE C95.1 1992 - SAFETY LIMIT Spatial Peak Uncontrolled Exposure/General Population								Body 1.6 W/kg (mW/g) averaged over 1 gram											

FCC ID: ZNFG710TM		<b>SAR EVALUATION REPORT</b>		Approved by: Quality Manager
Document S/N: 1M1804030060-01-R1-ZNF	Test Dates: 04/03/18 - 04/16/18	DUT Type: Portable Handset	Page 89 of 131	



**Table 11-31  
LTE Band 5 (Cell) Hotspot SAR**

MEASUREMENT RESULTS																			
FREQUENCY		Mode	Bandwidth [MHz]	Maximum Allowed Power [dBm]	Conducted Power [dBm]	Power Drift [dB]	MPR [dB]	Device Serial Number	Modulation	RB Size	RB Offset	Spacing	Side	Duty Cycle	SAR (1g)	Scaling Factor	Reported SAR (1g)	Plot #	
MHz	Ch.														(W/kg)		(W/kg)		
836.50	20525	Mid	LTE Band 5 (Cell)	10	25.5	25.16	0.03	0	09662	QPSK	1	49	10 mm	back	1:1	0.350	1.081	0.378	A29
836.50	20525	Mid	LTE Band 5 (Cell)	10	24.5	24.18	-0.02	1	09662	QPSK	25	0	10 mm	back	1:1	0.241	1.076	0.259	
836.50	20525	Mid	LTE Band 5 (Cell)	10	25.5	25.16	0.03	0	09662	QPSK	1	49	10 mm	front	1:1	0.341	1.081	0.369	
836.50	20525	Mid	LTE Band 5 (Cell)	10	24.5	24.18	-0.01	1	09662	QPSK	25	0	10 mm	front	1:1	0.228	1.076	0.245	
836.50	20525	Mid	LTE Band 5 (Cell)	10	25.5	25.16	-0.01	0	09662	QPSK	1	49	10 mm	bottom	1:1	0.261	1.081	0.282	
836.50	20525	Mid	LTE Band 5 (Cell)	10	24.5	24.18	-0.10	1	09662	QPSK	25	0	10 mm	bottom	1:1	0.189	1.076	0.203	
836.50	20525	Mid	LTE Band 5 (Cell)	10	25.5	25.16	-0.10	0	09662	QPSK	1	49	10 mm	right	1:1	0.290	1.081	0.313	
836.50	20525	Mid	LTE Band 5 (Cell)	10	24.5	24.18	0.03	1	09662	QPSK	25	0	10 mm	right	1:1	0.177	1.076	0.190	
836.50	20525	Mid	LTE Band 5 (Cell)	10	25.5	25.16	-0.01	0	09662	QPSK	1	49	10 mm	left	1:1	0.147	1.081	0.159	
836.50	20525	Mid	LTE Band 5 (Cell)	10	24.5	24.18	-0.01	1	09662	QPSK	25	0	10 mm	left	1:1	0.087	1.076	0.094	
ANSI / IEEE C95.1 1992 - SAFETY LIMIT Spatial Peak Uncontrolled Exposure/General Population									Body 1.6 W/kg (mW/g) averaged over 1 gram										

**Table 11-32  
LTE Band 66 (AWS) Hotspot SAR**

MEASUREMENT RESULTS																			
FREQUENCY		Mode	Bandwidth [MHz]	Maximum Allowed Power [dBm]	Conducted Power [dBm]	Power Drift [dB]	MPR [dB]	Device Serial Number	Modulation	RB Size	RB Offset	Spacing	Side	Duty Cycle	SAR (1g)	Scaling Factor	Reported SAR (1g)	Plot #	
MHz	Ch.														(W/kg)		(W/kg)		
1720.00	132072	Low	LTE Band 66 (AWS)	20	25.2	25.20	0.00	0	09696	QPSK	1	0	10 mm	back	1:1	0.618	1.000	0.618	
1720.00	132072	Low	LTE Band 66 (AWS)	20	24.2	24.20	-0.06	1	09696	QPSK	50	25	10 mm	back	1:1	0.454	1.000	0.454	
1720.00	132072	Low	LTE Band 66 (AWS)	20	25.2	25.20	0.02	0	09696	QPSK	1	0	10 mm	front	1:1	0.489	1.000	0.489	
1720.00	132072	Low	LTE Band 66 (AWS)	20	24.2	24.20	0.00	1	09696	QPSK	50	25	10 mm	front	1:1	0.367	1.000	0.367	
1720.00	132072	Low	LTE Band 66 (AWS)	20	25.2	25.20	0.00	0	09696	QPSK	1	0	10 mm	bottom	1:1	0.657	1.000	0.657	
1745.00	132322	Mid	LTE Band 66 (AWS)	20	25.2	25.05	0.02	0	09696	QPSK	1	0	10 mm	bottom	1:1	0.803	1.035	0.831	
1770.00	132572	High	LTE Band 66 (AWS)	20	25.2	25.14	-0.07	0	09696	QPSK	1	99	10 mm	bottom	1:1	1.050	1.014	1.065	A31
1720.00	132072	Low	LTE Band 66 (AWS)	20	24.2	24.20	0.00	1	09696	QPSK	50	25	10 mm	bottom	1:1	0.491	1.000	0.491	
1720.00	132072	Low	LTE Band 66 (AWS)	20	24.2	24.16	-0.01	1	09696	QPSK	100	0	10 mm	bottom	1:1	0.485	1.009	0.489	
1720.00	132072	Low	LTE Band 66 (AWS)	20	25.2	25.20	-0.01	0	09696	QPSK	1	0	10 mm	left	1:1	0.422	1.000	0.422	
1720.00	132072	Low	LTE Band 66 (AWS)	20	24.2	24.20	0.00	1	09696	QPSK	50	25	10 mm	left	1:1	0.312	1.000	0.312	
1770.00	132572	High	LTE Band 66 (AWS)	20	25.2	25.14	-0.05	0	09696	QPSK	1	99	10 mm	bottom	1:1	1.040	1.014	1.055	
ANSI / IEEE C95.1 1992 - SAFETY LIMIT Spatial Peak Uncontrolled Exposure/General Population									Body 1.6 W/kg (mW/g) averaged over 1 gram										

**Note: Blue entry represents variability measurement.**



FCC ID: ZNFG710TM		SAR EVALUATION REPORT		Approved by: Quality Manager
Document S/N: 1M1804030060-01-R1-ZNF	Test Dates: 04/03/18 - 04/16/18	DUT Type: Portable Handset	Page 90 of 131	

**Table 11-33  
LTE Band 25 (PCS) Hotspot SAR**

MEASUREMENT RESULTS																			
FREQUENCY		Mode	Bandwidth [MHz]	Maximum Allowed Power [dBm]	Conducted Power [dBm]	Power Drift [dB]	MPR [dB]	Device Serial Number	Modulation	RB Size	RB Offset	Spacing	Side	Duty Cycle	SAR (1g)	Scaling Factor	Reported SAR	Plot #	
MHz	Ch.														(W/kg)		(W/kg)		
1905.00	26590	High	LTE Band 25 (PCS)	20	25.5	25.32	-0.19	0	09670	QPSK	1	99	10 mm	back	1:1	0.294	1.042	0.306	
1882.50	26365	Mid	LTE Band 25 (PCS)	20	24.5	24.36	0.03	1	09670	QPSK	50	50	10 mm	back	1:1	0.197	1.033	0.204	
1905.00	26590	High	LTE Band 25 (PCS)	20	25.5	25.32	-0.13	0	09670	QPSK	1	99	10 mm	front	1:1	0.269	1.042	0.280	
1882.50	26365	Mid	LTE Band 25 (PCS)	20	24.5	24.36	0.07	1	09670	QPSK	50	50	10 mm	front	1:1	0.197	1.033	0.204	
1860.00	26140	Low	LTE Band 25 (PCS)	20	25.5	25.29	0.00	0	09670	QPSK	1	50	10 mm	bottom	1:1	0.752	1.050	0.790	
1882.50	26365	Mid	LTE Band 25 (PCS)	20	25.5	25.14	-0.03	0	09670	QPSK	1	99	10 mm	bottom	1:1	0.754	1.086	0.819	
1905.00	26590	High	LTE Band 25 (PCS)	20	25.5	25.32	-0.15	0	09670	QPSK	1	99	10 mm	bottom	1:1	0.883	1.042	0.920	A33
1882.50	26365	Mid	LTE Band 25 (PCS)	20	24.5	24.36	-0.02	1	09670	QPSK	50	50	10 mm	bottom	1:1	0.545	1.033	0.563	
1882.50	26365	Mid	LTE Band 25 (PCS)	20	24.5	24.34	-0.04	1	09670	QPSK	100	0	10 mm	bottom	1:1	0.551	1.038	0.572	
1905.00	26590	High	LTE Band 25 (PCS)	20	25.5	25.32	-0.18	0	09670	QPSK	1	99	10 mm	left	1:1	0.219	1.042	0.228	
1882.50	26365	Mid	LTE Band 25 (PCS)	20	24.5	24.36	0.03	1	09670	QPSK	50	50	10 mm	left	1:1	0.148	1.033	0.153	
ANSI / IEEE C95.1 1992 - SAFETY LIMIT Spatial Peak Uncontrolled Exposure/General Population										Body 1.6 W/kg (mW/g) averaged over 1 gram									

**Table 11-34  
LTE Band 30 Hotspot SAR**



MEASUREMENT RESULTS																			
FREQUENCY		Mode	Bandwidth [MHz]	Maximum Allowed Power [dBm]	Conducted Power [dBm]	Power Drift [dB]	MPR [dB]	Device Serial Number	Modulation	RB Size	RB Offset	Spacing	Side	Duty Cycle	SAR (1g)	Scaling Factor	Reported SAR	Plot #	
MHz	Ch.														(W/kg)		(W/kg)		
2310.00	27710	Mid	LTE Band 30	10	25.5	25.25	0.06	0	09670	QPSK	1	25	10 mm	back	1:1	0.290	1.059	0.307	A34
2310.00	27710	Mid	LTE Band 30	10	24.5	24.10	0.03	1	09670	QPSK	25	12	10 mm	back	1:1	0.244	1.096	0.267	
2310.00	27710	Mid	LTE Band 30	10	25.5	25.25	-0.02	0	09670	QPSK	1	25	10 mm	front	1:1	0.120	1.059	0.127	
2310.00	27710	Mid	LTE Band 30	10	24.5	24.10	-0.05	1	09670	QPSK	25	12	10 mm	front	1:1	0.099	1.096	0.109	
2310.00	27710	Mid	LTE Band 30	10	25.5	25.25	-0.10	0	09670	QPSK	1	25	10 mm	bottom	1:1	0.284	1.059	0.301	
2310.00	27710	Mid	LTE Band 30	10	24.5	24.10	-0.05	1	09670	QPSK	25	12	10 mm	bottom	1:1	0.238	1.096	0.261	
2310.00	27710	Mid	LTE Band 30	10	25.5	25.25	0.14	0	09670	QPSK	1	25	10 mm	right	1:1	0.005	1.059	0.005	
2310.00	27710	Mid	LTE Band 30	10	24.5	24.10	0.16	1	09670	QPSK	25	12	10 mm	right	1:1	0.004	1.096	0.004	
2310.00	27710	Mid	LTE Band 30	10	25.5	25.25	-0.13	0	09670	QPSK	1	25	10 mm	left	1:1	0.012	1.059	0.013	
2310.00	27710	Mid	LTE Band 30	10	24.5	24.10	0.01	1	09670	QPSK	25	12	10 mm	left	1:1	0.010	1.096	0.011	
ANSI / IEEE C95.1 1992 - SAFETY LIMIT Spatial Peak Uncontrolled Exposure/General Population										Body 1.6 W/kg (mW/g) averaged over 1 gram									

FCC ID: ZNFG710TM		SAR EVALUATION REPORT		Approved by: Quality Manager
Document S/N: 1M1804030060-01-R1.ZNF	Test Dates: 04/03/18 - 04/16/18	DUT Type: Portable Handset		Page 91 of 131

**Table 11-35  
LTE Band 7 Hotspot SAR**



MEASUREMENT RESULTS																			
FREQUENCY		Mode	Bandwidth [MHz]	Maximum Allowed Power [dBm]	Conducted Power [dBm]	Power Drift [dB]	MPR [dB]	Device Serial Number	Modulation	RB Size	RB Offset	Spacing	Side	Duty Cycle	SAR (1g)	Scaling Factor	Reported SAR	Plot #	
MHz	Ch.														(W/kg)		(1g)		
2510.00	20850	Low	LTE Band 7	20	25.5	25.03	0.11	0	09670	QPSK	1	99	10 mm	back	1:1	1.150	1.114	1.281	
2535.00	21100	Mid	LTE Band 7	20	25.5	25.20	-0.14	0	09670	QPSK	1	50	10 mm	back	1:1	1.210	1.072	1.297	A35
2560.00	21350	High	LTE Band 7	20	25.5	25.31	-0.07	0	09670	QPSK	1	50	10 mm	back	1:1	0.993	1.045	1.038	
2510.00	20850	Low	LTE Band 7	20	24.5	24.29	-0.08	1	09670	QPSK	50	25	10 mm	back	1:1	0.860	1.050	0.903	
2535.00	21100	Mid	LTE Band 7	20	24.5	24.27	0.08	1	09670	QPSK	50	0	10 mm	back	1:1	0.911	1.054	0.960	
2560.00	21350	High	LTE Band 7	20	24.5	24.05	-0.11	1	09670	QPSK	50	50	10 mm	back	1:1	0.770	1.109	0.854	
2560.00	21350	High	LTE Band 7	20	24.5	24.05	0.03	1	09670	QPSK	100	0	10 mm	back	1:1	0.787	1.109	0.873	
2560.00	21350	High	LTE Band 7	20	25.5	25.31	0.03	0	09670	QPSK	1	50	10 mm	front	1:1	0.320	1.045	0.334	
2510.00	20850	Low	LTE Band 7	20	24.5	24.29	0.01	1	09670	QPSK	50	25	10 mm	front	1:1	0.249	1.050	0.261	
2510.00	20850	Low	LTE Band 7	20	25.5	25.03	-0.07	0	09670	QPSK	1	99	10 mm	bottom	1:1	0.948	1.114	1.056	
2535.00	21100	Mid	LTE Band 7	20	25.5	25.20	0.03	0	09670	QPSK	1	50	10 mm	bottom	1:1	0.921	1.072	0.987	
2560.00	21350	High	LTE Band 7	20	25.5	25.31	0.05	0	09670	QPSK	1	50	10 mm	bottom	1:1	0.837	1.045	0.875	
2510.00	20850	Low	LTE Band 7	20	24.5	24.29	-0.06	1	09670	QPSK	50	25	10 mm	bottom	1:1	0.681	1.050	0.715	
2560.00	21350	High	LTE Band 7	20	24.5	24.05	-0.08	1	09670	QPSK	100	0	10 mm	bottom	1:1	0.622	1.109	0.690	
2560.00	21350	High	LTE Band 7	20	25.5	25.31	0.16	0	09670	QPSK	1	50	10 mm	right	1:1	0.048	1.045	0.050	
2510.00	20850	Low	LTE Band 7	20	24.5	24.29	0.15	1	09670	QPSK	50	25	10 mm	right	1:1	0.033	1.050	0.035	
2560.00	21350	High	LTE Band 7	20	25.5	25.31	0.16	0	09670	QPSK	1	50	10 mm	left	1:1	0.083	1.045	0.087	
2510.00	20850	Low	LTE Band 7	20	24.5	24.29	0.16	1	09670	QPSK	50	25	10 mm	left	1:1	0.061	1.050	0.064	
2510.00	20850	Low	LTE Band 7	20	25.5	25.03	-0.02	0	09670	QPSK	1	99	10 mm	back	1:1	1.070	1.114	1.192	
2535.00	21100	Mid	LTE Band 7	20	25.5	25.20	-0.14	0	09670	QPSK	1	50	10 mm	back	1:1	1.200	1.072	1.286	
ANSI / IEEE C95.1 1992 - SAFETY LIMIT Spatial Peak Uncontrolled Exposure/General Population								Body 1.6 W/kg (mW/g) averaged over 1 gram											

**Note: Blue entry represents variability measurement.**

FCC ID: ZNFG710TM		SAR EVALUATION REPORT		Approved by: Quality Manager
Document S/N: 1M1804030060-01-R1.ZNF	Test Dates: 04/03/18 - 04/16/18	DUT Type: Portable Handset	Page 92 of 131	



**Table 11-36  
LTE Band 41 Hotspot SAR**

MEASUREMENT RESULTS																			
FREQUENCY		Mode	Bandwidth [MHz]	Maximum Allowed Power [dBm]	Conducted Power [dBm]	Power Drift [dB]	MPR [dB]	Device Serial Number	Modulation	RB Size	RB Offset	Spacing	Side	Duty Cycle	SAR (1g)	Scaling Factor	Reported SAR	Plot #	
MHz	Ch.														(W/kg)		(1g)		
2506.00	39750	Low	LTE Band 41	20	25.2	25.20	-0.04	0	09654	QPSK	1	50	10 mm	back	1:1.58	0.700	1.000	0.700	
2549.50	40185	Low-Mid	LTE Band 41	20	25.2	25.11	-0.14	0	09654	QPSK	1	50	10 mm	back	1:1.58	0.699	1.021	0.714	
2593.00	40620	Mid	LTE Band 41	20	25.2	24.82	-0.01	0	09654	QPSK	1	0	10 mm	back	1:1.58	0.601	1.091	0.656	
2636.50	41055	Mid-High	LTE Band 41	20	25.2	25.02	0.10	0	09654	QPSK	1	0	10 mm	back	1:1.58	0.577	1.042	0.601	
2680.00	41490	High	LTE Band 41	20	25.2	24.87	-0.12	0	09654	QPSK	1	99	10 mm	back	1:1.58	0.435	1.079	0.469	
2680.00	41490	High	LTE Band 41	20	24.2	24.19	0.08	1	09654	QPSK	50	25	10 mm	back	1:1.58	0.392	1.002	0.393	
2593.00	40620	Mid	LTE Band 41	20	24.2	24.11	-0.13	1	09654	QPSK	100	0	10 mm	back	1:1.58	0.460	1.021	0.470	
2506.00	39750	Low	LTE Band 41	20	25.2	25.20	0.10	0	09654	QPSK	1	50	10 mm	front	1:1.58	0.406	1.000	0.406	
2680.00	41490	High	LTE Band 41	20	24.2	24.19	-0.05	1	09654	QPSK	50	25	10 mm	front	1:1.58	0.148	1.002	0.148	
2506.00	39750	Low	LTE Band 41	20	25.2	25.20	0.06	0	09654	QPSK	1	50	10 mm	bottom	1:1.58	0.883	1.000	0.883	A37
2549.50	40185	Low-Mid	LTE Band 41	20	25.2	25.11	-0.02	0	09654	QPSK	1	50	10 mm	bottom	1:1.58	0.847	1.021	0.865	
2593.00	40620	Mid	LTE Band 41	20	25.2	24.82	0.07	0	09654	QPSK	1	0	10 mm	bottom	1:1.58	0.792	1.091	0.864	
2636.50	41055	Mid-High	LTE Band 41	20	25.2	25.02	-0.04	0	09654	QPSK	1	0	10 mm	bottom	1:1.58	0.744	1.042	0.775	
2680.00	41490	High	LTE Band 41	20	25.2	24.87	-0.01	0	09654	QPSK	1	99	10 mm	bottom	1:1.58	0.510	1.079	0.550	
2680.00	41490	High	LTE Band 41	20	24.2	24.19	0.17	1	09654	QPSK	50	25	10 mm	bottom	1:1.58	0.476	1.002	0.477	
2593.00	40620	Mid	LTE Band 41	20	24.2	24.11	0.16	1	09654	QPSK	100	0	10 mm	bottom	1:1.58	0.543	1.021	0.554	
2506.00	39750	Low	LTE Band 41	20	25.2	25.20	-0.04	0	09654	QPSK	1	50	10 mm	right	1:1.58	0.030	1.000	0.030	
2680.00	41490	High	LTE Band 41	20	24.2	24.19	0.21	1	09654	QPSK	50	25	10 mm	right	1:1.58	0.025	1.002	0.025	
2506.00	39750	Low	LTE Band 41	20	25.2	25.20	0.21	0	09654	QPSK	1	50	10 mm	left	1:1.58	0.059	1.000	0.059	
2680.00	41490	High	LTE Band 41	20	24.2	24.19	0.16	1	09654	QPSK	50	25	10 mm	left	1:1.58	0.058	1.002	0.058	
ANSI / IEEE C95.1 1992 - SAFETY LIMIT Spatial Peak Uncontrolled Exposure/General Population								Body 1.6 W/kg (mW/g) averaged over 1 gram											

FCC ID: ZNFG710TM		SAR EVALUATION REPORT		Approved by: Quality Manager
Document S/N: 1M1804030060-01-R1.ZNF	Test Dates: 04/03/18 - 04/16/18	DUT Type: Portable Handset	Page 93 of 131	

**Table 11-37  
WLAN SISO Hotspot SAR**

MEASUREMENT RESULTS																			
FREQUENCY		Mode	Service	Bandwidth [MHz]	Maximum Allowed Power [dBm]	Conducted Power [dBm]	Power Drift [dB]	Spacing	Antenna Config.	Device Serial Number	Data Rate (Mbps)	Side	Duty Cycle (%)	Peak SAR of Area Scan	SAR (1g)	Scaling Factor (Power)	Scaling Factor (Duty Cycle)	Reported SAR (1g)	Plot #
MHz	Ch.													W/kg	(W/kg)			(W/kg)	
2437	6	802.11b	DSSS	22	21.0	20.84	0.21	10 mm	1	09688	1	back	99.2	0.456	0.376	1.038	1.008	0.393	
2437	6	802.11b	DSSS	22	21.0	20.84	0.11	10 mm	1	09688	1	front	99.2	0.232	-	1.038	1.008	-	
2437	6	802.11b	DSSS	22	21.0	20.84	0.07	10 mm	1	09688	1	top	99.2	0.512	0.384	1.038	1.008	0.402	
2437	6	802.11b	DSSS	22	21.0	20.84	0.18	10 mm	1	09688	1	left	99.2	0.100	-	1.038	1.008	-	
2462	11	802.11b	DSSS	22	21.0	20.78	0.13	10 mm	2	09688	1	back	99.3	0.420	0.363	1.052	1.007	0.385	
2462	11	802.11b	DSSS	22	21.0	20.78	0.20	10 mm	2	09688	1	front	99.3	0.035	-	1.052	1.007	-	
2462	11	802.11b	DSSS	22	21.0	20.78	-0.12	10 mm	2	09688	1	top	99.3	0.022	-	1.052	1.007	-	
2462	11	802.11b	DSSS	22	21.0	20.78	0.11	10 mm	2	09688	1	left	99.3	0.163	-	1.052	1.007	-	
5200	40	802.11a	OFDM	20	18.0	17.76	0.15	10 mm	1	09662	6	back	98.3	0.326	0.150	1.057	1.017	0.161	
5200	40	802.11a	OFDM	20	18.0	17.76	0.14	10 mm	1	09662	6	front	98.3	0.071	0.021	1.057	1.017	0.023	
5200	40	802.11a	OFDM	20	18.0	17.76	0.19	10 mm	1	09662	6	top	98.3	0.069	-	1.057	1.017	-	
5200	40	802.11a	OFDM	20	18.0	17.76	0.00	10 mm	1	09662	6	left	98.3	0.060	-	1.057	1.017	-	
5200	40	802.11a	OFDM	20	18.0	17.73	-0.12	10 mm	2	09662	6	back	98.3	1.461	0.618	1.064	1.017	0.669	
5200	40	802.11a	OFDM	20	18.0	17.73	0.02	10 mm	2	09662	6	front	98.3	0.017	0.006	1.064	1.017	0.006	
5200	40	802.11a	OFDM	20	18.0	17.73	0.12	10 mm	2	09662	6	top	98.3	0.081	-	1.064	1.017	-	
5200	40	802.11a	OFDM	20	18.0	17.73	0.18	10 mm	2	09662	6	left	98.3	0.343	0.145	1.064	1.017	0.157	
5785	157	802.11a	OFDM	20	18.0	17.42	0.10	10 mm	1	09662	6	back	98.3	0.117	0.039	1.143	1.017	0.045	
5785	157	802.11a	OFDM	20	18.0	17.42	0.00	10 mm	1	09662	6	front	98.3	0.073	0.025	1.143	1.017	0.029	
5785	157	802.11a	OFDM	20	18.0	17.42	0.17	10 mm	1	09662	6	top	98.3	0.052	-	1.143	1.017	-	
5785	157	802.11a	OFDM	20	18.0	17.42	0.00	10 mm	1	09662	6	left	98.3	0.055	-	1.143	1.017	-	
5785	157	802.11a	OFDM	20	18.0	17.57	0.04	10 mm	2	09662	6	back	98.3	1.808	0.769	1.104	1.017	0.863	
5805	161	802.11a	OFDM	20	18.0	17.46	0.05	10 mm	2	09662	6	back	98.3	1.896	0.753	1.132	1.017	0.867	
5825	165	802.11a	OFDM	20	17.0	16.67	-0.10	10 mm	2	09662	6	back	98.3	1.400	0.549	1.079	1.017	0.602	
5785	157	802.11a	OFDM	20	18.0	17.57	0.00	10 mm	2	09662	6	front	98.3	0.039	0.015	1.104	1.017	0.017	
5785	157	802.11a	OFDM	20	18.0	17.57	-0.21	10 mm	2	09662	6	top	98.3	0.167	-	1.104	1.017	-	
5785	157	802.11a	OFDM	20	18.0	17.57	0.00	10 mm	2	09662	6	left	98.3	0.497	0.186	1.104	1.017	0.209	
ANSI / IEEE C95.1 1992 - SAFETY LIMIT								Body											
Spatial Peak								1.6 W/kg (mW/g)											
Uncontrolled Exposure/General Population								averaged over 1 gram											

FCC ID: ZNFG710TM		SAR EVALUATION REPORT		Approved by: Quality Manager
Document S/N: 1M1804030060-01-R1.ZNF	Test Dates: 04/03/18 - 04/16/18	DUT Type: Portable Handset	Page 94 of 131	

**Table 11-38  
WLAN MIMO Hotspot SAR**

MEASUREMENT RESULTS																					
FREQUENCY		Mode	Service	Bandwidth [MHz]	Maximum Allowed Power (Ant 1) [dBm]	Conducted Power (Ant 1) [dBm]	Maximum Allowed Power (Ant 2) [dBm]	Conducted Power (Ant 2) [dBm]	Power Drift [dB]	Spacing	Antenna Config.	Device Serial Number	Data Rate (Mbps)	Side	Duty Cycle (%)	Peak SAR of Area Scan [W/kg]	SAR (1g) [W/kg]	Scaling Factor (Power)	Scaling Factor (Duty Cycle)	Reported SAR (1g) [W/kg]	Plot #
MHz	Ch.																				
2437	6	802.11g	OFDM	20	20.5	19.88	20.5	20.48	0.04	10 mm	MIMO	09688	6	back	98.5	0.590	0.404	1.153	1.015	0.473	A38
2437	6	802.11g	OFDM	20	20.5	19.88	20.5	20.48	-0.12	10 mm	MIMO	09688	6	front	98.5	0.224	-	1.153	1.015	-	
2437	6	802.11g	OFDM	20	20.5	19.88	20.5	20.48	0.14	10 mm	MIMO	09688	6	top	98.5	0.453	0.290	1.153	1.015	0.339	
2437	6	802.11g	OFDM	20	20.5	19.88	20.5	20.48	0.17	10 mm	MIMO	09688	6	left	98.5	0.212	-	1.153	1.015	-	
5200	40	802.11n	OFDM	20	18.0	17.43	18.0	17.42	0.06	10 mm	MIMO	09662	13	back	98.3	1.417	0.642	1.143	1.017	0.746	
5200	40	802.11n	OFDM	20	18.0	17.43	18.0	17.42	0.00	10 mm	MIMO	09662	13	front	98.3	0.060	0.012	1.143	1.017	0.014	
5200	40	802.11n	OFDM	20	18.0	17.43	18.0	17.42	0.15	10 mm	MIMO	09662	13	top	98.3	0.133	-	1.143	1.017	-	
5200	40	802.11n	OFDM	20	18.0	17.43	18.0	17.42	0.04	10 mm	MIMO	09662	13	left	98.3	0.356	0.165	1.143	1.017	0.192	
5745	149	802.11n	OFDM	20	17.0	16.04	17.0	16.37	0.00	10 mm	MIMO	09662	13	back	98.3	1.667	0.720	1.247	1.017	0.913	
5785	157	802.11n	OFDM	20	18.0	17.24	18.0	17.36	0.08	10 mm	MIMO	09662	13	back	98.3	2.056	0.825	1.191	1.017	0.999	A40
5805	161	802.11n	OFDM	20	18.0	17.23	18.0	17.28	0.04	10 mm	MIMO	09662	13	back	98.3	1.874	0.764	1.194	1.017	0.928	
5785	157	802.11n	OFDM	20	18.0	17.24	18.0	17.36	-0.12	10 mm	MIMO	09662	13	front	98.3	0.064	0.035	1.191	1.017	0.042	
5785	157	802.11n	OFDM	20	18.0	17.24	18.0	17.36	0.12	10 mm	MIMO	09662	13	top	98.3	0.224	-	1.191	1.017	-	
5785	157	802.11n	OFDM	20	18.0	17.24	18.0	17.36	0.18	10 mm	MIMO	09662	13	left	98.3	0.408	0.190	1.191	1.017	0.230	
5785	157	802.11n	OFDM	20	18.0	17.24	18.0	17.36	0.10	10 mm	MIMO	09662	13	back	98.3	1.829	0.817	1.191	1.017	0.990	
ANSI / IEEE C95.1 1992 - SAFETY LIMIT											Body										
Spatial Peak											1.6 W/kg (mW/g)										
Uncontrolled Exposure/General Population											averaged over 1 gram										



**Note:**

1. Blue entry represents variability measurement.
2. To achieve the 2.4 GHz WLAN 23.5 dBm maximum allowed MIMO power shown in the documentation, each antenna transmits at a maximum allowed power of 20.5 dBm.
3. To achieve the 5 GHz WLAN 21.0 dBm (Ch. 40, 157, 161) and 20.0 dBm (Ch. 149) maximum allowed MIMO power shown in the documentation, each antenna transmits at a maximum allowed power of 18.0 dBm (Ch. 40, 157, 161) and 17.0 dBm (Ch. 149).

**Table 11-39  
WLAN Hotspot SAR for Conditions with 2.4 GHz Ant 1 and 5 GHz WLAN Ant 2**

MEASUREMENT RESULTS																			
FREQUENCY		Mode	Service	Bandwidth [MHz]	Maximum Allowed Power [dBm]	Conducted Power [dBm]	Power Drift [dB]	Spacing	Antenna Config.	Device Serial Number	Data Rate (Mbps)	Side	Duty Cycle (%)	Peak SAR of Area Scan [W/kg]	SAR (1g) [W/kg]	Scaling Factor (Power)	Scaling Factor (Duty Cycle)	Reported SAR (1g) [W/kg]	Plot #
MHz	Ch.																		
2412	1	802.11b	DSSS	22	18.0	17.96	-0.05	10 mm	1	09704	1	back	99.2	0.257	0.226	1.009	1.008	0.230	
2412	1	802.11b	DSSS	22	18.0	17.96	0.11	10 mm	1	09704	1	front	99.2	0.144	-	1.009	1.008	-	
2412	1	802.11b	DSSS	22	18.0	17.96	0.20	10 mm	1	09704	1	top	99.2	0.290	0.244	1.009	1.008	0.248	
2412	1	802.11b	DSSS	22	18.0	17.96	0.13	10 mm	1	09704	1	left	99.2	0.078	-	1.009	1.008	-	
5230	46	802.11n	OFDM	40	15.0	14.53	0.05	10 mm	2	09704	13.5	back	97.4	0.858	0.292	1.114	1.027	0.334	
5230	46	802.11n	OFDM	40	15.0	14.53	-0.19	10 mm	2	09704	13.5	front	97.4	0.025	-	1.114	1.027	-	
5230	46	802.11n	OFDM	40	15.0	14.53	0.09	10 mm	2	09704	13.5	top	97.4	0.056	-	1.114	1.027	-	
5230	46	802.11n	OFDM	40	15.0	14.53	-0.15	10 mm	2	09704	13.5	left	97.4	0.180	-	1.114	1.027	-	
5795	159	802.11n	OFDM	40	15.0	14.51	-0.17	10 mm	2	09704	13.5	back	97.4	0.838	0.369	1.119	1.027	0.424	
5795	159	802.11n	OFDM	40	15.0	14.51	0.00	10 mm	2	09704	13.5	front	97.4	0.029	-	1.119	1.027	-	
5795	159	802.11n	OFDM	40	15.0	14.51	0.12	10 mm	2	09704	13.5	top	97.4	0.099	-	1.119	1.027	-	
5795	159	802.11n	OFDM	40	15.0	14.51	0.14	10 mm	2	09704	13.5	left	97.4	0.240	0.076	1.119	1.027	0.087	
ANSI / IEEE C95.1 1992 - SAFETY LIMIT											Body								
Spatial Peak											1.6 W/kg (mW/g)								
Uncontrolled Exposure/General Population											averaged over 1 gram								

DTS and NII were additionally evaluated at the maximum allowed output power during operations with Simultaneous 2.4 GHz Ant 1 and 5 GHz Ant 2 WLAN. 2.4 GHz Ant 1 WIFI was not transmitting during the NII evaluations, and 5 GHz Ant 2 WIFI was not transmitting during the DTS evaluations.

FCC ID: ZNFG710TM		<b>SAR EVALUATION REPORT</b>		Approved by: Quality Manager
Document S/N: 1M1804030060-01-R1.ZNF	Test Dates: 04/03/18 - 04/16/18	DUT Type: Portable Handset		Page 95 of 131

**Table 11-40  
DSS Hotspot SAR**



MEASUREMENT RESULTS																
FREQUENCY		Mode	Service	Maximum Allowed Power [dBm]	Conducted Power [dBm]	Power Drift [dB]	Spacing	Device Serial Number	Data Rate (Mbps)	Side	Duty Cycle (%)	SAR (1g)	Scaling Factor (Cond Power)	Scaling Factor (Duty Cycle)	Reported SAR (1g)	Plot #
MHz	Ch.											(W/kg)			(W/kg)	
2402	0	Bluetooth	FHSS	12.0	11.97	-0.06	10 mm	09688	1	back	77.3	0.031	1.007	1.294	0.040	
2402	0	Bluetooth	FHSS	12.0	11.97	0.15	10 mm	09688	1	front	77.3	0.018	1.007	1.294	0.023	
2402	0	Bluetooth	FHSS	12.0	11.97	-0.04	10 mm	09688	1	top	77.3	0.040	1.007	1.294	0.052	A42
2402	0	Bluetooth	FHSS	12.0	11.97	0.07	10 mm	09688	1	left	77.3	0.004	1.007	1.294	0.005	
ANSI / IEEE C95.1 1992 - SAFETY LIMIT Spatial Peak Uncontrolled Exposure/General Population							Body 1.6 W/kg (mW/g) averaged over 1 gram									

## 11.4 Standalone Phablet SAR Data

**Table 11-41  
UMTS Phablet SAR Data**

MEASUREMENT RESULTS															
FREQUENCY		Mode	Service	Maximum Allowed Power [dBm]	Conducted Power [dBm]	Power Drift [dB]	Spacing	Device Serial Number	Duty Cycle	Side	SAR (10g)	Scaling Factor	Reported SAR (10g)	Plot #	
MHz	Ch.										(W/kg)		(W/kg)		
1732.40	1412	UMTS 1750	RMC	25.2	25.16	0.03	5 mm	09654	1:1	back	0.625	1.009	0.631		
1732.40	1412	UMTS 1750	RMC	25.2	25.16	0.03	2 mm	09654	1:1	front	1.110	1.009	1.120		
1732.40	1412	UMTS 1750	RMC	25.2	25.16	-0.02	6 mm	09654	1:1	bottom	0.900	1.009	0.908		
1732.40	1412	UMTS 1750	RMC	25.2	25.16	0.01	0 mm	09654	1:1	left	0.796	1.009	0.803		
1732.40	1412	UMTS 1750	RMC	24.2	24.19	0.02	0 mm	09654	1:1	back	1.540	1.002	1.543		
1732.40	1412	UMTS 1750	RMC	24.2	24.19	-0.02	0 mm	09654	1:1	front	1.520	1.002	1.523		
1712.40	1312	UMTS 1750	RMC	24.2	24.19	0.01	0 mm	09654	1:1	bottom	2.540	1.002	2.545		
1732.40	1412	UMTS 1750	RMC	24.2	24.19	0.03	0 mm	09654	1:1	bottom	2.660	1.002	2.665		
1752.60	1513	UMTS 1750	RMC	24.2	24.18	-0.01	0 mm	09654	1:1	bottom	2.780	1.005	2.794	A43	
1752.60	1513	UMTS 1750	RMC	24.2	24.18	-0.05	0 mm	09654	1:1	bottom	2.710	1.005	2.724		
1880.00	9400	UMTS 1900	RMC	25.5	25.47	0.00	5 mm	09670	1:1	back	0.556	1.007	0.560		
1880.00	9400	UMTS 1900	RMC	25.5	25.47	-0.06	2 mm	09670	1:1	front	0.958	1.007	0.965		
1880.00	9400	UMTS 1900	RMC	25.5	25.47	-0.08	6 mm	09670	1:1	bottom	0.971	1.007	0.978		
1880.00	9400	UMTS 1900	RMC	25.5	25.47	-0.01	0 mm	09670	1:1	left	0.761	1.007	0.766		
1880.00	9400	UMTS 1900	RMC	24.5	24.37	-0.07	0 mm	09670	1:1	back	1.090	1.030	1.123		
1880.00	9400	UMTS 1900	RMC	24.5	24.37	-0.14	0 mm	09670	1:1	front	0.978	1.030	1.007		
1852.40	9262	UMTS 1900	RMC	24.5	24.29	-0.10	0 mm	09670	1:1	bottom	2.220	1.050	2.331		
1880.00	9400	UMTS 1900	RMC	24.5	24.37	-0.12	0 mm	09670	1:1	bottom	2.310	1.030	2.379	A44	
1907.60	9538	UMTS 1900	RMC	24.5	24.35	0.07	0 mm	09670	1:1	bottom	2.290	1.035	2.370		
ANSI / IEEE C95.1 1992 - SAFETY LIMIT Spatial Peak Uncontrolled Exposure/General Population							Phablet 4.0 W/kg (mW/g) averaged over 10 grams								

**Note: Blue entry represents variability measurement.**



FCC ID: ZNFG710TM	 <b>PCTEST</b> ENGINEERING LABORATORY, INC.	<b>SAR EVALUATION REPORT</b>		Approved by: Quality Manager
Document S/N: 1M1804030060-01-R1.ZNF	Test Dates: 04/03/18 - 04/16/18	DUT Type: Portable Handset		Page 96 of 131



**Table 11-42  
LTE Phablet SAR**

MEASUREMENT RESULTS																			
FREQUENCY		Mode	Bandwidth [MHz]	Maximum Allowed Power [dBm]	Conducted Power [dBm]	Power Drift [dB]	MPR [dB]	Device Serial Number	Modulation	RB Size	RB Offset	Spacing	Side	Duty Cycle	SAR (10g) [W/kg]	Scaling Factor	Reported SAR (10g) [W/kg]	Plot #	
MHz	Ch.																		
1720.00	132072	Low	LTE Band 66 (AWS)	20	25.2	25.20	0.02	0	09696	QPSK	1	0	5 mm	back	1:1	0.655	1.000	0.655	
1720.00	132072	Low	LTE Band 66 (AWS)	20	24.2	24.20	-0.04	1	09696	QPSK	50	25	5 mm	back	1:1	0.479	1.000	0.479	
1720.00	132072	Low	LTE Band 66 (AWS)	20	25.2	25.20	-0.05	0	09696	QPSK	1	0	2 mm	front	1:1	1.060	1.000	1.060	
1720.00	132072	Low	LTE Band 66 (AWS)	20	24.2	24.20	-0.04	1	09696	QPSK	50	25	2 mm	front	1:1	0.764	1.000	0.764	
1720.00	132072	Low	LTE Band 66 (AWS)	20	25.2	25.20	0.00	0	09696	QPSK	1	0	6 mm	bottom	1:1	0.668	1.000	0.668	
1720.00	132072	Low	LTE Band 66 (AWS)	20	24.2	24.20	0.02	1	09696	QPSK	50	25	6 mm	bottom	1:1	0.491	1.000	0.491	
1720.00	132072	Low	LTE Band 66 (AWS)	20	25.2	25.20	-0.02	0	09696	QPSK	1	0	0 mm	left	1:1	0.732	1.000	0.732	
1720.00	132072	Low	LTE Band 66 (AWS)	20	24.2	24.20	0.00	1	09696	QPSK	50	25	0 mm	left	1:1	0.551	1.000	0.551	
1770.00	132572	High	LTE Band 66 (AWS)	20	24.2	24.14	0.00	0	09696	QPSK	1	50	0 mm	back	1:1	1.520	1.014	1.541	
1770.00	132572	High	LTE Band 66 (AWS)	20	24.2	24.16	-0.01	0	09696	QPSK	50	25	0 mm	back	1:1	1.440	1.009	1.453	
1770.00	132572	High	LTE Band 66 (AWS)	20	24.2	24.14	0.01	0	09696	QPSK	1	50	0 mm	front	1:1	1.600	1.014	1.622	
1770.00	132572	High	LTE Band 66 (AWS)	20	24.2	24.16	0.00	0	09696	QPSK	50	25	0 mm	front	1:1	1.520	1.009	1.534	
1720.00	132072	Low	LTE Band 66 (AWS)	20	24.2	24.07	0.03	0	09696	QPSK	1	0	0 mm	bottom	1:1	2.310	1.030	2.379	
1745.00	132322	Mid	LTE Band 66 (AWS)	20	24.2	24.13	0.01	0	09696	QPSK	1	0	0 mm	bottom	1:1	2.490	1.016	2.530	
1770.00	132572	High	LTE Band 66 (AWS)	20	24.2	24.14	0.00	0	09696	QPSK	1	50	0 mm	bottom	1:1	2.570	1.014	2.606	A45
1720.00	132072	Low	LTE Band 66 (AWS)	20	24.2	24.12	0.02	0	09696	QPSK	50	50	0 mm	bottom	1:1	2.150	1.019	2.191	
1745.00	132322	Mid	LTE Band 66 (AWS)	20	24.2	24.11	0.03	0	09696	QPSK	50	50	0 mm	bottom	1:1	2.370	1.021	2.420	
1770.00	132572	High	LTE Band 66 (AWS)	20	24.2	24.16	0.03	0	09696	QPSK	50	25	0 mm	bottom	1:1	2.450	1.009	2.472	
1720.00	132072	Low	LTE Band 66 (AWS)	20	24.2	24.06	0.03	0	09696	QPSK	100	0	0 mm	bottom	1:1	2.330	1.033	2.407	
1905.00	26590	High	LTE Band 25 (PCS)	20	25.5	25.32	0.16	0	09670	QPSK	1	99	5 mm	back	1:1	0.472	1.042	0.492	
1882.50	26365	Mid	LTE Band 25 (PCS)	20	24.5	24.36	-0.01	1	09670	QPSK	50	50	5 mm	back	1:1	0.362	1.033	0.374	
1905.00	26590	High	LTE Band 25 (PCS)	20	25.5	25.32	0.15	0	09670	QPSK	1	99	2 mm	front	1:1	0.835	1.042	0.870	
1882.50	26365	Mid	LTE Band 25 (PCS)	20	24.5	24.36	-0.06	1	09670	QPSK	50	50	2 mm	front	1:1	0.620	1.033	0.640	
1905.00	26590	High	LTE Band 25 (PCS)	20	25.5	25.32	-0.02	0	09670	QPSK	1	99	6 mm	bottom	1:1	1.090	1.042	1.136	
1882.50	26365	Mid	LTE Band 25 (PCS)	20	24.5	24.36	-0.04	1	09670	QPSK	50	50	6 mm	bottom	1:1	0.714	1.033	0.738	
1905.00	26590	High	LTE Band 25 (PCS)	20	25.5	25.32	0.00	0	09670	QPSK	1	99	0 mm	left	1:1	0.695	1.042	0.724	
1882.50	26365	Mid	LTE Band 25 (PCS)	20	24.5	24.36	0.00	1	09670	QPSK	50	50	0 mm	left	1:1	0.524	1.033	0.541	
1860.00	26140	Low	LTE Band 25 (PCS)	20	24.5	24.41	0.03	0	09670	QPSK	1	99	0 mm	back	1:1	1.070	1.021	1.092	
1905.00	26590	High	LTE Band 25 (PCS)	20	24.5	24.45	-0.03	0	09670	QPSK	50	50	0 mm	back	1:1	0.993	1.012	1.005	
1860.00	26140	Low	LTE Band 25 (PCS)	20	24.5	24.41	-0.01	0	09670	QPSK	1	99	0 mm	front	1:1	1.270	1.021	1.297	
1905.00	26590	High	LTE Band 25 (PCS)	20	24.5	24.45	-0.01	0	09670	QPSK	50	50	0 mm	front	1:1	1.240	1.012	1.255	
1860.00	26140	Low	LTE Band 25 (PCS)	20	24.5	24.41	-0.05	0	09670	QPSK	1	99	0 mm	bottom	1:1	2.400	1.021	2.450	
1882.50	26365	Mid	LTE Band 25 (PCS)	20	24.5	24.39	-0.02	0	09670	QPSK	1	50	0 mm	bottom	1:1	2.490	1.026	2.555	
1905.00	26590	High	LTE Band 25 (PCS)	20	24.5	24.18	-0.05	0	09670	QPSK	1	0	0 mm	bottom	1:1	2.870	1.076	3.088	A46
1860.00	26140	Low	LTE Band 25 (PCS)	20	24.5	24.40	-0.03	0	09670	QPSK	50	50	0 mm	bottom	1:1	2.300	1.023	2.353	
1882.50	26365	Mid	LTE Band 25 (PCS)	20	24.5	24.28	0.00	0	09670	QPSK	50	50	0 mm	bottom	1:1	2.310	1.052	2.430	
1905.00	26590	High	LTE Band 25 (PCS)	20	24.5	24.45	-0.02	0	09670	QPSK	50	50	0 mm	bottom	1:1	2.500	1.012	2.530	
1905.00	26590	High	LTE Band 25 (PCS)	20	24.5	24.40	-0.05	0	09670	QPSK	100	0	0 mm	bottom	1:1	2.510	1.023	2.568	
1905.00	26590	High	LTE Band 25 (PCS)	20	24.5	24.18	-0.03	0	09670	QPSK	1	0	0 mm	bottom	1:1	2.830	1.076	3.045	
2510.00	20850	Low	LTE Band 7	20	25.5	25.03	-0.02	0	09670	QPSK	1	99	0 mm	back	1:1	2.200	1.114	2.451	
2535.00	21100	Mid	LTE Band 7	20	25.5	25.20	-0.05	0	09670	QPSK	1	50	0 mm	back	1:1	2.350	1.072	2.519	
2560.00	21350	High	LTE Band 7	20	25.5	25.31	0.02	0	09670	QPSK	1	50	0 mm	back	1:1	2.500	1.045	2.613	A47
2510.00	20850	Low	LTE Band 7	20	24.5	24.29	0.02	1	09670	QPSK	50	25	0 mm	back	1:1	1.940	1.050	2.037	
2535.00	21100	Mid	LTE Band 7	20	24.5	24.27	0.04	1	09670	QPSK	50	0	0 mm	back	1:1	1.930	1.054	2.034	
2560.00	21350	High	LTE Band 7	20	24.5	24.05	0.01	1	09670	QPSK	50	50	0 mm	back	1:1	1.990	1.109	2.207	
2560.00	21350	High	LTE Band 7	20	24.5	24.05	0.07	1	09670	QPSK	100	0	0 mm	back	1:1	1.980	1.109	2.196	
2510.00	20850	Low	LTE Band 7	20	25.5	25.03	-0.02	0	09670	QPSK	1	99	0 mm	back	1:1	2.340	1.114	2.607	
2560.00	21350	High	LTE Band 7	20	25.5	25.31	-0.02	0	09670	QPSK	1	50	0 mm	back	1:1	2.340	1.045	2.445	

**Note: Blue entries represent variability measurements.**

FCC ID: ZNFG710TM		SAR EVALUATION REPORT		Approved by: Quality Manager
Document S/N: 1M1804030060-01-R1.ZNF	Test Dates: 04/03/18 - 04/16/18	DUT Type: Portable Handset		Page 97 of 131

**Table 11-43  
WLAN SISO Phablet SAR**



MEASUREMENT RESULTS																			
FREQUENCY		Mode	Service	Bandwidth [MHz]	Maximum Allowed Power [dBm]	Conducted Power [dBm]	Power Drift [dB]	Spacing	Antenna Config.	Device Serial Number	Data Rate (Mbps)	Side	Duty Cycle (%)	Peak SAR of Area Scan [W/kg]	SAR (10g) [W/kg]	Scaling Factor (Power)	Scaling Factor (Duty Cycle)	Reported SAR (10g) [W/kg]	Plot #
MHz	Ch.																		
5280	56	802.11a	OFDM	20	18.0	17.67	0.09	0 mm	1	09662	6	back	98.3	2.006	0.298	1.079	1.017	0.327	
5280	56	802.11a	OFDM	20	18.0	17.67	0.00	0 mm	1	09662	6	front	98.3	1.863	-	1.079	1.017	-	
5280	56	802.11a	OFDM	20	18.0	17.67	-0.12	0 mm	1	09662	6	top	98.3	0.864	-	1.079	1.017	-	
5280	56	802.11a	OFDM	20	18.0	17.67	0.00	0 mm	1	09662	6	left	98.3	0.415	-	1.079	1.017	-	
5280	56	802.11a	OFDM	20	18.0	17.67	0.18	0 mm	2	09662	6	back	98.3	41.132	1.590	1.079	1.017	1.745	
5280	56	802.11a	OFDM	20	18.0	17.67	0.00	0 mm	2	09662	6	front	98.3	0.182	0.070	1.079	1.017	0.077	
5280	56	802.11a	OFDM	20	18.0	17.67	0.11	0 mm	2	09662	6	top	98.3	0.269	-	1.079	1.017	-	
5280	56	802.11a	OFDM	20	18.0	17.67	0.00	0 mm	2	09662	6	left	98.3	3.092	0.379	1.079	1.017	0.416	
5600	120	802.11a	OFDM	20	17.0	16.76	0.11	0 mm	1	09662	6	back	98.3	1.810	-	1.057	1.017	-	
5600	120	802.11a	OFDM	20	17.0	16.76	0.11	0 mm	1	09662	6	front	98.3	2.841	0.282	1.057	1.017	0.303	
5600	120	802.11a	OFDM	20	17.0	16.76	0.00	0 mm	1	09662	6	top	98.3	0.600	-	1.057	1.017	-	
5600	120	802.11a	OFDM	20	17.0	16.76	0.02	0 mm	1	09662	6	left	98.3	0.266	-	1.057	1.017	-	
5500	100	802.11a	OFDM	20	17.0	16.78	0.16	0 mm	2	09662	6	back	98.3	39.730	1.860	1.052	1.017	1.990	
5620	124	802.11a	OFDM	20	17.0	16.64	0.18	0 mm	2	09662	6	back	98.3	45.917	2.190	1.086	1.017	2.419	
5720	144	802.11a	OFDM	20	17.0	16.87	0.15	0 mm	2	09662	6	back	98.3	33.137	1.880	1.030	1.017	1.969	
5720	144	802.11a	OFDM	20	17.0	16.87	0.16	0 mm	2	09662	6	front	98.3	0.479	0.174	1.030	1.017	0.182	
5720	144	802.11a	OFDM	20	17.0	16.87	0.18	0 mm	2	09662	6	top	98.3	0.293	-	1.030	1.017	-	
5720	144	802.11a	OFDM	20	17.0	16.87	0.00	0 mm	2	09662	6	left	98.3	3.545	0.381	1.030	1.017	0.399	
ANSI / IEEE C95.1 1992 - SAFETY LIMIT Spatial Peak Uncontrolled Exposure/General Population										Phablet 4.0 W/kg (mW/g) averaged over 10 grams									

**Table 11-44  
WLAN MIMO Phablet SAR**

MEASUREMENT RESULTS																					
FREQUENCY		Mode	Service	Bandwidth [MHz]	Maximum Allowed Power (Ant 1) [dBm]	Conducted Power (Ant 1) [dBm]	Maximum Allowed Power (Ant 2) [dBm]	Conducted Power (Ant 2) [dBm]	Power Drift [dB]	Spacing	Antenna Config.	Device Serial Number	Data Rate (Mbps)	Side	Duty Cycle (%)	Peak SAR of Area Scan [W/kg]	SAR (10g) [W/kg]	Scaling Factor (Power)	Scaling Factor (Duty Cycle)	Reported SAR (10g) [W/kg]	Plot #
MHz	Ch.																				
5280	56	802.11n	OFDM	20	18.0	17.42	18.0	17.52	0.18	0 mm	MIMO	09662	13	back	98.3	21.288	1.670	1.143	1.017	1.941	
5280	56	802.11n	OFDM	20	18.0	17.42	18.0	17.52	0.00	0 mm	MIMO	09662	13	front	98.3	4.034	0.215	1.143	1.017	0.250	
5280	56	802.11n	OFDM	20	18.0	17.42	18.0	17.52	0.07	0 mm	MIMO	09662	13	top	98.3	0.649	-	1.143	1.017	-	
5280	56	802.11n	OFDM	20	18.0	17.42	18.0	17.52	0.01	0 mm	MIMO	09662	13	left	98.3	3.535	0.414	1.143	1.017	0.481	
5500	100	802.11n	OFDM	20	17.0	16.38	17.0	16.60	0.11	0 mm	MIMO	09662	13	back	98.3	44.971	2.340	1.153	1.017	2.744	A48
5620	124	802.11n	OFDM	20	17.0	16.28	17.0	16.39	0.11	0 mm	MIMO	09662	13	back	98.3	36.557	2.140	1.180	1.017	2.568	
5720	144	802.11n	OFDM	20	17.0	16.67	17.0	16.87	0.16	0 mm	MIMO	09662	13	back	98.3	40.432	1.910	1.079	1.017	2.096	
5720	144	802.11n	OFDM	20	17.0	16.67	17.0	16.87	0.12	0 mm	MIMO	09662	13	front	98.3	4.022	0.278	1.079	1.017	0.305	
5720	144	802.11n	OFDM	20	17.0	16.67	17.0	16.87	0.19	0 mm	MIMO	09662	13	top	98.3	0.548	-	1.079	1.017	-	
5720	144	802.11n	OFDM	20	17.0	16.67	17.0	16.87	0.00	0 mm	MIMO	09662	13	left	98.3	4.104	0.375	1.079	1.017	0.412	
5500	100	802.11n	OFDM	20	17.0	16.38	17.0	16.60	0.18	0 mm	MIMO	09662	13	back	98.3	36.261	2.220	1.153	1.017	2.603	
ANSI / IEEE C95.1 1992 - SAFETY LIMIT Spatial Peak Uncontrolled Exposure/General Population										Phablet 4.0 W/kg (mW/g) averaged over 10 grams											

**Note:**

- Blue entry represents variability measurement.
- To achieve the 5 GHz WLAN 21.0 dBm (Ch. 56) and 20.0 dBm (Ch. 100-144) maximum allowed MIMO power shown in the documentation, each antenna transmits at a maximum allowed power of 18.0 dBm (Ch. 56) and 17.0 dBm (Ch. 100-144).

FCC ID: ZNFG710TM		SAR EVALUATION REPORT		Approved by: Quality Manager
Document S/N: 1M1804030060-01-R1.ZNF	Test Dates: 04/03/18 - 04/16/18	DUT Type: Portable Handset		Page 98 of 131



## 11.5 SAR Test Notes

### General Notes:

1. The test data reported are the worst-case SAR values according to test procedures specified in IEEE 1528-2013, and FCC KDB Publication 447498 D01v06.
2. Batteries are fully charged at the beginning of the SAR measurements.
3. Liquid tissue depth was at least 15.0 cm for all frequencies.
4. The manufacturer has confirmed that the device(s) tested have the same physical, mechanical and thermal characteristics and are within operational tolerances expected for production units.
5. SAR results were scaled to the maximum allowed power to demonstrate compliance per FCC KDB Publication 447498 D01v06.
6. Device was tested using a fixed spacing for body-worn accessory testing. A separation distance of 10 mm was considered because the manufacturer has determined that there will be body-worn accessories available in the marketplace for users to support this separation distance.
7. Per FCC KDB Publication 648474 D04v01r03, body-worn SAR was evaluated without a headset connected to the device. When the standalone reported body-worn SAR was > 1.2 W/kg, body-worn SAR was additionally evaluated using a headset cable.
8. Per FCC KDB 865664 D01v01r04, variability SAR tests were performed when the measured SAR results for a frequency band were greater than or equal to 0.8 W/kg. Repeated SAR measurements are highlighted in the tables above for clarity. Please see Section 13 for variability analysis.
9. During SAR Testing for the Wireless Router conditions per FCC KDB Publication 941225 D06v02r01, the actual Portable Hotspot operation (with actual simultaneous transmission of a transmitter with WIFI) was not activated (See Section 6.7 for more details).
10. Per FCC KDB Publication 648474 D04v01r03, this device is considered a "phablet" since the diagonal dimension is > 160 mm and < 200 mm. Therefore, phablet SAR tests are required when wireless router mode does not apply or if wireless router 1g SAR > 1.2 W/kg.
11. This device utilizes power reduction for some wireless modes and technologies, as outlined in Section 1.3. The maximum output power allowed for each transmitter and exposure condition was evaluated for SAR compliance based on expected use conditions and simultaneous transmission scenarios.
12. Additional SAR tests for phablet SAR were evaluated per KDB 616217 Section 6 (See Section 6.9 for more information).
13. Unless otherwise noted, when 10g SAR measurement is considered, a factor of 2.5 is applied to the thresholds below.

### GSM Test Notes:

1. Body-Worn accessory testing is typically associated with voice operations. Therefore, GSM voice was evaluated for body-worn SAR.
2. Justification for reduced test configurations per KDB Publication 941225 D01v03r01 and October 2013 TCB Workshop Notes: The source-based frame-averaged output power was evaluated for all GPRS/EDGE slot configurations. The configuration with the highest target frame averaged output power was evaluated for hotspot SAR. When the maximum frame-averaged powers are equivalent across two or more slots (within 0.25 dB), the configuration with the most number of time slots was tested.
3. Per FCC KDB Publication 447498 D01v06, if the reported (scaled) SAR measured at the middle channel or highest output power channel for each test configuration is  $\leq 0.8$  W/kg for 1g evaluations then testing at the other channels is not required for such test configuration(s). When the maximum output power variation across the required test channels is > ½ dB, instead of the middle channel, the highest output power channel was used.
4. GPRS was additionally evaluated for head and body-worn exposure conditions to address possible VoIP scenarios.

FCC ID: ZNFG710TM	 PCTEST ENGINEERING LABORATORY, INC.	SAR EVALUATION REPORT	 LG	Approved by: Quality Manager
Document S/N: 1M1804030060-01-R1.ZNF	Test Dates: 04/03/18 - 04/16/18	DUT Type: Portable Handset	Page 99 of 131	

**UMTS Notes:**



1. UMTS mode in was tested under RMC 12.2 kbps with HSPA Inactive per KDB Publication 941225 D01v03r01. AMR and HSPA SAR was not required per the 3G Test Reduction Procedure in KDB Publication 941225 D01v03r01.
2. Per FCC KDB Publication 447498 D01v06, if the reported (scaled) SAR measured at the middle channel or highest output power channel for each test configuration is  $\leq 0.8$  W/kg for 1g evaluations then testing at the other channels is not required for such test configuration(s). When the maximum output power variation across the required test channels is  $> \frac{1}{2}$  dB, instead of the middle channel, the highest output power channel was used.

**LTE Notes:**

1. LTE Considerations: LTE test configurations are determined according to SAR Evaluation Considerations for LTE Devices in FCC KDB Publication 941225 D05v02r04. The general test procedures used for testing can be found in Section 8.5.4.
2. MPR is permanently implemented for this device by the manufacturer. The specific manufacturer target MPR is indicated alongside the SAR results. MPR is enabled for this device, according to 3GPP TS36.101 Section 6.2.3 – 6.2.5 under Table 6.2.3-1.
3. A-MPR was disabled for all SAR tests by setting NS=01 and MCC=001 on the base station simulator. SAR tests were performed with the same number of RB and RB offsets transmitting on all TTI frames (maximum TTI).
4. Per FCC KDB Publication 447498 D01v06, when the reported LTE Band 41 SAR measured at the highest output power channel in a given a test configuration was  $> 0.6$  W/kg for 1g evaluations, testing at the other channels was required for such test configurations.
5. TDD LTE was tested per the guidance provided in FCC KDB Publication 941225 D05v02r04. Testing was performed using UL-DL configuration 0 with 6 UL subframes and 2 S subframes using extended cyclic prefix only and special subframe configuration 6. SAR tests were performed at maximum output power and worst-case transmission duty factor in extended cyclic prefix. Per 3GPP 36.211 Section 4, the duty factor for special subframe configuration 6 using extended cyclic prefix is 0.633.
6. Per KDB Publication 941225 D05Av01r02, SAR for downlink only LTE CA operations was not needed since the maximum average output power in LTE CA mode was not  $>0.25$  dB higher than the maximum output power when downlink carrier aggregation was inactive.

**WLAN Notes:**



1. For held-to-ear, hotspot, and phablet operations, the initial test position procedures were applied. The test position with the highest extrapolated peak SAR will be used as the initial test position. When reported SAR for the initial test position is  $\leq 0.4$  W/kg for 1g evaluations, no additional testing for the remaining test positions was required. Otherwise, SAR is evaluated at the subsequent highest peak SAR positions until the reported SAR result is  $\leq 0.8$  W/kg or all test positions are measured.
2. Justification for test configurations for WLAN per KDB Publication 248227 D01v02r02 for 2.4 GHz WIFI single transmission chain operations, the highest measured maximum output power channel for DSSS was selected for SAR measurement. SAR for OFDM modes (2.4 GHz 802.11g/n) was not required due to the maximum allowed powers and the highest reported DSSS SAR. See Section 8.6.5 for more information.
3. Justification for test configurations for WLAN per KDB Publication 248227 D01v02r02 for 5 GHz WIFI single transmission chain operations, the initial test configuration was selected according to the transmission mode with the highest maximum allowed powers. Other transmission modes were not investigated since the highest reported SAR for initial test configuration adjusted by the ratio of maximum output powers is less than 1.2 W/kg for 1g evaluations. See Section 8.6.6 for more information.
4. Per KDB Publication 248227 D01v02r02, SAR for MIMO was evaluated by following the simultaneous SAR provisions from KDB Publication 447498 D01v06 by either evaluating the sum of the 1g SAR values of each antenna transmitting independently or making a SAR measurement with both antennas transmitting simultaneously. Please see Section 12 for complete analysis.

FCC ID: ZNFG710TM	 PCTEST ENGINEERING LABORATORY, INC.	SAR EVALUATION REPORT	 LG	Approved by: Quality Manager
Document S/N: 1M1804030060-01-R1.ZNF	Test Dates: 04/03/18 - 04/16/18	DUT Type: Portable Handset		Page 100 of 131

5. When the maximum reported 1g averaged SAR is  $\leq 0.8$  W/kg, SAR testing on additional channels was not required. Otherwise, SAR for the next highest output power channel was required until the reported SAR result was  $\leq 1.20$  W/kg for 1g evaluations or all test channels were measured.
6. The device was configured to transmit continuously at the required data rate, channel bandwidth and signal modulation, using the highest transmission duty factor supported by the test mode tools. The reported SAR was scaled to the 100% transmission duty factor to determine compliance. Procedures used to measure the duty factor are identical to that in the associated EMC test reports.
7. When 10-g SAR measurement is considered, a factor of 2.5 is applied to the thresholds above.

**Bluetooth Notes**

1. Bluetooth SAR was measured with the device connected to a call box with hopping disabled with DH5 operation and Tx Tests test mode type. Per October 2016 TCB Workshop Notes, the reported SAR was scaled to the 100% transmission duty factor to determine compliance. See Section 9.5 for the time domain plot and calculation for the duty factor of the device.

FCC ID: ZNFG710TM	 <b>SAR EVALUATION REPORT</b> 		<b>Approved by:</b> Quality Manager
<b>Document S/N:</b> 1M1804030060-01-R1.ZNF	<b>Test Dates:</b> 04/03/18 - 04/16/18	<b>DUT Type:</b> Portable Handset	Page 101 of 131

## 12 FCC MULTI-TX AND ANTENNA SAR CONSIDERATIONS

### 12.1 Introduction



The following procedures adopted from FCC KDB Publication 447498 D01v06 are applicable to devices with built-in unlicensed transmitters such as 802.11 and Bluetooth devices which may simultaneously transmit with the licensed transmitter.

### 12.2 Simultaneous Transmission Procedures

This device contains transmitters that may operate simultaneously. Therefore simultaneous transmission analysis is required. Per FCC KDB Publication 447498 D01v06 4.3.2 and IEEE 1528-2013 Section 6.3.4.1.2, simultaneous transmission SAR test exclusion may be applied when the sum of the 1g or 10g SAR for all the simultaneous transmitting antennas in a specific a physical test configuration is  $\leq 1.6$  W/kg for 1g and  $\leq 4$  W/kg for 10g. The different test positions in an exposure condition may be considered collectively to determine SAR test exclusion according to the sum of 1g or 10g SAR.

Per FCC KDB Publication 941225 D06v02r01, the devices edges with antennas more than 2.5 cm from edge are not required to be evaluated for SAR (“-”).



(\*) For test positions that were not required to be evaluated for WLAN SAR per FCC KDB publication 248227, the worst case WLAN SAR result for applicable exposure conditions was used for simultaneous transmission analysis.

FCC ID: ZNFG710TM		SAR EVALUATION REPORT		Approved by: Quality Manager
Document S/N: 1M1804030060-01-R1.ZNF	Test Dates: 04/03/18 - 04/16/18	DUT Type: Portable Handset		Page 102 of 131

## 12.3 Head SAR Simultaneous Transmission Analysis

**Table 12-1**  
**Simultaneous Transmission Scenario with 2.4 GHz WLAN (Held to Ear)**

Exposure Condition	Mode	2G/3G/4G SAR (W/kg)	2.4 GHz WLAN Ant 1 SAR (W/kg)	2.4 GHz WLAN Ant 2 SAR (W/kg)	Σ SAR (W/kg)		
		1	2	3	1+2	1+3	1+2+3
Head SAR	GSM/GPRS 850	0.138	0.354	0.074	0.492	0.212	0.566
	GSM/GPRS 1900	0.066	0.354	0.074	0.420	0.140	0.494
	UMTS 850	0.197	0.354	0.074	0.551	0.271	0.625
	UMTS 1750	0.203	0.354	0.074	0.557	0.277	0.631
	UMTS 1900	0.145	0.354	0.074	0.499	0.219	0.573
	LTE Band 71	0.115	0.354	0.074	0.469	0.189	0.543
	LTE Band 12	0.202	0.354	0.074	0.556	0.276	0.630
	LTE Band 13	0.223	0.354	0.074	0.577	0.297	<b>0.651</b>
	LTE Band 5 (Cell)	0.211	0.354	0.074	0.565	0.285	0.639
	LTE Band 66 (AWS)	0.206	0.354	0.074	0.560	0.280	0.634
	LTE Band 25 (PCS)	0.158	0.354	0.074	0.512	0.232	0.586
	LTE Band 30	0.021	0.354	0.074	0.375	0.095	0.449
	LTE Band 7	0.053	0.354	0.074	0.407	0.127	0.481
LTE Band 41	0.028	0.354	0.074	0.382	0.102	0.456	



FCC ID: ZNFG710TM		SAR EVALUATION REPORT		Approved by: Quality Manager
Document S/N: 1M1804030060-01-R1.ZNF	Test Dates: 04/03/18 - 04/16/18	DUT Type: Portable Handset		Page 103 of 131

**Table 12-2**  
**Simultaneous Transmission Scenario with 5 GHz WLAN (Held to Ear)**

Exposure Condition	Mode	2G/3G/4G SAR (W/kg)	5 GHz WLAN Ant 1 SAR (W/kg)	5 GHz WLAN Ant 2 SAR (W/kg)	Σ SAR (W/kg)		
		1	2	3	1+2	1+3	1+2+3
Head SAR	GSM/GPRS 850	0.138	0.478	0.085	0.616	0.223	0.701
	GSM/GPRS 1900	0.066	0.478	0.085	0.544	0.151	0.629
	UMTS 850	0.197	0.478	0.085	0.675	0.282	0.760
	UMTS 1750	0.203	0.478	0.085	0.681	0.288	0.766
	UMTS 1900	0.145	0.478	0.085	0.623	0.230	0.708
	LTE Band 71	0.115	0.478	0.085	0.593	0.200	0.678
	LTE Band 12	0.202	0.478	0.085	0.680	0.287	0.765
	LTE Band 13	0.223	0.478	0.085	0.701	0.308	<b>0.786</b>
	LTE Band 5 (Cell)	0.211	0.478	0.085	0.689	0.296	0.774
	LTE Band 66 (AWS)	0.206	0.478	0.085	0.684	0.291	0.769
	LTE Band 25 (PCS)	0.158	0.478	0.085	0.636	0.243	0.721
	LTE Band 30	0.021	0.478	0.085	0.499	0.106	0.584
	LTE Band 7	0.053	0.478	0.085	0.531	0.138	0.616
	LTE Band 41	0.028	0.478	0.085	0.506	0.113	0.591

**Table 12-3**  
**Simultaneous Transmission Scenario with 2.4 GHz WLAN and 5 GHz WLAN (Held to Ear)**



Exposure Condition	Mode	2G/3G/4G SAR (W/kg)	2.4 GHz WLAN Ant 1 SAR (W/kg)	5 GHz WLAN Ant 2 SAR (W/kg)	Σ SAR (W/kg)
		1	2	3	1+2+3
Head SAR	GSM/GPRS 850	0.138	0.354	0.085	0.577
	GSM/GPRS 1900	0.066	0.354	0.085	0.505
	UMTS 850	0.197	0.354	0.085	0.636
	UMTS 1750	0.203	0.354	0.085	0.642
	UMTS 1900	0.145	0.354	0.085	0.584
	LTE Band 71	0.115	0.354	0.085	0.554
	LTE Band 12	0.202	0.354	0.085	0.641
	LTE Band 13	0.223	0.354	0.085	<b>0.662</b>
	LTE Band 5 (Cell)	0.211	0.354	0.085	0.650
	LTE Band 66 (AWS)	0.206	0.354	0.085	0.645
	LTE Band 25 (PCS)	0.158	0.354	0.085	0.597
	LTE Band 30	0.021	0.354	0.085	0.460
	LTE Band 7	0.053	0.354	0.085	0.492
	LTE Band 41	0.028	0.354	0.085	0.467

FCC ID: ZNFG710TM		SAR EVALUATION REPORT		Approved by: Quality Manager
Document S/N: 1M1804030060-01-R1.ZNF	Test Dates: 04/03/18 - 04/16/18	DUT Type: Portable Handset		Page 104 of 131



**Table 12-4  
Simultaneous Transmission Scenario with Bluetooth (Held to Ear)**

Exposure Condition	Mode	2G/3G/4G SAR (W/kg)	Bluetooth SAR (W/kg)	$\Sigma$ SAR (W/kg)
		1	2	1+2
Head SAR	GSM/GPRS 850	0.138	0.129	0.267
	GSM/GPRS 1900	0.066	0.129	0.195
	UMTS 850	0.197	0.129	0.326
	UMTS 1750	0.203	0.129	0.332
	UMTS 1900	0.145	0.129	0.274
	LTE Band 71	0.115	0.129	0.244
	LTE Band 12	0.202	0.129	0.331
	LTE Band 13	0.223	0.129	<b>0.352</b>
	LTE Band 5 (Cell)	0.211	0.129	0.340
	LTE Band 66 (AWS)	0.206	0.129	0.335
	LTE Band 25 (PCS)	0.158	0.129	0.287
	LTE Band 30	0.021	0.129	0.150
	LTE Band 7	0.053	0.129	0.182
	LTE Band 41	0.028	0.129	0.157

FCC ID: ZNFG710TM		SAR EVALUATION REPORT		Approved by: Quality Manager
Document S/N: 1M1804030060-01-R1.ZNF	Test Dates: 04/03/18 - 04/16/18	DUT Type: Portable Handset		Page 105 of 131



## 12.4 Body-Worn Simultaneous Transmission Analysis

**Table 12-5**  
**Simultaneous Transmission Scenario with 2.4 GHz WLAN (Body-Worn at 1.0 cm)**

Exposure Condition	Mode	2G/3G/4G SAR (W/kg)	2.4 GHz WLAN Ant 1 SAR (W/kg)	2.4 GHz WLAN Ant 2 SAR (W/kg)	$\Sigma$ SAR (W/kg)		SPLSR	
		1	2	3	1+2	1+3	1+2	1+3
Body-Worn	GSM/GPRS 850	0.350	0.393	0.385	0.743	0.735	N/A	N/A
	GSM/GPRS 1900	0.291	0.393	0.385	0.684	0.676	N/A	N/A
	UMTS 850	0.444	0.393	0.385	0.837	0.829	N/A	N/A
	UMTS 1750	0.522	0.393	0.385	0.915	0.907	N/A	N/A
	UMTS 1900	0.505	0.393	0.385	0.898	0.890	N/A	N/A
	LTE Band 71	0.415	0.393	0.385	0.808	0.800	N/A	N/A
	LTE Band 12	0.530	0.393	0.385	0.923	0.915	N/A	N/A
	LTE Band 13	0.493	0.393	0.385	0.886	0.878	N/A	N/A
	LTE Band 5 (Cell)	0.378	0.393	0.385	0.771	0.763	N/A	N/A
	LTE Band 66 (AWS)	0.618	0.393	0.385	1.011	1.003	N/A	N/A
	LTE Band 25 (PCS)	0.306	0.393	0.385	0.699	0.691	N/A	N/A
	LTE Band 30	0.307	0.393	0.385	0.700	0.692	N/A	N/A
	LTE Band 7	1.297	0.393	0.385	See Note 1	See Note 1	0.02	0.02
LTE Band 41	0.714	0.393	0.385	<b>1.107</b>	1.099	N/A	N/A	

**Table 12-6**  
**Simultaneous Transmission Scenario with 2.4 GHz WLAN MIMO (Body-Worn at 1.0 cm)**

Exposure Condition	Mode	2G/3G/4G SAR (W/kg)	2.4 GHz WLAN MIMO SAR (W/kg)	$\Sigma$ SAR (W/kg)	SPLSR
		1	2	1+2	1+2
Body-Worn	GSM/GPRS 850	0.350	0.473	0.823	N/A
	GSM/GPRS 1900	0.291	0.473	0.764	N/A
	UMTS 850	0.444	0.473	0.917	N/A
	UMTS 1750	0.522	0.473	0.995	N/A
	UMTS 1900	0.505	0.473	0.978	N/A
	LTE Band 71	0.415	0.473	0.888	N/A
	LTE Band 12	0.530	0.473	1.003	N/A
	LTE Band 13	0.493	0.473	0.966	N/A
	LTE Band 5 (Cell)	0.378	0.473	0.851	N/A
	LTE Band 66 (AWS)	0.618	0.473	1.091	N/A
	LTE Band 25 (PCS)	0.306	0.473	0.779	N/A
	LTE Band 30	0.307	0.473	0.780	N/A
	LTE Band 7	1.297	0.473	See Note 1	0.02
LTE Band 41	0.714	0.473	<b>1.187</b>	N/A	



FCC ID: ZNFG710TM	 <b>PCTEST</b> ENGINEERING LABORATORY, INC.	<b>SAR EVALUATION REPORT</b>		<b>Approved by:</b> Quality Manager
<b>Document S/N:</b> 1M1804030060-01-R1.ZNF	<b>Test Dates:</b> 04/03/18 - 04/16/18	<b>DUT Type:</b> Portable Handset		Page 106 of 131

**Table 12-7**  
**Simultaneous Transmission Scenario with 5 GHz WLAN (Body-Worn at 1.0 cm)**

Exposure Condition	Mode	2G/3G/4G SAR (W/kg)	5 GHz WLAN Ant 1 SAR (W/kg)	5 GHz WLAN Ant 2 SAR (W/kg)	Σ SAR (W/kg)		SPLSR	
		1	2	3	1+2	1+3	1+2	1+3
Body-Worn	GSM/GPRS 850	0.350	0.178	0.898	0.528	1.248	N/A	N/A
	GSM/GPRS 1900	0.291	0.178	0.898	0.469	1.189	N/A	N/A
	UMTS 850	0.444	0.178	0.898	0.622	1.342	N/A	N/A
	UMTS 1750	0.522	0.178	0.898	0.700	1.420	N/A	N/A
	UMTS 1900	0.505	0.178	0.898	0.683	1.403	N/A	N/A
	LTE Band 71	0.415	0.178	0.898	0.593	1.313	N/A	N/A
	LTE Band 12	0.530	0.178	0.898	0.708	1.428	N/A	N/A
	LTE Band 13	0.493	0.178	0.898	0.671	1.391	N/A	N/A
	LTE Band 5 (Cell)	0.378	0.178	0.898	0.556	1.276	N/A	N/A
	LTE Band 66 (AWS)	0.618	0.178	0.898	0.796	<b>1.516</b>	N/A	N/A
	LTE Band 25 (PCS)	0.306	0.178	0.898	0.484	1.204	N/A	N/A
	LTE Band 30	0.307	0.178	0.898	0.485	1.205	N/A	N/A
	LTE Band 7	1.297	0.178	0.898	1.475	See Note 1	N/A	0.03
LTE Band 41	0.714	0.178	0.898	0.892	See Note 1	N/A	0.02	

**Table 12-8**  
**Simultaneous Transmission Scenario with 5 GHz WLAN MIMO (Body-Worn at 1.0 cm)**

Exposure Condition	Mode	2G/3G/4G SAR (W/kg)	5 GHz WLAN MIMO SAR (W/kg)	Σ SAR (W/kg)	SPLSR
		1	2	1+2	1+2
Body-Worn	GSM/GPRS 850	0.350	1.162	1.512	N/A
	GSM/GPRS 1900	0.291	1.162	1.453	N/A
	UMTS 850	0.444	1.162	See Note 1	0.02
	UMTS 1750	0.522	1.162	See Note 1	0.02
	UMTS 1900	0.505	1.162	See Note 1	0.02
	LTE Band 71	0.415	1.162	<b>1.577</b>	N/A
	LTE Band 12	0.530	1.162	See Note 1	0.02
	LTE Band 13	0.493	1.162	See Note 1	0.02
	LTE Band 5 (Cell)	0.378	1.162	1.540	N/A
	LTE Band 66 (AWS)	0.618	1.162	See Note 1	0.02
	LTE Band 25 (PCS)	0.306	1.162	1.468	N/A
	LTE Band 30	0.307	1.162	1.469	N/A
	LTE Band 7	1.297	1.162	See Note 1	0.03
LTE Band 41	0.714	1.162	See Note 1	0.02	

FCC ID: ZNFG710TM	 <b>PCTEST</b> <small>ENGINEERING LABORATORY, INC.</small>	SAR EVALUATION REPORT		Approved by: Quality Manager
Document S/N: 1M1804030060-01-R1-ZNF	Test Dates: 04/03/18 - 04/16/18	DUT Type: Portable Handset		Page 107 of 131

**Table 12-9**  
**Simultaneous Transmission Scenario with 2.4 GHz WLAN and 5 GHz WLAN (Body-Worn at 1.0 cm)**



Exposure Condition	Mode	2G/3G/4G SAR (W/kg)	2.4 GHz WLAN Ant 1 at 17 dBm SAR (W/kg)	5 GHz WLAN Ant 2 at 14 dBm SAR (W/kg)	$\Sigma$ SAR (W/kg)	SPLSR		
		1	2	3		1+2+3	1+2	1+3
Body-Worn	GSM/GPRS 850	0.350	0.230	0.571	1.151	N/A	N/A	N/A
	GSM/GPRS 1900	0.291	0.230	0.571	1.092	N/A	N/A	N/A
	UMTS 850	0.444	0.230	0.571	1.245	N/A	N/A	N/A
	UMTS 1750	0.522	0.230	0.571	1.323	N/A	N/A	N/A
	UMTS 1900	0.505	0.230	0.571	1.306	N/A	N/A	N/A
	LTE Band 71	0.415	0.230	0.571	1.216	N/A	N/A	N/A
	LTE Band 12	0.530	0.230	0.571	1.331	N/A	N/A	N/A
	LTE Band 13	0.493	0.230	0.571	1.294	N/A	N/A	N/A
	LTE Band 5 (Cell)	0.378	0.230	0.571	1.179	N/A	N/A	N/A
	LTE Band 66 (AWS)	0.618	0.230	0.571	1.419	N/A	N/A	N/A
	LTE Band 25 (PCS)	0.306	0.230	0.571	1.107	N/A	N/A	N/A
	LTE Band 30	0.307	0.230	0.571	1.108	N/A	N/A	N/A
	LTE Band 7	1.297	0.230	0.571	See Note 1	0.01	0.02	0.04
	LTE Band 41	0.714	0.230	0.571	<b>1.515</b>	N/A	N/A	N/A

**Table 12-10**  
**Simultaneous Transmission Scenario with Bluetooth (Body-Worn at 1.0 cm)**

Exposure Condition	Mode	2G/3G/4G SAR (W/kg)	Bluetooth SAR (W/kg)	$\Sigma$ SAR (W/kg)
		1	2	1+2
Body-Worn	GSM/GPRS 850	0.350	0.040	0.390
	GSM/GPRS 1900	0.291	0.040	0.331
	UMTS 850	0.444	0.040	0.484
	UMTS 1750	0.522	0.040	0.562
	UMTS 1900	0.505	0.040	0.545
	LTE Band 71	0.415	0.040	0.455
	LTE Band 12	0.530	0.040	0.570
	LTE Band 13	0.493	0.040	0.533
	LTE Band 5 (Cell)	0.378	0.040	0.418
	LTE Band 66 (AWS)	0.618	0.040	0.658
	LTE Band 25 (PCS)	0.306	0.040	0.346
	LTE Band 30	0.307	0.040	0.347
	LTE Band 7	1.297	0.040	<b>1.337</b>
	LTE Band 41	0.714	0.040	0.754

**Notes:**



- No evaluation was performed to determine the aggregate 1g SAR for these configurations as the SPLS ratio between the antenna pairs was not greater than 0.04 per FCC KDB 447498 D01v06. See Section 12.7 for detailed SPLS ratio analysis.

FCC ID: ZNFG710TM		SAR EVALUATION REPORT		Approved by: Quality Manager
Document S/N: 1M1804030060-01-R1.ZNF	Test Dates: 04/03/18 - 04/16/18	DUT Type: Portable Handset	Page 108 of 131	

## 12.5 Hotspot SAR Simultaneous Transmission Analysis



**Table 12-11**  
**Simultaneous Transmission Scenario with 2.4 GHz WLAN (Hotspot at 1.0 cm)**

Exposure Condition	Mode	2G/3G/4G SAR (W/kg)	2.4 GHz WLAN Ant 1 SAR (W/kg)	2.4 GHz WLAN Ant 2 SAR (W/kg)	Σ SAR (W/kg)			
		1	2	3	1+2	1+3		
Hotspot SAR	GPRS 850	0.350	0.402	0.385	0.752	0.735		
	GPRS 1900	0.735	0.402	0.385	1.137	1.120		
	UMTS 850	0.444	0.402	0.385	0.846	0.829		
	UMTS 1750	0.827	0.402	0.385	1.229	1.212		
	UMTS 1900	1.075	0.402	0.385	<b>1.477</b>	1.460		
	LTE Band 71	0.415	0.402	0.385	0.817	0.800		
	LTE Band 12	0.530	0.402	0.385	0.932	0.915		
	LTE Band 13	0.493	0.402	0.385	0.895	0.878		
	LTE Band 5 (Cell)	0.378	0.402	0.385	0.780	0.763		
	LTE Band 66 (AWS)	1.065	0.402	0.385	1.467	1.450		
	LTE Band 25 (PCS)	0.920	0.402	0.385	1.322	1.305		
	LTE Band 30	0.307	0.402	0.385	0.709	0.692		
	LTE Band 7	1.297	0.402	0.385	See Table Below	See Table Below		
	LTE Band 41	0.883	0.402	0.385	1.285	1.268		
Simult Tx	Configuration	LTE Band 7 SAR (W/kg)	2.4 GHz WLAN Ant 1 SAR (W/kg)	2.4 GHz WLAN Ant 2 SAR (W/kg)	Σ SAR (W/kg)		SPLSR	
		1	2	3	1+2	1+3	1+2	1+3
Hotspot SAR	Back	1.297	0.393	0.385	See Note 1	See Note 1	0.02	0.02
	Front	0.334	0.402*	0.385*	0.736	0.719	N/A	N/A
	Top	-	0.402	0.385*	0.402	0.385	N/A	N/A
	Bottom	1.056	-	-	<b>1.056</b>	<b>1.056</b>	N/A	N/A
	Right	0.050	-	-	-	0.050	N/A	N/A
	Left	0.087	0.402*	0.385*	0.489	0.472	N/A	N/A

FCC ID: ZNFG710TM		SAR EVALUATION REPORT		Approved by: Quality Manager
Document S/N: 1M1804030060-01-R1.ZNF	Test Dates: 04/03/18 - 04/16/18	DUT Type: Portable Handset		Page 109 of 131

**Table 12-12**  
**Simultaneous Transmission Scenario with 2.4 GHz WLAN MIMO (Hotspot at 1.0 cm)**

Exposure Condition	Mode	2G/3G/4G SAR (W/kg)	2.4 GHz WLAN MIMO SAR (W/kg)	$\Sigma$ SAR (W/kg)	
		1	2	1+2	
Hotspot SAR	GPRS 850	0.350	0.473	0.823	
	GPRS 1900	0.735	0.473	1.208	
	UMTS 850	0.444	0.473	0.917	
	UMTS 1750	0.827	0.473	1.300	
	UMTS 1900	1.075	0.473	<b>1.548</b>	
	LTE Band 71	0.415	0.473	0.888	
	LTE Band 12	0.530	0.473	1.003	
	LTE Band 13	0.493	0.473	0.966	
	LTE Band 5 (Cell)	0.378	0.473	0.851	
	LTE Band 66 (AWS)	1.065	0.473	1.538	
	LTE Band 25 (PCS)	0.920	0.473	1.393	
	LTE Band 30	0.307	0.473	0.780	
	LTE Band 7	1.297	0.473	See Table Below	
	LTE Band 41	0.883	0.473	1.356	
Simult Tx	Configuration	LTE Band 7 SAR (W/kg)	2.4 GHz WLAN MIMO SAR (W/kg)	$\Sigma$ SAR (W/kg)	SPLSR
		1	2	1+2	1+2
Hotspot SAR	Back	1.297	0.473	See Note 1	0.02
	Front	0.334	0.473*	0.807	N/A
	Top	-	0.339	0.339	N/A
	Bottom	1.056	-	<b>1.056</b>	N/A
	Right	0.050	-	-	N/A
	Left	0.087	0.473*	0.560	N/A

FCC ID: ZNFG710TM		SAR EVALUATION REPORT		Approved by: Quality Manager
Document S/N: 1M1804030060-01-R1.ZNF	Test Dates: 04/03/18 - 04/16/18	DUT Type: Portable Handset		Page 110 of 131

**Table 12-13**  
**Simultaneous Transmission Scenario with 5 GHz WLAN (Hotspot at 1.0 cm)**



Exposure Condition	Mode	2G/3G/4G SAR (W/kg)	5 GHz WLAN Ant 1 SAR (W/kg)	5 GHz WLAN Ant 2 SAR (W/kg)	Σ SAR (W/kg)	
		1	2	3	1+2	1+3
Hotspot SAR	GPRS 850	0.350	0.161	0.867	0.511	1.217
	GPRS 1900	0.735	0.161	0.867	0.896	See Table Below
	UMTS 850	0.444	0.161	0.867	0.605	1.311
	UMTS 1750	0.827	0.161	0.867	0.988	See Table Below
	UMTS 1900	1.075	0.161	0.867	1.236	See Table Below
	LTE Band 71	0.415	0.161	0.867	0.576	1.282
	LTE Band 12	0.530	0.161	0.867	0.691	1.397
	LTE Band 13	0.493	0.161	0.867	0.654	1.360
	LTE Band 5 (Cell)	0.378	0.161	0.867	0.539	1.245
	LTE Band 66 (AWS)	1.065	0.161	0.867	1.226	See Table Below
	LTE Band 25 (PCS)	0.920	0.161	0.867	1.081	See Table Below
	LTE Band 30	0.307	0.161	0.867	0.468	1.174
	LTE Band 7	1.297	0.161	0.867	<b>1.458</b>	See Table Below
	LTE Band 41	0.883	0.161	0.867	1.044	See Table Below

Simult Tx	Configuration	GPRS 1900 SAR (W/kg)	5 GHz WLAN Ant 2 SAR (W/kg)	Σ SAR (W/kg)	Simult Tx	Configuration	UMTS 1750 SAR (W/kg)	5 GHz WLAN Ant 2 SAR (W/kg)	Σ SAR (W/kg)
		1	2	1+2			1	2	1+2
Hotspot SAR	Back	0.291	0.867	1.158	Hotspot SAR	Back	0.522	0.867	<b>1.389</b>
	Front	0.246	0.017	0.263		Front	0.415	0.017	0.432
	Top	-	0.867*	0.867		Top	-	0.867*	0.867
	Bottom	0.735	-	0.735		Bottom	0.827	-	0.827
	Left	0.168	0.209	0.377		Left	0.306	0.209	0.515

Simult Tx	Configuration	UMTS 1900 SAR (W/kg)	5 GHz WLAN Ant 2 SAR (W/kg)	Σ SAR (W/kg)	Simult Tx	Configuration	LTE Band 66 (AWS) SAR (W/kg)	5 GHz WLAN Ant 2 SAR (W/kg)	Σ SAR (W/kg)
		1	2	1+2			1	2	1+2
Hotspot SAR	Back	0.505	0.867	<b>1.372</b>	Hotspot SAR	Back	0.618	0.867	<b>1.485</b>
	Front	0.422	0.017	0.439		Front	0.489	0.017	0.506
	Top	-	0.867*	0.867		Top	-	0.867*	0.867
	Bottom	1.075	-	1.075		Bottom	1.065	-	1.065
	Left	0.256	0.209	0.465		Left	0.422	0.209	0.631



Simult Tx	Configuration	LTE Band 25 (PCS) SAR (W/kg)	5 GHz WLAN Ant 2 SAR (W/kg)	Σ SAR (W/kg)
		1	2	1+2
Hotspot SAR	Back	0.306	0.867	<b>1.173</b>
	Front	0.280	0.017	0.297
	Top	-	0.867*	0.867
	Bottom	0.920	-	0.920
	Left	0.228	0.209	0.437

FCC ID: ZNFG710TM	 <b>SAR EVALUATION REPORT</b> 	<b>Approved by:</b> Quality Manager
Document S/N: 1M1804030060-01-R1-ZNF	Test Dates: 04/03/18 - 04/16/18	DUT Type: Portable Handset
		Page 111 of 131

Simult Tx	Configuration	LTE Band 7 SAR (W/kg)	5 GHz WLAN Ant 2 SAR (W/kg)	Σ SAR (W/kg)	SPLSR	Simult Tx	Configuration	LTE Band 41 SAR (W/kg)	5 GHz WLAN Ant 2 SAR (W/kg)	Σ SAR (W/kg)
		1	2	1+2	1+2			1	2	1+2
Hotspot SAR	Back	1.297	0.867	See Note 1	0.03	Hotspot SAR	Back	0.714	0.867	<b>1.581</b>
	Front	0.334	0.017	0.351	N/A		Front	0.406	0.017	0.423
	Top	-	0.867*	0.867	N/A		Top	-	0.867*	0.867
	Bottom	1.056	-	1.056	N/A		Bottom	0.883	-	0.883
	Right	0.050	-	-	N/A		Right	0.030	-	-
	Left	0.087	0.209	0.296	N/A		Left	0.059	0.209	0.268

**Table 12-14**  
**Simultaneous Transmission Scenario with 5 GHz WLAN MIMO (Hotspot at 1.0 cm)**

Exposure Condition	Mode	2G/3G/4G SAR (W/kg)	5 GHz WLAN MIMO SAR (W/kg)	Σ SAR (W/kg)
		1	2	1+2
Hotspot SAR	GPRS 850	0.350	0.999	1.349
	GPRS 1900	0.735	0.999	See Table Below
	UMTS 850	0.444	0.999	1.443
	UMTS 1750	0.827	0.999	See Table Below
	UMTS 1900	1.075	0.999	See Table Below
	LTE Band 71	0.415	0.999	1.414
	LTE Band 12	0.530	0.999	<b>1.529</b>
	LTE Band 13	0.493	0.999	1.492
	LTE Band 5 (Cell)	0.378	0.999	1.377
	LTE Band 66 (AWS)	1.065	0.999	See Table Below
	LTE Band 25 (PCS)	0.920	0.999	See Table Below
	LTE Band 30	0.307	0.999	1.306
	LTE Band 7	1.297	0.999	See Table Below
	LTE Band 41	0.883	0.999	See Table Below

FCC ID: ZNFG710TM		SAR EVALUATION REPORT		Approved by: Quality Manager
Document S/N: 1M1804030060-01-R1.ZNF	Test Dates: 04/03/18 - 04/16/18	DUT Type: Portable Handset		Page 112 of 131





Simult Tx	Configuration	GPRS 1900 SAR (W/kg)	5 GHz WLAN MIMO SAR (W/kg)	Σ SAR (W/kg)	Simult Tx	Configuration	UMTS 1750 SAR (W/kg)	5 GHz WLAN MIMO SAR (W/kg)	Σ SAR (W/kg)
		1	2	1+2			1	2	1+2
Hotspot SAR	Back	0.291	0.999	1.290	Hotspot SAR	Back	0.522	0.999	1.521
	Front	0.246	0.042	0.288		Front	0.415	0.042	0.457
	Top	-	0.999*	0.999		Top	-	0.999*	0.999
	Bottom	0.735	-	0.735		Bottom	0.827	-	0.827
	Left	0.168	0.230	0.398		Left	0.306	0.230	0.536

Simult Tx	Configuration	UMTS 1900 SAR (W/kg)	5 GHz WLAN MIMO SAR (W/kg)	Σ SAR (W/kg)	Simult Tx	Configuration	LTE Band 66 (AWS) SAR (W/kg)	5 GHz WLAN MIMO SAR (W/kg)	Σ SAR (W/kg)	SPLSR
		1	2	1+2			1	2	1+2	1+2
Hotspot SAR	Back	0.505	0.999	1.504	Hotspot SAR	Back	0.618	0.999	See Note 1	0.02
	Front	0.422	0.042	0.464		Front	0.489	0.042	0.531	N/A
	Top	-	0.999*	0.999		Top	-	0.999*	0.999	N/A
	Bottom	1.075	-	1.075		Bottom	1.065	-	1.065	N/A
	Left	0.256	0.230	0.486		Left	0.422	0.230	0.652	N/A

Simult Tx	Configuration	LTE Band 25 (PCS) SAR (W/kg)	5 GHz WLAN MIMO SAR (W/kg)	Σ SAR (W/kg)	Simult Tx	Configuration	LTE Band 7 SAR (W/kg)	5 GHz WLAN MIMO SAR (W/kg)	Σ SAR (W/kg)	SPLSR
		1	2	1+2			1	2	1+2	1+2
Hotspot SAR	Back	0.306	0.999	1.305	Hotspot SAR	Back	1.297	0.999	See Note 1	0.03
	Front	0.280	0.042	0.322		Front	0.334	0.042	0.376	N/A
	Top	-	0.999*	0.999		Top	-	0.999*	0.999	N/A
	Bottom	0.920	-	0.920		Bottom	1.056	-	1.056	N/A
	Right	-	-	-		Right	0.050	-	0.050	N/A
	Left	0.228	0.230	0.458		Left	0.087	0.230	0.317	N/A

Simult Tx	Configuration	LTE Band 41 SAR (W/kg)	5 GHz WLAN MIMO SAR (W/kg)	Σ SAR (W/kg)	SPLSR
		1	2	1+2	1+2
Hotspot SAR	Back	0.714	0.999	See Note 1	0.02
	Front	0.406	0.042	0.448	N/A
	Top	-	0.999*	0.999	N/A
	Bottom	0.883	-	0.883	N/A
	Right	0.030	-	0.030	N/A
	Left	0.059	0.230	0.289	N/A

FCC ID: ZNFG710TM	 PCTEST ENGINEERING LABORATORY, INC.	SAR EVALUATION REPORT		Approved by: Quality Manager
Document S/N: 1M1804030060-01-R1.ZNF	Test Dates: 04/03/18 - 04/16/18	DUT Type: Portable Handset		Page 113 of 131



**Table 12-15**

**Simultaneous Transmission Scenario with 2.4 GHz WLAN and 5 GHz WLAN (Hotspot at 1.0 cm)**

Exposure Condition	Mode	2G/3G/4G SAR (W/kg)	2.4 GHz WLAN Ant 1 at 17 dBm SAR (W/kg)	5 GHz WLAN Ant 2 at 14 dBm SAR (W/kg)	Σ SAR (W/kg)
		1	2	3	1+2+3
Hotspot SAR	GPRS 850	0.350	0.248	0.424	1.022
	GPRS 1900	0.735	0.248	0.424	1.407
	UMTS 850	0.444	0.248	0.424	1.116
	UMTS 1750	0.827	0.248	0.424	1.499
	UMTS 1900	1.075	0.248	0.424	See Table Below
	LTE Band 71	0.415	0.248	0.424	1.087
	LTE Band 12	0.530	0.248	0.424	1.202
	LTE Band 13	0.493	0.248	0.424	1.165
	LTE Band 5 (Cell)	0.378	0.248	0.424	1.050
	LTE Band 66 (AWS)	1.065	0.248	0.424	See Table Below
	LTE Band 25 (PCS)	0.920	0.248	0.424	<b>1.592</b>
	LTE Band 30	0.307	0.248	0.424	0.979
	LTE Band 7	1.297	0.248	0.424	See Table Below
LTE Band 41	0.883	0.248	0.424	1.555	

Simult Tx	Configuration	UMTS 1900 SAR (W/kg)	2.4 GHz WLAN Ant 1 at 17 dBm SAR (W/kg)	5 GHz WLAN Ant 2 at 14 dBm SAR (W/kg)	Σ SAR (W/kg)	Simult Tx	Configuration	LTE Band 66 (AWS) SAR (W/kg)	2.4 GHz WLAN Ant 1 at 17 dBm SAR (W/kg)	5 GHz WLAN Ant 2 at 14 dBm SAR (W/kg)	Σ SAR (W/kg)
		1	2	3	1+2+3			1	2	3	1+2+3
Hotspot SAR	Back	0.505	0.230	0.424	<b>1.159</b>	Hotspot SAR	Back	0.618	0.230	0.424	<b>1.272</b>
	Front	0.422	0.248*	0.424*	1.094		Front	0.489	0.248*	0.424*	1.161
	Top	-	0.248	0.424*	0.672		Top	-	0.248	0.424*	0.672
	Bottom	1.075	-	-	1.075		Bottom	1.065	-	-	1.065
	Left	0.256	0.248*	0.087	0.591		Left	0.422	0.248*	0.087	0.757

Simult Tx	Configuration	LTE Band 7 SAR (W/kg)	2.4 GHz WLAN Ant 1 at 17 dBm SAR (W/kg)	5 GHz WLAN Ant 2 at 14 dBm SAR (W/kg)	Σ SAR (W/kg)	SPLSR		
		1	2	3	1+2+3	1+2	1+3	2+3
Hotspot SAR	Back	1.297	0.230	0.424	See Note 1	0.01	0.02	0.02
	Front	0.334	0.248*	0.424*	1.006	N/A	N/A	N/A
	Top	-	0.248	0.424*	0.672	N/A	N/A	N/A
	Bottom	1.056	-	-	1.056	N/A	N/A	N/A
	Right	0.050	-	-	0.050	N/A	N/A	N/A
	Left	0.087	0.248*	0.087	0.422	N/A	N/A	N/A



FCC ID: ZNFG710TM	 PCTEST ENGINEERING LABORATORY, INC.	SAR EVALUATION REPORT		Approved by: Quality Manager
Document S/N: 1M1804030060-01-R1.ZNF	Test Dates: 04/03/18 - 04/16/18	DUT Type: Portable Handset		Page 114 of 131

**Table 12-16**  
**Simultaneous Transmission Scenario with Bluetooth (Hotspot at 1.0 cm)**

Exposure Condition	Mode	2G/3G/4G SAR (W/kg)	Bluetooth SAR (W/kg)	Σ SAR (W/kg)
		1	2	1+2
Hotspot SAR	GPRS 850	0.350	0.052	0.402
	GPRS 1900	0.735	0.052	0.787
	UMTS 850	0.444	0.052	0.496
	UMTS 1750	0.827	0.052	0.879
	UMTS 1900	1.075	0.052	1.127
	LTE Band 71	0.415	0.052	0.467
	LTE Band 12	0.530	0.052	0.582
	LTE Band 13	0.493	0.052	0.545
	LTE Band 5 (Cell)	0.378	0.052	0.430
	LTE Band 66 (AWS)	1.065	0.052	1.117
	LTE Band 25 (PCS)	0.920	0.052	0.972
	LTE Band 30	0.307	0.052	0.359
	LTE Band 7	1.297	0.052	<b>1.349</b>
	LTE Band 41	0.883	0.052	0.935

Notes:

1. No evaluation was performed to determine the aggregate 1g SAR for these configurations as the SPLS ratio between the antenna pairs was not greater than 0.04 per FCC KDB 447498 D01v06. See Section 12.7 for detailed SPLS ratio analysis.

FCC ID: ZNFG710TM		SAR EVALUATION REPORT		Approved by: Quality Manager
Document S/N: 1M1804030060-01-R1.ZNF	Test Dates: 04/03/18 - 04/16/18	DUT Type: Portable Handset		Page 115 of 131

## 12.6 Phablet Simultaneous Transmission Analysis



For SAR summation, the highest reported SAR across all test distances was used as the most conservative evaluation for simultaneous transmission analysis for each device edge.

Since wireless router 1g SAR was not > 1.2 W/kg, Phablet SAR was not required for 2.4 GHz WLAN. Thus, 2.4 GHz WLAN is not considered for Phablet Simultaneous Transmission Analysis.

**Table 12-17**  
**Simultaneous Transmission Scenario with 5 GHz WLAN (Phablet)**

Simult Tx	Configuration	UMTS 1750 SAR (W/kg)	5 GHz WLAN Ant 1 SAR (W/kg)	5 GHz WLAN Ant 2 SAR (W/kg)	Σ SAR (W/kg)		Simult Tx	Configuration	UMTS 1900 SAR (W/kg)	5 GHz WLAN Ant 1 SAR (W/kg)	5 GHz WLAN Ant 2 SAR (W/kg)	Σ SAR (W/kg)	
		1	2	3	1+2	1+3			1	2	3	1+2	1+3
Phablet SAR	Back	1.543	0.327	2.419	1.870	<b>3.962</b>	Phablet SAR	Back	1.123	0.327	2.419	1.450	3.542
	Front	1.523	0.303	0.182	1.826	1.705		Front	1.007	0.303	0.182	1.310	1.189
	Top	-	0.327*	2.419*	0.327	2.419		Top	-	0.327*	2.419*	0.327	2.419
	Bottom	2.794	-	-	2.794	2.794		Bottom	2.379	-	-	2.379	2.379
	Left	0.803	0.327*	0.416	1.130	1.218		Left	0.766	0.327*	0.416	1.093	1.182
Simult Tx	Configuration	LTE Band 66 (AWS) SAR (W/kg)	5 GHz WLAN Ant 1 SAR (W/kg)	5 GHz WLAN Ant 2 SAR (W/kg)	Σ SAR (W/kg)		Simult Tx	Configuration	LTE Band 25 (PCS) SAR (W/kg)	5 GHz WLAN Ant 1 SAR (W/kg)	5 GHz WLAN Ant 2 SAR (W/kg)	Σ SAR (W/kg)	
		1	2	3	1+2	1+3			1	2	3	1+2	1+3
Phablet SAR	Back	1.541	0.327	2.419	1.868	<b>3.960</b>	Phablet SAR	Back	1.092	0.327	2.419	1.419	3.511
	Front	1.622	0.303	0.182	1.925	1.804		Front	1.297	0.303	0.182	1.600	1.479
	Top	-	0.327*	2.419*	0.327	2.419		Top	-	0.327*	2.419*	0.327	2.419
	Bottom	2.606	-	-	2.606	2.606		Bottom	3.088	-	-	3.088	3.088
	Left	0.732	0.327*	0.416	1.059	1.148		Left	0.724	0.327*	0.416	1.051	1.140
Simult Tx	Configuration	LTE Band 7 SAR (W/kg)	5 GHz WLAN Ant 1 SAR (W/kg)	5 GHz WLAN Ant 2 SAR (W/kg)	Σ SAR (W/kg)		SPLSR						
		1	2	3	1+2	1+3	1+2	1+3					
Phablet SAR	Back	2.613	0.327	2.419	<b>2.940</b>	See Note 1	N/A	0.09					
	Front	-	0.303	0.182	0.303	0.182	N/A	N/A					
	Top	-	0.327*	2.419*	0.327	2.419	N/A	N/A					
	Left	-	0.327*	0.416	0.327	0.416	N/A	N/A					

Note: LTE Band 7 back side only is considered for Phablet Simultaneous Transmission Analysis. Front/Bottom/Left/Right Sides are excluded since wireless router 1g SAR was < 1.2 W/kg.



FCC ID: ZNFG710TM	 <b>PCTEST</b> ENGINEERING LABORATORY, INC.	<b>SAR EVALUATION REPORT</b>		<b>Approved by:</b> Quality Manager
<b>Document S/N:</b> 1M1804030060-01-R1.ZNF	<b>Test Dates:</b> 04/03/18 - 04/16/18	<b>DUT Type:</b> Portable Handset	Page 116 of 131	

**Table 12-18**  
**Simultaneous Transmission Scenario with 5 GHz WLAN MIMO (Phablet)**

Simult Tx	Configuration	UMTS 1750 SAR (W/kg)	5 GHz WLAN MIMO SAR (W/kg)	$\Sigma$ SAR (W/kg)	SPLSR	Simult Tx	Configuration	UMTS 1900 SAR (W/kg)	5 GHz WLAN MIMO SAR (W/kg)	$\Sigma$ SAR (W/kg)	
		1	2	1+2	1+2			1	2	1+2	
Phablet SAR	Back	1.543	2.744	See Note 1	0.07	Phablet SAR	Back	1.123	2.744	<b>3.867</b>	
	Front	1.523	0.305	1.828	N/A		Front	1.007	0.305	1.312	
	Top	-	2.744*	2.744	N/A		Top	-	2.744*	2.744	
	Bottom	2.794	-	2.794	N/A		Bottom	2.379	-	2.379	
	Left	0.803	0.481	1.284	N/A		Left	0.766	0.481	1.247	
Simult Tx	Configuration	LTE Band 66 (AWS) SAR (W/kg)	5 GHz WLAN MIMO SAR (W/kg)	$\Sigma$ SAR (W/kg)	SPLSR	Simult Tx	Configuration	LTE Band 25 (PCS) SAR (W/kg)	5 GHz WLAN MIMO SAR (W/kg)	$\Sigma$ SAR (W/kg)	
		1	2	1+2	1+2			1	2	1+2	
Phablet SAR	Back	1.541	2.744	See Note 1	0.07	Phablet SAR	Back	1.092	2.744	<b>3.836</b>	
	Front	1.622	0.305	1.927	N/A		Front	1.297	0.305	1.602	
	Top	-	2.744*	2.744	N/A		Top	-	2.744*	2.744	
	Bottom	2.606	-	2.606	N/A		Bottom	3.088	-	3.088	
	Left	0.732	0.481	1.213	N/A		Left	0.724	0.481	1.205	
Simult Tx	Configuration	LTE Band 7 SAR (W/kg)	5 GHz WLAN MIMO SAR (W/kg)	$\Sigma$ SAR (W/kg)	SPLSR	Simult Tx	Configuration	LTE Band 7 SAR (W/kg)	5 GHz WLAN MIMO SAR (W/kg)	$\Sigma$ SAR (W/kg)	SPLSR
		1	2	1+2	1+2			1	2	1+2	1+2
Phablet SAR	Back	2.613	2.744	See Note 1	0.10	Phablet SAR	Back	2.613	2.744	See Note 1	0.10
	Front	-	0.305	0.305	N/A		Front	-	0.305	0.305	N/A
	Top	-	2.744*	<b>2.744</b>	N/A		Top	-	2.744*	<b>2.744</b>	N/A
	Left	-	0.481	0.481	N/A		Left	-	0.481	0.481	N/A

Notes:

1. No evaluation was performed to determine the aggregate 10g SAR for these configurations as the SPLSR ratio between the antenna pairs was not greater than 0.1 per FCC KDB 447498 D01v06. See Section 12.7 for detailed SPLS ratio analysis.
2. LTE Band 7 back side only is considered for Phablet Simultaneous Transmission Analysis. Front/Bottom/Left/Right Sides are excluded since wireless router 1g SAR was < 1.2 W/kg.

FCC ID: ZNFG710TM		SAR EVALUATION REPORT		Approved by: Quality Manager
Document S/N: 1M1804030060-01-R1.ZNF	Test Dates: 04/03/18 - 04/16/18	DUT Type: Portable Handset		Page 117 of 131

## 12.7 SPLSR Evaluation and Analysis

Per FCC KDB Publication 447498 D01v06, when the sum of the standalone transmitters is more than 1.6 W/kg for 1g and 4 W/kg for 10g, the SAR sum to peak locations can be analyzed to determine SAR distribution overlaps. When the SAR peak to location ratio (shown below) for each pair of antennas is  $\leq 0.04$  for 1g and  $\leq 0.10$  for 10g, simultaneous SAR evaluation is not required. The distance between the transmitters was calculated using the following formula.



$$\text{Distance}_{Tx1 - Tx2} = R_i = \sqrt{(x_1 - x_2)^2 + (y_1 - y_2)^2}$$

$$\text{SPLS Ratio} = \frac{(SAR_1 + SAR_2)^{1.5}}{R_i}$$

### 12.7.1 Back Side Body-Worn SPLSR Evaluation and Analysis

**Table 12-19**  
**Peak SAR Locations for Body Back Side**

Mode/Band	x (mm)	y (mm)
2.4 GHz WLAN Ant 1	-9.20	61.20
2.4 GHz WLAN Ant 2	8.60	58.80
2.4 GHz WLAN MIMO	15.40	55.00
2.4 GHz WLAN Ant 1 at 17.0 dBm	-9.20	62.40
5 GHz WLAN Ant 2	9.00	48.00
5 GHz WLAN MIMO	11.00	49.00
5 GHz WLAN Ant 2 at 14.0 dBm	4.00	52.00
LTE Band 7	-14.20	-70.20
LTE Band 41	-16.70	-68.40
UMTS 850	-16.00	-80.00
UMTS 1750	-22.00	-72.00
UMTS 1900	-23.50	-73.50
LTE Band 12	-11.50	-73.50
LTE Band 13	-11.50	-72.00
LTE Band 66 (AWS)	-18.00	-72.00



FCC ID: ZNFG710TM		SAR EVALUATION REPORT		Approved by: Quality Manager
Document S/N: 1M1804030060-01-R1.ZNF	Test Dates: 04/03/18 - 04/16/18	DUT Type: Portable Handset		Page 118 of 131

**Table 12-20  
Back Side SAR to Peak Location Separation Ratio Calculations**

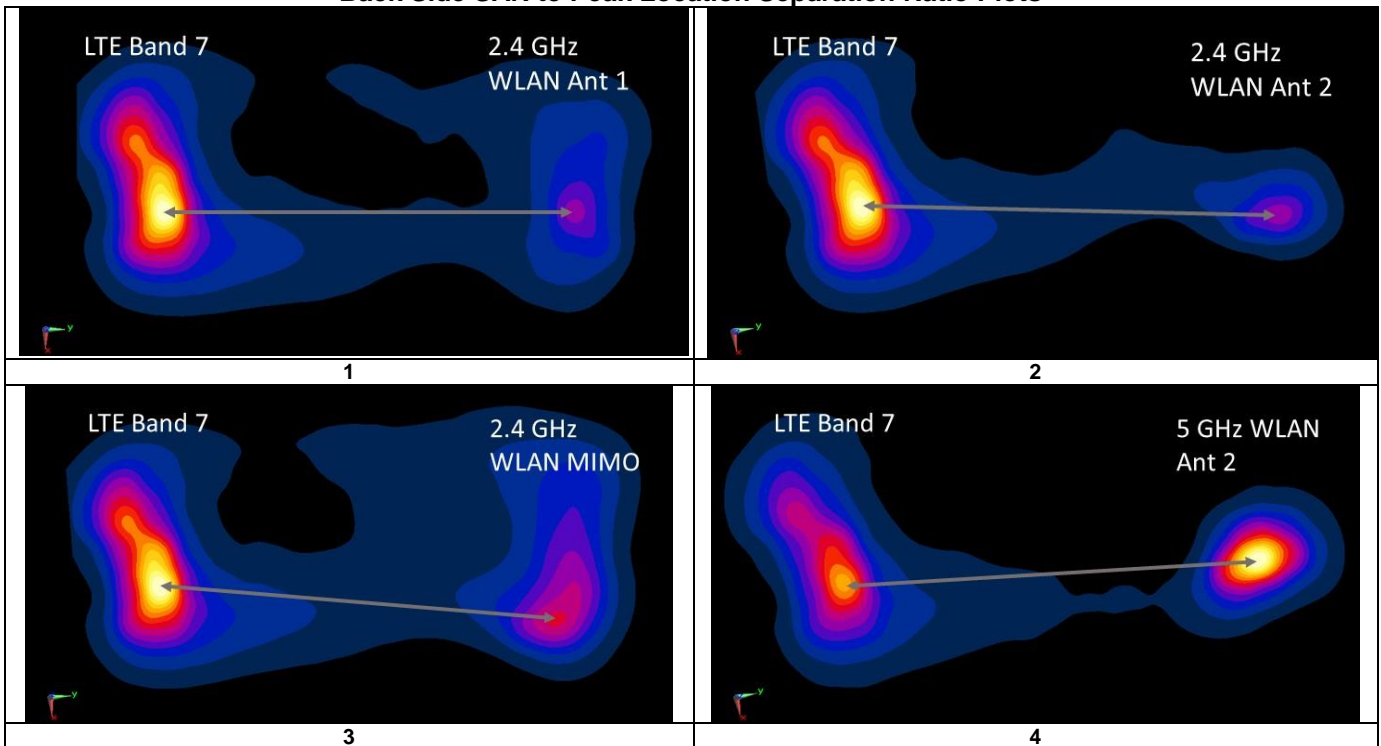

Antenna Pair		Standalone SAR (W/kg)		Standalone SAR Sum (W/kg)	Peak SAR Separation Distance (mm)	SPLS Ratio	Plot Number
Ant "a"	Ant "b"	a	b	a+b	D <sub>a-b</sub>	$(a+b)^{1.5}/D_{a-b}$	
2.4 GHz WLAN Ant 1	LTE Band 7	0.393	1.297	1.690	131.50	0.02	1
2.4 GHz WLAN Ant 2	LTE Band 7	0.385	1.297	1.682	131.00	0.02	2
2.4 GHz WLAN MIMO	LTE Band 7	0.473	1.297	1.770	128.65	0.02	3
5 GHz WLAN Ant 2	LTE Band 7	0.898	1.297	2.195	120.46	0.03	4
5 GHz WLAN Ant 2	LTE Band 41	0.898	0.714	1.612	119.20	0.02	5
5 GHz WLAN MIMO	UMTS 850	1.162	0.444	1.606	131.80	0.02	6
5 GHz WLAN MIMO	UMTS 1750	1.162	0.522	1.684	125.42	0.02	7
5 GHz WLAN MIMO	UMTS 1900	1.162	0.505	1.667	127.27	0.02	8
5 GHz WLAN MIMO	LTE Band 12	1.162	0.53	1.692	124.55	0.02	9
5 GHz WLAN MIMO	LTE Band 13	1.162	0.493	1.655	123.07	0.02	10
5 GHz WLAN MIMO	LTE Band 66 (AWS)	1.162	0.618	1.780	124.43	0.02	11
5 GHz WLAN MIMO	LTE Band 7	1.162	1.297	2.459	121.83	0.03	12
5 GHz WLAN MIMO	LTE Band 41	1.162	0.714	1.876	120.62	0.02	13
2.4 GHz WLAN Ant 1 at 17.0 dBm	5 GHz WLAN Ant 2 at 14.0 dBm	0.23	0.571	0.801	16.80	0.04	14
2.4 GHz WLAN Ant 1 at 17.0 dBm	LTE Band 7	0.23	1.297	1.527	132.69	0.01	
5 GHz WLAN Ant 2 at 14.0 dBm	LTE Band 7	0.571	1.297	1.868	123.55	0.02	

**Table 12-21  
Back Side SAR to Peak Location Separation Ratio Plots**

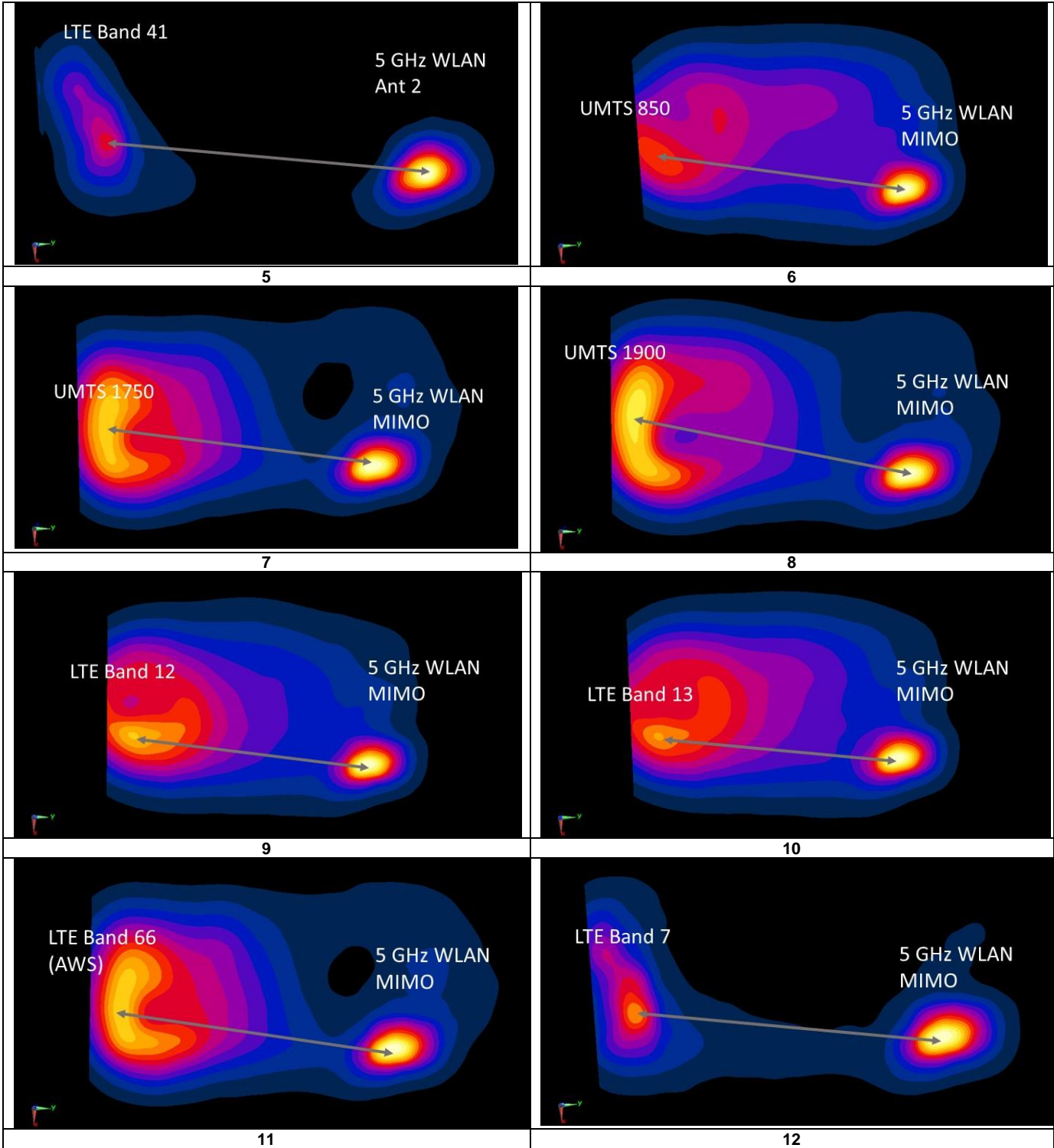

FCC ID: ZNFG710TM		SAR EVALUATION REPORT		Approved by: Quality Manager
Document S/N: 1M1804030060-01-R1.ZNF	Test Dates: 04/03/18 - 04/16/18	DUT Type: Portable Handset		Page 119 of 131



FCC ID: ZNFG710TM		SAR EVALUATION REPORT		Approved by: Quality Manager
Document S/N: 1M1804030060-01-R1.ZNF	Test Dates: 04/03/18 - 04/16/18	DUT Type: Portable Handset	Page 120 of 131	



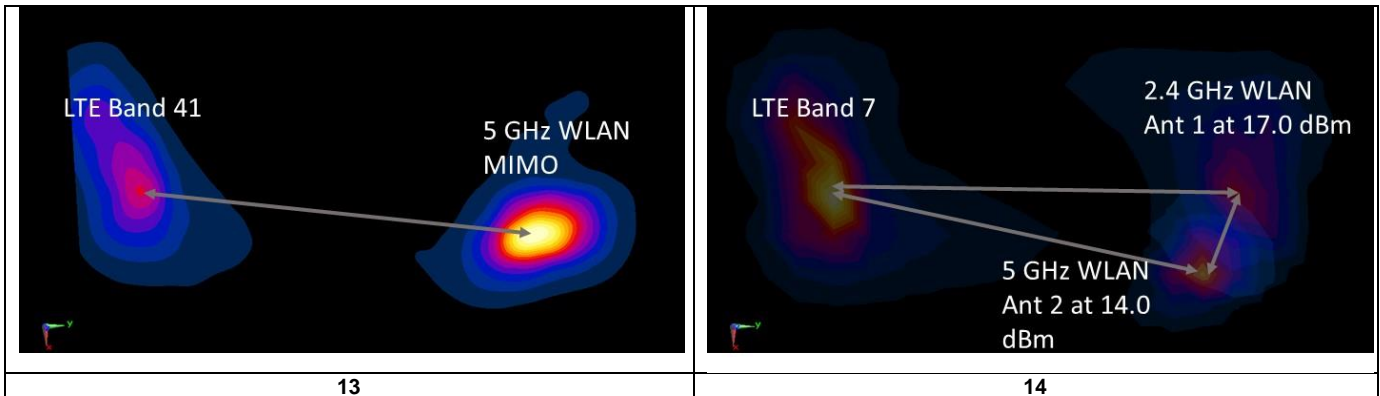

### 12.7.2 Back Side Hotspot SPLSR Evaluation and Analysis

**Table 12-22  
Peak SAR Locations for Body Back Side**

Mode/Band	x (mm)	y (mm)
2.4 GHz WLAN Ant 1	-9.20	61.20
2.4 GHz WLAN Ant 2	8.60	58.80
2.4 GHz WLAN MIMO	15.40	55.00
2.4 GHz WLAN Ant 1 at 17.0 dBm	-9.20	62.40
5 GHz WLAN Ant 2	11.00	51.00
5 GHz WLAN MIMO	11.00	50.00
5 GHz WLAN Ant 2 at 14.0 dBm	11.00	50.00
LTE Band 7	-14.20	-70.20
LTE Band 66 (AWS)	-18.00	-72.00
LTE Band 41	-16.70	-68.40



**Table 12-23  
Back Side SAR to Peak Location Separation Ratio Calculations**

Antenna Pair		Standalone SAR (W/kg)		Standalone SAR Sum (W/kg)	Peak SAR Separation Distance (mm)	SPLS Ratio	Plot Number
Ant "a"	Ant "b"	a	b	a+b	D <sub>a-b</sub>	(a+b) <sup>1.5</sup> /D <sub>a-b</sub>	
2.4 GHz WLAN Ant 1	LTE Band 7	0.393	1.297	1.690	131.50	0.02	1
2.4 GHz WLAN Ant 2	LTE Band 7	0.385	1.297	1.682	131.00	0.02	2
2.4 GHz WLAN MIMO	LTE Band 7	0.473	1.297	1.770	128.65	0.02	3
5 GHz WLAN Ant 2	LTE Band 7	0.867	1.297	2.164	123.79	0.03	4
5 GHz WLAN MIMO	LTE Band 66 (AWS)	0.999	0.618	1.617	125.40	0.02	5
5 GHz WLAN MIMO	LTE Band 7	0.999	1.297	2.296	122.81	0.03	6
5 GHz WLAN MIMO	LTE Band 41	0.999	0.714	1.713	121.60	0.02	7
2.4 GHz WLAN Ant 1 at 17.0 dBm	5 GHz WLAN Ant 2 at 14.0 dBm	0.23	0.424	0.654	23.70	0.02	8
2.4 GHz WLAN Ant 1 at 17.0 dBm	LTE Band 7	0.23	1.297	1.527	132.69	0.01	
5 GHz WLAN Ant 2 at 14.0 dBm	LTE Band 7	0.424	1.297	1.721	122.81	0.02	

FCC ID: ZNFG710TM	PCTEST ENGINEERING LABORATORY, INC.	SAR EVALUATION REPORT			Approved by: Quality Manager
Document S/N: 1M1804030060-01-R1.ZNF	Test Dates: 04/03/18 - 04/16/18	DUT Type: Portable Handset			Page 121 of 131

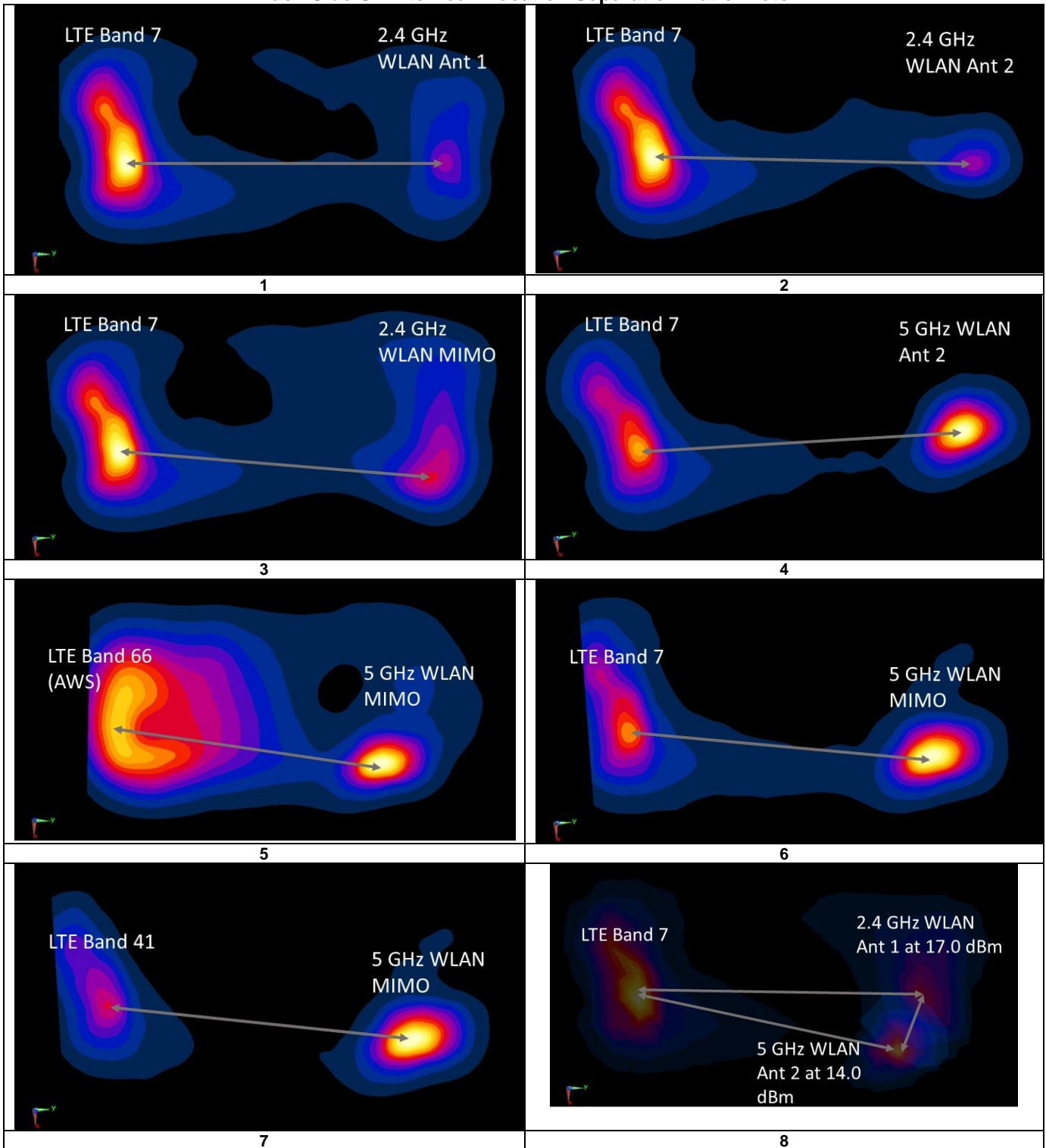
**Table 12-24**  
**Back Side SAR to Peak Location Separation Ratio Plots**



FCC ID: ZNFG710TM	 <b>PCTEST</b> <small>ENGINEERING LABORATORY, INC.</small>	<b>SAR EVALUATION REPORT</b>		Approved by: Quality Manager
Document S/N: 1M1804030060-01-R1.ZNF	Test Dates: 04/03/18 - 04/16/18	DUT Type: Portable Handset		Page 122 of 131

### 12.7.3 Back Side Phablet SPLSR Evaluation and Analysis

**Table 12-25**  
**Peak SAR Locations for Phablet Back Side**



Mode/Band	x (mm)	y (mm)
5 GHz WLAN Ant 2	13.00	50.00
5 GHz WLAN MIMO	12.00	50.00
LTE Band 7	-8.60	-67.20
UMTS 1750	-10.00	-72.00
LTE Band 66 (AWS)	-10.50	-78.50

**Table 12-26**  
**Phablet Back Side SAR to Peak Location Separation Ratio Calculations**

Antenna Pair		Standalone SAR (W/kg)		Standalone SAR Sum (W/kg)	Peak SAR Separation Distance (mm)	SPLS Ratio	Plot Number
Ant "a"	Ant "b"	a	b	a+b	D <sub>a-b</sub>	$(a+b)^{1.5}/D_{a-b}$	
5 GHz WLAN Ant 2	LTE Band 7	2.419	2.613	5.032	119.17	0.09	1
5 GHz WLAN MIMO	UMTS 1750	2.744	1.543	4.287	123.97	0.07	2
5 GHz WLAN MIMO	LTE Band 66 (AWS)	2.744	1.541	4.285	130.45	0.07	3
5 GHz WLAN MIMO	LTE Band 7	2.744	2.613	5.357	119.00	0.10	4

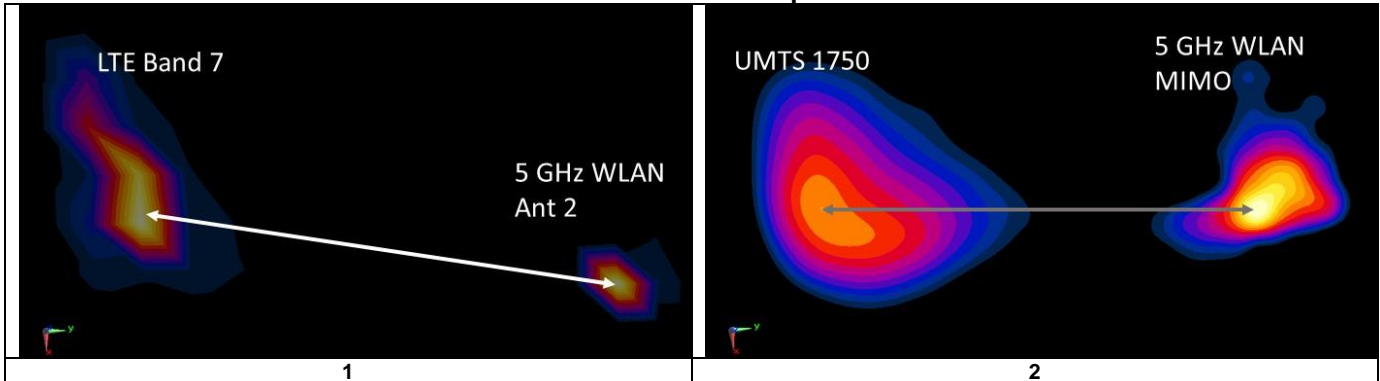
**Table 12-27**  
**Back Side SAR to Peak Location Separation Ratio Plots**



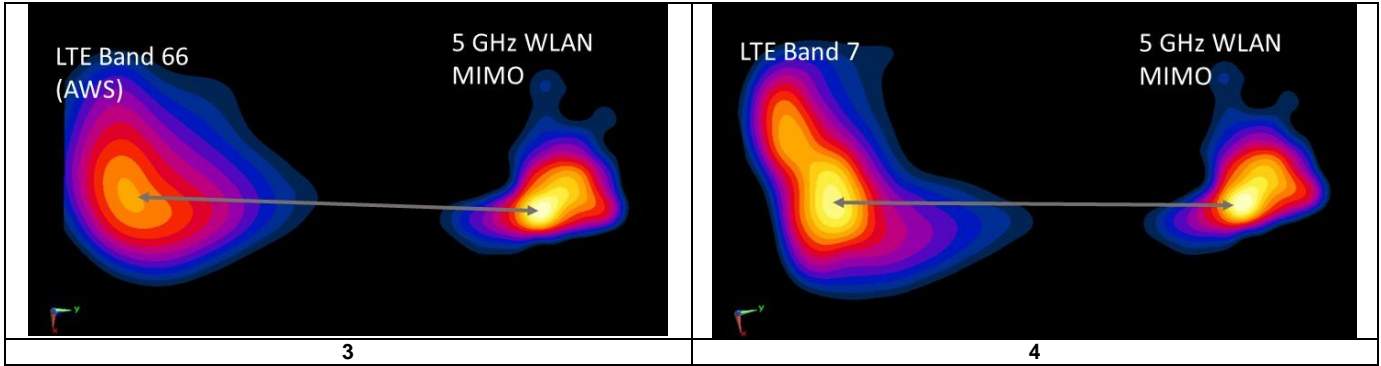

FCC ID: ZNFG710TM	 <b>PCTEST</b> ENGINEERING LABORATORY, INC.	<b>SAR EVALUATION REPORT</b>	 <b>LG</b>	<b>Approved by:</b> Quality Manager
<b>Document S/N:</b> 1M1804030060-01-R1.ZNF	<b>Test Dates:</b> 04/03/18 - 04/16/18	<b>DUT Type:</b> Portable Handset	Page 123 of 131	



### 12.8 Simultaneous Transmission Conclusion

The above numerical summed SAR results and SPLSR analysis are sufficient to determine that simultaneous transmission cases will not exceed the SAR limit and therefore no measured volumetric simultaneous SAR summation is required per FCC KDB Publication 447498 D01v06 and IEEE 1528- 2013 Section 6.3.4.1.

FCC ID: ZNFG710TM	 <b>SAR EVALUATION REPORT</b> 		<b>Approved by:</b> Quality Manager
<b>Document S/N:</b> 1M1804030060-01-R1.ZNF	<b>Test Dates:</b> 04/03/18 - 04/16/18	<b>DUT Type:</b> Portable Handset	Page 124 of 131

# 13 SAR MEASUREMENT VARIABILITY

## 13.1 Measurement Variability



Per FCC KDB Publication 865664 D01v01r04, SAR measurement variability was assessed for each frequency band, which was determined by the SAR probe calibration point and tissue-equivalent medium used for the device measurements. When both head and body tissue-equivalent media were required for SAR measurements in a frequency band, the variability measurement procedures were applied to the tissue medium with the highest measured SAR, using the highest measured SAR configuration for that tissue-equivalent medium. These additional measurements were repeated after the completion of all measurements requiring the same head or body tissue-equivalent medium in a frequency band. The test device was returned to ambient conditions (normal room temperature) with the battery fully charged before it was re-mounted on the device holder for the repeated measurement(s) to minimize any unexpected variations in the repeated results.

SAR Measurement Variability was assessed using the following procedures for each frequency band:

- 1) When the original highest measured SAR is  $\geq 0.80$  W/kg, the measurement was repeated once.
- 2) A second repeated measurement was performed only if the ratio of largest to smallest SAR for the original and first repeated measurements was  $> 1.20$  or when the original or repeated measurement was  $\geq 1.45$  W/kg (~ 10% from the 1g SAR limit).
- 3) A third repeated measurement was performed only if the original, first or second repeated measurement was  $\geq 1.5$  W/kg and the ratio of largest to smallest SAR for the original, first and second repeated measurements is  $> 1.20$ .
- 4) Repeated measurements are not required when the original highest measured SAR is  $< 0.80$  W/kg
- 5) When 10g SAR measurement is considered, a factor of 2.5 is applied to the thresholds above.

**Table 13-1  
Body SAR Measurement Variability Results**

BODY VARIABILITY RESULTS														
Band	FREQUENCY		Mode	Service	Data Rate (Mbps)	Side	Spacing	Measured SAR (1g)	1st Repeated SAR (1g)	Ratio	2nd Repeated SAR (1g)	Ratio	3rd Repeated SAR (1g)	Ratio
	MHz	Ch.						(W/kg)	(W/kg)		(W/kg)		(W/kg)	
1750	1770.00	132572	LTE Band 66 (AWS), 20 MHz Bandwidth	QPSK, 1 RB, 99 RB Offset	N/A	bottom	10 mm	1.050	1.040	1.01	N/A	N/A	N/A	N/A
1900	1907.60	9538	UMTS 1900	RMC	N/A	bottom	10 mm	1.060	1.050	1.01	N/A	N/A	N/A	N/A
2450	2510.00	20850	LTE Band 7, 20 MHz Bandwidth	QPSK, 1 RB, 99 RB Offset	N/A	back	10 mm	1.150	1.070	1.07	N/A	N/A	N/A	N/A
2600	2535.00	21100	LTE Band 7, 20 MHz Bandwidth	QPSK, 1 RB, 50 RB Offset	N/A	back	10 mm	1.210	1.200	1.01	N/A	N/A	N/A	N/A
5250	5280.00	56	802.11n, 20 MHz Bandwidth	OFDM, MIMO	13	back	10 mm	0.921	0.850	1.08	N/A	N/A	N/A	N/A
5600	5500.00	100	802.11n, 20 MHz Bandwidth	OFDM, MIMO	13	back	10 mm	0.991	0.960	1.03	N/A	N/A	N/A	N/A
5750	5785.00	157	802.11n, 20 MHz Bandwidth	OFDM, MIMO	13	back	10 mm	0.825	0.817	1.01	N/A	N/A	N/A	N/A
ANSI / IEEE C95.1 1992 - SAFETY LIMIT Spatial Peak Uncontrolled Exposure/General Population							Body 1.6 W/kg (mW/g) averaged over 1 gram							



FCC ID: ZNFG710TM		SAR EVALUATION REPORT		Approved by: Quality Manager
Document S/N: 1M1804030060-01-R1.ZNF	Test Dates: 04/03/18 - 04/16/18	DUT Type: Portable Handset	Page 125 of 131	

**Table 13-2  
Phablet SAR Measurement Variability Results**

PHABLET VARIABILITY RESULTS														
Band	FREQUENCY		Mode	Service	Data Rate (Mbps)	Side	Spacing	Measured SAR (10g)	1st Repeated SAR (10g)	Ratio	2nd Repeated SAR (10g)	Ratio	3rd Repeated SAR (10g)	Ratio
	MHz	Ch.						(W/kg)	(W/kg)		(W/kg)		(W/kg)	
1750	1752.60	1513	UMTS 1750	RMC	N/A	bottom	0 mm	2.780	2.710	1.03	N/A	N/A	N/A	N/A
1900	1905.00	26590	LTE Band 25 (PCS), 20 MHz Bandwidth	QPSK, 1 RB, 0 RB Offset	N/A	bottom	0 mm	2.870	2.830	1.01	N/A	N/A	N/A	N/A
2450	2510.00	20850	LTE Band 7, 20 MHz Bandwidth	QPSK, 1 RB, 99 RB Offset	N/A	back	0 mm	2.200	2.340	1.06	N/A	N/A	N/A	N/A
2600	2560.00	21350	LTE Band 7, 20 MHz Bandwidth	QPSK, 1 RB, 50 RB Offset	N/A	back	0 mm	2.500	2.340	1.07	N/A	N/A	N/A	N/A
5600	5500.00	100	802.11n, 20 MHz Bandwidth	OFDM, MIMO	13	back	0 mm	2.340	2.220	1.05	N/A	N/A	N/A	N/A
ANSI / IEEE C95.1 1992 - SAFETY LIMIT Spatial Peak Uncontrolled Exposure/General Population							Phablet 4.0 W/kg (mW/g) averaged over 10 grams							

### 13.2 Measurement Uncertainty



The measured SAR was <1.5 W/kg for 1g and <3.75 W/kg for 10g for all frequency bands. Therefore, per KDB Publication 865664 D01v01r04, the extended measurement uncertainty analysis per IEEE 1528-2013 was not required.

FCC ID: ZNFG710TM		SAR EVALUATION REPORT		Approved by: Quality Manager
Document S/N: 1M1804030060-01-R1.ZNF	Test Dates: 04/03/18 - 04/16/18	DUT Type: Portable Handset	Page 126 of 131	

# 14 EQUIPMENT LIST



Manufacturer	Model	Description	Cal Date	Cal Interval	Cal Due	Serial Number
Agilent	8648D	(9kHz-4GHz) Signal Generator	N/A	N/A	N/A	3629U00687
Agilent	8753ES	S-Parameter Vector Network Analyzer	8/17/2017	Annual	8/17/2018	MY40003841
Agilent	8753ES	S-Parameter Network Analyzer	9/14/2017	Annual	9/14/2018	US39170118
Agilent	E4438C	ESG Vector Signal Generator	3/21/2017	Biennial	3/21/2019	MY45090700
Agilent	E5515C	Wireless Communications Test Set	5/31/2017	Annual	5/31/2018	GB43304278
Agilent	E5515C	8960 Series 10 Wireless Communications Test Set	11/15/2017	Annual	11/15/2018	GB42230325
Agilent	E5515C	Wireless Communications Test Set	1/24/2018	Annual	1/24/2019	GB44400860
Agilent	N4010A	Wireless Connectivity Test Set	N/A	N/A	N/A	GB46170464
Agilent	N5182A	MKG Vector Signal Generator	1/24/2018	Annual	1/24/2019	MY47420651
Agilent	N9020A	MXA Signal Analyzer	1/24/2018	Annual	1/24/2019	US46470561
Amplifier Research	150A100C	DC Amplifier	CBT	N/A	CBT	348812
Amplifier Research	1551G6	Amplifier	CBT	N/A	CBT	433971
Anritsu	MA24106A	USB Power Sensor	6/7/2017	Annual	6/7/2018	1231538
Anritsu	MA24106A	USB Power Sensor	6/7/2017	Annual	6/7/2018	1231535
Anritsu	MA2411B	Pulse Power Sensor	3/2/2018	Annual	3/2/2019	1207364
Anritsu	MA2411B	Pulse Power Sensor	3/2/2018	Annual	3/2/2019	1339018
Anritsu	ML2495A	Power Meter	10/22/2017	Annual	10/22/2018	941001
Anritsu	MT8820C	Radio Communication Analyzer	5/23/2017	Annual	5/23/2018	6201240328
COMTECH	AR85729-5	Solid State Amplifier	CBT	N/A	CBT	M155A00-009
COMTECH	AR85729-5/5759B	Solid State Amplifier	CBT	N/A	CBT	M3W1A00-1002
Control Company	4040	Therm./ Clock/ Humidity Monitor	1/8/2018	Annual	1/8/2019	160473909
Control Company	4352	Ultra Long Stem Thermometer	1/8/2018	Annual	1/8/2019	160508097
Keysight	772D	Dual Directional Coupler	CBT	N/A	CBT	MY52180215
Keysight Technologies	85033E	Standard Mechanical Calibration Kit (DC to 9GHz, 3.5mm)	6/1/2017	Annual	6/1/2018	MY53401181
Keysight Technologies	U3401A	Digital Multimeter	5/23/2017	Annual	5/23/2018	MY57201470
MCL	BW-N6W5+	6dB Attenuator	CBT	N/A	CBT	1139
Mini Circuits	PWR-4GHS	USB Power Sensor	1/20/2018	Annual	1/20/2019	11710030063
Mini Circuits	PWR-4GHS	USB Power Sensor	1/22/2018	Annual	1/22/2019	11710030062
MiniCircuits	SLP-2400+	Low Pass Filter	CBT	N/A	CBT	R8979500903
MiniCircuits	VLF-6000+	Low Pass Filter	CBT	N/A	CBT	N/A
Mini-Circuits	BW-N20W5	Power Attenuator	CBT	N/A	CBT	1226
Mini-Circuits	BW-N20W5+	DC to 18 GHz Precision Fixed 20 dB Attenuator	CBT	N/A	CBT	N/A
Mini-Circuits	NLP-1200+	Low Pass Filter DC to 1000 MHz	CBT	N/A	CBT	N/A
Mini-Circuits	NLP-2950+	Low Pass Filter DC to 2700 MHz	CBT	N/A	CBT	N/A
Narda	4014C-6	4 - 8 GHz SMA 6 dB Directional Coupler	CBT	N/A	CBT	N/A
Narda	4772-3	Attenuator (3dB)	CBT	N/A	CBT	9406
Pasternack	PE2208-6	Bidirectional Coupler	CBT	N/A	CBT	N/A
Pasternack	PE2209-10	Bidirectional Coupler	CBT	N/A	CBT	N/A
Pasternack	PE5011-1	Torque Wrench	7/19/2017	Biennial	7/19/2019	N/A
Rohde & Schwarz	CMU200	Base Station Simulator	5/22/2017	Annual	5/22/2018	109892
Rohde & Schwarz	CMW500	Radio Communication Tester	5/4/2017	Annual	5/4/2018	112347
Rohde & Schwarz	CMW500	Wideband Radio Communication Tester	7/20/2017	Annual	7/20/2018	132885
Seekonk	NC-100	Torque Wrench (8" lb)	8/30/2016	Biennial	8/30/2018	N/A
Seekonk	NC-100	Torque Wrench	12/28/2017	Annual	12/28/2018	N/A
Seekonk	NC-100	Torque Wrench 5/16", 8" lbs	1/22/2018	Annual	1/22/2019	N/A
SPEAG	DAK-3.5	Dielectric Assessment Kit	9/12/2017	Annual	9/12/2018	1091
SPEAG	EX3DV4	SAR Probe	2/14/2018	Annual	2/14/2019	3914
SPEAG	ES3DV3	SAR Probe	2/13/2018	Annual	2/13/2019	3213
SPEAG	EX3DV4	SAR Probe	7/17/2017	Annual	7/17/2018	7410
SPEAG	ES3DV3	SAR Probe	8/14/2017	Annual	8/14/2018	3332
SPEAG	EX3DV4	SAR Probe	1/16/2018	Annual	1/16/2019	3589
SPEAG	ES3DV3	SAR Probe	9/18/2017	Annual	9/18/2018	3287
SPEAG	ES3DV3	SAR Probe	3/13/2018	Annual	3/13/2019	3319
SPEAG	EX3DV4	SAR Probe	8/16/2017	Annual	8/16/2018	7308
SPEAG	DAE4	Dasy Data Acquisition Electronics	2/15/2018	Annual	2/15/2019	665
SPEAG	DAE4	Dasy Data Acquisition Electronics	2/9/2018	Annual	2/9/2019	1272
SPEAG	DAE4	Dasy Data Acquisition Electronics	7/13/2017	Annual	7/13/2018	1322
SPEAG	DAE4	Dasy Data Acquisition Electronics	8/9/2017	Annual	8/9/2018	1323
SPEAG	DAE4	Dasy Data Acquisition Electronics	6/21/2017	Annual	6/21/2018	1333
SPEAG	DAE4	Dasy Data Acquisition Electronics	3/7/2018	Annual	3/7/2019	1368
SPEAG	DAE4	Dasy Data Acquisition Electronics	6/14/2017	Annual	6/14/2018	1334
SPEAG	D750V3	750 MHz SAR Dipole	1/15/2018	Annual	1/15/2019	1003
SPEAG	D835V2	835 MHz SAR Dipole	1/15/2018	Annual	1/15/2019	4d132
SPEAG	D1750V2	1750 MHz SAR Dipole	5/9/2017	Annual	5/9/2018	1148
SPEAG	D1900V2	1900 MHz SAR Dipole	2/7/2018	Annual	2/7/2019	5d148
SPEAG	D2300V2	2300 MHz SAR Dipole	7/25/2016	Biennial	7/25/2018	1073
SPEAG	D2450V2	2450 MHz SAR Dipole	9/11/2017	Annual	9/11/2018	797
SPEAG	D2600V2	2600 MHz SAR Dipole	7/10/2017	Annual	7/10/2018	1126
SPEAG	D5GHv2	5 GHz SAR Dipole	9/21/2016	Biennial	9/21/2018	1191
SPEAG	D750V3	750 MHz Dipole	3/7/2017	Biennial	3/7/2019	1054
SPEAG	D5GHv2	5 GHz SAR Dipole	8/15/2017	Annual	8/15/2018	1237

Note: CBT (Calibrated Before Testing). Prior to testing, the measurement paths containing a cable, amplifier, attenuator, coupler or filter were connected to a calibrated source (i.e. a signal generator) to determine the losses of the measurement path. The power meter offset was then adjusted to compensate for the measurement system losses. This level offset is stored within the power meter before measurements are made. This calibration verification procedure applies to the system verification and output power measurements. The calibrated reading is then taken directly from the power meter after compensation of the losses for all final power measurements.

FCC ID: ZNFG710TM		SAR EVALUATION REPORT		Approved by: Quality Manager
Document S/N: 1M1804030060-01-R1.ZNF	Test Dates: 04/03/18 - 04/16/18	DUT Type: Portable Handset	Page 127 of 131	

# 15 MEASUREMENT UNCERTAINTIES

a	c	d	e= f(d,k)	f	g	h = c x f/e	i = c x g/e	k
Uncertainty Component	Tol. (± %)	Prob. Dist.	Div.	c <sub>1</sub> 1gm	c <sub>1</sub> 10 gms	1gm u <sub>1</sub> (± %)	10gms u <sub>1</sub> (± %)	v <sub>1</sub>
<b>Measurement System</b>								
Probe Calibration	6.55	N	1	1.0	1.0	6.6	6.6	∞
Axial Isotropy	0.25	N	1	0.7	0.7	0.2	0.2	∞
Hemishperical Isotropy	1.3	N	1	0.7	0.7	0.9	0.9	∞
Boundary Effect	2.0	R	1.73	1.0	1.0	1.2	1.2	∞
Linearity	0.3	N	1	1.0	1.0	0.3	0.3	∞
System Detection Limits	0.25	R	1.73	1.0	1.0	0.1	0.1	∞
Readout Electronics	0.3	N	1	1.0	1.0	0.3	0.3	∞
Response Time	0.8	R	1.73	1.0	1.0	0.5	0.5	∞
Integration Time	2.6	R	1.73	1.0	1.0	1.5	1.5	∞
RF Ambient Conditions - Noise	3.0	R	1.73	1.0	1.0	1.7	1.7	∞
RF Ambient Conditions - Reflections	3.0	R	1.73	1.0	1.0	1.7	1.7	∞
Probe Positioner Mechanical Tolerance	0.4	R	1.73	1.0	1.0	0.2	0.2	∞
Probe Positioning w/ respect to Phantom	6.7	R	1.73	1.0	1.0	3.9	3.9	∞
Extrapolation, Interpolation & Integration algorithms for Max. SAR Evaluation	4.0	R	1.73	1.0	1.0	2.3	2.3	∞
<b>Test Sample Related</b>								
Test Sample Positioning	2.7	N	1	1.0	1.0	2.7	2.7	35
Device Holder Uncertainty	1.67	N	1	1.0	1.0	1.7	1.7	5
Output Power Variation - SAR drift measurement	5.0	R	1.73	1.0	1.0	2.9	2.9	∞
SAR Scaling	0.0	R	1.73	1.0	1.0	0.0	0.0	∞
<b>Phantom &amp; Tissue Parameters</b>								
Phantom Uncertainty (Shape & Thickness tolerances)	7.6	R	1.73	1.0	1.0	4.4	4.4	∞
Liquid Conductivity - measurement uncertainty	4.2	N	1	0.78	0.71	3.3	3.0	10
Liquid Permittivity - measurement uncertainty	4.1	N	1	0.23	0.26	1.0	1.1	10
Liquid Conductivity - Temperature Uncertainty	3.4	R	1.73	0.78	0.71	1.5	1.4	∞
Liquid Permittivity - Temperature Uncertainty	0.6	R	1.73	0.23	0.26	0.1	0.1	∞
Liquid Conductivity - deviation from target values	5.0	R	1.73	0.64	0.43	1.8	1.2	∞
Liquid Permittivity - deviation from target values	5.0	R	1.73	0.60	0.49	1.7	1.4	∞
<b>Combined Standard Uncertainty (k=1)</b>	RSS					11.5	11.3	60
<b>Expanded Uncertainty</b> (95% CONFIDENCE LEVEL)	k=2					23.0	22.6	

FCC ID: ZNFG710TM	 <b>PCTEST</b> ENGINEERING LABORATORY, INC.	<b>SAR EVALUATION REPORT</b>		<b>Approved by:</b> Quality Manager
<b>Document S/N:</b> 1M1804030060-01-R1.ZNF	<b>Test Dates:</b> 04/03/18 - 04/16/18	<b>DUT Type:</b> Portable Handset	Page 128 of 131	





# 16 CONCLUSION

## 16.1 Measurement Conclusion



The SAR evaluation indicates that the EUT complies with the RF radiation exposure limits of the FCC and Innovation, Science, and Economic Development Canada, with respect to all parameters subject to this test. These measurements were taken to simulate the RF effects of RF exposure under worst-case conditions. Precise laboratory measures were taken to assure repeatability of the tests. The results and statements relate only to the item(s) tested.

Please note that the absorption and distribution of electromagnetic energy in the body are very complex phenomena that depend on the mass, shape, and size of the body, the orientation of the body with respect to the field vectors, and the electrical properties of both the body and the environment. Other variables that may play a substantial role in possible biological effects are those that characterize the environment (e.g. ambient temperature, air velocity, relative humidity, and body insulation) and those that characterize the individual (e.g. age, gender, activity level, debilitation, or disease). Because various factors may interact with one another to vary the specific biological outcome of an exposure to electromagnetic fields, any protection guide should consider maximal amplification of biological effects as a result of field-body interactions, environmental conditions, and physiological variables. [3]



<b>FCC ID:</b> ZNFG710TM	 <b>PCTEST</b> ENGINEERING LABORATORY, INC.	<b>SAR EVALUATION REPORT</b>	 <b>LG</b>	<b>Approved by:</b> Quality Manager
<b>Document S/N:</b> 1M1804030060-01-R1.ZNF	<b>Test Dates:</b> 04/03/18 - 04/16/18	<b>DUT Type:</b> Portable Handset	Page 129 of 131	

## 17 REFERENCES

- [1] Federal Communications Commission, ET Docket 93-62, Guidelines for Evaluating the Environmental Effects of Radiofrequency Radiation, Aug. 1996.
- [2] ANSI/IEEE C95.1-2005, American National Standard safety levels with respect to human exposure to radio frequency electromagnetic fields, 3kHz to 300GHz, New York: IEEE, 2006.
- [3] ANSI/IEEE C95.1-1992, American National Standard safety levels with respect to human exposure to radio frequency electromagnetic fields, 3kHz to 300GHz, New York: IEEE, Sept. 1992.
- [4] ANSI/IEEE C95.3-2002, IEEE Recommended Practice for the Measurement of Potentially Hazardous Electromagnetic Fields - RF and Microwave, New York: IEEE, December 2002.
- [5] IEEE Standards Coordinating Committee 39 –Standards Coordinating Committee 34 – IEEE Std. 1528-2013, IEEE Recommended Practice for Determining the Peak Spatial-Average Specific Absorption Rate (SAR) in the Human Head from Wireless Communications Devices: Measurement Techniques.
- [6] NCRP, National Council on Radiation Protection and Measurements, Biological Effects and Exposure Criteria for RadioFrequency Electromagnetic Fields, NCRP Report No. 86, 1986. Reprinted Feb. 1995.
- [7] T. Schmid, O. Egger, N. Kuster, Automated E-field scanning system for dosimetric assessments, IEEE Transaction on Microwave Theory and Techniques, vol. 44, Jan. 1996, pp. 105-113.
- [8] K. Pokovic, T. Schmid, N. Kuster, Robust setup for precise calibration of E-field probes in tissue simulating liquids at mobile communications frequencies, ICECOM97, Oct. 1997, pp. 1 -124.
- [9] K. Pokovic, T. Schmid, and N. Kuster, E-field Probe with improved isotropy in brain simulating liquids, Proceedings of the ELMAR, Zadar, Croatia, June 23-25, 1996, pp. 172-175.
- [10] Schmid & Partner Engineering AG, Application Note: Data Storage and Evaluation, June 1998, p2.
- [11] V. Hombach, K. Meier, M. Burkhardt, E. Kuhn, N. Kuster, The Dependence of EM Energy Absorption upon Human Modeling at 900 MHz, IEEE Transaction on Microwave Theory and Techniques, vol. 44 no. 10, Oct. 1996, pp. 1865-1873.
- [12] N. Kuster and Q. Balzano, Energy absorption mechanism by biological bodies in the near field of dipole antennas above 300MHz, IEEE Transaction on Vehicular Technology, vol. 41, no. 1, Feb. 1992, pp. 17-23.
- [13] G. Hartsgrrove, A. Kraszewski, A. Surowiec, Simulated Biological Materials for Electromagnetic Radiation Absorption Studies, University of Ottawa, Bioelectromagnetics, Canada: 1987, pp. 29-36.
- [14] Q. Balzano, O. Garay, T. Manning Jr., Electromagnetic Energy Exposure of Simulated Users of Portable Cellular Telephones, IEEE Transactions on Vehicular Technology, vol. 44, no.3, Aug. 1995.
- [15] W. Gander, Computermathematick, Birkhaeuser, Basel, 1992.
- [16] W.H. Press, S.A. Teukolsky, W.T. Vetterling, and B.P. Flannery, Numerical Recipes in C, The Art of Scientific Computing, Second edition, Cambridge University Press, 1992.
- [17] N. Kuster, R. Kastle, T. Schmid, Dosimetric evaluation of mobile communications equipment with known precision, IEEE Transaction on Communications, vol. E80-B, no. 5, May 1997, pp. 645-652.

<b>FCC ID:</b> ZNFG710TM	 <b>SAR EVALUATION REPORT</b> 		<b>Approved by:</b> Quality Manager
<b>Document S/N:</b> 1M1804030060-01-R1.ZNF	<b>Test Dates:</b> 04/03/18 - 04/16/18	<b>DUT Type:</b> Portable Handset	Page 130 of 131

- [18] CENELEC CLC/SC111B, European Prestandard (prENV 50166-2), Human Exposure to Electromagnetic Fields High-frequency: 10kHz-300GHz, Jan. 1995.
- [19] Prof. Dr. Niels Kuster, ETH, Eidgenössische Technische Hochschule Zürich, Dosimetric Evaluation of the Cellular Phone.
- [20] IEC 62209-1, Measurement procedure for the assessment of specific absorption rate of human exposure to radio frequency fields from hand-held and body-mounted wireless communication devices - Part 1: Devices used next to the ear (Frequency range of 300 MHz to 6 GHz), July 2016.
- [21] Innovation, Science, Economic Development Canada RSS-102 Radio Frequency Exposure Compliance of Radiocommunication Apparatus (All Frequency Bands) Issue 5, March 2015.
- [22] Health Canada Safety Code 6 Limits of Human Exposure to Radio Frequency Electromagnetic Fields in the Frequency Range from 3 kHz – 300 GHz, 2015
- [23] FCC SAR Test Procedures for 2G-3G Devices, Mobile Hotspot and UMPC Devices KDB Publications 941225, D01-D07
- [24] SAR Measurement Guidance for IEEE 802.11 Transmitters, KDB Publication 248227 D01
- [25] FCC SAR Considerations for Handsets with Multiple Transmitters and Antennas, KDB Publications 648474 D03-D04
- [26] FCC SAR Evaluation Considerations for Laptop, Notebook, Netbook and Tablet Computers, FCC KDB Publication 616217 D04
- [27] FCC SAR Measurement and Reporting Requirements for 100MHz – 6 GHz, KDB Publications 865664 D01-D02
- [28] FCC General RF Exposure Guidance and SAR Procedures for Dongles, KDB Publication 447498, D01-D02
- [29] Anexo à Resolução No. 533, de 10 de Setembro de 2009.
- [30] IEC 62209-2, Human exposure to radio frequency fields from hand-held and body-mounted wireless communication devices - Human models, instrumentation, and procedures - Part 2: Procedure to determine the specific absorption rate (SAR) for wireless communication devices used in close proximity to the human body (frequency range of 30 MHz to 6 GHz), Mar. 2010.

<b>FCC ID:</b> ZNFG710TM	 <b>SAR EVALUATION REPORT</b> 		<b>Approved by:</b> Quality Manager
<b>Document S/N:</b> 1M1804030060-01-R1.ZNF	<b>Test Dates:</b> 04/03/18 - 04/16/18	<b>DUT Type:</b> Portable Handset	Page 131 of 131

## APPENDIX A: SAR TEST DATA

# PCTEST ENGINEERING LABORATORY, INC.

**DUT: ZNFG710TM; Type: Portable Handset; Serial: 09670**

Communication System: UID 0, GSM GPRS; 3 Tx slots; Frequency: 836.6 MHz; Duty Cycle: 1:2.76

Medium: 835 Head Medium parameters used (interpolated):

$f = 836.6 \text{ MHz}$ ;  $\sigma = 0.92 \text{ S/m}$ ;  $\epsilon_r = 42.807$ ;  $\rho = 1000 \text{ kg/m}^3$

Phantom section: Right Section

Test Date: 04-09-2018; Ambient Temp: 21.5°C; Tissue Temp: 20.7°C

Probe: ES3DV3 - SN3213; ConvF(6.42, 6.42, 6.42); Calibrated: 2/13/2018;

Sensor-Surface: 3mm (Mechanical Surface Detection)

Electronics: DAE4 Sn1272; Calibrated: 2/9/2018

Phantom: SAM 5.0 front; Type: QD000P40CD; Serial: 1648

Measurement SW: DASY52, Version 52.10;SEMCAD X Version 14.6.10 (7417)

**Mode: GPRS 850, Right Head, Cheek, Mid.ch, 3 Tx slots**

**Area Scan (9x15x1):** Measurement grid: dx=15mm, dy=15mm

**Zoom Scan (6x5x7)/Cube 0:** Measurement grid: dx=8mm, dy=8mm, dz=5mm

Reference Value = 12.57 V/m; Power Drift = 0.20 dB

Peak SAR (extrapolated) = 0.177 W/kg

**SAR(1 g) = 0.138 W/kg**

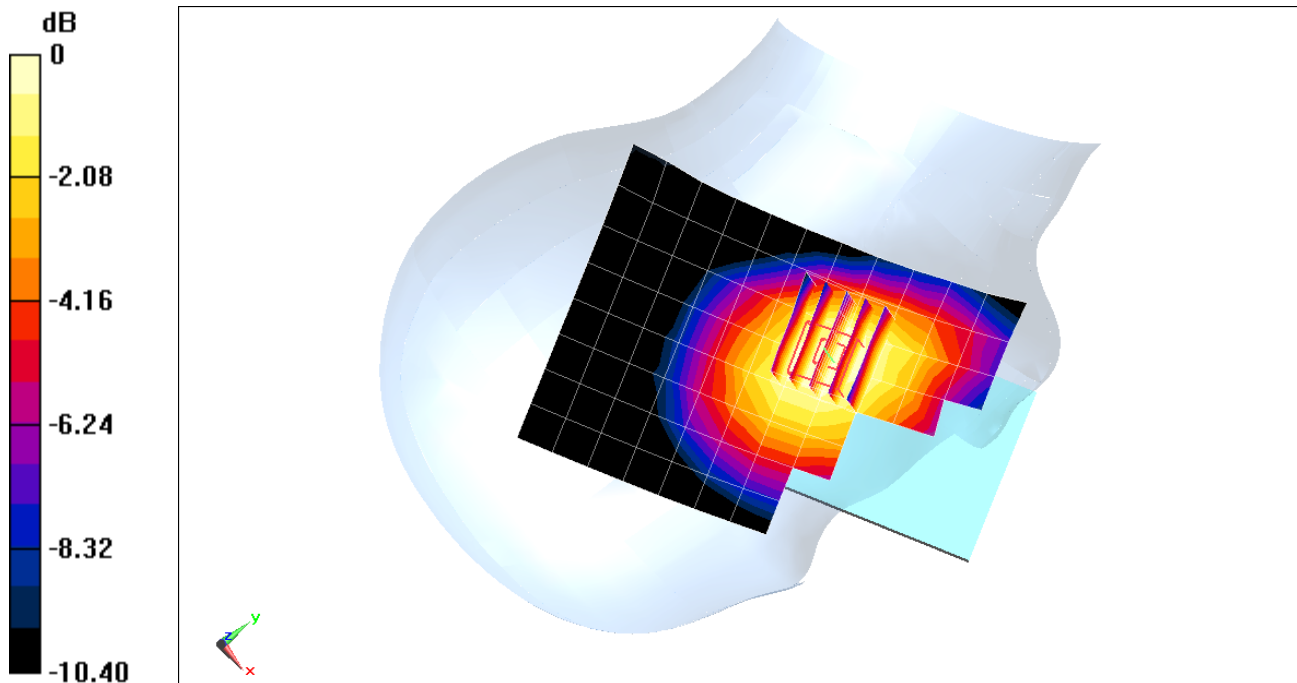

0 dB = 0.151 W/kg = -8.21 dBW/kg

# PCTEST ENGINEERING LABORATORY, INC.

**DUT: ZNFG710TM; Type: Portable Handset; Serial: 09688**

Communication System: UID 0, GSM GPRS; 2 Tx slots; Frequency: 1880 MHz; Duty Cycle: 1:4.15

Medium: 1900 Head Medium parameters used:

$f = 1880 \text{ MHz}$ ;  $\sigma = 1.422 \text{ S/m}$ ;  $\epsilon_r = 38.103$ ;  $\rho = 1000 \text{ kg/m}^3$

Phantom section: Left Section

Test Date: 04-13-2018; Ambient Temp: 21.9°C; Tissue Temp: 21.7°C

Probe: EX3DV4 - SN3914; ConvF(7.98, 7.98, 7.98); Calibrated: 2/14/2018;

Sensor-Surface: 1.4mm (Mechanical Surface Detection)

Electronics: DAE4 Sn665; Calibrated: 2/15/2018

Phantom: Twin-SAM V5.0 left; Type: QD 000 P40 CD; Serial: 1692

Measurement SW: DASY52, Version 52.10; SEMCAD X Version 14.6.10 (7417)

**Mode: GPRS 1900, Left Head, Cheek, Mid.ch, 2 Tx slots**

**Area Scan (9x14x1):** Measurement grid: dx=15mm, dy=15mm

**Zoom Scan (5x5x7)/Cube 0:** Measurement grid: dx=8mm, dy=8mm, dz=5mm

Reference Value = 6.375 V/m; Power Drift = -0.07 dB

Peak SAR (extrapolated) = 0.0990 W/kg

**SAR(1 g) = 0.059 W/kg**

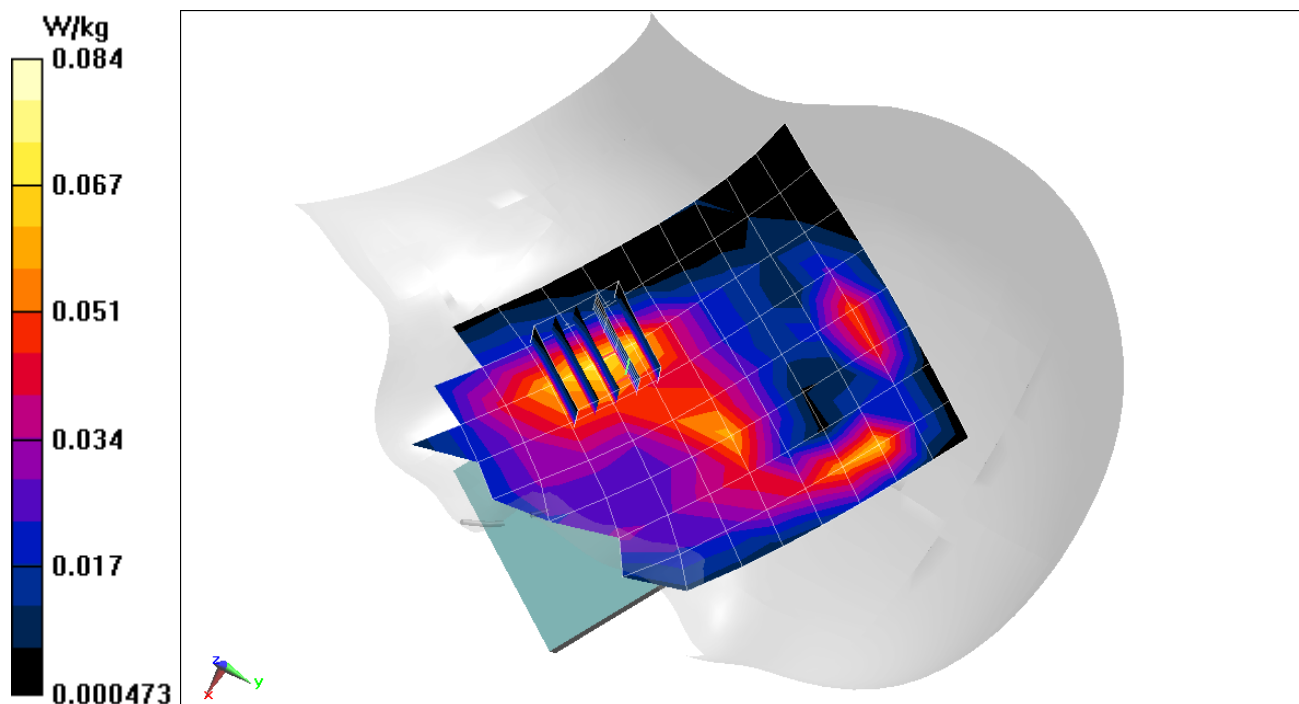

# PCTEST ENGINEERING LABORATORY, INC.

**DUT: ZNFG710TM; Type: Portable Handset; Serial: 09670**

Communication System: UID 0, UMTS; Frequency: 836.6 MHz; Duty Cycle: 1:1  
Medium: 835 Head Medium parameters used (interpolated):  
 $f = 836.6 \text{ MHz}$ ;  $\sigma = 0.92 \text{ S/m}$ ;  $\epsilon_r = 42.807$ ;  $\rho = 1000 \text{ kg/m}^3$   
Phantom section: Right Section

Test Date: 04-09-2018; Ambient Temp: 21.5°C; Tissue Temp: 20.7°C

Probe: ES3DV3 - SN3213; ConvF(6.42, 6.42, 6.42); Calibrated: 2/13/2018;  
Sensor-Surface: 3mm (Mechanical Surface Detection)  
Electronics: DAE4 Sn1272; Calibrated: 2/9/2018  
Phantom: SAM 5.0 front; Type: QD000P40CD; Serial: 1648  
Measurement SW: DASY52, Version 52.10; SEMCAD X Version 14.6.10 (7417)

**Mode: UMTS 850, Right Head, Cheek, Mid.ch**

**Area Scan (9x15x1):** Measurement grid: dx=15mm, dy=15mm

**Zoom Scan (6x5x7)/Cube 0:** Measurement grid: dx=8mm, dy=8mm, dz=5mm

Reference Value = 14.21 V/m; Power Drift = -0.01 dB

Peak SAR (extrapolated) = 0.229 W/kg

**SAR(1 g) = 0.177 W/kg**

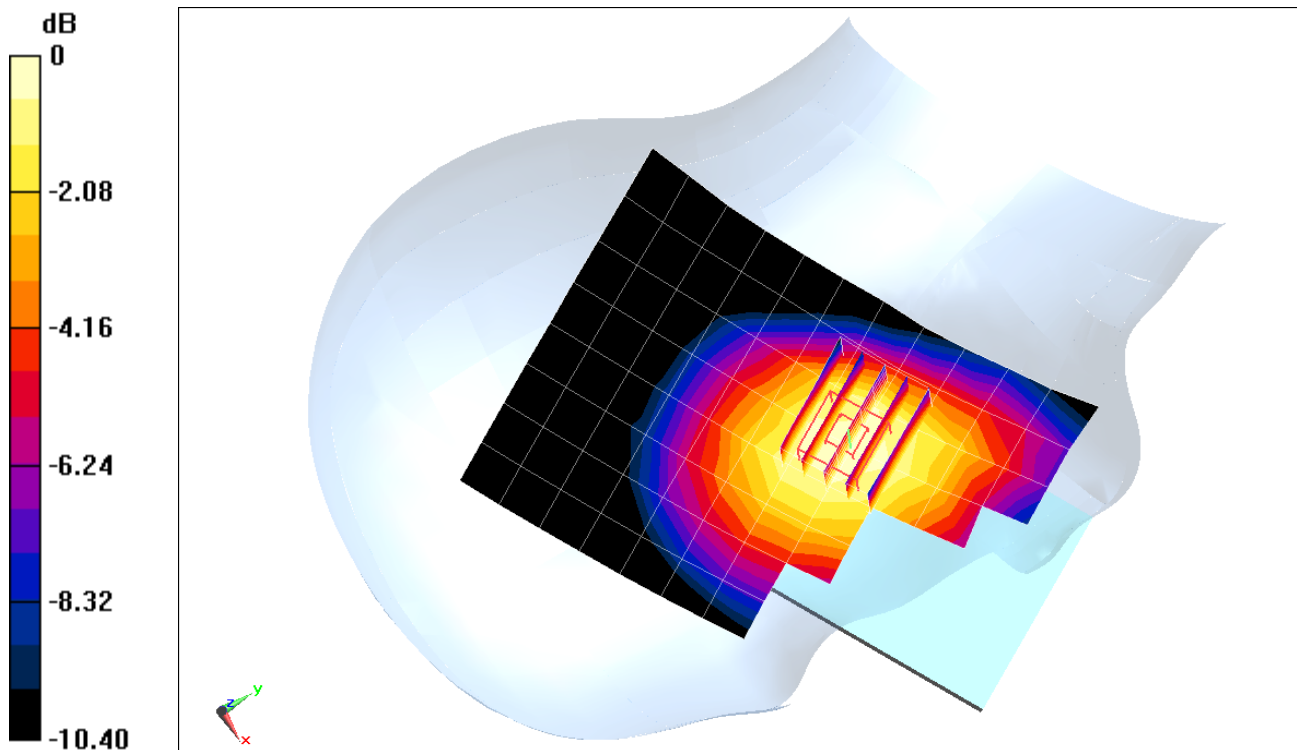

0 dB = 0.191 W/kg = -7.19 dBW/kg

# PCTEST ENGINEERING LABORATORY, INC.

**DUT: ZNFG710TM; Type: Portable Handset; Serial: 09654**

Communication System: UID 0, UMTS; Frequency: 1732.4 MHz; Duty Cycle: 1:1  
Medium: 1750 Head Medium parameters used (interpolated):  
 $f = 1732.4 \text{ MHz}$ ;  $\sigma = 1.384 \text{ S/m}$ ;  $\epsilon_r = 39.661$ ;  $\rho = 1000 \text{ kg/m}^3$   
Phantom section: Left Section

Test Date: 04-07-2018; Ambient Temp: 20.3°C; Tissue Temp: 21.4°C

Probe: EX3DV4 - SN7410; ConvF(8.66, 8.66, 8.66); Calibrated: 7/17/2017;  
Sensor-Surface: 1.4mm (Mechanical Surface Detection)  
Electronics: DAE4 Sn1322; Calibrated: 7/13/2017

Phantom: SAM with CRP v5.0 (Right); Type: QD000P40CD; Serial: TP:1759  
Measurement SW: DASY52, Version 52.10;SEMCAD X Version 14.6.10 (7417)

**Mode: UMTS 1750, Left Head, Tilt, Mid.ch**

**Area Scan (9x15x1):** Measurement grid: dx=15mm, dy=15mm

**Zoom Scan (5x5x7)/Cube 0:** Measurement grid: dx=8mm, dy=8mm, dz=5mm

Reference Value = 12.37 V/m; Power Drift = -0.15 dB

Peak SAR (extrapolated) = 0.379 W/kg

**SAR(1 g) = 0.201 W/kg**

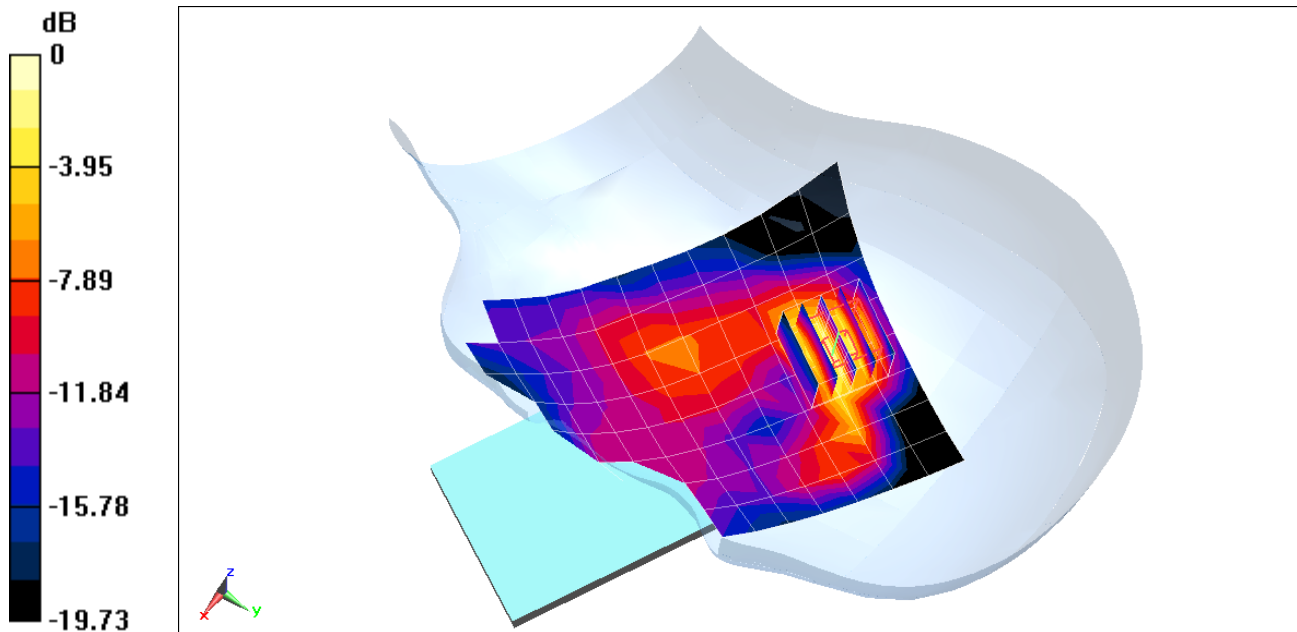

0 dB = 0.297 W/kg = -5.27 dBW/kg



# PCTEST ENGINEERING LABORATORY, INC.

**DUT: ZNFG710TM; Type: Portable Handset; Serial: 09688**

Communication System: UID 0, UMTS; Frequency: 1880 MHz; Duty Cycle: 1:1  
Medium: 1900 Head Medium parameters used:  
 $f = 1880 \text{ MHz}$ ;  $\sigma = 1.422 \text{ S/m}$ ;  $\epsilon_r = 38.103$ ;  $\rho = 1000 \text{ kg/m}^3$   
Phantom section: Left Section

Test Date: 04-13-2018; Ambient Temp: 21.9°C; Tissue Temp: 21.7°C

Probe: EX3DV4 - SN3914; ConvF(7.98, 7.98, 7.98); Calibrated: 2/14/2018;  
Sensor-Surface: 1.4mm (Mechanical Surface Detection)  
Electronics: DAE4 Sn665; Calibrated: 2/15/2018  
Phantom: Twin-SAM V5.0 left; Type: QD 000 P40 CD; Serial: 1692  
Measurement SW: DASY52, Version 52.10; SEMCAD X Version 14.6.10 (7417)

**Mode: UMTS 1900, Left Head, Cheek, Mid.ch**

**Area Scan (9x14x1):** Measurement grid:  $dx=15\text{mm}$ ,  $dy=15\text{mm}$

**Zoom Scan (5x5x7)/Cube 0:** Measurement grid:  $dx=8\text{mm}$ ,  $dy=8\text{mm}$ ,  $dz=5\text{mm}$

Reference Value = 10.50 V/m; Power Drift = -0.01 dB

Peak SAR (extrapolated) = 0.249 W/kg

**SAR(1 g) = 0.144 W/kg**

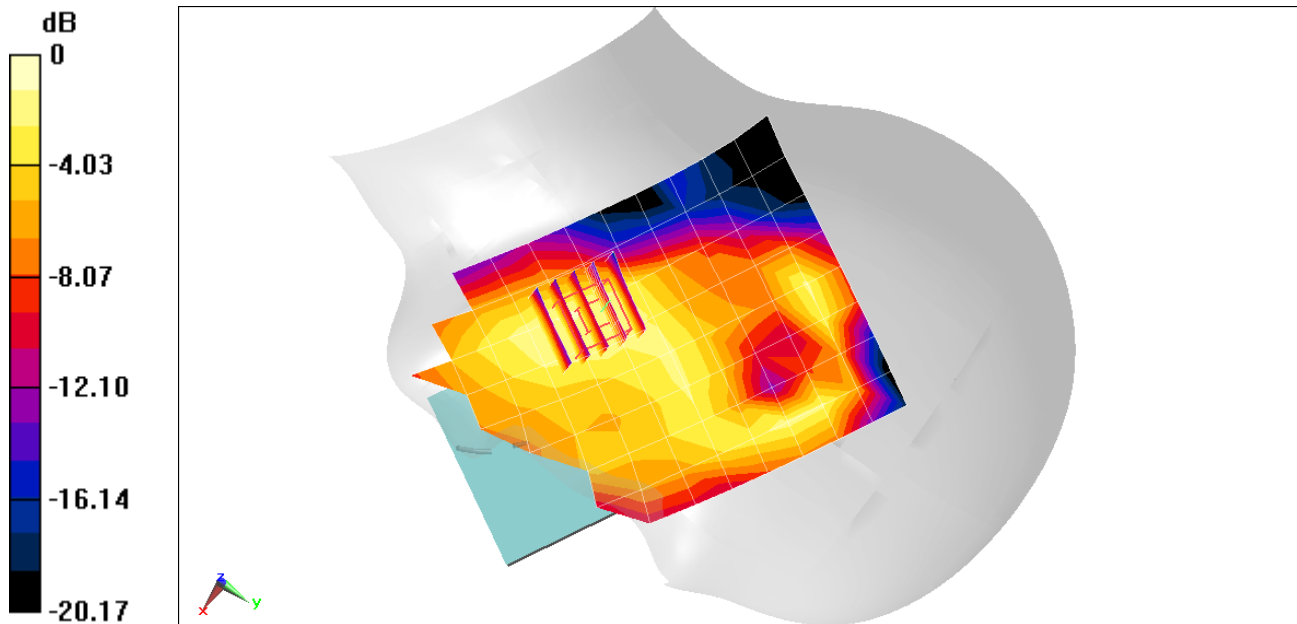

0 dB = 0.214 W/kg = -6.70 dBW/kg

# PCTEST ENGINEERING LABORATORY, INC.

**DUT: ZNFG710TM; Type: Portable Handset; Serial: 09654**

Communication System: UID 0, LTE Band 71; Frequency: 680.5 MHz; Duty Cycle: 1:1

Medium: 750 Head Medium parameters used (interpolated):

$f = 680.5 \text{ MHz}$ ;  $\sigma = 0.881 \text{ S/m}$ ;  $\epsilon_r = 41.272$ ;  $\rho = 1000 \text{ kg/m}^3$

Phantom section: Right Section

Test Date: 04-12-2018; Ambient Temp: 22.7°C; Tissue Temp: 21.7°C

Probe: EX3DV4 - SN3914; ConvF(10.18, 10.18, 10.18); Calibrated: 2/14/2018;

Sensor-Surface: 1.4mm (Mechanical Surface Detection)

Electronics: DAE4 Sn665; Calibrated: 2/15/2018

Phantom: Twin-SAM V5.0 left; Type: QD 000 P40 CD; Serial: 1692

Measurement SW: DASY52, Version 52.10; SEMCAD X Version 14.6.10 (7417)

**Mode: LTE Band 71, Right Head, Cheek, Mid.ch,  
20 MHz Bandwidth, QPSK, 1 RB, 99 RB Offset**

**Area Scan (9x14x1):** Measurement grid: dx=15mm, dy=15mm

**Zoom Scan (6x6x7)/Cube 0:** Measurement grid: dx=8mm, dy=8mm, dz=5mm

Reference Value = 10.22 V/m; Power Drift = 0.19 dB

Peak SAR (extrapolated) = 0.128 W/kg

**SAR(1 g) = 0.106 W/kg**

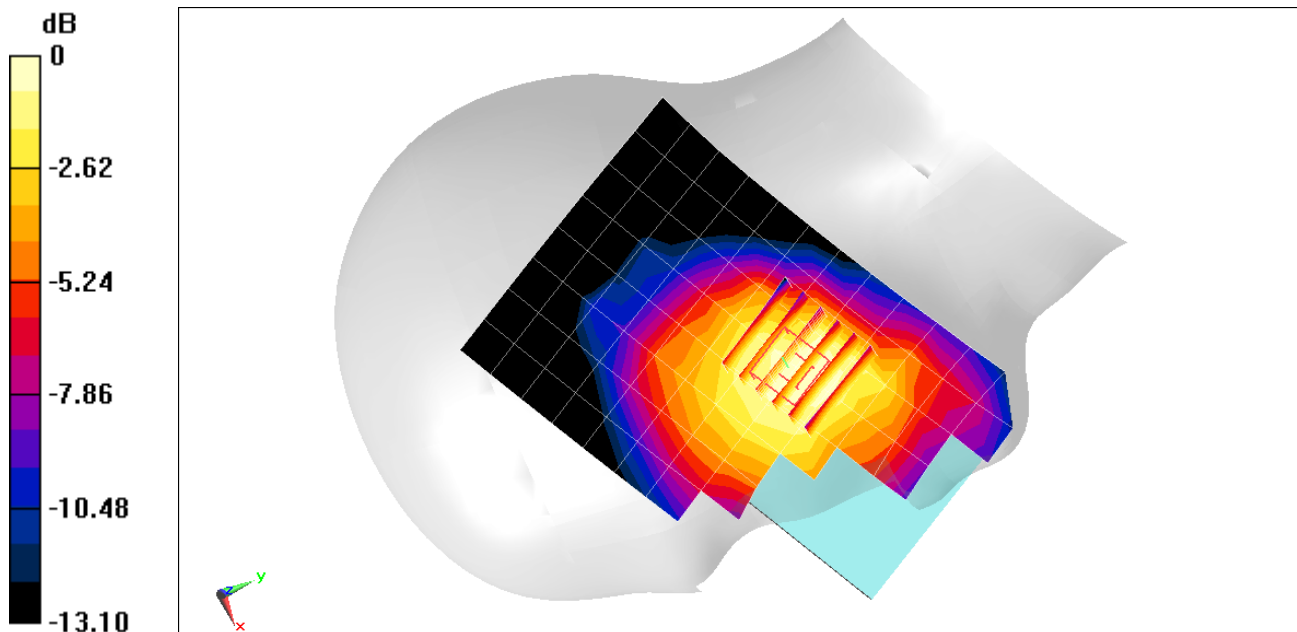

0 dB = 0.121 W/kg = -9.17 dBW/kg

# PCTEST ENGINEERING LABORATORY, INC.

**DUT: ZNFG710TM; Type: Portable Handset; Serial: 09654**

Communication System: UID 0, LTE Band 12; Frequency: 707.5 MHz; Duty Cycle: 1:1

Medium: 750 Head Medium parameters used (interpolated):

$f = 707.5$  MHz;  $\sigma = 0.889$  S/m;  $\epsilon_r = 41.243$ ;  $\rho = 1000$  kg/m<sup>3</sup>

Phantom section: Right Section

Test Date: 04-12-2018; Ambient Temp: 22.7°C; Tissue Temp: 21.7°C

Probe: EX3DV4 - SN3914; ConvF(10.18, 10.18, 10.18); Calibrated: 2/14/2018;

Sensor-Surface: 1.4mm (Mechanical Surface Detection)

Electronics: DAE4 Sn665; Calibrated: 2/15/2018

Phantom: Twin-SAM V5.0 left; Type: QD 000 P40 CD; Serial: 1692

Measurement SW: DASY52, Version 52.10;SEMCAD X Version 14.6.10 (7417)

**Mode: LTE Band 12, Right Head, Cheek, Mid.ch,  
10 MHz Bandwidth, QPSK, 1 RB, 49 RB Offset**

**Area Scan (9x14x1):** Measurement grid: dx=15mm, dy=15mm

**Zoom Scan (6x7x7)/Cube 0:** Measurement grid: dx=8mm, dy=8mm, dz=5mm

Reference Value = 14.42 V/m; Power Drift = 0.18 dB

Peak SAR (extrapolated) = 0.234 W/kg

**SAR(1 g) = 0.187 W/kg**

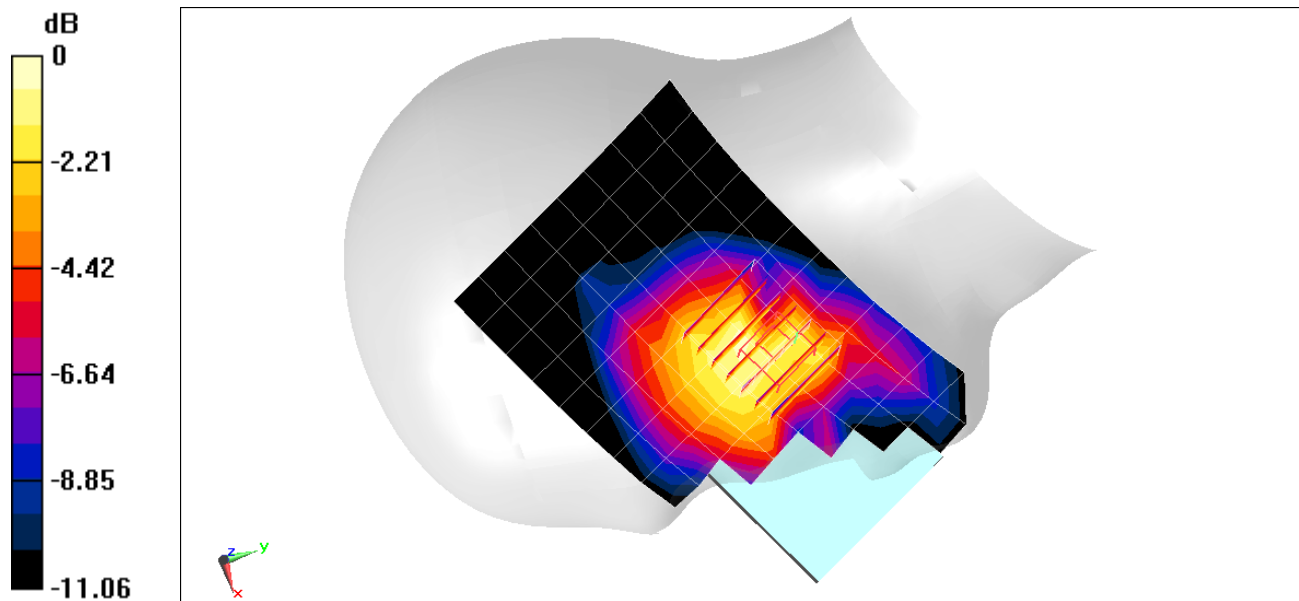

0 dB = 0.218 W/kg = -6.62 dBW/kg

# PCTEST ENGINEERING LABORATORY, INC.

**DUT: ZNFG710TM; Type: Portable Handset; Serial: 09654**

Communication System: UID 0, LTE Band 13; Frequency: 782 MHz; Duty Cycle: 1:1  
Medium: 750 Head Medium parameters used (interpolated):  
 $f = 782 \text{ MHz}$ ;  $\sigma = 0.916 \text{ S/m}$ ;  $\epsilon_r = 40.971$ ;  $\rho = 1000 \text{ kg/m}^3$   
Phantom section: Right Section

Test Date: 04-12-2018; Ambient Temp: 22.7°C; Tissue Temp: 21.7°C

Probe: EX3DV4 - SN3914; ConvF(10.18, 10.18, 10.18); Calibrated: 2/14/2018;  
Sensor-Surface: 1.4mm (Mechanical Surface Detection)  
Electronics: DAE4 Sn665; Calibrated: 2/15/2018  
Phantom: Twin-SAM V5.0 left; Type: QD 000 P40 CD; Serial: 1692  
Measurement SW: DASY52, Version 52.10;SEMCAD X Version 14.6.10 (7417)

**Mode: LTE Band 13, Right Head, Cheek, Mid.ch,  
10 MHz Bandwidth, QPSK, 1 RB, 25 RB Offset**

**Area Scan (9x14x1):** Measurement grid:  $dx=15\text{mm}$ ,  $dy=15\text{mm}$   
**Zoom Scan (5x5x7)/Cube 0:** Measurement grid:  $dx=8\text{mm}$ ,  $dy=8\text{mm}$ ,  $dz=5\text{mm}$   
Reference Value = 15.65 V/m; Power Drift = 0.14 dB  
Peak SAR (extrapolated) = 0.261 W/kg  
**SAR(1 g) = 0.208 W/kg**

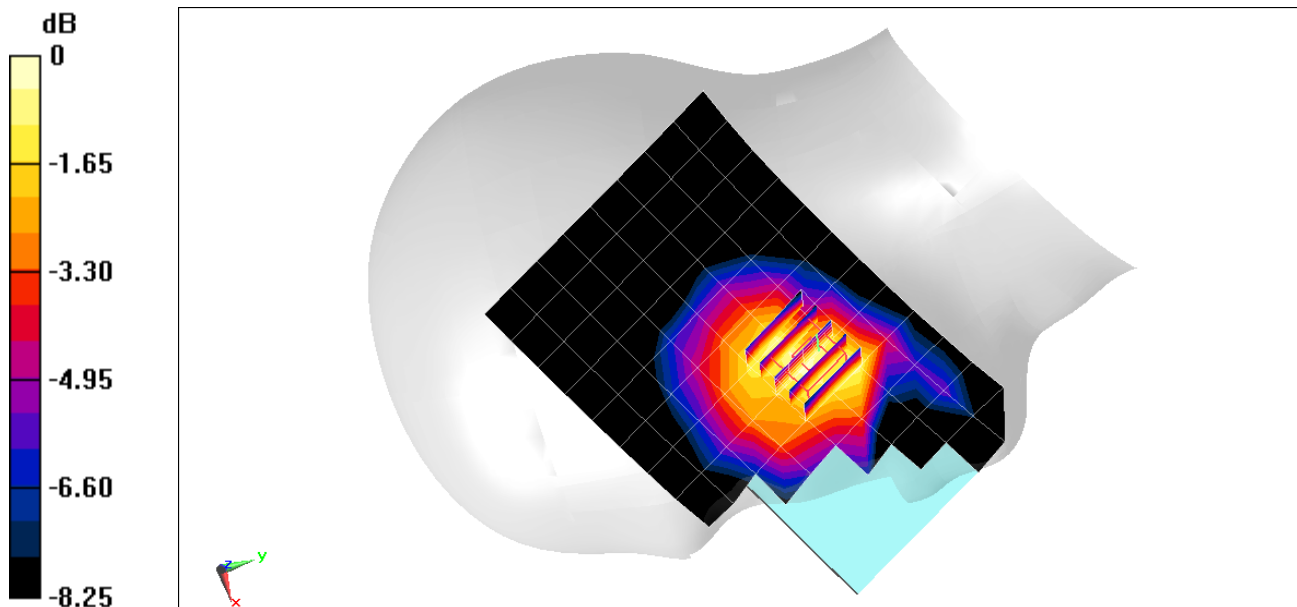

0 dB = 0.244 W/kg = -6.13 dBW/kg

# PCTEST ENGINEERING LABORATORY, INC.

**DUT: ZNFG710TM; Type: Portable Handset; Serial: 09670**

Communication System: UID 0, LTE Band 5 (Cell.); Frequency: 836.5 MHz; Duty Cycle: 1:1  
Medium: 835 Head Medium parameters used (interpolated):  
 $f = 836.5 \text{ MHz}$ ;  $\sigma = 0.92 \text{ S/m}$ ;  $\epsilon_r = 42.808$ ;  $\rho = 1000 \text{ kg/m}^3$   
Phantom section: Right Section

Test Date: 04-09-2018; Ambient Temp: 21.5°C; Tissue Temp: 20.7°C

Probe: ES3DV3 - SN3213; ConvF(6.42, 6.42, 6.42); Calibrated: 2/13/2018;  
Sensor-Surface: 3mm (Mechanical Surface Detection)  
Electronics: DAE4 Sn1272; Calibrated: 2/9/2018  
Phantom: SAM 5.0 front; Type: QD000P40CD; Serial: 1648  
Measurement SW: DASY52, Version 52.10; SEMCAD X Version 14.6.10 (7417)

**Mode: LTE Band 5 (Cell.), Right Head, Cheek, Mid.ch,  
10 MHz Bandwidth, QPSK, 1 RB, 49 RB Offset**

**Area Scan (9x15x1):** Measurement grid: dx=15mm, dy=15mm  
**Zoom Scan (5x5x7)/Cube 0:** Measurement grid: dx=8mm, dy=8mm, dz=5mm  
Reference Value = 15.68 V/m; Power Drift = -0.06 dB  
Peak SAR (extrapolated) = 0.250 W/kg  
**SAR(1 g) = 0.195 W/kg**

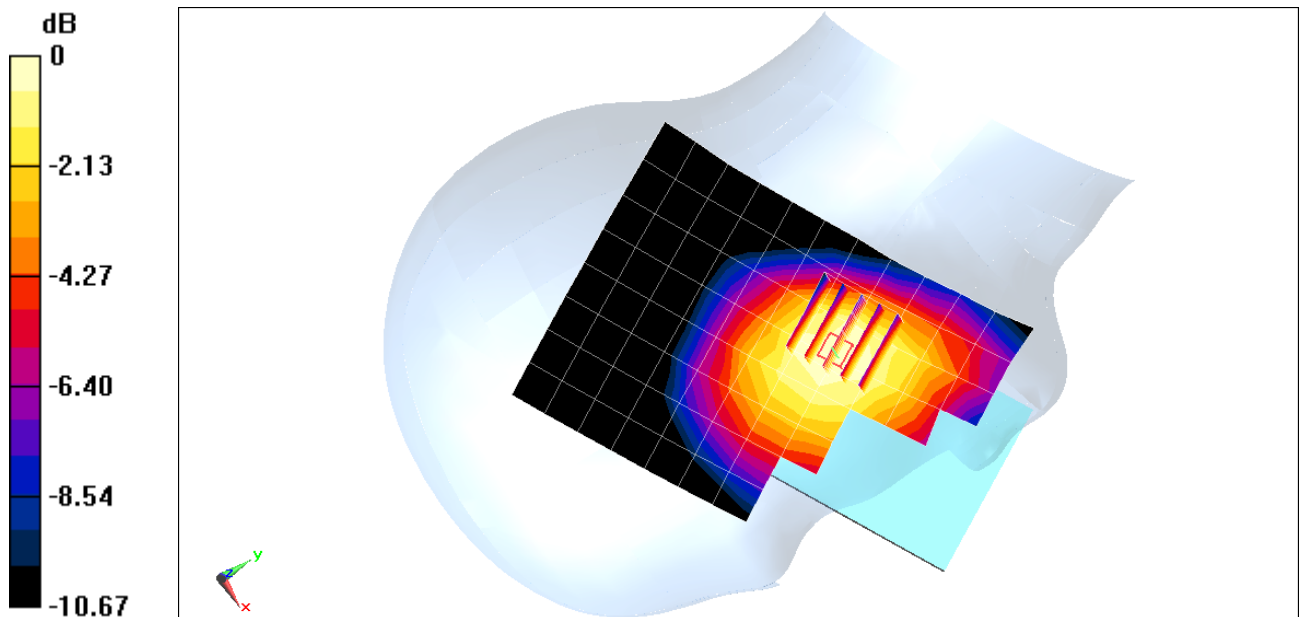

0 dB = 0.211 W/kg = -6.76 dBW/kg

# PCTEST ENGINEERING LABORATORY, INC.

**DUT: ZNFG710TM; Type: Portable Handset; Serial: 09654**

Communication System: UID 0, LTE Band 66 (AWS); Frequency: 1720 MHz; Duty Cycle: 1:1  
Medium: 1750 Head Medium parameters used (interpolated):  
 $f = 1720 \text{ MHz}$ ;  $\sigma = 1.371 \text{ S/m}$ ;  $\epsilon_r = 39.717$ ;  $\rho = 1000 \text{ kg/m}^3$   
Phantom section: Left Section

Test Date: 04-07-2018; Ambient Temp: 20.3°C; Tissue Temp: 21.4°C

Probe: EX3DV4 - SN7410; ConvF(8.66, 8.66, 8.66); Calibrated: 7/17/2017;

Sensor-Surface: 1.4mm (Mechanical Surface Detection)

Electronics: DAE4 Sn1322; Calibrated: 7/13/2017

Phantom: SAM with CRP v5.0 (Right); Type: QD000P40CD; Serial: TP:1759

Measurement SW: DASY52, Version 52.10;SEMCAD X Version 14.6.10 (7417)

**Mode: LTE Band 66 (AWS), Left Head, Tilt, Low.ch,  
20 MHz Bandwidth, QPSK, 1 RB, 0 RB Offset**

**Area Scan (9x15x1):** Measurement grid: dx=15mm, dy=15mm

**Zoom Scan (5x5x7)/Cube 0:** Measurement grid: dx=8mm, dy=8mm, dz=5mm

Reference Value = 13.93 V/m; Power Drift = -0.01 dB

Peak SAR (extrapolated) = 0.370 W/kg

**SAR(1 g) = 0.206 W/kg**

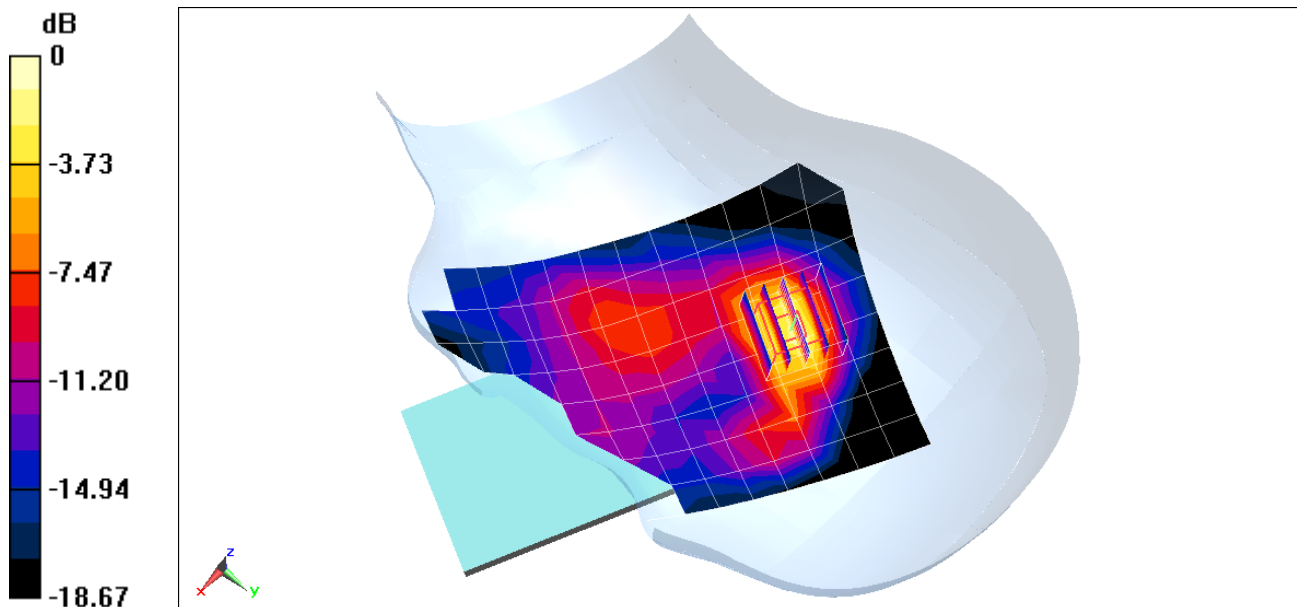

0 dB = 0.313 W/kg = -5.04 dBW/kg

# PCTEST ENGINEERING LABORATORY, INC.

**DUT: ZNFG710TM; Type: Portable Handset; Serial: 09688**

Communication System: UID 0, LTE Band 25 (PCS); Frequency: 1905 MHz; Duty Cycle: 1:1  
Medium: 1900 Head Medium parameters used (interpolated):  
 $f = 1905 \text{ MHz}$ ;  $\sigma = 1.438 \text{ S/m}$ ;  $\epsilon_r = 38.076$ ;  $\rho = 1000 \text{ kg/m}^3$   
Phantom section: Left Section

Test Date: 04-13-2018; Ambient Temp: 21.9°C; Tissue Temp: 21.7°C

Probe: EX3DV4 - SN3914; ConvF(7.98, 7.98, 7.98); Calibrated: 2/14/2018;

Sensor-Surface: 1.4mm (Mechanical Surface Detection)

Electronics: DAE4 Sn665; Calibrated: 2/15/2018

Phantom: Twin-SAM V5.0 left; Type: QD 000 P40 CD; Serial: 1692

Measurement SW: DASY52, Version 52.10; SEMCAD X Version 14.6.10 (7417)

**Mode: LTE Band 25 (PCS), Left Head, Cheek, High.ch,  
20 MHz Bandwidth, QPSK, 1 RB, 99 RB Offset**

**Area Scan (9x14x1):** Measurement grid:  $dx=15\text{mm}$ ,  $dy=15\text{mm}$

**Zoom Scan (5x5x7)/Cube 0:** Measurement grid:  $dx=8\text{mm}$ ,  $dy=8\text{mm}$ ,  $dz=5\text{mm}$

Reference Value = 11.02 V/m; Power Drift = 0.10 dB

Peak SAR (extrapolated) = 0.250 W/kg

**SAR(1 g) = 0.152 W/kg**

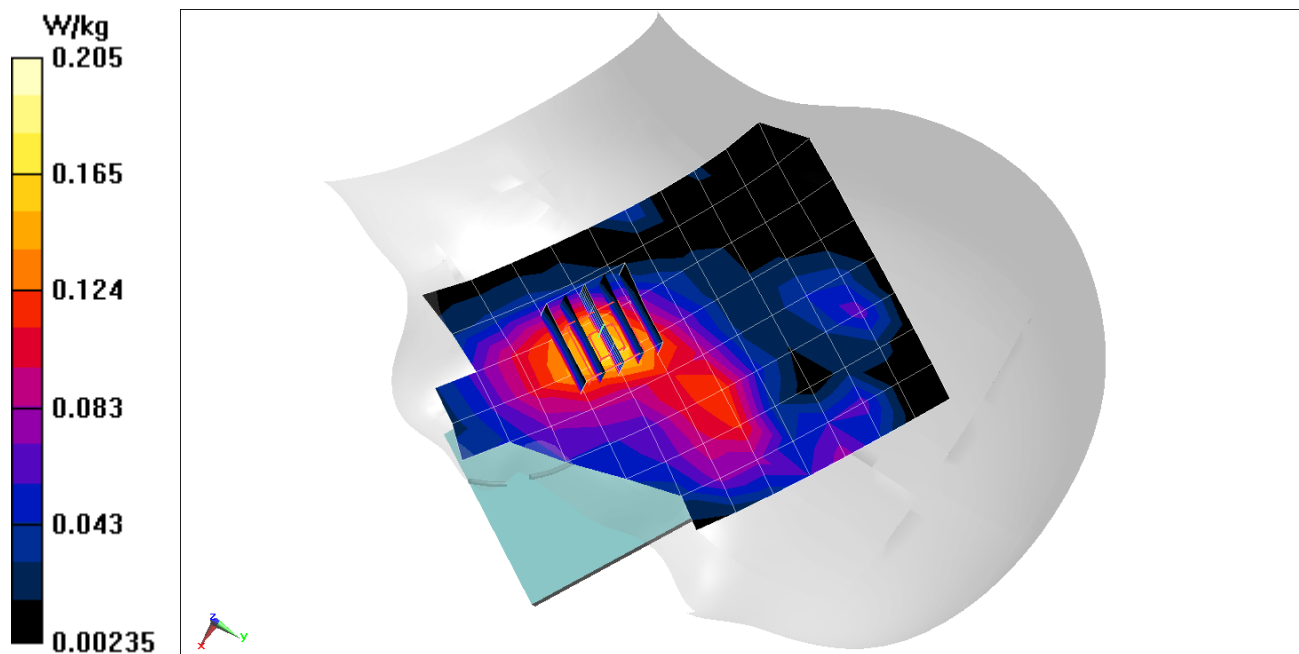

# PCTEST ENGINEERING LABORATORY, INC.

**DUT: ZNFG710TM; Type: Portable Handset; Serial: 09704**

Communication System: UID 0, LTE Band 30; Frequency: 2310 MHz; Duty Cycle: 1:1

Medium: 2300 Head Medium parameters used:

$f = 2310$  MHz;  $\sigma = 1.693$  S/m;  $\epsilon_r = 39.967$ ;  $\rho = 1000$  kg/m<sup>3</sup>

Phantom section: Left Section

Test Date: 04-11-2018; Ambient Temp: 22.1°C; Tissue Temp: 21.9°C

Probe: ES3DV3 - SN3332; ConvF(4.99, 4.99, 4.99); Calibrated: 8/14/2017;

Sensor-Surface: 3mm (Mechanical Surface Detection)

Electronics: DAE4 Sn1323; Calibrated: 8/9/2017

Phantom: SAM Front; Type: SAM; Serial: 1686

Measurement SW: DASY52, Version 52.10; SEMCAD X Version 14.6.10 (7417)

**Mode: LTE Band 30, Left Head, Cheek, Mid.ch,  
10 MHz Bandwidth, QPSK, 1 RB, 25 RB Offset**

**Area Scan (11x18x1):** Measurement grid: dx=12mm, dy=12mm

**Zoom Scan (8x10x7)/Cube 0:** Measurement grid: dx=5mm, dy=5mm, dz=5mm

Reference Value = 3.049 V/m; Power Drift = 0.18 dB

Peak SAR (extrapolated) = 0.0350 W/kg

**SAR(1 g) = 0.020 W/kg**

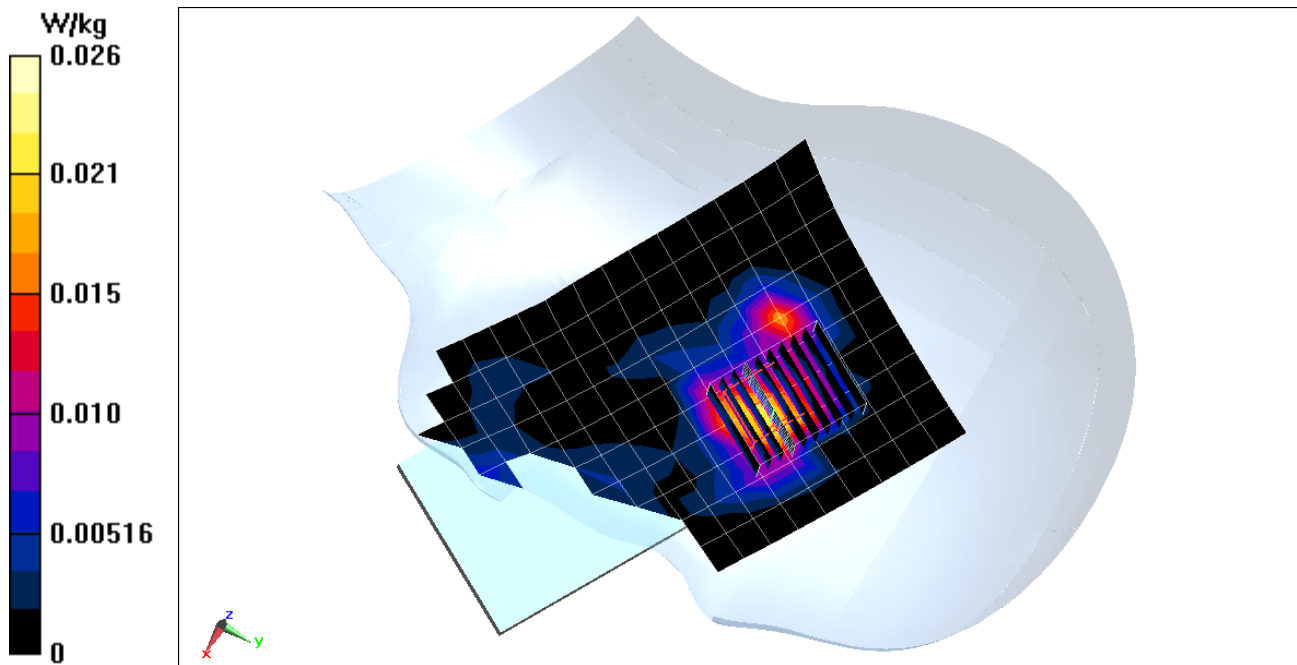



# PCTEST ENGINEERING LABORATORY, INC.

**DUT: ZNFG710TM; Type: Portable Handset; Serial: 09704**

Communication System: UID 0, LTE Band 7; Frequency: 2560 MHz; Duty Cycle: 1:1  
Medium: 2450 Head Medium parameters used (interpolated):  
 $f = 2560 \text{ MHz}$ ;  $\sigma = 1.969 \text{ S/m}$ ;  $\epsilon_r = 38.995$ ;  $\rho = 1000 \text{ kg/m}^3$   
Phantom section: Left Section

Test Date: 04-11-2018; Ambient Temp: 22.1°C; Tissue Temp: 21.9°C

Probe: ES3DV3 - SN3332; ConvF(4.56, 4.56, 4.56); Calibrated: 8/14/2017;  
Sensor-Surface: 3mm (Mechanical Surface Detection)  
Electronics: DAE4 Sn1323; Calibrated: 8/9/2017  
Phantom: SAM Front; Type: SAM; Serial: 1686  
Measurement SW: DASY52, Version 52.10; SEMCAD X Version 14.6.10 (7417)

**Mode: LTE Band 7, Left Head, Tilt, High.ch, QPSK,  
20 MHz Bandwidth, 1 RB, 50 RB Offset**

**Area Scan (11x18x1):** Measurement grid:  $dx=12\text{mm}$ ,  $dy=12\text{mm}$   
**Zoom Scan (7x7x7)/Cube 0:** Measurement grid:  $dx=5\text{mm}$ ,  $dy=5\text{mm}$ ,  $dz=5\text{mm}$   
Reference Value = 5.596 V/m; Power Drift = 0.13 dB  
Peak SAR (extrapolated) = 0.0970 W/kg  
**SAR(1 g) = 0.051 W/kg**

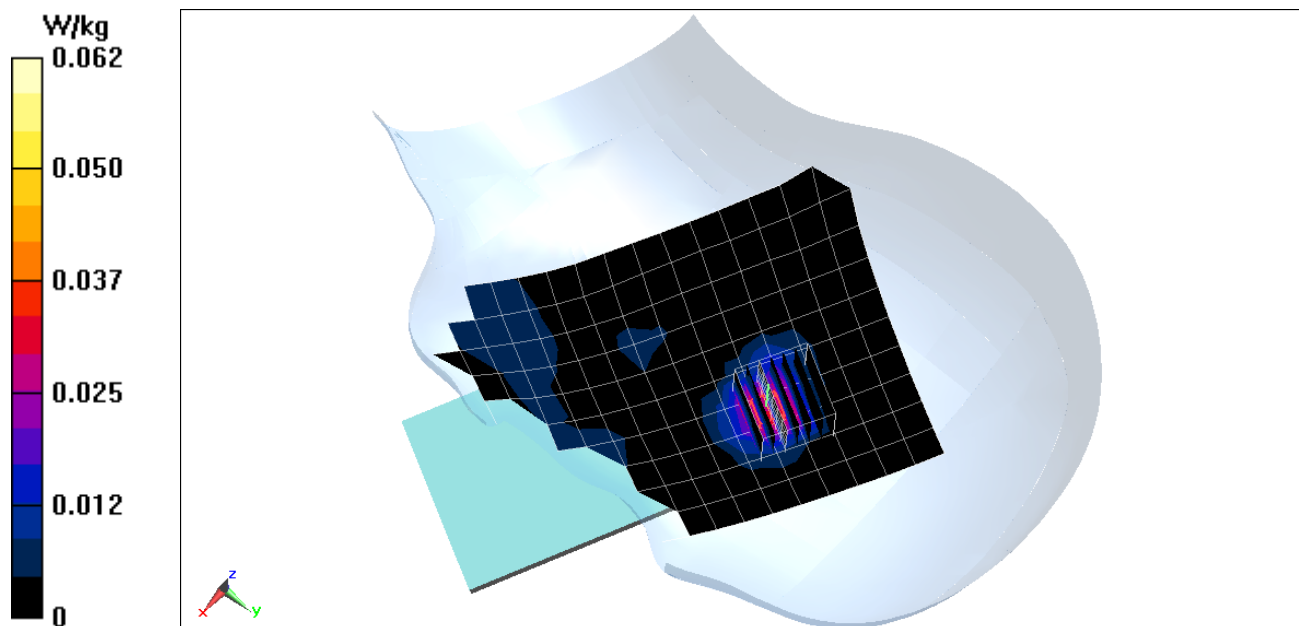

# PCTEST ENGINEERING LABORATORY, INC.

**DUT: ZNFG710TM; Type: Portable Handset; Serial: 09704**

Communication System: UID 0, LTE Band 41; Frequency: 2506 MHz; Duty Cycle: 1:1.58

Medium: 2450 Head Medium parameters used (interpolated):

$f = 2506 \text{ MHz}$ ;  $\sigma = 1.909 \text{ S/m}$ ;  $\epsilon_r = 39.194$ ;  $\rho = 1000 \text{ kg/m}^3$

Phantom section: Right Section

Test Date: 04-11-2018; Ambient Temp: 22.1°C; Tissue Temp: 21.9°C

Probe: ES3DV3 - SN3332; ConvF(4.68, 4.68, 4.68); Calibrated: 8/14/2017;

Sensor-Surface: 3mm (Mechanical Surface Detection)

Electronics: DAE4 Sn1323; Calibrated: 8/9/2017

Phantom: SAM Front; Type: SAM; Serial: 1686

Measurement SW: DASY52, Version 52.10; SEMCAD X Version 14.6.10 (7417)

**Mode: LTE Band 41, Right Head, Cheek, Low.ch,**

**20 MHz Bandwidth, QPSK, 1 RB, 50 RB Offset**

**Area Scan (10x17x1):** Measurement grid: dx=12mm, dy=12mm

**Zoom Scan (8x7x7)/Cube 0:** Measurement grid: dx=5mm, dy=5mm, dz=5mm

Reference Value = 4.554 V/m; Power Drift = 0.19 dB

Peak SAR (extrapolated) = 0.151 W/kg

**SAR(1 g) = 0.028 W/kg**

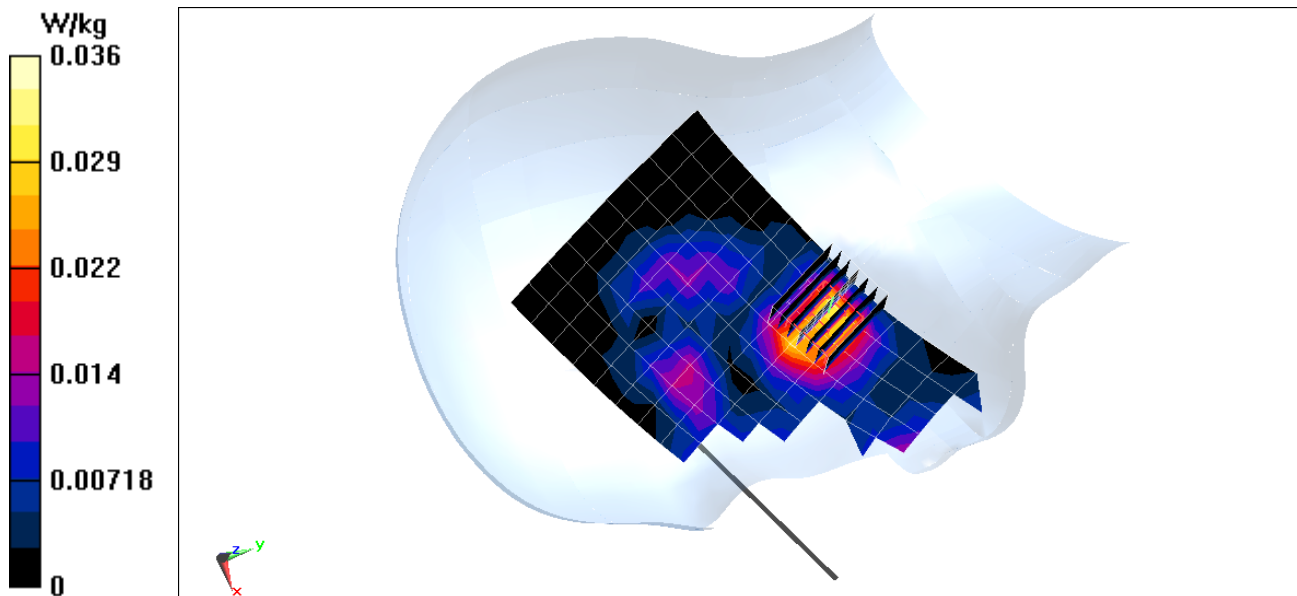

# PCTEST ENGINEERING LABORATORY, INC.

**DUT: ZNFG710TM; Type: Portable Handset; Serial: 09779**

Communication System: UID 0, \_IEEE 802.11b; Frequency: 2412 MHz; Duty Cycle: 1:1  
Medium: 2450 Head Medium parameters used (interpolated):  
 $f = 2412 \text{ MHz}$ ;  $\sigma = 1.794 \text{ S/m}$ ;  $\epsilon_r = 39.226$ ;  $\rho = 1000 \text{ kg/m}^3$   
Phantom section: Left Section

Test Date: 04-06-2018; Ambient Temp: 22.0°C; Tissue Temp: 21.7°C

Probe: ES3DV3 - SN3332; ConvF(4.68, 4.68, 4.68); Calibrated: 8/14/2017;  
Sensor-Surface: 3mm (Mechanical Surface Detection)  
Electronics: DAE4 Sn1323; Calibrated: 8/9/2017  
Phantom: SAM Front; Type: SAM; Serial: 1686  
Measurement SW: DASY52, Version 52.10; SEMCAD X Version 14.6.10 (7417)

**Mode: IEEE 802.11b, 22 MHz Bandwidth,  
Left Head, Tilt, Ch 1, 1 Mbps, Antenna 1**

**Area Scan (11x18x1):** Measurement grid:  $dx=12\text{mm}$ ,  $dy=12\text{mm}$   
**Zoom Scan (7x7x7)/Cube 0:** Measurement grid:  $dx=5\text{mm}$ ,  $dy=5\text{mm}$ ,  $dz=5\text{mm}$   
Reference Value = 15.13 V/m; Power Drift = 0.12 dB  
Peak SAR (extrapolated) = 0.748 W/kg  
**SAR(1 g) = 0.348 W/kg**

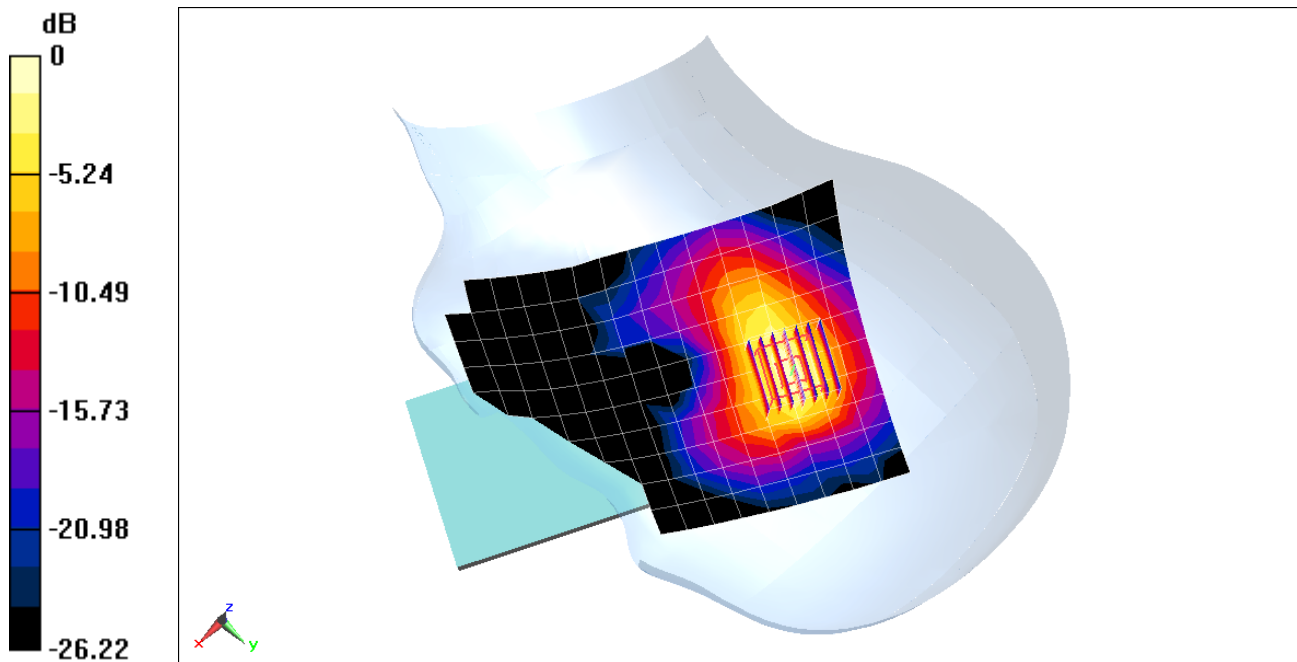

# PCTEST ENGINEERING LABORATORY, INC.

**DUT: ZNFG710TM; Type: Portable Handset; Serial: 09688**

Communication System: UID 0, 802.11a 5.2-5.8 GHz Band; Frequency: 5280 MHz; Duty Cycle: 1:1

Medium: 5GHz Head Medium parameters used:

$f = 5280 \text{ MHz}$ ;  $\sigma = 4.63 \text{ S/m}$ ;  $\epsilon_r = 37.162$ ;  $\rho = 1000 \text{ kg/m}^3$

Phantom section: Right Section

Test Date: 04-09-2018; Ambient Temp: 21.9°C; Tissue Temp: 21.6°C

Probe: EX3DV4 - SN3589; ConvF(4.69, 4.69, 4.69); Calibrated: 1/16/2018;

Sensor-Surface: 1.4mm (Mechanical Surface Detection)

Electronics: DAE4 Sn1322; Calibrated: 7/13/2017

Phantom: SAM with CRP v5.0 (Right); Type: QD000P40CD; Serial: TP:1759

Measurement SW: DASY52, Version 52.10;SEMCAD X Version 14.6.10 (7417)

**Mode: IEEE 802.11a, U-NII-2A, 20 MHz Bandwidth,  
Right Head, Cheek, Ch 56, 6 Mbps, Antenna 1**

**Area Scan (13x22x1):** Measurement grid: dx=10mm, dy=10mm

**Zoom Scan (8x8x7)/Cube 0:** Measurement grid: dx=4mm, dy=4mm, dz=1.4mm; Graded Ratio: 1.4

Reference Value = 4.450 V/m; Power Drift = 0.19 dB

Peak SAR (extrapolated) = 1.90 W/kg

**SAR(1 g) = 0.432 W/kg**

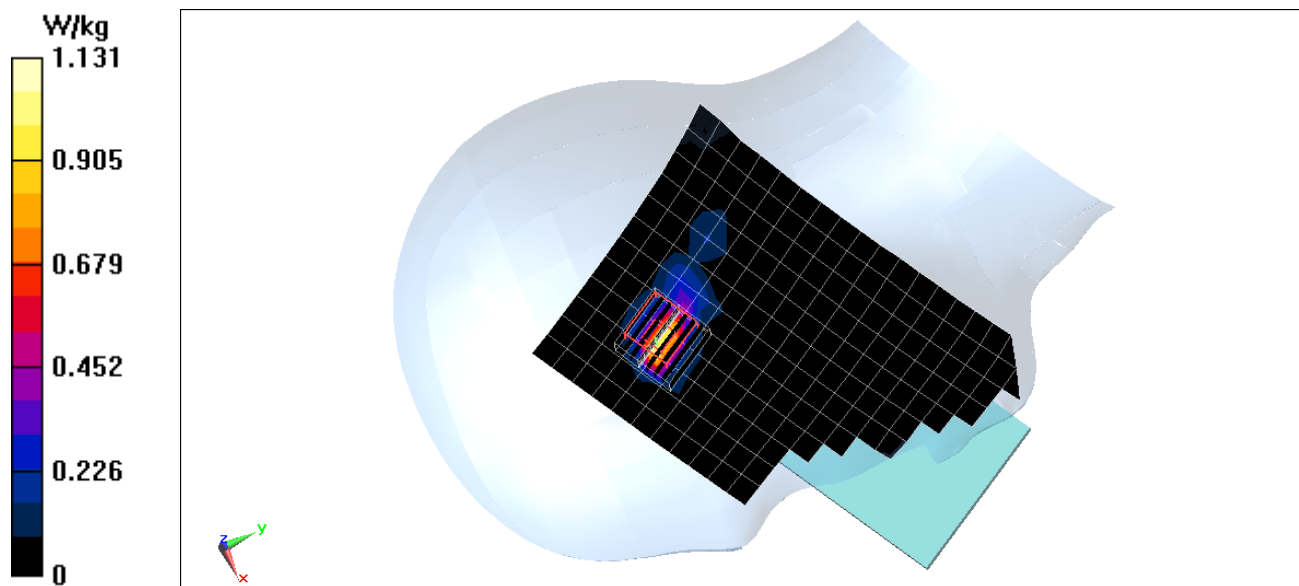

# PCTEST ENGINEERING LABORATORY, INC.

**DUT: ZNFG710TM; Type: Portable Handset; Serial: 09787**

Communication System: UID 0, Bluetooth; Frequency: 2402 MHz; Duty Cycle: 1:1.294

Medium: 2450 Head Medium parameters used (interpolated):

$f = 2402 \text{ MHz}$ ;  $\sigma = 1.783 \text{ S/m}$ ;  $\epsilon_r = 39.263$ ;  $\rho = 1000 \text{ kg/m}^3$

Phantom section: Right Section

Test Date: 04-06-2018; Ambient Temp: 22.0°C; Tissue Temp: 21.7°C

Probe: ES3DV3 - SN3332; ConvF(4.68, 4.68, 4.68); Calibrated: 8/14/2017;

Sensor-Surface: 3mm (Mechanical Surface Detection)

Electronics: DAE4 Sn1323; Calibrated: 8/9/2017

Phantom: SAM Front; Type: SAM; Serial: 1686

Measurement SW: DASY52, Version 52.10;SEMCAD X Version 14.6.10 (7417)

**Mode: Bluetooth, Right Head, Cheek, Ch 0, 1 Mbps**

**Area Scan (11x19x1):** Measurement grid: dx=12mm, dy=12mm

**Zoom Scan (8x7x7)/Cube 0:** Measurement grid: dx=5mm, dy=5mm, dz=5mm

Reference Value = 7.584 V/m; Power Drift = 0.08 dB

Peak SAR (extrapolated) = 0.199 W/kg

**SAR(1 g) = 0.099 W/kg**

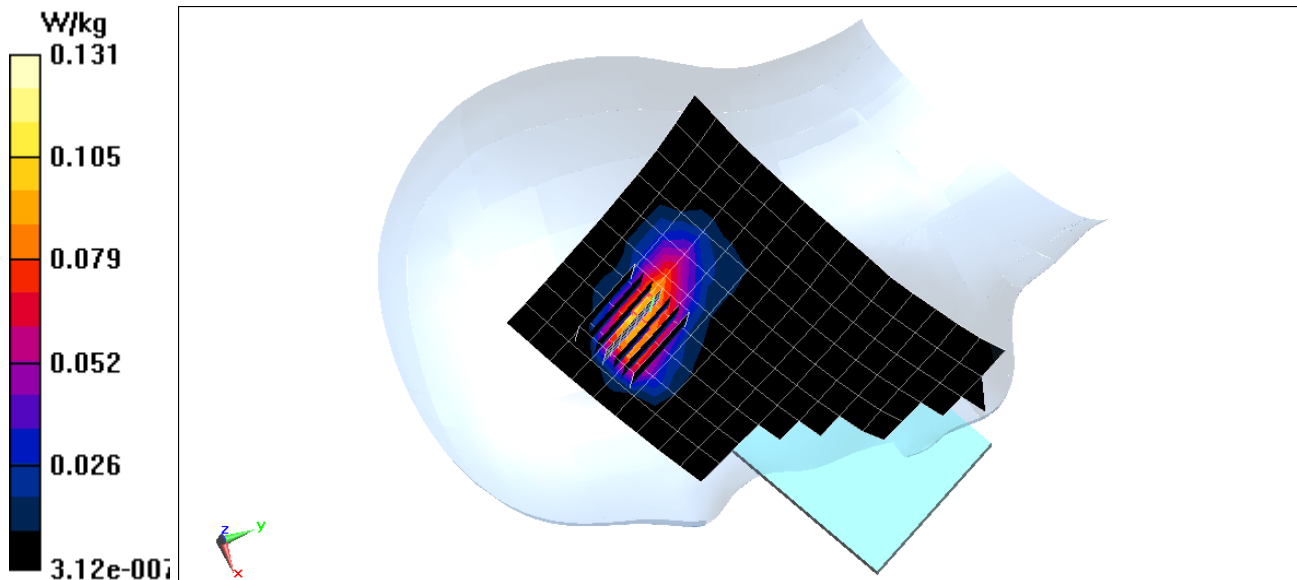

# PCTEST ENGINEERING LABORATORY, INC.

**DUT: ZNFG710TM; Type: Portable Handset; Serial: 09662**

Communication System: UID 0, GSM GPRS; 3 Tx slots; Frequency: 836.6 MHz; Duty Cycle: 1:2.76  
Medium: 835 Body Medium parameters used (interpolated):  
 $f = 836.6 \text{ MHz}$ ;  $\sigma = 0.976 \text{ S/m}$ ;  $\epsilon_r = 54.281$ ;  $\rho = 1000 \text{ kg/m}^3$   
Phantom section: Flat Section; Space: 1.0 cm

Test Date: 04-06-2018; Ambient Temp: 24.2°C; Tissue Temp: 22.0°C

Probe: ES3DV3 - SN3213; ConvF(6.2, 6.2, 6.2); Calibrated: 2/13/2018;  
Sensor-Surface: 3mm (Mechanical Surface Detection)  
Electronics: DAE4 Sn1272; Calibrated: 2/9/2018

Phantom: SAM V5.0 Right; Type: QD000P40CD; Serial: 1647  
Measurement SW: DASY52, Version 52.10; SEMCAD X Version 14.6.10 (7417)

**Mode: GPRS 850, Body SAR, Back side, Mid.ch, 3 Tx Slots**

**Area Scan (9x15x1):** Measurement grid: dx=15mm, dy=15mm

**Zoom Scan (5x5x7)/Cube 0:** Measurement grid: dx=8mm, dy=8mm, dz=5mm

Reference Value = 18.78 V/m; Power Drift = -0.18 dB

Peak SAR (extrapolated) = 0.592 W/kg

**SAR(1 g) = 0.350 W/kg**

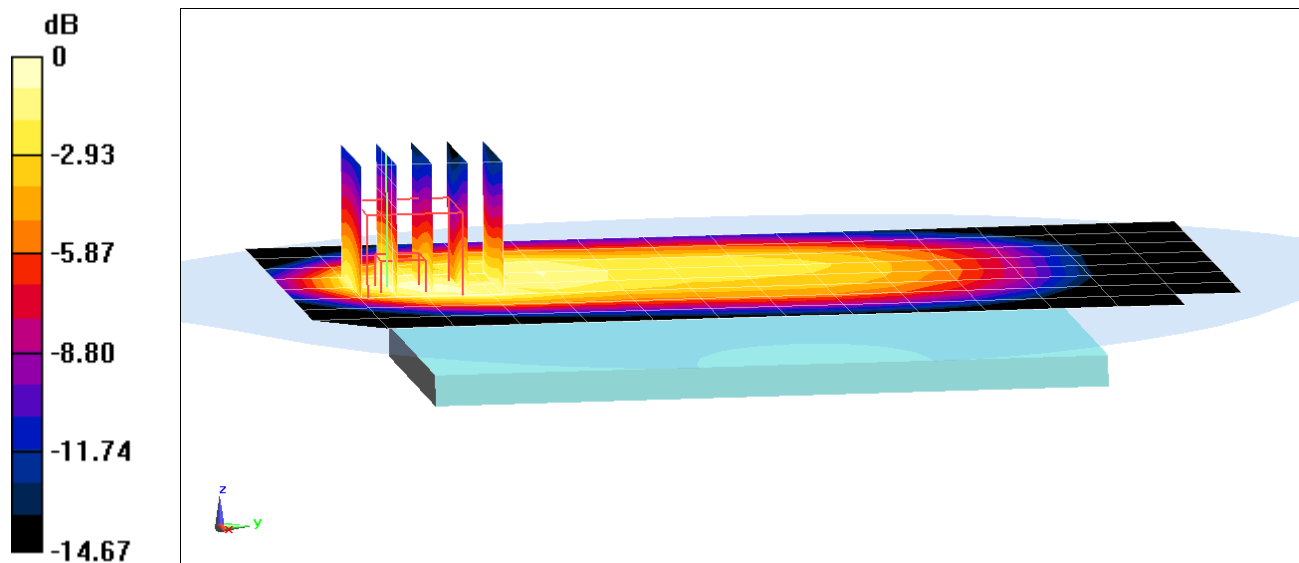

0 dB = 0.427 W/kg = -3.70 dBW/kg

# PCTEST ENGINEERING LABORATORY, INC.

**DUT: ZNFG710TM; Type: Portable Handset; Serial: 09670**

Communication System: UID 0, GSM GPRS; 2 Tx slots; Frequency: 1880 MHz; Duty Cycle: 1:4.15

Medium: 1900 Body Medium parameters used:

$f = 1880 \text{ MHz}$ ;  $\sigma = 1.553 \text{ S/m}$ ;  $\epsilon_r = 53.793$ ;  $\rho = 1000 \text{ kg/m}^3$

Phantom section: Flat Section; Space: 1.0 cm

Test Date: 04-05-2018; Ambient Temp: 21.9°C; Tissue Temp: 21.7°C

Probe: EX3DV4 - SN3914; ConvF(7.62, 7.62, 7.62); Calibrated: 2/14/2018;

Sensor-Surface: 1.4mm (Mechanical Surface Detection)

Electronics: DAE4 Sn665; Calibrated: 2/15/2018

Phantom: Twin-SAM V5.0 Right; Type: QD 000 P40 CD; Serial: 1800

Measurement SW: DASY52, Version 52.10; SEMCAD X Version 14.6.10 (7417)

**Mode: GPRS 1900, Body SAR, Back side, Mid.ch, 2 Tx Slots**

**Area Scan (9x14x1):** Measurement grid: dx=15mm, dy=15mm

**Zoom Scan (5x5x7)/Cube 0:** Measurement grid: dx=8mm, dy=8mm, dz=5mm

Reference Value = 13.72 V/m; Power Drift = -0.16 dB

Peak SAR (extrapolated) = 0.439 W/kg

**SAR(1 g) = 0.260 W/kg**

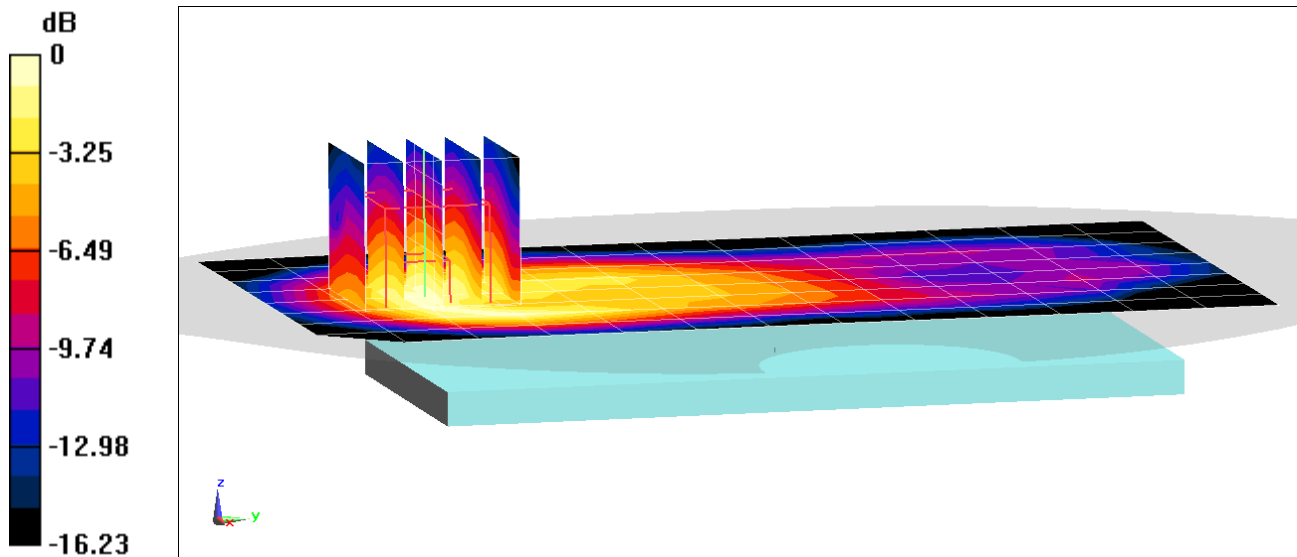

0 dB = 0.373 W/kg = -4.28 dBW/kg

# PCTEST ENGINEERING LABORATORY, INC.

**DUT: ZNFG710TM; Type: Portable Handset; Serial: 09670**

Communication System: UID 0, GSM GPRS; 2 Tx slots; Frequency: 1909.8 MHz; Duty Cycle: 1:4.15

Medium: 1900 Body Medium parameters used:

$f = 1910$  MHz;  $\sigma = 1.587$  S/m;  $\epsilon_r = 53.695$ ;  $\rho = 1000$  kg/m<sup>3</sup>

Phantom section: Flat Section; Space: 1.0 cm

Test Date: 04-05-2018; Ambient Temp: 21.9°C; Tissue Temp: 21.7°C

Probe: EX3DV4 - SN3914; ConvF(7.62, 7.62, 7.62); Calibrated: 2/14/2018;

Sensor-Surface: 1.4mm (Mechanical Surface Detection)

Electronics: DAE4 Sn665; Calibrated: 2/15/2018

Phantom: Twin-SAM V5.0 Right; Type: QD 000 P40 CD; Serial: 1800

Measurement SW: DASY52, Version 52.10; SEMCAD X Version 14.6.10 (7417)

**Mode: GPRS 1900, Body SAR, Bottom Edge, High.ch, 2 Tx Slots**

**Area Scan (10x8x1):** Measurement grid: dx=5mm, dy=15mm

**Zoom Scan (5x5x7)/Cube 0:** Measurement grid: dx=8mm, dy=8mm, dz=5mm

Reference Value = 20.94 V/m; Power Drift = 0.04 dB

Peak SAR (extrapolated) = 1.12 W/kg

**SAR(1 g) = 0.648 W/kg**

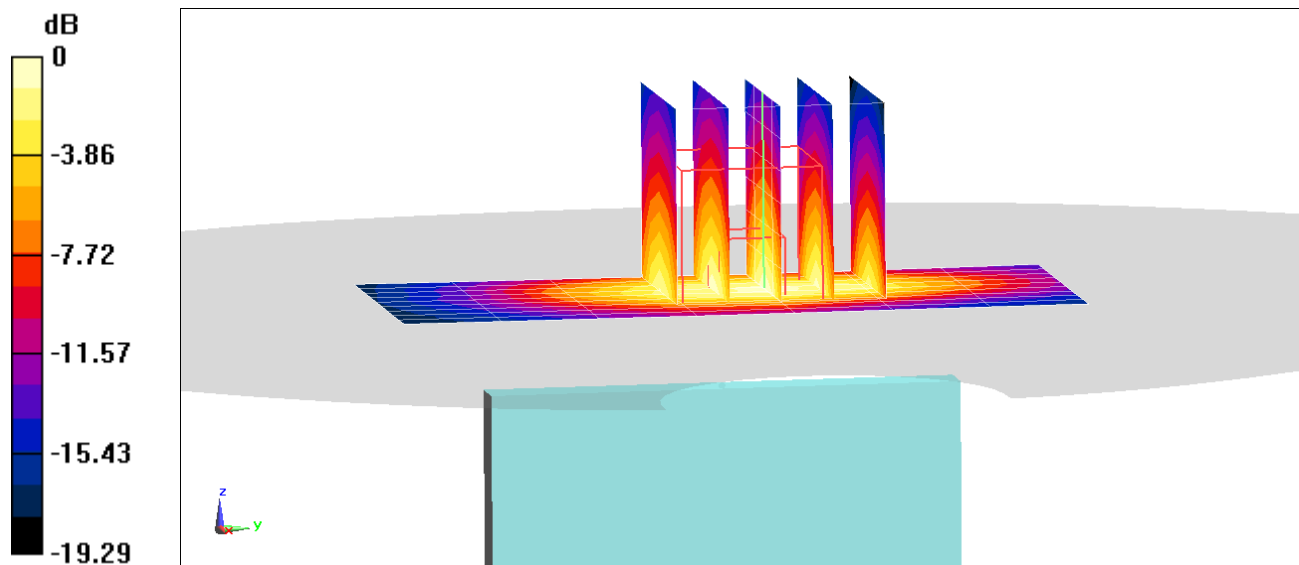

0 dB = 0.946 W/kg = -0.24 dBW/kg



# PCTEST ENGINEERING LABORATORY, INC.

**DUT: ZNFG710TM; Type: Portable Handset; Serial: 09662**

Communication System: UID 0, UMTS; Frequency: 836.6 MHz; Duty Cycle: 1:1  
Medium: 835 Body Medium parameters used (interpolated):  
 $f = 836.6 \text{ MHz}$ ;  $\sigma = 0.976 \text{ S/m}$ ;  $\epsilon_r = 54.281$ ;  $\rho = 1000 \text{ kg/m}^3$   
Phantom section: Flat Section; Space: 1.0 cm

Test Date: 04-06-2018; Ambient Temp: 24.2°C; Tissue Temp: 22.0°C

Probe: ES3DV3 - SN3213; ConvF(6.2, 6.2, 6.2); Calibrated: 2/13/2018;  
Sensor-Surface: 3mm (Mechanical Surface Detection)  
Electronics: DAE4 Sn1272; Calibrated: 2/9/2018

Phantom: SAM V5.0 Right; Type: QD000P40CD; Serial: 1647  
Measurement SW: DASY52, Version 52.10; SEMCAD X Version 14.6.10 (7417)

**Mode: UMTS 850, Body SAR, Back side, Mid.ch**

**Area Scan (9x15x1):** Measurement grid: dx=15mm, dy=15mm

**Zoom Scan (6x6x7)/Cube 0:** Measurement grid: dx=8mm, dy=8mm, dz=5mm

Reference Value = 21.22 V/m; Power Drift = 0.02 dB

Peak SAR (extrapolated) = 0.690 W/kg

**SAR(1 g) = 0.399 W/kg**

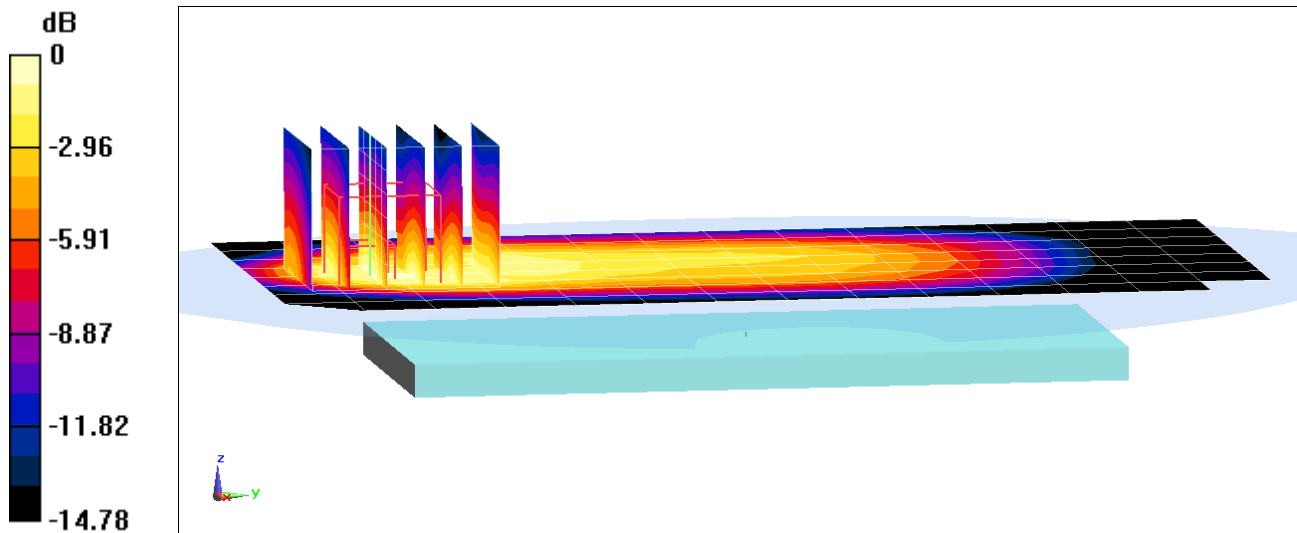

0 dB = 0.493 W/kg = -3.07 dBW/kg

# PCTEST ENGINEERING LABORATORY, INC.

**DUT: ZNFG710TM; Type: Portable Handset; Serial: 09654**

Communication System: UID 0, UMTS; Frequency: 1732.4 MHz; Duty Cycle: 1:1  
Medium: 1750 Body Medium parameters used (interpolated):  
 $f = 1732.4$  MHz;  $\sigma = 1.492$  S/m;  $\epsilon_r = 51.568$ ;  $\rho = 1000$  kg/m<sup>3</sup>  
Phantom section: Flat Section; Space: 1.0 cm

Test Date: 04-12-2018; Ambient Temp: 23.0°C; Tissue Temp: 20.8°C

Probe: ES3DV3 - SN3287; ConvF(5.19, 5.19, 5.19); Calibrated: 9/18/2017;  
Sensor-Surface: 3mm (Mechanical Surface Detection)  
Electronics: DAE4 Sn1333; Calibrated: 6/21/2017  
Phantom: Twin-SAM V4.0; Type: QD 000 P40 CC; Serial: 1167  
Measurement SW: DASY52, Version 52.10; SEMCAD X Version 14.6.10 (7417)

**Mode: UMTS 1750, Body SAR, Back side, Mid.ch**

**Area Scan (9x15x1):** Measurement grid: dx=15mm, dy=15mm  
**Zoom Scan (5x5x7)/Cube 0:** Measurement grid: dx=8mm, dy=8mm, dz=5mm  
Reference Value = 19.87 V/m; Power Drift = -0.01 dB  
Peak SAR (extrapolated) = 0.810 W/kg  
**SAR(1 g) = 0.517 W/kg**

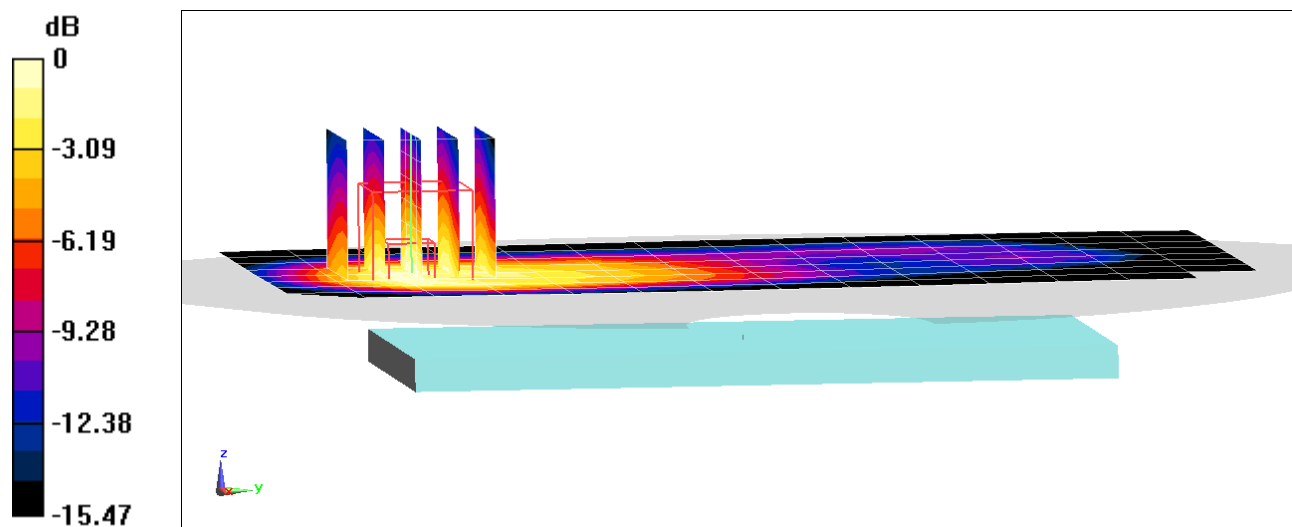

0 dB = 0.614 W/kg = -2.12 dBW/kg

# PCTEST ENGINEERING LABORATORY, INC.

**DUT: ZNFG710TM; Type: Portable Handset; Serial: 09654**

Communication System: UID 0, \_UMTS; Frequency: 1752.6 MHz; Duty Cycle: 1:1  
Medium: 1750 Body Medium parameters used (interpolated):  
 $f = 1752.6 \text{ MHz}$ ;  $\sigma = 1.516 \text{ S/m}$ ;  $\epsilon_r = 51.502$ ;  $\rho = 1000 \text{ kg/m}^3$   
Phantom section: Flat Section; Space: 1.0 cm

Test Date: 04-12-2018; Ambient Temp: 23.0°C; Tissue Temp: 20.8°C

Probe: ES3DV3 - SN3287; ConvF(5.19, 5.19, 5.19); Calibrated: 9/18/2017;  
Sensor-Surface: 3mm (Mechanical Surface Detection)  
Electronics: DAE4 Sn1333; Calibrated: 6/21/2017  
Phantom: Twin-SAM V4.0; Type: QD 000 P40 CC; Serial: 1167  
Measurement SW: DASY52, Version 52.10; SEMCAD X Version 14.6.10 (7417)

**Mode: UMTS 1750, Body SAR, Bottom Edge, High.ch**

**Area Scan (10x7x1):** Measurement grid:  $dx=5\text{mm}$ ,  $dy=15\text{mm}$   
**Zoom Scan (5x5x7)/Cube 0:** Measurement grid:  $dx=8\text{mm}$ ,  $dy=8\text{mm}$ ,  $dz=5\text{mm}$   
Reference Value = 24.80 V/m; Power Drift = -0.03 dB  
Peak SAR (extrapolated) = 1.36 W/kg  
**SAR(1 g) = 0.816 W/kg**

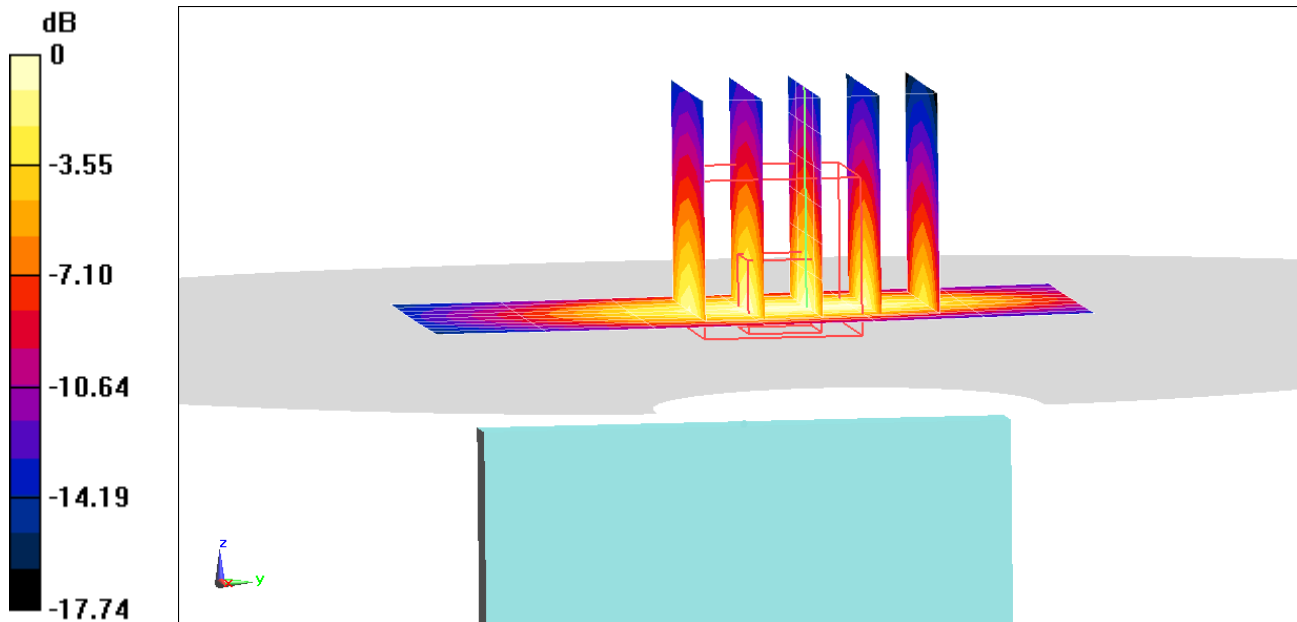

# PCTEST ENGINEERING LABORATORY, INC.

**DUT: ZNFG710TM; Type: Portable Handset; Serial: 09670**

Communication System: UID 0, UMTS; Frequency: 1880 MHz; Duty Cycle: 1:1  
Medium: 1900 Body Medium parameters used:  
 $f = 1880 \text{ MHz}$ ;  $\sigma = 1.553 \text{ S/m}$ ;  $\epsilon_r = 53.793$ ;  $\rho = 1000 \text{ kg/m}^3$   
Phantom section: Flat Section; Space: 1.0 cm

Test Date: 04-05-2018; Ambient Temp: 21.9°C; Tissue Temp: 21.7°C

Probe: EX3DV4 - SN3914; ConvF(7.62, 7.62, 7.62); Calibrated: 2/14/2018;  
Sensor-Surface: 1.4mm (Mechanical Surface Detection)  
Electronics: DAE4 Sn665; Calibrated: 2/15/2018  
Phantom: Twin-SAM V5.0 Right; Type: QD 000 P40 CD; Serial: 1800  
Measurement SW: DASY52, Version 52.10; SEMCAD X Version 14.6.10 (7417)

**Mode: UMTS 1900, Body SAR, Back side, Mid.ch**

**Area Scan (9x14x1):** Measurement grid: dx=15mm, dy=15mm  
**Zoom Scan (5x5x7)/Cube 0:** Measurement grid: dx=8mm, dy=8mm, dz=5mm  
Reference Value = 18.68 V/m; Power Drift = -0.02 dB  
Peak SAR (extrapolated) = 0.841 W/kg  
**SAR(1 g) = 0.501 W/kg**

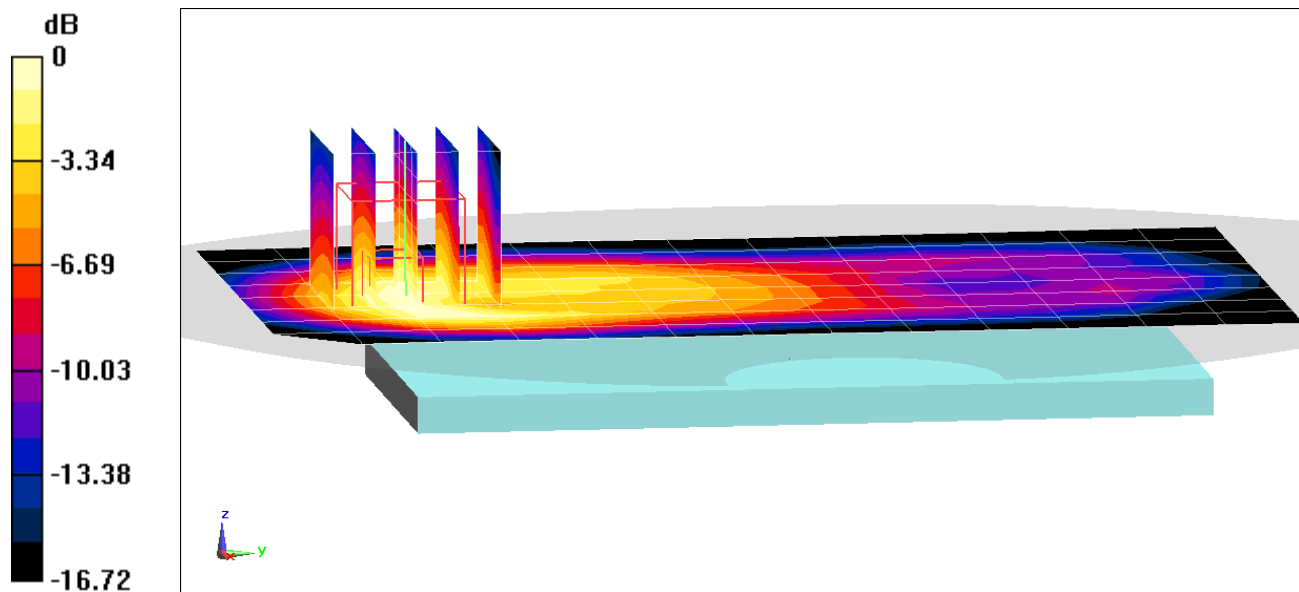

0 dB = 0.700 W/kg = -1.55 dBW/kg

# PCTEST ENGINEERING LABORATORY, INC.

**DUT: ZNFG710TM; Type: Portable Handset; Serial: 09670**

Communication System: UID 0, UMTS; Frequency: 1907.6 MHz; Duty Cycle: 1:1  
Medium: 1900 Body Medium parameters used (interpolated):  
 $f = 1907.6$  MHz;  $\sigma = 1.584$  S/m;  $\epsilon_r = 53.703$ ;  $\rho = 1000$  kg/m<sup>3</sup>  
Phantom section: Flat Section; Space: 1.0 cm

Test Date: 04-05-2018; Ambient Temp: 21.9°C; Tissue Temp: 21.7°C

Probe: EX3DV4 - SN3914; ConvF(7.62, 7.62, 7.62); Calibrated: 2/14/2018;  
Sensor-Surface: 1.4mm (Mechanical Surface Detection)

Electronics: DAE4 Sn665; Calibrated: 2/15/2018

Phantom: Twin-SAM V5.0 Right; Type: QD 000 P40 CD; Serial: 1800

Measurement SW: DASY52, Version 52.10; SEMCAD X Version 14.6.10 (7417)

**Mode: UMTS 1900, Body SAR, Bottom Edge, High.ch**

**Area Scan (10x8x1):** Measurement grid: dx=5mm, dy=15mm

**Zoom Scan (5x5x7)/Cube 0:** Measurement grid: dx=8mm, dy=8mm, dz=5mm

Reference Value = 27.21 V/m; Power Drift = -0.07 dB

Peak SAR (extrapolated) = 1.86 W/kg

**SAR(1 g) = 1.06 W/kg**

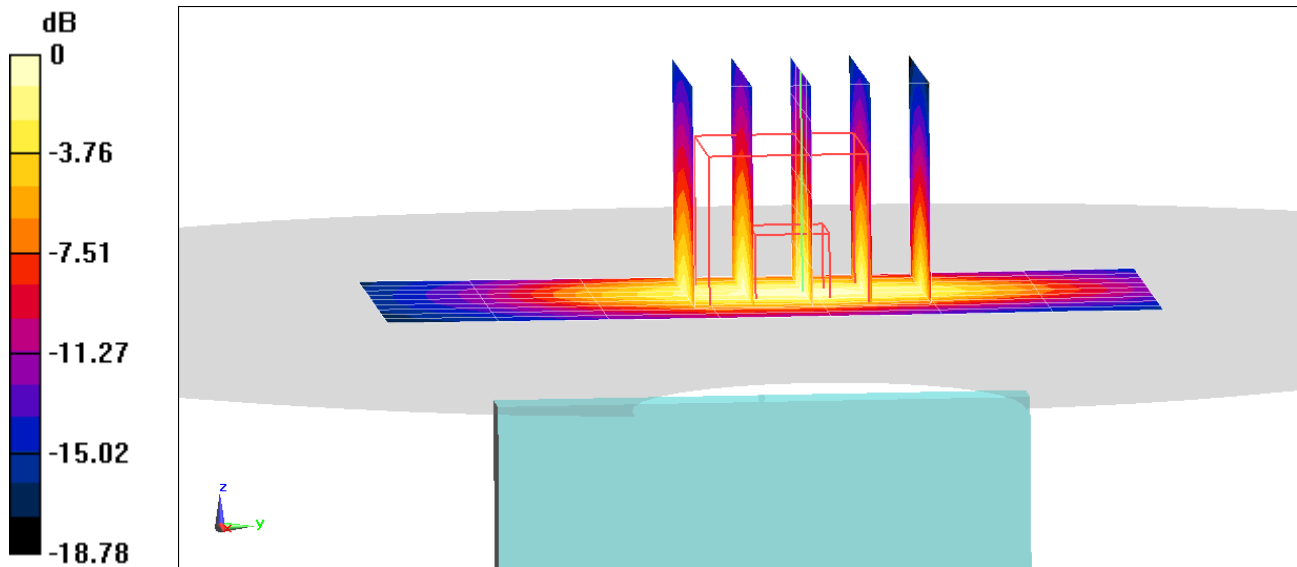

0 dB = 1.57 W/kg = 1.96 dBW/kg

# PCTEST ENGINEERING LABORATORY, INC.

**DUT: ZNFG710TM; Type: Portable Handset; Serial: 09662**

Communication System: UID 0, LTE Band 71; Frequency: 680.5 MHz; Duty Cycle: 1:1

Medium: 750 Body Medium parameters used (interpolated):

$f = 680.5 \text{ MHz}$ ;  $\sigma = 0.926 \text{ S/m}$ ;  $\epsilon_r = 54.262$ ;  $\rho = 1000 \text{ kg/m}^3$

Phantom section: Flat Section; Space: 1.0 cm

Test Date: 04-09-2018; Ambient Temp: 22.6°C; Tissue Temp: 21.5°C

Probe: ES3DV3 - SN3287; ConvF(6.71, 6.71, 6.71); Calibrated: 9/18/2017;

Sensor-Surface: 3mm (Mechanical Surface Detection)

Electronics: DAE4 Sn1333; Calibrated: 6/21/2017

Phantom: Twin-SAM V5.0; Type: QD 000 P40 CD; Serial: 1692

Measurement SW: DASY52, Version 52.10; SEMCAD X Version 14.6.10 (7417)

**Mode: LTE Band 71, Body SAR, Back side, Mid.ch,  
20 MHz Bandwidth, QPSK, 1 RB, 99 RB Offset**

**Area Scan (9x15x1):** Measurement grid: dx=15mm, dy=15mm

**Zoom Scan (5x5x7)/Cube 0:** Measurement grid: dx=8mm, dy=8mm, dz=5mm

Reference Value = 21.46 V/m; Power Drift = -0.04 dB

Peak SAR (extrapolated) = 0.695 W/kg

**SAR(1 g) = 0.383 W/kg**

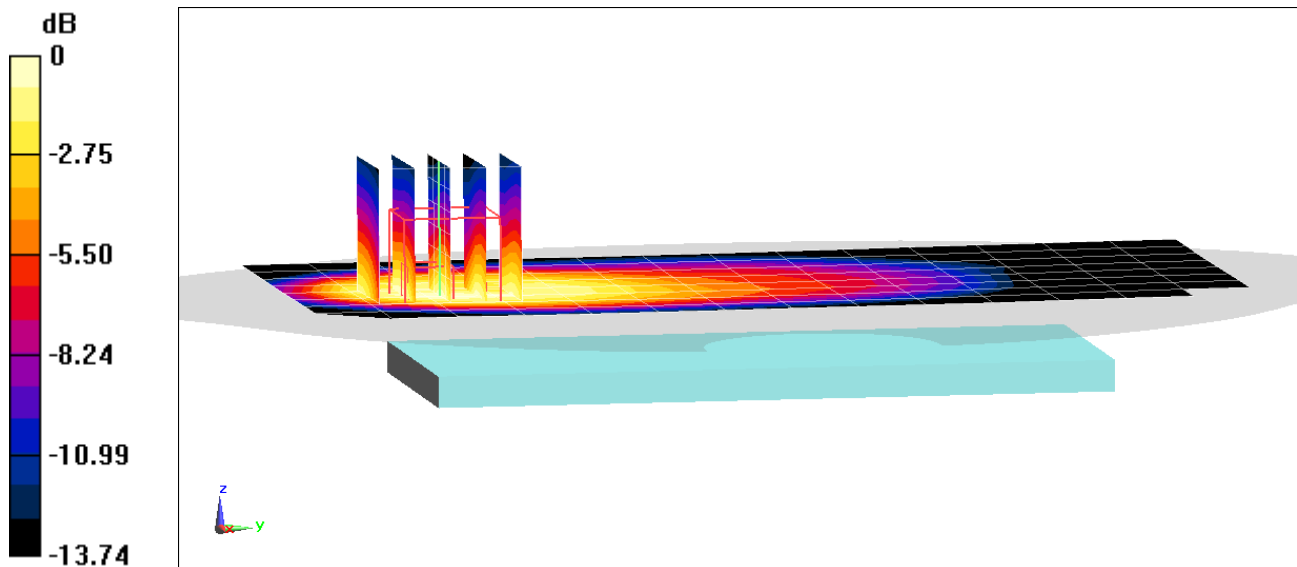

# PCTEST ENGINEERING LABORATORY, INC.

**DUT: ZNFG710TM; Type: Portable Handset; Serial: 09662**

Communication System: UID 0, LTE Band 12; Frequency: 707.5 MHz; Duty Cycle: 1:1

Medium: 750 Body Medium parameters used (interpolated):

$f = 707.5$  MHz;  $\sigma = 0.935$  S/m;  $\epsilon_r = 54.178$ ;  $\rho = 1000$  kg/m<sup>3</sup>

Phantom section: Flat Section; Space: 1.0 cm

Test Date: 04-09-2018; Ambient Temp: 22.6°C; Tissue Temp: 21.5°C

Probe: ES3DV3 - SN3287; ConvF(6.71, 6.71, 6.71); Calibrated: 9/18/2017;

Sensor-Surface: 3mm (Mechanical Surface Detection)

Electronics: DAE4 Sn1333; Calibrated: 6/21/2017

Phantom: Twin-SAM V5.0; Type: QD 000 P40 CD; Serial: 1692

Measurement SW: DASY52, Version 52.10; SEMCAD X Version 14.6.10 (7417)

**Mode: LTE Band 12, Body SAR, Back side, Mid.ch,  
10 MHz Bandwidth, QPSK, 1 RB, 49 RB Offset**

**Area Scan (9x13x1):** Measurement grid: dx=15mm, dy=15mm

**Zoom Scan (5x5x7)/Cube 0:** Measurement grid: dx=8mm, dy=8mm, dz=5mm

Reference Value = 24.21 V/m; Power Drift = -0.07 dB

Peak SAR (extrapolated) = 0.901 W/kg

**SAR(1 g) = 0.491 W/kg**

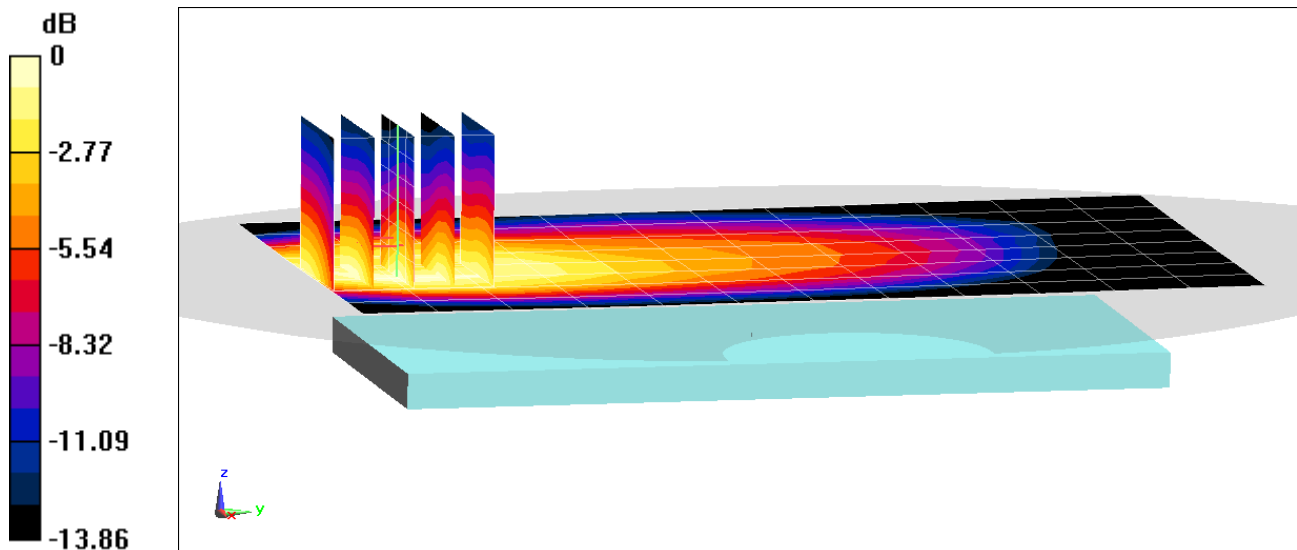

0 dB = 0.603 W/kg = -2.20 dBW/kg

# PCTEST ENGINEERING LABORATORY, INC.

**DUT: ZNFG710TM; Type: Portable Handset; Serial: 09696**

Communication System: UID 0, LTE Band 13; Frequency: 782 MHz; Duty Cycle: 1:1

Medium: 750 Body Medium parameters used (interpolated):

$f = 782 \text{ MHz}$ ;  $\sigma = 1.002 \text{ S/m}$ ;  $\epsilon_r = 52.956$ ;  $\rho = 1000 \text{ kg/m}^3$

Phantom section: Flat Section; Space: 1.0 cm

Test Date: 04-03-2018; Ambient Temp: 22.0°C; Tissue Temp: 20.9°C

Probe: ES3DV3 - SN3287; ConvF(6.71, 6.71, 6.71); Calibrated: 9/18/2017;

Sensor-Surface: 3mm (Mechanical Surface Detection)

Electronics: DAE4 Sn1333; Calibrated: 6/21/2017

Phantom: Twin-SAM V5.0; Type: QD 000 P40 CD; Serial: 1692

Measurement SW: DASY52, Version 52.10; SEMCAD X Version 14.6.10 (7417)

**Mode: LTE Band 13, Body SAR, Back side, Mid.ch,  
10 MHz Bandwidth, QPSK, 1 RB, 25 RB Offset**

**Area Scan (9x13x1):** Measurement grid: dx=15mm, dy=15mm

**Zoom Scan (5x5x7)/Cube 0:** Measurement grid: dx=8mm, dy=8mm, dz=5mm

Reference Value = 22.53 V/m; Power Drift = -0.02 dB

Peak SAR (extrapolated) = 0.813 W/kg

**SAR(1 g) = 0.459 W/kg**

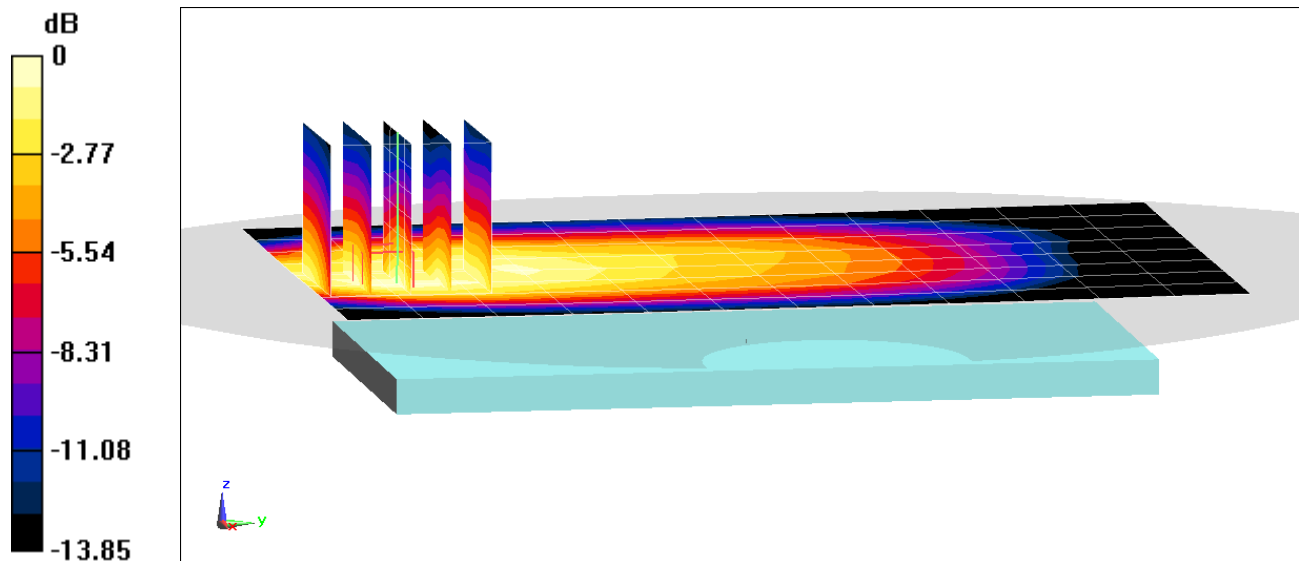

0 dB = 0.564 W/kg = -2.49 dBW/kg



# PCTEST ENGINEERING LABORATORY, INC.

**DUT: ZNFG710TM; Type: Portable Handset; Serial: 09662**

Communication System: UID 0, LTE Band 5; Frequency: 836.5 MHz; Duty Cycle: 1:1

Medium: 835 Body Medium parameters used (interpolated):

$f = 836.5$  MHz;  $\sigma = 0.976$  S/m;  $\epsilon_r = 54.282$ ;  $\rho = 1000$  kg/m<sup>3</sup>

Phantom section: Flat Section; Space: 1.0 cm

Test Date: 04-06-2018; Ambient Temp: 24.2°C; Tissue Temp: 22.0°C

Probe: ES3DV3 - SN3213; ConvF(6.2, 6.2, 6.2); Calibrated: 2/13/2018;

Sensor-Surface: 3mm (Mechanical Surface Detection)

Electronics: DAE4 Sn1272; Calibrated: 2/9/2018

Phantom: SAM V5.0 Right; Type: QD000P40CD; Serial: 1647

Measurement SW: DASY52, Version 52.10; SEMCAD X Version 14.6.10 (7417)

**Mode: LTE Band 5 (Cell.), Body SAR, Back side, Mid.ch,  
10 MHz Bandwidth, QPSK, 1 RB, 49 RB Offset**

**Area Scan (9x15x1):** Measurement grid: dx=15mm, dy=15mm

**Zoom Scan (6x6x7)/Cube 0:** Measurement grid: dx=8mm, dy=8mm, dz=5mm

Reference Value = 19.87 V/m; Power Drift = 0.03 dB

Peak SAR (extrapolated) = 0.597 W/kg

**SAR(1 g) = 0.350 W/kg**

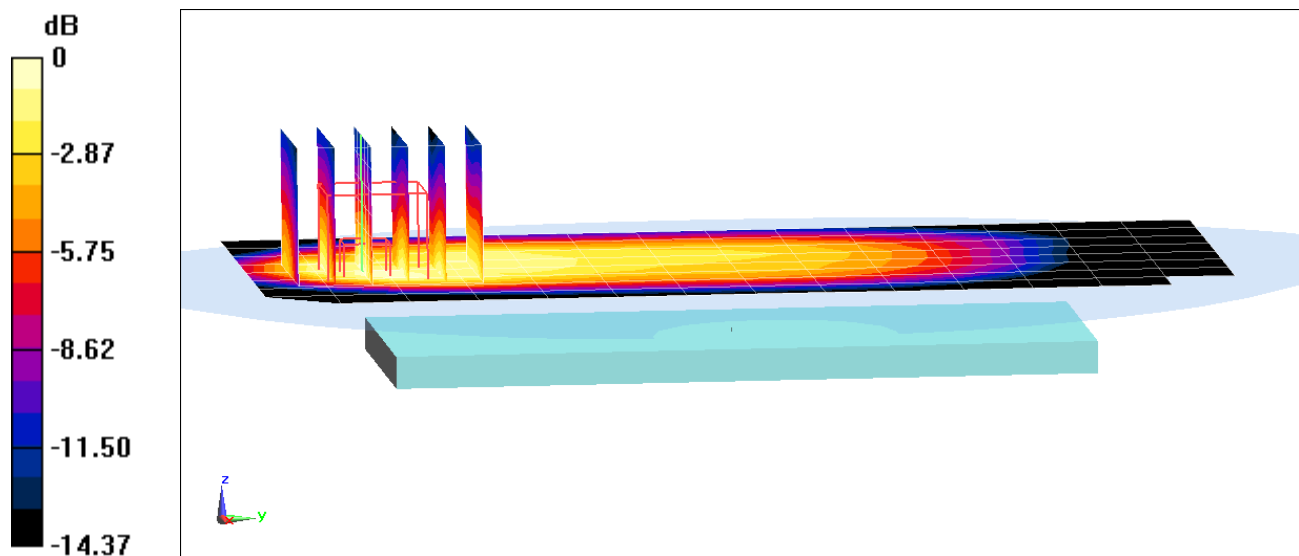

0 dB = 0.427 W/kg = -3.70 dBW/kg

# PCTEST ENGINEERING LABORATORY, INC.

**DUT: ZNFG710TM; Type: Portable Handset; Serial: 09696**

Communication System: UID 0, LTE Band 66 (AWS); Frequency: 1720 MHz; Duty Cycle: 1:1  
Medium: 1750 Body Medium parameters used (interpolated):  
 $f = 1720 \text{ MHz}$ ;  $\sigma = 1.478 \text{ S/m}$ ;  $\epsilon_r = 51.607$ ;  $\rho = 1000 \text{ kg/m}^3$   
Phantom section: Flat Section; Space: 1.0 cm

Test Date: 04-12-2018; Ambient Temp: 23.0°C; Tissue Temp: 20.8°C

Probe: ES3DV3 - SN3287; ConvF(5.19, 5.19, 5.19); Calibrated: 9/18/2017;  
Sensor-Surface: 3mm (Mechanical Surface Detection)  
Electronics: DAE4 Sn1333; Calibrated: 6/21/2017  
Phantom: Twin-SAM V4.0; Type: QD 000 P40 CC; Serial: 1167  
Measurement SW: DASY52, Version 52.10; SEMCAD X Version 14.6.10 (7417)

**Mode: LTE Band 66 (AWS), Body SAR, Back side, Low.ch,  
20 MHz Bandwidth, QPSK, 1 RB, 0 RB Offset**

**Area Scan (9x15x1):** Measurement grid: dx=15mm, dy=15mm  
**Zoom Scan (6x5x7)/Cube 0:** Measurement grid: dx=8mm, dy=8mm, dz=5mm  
Reference Value = 22.44 V/m; Power Drift = 0.00 dB  
Peak SAR (extrapolated) = 0.964 W/kg  
**SAR(1 g) = 0.618 W/kg**

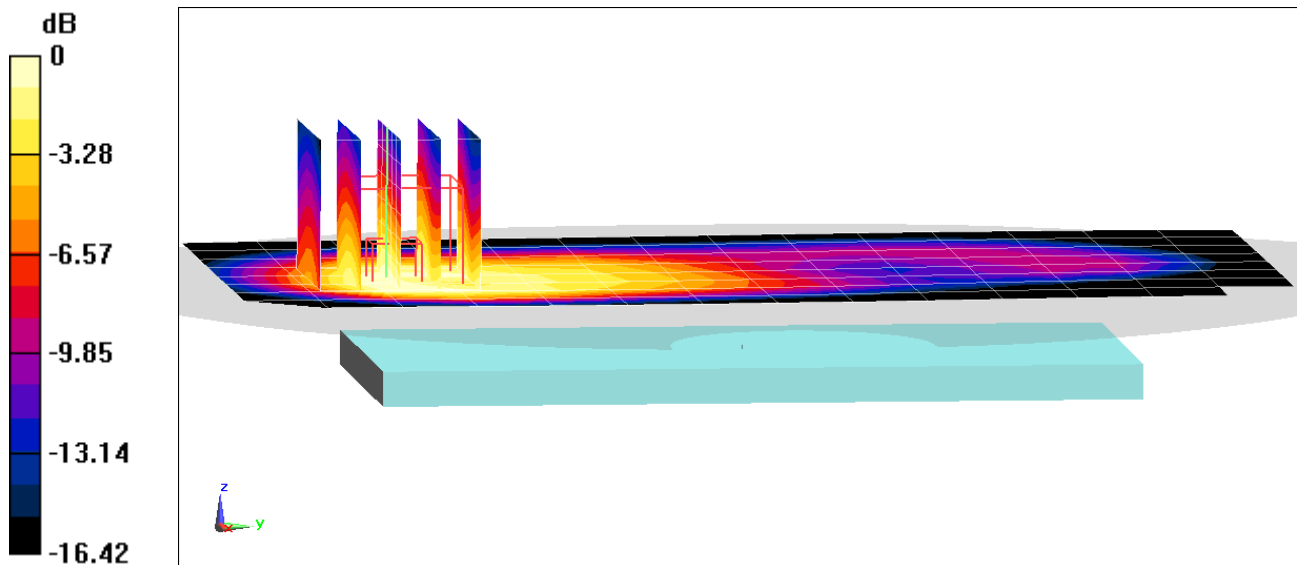

0 dB = 0.749 W/kg = -1.26 dBW/kg

# PCTEST ENGINEERING LABORATORY, INC.

**DUT: ZNFG710TM; Type: Portable Handset; Serial: 09696**

Communication System: UID 0, LTE Band 66 (AWS); Frequency: 1770 MHz; Duty Cycle: 1:1

Medium: 1750 Body Medium parameters used (interpolated):

$f = 1770 \text{ MHz}$ ;  $\sigma = 1.521 \text{ S/m}$ ;  $\epsilon_r = 51.791$ ;  $\rho = 1000 \text{ kg/m}^3$

Phantom section: Flat Section; Space: 1.0 cm

Test Date: 04-05-2018; Ambient Temp: 22.6°C; Tissue Temp: 21.2°C

Probe: ES3DV3 - SN3287; ConvF(5.19, 5.19, 5.19); Calibrated: 9/18/2017;

Sensor-Surface: 3mm (Mechanical Surface Detection)

Electronics: DAE4 Sn1333; Calibrated: 6/21/2017

Phantom: Twin-SAM V4.0; Type: QD 000 P40 CC; Serial: 1167

Measurement SW: DASY52, Version 52.10; SEMCAD X Version 14.6.10 (7417)

**Mode: LTE Band 66 (AWS), Body SAR, Bottom Edge, High.ch,  
20 MHz Bandwidth, QPSK, 1 RB, 99 RB Offset**

**Area Scan (11x7x1):** Measurement grid: dx=5mm, dy=15mm

**Zoom Scan (5x6x7)/Cube 0:** Measurement grid: dx=8mm, dy=8mm, dz=5mm

Reference Value = 27.96 V/m; Power Drift = -0.07 dB

Peak SAR (extrapolated) = 1.75 W/kg

**SAR(1 g) = 1.05 W/kg**

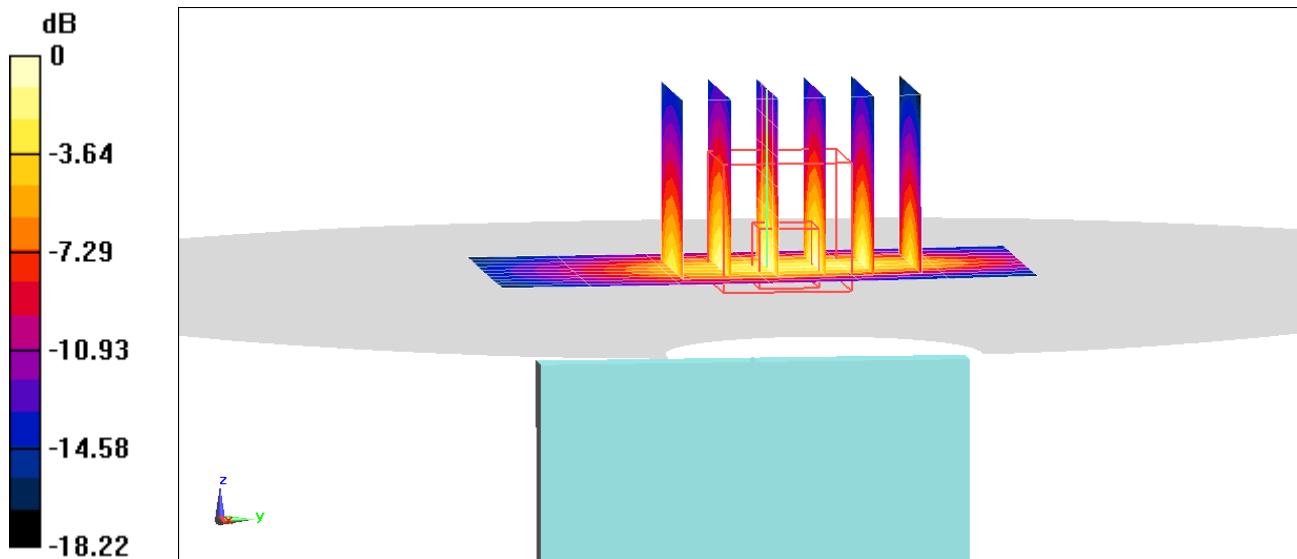

0 dB = 1.28 W/kg = 1.07 dBW/kg

# PCTEST ENGINEERING LABORATORY, INC.

**DUT: ZNFG710TM; Type: Portable Handset; Serial: 09670**

Communication System: UID 0, LTE Band 25 (PCS); Frequency: 1905 MHz; Duty Cycle: 1:1

Medium: 1900 Body Medium parameters used (interpolated):

$f = 1905$  MHz;  $\sigma = 1.581$  S/m;  $\epsilon_r = 53.711$ ;  $\rho = 1000$  kg/m<sup>3</sup>

Phantom section: Flat Section; Space: 1.0 cm

Test Date: 04-05-2018; Ambient Temp: 21.9°C; Tissue Temp: 21.7°C

Probe: EX3DV4 - SN3914; ConvF(7.62, 7.62, 7.62); Calibrated: 2/14/2018;

Sensor-Surface: 1.4mm (Mechanical Surface Detection)

Electronics: DAE4 Sn665; Calibrated: 2/15/2018

Phantom: Twin-SAM V5.0 Right; Type: QD 000 P40 CD; Serial: 1800

Measurement SW: DASY52, Version 52.10;SEMCAD X Version 14.6.10 (7417)

**Mode: LTE Band 25 (PCS), Body SAR, Back side, High.ch,  
20 MHz Bandwidth, QPSK, 1 RB, 99 RB Offset**

**Area Scan (8x13x1):** Measurement grid: dx=15mm, dy=15mm

**Zoom Scan (6x5x7)/Cube 0:** Measurement grid: dx=8mm, dy=8mm, dz=5mm

Reference Value = 15.18 V/m; Power Drift = -0.19 dB

Peak SAR (extrapolated) = 0.571 W/kg

**SAR(1 g) = 0.294 W/kg**

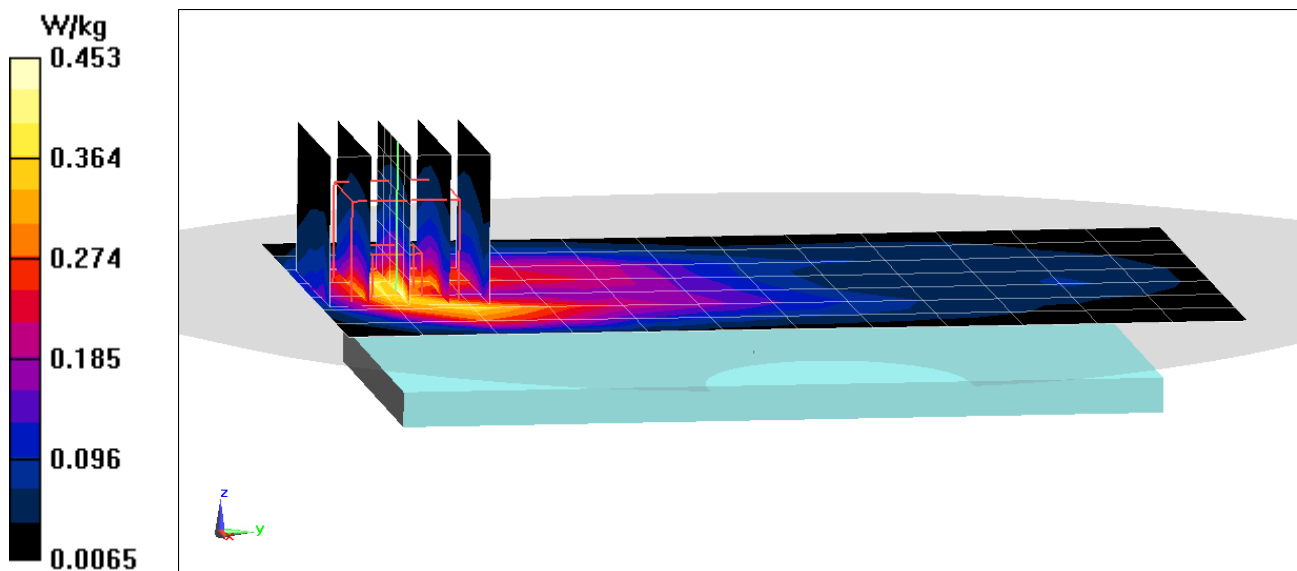

# PCTEST ENGINEERING LABORATORY, INC.

**DUT: ZNFG710TM; Type: Portable Handset; Serial: 09670**

Communication System: UID 0, LTE Band 25 (PCS); Frequency: 1905 MHz; Duty Cycle: 1:1

Medium: 1900 Body Medium parameters used (interpolated):

$f = 1905 \text{ MHz}$ ;  $\sigma = 1.581 \text{ S/m}$ ;  $\epsilon_r = 53.711$ ;  $\rho = 1000 \text{ kg/m}^3$

Phantom section: Flat Section; Space: 1.0 cm

Test Date: 04-05-2018; Ambient Temp: 21.9°C; Tissue Temp: 21.7°C

Probe: EX3DV4 - SN3914; ConvF(7.62, 7.62, 7.62); Calibrated: 2/14/2018;

Sensor-Surface: 1.4mm (Mechanical Surface Detection)

Electronics: DAE4 Sn665; Calibrated: 2/15/2018

Phantom: Twin-SAM V5.0 Right; Type: QD 000 P40 CD; Serial: 1800

Measurement SW: DASY52, Version 52.10; SEMCAD X Version 14.6.10 (7417)

**Mode: LTE Band 25 (PCS), Body SAR, Bottom Edge, High.ch,  
20 MHz Bandwidth, QPSK, 1 RB, 99 RB Offset**

**Area Scan (9x9x1):** Measurement grid: dx=5mm, dy=15mm

**Zoom Scan (5x5x7)/Cube 0:** Measurement grid: dx=8mm, dy=8mm, dz=5mm

Reference Value = 25.61 V/m; Power Drift = -0.15 dB

Peak SAR (extrapolated) = 1.57 W/kg

**SAR(1 g) = 0.883 W/kg**

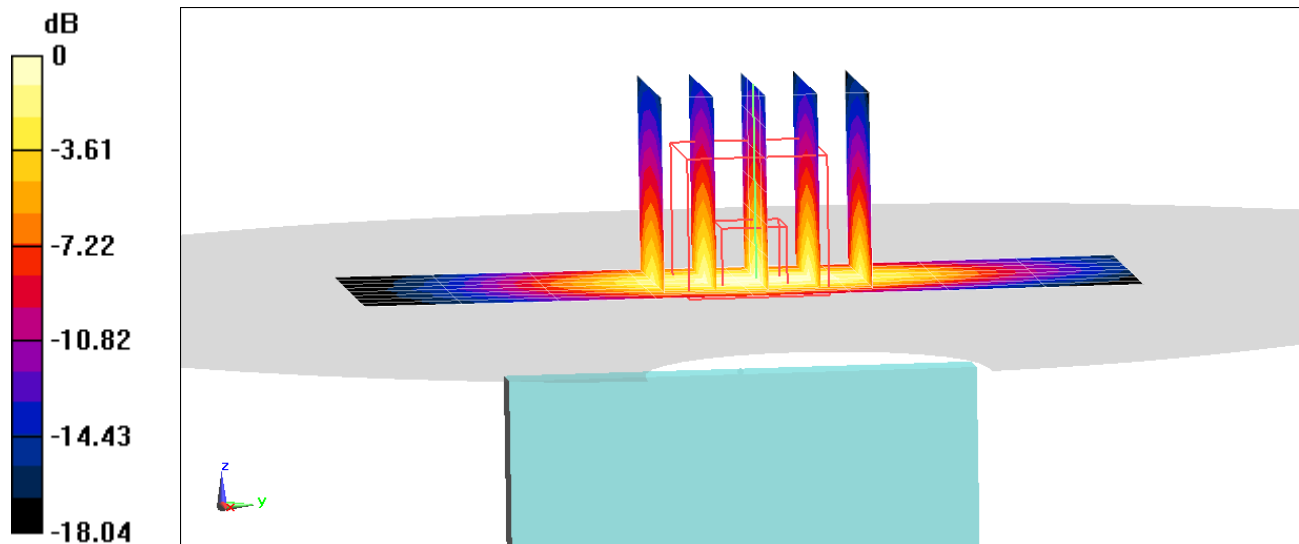

0 dB = 1.34 W/kg = 1.27 dBW/kg

# PCTEST ENGINEERING LABORATORY, INC.

**DUT: ZNFG710TM; Type: Portable Handset; Serial: 09670**

Communication System: UID 0, LTE Band 30; Frequency: 2310 MHz; Duty Cycle: 1:1

Medium: 2450 Body Medium parameters used:

$f = 2310$  MHz;  $\sigma = 1.887$  S/m;  $\epsilon_r = 51.577$ ;  $\rho = 1000$  kg/m<sup>3</sup>

Phantom section: Flat Section; Space: 1.0 cm

Test Date: 04-15-2018; Ambient Temp: 22.0°C; Tissue Temp: 20.9°C

Probe: ES3DV3 - SN3319; ConvF(4.63, 4.63, 4.63); Calibrated: 3/13/2018;

Sensor-Surface: 3mm (Mechanical Surface Detection)

Electronics: DAE4 Sn1368; Calibrated: 3/7/2018

Phantom: Right Twin-SAM V5.0; Type: QD 000 P40 CD; Serial: 1797

Measurement SW: DASY52, Version 52.10;SEMCAD X Version 14.6.10 (7417)

**Mode: LTE Band 30, Body SAR, Back side, Mid.ch,  
10 MHz Bandwidth, QPSK, 1 RB, 25 RB Offset**

**Area Scan (11x18x1):** Measurement grid: dx=12mm, dy=12mm

**Zoom Scan (7x7x7)/Cube 0:** Measurement grid: dx=5mm, dy=5mm, dz=5mm

Reference Value = 13.63 V/m; Power Drift = 0.06 dB

Peak SAR (extrapolated) = 0.571 W/kg

**SAR(1 g) = 0.290 W/kg**

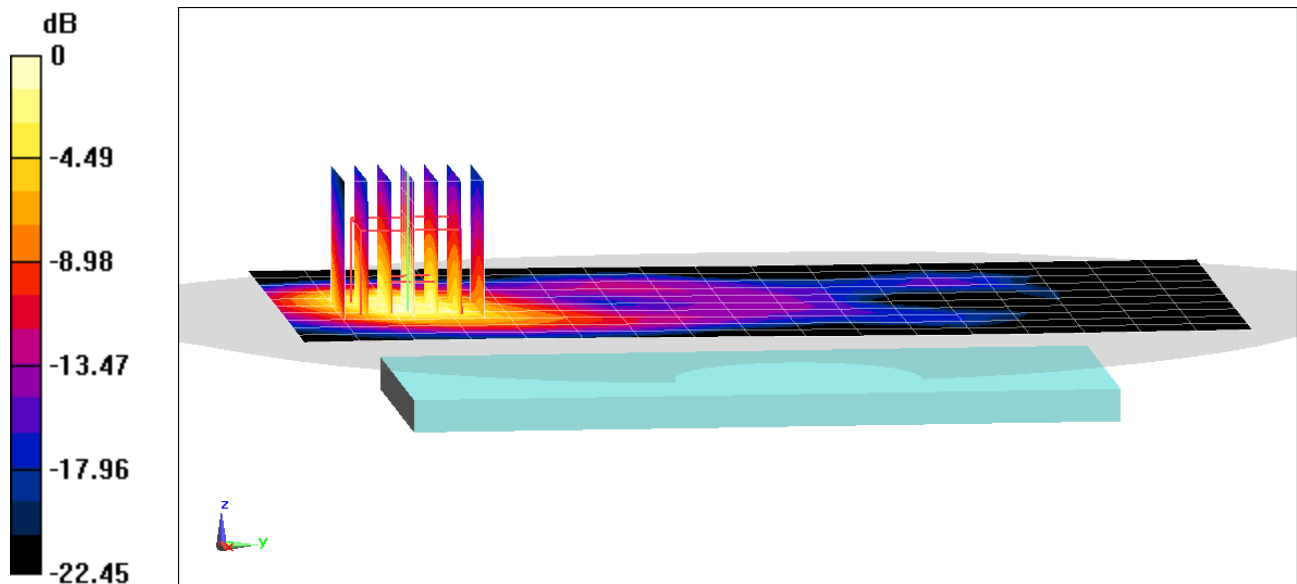

0 dB = 0.378 W/kg = -4.23 dBW/kg

# PCTEST ENGINEERING LABORATORY, INC.

**DUT: ZNFG710TM; Type: Portable Handset; Serial: 09670**

Communication System: UID 0, LTE Band 7; Frequency: 2535 MHz; Duty Cycle: 1:1

Medium: 2450 Body Medium parameters used (interpolated):

$f = 2535 \text{ MHz}$ ;  $\sigma = 2.133 \text{ S/m}$ ;  $\epsilon_r = 50.602$ ;  $\rho = 1000 \text{ kg/m}^3$

Phantom section: Flat Section; Space: 1.0 cm

Test Date: 04-12-2018; Ambient Temp: 24.0°C; Tissue Temp: 22.6°C

Probe: ES3DV3 - SN3319; ConvF(4.33, 4.33, 4.33); Calibrated: 3/13/2018;

Sensor-Surface: 3mm (Mechanical Surface Detection)

Electronics: DAE4 Sn1368; Calibrated: 3/7/2018

Phantom: Right Twin-SAM V5.0; Type: QD 000 P40 CD; Serial: 1797

Measurement SW: DASY52, Version 52.10; SEMCAD X Version 14.6.10 (7417)

**Mode: LTE Band 7, Body SAR, Back side, Mid.ch,  
20 MHz Bandwidth, QPSK, 1 RB, 50 RB Offset**

**Area Scan (11x18x1):** Measurement grid: dx=12mm, dy=12mm

**Zoom Scan (7x7x7)/Cube 0:** Measurement grid: dx=5mm, dy=5mm, dz=5mm

Reference Value = 25.92 V/m; Power Drift = -0.14 dB

Peak SAR (extrapolated) = 2.71 W/kg

**SAR(1 g) = 1.21 W/kg**

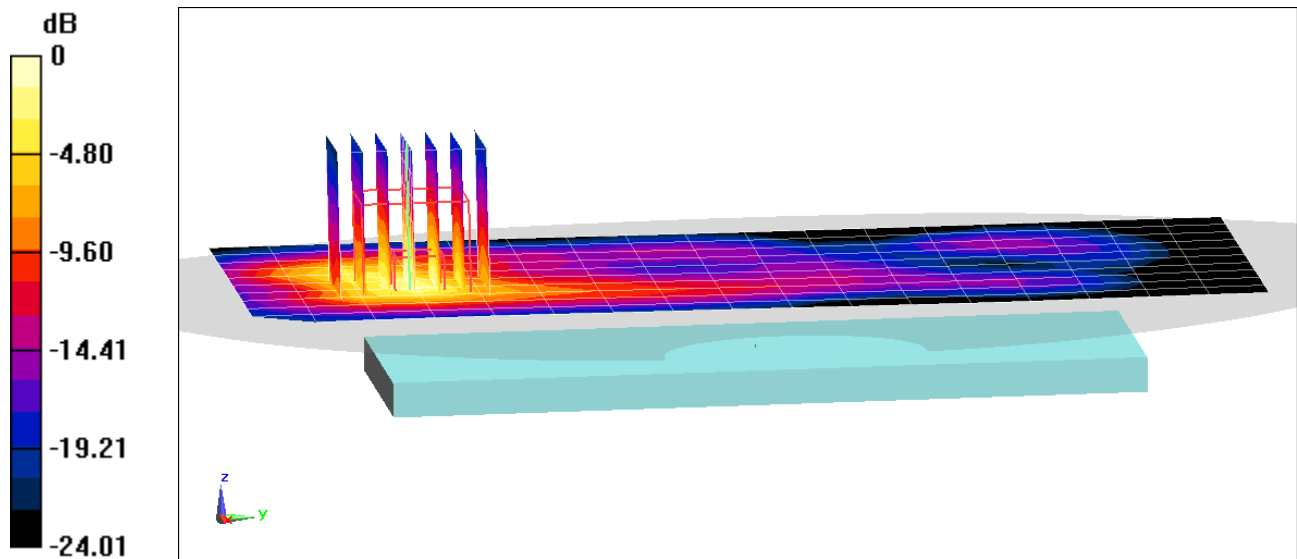

0 dB = 1.62 W/kg = 2.10 dBW/kg

# PCTEST ENGINEERING LABORATORY, INC.

**DUT: ZNFG710TM; Type: Portable Handset; Serial: 09654**

Communication System: UID 0, \_LTE Band 41; Frequency: 2506 MHz; Duty Cycle: 1:1.58  
Medium: 2450 Body Medium parameters used (interpolated):  
 $f = 2506 \text{ MHz}$ ;  $\sigma = 2.105 \text{ S/m}$ ;  $\epsilon_r = 50.566$ ;  $\rho = 1000 \text{ kg/m}^3$   
Phantom section: Flat Section; Space: 1.0 cm

Test Date: 04-09-2018; Ambient Temp: 23.4°C; Tissue Temp: 22.0°C

Probe: ES3DV3 - SN3319; ConvF(4.51, 4.51, 4.51); Calibrated: 3/13/2018;  
Sensor-Surface: 3mm (Mechanical Surface Detection)  
Electronics: DAE4 Sn1368; Calibrated: 3/7/2018  
Phantom: Right Twin-SAM V5.0; Type: QD 000 P40 CD; Serial: 1797  
Measurement SW: DASY52, Version 52.10; SEMCAD X Version 14.6.10 (7417)

**Mode: LTE Band 41, Body SAR, Back side, Low.ch,  
20 MHz Bandwidth, QPSK, 1 RB, 50 RB Offset**

**Area Scan (10x16x1):** Measurement grid: dx=12mm, dy=12mm  
**Zoom Scan (7x7x7)/Cube 0:** Measurement grid: dx=5mm, dy=5mm, dz=5mm  
Reference Value = 20.09 V/m; Power Drift = -0.04 dB  
Peak SAR (extrapolated) = 1.49 W/kg  
**SAR(1 g) = 0.700 W/kg**

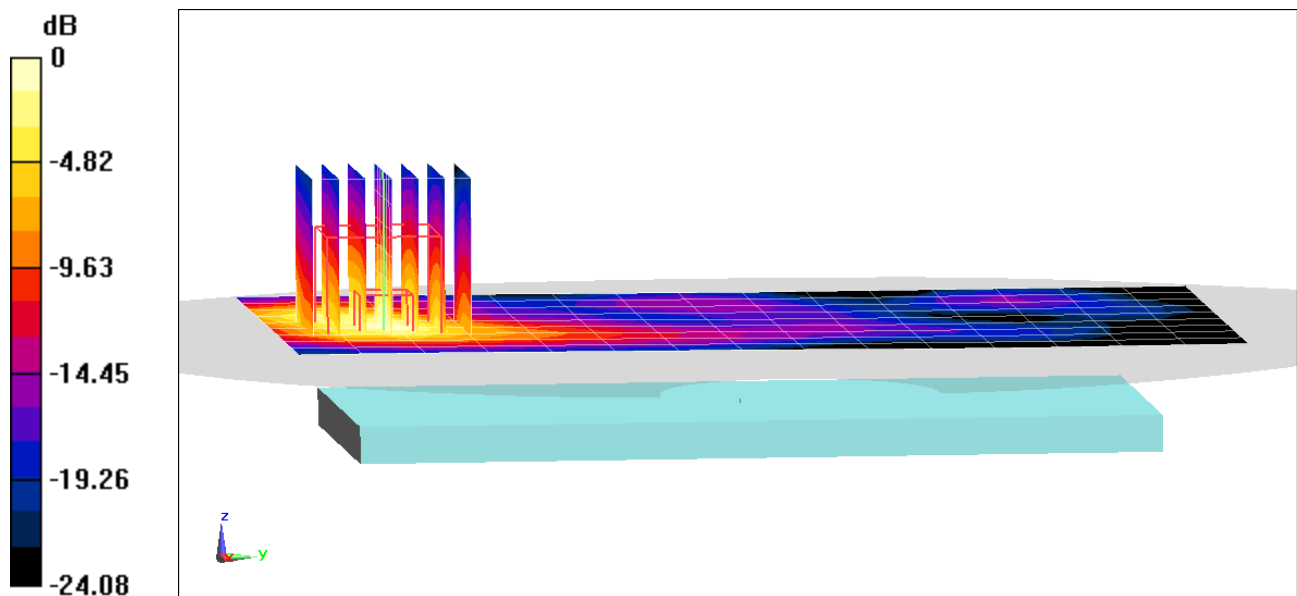

0 dB = 0.946 W/kg = -0.24 dBW/kg



# PCTEST ENGINEERING LABORATORY, INC.

**DUT: ZNFG710TM; Type: Portable Handset; Serial: 09654**

Communication System: UID 0, \_LTE Band 41; Frequency: 2506 MHz; Duty Cycle: 1:1.58  
Medium: 2450 Body Medium parameters used (interpolated):  
 $f = 2506 \text{ MHz}$ ;  $\sigma = 2.105 \text{ S/m}$ ;  $\epsilon_r = 50.566$ ;  $\rho = 1000 \text{ kg/m}^3$   
Phantom section: Flat Section; Space: 1.0 cm

Test Date: 04-09-2018; Ambient Temp: 23.4°C; Tissue Temp: 22.0°C

Probe: ES3DV3 - SN3319; ConvF(4.51, 4.51, 4.51); Calibrated: 3/13/2018;  
Sensor-Surface: 3mm (Mechanical Surface Detection)  
Electronics: DAE4 Sn1368; Calibrated: 3/7/2018  
Phantom: Right Twin-SAM V5.0; Type: QD 000 P40 CD; Serial: 1797  
Measurement SW: DASY52, Version 52.10; SEMCAD X Version 14.6.10 (7417)

**Mode: LTE Band 41, Body SAR, Bottom Edge, Low.ch,  
20 MHz Bandwidth, QPSK, 1 RB, 50 RB Offset**

**Area Scan (10x9x1):** Measurement grid: dx=5mm, dy=12mm  
**Zoom Scan (7x7x7)/Cube 0:** Measurement grid: dx=5mm, dy=5mm, dz=5mm  
Reference Value = 22.27 V/m; Power Drift = 0.06 dB  
Peak SAR (extrapolated) = 1.81 W/kg  
**SAR(1 g) = 0.883 W/kg**

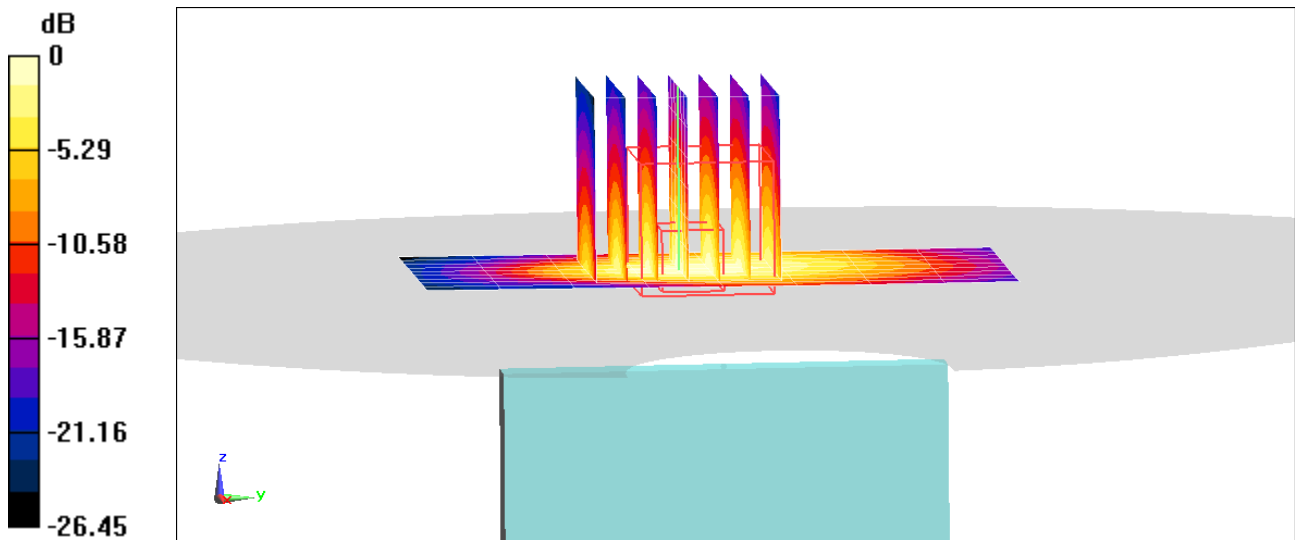

0 dB = 1.15 W/kg = 0.61 dBW/kg

# PCTEST ENGINEERING LABORATORY, INC.

**DUT: ZNFG710TM; Type: Portable Handset; Serial: 09688**

Communication System: UID 0, \_IEEE 802.11g; Frequency: 2437 MHz; Duty Cycle: 1:1  
Medium: 2450 Body Medium parameters used (interpolated):  
 $f = 2437 \text{ MHz}$ ;  $\sigma = 1.948 \text{ S/m}$ ;  $\epsilon_r = 52.188$ ;  $\rho = 1000 \text{ kg/m}^3$   
Phantom section: Flat Section; Space: 1.0 cm

Test Date: 04-16-2018; Ambient Temp: 22.6°C; Tissue Temp: 23.0°C

Probe: EX3DV4 - SN7410; ConvF(7.69, 7.69, 7.69); Calibrated: 7/17/2017;  
Sensor-Surface: 1.4mm (Mechanical Surface Detection)  
Electronics: DAE4 Sn1322; Calibrated: 7/13/2017  
Phantom: SAM with CRP (Left); Type: SAM; Serial: 1715  
Measurement SW: DASY52, Version 52.10; SEMCAD X Version 14.6.10 (7417)

**Mode: IEEE 802.11g, 20 MHz Bandwidth,  
Body SAR, Ch 6, 6 Mbps, Back Side, MIMO**

**Area Scan (11x17x1):** Measurement grid: dx=12mm, dy=12mm  
**Zoom Scan (7x7x7)/Cube 0:** Measurement grid: dx=5mm, dy=5mm, dz=5mm  
Reference Value = 15.30 V/m; Power Drift = 0.04 dB  
Peak SAR (extrapolated) = 0.887 W/kg  
**SAR(1 g) = 0.404 W/kg**

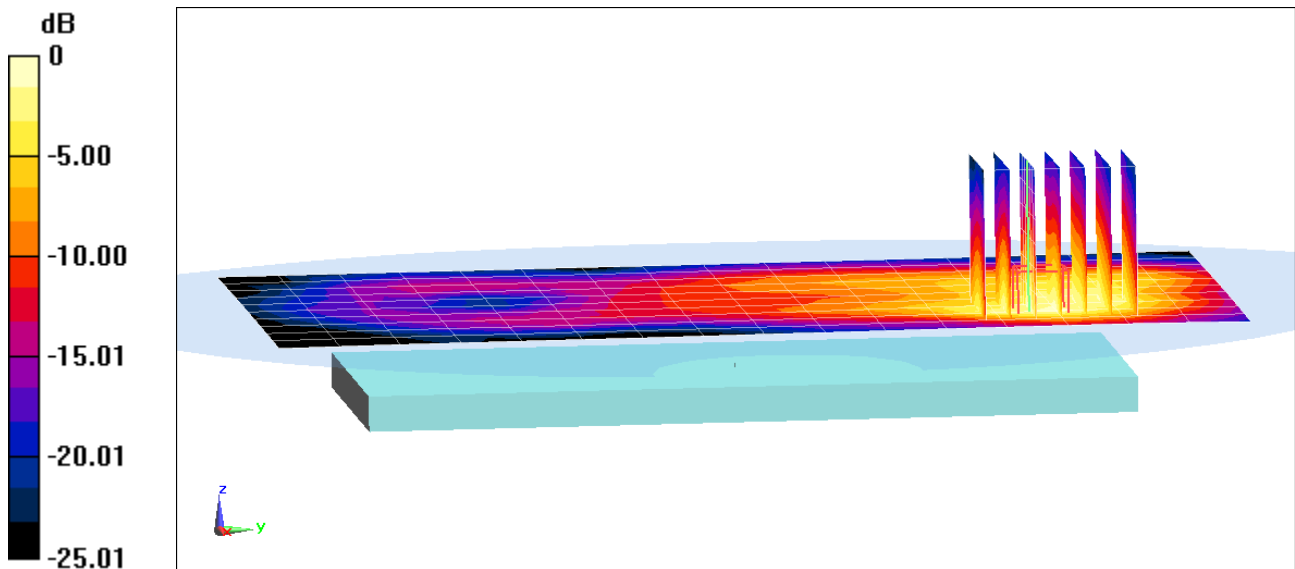

# PCTEST ENGINEERING LABORATORY, INC.

**DUT: ZNFG710TM; Type: Portable Handset; Serial: 09662**

Communication System: UID 0, 802.11n 5.2-5.8 GHz Band; Frequency: 5500 MHz; Duty Cycle: 1:1

Medium: 5 GHz Body Medium parameters used:

$f = 5500 \text{ MHz}$ ;  $\sigma = 5.844 \text{ S/m}$ ;  $\epsilon_r = 47.219$ ;  $\rho = 1000 \text{ kg/m}^3$

Phantom section: Flat Section; Space: 1.0 cm

Test Date: 04-14-2018; Ambient Temp: 22.3°C; Tissue Temp: 21.8°C

Probe: EX3DV4 - SN7308; ConvF(4.23, 4.23, 4.23); Calibrated: 8/16/2017;

Sensor-Surface: 1.4mm (Mechanical Surface Detection)

Electronics: DAE4 Sn1334; Calibrated: 6/14/2017

Phantom: SAM with CRP v5.0 Front; Type: QD000P40CD; Serial: 1646

Measurement SW: DASY52, Version 52.10; SEMCAD X Version 14.6.10 (7417)

**Mode: IEEE 802.11n, UNII-2C, 20 MHz Bandwidth,  
Body SAR, Ch 100, 13 Mbps, Back Side, MIMO**

**Area Scan (9x9x1):** Measurement grid: dx=10mm, dy=10mm

**Zoom Scan (7x7x7)/Cube 0:** Measurement grid: dx=4mm, dy=4mm, dz=1.4mm; Graded Ratio: 1.4

Reference Value = 13.62 V/m; Power Drift = 0.10 dB

Peak SAR (extrapolated) = 4.46 W/kg

**SAR(1 g) = 0.991 W/kg**

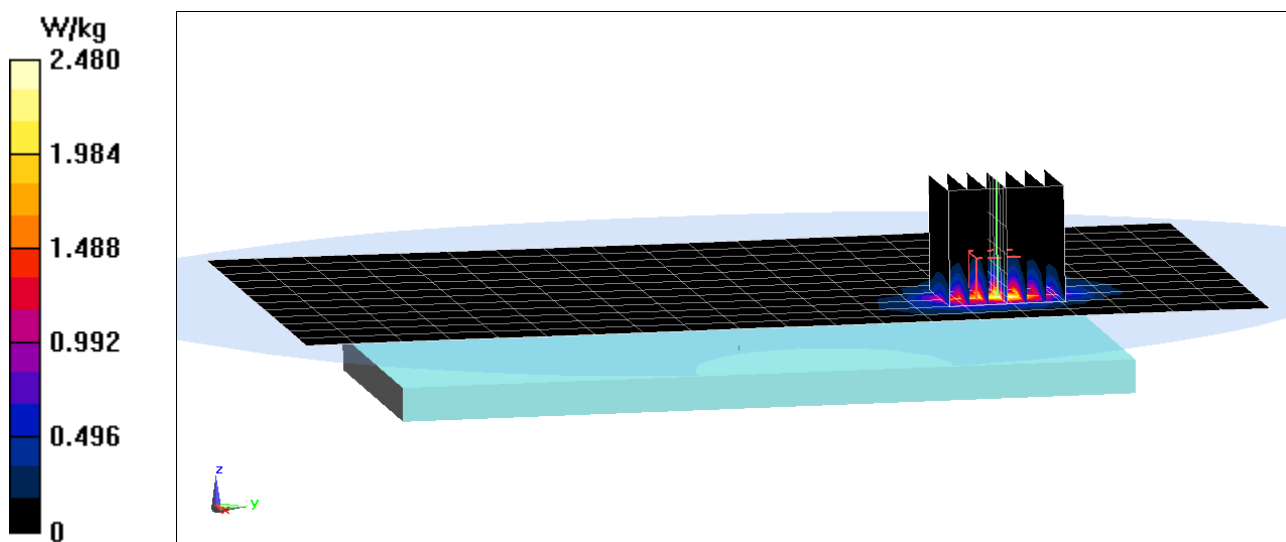

# PCTEST ENGINEERING LABORATORY, INC.

**DUT: ZNFG710TM; Type: Portable Handset; Serial: 09662**

Communication System: UID 0, 802.1n 5.2-5.8 GHz Band; Frequency: 5785 MHz; Duty Cycle: 1:1

Medium: 5 GHz Body Medium parameters used:

$f = 5785 \text{ MHz}$ ;  $\sigma = 6.244 \text{ S/m}$ ;  $\epsilon_r = 46.767$ ;  $\rho = 1000 \text{ kg/m}^3$

Phantom section: Flat Section; Space: 1.0 cm

Test Date: 04-14-2018; Ambient Temp: 22.3°C; Tissue Temp: 21.8°C

Probe: EX3DV4 - SN7308; ConvF(4.5, 4.5, 4.5); Calibrated: 8/16/2017;

Sensor-Surface: 1.4mm (Mechanical Surface Detection)

Electronics: DAE4 Sn1334; Calibrated: 6/14/2017

Phantom: SAM with CRP v5.0 Front; Type: QD000P40CD; Serial: 1646

Measurement SW: DASY52, Version 52.10;SEMCAD X Version 14.6.10 (7417)

**Mode: IEEE 802.11n, UNII-3, 20 MHz Bandwidth,  
Body SAR, Ch 157, 13 Mbps, Back Side, MIMO**

**Area Scan (9x9x1):** Measurement grid: dx=10mm, dy=10mm

**Zoom Scan (7x7x7)/Cube 0:** Measurement grid: dx=4mm, dy=4mm, dz=1.4mm; Graded Ratio: 1.4

Reference Value = 11.96 V/m; Power Drift = 0.08 dB

Peak SAR (extrapolated) = 4.14 W/kg

**SAR(1 g) = 0.825 W/kg**

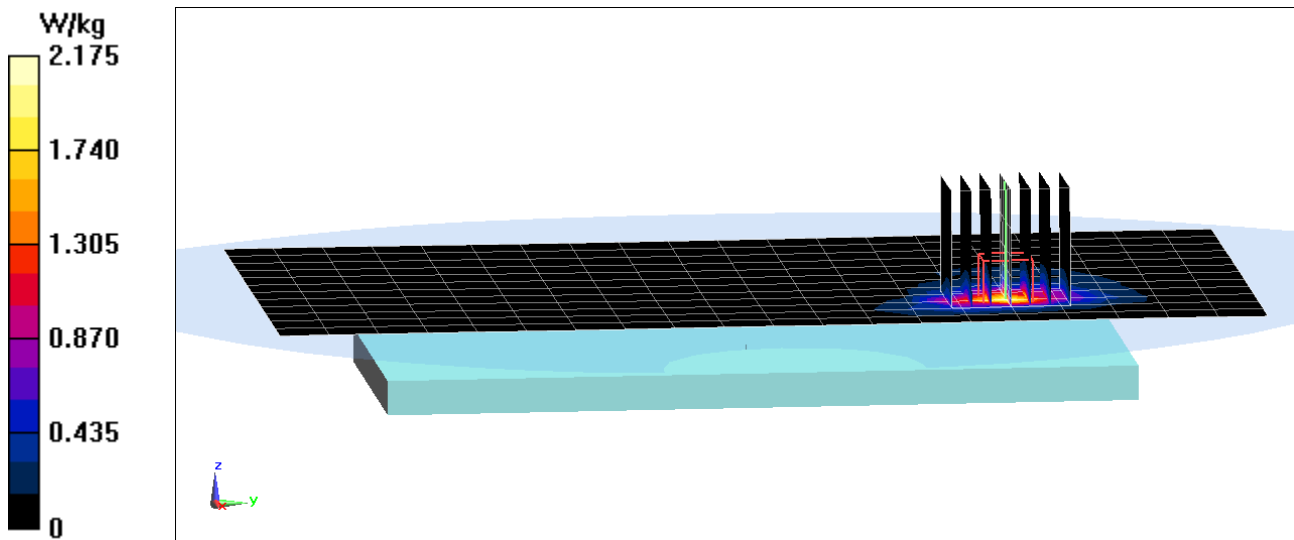

# PCTEST ENGINEERING LABORATORY, INC.

**DUT: ZNFG710TM; Type: Portable Handset; Serial: 09688**

Communication System: UID 0, Bluetooth; Frequency: 2402 MHz; Duty Cycle: 1:1.294

Medium: 2450 Body Medium parameters used (interpolated):

$f = 2402 \text{ MHz}$ ;  $\sigma = 1.904 \text{ S/m}$ ;  $\epsilon_r = 52.31$ ;  $\rho = 1000 \text{ kg/m}^3$

Phantom section: Flat Section; Space: 1.0 cm

Test Date: 04-16-2018; Ambient Temp: 22.6°C; Tissue Temp: 23.0°C

Probe: EX3DV4 - SN7410; ConvF(7.69, 7.69, 7.69); Calibrated: 7/17/2017;

Sensor-Surface: 1.4mm (Mechanical Surface Detection)

Electronics: DAE4 Sn1322; Calibrated: 7/13/2017

Phantom: SAM with CRP (Left); Type: SAM; Serial: 1715

Measurement SW: DASY52, Version 52.10;SEMCAD X Version 14.6.10 (7417)

**Mode: Bluetooth, Body SAR, Ch 0, 1 Mbps, Back Side**

**Area Scan (11x17x1):** Measurement grid: dx=12mm, dy=12mm

**Zoom Scan (7x7x7)/Cube 0:** Measurement grid: dx=5mm, dy=5mm, dz=5mm

Reference Value = 4.339 V/m; Power Drift = -0.06 dB

Peak SAR (extrapolated) = 0.0640 W/kg

**SAR(1 g) = 0.031 W/kg**

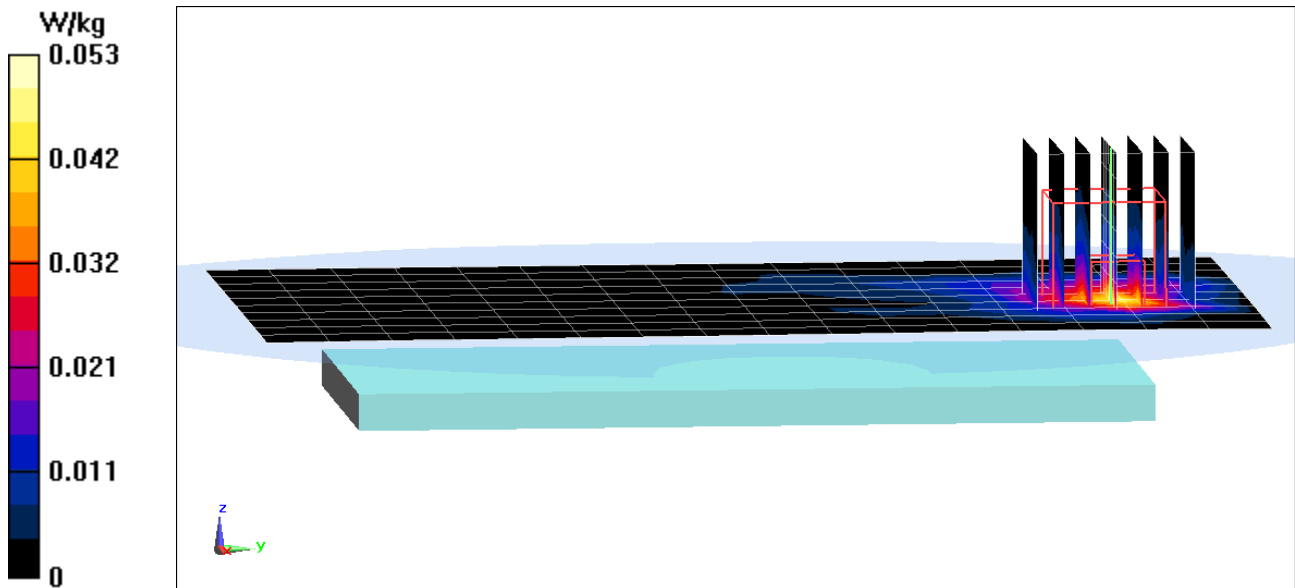

# PCTEST ENGINEERING LABORATORY, INC.

**DUT: ZNFG710TM; Type: Portable Handset; Serial: 09688**

Communication System: UID 0, Bluetooth; Frequency: 2402 MHz; Duty Cycle: 1:1.294

Medium: 2450 Body Medium parameters used (interpolated):

$f = 2402 \text{ MHz}$ ;  $\sigma = 1.904 \text{ S/m}$ ;  $\epsilon_r = 52.31$ ;  $\rho = 1000 \text{ kg/m}^3$

Phantom section: Flat Section; Space: 1.0 cm

Test Date: 04-16-2018; Ambient Temp: 22.6°C; Tissue Temp: 23.0°C

Probe: EX3DV4 - SN7410; ConvF(7.69, 7.69, 7.69); Calibrated: 7/17/2017;

Sensor-Surface: 1.4mm (Mechanical Surface Detection)

Electronics: DAE4 Sn1322; Calibrated: 7/13/2017

Phantom: SAM with CRP (Left); Type: SAM; Serial: 1715

Measurement SW: DASY52, Version 52.10;SEMCAD X Version 14.6.10 (7417)

**Mode: Bluetooth, Body SAR, Ch 0, 1 Mbps, Top Edge**

**Area Scan (10x11x1):** Measurement grid: dx=5mm, dy=12mm

**Zoom Scan (7x7x7)/Cube 0:** Measurement grid: dx=5mm, dy=5mm, dz=5mm

Reference Value = 4.856 V/m; Power Drift = -0.04 dB

Peak SAR (extrapolated) = 0.0760 W/kg

**SAR(1 g) = 0.040 W/kg**

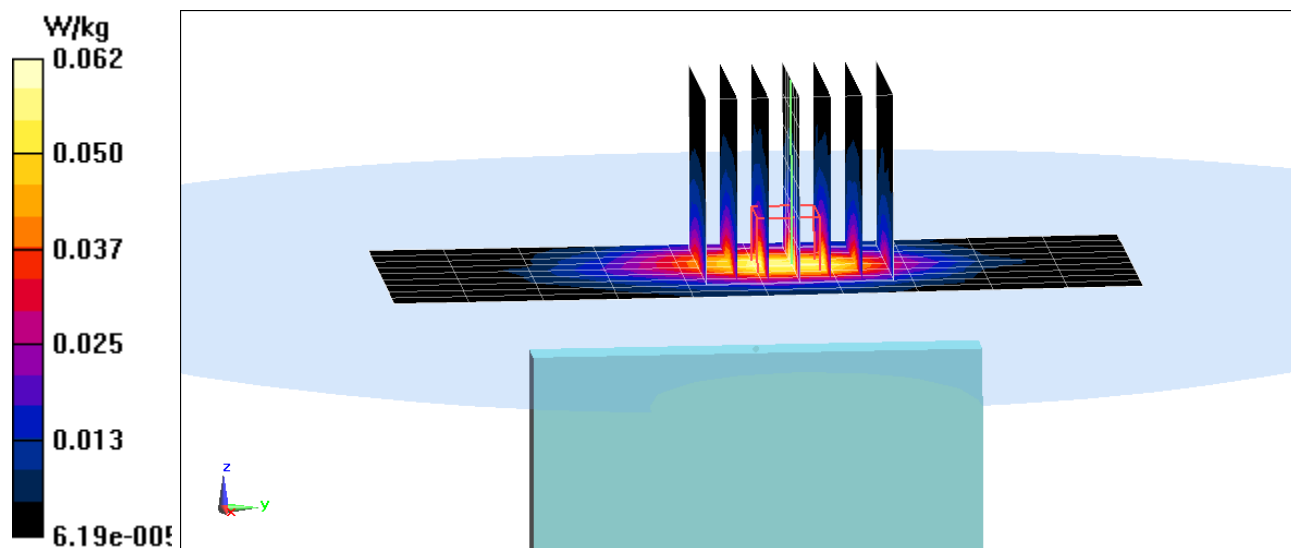

# PCTEST ENGINEERING LABORATORY, INC.

**DUT: ZNFG710TM; Type: Portable Handset; Serial: 09654**

Communication System: UID 0, UMTS; Frequency: 1752.6 MHz; Duty Cycle: 1:1  
Medium: 1750 Body Medium parameters used (interpolated):  
 $f = 1752.6 \text{ MHz}$ ;  $\sigma = 1.516 \text{ S/m}$ ;  $\epsilon_r = 51.502$ ;  $\rho = 1000 \text{ kg/m}^3$   
Phantom section: Flat Section; Space: 0.0 cm

Test Date: 04-12-2018; Ambient Temp: 23.0°C; Tissue Temp: 20.8°C

Probe: ES3DV3 - SN3287; ConvF(5.19, 5.19, 5.19); Calibrated: 9/18/2017;  
Sensor-Surface: 3mm (Mechanical Surface Detection)  
Electronics: DAE4 Sn1333; Calibrated: 6/21/2017  
Phantom: Twin-SAM V4.0; Type: QD 000 P40 CC; Serial: 1167  
Measurement SW: DASY52, Version 52.10; SEMCAD X Version 14.6.10 (7417)

**Mode: UMTS 1750, Phablet SAR, Bottom Edge, High.ch**

**Area Scan (10x9x1):** Measurement grid: dx=5mm, dy=15mm  
**Zoom Scan (5x6x7)/Cube 0:** Measurement grid: dx=8mm, dy=8mm, dz=5mm  
Reference Value = 68.00 V/m; Power Drift = -0.01 dB  
Peak SAR (extrapolated) = 13.2 W/kg  
**SAR(10 g) = 2.78 W/kg**

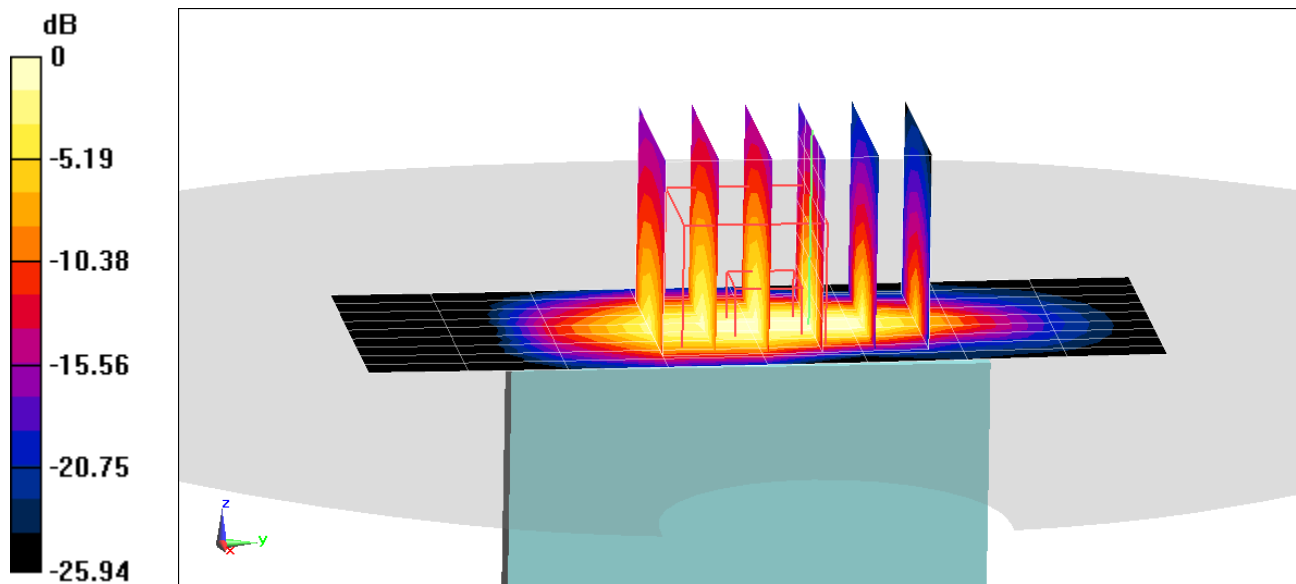

0 dB = 8.02 W/kg = 9.04 dBW/kg

# PCTEST ENGINEERING LABORATORY, INC.

**DUT: ZNFG710TM; Type: Portable Handset; Serial: 09670**

Communication System: UID 0, UMTS; Frequency: 1880 MHz; Duty Cycle: 1:1  
Medium: 1900 Body Medium parameters used:  
 $f = 1880 \text{ MHz}$ ;  $\sigma = 1.553 \text{ S/m}$ ;  $\epsilon_r = 53.793$ ;  $\rho = 1000 \text{ kg/m}^3$   
Phantom section: Flat Section; Space: 0.0 cm

Test Date: 04-05-2018; Ambient Temp: 21.9°C; Tissue Temp: 21.7°C

Probe: EX3DV4 - SN3914; ConvF(7.62, 7.62, 7.62); Calibrated: 2/14/2018;  
Sensor-Surface: 1.4mm (Mechanical Surface Detection)  
Electronics: DAE4 Sn665; Calibrated: 2/15/2018  
Phantom: Twin-SAM V5.0 Right; Type: QD 000 P40 CD; Serial: 1800  
Measurement SW: DASY52, Version 52.10;SEMCAD X Version 14.6.10 (7417)

**Mode: UMTS 1900, Phablet SAR, Bottom Edge, Mid.ch**

**Area Scan (11x8x1):** Measurement grid: dx=5mm, dy=15mm  
**Zoom Scan (5x5x7)/Cube 0:** Measurement grid: dx=8mm, dy=8mm, dz=5mm  
Reference Value = 64.55 V/m; Power Drift = -0.12 dB  
Peak SAR (extrapolated) = 11.6 W/kg  
**SAR(10 g) = 2.31 W/kg**

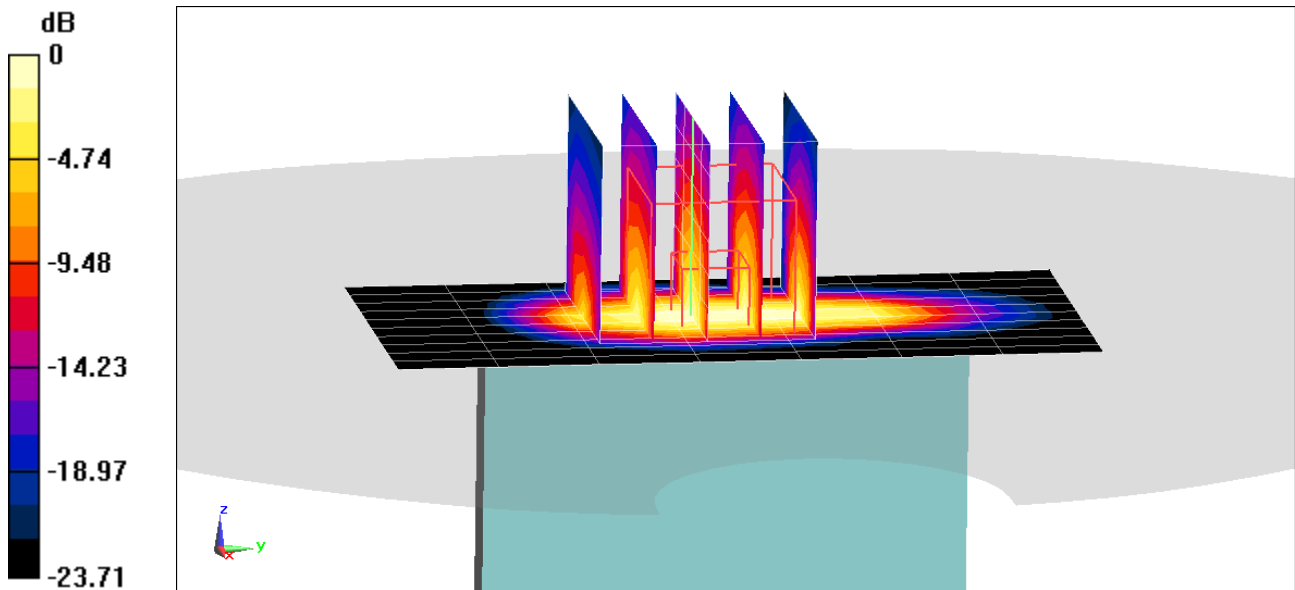



# PCTEST ENGINEERING LABORATORY, INC.

**DUT: ZNFG710TM; Type: Portable Handset; Serial: 09696**

Communication System: UID 0, LTE Band 66 (AWS); Frequency: 1770 MHz; Duty Cycle: 1:1

Medium: 1750 Body Medium parameters used (interpolated):

$f = 1770 \text{ MHz}$ ;  $\sigma = 1.521 \text{ S/m}$ ;  $\epsilon_r = 51.791$ ;  $\rho = 1000 \text{ kg/m}^3$

Phantom section: Flat Section; Space: 0.0 cm

Test Date: 04-05-2018; Ambient Temp: 22.6°C; Tissue Temp: 21.2°C

Probe: ES3DV3 - SN3287; ConvF(5.19, 5.19, 5.19); Calibrated: 9/18/2017;

Sensor-Surface: 3mm (Mechanical Surface Detection)

Electronics: DAE4 Sn1333; Calibrated: 6/21/2017

Phantom: Twin-SAM V4.0; Type: QD 000 P40 CC; Serial: 1167

Measurement SW: DASY52, Version 52.10; SEMCAD X Version 14.6.10 (7417)

**Mode: LTE Band 66 (AWS), Phablet SAR, Bottom Edge, High.ch,  
20 MHz Bandwidth, QPSK, 1 RB, 50 RB Offset**

**Area Scan (11x7x1):** Measurement grid: dx=5mm, dy=15mm

**Zoom Scan (5x6x7)/Cube 0:** Measurement grid: dx=8mm, dy=8mm, dz=5mm

Reference Value = 64.14 V/m; Power Drift = 0.00 dB

Peak SAR (extrapolated) = 11.9 W/kg

**SAR(10 g) = 2.57 W/kg**

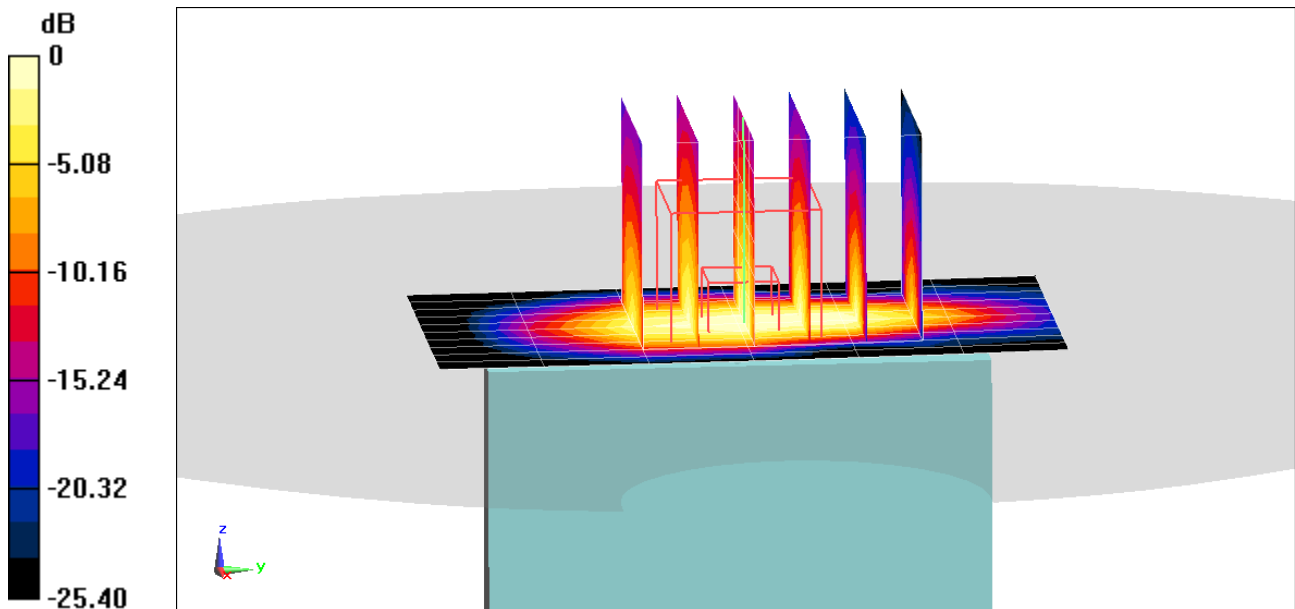

# PCTEST ENGINEERING LABORATORY, INC.

**DUT: ZNFG710TM; Type: Portable Handset; Serial: 09670**

Communication System: UID 0, LTE Band 25 (PCS); Frequency: 1905 MHz; Duty Cycle: 1:1  
Medium: 1900 Body Medium parameters used (interpolated):  
 $f = 1905 \text{ MHz}$ ;  $\sigma = 1.581 \text{ S/m}$ ;  $\epsilon_r = 53.711$ ;  $\rho = 1000 \text{ kg/m}^3$   
Phantom section: Flat Section; Space: 0.0 cm

Test Date: 04-05-2018; Ambient Temp: 21.9°C; Tissue Temp: 21.7°C

Probe: EX3DV4 - SN3914; ConvF(7.62, 7.62, 7.62); Calibrated: 2/14/2018;  
Sensor-Surface: 1.4mm (Mechanical Surface Detection)

Electronics: DAE4 Sn665; Calibrated: 2/15/2018

Phantom: Twin-SAM V5.0 Right; Type: QD 000 P40 CD; Serial: 1800

Measurement SW: DASY52, Version 52.10; SEMCAD X Version 14.6.10 (7417)

**Mode: LTE Band 25 (PCS), Phablet SAR, Bottom Edge, High.ch,  
20 MHz Bandwidth, QPSK, 1 RB, 0 RB Offset**

**Area Scan (10x8x1):** Measurement grid: dx=5mm, dy=15mm

**Zoom Scan (5x5x7)/Cube 0:** Measurement grid: dx=8mm, dy=8mm, dz=5mm

Reference Value = 69.35 V/m; Power Drift = -0.05 dB

Peak SAR (extrapolated) = 13.8 W/kg

**SAR(10 g) = 2.87 W/kg**

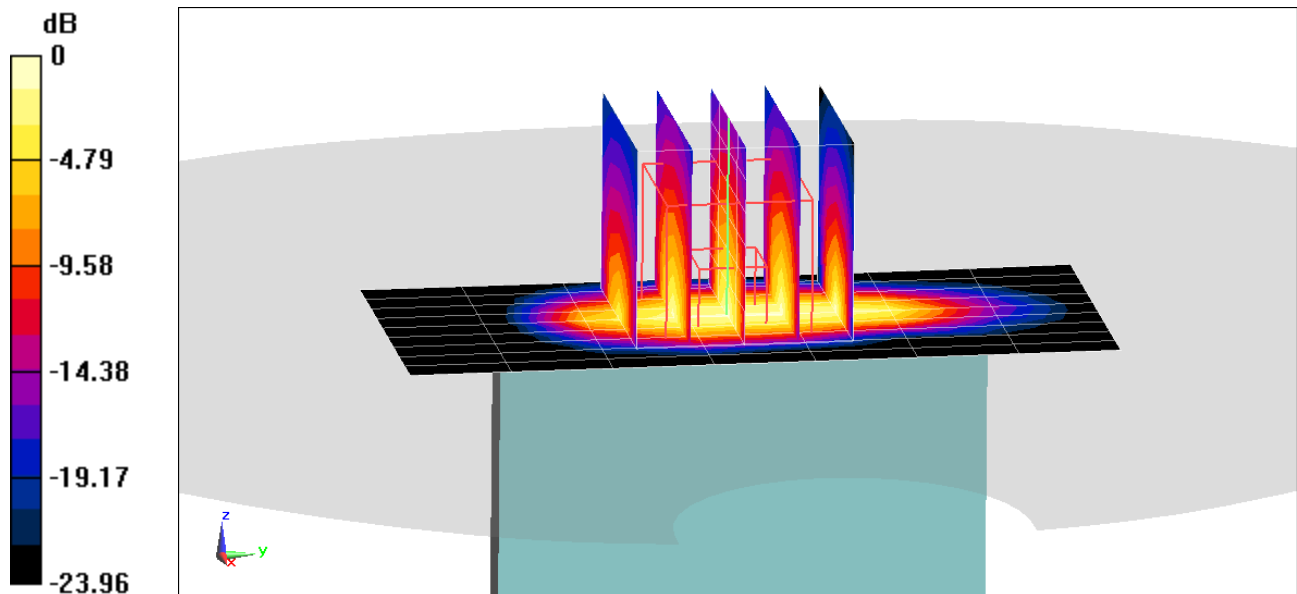

0 dB = 11.5 W/kg = 10.61 dBW/kg

# PCTEST ENGINEERING LABORATORY, INC.

**DUT: ZNFG710TM; Type: Portable Handset; Serial: 09670**

Communication System: UID 0, LTE Band 7; Frequency: 2560 MHz; Duty Cycle: 1:1

Medium: 2450 Body Medium parameters used (interpolated):

$f = 2560$  MHz;  $\sigma = 2.114$  S/m;  $\epsilon_r = 51.745$ ;  $\rho = 1000$  kg/m<sup>3</sup>

Phantom section: Flat Section; Space: 0.0 cm

Test Date: 04-16-2018; Ambient Temp: 22.6°C; Tissue Temp: 23.0°C

Probe: EX3DV4 - SN7410; ConvF(7.43, 7.43, 7.43); Calibrated: 7/17/2017;

Sensor-Surface: 1.4mm (Mechanical Surface Detection)

Electronics: DAE4 Sn1322; Calibrated: 7/13/2017

Phantom: SAM with CRP (Left); Type: SAM; Serial: 1715

Measurement SW: DASY52, Version 52.10; SEMCAD X Version 14.6.10 (7417)

**Mode: LTE Band 7, Phablet SAR, Back side, High.ch,**

**20 MHz Bandwidth, QPSK, 1 RB, 50 RB Offset**

**Area Scan (11x18x1):** Measurement grid: dx=12mm, dy=12mm

**Zoom Scan (7x7x7)/Cube 0:** Measurement grid: dx=5mm, dy=5mm, dz=5mm

Reference Value = 71.04 V/m; Power Drift = 0.02 dB

Peak SAR (extrapolated) = 29.1 W/kg

**SAR(10 g) = 2.5 W/kg**

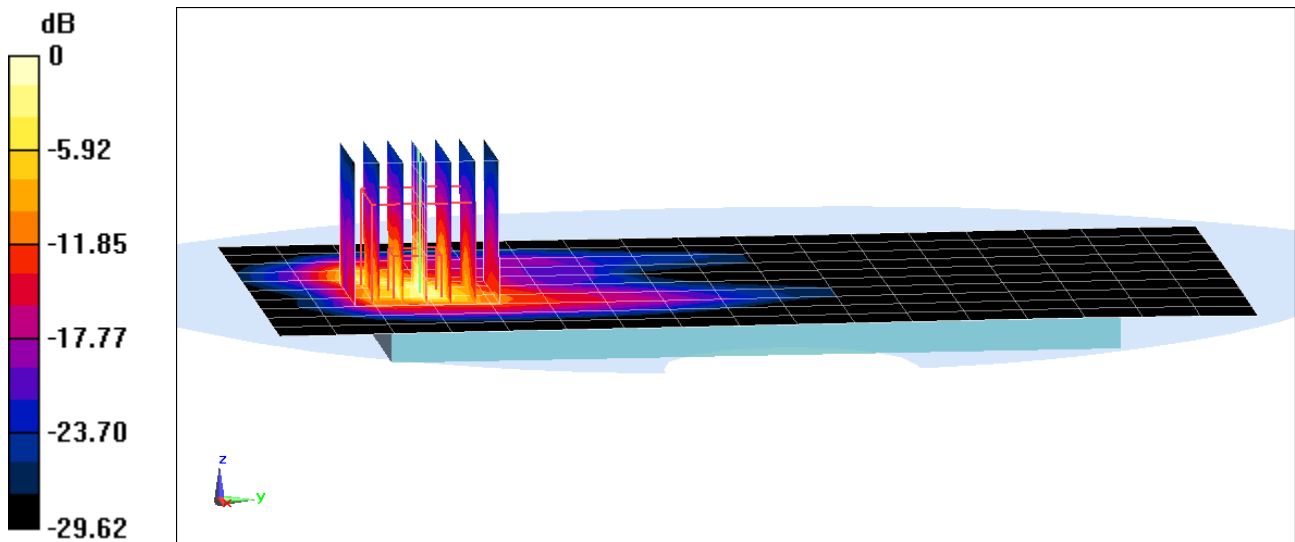

0 dB = 19.8 W/kg = 12.97 dBW/kg

# PCTEST ENGINEERING LABORATORY, INC.

**DUT: ZNFG710TM; Type: Portable Handset; Serial: 09662**

Communication System: UID 0, 802.11n 5.2-5.8 GHz Band; Frequency: 5500 MHz; Duty Cycle: 1:1

Medium: 5 GHz Body Medium parameters used:

$f = 5500 \text{ MHz}$ ;  $\sigma = 5.844 \text{ S/m}$ ;  $\epsilon_r = 47.219$ ;  $\rho = 1000 \text{ kg/m}^3$

Phantom section: Flat Section; Space: 0.0 cm

Test Date: 04-14-2018; Ambient Temp: 22.3°C; Tissue Temp: 21.8°C

Probe: EX3DV4 - SN7308; ConvF(4.23, 4.23, 4.23); Calibrated: 8/16/2017;

Sensor-Surface: 1.4mm (Mechanical Surface Detection)

Electronics: DAE4 Sn1334; Calibrated: 6/14/2017

Phantom: SAM with CRP v5.0 Front; Type: QD000P40CD; Serial: 1646

Measurement SW: DASY52, Version 52.10; SEMCAD X Version 14.6.10 (7417)

**Mode: IEEE 802.11n, U-NII-2C, 20 MHz Bandwidth,  
Phablet SAR, Ch 100, 13.0 Mbps, Back Side, MIMO**

**Area Scan (13x11x1):** Measurement grid: dx=10mm, dy=10mm

**Zoom Scan (8x8x7)/Cube 0:** Measurement grid: dx=4mm, dy=4mm, dz=1.4mm; Graded Ratio: 1.4

Reference Value = 3.816 V/m; Power Drift = 0.11 dB

Peak SAR (extrapolated) = 119 W/kg

**SAR(10 g) = 2.34 W/kg**

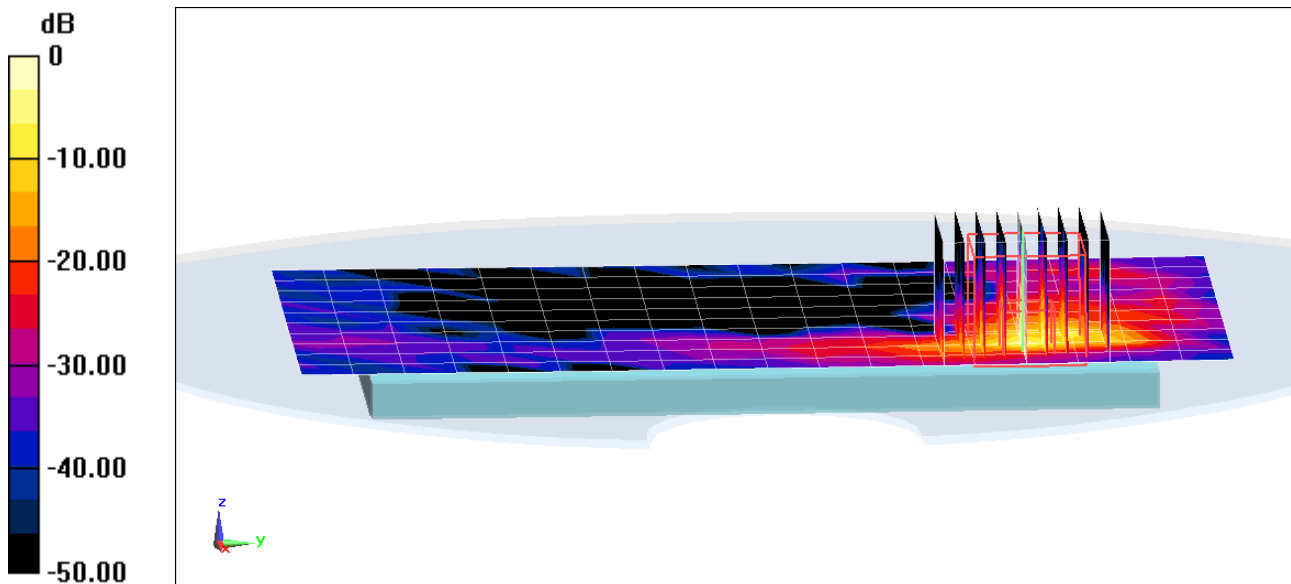

0 dB = 44.7 W/kg = 16.50 dBW/kg

## APPENDIX B: SYSTEM VERIFICATION

# PCTEST ENGINEERING LABORATORY, INC.

**DUT: Dipole 750 MHz; Type: D750V3; Serial: 1003**

Communication System: UID 0, CW; Frequency: 750 MHz; Duty Cycle: 1:1

Medium: 750 Head Medium parameters used (interpolated):

$f = 750 \text{ MHz}$ ;  $\sigma = 0.904 \text{ S/m}$ ;  $\epsilon_r = 41.09$ ;  $\rho = 1000 \text{ kg/m}^3$

Phantom section: Flat Section; Space: 1.5 cm

Test Date: 04-12-2018; Ambient Temp: 22.7°C; Tissue Temp: 21.7°C

Probe: EX3DV4 - SN3914; ConvF(10.18, 10.18, 10.18); Calibrated: 2/14/2018;

Sensor-Surface: 1.4mm (Mechanical Surface Detection)

Electronics: DAE4 Sn665; Calibrated: 2/15/2018

Phantom: Twin-SAM V5.0 left; Type: QD 000 P40 CD; Serial: 1692

Measurement SW: DASY52, Version 52.10;SEMCAD X Version 14.6.10 (7417)

## 750 MHz System Verification at 23.0 dBm (200 mW)

**Area Scan (7x15x1):** Measurement grid: dx=15mm, dy=15mm

**Zoom Scan (5x5x7)/Cube 0:** Measurement grid: dx=8mm, dy=8mm, dz=5mm

Peak SAR (extrapolated) = 2.57 W/kg

**SAR(1 g) = 1.72 W/kg**

Deviation(1 g) = 3.86%

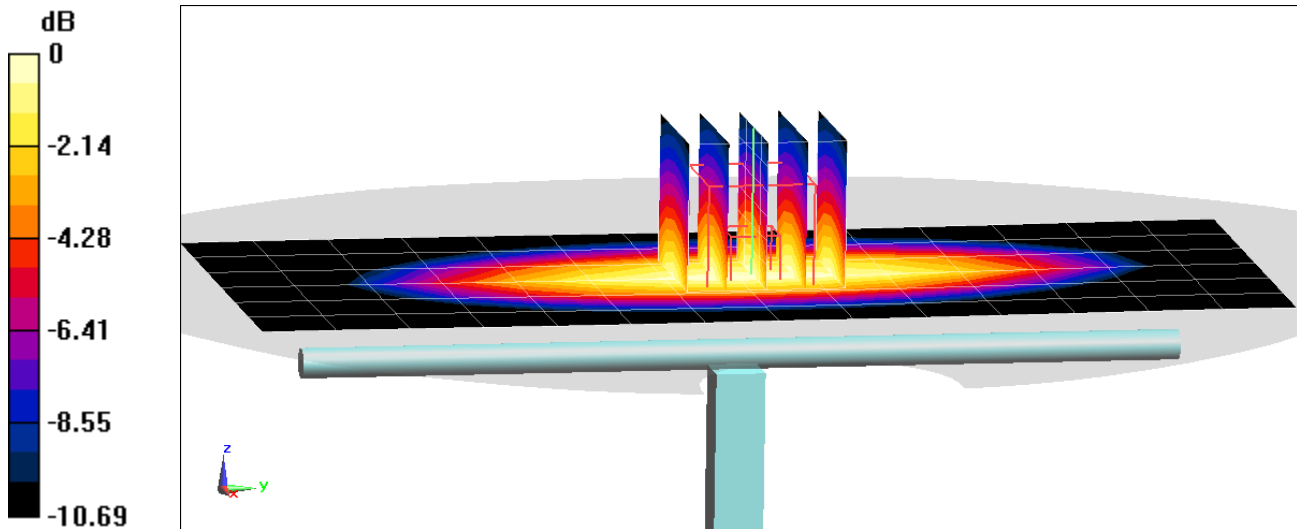

0 dB = 2.29 W/kg = 3.60 dBW/kg

# PCTEST ENGINEERING LABORATORY, INC.

**DUT: Dipole 835 MHz; Type: D835V2; Serial: 4d132**

Communication System: UID 0, CW; Frequency: 835 MHz; Duty Cycle: 1:1

Medium: 835 Head Medium parameters used:

$f = 835 \text{ MHz}$ ;  $\sigma = 0.918 \text{ S/m}$ ;  $\epsilon_r = 42.828$ ;  $\rho = 1000 \text{ kg/m}^3$

Phantom section: Flat Section; Space: 1.5 cm

Test Date: 04-09-2018; Ambient Temp: 21.5°C; Tissue Temp: 20.7°C

Probe: ES3DV3 - SN3213; ConvF(6.42, 6.42, 6.42); Calibrated: 2/13/2018;

Sensor-Surface: 3mm (Mechanical Surface Detection)

Electronics: DAE4 Sn1272; Calibrated: 2/9/2018

Phantom: SAM 5.0 front; Type: QD000P40CD; Serial: 1648

Measurement SW: DASY52, Version 52.10; SEMCAD X Version 14.6.10 (7417)

## 835 MHz System Verification at 23.0 dBm (200 mW)

**Area Scan (7x14x1):** Measurement grid: dx=15mm, dy=15mm

**Zoom Scan (5x5x7)/Cube 0:** Measurement grid: dx=8mm, dy=8mm, dz=5mm

Peak SAR (extrapolated) = 2.92 W/kg

**SAR(1 g) = 1.99 W/kg**

Deviation(1 g) = 6.30%

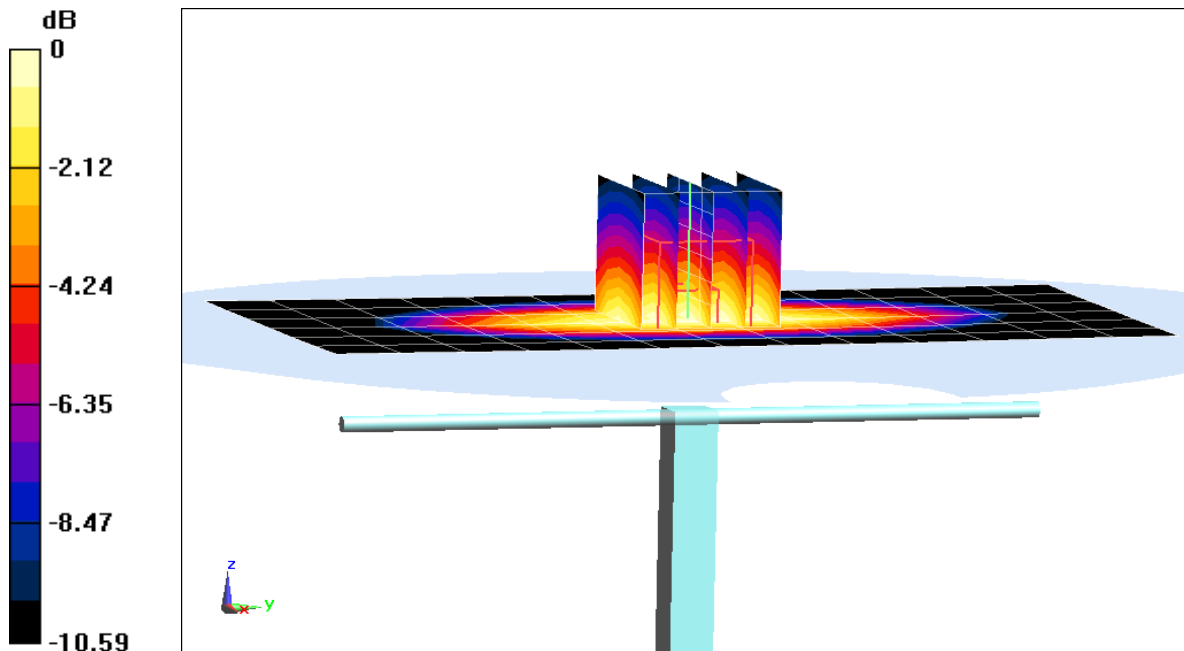

0 dB = 2.32 W/kg = 3.65 dBW/kg

# PCTEST ENGINEERING LABORATORY, INC.

**DUT: Dipole 1750 MHz; Type: D1750V2; Serial: 1148**

Communication System: UID 0, CW; Frequency: 1750 MHz; Duty Cycle: 1:1

Medium: 1750 Head Medium parameters used:

$f = 1750 \text{ MHz}$ ;  $\sigma = 1.403 \text{ S/m}$ ;  $\epsilon_r = 39.58$ ;  $\rho = 1000 \text{ kg/m}^3$

Phantom section: Flat Section; Space: 1.0 cm

Test Date: 04-07-2018; Ambient Temp: 20.3°C; Tissue Temp: 21.4°C

Probe: EX3DV4 - SN7410; ConvF(8.66, 8.66, 8.66); Calibrated: 7/17/2017;

Sensor-Surface: 1.4mm (Mechanical Surface Detection)

Electronics: DAE4 Sn1322; Calibrated: 7/13/2017

Phantom: SAM with CRP v5.0 (Right); Type: QD000P40CD; Serial: TP:1759

Measurement SW: DASY52, Version 52.10;SEMCAD X Version 14.6.10 (7417)

## 1750 MHz System Verification at 20.0 dBm (100 mW)

**Area Scan (7x9x1):** Measurement grid: dx=15mm, dy=15mm

**Zoom Scan (5x5x7)/Cube 0:** Measurement grid: dx=8mm, dy=8mm, dz=5mm

Peak SAR (extrapolated) = 6.84 W/kg

**SAR(1 g) = 3.72 W/kg**

Deviation(1 g) = 2.20%

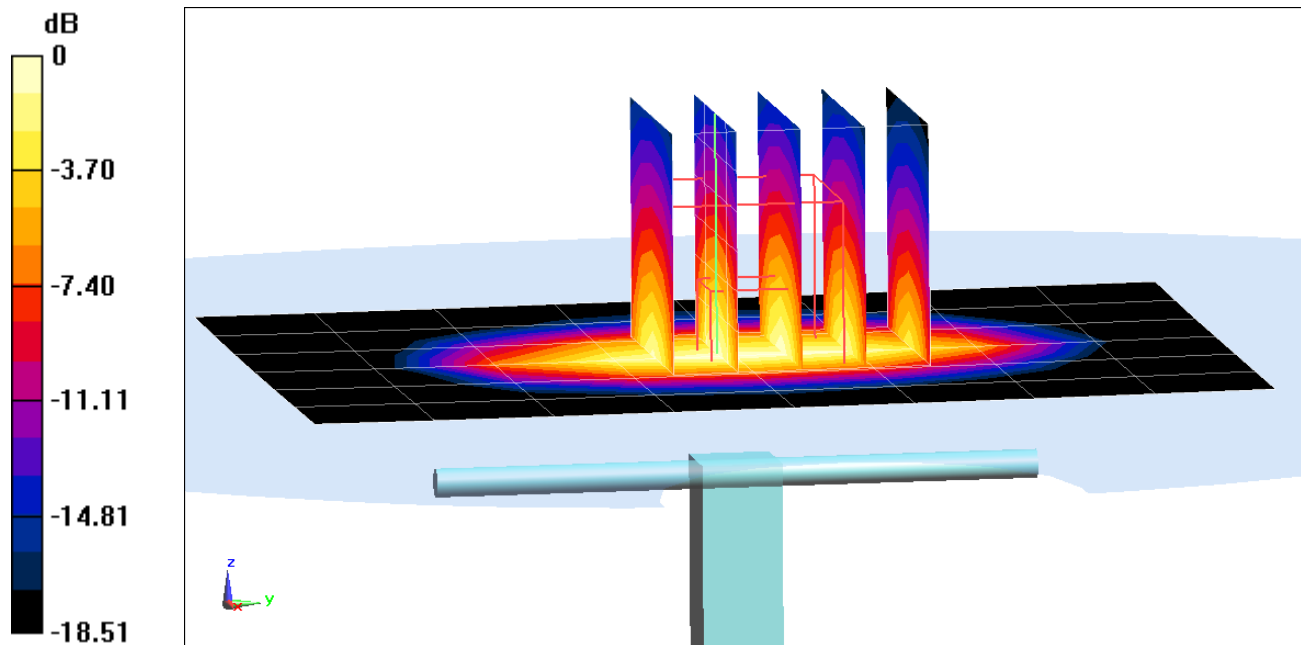

0 dB = 5.69 W/kg = 7.55 dBW/kg



# PCTEST ENGINEERING LABORATORY, INC.

**DUT: Dipole 1900 MHz; Type: D1900V2; Serial: 5d148**

Communication System: UID 0, CW; Frequency: 1900 MHz; Duty Cycle: 1:1  
Medium: 1900 Head Medium parameters used (interpolated):  
 $f = 1900 \text{ MHz}$ ;  $\sigma = 1.435 \text{ S/m}$ ;  $\epsilon_r = 38.081$ ;  $\rho = 1000 \text{ kg/m}^3$   
Phantom section: Flat Section; Space: 1.0 cm

Test Date: 04-13-2018; Ambient Temp: 21.9°C; Tissue Temp: 21.7°C

Probe: EX3DV4 - SN3914; ConvF(7.98, 7.98, 7.98); Calibrated: 2/14/2018;  
Sensor-Surface: 1.4mm (Mechanical Surface Detection)  
Electronics: DAE4 Sn665; Calibrated: 2/15/2018  
Phantom: Twin-SAM V5.0 left; Type: QD 000 P40 CD; Serial: 1692  
Measurement SW: DASY52, Version 52.10; SEMCAD X Version 14.6.10 (7417)

## 1900 MHz System Verification at 20.0 dBm (100 mW)

**Area Scan (7x11x1):** Measurement grid: dx=15mm, dy=15mm  
**Zoom Scan (5x5x7)/Cube 0:** Measurement grid: dx=8mm, dy=8mm, dz=5mm  
Peak SAR (extrapolated) = 8.17 W/kg  
**SAR(1 g) = 4.35 W/kg**  
Deviation(1 g) = 8.48%

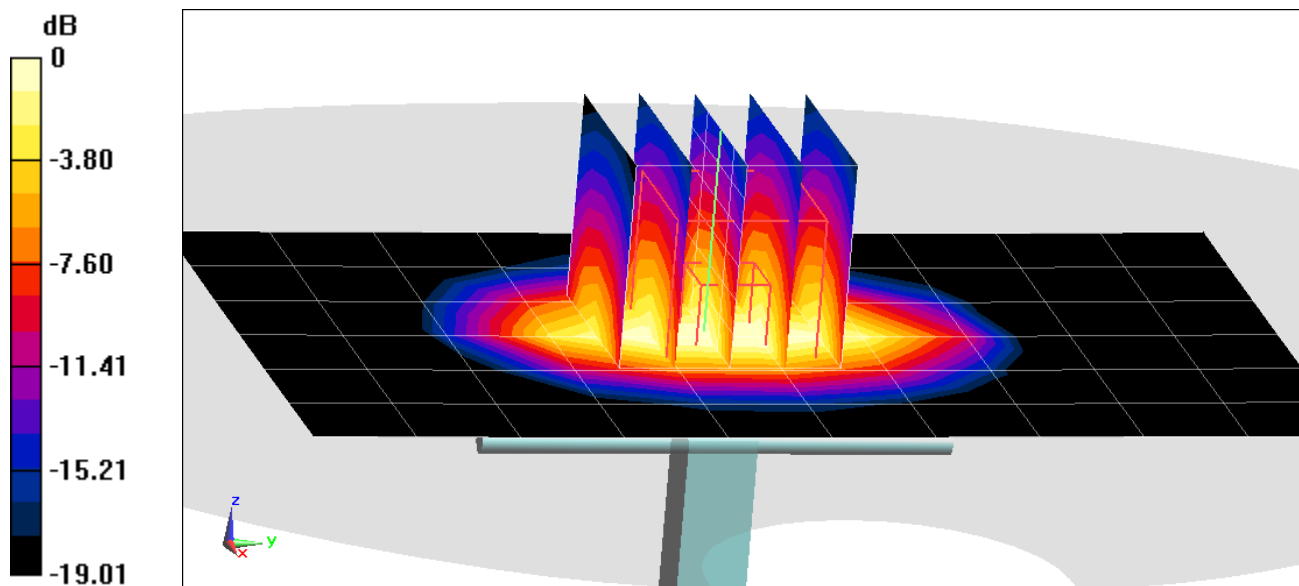

0 dB = 6.74 W/kg = 8.29 dBW/kg

# PCTEST ENGINEERING LABORATORY, INC.

**DUT: Dipole 2300 MHz; Type: D2300V2; Serial: 1073**

Communication System: UID 0, CW; Frequency: 2300 MHz; Duty Cycle: 1:1

Medium: 2300 Head Medium parameters used:

$f = 2300$  MHz;  $\sigma = 1.683$  S/m;  $\epsilon_r = 39.982$ ;  $\rho = 1000$  kg/m<sup>3</sup>

Phantom section: Flat Section; Space: 1.0 cm

Test Date: 04-11-2018; Ambient Temp: 22.1°C; Tissue Temp: 21.9°C

Probe: ES3DV3 - SN3332; ConvF(4.99, 4.99, 4.99); Calibrated: 8/14/2017;

Sensor-Surface: 3mm (Mechanical Surface Detection)

Electronics: DAE4 Sn1323; Calibrated: 8/9/2017

Phantom: SAM Front; Type: SAM; Serial: 1686

Measurement SW: DASY52, Version 52.10; SEMCAD X Version 14.6.10 (7417)

## 2300 MHz System Verification at 20.0 dBm (100 mW)

**Area Scan (8x9x1):** Measurement grid: dx=12mm, dy=12mm

**Zoom Scan (7x7x7)/Cube 0:** Measurement grid: dx=5mm, dy=5mm, dz=5mm

Peak SAR (extrapolated) = 9.86 W/kg

**SAR(1 g) = 4.95 W/kg**

Deviation(1 g) = 1.85%

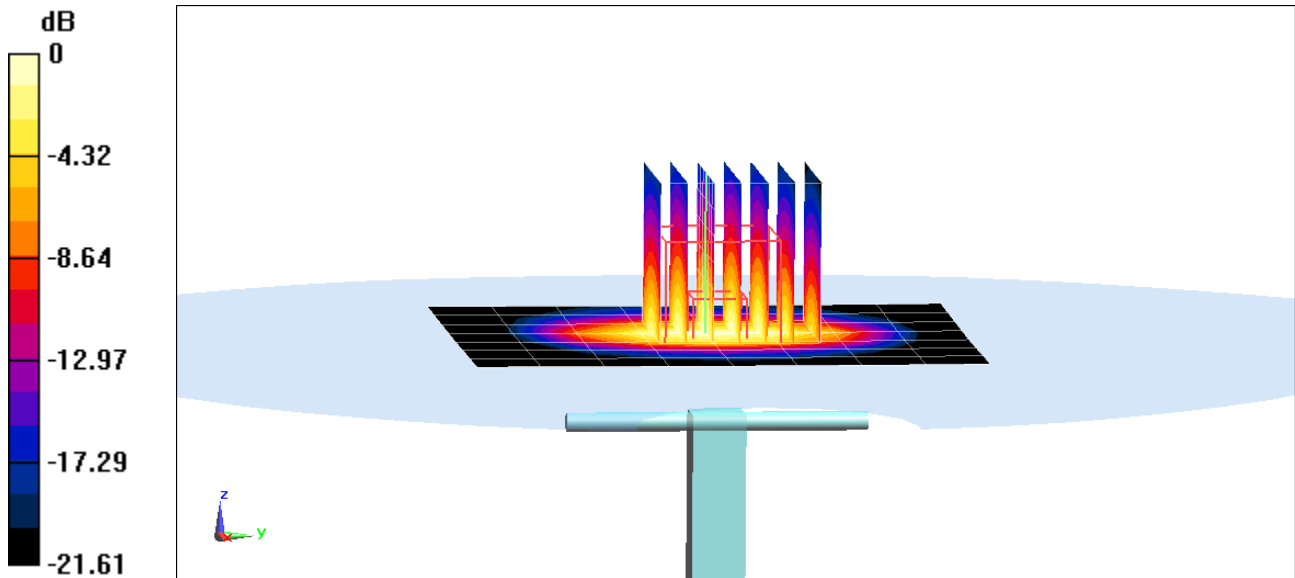

0 dB = 6.45 W/kg = 8.10 dBW/kg

# PCTEST ENGINEERING LABORATORY, INC.

**DUT: Dipole 2450 MHz; Type: D2450V2; Serial: 797**

Communication System: UID 0, CW; Frequency: 2450 MHz; Duty Cycle: 1:1

Medium: 2450 Head Medium parameters used:

$f = 2450$  MHz;  $\sigma = 1.834$  S/m;  $\epsilon_r = 39.087$ ;  $\rho = 1000$  kg/m<sup>3</sup>

Phantom section: Flat Section; Space: 1.0 cm

Test Date: 04-06-2018; Ambient Temp: 22.0°C; Tissue Temp: 21.7°C

Probe: ES3DV3 - SN3332; ConvF(4.68, 4.68, 4.68); Calibrated: 8/14/2017;

Sensor-Surface: 3mm (Mechanical Surface Detection)

Electronics: DAE4 Sn1323; Calibrated: 8/9/2017

Phantom: SAM Front; Type: SAM; Serial: 1686

Measurement SW: DASY52, Version 52.10;SEMCAD X Version 14.6.10 (7417)

## 2450 MHz System Verification at 20.0 dBm (100 mW)

**Area Scan (8x9x1):** Measurement grid: dx=12mm, dy=12mm

**Zoom Scan (7x7x7)/Cube 0:** Measurement grid: dx=5mm, dy=5mm, dz=5mm

Peak SAR (extrapolated) = 11.2 W/kg

**SAR(1 g) = 5.45 W/kg**

Deviation(1 g) = 3.42%

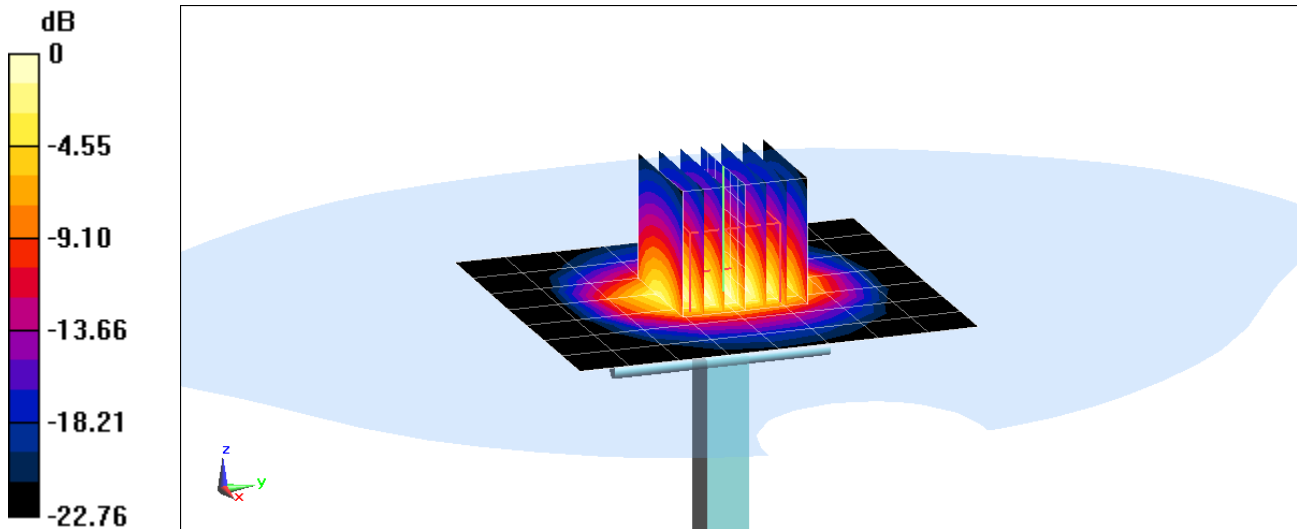

0 dB = 7.20 W/kg = 8.57 dBW/kg

# PCTEST ENGINEERING LABORATORY, INC.

**DUT: Dipole 2450 MHz; Type: D2450V2; Serial: 797**

Communication System: UID 0, CW; Frequency: 2450 MHz; Duty Cycle: 1:1  
Medium: 2450 Head Medium parameters used:

$f = 2450 \text{ MHz}$ ;  $\sigma = 1.847 \text{ S/m}$ ;  $\epsilon_r = 39.419$ ;  $\rho = 1000 \text{ kg/m}^3$   
Phantom section: Flat Section; Space: 1.0 cm

Test Date: 04-11-2018; Ambient Temp: 22.1°C; Tissue Temp: 21.9°C

Probe: ES3DV3 - SN3332; ConvF(4.68, 4.68, 4.68); Calibrated: 8/14/2017;  
Sensor-Surface: 3mm (Mechanical Surface Detection)  
Electronics: DAE4 Sn1323; Calibrated: 8/9/2017  
Phantom: SAM Front; Type: SAM; Serial: 1686

Measurement SW: DASY52, Version 52.10;SEMCAD X Version 14.6.10 (7417)

## 2450 MHz System Verification at 20.0 dBm (100 mW)

**Area Scan (8x9x1):** Measurement grid: dx=12mm, dy=12mm

**Zoom Scan (7x7x7)/Cube 0:** Measurement grid: dx=5mm, dy=5mm, dz=5mm

Peak SAR (extrapolated) = 10.6 W/kg

**SAR(1 g) = 5.13 W/kg**

Deviation(1 g) = -2.66%

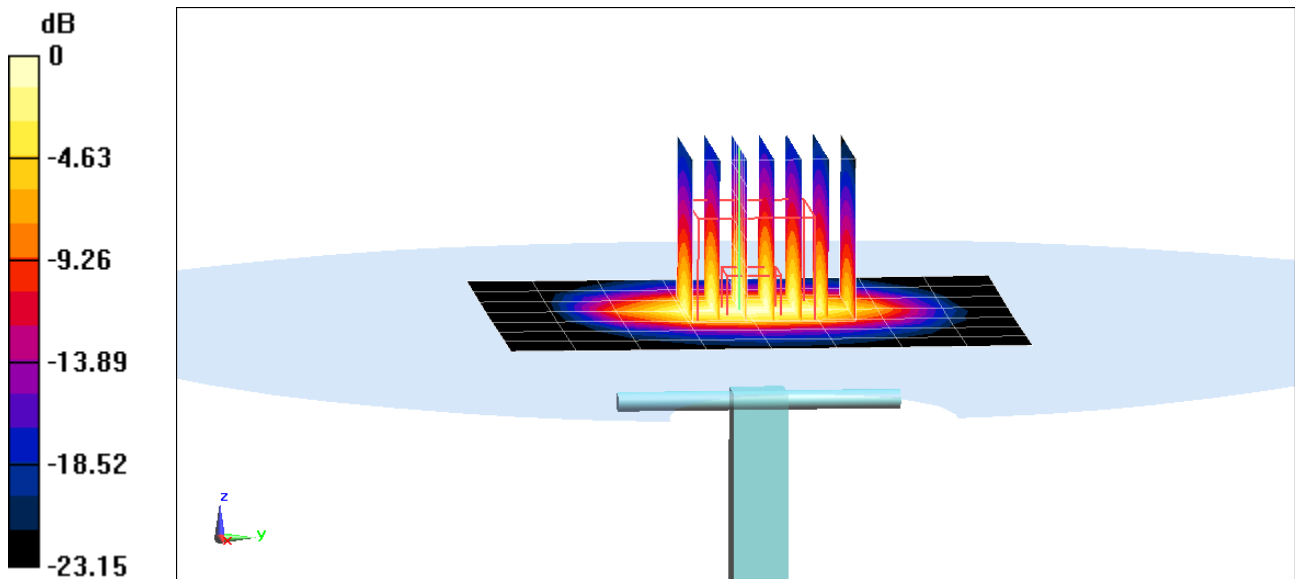

0 dB = 6.74 W/kg = 8.29 dBW/kg

# PCTEST ENGINEERING LABORATORY, INC.

**DUT: Dipole 2600 MHz; Type: D2600V2; Serial: 1126**

Communication System: UID 0, CW; Frequency: 2600 MHz; Duty Cycle: 1:1

Medium: 2450 Head Medium parameters used:

$f = 2600$  MHz;  $\sigma = 2.018$  S/m;  $\epsilon_r = 38.849$ ;  $\rho = 1000$  kg/m<sup>3</sup>

Phantom section: Flat Section; Space: 1.0 cm

Test Date: 04-11-2018; Ambient Temp: 22.1°C; Tissue Temp: 21.9°C

Probe: ES3DV3 - SN3332; ConvF(4.56, 4.56, 4.56); Calibrated: 8/14/2017;

Sensor-Surface: 3mm (Mechanical Surface Detection)

Electronics: DAE4 Sn1323; Calibrated: 8/9/2017

Phantom: SAM Front; Type: SAM; Serial: 1686

Measurement SW: DASY52, Version 52.10; SEMCAD X Version 14.6.10 (7417)

## 2600 MHz System Verification at 20.0 dBm (100 mW)

**Area Scan (8x9x1):** Measurement grid: dx=12mm, dy=12mm

**Zoom Scan (7x7x7)/Cube 0:** Measurement grid: dx=5mm, dy=5mm, dz=5mm

Peak SAR (extrapolated) = 12.7 W/kg

**SAR(1 g) = 5.76 W/kg**

Deviation(1 g) = 2.13%

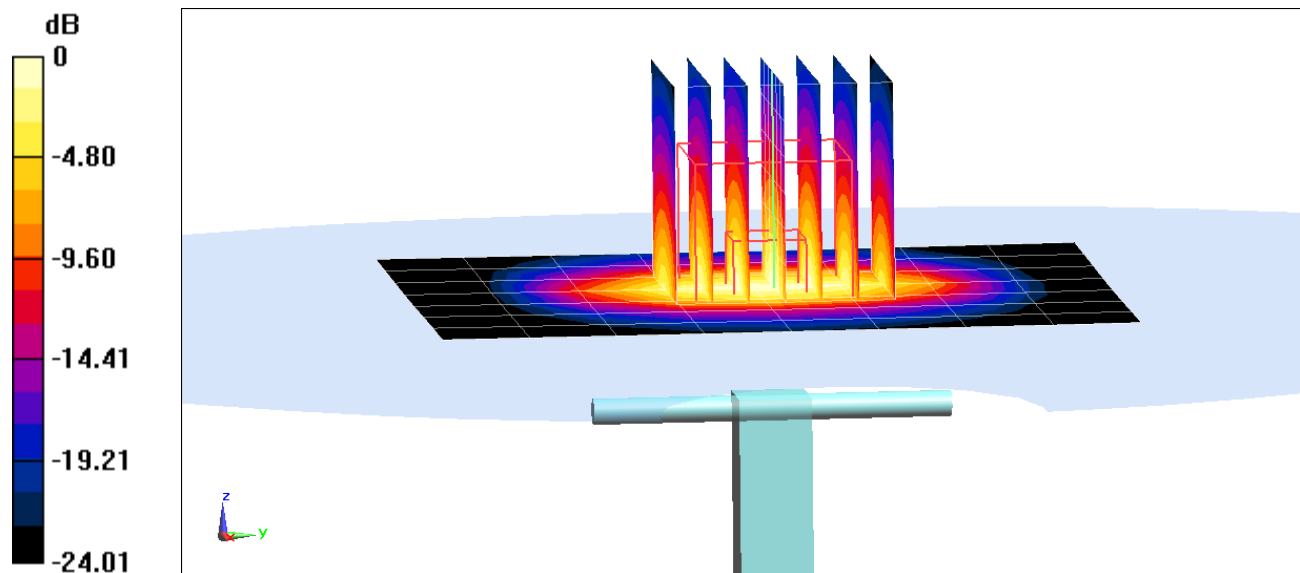

0 dB = 7.55 W/kg = 8.78 dBW/kg

# PCTEST ENGINEERING LABORATORY, INC.

**DUT: Dipole 5 GHz; Type: D5GHzV2; Serial: 1191**

Communication System: UID 0, CW; Frequency: 5250 MHz; Duty Cycle: 1:1  
Medium: 5GHz Head Medium parameters used (interpolated):  
 $f = 5250 \text{ MHz}$ ;  $\sigma = 4.614 \text{ S/m}$ ;  $\epsilon_r = 37.206$ ;  $\rho = 1000 \text{ kg/m}^3$   
Phantom section: Flat Section; Space: 1.0 cm

Test Date: 04-09-2018; Ambient Temp: 21.9°C; Tissue Temp: 21.6°C

Probe: EX3DV4 - SN3589; ConvF(4.69, 4.69, 4.69); Calibrated: 1/16/2018;  
Sensor-Surface: 1.4mm (Mechanical Surface Detection)

Electronics: DAE4 Sn1322; Calibrated: 7/13/2017

Phantom: SAM with CRP v5.0 (Right); Type: QD000P40CD; Serial: TP:1759  
Measurement SW: DASY52, Version 52.10; SEMCAD X Version 14.6.10 (7417)

## 5250 MHz System Verification at 17.0 dBm (50 mW)

**Area Scan (7x7x1):** Measurement grid: dx=10mm, dy=10mm

**Zoom Scan (8x8x7)/Cube 0:** Measurement grid: dx=4mm, dy=4mm, dz=1.4mm; Graded Ratio: 1.4

Peak SAR (extrapolated) = 15.1 W/kg

**SAR(1 g) = 3.68 W/kg**

Deviation(1 g) = -6.72%

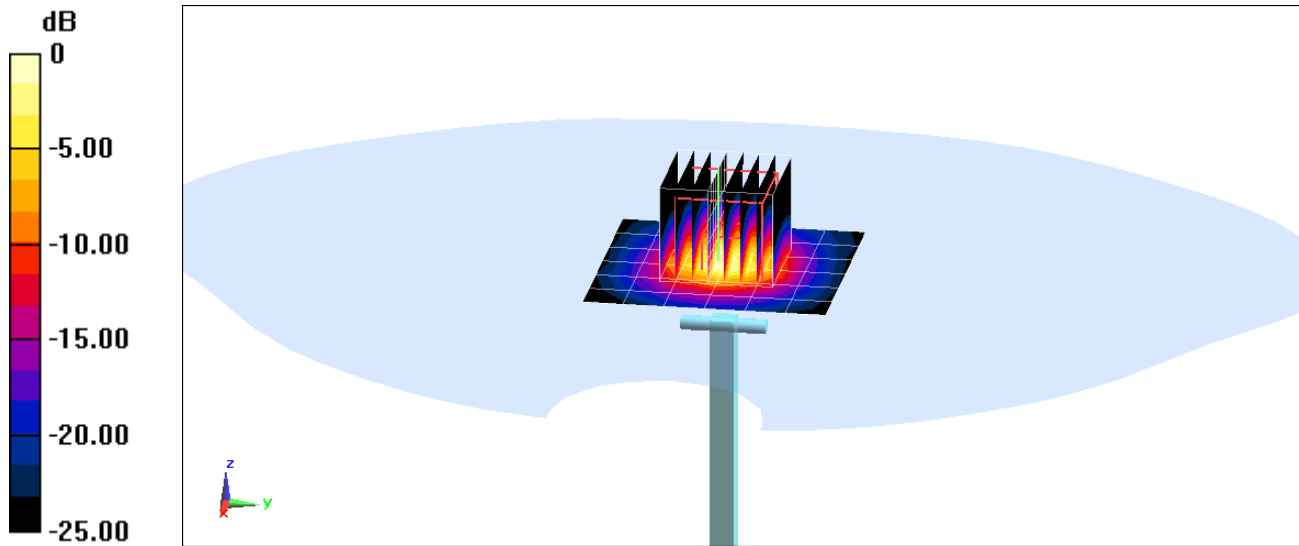

# PCTEST ENGINEERING LABORATORY, INC.

**DUT: Dipole 5 GHz; Type: D5GHzV2; Serial: 1191**

Communication System: UID 0, CW; Frequency: 5600 MHz; Duty Cycle: 1:1

Medium: 5GHz Head Medium parameters used:

$f = 5600 \text{ MHz}$ ;  $\sigma = 4.981 \text{ S/m}$ ;  $\epsilon_r = 36.743$ ;  $\rho = 1000 \text{ kg/m}^3$

Phantom section: Flat Section; Space: 1.0 cm

Test Date: 04-09-2018; Ambient Temp: 21.9°C; Tissue Temp: 21.6°C

Probe: EX3DV4 - SN3589; ConvF(4.17, 4.17, 4.17); Calibrated: 1/16/2018;

Sensor-Surface: 1.4mm (Mechanical Surface Detection)

Electronics: DAE4 Sn1322; Calibrated: 7/13/2017

Phantom: SAM with CRP v5.0 (Right); Type: QD000P40CD; Serial: TP:1759

Measurement SW: DASY52, Version 52.10; SEMCAD X Version 14.6.10 (7417)

## 5600 MHz System Verification at 17.0 dBm (50 mW)

**Area Scan (7x7x1):** Measurement grid: dx=10mm, dy=10mm

**Zoom Scan (8x8x7)/Cube 0:** Measurement grid: dx=4mm, dy=4mm, dz=1.4mm; Graded Ratio: 1.4

Peak SAR (extrapolated) = 16.8 W/kg

**SAR(1 g) = 3.91 W/kg**

Deviation(1 g) = -6.46%

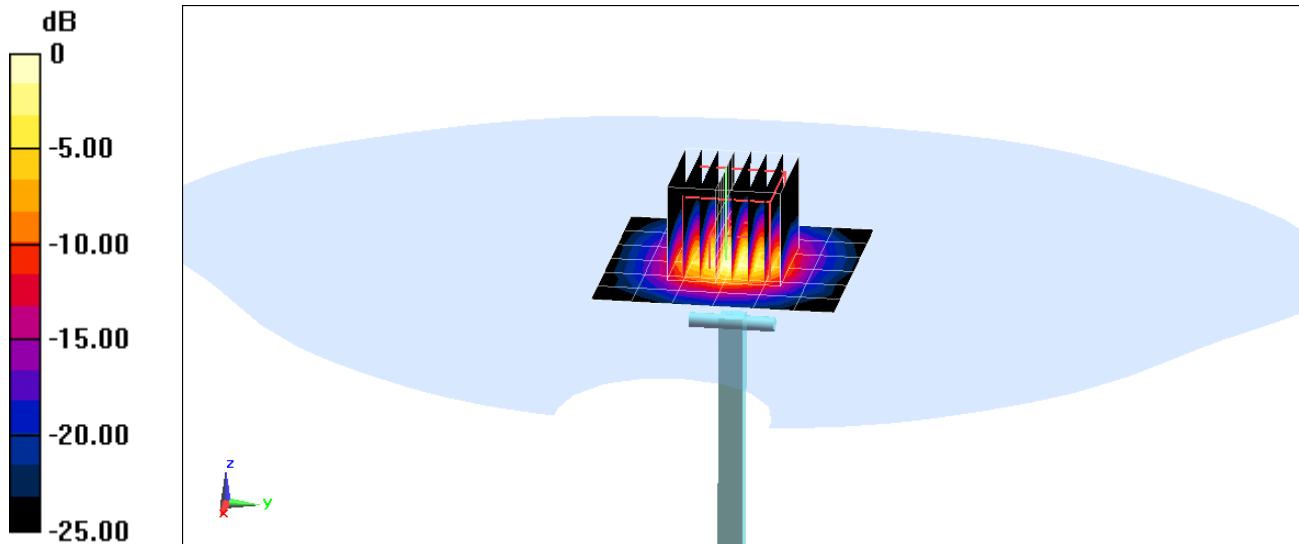

# PCTEST ENGINEERING LABORATORY, INC.

**DUT: Dipole 5 GHz; Type: D5GHzV2; Serial: 1191**

Communication System: UID 0, CW; Frequency: 5750 MHz; Duty Cycle: 1:1  
Medium: 5GHz Head Medium parameters used (interpolated):  
 $f = 5750 \text{ MHz}$ ;  $\sigma = 5.138 \text{ S/m}$ ;  $\epsilon_r = 36.474$ ;  $\rho = 1000 \text{ kg/m}^3$   
Phantom section: Flat Section; Space: 1.0cm

Test Date: 04-09-2018; Ambient Temp: 21.9°C; Tissue Temp: 21.6°C

Probe: EX3DV4 - SN3589; ConvF(4.42, 4.42, 4.42); Calibrated: 1/16/2018;  
Sensor-Surface: 1.4mm (Mechanical Surface Detection)  
Electronics: DAE4 Sn1322; Calibrated: 7/13/2017

Phantom: SAM with CRP v5.0 (Right); Type: QD000P40CD; Serial: TP:1759  
Measurement SW: DASY52, Version 52.10;SEMCAD X Version 14.6.10 (7417)

## 5750 MHz System Verification at 17.0 dBm (50 mW)

**Area Scan (7x7x1):** Measurement grid: dx=10mm, dy=10mm

**Zoom Scan (8x8x7)/Cube 0:** Measurement grid: dx=4mm, dy=4mm, dz=1.4mm; Graded Ratio: 1.4

Peak SAR (extrapolated) = 17.4 W/kg

**SAR(1 g) = 3.91 W/kg**

Deviation(1 g) = -1.14%

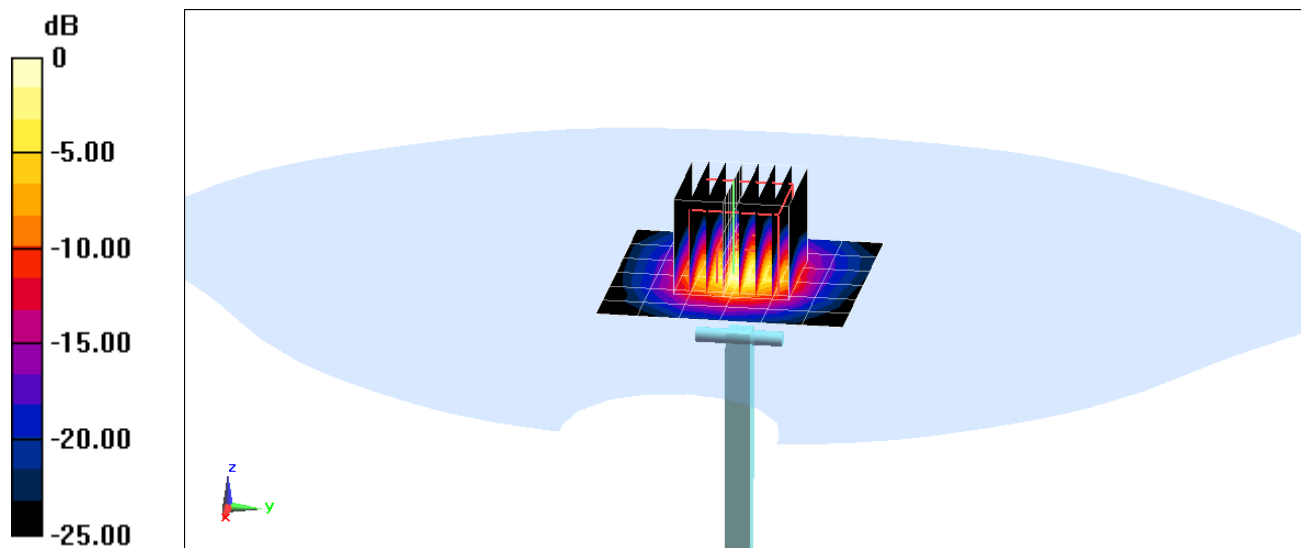

0 dB = 9.75 W/kg = 9.89 dBW/kg



# PCTEST ENGINEERING LABORATORY, INC.

**DUT: Dipole 750 MHz D750V3; Type: D750V3; Serial: 1054**

Communication System: UID 0, CW; Frequency: 750 MHz; Duty Cycle: 1:1

Medium: 750 Body Medium parameters used (interpolated):

$f = 750 \text{ MHz}$ ;  $\sigma = 0.988 \text{ S/m}$ ;  $\epsilon_r = 53.044$ ;  $\rho = 1000 \text{ kg/m}^3$

Phantom section: Flat Section; Space: 1.5 cm

Test Date: 04-03-2018; Ambient Temp: 22.0°C; Tissue Temp: 20.9°C

Probe: ES3DV3 - SN3287; ConvF(6.71, 6.71, 6.71); Calibrated: 9/18/2017;

Sensor-Surface: 3mm (Mechanical Surface Detection)

Electronics: DAE4 Sn1333; Calibrated: 6/21/2017

Phantom: Twin-SAM V5.0; Type: QD 000 P40 CD; Serial: 1692

Measurement SW: DASY52, Version 52.10; SEMCAD X Version 14.6.10 (7417)

## 750 MHz System Verification at 23.0 dBm (200 mW)

**Area Scan (7x15x1):** Measurement grid: dx=15mm, dy=15mm

**Zoom Scan (5x5x7)/Cube 0:** Measurement grid: dx=8mm, dy=8mm, dz=5mm

Peak SAR (extrapolated) = 2.59 W/kg

**SAR(1 g) = 1.75 W/kg**

Deviation(1 g) = 1.63%

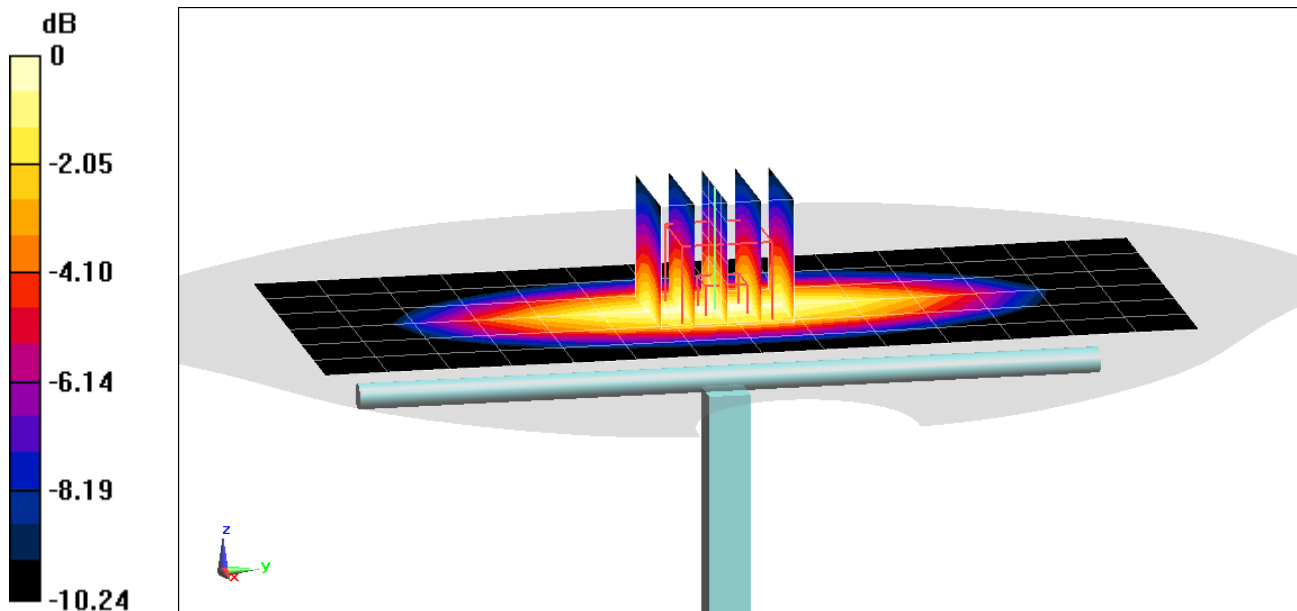

0 dB = 2.00 W/kg = 3.01 dBW/kg

# PCTEST ENGINEERING LABORATORY, INC.

**DUT: Dipole 750 MHz; Type: D750V3; Serial: 1003**

Communication System: UID 0, CW; Frequency: 750 MHz; Duty Cycle: 1:1  
Medium: 750 Body Medium parameters used (interpolated):  
 $f = 750 \text{ MHz}$ ;  $\sigma = 0.952 \text{ S/m}$ ;  $\epsilon_r = 54.075$ ;  $\rho = 1000 \text{ kg/m}^3$   
Phantom section: Flat Section; Space: 1.5 cm

Test Date: 04-09-2018; Ambient Temp: 22.6°C; Tissue Temp: 21.5°C

Probe: ES3DV3 - SN3287; ConvF(6.71, 6.71, 6.71); Calibrated: 9/18/2017;  
Sensor-Surface: 3mm (Mechanical Surface Detection)  
Electronics: DAE4 Sn1333; Calibrated: 6/21/2017  
Phantom: Twin-SAM V5.0; Type: QD 000 P40 CD; Serial: 1692  
Measurement SW: DASY52, Version 52.10; SEMCAD X Version 14.6.10 (7417)

## 750 MHz System Verification at 23.0 dBm (200 mW)

**Area Scan (7x15x1):** Measurement grid: dx=15mm, dy=15mm  
**Zoom Scan (5x5x7)/Cube 0:** Measurement grid: dx=8mm, dy=8mm, dz=5mm  
Peak SAR (extrapolated) = 2.60 W/kg  
**SAR(1 g) = 1.76 W/kg**  
Deviation(1 g) = 2.56%

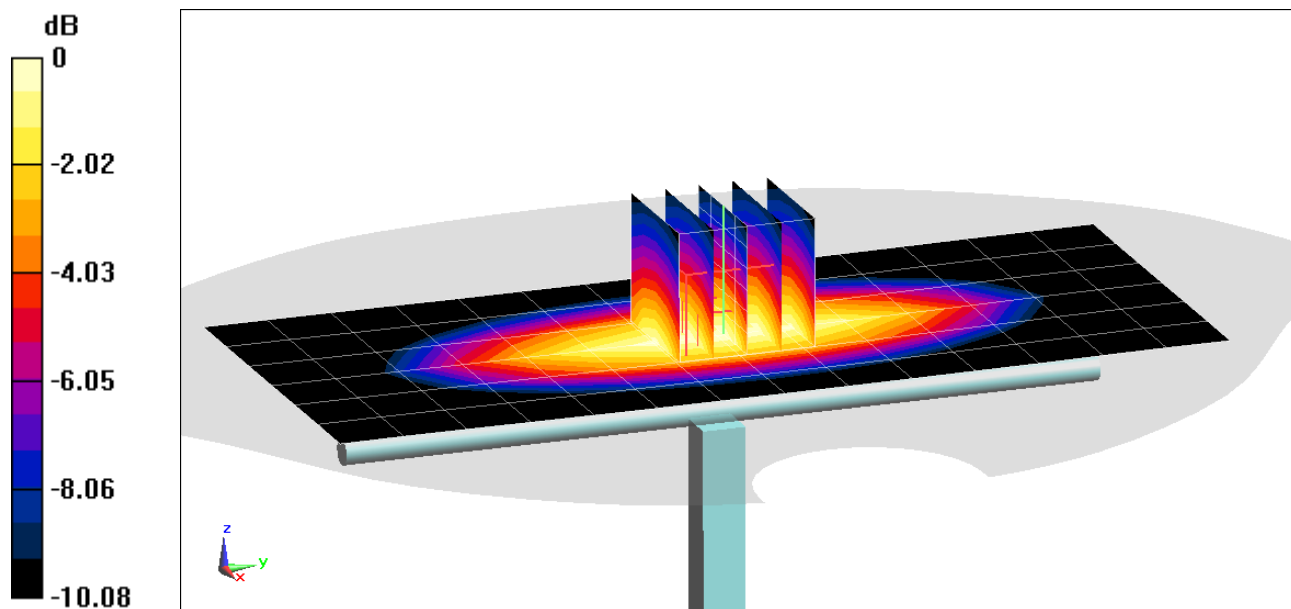

0 dB = 2.05 W/kg = 3.12 dBW/kg

# PCTEST ENGINEERING LABORATORY, INC.

**DUT: Dipole 835 MHz; Type: D835V2; Serial: 4d132**

Communication System: UID 0, CW; Frequency: 835 MHz; Duty Cycle: 1:1

Medium: 835 Body Medium parameters used:

$f = 835 \text{ MHz}$ ;  $\sigma = 0.975 \text{ S/m}$ ;  $\epsilon_r = 54.294$ ;  $\rho = 1000 \text{ kg/m}^3$

Phantom section: Flat Section; Space: 1.5 cm

Test Date: 04-06-2018; Ambient Temp: 24.2°C; Tissue Temp: 22.0°C

Probe: ES3DV3 - SN3213; ConvF(6.2, 6.2, 6.2); Calibrated: 2/13/2018;

Sensor-Surface: 3mm (Mechanical Surface Detection)

Electronics: DAE4 Sn1272; Calibrated: 2/9/2018

Phantom: SAM V5.0 Right; Type: QD000P40CD; Serial: 1647

Measurement SW: DASY52, Version 52.10; SEMCAD X Version 14.6.10 (7417)

## 835 MHz System Verification at 23.0 dBm (200 mW)

**Area Scan (7x14x1):** Measurement grid: dx=15mm, dy=15mm

**Zoom Scan (5x5x7)/Cube 0:** Measurement grid: dx=8mm, dy=8mm, dz=5mm

Peak SAR (extrapolated) = 2.88 W/kg

**SAR(1 g) = 1.96 W/kg**

Deviation(1 g) = 0.93%

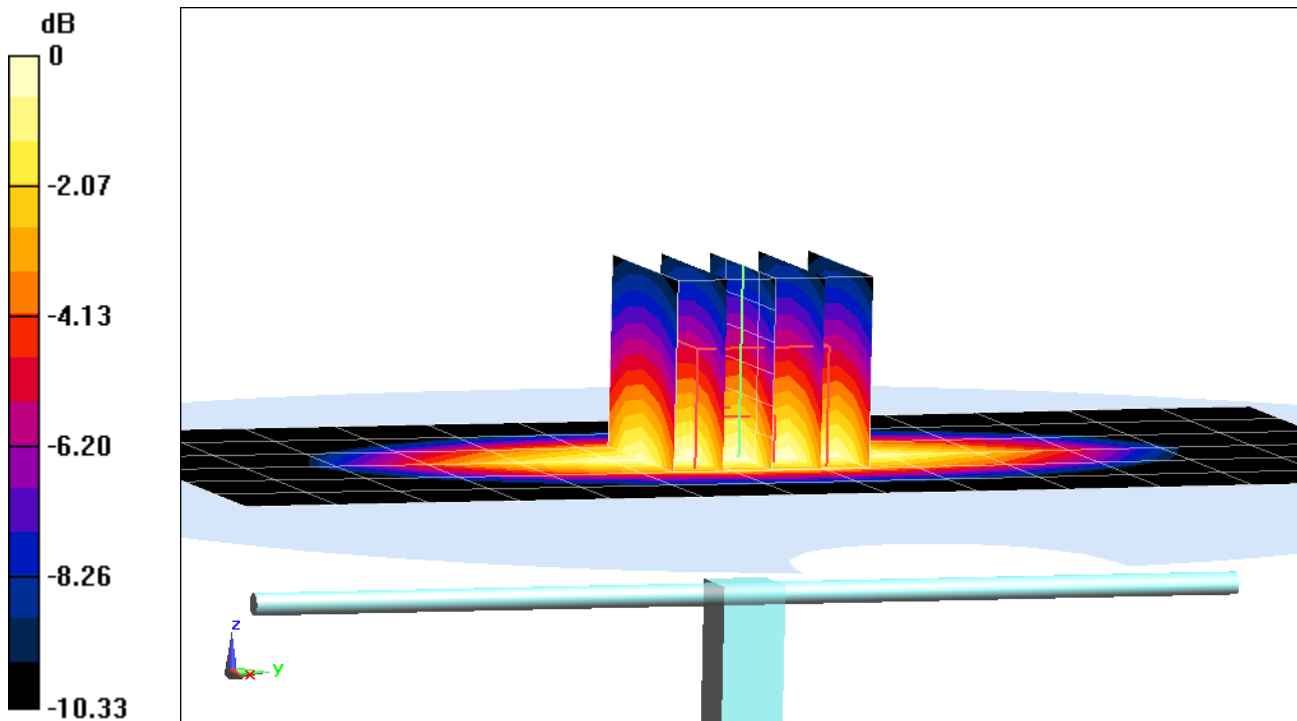

0 dB = 2.28 W/kg = 3.58 dBW/kg

# PCTEST ENGINEERING LABORATORY, INC.

**DUT: Dipole 1750 MHz; Type: D1750V2; Serial: 1148**

Communication System: UID 0, CW; Frequency: 1750 MHz; Duty Cycle: 1:1  
Medium: 1750 Body Medium parameters used:  
 $f = 1750 \text{ MHz}$ ;  $\sigma = 1.499 \text{ S/m}$ ;  $\epsilon_r = 51.867$ ;  $\rho = 1000 \text{ kg/m}^3$   
Phantom section: Flat Section; Space: 1.0 cm

Test Date: 04-05-2018; Ambient Temp: 22.6°C; Tissue Temp: 21.2°C

Probe: ES3DV3 - SN3287; ConvF(5.19, 5.19, 5.19); Calibrated: 9/18/2017;  
Sensor-Surface: 3mm (Mechanical Surface Detection)  
Electronics: DAE4 Sn1333; Calibrated: 6/21/2017  
Phantom: Twin-SAM V4.0; Type: QD 000 P40 CC; Serial: 1167  
Measurement SW: DASY52, Version 52.10; SEMCAD X Version 14.6.10 (7417)

## 1750 MHz System Verification at 20.0 dBm (100 mW)

**Area Scan (7x9x1):** Measurement grid: dx=15mm, dy=15mm  
**Zoom Scan (6x6x7)/Cube 0:** Measurement grid: dx=8mm, dy=8mm, dz=5mm  
Peak SAR (extrapolated) = 6.93 W/kg  
**SAR(1 g) = 3.93 W/kg; SAR(10 g) = 2.1 W/kg**  
Deviation(1 g) = 6.22%; Deviation(10 g) = 6.06%

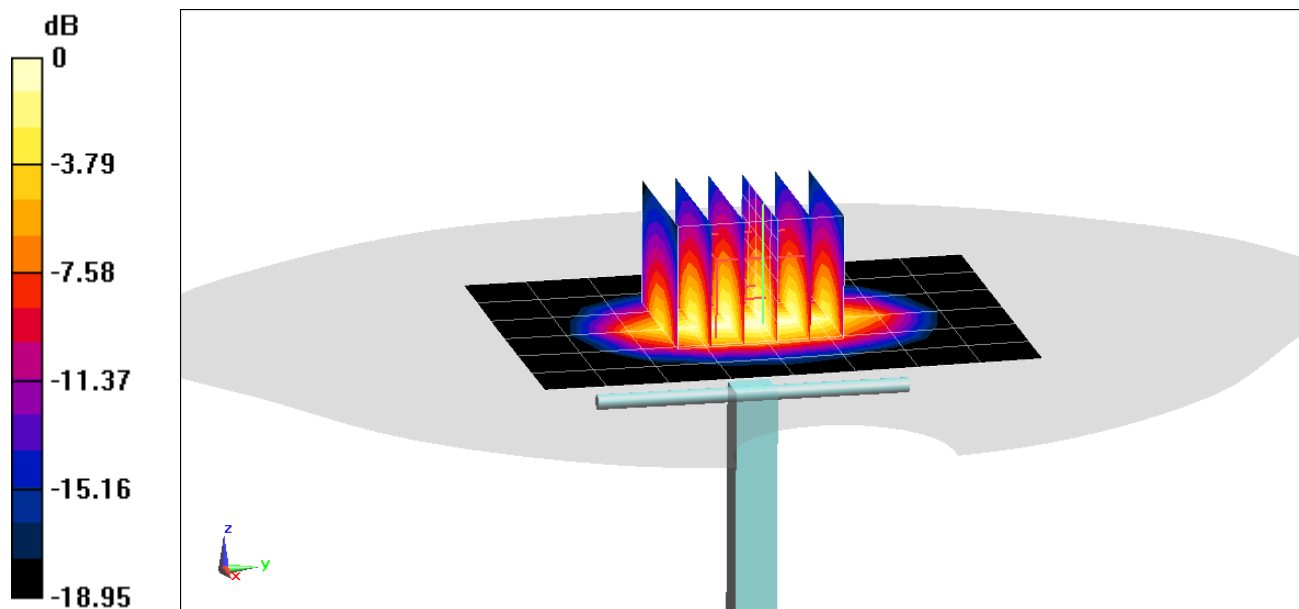

0 dB = 4.67 W/kg = 6.69 dBW/kg

# PCTEST ENGINEERING LABORATORY, INC.

**DUT: Dipole 1750 MHz; Type: D1750V2; Serial: 1148**

Communication System: UID 0, CW; Frequency: 1750 MHz; Duty Cycle: 1:1

Medium: 1750 Body Medium parameters used:

$f = 1750$  MHz;  $\sigma = 1.513$  S/m;  $\epsilon_r = 51.512$ ;  $\rho = 1000$  kg/m<sup>3</sup>

Phantom section: Flat Section; Space: 1.0 cm

Test Date: 04-12-2018; Ambient Temp: 23.0°C; Tissue Temp: 20.8°C

Probe: ES3DV3 - SN3287; ConvF(5.19, 5.19, 5.19); Calibrated: 9/18/2017;

Sensor-Surface: 3mm (Mechanical Surface Detection)

Electronics: DAE4 Sn1333; Calibrated: 6/21/2017

Phantom: Twin-SAM V4.0; Type: QD 000 P40 CC; Serial: 1167

Measurement SW: DASY52, Version 52.10; SEMCAD X Version 14.6.10 (7417)

## 1750 MHz System Verification at 20.0 dBm (100 mW)

**Area Scan (7x9x1):** Measurement grid: dx=15mm, dy=15mm

**Zoom Scan (5x5x7)/Cube 0:** Measurement grid: dx=8mm, dy=8mm, dz=5mm

Peak SAR (extrapolated) = 6.94 W/kg

**SAR(1 g) = 3.91 W/kg; SAR(10 g) = 2.07 W/kg**

Deviation(1 g) = 5.68%; Deviation(10 g) = 4.55%

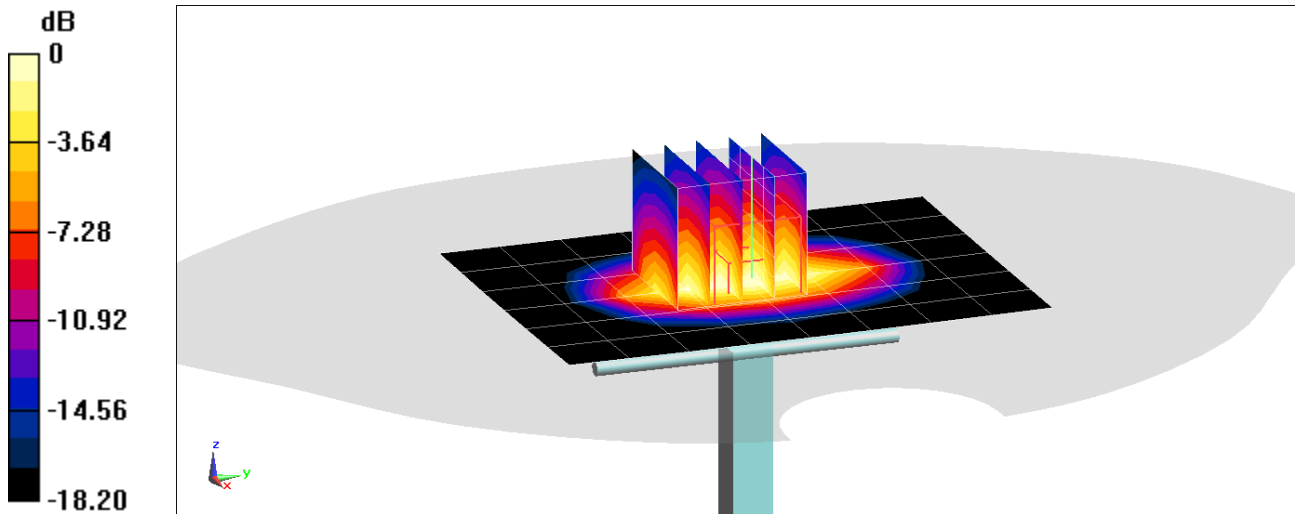

0 dB = 4.62 W/kg = 6.65 dBW/kg

# PCTEST ENGINEERING LABORATORY, INC.

**DUT: Dipole 1900 MHz; Type: D1900V2; Serial: 5d148**

Communication System: UID 0, CW; Frequency: 1900 MHz; Duty Cycle: 1:1  
Medium: 1900 Body Medium parameters used (interpolated):  
 $f = 1900$  MHz;  $\sigma = 1.576$  S/m;  $\epsilon_r = 53.728$ ;  $\rho = 1000$  kg/m<sup>3</sup>  
Phantom section: Flat Section; Space: 1.0 cm

Test Date: 04-05-2018; Ambient Temp: 21.9°C; Tissue Temp: 21.7°C

Probe: EX3DV4 - SN3914; ConvF(7.62, 7.62, 7.62); Calibrated: 2/14/2018;  
Sensor-Surface: 1.4mm (Mechanical Surface Detection)  
Electronics: DAE4 Sn665; Calibrated: 2/15/2018

Phantom: Twin-SAM V5.0 Right; Type: QD 000 P40 CD; Serial: 1800  
Measurement SW: DASY52, Version 52.10; SEMCAD X Version 14.6.10 (7417)

## 1900 MHz System Verification at 20.0 dBm (100 mW)

**Area Scan (7x11x1):** Measurement grid: dx=15mm, dy=15mm

**Zoom Scan (5x5x7)/Cube 0:** Measurement grid: dx=8mm, dy=8mm, dz=5mm

Peak SAR (extrapolated) = 7.67 W/kg

**SAR(1 g) = 4.18 W/kg; SAR(10 g) = 2.16 W/kg**

Deviation(1 g) = 5.56%; Deviation(10 g) = 3.35%

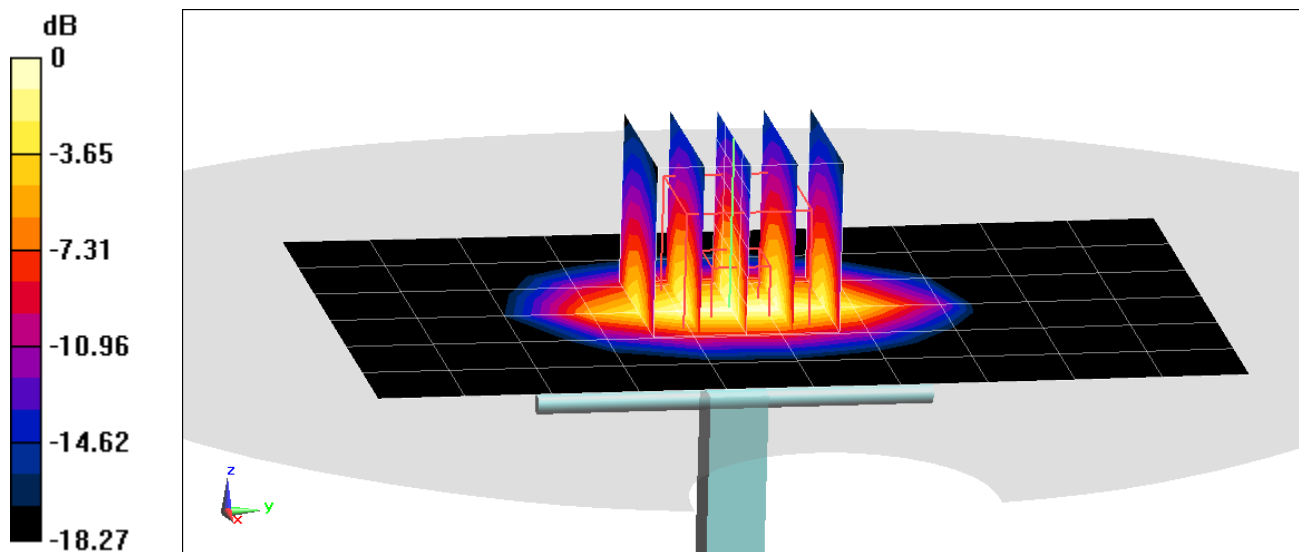

0 dB = 6.47 W/kg = 8.11 dBW/kg

# PCTEST ENGINEERING LABORATORY, INC.

**DUT: Dipole 1900 MHz; Type: D1900V2; Serial: 5d148**

Communication System: UID 0, CW; Frequency: 1900 MHz; Duty Cycle: 1:1  
Medium: 1900 Body Medium parameters used (interpolated):  
 $f = 1900 \text{ MHz}$ ;  $\sigma = 1.565 \text{ S/m}$ ;  $\epsilon_r = 53.852$ ;  $\rho = 1000 \text{ kg/m}^3$   
Phantom section: Flat Section; Space: 1.0 cm

Test Date: 04-15-2018; Ambient Temp: 22.5°C; Tissue Temp: 22.4°C

Probe: EX3DV4 - SN3914; ConvF(7.62, 7.62, 7.62); Calibrated: 2/14/2018;  
Sensor-Surface: 1.4mm (Mechanical Surface Detection)  
Electronics: DAE4 Sn665; Calibrated: 2/15/2018

Phantom: Twin-SAM V5.0 Right; Type: QD 000 P40 CD; Serial: 1800  
Measurement SW: DASY52, Version 52.10; SEMCAD X Version 14.6.10 (7417)

## 1900 MHz System Verification at 20.0 dBm (100 mW)

**Area Scan (7x11x1):** Measurement grid: dx=15mm, dy=15mm

**Zoom Scan (5x5x7)/Cube 0:** Measurement grid: dx=8mm, dy=8mm, dz=5mm

Peak SAR (extrapolated) = 7.55 W/kg

**SAR(1 g) = 4.14 W/kg**

Deviation(1 g) = 4.55%

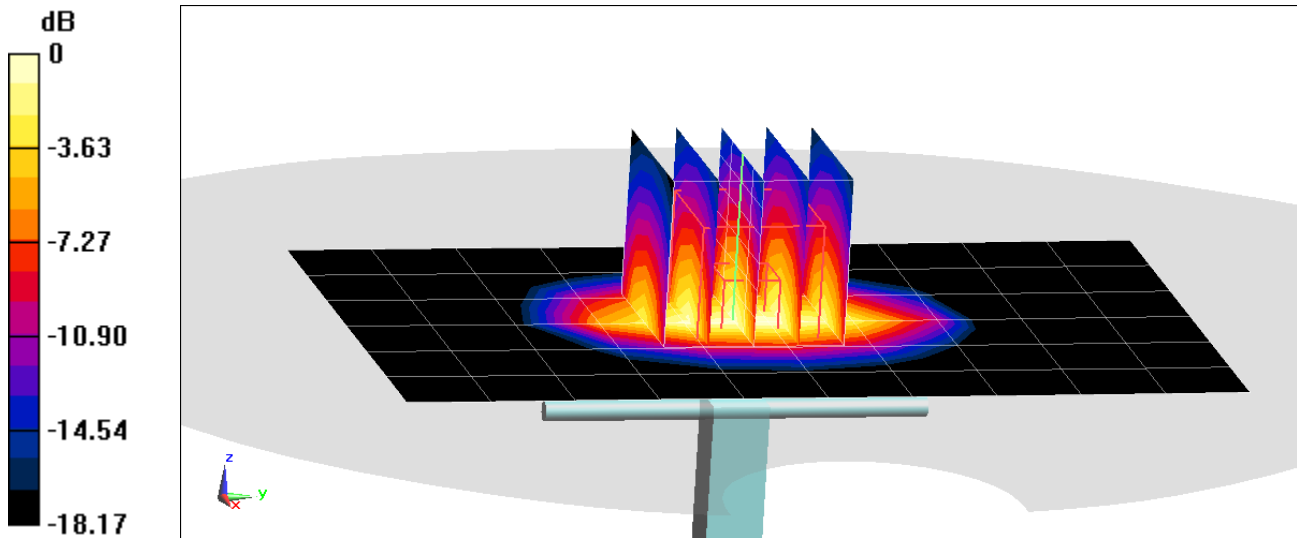

0 dB = 6.37 W/kg = 8.04 dBW/kg

# PCTEST ENGINEERING LABORATORY, INC.

**DUT: Dipole 2300 MHz; Type: D2300V2; Serial: 1073**

Communication System: UID 0, CW; Frequency: 2300 MHz; Duty Cycle: 1:1

Medium: 2300 Body Medium parameters used:

$f = 2300$  MHz;  $\sigma = 1.876$  S/m;  $\epsilon_r = 51.612$ ;  $\rho = 1000$  kg/m<sup>3</sup>

Phantom section: Flat Section; Space: 1.0 cm

Test Date: 04-15-2018; Ambient Temp: 22.0°C; Tissue Temp: 20.9°C

Probe: ES3DV3 - SN3319; ConvF(4.63, 4.63, 4.63); Calibrated: 3/13/2018;

Sensor-Surface: 3mm (Mechanical Surface Detection)

Electronics: DAE4 Sn1368; Calibrated: 3/7/2018

Phantom: Right Twin-SAM V5.0; Type: QD 000 P40 CD; Serial: 1797

Measurement SW: DASY52, Version 52.10; SEMCAD X Version 14.6.10 (7417)

## 2300 MHz System Verification at 20.0 dBm (100 mW)

**Area Scan (8x9x1):** Measurement grid: dx=12mm, dy=12mm

**Zoom Scan (7x7x7)/Cube 0:** Measurement grid: dx=5mm, dy=5mm, dz=5mm

Peak SAR (extrapolated) = 9.98 W/kg

**SAR(1 g) = 5.03 W/kg**

Deviation(1 g) = 4.57%

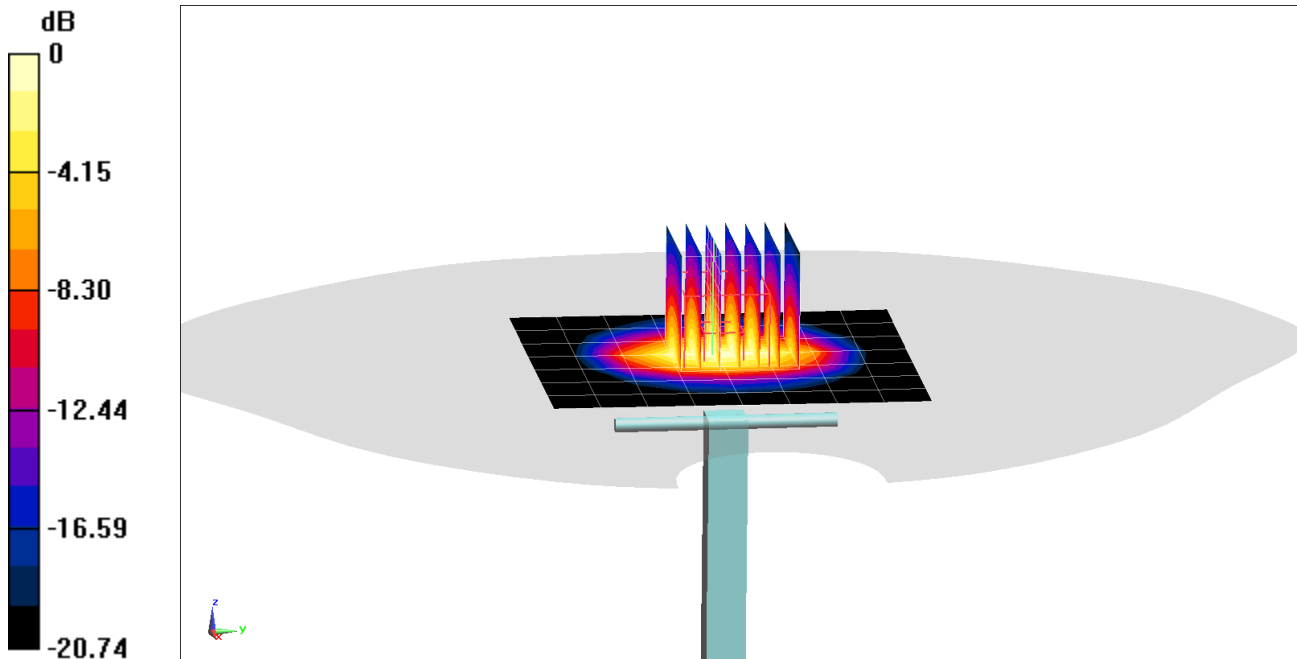

0 dB = 6.50 W/kg = 8.13 dBW/kg



# PCTEST ENGINEERING LABORATORY, INC.

**DUT: Dipole 2450 MHz; Type: D2450V2; Serial: 797**

Communication System: UID 0, CW; Frequency: 2450 MHz; Duty Cycle: 1:1

Medium: 2450 Body Medium parameters used:

$f = 2450 \text{ MHz}$ ;  $\sigma = 2.038 \text{ S/m}$ ;  $\epsilon_r = 50.739$ ;  $\rho = 1000 \text{ kg/m}^3$

Phantom section: Flat Section; Space: 1.0 cm

Test Date: 04-09-2018; Ambient Temp: 23.4°C; Tissue Temp: 22.0°C

Probe: ES3DV3 - SN3319; ConvF(4.51, 4.51, 4.51); Calibrated: 3/13/2018;

Sensor-Surface: 3mm (Mechanical Surface Detection)

Electronics: DAE4 Sn1368; Calibrated: 3/7/2018

Phantom: Right Twin-SAM V5.0; Type: QD 000 P40 CD; Serial: 1797

Measurement SW: DASY52, Version 52.10; SEMCAD X Version 14.6.10 (7417)

## 2450 MHz System Verification at 20.0 dBm (100 mW)

**Area Scan (8x9x1):** Measurement grid: dx=12mm, dy=12mm

**Zoom Scan (7x7x7)/Cube 0:** Measurement grid: dx=5mm, dy=5mm, dz=5mm

Peak SAR (extrapolated) = 10.8 W/kg

**SAR(1 g) = 5.15 W/kg**

Deviation(1 g) = 0.78%

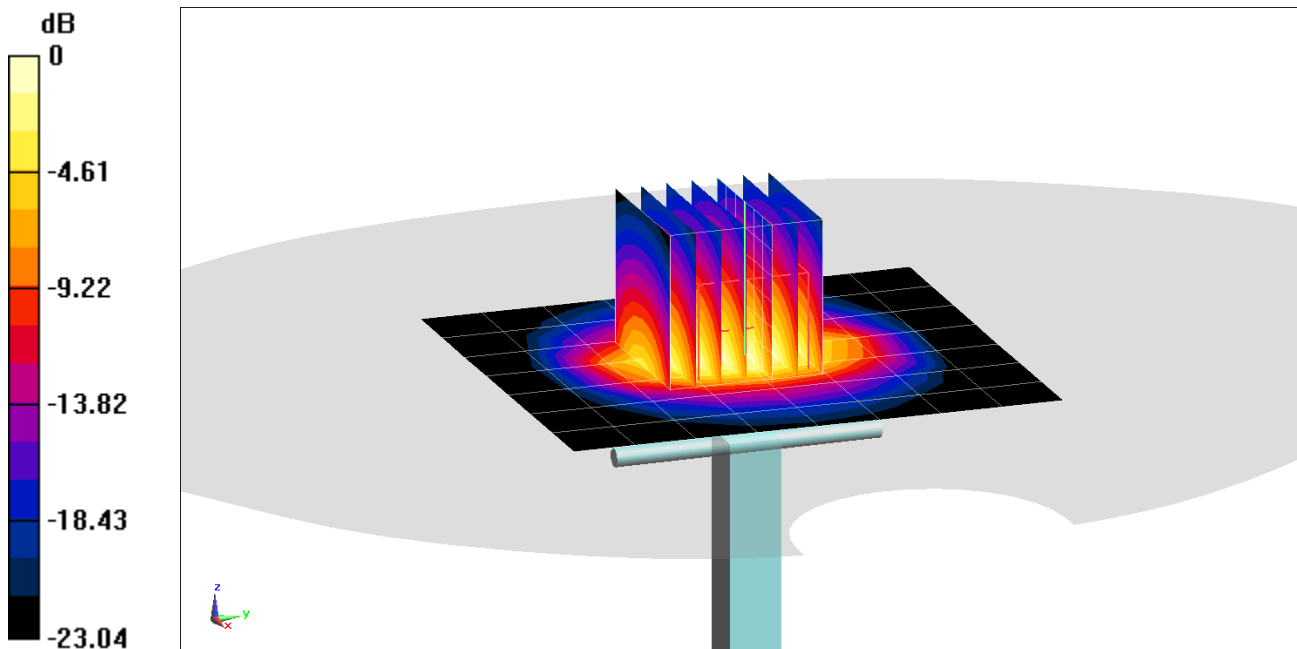

0 dB = 6.75 W/kg = 8.29 dBW/kg

# PCTEST ENGINEERING LABORATORY, INC.

**DUT: Dipole 2450 MHz; Type: D2450V2; Serial: 797**

Communication System: UID 0, CW; Frequency: 2450 MHz; Duty Cycle: 1:1

Medium: 2450 Body Medium parameters used:

$f = 2450$  MHz;  $\sigma = 2.025$  S/m;  $\epsilon_r = 50.788$ ;  $\rho = 1000$  kg/m<sup>3</sup>

Phantom section: Flat Section; Space: 1.0 cm

Test Date: 04-12-2018; Ambient Temp: 24.0°C; Tissue Temp: 22.6°C

Probe: ES3DV3 - SN3319; ConvF(4.51, 4.51, 4.51); Calibrated: 3/13/2018;

Sensor-Surface: 3mm (Mechanical Surface Detection)

Electronics: DAE4 Sn1368; Calibrated: 3/7/2018

Phantom: Right Twin-SAM V5.0; Type: QD 000 P40 CD; Serial: 1797

Measurement SW: DASY52, Version 52.10; SEMCAD X Version 14.6.10 (7417)

## 2450 MHz System Verification at 20.0 dBm (100 mW)

**Area Scan (8x9x1):** Measurement grid: dx=12mm, dy=12mm

**Zoom Scan (7x7x7)/Cube 0:** Measurement grid: dx=5mm, dy=5mm, dz=5mm

Peak SAR (extrapolated) = 10.4 W/kg

**SAR(1 g) = 5 W/kg**

Deviation(1 g) = -2.15%

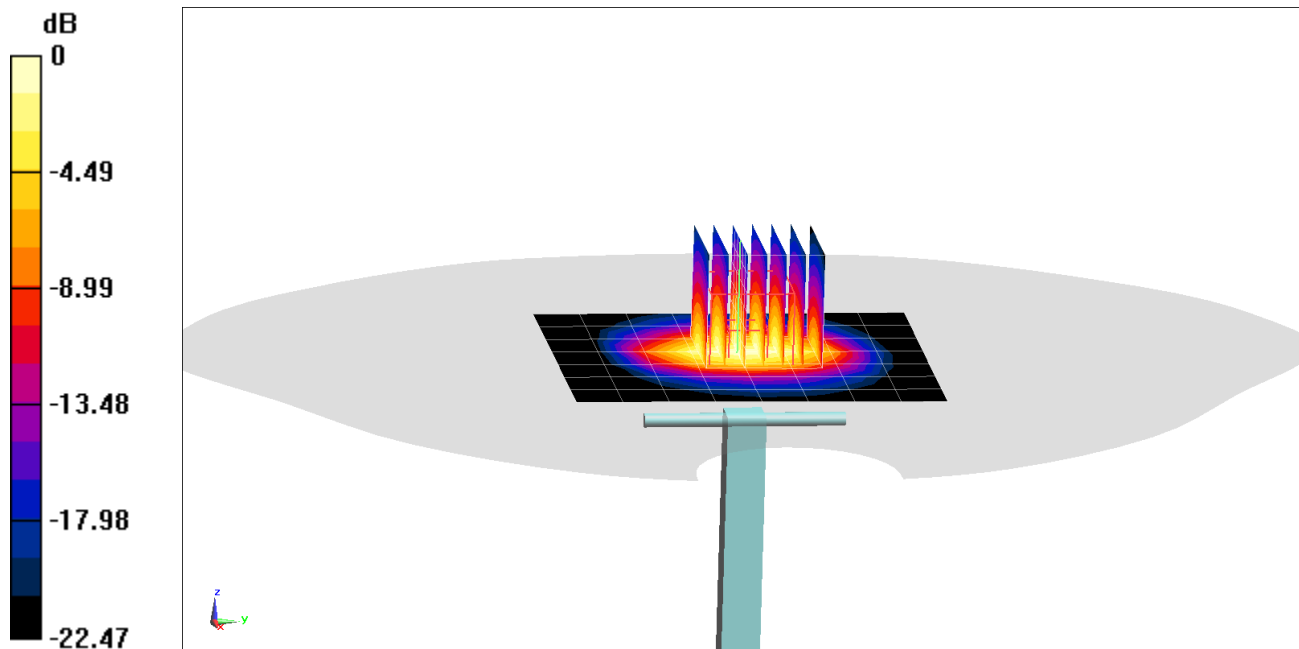

0 dB = 6.56 W/kg = 8.17 dBW/kg

# PCTEST ENGINEERING LABORATORY, INC.

**DUT: Dipole 2450 MHz; Type: D2450V2; Serial: 797**

Communication System: UID 0, CW; Frequency: 2450 MHz; Duty Cycle: 1:1

Medium: 2450 Body Medium parameters used:

$f = 2450$  MHz;  $\sigma = 1.964$  S/m;  $\epsilon_r = 52.143$ ;  $\rho = 1000$  kg/m<sup>3</sup>

Phantom section: Flat Section; Space: 1.0 cm

Test Date: 04-16-2018; Ambient Temp: 22.6°C; Tissue Temp: 23.0°C

Probe: EX3DV4 - SN7410; ConvF(7.69, 7.69, 7.69); Calibrated: 7/17/2017;

Sensor-Surface: 1.4mm (Mechanical Surface Detection)

Electronics: DAE4 Sn1322; Calibrated: 7/13/2017

Phantom: SAM with CRP (Left); Type: SAM; Serial: 1715

Measurement SW: DASY52, Version 52.10;SEMCAD X Version 14.6.10 (7417)

## 2450 MHz System Verification at 20.0 dBm (100 mW)

**Area Scan (8x9x1):** Measurement grid: dx=12mm, dy=12mm

**Zoom Scan (7x7x7)/Cube 0:** Measurement grid: dx=5mm, dy=5mm, dz=5mm

Peak SAR (extrapolated) = 10.5 W/kg

**SAR(1 g) = 5.02 W/kg; SAR(10 g) = 2.29 W/kg**

Deviation(1 g) = -1.76%; Deviation(10 g) = -5.37%

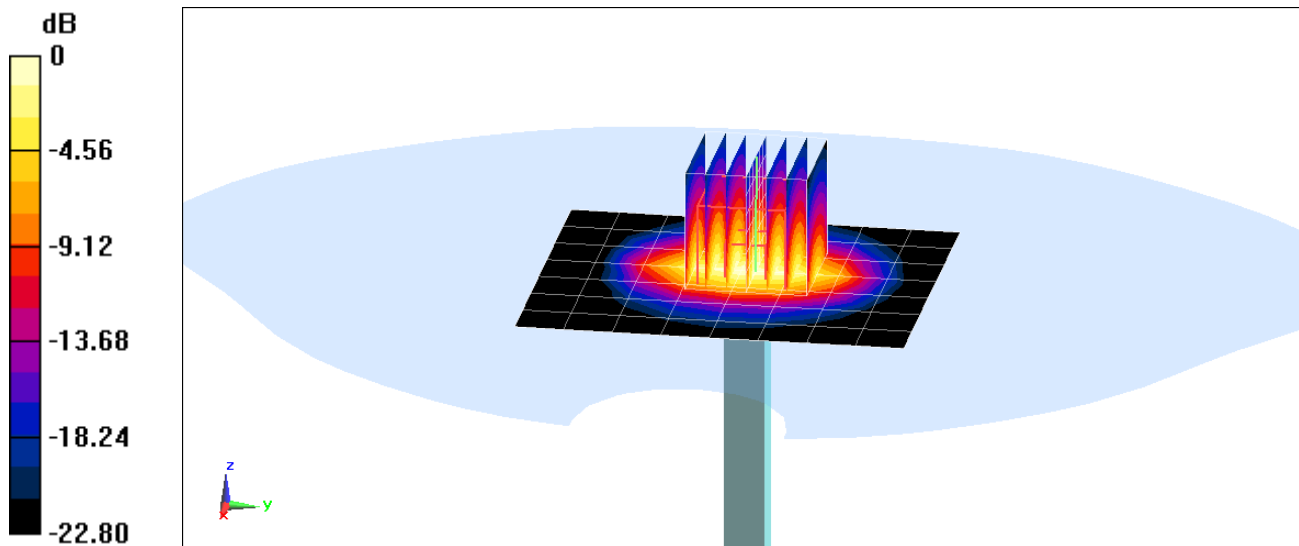

0 dB = 8.43 W/kg = 9.26 dBW/kg

# PCTEST ENGINEERING LABORATORY, INC.

**DUT: Dipole 2600 MHz; Type: D2600V2; Serial: 1126**

Communication System: UID 0, CW; Frequency: 2600 MHz; Duty Cycle: 1:1  
Medium: 2450 Body Medium parameters used:  
 $f = 2600 \text{ MHz}$ ;  $\sigma = 2.218 \text{ S/m}$ ;  $\epsilon_r = 50.276$ ;  $\rho = 1000 \text{ kg/m}^3$   
Phantom section: Flat Section; Space: 1.0 cm

Test Date: 04-09-2018; Ambient Temp: 23.4°C; Tissue Temp: 22.0°C

Probe: ES3DV3 - SN3319; ConvF(4.33, 4.33, 4.33); Calibrated: 3/13/2018;  
Sensor-Surface: 3mm (Mechanical Surface Detection)  
Electronics: DAE4 Sn1368; Calibrated: 3/7/2018

Phantom: Right Twin-SAM V5.0; Type: QD 000 P40 CD; Serial: 1797  
Measurement SW: DASY52, Version 52.10; SEMCAD X Version 14.6.10 (7417)

## 2600 MHz System Verification at 20.0 dBm (100 mW)

**Area Scan (8x9x1):** Measurement grid: dx=12mm, dy=12mm

**Zoom Scan (7x7x7)/Cube 0:** Measurement grid: dx=5mm, dy=5mm, dz=5mm

Peak SAR (extrapolated) = 12.4 W/kg

**SAR(1 g) = 5.56 W/kg**

Deviation(1 g) = 2.39%

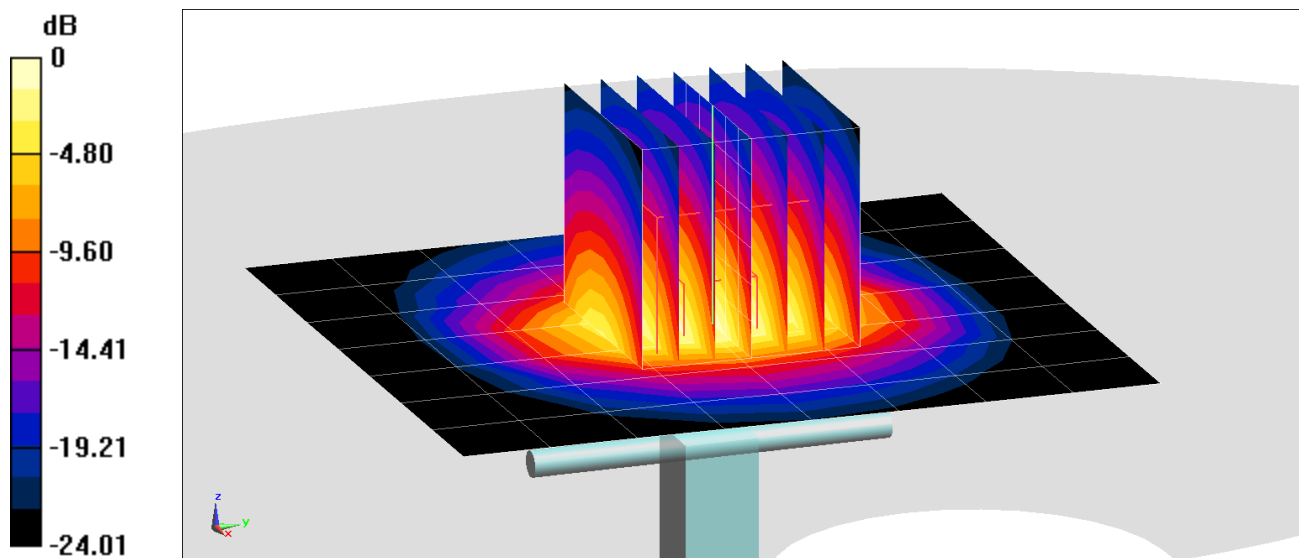

0 dB = 7.25 W/kg = 8.60 dBW/kg

# PCTEST ENGINEERING LABORATORY, INC.

**DUT: Dipole 2600 MHz; Type: D2600V2; Serial: 1126**

Communication System: UID 0, CW; Frequency: 2600 MHz; Duty Cycle: 1:1

Medium: 2450 Body Medium parameters used:

$f = 2600$  MHz;  $\sigma = 2.213$  S/m;  $\epsilon_r = 50.451$ ;  $\rho = 1000$  kg/m<sup>3</sup>

Phantom section: Flat Section; Space: 1.0 cm

Test Date: 04-12-2018; Ambient Temp: 24.0°C; Tissue Temp: 22.6°C

Probe: ES3DV3 - SN3319; ConvF(4.33, 4.33, 4.33); Calibrated: 3/13/2018;

Sensor-Surface: 3mm (Mechanical Surface Detection)

Electronics: DAE4 Sn1368; Calibrated: 3/7/2018

Phantom: Right Twin-SAM V5.0; Type: QD 000 P40 CD; Serial: 1797

Measurement SW: DASY52, Version 52.10; SEMCAD X Version 14.6.10 (7417)

## 2600 MHz System Verification at 20.0 dBm (100 mW)

**Area Scan (8x9x1):** Measurement grid: dx=12mm, dy=12mm

**Zoom Scan (7x7x7)/Cube 0:** Measurement grid: dx=5mm, dy=5mm, dz=5mm

Peak SAR (extrapolated) = 12.1 W/kg

**SAR(1 g) = 5.48 W/kg**

Deviation(1 g) = 0.92%

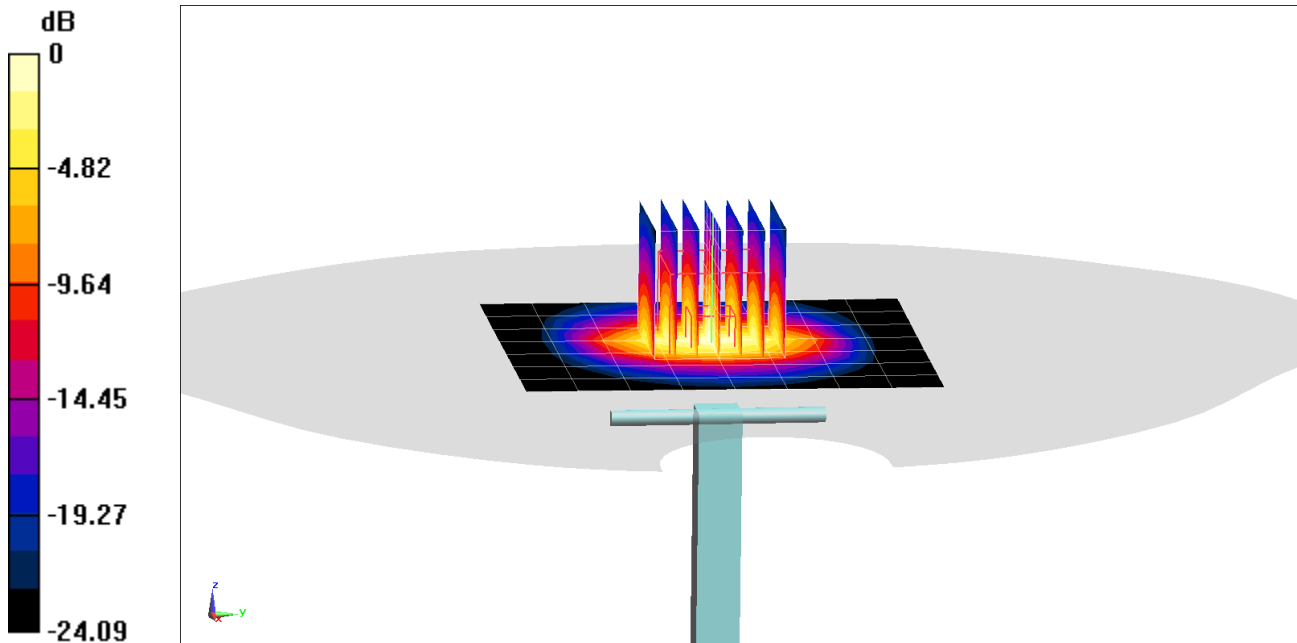

0 dB = 7.13 W/kg = 8.53 dBW/kg

# PCTEST ENGINEERING LABORATORY, INC.

**DUT: Dipole 2600 MHz; Type: D2600V2; Serial: 1126**

Communication System: UID 0, CW; Frequency: 2600 MHz; Duty Cycle: 1:1

Medium: 2450 Body Medium parameters used:

$f = 2600 \text{ MHz}$ ;  $\sigma = 2.166 \text{ S/m}$ ;  $\epsilon_r = 51.57$ ;  $\rho = 1000 \text{ kg/m}^3$

Phantom section: Flat Section; Space: 1.0 cm

Test Date: 04-16-2018; Ambient Temp: 22.6°C; Tissue Temp: 23.0°C

Probe: EX3DV4 - SN7410; ConvF(7.43, 7.43, 7.43); Calibrated: 7/17/2017;

Sensor-Surface: 1.4mm (Mechanical Surface Detection)

Electronics: DAE4 Sn1322; Calibrated: 7/13/2017

Phantom: SAM with CRP (Left); Type: SAM; Serial: 1715

Measurement SW: DASY52, Version 52.10;SEMCAD X Version 14.6.10 (7417)

## 2600 MHz System Verification at 20.0 dBm (100 mW)

**Area Scan (8x9x1):** Measurement grid: dx=12mm, dy=12mm

**Zoom Scan (7x7x7)/Cube 0:** Measurement grid: dx=5mm, dy=5mm, dz=5mm

Peak SAR (extrapolated) = 11.6 W/kg

**SAR(10 g) = 2.3 W/kg**

Deviation(10 g) = -5.74%

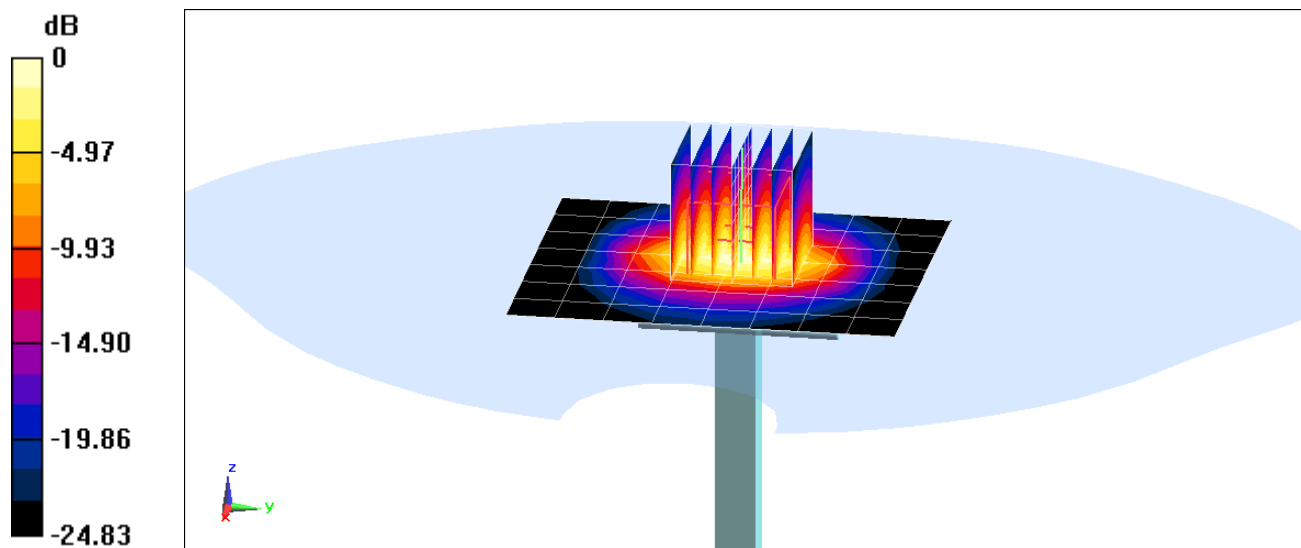

0 dB = 7.02 W/kg = 8.46 dBW/kg

# PCTEST ENGINEERING LABORATORY, INC.

**DUT: Dipole 5 GHz; Type: D5GHzV2; Serial: 1237**

Communication System: UID 0, CW; Frequency: 5250 MHz; Duty Cycle: 1:1  
Medium: 5 GHz Body Medium parameters used (interpolated):  
 $f = 5250 \text{ MHz}$ ;  $\sigma = 5.516 \text{ S/m}$ ;  $\epsilon_r = 47.642$ ;  $\rho = 1000 \text{ kg/m}^3$   
Phantom section: Flat Section; Space: 1.0 cm

Test Date: 04-14-2018; Ambient Temp: 22.3°C; Tissue Temp: 21.8°C

Probe: EX3DV4 - SN7308; ConvF(4.84, 4.84, 4.84); Calibrated: 8/16/2017;  
Sensor-Surface: 1.4mm (Mechanical Surface Detection)  
Electronics: DAE4 Sn1334; Calibrated: 6/14/2017

Phantom: SAM with CRP v5.0 Front; Type: QD000P40CD; Serial: 1646  
Measurement SW: DASY52, Version 52.10; SEMCAD X Version 14.6.10 (7417)

## 5250 MHz System Verification at 17.0 dBm (50 mW)

**Area Scan (7x7x1):** Measurement grid: dx=10mm, dy=10mm

**Zoom Scan (8x8x7)/Cube 0:** Measurement grid: dx=4mm, dy=4mm, dz=1.4mm; Graded Ratio: 1.4

Peak SAR (extrapolated) = 16.9 W/kg

**SAR(1 g) = 3.75 W/kg; SAR(10 g) = 1.05 W/kg**

Deviation(1 g) = -2.47%; Deviation(10 g) = -2.33%

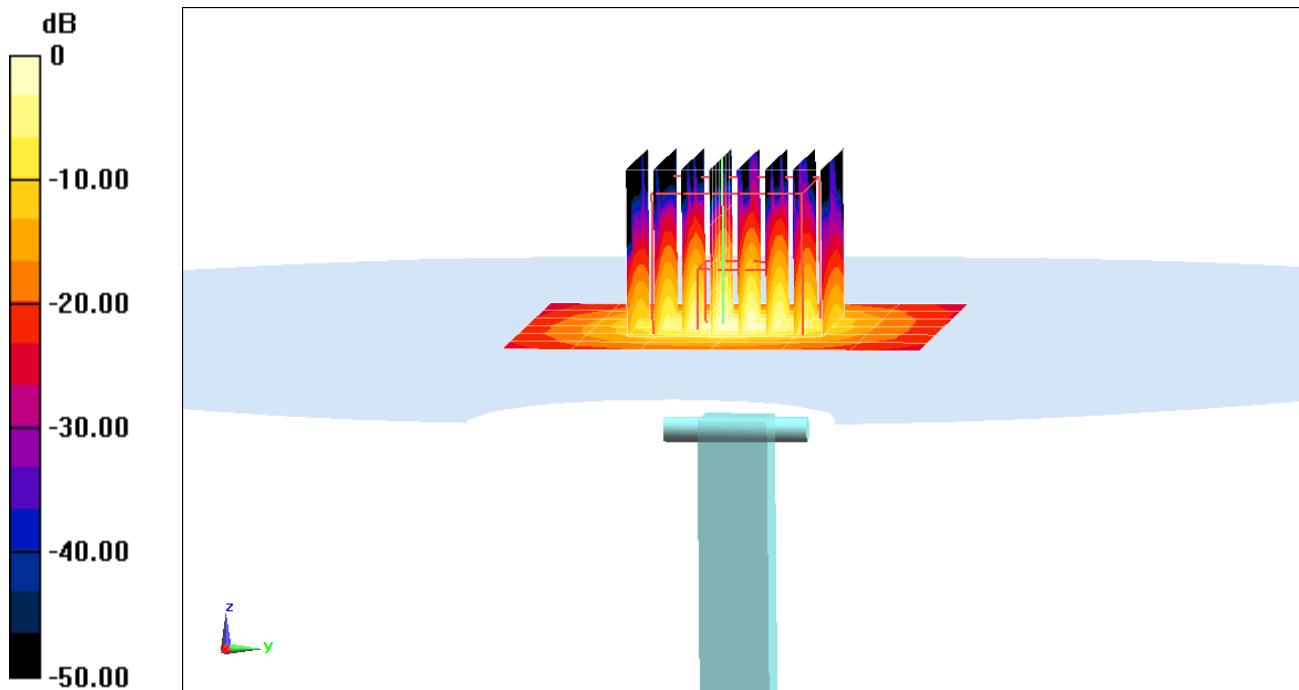

0 dB = 9.09 W/kg = 9.59 dBW/kg

# PCTEST ENGINEERING LABORATORY, INC.

**DUT: Dipole 5 GHz; Type: D5GHzV2; Serial: 1237**

Communication System: UID 0, CW; Frequency: 5600 MHz; Duty Cycle: 1:1

Medium: 5 GHz Body Medium parameters used:

$f = 5600 \text{ MHz}$ ;  $\sigma = 5.98 \text{ S/m}$ ;  $\epsilon_r = 47.052$ ;  $\rho = 1000 \text{ kg/m}^3$

Phantom section: Flat Section; Space: 1.0 cm

Test Date: 04-14-2018; Ambient Temp: 22.3°C; Tissue Temp: 21.8°C

Probe: EX3DV4 - SN7308; ConvF(4.23, 4.23, 4.23); Calibrated: 8/16/2017;

Sensor-Surface: 1.4mm (Mechanical Surface Detection)

Electronics: DAE4 Sn1334; Calibrated: 6/14/2017

Phantom: SAM with CRP v5.0 Front; Type: QD000P40CD; Serial: 1646

Measurement SW: DASY52, Version 52.10;SEMCAD X Version 14.6.10 (7417)

## 5600 MHz System Verification at 17.0 dBm (50 mW)

**Area Scan (7x7x1):** Measurement grid: dx=10mm, dy=10mm

**Zoom Scan (9x8x7)/Cube 0:** Measurement grid: dx=4mm, dy=4mm, dz=1.4mm; Graded Ratio: 1.4

Peak SAR (extrapolated) = 18.9 W/kg

**SAR(1 g) = 3.94 W/kg; SAR(10 g) = 1.09 W/kg**

Deviation(1 g) = 0.38%; Deviation(10 g) = -1.36%

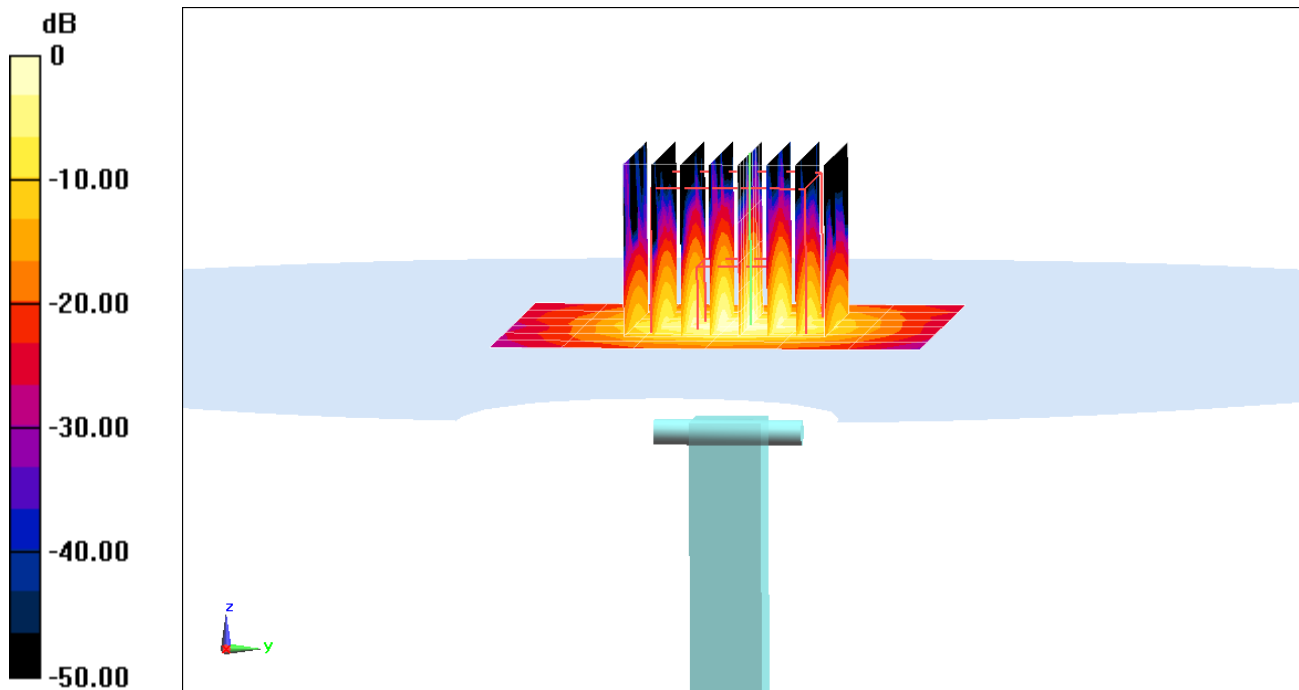

0 dB = 10.0 W/kg = 10.00 dBW/kg



# PCTEST ENGINEERING LABORATORY, INC.

**DUT: Dipole 5 GHz; Type: D5GHzV2; Serial: 1237**

Communication System: UID 0, CW; Frequency: 5750 MHz; Duty Cycle: 1:1

Medium: 5 GHz Body Medium parameters used (interpolated):

$f = 5750 \text{ MHz}$ ;  $\sigma = 6.192 \text{ S/m}$ ;  $\epsilon_r = 46.813$ ;  $\rho = 1000 \text{ kg/m}^3$

Phantom section: Flat Section; Space: 1.0 cm

Test Date: 04-14-2018; Ambient Temp: 22.3°C; Tissue Temp: 21.8°C

Probe: EX3DV4 - SN7308; ConvF(4.5, 4.5, 4.5); Calibrated: 8/16/2017;

Sensor-Surface: 1.4mm (Mechanical Surface Detection)

Electronics: DAE4 Sn1334; Calibrated: 6/14/2017

Phantom: SAM with CRP v5.0 Front; Type: QD000P40CD; Serial: 1646

Measurement SW: DASY52, Version 52.10; SEMCAD X Version 14.6.10 (7417)

## 5750 MHz System Verification at 17.0 dBm (50 mW)

**Area Scan (7x7x1):** Measurement grid: dx=10mm, dy=10mm

**Zoom Scan (8x8x7)/Cube 0:** Measurement grid: dx=4mm, dy=4mm, dz=1.4mm; Graded Ratio: 1.4

Peak SAR (extrapolated) = 18.4 W/kg

**SAR(1 g) = 3.67 W/kg; SAR(10 g) = 1.02 W/kg**

Deviation(1 g) = -4.80%; Deviation(10 g) = -4.67%

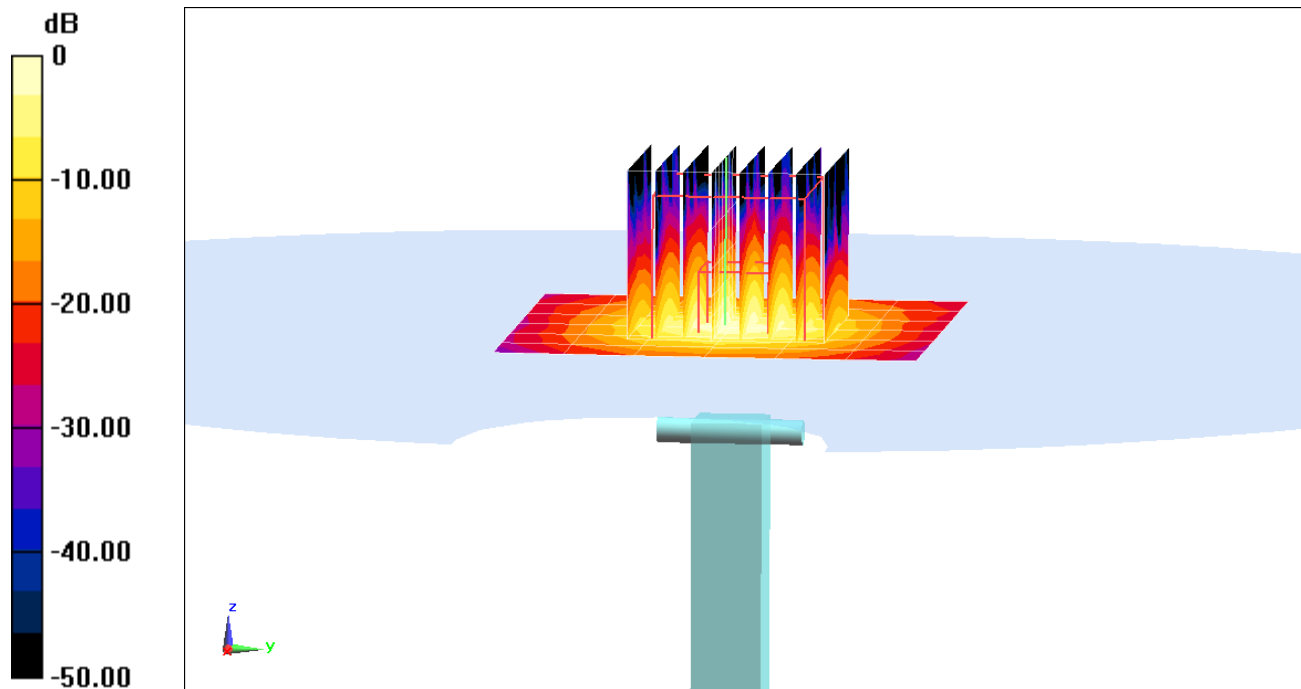

0 dB = 8.96 W/kg = 9.52 dBW/kg

## APPENDIX C: PROBE CALIBRATION



Accredited by the Swiss Accreditation Service (SAS)  
The Swiss Accreditation Service is one of the signatories to the EA  
Multilateral Agreement for the recognition of calibration certificates

Accreditation No.: **SCS 0108**

Client **PC Test**

Certificate No: **EX3-3914\_Feb18**

## CALIBRATION CERTIFICATE

Object **EX3DV4 - SN:3914**

Calibration procedure(s) **QA CAL-01.v9, QA CAL-12.v9, QA CAL-14.v4, QA CAL-23.v5,  
QA CAL-25.v6  
Calibration procedure for dosimetric E-field probes**

*BN  
02-29-2018*

Calibration date: **February 14, 2018**

This calibration certificate documents the traceability to national standards, which realize the physical units of measurements (SI).  
The measurements and the uncertainties with confidence probability are given on the following pages and are part of the certificate.

All calibrations have been conducted in the closed laboratory facility: environment temperature (22 ± 3)°C and humidity < 70%.

Calibration Equipment used (M&TE critical for calibration)

Primary Standards	ID	Cal Date (Certificate No.)	Scheduled Calibration
Power meter NRP	SN: 104778	04-Apr-17 (No. 217-02521/02522)	Apr-18
Power sensor NRP-Z91	SN: 103244	04-Apr-17 (No. 217-02521)	Apr-18
Power sensor NRP-Z91	SN: 103245	04-Apr-17 (No. 217-02525)	Apr-18
Reference 20 dB Attenuator	SN: S5277 (20x)	07-Apr-17 (No. 217-02528)	Apr-18
Reference Probe ES3DV2	SN: 3013	30-Dec-17 (No. ES3-3013_Dec17)	Dec-18
DAE4	SN: 660	21-Dec-17 (No. DAE4-660_Dec17)	Dec-18
Secondary Standards	ID	Check Date (in house)	Scheduled Check
Power meter E4419B	SN: GB41293874	06-Apr-16 (in house check Jun-16)	In house check: Jun-18
Power sensor E4412A	SN: MY41498087	06-Apr-16 (in house check Jun-16)	In house check: Jun-18
Power sensor E4412A	SN: 000110210	06-Apr-16 (in house check Jun-16)	In house check: Jun-18
RF generator HP 8648C	SN: US3642U01700	04-Aug-99 (in house check Jun-16)	In house check: Jun-18
Network Analyzer HP 8753E	SN: US37390585	18-Oct-01 (in house check Oct-17)	In house check: Oct-18

Calibrated by:	Name <b>Jeton Kastrati</b>	Function <b>Laboratory Technician</b>	Signature 
Approved by:	Name <b>Katja Pokovic</b>	Function <b>Technical Manager</b>	Signature 

Issued: February 14, 2018

This calibration certificate shall not be reproduced except in full without written approval of the laboratory.



Accredited by the Swiss Accreditation Service (SAS)

Accreditation No.: **SCS 0108**

The Swiss Accreditation Service is one of the signatories to the EA  
Multilateral Agreement for the recognition of calibration certificates

### Glossary:

TSL	tissue simulating liquid
NORM <sub>x,y,z</sub>	sensitivity in free space
ConvF	sensitivity in TSL / NORM <sub>x,y,z</sub>
DCP	diode compression point
CF	crest factor (1/duty_cycle) of the RF signal
A, B, C, D	modulation dependent linearization parameters
Polarization $\varphi$	$\varphi$ rotation around probe axis
Polarization $\vartheta$	$\vartheta$ rotation around an axis that is in the plane normal to probe axis (at measurement center), i.e., $\vartheta = 0$ is normal to probe axis
Connector Angle	information used in DASY system to align probe sensor X to the robot coordinate system

### Calibration is Performed According to the Following Standards:

- IEEE Std 1528-2013, "IEEE Recommended Practice for Determining the Peak Spatial-Averaged Specific Absorption Rate (SAR) in the Human Head from Wireless Communications Devices: Measurement Techniques", June 2013
- IEC 62209-1, "Measurement procedure for the assessment of Specific Absorption Rate (SAR) from hand-held and body-mounted devices used next to the ear (frequency range of 300 MHz to 6 GHz)", July 2016
- IEC 62209-2, "Procedure to determine the Specific Absorption Rate (SAR) for wireless communication devices used in close proximity to the human body (frequency range of 30 MHz to 6 GHz)", March 2010
- KDB 865664, "SAR Measurement Requirements for 100 MHz to 6 GHz"

### Methods Applied and Interpretation of Parameters:

- NORM<sub>x,y,z</sub>**: Assessed for E-field polarization  $\vartheta = 0$  ( $f \leq 900$  MHz in TEM-cell;  $f > 1800$  MHz: R22 waveguide). NORM<sub>x,y,z</sub> are only intermediate values, i.e., the uncertainties of NORM<sub>x,y,z</sub> does not affect the E<sup>2</sup>-field uncertainty inside TSL (see below ConvF).
- NORM(f)<sub>x,y,z</sub>** = NORM<sub>x,y,z</sub> \* frequency\_response (see Frequency Response Chart). This linearization is implemented in DASY4 software versions later than 4.2. The uncertainty of the frequency response is included in the stated uncertainty of ConvF.
- DCP<sub>x,y,z</sub>**: DCP are numerical linearization parameters assessed based on the data of power sweep with CW signal (no uncertainty required). DCP does not depend on frequency nor media.
- PAR**: PAR is the Peak to Average Ratio that is not calibrated but determined based on the signal characteristics
- A<sub>x,y,z</sub>; B<sub>x,y,z</sub>; C<sub>x,y,z</sub>; D<sub>x,y,z</sub>; VR<sub>x,y,z</sub>**: A, B, C, D are numerical linearization parameters assessed based on the data of power sweep for specific modulation signal. The parameters do not depend on frequency nor media. VR is the maximum calibration range expressed in RMS voltage across the diode.
- ConvF and Boundary Effect Parameters**: Assessed in flat phantom using E-field (or Temperature Transfer Standard for  $f \leq 800$  MHz) and inside waveguide using analytical field distributions based on power measurements for  $f > 800$  MHz. The same setups are used for assessment of the parameters applied for boundary compensation (alpha, depth) of which typical uncertainty values are given. These parameters are used in DASY4 software to improve probe accuracy close to the boundary. The sensitivity in TSL corresponds to NORM<sub>x,y,z</sub> \* ConvF whereby the uncertainty corresponds to that given for ConvF. A frequency dependent ConvF is used in DASY version 4.4 and higher which allows extending the validity from  $\pm 50$  MHz to  $\pm 100$  MHz.
- Spherical isotropy (3D deviation from isotropy)**: in a field of low gradients realized using a flat phantom exposed by a patch antenna.
- Sensor Offset**: The sensor offset corresponds to the offset of virtual measurement center from the probe tip (on probe axis). No tolerance required.
- Connector Angle**: The angle is assessed using the information gained by determining the NORM<sub>x</sub> (no uncertainty required).

# Probe EX3DV4

## SN:3914

Manufactured: December 18, 2012  
Calibrated: February 14, 2018

Calibrated for DASY/EASY Systems  
(Note: non-compatible with DASY2 system!)

## DASY/EASY - Parameters of Probe: EX3DV4 - SN:3914

### Basic Calibration Parameters

	Sensor X	Sensor Y	Sensor Z	Unc (k=2)
Norm ( $\mu\text{V}/(\text{V}/\text{m})^2$ ) <sup>A</sup>	0.47	0.41	0.44	$\pm 10.1\%$
DCP (mV) <sup>B</sup>	98.1	103.5	99.1	

### Modulation Calibration Parameters

UID	Communication System Name		A dB	B dB $\sqrt{\mu\text{V}}$	C	D dB	VR mV	Unc <sup>E</sup> (k=2)
0	CW	X	0.0	0.0	1.0	0.00	157.3	$\pm 3.5\%$
		Y	0.0	0.0	1.0		143.4	
		Z	0.0	0.0	1.0		153.1	

Note: For details on UID parameters see Appendix.

### Sensor Model Parameters

	C1 fF	C2 fF	$\alpha$ V <sup>-1</sup>	T1 ms.V <sup>-2</sup>	T2 ms.V <sup>-1</sup>	T3 ms	T4 V <sup>-2</sup>	T5 V <sup>-1</sup>	T6
X	44.52	338.7	36.78	11.30	0.699	5.054	0.000	0.544	1.006
Y	43.63	317.9	34.18	13.04	0.623	5.031	2.000	0.164	1.007
Z	41.48	314.2	36.51	10.96	0.847	5.054	0.251	0.494	1.008

The reported uncertainty of measurement is stated as the standard uncertainty of measurement multiplied by the coverage factor k=2, which for a normal distribution corresponds to a coverage probability of approximately 95%.

<sup>A</sup> The uncertainties of Norm X,Y,Z do not affect the E<sup>2</sup>-field uncertainty inside TSL (see Pages 5 and 6).

<sup>B</sup> Numerical linearization parameter: uncertainty not required.

<sup>E</sup> Uncertainty is determined using the max. deviation from linear response applying rectangular distribution and is expressed for the square of the field value.

## DASY/EASY - Parameters of Probe: EX3DV4 - SN:3914

### Calibration Parameter Determined in Head Tissue Simulating Media

f (MHz) <sup>C</sup>	Relative Permittivity <sup>F</sup>	Conductivity (S/m) <sup>F</sup>	ConvF X	ConvF Y	ConvF Z	Alpha <sup>G</sup>	Depth (mm) <sup>G</sup>	Unc (k=2)
6	55.5	0.75	21.06	21.06	21.06	0.00	1.00	± 13.3 %
13	55.5	0.75	17.97	17.97	17.97	0.00	1.00	± 13.3 %
750	41.9	0.89	10.18	10.18	10.18	0.58	0.80	± 12.0 %
835	41.5	0.90	9.70	9.70	9.70	0.52	0.80	± 12.0 %
1750	40.1	1.37	8.34	8.34	8.34	0.40	0.80	± 12.0 %
1900	40.0	1.40	7.98	7.98	7.98	0.41	0.84	± 12.0 %
2300	39.5	1.67	7.58	7.58	7.58	0.37	0.87	± 12.0 %
2450	39.2	1.80	7.26	7.26	7.26	0.43	0.84	± 12.0 %
2600	39.0	1.96	7.04	7.04	7.04	0.29	0.86	± 12.0 %
3500	37.9	2.91	6.99	6.99	6.99	0.25	1.20	± 13.1 %
3700	37.7	3.12	6.72	6.72	6.72	0.23	1.20	± 13.1 %
5250	35.9	4.71	5.41	5.41	5.41	0.30	1.80	± 13.1 %
5600	35.5	5.07	4.79	4.79	4.79	0.40	1.80	± 13.1 %
5750	35.4	5.22	4.78	4.78	4.78	0.40	1.80	± 13.1 %

<sup>C</sup> Frequency validity above 300 MHz of ± 100 MHz only applies for DASY v4.4 and higher (see Page 2), else it is restricted to ± 50 MHz. The uncertainty is the RSS of the ConvF uncertainty at calibration frequency and the uncertainty for the indicated frequency band. Frequency validity below 300 MHz is ± 10, 25, 40, 50 and 70 MHz for ConvF assessments at 30, 64, 128, 150 and 220 MHz respectively. Validity of ConvF assessed at 6 MHz is 4-9 MHz, and ConvF assessed at 13 MHz is 9-19 MHz. Above 5 GHz frequency validity can be extended to ± 110 MHz.

<sup>F</sup> At frequencies below 3 GHz, the validity of tissue parameters ( $\epsilon$  and  $\sigma$ ) can be relaxed to ± 10% if liquid compensation formula is applied to measured SAR values. At frequencies above 3 GHz, the validity of tissue parameters ( $\epsilon$  and  $\sigma$ ) is restricted to ± 5%. The uncertainty is the RSS of the ConvF uncertainty for indicated target tissue parameters.

<sup>G</sup> Alpha/Depth are determined during calibration. SPEAG warrants that the remaining deviation due to the boundary effect after compensation is always less than ± 1% for frequencies below 3 GHz and below ± 2% for frequencies between 3-6 GHz at any distance larger than half the probe tip diameter from the boundary.

## DASY/EASY - Parameters of Probe: EX3DV4 - SN:3914

### Calibration Parameter Determined in Body Tissue Simulating Media

f (MHz) <sup>C</sup>	Relative Permittivity <sup>F</sup>	Conductivity (S/m) <sup>F</sup>	ConvF X	ConvF Y	ConvF Z	Alpha <sup>G</sup>	Depth <sup>G</sup> (mm)	Unc (k=2)
750	55.5	0.96	9.75	9.75	9.75	0.47	0.80	± 12.0 %
835	55.2	0.97	9.57	9.57	9.57	0.44	0.89	± 12.0 %
1750	53.4	1.49	7.91	7.91	7.91	0.37	0.80	± 12.0 %
1900	53.3	1.52	7.62	7.62	7.62	0.29	1.01	± 12.0 %
2300	52.9	1.81	7.46	7.46	7.46	0.40	0.88	± 12.0 %
2450	52.7	1.95	7.39	7.39	7.39	0.39	0.86	± 12.0 %
2600	52.5	2.16	7.05	7.05	7.05	0.28	1.05	± 12.0 %
3500	51.3	3.31	6.81	6.81	6.81	0.30	1.25	± 13.1 %
3700	51.0	3.55	6.64	6.64	6.64	0.30	1.25	± 13.1 %
5250	48.9	5.36	4.81	4.81	4.81	0.35	1.90	± 13.1 %
5600	48.5	5.77	4.09	4.09	4.09	0.40	1.90	± 13.1 %
5750	48.3	5.94	4.22	4.22	4.22	0.40	1.90	± 13.1 %

<sup>C</sup> Frequency validity above 300 MHz of ± 100 MHz only applies for DASY v4.4 and higher (see Page 2), else it is restricted to ± 50 MHz. The uncertainty is the RSS of the ConvF uncertainty at calibration frequency and the uncertainty for the indicated frequency band. Frequency validity below 300 MHz is ± 10, 25, 40, 50 and 70 MHz for ConvF assessments at 30, 64, 128, 150 and 220 MHz respectively. Above 5 GHz frequency validity can be extended to ± 110 MHz.

<sup>F</sup> At frequencies below 3 GHz, the validity of tissue parameters ( $\epsilon$  and  $\sigma$ ) can be relaxed to ± 10% if liquid compensation formula is applied to measured SAR values. At frequencies above 3 GHz, the validity of tissue parameters ( $\epsilon$  and  $\sigma$ ) is restricted to ± 5%. The uncertainty is the RSS of the ConvF uncertainty for indicated target tissue parameters.

<sup>G</sup> Alpha/Depth are determined during calibration. SPEAG warrants that the remaining deviation due to the boundary effect after compensation is always less than ± 1% for frequencies below 3 GHz and below ± 2% for frequencies between 3-6 GHz at any distance larger than half the probe tip diameter from the boundary.



### Frequency Response of E-Field (TEM-Cell:ifi110 EXX, Waveguide: R22)

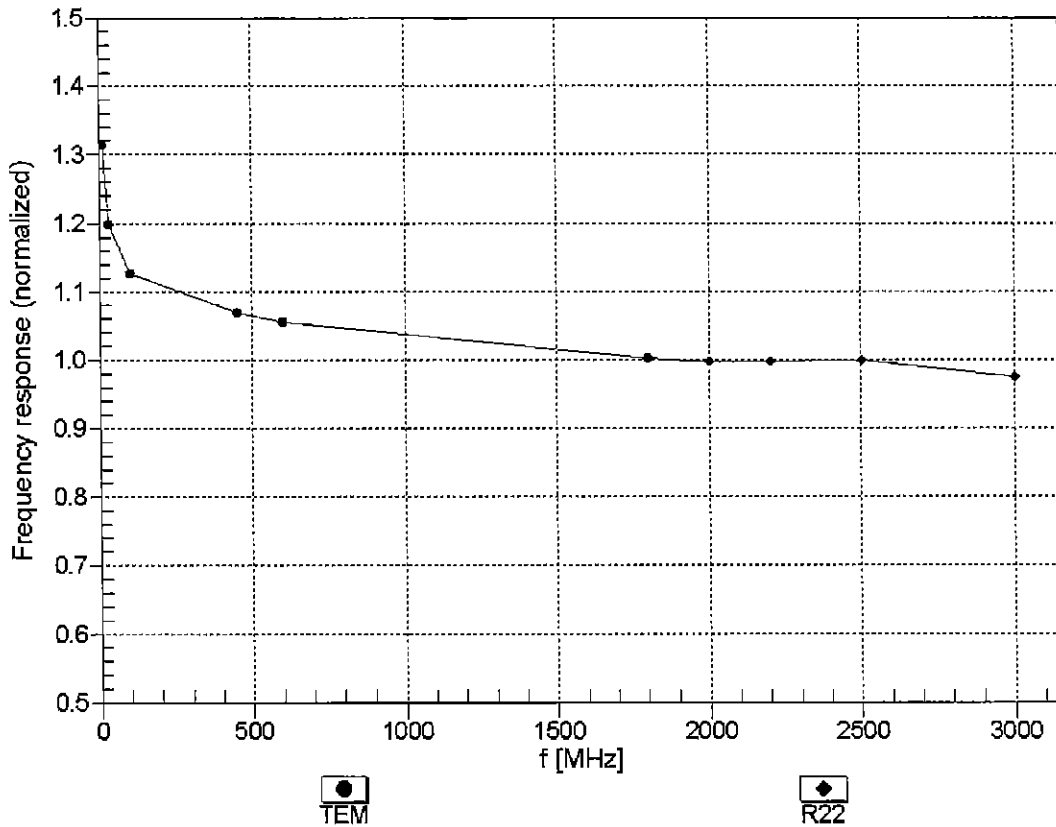

Uncertainty of Frequency Response of E-field:  $\pm 6.3\%$  (k=2)

### Receiving Pattern ( $\phi$ ), $\theta = 0^\circ$

f=600 MHz,TEM

f=1800 MHz,R22

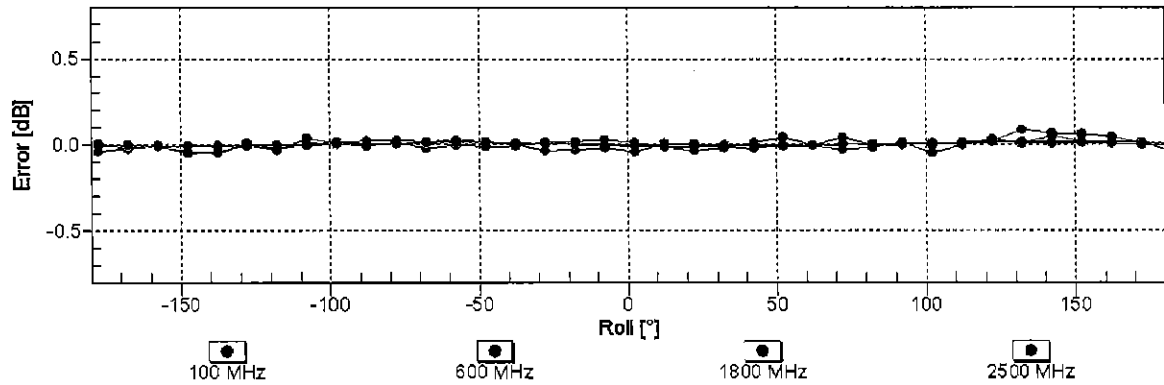
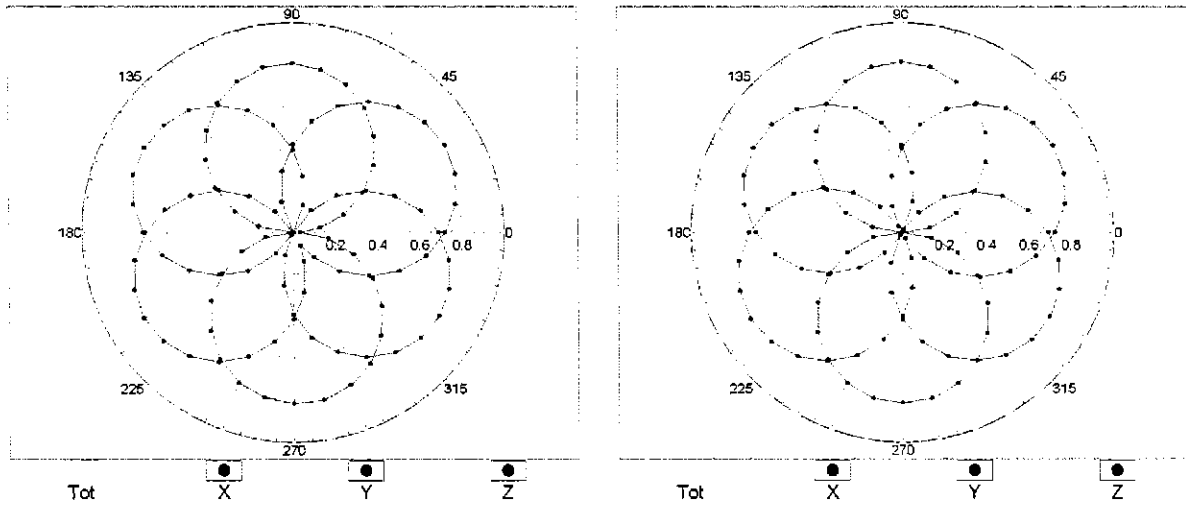

Uncertainty of Axial Isotropy Assessment:  $\pm 0.5\%$  (k=2)

### Dynamic Range $f(SAR_{head})$ (TEM cell , $f_{eval}= 1900$ MHz)

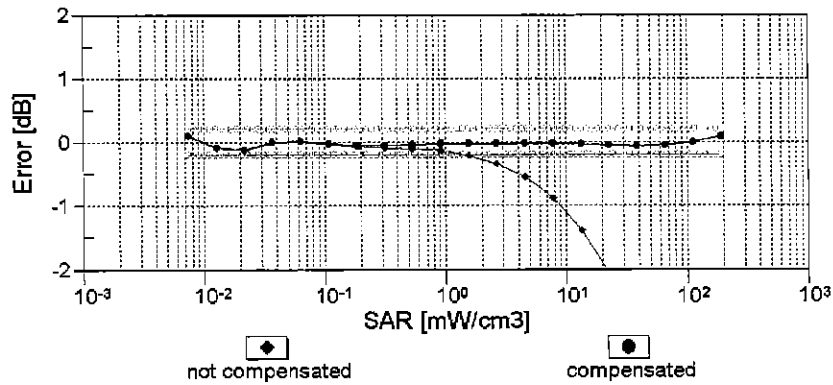
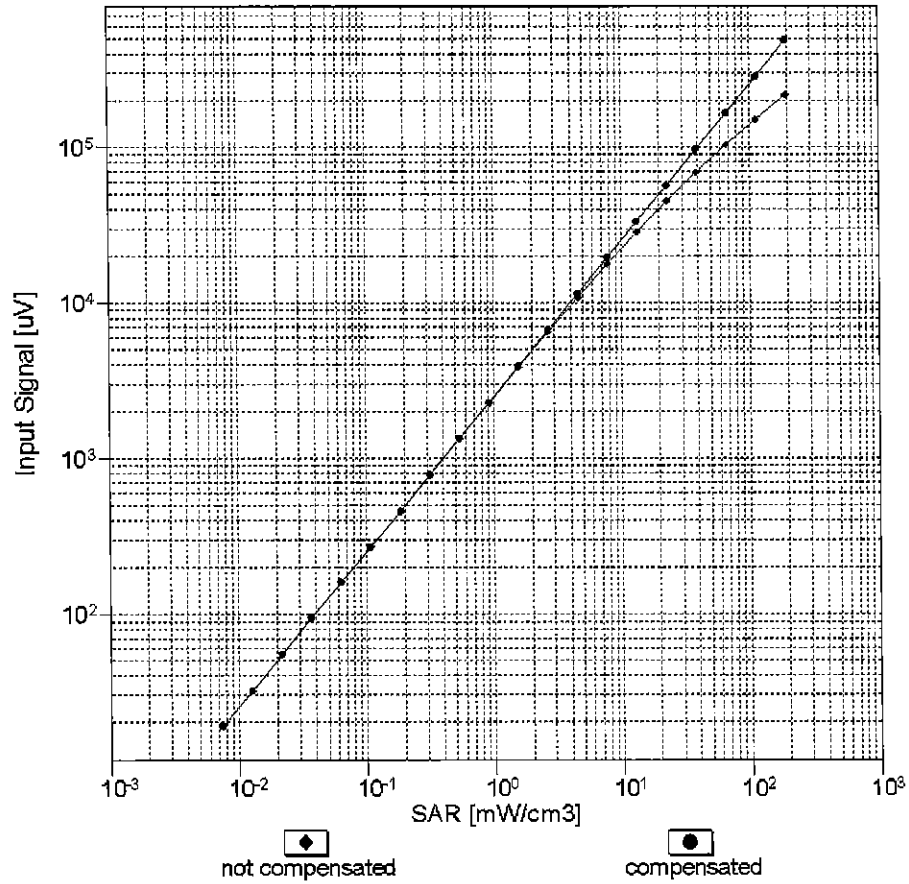

Uncertainty of Linearity Assessment:  $\pm 0.6\%$  (k=2)

# Conversion Factor Assessment

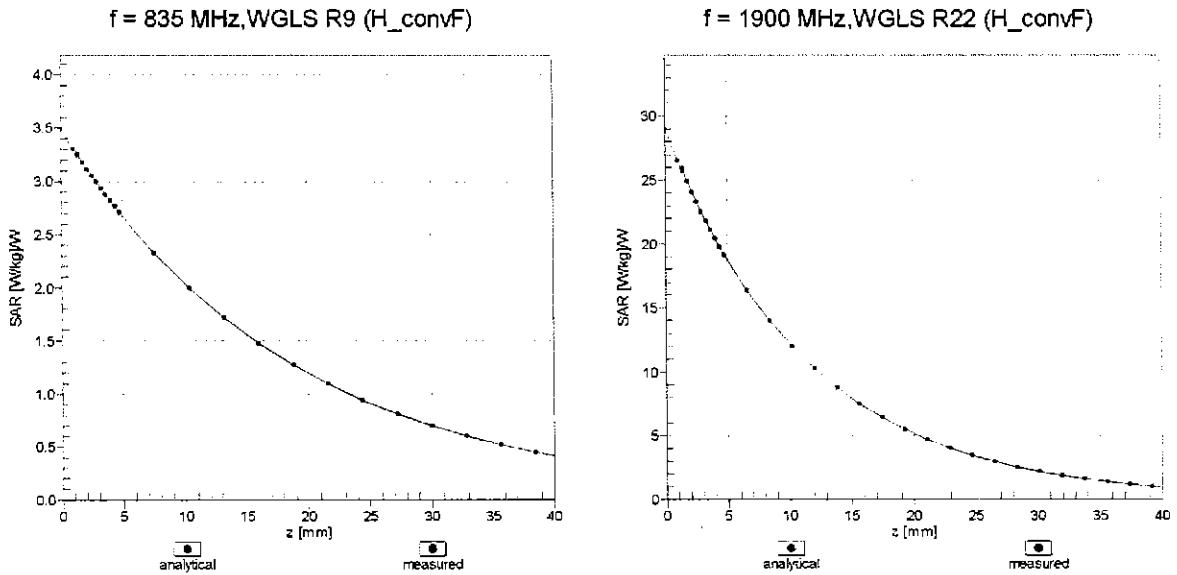

## Deviation from Isotropy in Liquid Error ( $\phi, \theta$ ), f = 900 MHz

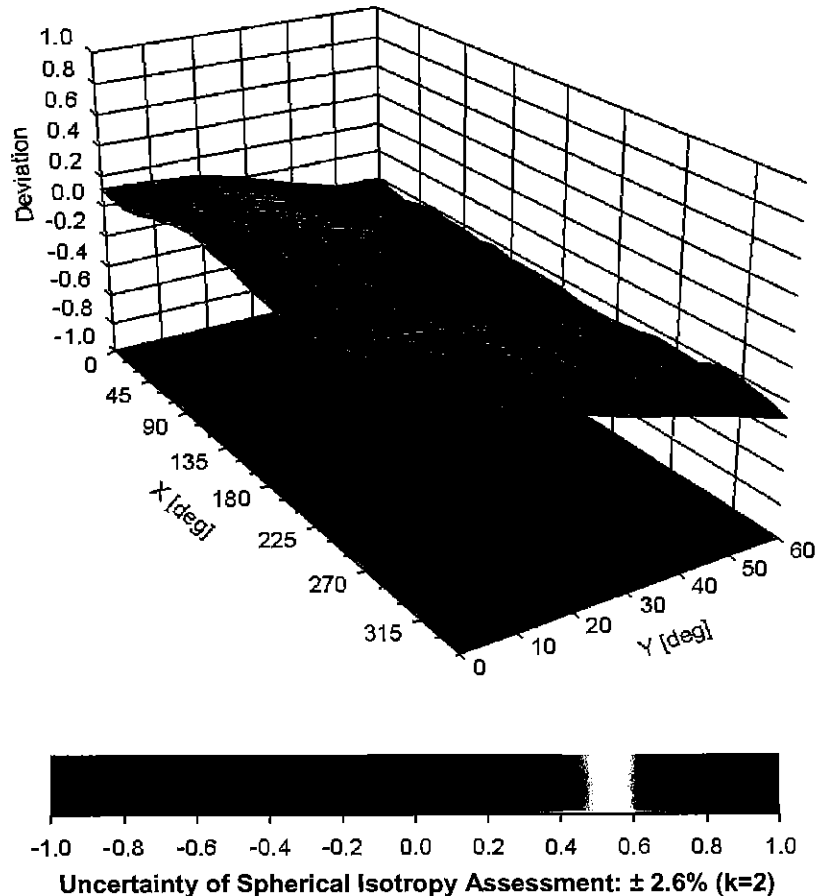

## DASY/EASY - Parameters of Probe: EX3DV4 - SN:3914

### Other Probe Parameters

Sensor Arrangement	Triangular
Connector Angle (°)	132.3
Mechanical Surface Detection Mode	enabled
Optical Surface Detection Mode	disabled
Probe Overall Length	337 mm
Probe Body Diameter	10 mm
Tip Length	9 mm
Tip Diameter	2.5 mm
Probe Tip to Sensor X Calibration Point	1 mm
Probe Tip to Sensor Y Calibration Point	1 mm
Probe Tip to Sensor Z Calibration Point	1 mm
Recommended Measurement Distance from Surface	1.4 mm

**Appendix: Modulation Calibration Parameters**

UID	Communication System Name		A dB	B dB $\mu$ V	C	D dB	VR mV	Max Unc <sup>E</sup> (k=2)
0	CW	X	0.00	0.00	1.00	0.00	157.3	$\pm 3.5\%$
		Y	0.00	0.00	1.00		143.4	
		Z	0.00	0.00	1.00		153.1	
10010- CAA	SAR Validation (Square, 100ms, 10ms)	X	2.02	63.97	9.10	10.00	20.0	$\pm 9.6\%$
		Y	2.59	66.85	10.84		20.0	
		Z	2.31	65.14	9.98		20.0	
10011- CAB	UMTS-FDD (WCDMA)	X	0.89	66.39	14.20	0.00	150.0	$\pm 9.6\%$
		Y	1.06	68.74	16.01		150.0	
		Z	0.90	66.80	14.44		150.0	
10012- CAB	IEEE 802.11b WiFi 2.4 GHz (DSSS, 1 Mbps)	X	1.06	63.38	14.79	0.41	150.0	$\pm 9.6\%$
		Y	1.17	64.37	15.54		150.0	
		Z	1.07	63.61	14.94		150.0	
10013- CAB	IEEE 802.11g WiFi 2.4 GHz (DSSS-OFDM, 6 Mbps)	X	4.75	66.53	16.97	1.46	150.0	$\pm 9.6\%$
		Y	4.80	66.78	17.02		150.0	
		Z	4.73	66.65	17.01		150.0	
10021- DAC	GSM-FDD (TDMA, GMSK)	X	100.00	110.09	25.45	9.39	50.0	$\pm 9.6\%$
		Y	100.00	112.00	26.43		50.0	
		Z	100.00	111.93	26.50		50.0	
10023- DAC	GPRS-FDD (TDMA, GMSK, TN 0)	X	100.00	109.83	25.39	9.57	50.0	$\pm 9.6\%$
		Y	100.00	111.69	26.33		50.0	
		Z	100.00	111.63	26.42		50.0	
10024- DAC	GPRS-FDD (TDMA, GMSK, TN 0-1)	X	100.00	107.43	23.14	6.56	60.0	$\pm 9.6\%$
		Y	100.00	110.61	24.77		60.0	
		Z	100.00	109.57	24.26		60.0	
10025- DAC	EDGE-FDD (TDMA, 8PSK, TN 0)	X	4.03	68.96	25.05	12.57	50.0	$\pm 9.6\%$
		Y	5.30	77.15	29.41		50.0	
		Z	4.06	68.52	24.65		50.0	
10026- DAC	EDGE-FDD (TDMA, 8PSK, TN 0-1)	X	8.87	91.28	32.17	9.56	60.0	$\pm 9.6\%$
		Y	10.08	94.25	33.27		60.0	
		Z	8.65	90.32	31.77		60.0	
10027- DAC	GPRS-FDD (TDMA, GMSK, TN 0-1-2)	X	100.00	105.82	21.66	4.80	80.0	$\pm 9.6\%$
		Y	100.00	111.09	24.24		80.0	
		Z	100.00	108.42	22.93		80.0	
10028- DAC	GPRS-FDD (TDMA, GMSK, TN 0-1-2-3)	X	100.00	104.11	20.26	3.55	100.0	$\pm 9.6\%$
		Y	100.00	112.84	24.34		100.0	
		Z	100.00	107.37	21.76		100.0	
10029- DAC	EDGE-FDD (TDMA, 8PSK, TN 0-1-2)	X	5.57	80.93	27.02	7.80	80.0	$\pm 9.6\%$
		Y	6.11	82.68	27.69		80.0	
		Z	5.53	80.55	26.85		80.0	
10030- CAA	IEEE 802.15.1 Bluetooth (GFSK, DH1)	X	100.00	104.99	21.59	5.30	70.0	$\pm 9.6\%$
		Y	100.00	109.04	23.62		70.0	
		Z	100.00	107.17	22.68		70.0	
10031- CAA	IEEE 802.15.1 Bluetooth (GFSK, DH3)	X	0.46	62.47	6.17	1.88	100.0	$\pm 9.6\%$
		Y	100.00	111.97	22.67		100.0	
		Z	100.00	95.35	15.52		100.0	

10032-CAA	IEEE 802.15.1 Bluetooth (GFSK, DH5)	X	0.19	60.00	3.78	1.17	100.0	± 9.6 %
		Y	100.00	120.03	24.95		100.0	
		Z	0.19	60.00	4.15		100.0	
10033-CAA	IEEE 802.15.1 Bluetooth (PI/4-DQPSK, DH1)	X	13.55	95.45	24.90	5.30	70.0	± 9.6 %
		Y	18.76	100.49	26.60		70.0	
		Z	13.36	94.67	24.55		70.0	
10034-CAA	IEEE 802.15.1 Bluetooth (PI/4-DQPSK, DH3)	X	2.70	75.51	16.71	1.88	100.0	± 9.6 %
		Y	4.49	82.47	19.70		100.0	
		Z	2.90	76.09	16.70		100.0	
10035-CAA	IEEE 802.15.1 Bluetooth (PI/4-DQPSK, DH5)	X	1.71	70.85	14.56	1.17	100.0	± 9.6 %
		Y	2.70	76.95	17.56		100.0	
		Z	1.78	71.24	14.48		100.0	
10036-CAA	IEEE 802.15.1 Bluetooth (8-DPSK, DH1)	X	22.62	103.29	27.18	5.30	70.0	± 9.6 %
		Y	32.35	108.98	28.96		70.0	
		Z	21.86	102.15	26.73		70.0	
10037-CAA	IEEE 802.15.1 Bluetooth (8-DPSK, DH3)	X	2.48	74.51	16.30	1.88	100.0	± 9.6 %
		Y	3.96	80.90	19.14		100.0	
		Z	2.61	74.90	16.23		100.0	
10038-CAA	IEEE 802.15.1 Bluetooth (8-DPSK, DH5)	X	1.74	71.34	14.88	1.17	100.0	± 9.6 %
		Y	2.75	77.52	17.90		100.0	
		Z	1.82	71.77	14.82		100.0	
10039-CAB	CDMA2000 (1xRTT, RC1)	X	1.34	68.49	13.13	0.00	150.0	± 9.6 %
		Y	2.27	75.66	16.89		150.0	
		Z	1.29	68.35	12.80		150.0	
10042-CAB	IS-54 / IS-136 FDD (TDMA/FDM, PI/4-DQPSK, Halfrate)	X	34.99	94.66	19.93	7.78	50.0	± 9.6 %
		Y	100.00	108.11	23.89		50.0	
		Z	100.00	107.01	23.40		50.0	
10044-CAA	IS-91/EIA/TIA-553 FDD (FDMA, FM)	X	0.17	126.30	3.13	0.00	150.0	± 9.6 %
		Y	0.00	107.81	5.46		150.0	
		Z	0.15	126.17	2.27		150.0	
10048-CAA	DECT (TDD, TDMA/FDM, GFSK, Full Slot, 24)	X	10.11	79.88	18.52	13.80	25.0	± 9.6 %
		Y	23.48	91.75	22.45		25.0	
		Z	12.25	82.71	19.92		25.0	
10049-CAA	DECT (TDD, TDMA/FDM, GFSK, Double Slot, 12)	X	11.72	83.69	18.67	10.79	40.0	± 9.6 %
		Y	40.84	100.05	23.71		40.0	
		Z	15.78	87.97	20.48		40.0	
10056-CAA	UMTS-TDD (TD-SCDMA, 1.28 Mcps)	X	18.86	95.31	25.05	9.03	50.0	± 9.6 %
		Y	26.98	101.35	27.04		50.0	
		Z	17.19	93.67	24.60		50.0	
10058-DAC	EDGE-FDD (TDMA, 8PSK, TN 0-1-2-3)	X	4.30	76.01	24.21	6.55	100.0	± 9.6 %
		Y	4.66	77.31	24.71		100.0	
		Z	4.30	75.85	24.15		100.0	
10059-CAB	IEEE 802.11b WiFi 2.4 GHz (DSSS, 2 Mbps)	X	1.10	64.51	15.41	0.61	110.0	± 9.6 %
		Y	1.22	65.59	16.19		110.0	
		Z	1.11	64.78	15.58		110.0	
10060-CAB	IEEE 802.11b WiFi 2.4 GHz (DSSS, 5.5 Mbps)	X	40.70	121.16	30.62	1.30	110.0	± 9.6 %
		Y	100.00	138.01	35.59		110.0	
		Z	76.47	130.66	32.92		110.0	

10061-CAB	IEEE 802.11b WiFi 2.4 GHz (DSSS, 11 Mbps)	X	2.97	81.68	22.34	2.04	110.0	± 9.6 %
		Y	3.52	84.01	23.42		110.0	
		Z	3.16	82.63	22.73		110.0	
10062-CAC	IEEE 802.11a/h WiFi 5 GHz (OFDM, 6 Mbps)	X	4.54	66.50	16.38	0.49	100.0	± 9.6 %
		Y	4.60	66.81	16.49		100.0	
		Z	4.51	66.59	16.41		100.0	
10063-CAC	IEEE 802.11a/h WiFi 5 GHz (OFDM, 9 Mbps)	X	4.56	66.59	16.48	0.72	100.0	± 9.6 %
		Y	4.62	66.89	16.58		100.0	
		Z	4.53	66.70	16.52		100.0	
10064-CAC	IEEE 802.11a/h WiFi 5 GHz (OFDM, 12 Mbps)	X	4.84	66.85	16.71	0.86	100.0	± 9.6 %
		Y	4.89	67.12	16.79		100.0	
		Z	4.80	66.93	16.74		100.0	
10065-CAC	IEEE 802.11a/h WiFi 5 GHz (OFDM, 18 Mbps)	X	4.71	66.74	16.80	1.21	100.0	± 9.6 %
		Y	4.76	67.01	16.87		100.0	
		Z	4.67	66.83	16.83		100.0	
10066-CAC	IEEE 802.11a/h WiFi 5 GHz (OFDM, 24 Mbps)	X	4.72	66.77	16.97	1.46	100.0	± 9.6 %
		Y	4.77	67.02	17.03		100.0	
		Z	4.69	66.86	17.00		100.0	
10067-CAC	IEEE 802.11a/h WiFi 5 GHz (OFDM, 36 Mbps)	X	5.02	66.97	17.43	2.04	100.0	± 9.6 %
		Y	5.06	67.18	17.45		100.0	
		Z	4.99	67.10	17.47		100.0	
10068-CAC	IEEE 802.11a/h WiFi 5 GHz (OFDM, 48 Mbps)	X	5.06	66.99	17.64	2.55	100.0	± 9.6 %
		Y	5.10	67.19	17.65		100.0	
		Z	5.03	67.09	17.67		100.0	
10069-CAC	IEEE 802.11a/h WiFi 5 GHz (OFDM, 54 Mbps)	X	5.14	67.01	17.83	2.67	100.0	± 9.6 %
		Y	5.18	67.19	17.83		100.0	
		Z	5.11	67.11	17.86		100.0	
10071-CAB	IEEE 802.11g WiFi 2.4 GHz (DSSS/OFDM, 9 Mbps)	X	4.84	66.62	17.27	1.99	100.0	± 9.6 %
		Y	4.89	66.85	17.31		100.0	
		Z	4.83	66.75	17.32		100.0	
10072-CAB	IEEE 802.11g WiFi 2.4 GHz (DSSS/OFDM, 12 Mbps)	X	4.82	66.93	17.48	2.30	100.0	± 9.6 %
		Y	4.86	67.16	17.51		100.0	
		Z	4.80	67.06	17.53		100.0	
10073-CAB	IEEE 802.11g WiFi 2.4 GHz (DSSS/OFDM, 18 Mbps)	X	4.88	67.11	17.81	2.83	100.0	± 9.6 %
		Y	4.92	67.32	17.83		100.0	
		Z	4.87	67.25	17.87		100.0	
10074-CAB	IEEE 802.11g WiFi 2.4 GHz (DSSS/OFDM, 24 Mbps)	X	4.87	67.01	17.95	3.30	100.0	± 9.6 %
		Y	4.91	67.22	17.97		100.0	
		Z	4.87	67.19	18.02		100.0	
10075-CAB	IEEE 802.11g WiFi 2.4 GHz (DSSS/OFDM, 36 Mbps)	X	4.90	67.11	18.25	3.82	90.0	± 9.6 %
		Y	4.95	67.32	18.26		90.0	
		Z	4.91	67.27	18.31		90.0	
10076-CAB	IEEE 802.11g WiFi 2.4 GHz (DSSS/OFDM, 48 Mbps)	X	4.92	66.92	18.38	4.15	90.0	± 9.6 %
		Y	4.97	67.13	18.38		90.0	
		Z	4.94	67.11	18.46		90.0	
10077-CAB	IEEE 802.11g WiFi 2.4 GHz (DSSS/OFDM, 54 Mbps)	X	4.95	66.99	18.48	4.30	90.0	± 9.6 %
		Y	5.00	67.21	18.49		90.0	
		Z	4.97	67.20	18.56		90.0	



10081-CAB	CDMA2000 (1xRTT, RC3)	X	0.61	63.26	9.90	0.00	150.0	± 9.6 %
		Y	0.87	67.43	13.01		150.0	
		Z	0.58	63.10	9.56		150.0	
10082-CAB	IS-54 / IS-136 FDD (TDMA/FDM, PI/4-DQPSK, Fullrate)	X	2.50	65.17	5.97	4.77	80.0	± 9.6 %
		Y	0.75	60.00	4.55		80.0	
		Z	0.72	60.00	4.31		80.0	
10090-DAC	GPRS-FDD (TDMA, GMSK, TN 0-4)	X	100.00	107.54	23.21	6.56	60.0	± 9.6 %
		Y	100.00	110.64	24.80		60.0	
		Z	100.00	109.67	24.33		60.0	
10097-CAB	UMTS-FDD (HSDPA)	X	1.69	67.19	15.08	0.00	150.0	± 9.6 %
		Y	1.88	68.79	16.18		150.0	
		Z	1.71	67.59	15.23		150.0	
10098-CAB	UMTS-FDD (HSUPA, Subtest 2)	X	1.65	67.13	15.04	0.00	150.0	± 9.6 %
		Y	1.84	68.75	16.15		150.0	
		Z	1.67	67.53	15.19		150.0	
10099-DAC	EDGE-FDD (TDMA, 8PSK, TN 0-4)	X	8.93	91.41	32.21	9.56	60.0	± 9.6 %
		Y	10.16	94.39	33.31		60.0	
		Z	8.70	90.44	31.80		60.0	
10100-CAD	LTE-FDD (SC-FDMA, 100% RB, 20 MHz, QPSK)	X	2.94	69.72	16.26	0.00	150.0	± 9.6 %
		Y	3.18	71.08	17.07		150.0	
		Z	2.94	69.89	16.39		150.0	
10101-CAD	LTE-FDD (SC-FDMA, 100% RB, 20 MHz, 16-QAM)	X	3.09	67.13	15.64	0.00	150.0	± 9.6 %
		Y	3.21	67.85	16.08		150.0	
		Z	3.07	67.21	15.70		150.0	
10102-CAD	LTE-FDD (SC-FDMA, 100% RB, 20 MHz, 64-QAM)	X	3.20	67.14	15.76	0.00	150.0	± 9.6 %
		Y	3.32	67.82	16.17		150.0	
		Z	3.18	67.23	15.82		150.0	
10103-CAD	LTE-TDD (SC-FDMA, 100% RB, 20 MHz, QPSK)	X	5.93	75.11	20.17	3.98	65.0	± 9.6 %
		Y	6.63	76.82	20.78		65.0	
		Z	5.91	75.14	20.21		65.0	
10104-CAD	LTE-TDD (SC-FDMA, 100% RB, 20 MHz, 16-QAM)	X	5.89	73.03	20.08	3.98	65.0	± 9.6 %
		Y	6.25	73.91	20.36		65.0	
		Z	5.90	73.09	20.11		65.0	
10105-CAD	LTE-TDD (SC-FDMA, 100% RB, 20 MHz, 64-QAM)	X	5.51	71.58	19.75	3.98	65.0	± 9.6 %
		Y	6.10	73.31	20.41		65.0	
		Z	5.86	72.81	20.30		65.0	
10108-CAE	LTE-FDD (SC-FDMA, 100% RB, 10 MHz, QPSK)	X	2.55	69.01	16.09	0.00	150.0	± 9.6 %
		Y	2.75	70.30	16.89		150.0	
		Z	2.54	69.20	16.22		150.0	
10109-CAE	LTE-FDD (SC-FDMA, 100% RB, 10 MHz, 16-QAM)	X	2.74	66.99	15.50	0.00	150.0	± 9.6 %
		Y	2.87	67.79	16.01		150.0	
		Z	2.72	67.11	15.56		150.0	
10110-CAE	LTE-FDD (SC-FDMA, 100% RB, 5 MHz, QPSK)	X	2.04	68.09	15.59	0.00	150.0	± 9.6 %
		Y	2.23	69.47	16.51		150.0	
		Z	2.03	68.32	15.72		150.0	
10111-CAE	LTE-FDD (SC-FDMA, 100% RB, 5 MHz, 16-QAM)	X	2.46	67.87	15.72	0.00	150.0	± 9.6 %
		Y	2.64	69.03	16.47		150.0	
		Z	2.45	68.15	15.81		150.0	

10112-CAE	LTE-FDD (SC-FDMA, 100% RB, 10 MHz, 64-QAM)	X	2.87	67.02	15.59	0.00	150.0	± 9.6 %
		Y	3.00	67.79	16.07		150.0	
		Z	2.85	67.16	15.65		150.0	
10113-CAE	LTE-FDD (SC-FDMA, 100% RB, 5 MHz, 64-QAM)	X	2.61	68.07	15.89	0.00	150.0	± 9.6 %
		Y	2.79	69.17	16.59		150.0	
		Z	2.61	68.36	15.98		150.0	
10114-CAC	IEEE 802.11n (HT Greenfield, 13.5 Mbps, BPSK)	X	5.01	67.03	16.34	0.00	150.0	± 9.6 %
		Y	5.06	67.33	16.45		150.0	
		Z	4.97	67.05	16.35		150.0	
10115-CAC	IEEE 802.11n (HT Greenfield, 81 Mbps, 16-QAM)	X	5.27	67.10	16.38	0.00	150.0	± 9.6 %
		Y	5.32	67.38	16.48		150.0	
		Z	5.22	67.11	16.39		150.0	
10116-CAC	IEEE 802.11n (HT Greenfield, 135 Mbps, 64-QAM)	X	5.09	67.20	16.35	0.00	150.0	± 9.6 %
		Y	5.14	67.50	16.46		150.0	
		Z	5.06	67.23	16.37		150.0	
10117-CAC	IEEE 802.11n (HT Mixed, 13.5 Mbps, BPSK)	X	4.97	66.87	16.27	0.00	150.0	± 9.6 %
		Y	5.03	67.20	16.40		150.0	
		Z	4.94	66.93	16.31		150.0	
10118-CAC	IEEE 802.11n (HT Mixed, 81 Mbps, 16-QAM)	X	5.35	67.31	16.50	0.00	150.0	± 9.6 %
		Y	5.39	67.55	16.57		150.0	
		Z	5.30	67.32	16.50		150.0	
10119-CAC	IEEE 802.11n (HT Mixed, 135 Mbps, 64-QAM)	X	5.08	67.16	16.34	0.00	150.0	± 9.6 %
		Y	5.12	67.45	16.45		150.0	
		Z	5.04	67.20	16.36		150.0	
10140-CAD	LTE-FDD (SC-FDMA, 100% RB, 15 MHz, 16-QAM)	X	3.23	67.13	15.67	0.00	150.0	± 9.6 %
		Y	3.35	67.82	16.08		150.0	
		Z	3.21	67.22	15.73		150.0	
10141-CAD	LTE-FDD (SC-FDMA, 100% RB, 15 MHz, 64-QAM)	X	3.36	67.28	15.87	0.00	150.0	± 9.6 %
		Y	3.48	67.94	16.26		150.0	
		Z	3.34	67.38	15.93		150.0	
10142-CAD	LTE-FDD (SC-FDMA, 100% RB, 3 MHz, QPSK)	X	1.80	67.92	15.04	0.00	150.0	± 9.6 %
		Y	2.02	69.71	16.23		150.0	
		Z	1.78	68.19	15.11		150.0	
10143-CAD	LTE-FDD (SC-FDMA, 100% RB, 3 MHz, 16-QAM)	X	2.28	68.33	15.13	0.00	150.0	± 9.6 %
		Y	2.56	70.16	16.27		150.0	
		Z	2.27	68.61	15.13		150.0	
10144-CAD	LTE-FDD (SC-FDMA, 100% RB, 3 MHz, 64-QAM)	X	2.03	65.81	13.36	0.00	150.0	± 9.6 %
		Y	2.22	67.14	14.29		150.0	
		Z	1.98	65.83	13.22		150.0	
10145-CAE	LTE-FDD (SC-FDMA, 100% RB, 1.4 MHz, QPSK)	X	0.92	62.55	9.46	0.00	150.0	± 9.6 %
		Y	1.17	65.32	11.54		150.0	
		Z	0.84	61.98	8.80		150.0	
10146-CAE	LTE-FDD (SC-FDMA, 100% RB, 1.4 MHz, 16-QAM)	X	1.39	62.93	9.23	0.00	150.0	± 9.6 %
		Y	1.99	66.57	11.19		150.0	
		Z	1.31	62.53	8.72		150.0	
10147-CAE	LTE-FDD (SC-FDMA, 100% RB, 1.4 MHz, 64-QAM)	X	1.52	63.83	9.83	0.00	150.0	± 9.6 %
		Y	2.52	69.22	12.51		150.0	
		Z	1.42	63.36	9.28		150.0	

10149-CAD	LTE-FDD (SC-FDMA, 50% RB, 20 MHz, 16-QAM)	X	2.75	67.05	15.55	0.00	150.0	± 9.6 %
		Y	2.88	67.86	16.07		150.0	
		Z	2.73	67.18	15.62		150.0	
10150-CAD	LTE-FDD (SC-FDMA, 50% RB, 20 MHz, 64-QAM)	X	2.88	67.08	15.63	0.00	150.0	± 9.6 %
		Y	3.01	67.85	16.12		150.0	
		Z	2.86	67.22	15.70		150.0	
10151-CAD	LTE-TDD (SC-FDMA, 50% RB, 20 MHz, QPSK)	X	6.32	77.90	21.36	3.98	65.0	± 9.6 %
		Y	6.91	79.14	21.77		65.0	
		Z	6.41	78.22	21.50		65.0	
10152-CAD	LTE-TDD (SC-FDMA, 50% RB, 20 MHz, 16-QAM)	X	5.42	72.95	19.71	3.98	65.0	± 9.6 %
		Y	5.78	73.88	20.03		65.0	
		Z	5.43	73.04	19.72		65.0	
10153-CAD	LTE-TDD (SC-FDMA, 50% RB, 20 MHz, 64-QAM)	X	5.81	74.06	20.59	3.98	65.0	± 9.6 %
		Y	6.20	74.97	20.87		65.0	
		Z	5.84	74.21	20.62		65.0	
10154-CAE	LTE-FDD (SC-FDMA, 50% RB, 10 MHz, QPSK)	X	2.09	68.53	15.87	0.00	150.0	± 9.6 %
		Y	2.29	69.96	16.81		150.0	
		Z	2.08	68.78	15.99		150.0	
10155-CAE	LTE-FDD (SC-FDMA, 50% RB, 10 MHz, 16-QAM)	X	2.46	67.89	15.74	0.00	150.0	± 9.6 %
		Y	2.64	69.05	16.49		150.0	
		Z	2.46	68.18	15.84		150.0	
10156-CAE	LTE-FDD (SC-FDMA, 50% RB, 5 MHz, QPSK)	X	1.63	67.76	14.61	0.00	150.0	± 9.6 %
		Y	1.89	69.98	16.07		150.0	
		Z	1.61	67.98	14.81		150.0	
10157-CAE	LTE-FDD (SC-FDMA, 50% RB, 5 MHz, 16-QAM)	X	1.84	66.10	13.16	0.00	150.0	± 9.6 %
		Y	2.08	67.93	14.40		150.0	
		Z	1.79	66.07	12.96		150.0	
10158-CAE	LTE-FDD (SC-FDMA, 50% RB, 10 MHz, 64-QAM)	X	2.62	68.14	15.95	0.00	150.0	± 9.6 %
		Y	2.80	69.25	16.65		150.0	
		Z	2.62	68.44	16.04		150.0	
10159-CAE	LTE-FDD (SC-FDMA, 50% RB, 5 MHz, 64-QAM)	X	1.94	66.53	13.44	0.00	150.0	± 9.6 %
		Y	2.21	68.50	14.73		150.0	
		Z	1.88	66.49	13.23		150.0	
10160-CAD	LTE-FDD (SC-FDMA, 50% RB, 15 MHz, QPSK)	X	2.59	68.31	15.97	0.00	150.0	± 9.6 %
		Y	2.73	69.19	16.57		150.0	
		Z	2.58	68.51	16.08		150.0	
10161-CAD	LTE-FDD (SC-FDMA, 50% RB, 15 MHz, 16-QAM)	X	2.77	67.03	15.54	0.00	150.0	± 9.6 %
		Y	2.91	67.84	16.05		150.0	
		Z	2.75	67.18	15.60		150.0	
10162-CAD	LTE-FDD (SC-FDMA, 50% RB, 15 MHz, 64-QAM)	X	2.88	67.21	15.67	0.00	150.0	± 9.6 %
		Y	3.02	68.01	16.17		150.0	
		Z	2.86	67.38	15.74		150.0	
10166-CAE	LTE-FDD (SC-FDMA, 50% RB, 1.4 MHz, QPSK)	X	3.37	69.04	18.77	3.01	150.0	± 9.6 %
		Y	3.72	71.09	19.82		150.0	
		Z	3.38	69.53	19.11		150.0	
10167-CAE	LTE-FDD (SC-FDMA, 50% RB, 1.4 MHz, 16-QAM)	X	4.04	71.49	19.00	3.01	150.0	± 9.6 %
		Y	5.05	75.77	20.88		150.0	
		Z	4.12	72.30	19.44		150.0	

10168-CAE	LTE-FDD (SC-FDMA, 50% RB, 1.4 MHz, 64-QAM)	X	4.56	74.09	20.53	3.01	150.0	± 9.6 %
		Y	5.99	79.40	22.74		150.0	
		Z	4.72	75.27	21.13		150.0	
10169-CAD	LTE-FDD (SC-FDMA, 1 RB, 20 MHz, QPSK)	X	2.74	67.94	18.26	3.01	150.0	± 9.6 %
		Y	3.25	71.55	20.05		150.0	
		Z	2.77	68.38	18.59		150.0	
10170-CAD	LTE-FDD (SC-FDMA, 1 RB, 20 MHz, 16-QAM)	X	3.65	73.29	20.42	3.01	150.0	± 9.6 %
		Y	6.00	83.03	24.31		150.0	
		Z	3.81	74.44	21.04		150.0	
10171-AAD	LTE-FDD (SC-FDMA, 1 RB, 20 MHz, 64-QAM)	X	2.98	69.09	17.51	3.01	150.0	± 9.6 %
		Y	4.17	75.40	20.24		150.0	
		Z	3.05	69.77	17.92		150.0	
10172-CAD	LTE-TDD (SC-FDMA, 1 RB, 20 MHz, QPSK)	X	6.26	85.95	26.48	6.02	65.0	± 9.6 %
		Y	13.49	101.43	31.66		65.0	
		Z	6.07	85.72	26.58		65.0	
10173-CAD	LTE-TDD (SC-FDMA, 1 RB, 20 MHz, 16-QAM)	X	11.36	93.09	26.93	6.02	65.0	± 9.6 %
		Y	61.90	122.46	34.86		65.0	
		Z	13.00	96.00	28.02		65.0	
10174-CAD	LTE-TDD (SC-FDMA, 1 RB, 20 MHz, 64-QAM)	X	8.36	86.77	24.30	6.02	65.0	± 9.6 %
		Y	35.10	110.72	31.17		65.0	
		Z	8.86	88.32	24.99		65.0	
10175-CAE	LTE-FDD (SC-FDMA, 1 RB, 10 MHz, QPSK)	X	2.71	67.63	18.00	3.01	150.0	± 9.6 %
		Y	3.19	71.11	19.75		150.0	
		Z	2.74	68.04	18.32		150.0	
10176-CAE	LTE-FDD (SC-FDMA, 1 RB, 10 MHz, 16-QAM)	X	3.66	73.32	20.43	3.01	150.0	± 9.6 %
		Y	6.01	83.07	24.33		150.0	
		Z	3.81	74.46	21.05		150.0	
10177-CAG	LTE-FDD (SC-FDMA, 1 RB, 5 MHz, QPSK)	X	2.73	67.78	18.10	3.01	150.0	± 9.6 %
		Y	3.23	71.31	19.86		150.0	
		Z	2.76	68.20	18.41		150.0	
10178-CAE	LTE-FDD (SC-FDMA, 1 RB, 5 MHz, 16-QAM)	X	3.63	73.10	20.31	3.01	150.0	± 9.6 %
		Y	5.90	82.67	24.15		150.0	
		Z	3.78	74.24	20.93		150.0	
10179-CAE	LTE-FDD (SC-FDMA, 1 RB, 10 MHz, 64-QAM)	X	3.28	71.01	18.80	3.01	150.0	± 9.6 %
		Y	4.94	78.87	22.07		150.0	
		Z	3.38	71.91	19.31		150.0	
10180-CAE	LTE-FDD (SC-FDMA, 1 RB, 5 MHz, 64-QAM)	X	2.98	69.03	17.47	3.01	150.0	± 9.6 %
		Y	4.15	75.28	20.17		150.0	
		Z	3.04	69.71	17.88		150.0	
10181-CAD	LTE-FDD (SC-FDMA, 1 RB, 15 MHz, QPSK)	X	2.73	67.76	18.09	3.01	150.0	± 9.6 %
		Y	3.22	71.29	19.85		150.0	
		Z	2.75	68.18	18.41		150.0	
10182-CAD	LTE-FDD (SC-FDMA, 1 RB, 15 MHz, 16-QAM)	X	3.62	73.08	20.30	3.01	150.0	± 9.6 %
		Y	5.88	82.63	24.13		150.0	
		Z	3.77	74.21	20.92		150.0	
10183-AAC	LTE-FDD (SC-FDMA, 1 RB, 15 MHz, 64-QAM)	X	2.97	69.01	17.46	3.01	150.0	± 9.6 %
		Y	4.14	75.24	20.16		150.0	
		Z	3.04	69.68	17.87		150.0	

10184-CAD	LTE-FDD (SC-FDMA, 1 RB, 3 MHz, QPSK)	X	2.74	67.80	18.11	3.01	150.0	± 9.6 %
		Y	3.24	71.35	19.88		150.0	
		Z	2.77	68.22	18.43		150.0	
10185-CAD	LTE-FDD (SC-FDMA, 1 RB, 3 MHz, 16-QAM)	X	3.64	73.15	20.34	3.01	150.0	± 9.6 %
		Y	5.93	82.75	24.19		150.0	
		Z	3.79	74.29	20.96		150.0	
10186-AAD	LTE-FDD (SC-FDMA, 1 RB, 3 MHz, 64-QAM)	X	2.99	69.07	17.49	3.01	150.0	± 9.6 %
		Y	4.16	75.34	20.20		150.0	
		Z	3.05	69.75	17.90		150.0	
10187-CAE	LTE-FDD (SC-FDMA, 1 RB, 1.4 MHz, QPSK)	X	2.75	67.86	18.18	3.01	150.0	± 9.6 %
		Y	3.25	71.43	19.96		150.0	
		Z	2.78	68.29	18.51		150.0	
10188-CAE	LTE-FDD (SC-FDMA, 1 RB, 1.4 MHz, 16-QAM)	X	3.76	73.83	20.74	3.01	150.0	± 9.6 %
		Y	6.30	84.02	24.77		150.0	
		Z	3.92	75.04	21.38		150.0	
10189-AAE	LTE-FDD (SC-FDMA, 1 RB, 1.4 MHz, 64-QAM)	X	3.05	69.47	17.77	3.01	150.0	± 9.6 %
		Y	4.32	76.05	20.59		150.0	
		Z	3.12	70.18	18.19		150.0	
10193-CAC	IEEE 802.11n (HT Greenfield, 6.5 Mbps, BPSK)	X	4.39	66.44	16.00	0.00	150.0	± 9.6 %
		Y	4.46	66.83	16.18		150.0	
		Z	4.36	66.53	16.02		150.0	
10194-CAC	IEEE 802.11n (HT Greenfield, 39 Mbps, 16-QAM)	X	4.55	66.74	16.13	0.00	150.0	± 9.6 %
		Y	4.63	67.12	16.30		150.0	
		Z	4.51	66.81	16.16		150.0	
10195-CAC	IEEE 802.11n (HT Greenfield, 65 Mbps, 64-QAM)	X	4.59	66.77	16.15	0.00	150.0	± 9.6 %
		Y	4.67	67.15	16.32		150.0	
		Z	4.55	66.84	16.18		150.0	
10196-CAC	IEEE 802.11n (HT Mixed, 6.5 Mbps, BPSK)	X	4.39	66.48	16.01	0.00	150.0	± 9.6 %
		Y	4.46	66.87	16.19		150.0	
		Z	4.35	66.57	16.03		150.0	
10197-CAC	IEEE 802.11n (HT Mixed, 39 Mbps, 16-QAM)	X	4.56	66.75	16.14	0.00	150.0	± 9.6 %
		Y	4.64	67.14	16.31		150.0	
		Z	4.53	66.83	16.17		150.0	
10198-CAC	IEEE 802.11n (HT Mixed, 65 Mbps, 64-QAM)	X	4.59	66.78	16.16	0.00	150.0	± 9.6 %
		Y	4.67	67.16	16.33		150.0	
		Z	4.55	66.85	16.19		150.0	
10219-CAC	IEEE 802.11n (HT Mixed, 7.2 Mbps, BPSK)	X	4.34	66.50	15.97	0.00	150.0	± 9.6 %
		Y	4.41	66.90	16.15		150.0	
		Z	4.30	66.59	15.99		150.0	
10220-CAC	IEEE 802.11n (HT Mixed, 43.3 Mbps, 16-QAM)	X	4.56	66.72	16.13	0.00	150.0	± 9.6 %
		Y	4.63	67.10	16.30		150.0	
		Z	4.52	66.79	16.15		150.0	
10221-CAC	IEEE 802.11n (HT Mixed, 72.2 Mbps, 64-QAM)	X	4.60	66.71	16.14	0.00	150.0	± 9.6 %
		Y	4.67	67.09	16.31		150.0	
		Z	4.56	66.79	16.17		150.0	
10222-CAC	IEEE 802.11n (HT Mixed, 15 Mbps, BPSK)	X	4.94	66.87	16.27	0.00	150.0	± 9.6 %
		Y	5.00	67.20	16.40		150.0	
		Z	4.91	66.93	16.30		150.0	

10223-CAC	IEEE 802.11n (HT Mixed, 90 Mbps, 16-QAM)	X	5.26	67.15	16.43	0.00	150.0	± 9.6 %
		Y	5.29	67.39	16.51		150.0	
		Z	5.21	67.16	16.44		150.0	
10224-CAC	IEEE 802.11n (HT Mixed, 150 Mbps, 64-QAM)	X	4.98	66.98	16.25	0.00	150.0	± 9.6 %
		Y	5.05	67.32	16.38		150.0	
		Z	4.95	67.03	16.28		150.0	
10225-CAB	UMTS-FDD (HSPA+)	X	2.65	65.82	14.94	0.00	150.0	± 9.6 %
		Y	2.77	66.54	15.42		150.0	
		Z	2.63	65.96	14.93		150.0	
10226-CAA	LTE-TDD (SC-FDMA, 1 RB, 1.4 MHz, 16-QAM)	X	12.29	94.61	27.52	6.02	65.0	± 9.6 %
		Y	76.74	126.49	35.96		65.0	
		Z	14.23	97.75	28.67		65.0	
10227-CAA	LTE-TDD (SC-FDMA, 1 RB, 1.4 MHz, 64-QAM)	X	11.60	92.16	26.09	6.02	65.0	± 9.6 %
		Y	58.51	119.10	33.33		65.0	
		Z	13.58	95.42	27.28		65.0	
10228-CAA	LTE-TDD (SC-FDMA, 1 RB, 1.4 MHz, QPSK)	X	8.07	91.29	28.44	6.02	65.0	± 9.6 %
		Y	14.98	103.75	32.45		65.0	
		Z	8.37	92.43	29.01		65.0	
10229-CAB	LTE-TDD (SC-FDMA, 1 RB, 3 MHz, 16-QAM)	X	11.46	93.21	26.98	6.02	65.0	± 9.6 %
		Y	62.74	122.68	34.92		65.0	
		Z	13.11	96.13	28.07		65.0	
10230-CAB	LTE-TDD (SC-FDMA, 1 RB, 3 MHz, 64-QAM)	X	10.78	90.84	25.59	6.02	65.0	± 9.6 %
		Y	48.68	115.84	32.42		65.0	
		Z	12.46	93.85	26.71		65.0	
10231-CAB	LTE-TDD (SC-FDMA, 1 RB, 3 MHz, QPSK)	X	7.66	90.18	27.97	6.02	65.0	± 9.6 %
		Y	13.86	102.08	31.86		65.0	
		Z	7.92	91.24	28.52		65.0	
10232-CAD	LTE-TDD (SC-FDMA, 1 RB, 5 MHz, 16-QAM)	X	11.44	93.19	26.97	6.02	65.0	± 9.6 %
		Y	62.67	122.68	34.92		65.0	
		Z	13.08	96.11	28.07		65.0	
10233-CAD	LTE-TDD (SC-FDMA, 1 RB, 5 MHz, 64-QAM)	X	10.75	90.81	25.58	6.02	65.0	± 9.6 %
		Y	48.50	115.79	32.41		65.0	
		Z	12.42	93.82	26.70		65.0	
10234-CAD	LTE-TDD (SC-FDMA, 1 RB, 5 MHz, QPSK)	X	7.34	89.19	27.51	6.02	65.0	± 9.6 %
		Y	12.98	100.59	31.27		65.0	
		Z	7.57	90.21	28.04		65.0	
10235-CAD	LTE-TDD (SC-FDMA, 1 RB, 10 MHz, 16-QAM)	X	11.45	93.23	26.99	6.02	65.0	± 9.6 %
		Y	63.03	122.79	34.95		65.0	
		Z	13.11	96.15	28.08		65.0	
10236-CAD	LTE-TDD (SC-FDMA, 1 RB, 10 MHz, 64-QAM)	X	10.87	90.96	25.62	6.02	65.0	± 9.6 %
		Y	49.65	116.13	32.49		65.0	
		Z	12.57	93.99	26.75		65.0	
10237-CAD	LTE-TDD (SC-FDMA, 1 RB, 10 MHz, QPSK)	X	7.67	90.24	28.00	6.02	65.0	± 9.6 %
		Y	13.91	102.19	31.90		65.0	
		Z	7.93	91.30	28.54		65.0	
10238-CAD	LTE-TDD (SC-FDMA, 1 RB, 15 MHz, 16-QAM)	X	11.41	93.16	26.96	6.02	65.0	± 9.6 %
		Y	62.56	122.66	34.91		65.0	
		Z	13.06	96.08	28.06		65.0	

10239-CAD	LTE-TDD (SC-FDMA, 1 RB, 15 MHz, 64-QAM)	X	10.72	90.78	25.57	6.02	65.0	± 9.6 %
		Y	48.29	115.74	32.40		65.0	
		Z	12.38	93.78	26.69		65.0	
10240-CAD	LTE-TDD (SC-FDMA, 1 RB, 15 MHz, QPSK)	X	7.65	90.20	27.98	6.02	65.0	± 9.6 %
		Y	13.86	102.14	31.88		65.0	
		Z	7.91	91.26	28.53		65.0	
10241-CAA	LTE-TDD (SC-FDMA, 50% RB, 1.4 MHz, 16-QAM)	X	7.49	79.94	24.73	6.98	65.0	± 9.6 %
		Y	9.15	84.52	26.53		65.0	
		Z	7.78	81.10	25.24		65.0	
10242-CAA	LTE-TDD (SC-FDMA, 50% RB, 1.4 MHz, 64-QAM)	X	6.76	77.82	23.76	6.98	65.0	± 9.6 %
		Y	8.56	83.16	25.93		65.0	
		Z	7.57	80.56	24.94		65.0	
10243-CAA	LTE-TDD (SC-FDMA, 50% RB, 1.4 MHz, QPSK)	X	5.55	74.73	23.33	6.98	65.0	± 9.6 %
		Y	6.44	78.27	24.91		65.0	
		Z	5.56	75.03	23.50		65.0	
10244-CAB	LTE-TDD (SC-FDMA, 50% RB, 3 MHz, 16-QAM)	X	4.91	73.06	16.84	3.98	65.0	± 9.6 %
		Y	6.23	76.34	18.14		65.0	
		Z	4.96	73.17	16.71		65.0	
10245-CAB	LTE-TDD (SC-FDMA, 50% RB, 3 MHz, 64-QAM)	X	4.78	72.39	16.50	3.98	65.0	± 9.6 %
		Y	5.96	75.43	17.72		65.0	
		Z	4.79	72.41	16.32		65.0	
10246-CAB	LTE-TDD (SC-FDMA, 50% RB, 3 MHz, QPSK)	X	4.86	76.58	18.54	3.98	65.0	± 9.6 %
		Y	5.74	78.81	19.49		65.0	
		Z	4.75	76.10	18.16		65.0	
10247-CAD	LTE-TDD (SC-FDMA, 50% RB, 5 MHz, 16-QAM)	X	4.54	72.63	17.68	3.98	65.0	± 9.6 %
		Y	5.00	73.89	18.23		65.0	
		Z	4.50	72.44	17.41		65.0	
10248-CAD	LTE-TDD (SC-FDMA, 50% RB, 5 MHz, 64-QAM)	X	4.51	72.01	17.39	3.98	65.0	± 9.6 %
		Y	4.93	73.18	17.90		65.0	
		Z	4.45	71.77	17.09		65.0	
10249-CAD	LTE-TDD (SC-FDMA, 50% RB, 5 MHz, QPSK)	X	6.38	81.20	21.41	3.98	65.0	± 9.6 %
		Y	7.34	83.11	22.13		65.0	
		Z	6.46	81.34	21.34		65.0	
10250-CAD	LTE-TDD (SC-FDMA, 50% RB, 10 MHz, 16-QAM)	X	5.54	75.67	20.83	3.98	65.0	± 9.6 %
		Y	5.99	76.71	21.17		65.0	
		Z	5.60	75.87	20.83		65.0	
10251-CAD	LTE-TDD (SC-FDMA, 50% RB, 10 MHz, 64-QAM)	X	5.22	73.28	19.41	3.98	65.0	± 9.6 %
		Y	5.60	74.26	19.76		65.0	
		Z	5.22	73.35	19.34		65.0	
10252-CAD	LTE-TDD (SC-FDMA, 50% RB, 10 MHz, QPSK)	X	6.60	81.03	22.49	3.98	65.0	± 9.6 %
		Y	7.35	82.49	22.99		65.0	
		Z	6.74	81.46	22.63		65.0	
10253-CAD	LTE-TDD (SC-FDMA, 50% RB, 15 MHz, 16-QAM)	X	5.32	72.45	19.46	3.98	65.0	± 9.6 %
		Y	5.67	73.38	19.78		65.0	
		Z	5.34	72.58	19.46		65.0	
10254-CAD	LTE-TDD (SC-FDMA, 50% RB, 15 MHz, 64-QAM)	X	5.67	73.46	20.23	3.98	65.0	± 9.6 %
		Y	6.04	74.36	20.52		65.0	
		Z	5.70	73.62	20.25		65.0	

10255-CAD	LTE-TDD (SC-FDMA, 50% RB, 15 MHz, QPSK)	X	6.00	77.17	21.28	3.98	65.0	± 9.6 %
		Y	6.54	78.36	21.67		65.0	
		Z	6.09	77.51	21.41		65.0	
10256-CAA	LTE-TDD (SC-FDMA, 100% RB, 1.4 MHz, 16-QAM)	X	3.55	68.31	13.56	3.98	65.0	± 9.6 %
		Y	4.31	70.70	14.63		65.0	
		Z	3.47	67.95	13.18		65.0	
10257-CAA	LTE-TDD (SC-FDMA, 100% RB, 1.4 MHz, 64-QAM)	X	3.46	67.65	13.15	3.98	65.0	± 9.6 %
		Y	4.12	69.78	14.12		65.0	
		Z	3.37	67.24	12.73		65.0	
10258-CAA	LTE-TDD (SC-FDMA, 100% RB, 1.4 MHz, QPSK)	X	3.31	70.56	15.03	3.98	65.0	± 9.6 %
		Y	3.93	72.68	16.08		65.0	
		Z	3.14	69.68	14.40		65.0	
10259-CAB	LTE-TDD (SC-FDMA, 100% RB, 3 MHz, 16-QAM)	X	4.95	73.85	18.86	3.98	65.0	± 9.6 %
		Y	5.40	75.01	19.32		65.0	
		Z	4.95	73.84	18.70		65.0	
10260-CAB	LTE-TDD (SC-FDMA, 100% RB, 3 MHz, 64-QAM)	X	4.97	73.54	18.73	3.98	65.0	± 9.6 %
		Y	5.40	74.66	19.18		65.0	
		Z	4.96	73.50	18.55		65.0	
10261-CAB	LTE-TDD (SC-FDMA, 100% RB, 3 MHz, QPSK)	X	6.09	80.15	21.50	3.98	65.0	± 9.6 %
		Y	6.88	81.79	22.11		65.0	
		Z	6.20	80.42	21.51		65.0	
10262-CAD	LTE-TDD (SC-FDMA, 100% RB, 5 MHz, 16-QAM)	X	5.53	75.60	20.77	3.98	65.0	± 9.6 %
		Y	5.97	76.64	21.12		65.0	
		Z	5.58	75.79	20.77		65.0	
10263-CAD	LTE-TDD (SC-FDMA, 100% RB, 5 MHz, 64-QAM)	X	5.21	73.26	19.40	3.98	65.0	± 9.6 %
		Y	5.59	74.24	19.76		65.0	
		Z	5.21	73.32	19.33		65.0	
10264-CAD	LTE-TDD (SC-FDMA, 100% RB, 5 MHz, QPSK)	X	6.52	80.79	22.38	3.98	65.0	± 9.6 %
		Y	7.26	82.25	22.87		65.0	
		Z	6.65	81.20	22.51		65.0	
10265-CAD	LTE-TDD (SC-FDMA, 100% RB, 10 MHz, 16-QAM)	X	5.42	72.95	19.72	3.98	65.0	± 9.6 %
		Y	5.78	73.89	20.03		65.0	
		Z	5.43	73.04	19.72		65.0	
10266-CAD	LTE-TDD (SC-FDMA, 100% RB, 10 MHz, 64-QAM)	X	5.81	74.04	20.57	3.98	65.0	± 9.6 %
		Y	6.19	74.96	20.86		65.0	
		Z	5.84	74.19	20.60		65.0	
10267-CAD	LTE-TDD (SC-FDMA, 100% RB, 10 MHz, QPSK)	X	6.31	77.85	21.33	3.98	65.0	± 9.6 %
		Y	6.90	79.09	21.75		65.0	
		Z	6.39	78.16	21.48		65.0	
10268-CAD	LTE-TDD (SC-FDMA, 100% RB, 15 MHz, 16-QAM)	X	6.05	72.91	20.14	3.98	65.0	± 9.6 %
		Y	6.40	73.76	20.40		65.0	
		Z	6.06	73.00	20.17		65.0	
10269-CAD	LTE-TDD (SC-FDMA, 100% RB, 15 MHz, 64-QAM)	X	6.03	72.50	20.01	3.98	65.0	± 9.6 %
		Y	6.37	73.34	20.27		65.0	
		Z	6.05	72.60	20.04		65.0	
10270-CAD	LTE-TDD (SC-FDMA, 100% RB, 15 MHz, QPSK)	X	6.14	75.03	20.36	3.98	65.0	± 9.6 %
		Y	6.59	76.06	20.69		65.0	
		Z	6.19	75.26	20.47		65.0	



10274-CAB	UMTS-FDD (HSUPA, Subtest 5, 3GPP Rel8.10)	X	2.45	66.18	14.83	0.00	150.0	± 9.6 %
		Y	2.58	67.05	15.42		150.0	
		Z	2.44	66.39	14.86		150.0	
10275-CAB	UMTS-FDD (HSUPA, Subtest 5, 3GPP Rel8.4)	X	1.45	67.15	14.79	0.00	150.0	± 9.6 %
		Y	1.65	68.98	16.07		150.0	
		Z	1.46	67.49	14.94		150.0	
10277-CAA	PHS (QPSK)	X	2.05	60.99	6.61	9.03	50.0	± 9.6 %
		Y	2.14	61.42	6.98		50.0	
		Z	2.15	61.21	6.84		50.0	
10278-CAA	PHS (QPSK, BW 884MHz, Rolloff 0.5)	X	3.88	69.24	13.58	9.03	50.0	± 9.6 %
		Y	4.38	71.00	14.54		50.0	
		Z	3.84	68.69	13.30		50.0	
10279-CAA	PHS (QPSK, BW 884MHz, Rolloff 0.38)	X	4.00	69.55	13.78	9.03	50.0	± 9.6 %
		Y	4.51	71.31	14.73		50.0	
		Z	3.94	68.96	13.47		50.0	
10290-AAB	CDMA2000, RC1, SO55, Full Rate	X	1.07	65.69	11.52	0.00	150.0	± 9.6 %
		Y	1.53	70.26	14.37		150.0	
		Z	1.01	65.37	11.10		150.0	
10291-AAB	CDMA2000, RC3, SO55, Full Rate	X	0.60	63.10	9.79	0.00	150.0	± 9.6 %
		Y	0.85	67.12	12.84		150.0	
		Z	0.57	62.93	9.45		150.0	
10292-AAB	CDMA2000, RC3, SO32, Full Rate	X	0.74	66.24	11.75	0.00	150.0	± 9.6 %
		Y	1.46	75.17	16.76		150.0	
		Z	0.73	66.36	11.54		150.0	
10293-AAB	CDMA2000, RC3, SO3, Full Rate	X	1.24	72.67	15.10	0.00	150.0	± 9.6 %
		Y	5.17	93.05	23.35		150.0	
		Z	1.42	74.33	15.45		150.0	
10295-AAB	CDMA2000, RC1, SO3, 1/8th Rate 25 fr.	X	9.92	85.20	23.12	9.03	50.0	± 9.6 %
		Y	9.50	84.91	23.23		50.0	
		Z	10.83	86.02	23.20		50.0	
10297-AAC	LTE-FDD (SC-FDMA, 50% RB, 20 MHz, QPSK)	X	2.57	69.12	16.16	0.00	150.0	± 9.6 %
		Y	2.77	70.42	16.97		150.0	
		Z	2.55	69.32	16.30		150.0	
10298-AAC	LTE-FDD (SC-FDMA, 50% RB, 3 MHz, QPSK)	X	1.27	65.66	12.33	0.00	150.0	± 9.6 %
		Y	1.58	68.64	14.32		150.0	
		Z	1.21	65.43	11.98		150.0	
10299-AAC	LTE-FDD (SC-FDMA, 50% RB, 3 MHz, 16-QAM)	X	2.00	66.49	12.18	0.00	150.0	± 9.6 %
		Y	3.31	72.57	14.96		150.0	
		Z	1.99	66.70	12.06		150.0	
10300-AAC	LTE-FDD (SC-FDMA, 50% RB, 3 MHz, 64-QAM)	X	1.58	63.09	9.74	0.00	150.0	± 9.6 %
		Y	1.99	65.54	11.08		150.0	
		Z	1.51	62.92	9.42		150.0	
10301-AAA	IEEE 802.16e WiMAX (29:18, 5ms, 10MHz, QPSK, PUSC)	X	4.69	65.76	17.48	4.17	50.0	± 9.6 %
		Y	4.64	65.55	17.37		50.0	
		Z	4.67	65.93	17.49		50.0	
10302-AAA	IEEE 802.16e WiMAX (29:18, 5ms, 10MHz, QPSK, PUSC, 3 CTRL symbols)	X	5.09	65.93	17.93	4.96	50.0	± 9.6 %
		Y	5.12	66.18	18.09		50.0	
		Z	5.09	66.17	17.98		50.0	

10303-AAA	IEEE 802.16e WiMAX (31:15, 5ms, 10MHz, 64QAM, PUSC)	X	4.84	65.58	17.76	4.96	50.0	± 9.6 %
		Y	4.88	65.83	17.92		50.0	
		Z	4.85	65.84	17.81		50.0	
10304-AAA	IEEE 802.16e WiMAX (29:18, 5ms, 10MHz, 64QAM, PUSC)	X	4.65	65.44	17.26	4.17	50.0	± 9.6 %
		Y	4.69	65.73	17.44		50.0	
		Z	4.65	65.69	17.31		50.0	
10305-AAA	IEEE 802.16e WiMAX (31:15, 10ms, 10MHz, 64QAM, PUSC, 15 symbols)	X	4.44	68.14	19.56	6.02	35.0	± 9.6 %
		Y	4.41	68.01	19.60		35.0	
		Z	4.62	69.17	19.86		35.0	
10306-AAA	IEEE 802.16e WiMAX (29:18, 10ms, 10MHz, 64QAM, PUSC, 18 symbols)	X	4.68	66.85	19.08	6.02	35.0	± 9.6 %
		Y	4.67	66.81	19.12		35.0	
		Z	4.77	67.53	19.30		35.0	
10307-AAA	IEEE 802.16e WiMAX (29:18, 10ms, 10MHz, QPSK, PUSC, 18 symbols)	X	4.59	67.04	19.05	6.02	35.0	± 9.6 %
		Y	4.58	66.99	19.09		35.0	
		Z	4.69	67.75	19.27		35.0	
10308-AAA	IEEE 802.16e WiMAX (29:18, 10ms, 10MHz, 16QAM, PUSC)	X	4.57	67.28	19.21	6.02	35.0	± 9.6 %
		Y	4.56	67.23	19.25		35.0	
		Z	4.69	68.04	19.45		35.0	
10309-AAA	IEEE 802.16e WiMAX (29:18, 10ms, 10MHz, 16QAM, AMC 2x3, 18 symbols)	X	4.73	67.04	19.22	6.02	35.0	± 9.6 %
		Y	4.72	66.99	19.24		35.0	
		Z	4.82	67.69	19.42		35.0	
10310-AAA	IEEE 802.16e WiMAX (29:18, 10ms, 10MHz, QPSK, AMC 2x3, 18 symbols)	X	4.63	66.94	19.07	6.02	35.0	± 9.6 %
		Y	4.63	66.90	19.11		35.0	
		Z	4.74	67.65	19.30		35.0	
10311-AAC	LTE-FDD (SC-FDMA, 100% RB, 15 MHz, QPSK)	X	2.92	68.38	15.85	0.00	150.0	± 9.6 %
		Y	3.14	69.67	16.60		150.0	
		Z	2.91	68.56	15.97		150.0	
10313-AAA	iDEN 1:3	X	2.95	70.69	14.66	6.99	70.0	± 9.6 %
		Y	3.98	74.43	16.48		70.0	
		Z	3.15	71.48	15.14		70.0	
10314-AAA	iDEN 1:6	X	5.04	79.92	21.00	10.00	30.0	± 9.6 %
		Y	6.78	84.92	23.16		30.0	
		Z	5.73	81.64	21.73		30.0	
10315-AAB	IEEE 802.11b WiFi 2.4 GHz (DSSS, 1 Mbps, 96pc duty cycle)	X	0.97	63.25	14.68	0.17	150.0	± 9.6 %
		Y	1.08	64.33	15.52		150.0	
		Z	0.98	63.49	14.85		150.0	
10316-AAB	IEEE 802.11g WiFi 2.4 GHz (ERP-OFDM, 6 Mbps, 96pc duty cycle)	X	4.44	66.48	16.13	0.17	150.0	± 9.6 %
		Y	4.51	66.82	16.27		150.0	
		Z	4.41	66.56	16.16		150.0	
10317-AAC	IEEE 802.11a WiFi 5 GHz (OFDM, 6 Mbps, 96pc duty cycle)	X	4.44	66.48	16.13	0.17	150.0	± 9.6 %
		Y	4.51	66.82	16.27		150.0	
		Z	4.41	66.56	16.16		150.0	
10400-AAD	IEEE 802.11ac WiFi (20MHz, 64-QAM, 99pc duty cycle)	X	4.53	66.78	16.11	0.00	150.0	± 9.6 %
		Y	4.61	67.15	16.28		150.0	
		Z	4.49	66.84	16.14		150.0	
10401-AAD	IEEE 802.11ac WiFi (40MHz, 64-QAM, 99pc duty cycle)	X	5.27	67.03	16.34	0.00	150.0	± 9.6 %
		Y	5.28	67.17	16.36		150.0	
		Z	5.22	67.01	16.33		150.0	

10402-AAD	IEEE 802.11ac WiFi (80MHz, 64-QAM, 99pc duty cycle)	X	5.50	67.24	16.31	0.00	150.0	± 9.6 %
		Y	5.56	67.57	16.43		150.0	
		Z	5.47	67.27	16.33		150.0	
10403-AAB	CDMA2000 (1xEV-DO, Rev. 0)	X	1.07	65.69	11.52	0.00	115.0	± 9.6 %
		Y	1.53	70.26	14.37		115.0	
		Z	1.01	65.37	11.10		115.0	
10404-AAB	CDMA2000 (1xEV-DO, Rev. A)	X	1.07	65.69	11.52	0.00	115.0	± 9.6 %
		Y	1.53	70.26	14.37		115.0	
		Z	1.01	65.37	11.10		115.0	
10406-AAB	CDMA2000, RC3, SO32, SCH0, Full Rate	X	23.46	102.23	25.39	0.00	100.0	± 9.6 %
		Y	100.00	115.29	27.21		100.0	
		Z	100.00	120.73	29.57		100.0	
10410-AAD	LTE-TDD (SC-FDMA, 1 RB, 10 MHz, QPSK, UL Subframe=2,3,4,7,8,9, Subframe Conf=4)	X	55.06	113.36	27.76	3.23	80.0	± 9.6 %
		Y	100.00	120.25	29.20		80.0	
		Z	100.00	122.59	30.17		80.0	
10415-AAA	IEEE 802.11b WiFi 2.4 GHz (DSSS, 1 Mbps, 99pc duty cycle)	X	0.91	62.47	14.11	0.00	150.0	± 9.6 %
		Y	1.00	63.52	14.99		150.0	
		Z	0.91	62.68	14.27		150.0	
10416-AAA	IEEE 802.11g WiFi 2.4 GHz (ERP-OFDM, 6 Mbps, 99pc duty cycle)	X	4.39	66.47	16.07	0.00	150.0	± 9.6 %
		Y	4.46	66.85	16.24		150.0	
		Z	4.36	66.56	16.10		150.0	
10417-AAB	IEEE 802.11a/h WiFi 5 GHz (OFDM, 6 Mbps, 99pc duty cycle)	X	4.39	66.47	16.07	0.00	150.0	± 9.6 %
		Y	4.46	66.85	16.24		150.0	
		Z	4.36	66.56	16.10		150.0	
10418-AAA	IEEE 802.11g WiFi 2.4 GHz (DSSS-OFDM, 6 Mbps, 99pc duty cycle, Long preamble)	X	4.38	66.64	16.10	0.00	150.0	± 9.6 %
		Y	4.46	67.04	16.28		150.0	
		Z	4.35	66.74	16.14		150.0	
10419-AAA	IEEE 802.11g WiFi 2.4 GHz (DSSS-OFDM, 6 Mbps, 99pc duty cycle, Short preamble)	X	4.40	66.59	16.10	0.00	150.0	± 9.6 %
		Y	4.48	66.98	16.27		150.0	
		Z	4.37	66.68	16.13		150.0	
10422-AAB	IEEE 802.11n (HT Greenfield, 7.2 Mbps, BPSK)	X	4.51	66.58	16.11	0.00	150.0	± 9.6 %
		Y	4.59	66.96	16.28		150.0	
		Z	4.48	66.67	16.14		150.0	
10423-AAB	IEEE 802.11n (HT Greenfield, 43.3 Mbps, 16-QAM)	X	4.67	66.88	16.22	0.00	150.0	± 9.6 %
		Y	4.74	67.25	16.38		150.0	
		Z	4.62	66.95	16.24		150.0	
10424-AAB	IEEE 802.11n (HT Greenfield, 72.2 Mbps, 64-QAM)	X	4.59	66.83	16.19	0.00	150.0	± 9.6 %
		Y	4.67	67.21	16.36		150.0	
		Z	4.55	66.90	16.22		150.0	
10425-AAB	IEEE 802.11n (HT Greenfield, 15 Mbps, BPSK)	X	5.20	67.12	16.39	0.00	150.0	± 9.6 %
		Y	5.25	67.39	16.48		150.0	
		Z	5.17	67.16	16.41		150.0	
10426-AAB	IEEE 802.11n (HT Greenfield, 90 Mbps, 16-QAM)	X	5.23	67.21	16.43	0.00	150.0	± 9.6 %
		Y	5.26	67.44	16.50		150.0	
		Z	5.19	67.25	16.45		150.0	

10427-AAB	IEEE 802.11n (HT Greenfield, 150 Mbps, 64-QAM)	X	5.23	67.14	16.39	0.00	150.0	± 9.6 %
		Y	5.27	67.40	16.48		150.0	
		Z	5.18	67.14	16.40		150.0	
10430-AAB	LTE-FDD (OFDMA, 5 MHz, E-TM 3.1)	X	4.20	71.33	18.23	0.00	150.0	± 9.6 %
		Y	4.38	72.12	18.67		150.0	
		Z	4.24	71.88	18.40		150.0	
10431-AAB	LTE-FDD (OFDMA, 10 MHz, E-TM 3.1)	X	4.04	67.01	16.00	0.00	150.0	± 9.6 %
		Y	4.14	67.47	16.25		150.0	
		Z	4.00	67.12	16.01		150.0	
10432-AAB	LTE-FDD (OFDMA, 15 MHz, E-TM 3.1)	X	4.35	66.89	16.12	0.00	150.0	± 9.6 %
		Y	4.44	67.29	16.32		150.0	
		Z	4.31	66.97	16.15		150.0	
10433-AAB	LTE-FDD (OFDMA, 20 MHz, E-TM 3.1)	X	4.61	66.86	16.21	0.00	150.0	± 9.6 %
		Y	4.68	67.24	16.38		150.0	
		Z	4.57	66.94	16.24		150.0	
10434-AAA	W-CDMA (BS Test Model 1, 64 DPCH)	X	4.31	72.22	18.13	0.00	150.0	± 9.6 %
		Y	4.57	73.29	18.72		150.0	
		Z	4.37	72.83	18.28		150.0	
10435-AAC	LTE-TDD (SC-FDMA, 1 RB, 20 MHz, QPSK, UL Subframe=2,3,4,7,8,9)	X	46.38	110.94	27.14	3.23	80.0	± 9.6 %
		Y	100.00	119.98	29.08		80.0	
		Z	100.00	122.32	30.05		80.0	
10447-AAB	LTE-FDD (OFDMA, 5 MHz, E-TM 3.1, Clipping 44%)	X	3.31	66.87	15.09	0.00	150.0	± 9.6 %
		Y	3.44	67.57	15.54		150.0	
		Z	3.26	66.97	15.03		150.0	
10448-AAB	LTE-FDD (OFDMA, 10 MHz, E-TM 3.1, Clipping 44%)	X	3.89	66.79	15.86	0.00	150.0	± 9.6 %
		Y	3.98	67.27	16.12		150.0	
		Z	3.85	66.90	15.88		150.0	
10449-AAB	LTE-FDD (OFDMA, 15 MHz, E-TM 3.1, Clipping 44%)	X	4.17	66.71	16.01	0.00	150.0	± 9.6 %
		Y	4.26	67.14	16.23		150.0	
		Z	4.14	66.80	16.04		150.0	
10450-AAB	LTE-FDD (OFDMA, 20 MHz, E-TM 3.1, Clipping 44%)	X	4.38	66.63	16.06	0.00	150.0	± 9.6 %
		Y	4.46	67.03	16.25		150.0	
		Z	4.35	66.71	16.09		150.0	
10451-AAA	W-CDMA (BS Test Model 1, 64 DPCH, Clipping 44%)	X	3.16	66.87	14.55	0.00	150.0	± 9.6 %
		Y	3.31	67.71	15.09		150.0	
		Z	3.09	66.88	14.41		150.0	
10456-AAB	IEEE 802.11ac WiFi (160MHz, 64-QAM, 99pc duty cycle)	X	6.10	67.71	16.58	0.00	150.0	± 9.6 %
		Y	6.13	67.95	16.63		150.0	
		Z	6.10	67.81	16.63		150.0	
10457-AAA	UMTS-FDD (DC-HSDPA)	X	3.68	65.12	15.78	0.00	150.0	± 9.6 %
		Y	3.75	65.52	15.96		150.0	
		Z	3.67	65.23	15.81		150.0	
10458-AAA	CDMA2000 (1xEV-DO, Rev. B, 2 carriers)	X	3.88	71.11	17.24	0.00	150.0	± 9.6 %
		Y	4.15	72.36	17.96		150.0	
		Z	3.88	71.47	17.22		150.0	
10459-AAA	CDMA2000 (1xEV-DO, Rev. B, 3 carriers)	X	5.03	68.93	18.26	0.00	150.0	± 9.6 %
		Y	5.12	69.27	18.40		150.0	
		Z	5.02	69.28	18.31		150.0	

10460-AAA	UMTS-FDD (WCDMA, AMR)	X	0.76	67.21	14.98	0.00	150.0	± 9.6 %
		Y	0.95	70.10	17.17		150.0	
		Z	0.78	67.84	15.35		150.0	
10461-AAA	LTE-TDD (SC-FDMA, 1 RB, 1.4 MHz, QPSK, UL Subframe=2,3,4,7,8,9)	X	100.00	124.22	31.05	3.29	80.0	± 9.6 %
		Y	100.00	126.59	32.12		80.0	
		Z	100.00	126.67	32.13		80.0	
10462-AAA	LTE-TDD (SC-FDMA, 1 RB, 1.4 MHz, 16-QAM, UL Subframe=2,3,4,7,8,9)	X	1.13	62.20	9.29	3.23	80.0	± 9.6 %
		Y	1.76	66.14	10.65		80.0	
		Z	1.32	63.88	10.13		80.0	
10463-AAA	LTE-TDD (SC-FDMA, 1 RB, 1.4 MHz, 64-QAM, UL Subframe=2,3,4,7,8,9)	X	0.91	60.00	7.67	3.23	80.0	± 9.6 %
		Y	0.95	60.52	7.63		80.0	
		Z	0.89	60.00	7.73		80.0	
10464-AAA	LTE-TDD (SC-FDMA, 1 RB, 3 MHz, QPSK, UL Subframe=2,3,4,7,8,9)	X	47.59	111.65	27.34	3.23	80.0	± 9.6 %
		Y	100.00	123.29	30.45		80.0	
		Z	100.00	123.26	30.40		80.0	
10465-AAA	LTE-TDD (SC-FDMA, 1 RB, 3 MHz, 16-QAM, UL Subframe=2,3,4,7,8,9)	X	1.05	61.52	8.89	3.23	80.0	± 9.6 %
		Y	1.46	64.47	9.90		80.0	
		Z	1.18	62.83	9.59		80.0	
10466-AAA	LTE-TDD (SC-FDMA, 1 RB, 3 MHz, 64-QAM, UL Subframe=2,3,4,7,8,9)	X	0.91	60.00	7.62	3.23	80.0	± 9.6 %
		Y	0.90	60.08	7.36		80.0	
		Z	0.89	60.00	7.68		80.0	
10467-AAC	LTE-TDD (SC-FDMA, 1 RB, 5 MHz, QPSK, UL Subframe=2,3,4,7,8,9)	X	72.09	117.06	28.59	3.23	80.0	± 9.6 %
		Y	100.00	123.66	30.60		80.0	
		Z	100.00	123.63	30.56		80.0	
10468-AAC	LTE-TDD (SC-FDMA, 1 RB, 5 MHz, 16-QAM, UL Subframe=2,3,4,7,8,9)	X	1.07	61.70	9.00	3.23	80.0	± 9.6 %
		Y	1.53	64.89	10.09		80.0	
		Z	1.22	63.12	9.74		80.0	
10469-AAC	LTE-TDD (SC-FDMA, 1 RB, 5 MHz, 64-QAM, UL Subframe=2,3,4,7,8,9)	X	0.91	60.00	7.62	3.23	80.0	± 9.6 %
		Y	0.90	60.09	7.36		80.0	
		Z	0.89	60.00	7.68		80.0	
10470-AAC	LTE-TDD (SC-FDMA, 1 RB, 10 MHz, QPSK, UL Subframe=2,3,4,7,8,9)	X	74.02	117.39	28.66	3.23	80.0	± 9.6 %
		Y	100.00	123.68	30.61		80.0	
		Z	100.00	123.65	30.56		80.0	
10471-AAC	LTE-TDD (SC-FDMA, 1 RB, 10 MHz, 16-QAM, UL Subframe=2,3,4,7,8,9)	X	1.07	61.65	8.96	3.23	80.0	± 9.6 %
		Y	1.51	64.78	10.03		80.0	
		Z	1.21	63.05	9.70		80.0	
10472-AAC	LTE-TDD (SC-FDMA, 1 RB, 10 MHz, 64-QAM, UL Subframe=2,3,4,7,8,9)	X	0.91	60.00	7.61	3.23	80.0	± 9.6 %
		Y	0.89	60.04	7.32		80.0	
		Z	0.89	60.00	7.66		80.0	
10473-AAC	LTE-TDD (SC-FDMA, 1 RB, 15 MHz, QPSK, UL Subframe=2,3,4,7,8,9)	X	72.58	117.11	28.59	3.23	80.0	± 9.6 %
		Y	100.00	123.64	30.59		80.0	
		Z	100.00	123.61	30.54		80.0	
10474-AAC	LTE-TDD (SC-FDMA, 1 RB, 15 MHz, 16-QAM, UL Subframe=2,3,4,7,8,9)	X	1.06	61.62	8.95	3.23	80.0	± 9.6 %
		Y	1.50	64.73	10.01		80.0	
		Z	1.20	63.02	9.68		80.0	
10475-AAC	LTE-TDD (SC-FDMA, 1 RB, 15 MHz, 64-QAM, UL Subframe=2,3,4,7,8,9)	X	0.91	60.00	7.61	3.23	80.0	± 9.6 %
		Y	0.89	60.02	7.32		80.0	
		Z	0.89	60.00	7.66		80.0	

10477-AAC	LTE-TDD (SC-FDMA, 1 RB, 20 MHz, 16-QAM, UL Subframe=2,3,4,7,8,9)	X	1.04	61.46	8.85	3.23	80.0	± 9.6 %
		Y	1.44	64.36	9.83		80.0	
		Z	1.17	62.77	9.54		80.0	
10478-AAC	LTE-TDD (SC-FDMA, 1 RB, 20 MHz, 64-QAM, UL Subframe=2,3,4,7,8,9)	X	0.91	60.00	7.60	3.23	80.0	± 9.6 %
		Y	0.89	60.00	7.29		80.0	
		Z	0.89	60.00	7.65		80.0	
10479-AAA	LTE-TDD (SC-FDMA, 50% RB, 1.4 MHz, QPSK, UL Subframe=2,3,4,7,8,9)	X	8.21	87.49	22.94	3.23	80.0	± 9.6 %
		Y	20.18	101.14	27.13		80.0	
		Z	18.46	99.74	26.54		80.0	
10480-AAA	LTE-TDD (SC-FDMA, 50% RB, 1.4 MHz, 16-QAM, UL Subframe=2,3,4,7,8,9)	X	5.14	76.02	17.14	3.23	80.0	± 9.6 %
		Y	17.56	91.22	21.83		80.0	
		Z	8.18	81.93	19.01		80.0	
10481-AAA	LTE-TDD (SC-FDMA, 50% RB, 1.4 MHz, 64-QAM, UL Subframe=2,3,4,7,8,9)	X	3.78	71.70	15.15	3.23	80.0	± 9.6 %
		Y	9.36	82.53	18.82		80.0	
		Z	4.98	75.18	16.32		80.0	
10482-AAA	LTE-TDD (SC-FDMA, 50% RB, 3 MHz, QPSK, UL Subframe=2,3,4,7,8,9)	X	2.35	69.25	15.02	2.23	80.0	± 9.6 %
		Y	3.01	72.46	16.59		80.0	
		Z	2.33	69.25	14.80		80.0	
10483-AAA	LTE-TDD (SC-FDMA, 50% RB, 3 MHz, 16-QAM, UL Subframe=2,3,4,7,8,9)	X	3.09	69.06	14.42	2.23	80.0	± 9.6 %
		Y	4.90	74.92	16.84		80.0	
		Z	3.31	69.99	14.61		80.0	
10484-AAA	LTE-TDD (SC-FDMA, 50% RB, 3 MHz, 64-QAM, UL Subframe=2,3,4,7,8,9)	X	2.93	68.12	14.03	2.23	80.0	± 9.6 %
		Y	4.36	73.23	16.22		80.0	
		Z	3.05	68.75	14.10		80.0	
10485-AAC	LTE-TDD (SC-FDMA, 50% RB, 5 MHz, QPSK, UL Subframe=2,3,4,7,8,9)	X	2.95	72.33	17.49	2.23	80.0	± 9.6 %
		Y	3.47	74.53	18.53		80.0	
		Z	3.08	73.09	17.68		80.0	
10486-AAC	LTE-TDD (SC-FDMA, 50% RB, 5 MHz, 16-QAM, UL Subframe=2,3,4,7,8,9)	X	2.76	67.89	15.02	2.23	80.0	± 9.6 %
		Y	3.16	69.70	15.94		80.0	
		Z	2.75	68.00	14.88		80.0	
10487-AAC	LTE-TDD (SC-FDMA, 50% RB, 5 MHz, 64-QAM, UL Subframe=2,3,4,7,8,9)	X	2.75	67.50	14.83	2.23	80.0	± 9.6 %
		Y	3.13	69.21	15.71		80.0	
		Z	2.74	67.55	14.66		80.0	
10488-AAC	LTE-TDD (SC-FDMA, 50% RB, 10 MHz, QPSK, UL Subframe=2,3,4,7,8,9)	X	3.27	71.87	18.23	2.23	80.0	± 9.6 %
		Y	3.61	73.22	18.84		80.0	
		Z	3.35	72.44	18.47		80.0	
10489-AAC	LTE-TDD (SC-FDMA, 50% RB, 10 MHz, 16-QAM, UL Subframe=2,3,4,7,8,9)	X	3.21	68.44	16.77	2.23	80.0	± 9.6 %
		Y	3.45	69.44	17.24		80.0	
		Z	3.25	68.82	16.89		80.0	
10490-AAC	LTE-TDD (SC-FDMA, 50% RB, 10 MHz, 64-QAM, UL Subframe=2,3,4,7,8,9)	X	3.29	68.29	16.72	2.23	80.0	± 9.6 %
		Y	3.53	69.24	17.16		80.0	
		Z	3.33	68.65	16.82		80.0	
10491-AAC	LTE-TDD (SC-FDMA, 50% RB, 15 MHz, QPSK, UL Subframe=2,3,4,7,8,9)	X	3.51	70.39	17.81	2.23	80.0	± 9.6 %
		Y	3.78	71.45	18.28		80.0	
		Z	3.55	70.76	17.99		80.0	
10492-AAC	LTE-TDD (SC-FDMA, 50% RB, 15 MHz, 16-QAM, UL Subframe=2,3,4,7,8,9)	X	3.56	67.76	16.86	2.23	80.0	± 9.6 %
		Y	3.76	68.54	17.20		80.0	
		Z	3.58	68.03	16.97		80.0	

10493-AAC	LTE-TDD (SC-FDMA, 50% RB, 15 MHz, 64-QAM, UL Subframe=2,3,4,7,8,9)	X	3.62	67.64	16.82	2.23	80.0	± 9.6 %
		Y	3.82	68.40	17.14		80.0	
		Z	3.64	67.90	16.91		80.0	
10494-AAC	LTE-TDD (SC-FDMA, 50% RB, 20 MHz, QPSK, UL Subframe=2,3,4,7,8,9)	X	3.79	71.83	18.26	2.23	80.0	± 9.6 %
		Y	4.13	73.06	18.79		80.0	
		Z	3.85	72.23	18.46		80.0	
10495-AAC	LTE-TDD (SC-FDMA, 50% RB, 20 MHz, 16-QAM, UL Subframe=2,3,4,7,8,9)	X	3.59	68.11	17.06	2.23	80.0	± 9.6 %
		Y	3.79	68.91	17.40		80.0	
		Z	3.61	68.36	17.17		80.0	
10496-AAC	LTE-TDD (SC-FDMA, 50% RB, 20 MHz, 64-QAM, UL Subframe=2,3,4,7,8,9)	X	3.67	67.87	17.00	2.23	80.0	± 9.6 %
		Y	3.86	68.62	17.31		80.0	
		Z	3.69	68.11	17.10		80.0	
10497-AAA	LTE-TDD (SC-FDMA, 100% RB, 1.4 MHz, QPSK, UL Subframe=2,3,4,7,8,9)	X	1.45	63.41	11.17	2.23	80.0	± 9.6 %
		Y	1.92	66.56	12.95		80.0	
		Z	1.35	62.71	10.54		80.0	
10498-AAA	LTE-TDD (SC-FDMA, 100% RB, 1.4 MHz, 16-QAM, UL Subframe=2,3,4,7,8,9)	X	1.28	60.00	8.33	2.23	80.0	± 9.6 %
		Y	1.38	60.59	8.91		80.0	
		Z	1.25	60.00	8.01		80.0	
10499-AAA	LTE-TDD (SC-FDMA, 100% RB, 1.4 MHz, 64-QAM, UL Subframe=2,3,4,7,8,9)	X	1.30	60.00	8.19	2.23	80.0	± 9.6 %
		Y	1.33	60.08	8.49		80.0	
		Z	1.27	60.00	7.87		80.0	
10500-AAA	LTE-TDD (SC-FDMA, 100% RB, 3 MHz, QPSK, UL Subframe=2,3,4,7,8,9)	X	3.04	71.93	17.72	2.23	80.0	± 9.6 %
		Y	3.46	73.67	18.54		80.0	
		Z	3.15	72.64	17.94		80.0	
10501-AAA	LTE-TDD (SC-FDMA, 100% RB, 3 MHz, 16-QAM, UL Subframe=2,3,4,7,8,9)	X	2.98	68.33	15.79	2.23	80.0	± 9.6 %
		Y	3.31	69.74	16.50		80.0	
		Z	3.01	68.63	15.79		80.0	
10502-AAA	LTE-TDD (SC-FDMA, 100% RB, 3 MHz, 64-QAM, UL Subframe=2,3,4,7,8,9)	X	3.03	68.16	15.65	2.23	80.0	± 9.6 %
		Y	3.36	69.55	16.35		80.0	
		Z	3.05	68.42	15.63		80.0	
10503-AAC	LTE-TDD (SC-FDMA, 100% RB, 5 MHz, QPSK, UL Subframe=2,3,4,7,8,9)	X	3.23	71.65	18.12	2.23	80.0	± 9.6 %
		Y	3.56	73.00	18.74		80.0	
		Z	3.30	72.21	18.35		80.0	
10504-AAC	LTE-TDD (SC-FDMA, 100% RB, 5 MHz, 16-QAM, UL Subframe=2,3,4,7,8,9)	X	3.19	68.33	16.71	2.23	80.0	± 9.6 %
		Y	3.43	69.33	17.17		80.0	
		Z	3.23	68.71	16.82		80.0	
10505-AAC	LTE-TDD (SC-FDMA, 100% RB, 5 MHz, 64-QAM, UL Subframe=2,3,4,7,8,9)	X	3.27	68.19	16.66	2.23	80.0	± 9.6 %
		Y	3.51	69.14	17.10		80.0	
		Z	3.31	68.54	16.75		80.0	
10506-AAC	LTE-TDD (SC-FDMA, 100% RB, 10 MHz, QPSK, UL Subframe=2,3,4,7,8,9)	X	3.76	71.67	18.18	2.23	80.0	± 9.6 %
		Y	4.10	72.90	18.71		80.0	
		Z	3.81	72.07	18.38		80.0	
10507-AAC	LTE-TDD (SC-FDMA, 100% RB, 10 MHz, 16-QAM, UL Subframe=2,3,4,7,8,9)	X	3.57	68.04	17.02	2.23	80.0	± 9.6 %
		Y	3.78	68.84	17.36		80.0	
		Z	3.59	68.29	17.13		80.0	