

TEST REPORT

of

FCC Part 15 Subpart C §15.247

FCC ID : ZNFDM01G

Equipment Under Test : Cellular/PCS GSM/GPRS/EDGE/WCDMA/HSDPA/HSUPA
Smart Phone

Model Name : DM-01G

Applicant : LG Electronics MobileComm U.S.A., Inc.

Manufacturer : LG Electronics MobileComm U.S.A., Inc.

Date of Test(s) : 2015.02.12 ~ 2015.03.09

Date of Issue : 2015.03.09

In the configuration tested, the EUT complied with the standards specified above.

Tested By:



Date:

2015.03.09

Youngmin Park

Approved By:



Date:

2015.03.09

Hyunchoe You

The results shown in this test report refer only to the sample(s) tested unless otherwise stated. This test report cannot be reproduced, except in full, without prior written permission of the Company.

INDEX

<u>Table of Contents</u>	Page
1. General Information -----	3
2. Radiated Spurious Emissions and Conducted Spurious Emission-----	6
3. 6 dB Bandwidth -----	24
4. Maximum Conducted output power -----	28
5. Power Spectral Density -----	31
6. AC Power Line Conducted Emission -----	34
7. Antenna Requirement -----	42

The results shown in this test report refer only to the sample(s) tested unless otherwise stated. This test report cannot be reproduced, except in full, without prior written permission of the Company.

1. General Information

1.1. Testing Laboratory

SGS Korea Co., Ltd. (Gunpo Laboratory)

-Wireless Div. 2FL, 10-2, LS-ro 182beon-gil, Gunpo-si, Gyeonggi-do, Korea, 435-837

All SGS services are rendered in accordance with the applicable SGS conditions of service available on request and accessible at <http://www.sgs.com/en/Terms-and-Conditions.aspx>.

Phone No. : + 82 31 688 0901

Fax No. : + 82 31 688 0921

1.2. Details of Applicant

Applicant : LG Electronics MobileComm U.S.A., Inc.

Address : 10101 Old Grove Road, San Diego, CA 92131

Contact Person : An, Hee-Ju

Phone No. : +82 2 2033 1103

1.3. Description of EUT

Kind of Product	Cellular/PCS GSM/GPRS/EDGE/WCDMA/HSDPA/HSUPA Smart Phone
Model Name	DM-01G
Power Supply	DC 3.8 V
Frequency Range	2 402 MHz ~ 2 480 MHz (BT LE)
Modulation Technique	DSSS
Number of Channels	40 channel (BT LE)
Antenna Type	Internal type
Antenna Gain	-1.7 dBi

The results shown in this test report refer only to the sample(s) tested unless otherwise stated. This test report cannot be reproduced, except in full, without prior written permission of the Company.

SGS Korea Co., Ltd. (Gunpo Laboratory) 4, LS-ro 182beon-gil, Gunpo-si, Gyeonggi-do, Korea, 435-040 <http://www.sgsgroup.kr>

RTT5041-20(2014.01.20)(2)

Tel. +82 31 428 5700 / Fax. +82 31 427 2370

A4(210 mm x 297 mm)

1.4. Test Equipment List

Equipment	Manufacturer	Model	S/N	Cal Date	Cal Interval	Cal Due.
Signal Generator	Agilent	E8257D	MY51501169	Jul. 17, 2014	Annual	Jul. 17, 2015
Spectrum Analyzer	Agilent	N9030A	MY53120526	Jul. 17, 2014	Annual	Jul. 17, 2015
Spectrum Analyzer	R&S	FSV30	100768	Mar. 27, 2014	Annual	Mar. 27, 2015
High Pass Filter	Wainwright	WHK3.0/18G-6SS	4	Jul. 02, 2014	Annual	Jul. 02, 2015
High Pass Filter	Wainwright	WHK7.5/26.5G-6SS	15	Jul. 02, 2014	Annual	Jul. 02, 2015
Low Pass Filter	Mini circuits	NLP-1200+	V 8979400903-2	Mar. 21, 2014	Annual	Mar. 21, 2015
Power Sensor	R&S	NRP-Z81	100669	Mar. 19, 2014	Annual	Mar. 19, 2015
Attenuator	AEROFLEX / INMET	18N-20 dB	2	Mar. 18, 2014	Annual	Mar. 18, 2015
DC Power Supply	Agilent	U8002A	MY49030063	Dec. 06, 2014	Annual	Dec. 06, 2015
Preamplifier	H.P.	8447F	2944A03909	Aug. 27, 2014	Annual	Aug. 27, 2015
Preamplifier	R&S	SCU 18	10117	Dec. 16, 2014	Annual	Dec. 16, 2015
Preamplifier	MITEQ Inc.	JS44-18004000-35-8P	1546891	Apr. 28, 2014	Annual	Apr. 28, 2015
Bilog Antenna	SCHWARZBECK MESSELEKTRONIK	VULB9163	396	Jun. 07, 2013	Biennial	Jun. 07, 2015
Loop Antenna	SCHWARZBECK MESSELEKTRONIK	FMZB 1519	1519-039	Jul. 09, 2013	Biennial	Jul. 09, 2015
Horn Antenna	R&S	HF906	100326	Dec. 10, 2013	Biennial	Dec. 10, 2015
Horn Antenna	SCHWARZBECK MESSELEKTRONIK	BBHA9170	BBHA9170431	May 15, 2014	Biennial	May 15, 2016
Antenna Master	INN-CO	MM4000	N/A	N/A	N/A	N.C.R.
Turn Table	INN-CO	DS 1200 S	N/A	N/A	N/A	N.C.R.
Test Receiver	R&S	ESU26	100368	Dec. 16, 2014	Annual	Dec. 16, 2015
Test Receiver	R&S	ESCI 7	100911	Dec. 24, 2014	Annual	Dec. 24, 2015
Two-Line V-Network	R&S	ENV216	100190	Dec. 25, 2014	Annual	Dec. 25, 2015
Anechoic Chamber	SY Corporation	L x W x H (9.6 m x 6.4 m x 6.6 m)	N/A	N/A	N/A	N.C.R.
Shield Room	SY Corporation	L x W x H (6.5 m x 3.5 m x 3.5 m)	N/A	N.C.R.	N/A	N.C.R.

The results shown in this test report refer only to the sample(s) tested unless otherwise stated. This test report cannot be reproduced, except in full, without prior written permission of the Company.

1.5. Summary of Test Results

The EUT has been tested according to the following specifications:

APPLIED STANDARD : FCC Part15 Subpart C		
Standard section	Test Item(s)	Result
15.205 15.209 15.247(d)	Radiated Spurious Emissions and Conducted Spurious Emission	Complied
15.247(a)(2)	6 dB Bandwidth	Complied
15.247(b)(3)	Maximum Conducted Output Power	Complied
15.247(e)	Power Spectral Density	Complied
15.207	AC Power Line Conducted Emission	Complied

1.6. Test Procedure(s)

The measurement procedures described in the American National Standard for Methods of Measurement of Radio-Noise Emission from Low-Voltage Electrical and Electronic Equipment in the Range of 9 kHz to 40 GHz (ANSI C63.4-2009) and the guidance provided in KDB 558074 v03r02 were used in the measurement of the DUT.

1.7. Sample calculation

Where relevant, the following sample calculation is provided:

1.7.1. Conducted test

Offset value (dB) = Attenuator (dB) + Cable loss (dB)

1.7.2. Radiation test

Field strength level (dB μ V/m) = Measured level (dB μ V) + Antenna factor (dB) + Cable loss (dB) – amplifier (dB)

1.8. Test report revision

Revision	Report number	Date of Issue	Description
0	F690501/RF-RTL008481	2015.03.09	Initial

The results shown in this test report refer only to the sample(s) tested unless otherwise stated. This test report cannot be reproduced, except in full, without prior written permission of the Company.

2. Radiated Spurious Emissions and Conducted Spurious Emission

2.1. Test Setup

2.1.1. Radiated Spurious Emissions

The diagram below shows the test setup that is utilized to make the measurements for emission from 9 kHz to 30 MHz Emissions.

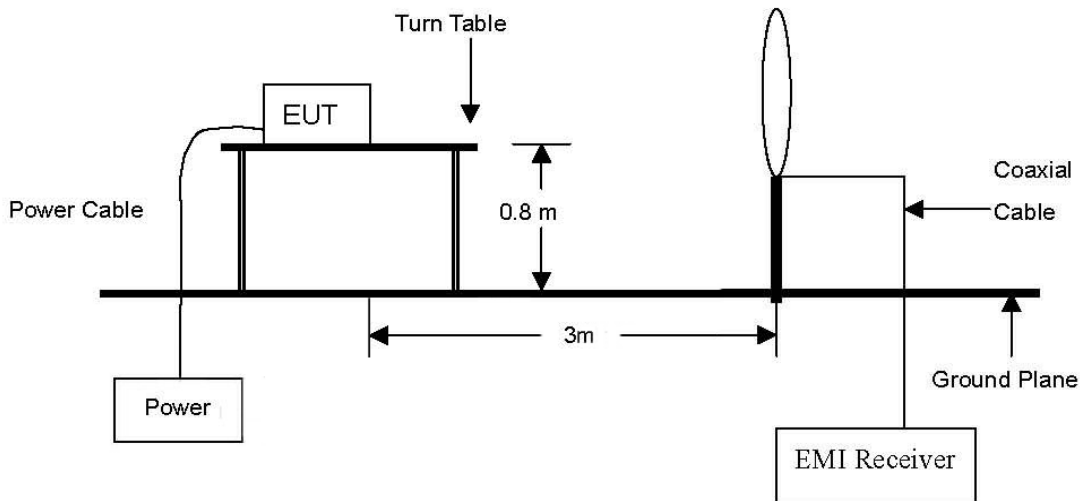

The diagram below shows the test setup that is utilized to make the measurements for emission from 30 MHz to 1 GHz Emissions.

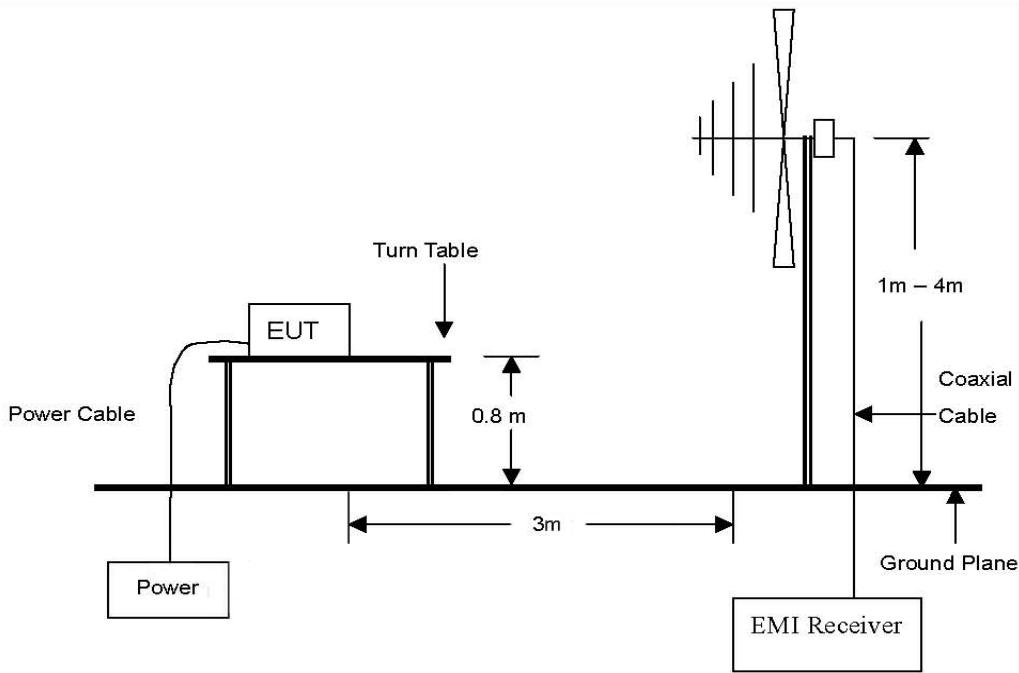

The results shown in this test report refer only to the sample(s) tested unless otherwise stated. This test report cannot be reproduced, except in full, without prior written permission of the Company.

The diagram below shows the test setup that is utilized to make the measurements for emission. The spurious emissions were investigated from 1 GHz to the 10th harmonic of the highest fundamental frequency or 40 GHz, whichever is lower.

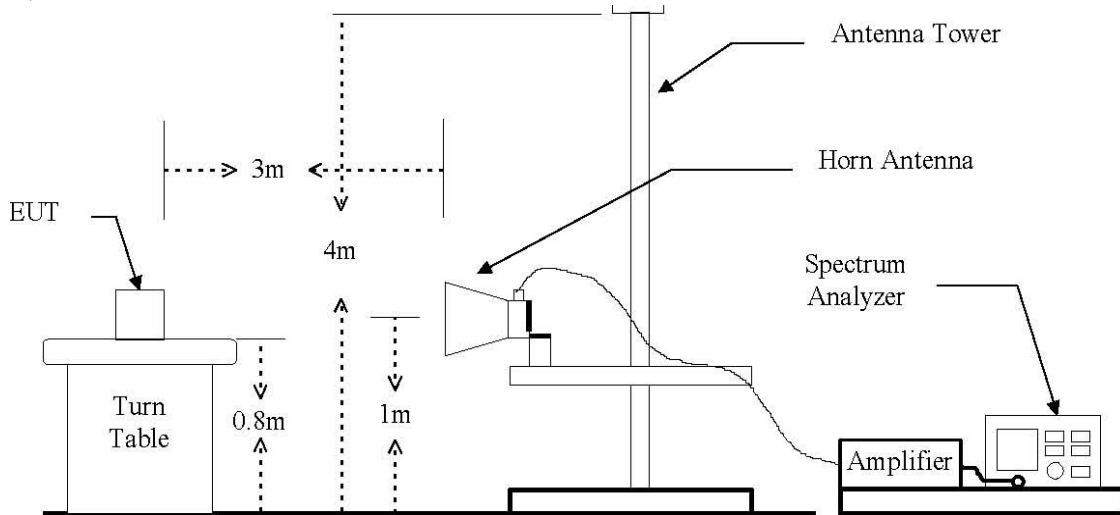

The results shown in this test report refer only to the sample(s) tested unless otherwise stated. This test report cannot be reproduced, except in full, without prior written permission of the Company.

2.1.2. Conducted Spurious Emissions

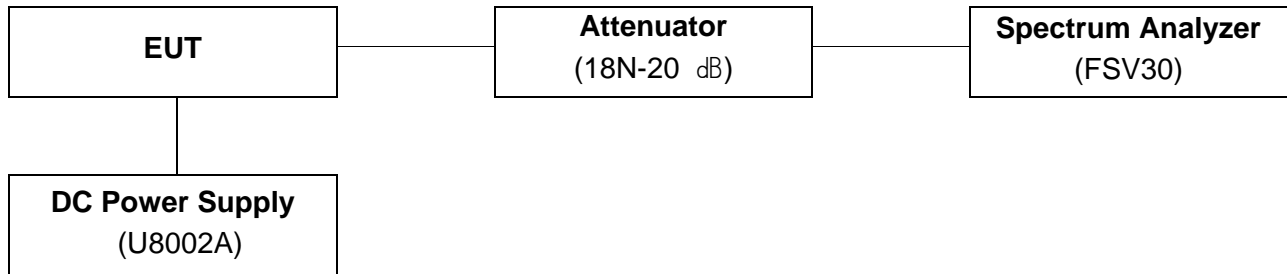

2.2. Limit

According to §15.247(d), in any 100 kHz bandwidth outside the frequency band in which the spread spectrum or digitally modulated intentional radiator is operating, the radio frequency power that is produced by the intentional radiator shall be at least 20 dB below that in the 100 kHz bandwidth within the band that contains the highest level of the desired power, based on either an RF conducted or a radiated measurement, provided the transmitter demonstrates compliance with the peak conducted power limits. If the transmitter complies with the conducted power limits based on the use of RMS averaging over a time interval, as permitted under paragraph(b)(3) of this section, the attenuation required under this paragraph shall be 30 dB instead of 20 dB. Attenuation below the general limits specified in section §15.209(a) is not required. In addition, radiated emission which in the restricted band, as define in section §15.205(a), must also comply the radiated emission limits specified in section §15.209(a) (see section §15.205(c))

According to § 15.209(a), Except as provided elsewhere in this Subpart, the emissions from an intentional radiator shall not exceed the field strength levels specified in the following table :

Frequency (MHz)	Distance (Meters)	Field Strength (dB μ V/m)	Field Strength (μ V/m)
0.009 – 0.490	300	20 log (2 400/F(kHz))	2 400/F(kHz)
0.490 – 1.705	30	20 log (24 000/F(kHz))	24 000/F(kHz)
1.705 – 30.0	30	29.54	30
30 - 88	3	40.0	100
88 – 216	3	43.5	150
216 – 960	3	46.0	200
Above 960	3	54.0	500

The results shown in this test report refer only to the sample(s) tested unless otherwise stated. This test report cannot be reproduced, except in full, without prior written permission of the Company.

2.3. Test Procedures

Radiated emissions from the EUT were measured according to the dictates in section 11.0 & 12.0 of KDB 558074_v03r02 and ANSI C63.4-2009.

2.3.1. Test Procedures for emission below 30 MHz

1. The EUT was placed on the top of a rotating table 0.8 meters above the ground at a 3 meter anechoic chamber test site. The table was rotated 360 degrees to determine the position of the highest radiation.
2. Then antenna is a loop antenna is fixed at one meter above the ground to determine the maximum value of the field strength. Both parallel and perpendicular of the antenna are set to make the measurement.
3. For each suspected emission, the EUT was arranged to its worst case and then the table was turned from 0 degrees to 360 degrees to find the maximum reading.
4. The test-receiver system was set to average or quasi peak detect function and Specified Bandwidth with Maximum Hold Mode.

2.3.2. Test Procedures for emission from above 30 MHz

1. The EUT was placed on the top of a rotating table 0.8 meters above the ground at a 3 meter anechoic chamber test site. The table was rotated 360 degrees to determine the position of the highest radiation.
2. During performing radiated emission below 1 GHz, the EUT was set 3 meters away from the interference receiving antenna, which was mounted on the top of a variable-height antenna tower. During performing radiated emission above 1 GHz, the EUT was set 3 meter away from the interference-receiving antenna.
3. The antenna is a bi-log antenna, a horn antenna and its height is varied from one meter to four meters above the ground to determine the maximum value of the field strength. Both horizontal and vertical polarizations of the antenna are set to make the measurement.
4. For each suspected emission, the EUT was arranged to its worst case and then the antenna was tuned to heights from 1 meter to 4 meters and the table was turned from 0 degrees to 360 degrees to find the maximum reading.
5. The test-receiver system was set to Peak Detect Function and Specified Bandwidth with Maximum Hold Mode.
6. If the emission level of the EUT in peak mode was 10 dB lower than the limit specified, then testing could be stopped and the peak values of the EUT would be reported. Otherwise the emissions that did not have 10 dB margin would be re-tested one by one using peak, quasi-peak or average method as specified and then reported in a data sheet.

The results shown in this test report refer only to the sample(s) tested unless otherwise stated. This test report cannot be reproduced, except in full, without prior written permission of the Company.

NOTE;

All data rates and modes were investigated for radiated spurious emissions. Only the radiated emissions of the configuration that produced the worst case emissions are reported in this section.

1. Unwanted Emissions into Non-Restricted Frequency Bands

- The Reference Level Measurement refer to section 11.2

Set analyzer center frequency to DTS channel center frequency, SPAN \geq 1.5 times the DTS channel bandwidth, the RBW = 100 kHz and VBW \geq 3 x RBW, Detector = Peak, Sweep time = Auto couple, Trace = Max hold

- Unwanted Emissions Level Measurement refer to section 11.3

Set the center frequency and span to encompass frequency range to be measured, the RBW = 100 kHz and VBW \geq 3 x RBW, Detector = Peak, Ensure that the number of measurement points \geq span/RBW, Sweep time = Auto couple, Trace = Max hold

2. Unwanted Emissions into Restricted Frequency Bands

- Peak Power measurement procedure refer to section 12.2.4

Set RBW = as specified in Table 1, VBW \geq 3 x RBW, SPAN \geq RBW, Detector = Peak, Sweep time = Auto couple, Trace = Max hold

Table 1- RBW as a function of frequency

Frequency	RBW
9 – 150 kHz	200 – 300 Hz
0.15 – 30 MHz	9 – 10 kHz
30 – 1 000 MHz	100 – 120 kHz
> 1 000 MHz	1 MHz

-Average Power measurements procedure refer to section 12.2.5.2

The EUT shall be configured to operate at the maximum achievable duty cycle.

Measure the duty cycle, x, of the transmitter output signal as described in section 6.0.

Set RBW = 1 MHz, VBW \geq 3 x RBW, Detector = RMS, if span / (# of points in sweep) \leq (RBW/2).

Satisfying this condition may require increasing the number of points in the sweep or reducing the span. If this condition cannot be satisfied then the detector mode shall be set to peak,

Averaging type = power (i.e., RMS).

As an alternative the detector and averaging type may be set for linear voltage averaging.

Some instruments require linear display mode in order to use linear voltage averaging. Log or dB averaging shall not be used. Sweep time = auto, Perform a trace average of at least 100 traces.

A correction factor shall be added to the measurement results prior to comparing to the emission limit in order to compute the emission level that would have been measured had the test been performed at 100 percent duty cycle. The correction factor is computed as follows:

- 1) If power averaging (RMS) mode was used in step f), then the applicable correction factor is $10 \log (1/x)$, where x is the duty cycle.

3. To get a maximum emission level from the EUT, the EUT is manipulated through three orthogonal planes. Definition of DUT three orthogonal planes were described in the test setup photo.

Worst orthogonal plan of EUT is **Y – axis** during radiation test.

The results shown in this test report refer only to the sample(s) tested unless otherwise stated. This test report cannot be reproduced, except in full, without prior written permission of the Company.

2.3.3. Test Procedures for Conducted Spurious Emissions

All data rates and modes were investigated for conducted spurious emissions. Only the conducted emissions of the configuration that produced the worst case emissions are reported in this section.

Per the guidance of KDB 558074 v03r02, section 11.1 & 11.2, the reference level for out of band emissions is established from the plots of this section since the band edge emissions are measured with a RBW of 100 kHz. This reference level is then used as the limit in subsequent plots for out of band spurious emissions shown in section 2.4.3. The limit for out of band spurious emission at the band edge is 20 dB or 30 dB below the fundamental emission level measured in a 100 kHz bandwidth.

1. Conducted Emissions at Band Edge

- The Measurement refer to section 11.3

Set the center frequency and span to encompass frequency range to be measured, the RBW = 100 kHz and VBW $\geq 3 \times$ RBW, Detector = Peak, Sweep time = Auto couple, Trace = Max hold, Ensure that the number of measurement points \geq span/RBW, The trace was allowed to stabilize.

2. Conducted Spurious Emissions

- The Measurement refer to section 11.3

Start frequency was set to 30 MHz and stop frequency was set to 24.8 GHz (separated into two plots per channel), RBW = 1 MHz, VBW = 3 MHz Detector = Peak, Sweep time = Auto couple, Trace = Max hold, The trace was allowed to stabilize.

- RBW was set to 1 MHz rather than 100 kHz in order to increase the measurement speed.
- The display line shown in section 2.4 plots denotes the limit at 20 dB below the fundamental emission level measured in a 100 kHz bandwidth. However, since the traces in the plots are measured with a 1 MHz RBW, the display line may not necessarily appear to be 20 dB below the level of the fundamental in a 1 MHz bandwidth.
- For plots showing conducted spurious emissions near the limits, the frequencies were investigated with a reduced RBW to ensure that no emissions were present.

3. Correction factor

- For plots showing conducted spurious emissions from 30 MHz to 24.8 GHz, all path loss of wide frequency range was investigated and compensated to spectrum analyzer as correction factor. The reading values shown in plots were final result.

The results shown in this test report refer only to the sample(s) tested unless otherwise stated. This test report cannot be reproduced, except in full, without prior written permission of the Company.

2.4. Test Results

Ambient temperature : (23 ± 1) °C

Relative humidity : 47 % R.H.

2.4.1. Spurious Radiated Emission below 1 000 MHz

The frequency spectrum from 9 kHz to 1 000 MHz was investigated.

-Normal cover

Radiated Emissions			Ant	Correction Factors		Total	FCC Limit	
Frequency (MHz)	Reading (dB μ V)	Detect Mode	Pol.	AF (dB/m)	AMP + CL (dB)	Actual (dB μ V/m)	Limit (dB μ V/m)	Margin (dB)
43.22	32.68	Peak	V	14.54	-26.92	20.30	40.00	19.70
44.63	33.10	Peak	H	16.11	-26.91	22.30	40.00	17.70
87.23	33.82	Peak	H	12.01	-26.43	19.40	40.00	20.60
154.81	35.10	Peak	H	9.65	-25.85	18.90	43.50	24.60
217.74	34.10	Peak	V	12.46	-25.26	21.30	46.00	24.70
324.76	33.95	Peak	V	15.80	-24.65	25.10	46.00	20.90
Above 400.00	Not detected	-	-	-	-	-	-	-

The results shown in this test report refer only to the sample(s) tested unless otherwise stated. This test report cannot be reproduced, except in full, without prior written permission of the Company.

-Quick cover

Radiated Emissions			Ant	Correction Factors		Total	FCC Limit	
Frequency (MHz)	Reading (dB μ V)	Detect Mode	Pol.	AF (dB/m)	AMP + CL (dB)	Actual (dB μ V/m)	Limit (dB μ V/m)	Margin (dB)
43.01	33.11	Peak	V	14.51	-26.92	20.70	40.00	19.30
49.93	32.89	Peak	H	15.79	-26.88	21.80	40.00	18.20
99.27	32.58	Peak	H	14.49	-26.27	20.80	43.50	22.70
182.65	34.35	Peak	H	10.74	-25.49	19.60	43.50	23.90
204.72	34.21	Peak	V	11.90	-25.31	20.80	43.50	22.70
355.72	34.33	Peak	V	16.47	-24.80	26.00	46.00	20.00
Above 400.00	Not detected	-	-	-	-	-	-	-

Remark:

1. All spurious emissions at channels are almost the same below 1 GHz, so that the middle channel was chosen at representative in final test.
2. Radiated spurious emission measurement as below
(Actual = Reading + AF + CL - AMP)
3. All reading values are peak values.

The results shown in this test report refer only to the sample(s) tested unless otherwise stated. This test report cannot be reproduced, except in full, without prior written permission of the Company.

2.4.2. Spurious Radiated Emission above 1 000 MHz

The frequency spectrum above 1 000 MHz was investigated.

-Normal cover

A. Low Channel (2 402 MHz)

Radiated Emissions			Ant	Correction Factors		Total	FCC Limit	
Frequency (MHz)	Reading (dB μ V)	Detect Mode	Pol.	AF (dB/m)	CL (dB)	Actual (dB μ V/m)	Limit (dB μ V/m)	Margin (dB)
*2 390.00	25.07	Peak	H	28.08	6.47	59.62	74.00	14.38
*2 390.00	15.06	Average	H	28.08	6.47	49.61	54.00	4.39

Radiated Emissions			Ant	Correction Factors		Total	FCC Limit	
Frequency (MHz)	Reading (dB μ V)	Detect Mode	Pol.	AF (dB/m)	AMP+CL (dB)	Actual (dB μ V/m)	Limit (dB μ V/m)	Margin (dB)
*4 804.06	41.86	Peak	H	32.61	-33.67	40.80	74.00	33.20
*4 804.06	37.98	Average	H	32.61	-33.67	36.92	54.00	17.08
Above 4 900.00	Not detected	-	-	-	-	-	-	-

B. Middle Channel (2 440 MHz)

Radiated Emissions			Ant	Correction Factors		Total	FCC Limit	
Frequency (MHz)	Reading (dB μ V)	Detect Mode	Pol.	AF (dB/m)	AMP+CL (dB)	Actual (dB μ V/m)	Limit (dB μ V/m)	Margin (dB)
*4 880.00	41.35	Peak	H	33.00	-33.45	40.90	74.00	33.10
*4 880.00	37.80	Average	H	33.00	-33.45	37.35	54.00	16.65
Above 4 900.00	Not detected	-	-	-	-	-	-	-

The results shown in this test report refer only to the sample(s) tested unless otherwise stated. This test report cannot be reproduced, except in full, without prior written permission of the Company.

C. High Channel (2 480 MHz)

Radiated Emissions			Ant	Correction Factors		Total	FCC Limit	
Frequency (MHz)	Reading (dB μ V)	Detect Mode	Pol.	AF (dB/m)	CL (dB)	Actual (dB μ V/m)	Limit (dB μ V/m)	Margin (dB)
*2 483.50	24.72	Peak	H	28.17	6.65	59.54	74.00	14.46
*2 483.50	15.40	Average	H	28.17	6.65	50.22	54.00	3.78

Radiated Emissions			Ant	Correction Factors		Total	FCC Limit	
Frequency (MHz)	Reading (dB μ V)	Detect Mode	Pol.	AF (dB/m)	AMP+CL (dB)	Actual (dB μ V/m)	Limit (dB μ V/m)	Margin (dB)
*4 959.58	41.78	Peak	H	33.16	-33.33	41.61	74.00	32.39
*4 959.58	38.14	Average	H	33.16	-33.33	37.97	54.00	16.03
Above 5 000.00	Not detected	-	-	-	-	-	-	-

The results shown in this test report refer only to the sample(s) tested unless otherwise stated. This test report cannot be reproduced, except in full, without prior written permission of the Company.

-Quick cover

A. Low Channel (2 402 MHz)

Radiated Emissions			Ant	Correction Factors		Total	FCC Limit	
Frequency (MHz)	Reading (dB μ V)	Detect Mode	Pol.	AF (dB/m)	CL (dB)	Actual (dB μ V/m)	Limit (dB μ V/m)	Margin (dB)
*2 390.00	24.93	Peak	H	28.08	6.47	59.48	74.00	14.52
*2 390.00	14.96	Average	H	28.08	6.47	49.51	54.00	4.49

Radiated Emissions			Ant	Correction Factors		Total	FCC Limit	
Frequency (MHz)	Reading (dB μ V)	Detect Mode	Pol.	AF (dB/m)	AMP+CL (dB)	Actual (dB μ V/m)	Limit (dB μ V/m)	Margin (dB)
*4 804.05	41.74	Peak	H	32.61	-33.67	40.68	74.00	33.32
*4 804.05	37.66	Average	H	32.61	-33.67	36.60	54.00	17.40
Above 4 900.00	Not detected	-	-	-	-	-	-	-

B. Middle Channel (2 440 MHz)

Radiated Emissions			Ant	Correction Factors		Total	FCC Limit	
Frequency (MHz)	Reading (dB μ V)	Detect Mode	Pol.	AF (dB/m)	AMP+CL (dB)	Actual (dB μ V/m)	Limit (dB μ V/m)	Margin (dB)
*4 880.03	41.24	Peak	H	33.00	-33.45	40.79	74.00	33.21
*4 880.03	37.60	Average	H	33.00	-33.45	37.15	54.00	16.85
Above 4 900.00	Not detected	-	-	-	-	-	-	-

The results shown in this test report refer only to the sample(s) tested unless otherwise stated. This test report cannot be reproduced, except in full, without prior written permission of the Company.

C. High Channel (2 480 MHz)

Radiated Emissions			Ant	Correction Factors		Total	FCC Limit	
Frequency (MHz)	Reading (dB μ V)	Detect Mode	Pol.	AF (dB/m)	CL (dB)	Actual (dB μ V/m)	Limit (dB μ V/m)	Margin (dB)
*2 483.50	24.65	Peak	H	28.17	6.65	59.47	74.00	14.53
*2 483.50	15.34	Average	H	28.17	6.65	50.16	54.00	3.84

Radiated Emissions			Ant	Correction Factors		Total	FCC Limit	
Frequency (MHz)	Reading (dB μ V)	Detect Mode	Pol.	AF (dB/m)	AMP+CL (dB)	Actual (dB μ V/m)	Limit (dB μ V/m)	Margin (dB)
*4 959.55	41.57	Peak	H	33.16	-33.33	41.40	74.00	32.60
*4 959.55	38.02	Average	H	33.16	-33.33	37.85	54.00	16.15
Above 5 000.00	Not detected	-	-	-	-	-	-	-

Remarks;

1. "*" means the restricted band.
2. Measuring frequencies from 1 GHz to the 10th harmonic of highest fundamental frequency.
3. Radiated emissions measured in frequency above 1 000 MHz were made with an instrument using peak/average detector mode.
4. Actual = Reading + AF + AMP + CL

The results shown in this test report refer only to the sample(s) tested unless otherwise stated. This test report cannot be reproduced, except in full, without prior written permission of the Company.

2.4.3. Spurious RF Conducted Emissions: Plot of Spurious RF Conducted Emission

Low Channel

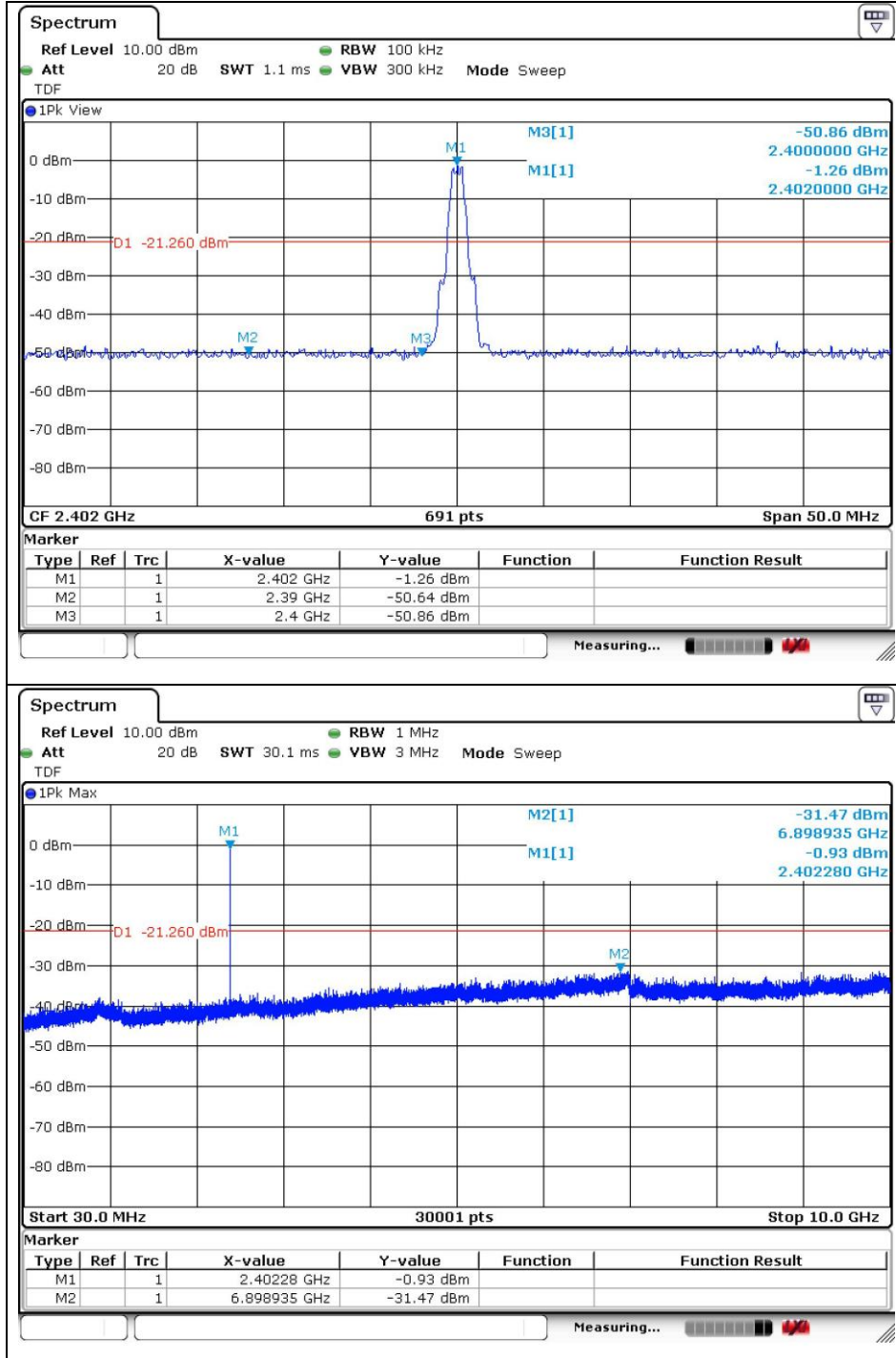

The results shown in this test report refer only to the sample(s) tested unless otherwise stated. This test report cannot be reproduced, except in full, without prior written permission of the Company.

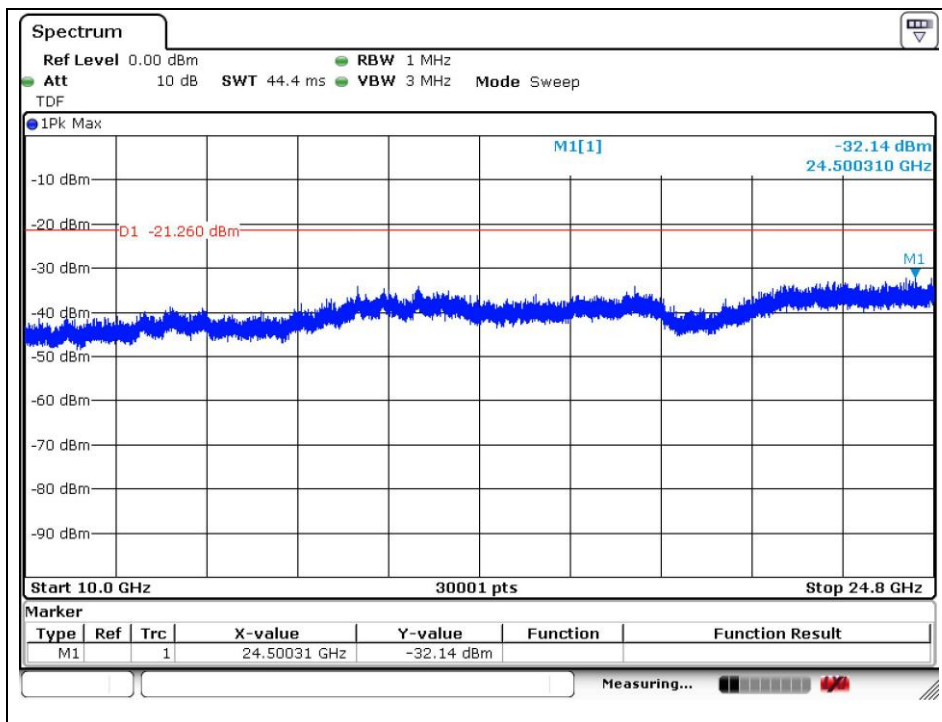

The results shown in this test report refer only to the sample(s) tested unless otherwise stated. This test report cannot be reproduced, except in full, without prior written permission of the Company.

Middle Channel

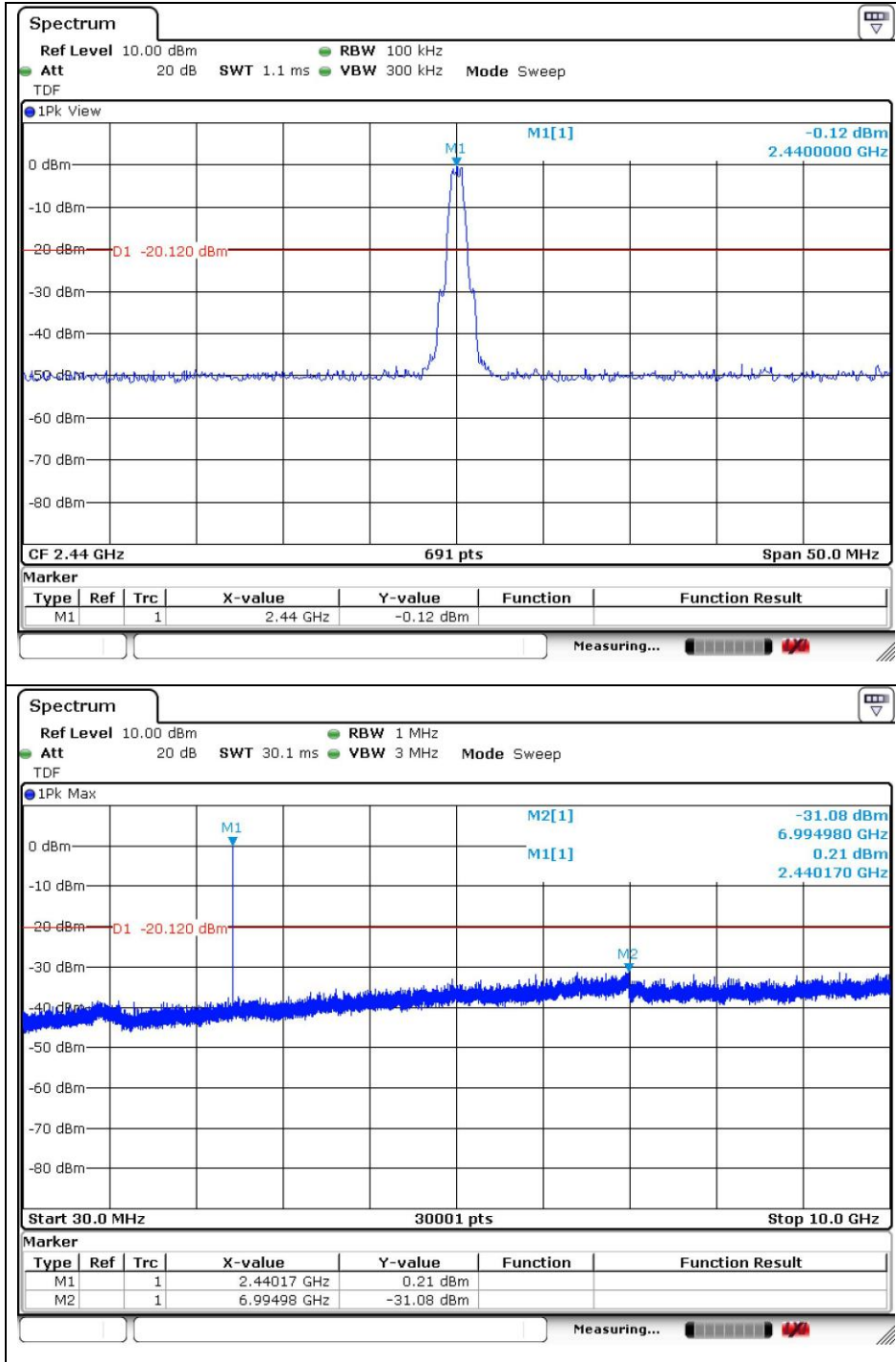

The results shown in this test report refer only to the sample(s) tested unless otherwise stated. This test report cannot be reproduced, except in full, without prior written permission of the Company.

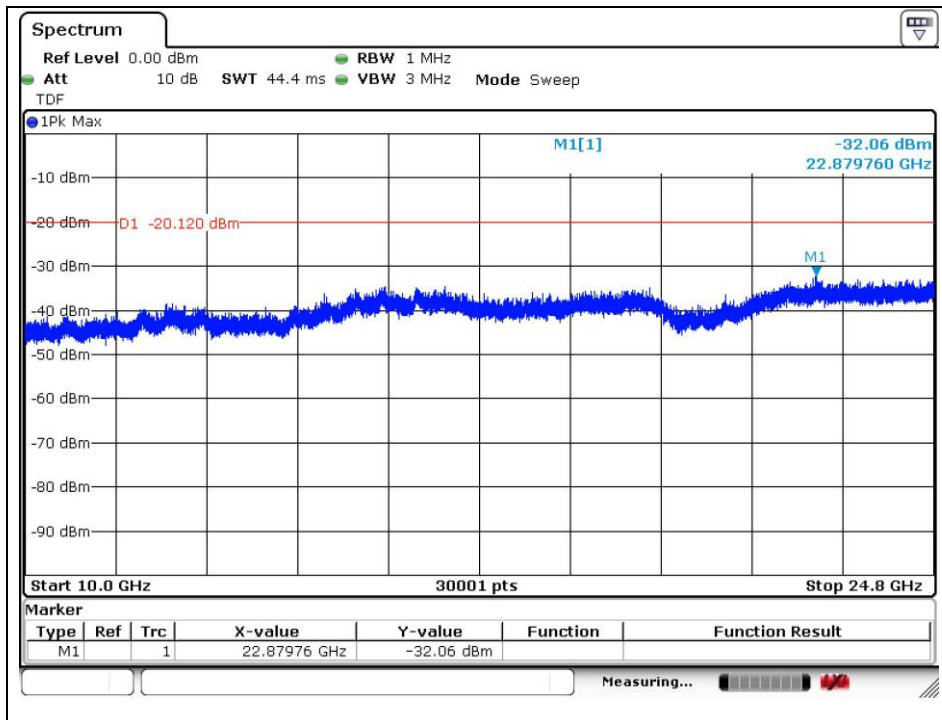

The results shown in this test report refer only to the sample(s) tested unless otherwise stated. This test report cannot be reproduced, except in full, without prior written permission of the Company.

High Channel

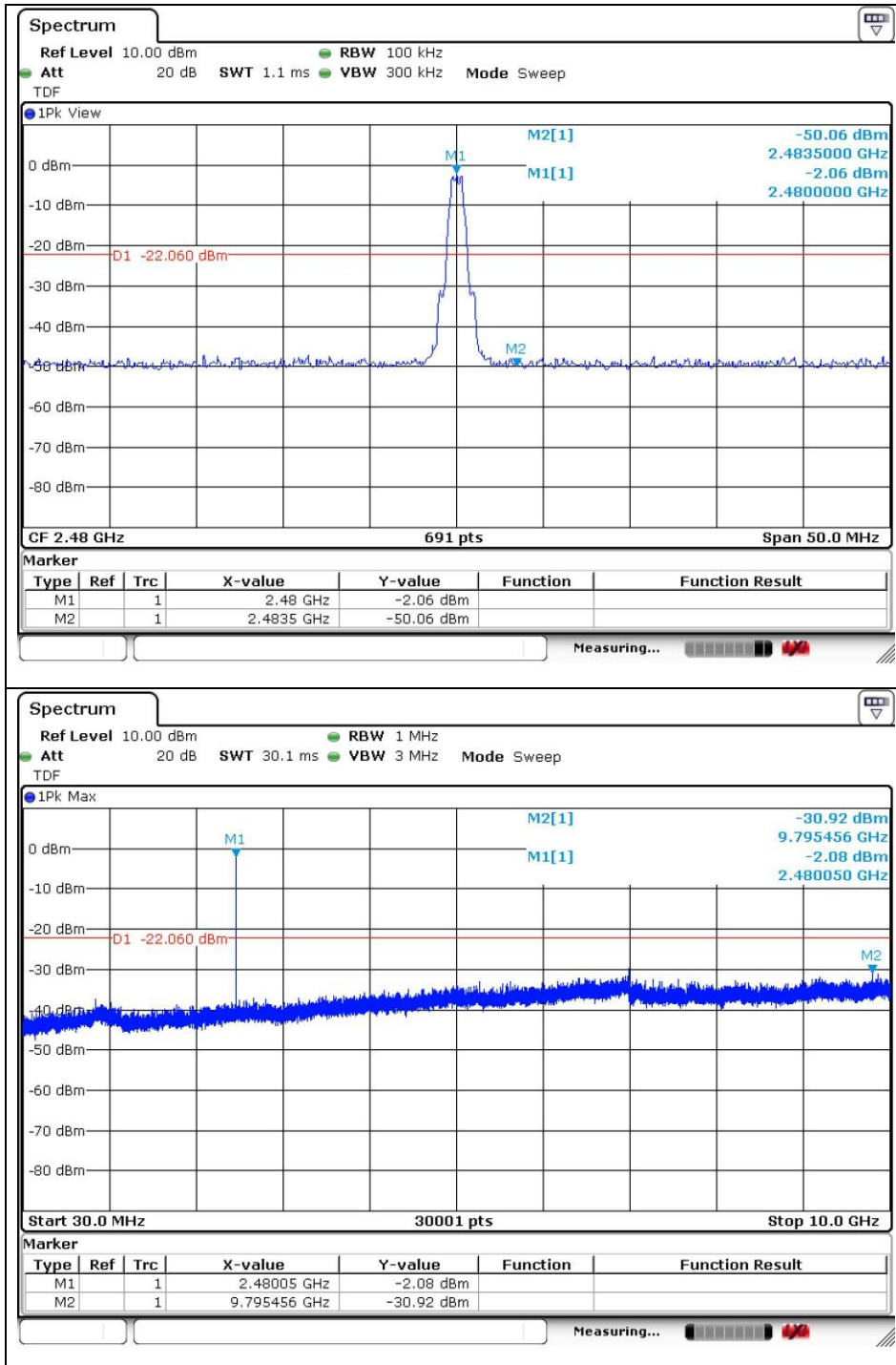

The results shown in this test report refer only to the sample(s) tested unless otherwise stated. This test report cannot be reproduced, except in full, without prior written permission of the Company.

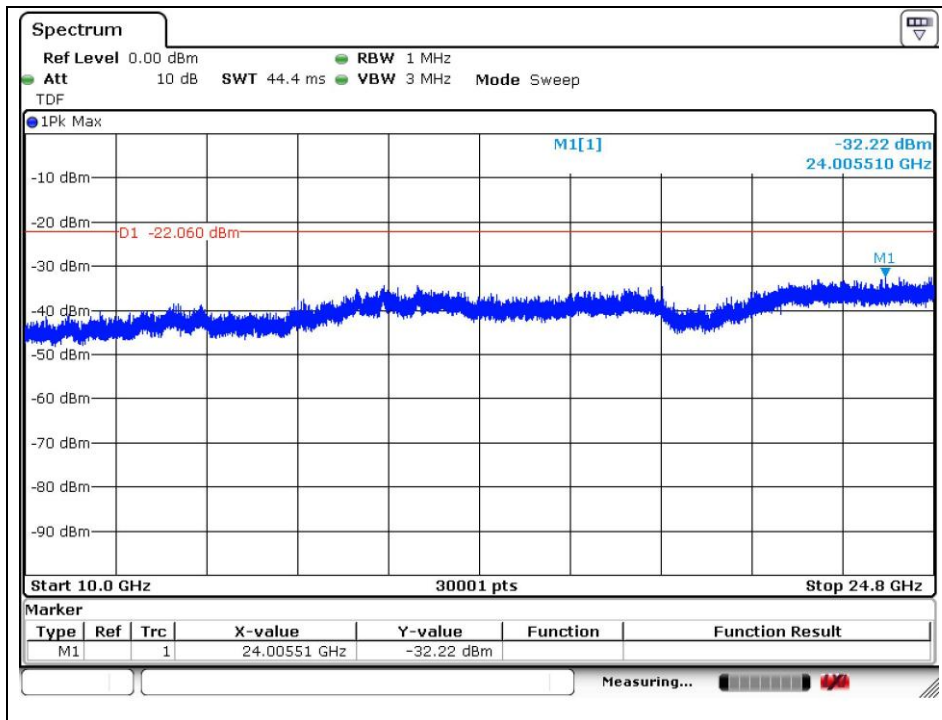

The results shown in this test report refer only to the sample(s) tested unless otherwise stated. This test report cannot be reproduced, except in full, without prior written permission of the Company.

3. 6 dB Bandwidth

3.1. Test Setup

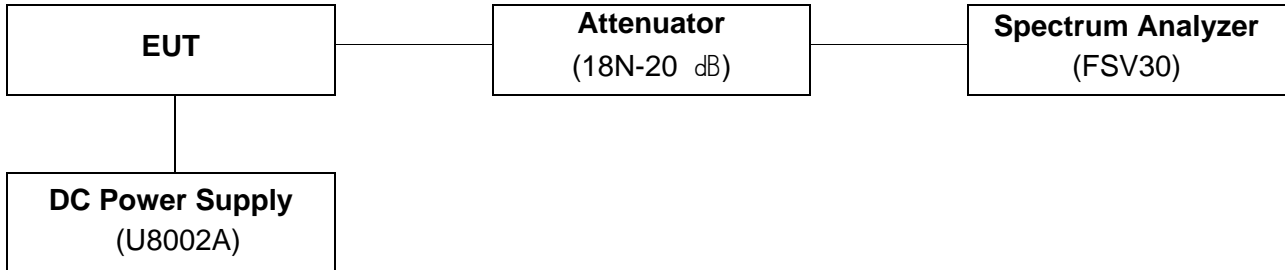

3.2. Limit

According to §15.247(a)(2), systems using digital modulation techniques may operate in the 902 ~ 928 MHz, 2 400 ~ 2 483.5 MHz, and 5 725 ~ 5 825 MHz bands. The minimum of 6 dB Bandwidth shall be at least 500 kHz

3.3. Test Procedure

3.3.1. 6 dB Bandwidth

All data rates and modes were investigated for this test. The full data for the worst case data rate are reported in this section.

The test follows section 8.0 DTS bandwidth of FCC KDB Publication 558074_v03r02

Tests performed using section 8.1 Option 1.

- Option 1

1. Set RBW = 100 kHz
2. Set the video bandwidth (VBW) $\geq 3 \times$ RBW
3. Detector = Peak.
4. Trace mode = max hold.
5. Sweep = auto couple
6. Allow the trace to stabilize.
7. Measure the maximum width of the emission that is constrained by the frequencies associated with the two outermost amplitude points (upper and lower frequencies) that are attenuated by 6 dB relative to the maximum level measured in the fundamental emission.

The results shown in this test report refer only to the sample(s) tested unless otherwise stated. This test report cannot be reproduced, except in full, without prior written permission of the Company.

3.4. Test Results

Ambient temperature : (23 ± 1) °C
 Relative humidity : 47 % R.H.

Operation Mode	Channel	Channel Frequency (MHz)	Data Rate (Mbps)	6 dB Bandwidth (kHz)	Minimum Bandwidth (kHz)
GFSK	Low	2 402	1	683.1	500
	Middle	2 440	1	671.5	500
	High	2 480	1	674.4	500

The results shown in this test report refer only to the sample(s) tested unless otherwise stated. This test report cannot be reproduced, except in full, without prior written permission of the Company.

6 dB Bandwidth

Low Channel

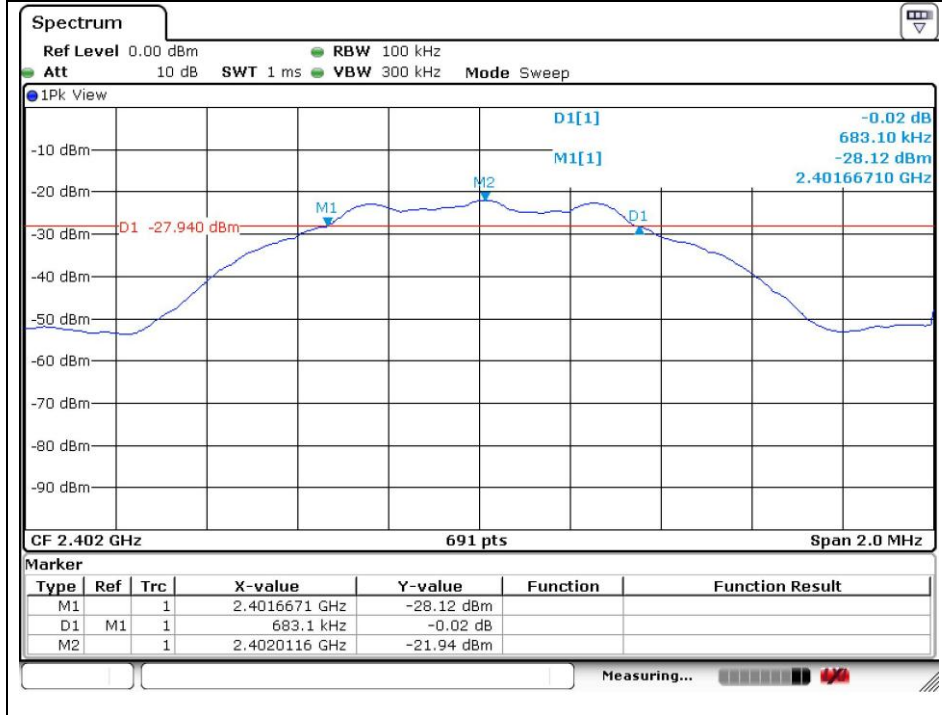

Middle Channel

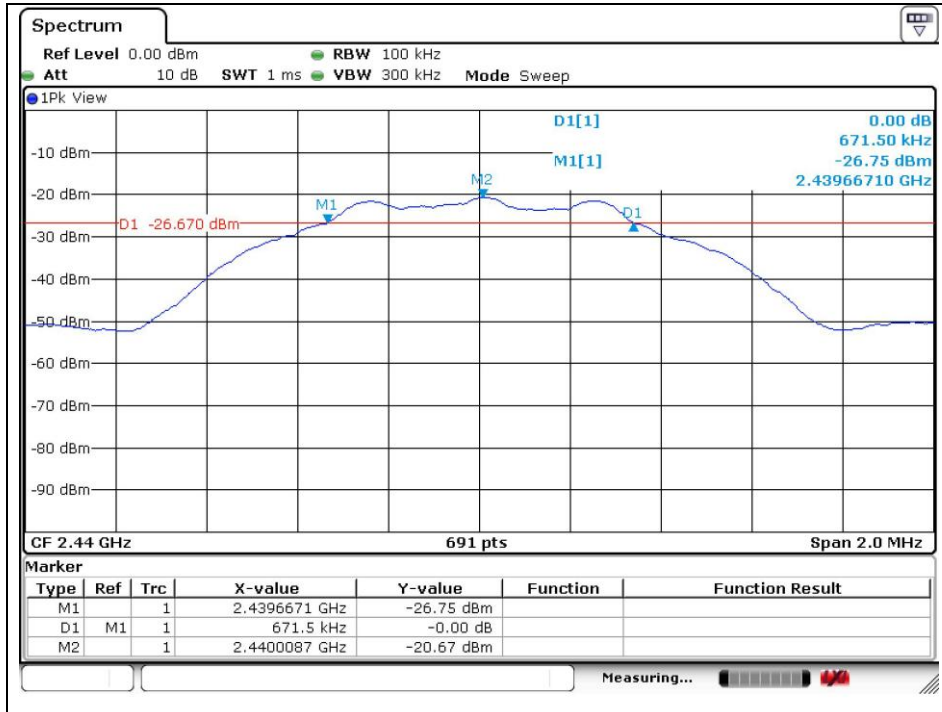

The results shown in this test report refer only to the sample(s) tested unless otherwise stated. This test report cannot be reproduced, except in full, without prior written permission of the Company.

High Channel

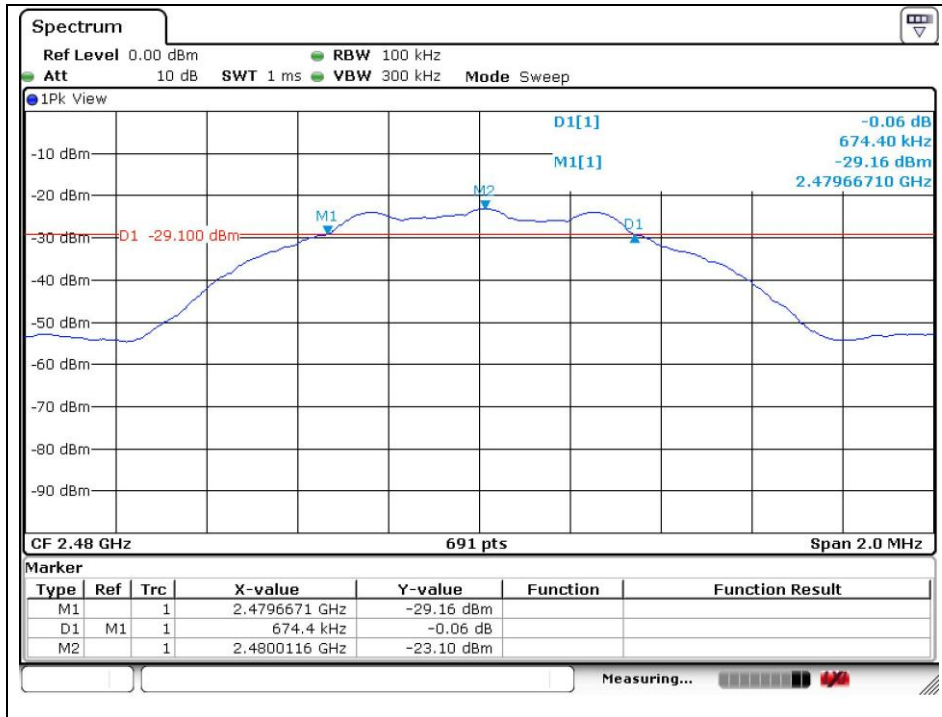

The results shown in this test report refer only to the sample(s) tested unless otherwise stated. This test report cannot be reproduced, except in full, without prior written permission of the Company.

4. Maximum Conducted Output Power

4.1. Test Setup

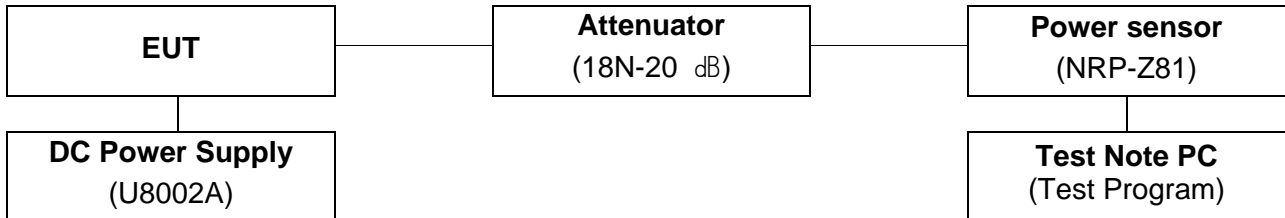

Test program : (S/W name : R&S Power Viewer, Version : 3.2.0)

The results shown in this test report refer only to the sample(s) tested unless otherwise stated. This test report cannot be reproduced, except in full, without prior written permission of the Company.

4.2. Limit

According to §15.247(b)(3), for systems using digital modulation in the 902 ~ 928 MHz, 2 400 ~ 2 483.5 MHz, and 5 725 ~ 5 850 MHz band : 1 Watt. As an alternative to a peak power measurement, compliance with the one watt limit can be based on a measurement of the maximum conducted output power. Maximum Conducted output Power is defined as the total transmit power delivered to all antennas and antenna elements averaged across all symbols in the signaling alphabet when the transmitter is operating at its maximum power control level. Power must be summed across all antenna elements. The average must not include any intervals during which the transmitter is off or is transmitting at a reduced power level. If multiple modes of operation are possible (e.g., alternative modulation methods), the maximum conducted output power is the highest total transmit power occurring in any mode.

According to §15.247(b)(4), the conducted output power limit specified in paragraph(b) of this section is based on the use of antenna with directional gains that do not exceed 6 dBi. Except as shown in paragraph(c) of this section, if transmitting antenna of directional gain greater than 6 dBi are used, the conducted output power from the intentional radiator shall be reduced below the stated values in paragraph (b)(1), (b)(2), and (b)(3) of this section, as appropriate, by the amount in dB that the directional gain of the antenna exceeds 6 dBi.

4.3. Test Procedure

All data rates and modes were investigated for this test. The full data for the worst case data rate are reported in this section.

The test follows section 9.1.2 & 9.2.3.1 of FCC KDB Publication 558074 v03r02

- Peak power meter method

-The maximum peak conducted output power may be measured using a broadband peak RF power meter. The power meter shall have a video bandwidth that is greater than or equal to the DTS bandwidth and shall utilize a fast-responding diode detector.

- Average power meter method

a) Measurements may be performed using a wideband RF power meter with a thermocouple detector or equivalent if all of the conditions listed below are satisfied.

- 1) The EUT is configured to transmit continuously, or to transmit with a constant duty factor.
- 2) At all times when the EUT is transmitting, it shall be transmitting at its maximum power control level.
- 3) The integration period of the power meter exceeds the repetition period of the transmitted signal by at least a factor of five.

b) If the transmitter does not transmit continuously, measure the duty cycle (x) of the transmitter output signal as described in Section 6.0 of KDB 558074 v03r02.

c) Measure the average power of the transmitter. This measurement is an average over both the on and off periods of the transmitter.

d) Adjust the measurement in dBm by adding $10 \log(1/x)$, where x is the duty cycle to the measurement result.

1. Place the EUT on the table and set it in the transmitting mode.
2. Remove the antenna from the EUT and then connect a low loss RF cable from the antenna port to the broadband power meter and power sensor. The power sensor employs a VBW = 30 MHz which is greater than the DTS bandwidth
3. Measure peak & average power each channel.

The results shown in this test report refer only to the sample(s) tested unless otherwise stated. This test report cannot be reproduced, except in full, without prior written permission of the Company.

4.4. Test Results

Ambient temperature : (23 ± 1) °C
 Relative humidity : 47 % R.H.

Mode	Channel	Channel Frequency (MHz)	Data Rate (Mbps)	Attenuator + Cable offset (dB)	Average power Result (dB m)			Peak Power Result (dB m)
					Reading	Duty factor	Result	
GFSK	Low	2 402	1	21.26	-2.92	2.08	-0.84	2.65
	Middle	2 440	1	21.21	-1.59	2.08	0.49	3.27
	High	2 480	1	21.29	-3.84	2.08	-1.76	2.35

Note;

1. Average power result = Reading + Duty factor
2. Duty cycle measurement of EUT
 Duty cycle (x) = Tx(on) / Tx(on+off) = 389 μs / 627 μs = 0.62
 Duty factor = 10log(1/x), 10log(1 / 0.62) = 2.08

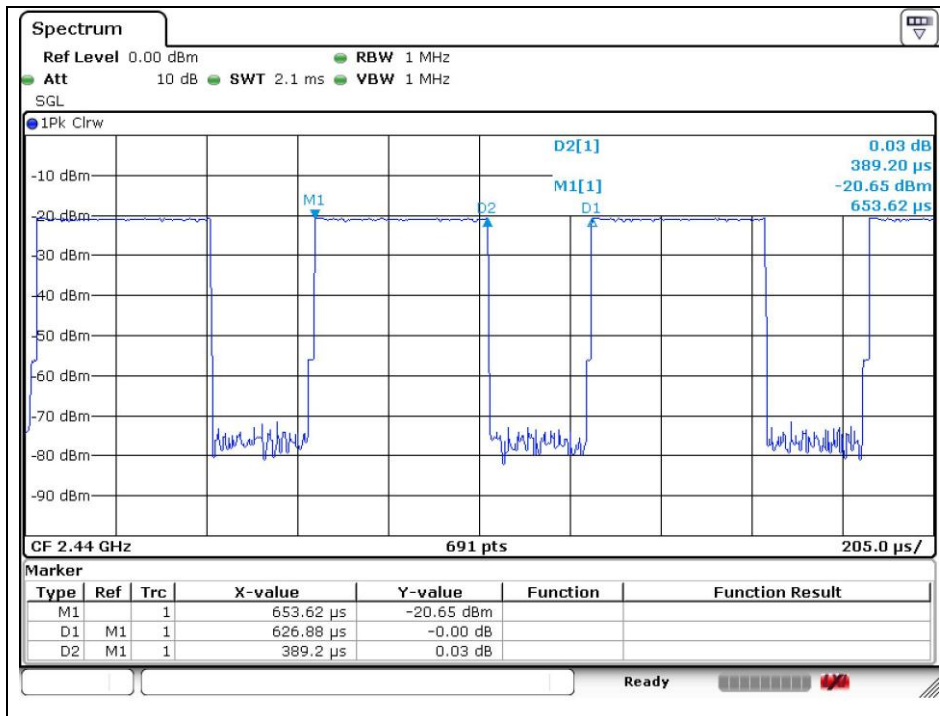

The results shown in this test report refer only to the sample(s) tested unless otherwise stated. This test report cannot be reproduced, except in full, without prior written permission of the Company.

5. Power Spectral Density

5.1. Test Setup

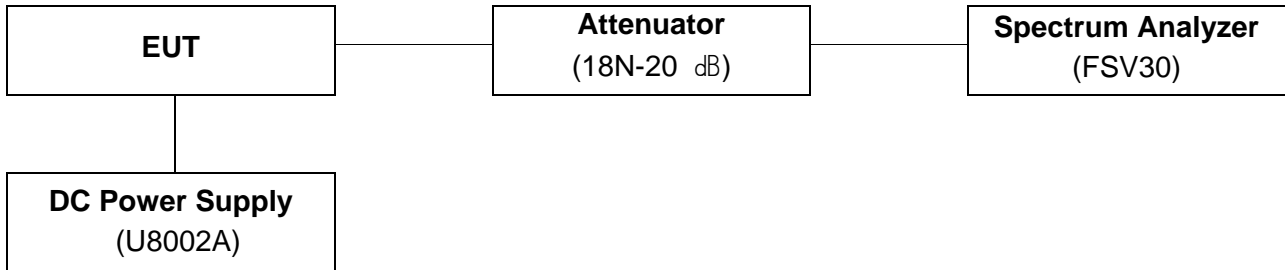

5.2. Limit

§15.247(e) For digitally modulated system, the power spectral density conducted from the intentional radiator to the antenna shall not be greater than 8 dB m in any 3 kHz band any time interval of continuous transmission. This power spectral density shall be determined in accordance with the provisions of paragraph (b) of this section. The same method of determining the conducted output power shall be used to determine the power spectral density.

5.3. Test Procedure

All data rates and modes were investigated for this test. The full data for the worst case data rate are reported in this section.

The measurement is recorded using the PKPSD measurement procedure in 10.2 of KDB 558074_v03r02.

- This procedure shall be used if maximum peak conducted output power was used to demonstrate compliance, and is optional if the maximum conducted (average) output power was used to demonstrate compliance.

1. Set analyzer center frequency to DTS channel center frequency.
2. Set the span to at least 1.5 times the DTS channel bandwidth.
3. Set the RBW to : $3 \text{ kHz} \leq \text{RBW} \leq 100 \text{ kHz}$
4. Set the VBW $\geq 3 \times \text{RBW}$
5. Detector = Peak
6. Sweep time = auto couple.
7. Trace mode = max hold.
8. Allow trace to fully stabilize.
9. Use the peak marker function to determine the maximum amplitude level within the RBW.
10. If measured value exceeds limit, reduce RBW (no less than 3 kHz) and repeat.

The results shown in this test report refer only to the sample(s) tested unless otherwise stated. This test report cannot be reproduced, except in full, without prior written permission of the Company.

5.4. Test Results

Ambient temperature : (23 ± 1) °C
 Relative humidity : 47 % R.H.

Mode	Channel	Frequency	Data Rate (Mbps)	Measured PSD (dB m)	Maximum Limit (dB m)
GFSK	Low	2 402 MHz	1	-10.87	8
	Middle	2 440 MHz	1	-9.93	8
	High	2 480 MHz	1	-11.59	8

Power spectral density measurement

Low Channel

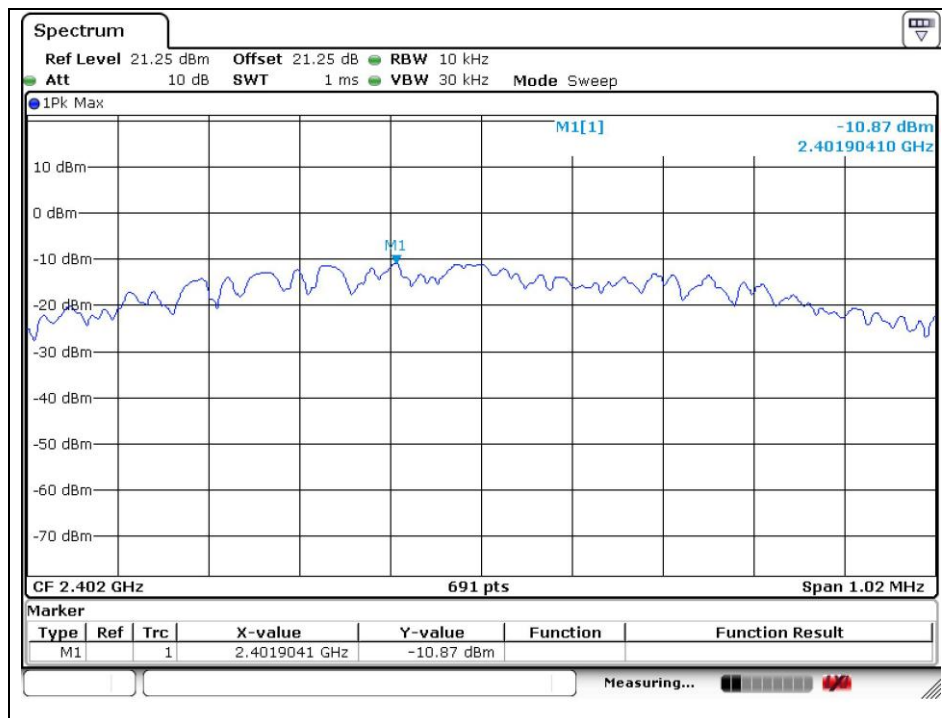

The results shown in this test report refer only to the sample(s) tested unless otherwise stated. This test report cannot be reproduced, except in full, without prior written permission of the Company.

Middle Channel

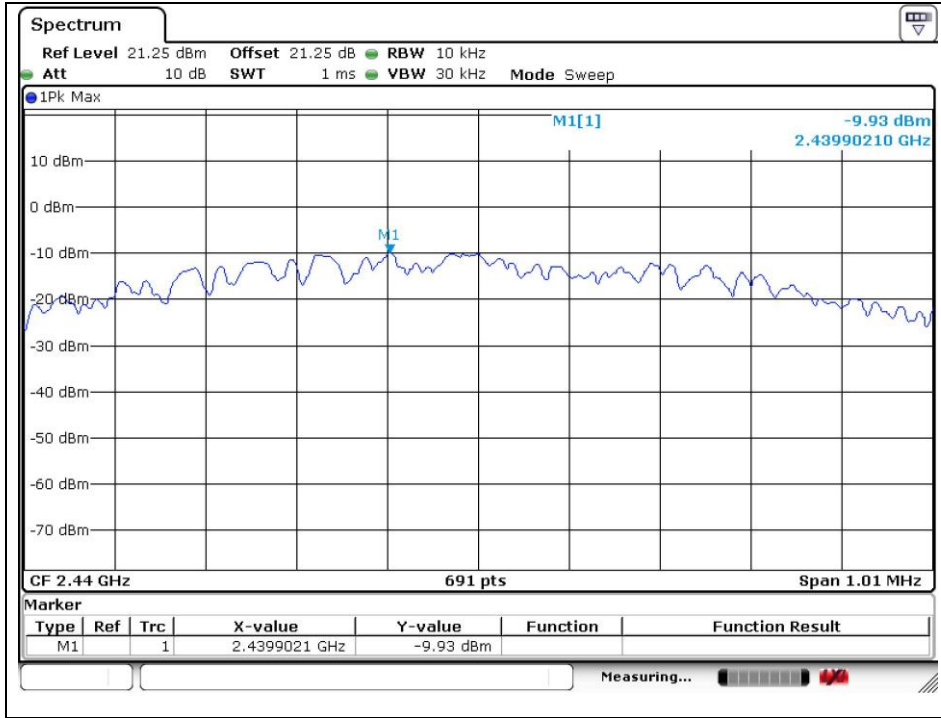

High Channel

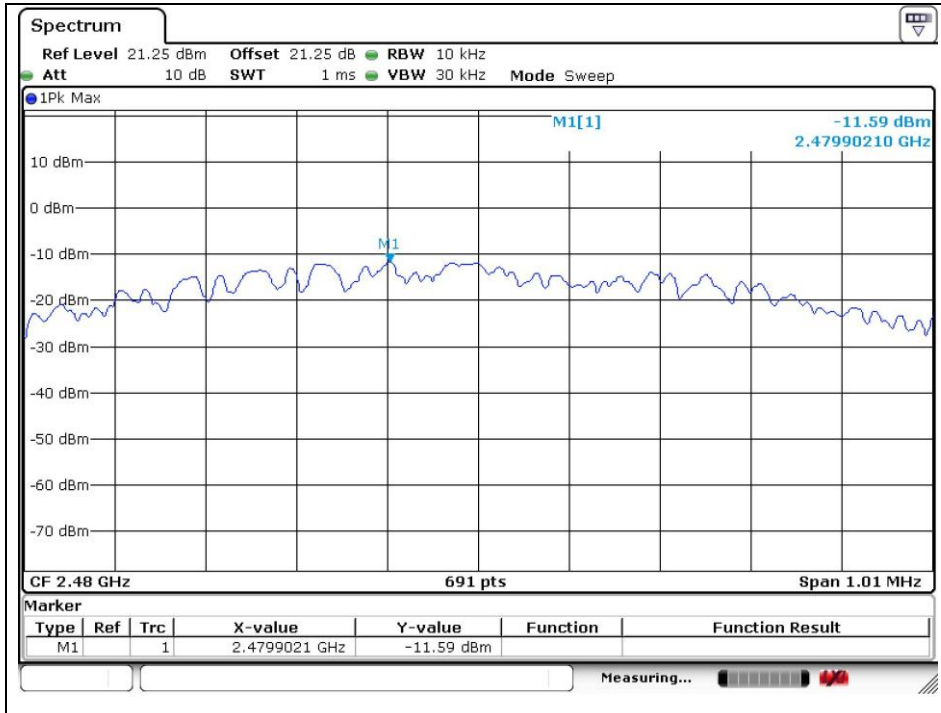

The results shown in this test report refer only to the sample(s) tested unless otherwise stated. This test report cannot be reproduced, except in full, without prior written permission of the Company.

6. AC Power Line Conducted Emission

6.1. Test Setup

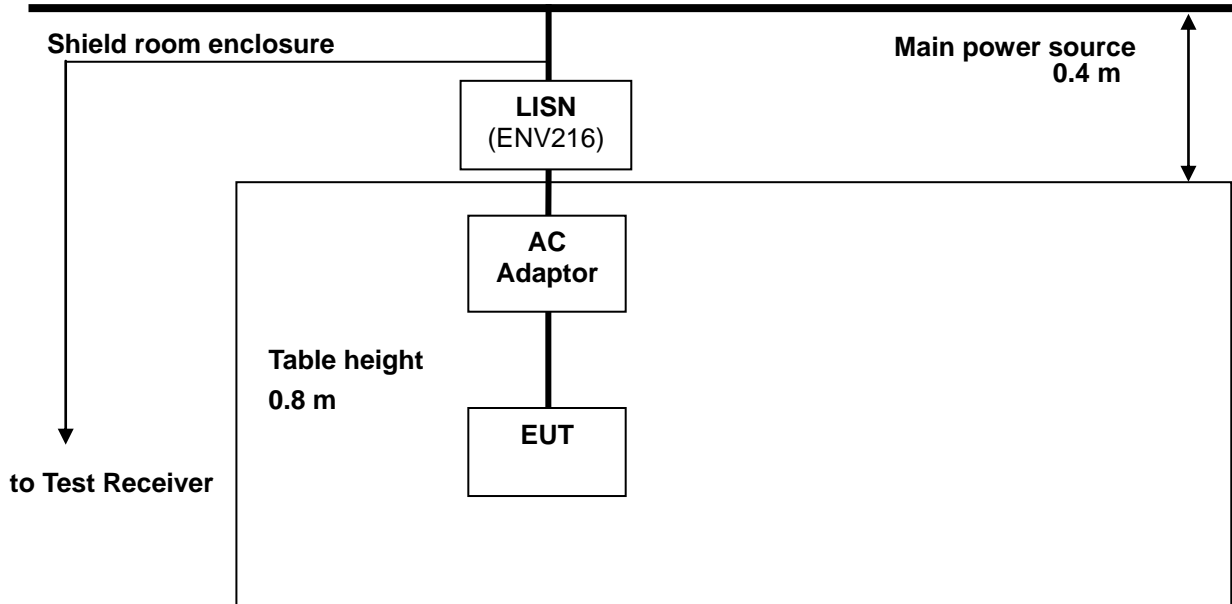

The results shown in this test report refer only to the sample(s) tested unless otherwise stated. This test report cannot be reproduced, except in full, without prior written permission of the Company.

6.2. Limit

According to §15.207(a) for an intentional radiator that is designed to be connected to the public utility (AC) power line, the radio frequency voltage that is conducted back onto the AC power line on any frequency or frequencies, within the band 150 kHz to 30 MHz, shall not exceed the limits in the following table, as measured using a 50 μ H /50 ohm line impedance stabilization network(LISN).

Compliance with the provision of this paragraph shall on the measurement of the radio frequency voltage between each power line and ground at the power terminal. The lower applies at the boundary between the frequency ranges.

Frequency of Emission (MHz)	Conducted limit (dB μ V)	
	Quasi-peak	Average
0.15 – 0.50	66 - 56*	56 - 46*
0.50 – 5.00	56	46
5.00 – 30.0	60	50

* Decreases with the logarithm of the frequency.

6.3. Test Procedures

All data rates and modes were investigated for this test. The full data for the worst case data rate are reported in this section.

AC power line conducted emissions from the EUT were measured according to the dictates of ANSI C63.4-2009

1. The test procedure is performed in a 6.5 m x 3.5 m x 3.5 m (L x W x H) shielded room. The EUT along with its peripherals were placed on a 1.0 m (W)x 1.5 m (L) and 0.8 m in height wooden table and the EUT was adjusted to maintain a 0.4 meter space from a vertical reference plane.
2. The EUT was connected to power mains through a line impedance stabilization network (LISN) which provides 50 ohm coupling impedance for measuring instrument and the chassis ground was bounded to the horizontal ground plane of shielded room.
3. The excess power cable between the EUT and the LISN was bundled. All connecting cables of EUT were moved to find the maximum emission.

The results shown in this test report refer only to the sample(s) tested unless otherwise stated. This test report cannot be reproduced, except in full, without prior written permission of the Company.

6.4. Test Results

The following table shows the highest levels of conducted emissions on both phase of Hot and Neutral line.

Ambient temperature : (23 ± 1) °C
 Relative humidity : 47 % R.H.

-Normal cover

Frequency range : 0.15 MHz – 30 MHz
 Measured Bandwidth : 9 kHz

FREQ. (MHz)	LEVEL(dB μ V)		LINE	LIMIT(dB μ V)		MARGIN(dB)	
	Quasi Peak	Average		Quasi Peak	Average	Quasi Peak	Average
0.49	28.40	20.50	N	56.17	46.17	27.77	25.67
1.08	28.50	20.80	N	56.00	46.00	27.50	25.20
3.38	15.00	8.60	N	56.00	46.00	41.00	37.40
8.12	21.70	15.20	N	60.00	50.00	38.30	34.80
12.26	29.70	23.20	N	60.00	50.00	30.30	26.80
22.51	31.10	22.80	N	60.00	50.00	28.90	27.20
0.49	29.20	20.80	H	56.17	46.17	26.97	25.37
0.83	29.00	20.40	H	56.00	46.00	27.00	25.60
1.82	27.50	20.20	H	56.00	46.00	28.50	25.80
2.75	20.20	12.60	H	56.00	46.00	35.80	33.40
12.45	34.40	26.20	H	60.00	50.00	25.60	23.80
20.09	36.00	25.80	H	60.00	50.00	24.00	24.20

Note ;

- Line (H): Hot, Line (N): Neutral
- All modes of operation were investigated and the worst-case emissions are reported. The above data was taken while the EUT was transmitting on middle channel.
- The limit for Class B device(s) from 150 kHz to 30 MHz are specified in Section of the Title 47 CFR.
- Traces shown in plot are made using a peak detector and average detector
- Deviations to the Specifications: None.

The results shown in this test report refer only to the sample(s) tested unless otherwise stated. This test report cannot be reproduced, except in full, without prior written permission of the Company.

Plots of Conducted Power line

Test mode : (Hot)

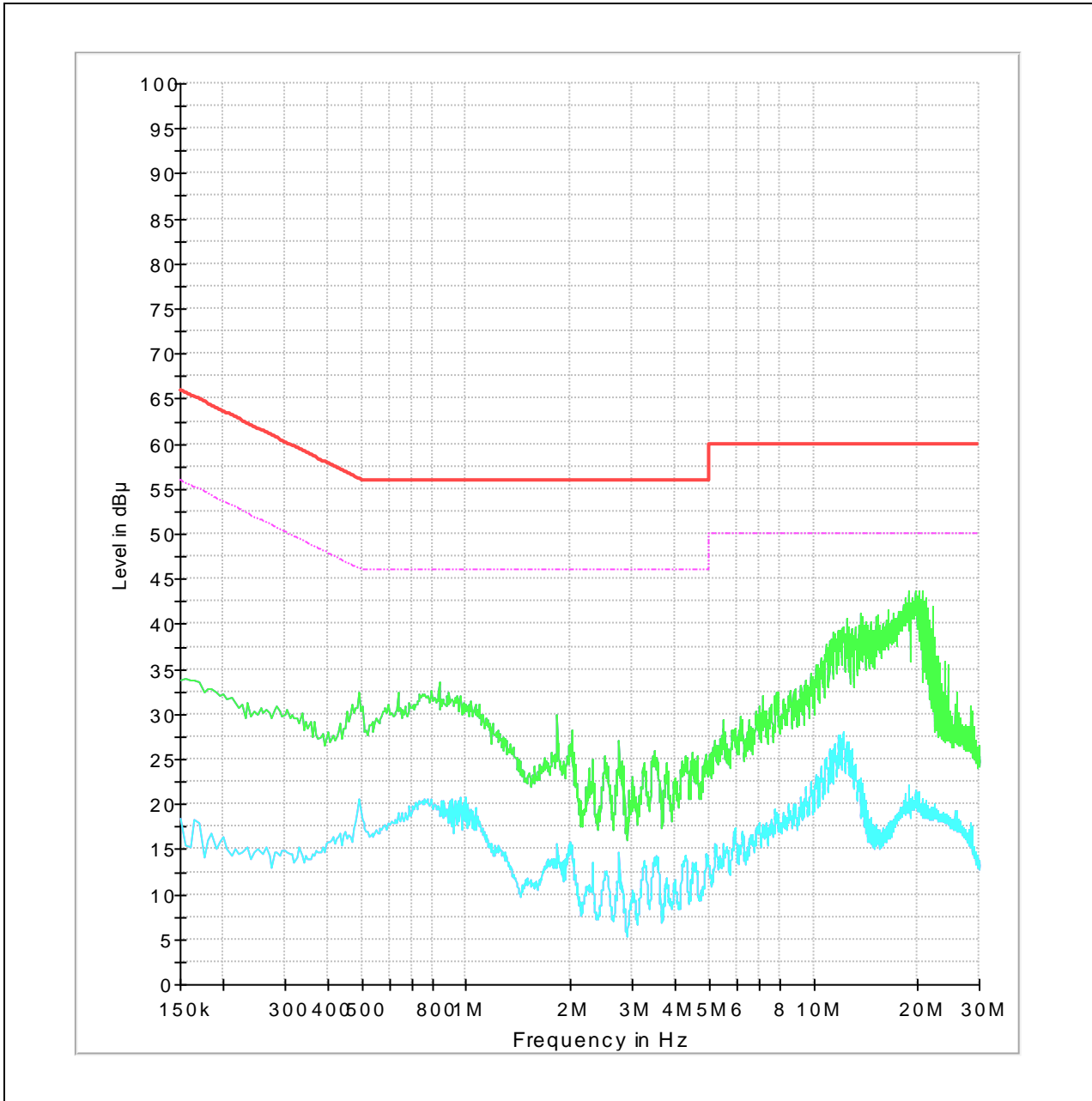

The results shown in this test report refer only to the sample(s) tested unless otherwise stated. This test report cannot be reproduced, except in full, without prior written permission of the Company.

Test mode : (Neutral)

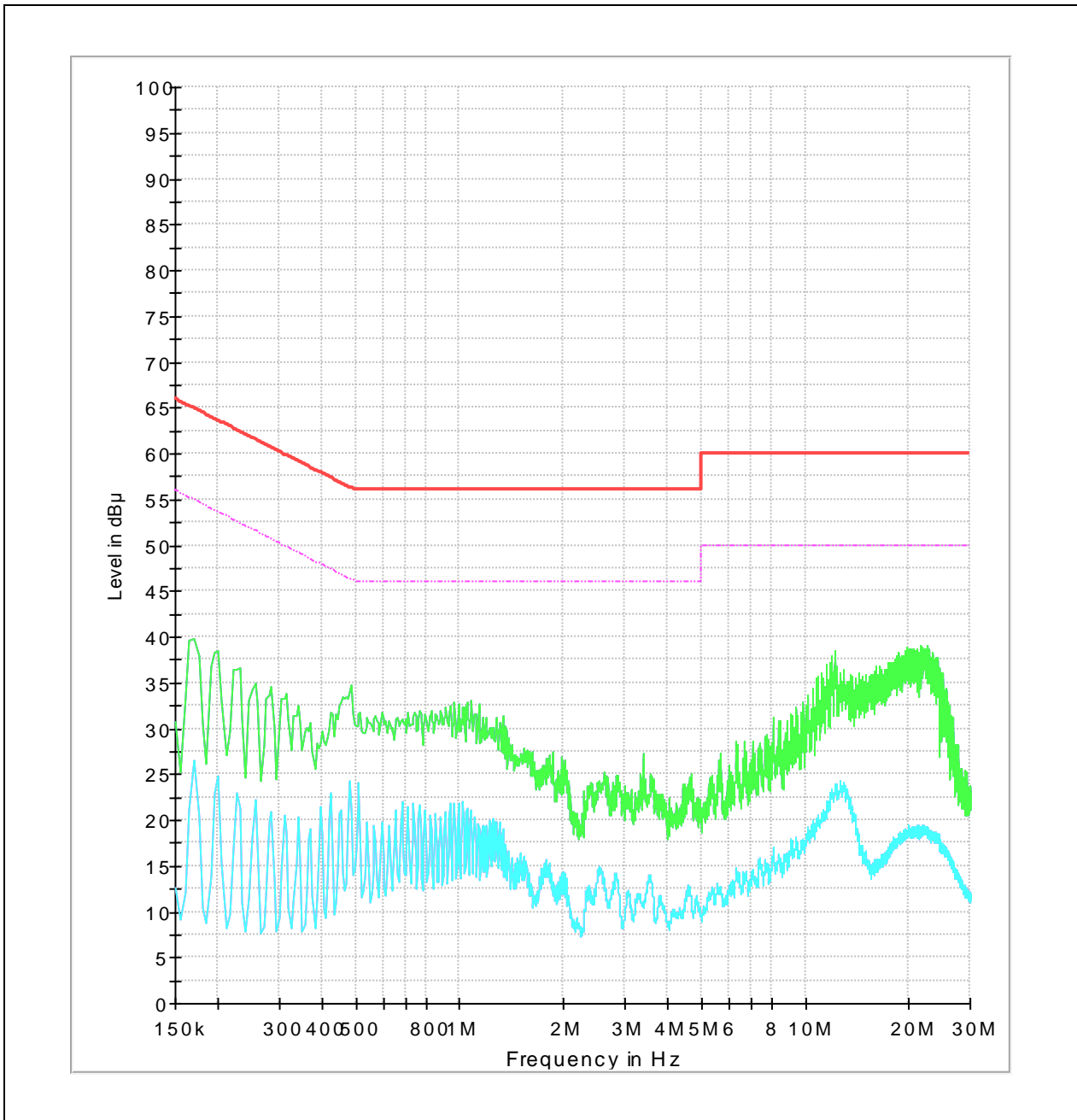

The results shown in this test report refer only to the sample(s) tested unless otherwise stated. This test report cannot be reproduced, except in full, without prior written permission of the Company.

-Quick cover

Frequency range : 0.15 MHz – 30 MHz
 Measured Bandwidth : 9 kHz

FREQ. (MHz)	LEVEL(dB μ V)		LINE	LIMIT(dB μ V)		MARGIN(dB)	
	Quasi Peak	Average		Quasi Peak	Average	Quasi Peak	Average
0.51	22.50	17.70	N	56.00	46.00	33.50	28.30
0.95	25.30	16.70	N	56.00	46.00	30.70	29.30
2.57	17.00	8.00	N	56.00	46.00	39.00	38.00
11.12	28.50	20.40	N	60.00	50.00	31.50	29.60
17.99	29.80	18.20	N	60.00	50.00	30.20	31.80
22.07	28.30	18.90	N	60.00	50.00	31.70	31.10
0.49	29.90	20.90	H	56.17	46.17	26.27	25.27
1.81	30.30	20.90	H	56.00	46.00	25.70	25.10
2.83	22.90	15.40	H	56.00	46.00	33.10	30.60
6.43	26.10	17.90	H	60.00	50.00	33.90	32.10
12.11	35.60	27.10	H	60.00	50.00	24.40	22.90
20.79	38.90	26.60	H	60.00	50.00	21.10	23.40

Note ;

1. Line (H): Hot, Line (N): Neutral
2. All modes of operation were investigated and the worst-case emissions are reported. The above data was taken while the EUT was transmitting on middle channel.
3. The limit for Class B device(s) from 150 kHz to 30 MHz are specified in Section of the Title 47 CFR.
4. Traces shown in plot are made using a peak detector and average detector
5. Deviations to the Specifications: None.

The results shown in this test report refer only to the sample(s) tested unless otherwise stated. This test report cannot be reproduced, except in full, without prior written permission of the Company.

Plots of Conducted Power line

Test mode : (Hot)

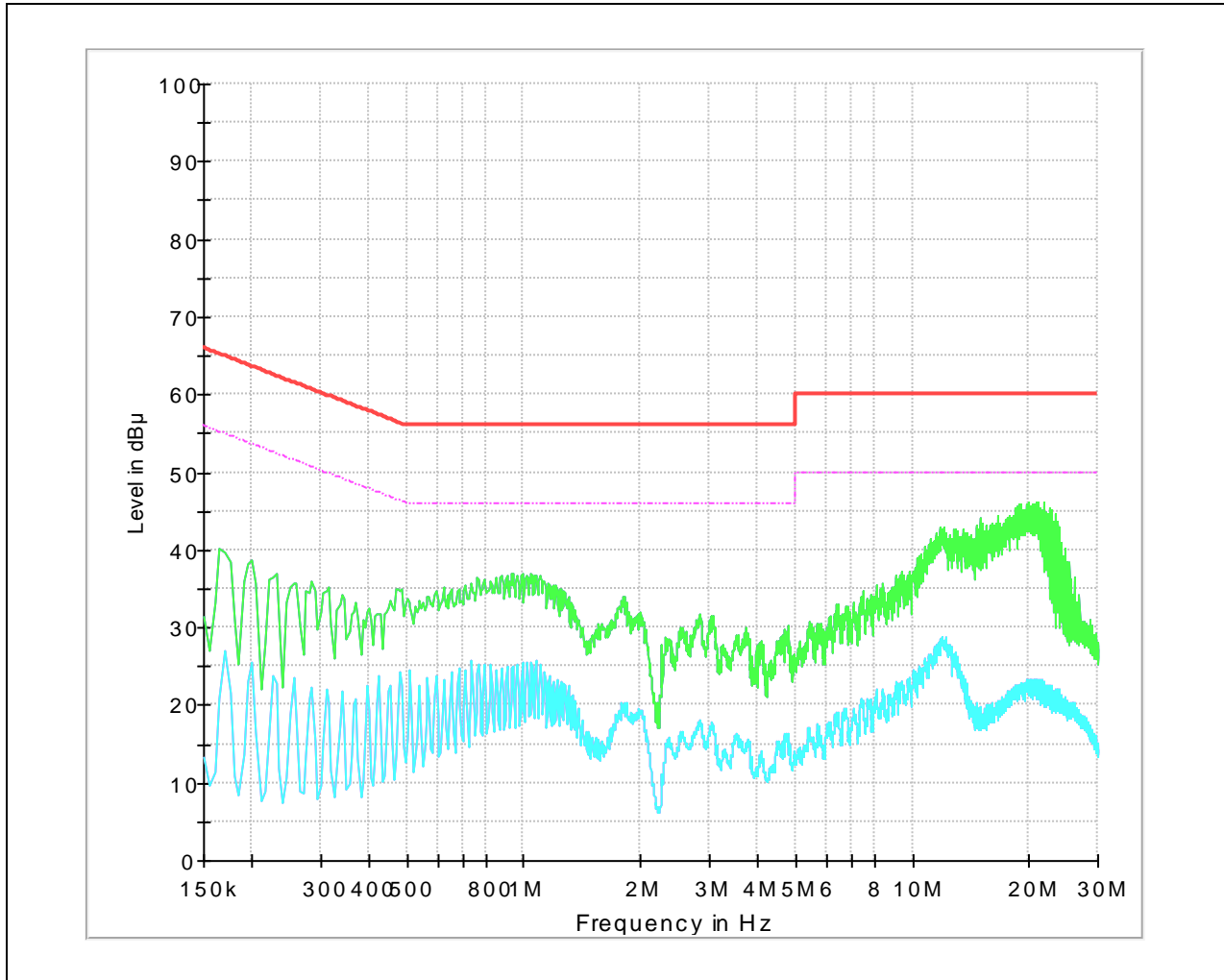

The results shown in this test report refer only to the sample(s) tested unless otherwise stated. This test report cannot be reproduced, except in full, without prior written permission of the Company.

Test mode : (Neutral)

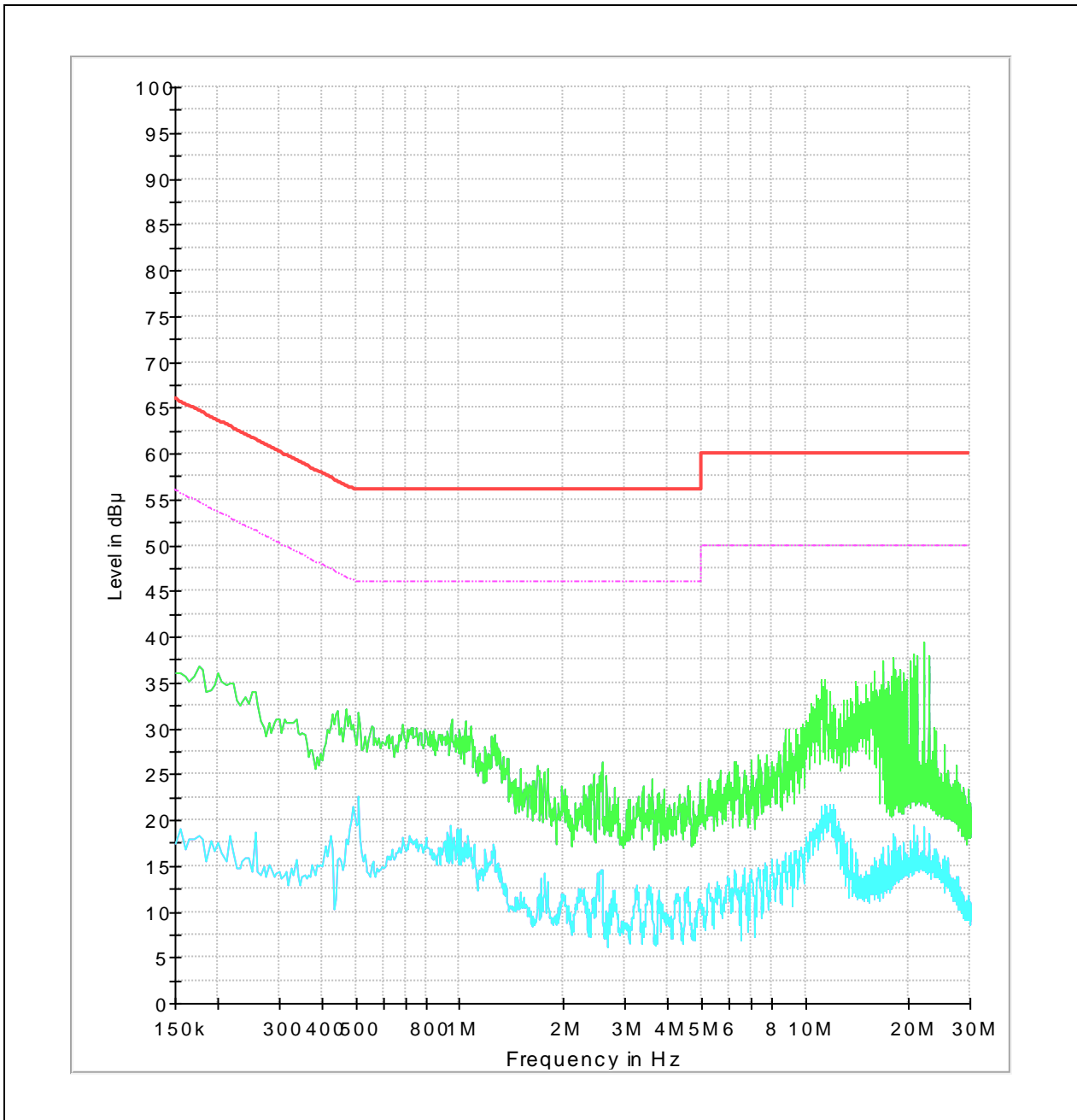

The results shown in this test report refer only to the sample(s) tested unless otherwise stated. This test report cannot be reproduced, except in full, without prior written permission of the Company.

7. Antenna Requirement

7.1. Standard Applicable

For intentional device, according to FCC 47 CFR Section §15.203, an intentional radiator shall be designed to ensure that no antenna other than that furnished by the responsible party shall be used with the device. And according to FCC 47 CFR Section §15.247 (b) if transmitting antennas of directional gain greater than 6 dB i are used, the power shall be reduced by the amount in dB that the gain of the antenna exceeds 6 dB i.

7.2. Antenna Connected Construction

Antenna used in this product is Integral antenna and peak max gain of antenna as below.

Band	2 402 MHz – 2 480 MHz (ISM)
Mode	LE (GFSK)
Gain	-1.7 dB i

The results shown in this test report refer only to the sample(s) tested unless otherwise stated. This test report cannot be reproduced, except in full, without prior written permission of the Company.