



SAR EVALUATION REPORT

Applicant Name:
 LG Electronics MobileComm U.S.A., Inc.
 1000 Sylvan Avenue
 Englewood Cliffs, NJ 07632
 United States

Date of Testing:
 12/02/13 - 12/16/13
Test Site/Location:
 PCTEST Lab, Columbia, MD, USA
Document Serial No.:
 0Y1312022312.ZNF

FCC ID: ZNFD950

APPLICANT: LG ELECTRONICS MOBILECOMM U.S.A., INC.

DUT Type: Portable Handset
Application Type: Class II Permissive Change
FCC Rule Part(s): CFR §2.1093
Model(s): LG-D950, D950, LGD950
Date of Original Certification: 11/22/2013

Equipment Class	Band & Mode	Tx Frequency	Measured Conducted Power [dBm]	SAR			
				1 gm Head (W/kg)	1 gm Body-Worn (W/kg)	1 gm Hotspot (W/kg)	10 gm Extremity (W/kg)
PCE	GSM/GPRS/EDGE 850	824.20 - 848.80 MHz	33.31	0.43	0.60	0.72	
PCE	UMTS 850	826.40 - 846.60 MHz	23.37	0.42	0.51	0.57	
PCE	GSM/GPRS/EDGE 1900	1850.20 - 1909.80 MHz	30.66	0.18	0.57	0.57	
PCE	UMTS 1900	1852.4 - 1907.6 MHz	23.70	0.25	0.87	0.88	
PCE	LTE Band 17	706.5 - 713.5 MHz	24.12	0.20	0.35	0.37	
PCE	LTE Band 5 (Cell)	826.5 - 846.5 MHz	23.63	0.49	0.40	0.46	
PCE	LTE Band 4 (AWS)	1712.5 - 1752.5 MHz	23.62	0.36	0.76	0.93	
PCE	LTE Band 2 (PCS)	1852.5 - 1907.5 MHz	23.70	0.25	0.99	0.99	
PCE	LTE Band 7	2502.5 - 2567.5 MHz	23.68	0.12	1.19	1.19	
DTS	2.4 GHz WLAN	2412 - 2462 MHz	16.14	0.37	0.16	0.16	
DTS/NII	5.8 GHz WLAN	5745 - 5825 MHz	9.88	< 0.1	< 0.1	< 0.1	
NII	5.2 GHz WLAN	5180 - 5240 MHz	10.56	0.13	0.10	0.25	
NII	5.3 GHz WLAN	5260 - 5320 MHz	10.87	0.12	< 0.1	0.24	
NII	5.5 GHz WLAN	5500 - 5700 MHz	10.51	< 0.1	< 0.1	0.13	
DSS/DTS	Bluetooth	2402 - 2480 MHz	10.03	N/A			
Simultaneous SAR per KDB 690783 D01v01r02:				0.74	1.47	1.35	0.25

Note: Powers in the above table represent output powers for the SAR test configurations and may not represent the highest output powers for all configurations for each mode.

This wireless portable device has been shown to be capable of compliance for localized specific absorption rate (SAR) for uncontrolled environment/general population exposure limits specified in ANSI/IEEE C95.1-1992 and has been tested in accordance with the measurement procedures specified in Section 1.9 of this report; for North American frequency bands only.

I attest to the accuracy of data. All measurements reported herein were performed by me or were made under my supervision and are correct to the best of my knowledge and belief. I assume full responsibility for the completeness of these measurements and vouch for the qualifications of all persons taking them. Test results reported herein relate only to the item(s) tested.



Randy Ortanez
 President



FCC ID: ZNFD950		SAR EVALUATION REPORT		Reviewed by: Quality Manager
Document S/N: 0Y1312022312.ZNF	Test Dates: 12/02/13 - 12/16/13	DUT Type: Portable Handset		Page 1 of 66

T A B L E O F C O N T E N T S

1	DEVICE UNDER TEST	3
2	LTE INFORMATION.....	10
3	INTRODUCTION.....	11
4	DOSIMETRIC ASSESSMENT	12
5	DEFINITION OF REFERENCE POINTS	13
6	TEST CONFIGURATION POSITIONS FOR HANDSETS.....	14
7	RF EXPOSURE LIMITS	17
8	FCC MEASUREMENT PROCEDURES.....	18
9	RF CONDUCTED POWERS.....	22
10	SYSTEM VERIFICATION.....	39
11	SAR DATA SUMMARY	42
12	FCC MULTI-TX AND ANTENNA SAR CONSIDERATIONS.....	54
13	SAR MEASUREMENT VARIABILITY	60
14	EQUIPMENT LIST.....	61
15	MEASUREMENT UNCERTAINTIES	62
16	CONCLUSION.....	64
17	REFERENCES	65
APPENDIX A: SAR TEST PLOTS		
APPENDIX B: SAR DIPOLE VERIFICATION PLOTS		
APPENDIX C: PROBE AND DIPOLE CALIBRATION CERTIFICATES		
APPENDIX D: SAR TISSUE SPECIFICATIONS		
APPENDIX E: SAR SYSTEM VALIDATION		
APPENDIX F: SAR TEST SETUP PHOTOGRAPHS		

FCC ID: ZNFD950	 PCTEST <small>ENGINEERING LABORATORY, INC.</small>	SAR EVALUATION REPORT		Reviewed by: Quality Manager
Document S/N: 0Y1312022312.ZNF	Test Dates: 12/02/13 - 12/16/13	DUT Type: Portable Handset	Page 2 of 66	

1 DEVICE UNDER TEST

1.1 Device Overview



Band & Mode	Operating Modes	Tx Frequency
GSM/GPRS/EDGE 850	Voice/Data	824.20 - 848.80 MHz
UMTS 850	Voice/Data	826.40 - 846.60 MHz
GSM/GPRS/EDGE 1900	Voice/Data	1850.20 - 1909.80 MHz
UMTS 1900	Voice/Data	1852.4 - 1907.6 MHz
LTE Band 17	Data	706.5 - 713.5 MHz
LTE Band 5 (Cell)	Data	826.5 - 846.5 MHz
LTE Band 4 (AWS)	Data	1712.5 - 1752.5 MHz
LTE Band 2 (PCS)	Data	1852.5 - 1907.5 MHz
LTE Band 7	Data	2502.5 - 2567.5 MHz
2.4 GHz WLAN	Data	2412 - 2462 MHz
5.8 GHz WLAN	Data	5745 - 5825 MHz
5.2 GHz WLAN	Data	5180 - 5240 MHz
5.3 GHz WLAN	Data	5260 - 5320 MHz
5.5 GHz WLAN	Data	5500 - 5700 MHz
Bluetooth	Data	2402 - 2480 MHz
NFC	Data	13.56 MHz

1.2 Nominal and Maximum Output Power Specifications

This device operates using the following maximum and nominal output power specifications. SAR values were scaled to the maximum allowed power to determine compliance per KDB Publication 447498 D01v05.



Mode / Band		Voice (dBm)	Burst Average GMSK (dBm)		Burst Average 8-PSK (dBm)	
		1 TX Slot	1 TX Slots	2 TX Slots	1 TX Slots	2 TX Slots
GSM/GPRS/EDGE 850	Maximum	33.7	33.7	31.7	27.2	26.2
	Nominal	33.2	33.2	31.2	26.7	25.7
GSM/GPRS/EDGE 1900	Maximum	30.7	30.7	28.7	26.2	25.7
	Nominal	30.2	30.2	28.2	25.7	25.2

Mode / Band		Modulated Average (dBm)		
		3GPP Rel 99	3GPP Rel 5	3GPP Rel 6
		RMC/AMR	HSDPA	HSUPA
UMTS Band 5 (850 MHz)	Maximum	23.7		
	Nominal	23.2		
UMTS Band 2 (1900 MHz)	Maximum	23.7		
	Nominal	23.2		

FCC ID: ZNFD950	 PCTEST ENGINEERING LABORATORY, INC.	SAR EVALUATION REPORT		Reviewed by: Quality Manager
Document S/N: 0Y1312022312.ZNF	Test Dates: 12/02/13 - 12/16/13	DUT Type: Portable Handset		Page 3 of 66

Mode / Band		Modulated Average (dBm)
LTE Band 17	Maximum	24.2
	Nominal	23.7
LTE Band 5 (Cell)	Maximum	23.7
	Nominal	23.2
LTE Band 4 (AWS)	Maximum	23.7
	Nominal	23.2
LTE Band 2 (PCS)	Maximum	23.7
	Nominal	23.2
LTE Band 7	Maximum	23.7
	Nominal	23.2

Mode / Band		Modulated Average (dBm)
IEEE 802.11b (2.4 GHz)	Maximum	17.0
	Nominal	16.0
IEEE 802.11g (2.4 GHz)	Maximum	13.0
	Nominal	12.0
IEEE 802.11n (2.4 GHz)	Maximum	12.0
	Nominal	11.0
IEEE 802.11ac (2.4 GHz)	Maximum	11.0
	Nominal	10.0
IEEE 802.11a (5 GHz)	Maximum	11.5
	Nominal	10.5
IEEE 802.11n (5 GHz)	Maximum	11.5
	Nominal	10.5
IEEE 802.11ac (5 GHz) (80 MHz BW)	Maximum	9.5
	Nominal	8.5
Bluetooth	Maximum	10.5
	Nominal	9.5
Bluetooth LE	Maximum	6.0
	Nominal	4.5

FCC ID: ZNFD950	 PCTEST ENGINEERING LABORATORY, INC.	SAR EVALUATION REPORT		Reviewed by: Quality Manager
Document S/N: 0Y1312022312.ZNF	Test Dates: 12/02/13 - 12/16/13	DUT Type: Portable Handset	Page 4 of 66	

1.3 DUT Antenna Locations

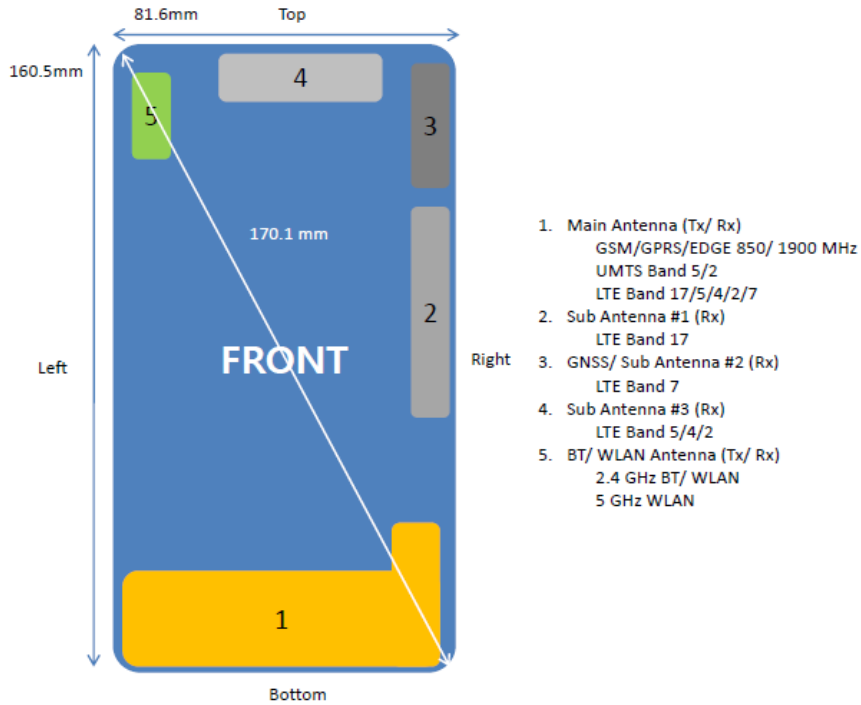

**Figure 1-1
DUT Antenna Locations**

Note:

1. Exact antenna dimensions and separation distances are shown in the Technical Descriptions.
2. Since the diagonal dimension of this device is greater than 160mm, but less than 200 mm, it is considered a "phablet."

**Table 1-1
Sides for SAR Testing**

Mode	Exposure Condition	Back	Front	Top	Bottom	Right	Left
GPRS 850	Wireless Router	Yes	Yes	No	Yes	Yes	Yes
UMTS 850	Wireless Router	Yes	Yes	No	Yes	Yes	Yes
GPRS 1900	Wireless Router	Yes	Yes	No	Yes	Yes	Yes
UMTS 1900	Wireless Router	Yes	Yes	No	Yes	Yes	Yes
LTE Band 17	Wireless Router	Yes	Yes	No	Yes	Yes	Yes
LTE Band 5 (Cell)	Wireless Router	Yes	Yes	No	Yes	Yes	Yes
LTE Band 4 (AWS)	Wireless Router	Yes	Yes	No	Yes	Yes	Yes
LTE Band 2 (PCS)	Wireless Router	Yes	Yes	No	Yes	Yes	Yes
LTE Band 7	Wireless Router	Yes	Yes	No	Yes	Yes	Yes
2.4 GHz WLAN	Wireless Router	Yes	Yes	Yes	No	No	Yes
5 GHz DTS WLAN	Wireless Router	Yes	Yes	Yes	No	No	Yes
5 GHz NII WLAN	Extremity	Yes	Yes	Yes	No	No	Yes

Note:

1. Particular DUT edges were not required to be evaluated for Wireless Router and/or Extremity SAR if the edges were greater than 2.5 cm from the transmitting antenna according to FCC KDB Publication 941225 D06v01 guidance, page 2 and FCC KDB Publication 648474 D04 Handset SAR v01r01 guidance, page 2.
2. 5 GHz WIFI Direct GO is supported in the 5 GHz DTS band only. The manufacturer expects 5 GHz DTS Wifi Direct GO may be used similar to wireless router usage. Therefore, 5 GHz DTS Wifi Direct GO was evaluated for SAR similar to wireless router SAR procedures in FCC KDB Publication 941225.

FCC ID: ZNFD950	PCTEST ENGINEERING LABORATORY, INC.	SAR EVALUATION REPORT			Reviewed by: Quality Manager
Document S/N: 0Y1312022312.ZNF	Test Dates: 12/02/13 - 12/16/13	DUT Type: Portable Handset			Page 5 of 66

1.4 Near Field Communications (NFC) Antenna

This DUT has NFC operations. The NFC antenna is integrated into the battery cover for this model. Therefore, all SAR tests performed with the battery cover already incorporate the NFC antenna.

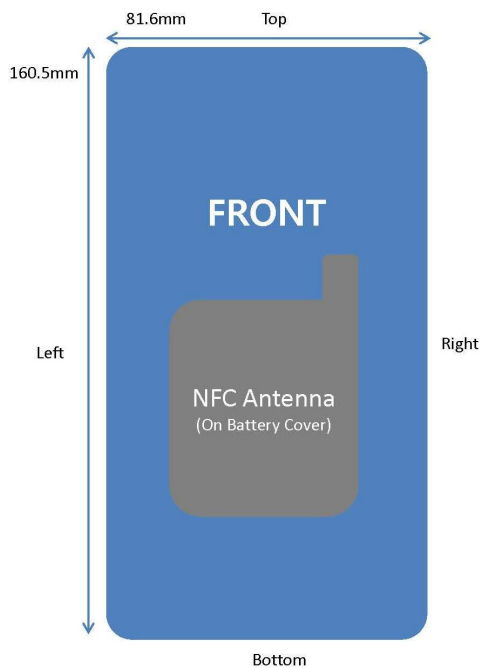



Figure 1-2
NFC Antenna Locations

FCC ID: ZNFD950	 PCTEST ENGINEERING LABORATORY, INC.	SAR EVALUATION REPORT		Reviewed by: Quality Manager
Document S/N: 0Y1312022312.ZNF	Test Dates: 12/02/13 - 12/16/13	DUT Type: Portable Handset		Page 6 of 66

1.5 Simultaneous Transmission Capabilities

According to FCC KDB Publication 447498 D05v01, transmitters are considered to be transmitting simultaneously when there is overlapping transmission, with the exception of transmissions during network hand-offs with maximum hand-off duration less than 30 seconds. Possible transmission paths for the DUT are shown in Figure 1-3 and are color-coded to indicate communication modes which share the same path. Modes which share the same transmission path cannot transmit simultaneously with one another.



Figure 1-3
Simultaneous Transmission Paths

This device contains multiple transmitters that may operate simultaneously, and therefore requires a simultaneous transmission analysis according to FCC KDB Publication 447498 D01v05 3) procedures.

Table 1-2
Simultaneous Transmission Scenarios

No.	Capable Transmit Configuration	Head	Body-Worn Accessory	Wireless Router	Extremity	Notes
1	GSM voice + 2.4 GHz WI-FI	Yes	Yes	N/A	Yes	
2	GSM voice + 5 GHz WI-FI	Yes	Yes	N/A	Yes	
3	GSM voice + 2.4 GHz Bluetooth	N/A	Yes	N/A	Yes	
4	UMTS + 2.4 GHz WI-FI	Yes	Yes	Yes	Yes	
5	UMTS + 5 GHz WI-FI	Yes	Yes	Yes	Yes	
6	UMTS + 2.4 GHz Bluetooth	N/A	Yes	N/A	Yes	
7	LTE + 2.4 GHz WI-FI	Yes*	Yes*	Yes	Yes	*-Pre-installed VOIP applications are considered.
8	LTE + 5 GHz WI-FI	Yes*	Yes*	Yes	Yes	*-Pre-installed VOIP applications are considered.
9	LTE + 2.4 GHz Bluetooth	N/A	Yes*	N/A	Yes	*-Pre-installed VOIP applications are considered.
10	GPRS/EDGE + 2.4 GHz WI-FI	Yes*	Yes*	Yes	Yes	*-Pre-installed VOIP applications are considered.
11	GPRS/EDGE + 5 GHz WI-FI	Yes*	Yes*	Yes	Yes	*-Pre-installed VOIP applications are considered.
12	GPRS/EDGE + 2.4 GHz Bluetooth	N/A	Yes*	N/A	Yes	*-Pre-installed VOIP applications are considered.



1. WiFi 2.4 GHz supports Hotspot and WiFi-Direct(GO/GC).
2. WiFi 5 GHz does not support Hotspot and supports WiFi-Direct (GC; 5.8 GHz only GO).
3. LTE, UMTS, GPRS/EDGE support Hotspot.
4. (*) = for VOIP 3rd party applications possibly installed and used by end-user.
5. Bluetooth and WiFi can not transmit simultaneously since they share the same chip.
6. GSM, UMTS and LTE can not transmit simultaneously since they share the same chip.
7. When the user utilizes multiple services in UMTS 3G mode it uses multi-Radio Access Bearer or multi-RAB. The power control is based on a physical control channel (Dedicated Physical Control Channel [DPCCH]) and power control will be adjusted to meet the needs of both services. Therefore, the UMTS+WLAN scenario also represents the UMTS Voice/DATA + WLAN Hotspot scenario.
8. Per the manufacturer, WiFi Direct is expected to be used in conjunction with a held-to-ear or body-worn accessory voice call. Simultaneous transmission scenarios involving WiFi direct are specified above.

1.6 SAR Test Exclusions Applied

(A) WIFI/BT

Since hotspot operations are not allowed by the chipset firmware using 5 GHz WIFI, only 2.4 GHz WIFI Hotspot SAR tests and combinations are considered for SAR with respect to Wireless Router configurations according to FCC KDB 941225 D06v01.

5 GHz WIFI Direct GO is supported in the 5.8 GHz band only. The manufacturer expects 5.8 GHz WIFI Direct GO may be used similar to wireless router usage. Therefore, 5.8 GHz WIFI Direct GO was evaluated for SAR similar to wireless router SAR procedures in FCC KDB Publication 941225.

FCC ID: ZNFD950	 PCTEST ENGINEERING LABORATORY, INC.	SAR EVALUATION REPORT		Reviewed by: Quality Manager
Document S/N: 0Y1312022312.ZNF	Test Dates: 12/02/13 - 12/16/13	DUT Type: Portable Handset		Page 7 of 66

Per FCC KDB Publication 648474 D04v01r01, this device is considered a "phablet" since the diagonal dimension is greater than 160mm and less than 200 mm. Therefore, extremity SAR tests are required when hotspot mode does not apply or if hotspot 1g SAR > 1.2 W/kg. Because WIFI Direct GO operations are supported for 5.8 GHz WLAN, but not for all other 5 GHz WIFI bands, extremity SAR was evaluated for 5.2-5.7 GHz WIFI. Extremity SAR was not evaluated for 2.4 GHz WIFI since Hotspot SAR for 2.4 GHz WIFI < 1.2 W/kg

Per FCC KDB 447498 D01v05, the SAR exclusion threshold for distances <50mm is defined by the following equation:

$$\frac{\text{Max Power of Channel (mW)}}{\text{Test Separation Dist (mm)}} * \sqrt{\text{Frequency(GHz)}} \leq 3.0$$

Based on the maximum conducted power of Bluetooth (rounded to the nearest mW) and the antenna to user separation distance, Bluetooth SAR was not required; $[(11/10) * \sqrt{2.441}] = 1.7 < 3.0$. Per KDB Publication 447498 D01v05, the maximum power of the channel was rounded to the nearest mW before calculation.

$$\frac{\text{Max Power of Channel (mW)}}{\text{Test Separation Dist (mm)}} * \sqrt{\text{Frequency (GHz)}} \leq 7.5$$

Based on the maximum conducted power of Bluetooth (rounded to the nearest mW) and the antenna to user separation distance, Bluetooth SAR was not required for extremity configurations; $[(11 / 5) * \sqrt{2.441}] = 3.4 < 7.5$. Per KDB Publication 447498 D01v05, the maximum power of the channel was rounded to the nearest mW before calculation.

This device supports IEEE 802.11ac for 2.4 GHz WIFI. IEEE 802.11ac was not evaluated for SAR since the average output power was not more than 0.25 dB higher than the average output power of IEEE 802.11b.

This device supports 20 MHz and 40 MHz Bandwidths for IEEE 802.11n for 5 GHz WIFI only. IEEE 802.11n was not evaluated for SAR since the average output power of 20 MHz and 40 MHz bandwidths was not more than 0.25 dB higher than the average output power of IEEE 802.11a.

This device supports IEEE 802.11ac with the following features:

- a) Up to 80 MHz Bandwidth only
- b) No aggregate channel configurations
- c) 1 Tx antenna output
- d) 256 QAM is supported



Full SAR evaluations for all IEEE 802.11ac configurations were not required since the average output power was not more than 0.25 dB higher than IEEE 802.11a mode. IEEE 802.11ac was evaluated for the highest IEEE 802.11a position in each 5 GHz band and exposure condition.

(B) Licensed Transmitter(s)

GSM/GPRS/EDGE DTM is not supported for US bands. Therefore, the GSM Voice modes in this report do not transmit simultaneously with GPRS/EDGE Data.

This device is only capable of QPSK HSUPA in the uplink. Therefore, no additional SAR tests are required beyond that described for devices with HSUPA in KDB 941225 D01v02.

LTE SAR for the higher modulations and lower bandwidths were not tested since the maximum average output power of all required channels and configurations was not more than 0.5 dB higher than the highest bandwidth; and the reported LTE SAR for the highest bandwidth was less than 1.45 W/kg for all configurations according to FCC KDB 941225 D05v02.

FCC ID: ZNFD950		SAR EVALUATION REPORT		Reviewed by: Quality Manager
Document S/N: 0Y1312022312.ZNF	Test Dates: 12/02/13 - 12/16/13	DUT Type: Portable Handset		Page 8 of 66

This device supports inter-band LTE Carrier Aggregation (CA) in the downlink only. All uplink communications are identical to Release 8 specifications. Per FCC Guidance, LTE CA SAR was not needed for testing since the data sent by uplink on uplink physical channels does not change between Rel 8 and Rel 10.

Per FCC KDB Publication 648474 D04 Handset SAR v01r01, since this device is a “phablet” and all hotspot SAR was < 1.2 W/kg, hand SAR was not required for licensed transmitters.

1.7 SAR Test Positioning Based on Form Factor

Due to the embowed design of the device, the test distance for Body SAR configurations was changed per FCC Guidance.

1g SAR:

For Back side, the device was tested at a distance of 8 mm at the center of the device. For Front side, the device was tested at a distance of 8 mm from the outer ends of the device. The remaining surface or edges within 25 mm of a Tx antenna were tested at a distance of 10 mm.

10g SAR:

For Back side, the device was tested at a distance of 0mm at the center. If the 10g SAR > 2.5 W/kg, the device was additionally tested bottom end touching the phantom as well as the top end touching the phantom. The remaining surface or edges within 25 mm of a Tx antenna were tested at a distance of 0 mm.

1.8 Power Reduction for SAR

There is no power reduction used for any band/mode implemented in this device for SAR purposes.



1.9 Guidance Applied

- FCC OET Bulletin 65 Supplement C [June 2001]
- IEEE 1528-2003
- FCC KDB Publication 941225 D01-D06 (2G/3G/4G and Hotspot)
- FCC KDB Publication 248227 D01v01r02 (SAR Considerations for 802.11 Devices)
- FCC KDB Publication 447498 D01v05 (General SAR Guidance)
- FCC KDB Publication 865664 D01-D02 (SAR Measurements up to 6 GHz)
- FCC KDB Publication 648474 D03-D04 (Phablet Procedures)
- April 2013 TCB Workshop Notes (IEEE 802.11 ac)

1.10 Device Serial Numbers

Several samples were used with identical hardware to support SAR testing. The manufacturer has confirmed that the device(s) tested have the same physical, mechanical and thermal characteristics and are within operational tolerances expected for production units.

	Head Serial Number	Body-Worn Serial Number	Hotspot Serial Number	Extremity Serial Number
GSM/GPRS/EDGE 850	FCC3	FCC3	FCC3	-
UMTS 850	FCC3	FCC3	FCC3	-
GSM/GPRS/EDGE 1900	FCC3	FCC3	FCC3	-
UMTS 1900	FCC3	FCC3	FCC3	-
LTE Band 17	FCC6	FCC6	FCC6	-
LTE Band 5 (Cell)	FCC6	FCC6	FCC6	-
LTE Band 4 (AWS)	FCC6	FCC6	FCC6	-
LTE Band 2 (PCS)	FCC6	FCC6	FCC6	-
LTE Band 7	FCC6	FCC6	FCC6	-
2.4 GHz WLAN	FCC6	FCC3	FCC3	-
5 GHz DTS WLAN	FCC7	FCC6	FCC6	-
5 GHz NII WLAN	FCC7	FCC6	-	FCC6

FCC ID: ZNFD950	 PCTEST ENGINEERING LABORATORY, INC.	SAR EVALUATION REPORT		Reviewed by: Quality Manager
Document S/N: 0Y1312022312.ZNF	Test Dates: 12/02/13 - 12/16/13	DUT Type: Portable Handset	Page 9 of 66	



2

LTE INFORMATION

LTE Release 10 Information			
FCC ID	ZNFD950		
Form Factor	Portable Handset		
Frequency Range of each LTE transmission band	LTE Band 17 (706.5 - 713.5 MHz)		
	LTE Band 5 (Cell) (826.5 - 846.5 MHz)		
	LTE Band 4 (AWS) (1712.5 - 1752.5 MHz)		
	LTE Band 2 (PCS) (1852.5 - 1907.5 MHz)		
	LTE Band 7 (2502.5 - 2567.5 MHz)		
Channel Bandwidths	LTE Band 17: 5 MHz, 10 MHz		
	LTE Band 5 (Cell): 5 MHz, 10 MHz		
	LTE Band 4 (AWS): 5 MHz, 10 MHz		
	LTE Band 2 (PCS): 5 MHz, 10 MHz		
	LTE Band 7: 5 MHz, 10 MHz, 15 MHz, 20 MHz		
Channel Numbers and Frequencies (MHz)	Low	Mid	High
LTE Band 17: 5 MHz	706.5 (23755)	710 (23790)	713.5 (23825)
LTE Band 17: 10 MHz	709 (23780)	710 (23790)	711 (23800)
LTE Band 5 (Cell): 5 MHz	826.5 (20425)	836.5 (20525)	846.5 (20625)
LTE Band 5 (Cell): 10 MHz	829 (20450)	836.5 (20525)	844 (20600)
LTE Band 4 (AWS): 5 MHz	1712.5 (19975)	1732.5 (20175)	1752.5 (20375)
LTE Band 4 (AWS): 10 MHz	1715 (20000)	1732.5 (20175)	1750 (20350)
LTE Band 2 (PCS): 5 MHz	1852.5 (18625)	1880 (18900)	1907.5 (19175)
LTE Band 2 (PCS): 10 MHz	1855 (18650)	1880 (18900)	1905 (19150)
LTE Band 7: 5 MHz	2502.5 (20775)	2535 (21100)	2567.5 (21425)
LTE Band 7: 10 MHz	2505 (20800)	2535 (21100)	2565 (21400)
LTE Band 7: 15 MHz	2507.5 (20825)	2535 (21100)	2562.5 (21375)
LTE Band 7: 20 MHz	2510 (20850)	2535 (21100)	2560 (21350)
UE Category	4		
Modulations Supported in UL	QPSK, 16QAM		
LTE Carrier Aggregation Possible Combinations	<u>B4 (PCC) + B17 (SCC)</u>	<u>B2 (PCC) + B17 (SCC)</u>	<u>B17 (PCC) + B2 (SCC)</u>
	5 MHz (B4) + 5 MHz (B17)	5 MHz (B2) + 5 MHz (B17)	5 MHz (B17) + 5 MHz (B2)
	10 MHz (B4) + 5 MHz (B17)	5 MHz (B2) + 10 MHz (B17)	5 MHz (B17) + 10 MHz (B2)
	5 MHz (B4) + 10 MHz (B17)	10 MHz (B2) + 5 MHz (B17)	10 MHz (B17) + 5 MHz (B2)
	10 MHz (B4) + 10 MHz (B17)	10 MHz (B2) + 10 MHz (B17)	10 MHz (B17) + 10 MHz (B2)
LTE Carrier Aggregation Additional Information	This device does not support full CA features on 3GPP Release 10. It supports a maximum of 2 carriers in the downlink with a total maximum bandwidth of 10 MHz of the spectrum. All uplink communications are identical to the Release 8 Specifications. Uplink communications are done on the PCC. Due to carrier capability, only B4 (PCC) + B17 (SCC), B2 (PCC) + B17 (SCC), and B17 (PCC) + B2 (SCC) is supported.		
LTE MPR Permanently implemented per 3GPP TS 36.101 section 6.2.3~6.2.5? (manufacturer attestation to be provided)	YES		
A-MPR (Additional MPR) disabled for SAR Testing?	YES		

The following LTE Release 10 Features are not supported: Relay, HetNet, Enhanced MIMO, eICIC, WIFI offloading, MDT, eMBMA, Cross-Carrier Scheduling, SC-FDMA.

Note: Primary Component Carrier (PCC) serves as the active component that handles the RCC connection establishment. Secondary Component Carrier (SCC) is configured after the connection is established to provide additional radio resources.

FCC ID: ZNFD950		SAR EVALUATION REPORT		Reviewed by: Quality Manager
Document S/N: 0Y1312022312.ZNF	Test Dates: 12/02/13 - 12/16/13	DUT Type: Portable Handset		Page 10 of 66

3 INTRODUCTION

The FCC and Industry Canada have adopted the guidelines for evaluating the environmental effects of radio frequency (RF) radiation in ET Docket 93-62 on Aug. 6, 1996 and Health Canada Safety Code 6 to protect the public and workers from the potential hazards of RF emissions due to FCC-regulated portable devices. [1]

The safety limits used for the environmental evaluation measurements are based on the criteria published by the American National Standards Institute (ANSI) for localized specific absorption rate (SAR) in IEEE/ANSI C95.1-1992 Standard for Safety Levels with Respect to Human Exposure to Radio Frequency Electromagnetic Fields, 3 kHz to 300 GHz [3] and Health Canada RF Exposure Guidelines Safety Code 6 [24]. The measurement procedure described in IEEE/ANSI C95.3-2002 Recommended Practice for the Measurement of Potentially Hazardous Electromagnetic Fields - RF and Microwave [4] is used for guidance in measuring the Specific Absorption Rate (SAR) due to the RF radiation exposure from the Equipment Under Test (EUT). These criteria for SAR evaluation are similar to those recommended by the International Committee for Non-Ionizing Radiation Protection (ICNIRP) in Biological Effects and Exposure Criteria for Radiofrequency Electromagnetic Fields,” Report No. Vol 74. SAR is a measure of the rate of energy absorption due to exposure to an RF transmitting source. SAR values have been related to threshold levels for potential biological hazards.

3.1 SAR Definition

Specific Absorption Rate is defined as the time derivative (rate) of the incremental energy (dU) absorbed by (dissipated in) an incremental mass (dm) contained in a volume element (dV) of a given density (ρ). It is also defined as the rate of RF energy absorption per unit mass at a point in an absorbing body (see Equation 3-1).

Equation 3-1
SAR Mathematical Equation

$$SAR = \frac{d}{dt} \left(\frac{dU}{dm} \right) = \frac{d}{dt} \left(\frac{dU}{\rho dv} \right)$$



SAR is expressed in units of Watts per Kilogram (W/kg).

$$SAR = \frac{\sigma \cdot E^2}{\rho}$$

where:

- σ = conductivity of the tissue-simulating material (S/m)
- ρ = mass density of the tissue-simulating material (kg/m³)
- E = Total RMS electric field strength (V/m)

NOTE: The primary factors that control rate of energy absorption were found to be the wavelength of the incident field in relation to the dimensions and geometry of the irradiated organism, the orientation of the organism in relation to the polarity of field vectors, the presence of reflecting surfaces, and whether conductive contact is made by the organism with a ground plane.[6]

FCC ID: ZNFD950	 PCTEST ENGINEERING LABORATORY, INC.	SAR EVALUATION REPORT		Reviewed by: Quality Manager
Document S/N: 0Y1312022312.ZNF	Test Dates: 12/02/13 - 12/16/13	DUT Type: Portable Handset		Page 11 of 66

4 DOSIMETRIC ASSESSMENT

4.1 Measurement Procedure

The evaluation was performed using the following procedure:

1. The SAR distribution at the exposed side of the head or body was measured at a distance no greater than 5.0 mm from the inner surface of the shell. The area covered the entire dimension of the device-head and body interface and the horizontal grid resolution was determined per FCC KDB Publication 865664 D01v01 (See Table 4-1).
2. The point SAR measurement was taken at the maximum SAR region determined from Step 1 to enable the monitoring of SAR fluctuations/drifts during the 1g/10g cube evaluation. SAR at this fixed point was measured and used as a reference value.
3. Based on the area scan data, the peak of the region with maximum SAR was determined by spline interpolation. Around this point, a volume was assessed according to the measurement resolution and volume size requirements of FCC KDB Publication 865664 D01v01 (See Table 4-1). On the basis of this data set, the spatial peak SAR value was evaluated with the following procedure (see references or the DASYS manual online for more details):
 - a. The data was extrapolated to the surface of the outer-shell of the phantom. The combined distance extrapolated was the combined distance from the center of the dipoles 2.7mm away from the tip of the probe housing plus the 1.2 mm distance between the surface and the lowest measuring point. The extrapolation was based on a least-squares algorithm. A polynomial of the fourth order was calculated through the points in the z-axis (normal to the phantom shell).
 - b. After the maximum interpolated values were calculated between the points in the cube, the SAR was averaged over the spatial volume (1g or 10g) using a 3D-Spline interpolation algorithm. The 3D-spline is composed of three one-dimensional splines with the “Not a knot” condition (in x, y, and z directions). The volume was then integrated with the trapezoidal algorithm. One thousand points (10 x 10 x 10) were obtained through interpolation, in order to calculate the averaged SAR.
 - c. All neighboring volumes were evaluated until no neighboring volume with a higher average value was found.
4. The SAR reference value, at the same location as step 2, was re-measured after the zoom scan was complete to calculate the SAR drift. If the drift deviated by more than 5%, the SAR test and drift measurements were repeated.

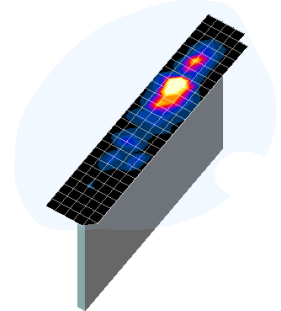



Figure 4-1
Sample SAR Area Scan

Table 4-1
Area and Zoom Scan Resolutions per FCC KDB Publication 865664 D01v01

Frequency	Maximum Area Scan Resolution (mm) ($\Delta x_{area}, \Delta y_{area}$)	Maximum Zoom Scan Resolution (mm) ($\Delta x_{zoom}, \Delta y_{zoom}$)	Maximum Zoom Scan Spatial Resolution (mm)			Minimum Zoom Scan Volume (mm) (x, y, z)
			Uniform Grid	Graded Grid		
			$\Delta z_{zoom}(n)$	$\Delta z_{zoom}(1)^*$	$\Delta z_{zoom}(n>1)^*$	
≤ 2 GHz	≤ 15	≤ 8	≤ 5	≤ 4	≤ 1.5* $\Delta z_{zoom}(n-1)$	≥ 30
2-3 GHz	≤ 12	≤ 5	≤ 5	≤ 4	≤ 1.5* $\Delta z_{zoom}(n-1)$	≥ 30
3-4 GHz	≤ 12	≤ 5	≤ 4	≤ 3	≤ 1.5* $\Delta z_{zoom}(n-1)$	≥ 28
4-5 GHz	≤ 10	≤ 4	≤ 3	≤ 2.5	≤ 1.5* $\Delta z_{zoom}(n-1)$	≥ 25
5-6 GHz	≤ 10	≤ 4	≤ 2	≤ 2	≤ 1.5* $\Delta z_{zoom}(n-1)$	≥ 22

FCC ID: ZNFD950	 PCTEST ENGINEERING LABORATORY, INC.	SAR EVALUATION REPORT		Reviewed by: Quality Manager
Document S/N: 0Y1312022312.ZNF	Test Dates: 12/02/13 - 12/16/13	DUT Type: Portable Handset		Page 12 of 66

5

DEFINITION OF REFERENCE POINTS

5.1 EAR REFERENCE POINT

Figure 5-2 shows the front, back and side views of the SAM Twin Phantom. The point “M” is the reference point for the center of the mouth, “LE” is the left ear reference point (ERP), and “RE” is the right ERP. The ERP is 15mm posterior to the entrance to the ear canal (EEC) along the B-M line (Back-Mouth), as shown in Figure 5-1. The plane passing through the two ear canals and M is defined as the Reference Plane. The line N-F (Neck-Front) is perpendicular to the reference plane and passing through the RE (or LE) is called the Reference Pivoting Line (see Figure 5-1). Line B-M is perpendicular to the N-F line. Both N-F and B-M lines are marked on the external phantom shell to facilitate handset positioning [5].

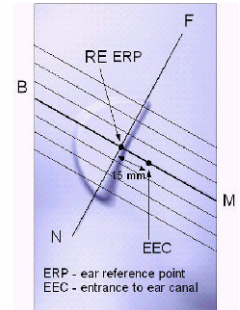

Figure 5-1
Close-Up Side view of ERP

5.2 HANDSET REFERENCE POINTS

Two imaginary lines on the handset were established: the vertical centerline and the horizontal line. The test device was placed in a normal operating position with the “test device reference point” located along the “vertical centerline” on the front of the device aligned to the “ear reference point” (See Figure 5-3). The “test device reference point” was then located at the same level as the center of the ear reference point. The test device was positioned so that the “vertical centerline” was bisecting the front surface of the handset at its top and bottom edges, positioning the “ear reference point” on the outer surface of the both the left and right head phantoms on the ear reference point.

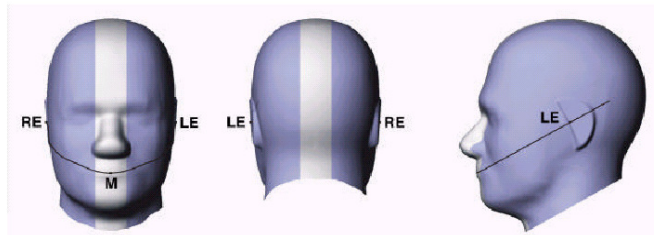

Figure 5-2
Front, back and side view of SAM Twin Phantom

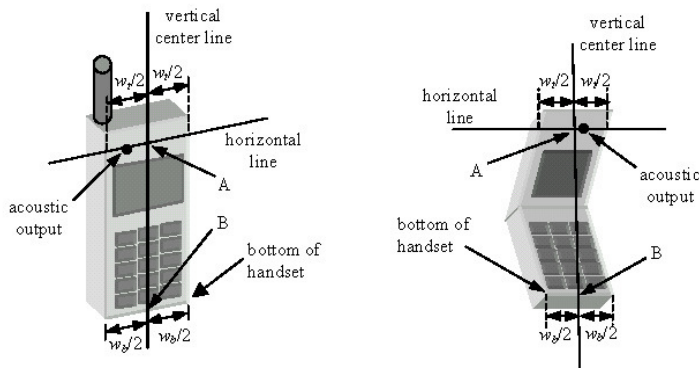



Figure 5-3
Handset Vertical Center & Horizontal Line Reference Points

FCC ID: ZNFD950	 PCTEST ENGINEERING LABORATORY, INC.	SAR EVALUATION REPORT		Reviewed by: Quality Manager
Document S/N: 0Y1312022312.ZNF	Test Dates: 12/02/13 - 12/16/13	DUT Type: Portable Handset		Page 13 of 66

6 TEST CONFIGURATION POSITIONS FOR HANDSETS

6.1 Device Holder

The device holder is made out of low-loss POM material having the following dielectric parameters: relative permittivity $\epsilon = 3$ and loss tangent $\delta = 0.02$.

6.2 Positioning for Cheek

1. The test device was positioned with the device close to the surface of the phantom such that point A is on the (virtual) extension of the line passing through points RE and LE on the phantom (see Figure 6-1), such that the plane defined by the vertical center line and the horizontal line of the phone is approximately parallel to the sagittal plane of the phantom.

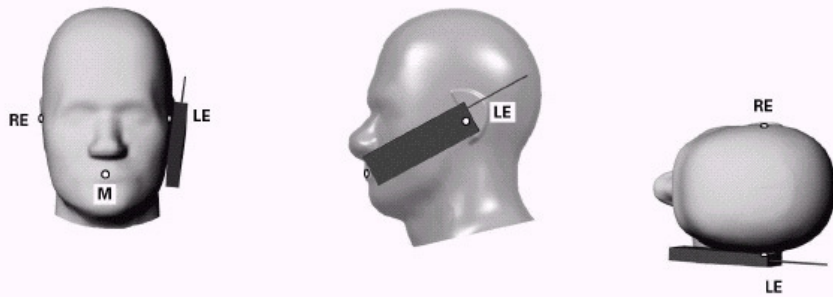



Figure 6-1 Front, Side and Top View of Cheek Position

2. The handset was translated towards the phantom along the line passing through RE & LE until the handset touches the ear.
3. While maintaining the handset in this plane, the handset was rotated around the LE-RE line until the vertical centerline was in the plane normal to MB-NF including the line MB (reference plane).
4. The phone was then rotated around the vertical centerline until the phone (horizontal line) was symmetrical with respect to the line NF.
5. While maintaining the vertical centerline in the reference plane, keeping point A on the line passing through RE and LE, and maintaining the device contact with the ear, the device was rotated about the NF line until any point on the handset made contact with a phantom point below the ear (cheek) (See Figure 6-2).

6.3 Positioning for Ear / 15° Tilt

With the test device aligned in the “Cheek Position”:

1. While maintaining the orientation of the phone, the phone was retracted parallel to the reference plane far enough to enable a rotation of the phone by 15 degrees.
2. The phone was then rotated around the horizontal line by 15 degrees.
3. While maintaining the orientation of the phone, the phone was moved parallel to the reference plane until any part of the handset touched the head. (In this position, point A was located on the line RE-LE). The tilted position is obtained when the contact is on the pinna. If the contact was at any location other than the pinna, the angle of the phone would then be reduced. The tilted position was obtained when any part of the phone was in contact of the ear as well as a second part of the phone was in contact with the head (see Figure 6-2).

FCC ID: ZNFD950	 PCTEST ENGINEERING LABORATORY, INC.	SAR EVALUATION REPORT		Reviewed by: Quality Manager
Document S/N: 0Y1312022312.ZNF	Test Dates: 12/02/13 - 12/16/13	DUT Type: Portable Handset		Page 14 of 66

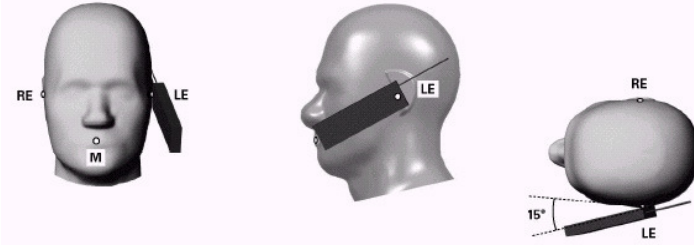

Figure 6-2 Front, Side and Top View of Ear/15° Tilt Position

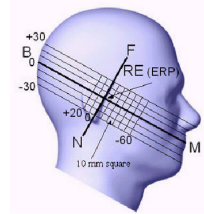

Figure 6-3 Side view w/ relevant markings

6.4 Body-Worn Accessory Configurations

Body-worn operating configurations are tested with the belt-clips and holsters attached to the device and positioned against a flat phantom in a normal use configuration (see Figure 6-4). Per FCC KDB Publication 648474 D04v01, Body-worn accessory exposure is typically related to voice mode operations when handsets are carried in body-worn accessories. The body-worn accessory procedures in FCC KDB Publication 447498 D01v05 should be used to test for body-worn accessory SAR compliance, without a headset connected to it. This enables the test results for such configuration to be compatible with that required for hotspot mode when the body-worn accessory test separation distance is greater than or equal to that required for hotspot mode, when applicable. When the reported SAR for a body-worn accessory, measured without a headset connected to the handset, is $> 1.2 \text{ W/kg}$, the highest reported SAR configuration for that wireless mode and frequency band should be repeated for that body-worn accessory with a headset attached to the handset.

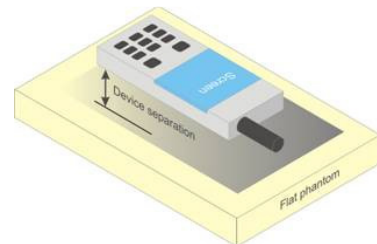



Figure 6-4 Sample Body-Worn Diagram

Accessories for Body-worn operation configurations are divided into two categories: those that do not contain metallic components and those that do contain metallic components. When multiple accessories that do not contain metallic components are supplied with the device, the device is tested with only the accessory that dictates the closest spacing to the body. Then multiple accessories that contain metallic components are tested with the device with each accessory. If multiple accessories share an identical metallic component (i.e. the same metallic belt-clip used with different holsters with no other metallic components) only the accessory that dictates the closest spacing to the body is tested.

Body-worn accessories may not always be supplied or available as options for some devices intended to be authorized for body-worn use. In this case, a test configuration with a separation distance between the back of the device and the flat phantom is used. Test position spacing was documented. Transmitters that are designed to operate in front of a person's face, as in push-to-talk configurations, are tested for SAR compliance with the front of the device positioned to face the flat phantom in head fluid. For devices that are carried next to the body such as a shoulder, waist or chest-worn transmitters, SAR compliance is tested with the accessories, including headsets and microphones, attached to the device and positioned against a flat phantom in a normal use configuration.

FCC ID: ZNFD950	 PCTEST ENGINEERING LABORATORY, INC.	SAR EVALUATION REPORT	 LG	Reviewed by: Quality Manager
Document S/N: 0Y1312022312.ZNF	Test Dates: 12/02/13 - 12/16/13	DUT Type: Portable Handset		Page 15 of 66

6.5 Extremity Exposure Configurations



Devices that are designed or intended for use on extremities or mainly operated in extremity only exposure conditions; i.e., hands, wrists, feet and ankles, may require extremity SAR evaluation. When the device also operates in close proximity to the user's body, SAR compliance for the body is also required. The 1-g body and 10-g extremity SAR Exclusion Thresholds found in KDB Publication 44798 D01v05 should be applied to determine SAR test requirements.

For smart phones with a display diagonal dimension > 15.0 cm or an overall diagonal dimension > 16.0 cm that provide similar mobile web access and multimedia support found in mini-tablets or UMPC minitables that support voice calls next to the ear, the phablets procedures outlined in KDB Publication 648474 D04 v01r01DR04 should be applied to evaluate SAR compliance. A device marketed as phablets, regardless of form factors and operating characteristics must be tested as a phablet to determine SAR compliance. In addition to the normally required head and body-worn accessory SAR test procedures required for handsets, the UMPC mini-tablet procedures must also be applied to test the SAR of all surfaces and edges with an antenna ≤ 25 mm from that surface or edge, in direct contact with the phantom, for 10-g SAR. The UMPC mini-tablet 1-g SAR at 5 mm is not required. When hotspot mode applies, 10-g SAR is required only for the surfaces and edges with hotspot mode 1-g SAR > 1.2 W/kg.

6.6 Wireless Router Configurations

Some battery-operated handsets have the capability to transmit and receive user data through simultaneous transmission of WIFI simultaneously with a separate licensed transmitter. The FCC has provided guidance in FCC KDB Publication 941225 D06 v01 where SAR test considerations for handsets ($L \times W \geq 9 \text{ cm} \times 5 \text{ cm}$) are based on a composite test separation distance of 10 mm from the front, back and edges of the device containing transmitting antennas within 2.5 cm of their edges, determined from general mixed use conditions for this type of devices. Since the hotspot SAR results may overlap with the body-worn accessory SAR requirements, the more conservative configurations can be considered, thus excluding some body-worn accessory SAR tests.

When the user enables the personal wireless router functions for the handset, actual operations include simultaneous transmission of both the WIFI transmitter and another licensed transmitter. Both transmitters often do not transmit at the same transmitting frequency and thus cannot be evaluated for SAR under actual use conditions due to the limitations of the SAR assessment probes. Therefore, SAR must be evaluated for each frequency transmission and mode separately and spatially summed with the WIFI transmitter according to FCC KDB Publication 447498 D01v05 publication procedures. The "Portable Hotspot" feature on the handset was NOT activated during SAR assessments, to ensure the SAR measurements were evaluated for a single transmission frequency RF signal at a time.

FCC ID: ZNFD950	 PCTEST ENGINEERING LABORATORY, INC.	SAR EVALUATION REPORT		Reviewed by: Quality Manager
Document S/N: 0Y1312022312.ZNF	Test Dates: 12/02/13 - 12/16/13	DUT Type: Portable Handset	Page 16 of 66	

7 RF EXPOSURE LIMITS

7.1 Uncontrolled Environment

UNCONTROLLED ENVIRONMENTS are defined as locations where there is the exposure of individuals who have no knowledge or control of their exposure. The general population/uncontrolled exposure limits are applicable to situations in which the general public may be exposed or in which persons who are exposed as a consequence of their employment may not be made fully aware of the potential for exposure or cannot exercise control over their exposure. Members of the general public would come under this category when exposure is not employment-related; for example, in the case of a wireless transmitter that exposes persons in its vicinity.



7.2 Controlled Environment

CONTROLLED ENVIRONMENTS are defined as locations where there is exposure that may be incurred by persons who are aware of the potential for exposure, (i.e. as a result of employment or occupation). In general, occupational/controlled exposure limits are applicable to situations in which persons are exposed as a consequence of their employment, who have been made fully aware of the potential for exposure and can exercise control over their exposure. This exposure category is also applicable when the exposure is of a transient nature due to incidental passage through a location where the exposure levels may be higher than the general population/uncontrolled limits, but the exposed person is fully aware of the potential for exposure and can exercise control over his or her exposure by leaving the area or by some other appropriate means.

**Table 7-1
SAR Human Exposure Specified in ANSI/IEEE C95.1-1992 and Health Canada Safety Code 6**

HUMAN EXPOSURE LIMITS		
	UNCONTROLLED ENVIRONMENT <i>General Population</i> (W/kg) or (mW/g)	CONTROLLED ENVIRONMENT <i>Occupational</i> (W/kg) or (mW/g)
Peak Spatial Average SAR Head	1.6	8.0
Whole Body SAR	0.08	0.4
Peak Spatial Average SAR Hands, Feet, Ankle, Wrists, etc.	4.0	20

1. The Spatial Peak value of the SAR averaged over any 1 gram of tissue (defined as a tissue volume in the shape of a cube) and over the appropriate averaging time.
2. The Spatial Average value of the SAR averaged over the whole body.
3. The Spatial Peak value of the SAR averaged over any 10 grams of tissue (defined as a tissue volume in the shape of a cube) and over the appropriate averaging time.

FCC ID: ZNFD950	 PCTEST ENGINEERING LABORATORY, INC.	SAR EVALUATION REPORT		Reviewed by: Quality Manager
Document S/N: 0Y1312022312.ZNF	Test Dates: 12/02/13 - 12/16/13	DUT Type: Portable Handset		Page 17 of 66

8 FCC MEASUREMENT PROCEDURES

8.1 Measured and Reported SAR

Per FCC KDB Publication 447498 D01v05, When SAR is not measured at the maximum power level allowed for production units, the results must be scaled to the maximum tune-up tolerance limit according to the power applied to the individual channels tested to determine compliance. For simultaneous transmission, the measured aggregate SAR must be scaled according to the sum of the differences between the maximum tune-up tolerance and actual power used to test each transmitter. When SAR is measured at or scaled to the maximum tune-up tolerance limit, the results are referred to as *reported* SAR. The highest *reported* SAR results are identified on the grant of equipment authorization according to procedures in KDB 690783 D01v01r02.

8.2 Procedures Used to Establish RF Signal for SAR

The following procedures are according to FCC KDB Publication 941225 D01 "SAR Measurement Procedures for 3G Devices" v02, October 2007.

The device was placed into a simulated call using a base station simulator in a RF shielded chamber. Establishing connections in this manner ensure a consistent means for testing SAR and are recommended for evaluating SAR [4]. Devices under test were evaluated prior to testing, with a fully charged battery and were configured to operate at maximum output power. In order to verify that the device was tested throughout the SAR test at maximum output power, the SAR measurement system measures a "point SAR" at an arbitrary reference point at the start and end of the 1 gram SAR evaluation, to assess for any power drifts during the evaluation. If the power drift deviated by more than 5%, the SAR test and drift measurements were repeated.

8.3 SAR Measurement Conditions for UMTS

8.3.1 Output Power Verification

Maximum output power is measured on the High, Middle and Low channels for each applicable transmission band according to the general descriptions in section 5.2 of 3GPP TS 34.121, using the appropriate RMC or AMR with TPC (transmit power control) set to all "1s".



Maximum output power is verified on the High, Middle and Low channels according to the general descriptions in section 5.2 of 3GPP TS 34.121 (release 5), using the appropriate RMC with TPC (transmit power control) set to all "1s" or applying the required inner loop power control procedures to maintain maximum output power while HSUPA is active. Results for all applicable physical channel configurations (DPCCH, DPDCHn and spreading codes, HS-DPCCH etc) are tabulated in this test report. All configurations that are not supported by the DUT or cannot be measured due to technical or equipment limitations are identified.

8.3.2 Head SAR Measurements for Handsets

SAR for head exposure configurations is measured using the 12.2 kbps RMC with TPC bits configured to all "1s". SAR in AMR configurations is not required when the maximum average output of each RF channel for 12.2 kbps AMR is less than 0.25 dB higher than that measured in 12.2 kbps RMC. Otherwise, SAR is measured on the maximum output channel in 12.2 AMR with a 3.4 kbps SRB (signaling radio bearer) using the exposure configuration that resulted in the highest SAR for that RF channel in the 12.2 kbps RMC mode.

8.3.3 Body SAR Measurements

SAR for body exposure configurations is measured using the 12.2 kbps RMC with the TPC bits all "1s".

FCC ID: ZNFD950		SAR EVALUATION REPORT		Reviewed by: Quality Manager
Document S/N: 0Y1312022312.ZNF	Test Dates: 12/02/13 - 12/16/13	DUT Type: Portable Handset		Page 18 of 66

8.3.4 SAR Measurements for Handsets with Rel 5 HSDPA

Body SAR for HSDPA is not required for handsets with HSDPA capabilities when the maximum average output power of each RF channel with HSDPA active is less than 0.25 dB higher than that measured without HSDPA using 12.2 kbps RMC and the maximum SAR for 12.2 kbps RMC is $\leq 75\%$ of the SAR limit. Otherwise, SAR is measured for HSDPA, using an FRC with H-Set 1 in Sub-test 1 and a 12.2 kbps RMC configured in Test Loop Mode 1, using the highest body SAR configuration measured in 12.2 kbps RMC without HSDPA, on the maximum output channel with the body exposure configuration that resulted in the highest SAR in 12.2 kbps RMC mode for that RF channel.

The H-set used in FRC for HSDPA should be configured according to the UE category of a test device. The number of HS-DSCH/HSPDSCHs, HARQ processes, minimum inter-TTI interval, transport block sizes and RV coding sequence are defined by the applicable H-set. To maintain a consistent test configuration and stable transmission conditions, QPSK is used in the FRC for SAR testing. HS-DPCCH should be configured with a CQI feedback cycle of 2 ms to maintain a constant rate of active CQI slots. DPCCH and DPDCH gain factors of $\beta_c=9$ and $\beta_d=15$, and power offset parameters of $\Delta_{ACK} = \Delta_{NACK} = 5$ and $\Delta_{CQI}=2$ is used. The CQI value is determined by the UE category, transport block size, number of HS-PDSCHs and modulation used in the FRC.

Sub-Test	β_c	β_d	β_d (SF)	β_c/β_d	β_{HS} (Note 1, Note 2)	CM (dB) (Note 3)	MPR (dB) (Note 3)
1	2/15	15/15	64	2/15	4/15	0.0	0.0
2	12/15 (Note 4)	15/15 (Note 4)	64	12/15 (Note 4)	24/15	1.0	0.0
3	15/15	8/15	64	15/8	30/15	1.5	0.5
4	15/15	4/15	64	15/4	30/15	1.5	0.5



Note 1: $\Delta_{ACK}, \Delta_{NACK}$ and $\Delta_{CQI} = 8 \Leftrightarrow A_{HS} = \beta_{HS}/\beta_c = 30/15 \Leftrightarrow \beta_{HS} = 30/15 * \beta_c$.
 Note 2: For the HS-DPCCH power mask requirement test in clause 5.2C, 5.7A, and the Error Vector Magnitude (EVM) with HS-DPCCH test in clause 5.13.1A, and HSDPA EVM with phase discontinuity in clause 5.13.1AA, Δ_{ACK} and $\Delta_{NACK} = 8$ ($A_{HS} = 30/15$) with $\beta_{HS} = 30/15 * \beta_c$, and $\Delta_{CQI} = 7$ ($A_{HS} = 24/15$) with $\beta_{HS} = 24/15 * \beta_c$.
 Note 3: CM = 1 for $\beta_c/\beta_d=12/15$, $\beta_{HS}/\beta_c=24/15$. For all other combinations of DPDCH, DPCCH and HS-DPCCH the MPR is based on the relative CM difference. This is applicable for only UEs that support HSDPA in release 6 and later releases.

Figure 8-1
Table C.10.1.4 of TS 234.121-1

8.3.5 SAR Measurements for Handsets with Rel 6 HSUPA

Body SAR for HSUPA is not required when the maximum average output of each RF channel with HSUPA/HSDPA active is less than 0.25 dB higher than as measured without HSUPA/HSDPA using 12.2 kbps RMC and maximum SAR for 12.2 kbps RMC is $\leq 75\%$ of the SAR limit. Otherwise SAR is measured on the maximum output channel for the body exposure configuration produced highest SAR in 12.2 kbps RMC for that RF channel, using the additional procedures under “Release 6 HSPA data devices”

Head SAR for VOIP operations under HSPA is not required when maximum average output of each RF channel with HSPA is less than 0.25 dB higher than as measured using 12.2 kbps RMC. Otherwise SAR is measured using same HSPA configuration as used for body SAR.

FCC ID: ZNFD950	 PCTEST ENGINEERING LABORATORY, INC.	SAR EVALUATION REPORT		Reviewed by: Quality Manager
Document S/N: 0Y1312022312.ZNF	Test Dates: 12/02/13 - 12/16/13	DUT Type: Portable Handset		Page 19 of 66

Sub-test	β_c	β_d	β_a (SF)	β_c/β_d	$\beta_{hs}^{(1)}$	β_{ec}	β_{ed}	β_{ed} (SF)	β_{ed} (codes)	CM ⁽²⁾ (dB)	MPR (dB)	AG ⁽⁴⁾ Index	E-TFCI
1	11/15 ⁽³⁾	15/15 ⁽³⁾	64	11/15 ⁽³⁾	22/15	209/225	1039/225	4	1	1.0	0.0	20	75
2	6/15	15/15	64	6/15	12/15	12/15	94/75	4	1	3.0	2.0	12	67
3	15/15	9/15	64	15/9	30/15	30/15	$\beta_{ed}: 47/15$ $\beta_{ed}: 47/15$	4	2	2.0	1.0	15	92
4	2/15	15/15	64	2/15	4/15	2/15	56/75	4	1	3.0	2.0	17	71
5	15/15 ⁽⁴⁾	15/15 ⁽⁴⁾	64	15/15 ⁽⁴⁾	30/15	24/15	134/15	4	1	1.0	0.0	21	81

Note 1: Δ_{ACK} , Δ_{NACK} and $\Delta_{CQI} = 8 \Leftrightarrow A_{hs} = \beta_{hs}/\beta_c = 30/15 \Leftrightarrow \beta_{hs} = 30/15 * \beta_c$.

Note 2: CM = 1 for $\beta_c/\beta_d = 12/15$, $\beta_{hs}/\beta_c = 24/15$. For all other combinations of DPDCH, DPCCH, HS-DPCCH, E-DPDCH and E-DPCCH the MPR is based on the relative CM difference.

Note 3: For subtest 1 the β_c/β_d ratio of 11/15 for the TFC during the measurement period (TF1, TF0) is achieved by setting the signaled gain factors for the reference TFC (TF1, TF1) to $\beta_c = 10/15$ and $\beta_d = 15/15$.

Note 4: For subtest 5 the β_c/β_d ratio of 15/15 for the TFC during the measurement period (TF1, TF0) is achieved by setting the signaled gain factors for the reference TFC (TF1, TF1) to $\beta_c = 14/15$ and $\beta_d = 15/15$.

Note 5: Testing UE using E-DPDCH Physical Layer category 1 Sub-test 3 is not required according to TS 25.306 Table 5.1g.

Note 6: β_{ed} can not be set directly; it is set by Absolute Grant Value.

8.4 SAR Measurement Conditions for LTE

LTE modes were tested according to FCC KDB 941225 D05v02 publication. Please see notes after the tabulated SAR data for required test configurations. Establishing connections with base station simulators ensure a consistent means for testing SAR and are recommended for evaluating SAR [4]. The R&S CMW500 was used for LTE output power measurements and SAR testing. Closed loop power control was used so the UE transmits with maximum output power during SAR testing.

8.4.1 Spectrum Plots for RB Configurations

A properly configured base station simulator was used for SAR tests and power measurements. Therefore, spectrum plots for RB configurations were not required to be included in this report.

8.4.2 MPR

MPR is permanently implemented for this device by the manufacturer. The specific manufacturer target MPR is indicated alongside the SAR results. MPR is enabled for this device, according to 3GPP TS36.101 Section 6.2.3 – 6.2.5 under Table 6.2.3-1.



8.4.3 A-MPR

A-MPR (Additional MPR) has been disabled for all SAR tests by setting NS=01 on the base station simulator.

8.4.4 Required RB Size and RB Offsets for SAR Testing

According to FCC KDB 941225 D05v02r01:

- a. Per Section 5.2.1, SAR is required for QPSK 1 RB Allocation for the largest bandwidth
 - i. The required channel and offset combination with the highest maximum output power is required for SAR.
 - ii. When the reported SAR is ≤ 0.8 W/kg, testing of the remaining RB offset configurations and required test channels is not required. Otherwise, SAR is required for the remaining required test channels using the RB offset configuration with highest output power for that channel.
 - iii. When the reported SAR for a required test channel is > 1.45 W/kg, SAR is required for all RB offset configurations for that channel.
- b. Per Section 5.2.2, SAR is required for 50% RB allocation using the largest bandwidth following the same procedures outlined in Section 5.2.1.
- c. Per Section 5.2.3, QPSK SAR is not required for the 100% allocation when the highest maximum output power for the 100% allocation is less than the highest maximum output

FCC ID: ZNFD950	 PCTEST ENGINEERING LABORATORY, INC.	SAR EVALUATION REPORT		Reviewed by: Quality Manager
Document S/N: 0Y1312022312.ZNF	Test Dates: 12/02/13 - 12/16/13	DUT Type: Portable Handset		Page 20 of 66

power of the 1 RB and 50% RB allocations and the reported SAR for the 1 RB and 50% RB allocations is < 0.8 W/kg.

- d. Per Section 5.2.4 and 5.3, SAR tests for higher order modulations and lower bandwidths configurations are not required when the conducted power of the required test configurations determined by Sections 5.2.1 through 5.2.3 is less than or equal to ½ dB higher than the equivalent configuration using QPSK modulation and when the QPSK SAR for those configurations is <1.45 W/kg.

8.4.5 Carrier Aggregation

LTE Carrier Aggregation (CA) measurements were made in accordance to 3GPP TS 36.521-1 V10.4.0 (2012-12). The RRC connection is only handled by one cell, the Primary component carrier (PCC) for downlink and uplink communications. After making a data connection to the PCC, the UE device adds the Secondary component carrier (SCC) on the downlink only. All uplink communications and acknowledgements remain identical to release 8 specifications on the PCC. Additional output powers were measured using two carriers in the downlink for the release 8 configurations with the highest output power among all channels, RB configurations and bandwidths for each uplink band. Per FCC Guidance, no SAR measurements were required.

8.5 SAR Testing with 802.11 Transmitters

Normal network operating configurations are not suitable for measuring the SAR of 802.11 a/b/g/n /ac transmitters. Unpredictable fluctuations in network traffic and antenna diversity conditions can introduce undesirable variations in SAR results. The SAR for these devices should be measured using chipset based test mode software to ensure the results are consistent and reliable. See KDB Publication 248227 D01v01r02 for more details.

8.5.1 General Device Setup



Chipset based test mode software is hardware dependent and generally varies among manufacturers. The device operating parameters established in test mode for SAR measurements must be identical to those programmed in production units, including output power levels, amplifier gain settings and other RF performance tuning parameters. The test frequencies should correspond to actual channel frequencies defined for domestic use. SAR for devices with switched diversity should be measured with only one antenna transmitting at a time during each SAR measurement, according to a fixed modulation and data rate. The same data pattern should be used for all measurements.

8.5.2 Frequency Channel Configurations [27]

For 2.4 GHz, the highest average RF output power channel between the low, mid and high channel at the lowest data rate was selected for SAR evaluation in 802.11b mode. 802.11g/n modes and higher data rates for 802.11b were additionally evaluated for SAR if the output power of the respective mode was 0.25 dB or higher than the powers of the SAR configurations tested in the 802.11b mode.

For 5 GHz, the highest average RF output power channel across the default test channels at the lowest data rate was selected for SAR evaluation in 802.11a. When the adjacent channels are higher in power than the default channels, these “required channels” were considered instead of the default channels for SAR testing. 802.11n modes and higher data rates for 802.11a/n were evaluated only if the respective mode was 0.25 dB or higher than the 802.11a mode. 802.11ac SAR was evaluated for highest 802.11a configuration in each 5 GHz band and each exposure condition. 802.11ac modes were additionally evaluated for SAR if the output power for the respective mode was more than 0.25 dB higher than powers of 802.11a modes.

If the maximum extrapolated peak SAR of the zoom scan for the highest output channel was less than 1.6 W/kg and if the 1g averaged SAR was less than 0.8 W/kg, SAR testing was not required for the other test channels in the band.

FCC ID: ZNFD950	 PCTEST ENGINEERING LABORATORY, INC.	SAR EVALUATION REPORT		Reviewed by: Quality Manager
Document S/N: 0Y1312022312.ZNF	Test Dates: 12/02/13 - 12/16/13	DUT Type: Portable Handset		Page 21 of 66

9 RF CONDUCTED POWERS

9.1 GSM Conducted Powers

		Maximum Burst-Averaged Output Power				
		Voice	GPRS/EDGE Data (GMSK)		EDGE Data (8-PSK)	
Band	Channel	GSM [dBm] CS (1 Slot)	GPRS [dBm] 1 Tx Slot	GPRS [dBm] 2 Tx Slot	EDGE [dBm] 1 Tx Slot	EDGE [dBm] 2 Tx Slot
GSM 850	128	33.36	33.37	31.23	26.99	25.98
	190	33.31	33.32	31.27	27.02	25.94
	251	33.63	33.67	31.23	26.95	25.96
GSM 1900	512	30.69	30.70	28.48	26.20	25.48
	661	30.66	30.65	28.41	26.13	25.33
	810	30.70	30.69	28.51	26.15	25.37

		Calculated Maximum Frame-Averaged Output Power				
		Voice	GPRS/EDGE Data (GMSK)		EDGE Data (8-PSK)	
Band	Channel	GSM [dBm] CS (1 Slot)	GPRS [dBm] 1 Tx Slot	GPRS [dBm] 2 Tx Slot	EDGE [dBm] 1 Tx Slot	EDGE [dBm] 2 Tx Slot
GSM 850	128	24.33	24.34	25.21	17.96	19.96
	190	24.28	24.29	25.25	17.99	19.92
	251	24.60	24.64	25.21	17.92	19.94
GSM 1900	512	21.66	21.67	22.46	17.17	19.46
	661	21.63	21.62	22.39	17.10	19.31
	810	21.67	21.66	22.49	17.12	19.35



Note:

- Both burst-averaged and calculated frame-averaged powers are included. Frame-averaged power was calculated from the measured burst-averaged power by converting the slot powers into linear units and calculating the energy over 8 timeslots.
- The source-based frame-averaged output power was evaluated for all GPRS/EDGE slot configurations. The configuration with the highest target frame averaged output power was evaluated for wireless router SAR. When the maximum frame-averaged powers are equivalent across two or more slots (within 0.25 dB), the configuration with the most number of time slots was tested.
- GPRS/EDGE (GMSK) output powers were measured with coding scheme setting of 1 (CS1) on the base station simulator. CS1 was configured to measure GPRS output power measurements and SAR to ensure GMSK modulation in the signal. Our Investigation has shown that CS1 - CS4 settings do not have any impact on the output levels or modulation in the GPRS modes.
- EDGE (8-PSK) output powers were measured with MCS7 on the base station simulator. MCS7 coding scheme was used to measure the output powers for EDGE since investigation has shown that choosing MCS7 coding scheme will ensure 8-PSK modulation. It has been shown that MCS levels that produce 8PSK modulation do not have an impact on output power.

GSM Class: B
GPRS Multislot class: 10 (Max 2 Tx uplink slots)
EDGE Multislot class: 10 (Max 2 Tx uplink slots)
DTM Multislot Class: N/A



Figure 9-1
Power Measurement Setup

FCC ID: ZNFD950	 PCTEST ENGINEERING LABORATORY, INC.	SAR EVALUATION REPORT		Reviewed by: Quality Manager
Document S/N: 0Y1312022312.ZNF	Test Dates: 12/02/13 - 12/16/13	DUT Type: Portable Handset	Page 22 of 66	

9.2 UMTS Conducted Powers

3GPP Release Version	Mode	3GPP 34.121 Subtest	Cellular Band [dBm]			PCS Band [dBm]			3GPP MPR [dB]
			4132	4183	4233	9262	9400	9538	
99	WCDMA	12.2 kbps RMC	23.70	23.37	23.33	23.67	23.70	23.68	-
99		12.2 kbps AMR	23.65	23.35	23.33	23.66	23.69	23.57	-
6	HSDPA	Subtest 1	23.65	23.50	23.53	23.60	23.55	23.50	0
6		Subtest 2	23.70	23.61	23.57	23.63	23.57	23.46	0
6		Subtest 3	23.20	22.84	22.98	23.10	23.01	22.99	0.5
6		Subtest 4	23.06	22.80	22.74	23.01	23.00	22.97	0.5
6	HSUPA	Subtest 1	23.62	23.55	23.36	23.70	23.46	23.50	0
6		Subtest 2	22.30	22.21	21.87	22.17	22.10	21.81	2
6		Subtest 3	22.52	23.36	22.39	22.44	22.30	22.17	1
6		Subtest 4	21.90	22.20	22.08	21.94	22.00	21.87	2
6		Subtest 5	23.50	22.91	23.10	23.67	23.04	22.90	0



UMTS SAR was tested under RMC 12.2 kbps with HSPA Inactive per KDB Publication 941225 D01v02. HSPA SAR was not required since the average output power of the HSPA subtests was not more than 0.25 dB higher than the RMC level and SAR was less than 1.2 W/kg.

This device does not support DC-HSDPA.

It is expected by the manufacturer that MPR for some HSPA subtests may be as low as 0 dB according to the chipset implementation in this model.



Figure 9-2
Power Measurement Setup

FCC ID: ZNFD950	 PCTEST ENGINEERING LABORATORY, INC.	SAR EVALUATION REPORT		Reviewed by: Quality Manager
Document S/N: 0Y1312022312.ZNF	Test Dates: 12/02/13 - 12/16/13	DUT Type: Portable Handset		Page 23 of 66

9.3 LTE Conducted Powers

9.3.1 LTE Band 17



Table 9-1
LTE Band 17 Conducted Powers - 10 MHz Bandwidth

	Frequency [MHz]	Channel	Bandwidth [MHz]	Modulation	RB Size	RB Offset	Conducted Power [dBm]	Target MPR [dB]	MPR Allowed per 3GPP [dB]
Mid	710.0	23790	10	QPSK	1	0	24.12	0	0
	710.0	23790	10	QPSK	1	25	24.00	0	0
	710.0	23790	10	QPSK	1	49	23.99	0	0
	710.0	23790	10	QPSK	25	0	22.95	1	0-1
	710.0	23790	10	QPSK	25	12	22.97	1	0-1
	710.0	23790	10	QPSK	25	25	23.01	1	0-1
	710.0	23790	10	QPSK	50	0	22.87	1	0-1
	710.0	23790	10	16QAM	1	0	22.93	1	0-1
	710.0	23790	10	16QAM	1	25	23.15	1	0-1
	710.0	23790	10	16QAM	1	49	23.17	1	0-1
	710.0	23790	10	16QAM	25	0	22.11	2	0-2
	710.0	23790	10	16QAM	25	12	22.04	2	0-2
	710.0	23790	10	16QAM	25	25	22.05	2	0-2
	710.0	23790	10	16QAM	50	0	22.00	2	0-2

Table 9-2
LTE Band 17 Conducted Powers - 5 MHz Bandwidth

	Frequency [MHz]	Channel	Bandwidth [MHz]	Modulation	RB Size	RB Offset	Conducted Power [dBm]	Target MPR [dB]	MPR Allowed per 3GPP [dB]
Mid	710.0	23790	5	QPSK	1	0	23.96	0	0
	710.0	23790	5	QPSK	1	12	23.93	0	0
	710.0	23790	5	QPSK	1	24	23.90	0	0
	710.0	23790	5	QPSK	12	0	22.97	1	0-1
	710.0	23790	5	QPSK	12	6	22.95	1	0-1
	710.0	23790	5	QPSK	12	13	22.99	1	0-1
	710.0	23790	5	QPSK	25	0	22.95	1	0-1
	710.0	23790	5	16-QAM	1	0	22.73	1	0-1
	710.0	23790	5	16-QAM	1	12	22.77	1	0-1
	710.0	23790	5	16-QAM	1	24	22.71	1	0-1
	710.0	23790	5	16-QAM	12	0	22.02	2	0-2
	710.0	23790	5	16-QAM	12	6	22.01	2	0-2
	710.0	23790	5	16-QAM	12	13	22.05	2	0-2
	710.0	23790	5	16-QAM	25	0	21.99	2	0-2

Note: LTE Band 17 at 5 and 10 MHz bandwidths do not support three non-overlapping channels. Per KDB Publication 941225 D05v02, when a device supports overlapping channel assignment in a channel bandwidth configuration, the middle channel of the group of overlapping channels should be selected for testing.

FCC ID: ZNFD950	 PCTEST ENGINEERING LABORATORY, INC.	SAR EVALUATION REPORT		Reviewed by: Quality Manager
Document S/N: 0Y1312022312.ZNF	Test Dates: 12/02/13 - 12/16/13	DUT Type: Portable Handset		Page 24 of 66



9.3.2

LTE Band 5 (Cell)

Table 9-3
LTE Band 5 (Cell) Conducted Powers - 10 MHz Bandwidth



	Frequency [MHz]	Channel	Bandwidth [MHz]	Modulation	RB Size	RB Offset	Conducted Power [dBm]	Target MPR [dB]	MPR Allowed per 3GPP [dB]
Mid	836.5	20525	10	QPSK	1	0	23.63	0	0
	836.5	20525	10	QPSK	1	25	23.55	0	0
	836.5	20525	10	QPSK	1	49	23.57	0	0
	836.5	20525	10	QPSK	25	0	22.67	1	0-1
	836.5	20525	10	QPSK	25	12	22.62	1	0-1
	836.5	20525	10	QPSK	25	25	22.58	1	0-1
	836.5	20525	10	QPSK	50	0	22.63	1	0-1
	836.5	20525	10	16QAM	1	0	22.66	1	0-1
	836.5	20525	10	16QAM	1	25	22.67	1	0-1
	836.5	20525	10	16QAM	1	49	22.64	1	0-1
	836.5	20525	10	16QAM	25	0	21.69	2	0-2
	836.5	20525	10	16QAM	25	12	21.65	2	0-2
	836.5	20525	10	16QAM	25	25	21.61	2	0-2
	836.5	20525	10	16QAM	50	0	21.66	2	0-2

Note: LTE Band 5 (Cell) at 10 MHz bandwidth does not support three non-overlapping channels. Per KDB Publication 941225 D05v02, when a device supports overlapping channel assignment in a channel bandwidth configuration, the middle channel of the group of overlapping channels should be selected for testing.

FCC ID: ZNFD950	 PCTEST ENGINEERING LABORATORY, INC.	SAR EVALUATION REPORT		Reviewed by: Quality Manager
Document S/N: 0Y1312022312.ZNF	Test Dates: 12/02/13 - 12/16/13	DUT Type: Portable Handset	Page 25 of 66	

**Table 9-4
LTE Band 5 (Cell) Conducted Powers - 5 MHz Bandwidth**

	Frequency [MHz]	Channel	Bandwidth [MHz]	Modulation	RB Size	RB Offset	Conducted Power [dBm]	Target MPR [dB]	MPR Allowed per 3GPP [dB]
Low	826.5	20425	5	QPSK	1	0	23.61	0	0
	826.5	20425	5	QPSK	1	12	23.53	0	0
	826.5	20425	5	QPSK	1	24	23.57	0	0
	826.5	20425	5	QPSK	12	0	22.65	1	0-1
	826.5	20425	5	QPSK	12	6	22.61	1	0-1
	826.5	20425	5	QPSK	12	13	22.67	1	0-1
	826.5	20425	5	QPSK	25	0	22.60	1	0-1
	826.5	20425	5	16-QAM	1	0	22.59	1	0-1
	826.5	20425	5	16-QAM	1	12	22.55	1	0-1
	826.5	20425	5	16-QAM	1	24	22.48	1	0-1
	826.5	20425	5	16-QAM	12	0	21.67	2	0-2
	826.5	20425	5	16-QAM	12	6	21.59	2	0-2
	826.5	20425	5	16-QAM	12	13	21.56	2	0-2
826.5	20425	5	16-QAM	25	0	21.62	2	0-2	
Mid	836.5	20525	5	QPSK	1	0	23.61	0	0
	836.5	20525	5	QPSK	1	12	23.56	0	0
	836.5	20525	5	QPSK	1	24	23.56	0	0
	836.5	20525	5	QPSK	12	0	22.68	1	0-1
	836.5	20525	5	QPSK	12	6	22.66	1	0-1
	836.5	20525	5	QPSK	12	13	22.65	1	0-1
	836.5	20525	5	QPSK	25	0	22.59	1	0-1
	836.5	20525	5	16-QAM	1	0	22.40	1	0-1
	836.5	20525	5	16-QAM	1	12	22.47	1	0-1
	836.5	20525	5	16-QAM	1	24	22.42	1	0-1
	836.5	20525	5	16-QAM	12	0	21.68	2	0-2
	836.5	20525	5	16-QAM	12	6	21.66	2	0-2
	836.5	20525	5	16-QAM	12	13	21.67	2	0-2
836.5	20525	5	16-QAM	25	0	21.59	2	0-2	
High	846.5	20625	5	QPSK	1	0	23.59	0	0
	846.5	20625	5	QPSK	1	12	23.63	0	0
	846.5	20625	5	QPSK	1	24	23.56	0	0
	846.5	20625	5	QPSK	12	0	22.68	1	0-1
	846.5	20625	5	QPSK	12	6	22.61	1	0-1
	846.5	20625	5	QPSK	12	13	22.67	1	0-1
	846.5	20625	5	QPSK	25	0	22.64	1	0-1
	846.5	20625	5	16-QAM	1	0	22.43	1	0-1
	846.5	20625	5	16-QAM	1	12	22.45	1	0-1
	846.5	20625	5	16-QAM	1	24	22.47	1	0-1
	846.5	20625	5	16-QAM	12	0	21.66	2	0-2
	846.5	20625	5	16-QAM	12	6	21.60	2	0-2
	846.5	20625	5	16-QAM	12	13	21.62	2	0-2
846.5	20625	5	16-QAM	25	0	21.65	2	0-2	



FCC ID: ZNFD950	 PCTEST ENGINEERING LABORATORY, INC.	SAR EVALUATION REPORT		Reviewed by: Quality Manager
Document S/N: 0Y1312022312.ZNF	Test Dates: 12/02/13 - 12/16/13	DUT Type: Portable Handset		Page 26 of 66

9.3.3

LTE Band 4 (AWS)



Table 9-5
LTE Band 4 (AWS) Conducted Powers - 10 MHz Bandwidth

	Frequency [MHz]	Channel	Bandwidth [MHz]	Modulation	RB Size	RB Offset	Conducted Power [dBm]	Target MPR [dB]	MPR Allowed per 3GPP [dB]
Low	1715	20000	10	QPSK	1	0	23.45	0	0
	1715	20000	10	QPSK	1	25	23.48	0	0
	1715	20000	10	QPSK	1	49	23.47	0	0
	1715	20000	10	QPSK	25	0	22.29	1	0-1
	1715	20000	10	QPSK	25	12	22.35	1	0-1
	1715	20000	10	QPSK	25	25	22.36	1	0-1
	1715	20000	10	QPSK	50	0	22.32	1	0-1
	1715	20000	10	16QAM	1	0	22.30	1	0-1
	1715	20000	10	16QAM	1	25	22.35	1	0-1
	1715	20000	10	16QAM	1	49	22.27	1	0-1
	1715	20000	10	16QAM	25	0	21.44	2	0-2
	1715	20000	10	16QAM	25	12	21.43	2	0-2
Mid	1732.5	20175	10	QPSK	25	25	21.38	2	0-2
	1715	20000	10	16QAM	50	0	21.41	2	0-2
	1732.5	20175	10	QPSK	1	0	23.55	0	0
	1732.5	20175	10	QPSK	1	25	23.61	0	0
	1732.5	20175	10	QPSK	1	49	23.46	0	0
	1732.5	20175	10	QPSK	25	0	22.40	1	0-1
	1732.5	20175	10	QPSK	25	12	22.41	1	0-1
	1732.5	20175	10	QPSK	25	25	22.45	1	0-1
	1732.5	20175	10	QPSK	50	0	22.36	1	0-1
	1732.5	20175	10	16QAM	1	0	22.32	1	0-1
	1732.5	20175	10	16QAM	1	25	22.38	1	0-1
	1732.5	20175	10	16QAM	1	49	22.33	1	0-1
High	1732.5	20175	10	16QAM	25	0	21.42	2	0-2
	1732.5	20175	10	16QAM	25	12	21.47	2	0-2
	1732.5	20175	10	16QAM	25	25	21.39	2	0-2
	1732.5	20175	10	16QAM	50	0	21.40	2	0-2
	1750	20350	10	QPSK	1	0	23.51	0	0
	1750	20350	10	QPSK	1	25	23.62	0	0
	1750	20350	10	QPSK	1	49	23.56	0	0
	1750	20350	10	QPSK	25	0	22.52	1	0-1
	1750	20350	10	QPSK	25	12	22.57	1	0-1
	1750	20350	10	QPSK	25	25	22.49	1	0-1
	1750	20350	10	QPSK	50	0	22.55	1	0-1
	1750	20350	10	16QAM	1	0	22.52	1	0-1
1750	20350	10	16QAM	1	25	22.50	1	0-1	
1750	20350	10	16QAM	1	49	22.45	1	0-1	
1750	20350	10	16QAM	25	0	21.52	2	0-2	
1750	20350	10	16QAM	25	12	21.47	2	0-2	
1750	20350	10	16QAM	25	25	21.59	2	0-2	
1750	20350	10	16QAM	50	0	21.58	2	0-2	

FCC ID: ZNFD950	 PCTEST ENGINEERING LABORATORY, INC.	SAR EVALUATION REPORT		Reviewed by: Quality Manager
Document S/N: 0Y1312022312.ZNF	Test Dates: 12/02/13 - 12/16/13	DUT Type: Portable Handset		Page 27 of 66

**Table 9-6
LTE Band 4 (AWS) Conducted Powers - 5 MHz Bandwidth**

	Frequency [MHz]	Channel	Bandwidth [MHz]	Modulation	RB Size	RB Offset	Conducted Power [dBm]	Target MPR [dB]	MPR Allowed per 3GPP [dB]
Low	1712.5	19975	5	QPSK	1	0	23.50	0	0
	1712.5	19975	5	QPSK	1	12	23.36	0	0
	1712.5	19975	5	QPSK	1	24	23.44	0	0
	1712.5	19975	5	QPSK	12	0	22.36	1	0-1
	1712.5	19975	5	QPSK	12	6	22.28	1	0-1
	1712.5	19975	5	QPSK	12	13	22.37	1	0-1
	1712.5	19975	5	QPSK	25	0	22.32	1	0-1
	1712.5	19975	5	16-QAM	1	0	22.22	1	0-1
	1712.5	19975	5	16-QAM	1	12	22.06	1	0-1
	1712.5	19975	5	16-QAM	1	24	22.15	1	0-1
	1712.5	19975	5	16-QAM	12	0	21.47	2	0-2
	1712.5	19975	5	16-QAM	12	6	21.23	2	0-2
	1712.5	19975	5	16-QAM	12	13	21.46	2	0-2
Mid	1732.5	20175	5	QPSK	1	0	23.48	0	0
	1732.5	20175	5	QPSK	1	12	23.62	0	0
	1732.5	20175	5	QPSK	1	24	23.54	0	0
	1732.5	20175	5	QPSK	12	0	22.49	1	0-1
	1732.5	20175	5	QPSK	12	6	22.55	1	0-1
	1732.5	20175	5	QPSK	12	13	22.45	1	0-1
	1732.5	20175	5	QPSK	25	0	22.38	1	0-1
	1732.5	20175	5	16-QAM	1	0	22.48	1	0-1
	1732.5	20175	5	16-QAM	1	12	22.59	1	0-1
	1732.5	20175	5	16-QAM	1	24	22.51	1	0-1
	1732.5	20175	5	16-QAM	12	0	21.47	2	0-2
	1732.5	20175	5	16-QAM	12	6	21.54	2	0-2
	1732.5	20175	5	16-QAM	12	13	21.40	2	0-2
High	1752.5	20375	5	QPSK	1	0	23.64	0	0
	1752.5	20375	5	QPSK	1	12	23.68	0	0
	1752.5	20375	5	QPSK	1	24	23.70	0	0
	1752.5	20375	5	QPSK	12	0	22.66	1	0-1
	1752.5	20375	5	QPSK	12	6	22.65	1	0-1
	1752.5	20375	5	QPSK	12	13	22.59	1	0-1
	1752.5	20375	5	QPSK	25	0	22.51	1	0-1
	1752.5	20375	5	16-QAM	1	0	22.63	1	0-1
	1752.5	20375	5	16-QAM	1	12	22.67	1	0-1
	1752.5	20375	5	16-QAM	1	24	22.60	1	0-1
	1752.5	20375	5	16-QAM	12	0	21.66	2	0-2
	1752.5	20375	5	16-QAM	12	6	21.68	2	0-2
	1752.5	20375	5	16-QAM	12	13	21.62	2	0-2
1752.5	20375	5	16-QAM	25	0	21.60	2	0-2	

FCC ID: ZNFD950	 PCTEST ENGINEERING LABORATORY, INC.	SAR EVALUATION REPORT		Reviewed by: Quality Manager
Document S/N: 0Y1312022312.ZNF	Test Dates: 12/02/13 - 12/16/13	DUT Type: Portable Handset		Page 28 of 66



9.3.4

LTE Band 2 (PCS)

Table 9-7



LTE Band 2 (PCS) Conducted Powers - 10 MHz Bandwidth

	Frequency [MHz]	Channel	Bandwidth [MHz]	Modulation	RB Size	RB Offset	Conducted Power [dBm]	Target MPR [dB]	MPR Allowed per 3GPP [dB]
Low	1855	18650	10	QPSK	1	0	23.68	0	0
	1855	18650	10	QPSK	1	25	23.67	0	0
	1855	18650	10	QPSK	1	49	23.67	0	0
	1855	18650	10	QPSK	25	0	22.58	1	0-1
	1855	18650	10	QPSK	25	12	22.68	1	0-1
	1855	18650	10	QPSK	25	25	22.53	1	0-1
	1855	18650	10	QPSK	50	0	22.57	1	0-1
	1855	18650	10	16QAM	1	0	22.55	1	0-1
	1855	18650	10	16QAM	1	25	22.47	1	0-1
	1855	18650	10	16QAM	1	49	22.46	1	0-1
	1855	18650	10	16QAM	25	0	21.47	2	0-2
	1855	18650	10	16QAM	25	12	21.48	2	0-2
	1855	18650	10	16QAM	25	25	21.58	2	0-2
Mid	1880.0	18900	10	QPSK	1	0	23.70	0	0
	1880.0	18900	10	QPSK	1	25	23.69	0	0
	1880.0	18900	10	QPSK	1	49	23.65	0	0
	1880.0	18900	10	QPSK	25	0	22.64	1	0-1
	1880.0	18900	10	QPSK	25	12	22.69	1	0-1
	1880.0	18900	10	QPSK	25	25	22.67	1	0-1
	1880.0	18900	10	QPSK	50	0	22.68	1	0-1
	1880.0	18900	10	16QAM	1	0	22.31	1	0-1
	1880.0	18900	10	16QAM	1	25	22.37	1	0-1
	1880.0	18900	10	16QAM	1	49	22.46	1	0-1
	1880.0	18900	10	16QAM	25	0	21.61	2	0-2
	1880.0	18900	10	16QAM	25	12	21.67	2	0-2
	1880.0	18900	10	16QAM	25	25	21.67	2	0-2
1880.0	18900	10	16QAM	50	0	21.51	2	0-2	
High	1905	19150	10	QPSK	1	0	23.57	0	0
	1905	19150	10	QPSK	1	25	23.68	0	0
	1905	19150	10	QPSK	1	49	23.59	0	0
	1905	19150	10	QPSK	25	0	22.55	1	0-1
	1905	19150	10	QPSK	25	12	22.61	1	0-1
	1905	19150	10	QPSK	25	25	22.60	1	0-1
	1905	19150	10	QPSK	50	0	22.50	1	0-1
	1905	19150	10	16QAM	1	0	22.61	1	0-1
	1905	19150	10	16QAM	1	25	22.65	1	0-1
	1905	19150	10	16QAM	1	49	22.63	1	0-1
	1905	19150	10	16QAM	25	0	21.61	2	0-2
	1905	19150	10	16QAM	25	12	21.67	2	0-2
	1905	19150	10	16QAM	25	25	21.65	2	0-2
1905	19150	10	16QAM	50	0	21.54	2	0-2	

FCC ID: ZNFD950	 PCTEST ENGINEERING LABORATORY, INC.	SAR EVALUATION REPORT		Reviewed by: Quality Manager
Document S/N: 0Y1312022312.ZNF	Test Dates: 12/02/13 - 12/16/13	DUT Type: Portable Handset		Page 29 of 66

**Table 9-8
LTE Band 2 (PCS) Conducted Powers - 5 MHz Bandwidth**

	Frequency [MHz]	Channel	Bandwidth [MHz]	Modulation	RB Size	RB Offset	Conducted Power [dBm]	Target MPR [dB]	MPR Allowed per 3GPP [dB]
Low	1852.5	18625	5	QPSK	1	0	23.69	0	0
	1852.5	18625	5	QPSK	1	12	23.65	0	0
	1852.5	18625	5	QPSK	1	24	23.67	0	0
	1852.5	18625	5	QPSK	12	0	22.68	1	0-1
	1852.5	18625	5	QPSK	12	6	22.70	1	0-1
	1852.5	18625	5	QPSK	12	13	22.65	1	0-1
	1852.5	18625	5	QPSK	25	0	22.61	1	0-1
	1852.5	18625	5	16-QAM	1	0	22.64	1	0-1
	1852.5	18625	5	16-QAM	1	12	22.69	1	0-1
	1852.5	18625	5	16-QAM	1	24	22.63	1	0-1
	1852.5	18625	5	16-QAM	12	0	21.66	2	0-2
	1852.5	18625	5	16-QAM	12	6	21.62	2	0-2
	1852.5	18625	5	16-QAM	12	13	21.69	2	0-2
	1852.5	18625	5	16-QAM	25	0	21.59	2	0-2
Mid	1880.0	18900	5	QPSK	1	0	23.66	0	0
	1880.0	18900	5	QPSK	1	12	23.67	0	0
	1880.0	18900	5	QPSK	1	24	23.69	0	0
	1880.0	18900	5	QPSK	12	0	22.65	1	0-1
	1880.0	18900	5	QPSK	12	6	22.69	1	0-1
	1880.0	18900	5	QPSK	12	13	22.67	1	0-1
	1880.0	18900	5	QPSK	25	0	22.70	1	0-1
	1880.0	18900	5	16-QAM	1	0	22.48	1	0-1
	1880.0	18900	5	16-QAM	1	12	22.44	1	0-1
	1880.0	18900	5	16-QAM	1	24	22.32	1	0-1
	1880.0	18900	5	16-QAM	12	0	21.59	2	0-2
	1880.0	18900	5	16-QAM	12	6	21.50	2	0-2
	1880.0	18900	5	16-QAM	12	13	21.67	2	0-2
	1880.0	18900	5	16-QAM	25	0	21.59	2	0-2
High	1907.5	19175	5	QPSK	1	0	23.23	0	0
	1907.5	19175	5	QPSK	1	12	23.20	0	0
	1907.5	19175	5	QPSK	1	24	23.21	0	0
	1907.5	19175	5	QPSK	12	0	22.66	1	0-1
	1907.5	19175	5	QPSK	12	6	22.70	1	0-1
	1907.5	19175	5	QPSK	12	13	22.56	1	0-1
	1907.5	19175	5	QPSK	25	0	22.56	1	0-1
	1907.5	19175	5	16-QAM	1	0	22.45	1	0-1
	1907.5	19175	5	16-QAM	1	12	22.55	1	0-1
	1907.5	19175	5	16-QAM	1	24	22.56	1	0-1
	1907.5	19175	5	16-QAM	12	0	21.70	2	0-2
	1907.5	19175	5	16-QAM	12	6	21.60	2	0-2
	1907.5	19175	5	16-QAM	12	13	21.59	2	0-2
	1907.5	19175	5	16-QAM	25	0	21.69	2	0-2

FCC ID: ZNFD950	 PCTEST ENGINEERING LABORATORY, INC.	SAR EVALUATION REPORT		Reviewed by: Quality Manager
Document S/N: 0Y1312022312.ZNF	Test Dates: 12/02/13 - 12/16/13	DUT Type: Portable Handset	Page 30 of 66	

9.3.5

LTE Band 7

Table 9-9
LTE Band 7 Conducted Powers - 20 MHz Bandwidth

	Frequency [MHz]	Channel	Bandwidth [MHz]	Modulation	RB Size	RB Offset	Conducted Power [dBm]	Target MPR [dB]	MPR Allowed per 3GPP [dB]
Low	2510	20850	20	QPSK	1	0	23.64	0	0
	2510	20850	20	QPSK	1	49	23.59	0	0
	2510	20850	20	QPSK	1	99	23.51	0	0
	2510	20850	20	QPSK	50	0	22.61	1	0-1
	2510	20850	20	QPSK	50	25	22.37	1	0-1
	2510	20850	20	QPSK	50	50	22.46	1	0-1
	2510	20850	20	QPSK	100	0	22.29	1	0-1
	2510	20850	20	16QAM	1	0	22.33	1	0-1
	2510	20850	20	16QAM	1	49	22.40	1	0-1
	2510	20850	20	16QAM	1	99	22.39	1	0-1
	2510	20850	20	16QAM	50	0	21.48	2	0-2
	2510	20850	20	16QAM	50	25	21.44	2	0-2
Mid	2535.0	21100	20	QPSK	1	0	23.68	0	0
	2535.0	21100	20	QPSK	1	49	23.53	0	0
	2535.0	21100	20	QPSK	1	99	23.46	0	0
	2535.0	21100	20	QPSK	50	0	22.65	1	0-1
	2535.0	21100	20	QPSK	50	25	22.58	1	0-1
	2535.0	21100	20	QPSK	50	50	22.57	1	0-1
	2535.0	21100	20	QPSK	100	0	22.31	1	0-1
	2535.0	21100	20	16QAM	1	0	22.50	1	0-1
	2535.0	21100	20	16QAM	1	49	22.45	1	0-1
	2535.0	21100	20	16QAM	1	99	22.44	1	0-1
	2535.0	21100	20	16QAM	50	0	21.33	2	0-2
	2535.0	21100	20	16QAM	50	25	21.37	2	0-2
High	2560	21350	20	QPSK	1	0	23.63	0	0
	2560	21350	20	QPSK	1	49	23.60	0	0
	2560	21350	20	QPSK	1	99	23.53	0	0
	2560	21350	20	QPSK	50	0	22.62	1	0-1
	2560	21350	20	QPSK	50	25	22.45	1	0-1
	2560	21350	20	QPSK	50	50	22.47	1	0-1
	2560	21350	20	QPSK	100	0	22.24	1	0-1
	2560	21350	20	16QAM	1	0	22.36	1	0-1
	2560	21350	20	16QAM	1	49	22.30	1	0-1
	2560	21350	20	16QAM	1	99	22.35	1	0-1
	2560	21350	20	16QAM	50	0	21.40	2	0-2
	2560	21350	20	16QAM	50	25	21.35	2	0-2
2560	21350	20	16QAM	50	50	21.22	2	0-2	
2560	21350	20	16QAM	100	0	21.27	2	0-2	





FCC ID: ZNFD950	 PCTEST ENGINEERING LABORATORY, INC.	SAR EVALUATION REPORT		Reviewed by: Quality Manager
Document S/N: 0Y1312022312.ZNF	Test Dates: 12/02/13 - 12/16/13	DUT Type: Portable Handset		Page 31 of 66

Table 9-10
LTE Band 7 Conducted Powers - 15 MHz Bandwidth

	Frequency [MHz]	Channel	Bandwidth [MHz]	Modulation	RB Size	RB Offset	Conducted Power [dBm]	Target MPR [dB]	MPR Allowed per 3GPP [dB]
Low	2507.5	20825	15	QPSK	1	0	23.45	0	0
	2507.5	20825	15	QPSK	1	36	23.40	0	0
	2507.5	20825	15	QPSK	1	74	23.43	0	0
	2507.5	20825	15	QPSK	36	0	22.47	1	0-1
	2507.5	20825	15	QPSK	36	18	22.36	1	0-1
	2507.5	20825	15	QPSK	36	37	22.33	1	0-1
	2507.5	20825	15	QPSK	75	0	22.39	1	0-1
	2507.5	20825	15	16QAM	1	0	22.49	1	0-1
	2507.5	20825	15	16QAM	1	36	22.34	1	0-1
	2507.5	20825	15	16QAM	1	74	22.39	1	0-1
	2507.5	20825	15	16QAM	36	0	21.22	2	0-2
	2507.5	20825	15	16QAM	36	18	21.37	2	0-2
	2507.5	20825	15	16QAM	36	37	21.39	2	0-2
	2507.5	20825	15	16QAM	75	0	21.40	2	0-2
Mid	2535.0	21100	15	QPSK	1	0	23.43	0	0
	2535.0	21100	15	QPSK	1	36	23.49	0	0
	2535.0	21100	15	QPSK	1	74	23.60	0	0
	2535.0	21100	15	QPSK	36	0	22.41	1	0-1
	2535.0	21100	15	QPSK	36	18	22.22	1	0-1
	2535.0	21100	15	QPSK	36	37	22.21	1	0-1
	2535.0	21100	15	QPSK	75	0	22.24	1	0-1
	2535.0	21100	15	16QAM	1	0	22.61	1	0-1
	2535.0	21100	15	16QAM	1	36	22.56	1	0-1
	2535.0	21100	15	16QAM	1	74	22.59	1	0-1
	2535.0	21100	15	16QAM	36	0	21.45	2	0-2
	2535.0	21100	15	16QAM	36	18	21.38	2	0-2
	2535.0	21100	15	16QAM	36	37	21.33	2	0-2
	2535.0	21100	15	16QAM	75	0	21.33	2	0-2
High	2562.5	21375	15	QPSK	1	0	23.44	0	0
	2562.5	21375	15	QPSK	1	36	23.54	0	0
	2562.5	21375	15	QPSK	1	74	23.46	0	0
	2562.5	21375	15	QPSK	36	0	22.42	1	0-1
	2562.5	21375	15	QPSK	36	18	22.44	1	0-1
	2562.5	21375	15	QPSK	36	37	22.40	1	0-1
	2562.5	21375	15	QPSK	75	0	22.36	1	0-1
	2562.5	21375	15	16QAM	1	0	22.36	1	0-1
	2562.5	21375	15	16QAM	1	36	22.33	1	0-1
	2562.5	21375	15	16QAM	1	74	22.41	1	0-1
	2562.5	21375	15	16QAM	36	0	21.25	2	0-2
	2562.5	21375	15	16QAM	36	18	21.37	2	0-2
	2562.5	21375	15	16QAM	36	37	21.40	2	0-2
	2562.5	21375	15	16QAM	75	0	21.29	2	0-2

FCC ID: ZNFD950	 PCTEST ENGINEERING LABORATORY, INC.	SAR EVALUATION REPORT		Reviewed by: Quality Manager
Document S/N: 0Y1312022312.ZNF	Test Dates: 12/02/13 - 12/16/13	DUT Type: Portable Handset		Page 32 of 66

**Table 9-11
LTE Band 7 Conducted Powers - 10 MHz Bandwidth**

	Frequency [MHz]	Channel	Bandwidth [MHz]	Modulation	RB Size	RB Offset	Conducted Power [dBm]	Target MPR [dB]	MPR Allowed per 3GPP [dB]
Low	2505	20800	10	QPSK	1	0	23.47	0	0
	2505	20800	10	QPSK	1	25	23.55	0	0
	2505	20800	10	QPSK	1	49	23.45	0	0
	2505	20800	10	QPSK	25	0	22.49	1	0-1
	2505	20800	10	QPSK	25	12	22.33	1	0-1
	2505	20800	10	QPSK	25	25	22.37	1	0-1
	2505	20800	10	QPSK	50	0	22.39	1	0-1
	2505	20800	10	16QAM	1	0	22.41	1	0-1
	2505	20800	10	16QAM	1	25	22.45	1	0-1
	2505	20800	10	16QAM	1	49	22.41	1	0-1
	2505	20800	10	16QAM	25	0	21.31	2	0-2
	2505	20800	10	16QAM	25	12	21.29	2	0-2
	2505	20800	10	16QAM	25	25	21.35	2	0-2
Mid	2535.0	21100	10	QPSK	1	0	23.44	0	0
	2535.0	21100	10	QPSK	1	25	23.30	0	0
	2535.0	21100	10	QPSK	1	49	23.50	0	0
	2535.0	21100	10	QPSK	25	0	22.45	1	0-1
	2535.0	21100	10	QPSK	25	12	22.47	1	0-1
	2535.0	21100	10	QPSK	25	25	22.35	1	0-1
	2535.0	21100	10	QPSK	50	0	22.35	1	0-1
	2535.0	21100	10	16QAM	1	0	22.39	1	0-1
	2535.0	21100	10	16QAM	1	25	22.40	1	0-1
	2535.0	21100	10	16QAM	1	49	22.41	1	0-1
	2535.0	21100	10	16QAM	25	0	21.49	2	0-2
	2535.0	21100	10	16QAM	25	12	21.36	2	0-2
	2535.0	21100	10	16QAM	25	25	21.35	2	0-2
High	2565	21400	10	QPSK	1	0	23.31	0	0
	2565	21400	10	QPSK	1	25	23.44	0	0
	2565	21400	10	QPSK	1	49	23.41	0	0
	2565	21400	10	QPSK	25	0	22.29	1	0-1
	2565	21400	10	QPSK	25	12	22.36	1	0-1
	2565	21400	10	QPSK	25	25	22.39	1	0-1
	2565	21400	10	QPSK	50	0	22.40	1	0-1
	2565	21400	10	16QAM	1	0	22.41	1	0-1
	2565	21400	10	16QAM	1	25	22.22	1	0-1
	2565	21400	10	16QAM	1	49	22.47	1	0-1
	2565	21400	10	16QAM	25	0	21.30	2	0-2
	2565	21400	10	16QAM	25	12	21.32	2	0-2
	2565	21400	10	16QAM	25	25	21.38	2	0-2
2565	21400	10	16QAM	50	0	21.33	2	0-2	





FCC ID: ZNFD950	 PCTEST ENGINEERING LABORATORY, INC.	SAR EVALUATION REPORT		Reviewed by: Quality Manager
Document S/N: 0Y1312022312.ZNF	Test Dates: 12/02/13 - 12/16/13	DUT Type: Portable Handset		Page 33 of 66

Table 9-12
LTE Band 7 Conducted Powers - 5 MHz Bandwidth

	Frequency [MHz]	Channel	Bandwidth [MHz]	Modulation	RB Size	RB Offset	Conducted Power [dBm]	Target MPR [dB]	MPR Allowed per 3GPP [dB]
Low	2502.5	20775	5	QPSK	1	0	23.29	0	0
	2502.5	20775	5	QPSK	1	12	23.40	0	0
	2502.5	20775	5	QPSK	1	24	23.33	0	0
	2502.5	20775	5	QPSK	12	0	22.45	1	0-1
	2502.5	20775	5	QPSK	12	6	22.49	1	0-1
	2502.5	20775	5	QPSK	12	13	22.34	1	0-1
	2502.5	20775	5	QPSK	25	0	22.48	1	0-1
	2502.5	20775	5	16-QAM	1	0	22.31	1	0-1
	2502.5	20775	5	16-QAM	1	12	22.33	1	0-1
	2502.5	20775	5	16-QAM	1	24	22.30	1	0-1
	2502.5	20775	5	16-QAM	12	0	21.39	2	0-2
	2502.5	20775	5	16-QAM	12	6	21.22	2	0-2
	2502.5	20775	5	16-QAM	12	13	21.28	2	0-2
	2502.5	20775	5	16-QAM	25	0	21.29	2	0-2
Mid	2535.0	21100	5	QPSK	1	0	23.48	0	0
	2535.0	21100	5	QPSK	1	12	23.45	0	0
	2535.0	21100	5	QPSK	1	24	23.29	0	0
	2535.0	21100	5	QPSK	12	0	22.38	1	0-1
	2535.0	21100	5	QPSK	12	6	22.31	1	0-1
	2535.0	21100	5	QPSK	12	13	22.29	1	0-1
	2535.0	21100	5	QPSK	25	0	22.48	1	0-1
	2535.0	21100	5	16-QAM	1	0	22.45	1	0-1
	2535.0	21100	5	16-QAM	1	12	22.45	1	0-1
	2535.0	21100	5	16-QAM	1	24	22.37	1	0-1
	2535.0	21100	5	16-QAM	12	0	21.29	2	0-2
	2535.0	21100	5	16-QAM	12	6	21.38	2	0-2
	2535.0	21100	5	16-QAM	12	13	21.43	2	0-2
	2535.0	21100	5	16-QAM	25	0	21.33	2	0-2
High	2567.5	21425	5	QPSK	1	0	23.50	0	0
	2567.5	21425	5	QPSK	1	12	23.55	0	0
	2567.5	21425	5	QPSK	1	24	23.49	0	0
	2567.5	21425	5	QPSK	12	0	22.49	1	0-1
	2567.5	21425	5	QPSK	12	6	22.34	1	0-1
	2567.5	21425	5	QPSK	12	13	22.38	1	0-1
	2567.5	21425	5	QPSK	25	0	22.48	1	0-1
	2567.5	21425	5	16-QAM	1	0	22.43	1	0-1
	2567.5	21425	5	16-QAM	1	12	22.49	1	0-1
	2567.5	21425	5	16-QAM	1	24	22.32	1	0-1
	2567.5	21425	5	16-QAM	12	0	21.40	2	0-2
	2567.5	21425	5	16-QAM	12	6	21.50	2	0-2
	2567.5	21425	5	16-QAM	12	13	21.48	2	0-2
	2567.5	21425	5	16-QAM	25	0	21.45	2	0-2

FCC ID: ZNFD950	 PCTEST ENGINEERING LABORATORY, INC.	SAR EVALUATION REPORT		Reviewed by: Quality Manager
Document S/N: 0Y1312022312.ZNF	Test Dates: 12/02/13 - 12/16/13	DUT Type: Portable Handset		Page 34 of 66

9.4 LTE CA Conducted Powers

Table 9-13
LTE Carrier Aggregation Conducted Powers - Band 17 (PCC) + Band 2 (SCC) 10 MHz BW

Band 17 (PCC) + Band 2 (SCC) PCC UL Ch. 23790 + SCC DL Ch. 900				
PCC UL # RB	PCC UL RB off.	PCC UL Freq. (MHz)	SCC DL Freq (MHz)	B17+B2 CA Tx. Power (dBm)
1	0	710.0	1960.0	23.91

Table 9-14
LTE Carrier Aggregation Conducted Powers - Band 4 (PCC) + Band 17 (SCC) 10 MHz BW

Band 4 (PCC) + Band 17 (SCC) 10 MHz BW PCC UL Ch. 20350 + SCC DL Ch. 5790				
PCC UL # RB	PCC UL RB off.	PCC UL Freq. (MHz)	SCC DL Freq (MHz)	B4+B17 CA Tx. Power (dBm)
1	25	1750.0	740.0	23.64

Table 9-15
LTE Carrier Aggregation Conducted Powers - Band 2 (PCC) + Band 17 (SCC) 10 MHz BW

Band 2 (PCC) + Band 17 (SCC) 10 MHz BW PCC UL Ch. 18900 + SCC DL Ch. 5790				
PCC UL # RB	PCC UL RB off.	PCC UL Freq. (MHz)	SCC DL Freq (MHz)	B2+B17 CA Tx. Power (dBm)
1	0	1880.0	740.0	23.69

Notes:

1. The device does not support all Rel. 10 Carrier Aggregation features due to modem chipset limitation.
2. The device only supports downlink Carrier Aggregation. Uplink Carrier Aggregation is not supported. Power measurements were performed with two DL carriers for the Release 8 configuration that had the highest output power (across all bandwidths, channels and RB Configurations) for each band
3. This device only supports inter-band CA with 2 carriers (B4+B17, B2+B17) with a maximum of 10 MHz of spectrum.
4. All control and acknowledge data is sent on uplink channels that operate identical to release 8 specifications.

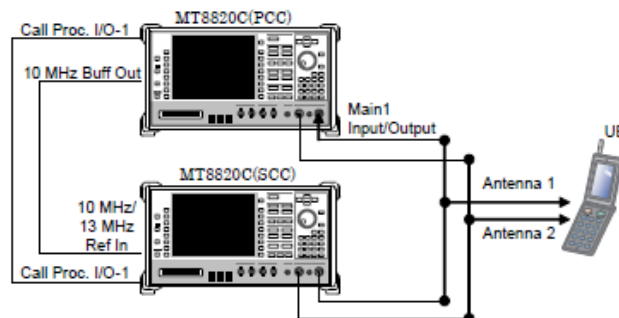



Figure 9-3
Power Measurement Setup

FCC ID: ZNFD950	 PCTEST ENGINEERING LABORATORY, INC.	SAR EVALUATION REPORT		Reviewed by: Quality Manager
Document S/N: 0Y1312022312.ZNF	Test Dates: 12/02/13 - 12/16/13	DUT Type: Portable Handset		Page 35 of 66

9.5 WLAN Conducted Powers

Table 9-16
IEEE 802.11b Average RF Power

Mode	Freq [MHz]	Channel	802.11b (2.4 GHz) Conducted Power [dBm]			
			Data Rate [Mbps]			
			1	2	5.5	11
802.11b	2412	1*	15.48	15.44	15.57	15.58
802.11b	2437	6*	16.14	16.07	16.10	16.20
802.11b	2462	11*	15.68	15.59	15.73	15.68

Table 9-17
IEEE 802.11g Average RF Power

Mode	Freq [MHz]	Channel	802.11g (2.4 GHz) Conducted Power [dBm]							
			Data Rate [Mbps]							
			6	9	12	18	24	36	48	54
802.11g	2412	1	11.76	11.87	11.87	11.98	11.87	12.01	12.03	12.04
802.11g	2437	6	12.43	12.50	12.44	12.57	12.39	12.42	12.69	12.44
802.11g	2462	11	11.97	11.96	12.03	12.12	12.07	11.96	12.25	12.05

Table 9-18
IEEE 802.11n Average RF Power

Mode	Freq [MHz]	Channel	802.11n (2.4 GHz) Conducted Power [dBm]							
			Data Rate [Mbps]							
			6.5	13	20	26	39	52	58	65
802.11n	2412	1	10.88	11.04	11.07	11.15	11.17	11.23	11.22	11.23
802.11n	2437	6	11.60	11.77	11.60	11.75	11.71	11.80	11.75	11.90
802.11n	2462	11	11.18	11.30	11.30	11.32	11.25	11.36	11.27	11.43

Table 9-19
IEEE 802.11a Average RF Power

Mode	Freq [MHz]	Channel	802.11a (5GHz) Conducted Power [dBm]							
			Data Rate [Mbps]							
			6	9	12	18	24	36	48	54
802.11a	5180	36*	9.83	9.60	9.70	9.63	9.65	9.61	9.71	9.44
802.11a	5200	40	10.56	10.26	10.56	10.49	10.54	10.35	10.67	10.36
802.11a	5220	44	10.46	10.40	10.51	10.50	10.50	10.29	10.59	10.31
802.11a	5240	48*	10.48	10.57	10.64	10.55	10.42	10.29	10.48	10.34
802.11a	5260	52*	10.87	10.82	10.94	10.82	10.79	10.72	10.94	10.53
802.11a	5280	56	10.71	10.85	10.80	10.71	10.80	10.73	10.93	10.25
802.11a	5300	60	10.66	10.63	10.78	10.78	10.72	10.71	10.74	10.60
802.11a	5320	64*	10.70	10.43	10.74	10.75	10.66	10.66	10.59	10.55
802.11a	5500	100	10.45	10.50	10.69	10.68	10.57	10.35	10.55	10.30
802.11a	5520	104*	10.45	10.52	10.49	10.67	10.54	10.46	10.60	10.37
802.11a	5540	108	10.51	10.60	10.52	10.41	10.51	10.34	10.43	10.24
802.11a	5560	112	10.26	10.40	10.37	10.43	9.86	10.42	10.41	10.10
802.11a	5580	116*	10.14	10.37	10.27	10.20	10.24	10.13	10.10	10.10
802.11a	5600	120	N/A	N/A	N/A	N/A	N/A	N/A	N/A	N/A
802.11a	5620	124	N/A	N/A	N/A	N/A	N/A	N/A	N/A	N/A
802.11a	5640	128	N/A	N/A	N/A	N/A	N/A	N/A	N/A	N/A
802.11a	5660	132	10.10	10.10	10.21	10.16	10.00	9.95	10.13	9.82
802.11a	5680	136*	9.99	9.82	9.99	10.10	10.10	9.94	10.14	9.90
802.11a	5700	140	9.94	9.95	9.75	9.94	9.88	9.91	10.00	9.75
802.11a	5720	144	9.15	9.21	9.19	9.16	9.11	9.06	9.33	8.46
802.11a	5745	149*	9.88	9.96	9.99	10.00	9.99	9.98	10.08	9.72
802.11a	5765	153	9.63	9.85	10.00	9.92	9.95	9.84	10.05	9.65
802.11a	5785	157*	9.84	9.81	9.80	9.82	9.96	9.71	10.00	9.70
802.11a	5805	161*	9.84	9.83	9.82	9.85	9.62	9.72	9.82	9.57
802.11a	5825	165	8.71	8.82	8.74	8.76	8.67	8.61	8.81	8.50

Per FCC KDB Publication 443999 and RSS-210 A9.2(3), transmission on channels which overlap the 5600-5650 MHz is prohibited as a client. This device does not transmit any beacons or initiate any transmissions in 5.3 and 5.5 GHz Band.

(*) – indicates default channels per KDB Publication 248227 D01v01r02. When the adjacent channels are higher in power than the default channels, these “required channels” are considered for SAR testing instead of the default channels.



FCC ID: ZNFD950	 PCTEST ENGINEERING LABORATORY, INC.	SAR EVALUATION REPORT		Reviewed by: Quality Manager
Document S/N: 0Y1312022312.ZNF	Test Dates: 12/02/13 - 12/16/13	DUT Type: Portable Handset		Page 36 of 66

Table 9-20
IEEE 802.11n Average RF Power – 20 MHz Bandwidth



Mode	Freq [MHz]	Channel	20MHz BW 802.11n (5GHz) Conducted Power [dBm]							
			Data Rate [Mbps]							
			6.5	13	19.5	26	39	52	58.5	65
802.11n	5180	36	8.80	8.97	9.37	9.31	9.17	9.25	9.17	9.21
802.11n	5200	40	10.15	10.60	10.55	10.52	10.56	10.50	10.59	10.51
802.11n	5220	44	10.57	10.54	10.58	10.61	10.52	10.52	10.54	10.46
802.11n	5240	48	10.55	10.51	10.51	10.50	10.37	10.47	10.36	10.45
802.11n	5260	52	10.77	10.76	10.81	10.81	10.78	10.73	10.73	10.60
802.11n	5280	56	10.78	10.81	10.74	10.63	10.76	10.71	10.61	10.69
802.11n	5300	60	10.78	10.60	10.69	10.62	10.67	10.69	10.61	10.54
802.11n	5320	64	10.58	10.62	10.63	10.65	10.57	10.63	10.52	10.57
802.11n	5500	100	10.53	10.43	10.54	10.26	10.47	10.37	10.23	10.38
802.11n	5520	104	10.21	10.44	10.37	10.47	10.31	10.33	10.43	10.32
802.11n	5540	108	10.34	10.39	10.34	10.32	10.21	10.18	10.26	10.21
802.11n	5560	112	10.35	10.30	10.28	10.25	10.25	10.24	10.29	10.26
802.11n	5580	116	10.21	10.18	10.22	10.08	10.19	10.09	10.15	10.12
802.11n	5600	120	N/A	N/A	N/A	N/A	N/A	N/A	N/A	N/A
802.11n	5620	124	N/A	N/A	N/A	N/A	N/A	N/A	N/A	N/A
802.11n	5640	128	N/A	N/A	N/A	N/A	N/A	N/A	N/A	N/A
802.11n	5660	132	9.92	9.94	9.99	9.98	9.93	9.80	9.74	9.94
802.11n	5680	136	9.88	9.88	9.79	9.83	9.76	9.72	9.82	9.67
802.11n	5700	140	9.94	9.74	9.74	9.73	9.79	9.86	9.81	9.74
802.11n	5720	144	9.08	9.14	9.05	9.08	8.92	8.54	8.49	8.03
802.11n	5745	149	9.73	9.91	9.77	9.88	9.86	9.91	9.97	9.96
802.11n	5765	153	9.87	9.88	9.86	9.54	9.92	9.83	9.81	9.82
802.11n	5785	157	9.95	9.70	9.75	9.67	9.65	9.73	9.86	9.75
802.11n	5805	161	9.69	9.45	9.72	9.68	9.63	9.83	9.70	9.58
802.11n	5825	165	8.68	8.72	9.15	8.77	8.58	8.59	8.52	8.71

Table 9-21
IEEE 802.11n Average RF Power – 40 MHz Bandwidth

Mode	Freq [MHz]	Channel	40MHz BW 802.11n (5GHz) Conducted Power [dBm]							
			Data Rate [Mbps]							
			13.5	27	40.5	54	81	108	121.5	135
802.11n	5190	38	9.10	9.10	8.76	8.54	9.17	9.06	9.05	8.94
802.11n	5230	46	9.44	9.09	9.51	9.63	9.80	9.52	9.69	9.35
802.11n	5270	54	9.59	9.88	9.60	9.62	10.03	9.97	9.97	9.29
802.11n	5310	62	9.68	9.69	9.50	9.75	9.75	9.48	9.35	8.68
802.11n	5510	102	8.17	8.89	8.91	8.86	8.86	8.67	8.58	8.64
802.11n	5550	110	7.86	8.20	8.05	7.97	7.69	8.19	8.16	7.70
802.11n	5590	118	N/A	N/A	N/A	N/A	N/A	N/A	N/A	N/A
802.11n	5630	126	N/A	N/A	N/A	N/A	N/A	N/A	N/A	N/A
802.11n	5670	134	8.04	8.16	8.01	8.29	8.21	7.57	8.18	7.32
802.11n	5710	142	6.91	6.98	7.08	7.34	7.57	7.64	7.53	7.54
802.11n	5755	151	7.47	7.79	7.33	7.25	7.61	7.65	8.34	8.05
802.11n	5795	159	6.96	6.88	6.68	7.20	7.37	6.82	7.56	7.54

Table 9-22
IEEE 802.11ac Average RF Power – 80 MHz Bandwidth

Mode	Freq [MHz]	Channel	80MHz BW 802.11ac (5GHz) Conducted Power [dBm]									
			Data Rate [Mbps]									
			29.3	58.5	87.8	117	175.5	234	263.3	292.5	351	390
802.11ac	5210	42	8.24	8.12	8.48	8.33	8.40	8.25	7.96	8.06	8.03	8.08
802.11ac	5290	58	9.00	9.22	9.08	9.07	9.13	8.83	8.84	9.15	8.82	9.19
802.11ac	5530	106	9.10	8.13	9.07	8.81	8.90	7.91	8.82	8.99	9.07	9.01
802.11ac	5690	138	7.48	7.53	7.43	7.19	7.11	7.21	7.23	7.20	7.14	7.09
802.11ac	5775	155	7.51	7.62	7.53	7.72	7.54	7.53	7.41	7.43	7.71	7.68

FCC ID: ZNFD950	 PCTEST ENGINEERING LABORATORY, INC.	SAR EVALUATION REPORT		Reviewed by: Quality Manager
Document S/N: 0Y1312022312.ZNF	Test Dates: 12/02/13 - 12/16/13	DUT Type: Portable Handset		Page 37 of 66

Justification for reduced test configurations for WIFI channels per KDB Publication 248227 D01v01r02 and October 2012/April 2013 FCC/TCB Meeting Notes:

- For 2.4 GHz, highest average RF output power channel for the lowest data rate for IEEE 802.11b were selected for SAR evaluation. Other IEEE 802.11 modes (including 802.11g/n) were not investigated since the average output powers over all channels and data rates were not more than 0.25 dB higher than the tested channel in the lowest data rate of IEEE 802.11b mode.
- For 5 GHz, highest average RF output power channel for the lowest data rate for IEEE 802.11a were selected for SAR evaluation. Other IEEE 802.11 modes (including 802.11n 20 MHz and 40 MHz) were not investigated since the average output powers over all channels and data rates were not more than 0.25 dB higher than the tested channel in the lowest data rate of IEEE 802.11a mode.
- Full SAR tests for all IEEE 802.11ac configurations were not required because the average output power was not more than 0.25 dB higher than IEEE 802.11a mode. IEEE 802.11ac was evaluated for the highest IEEE 802.11a position in each 5 GHz band and exposure condition.
- When the maximum extrapolated peak SAR of the zoom scan for the maximum output channel is <1.6 W/kg and the reported 1g averaged SAR is <0.8 W/kg, SAR testing on other channels is not required. Otherwise, the other default (or corresponding required) test channels were additionally tested using the lowest data rate.
- The bolded data rate and channel above were tested for SAR.

Power Measurements for signals < 50 MHz

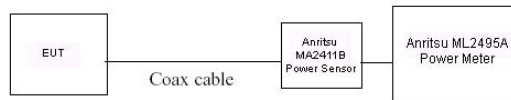

Power Measurements for signals > 50 MHz

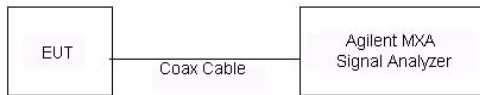



Figure 9-4
Power Measurement Setup



FCC ID: ZNFD950	 PCTEST ENGINEERING LABORATORY, INC.	SAR EVALUATION REPORT		Reviewed by: Quality Manager
Document S/N: 0Y1312022312.ZNF	Test Dates: 12/02/13 - 12/16/13	DUT Type: Portable Handset	Page 38 of 66	

10 SYSTEM VERIFICATION

10.1 Tissue Verification

**Table 10-1
Measured Head Tissue Properties**



Calibrated for Tests Performed on:	Tissue Type	Tissue Temp During Calibration (C°)	Measured Frequency (MHz)	Measured Conductivity, σ (S/m)	Measured Dielectric Constant, ϵ	TARGET Conductivity, σ (S/m)	TARGET Dielectric Constant, ϵ	% dev σ	% dev ϵ
12/02/2013	750H	21.0	710	0.883	41.996	0.890	42.149	-0.79%	-0.36%
			725	0.898	41.783	0.891	42.071	0.79%	-0.68%
			740	0.912	41.553	0.893	41.994	2.13%	-1.05%
			755	0.928	41.346	0.894	41.916	3.80%	-1.36%
12/04/2013	835H	21.1	820	0.917	43.212	0.899	41.578	2.00%	3.93%
			835	0.931	42.987	0.900	41.500	3.44%	3.58%
			850	0.946	42.811	0.916	41.500	3.28%	3.16%
12/04/2013	1750H	22.7	1710	1.338	40.870	1.348	40.142	-0.74%	1.81%
			1750	1.378	40.664	1.371	40.079	0.51%	1.46%
			1790	1.420	40.503	1.394	40.016	1.87%	1.22%
12/09/2013	1900H	22.9	1850	1.365	39.771	1.400	40.000	-2.50%	-0.57%
			1880	1.395	39.634	1.400	40.000	-0.36%	-0.91%
			1910	1.428	39.524	1.400	40.000	2.00%	-1.19%
12/12/2013	1900H	22.0	1850	1.398	40.212	1.400	40.000	-0.14%	0.53%
			1880	1.435	40.112	1.400	40.000	2.50%	0.28%
			1910	1.465	40.028	1.400	40.000	4.64%	0.07%
12/02/2013	2450H	21.4	2401	1.767	39.170	1.756	39.287	0.63%	-0.30%
			2450	1.823	38.989	1.800	39.200	1.28%	-0.54%
			2499	1.873	38.798	1.853	39.138	1.08%	-0.87%
12/10/2013	2600H	24.1	2500	1.920	38.352	1.855	39.136	3.50%	-2.00%
			2550	1.981	38.158	1.909	39.073	3.77%	-2.34%
			2600	2.040	37.935	1.964	39.009	3.87%	-2.75%
12/04/2013	5200H-5800H	22.3	5200	4.501	36.509	4.655	35.986	-3.31%	1.45%
			5220	4.529	36.490	4.676	35.963	-3.14%	1.47%
			5260	4.580	36.449	4.717	35.917	-2.90%	1.48%
			5280	4.590	36.431	4.737	35.894	-3.10%	1.50%
			5300	4.602	36.390	4.758	35.871	-3.28%	1.45%
			5500	4.812	36.137	4.963	35.643	-3.04%	1.39%
			5520	4.840	36.091	4.983	35.620	-2.87%	1.32%
			5540	4.843	36.104	5.004	35.597	-3.22%	1.42%
			5745	5.089	35.820	5.214	35.363	-2.40%	1.29%
			5765	5.106	35.805	5.234	35.340	-2.45%	1.32%
			5785	5.107	35.782	5.255	35.317	-2.82%	1.32%
			5800	5.113	35.753	5.270	35.300	-2.98%	1.28%

FCC ID: ZNFD950	 PCTEST ENGINEERING LABORATORY, INC.	SAR EVALUATION REPORT		Reviewed by: Quality Manager
Document S/N: 0Y1312022312.ZNF	Test Dates: 12/02/13 - 12/16/13	DUT Type: Portable Handset		Page 39 of 66

**Table 10-2
Measured Body Tissue Properties**

Calibrated for Tests Performed on:	Tissue Type	Tissue Temp During Calibration (C°)	Measured Frequency (MHz)	Measured Conductivity, σ (S/m)	Measured Dielectric Constant, ϵ	TARGET Conductivity, σ (S/m)	TARGET Dielectric Constant, ϵ	% dev σ	% dev ϵ
12/04/2013	750B	22.5	710	0.945	56.788	0.960	55.687	-1.56%	1.98%
			725	0.959	56.655	0.961	55.629	-0.21%	1.84%
			740	0.973	56.531	0.963	55.570	1.04%	1.73%
			755	0.987	56.359	0.964	55.512	2.39%	1.53%
12/02/2013	835B	21.3	820	0.994	54.056	0.969	55.258	2.58%	-2.18%
			835	1.010	53.891	0.970	55.200	4.12%	-2.37%
			850	1.026	53.740	0.988	55.154	3.85%	-2.56%
12/05/2013	835B	22.3	820	0.983	54.341	0.969	55.258	1.44%	-1.66%
			835	0.999	54.190	0.970	55.200	2.99%	-1.83%
			850	1.013	54.036	0.988	55.154	2.53%	-2.03%
12/05/2013	1750B	21.3	1710	1.409	52.292	1.463	53.537	-3.69%	-2.33%
			1750	1.454	52.145	1.488	53.432	-2.28%	-2.41%
			1790	1.500	52.034	1.514	53.326	-0.92%	-2.42%
12/02/2013	1900B	21.5	1850	1.480	52.234	1.520	53.300	-2.63%	-2.00%
			1880	1.513	52.103	1.520	53.300	-0.46%	-2.25%
			1910	1.549	51.988	1.520	53.300	1.91%	-2.46%
12/16/2013	1900B	23.1	1850	1.480	51.489	1.520	53.300	-2.63%	-3.40%
			1880	1.511	51.397	1.520	53.300	-0.59%	-3.57%
			1910	1.545	51.317	1.520	53.300	1.64%	-3.72%
12/02/2013	2450B	22.4	2401	1.969	51.263	1.903	52.765	3.47%	-2.85%
			2450	2.036	51.063	1.950	52.700	4.41%	-3.11%
			2499	2.111	50.908	2.019	52.638	4.56%	-3.29%
12/02/2013	2600B	22.4	2500	2.109	50.894	2.021	52.636	4.35%	-3.31%
			2550	2.179	50.710	2.092	52.573	4.16%	-3.54%
			2600	2.245	50.458	2.163	52.509	3.79%	-3.91%
12/10/2014	2450B-2600B	22.6	2401	1.893	51.770	1.903	52.765	-0.53%	-1.89%
			2450	1.962	51.606	1.950	52.700	0.62%	-2.08%
			2499	2.028	51.446	2.019	52.638	0.45%	-2.26%
			2500	2.031	51.443	2.021	52.636	0.49%	-2.27%
			2550	2.103	51.214	2.092	52.573	0.53%	-2.58%
			2600	2.173	51.058	2.163	52.509	0.46%	-2.76%
12/02/2013	5200B-5800B	22.1	5200	5.300	46.959	5.299	49.014	0.02%	-4.19%
			5220	5.369	47.018	5.323	48.987	0.86%	-4.02%
			5260	5.432	46.851	5.369	48.933	1.17%	-4.25%
			5280	5.486	46.680	5.393	48.906	1.72%	-4.55%
			5300	5.470	46.658	5.416	48.879	1.00%	-4.54%
			5500	5.840	46.279	5.650	48.607	3.36%	-4.79%
			5520	5.880	46.252	5.673	48.580	3.65%	-4.79%
			5540	5.910	46.251	5.696	48.553	3.76%	-4.74%
			5745	6.199	46.128	5.936	48.275	4.43%	-4.45%
			5765	6.205	46.065	5.959	48.248	4.13%	-4.52%
			5785	6.225	46.086	5.982	48.220	4.06%	-4.43%
			5800	6.238	45.967	6.000	48.200	3.97%	-4.63%

The above measured tissue parameters were used in the DASY software. The DASY software was used to perform interpolation to determine the dielectric parameters at the SAR test device frequencies (per IEEE 1528 6.6.1.2). The tissue parameters listed in the SAR test plots may slightly differ from the table above due to significant digit rounding in the software.

FCC ID: ZNFD950	 PCTEST ENGINEERING LABORATORY, INC.	SAR EVALUATION REPORT		Reviewed by: Quality Manager
Document S/N: OY1312022312.ZNF	Test Dates: 12/02/13 - 12/16/13	DUT Type: Portable Handset		Page 40 of 66

10.2 Test System Verification

Prior to SAR assessment, the system is verified to $\pm 10\%$ of the SAR measurement on the reference dipole at the time of calibration by the calibration facility. Full system validation status and result summary can be found in Appendix E.

Table 10-3
1g System Verification Results

System Verification TARGET & MEASURED												
SAR System #	Tissue Frequency (MHz)	Tissue Type	Date:	Amb. Temp (°C)	Liquid Temp (°C)	Input Power (W)	Dipole SN	Probe SN	Measured SAR _{1g} (W/kg)	1 W Target SAR _{1g} (W/kg)	1 W Normalized SAR _{1g} (W/kg)	Deviation _{1g} (%)
E	750	HEAD	12/02/2013	23.0	21.0	0.100	1046	3914	0.831	8.500	8.310	-2.24%
G	835	HEAD	12/04/2013	24.5	23.0	0.100	4d119	3209	0.976	9.680	9.760	0.83%
I	1750	HEAD	12/04/2013	23.4	22.9	0.100	1051	3319	3.550	36.500	35.500	-2.74%
C	1900	HEAD	12/09/2013	21.0	22.3	0.100	5d141	3263	3.790	40.800	37.900	-7.11%
C	1900	HEAD	12/12/2013	21.1	22.0	0.100	5d141	3263	3.810	40.800	38.100	-6.62%
H	2450	HEAD	12/02/2013	21.7	20.8	0.100	797	3318	5.010	52.500	50.100	-4.57%
B	2600	HEAD	12/10/2013	24.5	24.1	0.100	1004	3288	5.550	58.200	55.500	-4.64%
E	5200	HEAD	12/04/2013	24.1	22.9	0.040	1120	3914	3.060	76.000	76.500	0.66%
E	5300	HEAD	12/04/2013	24.1	23.0	0.040	1120	3914	2.990	78.700	74.750	-5.02%
E	5500	HEAD	12/04/2013	24.4	23.0	0.040	1120	3914	3.000	80.100	75.000	-6.37%
E	5800	HEAD	12/04/2013	24.1	23.1	0.040	1120	3914	2.830	74.900	70.750	-5.54%
B	750	BODY	12/04/2013	23.5	22.5	0.100	1054	3288	0.894	8.720	8.940	2.52%
G	835	BODY	12/02/2013	23.2	21.3	0.100	4d119	3209	1.010	9.540	10.100	5.87%
G	835	BODY	12/05/2013	24.5	23.0	0.100	4d119	3209	0.949	9.540	9.490	-0.52%
I	1750	BODY	12/05/2013	21.8	21.3	0.100	1051	3319	3.550	37.800	35.500	-6.08%
C	1900	BODY	12/02/2013	22.2	21.1	0.100	5d141	3263	4.070	41.500	40.700	-1.93%
I	1900	BODY	12/16/2013	21.9	22.7	0.100	5d148	3319	4.070	40.800	40.700	-0.25%
D	2450	BODY	12/02/2013	22.2	22.4	0.100	797	3022	5.000	49.600	50.000	0.81%
D	2450	BODY	12/10/2014	23.3	22.2	0.100	797	3022	4.960	49.600	49.600	0.00%
D	2600	BODY	12/02/2013	22.2	22.4	0.100	1004	3022	5.480	57.500	54.800	-4.70%
D	2600	BODY	12/10/2014	23.3	22.2	0.100	1004	3022	5.740	57.500	57.400	-0.17%
A	5200	BODY	12/02/2013	23.6	21.8	0.100	1057	3589	7.660	75.500	76.600	1.46%
A	5300	BODY	12/02/2013	23.5	21.9	0.100	1057	3589	7.720	75.300	77.200	2.52%
A	5500	BODY	12/02/2013	23.6	21.7	0.100	1057	3589	7.940	80.800	79.400	-1.73%
A	5800	BODY	12/02/2013	23.5	21.8	0.100	1057	3589	7.410	75.100	74.100	-1.33%

Table 10-4
10g System Verification Results

System Verification TARGET & MEASURED												
SAR System #	Tissue Frequency (MHz)	Tissue Type	Date:	Amb. Temp (°C)	Liquid Temp (°C)	Input Power (W)	Dipole SN	Probe SN	Measured SAR _{10g} (W/kg)	1 W Target SAR _{10g} (W/kg)	1 W Normalized SAR _{10g} (W/kg)	Deviation _{10g} (%)
A	5200	BODY	12/02/2013	23.6	21.8	0.100	1057	3589	2.180	21.100	21.800	3.32%
A	5300	BODY	12/02/2013	23.5	21.9	0.100	1057	3589	2.170	21.100	21.700	2.84%
A	5500	BODY	12/02/2013	23.6	21.7	0.100	1057	3589	2.230	22.400	22.300	-0.45%

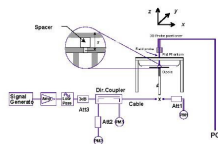



Figure 10-1
System Verification Setup Diagram



Figure 10-2
System Verification Setup Photo

FCC ID: ZNFD950	 PCTEST ENGINEERING LABORATORY, INC.	SAR EVALUATION REPORT	 LG	Reviewed by: Quality Manager
Document S/N: 0Y1312022312.ZNF	Test Dates: 12/02/13 - 12/16/13	DUT Type: Portable Handset	Page 41 of 66	

11 SAR DATA SUMMARY

11.1 Standalone Head SAR Data

**Table 11-1
GSM 850 Head SAR**



MEASUREMENT RESULTS															
FREQUENCY		Mode/Band	Service	Maximum Allowed Power [dBm]	Conducted Power [dBm]	Power Drift [dB]	Side	Test Position	Device Serial Number	# of Time Slots	Duty Cycle	SAR (1g)	Scaling Factor	Scaled SAR (1g)	Plot #
MHz	Ch.											(W/kg)		(W/kg)	
836.60	190	GSM 850	GSM	33.7	33.31	0.01	Right	Cheek	FCC3	1	1:8.3	0.298	1.094	0.326	
836.60	190	GSM 850	GSM	33.7	33.31	-0.01	Right	Tilt	FCC3	1	1:8.3	0.197	1.094	0.216	
836.60	190	GSM 850	GSM	33.7	33.31	-0.09	Left	Cheek	FCC3	1	1:8.3	0.325	1.094	0.356	
836.60	190	GSM 850	GSM	33.7	33.31	0.00	Left	Tilt	FCC3	1	1:8.3	0.193	1.094	0.211	
836.60	190	GSM 850	GPRS	31.7	31.27	0.07	Right	Cheek	FCC3	2	1:4.15	0.326	1.104	0.360	
836.60	190	GSM 850	GPRS	31.7	31.27	-0.10	Right	Tilt	FCC3	2	1:4.15	0.237	1.104	0.262	
836.60	190	GSM 850	GPRS	31.7	31.27	0.14	Left	Cheek	FCC3	2	1:4.15	0.392	1.104	0.433	A1
836.60	190	GSM 850	GPRS	31.7	31.27	-0.04	Left	Tilt	FCC3	2	1:4.15	0.212	1.104	0.234	
ANSI / IEEE C95.1 1992 - SAFETY LIMIT Spatial Peak Uncontrolled Exposure/General Population							Head 1.6 W/kg (mW/g) averaged over 1 gram								

**Table 11-2
UMTS 850 Head SAR**

MEASUREMENT RESULTS														
FREQUENCY		Mode/Band	Service	Maximum Allowed Power [dBm]	Conducted Power [dBm]	Power Drift [dB]	Side	Test Position	Device Serial Number	Duty Cycle	SAR (1g)	Scaling Factor	Scaled SAR (1g)	Plot #
MHz	Ch.										(W/kg)		(W/kg)	
836.60	4183	UMTS 850	RMC	23.7	23.37	0.03	Right	Cheek	FCC3	1:1	0.312	1.079	0.337	
836.60	4183	UMTS 850	RMC	23.7	23.37	-0.02	Right	Tilt	FCC3	1:1	0.221	1.079	0.238	
836.60	4183	UMTS 850	RMC	23.7	23.37	0.00	Left	Cheek	FCC3	1:1	0.391	1.079	0.422	A2
836.60	4183	UMTS 850	RMC	23.7	23.37	-0.02	Left	Tilt	FCC3	1:1	0.214	1.079	0.231	
ANSI / IEEE C95.1 1992 - SAFETY LIMIT Spatial Peak Uncontrolled Exposure/General Population							Head 1.6 W/kg (mW/g) averaged over 1 gram							

**Table 11-3
GSM 1900 Head SAR**

MEASUREMENT RESULTS															
FREQUENCY		Mode/Band	Service	Maximum Allowed Power [dBm]	Conducted Power [dBm]	Power Drift [dB]	Side	Test Position	Device Serial Number	# of Time Slots	Duty Cycle	SAR (1g)	Scaling Factor	Scaled SAR (1g)	Plot #
MHz	Ch.											(W/kg)		(W/kg)	
1880.00	661	GSM 1900	GSM	30.7	30.66	0.09	Right	Cheek	FCC3	1	1:8.3	0.142	1.009	0.143	
1880.00	661	GSM 1900	GSM	30.7	30.66	-0.07	Right	Tilt	FCC3	1	1:8.3	0.077	1.009	0.078	
1880.00	661	GSM 1900	GSM	30.7	30.66	-0.08	Left	Cheek	FCC3	1	1:8.3	0.133	1.009	0.134	
1880.00	661	GSM 1900	GSM	30.7	30.66	-0.04	Left	Tilt	FCC3	1	1:8.3	0.052	1.009	0.052	
1880.00	661	GSM 1900	GPRS	28.7	28.41	-0.13	Right	Cheek	FCC3	2	1:4.15	0.165	1.069	0.176	A3
1880.00	661	GSM 1900	GPRS	28.7	28.41	0.09	Right	Tilt	FCC3	2	1:4.15	0.078	1.069	0.083	
1880.00	661	GSM 1900	GPRS	28.7	28.41	0.05	Left	Cheek	FCC3	2	1:4.15	0.128	1.069	0.137	
1880.00	661	GSM 1900	GPRS	28.7	28.41	0.21	Left	Tilt	FCC3	2	1:4.15	0.053	1.069	0.057	
ANSI / IEEE C95.1 1992 - SAFETY LIMIT Spatial Peak Uncontrolled Exposure/General Population							Head 1.6 W/kg (mW/g) averaged over 1 gram								

FCC ID: ZNFD950		SAR EVALUATION REPORT		Reviewed by: Quality Manager
Document S/N: 0Y1312022312.ZNF	Test Dates: 12/02/13 - 12/16/13	DUT Type: Portable Handset		Page 42 of 66

**Table 11-4
UMTS 1900 Head SAR**



MEASUREMENT RESULTS														
FREQUENCY		Mode/Band	Service	Maximum Allowed Power [dBm]	Conducted Power [dBm]	Power Drift [dB]	Side	Test Position	Device Serial Number	Duty Cycle	SAR (1g)	Scaling Factor	Scaled SAR (1g)	Plot #
MHz	Ch.										(W/kg)		(W/kg)	
1880.00	9400	UMTS 1900	RMC	23.7	23.70	0.01	Right	Cheek	FCC3	1:1	0.249	1.000	0.249	A4
1880.00	9400	UMTS 1900	RMC	23.7	23.70	0.05	Right	Tilt	FCC3	1:1	0.151	1.000	0.151	
1880.00	9400	UMTS 1900	RMC	23.7	23.70	0.10	Left	Cheek	FCC3	1:1	0.248	1.000	0.248	
1880.00	9400	UMTS 1900	RMC	23.7	23.70	0.01	Left	Tilt	FCC3	1:1	0.096	1.000	0.096	
ANSI / IEEE C95.1 1992 - SAFETY LIMIT Spatial Peak Uncontrolled Exposure/General Population							Head 1.6 W/kg (mW/g) averaged over 1 gram							

**Table 11-5
LTE Band 17 Head SAR**

MEASUREMENT RESULTS																			
FREQUENCY		Mode	Bandwidth [MHz]	Maximum Allowed Power [dBm]	Conducted Power [dBm]	Power Drift [dB]	MPR [dB]	Side	Test Position	Modulation	RB Size	RB Offset	Device Serial Number	Duty Cycle	SAR (1g)	Scaling Factor	Scaled SAR (1g)	Plot #	
MHz	Ch.														(W/kg)		(W/kg)		
710.00	23790	Mid	LTE Band 17	10	24.2	24.12	-0.01	0	Right	Cheek	QPSK	1	0	FCC6	1:1	0.200	1.019	0.204	A5
710.00	23790	Mid	LTE Band 17	10	23.2	23.01	0.05	1	Right	Cheek	QPSK	25	25	FCC6	1:1	0.171	1.045	0.179	
710.00	23790	Mid	LTE Band 17	10	24.2	24.12	0.05	0	Right	Tilt	QPSK	1	0	FCC6	1:1	0.093	1.019	0.095	
710.00	23790	Mid	LTE Band 17	10	23.2	23.01	0.08	1	Right	Tilt	QPSK	25	25	FCC6	1:1	0.082	1.045	0.086	
710.00	23790	Mid	LTE Band 17	10	24.2	24.12	-0.01	0	Left	Cheek	QPSK	1	0	FCC6	1:1	0.171	1.019	0.174	
710.00	23790	Mid	LTE Band 17	10	23.2	23.01	0.12	1	Left	Cheek	QPSK	25	25	FCC6	1:1	0.147	1.045	0.154	
710.00	23790	Mid	LTE Band 17	10	24.2	24.12	0.13	0	Left	Tilt	QPSK	1	0	FCC6	1:1	0.088	1.019	0.090	
710.00	23790	Mid	LTE Band 17	10	23.2	23.01	0.10	1	Left	Tilt	QPSK	25	25	FCC6	1:1	0.073	1.045	0.076	
ANSI / IEEE C95.1 1992 - SAFETY LIMIT Spatial Peak Uncontrolled Exposure/General Population							Head 1.6 W/kg (mW/g) averaged over 1 gram												

**Table 11-6
LTE Band 5 (Cell) Head SAR**

MEASUREMENT RESULTS																			
FREQUENCY		Mode	Bandwidth [MHz]	Maximum Allowed Power [dBm]	Conducted Power [dBm]	Power Drift [dB]	MPR [dB]	Side	Test Position	Modulation	RB Size	RB Offset	Device Serial Number	Duty Cycle	SAR (1g)	Scaling Factor	Scaled SAR (1g)	Plot #	
MHz	Ch.														(W/kg)		(W/kg)		
836.50	20525	Mid	LTE Band 5 (Cell)	10	23.7	23.63	-0.04	0	Right	Cheek	QPSK	1	0	FCC6	1:1	0.361	1.016	0.367	
836.50	20525	Mid	LTE Band 5 (Cell)	10	22.7	22.67	-0.21	1	Right	Cheek	QPSK	25	0	FCC6	1:1	0.266	1.007	0.268	
836.50	20525	Mid	LTE Band 5 (Cell)	10	23.7	23.63	0.03	0	Right	Tilt	QPSK	1	0	FCC6	1:1	0.226	1.016	0.230	
836.50	20525	Mid	LTE Band 5 (Cell)	10	22.7	22.67	-0.01	1	Right	Tilt	QPSK	25	0	FCC6	1:1	0.167	1.007	0.168	
836.50	20525	Mid	LTE Band 5 (Cell)	10	23.7	23.63	-0.05	0	Left	Cheek	QPSK	1	0	FCC6	1:1	0.484	1.016	0.492	A6
836.50	20525	Mid	LTE Band 5 (Cell)	10	22.7	22.67	0.01	1	Left	Cheek	QPSK	25	0	FCC6	1:1	0.383	1.007	0.386	
836.50	20525	Mid	LTE Band 5 (Cell)	10	23.7	23.63	0.03	0	Left	Tilt	QPSK	1	0	FCC6	1:1	0.252	1.016	0.256	
836.50	20525	Mid	LTE Band 5 (Cell)	10	22.7	22.67	0.04	1	Left	Tilt	QPSK	25	0	FCC6	1:1	0.195	1.007	0.196	
ANSI / IEEE C95.1 1992 - SAFETY LIMIT Spatial Peak Uncontrolled Exposure/General Population							Head 1.6 W/kg (mW/g) averaged over 1 gram												

FCC ID: ZNFD950	 PCTEST ENGINEERING LABORATORY, INC.	SAR EVALUATION REPORT		Reviewed by: Quality Manager
Document S/N: 0Y1312022312.ZNF	Test Dates: 12/02/13 - 12/16/13	DUT Type: Portable Handset		Page 43 of 66

**Table 11-7
LTE Band 4 (AWS) Head SAR**



MEASUREMENT RESULTS																			
FREQUENCY		Mode	Bandwidth [MHz]	Maximum Allowed Power [dBm]	Conducted Power [dBm]	Power Drift [dB]	MPR [dB]	Side	Test Position	Modulation	RB Size	RB Offset	Device Serial Number	Duty Cycle	SAR (1g)	Scaling Factor	Scale d SAR (1g)	Plot #	
MHz	Ch.														(W/kg)		(W/kg)		
1750.00	20350	High	LTE Band 4 (AWS)	10	23.7	23.62	-0.01	0	Right	Cheek	QPSK	1	25	FCC6	1:1	0.350	1.019	0.357	A7
1750.00	20350	High	LTE Band 4 (AWS)	10	22.7	22.57	-0.05	1	Right	Cheek	QPSK	25	12	FCC6	1:1	0.272	1.030	0.280	
1750.00	20350	High	LTE Band 4 (AWS)	10	23.7	23.62	-0.06	0	Right	Tilt	QPSK	1	25	FCC6	1:1	0.226	1.019	0.230	
1750.00	20350	High	LTE Band 4 (AWS)	10	22.7	22.57	0.07	1	Right	Tilt	QPSK	25	12	FCC6	1:1	0.173	1.030	0.178	
1750.00	20350	High	LTE Band 4 (AWS)	10	23.7	23.62	0.01	0	Left	Cheek	QPSK	1	25	FCC6	1:1	0.318	1.019	0.324	
1750.00	20350	High	LTE Band 4 (AWS)	10	22.7	22.57	-0.01	1	Left	Cheek	QPSK	25	12	FCC6	1:1	0.252	1.030	0.260	
1750.00	20350	High	LTE Band 4 (AWS)	10	23.7	23.62	0.07	0	Left	Tilt	QPSK	1	25	FCC6	1:1	0.168	1.019	0.171	
1750.00	20350	High	LTE Band 4 (AWS)	10	22.7	22.57	0.10	1	Left	Tilt	QPSK	25	12	FCC6	1:1	0.130	1.030	0.134	
ANSI / IEEE C95.1 1992 - SAFETY LIMIT Spatial Peak Uncontrolled Exposure/General Population										Head 1.6 W/kg (mW/g) averaged over 1 gram									

**Table 11-8
LTE Band 2 (PCS) Head SAR**

MEASUREMENT RESULTS																			
FREQUENCY		Mode	Bandwidth [MHz]	Maximum Allowed Power [dBm]	Conducted Power [dBm]	Power Drift [dB]	MPR [dB]	Side	Test Position	Modulation	RB Size	RB Offset	Device Serial Number	Duty Cycle	SAR (1g)	Scaling Factor	Scale d SAR (1g)	Plot #	
MHz	Ch.														(W/kg)		(W/kg)		
1880.00	18900	Mid	LTE Band 2 (PCS)	10	23.7	23.70	-0.02	0	Right	Cheek	QPSK	1	0	FCC6	1:1	0.245	1.000	0.245	A8
1880.00	18900	Mid	LTE Band 2 (PCS)	10	22.7	22.69	0.05	1	Right	Cheek	QPSK	25	12	FCC6	1:1	0.200	1.002	0.200	
1880.00	18900	Mid	LTE Band 2 (PCS)	10	23.7	23.70	0.11	0	Right	Tilt	QPSK	1	0	FCC6	1:1	0.113	1.000	0.113	
1880.00	18900	Mid	LTE Band 2 (PCS)	10	22.7	22.69	0.08	1	Right	Tilt	QPSK	25	12	FCC6	1:1	0.086	1.002	0.086	
1880.00	18900	Mid	LTE Band 2 (PCS)	10	23.7	23.70	-0.10	0	Left	Cheek	QPSK	1	0	FCC6	1:1	0.236	1.000	0.236	
1880.00	18900	Mid	LTE Band 2 (PCS)	10	22.7	22.69	-0.10	1	Left	Cheek	QPSK	25	12	FCC6	1:1	0.179	1.002	0.179	
1880.00	18900	Mid	LTE Band 2 (PCS)	10	23.7	23.70	0.01	0	Left	Tilt	QPSK	1	0	FCC6	1:1	0.082	1.000	0.082	
1880.00	18900	Mid	LTE Band 2 (PCS)	10	22.7	22.69	-0.01	1	Left	Tilt	QPSK	25	12	FCC6	1:1	0.062	1.002	0.062	
ANSI / IEEE C95.1 1992 - SAFETY LIMIT Spatial Peak Uncontrolled Exposure/General Population										Head 1.6 W/kg (mW/g) averaged over 1 gram									

**Table 11-9
LTE Band 7 Head SAR**

MEASUREMENT RESULTS																			
FREQUENCY		Mode	Bandwidth [MHz]	Maximum Allowed Power [dBm]	Conducted Power [dBm]	Power Drift [dB]	MPR [dB]	Side	Test Position	Modulation	RB Size	RB Offset	Device Serial Number	Duty Cycle	SAR (1g)	Scaling Factor	Scale d SAR (1g)	Plot #	
MHz	Ch.														(W/kg)		(W/kg)		
2535.00	21100	Mid	LTE Band 7	20	23.7	23.68	0.12	0	Right	Cheek	QPSK	1	0	FCC6	1:1	0.117	1.005	0.118	A9
2535.00	21100	Mid	LTE Band 7	20	22.7	22.65	0.19	1	Right	Cheek	QPSK	50	0	FCC6	1:1	0.090	1.012	0.091	
2535.00	21100	Mid	LTE Band 7	20	23.7	23.68	-0.05	0	Right	Tilt	QPSK	1	0	FCC6	1:1	0.069	1.005	0.069	
2535.00	21100	Mid	LTE Band 7	20	22.7	22.65	0.13	1	Right	Tilt	QPSK	50	0	FCC6	1:1	0.054	1.012	0.055	
2535.00	21100	Mid	LTE Band 7	20	23.7	23.68	0.14	0	Left	Cheek	QPSK	1	0	FCC6	1:1	0.062	1.005	0.062	
2535.00	21100	Mid	LTE Band 7	20	22.7	22.65	0.04	1	Left	Cheek	QPSK	50	0	FCC6	1:1	0.053	1.012	0.054	
2535.00	21100	Mid	LTE Band 7	20	23.7	23.68	-0.09	0	Left	Tilt	QPSK	1	0	FCC6	1:1	0.101	1.005	0.102	
2535.00	21100	Mid	LTE Band 7	20	22.7	22.65	-0.19	1	Left	Tilt	QPSK	50	0	FCC6	1:1	0.075	1.012	0.076	
ANSI / IEEE C95.1 1992 - SAFETY LIMIT Spatial Peak Uncontrolled Exposure/General Population										Head 1.6 W/kg (mW/g) averaged over 1 gram									



FCC ID: ZNFD950		SAR EVALUATION REPORT		Reviewed by: Quality Manager
Document S/N: 0Y1312022312.ZNF	Test Dates: 12/02/13 - 12/16/13	DUT Type: Portable Handset		Page 44 of 66

**Table 11-10
DTS Head SAR**

MEASUREMENT RESULTS															
FREQUENCY		Mode	Service	Maximum Allowed Power [dBm]	Conducted Power [dBm]	Power Drift [dB]	Side	Test Position	Device Serial Number	Data Rate (Mbps)	Duty Cycle	SAR (1g)	Scaling Factor	Scaled SAR (1g)	Plot #
MHz	Ch.											(W/kg)		(W/kg)	
2437	6	IEEE 802.11b	DSSS	17.0	16.14	-0.02	Right	Cheek	FCC6	1	1:1	0.306	1.219	0.373	A10
2437	6	IEEE 802.11b	DSSS	17.0	16.14	0.07	Right	Tilt	FCC6	1	1:1	0.157	1.219	0.191	
2437	6	IEEE 802.11b	DSSS	17.0	16.14	-0.02	Left	Cheek	FCC6	1	1:1	0.107	1.219	0.130	
2437	6	IEEE 802.11b	DSSS	17.0	16.14	0.16	Left	Tilt	FCC6	1	1:1	0.074	1.219	0.090	
5745	149	IEEE 802.11a	OFDM	11.5	9.88	0.07	Right	Cheek	FCC7	6	1:1	0.052	1.452	0.076	A11
5775	155	IEEE 802.11ac	OFDM	9.5	7.51	-0.12	Right	Cheek	FCC7	29.3	1:1	0.021	1.581	0.033	
5745	149	IEEE 802.11a	OFDM	11.5	9.88	-0.18	Right	Tilt	FCC7	6	1:1	0.024	1.452	0.035	
5745	149	IEEE 802.11a	OFDM	11.5	9.88	0.21	Left	Cheek	FCC7	6	1:1	0.011	1.452	0.016	
5745	149	IEEE 802.11a	OFDM	11.5	9.88	-0.19	Left	Tilt	FCC7	6	1:1	0.012	1.452	0.017	
ANSI / IEEE C95.1 1992 - SAFETY LIMIT Spatial Peak Uncontrolled Exposure/General Population								Head 1.6 W/kg (mW/g) averaged over 1 gram							

**Table 11-11
NII Head SAR**

MEASUREMENT RESULTS															
FREQUENCY		Mode	Service	Maximum Allowed Power [dBm]	Conducted Power [dBm]	Power Drift [dB]	Side	Test Position	Device Serial Number	Data Rate (Mbps)	Duty Cycle	SAR (1g)	Scaling Factor	Scaled SAR (1g)	Plot #
MHz	Ch.											(W/kg)		(W/kg)	
5200	40	IEEE 802.11a	OFDM	11.5	10.56	0.01	Right	Cheek	FCC7	6	1:1	0.108	1.242	0.134	A12
5210	42	IEEE 802.11ac	OFDM	9.5	8.24	0.11	Right	Cheek	FCC7	29.3	1:1	0.044	1.337	0.059	
5200	40	IEEE 802.11a	OFDM	11.5	10.56	-0.14	Right	Tilt	FCC7	6	1:1	0.054	1.242	0.067	
5200	40	IEEE 802.11a	OFDM	11.5	10.56	0.08	Left	Cheek	FCC7	6	1:1	0.019	1.242	0.024	
5200	40	IEEE 802.11a	OFDM	11.5	10.56	0.16	Left	Tilt	FCC7	6	1:1	0.015	1.242	0.019	
5260	52	IEEE 802.11a	OFDM	11.5	10.87	-0.18	Right	Cheek	FCC7	6	1:1	0.101	1.156	0.117	
5290	58	IEEE 802.11ac	OFDM	9.5	9.00	0.16	Right	Cheek	FCC7	29.3	1:1	0.051	1.122	0.057	
5260	52	IEEE 802.11a	OFDM	11.5	10.87	-0.06	Right	Tilt	FCC7	6	1:1	0.046	1.156	0.053	
5260	52	IEEE 802.11a	OFDM	11.5	10.87	-0.16	Left	Cheek	FCC7	6	1:1	0.019	1.156	0.022	
5260	52	IEEE 802.11a	OFDM	11.5	10.87	-0.14	Left	Tilt	FCC7	6	1:1	0.015	1.156	0.017	
5540	108	IEEE 802.11a	OFDM	11.5	10.51	0.05	Right	Cheek	FCC7	6	1:1	0.052	1.256	0.065	
5530	106	IEEE 802.11ac	OFDM	9.5	9.10	0.16	Right	Cheek	FCC7	29.3	1:1	0.036	1.096	0.039	
5540	108	IEEE 802.11a	OFDM	11.5	10.51	-0.16	Right	Tilt	FCC7	6	1:1	0.035	1.256	0.044	
5540	108	IEEE 802.11a	OFDM	11.5	10.51	-0.21	Left	Cheek	FCC7	6	1:1	0.013	1.256	0.016	
5540	108	IEEE 802.11a	OFDM	11.5	10.51	-0.17	Left	Tilt	FCC7	6	1:1	0.011	1.256	0.014	
ANSI / IEEE C95.1 1992 - SAFETY LIMIT Spatial Peak Uncontrolled Exposure/General Population								Head 1.6 W/kg (mW/g) averaged over 1 gram							

FCC ID: ZNFD950	 PCTEST ENGINEERING LABORATORY, INC.	SAR EVALUATION REPORT		Reviewed by: Quality Manager
Document S/N: 0Y1312022312.ZNF	Test Dates: 12/02/13 - 12/16/13	DUT Type: Portable Handset		Page 45 of 66

11.2 Standalone Body-Worn SAR Data



Table 11-12
GSM/UMTS Body-Worn SAR Data

MEASUREMENT RESULTS																
FREQUENCY		Mode	Service	Maximum Allowed Power [dBm]	Conducted Power [dBm]	Power Drift [dB]	Position	Spacing	Device Serial Number	# of Time Slots	Duty Cycle	Side	SAR (1g)	Scaling Factor	Scaled SAR (1g)	Plot #
MHz	Ch.												(W/kg)		(W/kg)	
836.60	190	GSM 850	GSM	33.7	33.31	-0.01	Body	8 mm	FCC3	1	1:8.3	back	0.488	1.094	0.534	
836.60	190	GSM 850	GPRS	31.7	31.27	0.03	Body	8 mm	FCC3	2	1:4.15	back	0.543	1.104	0.599	A13
836.60	4183	UMTS 850	RMC	23.7	23.37	-0.17	Body	8 mm	FCC3	N/A	1:1	back	0.474	1.079	0.511	A15
1880.00	661	GSM 1900	GSM	30.7	30.66	-0.06	Body	8 mm	FCC3	1	1:8.3	back	0.501	1.009	0.506	
1880.00	661	GSM 1900	GPRS	28.7	28.41	0.02	Body	8 mm	FCC3	2	1:4.15	back	0.536	1.069	0.573	A17
1852.40	9262	UMTS 1900	RMC	23.7	23.67	-0.09	Body	8 mm	FCC3	N/A	1:1	back	0.754	1.007	0.759	
1880.00	9400	UMTS 1900	RMC	23.7	23.70	0.05	Body	8 mm	FCC3	N/A	1:1	back	0.816	1.000	0.816	
1907.60	9538	UMTS 1900	RMC	23.7	23.68	0.05	Body	8 mm	FCC3	N/A	1:1	back	0.866	1.005	0.870	A18
ANSI / IEEE C95.1 1992 - SAFETY LIMIT Spatial Peak Uncontrolled Exposure/General Population								Body 1.6 W/kg (mW/g) averaged over 1 gram								

Table 11-13
LTE Body-Worn SAR

MEASUREMENT RESULTS																			
FREQUENCY		Mode	Bandwidth [MHz]	Maximum Allowed Power [dBm]	Conducted Power [dBm]	Power Drift [dB]	MPR [dB]	Device Serial Number	Modulation	RB Size	RB Offset	Spacing	Side	Duty Cycle	SAR (1g)	Scaling Factor	Scaled SAR (1g)	Plot #	
MHz	Ch.														(W/kg)		(W/kg)		
710.00	23790	Mid	LTE Band 17	10	24.2	24.12	0.00	0	FCC6	QPSK	1	0	8 mm	back	1:1	0.347	1.019	0.354	A20
710.00	23790	Mid	LTE Band 17	10	23.2	23.01	-0.05	1	FCC6	QPSK	25	25	8 mm	back	1:1	0.265	1.045	0.277	
836.50	20525	Mid	LTE Band 5 (Cell)	10	23.7	23.63	0.00	0	FCC6	QPSK	1	0	8 mm	back	1:1	0.397	1.016	0.403	A22
836.50	20525	Mid	LTE Band 5 (Cell)	10	22.7	22.67	-0.03	1	FCC6	QPSK	25	0	8 mm	back	1:1	0.315	1.007	0.317	
1750.00	20350	High	LTE Band 4 (AWS)	10	23.7	23.62	-0.06	0	FCC6	QPSK	1	25	8 mm	back	1:1	0.742	1.019	0.756	A24
1750.00	20350	High	LTE Band 4 (AWS)	10	22.7	22.57	0.04	1	FCC6	QPSK	25	12	8 mm	back	1:1	0.577	1.030	0.594	
1855.00	18650	Low	LTE Band 2 (PCS)	10	23.7	23.68	-0.01	0	FCC6	QPSK	1	0	8 mm	back	1:1	0.856	1.005	0.860	
1880.00	18900	Mid	LTE Band 2 (PCS)	10	23.7	23.70	-0.03	0	FCC6	QPSK	1	0	8 mm	back	1:1	0.915	1.000	0.915	
1905.00	19150	High	LTE Band 2 (PCS)	10	23.7	23.68	0.01	0	FCC6	QPSK	1	25	8 mm	back	1:1	0.987	1.005	0.992	A26
1880.00	18900	Mid	LTE Band 2 (PCS)	10	22.7	22.69	0.07	1	FCC6	QPSK	25	12	8 mm	back	1:1	0.730	1.002	0.731	
1880.00	18900	Mid	LTE Band 2 (PCS)	10	22.7	22.68	-0.02	1	FCC6	QPSK	50	0	8 mm	back	1:1	0.726	1.005	0.730	
1905.00	19150	High	LTE Band 2 (PCS)	10	23.7	23.68	-0.05	0	FCC6	QPSK	1	25	8 mm	back	1:1	0.842	1.005	0.846	
2510.00	20850	Low	LTE Band 7	20	23.7	23.64	-0.03	0	FCC6	QPSK	1	0	8 mm	back	1:1	1.110	1.014	1.126	
2535.00	21100	Mid	LTE Band 7	20	23.7	23.68	0.01	0	FCC6	QPSK	1	0	8 mm	back	1:1	1.180	1.005	1.186	A27
2560.00	21350	High	LTE Band 7	20	23.7	23.63	0.04	0	FCC6	QPSK	1	0	8 mm	back	1:1	1.090	1.016	1.107	
2510.00	20850	Low	LTE Band 7	20	22.7	22.61	0.03	1	FCC6	QPSK	50	0	8 mm	back	1:1	0.829	1.021	0.846	
2535.00	21100	Mid	LTE Band 7	20	22.7	22.65	0.12	1	FCC6	QPSK	50	0	8 mm	back	1:1	0.895	1.012	0.906	
2560.00	21350	High	LTE Band 7	20	22.7	22.62	0.07	1	FCC6	QPSK	50	0	8 mm	back	1:1	0.856	1.019	0.872	
2535.00	21100	Mid	LTE Band 7	20	22.7	22.31	0.03	1	FCC6	QPSK	100	0	8 mm	back	1:1	0.881	1.094	0.964	
2510.00	20850	Low	LTE Band 7	20	23.7	23.64	0.03	0	FCC6	QPSK	1	0	8 mm	back	1:1	1.040	1.014	1.055	
2535.00	21100	Mid	LTE Band 7	20	23.7	23.68	0.04	0	FCC6	QPSK	1	0	8 mm	back	1:1	1.100	1.005	1.106	
ANSI / IEEE C95.1 1992 - SAFETY LIMIT Spatial Peak Uncontrolled Exposure/General Population								Body 1.6 W/kg (mW/g) averaged over 1 gram											

Note: Variability data is highlighted blue in the table above.



FCC ID: ZNFD950	 PCTEST ENGINEERING LABORATORY, INC.	SAR EVALUATION REPORT		Reviewed by: Quality Manager
Document S/N: 0Y1312022312.ZNF	Test Dates: 12/02/13 - 12/16/13	DUT Type: Portable Handset		Page 46 of 66

**Table 11-14
DTS Body-Worn SAR**

MEASUREMENT RESULTS															
FREQUENCY		Mode	Service	Maximum Allowed Power [dBm]	Conducted Power [dBm]	Power Drift [dB]	Spacing	Device Serial Number	Data Rate (Mbps)	Side	Duty Cycle	SAR (1g)	Scaling Factor	Scaled SAR (1g)	Plot #
MHz	Ch.											(W/kg)		(W/kg)	
2437	6	IEEE 802.11b	DSSS	17.0	16.14	-0.04	8 mm	FCC3	1	back	1:1	0.133	1.219	0.162	A28
5745	149	IEEE 802.11a	OFDM	11.5	9.88	0.13	8 mm	FCC6	6	back	1:1	0.028	1.452	0.041	A29
5775	155	IEEE 802.11ac	OFDM	9.5	7.51	0.21	8 mm	FCC6	29.3	back	1:1	0.009	1.581	0.014	
ANSI / IEEE C95.1 1992 - SAFETY LIMIT Spatial Peak Uncontrolled Exposure/General Population							Body 1.6 W/kg (mW/g) averaged over 1 gram								

**Table 11-15
NII Body-Worn SAR**

MEASUREMENT RESULTS															
FREQUENCY		Mode	Service	Maximum Allowed Power [dBm]	Conducted Power [dBm]	Power Drift [dB]	Spacing	Device Serial Number	Data Rate (Mbps)	Side	Duty Cycle	SAR (1g)	Scaling Factor	Scaled SAR (1g)	Plot #
MHz	Ch.											(W/kg)		(W/kg)	
5200	40	IEEE 802.11a	OFDM	11.5	10.56	-0.14	8 mm	FCC6	6	back	1:1	0.079	1.242	0.098	A31
5210	42	IEEE 802.11ac	OFDM	9.5	8.24	0.19	8 mm	FCC6	29.3	back	1:1	0.035	1.337	0.047	
5260	52	IEEE 802.11a	OFDM	11.5	10.87	0.19	8 mm	FCC6	6	back	1:1	0.078	1.156	0.090	
5290	58	IEEE 802.11ac	OFDM	9.5	9.00	0.15	8 mm	FCC6	29.3	back	1:1	0.038	1.122	0.043	
5540	108	IEEE 802.11a	OFDM	11.5	10.51	0.15	8 mm	FCC6	6	back	1:1	0.034	1.256	0.043	
5530	106	IEEE 802.11ac	OFDM	9.5	9.10	-0.13	8 mm	FCC6	29.3	back	1:1	0.025	1.096	0.027	
ANSI / IEEE C95.1 1992 - SAFETY LIMIT Spatial Peak Uncontrolled Exposure/General Population							Body 1.6 W/kg (mW/g) averaged over 1 gram								

FCC ID: ZNFD950	 PCTEST ENGINEERING LABORATORY, INC.	SAR EVALUATION REPORT		Reviewed by: Quality Manager
Document S/N: 0Y1312022312.ZNF	Test Dates: 12/02/13 - 12/16/13	DUT Type: Portable Handset		Page 47 of 66



11.3 Standalone Wireless Router SAR Data

**Table 11-16
GPRS/UMTS Hotspot SAR Data**

MEASUREMENT RESULTS															
FREQUENCY		Mode	Service	Maximum Allowed Power [dBm]	Conducted Power [dBm]	Power Drift [dB]	Spacing	Device Serial Number	# of GPRS Slots	Duty Cycle	Side	SAR (1g)	Scaling Factor	Scaled SAR (1g)	Plot #
MHz	Ch.											(W/kg)		(W/kg)	
836.60	190	GSM 850	GPRS	31.7	31.27	0.03	8 mm	FCC3	2	1:4.15	back	0.543	1.104	0.599	
836.60	190	GSM 850	GPRS	31.7	31.27	0.01	8 mm	FCC3	2	1:4.15	front	0.656	1.104	0.724	A14
836.60	190	GSM 850	GPRS	31.7	31.27	-0.09	10 mm	FCC3	2	1:4.15	bottom	0.233	1.104	0.257	
836.60	190	GSM 850	GPRS	31.7	31.27	-0.04	10 mm	FCC3	2	1:4.15	right	0.282	1.104	0.311	
836.60	190	GSM 850	GPRS	31.7	31.27	-0.06	10 mm	FCC3	2	1:4.15	left	0.528	1.104	0.583	
836.60	4183	UMTS 850	RMC	23.7	23.37	-0.17	8 mm	FCC3	N/A	1:1	back	0.474	1.079	0.511	
836.60	4183	UMTS 850	RMC	23.7	23.37	0.01	8 mm	FCC3	N/A	1:1	front	0.532	1.079	0.574	A16
836.60	4183	UMTS 850	RMC	23.7	23.37	-0.09	10 mm	FCC3	N/A	1:1	bottom	0.230	1.079	0.248	
836.60	4183	UMTS 850	RMC	23.7	23.37	0.04	10 mm	FCC3	N/A	1:1	right	0.305	1.079	0.329	
836.60	4183	UMTS 850	RMC	23.7	23.37	-0.03	10 mm	FCC3	N/A	1:1	left	0.489	1.079	0.528	
1880.00	661	GSM 1900	GPRS	28.7	28.41	0.02	8 mm	FCC3	2	1:4.15	back	0.536	1.069	0.573	A17
1880.00	661	GSM 1900	GPRS	28.7	28.41	0.06	8 mm	FCC3	2	1:4.15	front	0.442	1.069	0.472	
1880.00	661	GSM 1900	GPRS	28.7	28.41	-0.21	10 mm	FCC3	2	1:4.15	bottom	0.433	1.069	0.463	
1880.00	661	GSM 1900	GPRS	28.7	28.41	-0.13	10 mm	FCC3	2	1:4.15	right	0.157	1.069	0.168	
1880.00	661	GSM 1900	GPRS	28.7	28.41	-0.03	10 mm	FCC3	2	1:4.15	left	0.151	1.069	0.161	
1852.40	9262	UMTS 1900	RMC	23.7	23.67	-0.09	8 mm	FCC3	N/A	1:1	back	0.754	1.007	0.759	
1880.00	9400	UMTS 1900	RMC	23.7	23.70	0.05	8 mm	FCC3	N/A	1:1	back	0.816	1.000	0.816	
1907.60	9538	UMTS 1900	RMC	23.7	23.68	0.05	8 mm	FCC3	N/A	1:1	back	0.866	1.005	0.870	
1852.40	9262	UMTS 1900	RMC	23.7	23.67	0.04	8 mm	FCC3	N/A	1:1	front	0.779	1.007	0.784	
1880.00	9400	UMTS 1900	RMC	23.7	23.70	-0.01	8 mm	FCC3	N/A	1:1	front	0.850	1.000	0.850	
1907.60	9538	UMTS 1900	RMC	23.7	23.68	-0.03	8 mm	FCC3	N/A	1:1	front	0.795	1.005	0.799	
1852.40	9262	UMTS 1900	RMC	23.7	23.67	0.01	10 mm	FCC3	N/A	1:1	bottom	0.755	1.007	0.760	
1880.00	9400	UMTS 1900	RMC	23.7	23.70	0.12	10 mm	FCC3	N/A	1:1	bottom	0.851	1.000	0.851	
1907.60	9538	UMTS 1900	RMC	23.7	23.68	0.01	10 mm	FCC3	N/A	1:1	bottom	0.872	1.005	0.876	A19
1880.00	9400	UMTS 1900	RMC	23.7	23.70	0.04	10 mm	FCC3	N/A	1:1	right	0.258	1.000	0.258	
1880.00	9400	UMTS 1900	RMC	23.7	23.70	0.05	10 mm	FCC3	N/A	1:1	left	0.277	1.000	0.277	
ANSI / IEEE C95.1 1992 - SAFETY LIMIT							Body								
Spatial Peak							1.6 W/kg (mW/g)								
Uncontrolled Exposure/General Population							averaged over 1 gram								

**Table 11-17
LTE Band 17 Hotspot SAR**

MEASUREMENT RESULTS																			
FREQUENCY		Mode	Bandwidth [MHz]	Maximum Allowed Power [dBm]	Conducted Power [dBm]	Power Drift [dB]	MPR [dB]	Device Serial Number	Modulation	RB Size	RB Offset	Spacing	Side	Duty Cycle	SAR (1g)	Scaling Factor	Scaled SAR (1g)	Plot #	
MHz	Ch.														(W/kg)		(W/kg)		
710.00	23790	Mid	LTE Band 17	10	24.2	24.12	0.00	0	FCC6	QPSK	1	0	8 mm	back	1:1	0.347	1.019	0.354	
710.00	23790	Mid	LTE Band 17	10	23.2	23.01	-0.05	1	FCC6	QPSK	25	25	8 mm	back	1:1	0.265	1.045	0.277	
710.00	23790	Mid	LTE Band 17	10	24.2	24.12	0.04	0	FCC6	QPSK	1	0	8 mm	front	1:1	0.290	1.019	0.296	
710.00	23790	Mid	LTE Band 17	10	23.2	23.01	0.00	1	FCC6	QPSK	25	25	8 mm	front	1:1	0.245	1.045	0.256	
710.00	23790	Mid	LTE Band 17	10	24.2	24.12	0.18	0	FCC6	QPSK	1	0	10 mm	bottom	1:1	0.181	1.019	0.184	
710.00	23790	Mid	LTE Band 17	10	23.2	23.01	-0.04	1	FCC6	QPSK	25	25	10 mm	bottom	1:1	0.178	1.045	0.186	
710.00	23790	Mid	LTE Band 17	10	24.2	24.12	0.08	0	FCC6	QPSK	1	0	10 mm	right	1:1	0.360	1.019	0.367	A21
710.00	23790	Mid	LTE Band 17	10	23.2	23.01	0.07	1	FCC6	QPSK	25	25	10 mm	right	1:1	0.309	1.045	0.323	
710.00	23790	Mid	LTE Band 17	10	24.2	24.12	0.15	0	FCC6	QPSK	1	0	10 mm	left	1:1	0.173	1.019	0.176	
710.00	23790	Mid	LTE Band 17	10	23.2	23.01	0.18	1	FCC6	QPSK	25	25	10 mm	left	1:1	0.161	1.045	0.168	
ANSI / IEEE C95.1 1992 - SAFETY LIMIT							Body												
Spatial Peak							1.6 W/kg (mW/g)												
Uncontrolled Exposure/General Population							averaged over 1 gram												

FCC ID: ZNFD950		SAR EVALUATION REPORT		Reviewed by: Quality Manager
Document S/N: OY1312022312.ZNF	Test Dates: 12/02/13 - 12/16/13	DUT Type: Portable Handset	Page 48 of 66	



**Table 11-18
LTE Band 5 (Cell) Hotspot SAR**

MEASUREMENT RESULTS																			
FREQUENCY		Mode	Bandwidth [MHz]	Maximum Allowed Power [dBm]	Conducted Power [dBm]	Power Drift [dB]	MPR [dB]	Device Serial Number	Modulation	RB Size	RB Offset	Spacing	Side	Duty Cycle	SAR (1g)	Scaling Factor	Scaled SAR (1g)	Plot #	
MHz	Ch.														(W/kg)		(W/kg)		
836.50	20525	Md	LTE Band 5 (Cell)	10	23.7	23.63	0.00	0	FCC6	QPSK	1	0	8 mm	back	1:1	0.397	1.016	0.403	
836.50	20525	Md	LTE Band 5 (Cell)	10	22.7	22.67	-0.03	1	FCC6	QPSK	25	0	8 mm	back	1:1	0.315	1.007	0.317	
836.50	20525	Md	LTE Band 5 (Cell)	10	23.7	23.63	-0.07	0	FCC6	QPSK	1	0	8 mm	front	1:1	0.448	1.016	0.455	A23
836.50	20525	Md	LTE Band 5 (Cell)	10	22.7	22.67	-0.06	1	FCC6	QPSK	25	0	8 mm	front	1:1	0.368	1.007	0.371	
836.50	20525	Md	LTE Band 5 (Cell)	10	23.7	23.63	-0.03	0	FCC6	QPSK	1	0	10 mm	bottom	1:1	0.234	1.016	0.238	
836.50	20525	Md	LTE Band 5 (Cell)	10	22.7	22.67	-0.01	1	FCC6	QPSK	25	0	10 mm	bottom	1:1	0.192	1.007	0.193	
836.50	20525	Md	LTE Band 5 (Cell)	10	23.7	23.63	0.03	0	FCC6	QPSK	1	0	10 mm	right	1:1	0.243	1.016	0.247	
836.50	20525	Md	LTE Band 5 (Cell)	10	22.7	22.67	-0.06	1	FCC6	QPSK	25	0	10 mm	right	1:1	0.215	1.007	0.217	
836.50	20525	Md	LTE Band 5 (Cell)	10	23.7	23.63	0.05	0	FCC6	QPSK	1	0	10 mm	left	1:1	0.360	1.016	0.366	
836.50	20525	Md	LTE Band 5 (Cell)	10	22.7	22.67	-0.07	1	FCC6	QPSK	25	0	10 mm	left	1:1	0.280	1.007	0.282	
ANSI / IEEE C95.1 1992 - SAFETY LIMIT Spatial Peak Uncontrolled Exposure/General Population									Body 1.6 W/kg (mW/g) averaged over 1 gram										

**Table 11-19
LTE Band 4 (AWS) Hotspot SAR**

MEASUREMENT RESULTS																			
FREQUENCY		Mode	Bandwidth [MHz]	Maximum Allowed Power [dBm]	Conducted Power [dBm]	Power Drift [dB]	MPR [dB]	Device Serial Number	Modulation	RB Size	RB Offset	Spacing	Side	Duty Cycle	SAR (1g)	Scaling Factor	Scaled SAR (1g)	Plot #	
MHz	Ch.														(W/kg)		(W/kg)		
1750.00	20350	High	LTE Band 4 (AWS)	10	23.7	23.62	-0.06	0	FCC6	QPSK	1	25	8 mm	back	1:1	0.742	1.019	0.756	
1750.00	20350	High	LTE Band 4 (AWS)	10	22.7	22.57	0.04	1	FCC6	QPSK	25	12	8 mm	back	1:1	0.577	1.030	0.594	
1715.00	20000	Low	LTE Band 4 (AWS)	10	23.7	23.48	0.12	0	FCC6	QPSK	1	25	8 mm	front	1:1	0.839	1.052	0.883	
1732.50	20175	Mid	LTE Band 4 (AWS)	10	23.7	23.61	-0.02	0	FCC6	QPSK	1	25	8 mm	front	1:1	0.898	1.021	0.917	
1750.00	20350	High	LTE Band 4 (AWS)	10	23.7	23.62	0.07	0	FCC6	QPSK	1	25	8 mm	front	1:1	0.915	1.019	0.932	A25
1750.00	20350	High	LTE Band 4 (AWS)	10	22.7	22.57	0.09	1	FCC6	QPSK	25	12	8 mm	front	1:1	0.694	1.030	0.715	
1750.00	20350	High	LTE Band 4 (AWS)	10	22.7	22.55	0.09	1	FCC6	QPSK	50	0	8 mm	front	1:1	0.705	1.035	0.730	
1750.00	20350	High	LTE Band 4 (AWS)	10	23.7	23.62	-0.08	0	FCC6	QPSK	1	25	10 mm	bottom	1:1	0.656	1.019	0.668	
1750.00	20350	High	LTE Band 4 (AWS)	10	22.7	22.57	0.01	1	FCC6	QPSK	25	12	10 mm	bottom	1:1	0.484	1.030	0.499	
1750.00	20350	High	LTE Band 4 (AWS)	10	23.7	23.62	0.06	0	FCC6	QPSK	1	25	10 mm	right	1:1	0.224	1.019	0.228	
1750.00	20350	High	LTE Band 4 (AWS)	10	22.7	22.57	-0.07	1	FCC6	QPSK	25	12	10 mm	right	1:1	0.168	1.030	0.173	
1750.00	20350	High	LTE Band 4 (AWS)	10	23.7	23.62	-0.09	0	FCC6	QPSK	1	25	10 mm	left	1:1	0.327	1.019	0.333	
1750.00	20350	High	LTE Band 4 (AWS)	10	22.7	22.57	-0.02	1	FCC6	QPSK	25	12	10 mm	left	1:1	0.247	1.030	0.254	
1750.00	20350	High	LTE Band 4 (AWS)	10	23.7	23.62	-0.02	0	FCC6	QPSK	1	25	8 mm	front	1:1	0.898	1.019	0.915	
ANSI / IEEE C95.1 1992 - SAFETY LIMIT Spatial Peak Uncontrolled Exposure/General Population									Body 1.6 W/kg (mW/g) averaged over 1 gram										

Note: Variability data is highlighted blue in the table above.

FCC ID: ZNFD950	 PCTEST ENGINEERING LABORATORY, INC.	SAR EVALUATION REPORT		Reviewed by: Quality Manager
Document S/N: 0Y1312022312.ZNF	Test Dates: 12/02/13 - 12/16/13	DUT Type: Portable Handset		Page 49 of 66

**Table 11-20
LTE Band 2 (PCS) Hotspot SAR**



MEASUREMENT RESULTS																			
FREQUENCY		Mode	Bandwidth [MHz]	Maximum Allowed Power [dBm]	Conducted Power [dBm]	Power Drift [dB]	MPR [dB]	Device Serial Number	Modulation	RB Size	RB Offset	Spacing	Side	Duty Cycle	SAR (1g) (W/kg)	Scaling Factor	Scaled SAR (1g) (W/kg)	Plot #	
MHz	Ch.																		
1855.00	18650	Low	LTE Band 2 (PCS)	10	23.7	23.68	-0.01	0	FCC6	QPSK	1	0	8 mm	back	1:1	0.856	1.005	0.860	
1880.00	18900	Mid	LTE Band 2 (PCS)	10	23.7	23.70	-0.03	0	FCC6	QPSK	1	0	8 mm	back	1:1	0.915	1.000	0.915	
1905.00	19150	High	LTE Band 2 (PCS)	10	23.7	23.68	0.01	0	FCC6	QPSK	1	25	8 mm	back	1:1	0.987	1.005	0.992	A26
1880.00	18900	Mid	LTE Band 2 (PCS)	10	22.7	22.69	0.07	1	FCC6	QPSK	25	12	8 mm	back	1:1	0.730	1.002	0.731	
1880.00	18900	Mid	LTE Band 2 (PCS)	10	22.7	22.68	-0.02	1	FCC6	QPSK	50	0	8 mm	back	1:1	0.726	1.005	0.730	
1855.00	18650	Low	LTE Band 2 (PCS)	10	23.7	23.68	0.04	0	FCC6	QPSK	1	0	8 mm	front	1:1	0.807	1.005	0.811	
1880.00	18900	Mid	LTE Band 2 (PCS)	10	23.7	23.70	0.05	0	FCC6	QPSK	1	0	8 mm	front	1:1	0.857	1.000	0.857	
1905.00	19150	High	LTE Band 2 (PCS)	10	23.7	23.68	0.04	0	FCC6	QPSK	1	25	8 mm	front	1:1	0.859	1.005	0.863	
1880.00	18900	Mid	LTE Band 2 (PCS)	10	22.7	22.69	-0.03	1	FCC6	QPSK	25	12	8 mm	front	1:1	0.667	1.002	0.668	
1880.00	18900	Mid	LTE Band 2 (PCS)	10	22.7	22.68	0.05	1	FCC6	QPSK	50	0	8 mm	front	1:1	0.657	1.005	0.660	
1880.00	18900	Mid	LTE Band 2 (PCS)	10	23.7	23.70	-0.01	0	FCC6	QPSK	1	0	10 mm	bottom	1:1	0.688	1.000	0.688	
1880.00	18900	Mid	LTE Band 2 (PCS)	10	22.7	22.69	0.00	1	FCC6	QPSK	25	12	10 mm	bottom	1:1	0.534	1.002	0.535	
1880.00	18900	Mid	LTE Band 2 (PCS)	10	23.7	23.70	-0.09	0	FCC6	QPSK	1	0	10 mm	right	1:1	0.246	1.000	0.246	
1880.00	18900	Mid	LTE Band 2 (PCS)	10	22.7	22.69	-0.04	1	FCC6	QPSK	25	12	10 mm	right	1:1	0.185	1.002	0.185	
1880.00	18900	Mid	LTE Band 2 (PCS)	10	23.7	23.70	-0.01	0	FCC6	QPSK	1	0	10 mm	left	1:1	0.288	1.000	0.288	
1880.00	18900	Mid	LTE Band 2 (PCS)	10	22.7	22.69	0.02	1	FCC6	QPSK	25	12	10 mm	left	1:1	0.215	1.002	0.215	
1905.00	19150	High	LTE Band 2 (PCS)	10	23.7	23.68	-0.05	0	FCC6	QPSK	1	25	8 mm	back	1:1	0.842	1.005	0.846	
ANSI / IEEE C95.1 1992 - SAFETY LIMIT Spatial Peak Uncontrolled Exposure/General Population									Body 1.6 W/kg (mW/g) averaged over 1 gram										

Note: Variability data is highlighted blue in the table above.

**Table 11-21
LTE Band 7 Hotspot SAR**

MEASUREMENT RESULTS																			
FREQUENCY		Mode	Bandwidth [MHz]	Maximum Allowed Power [dBm]	Conducted Power [dBm]	Power Drift [dB]	MPR [dB]	Device Serial Number	Modulation	RB Size	RB Offset	Spacing	Side	Duty Cycle	SAR (1g) (W/kg)	Scaling Factor	Scaled SAR (1g) (W/kg)	Plot #	
MHz	Ch.																		
2510.00	20850	Low	LTE Band 7	20	23.7	23.64	-0.03	0	FCC6	QPSK	1	0	8 mm	back	1:1	1.110	1.014	1.126	
2535.00	21100	Mid	LTE Band 7	20	23.7	23.68	0.01	0	FCC6	QPSK	1	0	8 mm	back	1:1	1.180	1.005	1.186	A27
2560.00	21350	High	LTE Band 7	20	23.7	23.63	0.04	0	FCC6	QPSK	1	0	8 mm	back	1:1	1.090	1.016	1.107	
2510.00	20850	Low	LTE Band 7	20	22.7	22.61	0.03	1	FCC6	QPSK	50	0	8 mm	back	1:1	0.829	1.021	0.846	
2535.00	21100	Mid	LTE Band 7	20	22.7	22.65	0.12	1	FCC6	QPSK	50	0	8 mm	back	1:1	0.895	1.012	0.906	
2560.00	21350	High	LTE Band 7	20	22.7	22.62	0.07	1	FCC6	QPSK	50	0	8 mm	back	1:1	0.856	1.019	0.872	
2535.00	21100	Mid	LTE Band 7	20	22.7	22.31	0.03	1	FCC6	QPSK	100	0	8 mm	back	1:1	0.881	1.094	0.964	
2535.00	21100	Mid	LTE Band 7	20	23.7	23.68	0.02	0	FCC6	QPSK	1	0	8 mm	front	1:1	0.403	1.005	0.405	
2535.00	21100	Mid	LTE Band 7	20	22.7	22.65	0.04	1	FCC6	QPSK	50	0	8 mm	front	1:1	0.292	1.012	0.296	
2535.00	21100	Mid	LTE Band 7	20	23.7	23.68	-0.02	0	FCC6	QPSK	1	0	10 mm	bottom	1:1	0.207	1.005	0.208	
2535.00	21100	Mid	LTE Band 7	20	22.7	22.65	-0.05	1	FCC6	QPSK	50	0	10 mm	bottom	1:1	0.152	1.012	0.154	
2510.00	20850	Low	LTE Band 7	20	23.7	23.64	0.13	0	FCC6	QPSK	1	0	10 mm	right	1:1	0.808	1.014	0.819	
2535.00	21100	Mid	LTE Band 7	20	23.7	23.68	-0.02	0	FCC6	QPSK	1	0	10 mm	right	1:1	0.911	1.005	0.916	
2560.00	21350	High	LTE Band 7	20	23.7	23.63	0.05	0	FCC6	QPSK	1	0	10 mm	right	1:1	0.833	1.016	0.846	
2535.00	21100	Mid	LTE Band 7	20	22.7	22.65	-0.09	1	FCC6	QPSK	50	0	10 mm	right	1:1	0.704	1.012	0.712	
2535.00	21100	Mid	LTE Band 7	20	22.7	22.31	-0.04	1	FCC6	QPSK	100	0	10 mm	right	1:1	0.687	1.094	0.752	
2535.00	21100	Mid	LTE Band 7	20	23.7	23.68	0.19	0	FCC6	QPSK	1	0	10 mm	left	1:1	0.005	1.005	0.005	
2535.00	21100	Mid	LTE Band 7	20	22.7	22.65	-0.06	1	FCC6	QPSK	50	0	10 mm	left	1:1	0.002	1.012	0.002	
2510.00	20850	Low	LTE Band 7	20	23.7	23.64	0.03	0	FCC6	QPSK	1	0	8 mm	back	1:1	1.040	1.014	1.055	
2535.00	21100	Mid	LTE Band 7	20	23.7	23.68	0.04	0	FCC6	QPSK	1	0	8 mm	back	1:1	1.100	1.005	1.106	
ANSI / IEEE C95.1 1992 - SAFETY LIMIT Spatial Peak Uncontrolled Exposure/General Population									Body 1.6 W/kg (mW/g) averaged over 1 gram										

Note: Variability data is highlighted blue in the table above.

FCC ID: ZNFD950	 PCTEST ENGINEERING LABORATORY, INC.	SAR EVALUATION REPORT		Reviewed by: Quality Manager
Document S/N: 0Y1312022312.ZNF	Test Dates: 12/02/13 - 12/16/13	DUT Type: Portable Handset		Page 50 of 66



**Table 11-22
WLAN Hotspot SAR**

MEASUREMENT RESULTS															
FREQUENCY		Mode	Service	Maximum Allowed Power [dBm]	Conducted Power [dBm]	Power Drift [dB]	Spacing	Device Serial Number	Data Rate (Mbps)	Side	Duty Cycle	SAR (1g)	Scaling Factor	Scaled SAR (1g)	Plot #
MHz	Ch.											(W/kg)		(W/kg)	
2437	6	IEEE 802.11b	DSSS	17.0	16.14	-0.04	8 mm	FCC3	1	back	1:1	0.133	1.219	0.162	A28
2437	6	IEEE 802.11b	DSSS	17.0	16.14	0.00	8 mm	FCC3	1	front	1:1	0.067	1.219	0.082	
2437	6	IEEE 802.11b	DSSS	17.0	16.14	0.15	10 mm	FCC3	1	top	1:1	0.029	1.219	0.035	
2437	6	IEEE 802.11b	DSSS	17.0	16.14	0.08	10 mm	FCC3	1	left	1:1	0.110	1.219	0.134	
5745	149	IEEE 802.11a	OFDM	11.5	9.88	0.13	8 mm	FCC6	6	back	1:1	0.028	1.452	0.041	
5745	149	IEEE 802.11a	OFDM	11.5	9.88	0.00	8 mm	FCC6	6	front	1:1	0.000	1.452	0.000	
5745	149	IEEE 802.11a	OFDM	11.5	9.88	0.00	10 mm	FCC6	6	top	1:1	0.000	1.452	0.000	
5745	149	IEEE 802.11a	OFDM	11.5	9.88	0.00	10 mm	FCC6	6	left	1:1	0.028	1.452	0.041	A30
5775	155	IEEE 802.11ac	OFDM	9.5	7.51	-0.12	10 mm	FCC6	29.3	left	1:1	0.003	1.581	0.005	
ANSI / IEEE C95.1 1992 - SAFETY LIMIT Spatial Peak Uncontrolled Exposure/General Population							Body 1.6 W/kg (mW/g) averaged over 1 gram								

11.4 Standalone Extremity SAR Data

**Table 11-23
WLAN Extremity SAR**

MEASUREMENT RESULTS															
FREQUENCY		Mode	Service	Maximum Allowed Power [dBm]	Conducted Power [dBm]	Power Drift [dB]	Spacing	Device Serial Number	Data Rate (Mbps)	Side	Duty Cycle	SAR (10g)	Scaling Factor	Scaled SAR (10g)	Plot #
MHz	Ch.											(W/kg)		(W/kg)	
5200	40	IEEE 802.11a	OFDM	11.5	10.56	0.04	0 mm	FCC6	6	back	1:1	0.132	1.242	0.164	
5200	40	IEEE 802.11a	OFDM	11.5	10.56	-0.17	0 mm	FCC6	6	front	1:1	0.050	1.242	0.062	
5200	40	IEEE 802.11a	OFDM	11.5	10.56	0.19	0 mm	FCC6	6	top	1:1	0.019	1.242	0.024	
5200	40	IEEE 802.11a	OFDM	11.5	10.56	-0.21	0 mm	FCC6	6	left	1:1	0.203	1.242	0.252	
5210	42	IEEE 802.11ac	OFDM	9.5	8.24	-0.14	0 mm	FCC6	29.3	left	1:1	0.095	1.337	0.127	
5260	52	IEEE 802.11a	OFDM	11.5	10.87	-0.05	0 mm	FCC6	6	back	1:1	0.141	1.156	0.163	
5260	52	IEEE 802.11a	OFDM	11.5	10.87	-0.21	0 mm	FCC6	6	front	1:1	0.057	1.156	0.066	
5260	52	IEEE 802.11a	OFDM	11.5	10.87	-0.08	0 mm	FCC6	6	top	1:1	0.022	1.156	0.025	
5260	52	IEEE 802.11a	OFDM	11.5	10.87	-0.13	0 mm	FCC6	6	left	1:1	0.206	1.156	0.238	A32
5290	58	IEEE 802.11ac	OFDM	9.5	9.00	-0.16	0 mm	FCC6	29.3	left	1:1	0.112	1.122	0.126	
5540	108	IEEE 802.11a	OFDM	11.5	10.51	0.04	0 mm	FCC6	6	back	1:1	0.073	1.256	0.092	
5540	108	IEEE 802.11a	OFDM	11.5	10.51	0.17	0 mm	FCC6	6	front	1:1	0.032	1.256	0.040	
5540	108	IEEE 802.11a	OFDM	11.5	10.51	0.15	0 mm	FCC6	6	top	1:1	0.013	1.256	0.016	
5540	108	IEEE 802.11a	OFDM	11.5	10.51	-0.13	0 mm	FCC6	6	left	1:1	0.107	1.256	0.134	
5530	106	IEEE 802.11ac	OFDM	9.5	9.10	-0.17	0 mm	FCC6	29.3	left	1:1	0.072	1.096	0.079	
ANSI / IEEE C95.1 1992 - SAFETY LIMIT Spatial Peak Uncontrolled Exposure/General Population							Extremity 4.0 W/kg (mW/g) averaged over 10 grams								

FCC ID: ZNFD950	 PCTEST ENGINEERING LABORATORY, INC.	SAR EVALUATION REPORT		Reviewed by: Quality Manager
Document S/N: 0Y1312022312.ZNF	Test Dates: 12/02/13 - 12/16/13	DUT Type: Portable Handset		Page 51 of 66

11.5 SAR Test Notes

General Notes:

1. The test data reported are the worst-case SAR values according to test procedures specified in IEEE 1528-2003, FCC/OET Bulletin 65, Supplement C [June 2001] and FCC KDB Publication 447498 D01v05.
2. Batteries are fully charged at the beginning of the SAR measurements. A standard battery was used for all SAR measurements.
3. Liquid tissue depth was at least 15.0 cm for all frequencies.
4. The manufacturer has confirmed that the device(s) tested have the same physical, mechanical and thermal characteristics and are within operational tolerances expected for production units.
5. SAR results were scaled to the maximum allowed power to demonstrate compliance per FCC KDB Publication 447498 D01v05.
6. Per FCC KDB Publication 648474 D04v01, SAR was evaluated without a headset connected to the device. Since the standalone reported SAR was ≤ 1.2 W/kg, no additional SAR evaluations using a headset cable were required.
7. Per FCC KDB 865664 D01 v01, variability SAR tests were performed when the measured SAR results for a frequency band were greater than 0.8 W/kg. Repeated SAR measurements are highlighted in the tables above for clarity. Please see Section 13 for variability analysis.
8. During SAR Testing for the Wireless Router conditions per FCC KDB Publication 941225 D06v01, the actual Portable Hotspot operation (with actual simultaneous transmission of a transmitter with WIFI) was not activated (See Section 6.6 for more details).
9. Per FCC KDB Publication 648474 D04v01r01, this device is considered a “phablet” since the diagonal dimension is greater than 160 mm, but less than 200 mm. However, extremity SAR tests for Main Antenna and DTS WLAN was not required since Hotspot SAR was < 1.2 W/kg.

GSM/GPRS Test Notes:



1. Body-Worn accessory testing is typically associated with voice operations. Therefore, GSM voice was evaluated for body-worn SAR.
2. This device supports GSM VOIP in the head and body-worn configurations; therefore GPRS was additionally evaluated for head and body-worn compliance.
3. Justification for reduced test configurations per KDB Publication 941225 D03v01 and October 2013 TCB Workshop Notes: The source-based frame-averaged output power was evaluated for all GPRS/EDGE slot configurations. The configuration with the highest target frame averaged output power was evaluated for wireless router SAR. When the maximum frame-averaged powers are equivalent across two or more slots (within 0.25 dB), the configuration with the most number of time slots was tested.
4. Per FCC KDB Publication 447498 D01v05, since the reported (scaled) SAR measured at the middle channel or highest output power channel for each test configuration is ≤ 0.8 W/kg, testing at the other channels is not required for such test configuration(s). Since the maximum output power variation across the required test channels is $\leq \frac{1}{2}$ dB, middle channel was the default channel used.

UMTS Notes:

1. UMTS mode in Body SAR was tested under RMC 12.2 kbps with HSPA Inactive per KDB Publication 941225 D01v02. HSPA SAR was not required since the average output power of the HSPA subtests was not more than 0.25 dB higher than the RMC level and SAR was less than 1.2 W/kg.
2. Per FCC KDB Publication 447498 D01v05, when the reported (scaled) SAR measured at the middle channel or highest output power channel for each test configuration is > 0.8 W/kg, testing at the other channels is required for such test configuration(s). Since the maximum output power variation across the required test channels is $\leq \frac{1}{2}$ dB, middle channel was the default channel used.



LTE Notes:

1. LTE Considerations: LTE test configurations are determined according to SAR Evaluation Considerations for LTE Devices in FCC KDB Publication 941225 D05v02r01. The general test procedures used for testing can be found in Section 8.4.4.
2. MPR is permanently implemented for this device by the manufacturer. The specific manufacturer target MPR is indicated alongside the SAR results. MPR is enabled for this device, according to 3GPP TS36.101 Section 6.2.3 – 6.2.5 under Table 6.2.3-1.
3. A-MPR was disabled for all SAR tests by setting NS=01 on the base station simulator.
4. Per FCC Guidance, LTE CA SAR was not needed for testing since the data sent by uplink on uplink physical channels does not change between Rel 8 and Rel 10.

FCC ID: ZNFD950	 PCTEST ENGINEERING LABORATORY, INC.	SAR EVALUATION REPORT		Reviewed by: Quality Manager
Document S/N: 0Y1312022312.ZNF	Test Dates: 12/02/13 - 12/16/13	DUT Type: Portable Handset	Page 52 of 66	

WLAN Notes:

1. Justification for reduced test configurations for WIFI channels per KDB Publication 248227 D01v01r02 and October 2012 FCC/TCB Meeting Notes for 2.4 GHz WIFI: Highest average RF output power channel for the lowest data rate was selected for SAR evaluation in 802.11b. Other IEEE 802.11 modes (including 802.11g/n) were not investigated since the average output powers over all channels and data rates were not more than 0.25 dB higher than the tested channel in the lowest data rate of IEEE 802.11b mode.
2. Justification for reduced test configurations for WIFI channels per KDB Publication 248227 D01v01r02 and October 2012 FCC/TCB Meeting Notes for 5 GHz WIFI: Highest average RF output power channel for the lowest data rate was selected for SAR evaluation in 802.11a. Other IEEE 802.11 modes (including 802.11n 20 MHz and 40 MHz bandwidths) were not investigated since the average output powers over all channels and data rates were not more than 0.25 dB higher than the tested channel in the lowest data rate of IEEE 802.11a mode.
3. Per April 2013 TCB Workshop notes, full SAR tests for all IEEE 802.11ac configurations were not required because the average output power was not more than 0.25 dB higher than IEEE 802.11a mode. IEEE 802.11ac was evaluated for the highest IEEE 802.11a position in each 5 GHz band and exposure condition.
4. When Hotspot is enabled, all 5 GHz bands are disabled. Therefore no 5 GHz WIFI Hotspot SAR Data was required.
5. 5 GHz WIFI Direct GO is supported in the 5.8 GHz band only. The manufacturer expects 5.8 GHz WIFI Direct GO may be used similar to wireless router usage. Therefore, 5.8 GHz WIFI Direct GO was evaluated for SAR similar to wireless router SAR procedures in FCC KDB Publication 941225.
6. WIFI transmission was verified using an uncalibrated spectrum analyzer.
7. Since the maximum extrapolated peak SAR of the zoom scan for the maximum output channel is <1.6 W/kg and the reported 1g averaged SAR is <0.8 W/kg, SAR testing on other default channels was not required.
8. Per FCC KDB Publication 648474 D04v01r01, this device is considered a "phablet" since the diagonal dimension is greater than 160 mm, but less than 200 mm. Therefore, hand SAR tests are required when hotspot mode does not apply or if hotspot 1g SAR > 1.2 W/kg. Since wireless router operations are not supported for 5 GHz NII WLAN, Extremity SAR was evaluated for 5 GHz NII WLAN. Extremity SAR was not evaluated for 2.4 GHz and 5 GHz DTS WIFI since Hotspot/ WIFI Direct GO 1g SAR < 1.2 W/kg.

FCC ID: ZNFD950	 PCTEST ENGINEERING LABORATORY, INC.	SAR EVALUATION REPORT		Reviewed by: Quality Manager
Document S/N: 0Y1312022312.ZNF	Test Dates: 12/02/13 - 12/16/13	DUT Type: Portable Handset	Page 53 of 66	

12 FCC MULTI-TX AND ANTENNA SAR CONSIDERATIONS

12.1 Introduction

The following procedures adopted from FCC KDB Publication 447498 D01v05 are applicable to handsets with built-in unlicensed transmitters such as 802.11a/b/g/n/ac and Bluetooth devices which may simultaneously transmit with the licensed transmitter.

12.2 Simultaneous Transmission Procedures

This device contains transmitters that may operate simultaneously. Therefore simultaneous transmission analysis is required. Per FCC KDB 447498 D01v05 IV.C.1.iii, simultaneous transmission SAR test exclusion may be applied when the sum of the 1-g SAR for all the simultaneous transmitting antennas in a specific a physical test configuration is ≤ 1.6 W/kg. When standalone SAR is not required to be measured, per FCC KDB 447498 D01v05 4.3.2 2), the following equation must be used to estimate the standalone 1g SAR for simultaneous transmission assessment involving that transmitter.



$$\text{Estimated SAR} = \frac{\sqrt{f(\text{GHz})}}{7.5} * \frac{(\text{Max Power of channel, mW})}{\text{Min. Separation Distance, mm}}$$

**Table 12-1
Estimated SAR**

Mode	Frequency	Maximum Allowed Power	Separation Distance (Body)	Estimated SAR (Body)
	[MHz]	[dBm]	[mm]	[W/kg]
Bluetooth	2441	10.50	8	0.286

Note:

1. Held-to ear configurations are not applicable to Bluetooth operations and therefore were not considered for simultaneous transmission. Per KDB Publication 447498 D01v05, the maximum power of the channel was rounded to the nearest mW before calculation.
2. Main antenna and DTS WLAN SAR testing was not required for extremity exposure conditions per FCC KDB 648474. Therefore, no further analysis was required to determine that possible simultaneous scenarios would not exceed the SAR limit.

FCC ID: ZNFD950	 PCTEST <small>ENGINEERING LABORATORY, INC.</small>	SAR EVALUATION REPORT		Reviewed by: Quality Manager
Document S/N: 0Y1312022312.ZNF	Test Dates: 12/02/13 - 12/16/13	DUT Type: Portable Handset	Page 54 of 66	

12.3 Head SAR Simultaneous Transmission Analysis

Table 12-2
Simultaneous Transmission Scenario with 2.4 GHz WLAN (Held to Ear)

Simult Tx	Configuration	GSM 850 SAR (W/kg)	2.4 GHz WLAN SAR (W/kg)	Σ SAR (W/kg)	Simult Tx	Configuration	GPRS 850 SAR (W/kg)	2.4 GHz WLAN SAR (W/kg)	Σ SAR (W/kg)
Head SAR	Right Cheek	0.326	0.373	0.699	Head SAR	Right Cheek	0.360	0.373	0.733
	Right Tilt	0.216	0.191	0.407		Right Tilt	0.262	0.191	0.453
	Left Cheek	0.356	0.130	0.486		Left Cheek	0.433	0.130	0.563
	Left Tilt	0.211	0.090	0.301		Left Tilt	0.234	0.090	0.324
Simult Tx	Configuration	UMTS 850 SAR (W/kg)	2.4 GHz WLAN SAR (W/kg)	Σ SAR (W/kg)	Simult Tx	Configuration	GSM 1900 SAR (W/kg)	2.4 GHz WLAN SAR (W/kg)	Σ SAR (W/kg)
Head SAR	Right Cheek	0.337	0.373	0.710	Head SAR	Right Cheek	0.143	0.373	0.516
	Right Tilt	0.238	0.191	0.429		Right Tilt	0.078	0.191	0.269
	Left Cheek	0.422	0.130	0.552		Left Cheek	0.134	0.130	0.264
	Left Tilt	0.231	0.090	0.321		Left Tilt	0.052	0.090	0.142
Simult Tx	Configuration	GPRS 1900 SAR (W/kg)	2.4 GHz WLAN SAR (W/kg)	Σ SAR (W/kg)	Simult Tx	Configuration	UMTS 1900 SAR (W/kg)	2.4 GHz WLAN SAR (W/kg)	Σ SAR (W/kg)
Head SAR	Right Cheek	0.176	0.373	0.549	Head SAR	Right Cheek	0.249	0.373	0.622
	Right Tilt	0.083	0.191	0.274		Right Tilt	0.151	0.191	0.342
	Left Cheek	0.137	0.130	0.267		Left Cheek	0.248	0.130	0.378
	Left Tilt	0.057	0.090	0.147		Left Tilt	0.096	0.090	0.186
Simult Tx	Configuration	LTE Band 17 SAR (W/kg)	2.4 GHz WLAN SAR (W/kg)	Σ SAR (W/kg)	Simult Tx	Configuration	LTE Band 5 (Cell) SAR (W/kg)	2.4 GHz WLAN SAR (W/kg)	Σ SAR (W/kg)
Head SAR	Right Cheek	0.204	0.373	0.577	Head SAR	Right Cheek	0.367	0.373	0.740
	Right Tilt	0.095	0.191	0.286		Right Tilt	0.230	0.191	0.421
	Left Cheek	0.174	0.130	0.304		Left Cheek	0.492	0.130	0.622
	Left Tilt	0.090	0.090	0.180		Left Tilt	0.256	0.090	0.346
Simult Tx	Configuration	LTE Band 4 (AWS) SAR (W/kg)	2.4 GHz WLAN SAR (W/kg)	Σ SAR (W/kg)	Simult Tx	Configuration	LTE Band 2 (PCS) SAR (W/kg)	2.4 GHz WLAN SAR (W/kg)	Σ SAR (W/kg)
Head SAR	Right Cheek	0.357	0.373	0.730	Head SAR	Right Cheek	0.245	0.373	0.618
	Right Tilt	0.230	0.191	0.421		Right Tilt	0.113	0.191	0.304
	Left Cheek	0.324	0.130	0.454		Left Cheek	0.236	0.130	0.366
	Left Tilt	0.171	0.090	0.261		Left Tilt	0.082	0.090	0.172
Simult Tx	Configuration	LTE Band 7 SAR (W/kg)	2.4 GHz WLAN SAR (W/kg)	Σ SAR (W/kg)					
Head SAR	Right Cheek	0.118	0.373	0.491					
	Right Tilt	0.069	0.191	0.260					
	Left Cheek	0.062	0.130	0.192					
	Left Tilt	0.102	0.090	0.192					





FCC ID: ZNFD950	 PCTEST ENGINEERING LABORATORY, INC.	SAR EVALUATION REPORT		Reviewed by: Quality Manager
Document S/N: 0Y1312022312.ZNF	Test Dates: 12/02/13 - 12/16/13	DUT Type: Portable Handset	Page 55 of 66	

Table 12-3
Simultaneous Transmission Scenario with 5 GHz WLAN (Held to Ear)

Simult Tx	Configuration	GSM 850 SAR (W/kg)	5 GHz WLAN SAR (W/kg)	Σ SAR (W/kg)	Simult Tx	Configuration	GPRS 850 SAR (W/kg)	5 GHz WLAN SAR (W/kg)	Σ SAR (W/kg)
Head SAR	Right Cheek	0.326	0.134	0.460	Head SAR	Right Cheek	0.360	0.134	0.494
	Right Tilt	0.216	0.067	0.283		Right Tilt	0.262	0.067	0.329
	Left Cheek	0.356	0.024	0.380		Left Cheek	0.433	0.024	0.457
	Left Tilt	0.211	0.019	0.230		Left Tilt	0.234	0.019	0.253
Simult Tx	Configuration	UMTS 850 SAR (W/kg)	5 GHz WLAN SAR (W/kg)	Σ SAR (W/kg)	Simult Tx	Configuration	GSM 1900 SAR (W/kg)	5 GHz WLAN SAR (W/kg)	Σ SAR (W/kg)
Head SAR	Right Cheek	0.337	0.134	0.471	Head SAR	Right Cheek	0.143	0.134	0.277
	Right Tilt	0.238	0.067	0.305		Right Tilt	0.078	0.067	0.145
	Left Cheek	0.422	0.024	0.446		Left Cheek	0.134	0.024	0.158
	Left Tilt	0.231	0.019	0.250		Left Tilt	0.052	0.019	0.071
Simult Tx	Configuration	GPRS 1900 SAR (W/kg)	5 GHz WLAN SAR (W/kg)	Σ SAR (W/kg)	Simult Tx	Configuration	UMTS 1900 SAR (W/kg)	5 GHz WLAN SAR (W/kg)	Σ SAR (W/kg)
Head SAR	Right Cheek	0.176	0.134	0.310	Head SAR	Right Cheek	0.249	0.134	0.383
	Right Tilt	0.083	0.067	0.150		Right Tilt	0.151	0.067	0.218
	Left Cheek	0.137	0.024	0.161		Left Cheek	0.248	0.024	0.272
	Left Tilt	0.057	0.019	0.076		Left Tilt	0.096	0.019	0.115
Simult Tx	Configuration	LTE Band 17 SAR (W/kg)	5 GHz WLAN SAR (W/kg)	Σ SAR (W/kg)	Simult Tx	Configuration	LTE Band 5 (Cell) SAR (W/kg)	5 GHz WLAN SAR (W/kg)	Σ SAR (W/kg)
Head SAR	Right Cheek	0.204	0.134	0.338	Head SAR	Right Cheek	0.367	0.134	0.501
	Right Tilt	0.095	0.067	0.162		Right Tilt	0.230	0.067	0.297
	Left Cheek	0.174	0.024	0.198		Left Cheek	0.492	0.024	0.516
	Left Tilt	0.090	0.019	0.109		Left Tilt	0.256	0.019	0.275
Simult Tx	Configuration	LTE Band 4 (AWS) SAR (W/kg)	5 GHz WLAN SAR (W/kg)	Σ SAR (W/kg)	Simult Tx	Configuration	LTE Band 2 (PCS) SAR (W/kg)	5 GHz WLAN SAR (W/kg)	Σ SAR (W/kg)
Head SAR	Right Cheek	0.357	0.134	0.491	Head SAR	Right Cheek	0.245	0.134	0.379
	Right Tilt	0.230	0.067	0.297		Right Tilt	0.113	0.067	0.180
	Left Cheek	0.324	0.024	0.348		Left Cheek	0.236	0.024	0.260
	Left Tilt	0.171	0.019	0.190		Left Tilt	0.082	0.019	0.101
Simult Tx	Configuration	LTE Band 7 SAR (W/kg)	5 GHz WLAN SAR (W/kg)	Σ SAR (W/kg)					
Head SAR	Right Cheek	0.118	0.134	0.252					
	Right Tilt	0.069	0.067	0.136					
	Left Cheek	0.062	0.024	0.086					
	Left Tilt	0.102	0.019	0.121					

Note: The worst case 5 GHz WLAN reported SAR for each head configuration was used for SAR summation, regardless of whether the WLAN channel has WIFI Direct capability. Therefore, the summations above represent the absolute worst cases for simultaneous transmission with 5 GHz WLAN.

FCC ID: ZNFD950	 PCTEST ENGINEERING LABORATORY, INC.	SAR EVALUATION REPORT		Reviewed by: Quality Manager
Document S/N: 0Y1312022312.ZNF	Test Dates: 12/02/13 - 12/16/13	DUT Type: Portable Handset	Page 56 of 66	

12.4 Body-Worn Simultaneous Transmission Analysis

Table 12-4
Simultaneous Transmission Scenario with 2.4 GHz WLAN (Body-Worn)

Configuration	Mode	2G/3G/4G SAR (W/kg)	2.4 GHz WLAN SAR (W/kg)	Σ SAR (W/kg)
Back Side	GSM 850	0.534	0.162	0.696
Back Side	GRPS 850	0.599	0.162	0.761
Back Side	UMTS 850	0.511	0.162	0.673
Back Side	GSM 1900	0.506	0.162	0.668
Back Side	GPRS1900	0.573	0.162	0.735
Back Side	UMTS 1900	0.870	0.162	1.032
Back Side	LTE Band 17	0.354	0.162	0.516
Back Side	LTE Band 5 (Cell)	0.403	0.162	0.565
Back Side	LTE Band 4 (AWS)	0.756	0.162	0.918
Back Side	LTE Band 2 (PCS)	0.992	0.162	1.154
Back Side	LTE Band 7	1.186	0.162	1.348

Table 12-5
Simultaneous Transmission Scenario with 5 GHz WLAN (Body-Worn)



Configuration	Mode	2G/3G/4G SAR (W/kg)	5 GHz WLAN SAR (W/kg)	Σ SAR (W/kg)
Back Side	GSM 850	0.534	0.098	0.632
Back Side	GRPS 850	0.599	0.098	0.697
Back Side	UMTS 850	0.511	0.098	0.609
Back Side	GSM 1900	0.506	0.098	0.604
Back Side	GPRS1900	0.573	0.098	0.671
Back Side	UMTS 1900	0.870	0.098	0.968
Back Side	LTE Band 17	0.354	0.098	0.452
Back Side	LTE Band 5 (Cell)	0.403	0.098	0.501
Back Side	LTE Band 4 (AWS)	0.756	0.098	0.854
Back Side	LTE Band 2 (PCS)	0.992	0.098	1.090
Back Side	LTE Band 7	1.186	0.098	1.284

Note: The worst case 5 GHz WLAN reported SAR for each body-worn configuration was used for SAR summation, regardless of whether the WLAN channel has WIFI Direct capability. Therefore, the summations above represent the absolute worst cases for simultaneous transmission with 5 GHz WLAN.

Table 12-6
Simultaneous Transmission Scenario with Bluetooth (Body-Worn)

Configuration	Mode	2G/3G/4G SAR (W/kg)	Bluetooth SAR (W/kg)	Σ SAR (W/kg)
Back Side	GSM 850	0.534	0.286	0.820
Back Side	GRPS 850	0.599	0.286	0.885
Back Side	UMTS 850	0.511	0.286	0.797
Back Side	GSM 1900	0.506	0.286	0.792
Back Side	GPRS1900	0.573	0.286	0.859
Back Side	UMTS 1900	0.870	0.286	1.156
Back Side	LTE Band 17	0.354	0.286	0.640
Back Side	LTE Band 5 (Cell)	0.403	0.286	0.689
Back Side	LTE Band 4 (AWS)	0.756	0.286	1.042
Back Side	LTE Band 2 (PCS)	0.992	0.286	1.278
Back Side	LTE Band 7	1.186	0.286	1.472

Note: Bluetooth SAR was not required to be measured per FCC KDB 447498. Estimated SAR results were used in the above table to determine simultaneous transmission SAR test exclusion.

FCC ID: ZNFD950	 PCTEST ENGINEERING LABORATORY, INC.	SAR EVALUATION REPORT		Reviewed by: Quality Manager
Document S/N: 0Y1312022312.ZNF	Test Dates: 12/02/13 - 12/16/13	DUT Type: Portable Handset	Page 57 of 66	

12.5 Hotspot SAR Simultaneous Transmission Analysis

Per FCC KDB Publication 941225 D06v01, the devices edges with antennas more than 2.5 cm from edge are not required to be evaluated for SAR (“-”).

Table 12-7
Simultaneous Transmission Scenario (2.4 GHz Hotspot)

Simult Tx	Configuration	GPRS 850 SAR (W/kg)	2.4 GHz WLAN SAR (W/kg)	Σ SAR (W/kg)	Simult Tx	Configuration	UMTS 850 SAR (W/kg)	2.4 GHz WLAN SAR (W/kg)	Σ SAR (W/kg)
Body SAR	Back	0.599	0.162	0.761	Body SAR	Back	0.511	0.162	0.673
	Front	0.724	0.082	0.806		Front	0.574	0.082	0.656
	Top	-	0.035	0.035		Top	-	0.035	0.035
	Bottom	0.257	-	0.257		Bottom	0.248	-	0.248
	Right	0.311	-	0.311		Right	0.329	-	0.329
	Left	0.583	0.134	0.717		Left	0.528	0.134	0.662

Simult Tx	Configuration	GPRS 1900 SAR (W/kg)	2.4 GHz WLAN SAR (W/kg)	Σ SAR (W/kg)	Simult Tx	Configuration	UMTS 1900 SAR (W/kg)	2.4 GHz WLAN SAR (W/kg)	Σ SAR (W/kg)
Body SAR	Back	0.573	0.162	0.735	Body SAR	Back	0.870	0.162	1.032
	Front	0.472	0.082	0.554		Front	0.850	0.082	0.932
	Top	-	0.035	0.035		Top	-	0.035	0.035
	Bottom	0.463	-	0.463		Bottom	0.876	-	0.876
	Right	0.168	-	0.168		Right	0.258	-	0.258
	Left	0.161	0.134	0.295		Left	0.277	0.134	0.411

Simult Tx	Configuration	LTE Band 17 SAR (W/kg)	2.4 GHz WLAN SAR (W/kg)	Σ SAR (W/kg)	Simult Tx	Configuration	LTE Band 5 (Cell) SAR (W/kg)	2.4 GHz WLAN SAR (W/kg)	Σ SAR (W/kg)
Body SAR	Back	0.354	0.162	0.516	Body SAR	Back	0.403	0.162	0.565
	Front	0.296	0.082	0.378		Front	0.455	0.082	0.537
	Top	-	0.035	0.035		Top	-	0.035	0.035
	Bottom	0.186	-	0.186		Bottom	0.238	-	0.238
	Right	0.367	-	0.367		Right	0.247	-	0.247
	Left	0.176	0.134	0.310		Left	0.366	0.134	0.500

Simult Tx	Configuration	LTE Band 4 (AWS) SAR (W/kg)	2.4 GHz WLAN SAR (W/kg)	Σ SAR (W/kg)	Simult Tx	Configuration	LTE Band 2 (PCS) SAR (W/kg)	2.4 GHz WLAN SAR (W/kg)	Σ SAR (W/kg)
Body SAR	Back	0.756	0.162	0.918	Body SAR	Back	0.992	0.162	1.154
	Front	0.932	0.082	1.014		Front	0.863	0.082	0.945
	Top	-	0.035	0.035		Top	-	0.035	0.035
	Bottom	0.668	-	0.668		Bottom	0.688	-	0.688
	Right	0.228	-	0.228		Right	0.246	-	0.246
	Left	0.333	0.134	0.467		Left	0.288	0.134	0.422

Simult Tx	Configuration	LTE Band 7 SAR (W/kg)	2.4 GHz WLAN SAR (W/kg)	Σ SAR (W/kg)
Body SAR	Back	1.186	0.162	1.348
	Front	0.405	0.082	0.487
	Top	-	0.035	0.035
	Bottom	0.208	-	0.208
	Right	0.916	-	0.916
	Left	0.005	0.134	0.139





FCC ID: ZNFD950	 PCTEST ENGINEERING LABORATORY, INC.	SAR EVALUATION REPORT		Reviewed by: Quality Manager
Document S/N: 0Y1312022312.ZNF	Test Dates: 12/02/13 - 12/16/13	DUT Type: Portable Handset	Page 58 of 66	

Table 12-8
Simultaneous Transmission Scenario (5.8 GHz WIFI Direct GO)

Simult Tx	Configuration	GPRS 850 SAR (W/kg)	5.8 GHz WLAN SAR (W/kg)	Σ SAR (W/kg)	Simult Tx	Configuration	UMTS 850 SAR (W/kg)	5.8 GHz WLAN SAR (W/kg)	Σ SAR (W/kg)
Body SAR	Back	0.599	0.041	0.640	Body SAR	Back	0.511	0.041	0.552
	Front	0.724	0.000	0.724		Front	0.574	0.000	0.574
	Top	-	0.000	0.000		Top	-	0.000	0.000
	Bottom	0.257	-	0.257		Bottom	0.248	-	0.248
	Right	0.311	-	0.311		Right	0.329	-	0.329
	Left	0.583	0.041	0.624		Left	0.528	0.041	0.569
Simult Tx	Configuration	GPRS 1900 SAR (W/kg)	5.8 GHz WLAN SAR (W/kg)	Σ SAR (W/kg)	Simult Tx	Configuration	UMTS 1900 SAR (W/kg)	5.8 GHz WLAN SAR (W/kg)	Σ SAR (W/kg)
Body SAR	Back	0.573	0.041	0.614	Body SAR	Back	0.870	0.041	0.911
	Front	0.472	0.000	0.472		Front	0.850	0.000	0.850
	Top	-	0.000	0.000		Top	-	0.000	0.000
	Bottom	0.463	-	0.463		Bottom	0.876	-	0.876
	Right	0.168	-	0.168		Right	0.258	-	0.258
	Left	0.161	0.041	0.202		Left	0.277	0.041	0.318
Simult Tx	Configuration	LTE Band 17 SAR (W/kg)	5.8 GHz WLAN SAR (W/kg)	Σ SAR (W/kg)	Simult Tx	Configuration	LTE Band 5 (Cell) SAR (W/kg)	5.8 GHz WLAN SAR (W/kg)	Σ SAR (W/kg)
Body SAR	Back	0.354	0.041	0.395	Body SAR	Back	0.403	0.041	0.444
	Front	0.296	0.000	0.296		Front	0.455	0.000	0.455
	Top	-	0.000	0.000		Top	-	0.000	0.000
	Bottom	0.186	-	0.186		Bottom	0.238	-	0.238
	Right	0.367	-	0.367		Right	0.247	-	0.247
	Left	0.176	0.041	0.217		Left	0.366	0.041	0.407
Simult Tx	Configuration	LTE Band 4 (AWS) SAR (W/kg)	5.8 GHz WLAN SAR (W/kg)	Σ SAR (W/kg)	Simult Tx	Configuration	LTE Band 2 (PCS) SAR (W/kg)	5.8 GHz WLAN SAR (W/kg)	Σ SAR (W/kg)
Body SAR	Back	0.756	0.041	0.797	Body SAR	Back	0.992	0.041	1.033
	Front	0.932	0.000	0.932		Front	0.863	0.000	0.863
	Top	-	0.000	0.000		Top	-	0.000	0.000
	Bottom	0.668	-	0.668		Bottom	0.688	-	0.688
	Right	0.228	-	0.228		Right	0.246	-	0.246
	Left	0.333	0.041	0.374		Left	0.288	0.041	0.329
Simult Tx	Configuration	LTE Band 7 SAR (W/kg)	5.8 GHz WLAN SAR (W/kg)	Σ SAR (W/kg)					
Body SAR	Back	1.186	0.041	1.227					
	Front	0.405	0.000	0.405					
	Top	-	0.000	0.000					
	Bottom	0.208	-	0.208					
	Right	0.916	-	0.916					
	Left	0.005	0.041	0.046					

12.6 Simultaneous Transmission Conclusion

The above numerical summed SAR results for all the worst-case simultaneous transmission conditions were below the SAR limit. Therefore, the above analysis is sufficient to determine that simultaneous transmission cases will not exceed the SAR limit and therefore no measured volumetric simultaneous SAR summation is required per FCC KDB Publication 447498 D01v05.

FCC ID: ZNFD950		SAR EVALUATION REPORT		Reviewed by: Quality Manager
Document S/N: 0Y1312022312.ZNF	Test Dates: 12/02/13 - 12/16/13	DUT Type: Portable Handset	Page 59 of 66	

13 SAR MEASUREMENT VARIABILITY

13.1 Measurement Variability

Per FCC KDB Publication 865664 D01v01, SAR measurement variability was assessed for each frequency band, which was determined by the SAR probe calibration point and tissue-equivalent medium used for the device measurements. When both head and body tissue-equivalent media were required for SAR measurements in a frequency band, the variability measurement procedures were applied to the tissue medium with the highest measured SAR, using the highest measured SAR configuration for that tissue-equivalent medium. These additional measurements were repeated after the completion of all measurements requiring the same head or body tissue-equivalent medium in a frequency band. The test device was returned to ambient conditions (normal room temperature) with the battery fully charged before it was re-mounted on the device holder for the repeated measurement(s) to minimize any unexpected variations in the repeated results.

SAR Measurement Variability was assessed using the following procedures for each frequency band:



- 1) When the original highest measured SAR is ≥ 0.80 W/kg, the measurement was repeated once.
- 2) A second repeated measurement was performed only if the ratio of largest to smallest SAR for the original and first repeated measurements was > 1.20 or when the original or repeated measurement was ≥ 1.45 W/kg (~ 10% from the 1-g SAR limit).
- 3) A third repeated measurement was performed only if the original, first or second repeated measurement was ≥ 1.5 W/kg and the ratio of largest to smallest SAR for the original, first and second repeated measurements is > 1.20 .
- 4) Repeated measurements are not required when the original highest measured SAR is < 0.80 W/kg

**Table 13-1
Body SAR Measurement Variability Results**

BODY VARIABILITY RESULTS													
Band	FREQUENCY		Mode	Service	Side	Spacing	Measured SAR (1g)	1st Repeated SAR (1g)	Ratio	2nd Repeated SAR (1g)	Ratio	3rd Repeated SAR (1g)	Ratio
	MHz	Ch.					(W/kg)	(W/kg)		(W/kg)		(W/kg)	
1750	1750.00	20350	LTE Band 4 (AWS)	QPSK, 1 RB, 25 RB Offset	front	8 mm	0.915	0.898	1.02	N/A	N/A	N/A	N/A
1900	1905.00	19150	LTE Band 2 (PCS)	QPSK, 1 RB, 25 RB Offset	back	8 mm	0.987	0.842	1.17	N/A	N/A	N/A	N/A
2450	2510.00	20850	LTE Band 7	QPSK, 1 RB, 0 RB Offset	back	8 mm	1.110	1.040	1.07	N/A	N/A	N/A	N/A
2600	2535.00	21100	LTE Band 7	QPSK, 1 RB, 0 RB Offset	back	8 mm	1.180	1.100	1.07	N/A	N/A	N/A	N/A
ANSI / IEEE C95.1 1992 - SAFETY LIMIT Spatial Peak Uncontrolled Exposure/General Population							Body 1.6 W/kg (mW/g) averaged over 1 gram						

13.2 Measurement Uncertainty



The measured SAR was < 1.5 W/kg for all frequency bands. Therefore, per KDB Publication 865664 D01v01, the extended measurement uncertainty analysis per IEEE 1528-2003 was not required.

FCC ID: ZNFD950	 PCTEST ENGINEERING LABORATORY, INC.	SAR EVALUATION REPORT		Reviewed by: Quality Manager
Document S/N: 0Y1312022312.ZNF	Test Dates: 12/02/13 - 12/16/13	DUT Type: Portable Handset		Page 60 of 66

14 EQUIPMENT LIST

Manufacturer	Model	Description	Cal Date	Cal Interval	Cal Due	Serial Number
Agilent	85047A	S-Parameter Test Set	N/A	N/A	N/A	2904A00579
Agilent	85070C	Dielectric Probe Kit	2/14/2013	Annual	2/14/2014	MY44300633
Agilent	8594A	(9kHz-2.9GHz) Spectrum Analyzer	N/A	N/A	N/A	3051A00187
Agilent	8648D	(9kHz-4GHz) Signal Generator	4/17/2013	Annual	4/17/2014	3629U00687
Agilent	8753E	(30kHz-6GHz) Network Analyzer	4/16/2013	Annual	4/16/2014	JP38020182
Agilent	8753E5	S-Parameter Network Analyzer	10/29/2013	Annual	10/29/2014	US39170122
Agilent	E8257D	(250kHz-20GHz) Signal Generator	4/16/2013	Annual	4/16/2014	MY45470194
Agilent	N5182A	MXG Vector Signal Generator	10/28/2013	Annual	10/28/2014	US46240505
Agilent	N9020A	MXA Signal Analyzer	10/29/2013	Annual	10/29/2014	US46470561
Amplifier Research	5S1G4	5W, 800MHz-4.2GHz	CBT	N/A	CBT	21910
Anritsu	MA2481A	Power Sensor	2/14/2013	Annual	2/14/2014	2400
Anritsu	MA2481A	Power Sensor	2/14/2013	Annual	2/14/2014	5318
Anritsu	MA2481A	Power Sensor	10/30/2013	Annual	10/30/2014	5605
Anritsu	MA2481A	Power Sensor	2/14/2013	Annual	2/14/2014	5821
Anritsu	MA2481D	Universal Sensor	12/17/2012	Annual	12/17/2013	1204343
Anritsu	MA2481D	Universal Sensor	12/17/2012	Annual	12/17/2013	1204419
Anritsu	MA2411B	Pulse Sensor	11/13/2013	Annual	11/13/2014	846215
Anritsu	MA2411B	Pulse Sensor	11/13/2013	Annual	11/13/2014	1027293
Anritsu	ML2438A	Power Meter	2/14/2013	Annual	2/14/2014	1190013
Anritsu	ML2495A	Power Meter	10/31/2013	Annual	10/31/2014	1039008
Anritsu	ML2496A	Power Meter	11/14/2013	Annual	11/14/2014	1138001
Anritsu	MT8820C	Radio Communication Analyzer	6/28/2013	Annual	6/28/2014	6201240328
COMTech	AR85729-5	Solid State Amplifier	CBT	N/A	CBT	M155A00-009
Control Company	4353	Long Stem Thermometer	9/25/2012	Biennial	9/25/2014	122539615
Control Company	36934-158	Wall-Mounted Thermometer	1/4/2012	Biennial	1/4/2014	122014497
Fisher Scientific	15-077-960	Thermometer	11/6/2012	Biennial	11/6/2014	122640025
Fisher Scientific	15-0781	Long Stem Thermometer	1/7/2013	Biennial	1/7/2015	130018243
Gigatronix	80701A	(0.05-18GHz) Power Sensor	10/30/2013	Annual	10/30/2014	1833460
Gigatronix	8651A	Universal Power Meter	10/30/2013	Annual	10/30/2014	8650319
NCL	BW-N6W5+	6dB Attenuator	CBT	N/A	CBT	1139
MiniCircuits	SLP-2400+	Low Pass Filter	CBT	N/A	CBT	R8975500903
MiniCircuits	VLF-6000+	Low Pass Filter	CBT	N/A	CBT	N/A
Mini-Circuits	BW-N20W5	Power Attenuator	CBT	N/A	CBT	1226
Mini-Circuits	BW-N20W5+	DC to 18 GHz Precision Fixed 20 dB Attenuator	CBT	N/A	CBT	N/A
Mini-Circuits	NLP-2950+	Low Pass Filter DC to 2700 MHz	CBT	N/A	CBT	N/A
Narda	4014C-6	4 - 8 GHz SMA 6 dB Directional Coupler	CBT	N/A	CBT	N/A
Narda	4772-3	Attenuator (3dB)	CBT	N/A	CBT	9406
Narda	BW-53W2	Attenuator (3dB)	CBT	N/A	CBT	120
Pasternack	PE2208-6	Bidirectional Coupler	CBT	N/A	CBT	N/A
Pasternack	PE2209-10	Bidirectional Coupler	CBT	N/A	CBT	N/A
Rohde & Schwarz	CMU200	Base Station Simulator	9/23/2013	Annual	9/23/2014	109892
Rohde & Schwarz	CMU200	Base Station Simulator	5/3/2013	Annual	5/3/2014	836371/0079
Rohde & Schwarz	CMW500	LTE Radio Communication Tester	10/16/2013	Annual	10/16/2014	100976
Rohde & Schwarz	CMW500	LTE Radio Communication Tester	2/8/2013	Annual	2/8/2014	101699
Rohde & Schwarz	CMW500	LTE Radio Communication Tester	6/6/2013	Annual	6/6/2014	111427
Rohde & Schwarz	NRVd	Dual Channel Power Meter	10/12/2012	Biennial	10/12/2014	101695
Rohde & Schwarz	NRV5	Single Channel Power Meter	10/31/2013	Annual	10/31/2014	835360/0079
Rohde & Schwarz	NRV-232	Peak Power Sensor	10/12/2012	Biennial	10/12/2014	836019/013
Rohde & Schwarz	SMEO3B	Signal Generator	10/30/2013	Annual	10/30/2014	832026
Rohde & Schwarz	SMIQ03B	Signal Generator	4/17/2013	Annual	4/17/2014	DE27259
Seekonk	NC-100	Torque Wrench (8" lb)	11/29/2011	Triennial	11/29/2014	21053
Seekonk	NC-100	Torque Wrench (8" lb)	3/5/2012	Triennial	3/5/2015	N/A
SPEAG	D750V3	750 MHz Dipole	2/13/2013	Annual	2/13/2014	1046
SPEAG	D750V3	750 MHz Dipole	3/18/2013	Annual	3/18/2014	1054
SPEAG	D835V2	835 MHz SAR Dipole	4/25/2013	Annual	4/25/2014	44119
SPEAG	D1750V2	1750 MHz SAR Dipole	4/30/2013	Annual	4/30/2014	1051
SPEAG	D1900V2	1900 MHz SAR Dipole	5/2/2013	Annual	5/2/2014	54141
SPEAG	D1900V2	1900 MHz SAR Dipole	2/6/2013	Annual	2/6/2014	54148
SPEAG	D2450V2	2450 MHz SAR Dipole	1/8/2013	Annual	1/8/2014	797
SPEAG	D2600V2	2600 MHz SAR Dipole	5/2/2013	Annual	5/2/2014	1004
SPEAG	D5GHV2	5 GHz SAR Dipole	1/11/2013	Annual	1/11/2014	1057
SPEAG	D5GHV2	5 GHz SAR Dipole	2/14/2013	Annual	2/14/2014	1120
SPEAG	DAE4	Dasy Data Acquisition Electronics	2/6/2013	Annual	2/6/2014	649
SPEAG	DAE4	Dasy Data Acquisition Electronics	5/13/2013	Annual	5/13/2014	859
SPEAG	DAE4	Dasy Data Acquisition Electronics	1/17/2013	Annual	1/17/2014	1272
SPEAG	DAE4	Dasy Data Acquisition Electronics	8/21/2013	Annual	8/21/2014	1322
SPEAG	DAE4	Dasy Data Acquisition Electronics	9/17/2013	Annual	9/17/2014	1323
SPEAG	DAE4	Dasy Data Acquisition Electronics	11/19/2013	Annual	11/19/2014	1333
SPEAG	DAE4	Dasy Data Acquisition Electronics	3/8/2013	Annual	3/8/2014	1334
SPEAG	DAE4	Dasy Data Acquisition Electronics	4/22/2013	Annual	4/22/2014	1364
SPEAG	DAE4	Dasy Data Acquisition Electronics	4/22/2013	Annual	4/22/2014	1368
SPEAG	DAK-3.5	Dielectric Assessment Kit	5/14/2013	Annual	5/14/2014	1070
SPEAG	DAK-3.5	Dielectric Assessment Kit	11/13/2013	Annual	11/13/2014	1091
SPEAG	DAKS-3.5	Portable Dielectric Assessment Kit	8/18/2013	Annual	8/18/2014	1008
SPEAG	DAKS-3.5	Portable Dielectric Assessment Kit	8/18/2013	Annual	8/18/2014	1009
SPEAG	ES3DV2	SAR Probe	8/22/2013	Annual	8/22/2014	3022
SPEAG	ES3DV3	SAR Probe	3/15/2013	Annual	3/15/2014	3209
SPEAG	ES3DV3	SAR Probe	5/16/2013	Annual	5/16/2014	3263
SPEAG	ES3DV3	SAR Probe	9/23/2013	Annual	9/23/2014	3288
SPEAG	ES3DV3	SAR Probe	4/29/2013	Annual	4/29/2014	3318
SPEAG	ES3DV3	SAR Probe	4/29/2013	Annual	4/29/2014	3319
SPEAG	EX3DV4	SAR Probe	1/17/2013	Annual	1/17/2014	3589
SPEAG	EX3DV4	SAR Probe	10/23/2013	Annual	10/23/2014	3914
Tektronix	RSA6114A	Real Time Spectrum Analyzer	4/17/2013	Annual	4/17/2014	8010177
VWR	23226-658	Long Stem Thermometer	3/30/2012	Biennial	3/30/2014	122179874
VWR	36934-158	Digital Thermometer	8/8/2013	Annual	8/8/2014	130477877

Note: CBT (Calibrated Before Testing). Prior to testing, the measurement paths containing a cable, amplifier, attenuator, coupler or filter were connected to a calibrated source (i.e. a signal generator) to determine the losses of the measurement path. The power meter offset was then adjusted to compensate for the measurement system losses. This level offset is stored within the power meter before measurements are made. This calibration verification procedure applies to the system verification and output power measurements. The calibrated reading is then taken directly from the power meter after compensation of the losses for all final power measurements.



FCC ID: ZNFD950	 PCTEST ENGINEERING LABORATORY, INC.	SAR EVALUATION REPORT		Reviewed by: Quality Manager
Document S/N: OY1312022312.ZNF	Test Dates: 12/02/13 - 12/16/13	DUT Type: Portable Handset		Page 61 of 66

15 MEASUREMENT UNCERTAINTIES

Applicable for frequencies less than 3000 MHz:

a	b	c	d	e= f(d,k)	f	g	h = c x f/e	i = c x g/e	k
Uncertainty Component	IEEE 1528 Sec.	Tol. (± %)	Prob. Dist.	Div.	c _i 1gm	c _i 10 gms	1gm u _i (± %)	10gms u _i (± %)	v _i
Measurement System									
Probe Calibration	E.2.1	6.0	N	1	1.0	1.0	6.0	6.0	∞
Axial Isotropy	E.2.2	0.25	N	1	0.7	0.7	0.2	0.2	∞
Hemishperical Isotropy	E.2.2	1.3	N	1	1.0	1.0	1.3	1.3	∞
Boundary Effect	E.2.3	0.4	N	1	1.0	1.0	0.4	0.4	∞
Linearity	E.2.4	0.3	N	1	1.0	1.0	0.3	0.3	∞
System Detection Limits	E.2.5	5.1	N	1	1.0	1.0	5.1	5.1	∞
Readout Electronics	E.2.6	1.0	N	1	1.0	1.0	1.0	1.0	∞
Response Time	E.2.7	0.8	R	1.73	1.0	1.0	0.5	0.5	∞
Integration Time	E.2.8	2.6	R	1.73	1.0	1.0	1.5	1.5	∞
RF Ambient Conditions	E.6.1	3.0	R	1.73	1.0	1.0	1.7	1.7	∞
Probe Positioner Mechanical Tolerance	E.6.2	0.4	R	1.73	1.0	1.0	0.2	0.2	∞
Probe Positioning w/ respect to Phantom	E.6.3	2.9	R	1.73	1.0	1.0	1.7	1.7	∞
Extrapolation, Interpolation & Integration algorithms for Max. SAR Evaluation	E.5	1.0	R	1.73	1.0	1.0	0.6	0.6	∞
Test Sample Related									
Test Sample Positioning	E.4.2	6.0	N	1	1.0	1.0	6.0	6.0	287
Device Holder Uncertainty	E.4.1	3.32	R	1.73	1.0	1.0	1.9	1.9	∞
Output Power Variation - SAR drift measurement	6.6.2	5.0	R	1.73	1.0	1.0	2.9	2.9	∞
Phantom & Tissue Parameters									
Phantom Uncertainty (Shape & Thickness tolerances)	E.3.1	4.0	R	1.73	1.0	1.0	2.3	2.3	∞
Liquid Conductivity - deviation from target values	E.3.2	5.0	R	1.73	0.64	0.43	1.8	1.2	∞
Liquid Conductivity - measurement uncertainty	E.3.3	3.8	N	1	0.64	0.43	2.4	1.6	6
Liquid Permittivity - deviation from target values	E.3.2	5.0	R	1.73	0.60	0.49	1.7	1.4	∞
Liquid Permittivity - measurement uncertainty	E.3.3	4.5	N	1	0.60	0.49	2.7	2.2	6
Combined Standard Uncertainty (k=1)				RSS			12.1	11.7	299
Expanded Uncertainty (95% CONFIDENCE LEVEL)				k=2			24.2	23.5	



The above measurement uncertainties are according to IEEE Std. 1528-2003

FCC ID: ZNFD950	 PCTEST ENGINEERING LABORATORY, INC.	SAR EVALUATION REPORT		Reviewed by: Quality Manager
Document S/N: 0Y1312022312.ZNF	Test Dates: 12/02/13 - 12/16/13	DUT Type: Portable Handset		Page 62 of 66

Applicable for frequencies up to 6 GHz:

a	b	c	d	e= f(d,k)	f	g	h = c x f/e	i = c x g/e	k	
Uncertainty Component	IEEE 1528 Sec.	Tol. (± %)	Prob. Dist.	Div.	c _i 1gm	c _i 10 gms	1gm u _i (± %)	10gms u _i (± %)	v _i	
Measurement System										
Probe Calibration	E.2.1	6.55	N	1	1.0	1.0	6.6	6.6	∞	
Axial Isotropy	E.2.2	0.25	N	1	0.7	0.7	0.2	0.2	∞	
Hemishperical Isotropy	E.2.2	1.3	N	1	1.0	1.0	1.3	1.3	∞	
Boundary Effect	E.2.3	0.4	N	1	1.0	1.0	0.4	0.4	∞	
Linearity	E.2.4	0.3	N	1	1.0	1.0	0.3	0.3	∞	
System Detection Limits	E.2.5	5.1	N	1	1.0	1.0	5.1	5.1	∞	
Readout Electronics	E.2.6	1.0	N	1	1.0	1.0	1.0	1.0	∞	
Response Time	E.2.7	0.8	R	1.73	1.0	1.0	0.5	0.5	∞	
Integration Time	E.2.8	2.6	R	1.73	1.0	1.0	1.5	1.5	∞	
RF Ambient Conditions	E.6.1	3.0	R	1.73	1.0	1.0	1.7	1.7	∞	
Probe Positioner Mechanical Tolerance	E.6.2	0.4	R	1.73	1.0	1.0	0.2	0.2	∞	
Probe Positioning w/ respect to Phantom	E.6.3	2.9	R	1.73	1.0	1.0	1.7	1.7	∞	
Extrapolation, Interpolation & Integration algorithms for Max. SAR Evaluation	E.5	1.0	R	1.73	1.0	1.0	0.6	0.6	∞	
Test Sample Related										
Test Sample Positioning	E.4.2	6.0	N	1	1.0	1.0	6.0	6.0	287	
Device Holder Uncertainty	E.4.1	3.32	R	1.73	1.0	1.0	1.9	1.9	∞	
Output Power Variation - SAR drift measurement	6.6.2	5.0	R	1.73	1.0	1.0	2.9	2.9	∞	
Phantom & Tissue Parameters										
Phantom Uncertainty (Shape & Thickness tolerances)	E.3.1	4.0	R	1.73	1.0	1.0	2.3	2.3	∞	
Liquid Conductivity - deviation from target values	E.3.2	5.0	R	1.73	0.64	0.43	1.8	1.2	∞	
Liquid Conductivity - measurement uncertainty	E.3.3	3.8	N	1	0.64	0.43	2.4	1.6	6	
Liquid Permittivity - deviation from target values	E.3.2	5.0	R	1.73	0.60	0.49	1.7	1.4	∞	
Liquid Permittivity - measurement uncertainty	E.3.3	4.5	N	1	0.60	0.49	2.7	2.2	6	
Combined Standard Uncertainty (k=1)							RSS	12.4	12.0	299
Expanded Uncertainty (95% CONFIDENCE LEVEL)							k=2	24.7	24.0	

The above measurement uncertainties are according to IEEE Std. 1528-2003



FCC ID: ZNFD950	 PCTEST ENGINEERING LABORATORY, INC.	SAR EVALUATION REPORT		Reviewed by: Quality Manager
Document S/N: 0Y1312022312.ZNF	Test Dates: 12/02/13 - 12/16/13	DUT Type: Portable Handset		Page 63 of 66

16 CONCLUSION

16.1 Measurement Conclusion



The SAR evaluation indicates that the EUT complies with the RF radiation exposure limits of the FCC and Industry Canada, with respect to all parameters subject to this test. These measurements were taken to simulate the RF effects of RF exposure under worst-case conditions. Precise laboratory measures were taken to assure repeatability of the tests. The results and statements relate only to the item(s) tested.

Please note that the absorption and distribution of electromagnetic energy in the body are very complex phenomena that depend on the mass, shape, and size of the body, the orientation of the body with respect to the field vectors, and the electrical properties of both the body and the environment. Other variables that may play a substantial role in possible biological effects are those that characterize the environment (e.g. ambient temperature, air velocity, relative humidity, and body insulation) and those that characterize the individual (e.g. age, gender, activity level, debilitation, or disease). Because various factors may interact with one another to vary the specific biological outcome of an exposure to electromagnetic fields, any protection guide should consider maximal amplification of biological effects as a result of field-body interactions, environmental conditions, and physiological variables. [3]



FCC ID: ZNFD950	 PCTEST ENGINEERING LABORATORY, INC.	SAR EVALUATION REPORT		Reviewed by: Quality Manager
Document S/N: 0Y1312022312.ZNF	Test Dates: 12/02/13 - 12/16/13	DUT Type: Portable Handset		Page 64 of 66

17 REFERENCES

- [1] Federal Communications Commission, ET Docket 93-62, Guidelines for Evaluating the Environmental Effects of Radiofrequency Radiation, Aug. 1996.
- [2] ANSI/IEEE C95.1-2005, American National Standard safety levels with respect to human exposure to radio frequency electromagnetic fields, 3kHz to 300GHz, New York: IEEE, 2006.
- [3] ANSI/IEEE C95.1-1992, American National Standard safety levels with respect to human exposure to radio frequency electromagnetic fields, 3kHz to 300GHz, New York: IEEE, Sept. 1992.
- [4] ANSI/IEEE C95.3-2002, IEEE Recommended Practice for the Measurement of Potentially Hazardous Electromagnetic Fields - RF and Microwave, New York: IEEE, December 2002.
- [5] Federal Communications Commission, OET Bulletin 65 (Edition 97-01), Supplement C (Edition 01-01), Evaluating Compliance with FCC Guidelines for Human Exposure to Radiofrequency Electromagnetic Fields, June 2001.
- [6] IEEE Standards Coordinating Committee 34 – IEEE Std. 1528-2003, Recommended Practice for Determining the Peak Spatial-Average Specific Absorption Rate (SAR) in the Human Body Due to Wireless Communications Devices.
- [7] NCRP, National Council on Radiation Protection and Measurements, Biological Effects and Exposure Criteria for RadioFrequency Electromagnetic Fields, NCRP Report No. 86, 1986. Reprinted Feb. 1995.
- [8] T. Schmid, O. Egger, N. Kuster, Automated E-field scanning system for dosimetric assessments, IEEE Transaction on Microwave Theory and Techniques, vol. 44, Jan. 1996, pp. 105-113.
- [9] K. Pokovic, T. Schmid, N. Kuster, Robust setup for precise calibration of E-field probes in tissue simulating liquids at mobile communications frequencies, ICECOM97, Oct. 1997, pp. -124.
- [10] K. Pokovic, T. Schmid, and N. Kuster, E-field Probe with improved isotropy in brain simulating liquids, Proceedings of the ELMAR, Zadar, Croatia, June 23-25, 1996, pp. 172-175.
- [11] Schmid & Partner Engineering AG, Application Note: Data Storage and Evaluation, June 1998, p2.
- [12] V. Hombach, K. Meier, M. Burkhardt, E. Kuhn, N. Kuster, The Dependence of EM Energy Absorption upon Human Modeling at 900 MHz, IEEE Transaction on Microwave Theory and Techniques, vol. 44 no. 10, Oct. 1996, pp. 1865-1873.
- [13] N. Kuster and Q. Balzano, Energy absorption mechanism by biological bodies in the near field of dipole antennas above 300MHz, IEEE Transaction on Vehicular Technology, vol. 41, no. 1, Feb. 1992, pp. 17-23.
- [14] G. Hartsgrove, A. Kraszewski, A. Surowiec, Simulated Biological Materials for Electromagnetic Radiation Absorption Studies, University of Ottawa, Bioelectromagnetics, Canada: 1987, pp. 29-36.
- [15] Q. Balzano, O. Garay, T. Manning Jr., Electromagnetic Energy Exposure of Simulated Users of Portable Cellular Telephones, IEEE Transactions on Vehicular Technology, vol. 44, no.3, Aug. 1995.
- [16] W. Gander, Computermathematik, Birkhaeuser, Basel, 1992.
- [17] W.H. Press, S.A. Teukolsky, W.T. Vetterling, and B.P. Flannery, Numerical Recipes in C, The Art of Scientific Computing, Second edition, Cambridge University Press, 1992.
- [18] Federal Communications Commission, OET Bulletin 65, Evaluating Compliance with FCC Guidelines for Human Exposure to Radiofrequency Electromagnetic Fields. Supplement C, Dec. 1997.

FCC ID: ZNFD950	 PCTEST ENGINEERING LABORATORY, INC.	SAR EVALUATION REPORT		Reviewed by: Quality Manager
Document S/N: 0Y1312022312.ZNF	Test Dates: 12/02/13 - 12/16/13	DUT Type: Portable Handset	Page 65 of 66	

- [19] N. Kuster, R. Kastle, T. Schmid, Dosimetric evaluation of mobile communications equipment with known precision, IEEE Transaction on Communications, vol. E80-B, no. 5, May 1997, pp. 645-652.
- [20] CENELEC CLC/SC111B, European Prestandard (prENV 50166-2), Human Exposure to Electromagnetic Fields High-frequency: 10kHz-300GHz, Jan. 1995.
- [21] Prof. Dr. Niels Kuster, ETH, Eidgenössische Technische Hochschule Zürich, Dosimetric Evaluation of the Cellular Phone.
- [22] IEC 62209-1, Human exposure to radio frequency fields from hand-held and body-mounted wireless communication devices - Human models, instrumentation, and procedures - Part 1: Procedure to determine the specific absorption rate (SAR) for hand-held devices used in close proximity to the ear (frequency range of 300 MHz to 3 GHz), Feb. 2005.
- [23] Industry Canada RSS-102 Radio Frequency Exposure Compliance of Radiocommunication Apparatus (All Frequency Bands) Issue 4, March 2010.
- [24] Health Canada Safety Code 6 Limits of Human Exposure to Radio Frequency Electromagnetic Fields in the Frequency Range from 3 kHz – 300 GHz, 2009
- [25] FCC Public Notice DA-02-1438. Office of Engineering and Technology Announces a Transition Period for the Phantom Requirements of Supplement C to OET Bulletin 65, June 19, 2002
- [26] FCC SAR Test Procedures for 2G-3G Devices, Mobile Hotspot and UMPC Devices KDB Publications 941225, D01-D07
- [27] SAR Measurement procedures for IEEE 802.11a/b/g KDB Publication 248227 D01v01r02
- [28] FCC SAR Considerations for Handsets with Multiple Transmitters and Antennas, KDB Publications 648474 D02-D04
- [29] FCC SAR Evaluation Considerations for Laptop, Notebook, Netbook and Tablet Computers, FCC KDB Publication 616217 D04
- [30] FCC SAR Measurement and Reporting Requirements for 100MHz – 6 GHz, KDB Publications 865664 D01-D02
- [31] FCC General RF Exposure Guidance and SAR Procedures for Dongles, KDB Publication 447498, D01-D02
- [32] Anexo à Resolução No. 533, de 10 de Setembro de 2009.
- [33] IEC 62209-2, Human exposure to radio frequency fields from hand-held and body-mounted wireless communication devices - Human models, instrumentation, and procedures - Part 2: Procedure to determine the specific absorption rate (SAR) for wireless communication devices used in close proximity to the human body (frequency range of 30 MHz to 6 GHz), Mar. 2010.

FCC ID: ZNFD950	 PCTEST ENGINEERING LABORATORY, INC.	SAR EVALUATION REPORT		Reviewed by: Quality Manager
Document S/N: 0Y1312022312.ZNF	Test Dates: 12/02/13 - 12/16/13	DUT Type: Portable Handset	Page 66 of 66	

APPENDIX A: SAR TEST DATA

PCTEST ENGINEERING LABORATORY, INC.

DUT: ZNFD950; Type: Portable Handset; Serial: FCC3

Communication System: UID 0, GSM GPRS; 2 Tx slots; Frequency: 836.6 MHz; Duty Cycle: 1:4.15

Medium: 835 Head, Medium parameters used (interpolated):

$f = 836.6 \text{ MHz}$; $\sigma = 0.933 \text{ S/m}$; $\epsilon_r = 42.968$; $\rho = 1000 \text{ kg/m}^3$

Phantom section: Left Section

Test Date: 12-04-2013; Ambient Temp: 24.5°C; Tissue Temp: 23.0°C

Probe: ES3DV3 - SN3209; ConvF(6.46, 6.46, 6.46); Calibrated: 3/15/2013;

Sensor-Surface: 4mm (Mechanical Surface Detection)

Electronics: DAE4 Sn1334; Calibrated: 3/8/2013

Phantom: SAM Right; Type: QD000P40CD; Serial: 1686

Measurement SW: DASY52, Version 52.8 (7); SEMCAD X Version 14.6.10 (7164)

Mode: GPRS 850, Left Head, Cheek, Mid.ch, 2 Tx slots

Area Scan (9x15x1): Measurement grid: dx=15mm, dy=15mm

Zoom Scan (5x5x7)/Cube 0: Measurement grid: dx=8mm, dy=8mm, dz=5mm

Reference Value = 20.682 V/m; Power Drift = 0.14 dB

Peak SAR (extrapolated) = 0.477 W/kg

SAR(1 g) = 0.392 W/kg

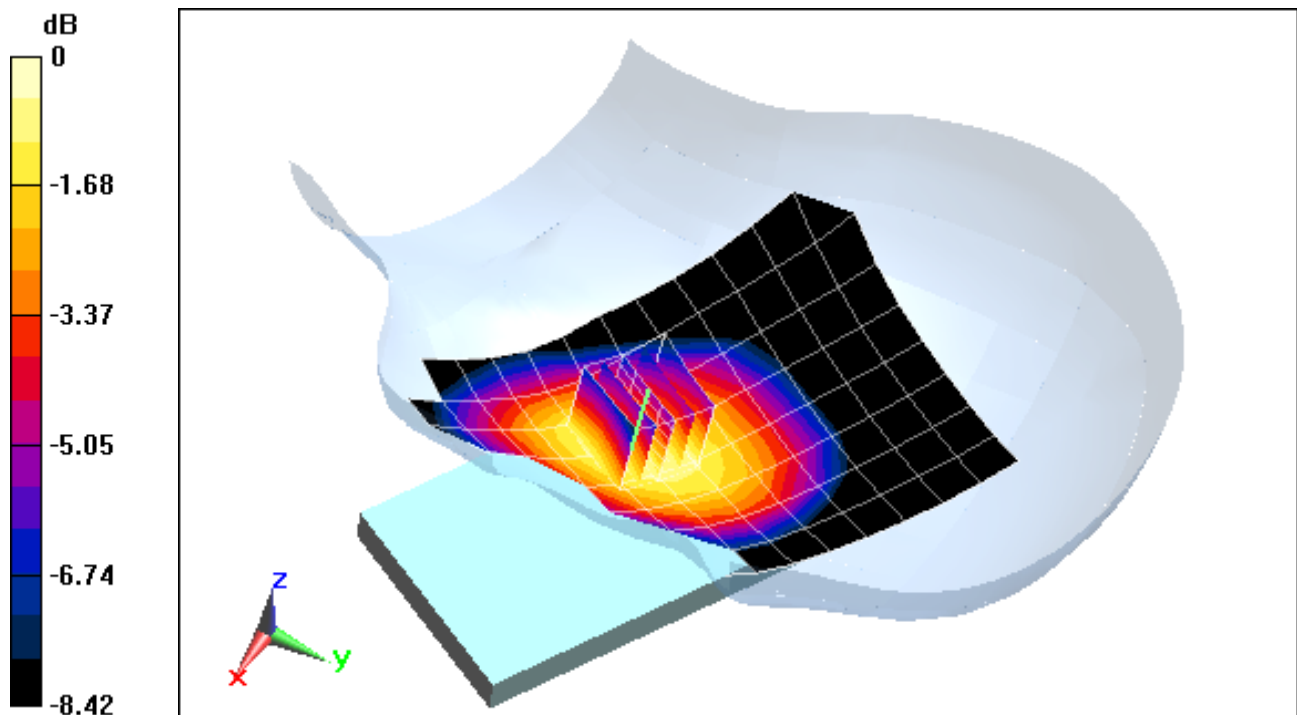

0 dB = 0.413 W/kg = -3.84 dBW/kg

PCTEST ENGINEERING LABORATORY, INC.

DUT: ZNFD950; Type: Portable Handset; Serial: FCC3

Communication System: UID 0, UMTS; Frequency: 836.6 MHz; Duty Cycle: 1:1

Medium: 835 Head, Medium parameters used (interpolated):

$f = 836.6 \text{ MHz}$; $\sigma = 0.933 \text{ S/m}$; $\epsilon_r = 42.968$; $\rho = 1000 \text{ kg/m}^3$

Phantom section: Left Section

Test Date: 12-04-2013; Ambient Temp: 24.5°C; Tissue Temp: 23.0°C

Probe: ES3DV3 - SN3209; ConvF(6.46, 6.46, 6.46); Calibrated: 3/15/2013;

Sensor-Surface: 4mm (Mechanical Surface Detection)

Electronics: DAE4 Sn1334; Calibrated: 3/8/2013

Phantom: SAM Right; Type: QD000P40CD; Serial: 1686

Measurement SW: DASY52, Version 52.8 (7); SEMCAD X Version 14.6.10 (7164)

Mode: UMTS 850, Left Head, Cheek, Mid.ch

Area Scan (9x10x1): Measurement grid: dx=15mm, dy=15mm

Zoom Scan (5x5x7)/Cube 0: Measurement grid: dx=8mm, dy=8mm, dz=5mm

Reference Value = 21.124 V/m; Power Drift = 0.00 dB

Peak SAR (extrapolated) = 0.490 W/kg

SAR(1 g) = 0.391 W/kg

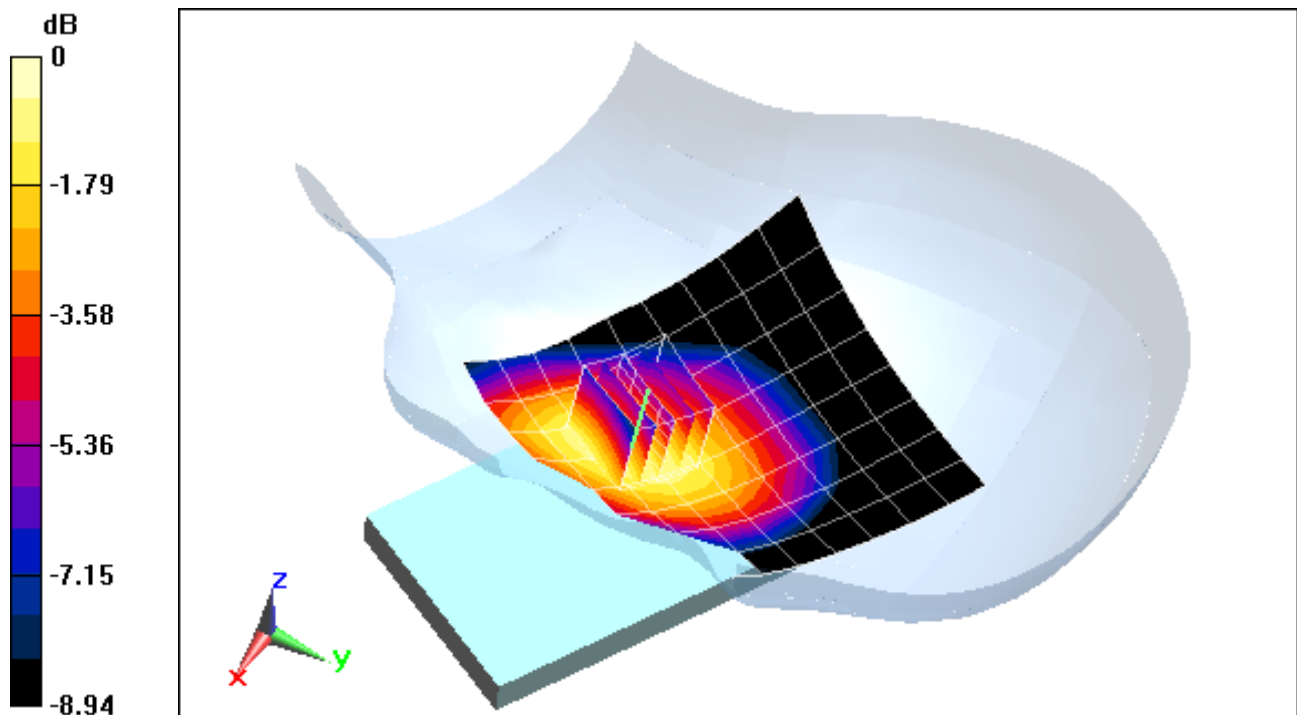

0 dB = 0.412 W/kg = -3.85 dBW/kg

PCTEST ENGINEERING LABORATORY, INC.

DUT: ZNFD950; Type: Portable Handset; Serial: FCC3

Communication System: UID 0, GSM GPRS; 2 Tx slots; Frequency: 1880 MHz; Duty Cycle: 1:4.15

Medium: 1900 Head, Medium parameters used:

$f = 1880 \text{ MHz}$; $\sigma = 1.435 \text{ S/m}$; $\epsilon_r = 40.112$; $\rho = 1000 \text{ kg/m}^3$

Phantom section: Right Section

Test Date: 12-12-2013; Ambient Temp: 21.1°C; Tissue Temp: 22.0°C

Probe: ES3DV3 - SN3263; ConvF(5.11, 5.11, 5.11); Calibrated: 5/16/2013;

Sensor-Surface: 4mm (Mechanical Surface Detection)

Electronics: DAE4 Sn859; Calibrated: 5/13/2013

Phantom: SAM Main; Type: SAM 4.0; Serial: TP-1406

Measurement SW: DASY4, Version 4.7 (80); SEMCAD X Version 14.6.10 (7164)

Mode: GPRS 1900, Right Head, Cheek, Mid.ch, 2 Tx Slots

Area Scan (9x15x1): Measurement grid: dx=15mm, dy=15mm

Zoom Scan (5x5x7)/Cube 0: Measurement grid: dx=8mm, dy=8mm, dz=5mm

Reference Value = 11.134 V/m; Power Drift = -0.13 dB

Peak SAR (extrapolated) = 0.261 W/kg

SAR(1 g) = 0.165 W/kg

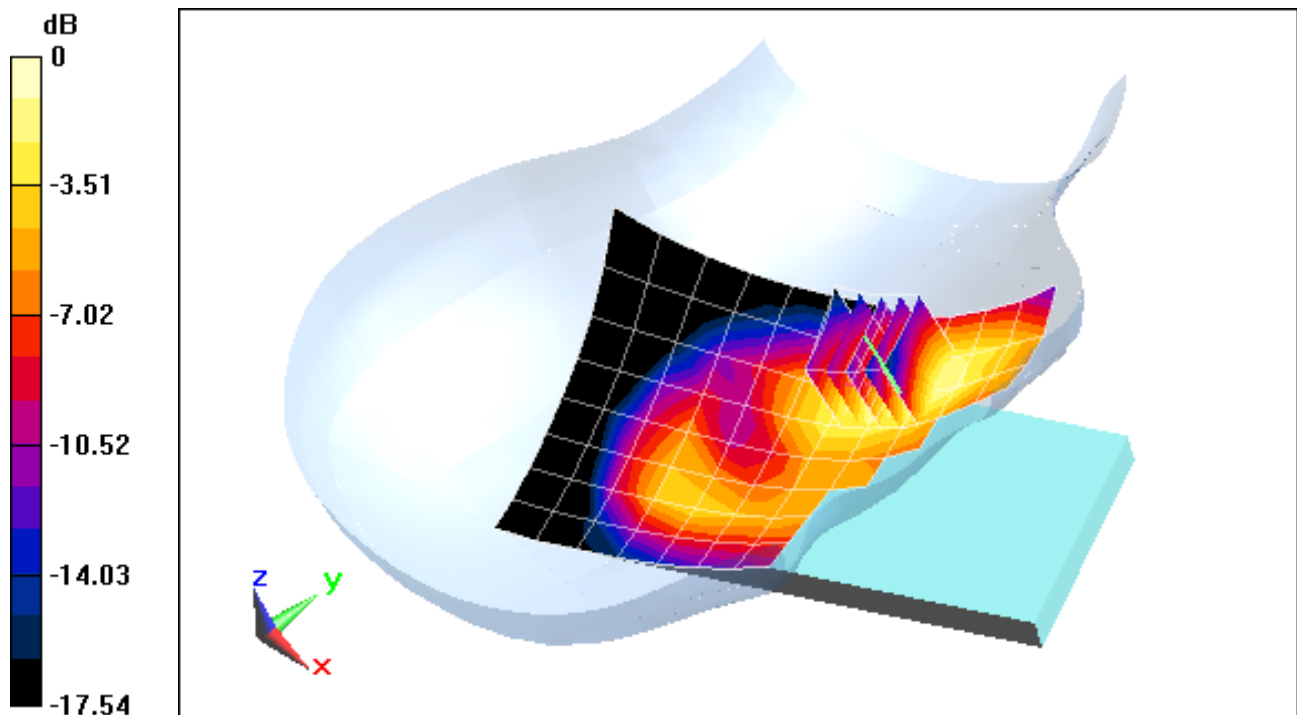

0 dB = 0.179 W/kg = -7.47 dBW/kg

PCTEST ENGINEERING LABORATORY, INC.

DUT: ZNFD950; Type: Portable Handset; Serial: FCC3

Communication System: UID 0, UMTS; Frequency: 1880 MHz; Duty Cycle: 1:1

Medium: 1900 Head, Medium parameters used:

$f = 1880 \text{ MHz}$; $\sigma = 1.395 \text{ S/m}$; $\epsilon_r = 39.634$; $\rho = 1000 \text{ kg/m}^3$

Phantom section: Right Section

Test Date: 12-09-2013; Ambient Temp: 21.0°C; Tissue Temp: 22.3°C

Probe: ES3DV3 - SN3263; ConvF(5.11, 5.11, 5.11); Calibrated: 5/16/2013;

Sensor-Surface: 4mm (Mechanical Surface Detection)

Electronics: DAE4 Sn859; Calibrated: 5/13/2013

Phantom: SAM Main; Type: SAM 4.0; Serial: TP-1406

Measurement SW: DASY4, Version 4.7 (80); SEMCAD X Version 14.6.10 (7164)

Mode: UMTS 1900, Right Head, Cheek, Mid.ch

Area Scan (9x15x1): Measurement grid: dx=15mm, dy=15mm

Zoom Scan (5x5x7)/Cube 0: Measurement grid: dx=8mm, dy=8mm, dz=5mm

Reference Value = 13.898 V/m; Power Drift = 0.01 dB

Peak SAR (extrapolated) = 0.380 W/kg

SAR(1 g) = 0.249 W/kg

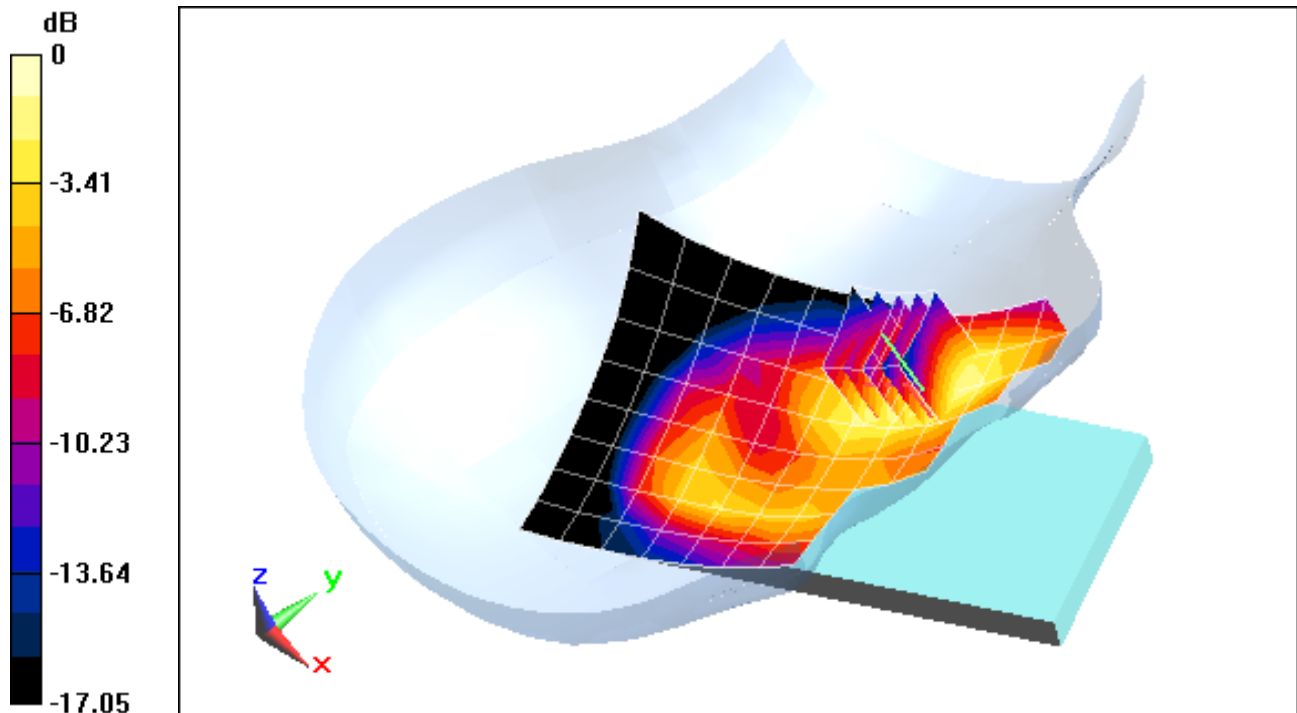

0 dB = 0.268 W/kg = -5.72 dBW/kg

PCTEST ENGINEERING LABORATORY, INC.

DUT: ZNFD950; Type: Portable Handset; Serial: FCC6

Communication System: UID 0, LTE Band 17; Frequency: 710 MHz; Duty Cycle: 1:1

Medium: 750 Head, Medium parameters used:

$$f = 710 \text{ MHz}; \sigma = 0.883 \text{ S/m}; \epsilon_r = 41.996; \rho = 1000 \text{ kg/m}^3$$

Phantom section: Right Section

Test Date: 12-02-2013; Ambient Temp: 23.0°C; Tissue Temp: 21.0°C

Probe: EX3DV4 - SN3914; ConvF(9.7, 9.7, 9.7); Calibrated: 10/23/2013;

Sensor-Surface: 4mm (Mechanical Surface Detection)

Electronics: DAE4 Sn649; Calibrated: 2/6/2013

Phantom: SAM V5.0 Right; Type: QD000P40CD; Serial: 1647

Measurement SW: DASY52, Version 52.8 (7); SEMCAD X Version 14.6.10 (7164)

**Mode: LTE Band 17, Right Head, Cheek, Mid.ch,
10 MHz Bandwidth, QPSK, 1 RB, 0 RB Offset**

Area Scan (9x14x1): Measurement grid: dx=15mm, dy=15mm

Zoom Scan (6x5x7)/Cube 0: Measurement grid: dx=8mm, dy=8mm, dz=5mm

Reference Value = 15.585 V/m; Power Drift = -0.01 dB

Peak SAR (extrapolated) = 0.256 W/kg

SAR(1 g) = 0.200 W/kg

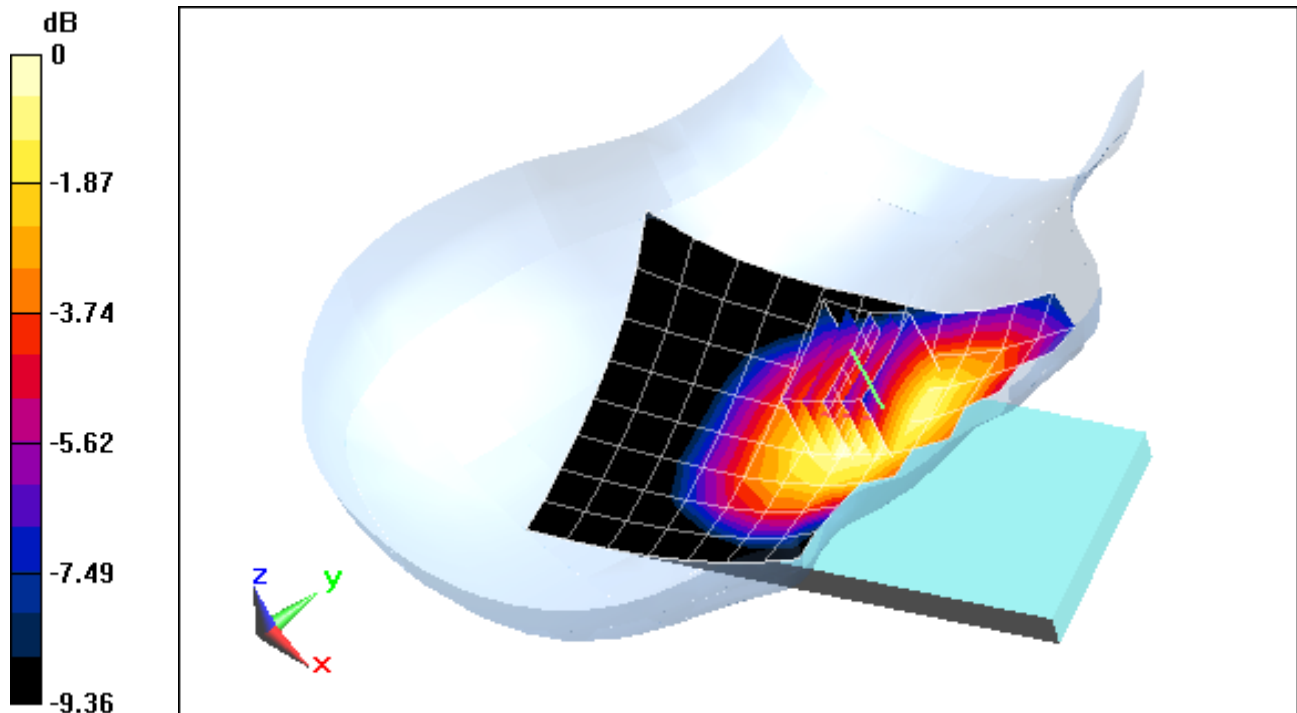

0 dB = 0.210 W/kg = -6.78 dBW/kg

PCTEST ENGINEERING LABORATORY, INC.

DUT: ZNFD950; Type: Portable Handset; Serial: FCC6

Communication System: UID 0, LTE Band 5 (Cell.); Frequency: 836.5 MHz; Duty Cycle: 1:1

Medium: 835 Head, Medium parameters used (interpolated):

$f = 836.5 \text{ MHz}$; $\sigma = 0.933 \text{ S/m}$; $\epsilon_r = 42.969$; $\rho = 1000 \text{ kg/m}^3$

Phantom section: Left Section

Test Date: 12-04-2013; Ambient Temp: 24.5°C; Tissue Temp: 23.0°C

Probe: ES3DV3 - SN3209; ConvF(6.46, 6.46, 6.46); Calibrated: 3/15/2013;

Sensor-Surface: 4mm (Mechanical Surface Detection)

Electronics: DAE4 Sn1334; Calibrated: 3/8/2013

Phantom: SAM Right; Type: QD000P40CD; Serial: 1686

Measurement SW: DASY52, Version 52.8 (7); SEMCAD X Version 14.6.10 (7164)

**Mode: LTE Band 5 (Cell.), Left Head, Cheek, Mid.ch,
10 MHz Bandwidth, QPSK, 1 RB, 0 RB Offset**

Area Scan (9x14x1): Measurement grid: dx=15mm, dy=15mm

Zoom Scan (5x5x7)/Cube 0: Measurement grid: dx=8mm, dy=8mm, dz=5mm

Reference Value = 24.729 V/m; Power Drift = -0.05 dB

Peak SAR (extrapolated) = 0.586 W/kg

SAR(1 g) = 0.484 W/kg

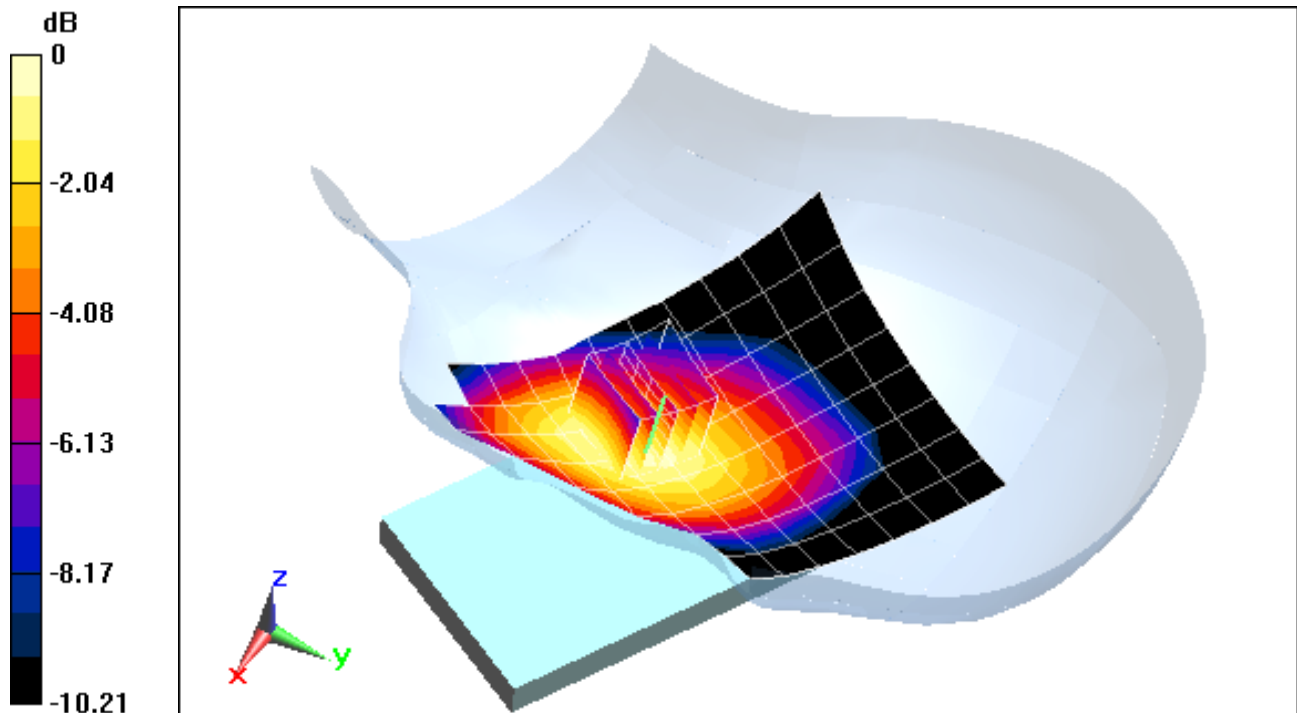

0 dB = 0.502 W/kg = -2.99 dBW/kg

PCTEST ENGINEERING LABORATORY, INC.

DUT: ZNFD950; Type: Portable Handset; Serial: FCC6

Communication System: UID 0, LTE Band 4 (AWS); Frequency: 1750 MHz; Duty Cycle: 1:1

Medium: 1750 Head, Medium parameters used:

$f = 1750 \text{ MHz}$; $\sigma = 1.378 \text{ S/m}$; $\epsilon_r = 40.664$; $\rho = 1000 \text{ kg/m}^3$

Phantom section: Right Section

Test Date: 12-04-2013; Ambient Temp: 23.4°C; Tissue Temp: 22.9°C

Probe: ES3DV3 - SN3319; ConvF(5.59, 5.59, 5.59); Calibrated: 6/28/2013;

Sensor-Surface: 4mm (Mechanical Surface Detection)

Electronics: DAE4 Sn1368; Calibrated: 4/22/2013

Phantom: SAM right; Type: QD000P40CD; Serial: TP:1757

Measurement SW: DASY52, Version 52.8 (7); SEMCAD X Version 14.6.10 (7164)

**Mode: LTE Band 4 (AWS), Right Head, Cheek, High.ch,
10 MHz Bandwidth, QPSK, 1 RB, 25 RB Offset**

Area Scan (8x13x1): Measurement grid: dx=15mm, dy=15mm

Zoom Scan (5x5x7)/Cube 0: Measurement grid: dx=8mm, dy=8mm, dz=5mm

Reference Value = 17.721 V/m; Power Drift = -0.01 dB

Peak SAR (extrapolated) = 0.550 W/kg

SAR(1 g) = 0.350 W/kg

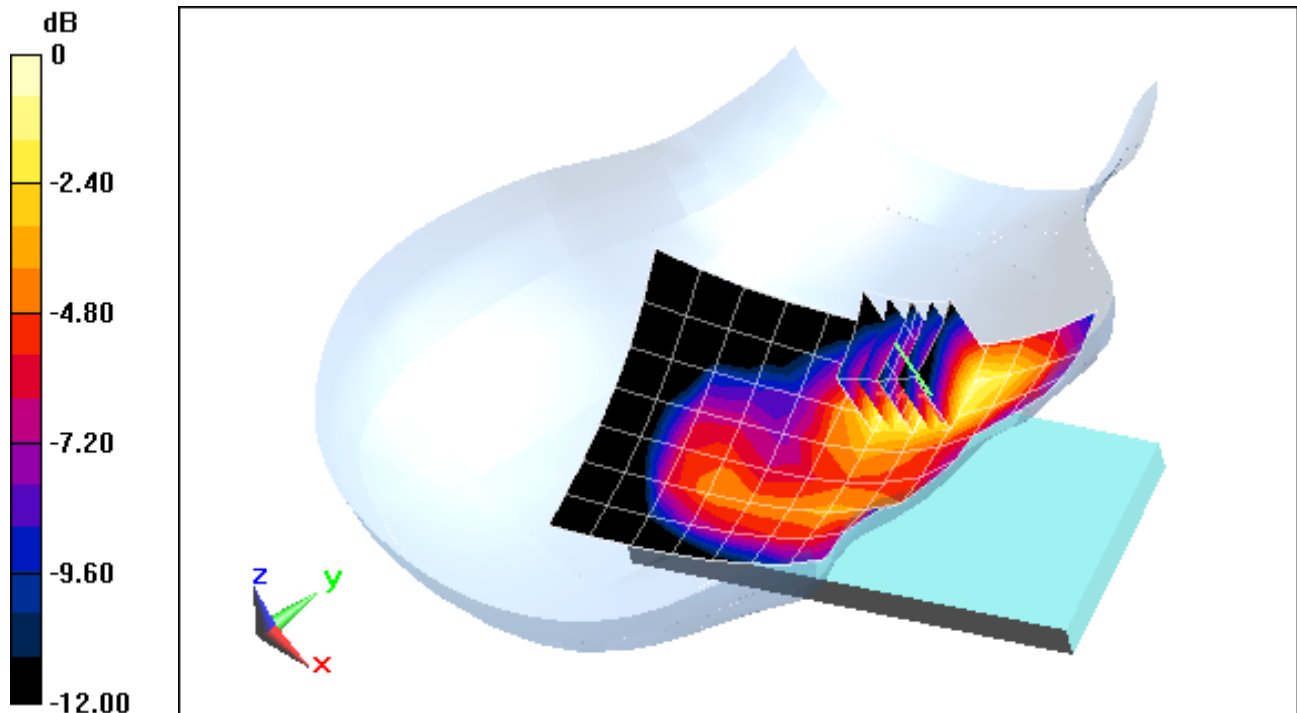

0 dB = 0.381 W/kg = -4.19 dBW/kg

PCTEST ENGINEERING LABORATORY, INC.

DUT: ZNFD950; Type: Portable Handset; Serial: FCC6

Communication System: UID 0, LTE Band 2; Frequency: 1880 MHz; Duty Cycle: 1:1

Medium: 1900 Head, Medium parameters used:

$f = 1880 \text{ MHz}$; $\sigma = 1.395 \text{ S/m}$; $\epsilon_r = 39.634$; $\rho = 1000 \text{ kg/m}^3$

Phantom section: Right Section

Test Date: 12-09-2013; Ambient Temp: 21.0°C; Tissue Temp: 22.3°C

Probe: ES3DV3 - SN3263; ConvF(5.11, 5.11, 5.11); Calibrated: 5/16/2013;

Sensor-Surface: 4mm (Mechanical Surface Detection)

Electronics: DAE4 Sn859; Calibrated: 5/13/2013

Phantom: SAM Main; Type: SAM 4.0; Serial: TP-1406

Measurement SW: DASY4, Version 4.7 (80); SEMCAD X Version 14.6.10 (7164)

**Mode: LTE Band 2 (PCS), Right Head, Cheek, Mid.ch,
10 MHz Bandwidth, QPSK, 1 RB, 0 RB Offset**

Area Scan (9x15x1): Measurement grid: dx=15mm, dy=15mm

Zoom Scan (5x5x7)/Cube 0: Measurement grid: dx=8mm, dy=8mm, dz=5mm

Reference Value = 14.648 V/m; Power Drift = -0.02 dB

Peak SAR (extrapolated) = 0.375 W/kg

SAR(1 g) = 0.245 W/kg

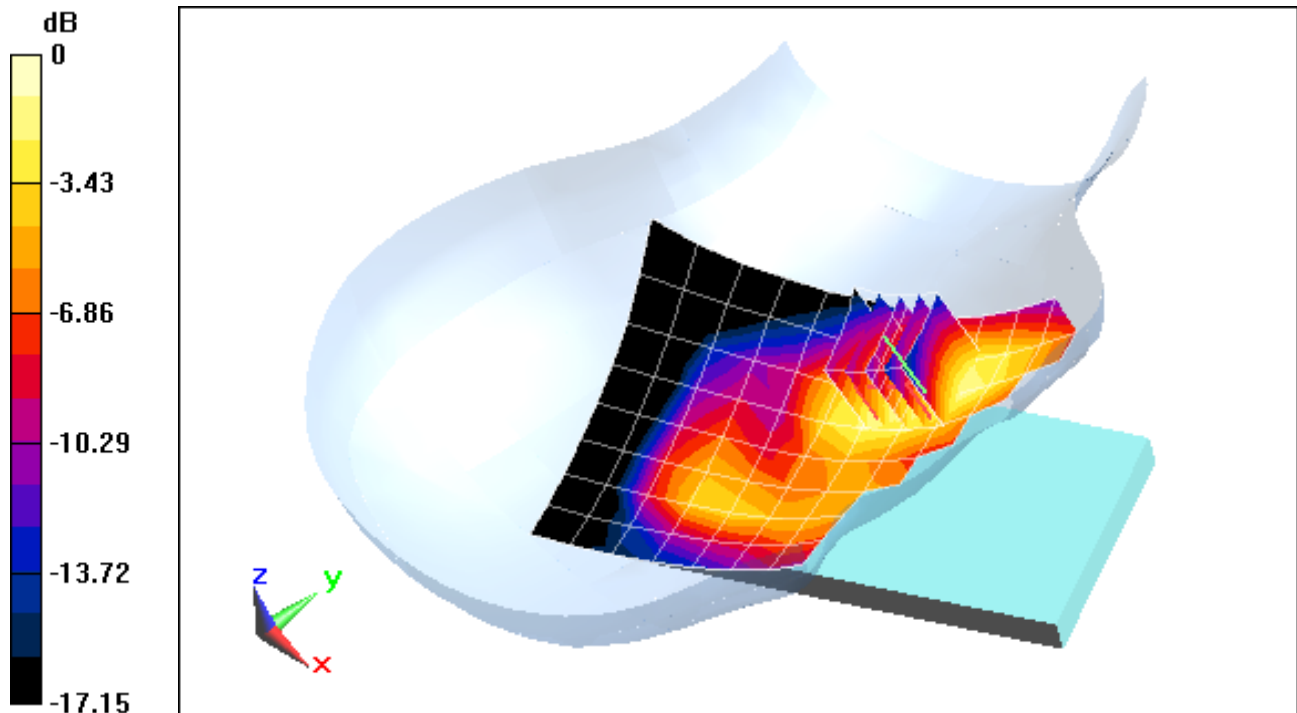

0 dB = 0.265 W/kg = -5.77 dBW/kg

PCTEST ENGINEERING LABORATORY, INC.

DUT: ZNFD950; Type: Portable Handset; Serial: FCC6

Communication System: UID 0, LTE Band 7; Frequency: 2535 MHz; Duty Cycle: 1:1

Medium: 2600 Head, Medium parameters used (interpolated):

$f = 2535 \text{ MHz}$; $\sigma = 1.963 \text{ S/m}$; $\epsilon_r = 38.216$; $\rho = 1000 \text{ kg/m}^3$

Phantom section: Right Section

Test Date: 12-10-2013; Ambient Temp: 24.5°C; Tissue Temp: 24.1°C

Probe: ES3DV3 - SN3288; ConvF(4.55, 4.55, 4.55); Calibrated: 9/23/2013;

Sensor-Surface: 3mm (Mechanical Surface Detection)

Electronics: DAE4 Sn1323; Calibrated: 9/17/2013

Phantom: SAM with CRP; Type: SAM 4.0; Serial: TP1375

Measurement SW: DASY4, Version 4.7 (80); SEMCAD X Version 14.6.10 (7164)

**Mode: LTE Band 7, Right Head, Cheek, Mid.ch,
20 MHz Bandwidth, QPSK, 1 RB, 0 RB Offset**

Area Scan (10x17x1): Measurement grid: dx=12mm, dy=12mm

Zoom Scan (7x7x7)/Cube 0: Measurement grid: dx=5mm, dy=5mm, dz=5mm

Reference Value = 9.078 V/m; Power Drift = 0.12 dB

Peak SAR (extrapolated) = 0.212 W/kg

SAR(1 g) = 0.117 W/kg

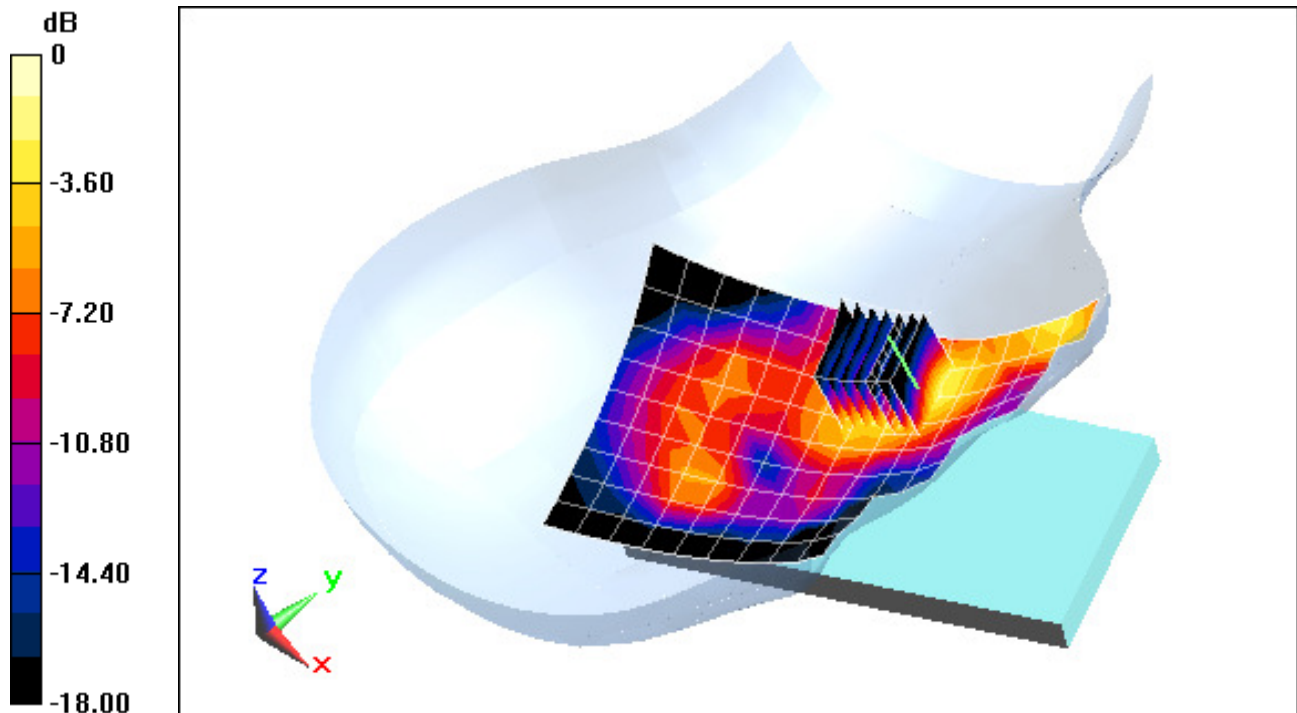

0 dB = 0.148 W/kg = -8.30 dBW/kg

PCTEST ENGINEERING LABORATORY, INC.

DUT: ZNFD950; Type: Portable Handset; Serial: FCC6

Communication System: UID 0, IEEE 802.11b; Frequency: 2437 MHz; Duty Cycle: 1:1

Medium: 2450 Head, Medium parameters used (interpolated):

$f = 2437 \text{ MHz}$; $\sigma = 1.808 \text{ S/m}$; $\epsilon_r = 39.037$; $\rho = 1000 \text{ kg/m}^3$

Phantom section: Right Section

Test Date: 12-02-2013; Ambient Temp: 21.7°C; Tissue Temp: 20.8°C

Probe: ES3DV3 - SN3318; ConvF(4.59, 4.59, 4.59); Calibrated: 4/29/2013;

Sensor-Surface: 3mm (Mechanical Surface Detection)

Electronics: DAE4 Sn1364; Calibrated: 4/22/2013

Phantom: SAM; Type: QD000P40CD; Serial: TP:1758

Measurement SW: DASY52, Version 52.8 (7); SEMCAD X Version 14.6.10 (7164)

Mode: IEEE 802.11b, Right Head, Cheek, Ch 06, 1 Mbps

Area Scan (10x17x1): Measurement grid: dx=12mm, dy=12mm

Zoom Scan (7x7x7)/Cube 0: Measurement grid: dx=5mm, dy=5mm, dz=5mm

Reference Value = 14.122 V/m; Power Drift = -0.02 dB

Peak SAR (extrapolated) = 0.624 W/kg

SAR(1 g) = 0.306 W/kg

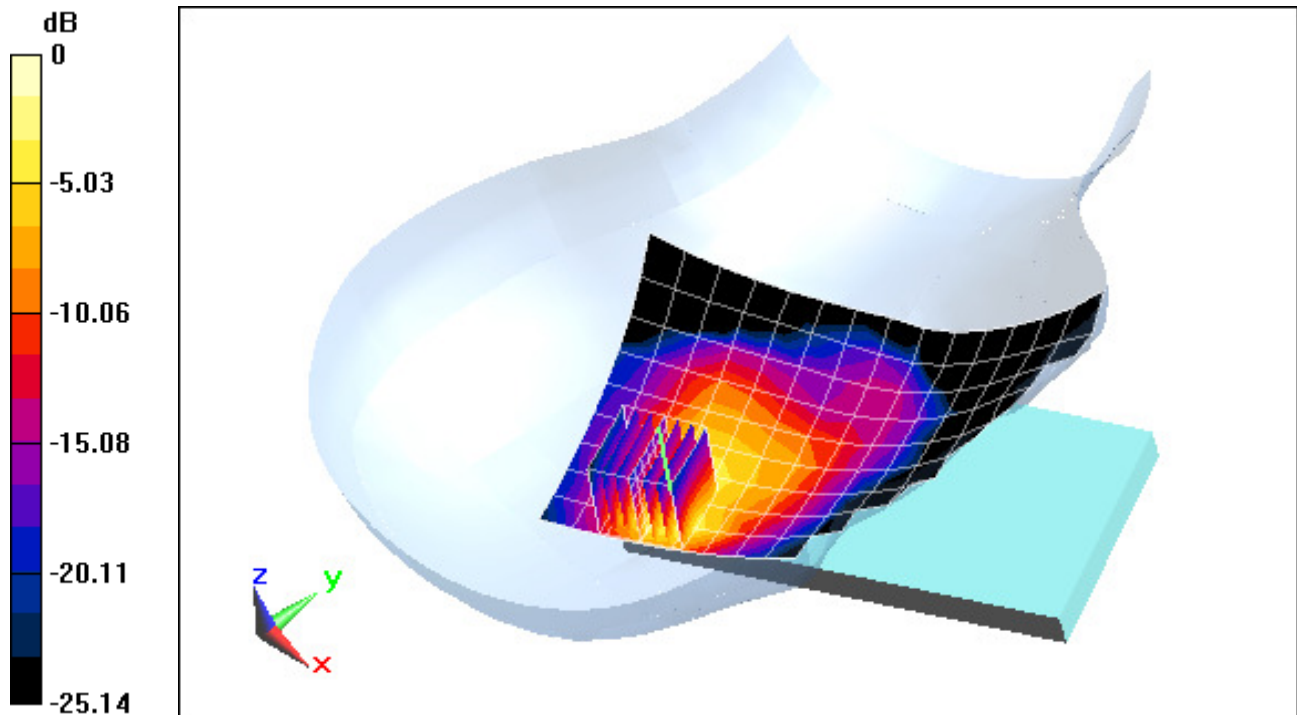

0 dB = 0.387 W/kg = -4.12 dBW/kg

PCTEST ENGINEERING LABORATORY, INC.

DUT: ZNFD950; Type: Portable Handset; Serial: FCC7

Communication System: UID 0, IEEE 802.11a; Frequency: 5745 MHz; Duty Cycle: 1:1

Medium: 5 GHz Head, Medium parameters used:

$f = 5745 \text{ MHz}$; $\sigma = 5.089 \text{ S/m}$; $\epsilon_r = 35.82$; $\rho = 1000 \text{ kg/m}^3$

Phantom section: Right Section

Test Date: 12-04-2013; Ambient Temp: 24.1°C; Tissue Temp: 23.1°C

Probe: EX3DV4 - SN3914; ConvF(4.52, 4.52, 4.52); Calibrated: 10/23/2013;

Sensor-Surface: 1.4mm (Mechanical Surface Detection)

Electronics: DAE4 Sn1333; Calibrated: 11/19/2013

Phantom: SAM V5.0 Right; Type: QD000P40CD; Serial: 1647

Measurement SW: DASY52, Version 52.8 (7); SEMCAD X Version 14.6.10 (7164)

Mode: IEEE 802.11a, 5.8 GHz, Right Head, Cheek, Ch 149, 6 Mbps

Area Scan (13x21x1): Measurement grid: dx=10mm, dy=10mm

Zoom Scan (7x7x7)/Cube 0: Measurement grid: dx=4mm, dy=4mm, dz=1.4mm; Graded Ratio: 1.4

Reference Value = 3.080 V/m; Power Drift = 0.07 dB

Peak SAR (extrapolated) = 0.249 W/kg

SAR(1 g) = 0.052 W/kg

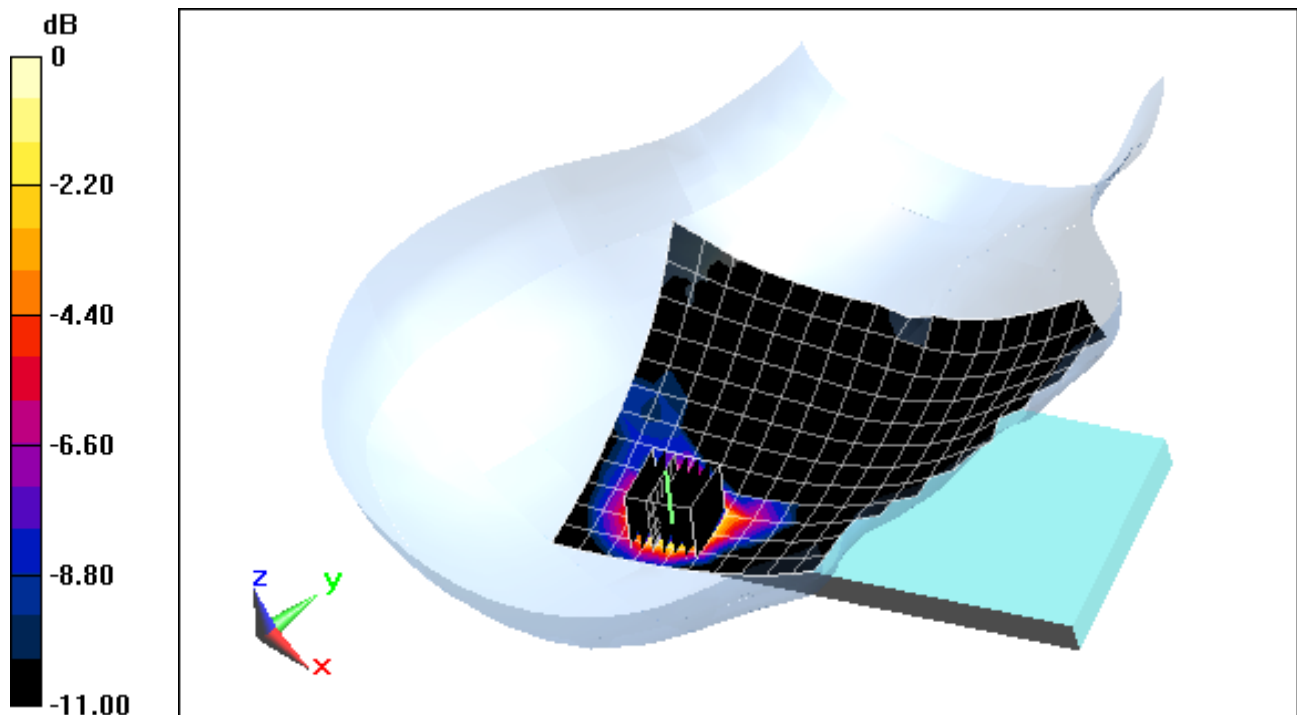

0 dB = 0.151 W/kg = -8.21 dBW/kg

PCTEST ENGINEERING LABORATORY, INC.

DUT: ZNFD950; Type: Portable Handset; Serial: FCC7

Communication System: UID 0, IEEE 802.11a; Frequency: 5200 MHz; Duty Cycle: 1:1

Medium: 5 GHz Head, Medium parameters used:

$f = 5200 \text{ MHz}$; $\sigma = 4.501 \text{ S/m}$; $\epsilon_r = 36.509$; $\rho = 1000 \text{ kg/m}^3$

Phantom section: Right Section

Test Date: 12-04-2013; Ambient Temp: 24.1°C; Tissue Temp: 22.9°C

Probe: EX3DV4 - SN3914; ConvF(4.99, 4.99, 4.99); Calibrated: 10/23/2013;

Sensor-Surface: 1.4mm (Mechanical Surface Detection)

Electronics: DAE4 Sn1333; Calibrated: 11/19/2013

Phantom: SAM V5.0 Right; Type: QD000P40CD; Serial: 1647

Measurement SW: DASY52, Version 52.8 (7); SEMCAD X Version 14.6.10 (7164)

Mode: IEEE 802.11a, 5.2 GHz, Right Head, Cheek, Ch 40, 6 Mbps

Area Scan (13x21x1): Measurement grid: dx=10mm, dy=10mm

Zoom Scan (7x7x7)/Cube 0: Measurement grid: dx=4mm, dy=4mm, dz=1.4mm; Graded Ratio: 1.4

Reference Value = 4.546 V/m; Power Drift = 0.01 dB

Peak SAR (extrapolated) = 0.387 W/kg

SAR(1 g) = 0.108 W/kg

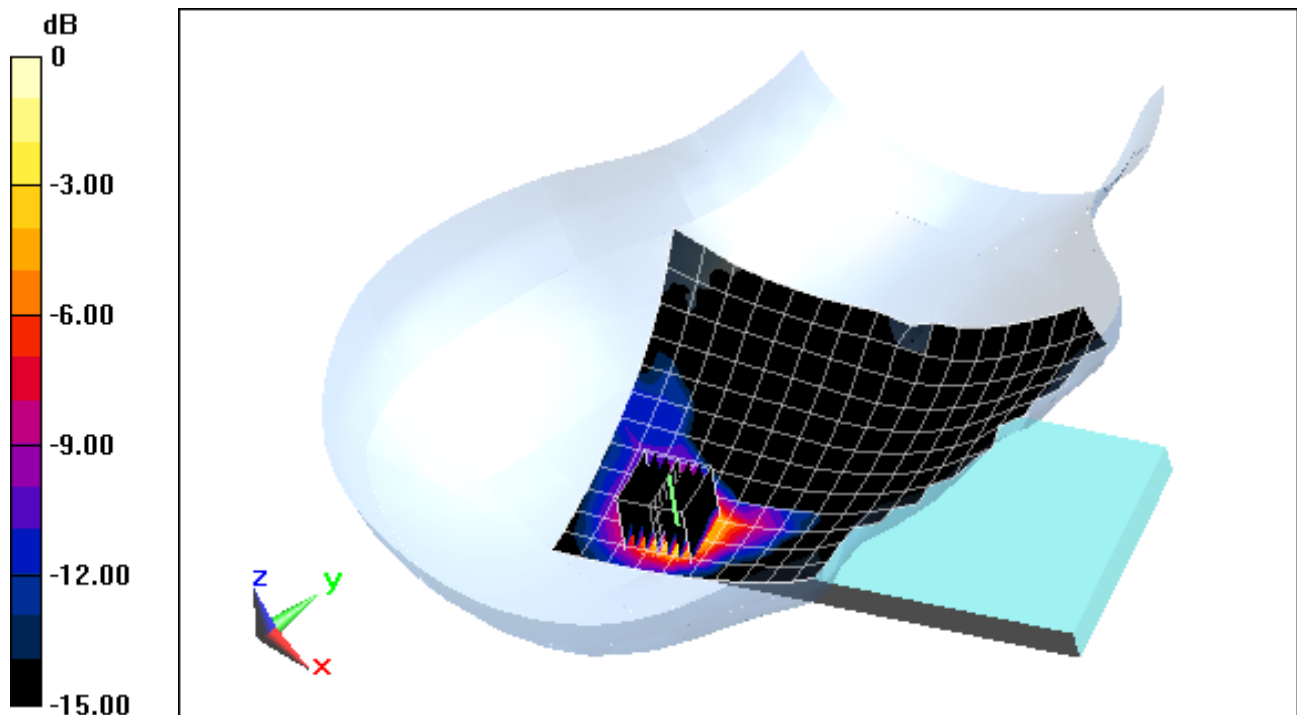

0 dB = 0.253 W/kg = -5.97 dBW/kg

PCTEST ENGINEERING LABORATORY, INC.

DUT: ZNFD950; Type: Portable Handset; Serial: FCC3

Communication System: UID 0, GSM GPRS; 2 Tx slots; Frequency: 836.6 MHz; Duty Cycle: 1:4.15

Medium: 835 Body, Medium parameters used (interpolated):

$f = 836.6 \text{ MHz}$; $\sigma = 1.012 \text{ S/m}$; $\epsilon_r = 53.875$; $\rho = 1000 \text{ kg/m}^3$

Phantom section: Flat Section; Space: 0.8 cm

Test Date: 12-02-2013; Ambient Temp: 23.2°C; Tissue Temp: 21.3°C

Probe: ES3DV3 - SN3209; ConvF(6.28, 6.28, 6.28); Calibrated: 3/15/2013;

Sensor-Surface: 4mm (Mechanical Surface Detection)

Electronics: DAE4 Sn1334; Calibrated: 3/8/2013

Phantom: ELI v5.0; Type: QDOVA002AA; Serial: TP-1158

Measurement SW: DASYS2, Version 52.8 (7); SEMCAD X Version 14.6.10 (7164)

Mode: GPRS 850, Body SAR, Back Side, Mid.ch, 2 Tx Slots

Area Scan (9x14x1): Measurement grid: dx=15mm, dy=15mm

Zoom Scan (5x5x7)/Cube 0: Measurement grid: dx=8mm, dy=8mm, dz=5mm

Reference Value = 24.028 V/m; Power Drift = 0.03 dB

Peak SAR (extrapolated) = 0.692 W/kg

SAR(1 g) = 0.543 W/kg

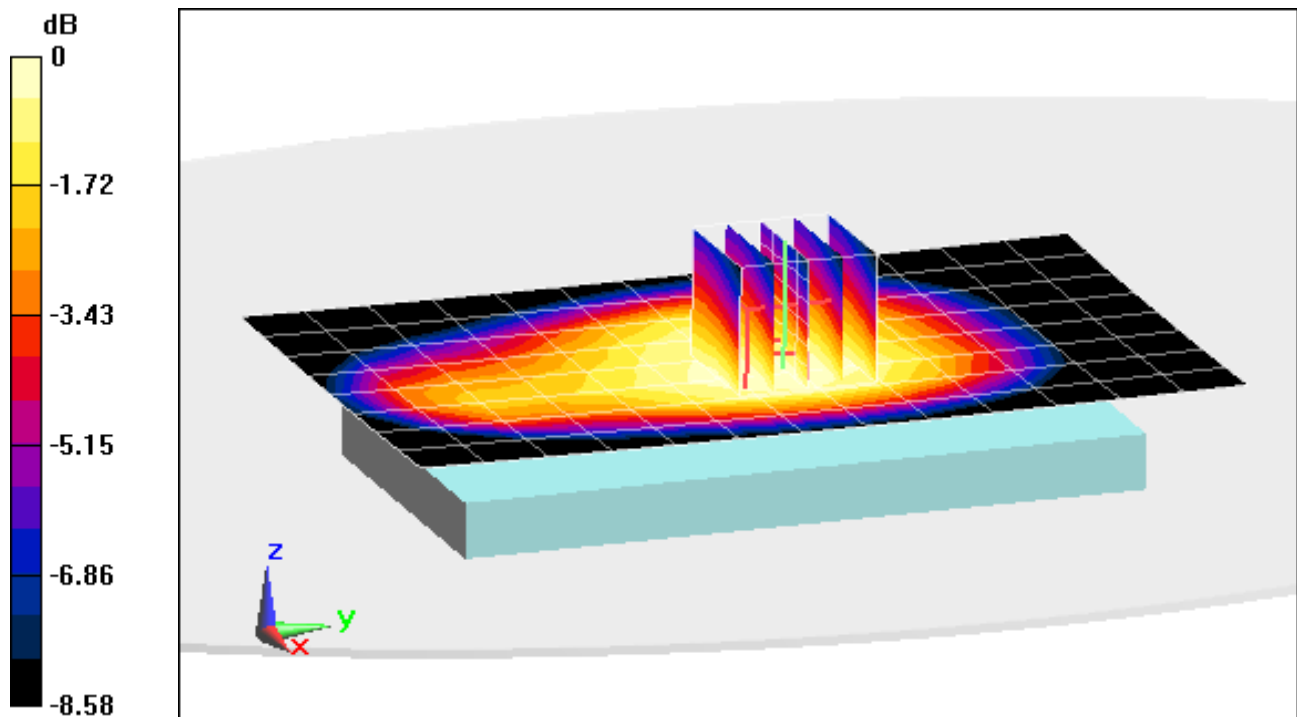

0 dB = 0.568 W/kg = -2.46 dBW/kg

PCTEST ENGINEERING LABORATORY, INC.

DUT: ZNFD950; Type: Portable Handset; Serial: FCC3

Communication System: UID 0, GSM GPRS; 2 Tx slots; Frequency: 836.6 MHz; Duty Cycle: 1:4.15

Medium: 835 Body, Medium parameters used (interpolated):

$f = 836.6 \text{ MHz}$; $\sigma = 1.012 \text{ S/m}$; $\epsilon_r = 53.875$; $\rho = 1000 \text{ kg/m}^3$

Phantom section: Flat Section; Space: 0.8 cm

Test Date: 12-02-2013; Ambient Temp: 23.2°C; Tissue Temp: 21.3°C

Probe: ES3DV3 - SN3209; ConvF(6.28, 6.28, 6.28); Calibrated: 3/15/2013;

Sensor-Surface: 4mm (Mechanical Surface Detection)

Electronics: DAE4 Sn1334; Calibrated: 3/8/2013

Phantom: ELI v5.0; Type: QDOVA002AA; Serial: TP-1158

Measurement SW: DASY52, Version 52.8 (7); SEMCAD X Version 14.6.10 (7164)

Mode: GPRS 850, Body SAR, Front Side, Mid.ch, 2 Tx Slots

Area Scan (9x14x1): Measurement grid: dx=15mm, dy=15mm

Zoom Scan (5x5x7)/Cube 0: Measurement grid: dx=8mm, dy=8mm, dz=5mm

Reference Value = 25.740 V/m; Power Drift = 0.01 dB

Peak SAR (extrapolated) = 1.11 W/kg

SAR(1 g) = 0.656 W/kg

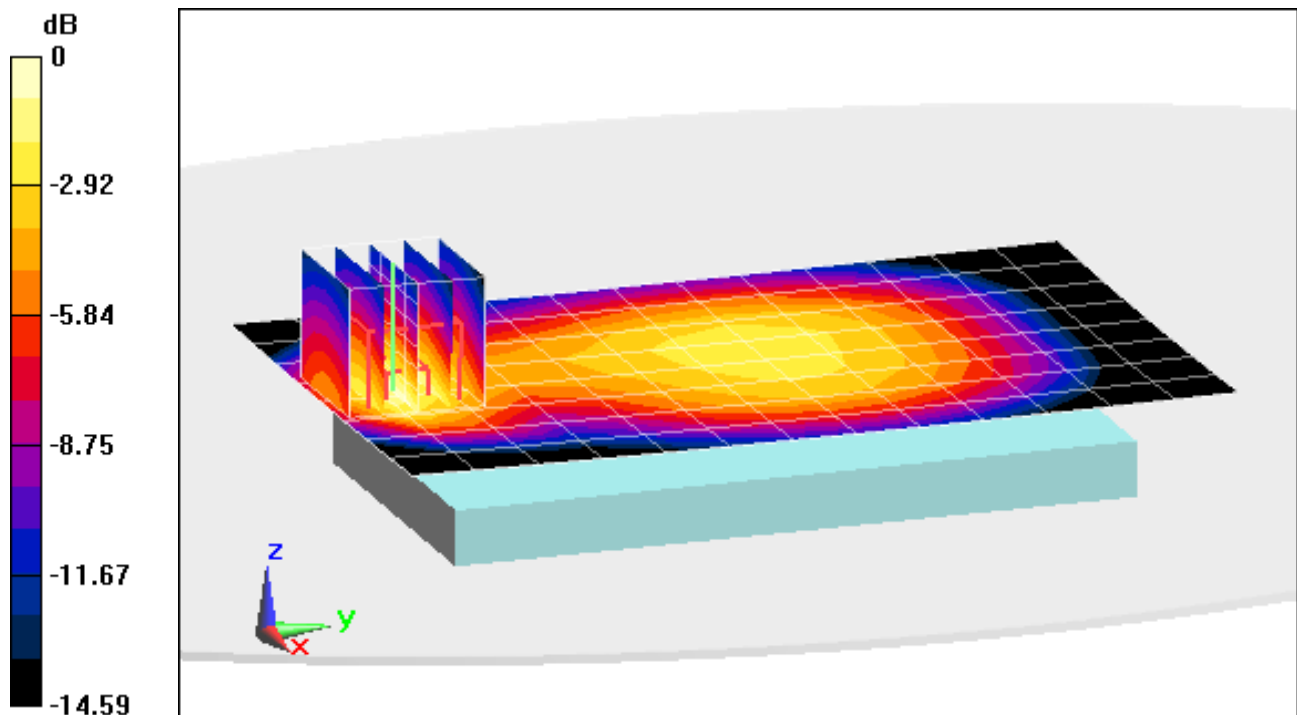

0 dB = 0.722 W/kg = -1.41 dBW/kg

PCTEST ENGINEERING LABORATORY, INC.

DUT: ZNFD950; Type: Portable Handset; Serial: FCC3

Communication System: UID 0, UMTS; Frequency: 836.6 MHz; Duty Cycle: 1:1

Medium: 835 Body, Medium parameters used (interpolated):

$f = 836.6 \text{ MHz}$; $\sigma = 1.012 \text{ S/m}$; $\epsilon_r = 53.875$; $\rho = 1000 \text{ kg/m}^3$

Phantom section: Flat Section; Space: 0.8 cm

Test Date: 12-02-2013; Ambient Temp: 23.2°C; Tissue Temp: 21.3°C

Probe: ES3DV3 - SN3209; ConvF(6.28, 6.28, 6.28); Calibrated: 3/15/2013;

Sensor-Surface: 4mm (Mechanical Surface Detection)

Electronics: DAE4 Sn1334; Calibrated: 3/8/2013

Phantom: ELI v5.0; Type: QDOVA002AA; Serial: TP-1158

Measurement SW: DASYS2, Version 52.8 (7); SEMCAD X Version 14.6.10 (7164)

Mode: UMTS 850, Body SAR, Back Side, Mid.ch

Area Scan (9x14x1): Measurement grid: dx=15mm, dy=15mm

Zoom Scan (5x5x7)/Cube 0: Measurement grid: dx=8mm, dy=8mm, dz=5mm

Reference Value = 22.274 V/m; Power Drift = -0.17 dB

Peak SAR (extrapolated) = 0.606 W/kg

SAR(1 g) = 0.474 W/kg

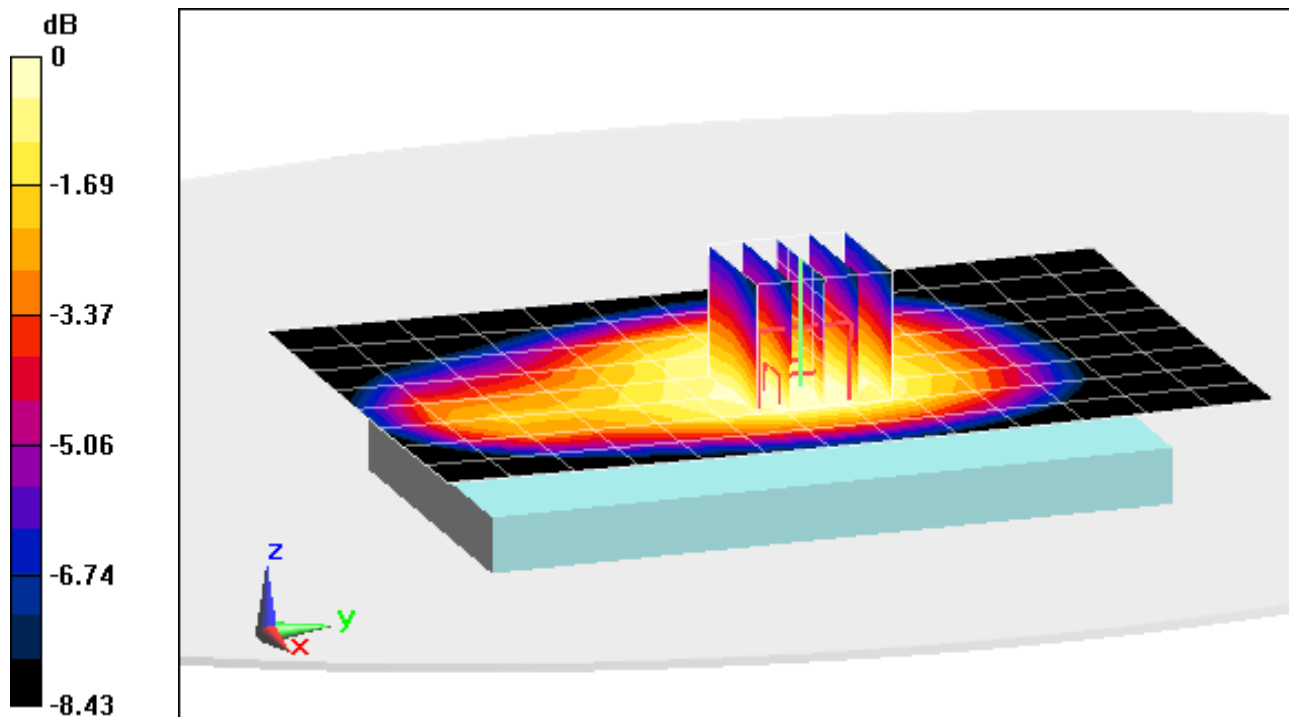

0 dB = 0.494 W/kg = -3.06 dBW/kg

PCTEST ENGINEERING LABORATORY, INC.

DUT: ZNFD950; Type: Portable Handset; Serial: FCC3

Communication System: UID 0, UMTS; Frequency: 836.6 MHz; Duty Cycle: 1:1

Medium: 835 Body, Medium parameters used (interpolated):

$f = 836.6 \text{ MHz}$; $\sigma = 1.012 \text{ S/m}$; $\epsilon_r = 53.875$; $\rho = 1000 \text{ kg/m}^3$

Phantom section: Flat Section; Space: 0.8 cm

Test Date: 12-02-2013; Ambient Temp: 23.2°C; Tissue Temp: 21.3°C

Probe: ES3DV3 - SN3209; ConvF(6.28, 6.28, 6.28); Calibrated: 3/15/2013;

Sensor-Surface: 4mm (Mechanical Surface Detection)

Electronics: DAE4 Sn1334; Calibrated: 3/8/2013

Phantom: ELI v5.0; Type: QDOVA002AA; Serial: TP-1158

Measurement SW: DASY52, Version 52.8 (7); SEMCAD X Version 14.6.10 (7164)

Mode: UMTS 850, Body SAR, Front Side, Mid.ch

Area Scan (9x14x1): Measurement grid: dx=15mm, dy=15mm

Zoom Scan (5x5x7)/Cube 0: Measurement grid: dx=8mm, dy=8mm, dz=5mm

Reference Value = 23.150 V/m; Power Drift = 0.01 dB

Peak SAR (extrapolated) = 0.892 W/kg

SAR(1 g) = 0.532 W/kg

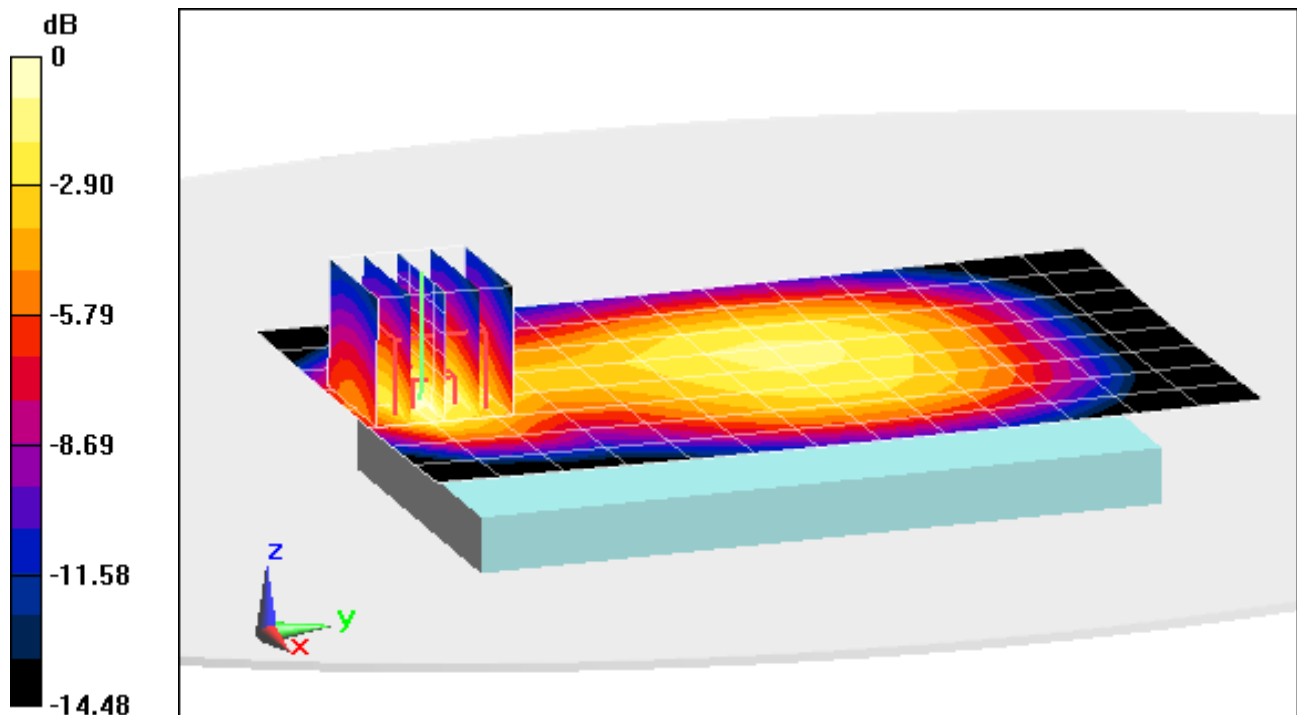

0 dB = 0.581 W/kg = -2.36 dBW/kg

PCTEST ENGINEERING LABORATORY, INC.

DUT: ZNFD950; Type: Portable Handset; Serial: FCC3

Communication System: UID 0, GSM GPRS; 2 Tx slots; Frequency: 1880 MHz; Duty Cycle: 1:4.15

Medium: 1900 Body, Medium parameters used:

$f = 1880 \text{ MHz}$; $\sigma = 1.513 \text{ S/m}$; $\epsilon_r = 52.103$; $\rho = 1000 \text{ kg/m}^3$

Phantom section: Flat Section; Space: 0.8 cm

Test Date: 12-02-2013; Ambient Temp: 22.2°C; Tissue Temp: 21.1°C

Probe: ES3DV3 - SN3263; ConvF(4.78, 4.78, 4.78); Calibrated: 5/16/2013;

Sensor-Surface: 4mm (Mechanical Surface Detection)

Electronics: DAE4 Sn859; Calibrated: 5/13/2013

Phantom: SAM Main; Type: SAM 4.0; Serial: TP-1406

Measurement SW: DASY4, Version 4.7 (80); SEMCAD X Version 14.6.10 (7164)

Mode: GPRS 1900, Body SAR, Back Side, Mid.ch, 2 Tx Slots

Area Scan (8x14x1): Measurement grid: dx=15mm, dy=15mm

Zoom Scan (5x5x7)/Cube 0: Measurement grid: dx=8mm, dy=8mm, dz=5mm

Reference Value = 18.125 V/m; Power Drift = 0.02 dB

Peak SAR (extrapolated) = 0.889 W/kg

SAR(1 g) = 0.536 W/kg

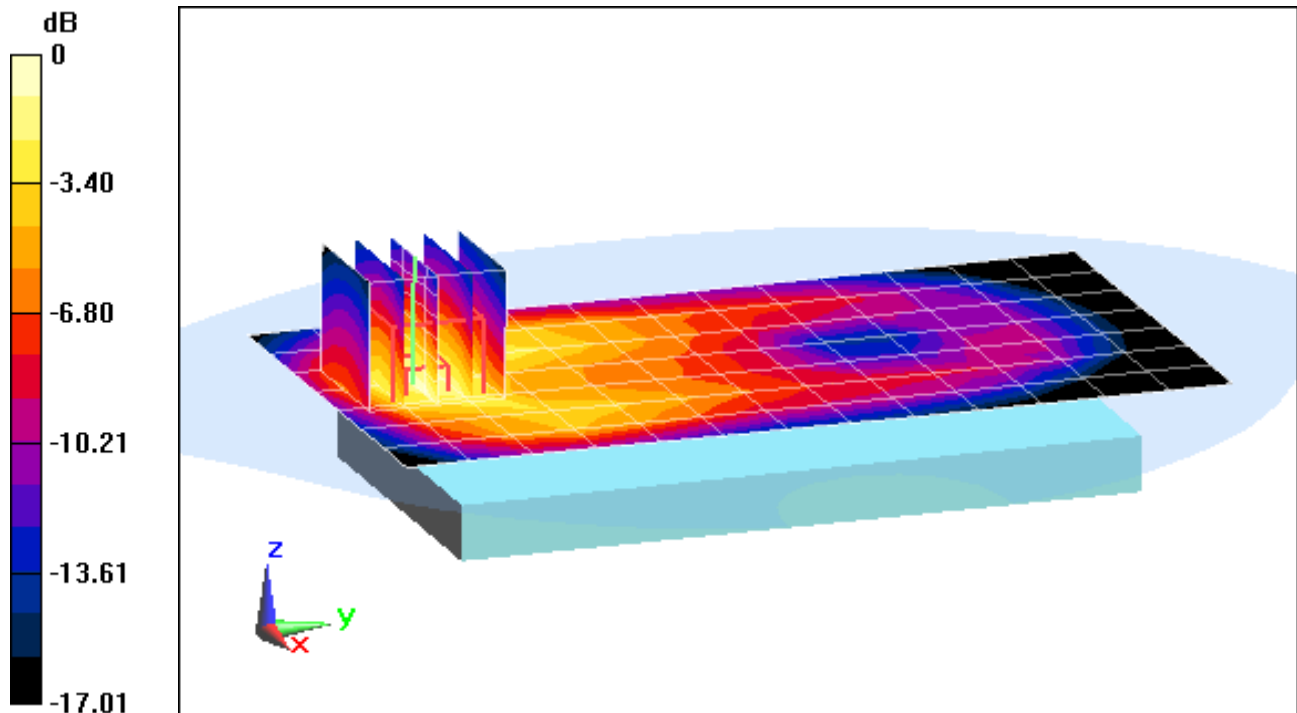

0 dB = 0.603 W/kg = -2.20 dBW/kg

PCTEST ENGINEERING LABORATORY, INC.

DUT: ZNFD950; Type: Portable Handset; Serial: FCC3

Communication System: UID 0, UMTS; Frequency: 1907.6 MHz; Duty Cycle: 1:1

Medium: 1900 Body, Medium parameters used (interpolated):

$f = 1907.6 \text{ MHz}$; $\sigma = 1.546 \text{ S/m}$; $\epsilon_r = 51.997$; $\rho = 1000 \text{ kg/m}^3$

Phantom section: Flat Section; Space: 0.8 cm

Test Date: 12-02-2013; Ambient Temp: 22.2°C; Tissue Temp: 21.1°C

Probe: ES3DV3 - SN3263; ConvF(4.78, 4.78, 4.78); Calibrated: 5/16/2013;

Sensor-Surface: 4mm (Mechanical Surface Detection)

Electronics: DAE4 Sn859; Calibrated: 5/13/2013

Phantom: SAM Main; Type: SAM 4.0; Serial: TP-1406

Measurement SW: DASY4, Version 4.7 (80); SEMCAD X Version 14.6.10 (7164)

Mode: UMTS 1900, Body SAR, Back Side, High.ch

Area Scan (8x14x1): Measurement grid: dx=15mm, dy=15mm

Zoom Scan (5x5x7)/Cube 0: Measurement grid: dx=8mm, dy=8mm, dz=5mm

Reference Value = 25.245 V/m; Power Drift = 0.05 dB

Peak SAR (extrapolated) = 1.46 W/kg

SAR(1 g) = 0.866 W/kg

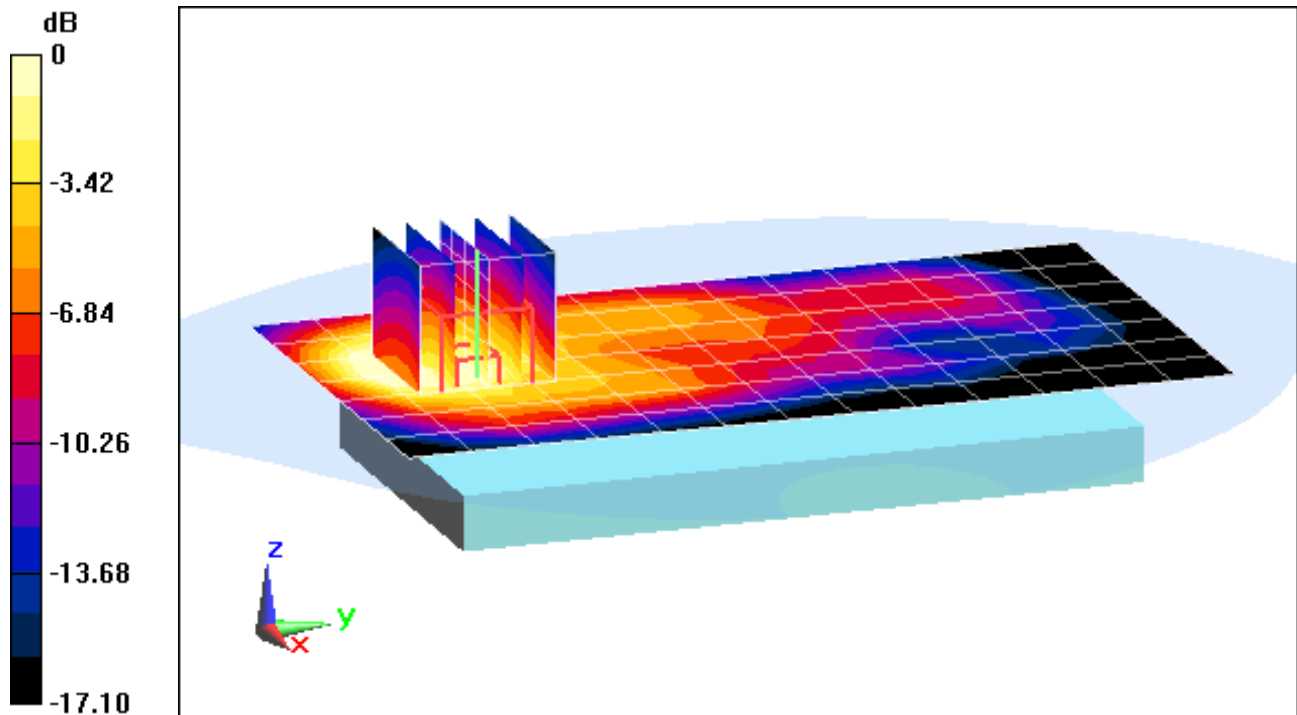

0 dB = 0.987 W/kg = -0.06 dBW/kg

PCTEST ENGINEERING LABORATORY, INC.

DUT: ZNFD950; Type: Portable Handset; Serial: FCC3

Communication System: UID 0, UMTS; Frequency: 1907.6 MHz; Duty Cycle: 1:1

Medium: 1900 Body, Medium parameters used (interpolated):

$f = 1907.6 \text{ MHz}$; $\sigma = 1.546 \text{ S/m}$; $\epsilon_r = 51.997$; $\rho = 1000 \text{ kg/m}^3$

Phantom section: Flat Section; Space: 1.0 cm

Test Date: 12-02-2013; Ambient Temp: 22.2°C; Tissue Temp: 21.1°C

Probe: ES3DV3 - SN3263; ConvF(4.78, 4.78, 4.78); Calibrated: 5/16/2013;

Sensor-Surface: 4mm (Mechanical Surface Detection)

Electronics: DAE4 Sn859; Calibrated: 5/13/2013

Phantom: SAM Main; Type: SAM 4.0; Serial: TP-1406

Measurement SW: DASY4, Version 4.7 (80); SEMCAD X Version 14.6.10 (7164)

Mode: UMTS 1900, Body SAR, Bottom Edge, High.ch

Area Scan (11x8x1): Measurement grid: dx=5mm, dy=15mm

Zoom Scan (5x5x7)/Cube 0: Measurement grid: dx=8mm, dy=8mm, dz=5mm

Reference Value = 24.564 V/m; Power Drift = 0.01 dB

Peak SAR (extrapolated) = 1.43 W/kg

SAR(1 g) = 0.872 W/kg

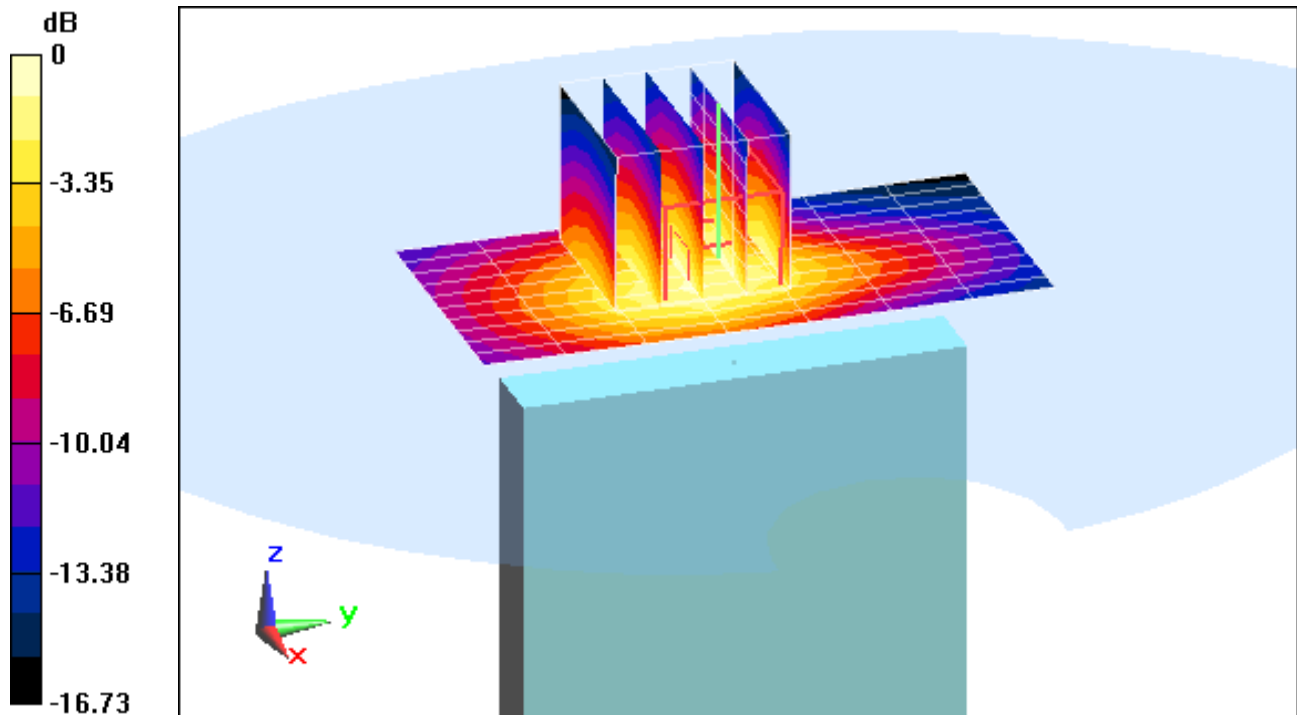

0 dB = 0.946 W/kg = -0.24 dBW/kg

PCTEST ENGINEERING LABORATORY, INC.

DUT: ZNFD950; Type: Portable Handset; Serial: FCC6

Communication System: UID 0, LTE Band 17; Frequency: 710 MHz; Duty Cycle: 1:1

Medium: 750 Body, Medium parameters used:

$f = 710 \text{ MHz}$; $\sigma = 0.945 \text{ S/m}$; $\epsilon_r = 56.788$; $\rho = 1000 \text{ kg/m}^3$

Phantom section: Flat Section; Space: 0.8 cm

Test Date: 12-04-2013; Ambient Temp: 23.5°C; Tissue Temp: 22.5°C

Probe: ES3DV3 - SN3288; ConvF(6.25, 6.25, 6.25); Calibrated: 9/23/2013;

Sensor-Surface: 4mm (Mechanical Surface Detection)

Electronics: DAE4 Sn1323; Calibrated: 9/17/2013

Phantom: SAM with CRP; Type: SAM; Serial: TP1375

Measurement SW: DASY4, Version 4.7 (80); SEMCAD X Version 14.6.10 (7164)

**Mode: LTE Band 17, Body SAR, Back Side, Mid.ch,
10 MHz Bandwidth, QPSK, 1 RB, 0 RB Offset**

Area Scan (9x14x1): Measurement grid: dx=15mm, dy=15mm

Zoom Scan (5x5x7)/Cube 0: Measurement grid: dx=8mm, dy=8mm, dz=5mm

Reference Value = 20.086 V/m; Power Drift = 0.00 dB

Peak SAR (extrapolated) = 0.543 W/kg

SAR(1 g) = 0.347 W/kg

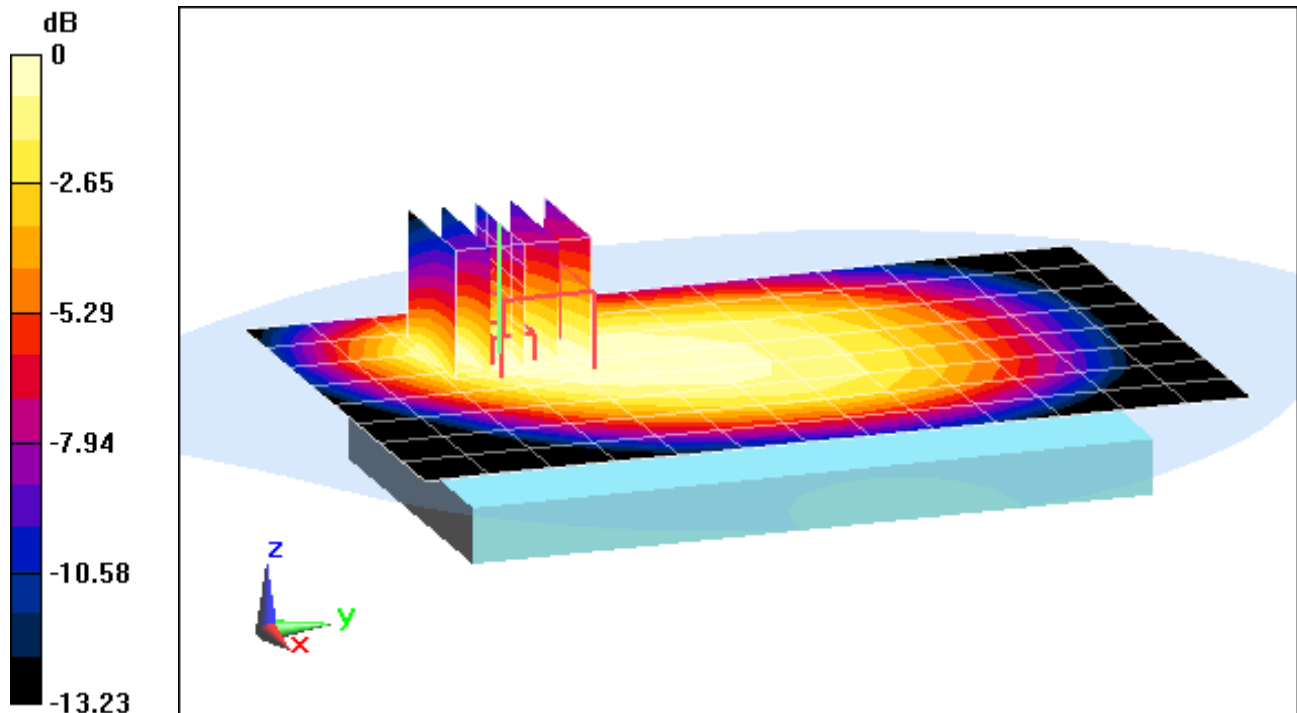

0 dB = 0.370 W/kg = -4.32 dBW/kg

PCTEST ENGINEERING LABORATORY, INC.

DUT: ZNFD950; Type: Portable Handset; Serial: FCC6

Communication System: UID 0, LTE Band 17; Frequency: 710 MHz; Duty Cycle: 1:1

Medium: 750 Body, Medium parameters used:

$f = 710 \text{ MHz}$; $\sigma = 0.945 \text{ S/m}$; $\epsilon_r = 56.788$; $\rho = 1000 \text{ kg/m}^3$

Phantom section: Flat Section; Space: 1.0 cm

Test Date: 12-04-2013; Ambient Temp: 23.5°C; Tissue Temp: 22.5°C

Probe: ES3DV3 - SN3288; ConvF(6.25, 6.25, 6.25); Calibrated: 9/23/2013;

Sensor-Surface: 4mm (Mechanical Surface Detection)

Electronics: DAE4 Sn1323; Calibrated: 9/17/2013

Phantom: SAM with CRP; Type: SAM; Serial: TP1375

Measurement SW: DASY4, Version 4.7 (80); SEMCAD X Version 14.6.10 (7164)

**Mode: LTE Band 17, Body SAR, Right Edge, Mid.ch,
10 MHz Bandwidth, QPSK, 1 RB, 0 RB Offset**

Area Scan (11x15x1): Measurement grid: dx=5mm, dy=15mm

Zoom Scan (5x5x7)/Cube 0: Measurement grid: dx=8mm, dy=8mm, dz=5mm

Reference Value = 20.598 V/m; Power Drift = 0.08 dB

Peak SAR (extrapolated) = 0.485 W/kg

SAR(1 g) = 0.360 W/kg

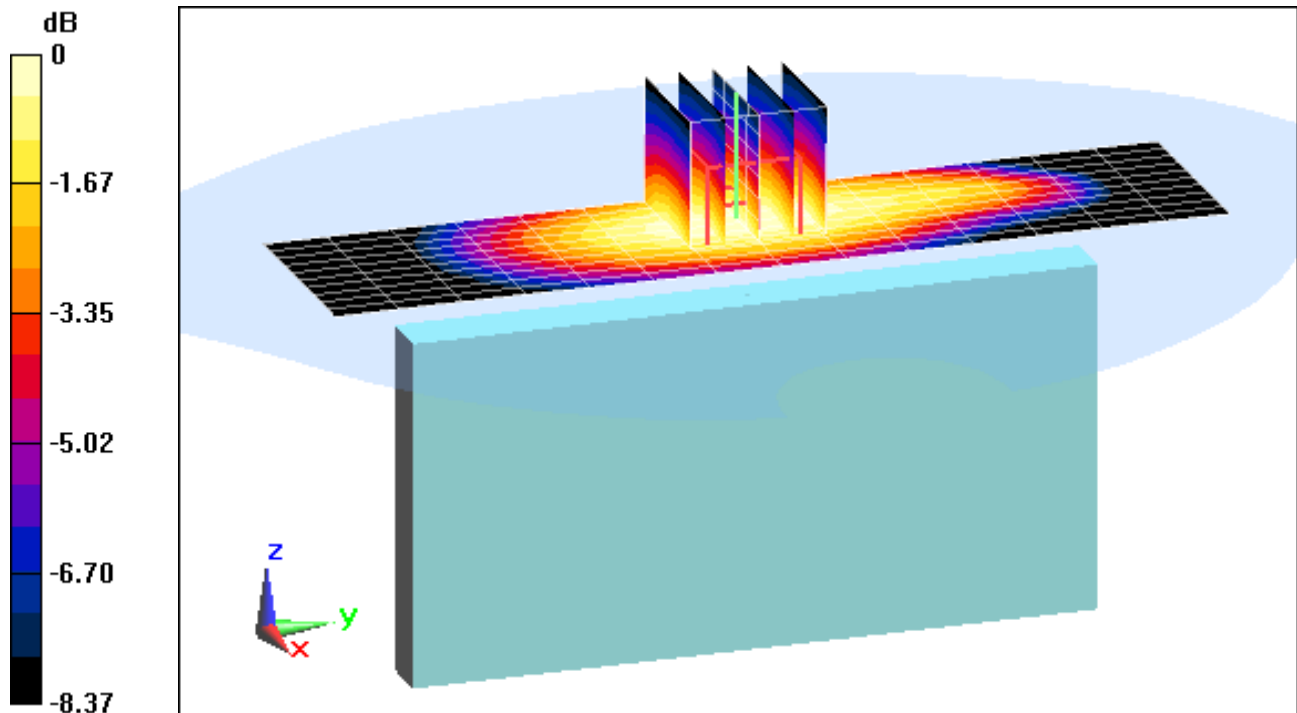

0 dB = 0.383 W/kg = -4.17 dBW/kg

PCTEST ENGINEERING LABORATORY, INC.

DUT: ZNFD950; Type: Portable Handset; Serial: FCC6

Communication System: UID 0, LTE Band 5 (Cell.); Frequency: 836.5 MHz; Duty Cycle: 1:1

Medium: 835 Body, Medium parameters used (interpolated):

$$f = 836.5 \text{ MHz}; \sigma = 1 \text{ S/m}; \epsilon_r = 54.175; \rho = 1000 \text{ kg/m}^3$$

Phantom section: Flat Section; Space: 0.8 cm

Test Date: 12-05-2013; Ambient Temp: 24.5°C; Tissue Temp: 23.0°C

Probe: ES3DV3 - SN3209; ConvF(6.28, 6.28, 6.28); Calibrated: 3/15/2013;

Sensor-Surface: 4mm (Mechanical Surface Detection)

Electronics: DAE4 Sn1334; Calibrated: 3/8/2013

Phantom: ELI v5.0; Type: QDOVA002AA; Serial: TP-1158

Measurement SW: DASYS2, Version 52.8 (7); SEMCAD X Version 14.6.10 (7164)

**Mode: LTE Band 5 (Cell.), Body SAR, Back Side, Mid.ch,
10 MHz Bandwidth, QPSK, 1 RB, 0 RB Offset**

Area Scan (9x14x1): Measurement grid: dx=15mm, dy=15mm

Zoom Scan (6x5x7)/Cube 0: Measurement grid: dx=8mm, dy=8mm, dz=5mm

Reference Value = 20.825 V/m; Power Drift = 0.00 dB

Peak SAR (extrapolated) = 0.506 W/kg

SAR(1 g) = 0.397 W/kg

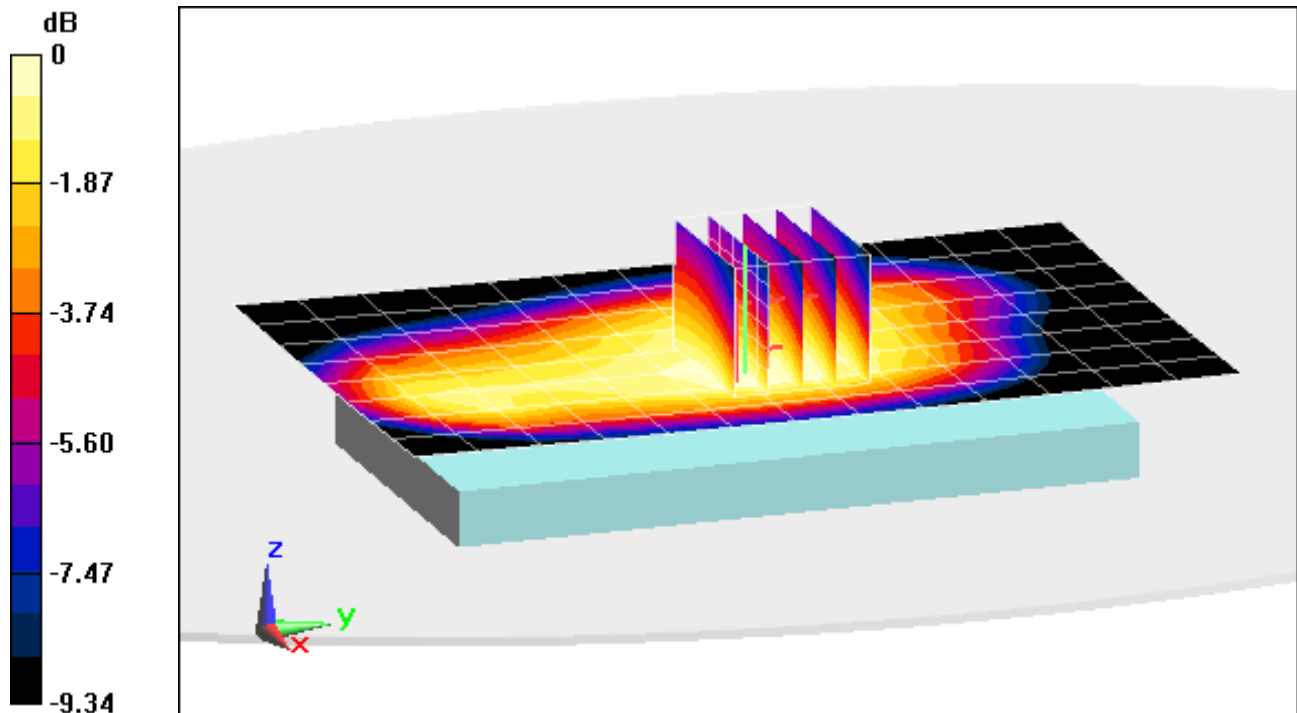

0 dB = 0.415 W/kg = -3.82 dBW/kg

PCTEST ENGINEERING LABORATORY, INC.

DUT: ZNFD950; Type: Portable Handset; Serial: FCC6

Communication System: UID 0, LTE Band 5 (Cell.); Frequency: 836.5 MHz; Duty Cycle: 1:1

Medium: 835 Body, Medium parameters used (interpolated):

$$f = 836.5 \text{ MHz}; \sigma = 1 \text{ S/m}; \epsilon_r = 54.175; \rho = 1000 \text{ kg/m}^3$$

Phantom section: Flat Section; Space: 0.8 cm

Test Date: 12-05-2013; Ambient Temp: 24.5°C; Tissue Temp: 23.0°C

Probe: ES3DV3 - SN3209; ConvF(6.28, 6.28, 6.28); Calibrated: 3/15/2013;

Sensor-Surface: 4mm (Mechanical Surface Detection)

Electronics: DAE4 Sn1334; Calibrated: 3/8/2013

Phantom: ELI v5.0; Type: QDOVA002AA; Serial: TP-1158

Measurement SW: DASY52, Version 52.8 (7); SEMCAD X Version 14.6.10 (7164)

**Mode: LTE Band 5 (Cell.), Body SAR, Front Side, Mid.ch,
10 MHz Bandwidth, QPSK, 1 RB, 0 RB Offset**

Area Scan (9x14x1): Measurement grid: dx=15mm, dy=15mm

Zoom Scan (5x5x7)/Cube 0: Measurement grid: dx=8mm, dy=8mm, dz=5mm

Reference Value = 22.798 V/m; Power Drift = -0.07 dB

Peak SAR (extrapolated) = 0.733 W/kg

SAR(1 g) = 0.448 W/kg

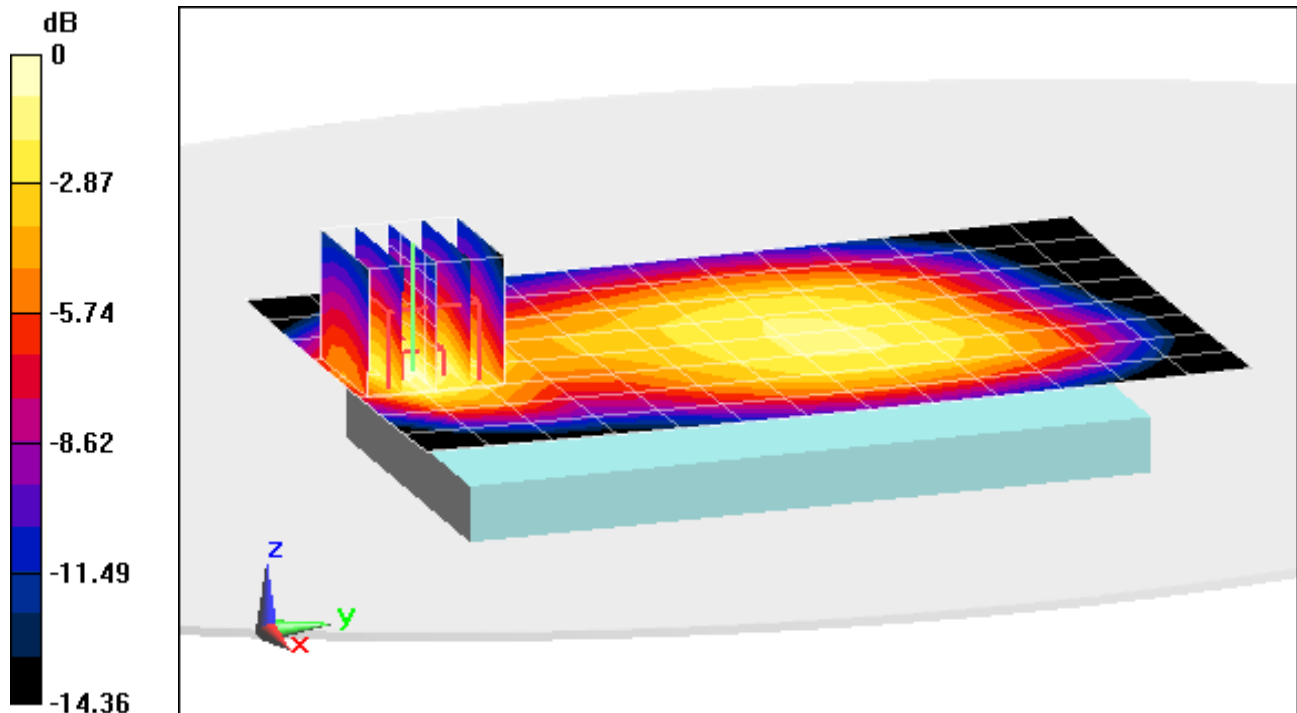

0 dB = 0.494 W/kg = -3.06 dBW/kg

PCTEST ENGINEERING LABORATORY, INC.

DUT: ZNFD950; Type: Portable Handset; Serial: FCC6

Communication System: UID 0, LTE Band 4 (AWS); Frequency: 1750 MHz; Duty Cycle: 1:1

Medium: 1750 Body, Medium parameters used:

$f = 1750 \text{ MHz}$; $\sigma = 1.454 \text{ S/m}$; $\epsilon_r = 52.145$; $\rho = 1000 \text{ kg/m}^3$

Phantom section: Flat Section; Space: 0.8 cm

Test Date: 12-05-2013; Ambient Temp: 21.8°C; Tissue Temp: 21.3°C

Probe: ES3DV3 - SN3319; ConvF(5.22, 5.22, 5.22); Calibrated: 6/28/2013;

Sensor-Surface: 4mm (Mechanical Surface Detection)

Electronics: DAE4 Sn1368; Calibrated: 4/22/2013

Phantom: SAM front; Type: QD000P40CD; Serial: TP:1759

Measurement SW: DASY52, Version 52.8 (7); SEMCAD X Version 14.6.10 (7164)

**Mode: LTE Band 4 (AWS), Body SAR, Back Side, High.ch,
10 MHz Bandwidth, QPSK, 1 RB, 25 RB Offset**

Area Scan (9x14x1): Measurement grid: dx=15mm, dy=15mm

Zoom Scan (5x5x7)/Cube 0: Measurement grid: dx=8mm, dy=8mm, dz=5mm

Reference Value = 23.340 V/m; Power Drift = -0.06 dB

Peak SAR (extrapolated) = 1.23 W/kg

SAR(1 g) = 0.742 W/kg

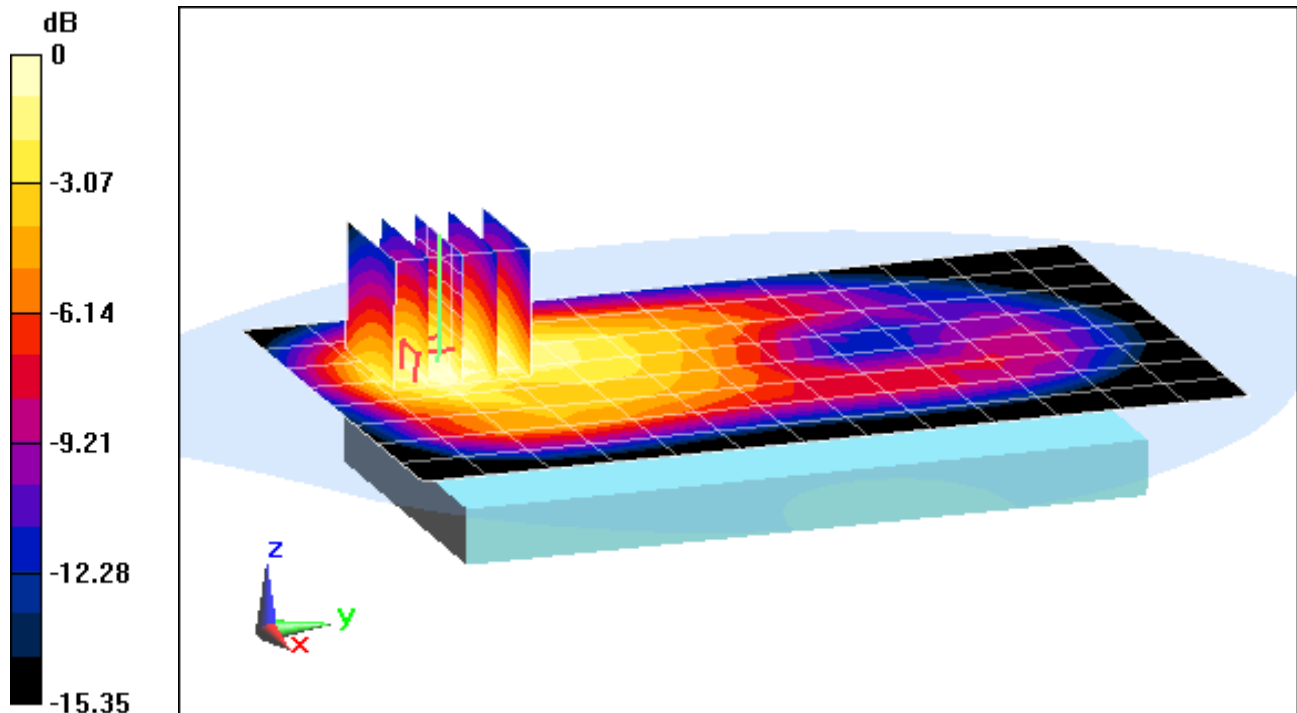

0 dB = 0.780 W/kg = -1.08 dBW/kg

PCTEST ENGINEERING LABORATORY, INC.

DUT: ZNFD950; Type: Portable Handset; Serial: FCC6

Communication System: UID 0, LTE Band 4 (AWS); Frequency: 1750 MHz; Duty Cycle: 1:1

Medium: 1750 Body, Medium parameters used:

$f = 1750 \text{ MHz}$; $\sigma = 1.454 \text{ S/m}$; $\epsilon_r = 52.145$; $\rho = 1000 \text{ kg/m}^3$

Phantom section: Flat Section; Space: 0.8 cm

Test Date: 12-05-2013; Ambient Temp: 21.8°C; Tissue Temp: 21.3°C

Probe: ES3DV3 - SN3319; ConvF(5.22, 5.22, 5.22); Calibrated: 6/28/2013;

Sensor-Surface: 4mm (Mechanical Surface Detection)

Electronics: DAE4 Sn1368; Calibrated: 4/22/2013

Phantom: SAM front; Type: QD000P40CD; Serial: TP:1759

Measurement SW: DASY52, Version 52.8 (7); SEMCAD X Version 14.6.10 (7164)

**Mode: LTE Band 4 (AWS), Body SAR, Front Side, High.ch,
10 MHz Bandwidth, QPSK, 1 RB, 25 RB Offset**

Area Scan (9x14x1): Measurement grid: dx=15mm, dy=15mm

Zoom Scan (5x5x7)/Cube 0: Measurement grid: dx=8mm, dy=8mm, dz=5mm

Reference Value = 26.442 V/m; Power Drift = 0.07 dB

Peak SAR (extrapolated) = 1.68 W/kg

SAR(1 g) = 0.915 W/kg

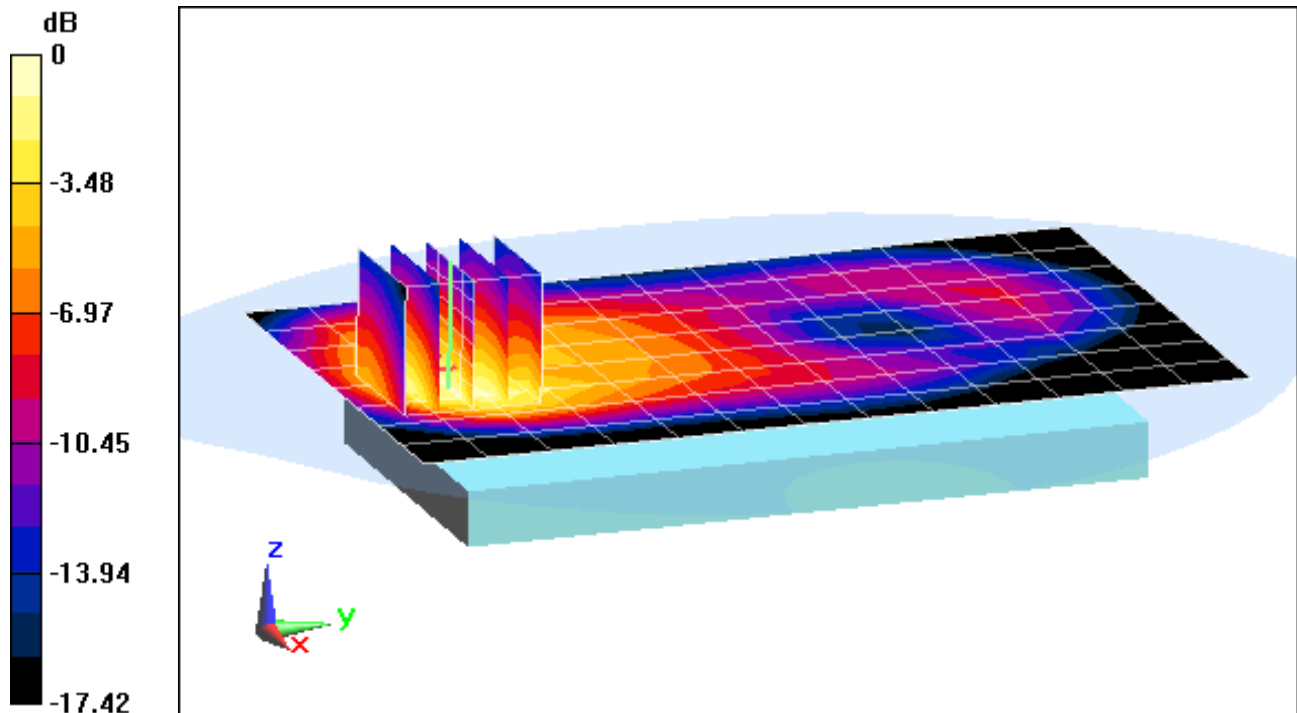

0 dB = 1.03 W/kg = 0.13 dBW/kg

PCTEST ENGINEERING LABORATORY, INC.

DUT: ZNFD950; Type: Portable Handset; Serial: FCC6

Communication System: UID 0, LTE Band 2; Frequency: 1905 MHz; Duty Cycle: 1:1

Medium: 1900 Body, Medium parameters used (interpolated):

$f = 1905 \text{ MHz}$; $\sigma = 1.543 \text{ S/m}$; $\epsilon_r = 52.007$; $\rho = 1000 \text{ kg/m}^3$

Phantom section: Flat Section; Space: 0.8 cm

Test Date: 12-02-2013; Ambient Temp: 22.2°C; Tissue Temp: 21.1°C

Probe: ES3DV3 - SN3263; ConvF(4.78, 4.78, 4.78); Calibrated: 5/16/2013;

Sensor-Surface: 4mm (Mechanical Surface Detection)

Electronics: DAE4 Sn859; Calibrated: 5/13/2013

Phantom: SAM Main; Type: SAM 4.0; Serial: TP-1406

Measurement SW: DASY4, Version 4.7 (80); SEMCAD X Version 14.6.10 (7164)

**Mode: LTE Band 2 (PCS), Body SAR, Back Side, High.ch,
10 MHz Bandwidth, QPSK, 1 RB, 25 RB Offset**

Area Scan (8x14x1): Measurement grid: dx=15mm, dy=15mm

Zoom Scan (5x5x7)/Cube 0: Measurement grid: dx=8mm, dy=8mm, dz=5mm

Reference Value = 27.399 V/m; Power Drift = 0.01 dB

Peak SAR (extrapolated) = 1.64 W/kg

SAR(1 g) = 0.987 W/kg

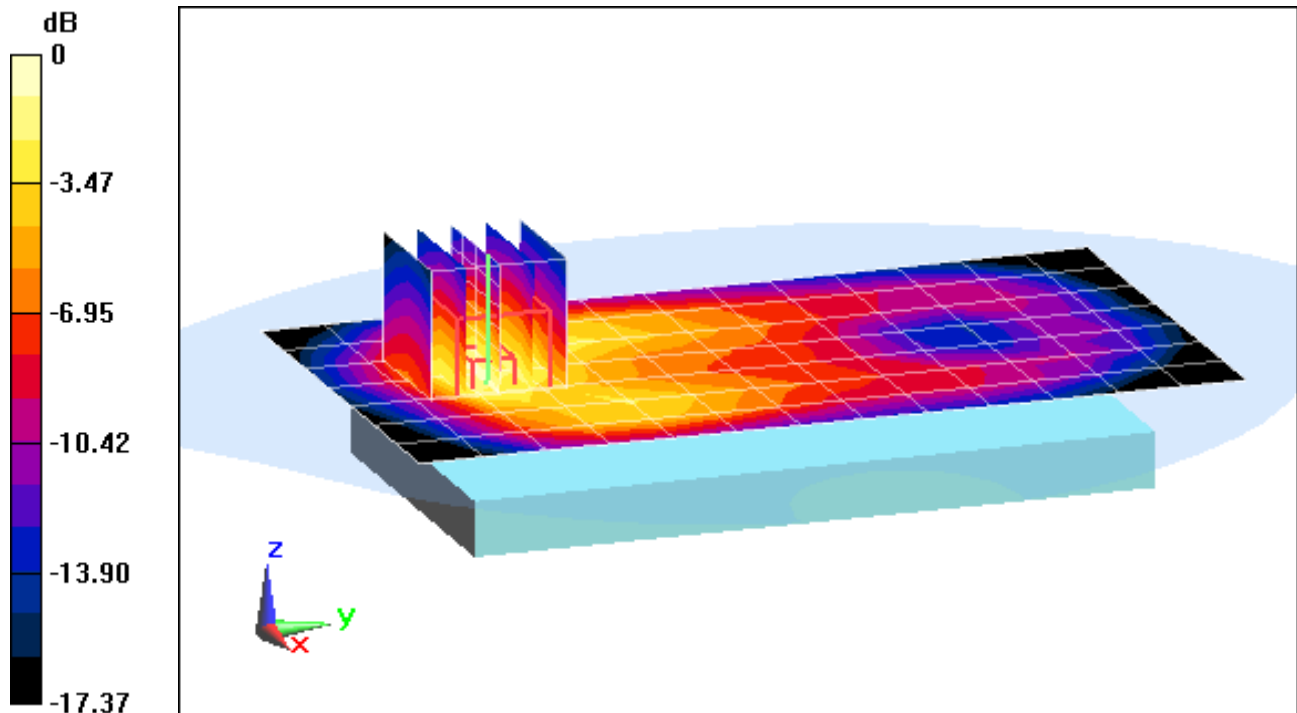

0 dB = 1.10 W/kg = 0.41 dBW/kg

PCTEST ENGINEERING LABORATORY, INC.

DUT: ZNFD950; Type: Portable Handset; Serial: FCC6

Communication System: UID 0, LTE Band 7; Frequency: 2535 MHz; Duty Cycle: 1:1

Medium: 2600 Body, Medium parameters used (interpolated):

$f = 2535 \text{ MHz}$; $\sigma = 2.158 \text{ S/m}$; $\epsilon_r = 50.765$; $\rho = 1000 \text{ kg/m}^3$

Phantom section: Flat Section; Space: 0.8 cm

Test Date: 12-02-2013; Ambient Temp: 22.2°C; Tissue Temp: 22.4°C

Probe: ES3DV2 - SN3022; ConvF(3.85, 3.85, 3.85); Calibrated: 8/22/2013;

Sensor-Surface: 3mm (Mechanical Surface Detection)

Electronics: DAE4 Sn1322; Calibrated: 8/21/2013

Phantom: SAM v5.0 front; Type: QD000P40CD; Serial: TP-1646

Measurement SW: DASYS2, Version 52.8 (7); SEMCAD X Version 14.6.10 (7164)

**Mode: LTE Band 7, Body SAR, Back Side, Mid.ch,
20 MHz Bandwidth, QPSK, 1 RB, 0 RB Offset**

Area Scan (11x16x1): Measurement grid: dx=12mm, dy=12mm

Zoom Scan (7x7x7)/Cube 0: Measurement grid: dx=5mm, dy=5mm, dz=5mm

Reference Value = 25.414 V/m; Power Drift = 0.01 dB

Peak SAR (extrapolated) = 2.54 W/kg

SAR(1 g) = 1.18 W/kg

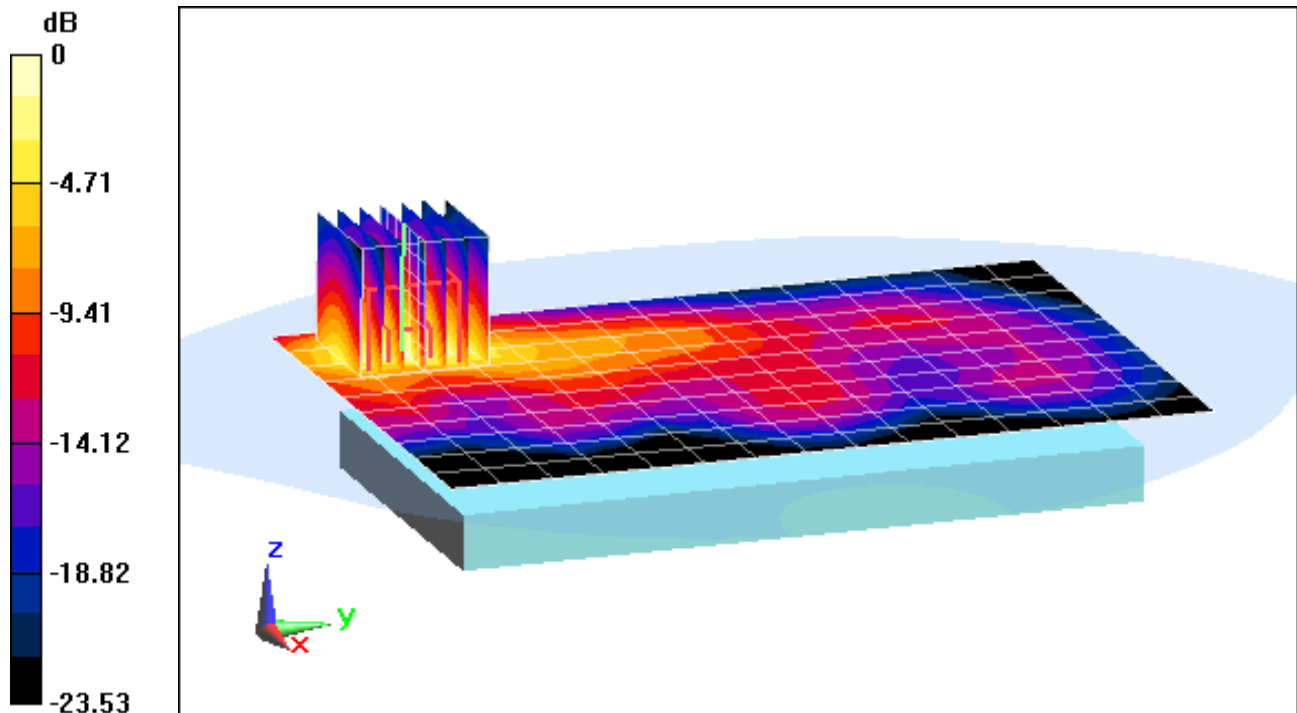

0 dB = 1.58 W/kg = 1.99 dBW/kg

PCTEST ENGINEERING LABORATORY, INC.

DUT: ZNFD950; Type: Portable Handset; Serial: FCC3

Communication System: UID 0, IEEE 802.11b; Frequency: 2437 MHz; Duty Cycle: 1:1

Medium: 2450 Body, Medium parameters used (interpolated):

$f = 2437 \text{ MHz}$; $\sigma = 2.018 \text{ S/m}$; $\epsilon_r = 51.116$; $\rho = 1000 \text{ kg/m}^3$

Phantom section: Flat Section; Space: 0.8 cm

Test Date: 12-02-2013; Ambient Temp: 22.2°C; Tissue Temp: 22.4°C

Probe: ES3DV2 - SN3022; ConvF(4.01, 4.01, 4.01); Calibrated: 8/22/2013;

Sensor-Surface: 3mm (Mechanical Surface Detection)

Electronics: DAE4 Sn1322; Calibrated: 8/21/2013

Phantom: SAM v5.0 front; Type: QD000P40CD; Serial: TP-1646

Measurement SW: DASY52, Version 52.8 (7); SEMCAD X Version 14.6.10 (7164)

Mode: IEEE 802.11b, Body SAR, Ch 06, 1 Mbps, Back Side

Area Scan (10x17x1): Measurement grid: dx=12mm, dy=12mm

Zoom Scan (7x7x7)/Cube 0: Measurement grid: dx=5mm, dy=5mm, dz=5mm

Reference Value = 8.710 V/m; Power Drift = -0.04 dB

Peak SAR (extrapolated) = 0.281 W/kg

SAR(1 g) = 0.133 W/kg

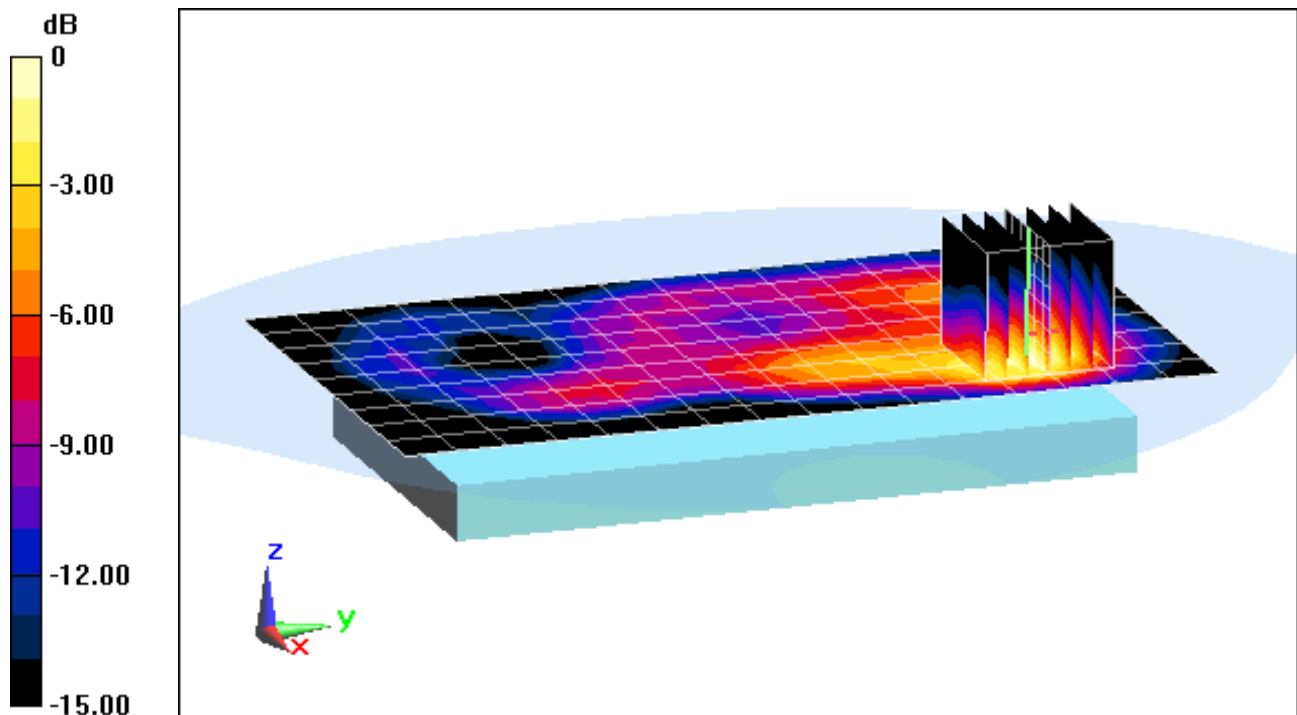

0 dB = 0.174 W/kg = -7.59 dBW/kg

PCTEST ENGINEERING LABORATORY, INC.

DUT: ZNFD950; Type: Portable Handset; Serial: FCC6

Communication System: UID 0, IEEE 802.11a; Frequency: 5745 MHz; Duty Cycle: 1:1

Medium: 5 GHz Body, Medium parameters used:

$f = 5745 \text{ MHz}$; $\sigma = 6.199 \text{ S/m}$; $\epsilon_r = 46.128$; $\rho = 1000 \text{ kg/m}^3$

Phantom section: Flat Section; Space: 0.8 cm

Test Date: 12-02-2013; Ambient Temp: 23.5°C; Tissue Temp: 21.8°C

Probe: EX3DV4 - SN3589; ConvF(3.66, 3.66, 3.66); Calibrated: 1/17/2013;

Sensor-Surface: 1.4mm (Mechanical Surface Detection)

Electronics: DAE4 Sn1272; Calibrated: 1/17/2013

Phantom: SAM Sub; Type: SAM 4.0; Serial: TP-1357

Measurement SW: DASY4, Version 4.7 (80); SEMCAD X Version 14.6.10 (7164)

Mode: IEEE 802.11a, 5.8 GHz, Body SAR, Ch 149, 6 Mbps, Back Side

Area Scan (13x21x1): Measurement grid: dx=10mm, dy=10mm

Zoom Scan (8x8x7)/Cube 0: Measurement grid: dx=4mm, dy=4mm, dz=1.4mm; Graded Ratio: 1.4

Reference Value = 1.569 V/m; Power Drift = 0.13 dB

Peak SAR (extrapolated) = 0.479 W/kg

SAR(1 g) = 0.0282 W/kg

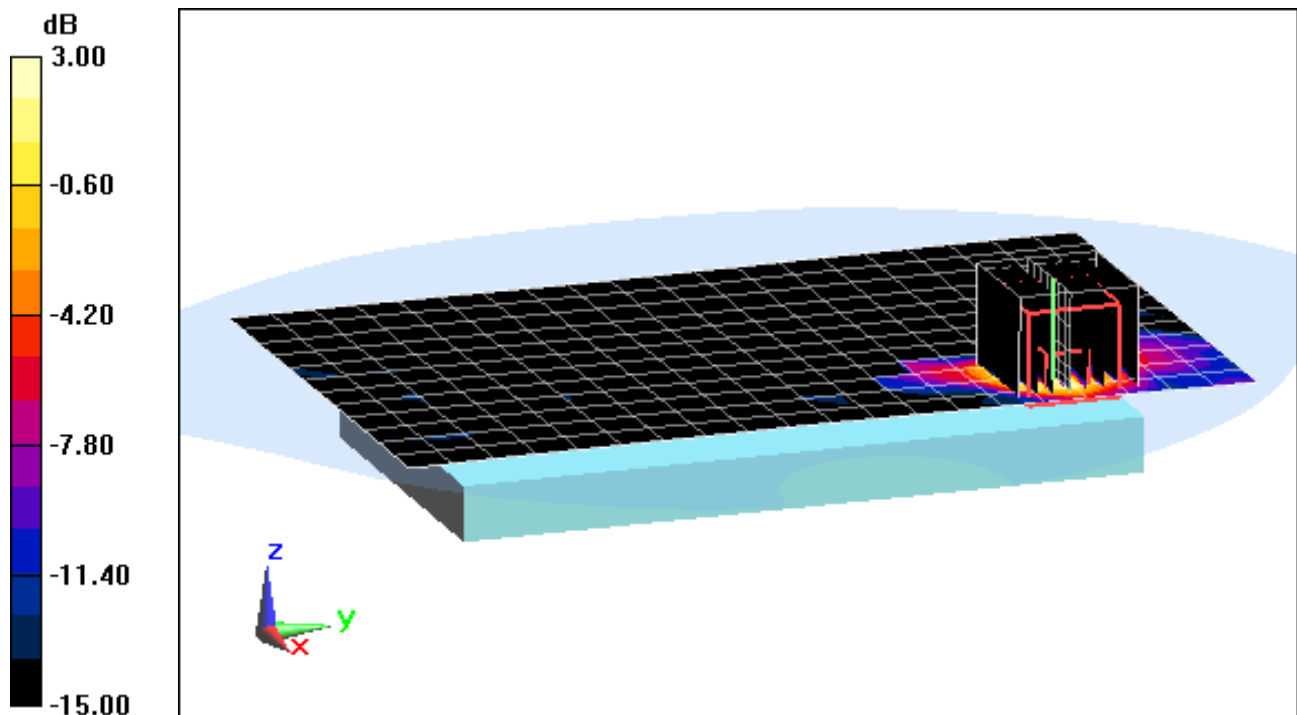

0 dB = 0.0816 W/kg = -10.88 dBW/kg

PCTEST ENGINEERING LABORATORY, INC.

DUT: ZNFD950; Type: Portable Handset; Serial: FCC6

Communication System: UID 0, IEEE 802.11a; Frequency: 5745 MHz; Duty Cycle: 1:1

Medium: 5 GHz Body, Medium parameters used:

$f = 5745 \text{ MHz}; \sigma = 6.199 \text{ S/m}; \epsilon_r = 46.128; \rho = 1000 \text{ kg/m}^3$

Phantom section: Flat Section; Space: 1.0 cm

Test Date: 12-02-2013; Ambient Temp: 23.5°C; Tissue Temp: 21.8°C

Probe: EX3DV4 - SN3589; ConvF(3.66, 3.66, 3.66); Calibrated: 1/17/2013;

Sensor-Surface: 1.4mm (Mechanical Surface Detection)

Electronics: DAE4 Sn1272; Calibrated: 1/17/2013

Phantom: SAM Sub; Type: SAM 4.0; Serial: TP-1357

Measurement SW: DASY4, Version 4.7 (80); SEMCAD X Version 14.6.10 (7164)

Mode: IEEE 802.11a, 5.8 GHz, Body SAR, Ch 149, 6 Mbps, Left Edge

Area Scan (13x21x1): Measurement grid: dx=5mm, dy=10mm

Zoom Scan (8x8x7)/Cube 0: Measurement grid: dx=4mm, dy=4mm, dz=1.4mm; Graded Ratio: 1.4

Reference Value = 0 V/m; Power Drift = 0.00 dB

Peak SAR (extrapolated) = 0.434 W/kg

SAR(1 g) = 0.0283 W/kg

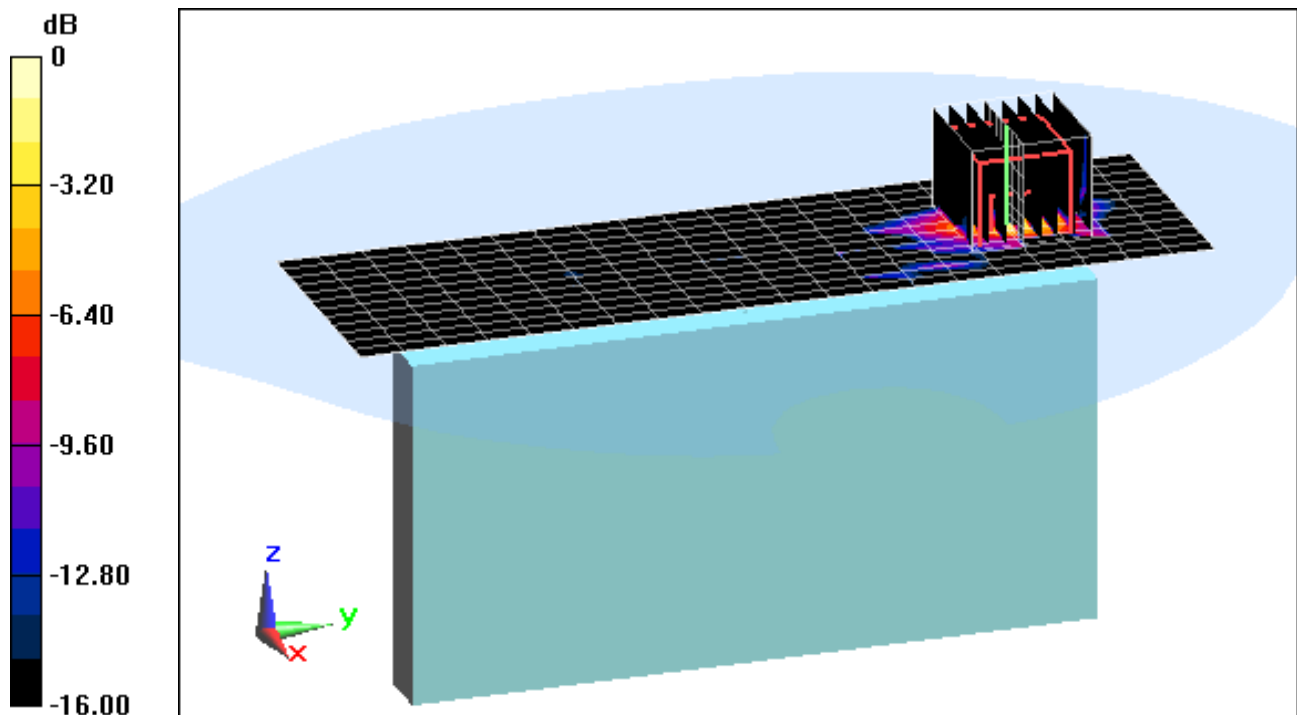

0 dB = 0.0774 W/kg = -11.11 dBW/kg

PCTEST ENGINEERING LABORATORY, INC.

DUT: ZNFD950; Type: Portable Handset; Serial: FCC6

Communication System: UID 0, IEEE 802.11a; Frequency: 5200 MHz; Duty Cycle: 1:1

Medium: 5 GHz Body, Medium parameters used:

$f = 5200 \text{ MHz}$; $\sigma = 5.3 \text{ S/m}$; $\epsilon_r = 46.959$; $\rho = 1000 \text{ kg/m}^3$

Phantom section: Flat Section; Space: 0.8 cm

Test Date: 12-02-2013; Ambient Temp: 23.6°C; Tissue Temp: 21.8°C

Probe: EX3DV4 - SN3589; ConvF(3.99, 3.99, 3.99); Calibrated: 1/17/2013;

Sensor-Surface: 1.4mm (Mechanical Surface Detection)

Electronics: DAE4 Sn1272; Calibrated: 1/17/2013

Phantom: SAM Sub; Type: SAM 4.0; Serial: TP-1357

Measurement SW: DASY4, Version 4.7 (80); SEMCAD X Version 14.6.10 (7164)

Mode: IEEE 802.11a, 5.2 GHz, Body SAR, Ch 40, 6 Mbps, Back Side

Area Scan (13x21x1): Measurement grid: dx=10mm, dy=10mm

Zoom Scan (8x8x7)/Cube 0: Measurement grid: dx=4mm, dy=4mm, dz=1.4mm; Graded Ratio: 1.4

Reference Value = 4.288 V/m; Power Drift = -0.14 dB

Peak SAR (extrapolated) = 0.404 W/kg

SAR(1 g) = 0.079 W/kg

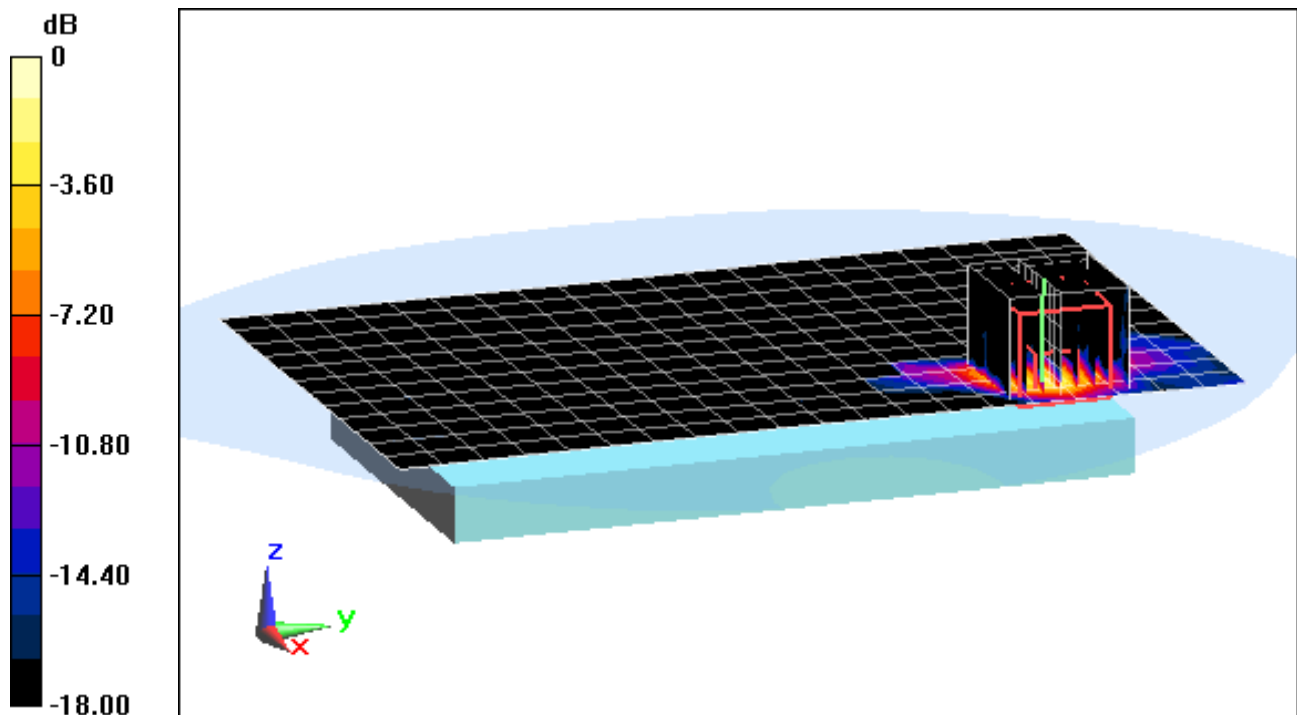

0 dB = 0.231 W/kg = -6.36 dBW/kg

PCTEST ENGINEERING LABORATORY, INC.

DUT: ZNFD950; Type: Portable Handset; Serial: FCC6

Communication System: UID 0, IEEE 802.11a; Frequency: 5260 MHz; Duty Cycle: 1:1

Medium: 5 GHz Body, Medium parameters used:

$f = 5260 \text{ MHz}$; $\sigma = 5.432 \text{ S/m}$; $\epsilon_r = 46.851$; $\rho = 1000 \text{ kg/m}^3$

Phantom section: Flat Section; Space: 0.0 cm

Test Date: 12-02-2013; Ambient Temp: 23.5°C; Tissue Temp: 21.9°C

Probe: EX3DV4 - SN3589; ConvF(3.81, 3.81, 3.81); Calibrated: 1/17/2013;

Sensor-Surface: 1.4mm (Mechanical Surface Detection)

Electronics: DAE4 Sn1272; Calibrated: 1/17/2013

Phantom: SAM Sub; Type: SAM 4.0; Serial: TP-1357

Measurement SW: DASY4, Version 4.7 (80); SEMCAD X Version 14.6.10 (7164)

Mode: IEEE 802.11a, 5.3 GHz, Extremity SAR, Ch 52, 6 Mbps, Left Edge

Area Scan (13x21x1): Measurement grid: dx=5mm, dy=10mm

Zoom Scan (9x9x7)/Cube 0: Measurement grid: dx=4mm, dy=4mm, dz=1.4mm; Graded Ratio: 1.4

Reference Value = 13.308 V/m; Power Drift = -0.13 dB

Peak SAR (extrapolated) = 4.22 W/kg

SAR(10 g) = 0.206 W/kg

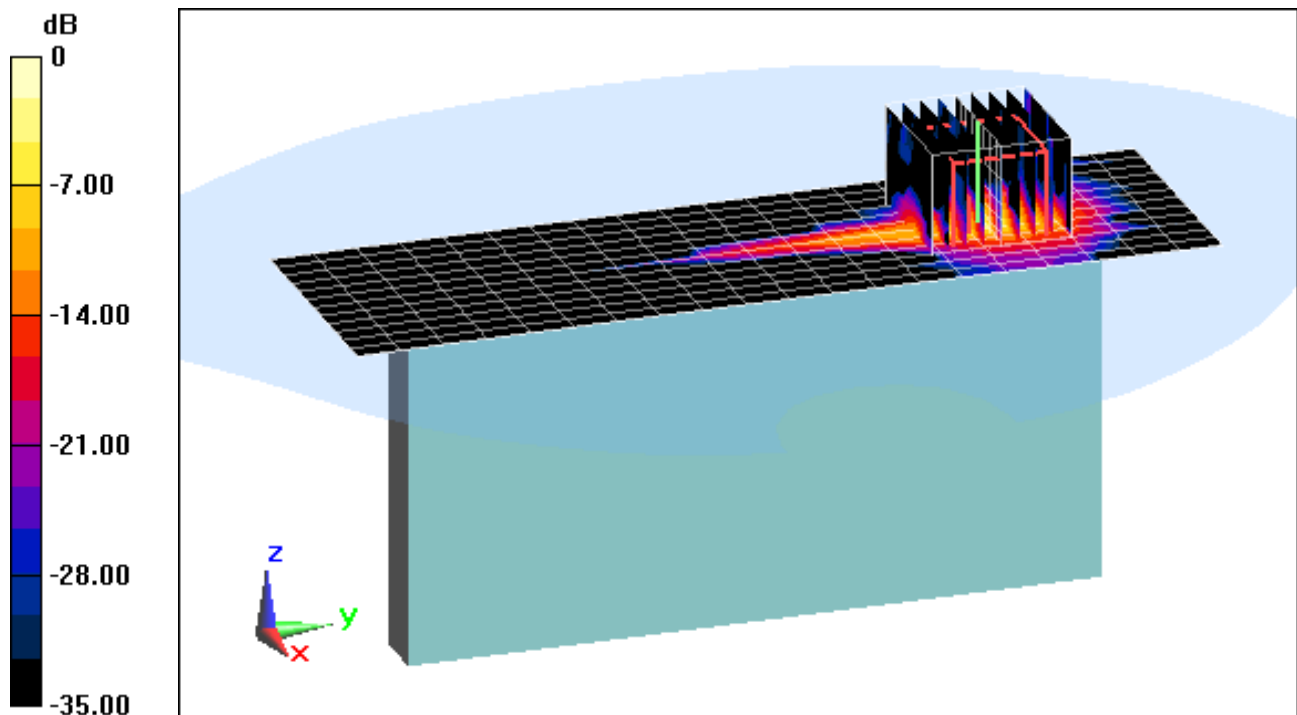

0 dB = 2.55 W/kg = 4.07 dBW/kg

APPENDIX B: SYSTEM VERIFICATION

PCTEST ENGINEERING LABORATORY, INC.

DUT: Dipole 750 MHz; Type: D750V3; Serial: 1046

Communication System: UID 0, CW; Frequency: 750 MHz; Duty Cycle: 1:1

Medium: 750 Head, Medium parameters used (interpolated):

$f = 750 \text{ MHz}$; $\sigma = 0.923 \text{ S/m}$; $\epsilon_r = 41.415$; $\rho = 1000 \text{ kg/m}^3$

Phantom section: Flat Section; Space: 1.5 cm

Test Date: 12-02-2013; Ambient Temp: 23.0°C; Tissue Temp: 21.0°C

Probe: EX3DV4 - SN3914; ConvF(9.7, 9.7, 9.7); Calibrated: 10/23/2013;

Sensor-Surface: 4mm (Mechanical Surface Detection)

Electronics: DAE4 Sn649; Calibrated: 2/6/2013

Phantom: SAM V5.0 Right; Type: QD000P40CD; Serial: 1647

Measurement SW: DASY52, Version 52.8 (7); SEMCAD X Version 14.6.10 (7164)

750 MHz System Verification

Area Scan (7x15x1): Measurement grid: dx=15mm, dy=15mm

Zoom Scan (5x5x7)/Cube 0: Measurement grid: dx=8mm, dy=8mm, dz=5mm

Input Power = 20.0 dBm (100 mW)

Peak SAR (extrapolated) = 1.24 W/kg

SAR(1 g) = 0.831 W/kg

Deviation (1 g) = -2.24%

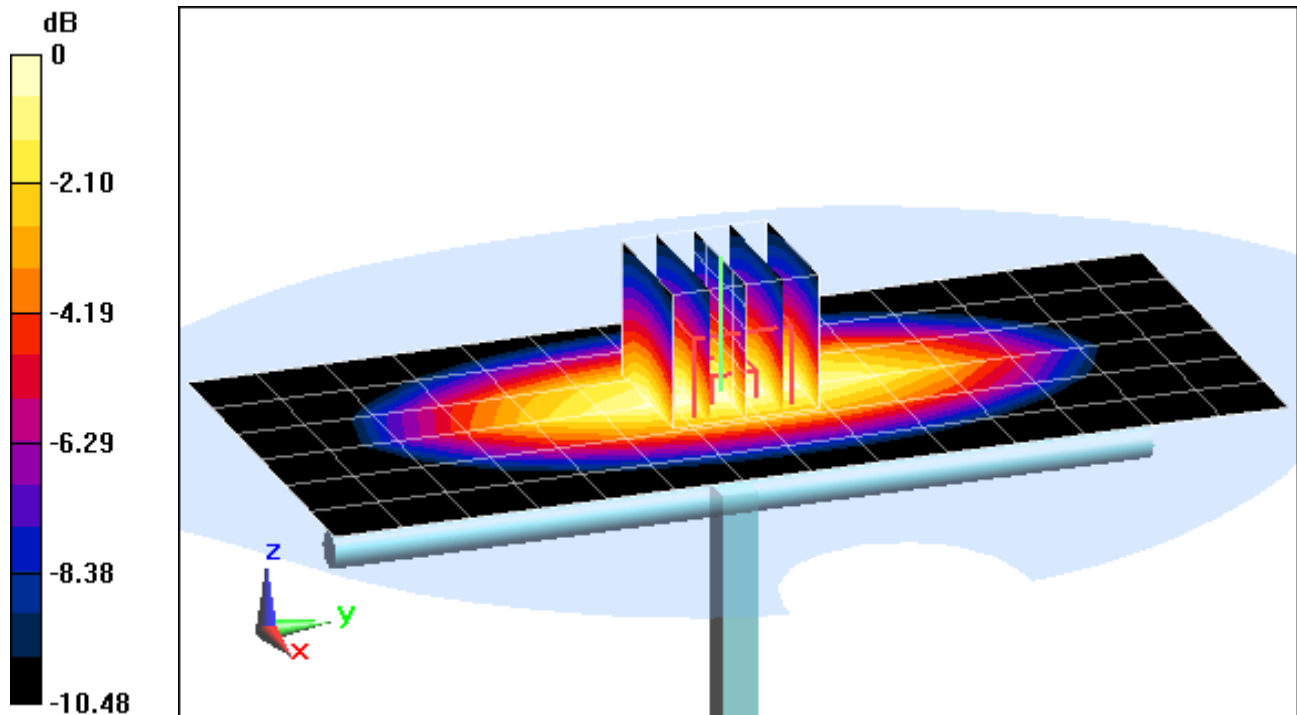

0 dB = 0.896 W/kg = -0.48 dBW/kg

PCTEST ENGINEERING LABORATORY, INC.

DUT: Dipole 835 MHz; Type: D835V2; Serial: 4d119

Communication System: UID 0, CW; Frequency: 835 MHz; Duty Cycle: 1:1

Medium: 835 Head, Medium parameters used:

$f = 835 \text{ MHz}$; $\sigma = 0.931 \text{ S/m}$; $\epsilon_r = 42.987$; $\rho = 1000 \text{ kg/m}^3$

Phantom section: Flat Section; Space: 1.5 cm

Test Date: 12-04-2013; Ambient Temp: 24.5°C; Tissue Temp: 23.0°C

Probe: ES3DV3 - SN3209; ConvF(6.46, 6.46, 6.46); Calibrated: 3/15/2013;

Sensor-Surface: 4mm (Mechanical Surface Detection)

Electronics: DAE4 Sn1334; Calibrated: 3/8/2013

Phantom: SAM Right; Type: QD000P40CD; Serial: 1686

Measurement SW: DASY52, Version 52.8 (7); SEMCAD X Version 14.6.10 (7164)

835 MHz System Verification

Area Scan (7x14x1): Measurement grid: dx=15mm, dy=15mm

Zoom Scan (5x5x7)/Cube 0: Measurement grid: dx=8mm, dy=8mm, dz=5mm

Input Power = 20.0 dBm (100 mW)

Peak SAR (extrapolated) = 1.43 W/kg

SAR(1 g) = 0.976 W/kg

Deviation (1 g) = 0.83%

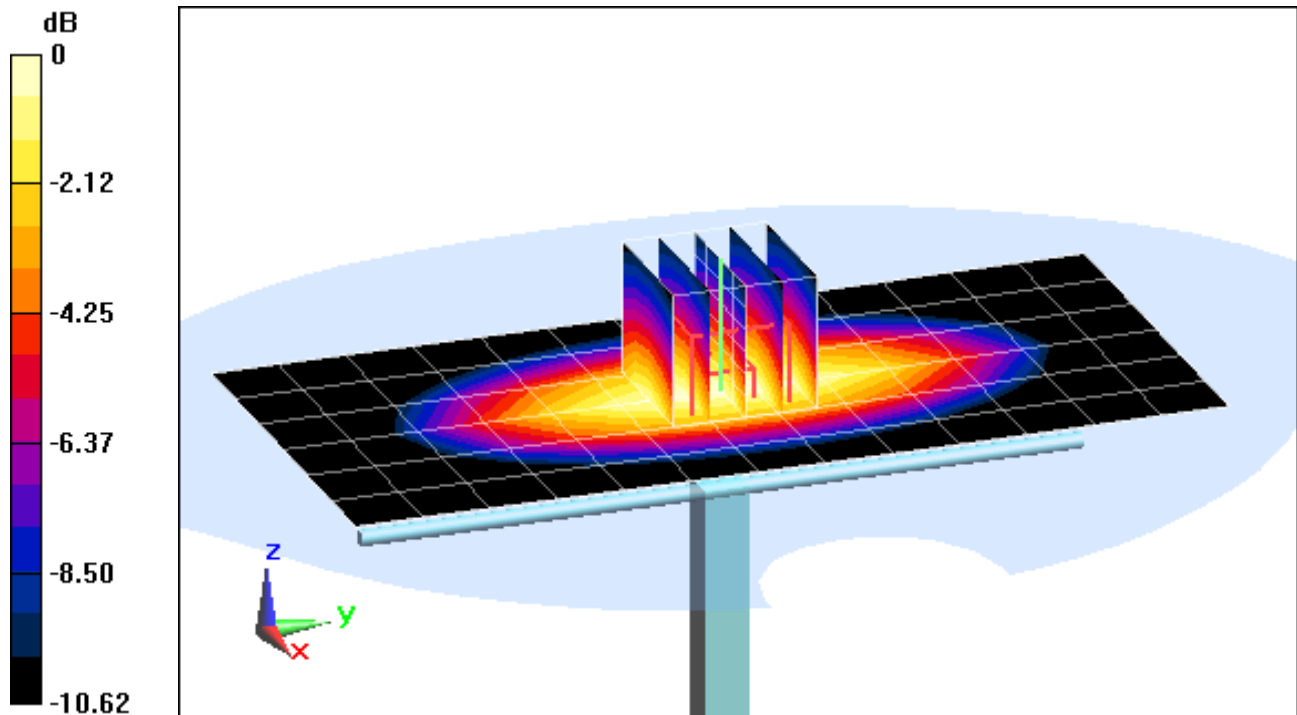

0 dB = 1.06 W/kg = 0.25 dBW/kg

PCTEST ENGINEERING LABORATORY, INC.

DUT: Dipole 1750 MHz; Type: D1750V2; Serial: 1051

Communication System: UID 0, CW; Frequency: 1750 MHz; Duty Cycle: 1:1

Medium: 1750 Head, Medium parameters used:

$f = 1750 \text{ MHz}$; $\sigma = 1.378 \text{ S/m}$; $\epsilon_r = 40.664$; $\rho = 1000 \text{ kg/m}^3$

Phantom section: Flat Section; Space: 1.0 cm

Test Date: 12-04-2013; Ambient Temp: 23.4°C; Tissue Temp: 22.9°C

Probe: ES3DV3 - SN3319; ConvF(5.59, 5.59, 5.59); Calibrated: 6/28/2013;

Sensor-Surface: 4mm (Mechanical Surface Detection)

Electronics: DAE4 Sn1368; Calibrated: 4/22/2013

Phantom: SAM right; Type: QD000P40CD; Serial: TP:1757

Measurement SW: DASY52, Version 52.8 (7); SEMCAD X Version 14.6.10 (7164)

1750 MHz System Verification

Area Scan (5x9x1): Measurement grid: dx=15mm, dy=15mm

Zoom Scan (5x5x7)/Cube 0: Measurement grid: dx=8mm, dy=8mm, dz=5mm

Input Power = 20.0 dBm (100 mW)

Peak SAR (extrapolated) = 6.78 W/kg

SAR(1 g) = 3.55 W/kg

Deviation (1 g) = -2.74%

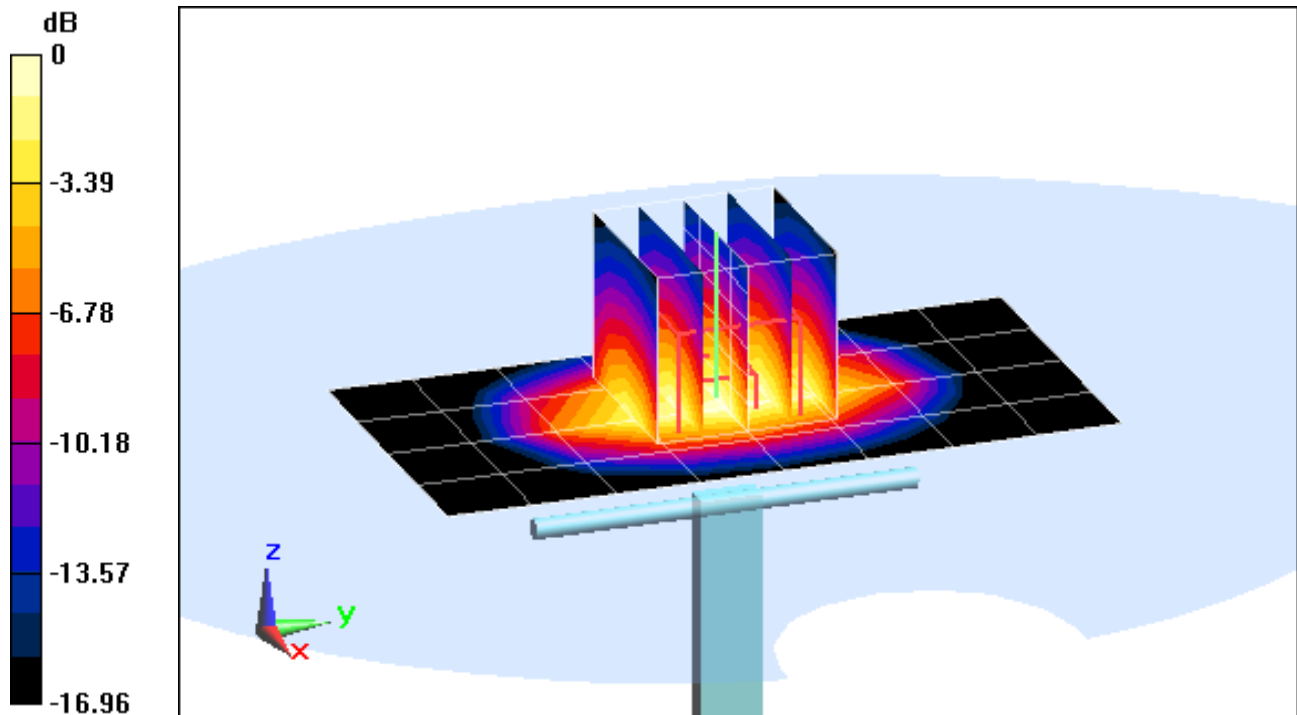

0 dB = 3.92 W/kg = 5.93 dBW/kg

PCTEST ENGINEERING LABORATORY, INC.

DUT: Dipole 1900 MHz; Type: D1900V2; Serial: 5d141

Communication System: UID 0, CW; Frequency: 1900 MHz; Duty Cycle: 1:1

Medium: 1900 Head, Medium parameters used (interpolated):

$f = 1900 \text{ MHz}$; $\sigma = 1.417 \text{ S/m}$; $\epsilon_r = 39.561$; $\rho = 1000 \text{ kg/m}^3$

Phantom section: Flat Section; Space: 1.0 cm

Test Date: 12-09-2013; Ambient Temp: 21.0°C; Tissue Temp: 22.3°C

Probe: ES3DV3 - SN3263; ConvF(5.11, 5.11, 5.11); Calibrated: 5/16/2013;

Sensor-Surface: 4mm (Mechanical Surface Detection)

Electronics: DAE4 Sn859; Calibrated: 5/13/2013

Phantom: SAM Main; Type: SAM 4.0; Serial: TP-1406

Measurement SW: DASY4, Version 4.7 (80); SEMCAD X Version 14.6.10 (7164)

1900 MHz System Verification

Area Scan (5x7x1): Measurement grid: dx=15mm, dy=15mm

Zoom Scan (5x5x7)/Cube 0: Measurement grid: dx=8mm, dy=8mm, dz=5mm

Input Power = 20.0 dBm (100 mW)

Peak SAR (extrapolated) = 6.89 W/kg

SAR(1 g) = 3.79 W/kg

Deviation (1 g) = -7.11%

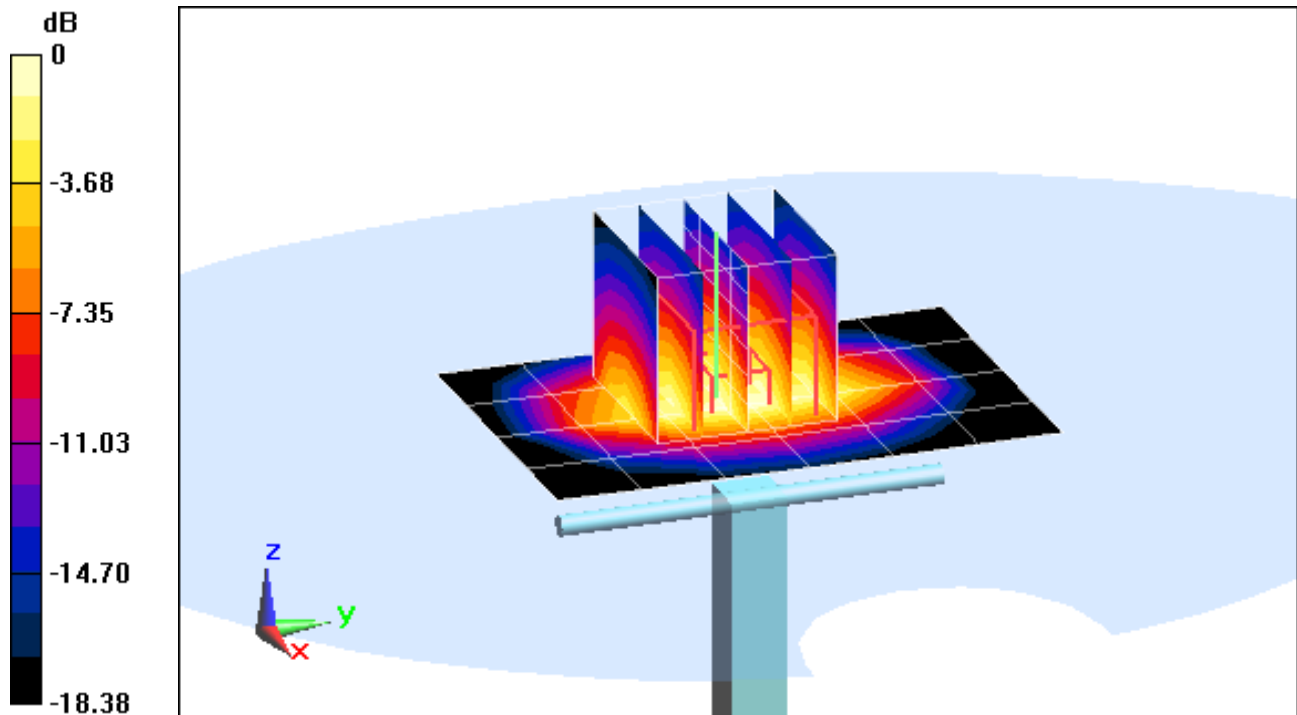

0 dB = 4.24 W/kg = 6.27 dBW/kg

PCTEST ENGINEERING LABORATORY, INC.

DUT: Dipole 2450 MHz; Type: D2450V2; Serial: 797

Communication System: UID 0, CW; Frequency: 2450 MHz; Duty Cycle: 1:1

Medium: 2450 Head, Medium parameters used:

$f = 2450 \text{ MHz}$; $\sigma = 1.823 \text{ S/m}$; $\epsilon_r = 38.989$; $\rho = 1000 \text{ kg/m}^3$

Phantom section: Flat Section; Space: 1.0 cm

Test Date: 12-02-2013; Ambient Temp: 21.7°C; Tissue Temp: 20.8°C

Probe: ES3DV3 - SN3318; ConvF(4.59, 4.59, 4.59); Calibrated: 4/29/2013;

Sensor-Surface: 3mm (Mechanical Surface Detection)

Electronics: DAE4 Sn1364; Calibrated: 4/22/2013

Phantom: SAM; Type: QD000P40CD; Serial: TP:1758

Measurement SW: DASY52, Version 52.8 (7); SEMCAD X Version 14.6.10 (7164)

2450 MHz System Verification

Area Scan (8x9x1): Measurement grid: dx=12mm, dy=12mm

Zoom Scan (7x7x7)/Cube 0: Measurement grid: dx=5mm, dy=5mm, dz=5mm

Input Power = 20.0 dBm (100 mW)

Peak SAR (extrapolated) = 10.3 W/kg

SAR(1 g) = 5.01 W/kg

Deviation (1 g) = -4.57%

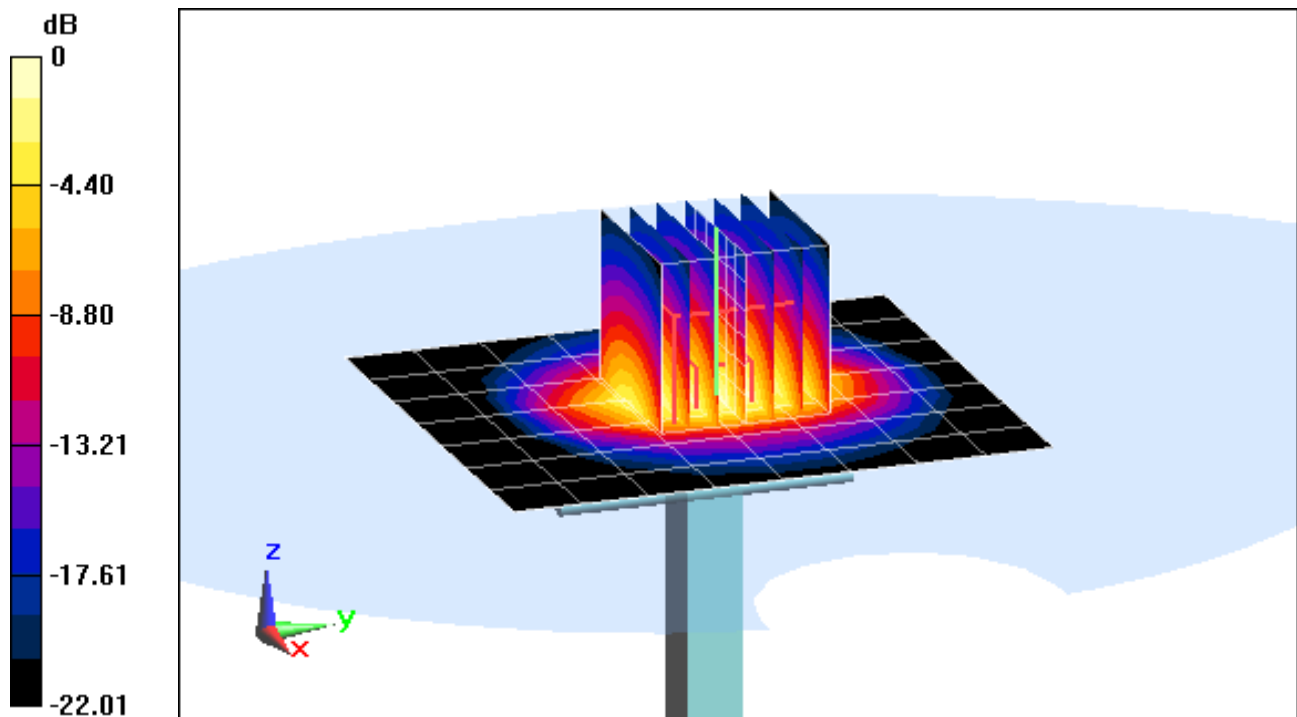

0 dB = 6.57 W/kg = 8.18 dBW/kg

PCTEST ENGINEERING LABORATORY, INC.

DUT: Dipole 2600 MHz; Type: D2600V2; Serial: 1004

Communication System: UID 0, CW; Frequency: 2600 MHz; Duty Cycle: 1:1

Medium: 2600 Head, Medium parameters used:

$f = 2600 \text{ MHz}$; $\sigma = 2.04 \text{ S/m}$; $\epsilon_r = 37.935$; $\rho = 1000 \text{ kg/m}^3$

Phantom section: Flat Section; Space: 1.0 cm

Test Date: 12-10-2013; Ambient Temp: 24.5°C; Tissue Temp: 24.1°C

Probe: ES3DV3 - SN3288; ConvF(4.55, 4.55, 4.55); Calibrated: 9/23/2013;

Sensor-Surface: 3mm (Mechanical Surface Detection)

Electronics: DAE4 Sn1323; Calibrated: 9/17/2013

Phantom: SAM with CRP; Type: SAM 4.0; Serial: TP1375

Measurement SW: DASY4, Version 4.7 (80); SEMCAD X Version 14.6.10 (7164)

2600 MHz System Verification

Area Scan (6x8x1): Measurement grid: dx=12mm, dy=12mm

Zoom Scan (7x7x7)/Cube 0: Measurement grid: dx=5mm, dy=5mm, dz=5mm

Input Power = 20.0 dBm (100 mW)

Peak SAR (extrapolated) = 11.8 W/kg

SAR(1 g) = 5.55 W/kg

Deviation (1 g) = -4.64%

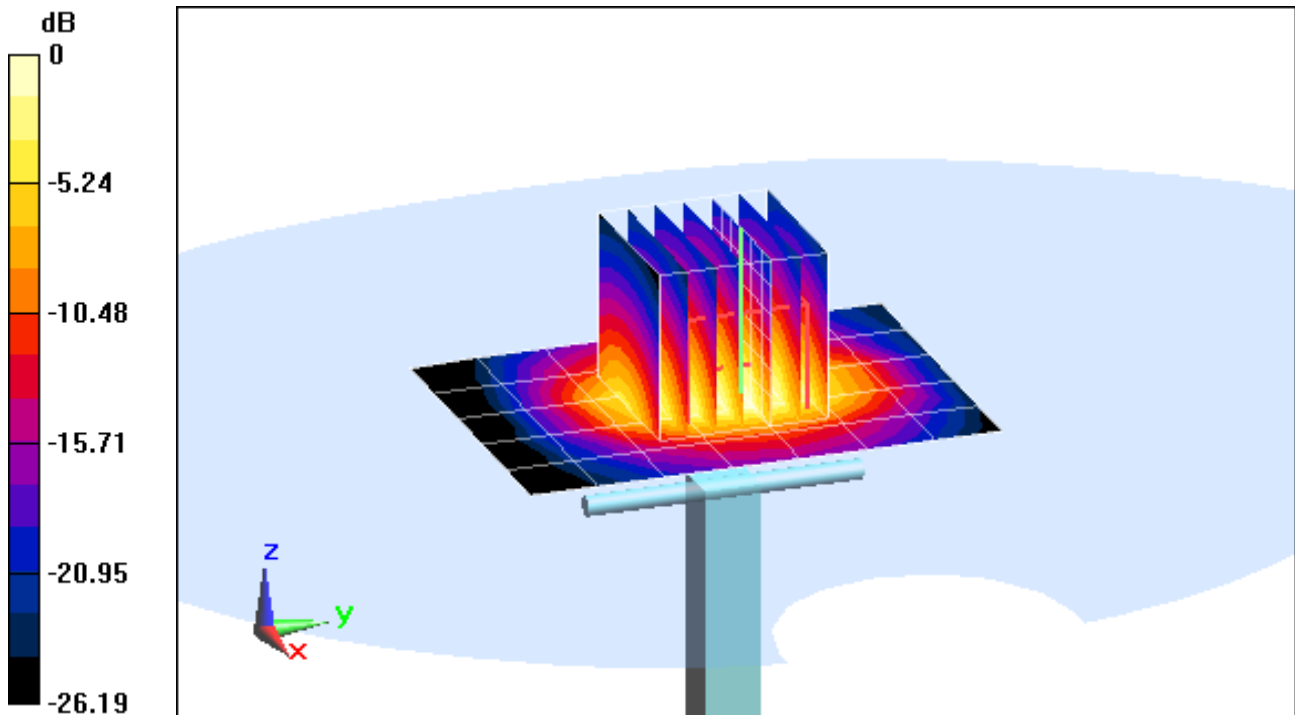

0 dB = 7.18 W/kg = 8.56 dBW/kg

PCTEST ENGINEERING LABORATORY, INC.

DUT: Dipole 5200 MHz; Type: D5GHzV2; Serial: 1120

Communication System: UID 0, CW; Frequency: 5200 MHz; Duty Cycle: 1:1

Medium: 5 GHz Head, Medium parameters used:

$f = 5200 \text{ MHz}$; $\sigma = 4.501 \text{ S/m}$; $\epsilon_r = 36.509$; $\rho = 1000 \text{ kg/m}^3$

Phantom section: Flat Section; Space: 1.0 cm

Test Date: 12-04-2013; Ambient Temp: 24.1°C; Tissue Temp: 22.9°C

Probe: EX3DV4 - SN3914; ConvF(4.99, 4.99, 4.99); Calibrated: 10/23/2013;

Sensor-Surface: 1.4mm (Mechanical Surface Detection)

Electronics: DAE4 Sn1333; Calibrated: 11/19/2013

Phantom: SAM V5.0 Right; Type: QD000P40CD; Serial: 1647

Measurement SW: DASYS2, Version 52.8 (7); SEMCAD X Version 14.6.10 (7164)

5200 MHz System Verification

Area Scan (7x8x1): Measurement grid: $dx=10\text{mm}$, $dy=10\text{mm}$

Zoom Scan (7x7x7)/Cube 0: Measurement grid: $dx=4\text{mm}$, $dy=4\text{mm}$, $dz=1.4\text{mm}$; Graded Ratio: 1.4

Input Power = 16.0 dBm (40 mW)

Peak SAR (extrapolated) = 13.0 W/kg

SAR(1 g) = 3.06 W/kg

Deviation (1 g) = 0.66%

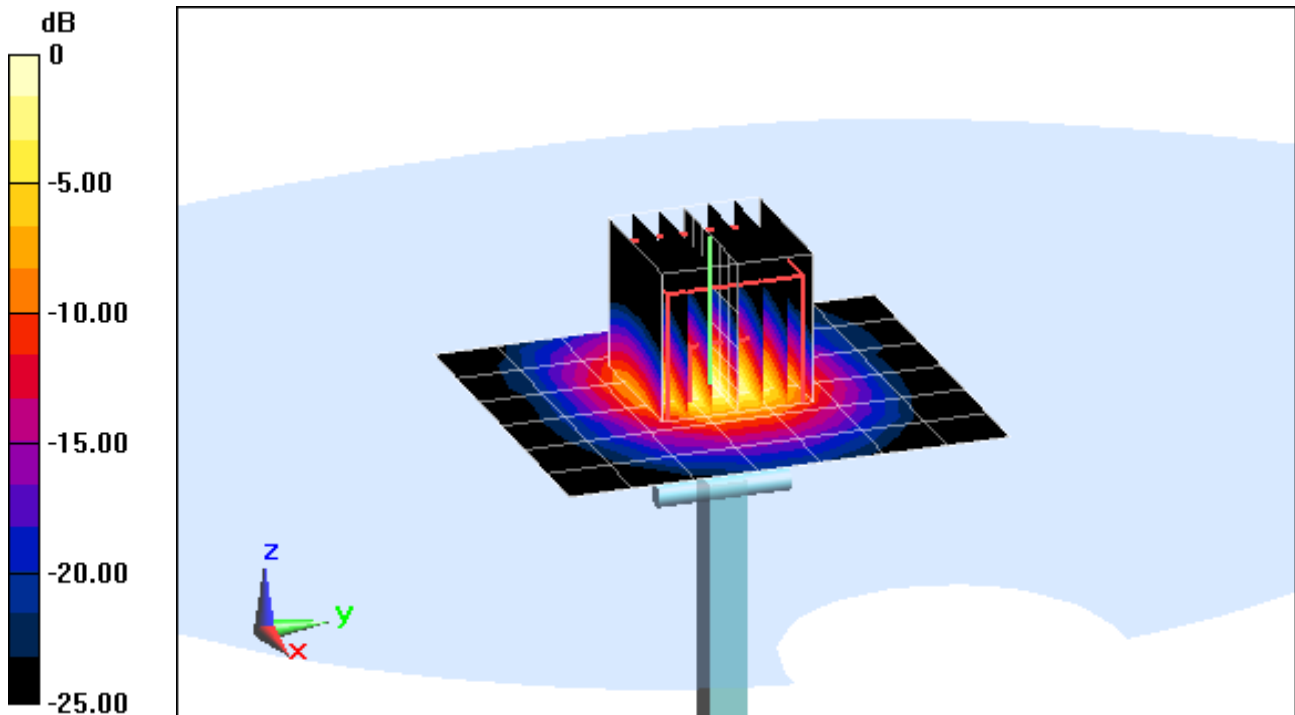

0 dB = 7.73 W/kg = 8.88 dBW/kg

PCTEST ENGINEERING LABORATORY, INC.

DUT: Dipole 5300 MHz; Type: D5GHzV2; Serial: 1120

Communication System: UID 0, CW; Frequency: 5300 MHz; Duty Cycle: 1:1

Medium: 5 GHz Head, Medium parameters used:

$f = 5300 \text{ MHz}$; $\sigma = 4.602 \text{ S/m}$; $\epsilon_r = 36.39$; $\rho = 1000 \text{ kg/m}^3$

Phantom section: Flat Section; Space: 1.0 cm

Test Date: 12-04-2013; Ambient Temp: 24.1°C; Tissue Temp: 23.0°C

Probe: EX3DV4 - SN3914; ConvF(4.82, 4.82, 4.82); Calibrated: 10/23/2013;

Sensor-Surface: 1.4mm (Mechanical Surface Detection)

Electronics: DAE4 Sn1333; Calibrated: 11/19/2013

Phantom: SAM V5.0 Right; Type: QD000P40CD; Serial: 1647

Measurement SW: DASYS2, Version 52.8 (7); SEMCAD X Version 14.6.10 (7164)

5300 MHz System Verification

Area Scan (7x8x1): Measurement grid: $dx=10\text{mm}$, $dy=10\text{mm}$

Zoom Scan (7x7x7)/Cube 0: Measurement grid: $dx=4\text{mm}$, $dy=4\text{mm}$, $dz=1.4\text{mm}$; Graded Ratio: 1.4

Input Power = 16.0 dBm (40 mW)

Peak SAR (extrapolated) = 13.1 W/kg

SAR(1 g) = 2.99 W/kg

Deviation (1 g) = -5.02%

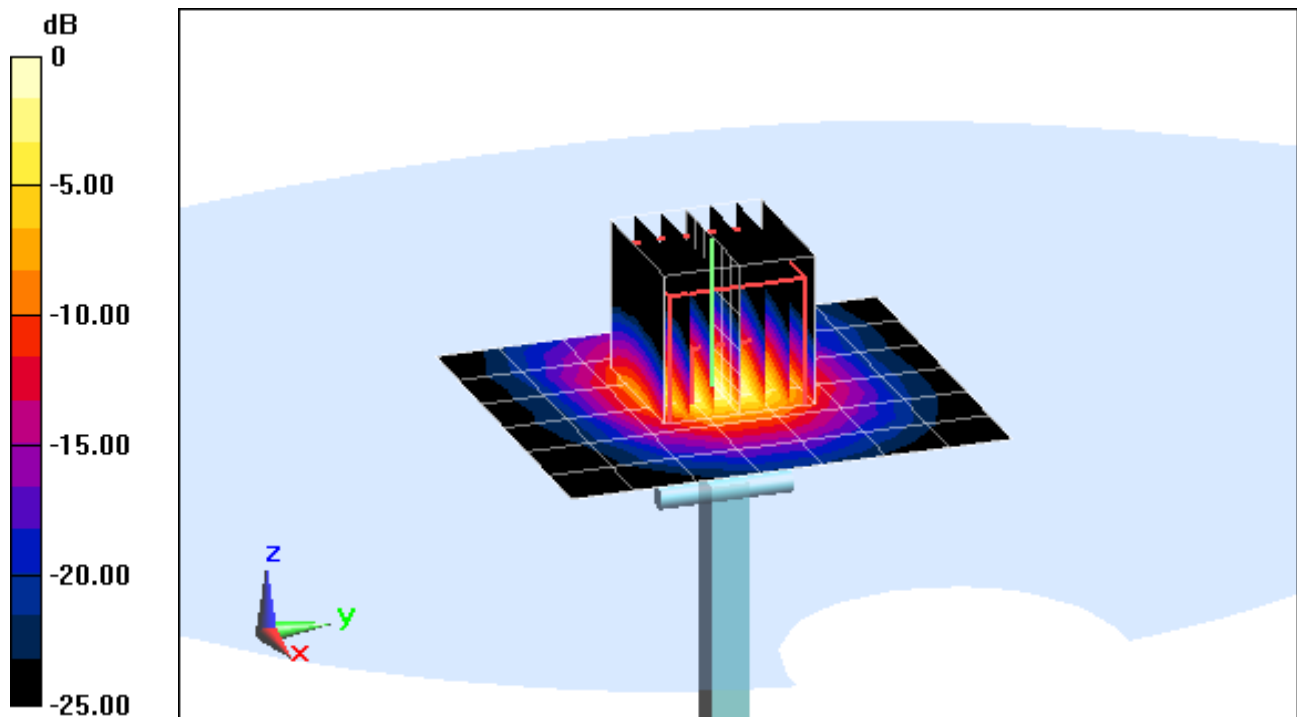

0 dB = 7.67 W/kg = 8.85 dBW/kg

PCTEST ENGINEERING LABORATORY, INC.

DUT: Dipole 5500 MHz; Type: D5GHzV2; Serial: 1120

Communication System: UID 0, CW; Frequency: 5500 MHz; Duty Cycle: 1:1

Medium: 5 GHz Head, Medium parameters used:

$f = 5500 \text{ MHz}$; $\sigma = 4.812 \text{ S/m}$; $\epsilon_r = 36.137$; $\rho = 1000 \text{ kg/m}^3$

Phantom section: Flat Section; Space: 1.0 cm

Test Date: 12-04-2013; Ambient Temp: 24.4°C; Tissue Temp: 23.0°C

Probe: EX3DV4 - SN3914; ConvF(4.55, 4.55, 4.55); Calibrated: 10/23/2013;

Sensor-Surface: 1.4mm (Mechanical Surface Detection)

Electronics: DAE4 Sn1333; Calibrated: 11/19/2013

Phantom: SAM V5.0 Right; Type: QD000P40CD; Serial: 1647

Measurement SW: DASYS2, Version 52.8 (7); SEMCAD X Version 14.6.10 (7164)

5500 MHz System Verification

Area Scan (7x8x1): Measurement grid: $dx=10\text{mm}$, $dy=10\text{mm}$

Zoom Scan (7x7x7)/Cube 0: Measurement grid: $dx=4\text{mm}$, $dy=4\text{mm}$, $dz=1.4\text{mm}$; Graded Ratio: 1.4

Input Power = 16.0 dBm (40 mW)

Peak SAR (extrapolated) = 13.1 W/kg

SAR(1 g) = 3.00 W/kg

Deviation (1 g) = -6.37%

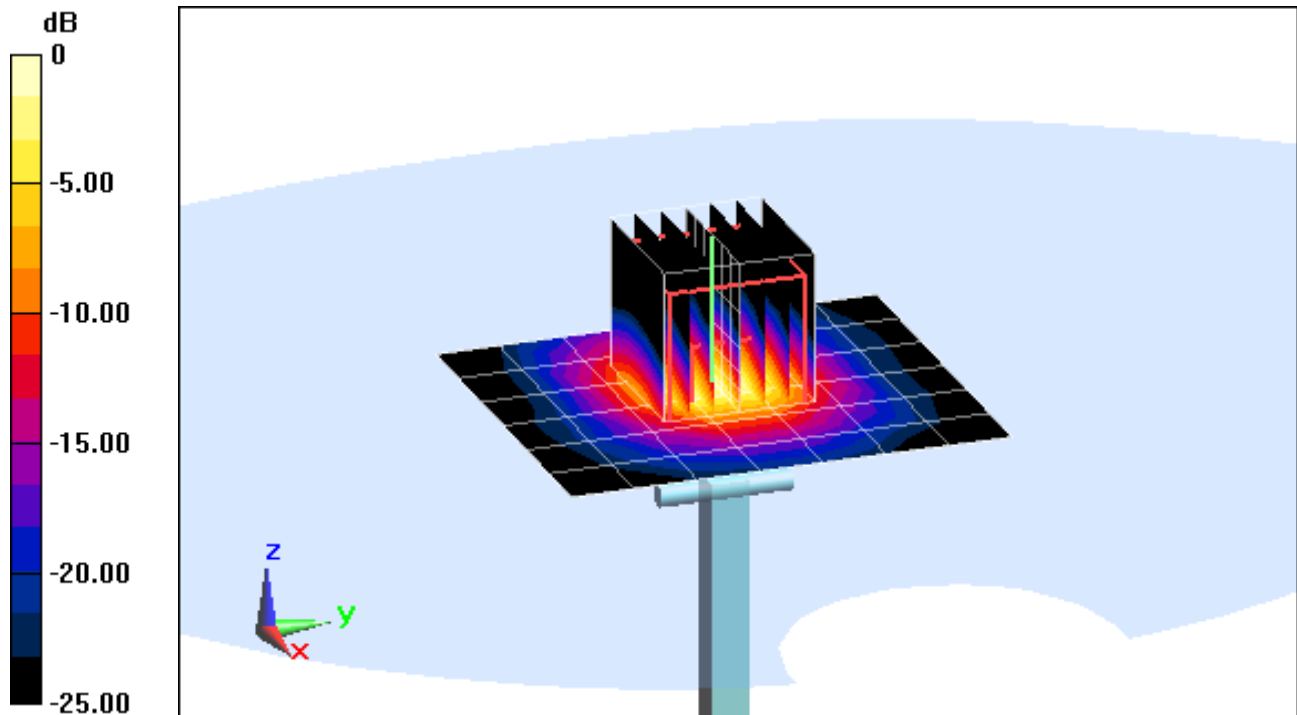

0 dB = 7.75 W/kg = 8.89 dBW/kg

PCTEST ENGINEERING LABORATORY, INC.

DUT: Dipole 5800 MHz; Type: D5GHzV2; Serial: 1120

Communication System: UID 0, CW; Frequency: 5800 MHz; Duty Cycle: 1:1

Medium: 5 GHz Head, Medium parameters used:

$f = 5800 \text{ MHz}$; $\sigma = 5.113 \text{ S/m}$; $\epsilon_r = 35.753$; $\rho = 1000 \text{ kg/m}^3$

Phantom section: Flat Section; Space: 1.0 cm

Test Date: 12-04-2013; Ambient Temp: 24.1°C; Tissue Temp: 23.1°C

Probe: EX3DV4 - SN3914; ConvF(4.52, 4.52, 4.52); Calibrated: 10/23/2013;

Sensor-Surface: 1.4mm (Mechanical Surface Detection)

Electronics: DAE4 Sn1333; Calibrated: 11/19/2013

Phantom: SAM V5.0 Right; Type: QD000P40CD; Serial: 1647

Measurement SW: DASY52, Version 52.8 (7); SEMCAD X Version 14.6.10 (7164)

5800 MHz System Verification

Area Scan (7x8x1): Measurement grid: $dx=10\text{mm}$, $dy=10\text{mm}$

Zoom Scan (7x7x7)/Cube 0: Measurement grid: $dx=4\text{mm}$, $dy=4\text{mm}$, $dz=1.4\text{mm}$; Graded Ratio: 1.4

Input Power = 16.0 dBm (40 mW)

Peak SAR (extrapolated) = 13.2 W/kg

SAR(1 g) = 2.83 W/kg

Deviation (1 g) = -5.54%

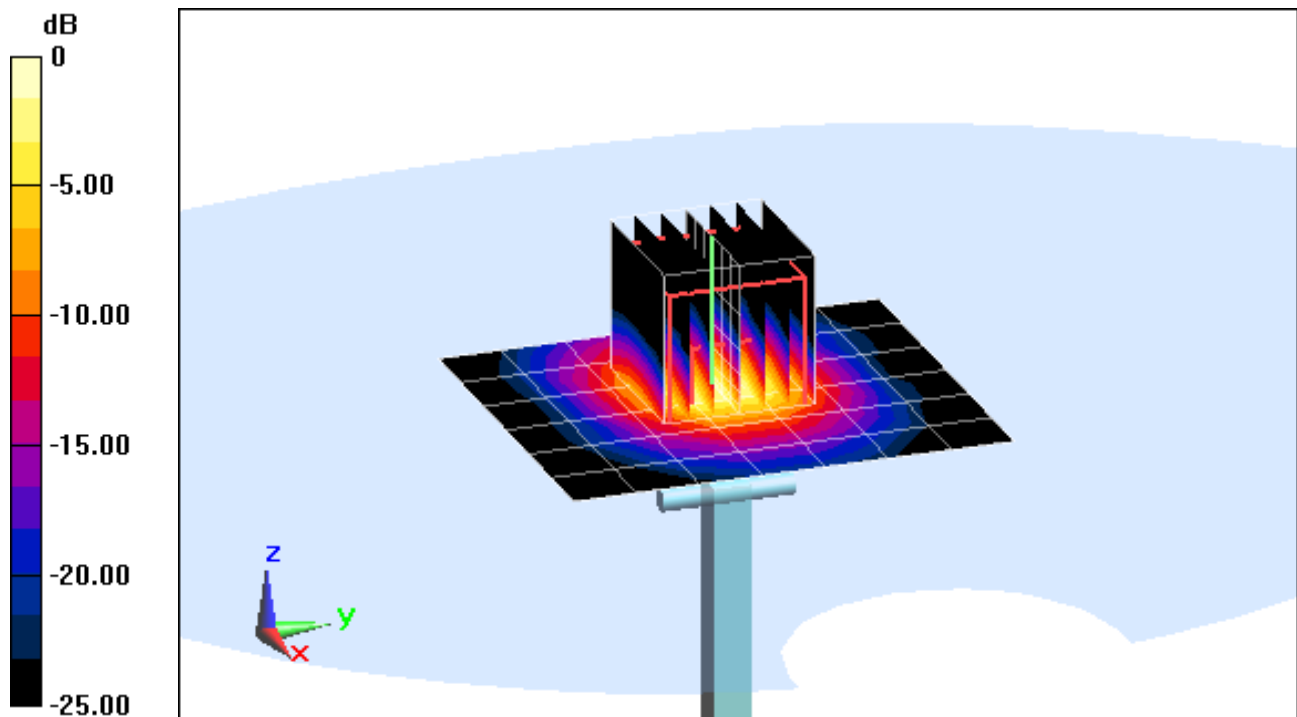

0 dB = 7.42 W/kg = 8.70 dBW/kg

PCTEST ENGINEERING LABORATORY, INC.

DUT: Dipole 750 MHz; Type: D750V3; Serial: 1054

Communication System: UID 0, CW; Frequency: 750 MHz; Duty Cycle: 1:1

Medium: 750 Body, Medium parameters used (interpolated):

$f = 750 \text{ MHz}$; $\sigma = 0.982 \text{ S/m}$; $\epsilon_r = 56.416$; $\rho = 1000 \text{ kg/m}^3$

Phantom section: Flat Section; Space: 1.5 cm

Test Date: 12-04-2013; Ambient Temp: 23.5°C; Tissue Temp: 22.5°C

Probe: ES3DV3 - SN3288; ConvF(6.25, 6.25, 6.25); Calibrated: 9/23/2013;

Sensor-Surface: 4mm (Mechanical Surface Detection)

Electronics: DAE4 Sn1323; Calibrated: 9/17/2013

Phantom: SAM with CRP; Type: SAM; Serial: TP1375

Measurement SW: DASY4, Version 4.7 (80); SEMCAD X Version 14.6.10 (7164)

750 MHz System Verification

Area Scan (7x13x1): Measurement grid: dx=15mm, dy=15mm

Zoom Scan (5x5x7)/Cube 0: Measurement grid: dx=8mm, dy=8mm, dz=5mm

Input Power = 20.0 dBm (100 mW)

Peak SAR (extrapolated) = 1.31 W/kg

SAR(1 g) = 0.894 W/kg

Deviation (1 g) = 2.52%%

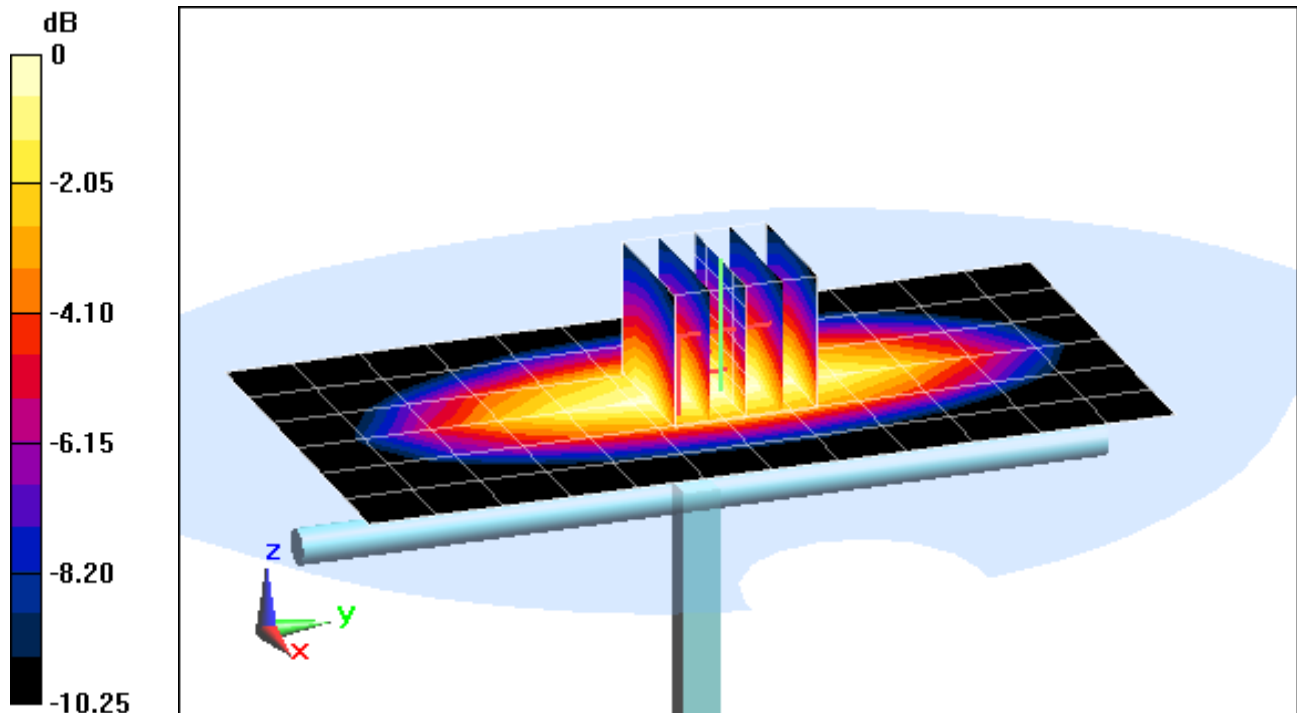

0 dB = 0.955 W/kg = -0.20 dBW/kg

PCTEST ENGINEERING LABORATORY, INC.

DUT: SAR Dipole 835 MHz; Type: D835V2; Serial: 4d119

Communication System: UID 0, CW; Frequency: 835 MHz; Duty Cycle: 1:1

Medium: 835 Body, Medium parameters used:

$f = 835 \text{ MHz}$; $\sigma = 1.01 \text{ S/m}$; $\epsilon_r = 53.891$; $\rho = 1000 \text{ kg/m}^3$

Phantom section: Flat Section; Space: 1.5 cm

Test Date: 12-02-2013; Ambient Temp: 23.2°C; Tissue Temp: 21.3°C

Probe: ES3DV3 - SN3209; ConvF(6.28, 6.28, 6.28); Calibrated: 3/15/2013;

Sensor-Surface: 4mm (Mechanical Surface Detection)

Electronics: DAE4 Sn1334; Calibrated: 3/8/2013

Phantom: ELI v5.0; Type: QDOVA002AA; Serial: TP-1158

Measurement SW: DASYS2, Version 52.8 (7); SEMCAD X Version 14.6.10 (7164)

835 MHz System Verification

Area Scan (7x14x1): Measurement grid: dx=15mm, dy=15mm

Zoom Scan (5x5x7)/Cube 0: Measurement grid: dx=8mm, dy=8mm, dz=5mm

Input Power = 20.0 dBm (100 mW)

Peak SAR (extrapolated) = 1.48 W/kg

SAR(1 g) = 1.01 W/kg

Deviation (1 g) = 5.87%

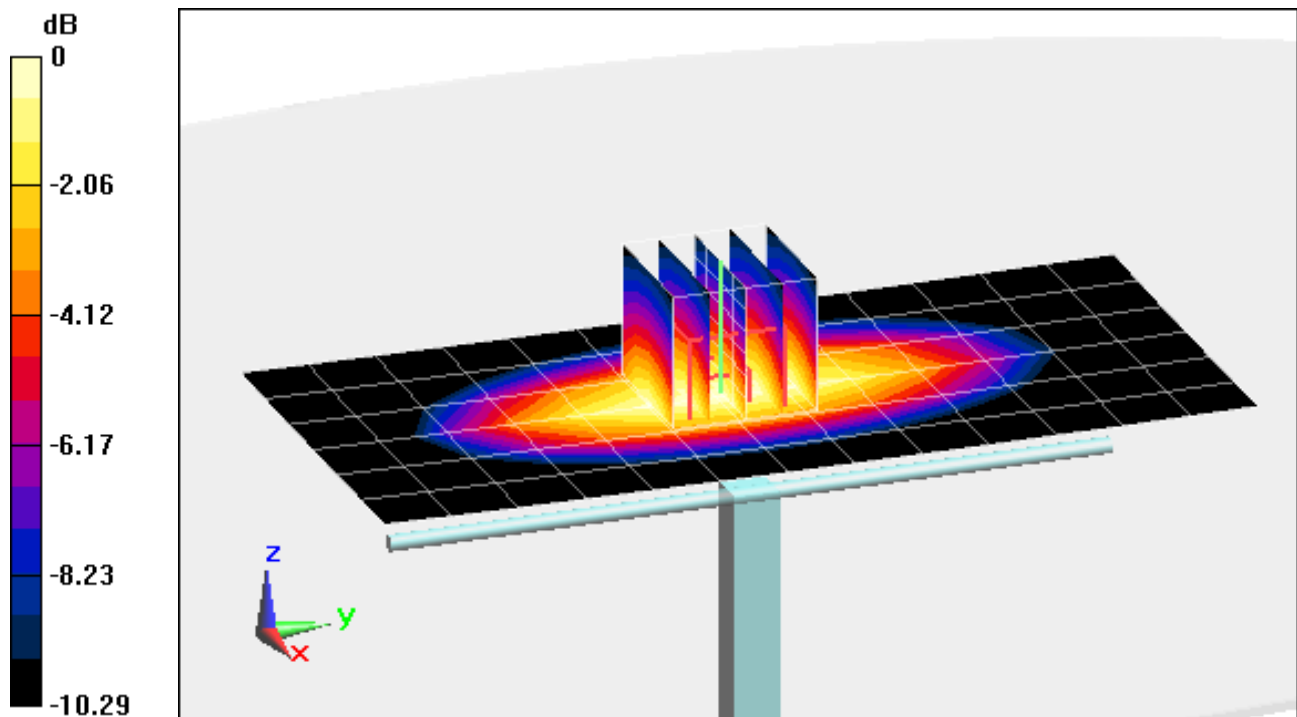

0 dB = 1.10 W/kg = 0.41 dBW/kg

PCTEST ENGINEERING LABORATORY, INC.

DUT: Dipole 1750 MHz; Type: D1750V2; Serial: 1051

Communication System: UID 0, CW; Frequency: 1750 MHz; Duty Cycle: 1:1

Medium: 1750 Body, Medium parameters used:

$f = 1750 \text{ MHz}$; $\sigma = 1.454 \text{ S/m}$; $\epsilon_r = 52.145$; $\rho = 1000 \text{ kg/m}^3$

Phantom section: Flat Section; Space: 1.0 cm

Test Date: 12-05-2013; Ambient Temp: 21.8°C; Tissue Temp: 21.3°C

Probe: ES3DV3 - SN3319; ConvF(5.22, 5.22, 5.22); Calibrated: 6/28/2013;

Sensor-Surface: 4mm (Mechanical Surface Detection)

Electronics: DAE4 Sn1368; Calibrated: 4/22/2013

Phantom: SAM front; Type: QD000P40CD; Serial: TP:1759

Measurement SW: DASY52, Version 52.8 (7); SEMCAD X Version 14.6.10 (7164)

1750 MHz System Verification

Area Scan (7x9x1): Measurement grid: dx=15mm, dy=15mm

Zoom Scan (5x5x7)/Cube 0: Measurement grid: dx=8mm, dy=8mm, dz=5mm

Input Power = 20.0 dBm (100 mW)

Peak SAR (extrapolated) = 6.70 W/kg

SAR(1 g) = 3.55 W/kg

Deviation (1 g) = -6.08%

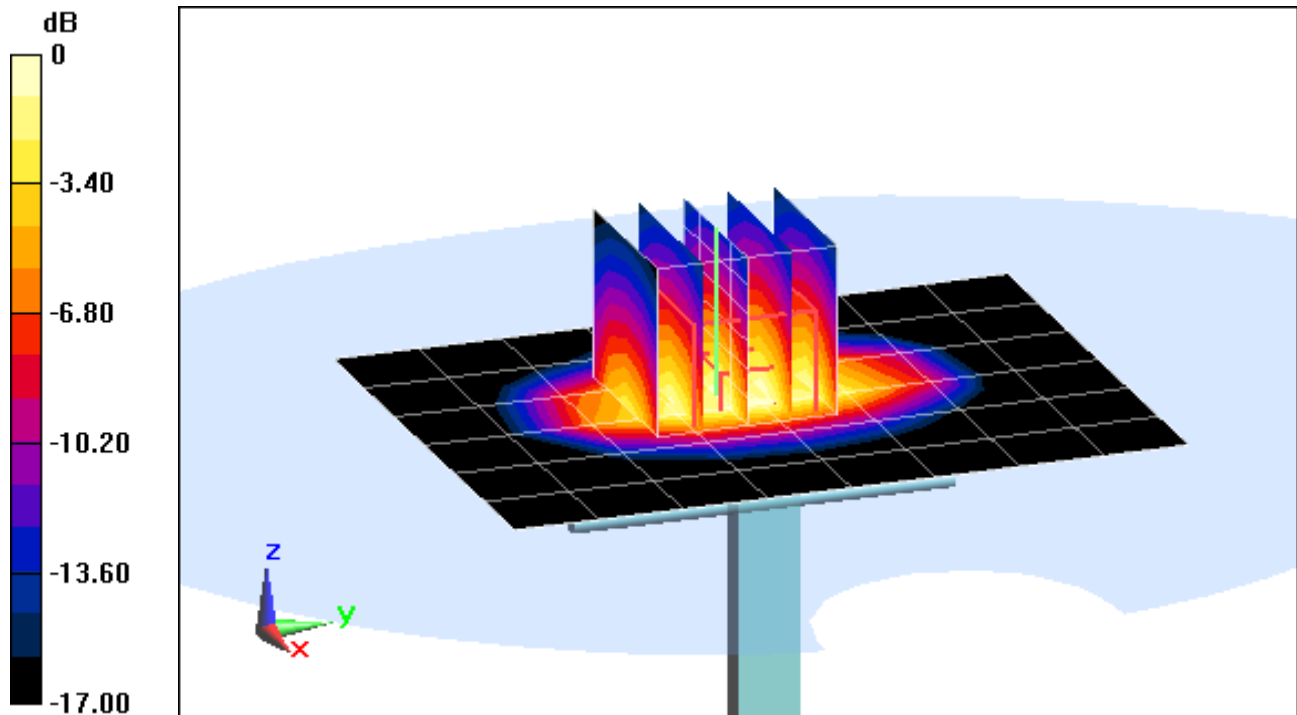

0 dB = 3.89 W/kg = 5.90 dBW/kg

PCTEST ENGINEERING LABORATORY, INC.

DUT: Dipole 1900 MHz; Type: D1900V2; Serial: 5d141

Communication System: UID 0, CW; Frequency: 1900 MHz; Duty Cycle: 1:1

Medium: 1900 Body, Medium parameters used (interpolated):

$f = 1900 \text{ MHz}$; $\sigma = 1.537 \text{ S/m}$; $\epsilon_r = 52.026$; $\rho = 1000 \text{ kg/m}^3$

Phantom section: Flat Section; Space: 1.0 cm

Test Date: 12-02-2013; Ambient Temp: 22.2°C; Tissue Temp: 21.1°C

Probe: ES3DV3 - SN3263; ConvF(4.78, 4.78, 4.78); Calibrated: 5/16/2013;

Sensor-Surface: 4mm (Mechanical Surface Detection)

Electronics: DAE4 Sn859; Calibrated: 5/13/2013

Phantom: SAM Main; Type: SAM 4.0; Serial: TP-1406

Measurement SW: DASY4, Version 4.7 (80); SEMCAD X Version 14.6.10 (7164)

1900 MHz System Verification

Area Scan (5x7x1): Measurement grid: dx=15mm, dy=15mm

Zoom Scan (5x5x7)/Cube 0: Measurement grid: dx=8mm, dy=8mm, dz=5mm

Input Power = 20.0 dBm (100 mW)

Peak SAR (extrapolated) = 7.13 W/kg

SAR(1 g) = 4.07 W/kg

Deviation (1 g) = -1.93%

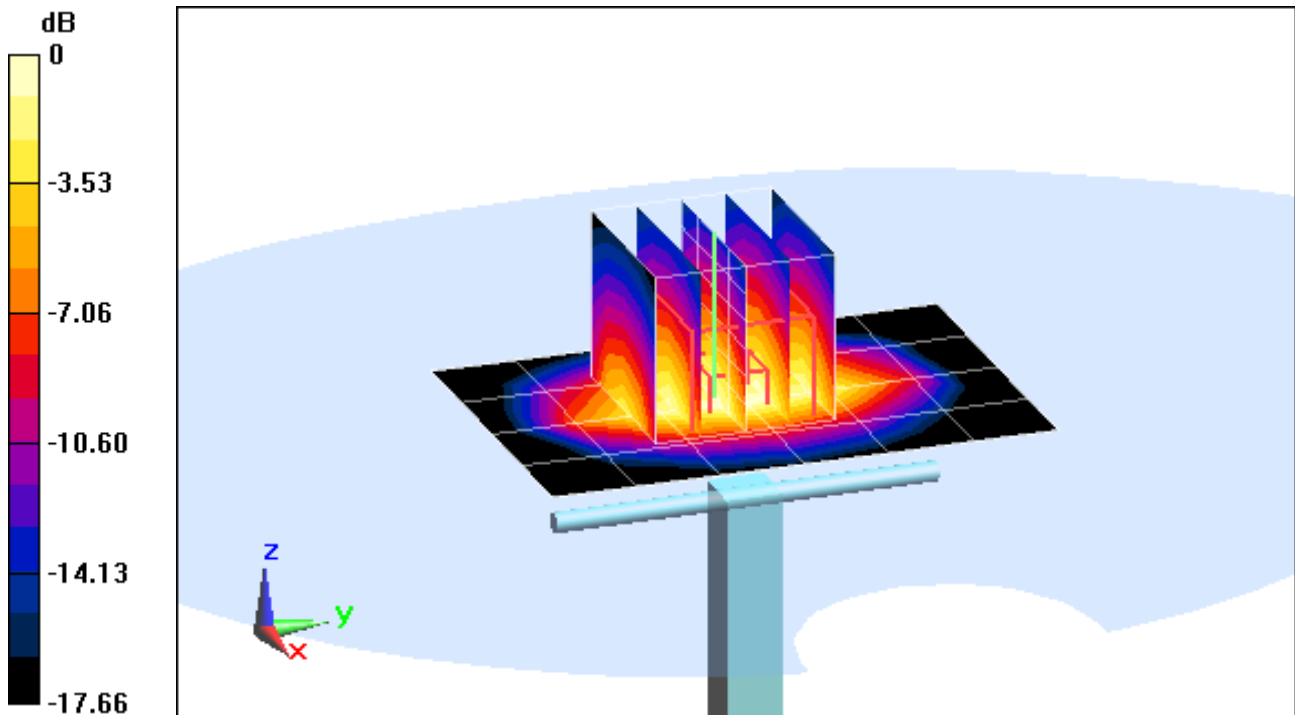

0 dB = 4.56 W/kg = 6.59 dBW/kg

PCTEST ENGINEERING LABORATORY, INC.

DUT: Dipole 1900 MHz; Type: D1900V2; Serial: 5d148

Communication System: UID 0, CW; Frequency: 1900 MHz; Duty Cycle: 1:1

Medium: 1900 Body, Medium parameters used (interpolated):

$f = 1900 \text{ MHz}$; $\sigma = 1.534 \text{ S/m}$; $\epsilon_r = 51.344$; $\rho = 1000 \text{ kg/m}^3$

Phantom section: Flat Section; Space: 1.0 cm

Test Date: 12-16-2013; Ambient Temp: 21.9°C; Tissue Temp: 22.7°C

Probe: ES3DV3 - SN3319; ConvF(4.85, 4.85, 4.85); Calibrated: 4/29/2013;

Sensor-Surface: 4mm (Mechanical Surface Detection)

Electronics: DAE4 Sn1368; Calibrated: 4/22/2013

Phantom: SAM front; Type: QD000P40CD; Serial: TP:1759

Measurement SW: DASYS2, Version 52.8 (7); SEMCAD X Version 14.6.10 (7164)

1900 MHz System Verification

Area Scan (7x10x1): Measurement grid: dx=15mm, dy=15mm

Zoom Scan (5x5x7)/Cube 0: Measurement grid: dx=8mm, dy=8mm, dz=5mm

Input Power = 20.0 dBm (100 mW)

Peak SAR (extrapolated) = 7.42 W/kg

SAR(1 g) = 4.07 W/kg

Deviation (1 g) = -0.25%

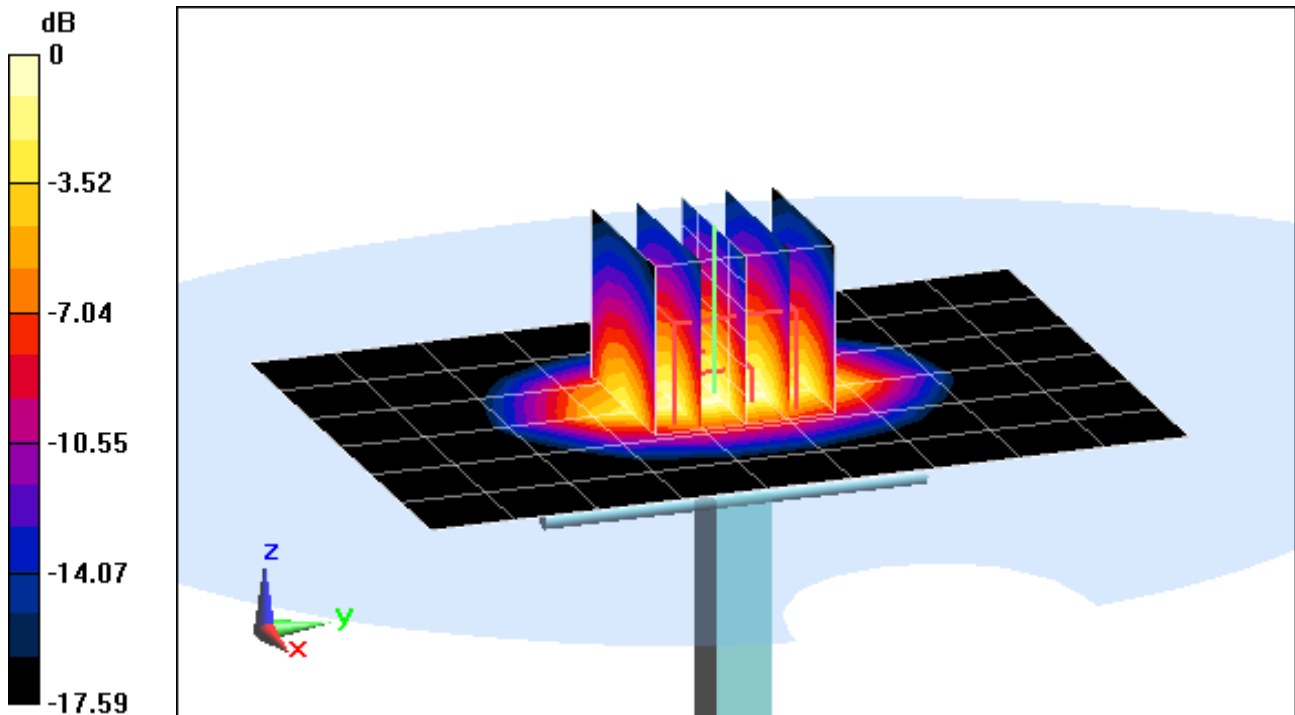

0 dB = 4.61 W/kg = 6.64 dBW/kg

PCTEST ENGINEERING LABORATORY, INC.

DUT: Dipole 2450 MHz; Type: D2450V2; Serial: 797

Communication System: UID 0, CW; Frequency: 2450 MHz; Duty Cycle: 1:1

Medium: 2450 Body, Medium parameters used:

$f = 2450 \text{ MHz}$; $\sigma = 2.036 \text{ S/m}$; $\epsilon_r = 51.063$; $\rho = 1000 \text{ kg/m}^3$

Phantom section: Flat Section; Space: 1.0 cm

Test Date: 12-02-2013; Ambient Temp: 22.2°C; Tissue Temp: 22.4°C

Probe: ES3DV2 - SN3022; ConvF(4.01, 4.01, 4.01); Calibrated: 8/22/2013;

Sensor-Surface: 3mm (Mechanical Surface Detection)

Electronics: DAE4 Sn1322; Calibrated: 8/21/2013

Phantom: SAM v5.0 front; Type: QD000P40CD; Serial: TP-1646

Measurement SW: DASY52, Version 52.8 (7); SEMCAD X Version 14.6.10 (7164)

2450 MHz System Verification

Area Scan (8x9x1): Measurement grid: dx=12mm, dy=12mm

Zoom Scan (7x8x7)/Cube 0: Measurement grid: dx=5mm, dy=5mm, dz=5mm

Input Power = 20.0 dBm (100 mW)

Peak SAR (extrapolated) = 10.8 W/kg

SAR(1 g) = 5.00 W/kg

Deviation (1 g) = 0.81%

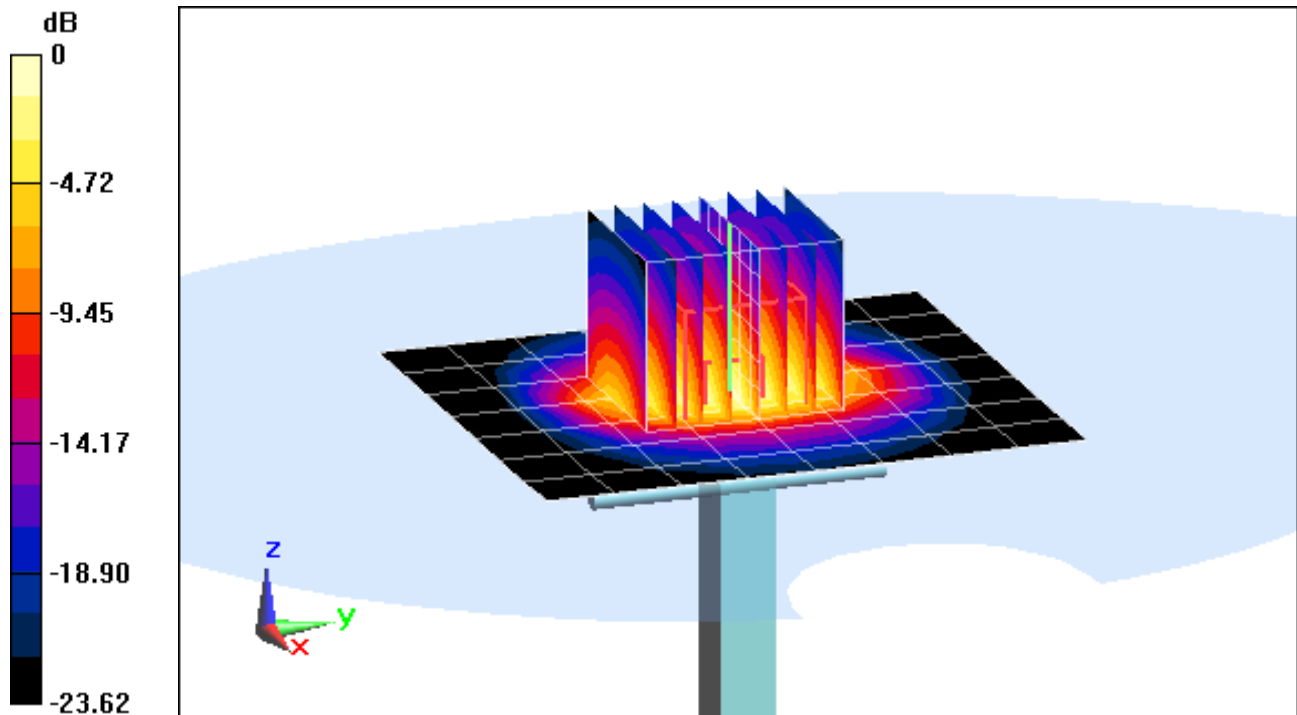

0 dB = 6.57 W/kg = 8.18 dBW/kg

PCTEST ENGINEERING LABORATORY, INC.

DUT: Dipole 2600 MHz; Type: D2600V2; Serial: 1004

Communication System: UID 0, CW; Frequency: 2600 MHz; Duty Cycle: 1:1

Medium: 2600 Body, Medium parameters used:

$f = 2600 \text{ MHz}$; $\sigma = 2.245 \text{ S/m}$; $\epsilon_r = 50.458$; $\rho = 1000 \text{ kg/m}^3$

Phantom section: Flat Section; Space: 1.0 cm

Test Date: 12-02-2013; Ambient Temp: 22.2°C; Tissue Temp: 22.4°C

Probe: ES3DV2 - SN3022; ConvF(3.85, 3.85, 3.85); Calibrated: 8/22/2013;

Sensor-Surface: 3mm (Mechanical Surface Detection)

Electronics: DAE4 Sn1322; Calibrated: 8/21/2013

Phantom: SAM v5.0 front; Type: QD000P40CD; Serial: TP-1646

Measurement SW: DASYS2, Version 52.8 (7); SEMCAD X Version 14.6.10 (7164)

2600 MHz System Verification

Area Scan (8x9x1): Measurement grid: dx=12mm, dy=12mm

Zoom Scan (7x7x7)/Cube 0: Measurement grid: dx=5mm, dy=5mm, dz=5mm

Input Power = 20.0 dBm (100 mW)

Peak SAR (extrapolated) = 12.5 W/kg

SAR(1 g) = 5.48 W/kg

Deviation (1 g) = -4.70%

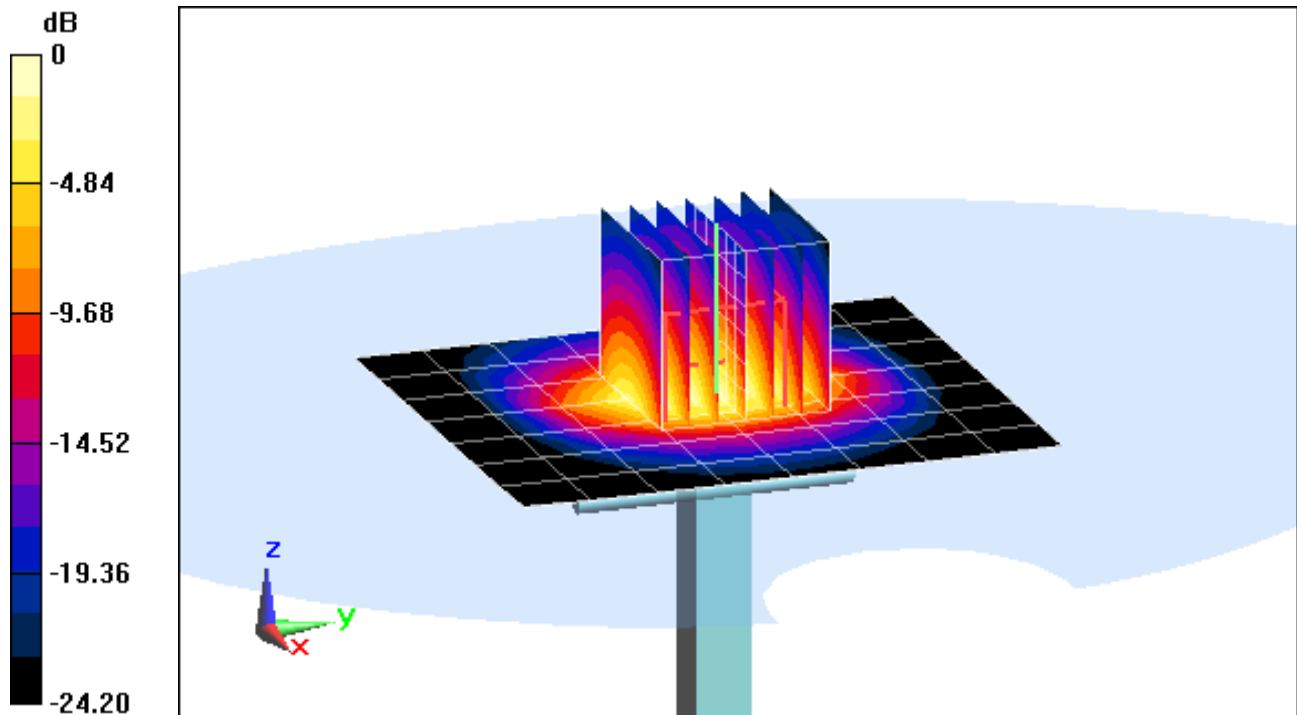

0 dB = 7.22 W/kg = 8.59 dBW/kg

PCTEST ENGINEERING LABORATORY, INC.

DUT: Dipole 5200 MHz; Type: D5GHzV2; Serial: 1057

Communication System: UID 0, CW; Frequency: 5200 MHz; Duty Cycle: 1:1

Medium: 5 GHz Body, Medium parameters used:

$f = 5200 \text{ MHz}$; $\sigma = 5.3 \text{ S/m}$; $\epsilon_r = 46.959$; $\rho = 1000 \text{ kg/m}^3$

Phantom section: Flat Section; Space: 1.0 cm

Test Date: 12-02-2013; Ambient Temp: 23.6°C; Tissue Temp: 21.8°C

Probe: EX3DV4 - SN3589; ConvF(3.99, 3.99, 3.99); Calibrated: 1/17/2013;

Sensor-Surface: 1.4mm (Mechanical Surface Detection)

Electronics: DAE4 Sn1272; Calibrated: 1/17/2013

Phantom: SAM Sub; Type: SAM 4.0; Serial: TP-1357

Measurement SW: DASY4, Version 4.7 (80); SEMCAD X Version 14.6.10 (7164)

5200 MHz System Verification

Area Scan (7x9x1): Measurement grid: dx=10mm, dy=10mm

Zoom Scan (9x9x7)/Cube 0: Measurement grid: dx=4mm, dy=4mm, dz=1.4mm; Graded Ratio: 1.4

Input Power = 20.0 dBm (100 mW)

Peak SAR (extrapolated) = 31.4 W/kg

SAR(1 g) = 7.66 W/kg; SAR(10 g) = 2.18 W/kg

Deviation (1 g) = 1.46%; Deviation (10 g) = 3.32%

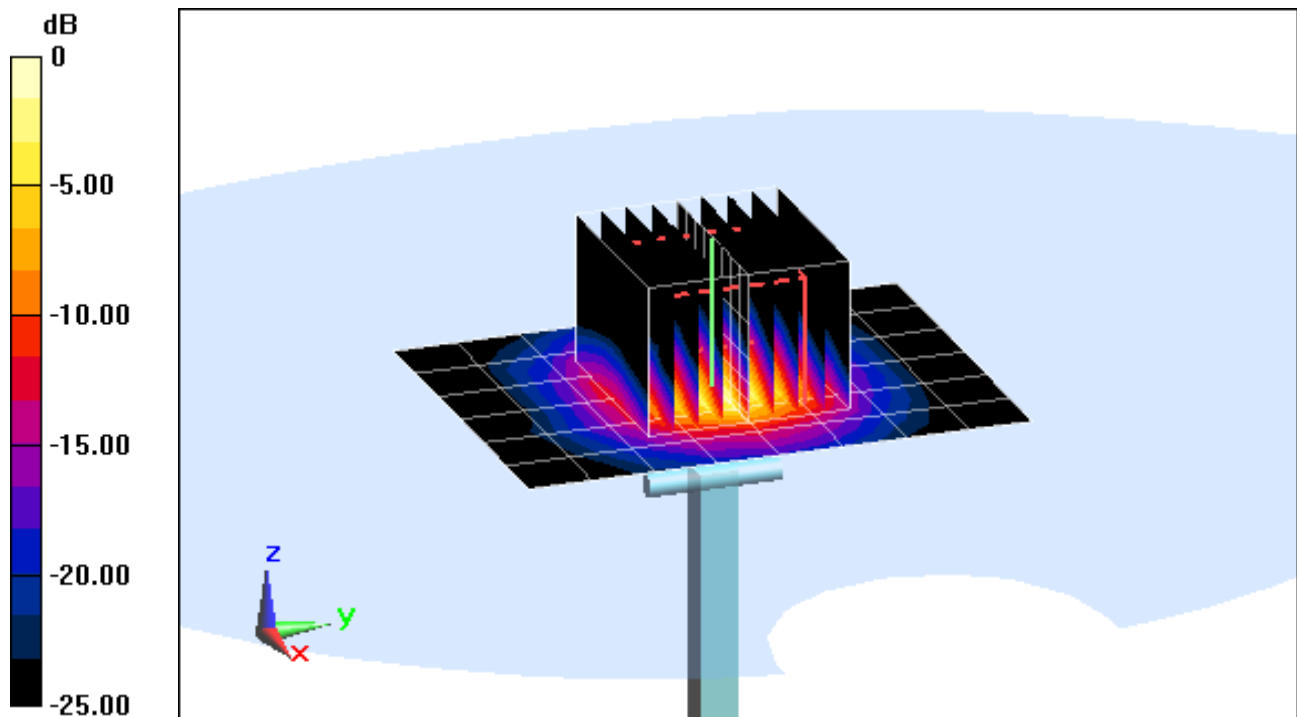

PCTEST ENGINEERING LABORATORY, INC.

DUT: Dipole 5300 MHz; Type: D5GHzV2; Serial: 1057

Communication System: UID 0, CW; Frequency: 5300 MHz; Duty Cycle: 1:1

Medium: 5 GHz Body, Medium parameters used:

$f = 5300 \text{ MHz}$; $\sigma = 5.47 \text{ S/m}$; $\epsilon_r = 46.658$; $\rho = 1000 \text{ kg/m}^3$

Phantom section: Flat Section; Space: 1.0 cm

Test Date: 12-02-2013; Ambient Temp: 23.5°C; Tissue Temp: 21.9°C

Probe: EX3DV4 - SN3589; ConvF(3.81, 3.81, 3.81); Calibrated: 1/17/2013;

Sensor-Surface: 1.4mm (Mechanical Surface Detection)

Electronics: DAE4 Sn1272; Calibrated: 1/17/2013

Phantom: SAM Sub; Type: SAM 4.0; Serial: TP-1357

Measurement SW: DASY4, Version 4.7 (80); SEMCAD X Version 14.6.10 (7164)

5300 MHz System Verification

Area Scan (7x9x1): Measurement grid: dx=10mm, dy=10mm

Zoom Scan (9x9x7)/Cube 0: Measurement grid: dx=4mm, dy=4mm, dz=1.4mm; Graded Ratio: 1.4

Input Power = 20.0 dBm (100 mW)

Peak SAR (extrapolated) = 30.4 W/kg

SAR(1 g) = 7.72 W/kg; SAR(10 g) = 2.17 W/kg

Deviation (1 g) = 2.52%; Deviation (10 g) = 2.84%

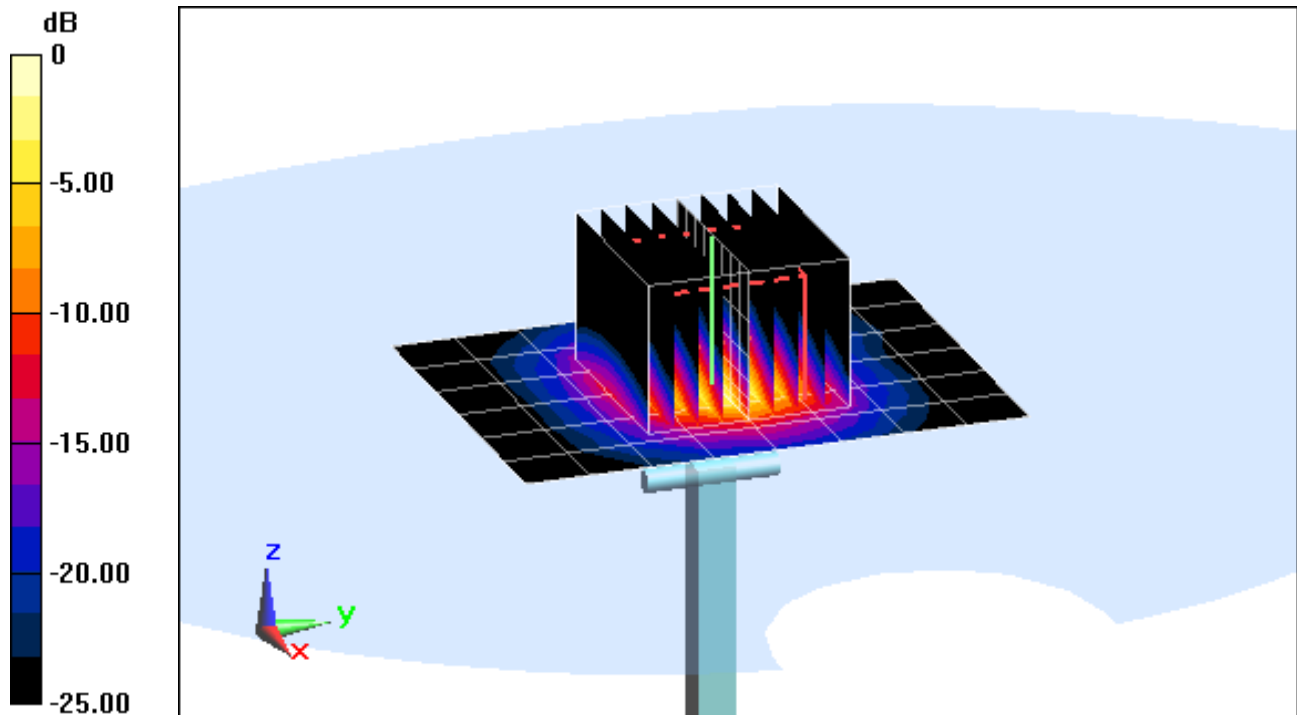

0 dB = 19.6 W/kg = 12.92 dBW/kg

PCTEST ENGINEERING LABORATORY, INC.

DUT: Dipole 5500 MHz; Type: D5GHzV2; Serial: 1057

Communication System: UID 0, CW; Frequency: 5500 MHz; Duty Cycle: 1:1

Medium: 5 GHz Body, Medium parameters used:

$f = 5500 \text{ MHz}$; $\sigma = 5.84 \text{ S/m}$; $\epsilon_r = 46.279$; $\rho = 1000 \text{ kg/m}^3$

Phantom section: Flat Section; Space: 1.0 cm

Test Date: 12-02-2013; Ambient Temp: 23.6°C; Tissue Temp: 21.7°C

Probe: EX3DV4 - SN3589; ConvF(3.52, 3.52, 3.52); Calibrated: 1/17/2013;

Sensor-Surface: 1.4mm (Mechanical Surface Detection)

Electronics: DAE4 Sn1272; Calibrated: 1/17/2013

Phantom: SAM Sub; Type: SAM 4.0; Serial: TP-1357

Measurement SW: DASY4, Version 4.7 (80); SEMCAD X Version 14.6.10 (7164)

5500 MHz System Verification

Area Scan (7x9x1): Measurement grid: dx=10mm, dy=10mm

Zoom Scan (9x9x7)/Cube 0: Measurement grid: dx=4mm, dy=4mm, dz=1.4mm; Graded Ratio: 1.4

Input Power = 20.0 dBm (100 mW)

Peak SAR (extrapolated) = 31.4 W/kg

SAR(1 g) = 7.94 W/kg; SAR(10 g) = 2.23 W/kg

Deviation (1 g) = -1.73%; Deviation (10 g) = -0.45%

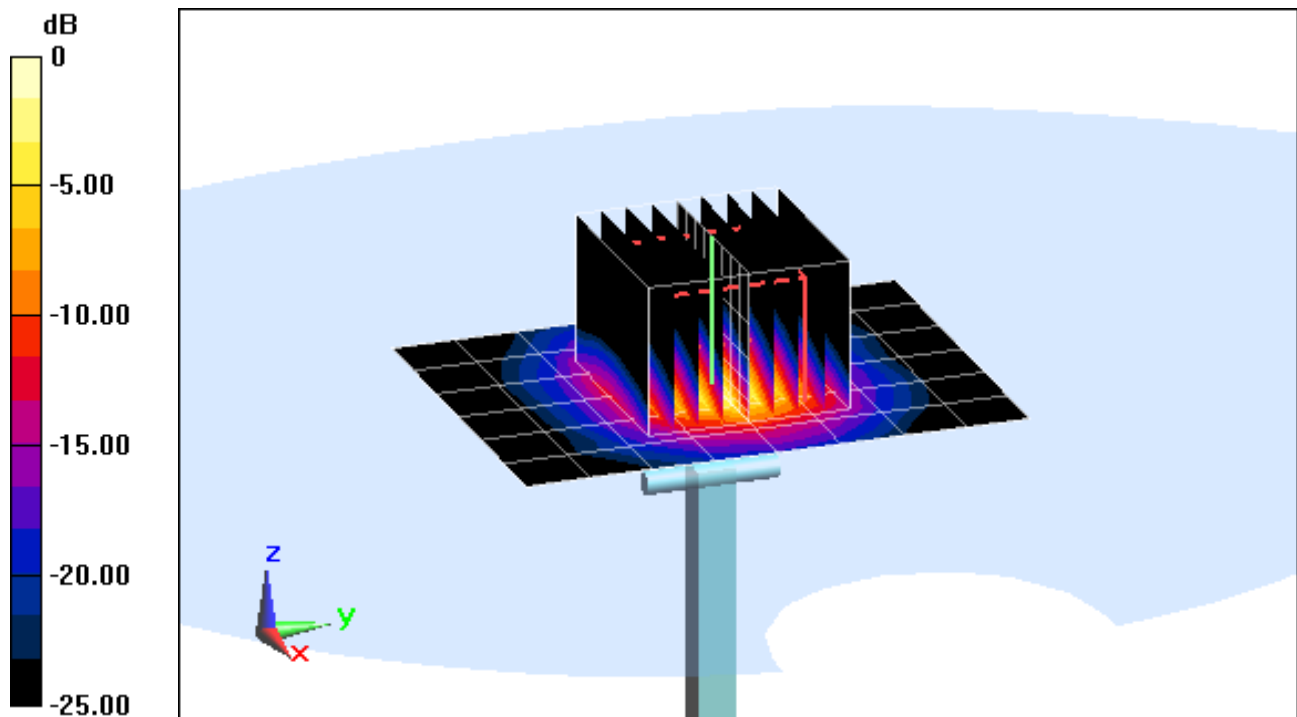

0 dB = 20.3 W/kg = 13.07 dBW/kg

PCTEST ENGINEERING LABORATORY, INC.

DUT: Dipole 5800 MHz; Type: D5GHzV2; Serial: 1057

Communication System: UID 0, CW; Frequency: 5800 MHz; Duty Cycle: 1:1

Medium: 5 GHz Body, Medium parameters used:

$f = 5800 \text{ MHz}$; $\sigma = 6.238 \text{ S/m}$; $\epsilon_r = 45.967$; $\rho = 1000 \text{ kg/m}^3$

Phantom section: Flat Section; Space: 1.0 cm

Test Date: 12-02-2013; Ambient Temp: 23.5°C; Tissue Temp: 21.8°C

Probe: EX3DV4 - SN3589; ConvF(3.66, 3.66, 3.66); Calibrated: 1/17/2013;

Sensor-Surface: 1.4mm (Mechanical Surface Detection)

Electronics: DAE4 Sn1272; Calibrated: 1/17/2013

Phantom: SAM Sub; Type: SAM 4.0; Serial: TP-1357

Measurement SW: DASY4, Version 4.7 (80); SEMCAD X Version 14.6.10 (7164)

5800 MHz System Verification

Area Scan (7x9x1): Measurement grid: dx=10mm, dy=10mm

Zoom Scan (9x9x7)/Cube 0: Measurement grid: dx=4mm, dy=4mm, dz=1.4mm; Graded Ratio: 1.4

Input Power = 20.0 dBm (100 mW)

Peak SAR (extrapolated) = 31.7 W/kg

SAR(1 g) = 7.41 W/kg

Deviation (1 g) = -1.33%

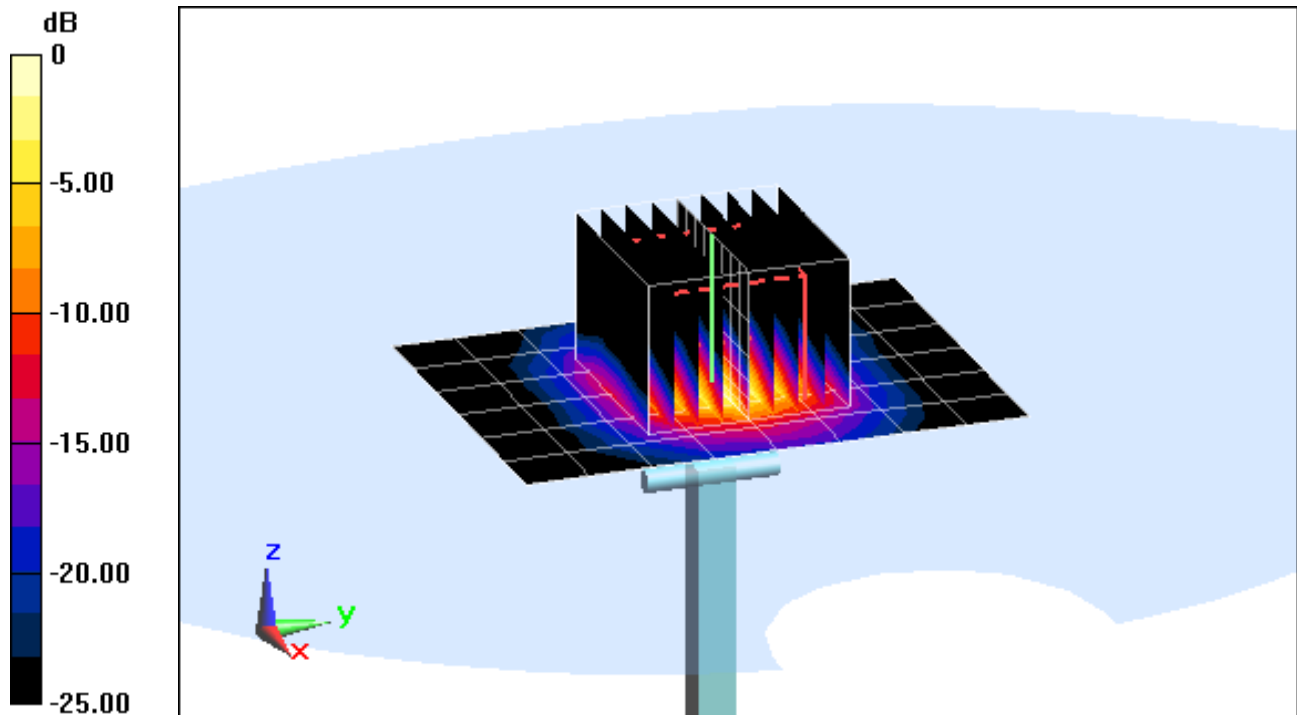

0 dB = 18.7 W/kg = 12.72 dBW/kg

APPENDIX C: PROBE CALIBRATION



Accredited by the Swiss Accreditation Service (SAS)
The Swiss Accreditation Service is one of the signatories to the EA
Multilateral Agreement for the recognition of calibration certificates

Accreditation No.: **SCS 108**

Client **PC Test**

Certificate No: **D750V3-1046_Feb13**

CALIBRATION CERTIFICATE

Object **D750V3 - SN: 1046**

Calibration procedure(s) **QA CAL-05.v9
Calibration procedure for dipole validation kits above 700 MHz**

Calibration date: **February 13, 2013**

✓
KOK
2/21/13

This calibration certificate documents the traceability to national standards, which realize the physical units of measurements (SI).
The measurements and the uncertainties with confidence probability are given on the following pages and are part of the certificate.

All calibrations have been conducted in the closed laboratory facility: environment temperature (22 ± 3)°C and humidity < 70%.

Calibration Equipment used (M&TE critical for calibration)

Primary Standards	ID #	Cal Date (Certificate No.)	Scheduled Calibration
Power meter EPM-442A	GB37480704	01-Nov-12 (No. 217-01640)	Oct-13
Power sensor HP 8481A	US37292783	01-Nov-12 (No. 217-01640)	Oct-13
Reference 20 dB Attenuator	SN: 5058 (20k)	27-Mar-12 (No. 217-01530)	Apr-13
Type-N mismatch combination	SN: 5047.3 / 06327	27-Mar-12 (No. 217-01533)	Apr-13
Reference Probe ES3DV3	SN: 3205	28-Dec-12 (No. ES3-3205_Dec12)	Dec-13
DAE4	SN: 601	27-Jun-12 (No. DAE4-601_Jun12)	Jun-13
Secondary Standards	ID #	Check Date (in house)	Scheduled Check
Power sensor HP 8481A	MY41092317	18-Oct-02 (in house check Oct-11)	In house check: Oct-13
RF generator R&S SMT-06	100005	04-Aug-99 (in house check Oct-11)	In house check: Oct-13
Network Analyzer HP 8753E	US37390585 S4206	18-Oct-01 (in house check Oct-12)	In house check: Oct-13

	Name	Function	Signature
Calibrated by:	Leif Klysner	Laboratory Technician	
Approved by:	Katja Pokovic	Technical Manager	

Issued: February 13, 2013

This calibration certificate shall not be reproduced except in full without written approval of the laboratory.



Accredited by the Swiss Accreditation Service (SAS)

The Swiss Accreditation Service is one of the signatories to the EA
Multilateral Agreement for the recognition of calibration certificates

Accreditation No.: **SCS 108**

Glossary:

TSL	tissue simulating liquid
ConvF	sensitivity in TSL / NORM x,y,z
N/A	not applicable or not measured

Calibration is Performed According to the Following Standards:

- IEEE Std 1528-2003, "IEEE Recommended Practice for Determining the Peak Spatial-Averaged Specific Absorption Rate (SAR) in the Human Head from Wireless Communications Devices: Measurement Techniques", December 2003
- IEC 62209-1, "Procedure to measure the Specific Absorption Rate (SAR) for hand-held devices used in close proximity to the ear (frequency range of 300 MHz to 3 GHz)", February 2005
- Federal Communications Commission Office of Engineering & Technology (FCC OET), "Evaluating Compliance with FCC Guidelines for Human Exposure to Radiofrequency Electromagnetic Fields; Additional Information for Evaluating Compliance of Mobile and Portable Devices with FCC Limits for Human Exposure to Radiofrequency Emissions", Supplement C (Edition 01-01) to Bulletin 65

Additional Documentation:

- DASY4/5 System Handbook

Methods Applied and Interpretation of Parameters:

- Measurement Conditions:** Further details are available from the Validation Report at the end of the certificate. All figures stated in the certificate are valid at the frequency indicated.
- Antenna Parameters with TSL:** The dipole is mounted with the spacer to position its feed point exactly below the center marking of the flat phantom section, with the arms oriented parallel to the body axis.
- Feed Point Impedance and Return Loss:** These parameters are measured with the dipole positioned under the liquid filled phantom. The impedance stated is transformed from the measurement at the SMA connector to the feed point. The Return Loss ensures low reflected power. No uncertainty required.
- Electrical Delay:** One-way delay between the SMA connector and the antenna feed point. No uncertainty required.
- SAR measured:** SAR measured at the stated antenna input power.
- SAR normalized:** SAR as measured, normalized to an input power of 1 W at the antenna connector.
- SAR for nominal TSL parameters:** The measured TSL parameters are used to calculate the nominal SAR result.

The reported uncertainty of measurement is stated as the standard uncertainty of measurement multiplied by the coverage factor $k=2$, which for a normal distribution corresponds to a coverage probability of approximately 95%.

Measurement Conditions

DASY system configuration, as far as not given on page 1.

DASY Version	DASY5	V52.8.5
Extrapolation	Advanced Extrapolation	
Phantom	Modular Flat Phantom	
Distance Dipole Center - TSL	15 mm	with Spacer
Zoom Scan Resolution	dx, dy, dz = 5 mm	
Frequency	750 MHz \pm 1 MHz	

Head TSL parameters

The following parameters and calculations were applied.

	Temperature	Permittivity	Conductivity
Nominal Head TSL parameters	22.0 °C	41.9	0.89 mho/m
Measured Head TSL parameters	(22.0 \pm 0.2) °C	41.2 \pm 6 %	0.91 mho/m \pm 6 %
Head TSL temperature change during test	< 0.5 °C	----	----

SAR result with Head TSL

SAR averaged over 1 cm ³ (1 g) of Head TSL	Condition	
SAR measured	250 mW input power	2.17 W/kg
SAR for nominal Head TSL parameters	normalized to 1W	8.50 W/kg \pm 17.0 % (k=2)

SAR averaged over 10 cm ³ (10 g) of Head TSL	condition	
SAR measured	250 mW input power	1.41 W/kg
SAR for nominal Head TSL parameters	normalized to 1W	5.55 W/kg \pm 16.5 % (k=2)

Body TSL parameters

The following parameters and calculations were applied.

	Temperature	Permittivity	Conductivity
Nominal Body TSL parameters	22.0 °C	55.5	0.96 mho/m
Measured Body TSL parameters	(22.0 \pm 0.2) °C	54.8 \pm 6 %	0.99 mho/m \pm 6 %
Body TSL temperature change during test	< 0.5 °C	----	----

SAR result with Body TSL

SAR averaged over 1 cm ³ (1 g) of Body TSL	Condition	
SAR measured	250 mW input power	2.25 W/kg
SAR for nominal Body TSL parameters	normalized to 1W	8.77 W/kg \pm 17.0 % (k=2)

SAR averaged over 10 cm ³ (10 g) of Body TSL	condition	
SAR measured	250 mW input power	1.49 W/kg
SAR for nominal Body TSL parameters	normalized to 1W	5.84 W/kg \pm 16.5 % (k=2)

Appendix

Antenna Parameters with Head TSL

Impedance, transformed to feed point	56.3 Ω + 1.4 j Ω
Return Loss	- 24.3 dB

Antenna Parameters with Body TSL

Impedance, transformed to feed point	52.0 Ω - 1.1 j Ω
Return Loss	- 32.9 dB

General Antenna Parameters and Design

Electrical Delay (one direction)	1.038 ns
----------------------------------	----------

After long term use with 100W radiated power, only a slight warming of the dipole near the feedpoint can be measured.

The dipole is made of standard semirigid coaxial cable. The center conductor of the feeding line is directly connected to the second arm of the dipole. The antenna is therefore short-circuited for DC-signals. On some of the dipoles, small end caps are added to the dipole arms in order to improve matching when loaded according to the position as explained in the "Measurement Conditions" paragraph. The SAR data are not affected by this change. The overall dipole length is still according to the Standard.

No excessive force must be applied to the dipole arms, because they might bend or the soldered connections near the feedpoint may be damaged.

Additional EUT Data

Manufactured by	SPEAG
Manufactured on	September 02, 2011

DASY5 Validation Report for Head TSL

Date: 13.02.2013

Test Laboratory: SPEAG, Zurich, Switzerland

DUT: Dipole 750 MHz; Type: D750V3; Serial: D750V3 - SN: 1046

Communication System: CW; Frequency: 750 MHz

Medium parameters used: $f = 750$ MHz; $\sigma = 0.91$ S/m; $\epsilon_r = 41.2$; $\rho = 1000$ kg/m³

Phantom section: Flat Section

Measurement Standard: DASY5 (IEEE/IEC/ANSI C63.19-2007)

DASY52 Configuration:

- Probe: ES3DV3 - SN3205; ConvF(6.28, 6.28, 6.28); Calibrated: 28.12.2012;
- Sensor-Surface: 3mm (Mechanical Surface Detection)
- Electronics: DAE4 Sn601; Calibrated: 27.06.2012
- Phantom: Flat Phantom 4.9L; Type: QD000P49AA; Serial: 1001
- DASY52 52.8.5(1059); SEMCAD X 14.6.8(7028)

Dipole Calibration for Head Tissue/Pin=250 mW, d=15mm/Zoom Scan (7x7x7)/Cube 0:

Measurement grid: dx=5mm, dy=5mm, dz=5mm

Reference Value = 52.942 V/m; Power Drift = 0.02 dB

Peak SAR (extrapolated) = 3.32 W/kg

SAR(1 g) = 2.17 W/kg; SAR(10 g) = 1.41 W/kg

Maximum value of SAR (measured) = 2.55 W/kg

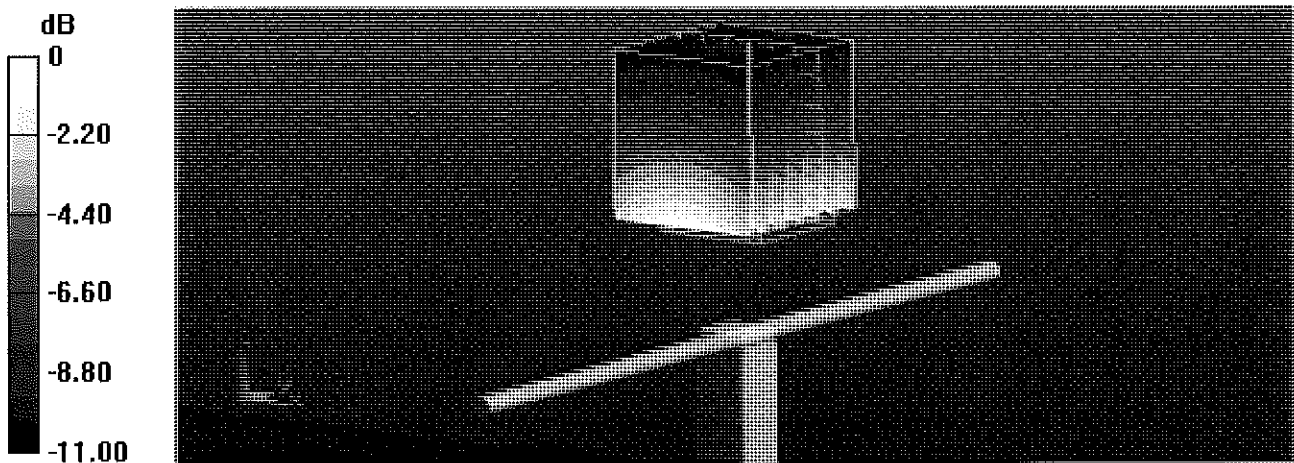

0 dB = 2.55 W/kg = 4.07 dBW/kg

Impedance Measurement Plot for Head TSL

13 Feb 2013 16:15:52
CH1 S11 1 U FS 1: 56.305 Ω 1.4043 Ω 298.00 pF 750.000 000 MHz

*
De1
Cor
Avg
16
H1d

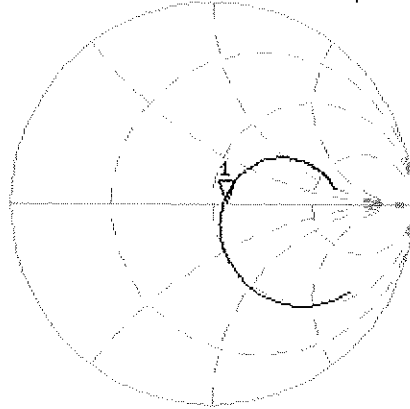

CH2 S11 LOG 5 dB/REF -20 dB 1:-24.327 dB 750.000 000 MHz

Cor
Avg
16
H1d

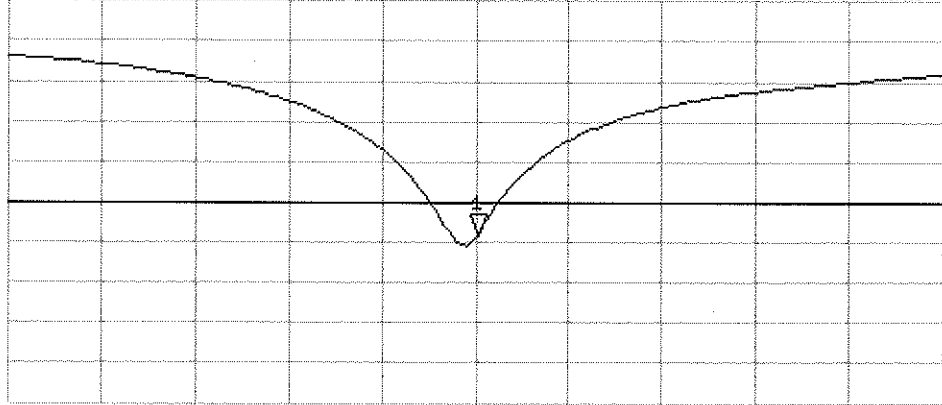

START 550.000 000 MHz

STOP 950.000 000 MHz

DASY5 Validation Report for Body TSL

Date: 13.02.2013

Test Laboratory: SPEAG, Zurich, Switzerland

DUT: Dipole 750 MHz; Type: D750V3; Serial: D750V3 - SN: 1046

Communication System: CW; Frequency: 750 MHz

Medium parameters used: $f = 750$ MHz; $\sigma = 0.99$ S/m; $\epsilon_r = 54.8$; $\rho = 1000$ kg/m³

Phantom section: Flat Section

Measurement Standard: DASY5 (IEEE/IEC/ANSI C63.19-2007)

DASY52 Configuration:

- Probe: ES3DV3 - SN3205; ConvF(6.11, 6.11, 6.11); Calibrated: 28.12.2012;
- Sensor-Surface: 3mm (Mechanical Surface Detection)
- Electronics: DAE4 Sn601; Calibrated: 27.06.2012
- Phantom: Flat Phantom 4.9L; Type: QD000P49AA; Serial: 1001
- DASY52 52.8.5(1059); SEMCAD X 14.6.8(7028)

Dipole Calibration for Body Tissue/Pin=250 mW, d=15mm/Zoom Scan (7x7x7)/Cube 0:

Measurement grid: dx=5mm, dy=5mm, dz=5mm

Reference Value = 52.942 V/m; Power Drift = 0.02 dB

Peak SAR (extrapolated) = 3.29 W/kg

SAR(1 g) = 2.25 W/kg; SAR(10 g) = 1.49 W/kg

Maximum value of SAR (measured) = 2.61 W/kg

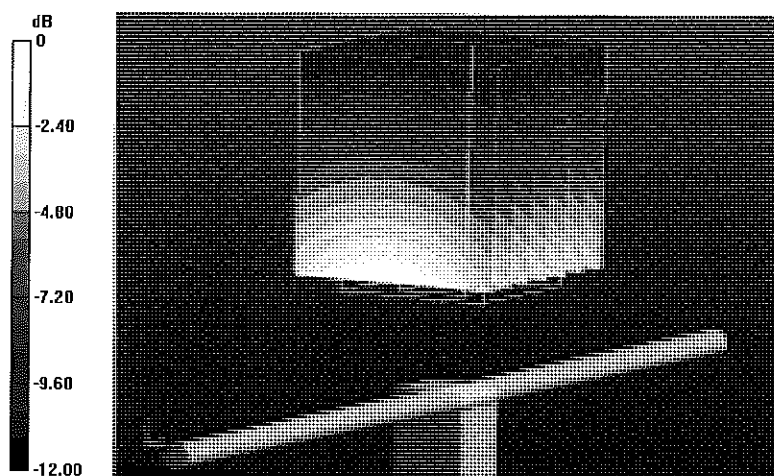

0 dB = 2.61 W/kg = 4.17 dBW/kg

Impedance Measurement Plot for Body TSL

13 Feb 2013 10:40:44
 CH1 S11 1 U FS 1: 52.045 Ω -1.0898 Ω 194.71 pF 750.000 000 MHz

 Del
 CA

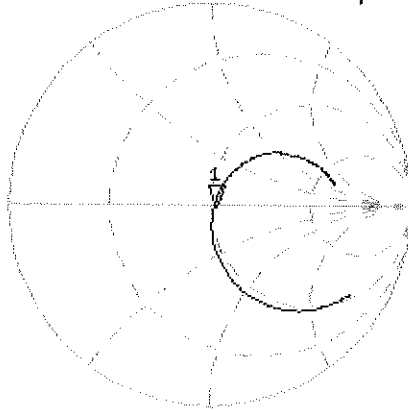

Avg
 16

H1d

CH2 S11 LOG 5 dB/REF -20 dB 1: -32.854 dB 750.000 000 MHz

CA

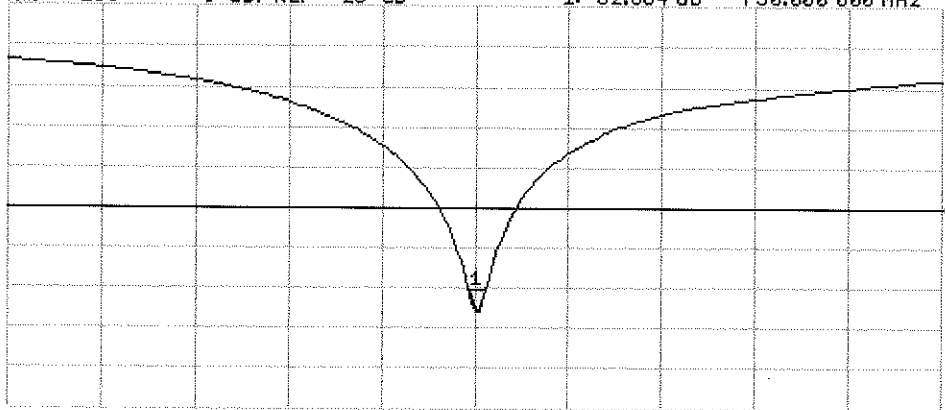

Avg
 16

H1d

START 550.000 000 MHz

STOP 950.000 000 MHz



Accredited by the Swiss Accreditation Service (SAS)
The Swiss Accreditation Service is one of the signatories to the EA
Multilateral Agreement for the recognition of calibration certificates

Accreditation No.: **SCS 108**

Client **PC Test**

Certificate No: **D835V2-4d119_Apr13**

CALIBRATION CERTIFICATE

Object **D835V2 - SN: 4d119**

Calibration procedure(s) **QA CAL-05.v9
Calibration procedure for dipole validation kits above 700 MHz**

Calibration date: **April 25, 2013**

✓
KOK
5/8/13

This calibration certificate documents the traceability to national standards, which realize the physical units of measurements (SI).
The measurements and the uncertainties with confidence probability are given on the following pages and are part of the certificate.

All calibrations have been conducted in the closed laboratory facility: environment temperature (22 ± 3)°C and humidity < 70%.

Calibration Equipment used (M&TE critical for calibration)

Primary Standards	ID #	Cal Date (Certificate No.)	Scheduled Calibration
Power meter EPM-442A	GB37480704	01-Nov-12 (No. 217-01640)	Oct-13
Power sensor HP 8481A	US37292783	01-Nov-12 (No. 217-01640)	Oct-13
Reference 20 dB Attenuator	SN: 5058 (20k)	04-Apr-13 (No. 217-01736)	Apr-14
Type-N mismatch combination	SN: 5047.3 / 06327	04-Apr-13 (No. 217-01739)	Apr-14
Reference Probe ES3DV3	SN: 3205	28-Dec-12 (No. ES3-3205_Dec12)	Dec-13
DAE4	SN: 909	11-Sep-12 (No. DAE4-909_Sep12)	Sep-13
Secondary Standards	ID #	Check Date (in house)	Scheduled Check
Power sensor HP 8481A	MY41092317	18-Oct-02 (in house check Oct-11)	In house check: Oct-13
RF generator R&S SMT-06	100005	04-Aug-99 (in house check Oct-11)	In house check: Oct-13
Network Analyzer HP 8753E	US37390585 S4206	18-Oct-01 (in house check Oct-12)	In house check: Oct-13

Calibrated by: **Claudio Leubler** Name: Claudio Leubler Function: Laboratory Technician

Approved by: **Katja Pokovic** Name: Katja Pokovic Technical Manager

Signature

Issued: April 26, 2013

This calibration certificate shall not be reproduced except in full without written approval of the laboratory.



Accredited by the Swiss Accreditation Service (SAS)
The Swiss Accreditation Service is one of the signatories to the EA
Multilateral Agreement for the recognition of calibration certificates

Accreditation No.: **SCS 108**

Glossary:

TSL	tissue simulating liquid
ConvF	sensitivity in TSL / NORM x,y,z
N/A	not applicable or not measured

Calibration is Performed According to the Following Standards:

- IEEE Std 1528-2003, "IEEE Recommended Practice for Determining the Peak Spatial-Averaged Specific Absorption Rate (SAR) in the Human Head from Wireless Communications Devices: Measurement Techniques", December 2003
- IEC 62209-1, "Procedure to measure the Specific Absorption Rate (SAR) for hand-held devices used in close proximity to the ear (frequency range of 300 MHz to 3 GHz)", February 2005
- Federal Communications Commission Office of Engineering & Technology (FCC OET), "Evaluating Compliance with FCC Guidelines for Human Exposure to Radiofrequency Electromagnetic Fields; Additional Information for Evaluating Compliance of Mobile and Portable Devices with FCC Limits for Human Exposure to Radiofrequency Emissions", Supplement C (Edition 01-01) to Bulletin 65

Additional Documentation:

- DASY4/5 System Handbook

Methods Applied and Interpretation of Parameters:

- Measurement Conditions:* Further details are available from the Validation Report at the end of the certificate. All figures stated in the certificate are valid at the frequency indicated.
- Antenna Parameters with TSL:* The dipole is mounted with the spacer to position its feed point exactly below the center marking of the flat phantom section, with the arms oriented parallel to the body axis.
- Feed Point Impedance and Return Loss:* These parameters are measured with the dipole positioned under the liquid filled phantom. The impedance stated is transformed from the measurement at the SMA connector to the feed point. The Return Loss ensures low reflected power. No uncertainty required.
- Electrical Delay:* One-way delay between the SMA connector and the antenna feed point. No uncertainty required.
- SAR measured:* SAR measured at the stated antenna input power.
- SAR normalized:* SAR as measured, normalized to an input power of 1 W at the antenna connector.
- SAR for nominal TSL parameters:* The measured TSL parameters are used to calculate the nominal SAR result.

The reported uncertainty of measurement is stated as the standard uncertainty of measurement multiplied by the coverage factor $k=2$, which for a normal distribution corresponds to a coverage probability of approximately 95%.

Measurement Conditions

DASY system configuration, as far as not given on page 1.

DASY Version	DASY5	V52.8.6
Extrapolation	Advanced Extrapolation	
Phantom	Modular Flat Phantom	
Distance Dipole Center - TSL	15 mm	with Spacer
Zoom Scan Resolution	dx, dy, dz = 5 mm	
Frequency	835 MHz \pm 1 MHz	

Head TSL parameters

The following parameters and calculations were applied.

	Temperature	Permittivity	Conductivity
Nominal Head TSL parameters	22.0 °C	41.5	0.90 mho/m
Measured Head TSL parameters	(22.0 \pm 0.2) °C	40.8 \pm 6 %	0.94 mho/m \pm 6 %
Head TSL temperature change during test	< 0.5 °C	----	----

SAR result with Head TSL

SAR averaged over 1 cm ³ (1 g) of Head TSL	Condition	
SAR measured	250 mW input power	2.51 W/kg
SAR for nominal Head TSL parameters	normalized to 1W	9.68 W/kg \pm 17.0 % (k=2)

SAR averaged over 10 cm ³ (10 g) of Head TSL	condition	
SAR measured	250 mW input power	1.62 W/kg
SAR for nominal Head TSL parameters	normalized to 1W	6.30 W/kg \pm 16.5 % (k=2)

Body TSL parameters

The following parameters and calculations were applied.

	Temperature	Permittivity	Conductivity
Nominal Body TSL parameters	22.0 °C	55.2	0.97 mho/m
Measured Body TSL parameters	(22.0 \pm 0.2) °C	54.0 \pm 6 %	1.01 mho/m \pm 6 %
Body TSL temperature change during test	< 0.5 °C	----	----

SAR result with Body TSL

SAR averaged over 1 cm ³ (1 g) of Body TSL	Condition	
SAR measured	250 mW input power	2.47 W/kg
SAR for nominal Body TSL parameters	normalized to 1W	9.54 W/kg \pm 17.0 % (k=2)

SAR averaged over 10 cm ³ (10 g) of Body TSL	condition	
SAR measured	250 mW input power	1.62 W/kg
SAR for nominal Body TSL parameters	normalized to 1W	6.31 W/kg \pm 16.5 % (k=2)

Appendix

Antenna Parameters with Head TSL

Impedance, transformed to feed point	50.1 Ω - 4.7 j Ω
Return Loss	- 26.6 dB

Antenna Parameters with Body TSL

Impedance, transformed to feed point	45.8 Ω - 6.3 j Ω
Return Loss	- 22.1 dB

General Antenna Parameters and Design

Electrical Delay (one direction)	1.385 ns
----------------------------------	----------

After long term use with 100W radiated power, only a slight warming of the dipole near the feedpoint can be measured.

The dipole is made of standard semirigid coaxial cable. The center conductor of the feeding line is directly connected to the second arm of the dipole. The antenna is therefore short-circuited for DC-signals. On some of the dipoles, small end caps are added to the dipole arms in order to improve matching when loaded according to the position as explained in the "Measurement Conditions" paragraph. The SAR data are not affected by this change. The overall dipole length is still according to the Standard.

No excessive force must be applied to the dipole arms, because they might bend or the soldered connections near the feedpoint may be damaged.

Additional EUT Data

Manufactured by	SPEAG
Manufactured on	June 29, 2010

DASY5 Validation Report for Head TSL

Date: 25.04.2013

Test Laboratory: SPEAG, Zurich, Switzerland

DUT: Dipole 835 MHz; Type: D835V2; Serial: D835V2 - SN: 4d119

Communication System: UID 0 - CW; Frequency: 835 MHz

Medium parameters used: $f = 835$ MHz; $\sigma = 0.94$ S/m; $\epsilon_r = 40.8$; $\rho = 1000$ kg/m³

Phantom section: Flat Section

Measurement Standard: DASY5 (IEEE/IEC/ANSI C63.19-2007)

DASY52 Configuration:

- Probe: ES3DV3 - SN3205; ConvF(6.05, 6.05, 6.05); Calibrated: 28.12.2012;
- Sensor-Surface: 3mm (Mechanical Surface Detection)
- Electronics: DAE4 Sn909; Calibrated: 11.09.2012
- Phantom: Flat Phantom 4.9L; Type: QD000P49AA; Serial: 1001
- DASY52 52.8.6(1115); SEMCAD X 14.6.9(7117)

Dipole Calibration for Head Tissue/Pin=250 mW, d=15mm/Zoom Scan (7x7x7)/Cube 0:

Measurement grid: dx=5mm, dy=5mm, dz=5mm

Reference Value = 57.387 V/m; Power Drift = 0.03 dB

Peak SAR (extrapolated) = 3.86 W/kg

SAR(1 g) = 2.51 W/kg; SAR(10 g) = 1.62 W/kg

Maximum value of SAR (measured) = 2.93 W/kg

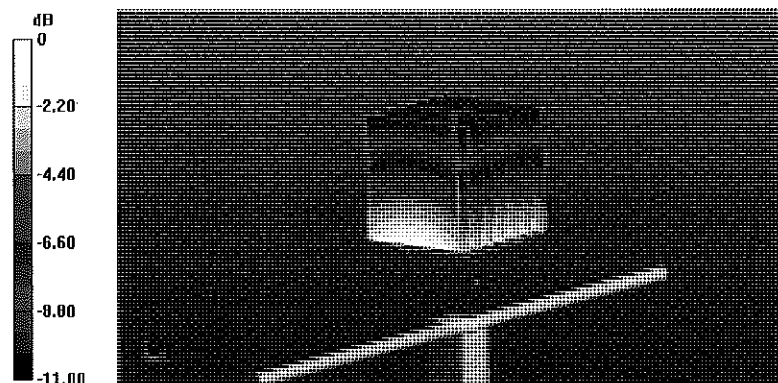

0 dB = 2.93 W/kg = 4.67 dBW/kg

Impedance Measurement Plot for Head TSL

25 Apr 2013 09:11:06

CH1 S11 1 U FS

1: 50.061 Ω -4.6621 Ω 40.884 pF

835.000 000 MHz

*
Del

CA

Avg
16

H1 d

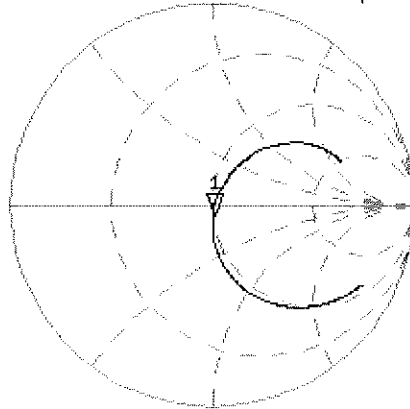

CH2 S11 LOG 5 dB/REF -20 dB 1:-26.641 dB 835.000 000 MHz

CA

Avg
16

H1 d

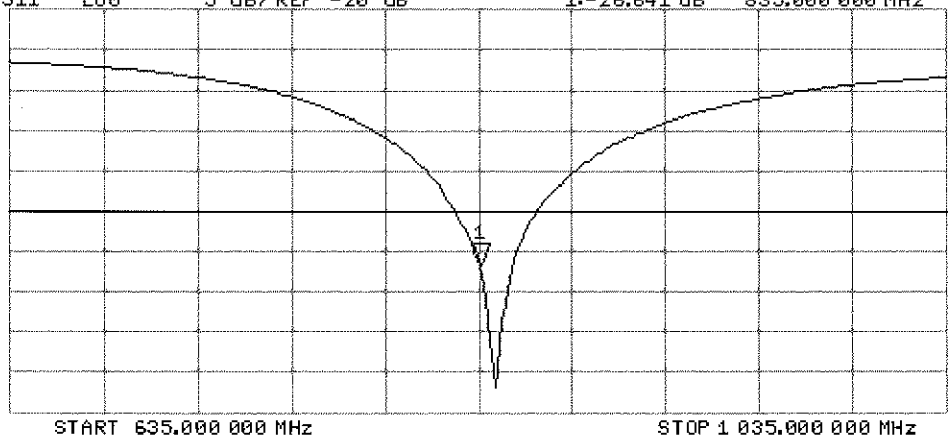

DASY5 Validation Report for Body TSL

Date: 24.04.2013

Test Laboratory: SPEAG, Zurich, Switzerland

DUT: Dipole 835 MHz; Type: D835V2; Serial: D835V2 - SN: 4d119

Communication System: UID 0 - CW; Frequency: 835 MHz

Medium parameters used: $f = 835$ MHz; $\sigma = 1.01$ S/m; $\epsilon_r = 54$; $\rho = 1000$ kg/m³

Phantom section: Flat Section

Measurement Standard: DASY5 (IEEE/IEC/ANSI C63.19-2007)

DASY52 Configuration:

- Probe: ES3DV3 - SN3205; ConvF(6.04, 6.04, 6.04); Calibrated: 28.12.2012;
- Sensor-Surface: 3mm (Mechanical Surface Detection)
- Electronics: DAE4 Sn909; Calibrated: 11.09.2012
- Phantom: Flat Phantom 4.9L; Type: QD000P49AA; Serial: 1001
- DASY52 52.8.6(1115); SEMCAD X 14.6.9(7117)

Dipole Calibration for Body Tissue/Pin=250 mW, d=15mm/Zoom Scan (7x7x7)/Cube 0:

Measurement grid: dx=5mm, dy=5mm, dz=5mm

Reference Value = 55.178 V/m; Power Drift = 0.03 dB

Peak SAR (extrapolated) = 3.68 W/kg

SAR(1 g) = 2.47 W/kg; SAR(10 g) = 1.62 W/kg

Maximum value of SAR (measured) = 2.89 W/kg

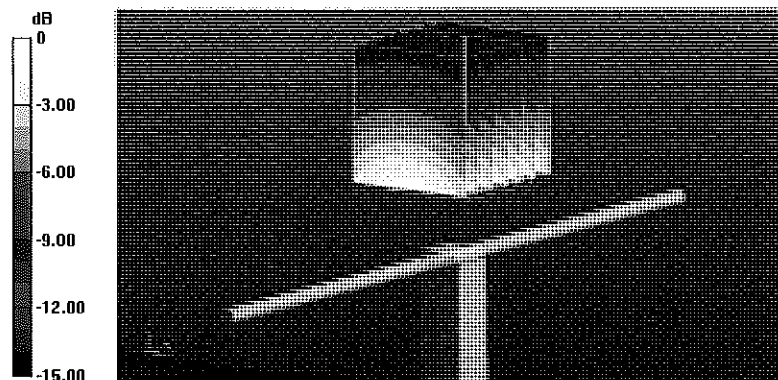

0 dB = 2.89 W/kg = 4.61 dBW/kg

Impedance Measurement Plot for Body TSL

24 Apr 2013 11:33:44

CH1 S11 1 U FS

2: 45.773 Ω -6.2773 Δ 30.364 pF

835.000 000 MHz

*
DeI

CΔ

Avg
16

H1d

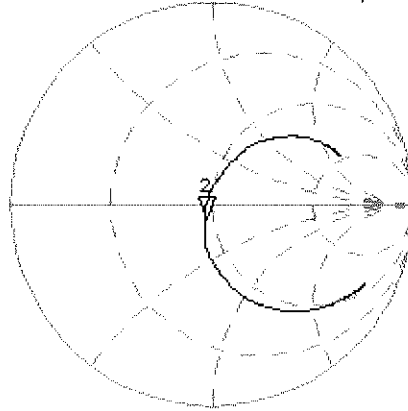

CH2 S11 LOG

5 dB/REF -20 dB

2: -22.065 dB

835.000 000 MHz

CΔ

Avg
16

H1d

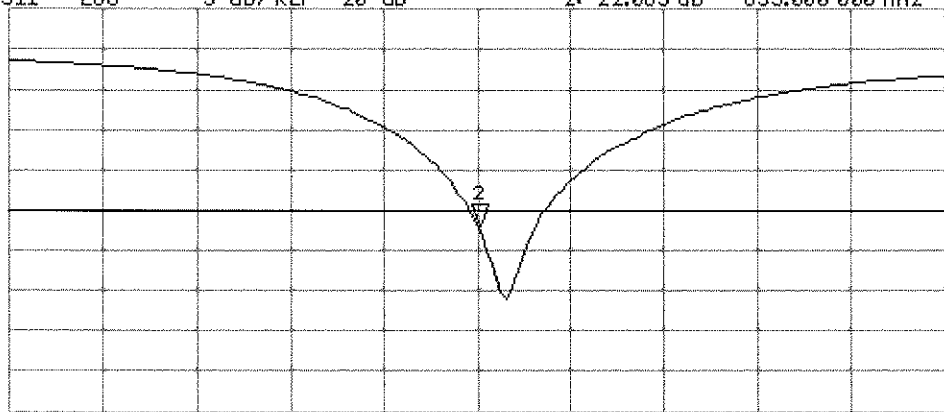

START 635.000 000 MHz

STOP 1 035.000 000 MHz



Accredited by the Swiss Accreditation Service (SAS)
The Swiss Accreditation Service is one of the signatories to the EA
Multilateral Agreement for the recognition of calibration certificates

Accreditation No.: **SCS 108**

Client **PC Test**

Certificate No: **D1750V2-1051_Apr13**

CALIBRATION CERTIFICATE

Object **D1750V2 - SN: 1051**

Calibration procedure(s) **QA CAL-05.v9
Calibration procedure for dipole validation kits above 700 MHz**

Calibration date: **April 30, 2013**

✓
LOK
5/8/13

This calibration certificate documents the traceability to national standards, which realize the physical units of measurements (SI).
The measurements and the uncertainties with confidence probability are given on the following pages and are part of the certificate.

All calibrations have been conducted in the closed laboratory facility: environment temperature (22 ± 3)°C and humidity < 70%.

Calibration Equipment used (M&TE critical for calibration)

Primary Standards	ID #	Cal Date (Certificate No.)	Scheduled Calibration
Power meter EPM-442A	GB37480704	01-Nov-12 (No. 217-01640)	Oct-13
Power sensor HP 8481A	US37292783	01-Nov-12 (No. 217-01640)	Oct-13
Reference 20 dB Attenuator	SN: 5058 (20k)	04-Apr-13 (No. 217-01736)	Apr-14
Type-N mismatch combination	SN: 5047.3 / 06327	04-Apr-13 (No. 217-01739)	Apr-14
Reference Probe ES3DV3	SN: 3205	28-Dec-12 (No. ES3-3205_Dec12)	Dec-13
DAE4	SN: 601	25-Apr-13 (No. DAE4-601_Apr13)	Apr-14
Secondary Standards	ID #	Check Date (in house)	Scheduled Check
Power sensor HP 8481A	MY41092317	18-Oct-02 (in house check Oct-11)	In house check: Oct-13
RF generator R&S SMT-06	100005	04-Aug-99 (in house check Oct-11)	In house check: Oct-13
Network Analyzer HP 8753E	US37390585 S4206	18-Oct-01 (in house check Oct-12)	In house check: Oct-13

Calibrated by: **Claudio Leubler** Name: Claudio Leubler Function: Laboratory Technician

Signature

Approved by: **Katja Pokovic** Name: Katja Pokovic Technical Manager

Issued: April 30, 2013

This calibration certificate shall not be reproduced except in full without written approval of the laboratory.



Accredited by the Swiss Accreditation Service (SAS)

The Swiss Accreditation Service is one of the signatories to the EA Multilateral Agreement for the recognition of calibration certificates

Accreditation No.: **SCS 108**

Glossary:

TSL	tissue simulating liquid
ConvF	sensitivity in TSL / NORM x,y,z
N/A	not applicable or not measured

Calibration is Performed According to the Following Standards:

- IEEE Std 1528-2003, "IEEE Recommended Practice for Determining the Peak Spatial-Averaged Specific Absorption Rate (SAR) in the Human Head from Wireless Communications Devices: Measurement Techniques", December 2003
- IEC 62209-1, "Procedure to measure the Specific Absorption Rate (SAR) for hand-held devices used in close proximity to the ear (frequency range of 300 MHz to 3 GHz)", February 2005
- Federal Communications Commission Office of Engineering & Technology (FCC OET), "Evaluating Compliance with FCC Guidelines for Human Exposure to Radiofrequency Electromagnetic Fields; Additional Information for Evaluating Compliance of Mobile and Portable Devices with FCC Limits for Human Exposure to Radiofrequency Emissions", Supplement C (Edition 01-01) to Bulletin 65

Additional Documentation:

- DASY4/5 System Handbook

Methods Applied and Interpretation of Parameters:

- Measurement Conditions:** Further details are available from the Validation Report at the end of the certificate. All figures stated in the certificate are valid at the frequency indicated.
- Antenna Parameters with TSL:** The dipole is mounted with the spacer to position its feed point exactly below the center marking of the flat phantom section, with the arms oriented parallel to the body axis.
- Feed Point Impedance and Return Loss:** These parameters are measured with the dipole positioned under the liquid filled phantom. The impedance stated is transformed from the measurement at the SMA connector to the feed point. The Return Loss ensures low reflected power. No uncertainty required.
- Electrical Delay:** One-way delay between the SMA connector and the antenna feed point. No uncertainty required.
- SAR measured:** SAR measured at the stated antenna input power.
- SAR normalized:** SAR as measured, normalized to an input power of 1 W at the antenna connector.
- SAR for nominal TSL parameters:** The measured TSL parameters are used to calculate the nominal SAR result.

The reported uncertainty of measurement is stated as the standard uncertainty of measurement multiplied by the coverage factor $k=2$, which for a normal distribution corresponds to a coverage probability of approximately 95%.

Measurement Conditions

DASY system configuration, as far as not given on page 1.

DASY Version	DASY5	V52.8.6
Extrapolation	Advanced Extrapolation	
Phantom	Modular Flat Phantom	
Distance Dipole Center - TSL	10 mm	with Spacer
Zoom Scan Resolution	dx, dy, dz = 5 mm	
Frequency	1750 MHz \pm 1 MHz	

Head TSL parameters

The following parameters and calculations were applied.

	Temperature	Permittivity	Conductivity
Nominal Head TSL parameters	22.0 °C	40.1	1.37 mho/m
Measured Head TSL parameters	(22.0 \pm 0.2) °C	39.1 \pm 6 %	1.33 mho/m \pm 6 %
Head TSL temperature change during test	< 0.5 °C	----	----

SAR result with Head TSL

SAR averaged over 1 cm³ (1 g) of Head TSL	Condition	
SAR measured	250 mW input power	9.01 W/kg
SAR for nominal Head TSL parameters	normalized to 1W	36.5 W/kg \pm 17.0 % (k=2)

SAR averaged over 10 cm³ (10 g) of Head TSL	condition	
SAR measured	250 mW input power	4.83 W/kg
SAR for nominal Head TSL parameters	normalized to 1W	19.5 W/kg \pm 16.5 % (k=2)

Body TSL parameters

The following parameters and calculations were applied.

	Temperature	Permittivity	Conductivity
Nominal Body TSL parameters	22.0 °C	53.4	1.49 mho/m
Measured Body TSL parameters	(22.0 \pm 0.2) °C	51.8 \pm 6 %	1.50 mho/m \pm 6 %
Body TSL temperature change during test	< 0.5 °C	----	----

SAR result with Body TSL

SAR averaged over 1 cm³ (1 g) of Body TSL	Condition	
SAR measured	250 mW input power	9.55 W/kg
SAR for nominal Body TSL parameters	normalized to 1W	37.8 W/kg \pm 17.0 % (k=2)

SAR averaged over 10 cm³ (10 g) of Body TSL	condition	
SAR measured	250 mW input power	5.13 W/kg
SAR for nominal Body TSL parameters	normalized to 1W	20.4 W/kg \pm 16.5 % (k=2)

Appendix

Antenna Parameters with Head TSL

Impedance, transformed to feed point	50.9 Ω + 0.3 j Ω
Return Loss	- 40.7 dB

Antenna Parameters with Body TSL

Impedance, transformed to feed point	47.0 Ω + 0.4 j Ω
Return Loss	- 30.1 dB

General Antenna Parameters and Design

Electrical Delay (one direction)	1.222 ns
----------------------------------	----------

After long term use with 100W radiated power, only a slight warming of the dipole near the feedpoint can be measured.

The dipole is made of standard semirigid coaxial cable. The center conductor of the feeding line is directly connected to the second arm of the dipole. The antenna is therefore short-circuited for DC-signals. On some of the dipoles, small end caps are added to the dipole arms in order to improve matching when loaded according to the position as explained in the "Measurement Conditions" paragraph. The SAR data are not affected by this change. The overall dipole length is still according to the Standard.

No excessive force must be applied to the dipole arms, because they might bend or the soldered connections near the feedpoint may be damaged.

Additional EUT Data

Manufactured by	SPEAG
Manufactured on	February 19, 2010

DASY5 Validation Report for Head TSL

Date: 30.04.2013

Test Laboratory: SPEAG, Zurich, Switzerland

DUT: Dipole 1750 MHz; Type: D1750V2; Serial: D1750V2 - SN: 1051

Communication System: UID 0 - CW; Frequency: 1750 MHz

Medium parameters used: $f = 1750$ MHz; $\sigma = 1.33$ S/m; $\epsilon_r = 39.1$; $\rho = 1000$ kg/m³

Phantom section: Flat Section

Measurement Standard: DASY5 (IEEE/IEC/ANSI C63.19-2007)

DASY52 Configuration:

- Probe: ES3DV3 - SN3205; ConvF(5.18, 5.18, 5.18); Calibrated: 28.12.2012;
- Sensor-Surface: 3mm (Mechanical Surface Detection)
- Electronics: DAE4 Sn601; Calibrated: 25.04.2013
- Phantom: Flat Phantom 5.0 (front); Type: QD000P50AA; Serial: 1001
- DASY52 52.8.6(1115); SEMCAD X 14.6.9(7117)

Dipole Calibration for Head Tissue/Pin=250 mW, d=10mm/Zoom Scan (8x7x7)/Cube 0:

Measurement grid: dx=5mm, dy=5mm, dz=5mm

Reference Value = 90.104 V/m; Power Drift = 0.09 dB

Peak SAR (extrapolated) = 16.0 W/kg

SAR(1 g) = 9.01 W/kg; SAR(10 g) = 4.83 W/kg

Maximum value of SAR (measured) = 11.3 W/kg

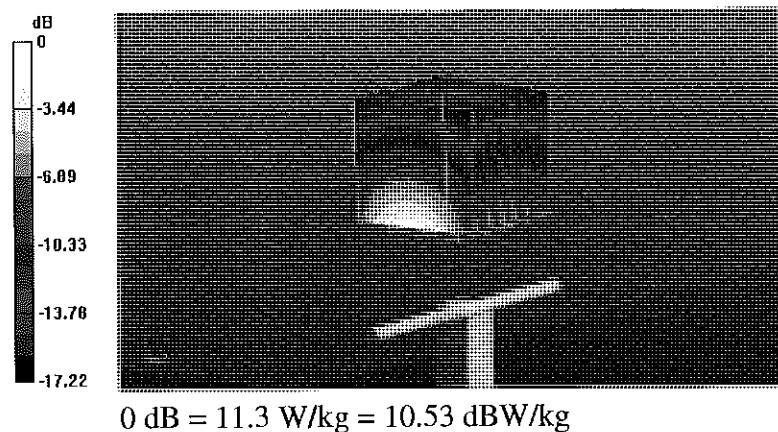

Impedance Measurement Plot for Head TSL

30 Apr 2013 12:59:57

CH1 S11 1 U FS 1: 50.889 Ω 0.2813 Ω 25.578 pF 1 750.000 000 MHz

*
Del
CA
Avg
4
Hid

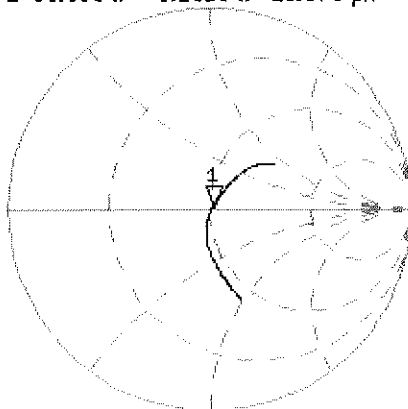

CH2 S11 LOG 5 dB/REF -20 dB 1:-40.692 dB 1 750.000 000 MHz

CA
Avg
4
Hid

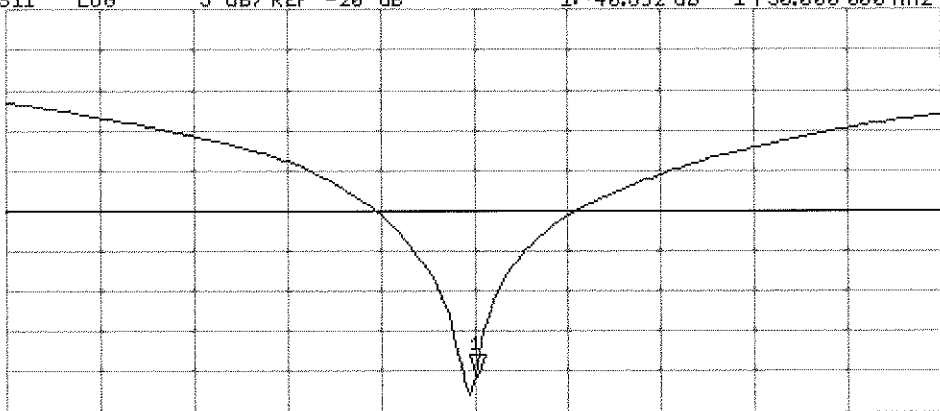

START 1 550.000 000 MHz

STOP 1 950.000 000 MHz

DASY5 Validation Report for Body TSL

Date: 30.04.2013

Test Laboratory: SPEAG, Zurich, Switzerland

DUT: Dipole 1750 MHz; Type: D1750V2; Serial: D1750V2 - SN: 1051

Communication System: UID 0 - CW; Frequency: 1750 MHz

Medium parameters used: $f = 1750$ MHz; $\sigma = 1.5$ S/m; $\epsilon_r = 51.8$; $\rho = 1000$ kg/m³

Phantom section: Flat Section

Measurement Standard: DASY5 (IEEE/IEC/ANSI C63.19-2007)

DASY52 Configuration:

- Probe: ES3DV3 - SN3205; ConvF(4.83, 4.83, 4.83); Calibrated: 28.12.2012;
- Sensor-Surface: 3mm (Mechanical Surface Detection)
- Electronics: DAE4 Sn601; Calibrated: 25.04.2013
- Phantom: Flat Phantom 5.0 (back); Type: QD000P50AA; Serial: 1002
- DASY52 52.8.6(1115); SEMCAD X 14.6.9(7117)

Dipole Calibration for Body Tissue/Pin=250 mW, d=10mm/Zoom Scan (7x7x7)/Cube 0:

Measurement grid: dx=5mm, dy=5mm, dz=5mm

Reference Value = 93.473 V/m; Power Drift = 0.01 dB

Peak SAR (extrapolated) = 16.4 W/kg

SAR(1 g) = 9.55 W/kg; SAR(10 g) = 5.13 W/kg

Maximum value of SAR (measured) = 12.0 W/kg

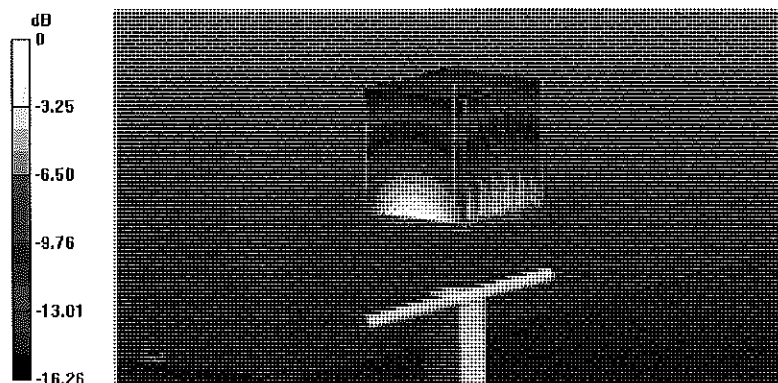

0 dB = 12.0 W/kg = 10.79 dBW/kg

Impedance Measurement Plot for Body TSL

30 Apr 2013 12:59:14

CH1 S11 1 U FS 1: 46.998 Ω 0.4160 Ω 37.835 pF 1 750.000 000 MHz

*
De1
CA
Avg
16
H1d

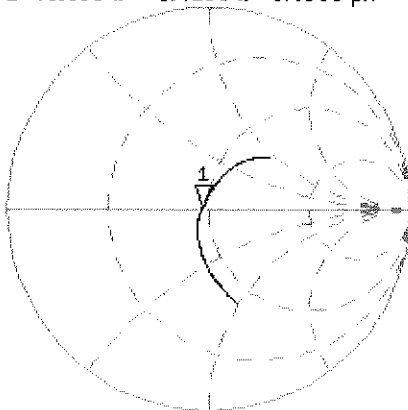

CH2 S11 LOG 5 dB/REF -20 dB 1:-30.102 dB 1 750.000 000 MHz

CA
Avg
16
H1d

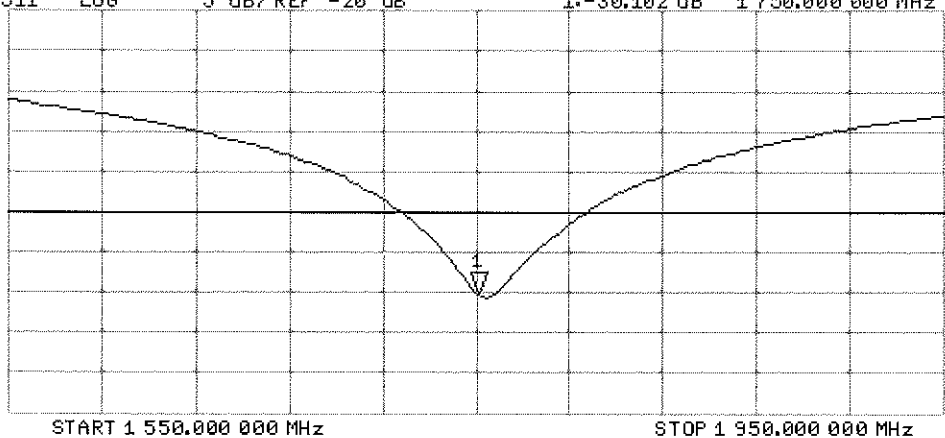



Accredited by the Swiss Accreditation Service (SAS)
The Swiss Accreditation Service is one of the signatories to the EA
Multilateral Agreement for the recognition of calibration certificates

Accreditation No.: **SCS 108**

Client **PC Test**

Certificate No: **D1900V2-5d141_May13**

CALIBRATION CERTIFICATE

Object **D1900V2 - SN: 5d141**

Calibration procedure(s) **QA CAL-05.v9
Calibration procedure for dipole validation kits above 700 MHz**

Calibration date: **May 02, 2013**

✓
5/8/13

This calibration certificate documents the traceability to national standards, which realize the physical units of measurements (SI).
The measurements and the uncertainties with confidence probability are given on the following pages and are part of the certificate.

All calibrations have been conducted in the closed laboratory facility: environment temperature (22 ± 3)°C and humidity < 70%.

Calibration Equipment used (M&TE critical for calibration)

Primary Standards	ID #	Cal Date (Certificate No.)	Scheduled Calibration
Power meter EPM-442A	GB37480704	01-Nov-12 (No. 217-01640)	Oct-13
Power sensor HP 8481A	US37292783	01-Nov-12 (No. 217-01640)	Oct-13
Reference 20 dB Attenuator	SN: 5058 (20k)	04-Apr-13 (No. 217-01736)	Apr-14
Type-N mismatch combination	SN: 5047.3 / 06327	04-Apr-13 (No. 217-01739)	Apr-14
Reference Probe ES3DV3	SN: 3205	28-Dec-12 (No. ES3-3205_Dec12)	Dec-13
DAE4	SN: 601	25-Apr-13 (No. DAE4-601_Apr13)	Apr-14

Secondary Standards	ID #	Check Date (in house)	Scheduled Check
Power sensor HP 8481A	MY41092317	18-Oct-02 (in house check Oct-11)	In house check: Oct-13
RF generator R&S SMT-06	100005	04-Aug-99 (in house check Oct-11)	In house check: Oct-13
Network Analyzer HP 8753E	US37390585 S4206	18-Oct-01 (in house check Oct-12)	In house check: Oct-13

Calibrated by: **Claudio Leubler** Function: **Laboratory Technician**

Signature

Approved by: **Katja Pokovic** Technical Manager

Issued: May 2, 2013

This calibration certificate shall not be reproduced except in full without written approval of the laboratory.



Accredited by the Swiss Accreditation Service (SAS)
The Swiss Accreditation Service is one of the signatories to the EA
Multilateral Agreement for the recognition of calibration certificates

Accreditation No.: **SCS 108**

Glossary:

TSL	tissue simulating liquid
ConvF	sensitivity in TSL / NORM x,y,z
N/A	not applicable or not measured

Calibration is Performed According to the Following Standards:

- IEEE Std 1528-2003, "IEEE Recommended Practice for Determining the Peak Spatial-Averaged Specific Absorption Rate (SAR) in the Human Head from Wireless Communications Devices: Measurement Techniques", December 2003
- IEC 62209-1, "Procedure to measure the Specific Absorption Rate (SAR) for hand-held devices used in close proximity to the ear (frequency range of 300 MHz to 3 GHz)", February 2005
- Federal Communications Commission Office of Engineering & Technology (FCC OET), "Evaluating Compliance with FCC Guidelines for Human Exposure to Radiofrequency Electromagnetic Fields; Additional Information for Evaluating Compliance of Mobile and Portable Devices with FCC Limits for Human Exposure to Radiofrequency Emissions", Supplement C (Edition 01-01) to Bulletin 65

Additional Documentation:

- DASY4/5 System Handbook

Methods Applied and Interpretation of Parameters:

- Measurement Conditions:** Further details are available from the Validation Report at the end of the certificate. All figures stated in the certificate are valid at the frequency indicated.
- Antenna Parameters with TSL:** The dipole is mounted with the spacer to position its feed point exactly below the center marking of the flat phantom section, with the arms oriented parallel to the body axis.
- Feed Point Impedance and Return Loss:** These parameters are measured with the dipole positioned under the liquid filled phantom. The impedance stated is transformed from the measurement at the SMA connector to the feed point. The Return Loss ensures low reflected power. No uncertainty required.
- Electrical Delay:** One-way delay between the SMA connector and the antenna feed point. No uncertainty required.
- SAR measured:** SAR measured at the stated antenna input power.
- SAR normalized:** SAR as measured, normalized to an input power of 1 W at the antenna connector.
- SAR for nominal TSL parameters:** The measured TSL parameters are used to calculate the nominal SAR result.

The reported uncertainty of measurement is stated as the standard uncertainty of measurement multiplied by the coverage factor $k=2$, which for a normal distribution corresponds to a coverage probability of approximately 95%.

Measurement Conditions

DASY system configuration, as far as not given on page 1.

DASY Version	DASY5	V52.8.6
Extrapolation	Advanced Extrapolation	
Phantom	Modular Flat Phantom	
Distance Dipole Center - TSL	10 mm	with Spacer
Zoom Scan Resolution	dx, dy, dz = 5 mm	
Frequency	1900 MHz \pm 1 MHz	

Head TSL parameters

The following parameters and calculations were applied.

	Temperature	Permittivity	Conductivity
Nominal Head TSL parameters	22.0 °C	40.0	1.40 mho/m
Measured Head TSL parameters	(22.0 \pm 0.2) °C	39.3 \pm 6 %	1.37 mho/m \pm 6 %
Head TSL temperature change during test	< 0.5 °C	----	----

SAR result with Head TSL

SAR averaged over 1 cm³ (1 g) of Head TSL	Condition	
SAR measured	250 mW input power	10.1 W/kg
SAR for nominal Head TSL parameters	normalized to 1W	40.8 W/kg \pm 17.0 % (k=2)

SAR averaged over 10 cm³ (10 g) of Head TSL	condition	
SAR measured	250 mW input power	5.30 W/kg
SAR for nominal Head TSL parameters	normalized to 1W	21.3 W/kg \pm 16.5 % (k=2)

Body TSL parameters

The following parameters and calculations were applied.

	Temperature	Permittivity	Conductivity
Nominal Body TSL parameters	22.0 °C	53.3	1.52 mho/m
Measured Body TSL parameters	(22.0 \pm 0.2) °C	54.0 \pm 6 %	1.51 mho/m \pm 6 %
Body TSL temperature change during test	< 0.5 °C	----	----

SAR result with Body TSL

SAR averaged over 1 cm³ (1 g) of Body TSL	Condition	
SAR measured	250 mW input power	10.3 W/kg
SAR for nominal Body TSL parameters	normalized to 1W	41.5 W/kg \pm 17.0 % (k=2)

SAR averaged over 10 cm³ (10 g) of Body TSL	condition	
SAR measured	250 mW input power	5.51 W/kg
SAR for nominal Body TSL parameters	normalized to 1W	22.1 W/kg \pm 16.5 % (k=2)

Appendix

Antenna Parameters with Head TSL

Impedance, transformed to feed point	52.6 Ω + 4.9 j Ω
Return Loss	- 25.3 dB

Antenna Parameters with Body TSL

Impedance, transformed to feed point	48.3 Ω + 5.9 j Ω
Return Loss	- 24.1 dB

General Antenna Parameters and Design

Electrical Delay (one direction)	1.199 ns
----------------------------------	----------

After long term use with 100W radiated power, only a slight warming of the dipole near the feedpoint can be measured.

The dipole is made of standard semirigid coaxial cable. The center conductor of the feeding line is directly connected to the second arm of the dipole. The antenna is therefore short-circuited for DC-signals. On some of the dipoles, small end caps are added to the dipole arms in order to improve matching when loaded according to the position as explained in the "Measurement Conditions" paragraph. The SAR data are not affected by this change. The overall dipole length is still according to the Standard.

No excessive force must be applied to the dipole arms, because they might bend or the soldered connections near the feedpoint may be damaged.

Additional EUT Data

Manufactured by	SPEAG
Manufactured on	March 11, 2011

DASY5 Validation Report for Head TSL

Date: 02.05.2013

Test Laboratory: SPEAG, Zurich, Switzerland

DUT: Dipole 1900 MHz; Type: D1900V2; Serial: D1900V2 - SN: 5d141

Communication System: UID 0 - CW; Frequency: 1900 MHz

Medium parameters used: $f = 1900$ MHz; $\sigma = 1.37$ S/m; $\epsilon_r = 39.3$; $\rho = 1000$ kg/m³

Phantom section: Flat Section

Measurement Standard: DASY5 (IEEE/IEC/ANSI C63.19-2007)

DASY52 Configuration:

- Probe: ES3DV3 - SN3205; ConvF(4.98, 4.98, 4.98); Calibrated: 28.12.2012;
- Sensor-Surface: 3mm (Mechanical Surface Detection)
- Electronics: DAE4 Sn601; Calibrated: 25.04.2013
- Phantom: Flat Phantom 5.0 (front); Type: QD000P50AA; Serial: 1001
- DASY52 52.8.6(1115); SEMCAD X 14.6.9(7117)

Dipole Calibration for Head Tissue/Pin=250 mW, d=10mm/Zoom Scan (7x7x7)/Cube 0:

Measurement grid: dx=5mm, dy=5mm, dz=5mm

Reference Value = 97.124 V/m; Power Drift = 0.05 dB

Peak SAR (extrapolated) = 18.2 W/kg

SAR(1 g) = 10.1 W/kg; SAR(10 g) = 5.3 W/kg

Maximum value of SAR (measured) = 12.5 W/kg

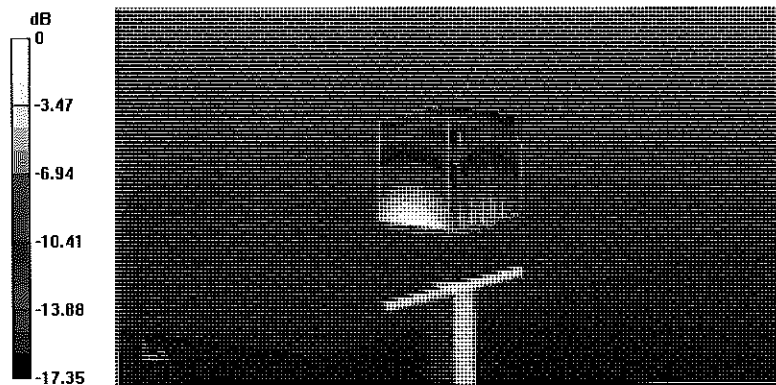

0 dB = 12.5 W/kg = 10.97 dBW/kg

Impedance Measurement Plot for Head TSL

2 May 2013 15:38:50

CH1 S11 1 U FS 1: 52.600 Ω 4.9375 Ω 413.59 μ H 1 900.000 000 MHz

*
De1
Cor
Avg
4
H1d

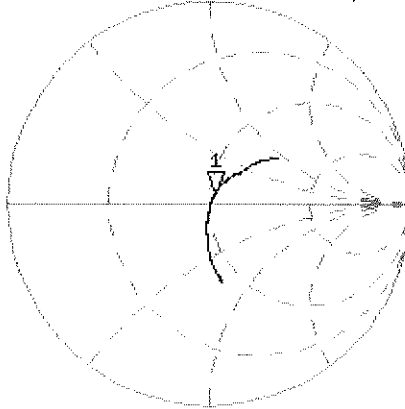

CH2 S11 LOG 5 dB/REF -20 dB 1:-25.293 dB 1 900.000 000 MHz

Cor
Avg
4
H1d

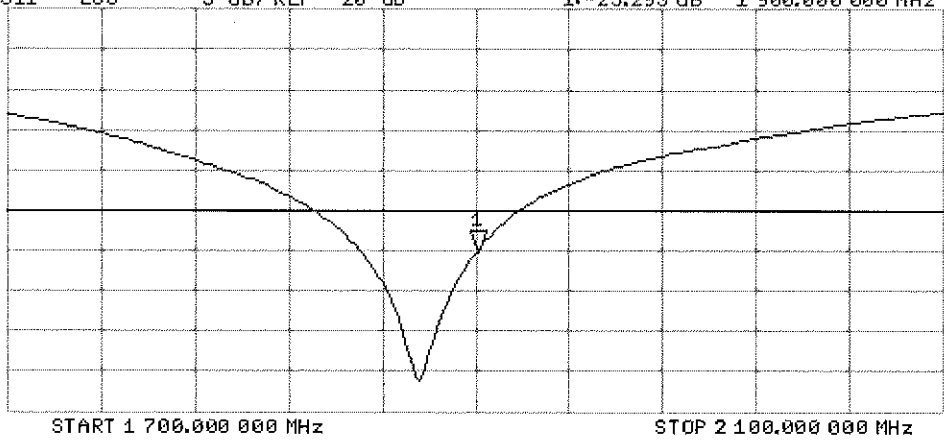

DASY5 Validation Report for Body TSL

Date: 02.05.2013

Test Laboratory: SPEAG, Zurich, Switzerland

DUT: Dipole 1900 MHz; Type: D1900V2; Serial: D1900V2 - SN: 5d141

Communication System: UID 0 - CW; Frequency: 1900 MHz

Medium parameters used: $f = 1900$ MHz; $\sigma = 1.51$ S/m; $\epsilon_r = 54$; $\rho = 1000$ kg/m³

Phantom section: Flat Section

Measurement Standard: DASY5 (IEEE/IEC/ANSI C63.19-2007)

DASY52 Configuration:

- Probe: ES3DV3 - SN3205; ConvF(4.6, 4.6, 4.6); Calibrated: 28.12.2012;
- Sensor-Surface: 3mm (Mechanical Surface Detection)
- Electronics: DAE4 Sn601; Calibrated: 25.04.2013
- Phantom: Flat Phantom 5.0 (back); Type: QD000P50AA; Serial: 1002
- DASY52 52.8.6(1115); SEMCAD X 14.6.9(7117)

Dipole Calibration for Body Tissue/Pin=250 mW, d=10mm/Zoom Scan (7x7x7)/Cube 0:

Measurement grid: dx=5mm, dy=5mm, dz=5mm

Reference Value = 97.124 V/m; Power Drift = -0.00 dB

Peak SAR (extrapolated) = 17.6 W/kg

SAR(1 g) = 10.3 W/kg; SAR(10 g) = 5.51 W/kg

Maximum value of SAR (measured) = 13.0 W/kg

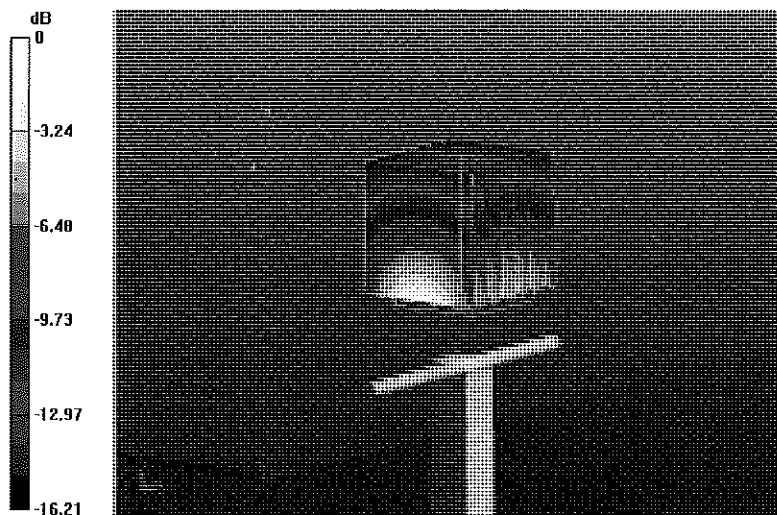

0 dB = 13.0 W/kg = 11.14 dBW/kg

Impedance Measurement Plot for Body TSL

2 May 2013 15:38:04

[CH1] S11 1 U FS 1: 48.273 Ω 5.9121 Ω 495.23 μ H 1 900.000 000 MHz

*
De1
Cor
Avg
16
H1d

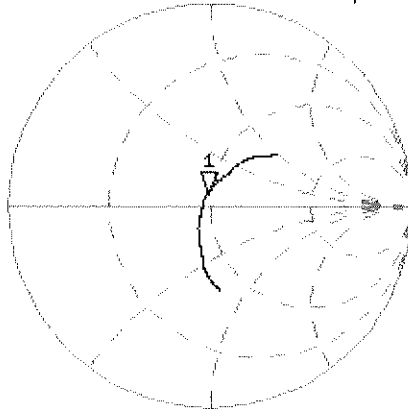

CH2 S11 LOG 5 dB/REF -20 dB 1:-24.074 dB 1 900.000 000 MHz

Cor
Avg
16
H1d

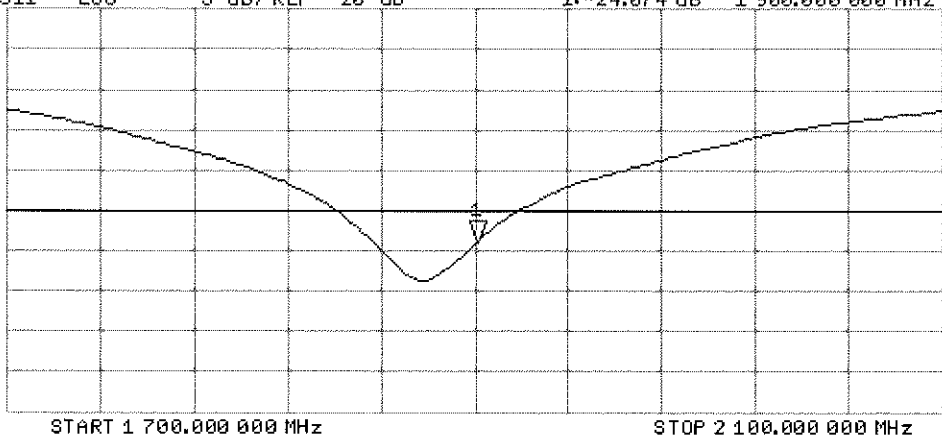



Accredited by the Swiss Accreditation Service (SAS)
The Swiss Accreditation Service is one of the signatories to the EA
Multilateral Agreement for the recognition of calibration certificates

Accreditation No.: **SCS 108**

Client **PC Test**

Certificate No: **D2450V2-797_Jan13**

CALIBRATION CERTIFICATE

Object **D2450V2 - SN: 797**

Calibration procedure(s) **QA CAL-05.v9
Calibration procedure for dipole validation kits above 700 MHz**

Calibration date: **January 08, 2013**

*KOK
1/28/13*

This calibration certificate documents the traceability to national standards, which realize the physical units of measurements (SI).
The measurements and the uncertainties with confidence probability are given on the following pages and are part of the certificate.

All calibrations have been conducted in the closed laboratory facility: environment temperature (22 ± 3)°C and humidity < 70%.

Calibration Equipment used (M&TE critical for calibration)

Primary Standards	ID #	Cal Date (Certificate No.)	Scheduled Calibration
Power meter EPM-442A	GB37480704	01-Nov-12 (No. 217-01640)	Oct-13
Power sensor HP 8481A	US37292783	01-Nov-12 (No. 217-01640)	Oct-13
Reference 20 dB Attenuator	SN: 5058 (20k)	27-Mar-12 (No. 217-01530)	Apr-13
Type-N mismatch combination	SN: 5047.3 / 06327	27-Mar-12 (No. 217-01533)	Apr-13
Reference Probe ES3DV3	SN: 3205	28-Dec-12 (No. ES3-3205_Dec12)	Dec-13
DAE4	SN: 601	27-Jun-12 (No. DAE4-601_Jun12)	Jun-13

Secondary Standards	ID #	Check Date (in house)	Scheduled Check
Power sensor HP 8481A	MY41092317	18-Oct-02 (in house check Oct-11)	In house check: Oct-13
RF generator R&S SMT-06	100005	04-Aug-99 (in house check Oct-11)	In house check: Oct-13
Network Analyzer HP 8753E	US37390585 S4206	18-Oct-01 (in house check Oct-12)	In house check: Oct-13

Calibrated by: **Israe El-Naouq** (Name) / **Laboratory Technician** (Function) / *Israe El-Naouq* (Signature)

Approved by: **Katja Pokovic** (Name) / **Technical Manager** (Function) / *Katja Pokovic* (Signature)

Issued: January 8, 2013

This calibration certificate shall not be reproduced except in full without written approval of the laboratory.



Accredited by the Swiss Accreditation Service (SAS)

The Swiss Accreditation Service is one of the signatories to the EA
Multilateral Agreement for the recognition of calibration certificates

Accreditation No.: **SCS 108**

Glossary:

TSL	tissue simulating liquid
ConvF	sensitivity in TSL / NORM x,y,z
N/A	not applicable or not measured

Calibration is Performed According to the Following Standards:

- a) IEEE Std 1528-2003, "IEEE Recommended Practice for Determining the Peak Spatial-Averaged Specific Absorption Rate (SAR) in the Human Head from Wireless Communications Devices: Measurement Techniques", December 2003
- b) IEC 62209-1, "Procedure to measure the Specific Absorption Rate (SAR) for hand-held devices used in close proximity to the ear (frequency range of 300 MHz to 3 GHz)", February 2005
- c) Federal Communications Commission Office of Engineering & Technology (FCC OET), "Evaluating Compliance with FCC Guidelines for Human Exposure to Radiofrequency Electromagnetic Fields; Additional Information for Evaluating Compliance of Mobile and Portable Devices with FCC Limits for Human Exposure to Radiofrequency Emissions", Supplement C (Edition 01-01) to Bulletin 65

Additional Documentation:

- d) DASY4/5 System Handbook

Methods Applied and Interpretation of Parameters:

- *Measurement Conditions:* Further details are available from the Validation Report at the end of the certificate. All figures stated in the certificate are valid at the frequency indicated.
- *Antenna Parameters with TSL:* The dipole is mounted with the spacer to position its feed point exactly below the center marking of the flat phantom section, with the arms oriented parallel to the body axis.
- *Feed Point Impedance and Return Loss:* These parameters are measured with the dipole positioned under the liquid filled phantom. The impedance stated is transformed from the measurement at the SMA connector to the feed point. The Return Loss ensures low reflected power. No uncertainty required.
- *Electrical Delay:* One-way delay between the SMA connector and the antenna feed point. No uncertainty required.
- *SAR measured:* SAR measured at the stated antenna input power.
- *SAR normalized:* SAR as measured, normalized to an input power of 1 W at the antenna connector.
- *SAR for nominal TSL parameters:* The measured TSL parameters are used to calculate the nominal SAR result.

The reported uncertainty of measurement is stated as the standard uncertainty of measurement multiplied by the coverage factor $k=2$, which for a normal distribution corresponds to a coverage probability of approximately 95%.

Measurement Conditions

DASY system configuration, as far as not given on page 1.

DASY Version	DASY5	V52.8.4
Extrapolation	Advanced Extrapolation	
Phantom	Modular Flat Phantom	
Distance Dipole Center - TSL	10 mm	with Spacer
Zoom Scan Resolution	dx, dy, dz = 5 mm	
Frequency	2450 MHz ± 1 MHz	

Head TSL parameters

The following parameters and calculations were applied.

	Temperature	Permittivity	Conductivity
Nominal Head TSL parameters	22.0 °C	39.2	1.80 mho/m
Measured Head TSL parameters	(22.0 ± 0.2) °C	37.9 ± 6 %	1.85 mho/m ± 6 %
Head TSL temperature change during test	< 0.5 °C	----	----

SAR result with Head TSL

SAR averaged over 1 cm ³ (1 g) of Head TSL	Condition	
SAR measured	250 mW input power	13.4 W/kg
SAR for nominal Head TSL parameters	normalized to 1W	52.5 W/kg ± 17.0 % (k=2)

SAR averaged over 10 cm ³ (10 g) of Head TSL	condition	
SAR measured	250 mW input power	6.20 W/kg
SAR for nominal Head TSL parameters	normalized to 1W	24.5 W/kg ± 16.5 % (k=2)

Body TSL parameters

The following parameters and calculations were applied.

	Temperature	Permittivity	Conductivity
Nominal Body TSL parameters	22.0 °C	52.7	1.95 mho/m
Measured Body TSL parameters	(22.0 ± 0.2) °C	50.5 ± 6 %	2.01 mho/m ± 6 %
Body TSL temperature change during test	< 0.5 °C	----	----

SAR result with Body TSL

SAR averaged over 1 cm ³ (1 g) of Body TSL	Condition	
SAR measured	250 mW input power	12.7 W/kg
SAR for nominal Body TSL parameters	normalized to 1W	49.6 W/kg ± 17.0 % (k=2)

SAR averaged over 10 cm ³ (10 g) of Body TSL	condition	
SAR measured	250 mW input power	5.88 W/kg
SAR for nominal Body TSL parameters	normalized to 1W	23.2 W/kg ± 16.5 % (k=2)

Appendix

Antenna Parameters with Head TSL

Impedance, transformed to feed point	$53.3 \Omega + 3.1 j\Omega$
Return Loss	- 27.1 dB

Antenna Parameters with Body TSL

Impedance, transformed to feed point	$49.1 \Omega + 4.9 j\Omega$
Return Loss	- 26.0 dB

General Antenna Parameters and Design

Electrical Delay (one direction)	1.152 ns
----------------------------------	----------

After long term use with 100W radiated power, only a slight warming of the dipole near the feedpoint can be measured.

The dipole is made of standard semirigid coaxial cable. The center conductor of the feeding line is directly connected to the second arm of the dipole. The antenna is therefore short-circuited for DC-signals. On some of the dipoles, small end caps are added to the dipole arms in order to improve matching when loaded according to the position as explained in the "Measurement Conditions" paragraph. The SAR data are not affected by this change. The overall dipole length is still according to the Standard.

No excessive force must be applied to the dipole arms, because they might bend or the soldered connections near the feedpoint may be damaged.

Additional EUT Data

Manufactured by	SPEAG
Manufactured on	January 24, 2006

DASY5 Validation Report for Head TSL

Date: 08.01.2013

Test Laboratory: SPEAG, Zurich, Switzerland

DUT: Dipole 2450 MHz; Type: D2450V2; Serial: D2450V2 - SN: 797

Communication System: CW; Frequency: 2450 MHz

Medium parameters used: $f = 2450$ MHz; $\sigma = 1.85$ S/m; $\epsilon_r = 37.9$; $\rho = 1000$ kg/m³

Phantom section: Flat Section

Measurement Standard: DASY5 (IEEE/IEC/ANSI C63.19-2007)

DASY52 Configuration:

- Probe: ES3DV3 - SN3205; ConvF(4.52, 4.52, 4.52); Calibrated: 28.12.2012;
- Sensor-Surface: 3mm (Mechanical Surface Detection)
- Electronics: DAE4 Sn601; Calibrated: 27.06.2012
- Phantom: Flat Phantom 5.0 (front); Type: QD000P50AA; Serial: 1001
- DASY52 52.8.4(1052); SEMCAD X 14.6.8(7028)

Dipole Calibration for Head Tissue/ $P_{in}=250$ mW, $d=10$ mm/Zoom Scan (7x7x7)/Cube 0:

Measurement grid: $dx=5$ mm, $dy=5$ mm, $dz=5$ mm

Reference Value = 99.154 V/m; Power Drift = 0.06 dB

Peak SAR (extrapolated) = 27.8 W/kg

SAR(1 g) = 13.4 W/kg; SAR(10 g) = 6.2 W/kg

Maximum value of SAR (measured) = 17.0 W/kg

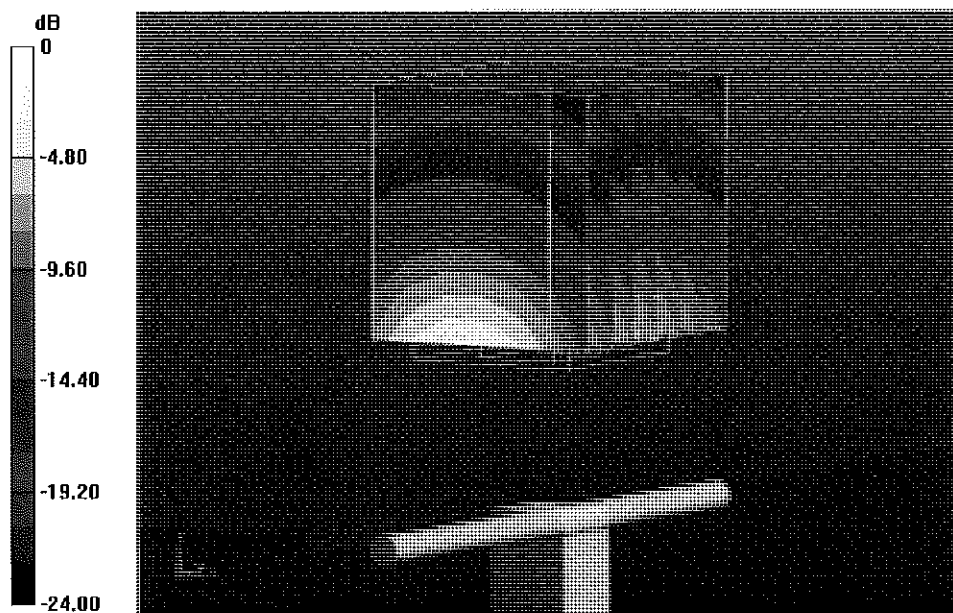

0 dB = 17.0 W/kg = 12.30 dBW/kg

Impedance Measurement Plot for Head TSL

8 Jan 2013 12:37:14

CH1 S11 1 U FS 1: 53.346 Δ 3.0762 Δ 199.83 pH 2 450.000 000 MHz

De1

Cor

Avg
16

H1d

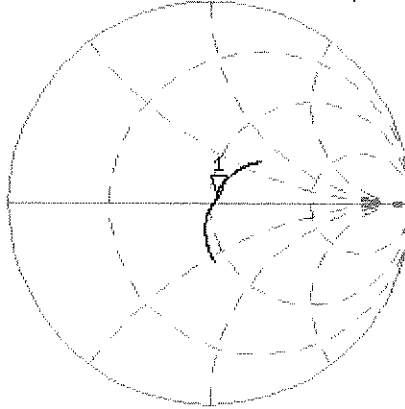

CH2 S11 LOG 5 dB/REF -20 dB 1: -27.136 dB 2 450.000 000 MHz

Cor

Avg
16

H1d

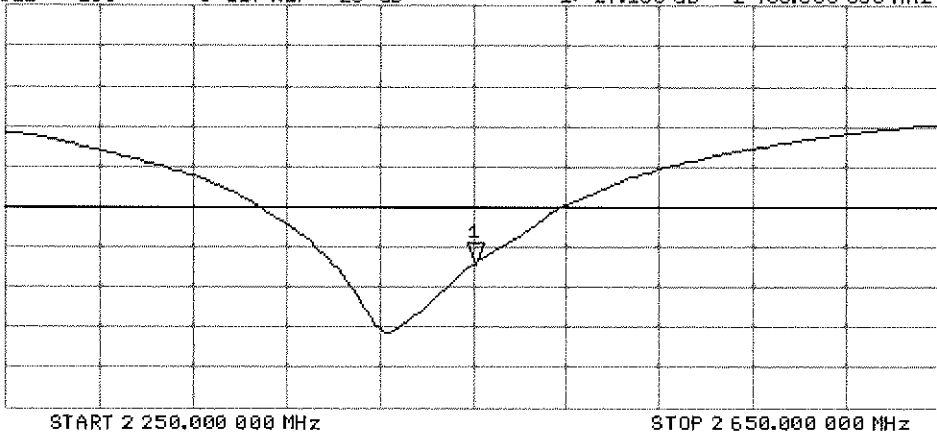

DASY5 Validation Report for Body TSL

Date: 08.01.2013

Test Laboratory: SPEAG, Zurich, Switzerland

DUT: Dipole 2450 MHz; Type: D2450V2; Serial: D2450V2 - SN: 797

Communication System: CW; Frequency: 2450 MHz

Medium parameters used: $f = 2450$ MHz; $\sigma = 2.01$ S/m; $\epsilon_r = 50.5$; $\rho = 1000$ kg/m³

Phantom section: Flat Section

Measurement Standard: DASY5 (IEEE/IEC/ANSI C63.19-2007)

DASY52 Configuration:

- Probe: ES3DV3 - SN3205; ConvF(4.42, 4.42, 4.42); Calibrated: 28.12.2012;
- Sensor-Surface: 3mm (Mechanical Surface Detection)
- Electronics: DAE4 Sn601; Calibrated: 27.06.2012
- Phantom: Flat Phantom 5.0 (back); Type: QD000P50AA; Serial: 1002
- DASY52 52.8.4(1052); SEMCAD X 14.6.8(7028)

Dipole Calibration for Body Tissue/Pin=250 mW, d=10mm/Zoom Scan (7x7x7)/Cube 0:

Measurement grid: dx=5mm, dy=5mm, dz=5mm

Reference Value = 93.935 V/m; Power Drift = 0.01 dB

Peak SAR (extrapolated) = 26.7 W/kg

SAR(1 g) = 12.7 W/kg; SAR(10 g) = 5.88 W/kg

Maximum value of SAR (measured) = 16.7 W/kg

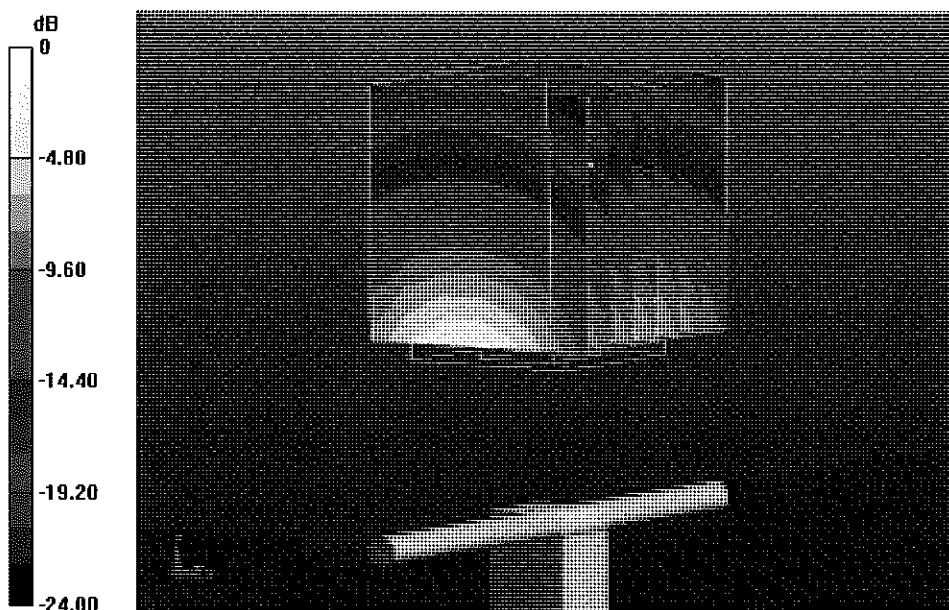

0 dB = 16.7 W/kg = 12.23 dBW/kg

Impedance Measurement Plot for Body TSL

8 Jan 2013 12:36:45

CH1 S11 1 U FS

1: 49.090 \angle 4.9102 \angle 318.97 μ H

2 450.000 000 MHz

*
De1

Cor

Avg
16

H1d

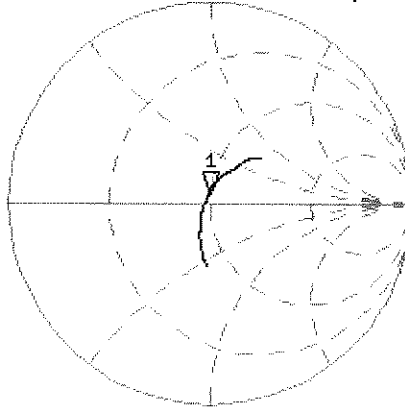

CH2 S11 LOG 5 dB/REF -20 dB 1: -25.963 dB 2 450.000 000 MHz

Cor

Avg
16

H1d

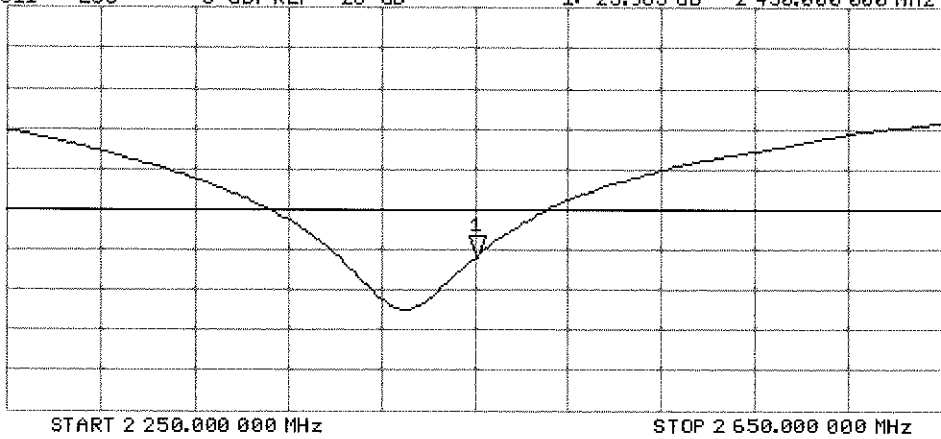



Accredited by the Swiss Accreditation Service (SAS)
The Swiss Accreditation Service is one of the signatories to the EA
Multilateral Agreement for the recognition of calibration certificates

Accreditation No.: **SCS 108**

Client **PC Test**

Certificate No: **D2600V2-1004_May13**

CALIBRATION CERTIFICATE

Object **D2600V2 - SN: 1004**

Calibration procedure(s) **QA CAL-05.v9
Calibration procedure for dipole validation kits above 700 MHz**

Calibration date: **May 02, 2013**

✓
1004
5/8/13

This calibration certificate documents the traceability to national standards, which realize the physical units of measurements (SI).
The measurements and the uncertainties with confidence probability are given on the following pages and are part of the certificate.

All calibrations have been conducted in the closed laboratory facility: environment temperature (22 ± 3)°C and humidity < 70%.

Calibration Equipment used (M&TE critical for calibration)

Primary Standards	ID #	Cal Date (Certificate No.)	Scheduled Calibration
Power meter EPM-442A	GB37480704	01-Nov-12 (No. 217-01640)	Oct-13
Power sensor HP 8481A	US37292783	01-Nov-12 (No. 217-01640)	Oct-13
Reference 20 dB Attenuator	SN: 5058 (20k)	04-Apr-13 (No. 217-01736)	Apr-14
Type-N mismatch combination	SN: 5047.3 / 06327	04-Apr-13 (No. 217-01739)	Apr-14
Reference Probe ES3DV3	SN: 3205	28-Dec-12 (No. ES3-3205_Dec12)	Dec-13
DAE4	SN: 601	25-Apr-13 (No. DAE4-601_Apr13)	Apr-14
DAE4	SN: 909	11-Sep-12 (No. DAE4-909_Sep12)	Sep-13
Secondary Standards	ID #	Check Date (in house)	Scheduled Check
Power sensor HP 8481A	MY41092317	18-Oct-02 (in house check Oct-11)	In house check: Oct-13
RF generator R&S SMT-06	100005	04-Aug-99 (in house check Oct-11)	In house check: Oct-13
Network Analyzer HP 8753E	US37390585 S4206	18-Oct-01 (in house check Oct-12)	In house check: Oct-13

Calibrated by: **Claudio Leubler** Laboratory Technician

Signature

Approved by: **Katja Pokovic** Technical Manager

Issued: May 2, 2013

This calibration certificate shall not be reproduced except in full without written approval of the laboratory.



Accredited by the Swiss Accreditation Service (SAS)

The Swiss Accreditation Service is one of the signatories to the EA
Multilateral Agreement for the recognition of calibration certificates

Accreditation No.: **SCS 108**

Glossary:

TSL	tissue simulating liquid
ConvF	sensitivity in TSL / NORM x,y,z
N/A	not applicable or not measured

Calibration is Performed According to the Following Standards:

- IEEE Std 1528-2003, "IEEE Recommended Practice for Determining the Peak Spatial-Averaged Specific Absorption Rate (SAR) in the Human Head from Wireless Communications Devices: Measurement Techniques", December 2003
- IEC 62209-1, "Procedure to measure the Specific Absorption Rate (SAR) for hand-held devices used in close proximity to the ear (frequency range of 300 MHz to 3 GHz)", February 2005
- Federal Communications Commission Office of Engineering & Technology (FCC OET), "Evaluating Compliance with FCC Guidelines for Human Exposure to Radiofrequency Electromagnetic Fields; Additional Information for Evaluating Compliance of Mobile and Portable Devices with FCC Limits for Human Exposure to Radiofrequency Emissions", Supplement C (Edition 01-01) to Bulletin 65

Additional Documentation:

- DASY4/5 System Handbook

Methods Applied and Interpretation of Parameters:

- Measurement Conditions:* Further details are available from the Validation Report at the end of the certificate. All figures stated in the certificate are valid at the frequency indicated.
- Antenna Parameters with TSL:* The dipole is mounted with the spacer to position its feed point exactly below the center marking of the flat phantom section, with the arms oriented parallel to the body axis.
- Feed Point Impedance and Return Loss:* These parameters are measured with the dipole positioned under the liquid filled phantom. The impedance stated is transformed from the measurement at the SMA connector to the feed point. The Return Loss ensures low reflected power. No uncertainty required.
- Electrical Delay:* One-way delay between the SMA connector and the antenna feed point. No uncertainty required.
- SAR measured:* SAR measured at the stated antenna input power.
- SAR normalized:* SAR as measured, normalized to an input power of 1 W at the antenna connector.
- SAR for nominal TSL parameters:* The measured TSL parameters are used to calculate the nominal SAR result.

The reported uncertainty of measurement is stated as the standard uncertainty of measurement multiplied by the coverage factor $k=2$, which for a normal distribution corresponds to a coverage probability of approximately 95%.

Measurement Conditions

DASY system configuration, as far as not given on page 1.

DASY Version	DASY5	V52.8.6
Extrapolation	Advanced Extrapolation	
Phantom	Modular Flat Phantom	
Distance Dipole Center - TSL	10 mm	with Spacer
Zoom Scan Resolution	dx, dy, dz = 5 mm	
Frequency	2600 MHz \pm 1 MHz	

Head TSL parameters

The following parameters and calculations were applied.

	Temperature	Permittivity	Conductivity
Nominal Head TSL parameters	22.0 °C	39.0	1.96 mho/m
Measured Head TSL parameters	(22.0 \pm 0.2) °C	37.2 \pm 6 %	1.99 mho/m \pm 6 %
Head TSL temperature change during test	< 0.5 °C	----	----

SAR result with Head TSL

SAR averaged over 1 cm ³ (1 g) of Head TSL	Condition	
SAR measured	250 mW input power	14.8 W/kg
SAR for nominal Head TSL parameters	normalized to 1W	58.2 W/kg \pm 17.0 % (k=2)

SAR averaged over 10 cm ³ (10 g) of Head TSL	condition	
SAR measured	250 mW input power	6.57 W/kg
SAR for nominal Head TSL parameters	normalized to 1W	26.0 W/kg \pm 16.5 % (k=2)

Body TSL parameters

The following parameters and calculations were applied.

	Temperature	Permittivity	Conductivity
Nominal Body TSL parameters	22.0 °C	52.5	2.16 mho/m
Measured Body TSL parameters	(22.0 \pm 0.2) °C	50.8 \pm 6 %	2.20 mho/m \pm 6 %
Body TSL temperature change during test	< 0.5 °C	----	----

SAR result with Body TSL

SAR averaged over 1 cm ³ (1 g) of Body TSL	Condition	
SAR measured	250 mW input power	14.6 W/kg
SAR for nominal Body TSL parameters	normalized to 1W	57.5 W/kg \pm 17.0 % (k=2)

SAR averaged over 10 cm ³ (10 g) of Body TSL	condition	
SAR measured	250 mW input power	6.43 W/kg
SAR for nominal Body TSL parameters	normalized to 1W	25.5 W/kg \pm 16.5 % (k=2)

Appendix

Antenna Parameters with Head TSL

Impedance, transformed to feed point	50.0 Ω - 4.3 j Ω
Return Loss	- 27.3 dB

Antenna Parameters with Body TSL

Impedance, transformed to feed point	46.7 Ω - 2.9 j Ω
Return Loss	- 26.8 dB

General Antenna Parameters and Design

Electrical Delay (one direction)	1.149 ns
----------------------------------	----------

After long term use with 100W radiated power, only a slight warming of the dipole near the feedpoint can be measured.

The dipole is made of standard semirigid coaxial cable. The center conductor of the feeding line is directly connected to the second arm of the dipole. The antenna is therefore short-circuited for DC-signals. On some of the dipoles, small end caps are added to the dipole arms in order to improve matching when loaded according to the position as explained in the "Measurement Conditions" paragraph. The SAR data are not affected by this change. The overall dipole length is still according to the Standard.

No excessive force must be applied to the dipole arms, because they might bend or the soldered connections near the feedpoint may be damaged.

Additional EUT Data

Manufactured by	SPEAG
Manufactured on	December 23, 2006

DASY5 Validation Report for Head TSL

Date: 02.05.2013

Test Laboratory: SPEAG, Zurich, Switzerland

DUT: Dipole 2600 MHz; Type: D2600V2; Serial: D2600V2 - SN: 1004

Communication System: UID 0 - CW; Frequency: 2600 MHz

Medium parameters used: $f = 2600$ MHz; $\sigma = 1.99$ S/m; $\epsilon_r = 37.2$; $\rho = 1000$ kg/m³

Phantom section: Flat Section

Measurement Standard: DASY5 (IEEE/IEC/ANSI C63.19-2007)

DASY52 Configuration:

- Probe: ES3DV3 - SN3205; ConvF(4.45, 4.45, 4.45); Calibrated: 28.12.2012;
- Sensor-Surface: 3mm (Mechanical Surface Detection)
- Electronics: DAE4 Sn601; Calibrated: 25.04.2013
- Phantom: Flat Phantom 5.0 (front); Type: QD000P50AA; Serial: 1001
- DASY52 52.8.6(1115); SEMCAD X 14.6.9(7117)

Dipole Calibration for Head Tissue/ $P_{in}=250$ mW, $d=10$ mm/Zoom Scan (7x7x7)/Cube 0:

Measurement grid: $dx=5$ mm, $dy=5$ mm, $dz=5$ mm

Reference Value = 101.3 V/m; Power Drift = 0.07 dB

Peak SAR (extrapolated) = 31.9 W/kg

SAR(1 g) = 14.8 W/kg; SAR(10 g) = 6.57 W/kg

Maximum value of SAR (measured) = 19.0 W/kg

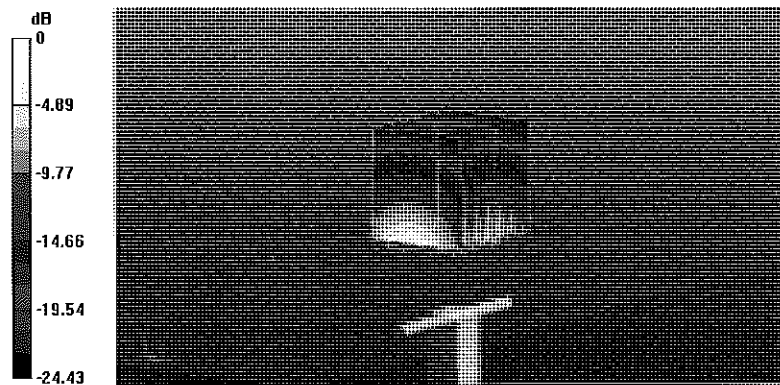

0 dB = 19.0 W/kg = 12.79 dBW/kg

Impedance Measurement Plot for Head TSL

2 May 2013 10:13:16

[CH1] S11 1 U FS 1: 49.990 Ω -4.3359 Ω 14.118 μ F 2 600.000 000 MHz

De1

CΔ

Avg
16

H1 d

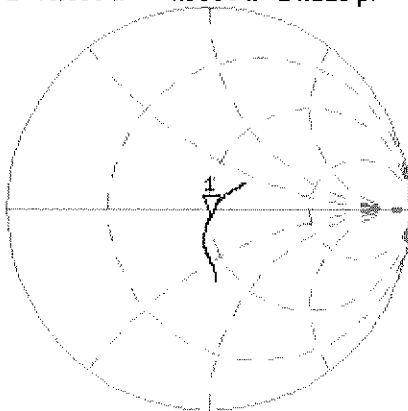

CH2 S11 LOG 5 dB/REF -20 dB 1: -27.259 dB 2 600.000 000 MHz

CΔ

Avg
16

H1 d

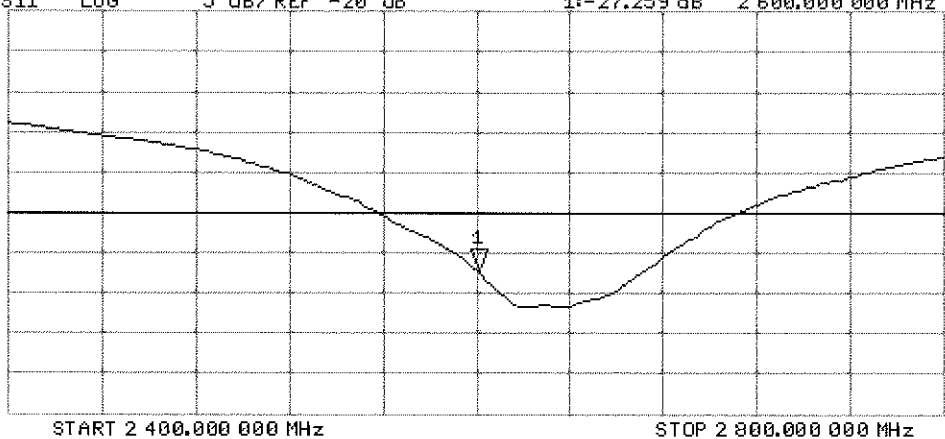

DASY5 Validation Report for Body TSL

Date: 25.04.2013

Test Laboratory: SPEAG, Zurich, Switzerland

DUT: Dipole 2600 MHz; Type: D2600V2; Serial: D2600V2 - SN: 1004

Communication System: UID 0 - CW; Frequency: 2600 MHz

Medium parameters used: $f = 2600$ MHz; $\sigma = 2.2$ S/m; $\epsilon_r = 50.8$; $\rho = 1000$ kg/m³

Phantom section: Flat Section

Measurement Standard: DASY5 (IEEE/IEC/ANSI C63.19-2007)

DASY52 Configuration:

- Probe: ES3DV3 - SN3205; ConvF(4.32, 4.32, 4.32); Calibrated: 28.12.2012;
- Sensor-Surface: 3mm (Mechanical Surface Detection)
- Electronics: DAE4 Sn909; Calibrated: 11.09.2012
- Phantom: Flat Phantom 5.0 (back); Type: QD000P50AA; Serial: 1002
- DASY52 52.8.6(1115); SEMCAD X 14.6.9(7117)

Dipole Calibration for Body Tissue/Pin=250 mW, d=10mm/Zoom Scan (7x7x7)/Cube 0:

Measurement grid: dx=5mm, dy=5mm, dz=5mm

Reference Value = 96.605 V/m; Power Drift = 0.02 dB

Peak SAR (extrapolated) = 32.0 W/kg

SAR(1 g) = 14.6 W/kg; SAR(10 g) = 6.43 W/kg

Maximum value of SAR (measured) = 19.4 W/kg

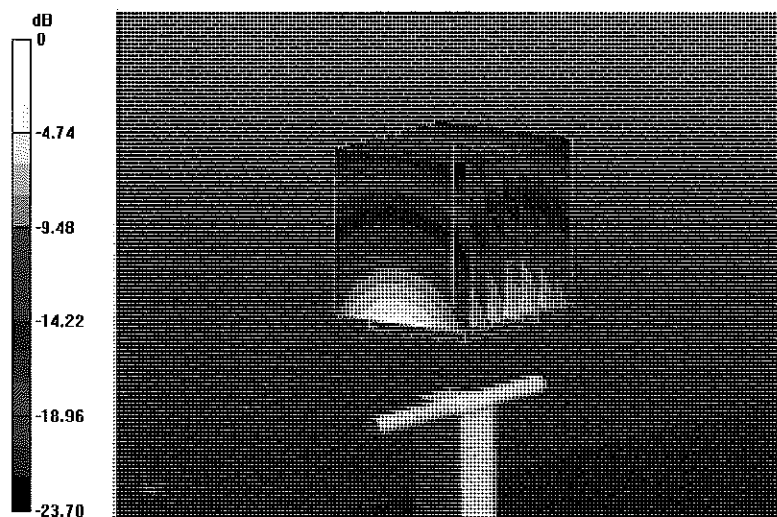

0 dB = 19.4 W/kg = 12.88 dBW/kg

Impedance Measurement Plot for Body TSL

25 Apr 2013 17:47:33

CH1 S11 1 U FS 1: 46.711 Ω -2.9453 Ω 20.783 pF 2 500.000 000 MHz

*

DeI

Cor

Avg
16

H1d

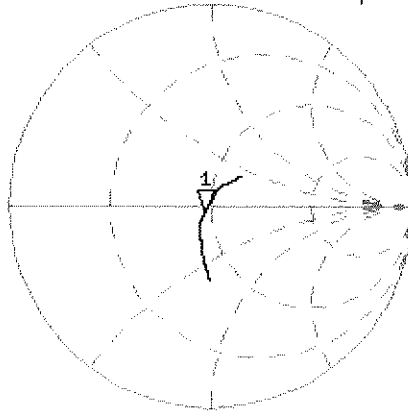

CH2 S11 LOG 5 dB/REF -20 dB 1: -26.810 dB 2 500.000 000 MHz

Cor

Avg
16

H1d

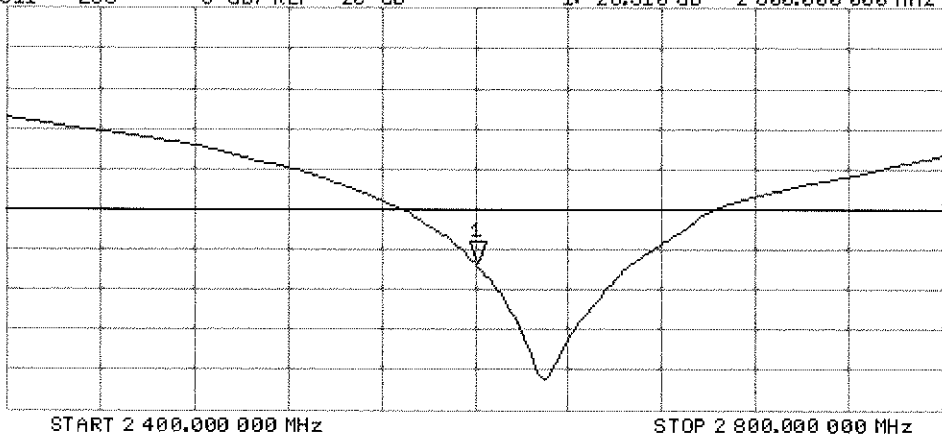



Accredited by the Swiss Accreditation Service (SAS)
The Swiss Accreditation Service is one of the signatories to the EA
Multilateral Agreement for the recognition of calibration certificates

Accreditation No.: **SCS 108**

Client **PC Test**

Certificate No: **D5GHzV2-1120_Feb13**

CALIBRATION CERTIFICATE

Object **D5GHzV2 - SN: 1120**

Calibration procedure(s) **QA CAL-22.v2
Calibration procedure for dipole validation kits between 3-6 GHz**

Calibration date: **February 14, 2013**

*✓
Kok
2/2/13*

This calibration certificate documents the traceability to national standards, which realize the physical units of measurements (SI).
The measurements and the uncertainties with confidence probability are given on the following pages and are part of the certificate.

All calibrations have been conducted in the closed laboratory facility: environment temperature (22 ± 3)°C and humidity < 70%.

Calibration Equipment used (M&TE critical for calibration)

Primary Standards	ID #	Cal Date (Certificate No.)	Scheduled Calibration
Power meter EPM-442A	GB37480704	01-Nov-12 (No. 217-01640)	Oct-13
Power sensor HP 8481A	US37292783	01-Nov-12 (No. 217-01640)	Oct-13
Reference 20 dB Attenuator	SN: 5058 (20k)	27-Mar-12 (No. 217-01530)	Apr-13
Type-N mismatch combination	SN: 5047.3 / 06327	27-Mar-12 (No. 217-01533)	Apr-13
Reference Probe EX3DV4	SN: 3503	28-Dec-12 (No. EX3-3503_Dec12)	Dec-13
DAE4	SN: 601	27-Jun-12 (No. DAE4-601_Jun12)	Jun-13
Secondary Standards	ID #	Check Date (in house)	Scheduled Check
Power sensor HP 8481A	MY41092317	18-Oct-02 (in house check Oct-11)	In house check: Oct-13
RF generator R&S SMT-06	100005	04-Aug-99 (in house check Oct-11)	In house check: Oct-13
Network Analyzer HP 8753E	US37390585 S4206	18-Oct-01 (in house check Oct-12)	In house check: Oct-13

Calibrated by: **Israe El-Naouq** Function: **Laboratory Technician**

Approved by: **Katja Pokovic** Technical Manager

Signature
Israe El-Naouq
Katja Pokovic

Issued: February 14, 2013

This calibration certificate shall not be reproduced except in full without written approval of the laboratory.



Accredited by the Swiss Accreditation Service (SAS)

The Swiss Accreditation Service is one of the signatories to the EA Multilateral Agreement for the recognition of calibration certificates

Accreditation No.: **SCS 108**

Glossary:

TSL	tissue simulating liquid
ConvF	sensitivity in TSL / NORM x,y,z
N/A	not applicable or not measured

Calibration is Performed According to the Following Standards:

- a) IEC 62209-2, "Evaluation of Human Exposure to Radio Frequency Fields from Handheld and Body-Mounted Wireless Communication Devices in the Frequency Range of 30 MHz to 6 GHz: Human models, Instrumentation, and Procedures"; Part 2: "Procedure to determine the Specific Absorption Rate (SAR) for including accessories and multiple transmitters", March 2010
- b) Federal Communications Commission Office of Engineering & Technology (FCC OET), "Evaluating Compliance with FCC Guidelines for Human Exposure to Radiofrequency Electromagnetic Fields; Additional Information for Evaluating Compliance of Mobile and Portable Devices with FCC Limits for Human Exposure to Radiofrequency Emissions", Supplement C (Edition 01-01) to Bulletin 65

Additional Documentation:

- c) DASY4/5 System Handbook

Methods Applied and Interpretation of Parameters:

- *Measurement Conditions:* Further details are available from the Validation Report at the end of the certificate. All figures stated in the certificate are valid at the frequency indicated.
- *Antenna Parameters with TSL:* The dipole is mounted with the spacer to position its feed point exactly below the center marking of the flat phantom section, with the arms oriented parallel to the body axis.
- *Feed Point Impedance and Return Loss:* These parameters are measured with the dipole positioned under the liquid filled phantom. The impedance stated is transformed from the measurement at the SMA connector to the feed point. The Return Loss ensures low reflected power. No uncertainty required.
- *Electrical Delay:* One-way delay between the SMA connector and the antenna feed point. No uncertainty required.
- *SAR measured:* SAR measured at the stated antenna input power.
- *SAR normalized:* SAR as measured, normalized to an input power of 1 W at the antenna connector.
- *SAR for nominal TSL parameters:* The measured TSL parameters are used to calculate the nominal SAR result.

The reported uncertainty of measurement is stated as the standard uncertainty of measurement multiplied by the coverage factor $k=2$, which for a normal distribution corresponds to a coverage probability of approximately 95%.

Measurement Conditions

DASY system configuration, as far as not given on page 1.

DASY Version	DASY5	V52.8.5
Extrapolation	Advanced Extrapolation	
Phantom	Modular Flat Phantom V5.0	
Distance Dipole Center - TSL	10 mm	with Spacer
Zoom Scan Resolution	dx, dy = 4.0 mm, dz = 1.4 mm	Graded Ratio = 1.4 (Z direction)
Frequency	5200 MHz ± 1 MHz 5300 MHz ± 1 MHz 5500 MHz ± 1 MHz 5600 MHz ± 1 MHz 5800 MHz ± 1 MHz	

Head TSL parameters at 5200 MHz

The following parameters and calculations were applied.

	Temperature	Permittivity	Conductivity
Nominal Head TSL parameters	22.0 °C	36.0	4.66 mho/m
Measured Head TSL parameters	(22.0 ± 0.2) °C	34.7 ± 6 %	4.47 mho/m ± 6 %
Head TSL temperature change during test	< 0.5 °C	----	----

SAR result with Head TSL at 5200 MHz

SAR averaged over 1 cm³ (1 g) of Head TSL	Condition	
SAR measured	100 mW input power	7.67 W/kg
SAR for nominal Head TSL parameters	normalized to 1W	76.0 W/kg ± 19.9 % (k=2)

SAR averaged over 10 cm³ (10 g) of Head TSL	condition	
SAR measured	100 mW input power	2.18 W/kg
SAR for nominal Head TSL parameters	normalized to 1W	21.5 W/kg ± 19.5 % (k=2)

Head TSL parameters at 5300 MHz

The following parameters and calculations were applied.

	Temperature	Permittivity	Conductivity
Nominal Head TSL parameters	22.0 °C	35.9	4.76 mho/m
Measured Head TSL parameters	(22.0 ± 0.2) °C	34.5 ± 6 %	4.57 mho/m ± 6 %
Head TSL temperature change during test	< 0.5 °C	----	----

SAR result with Head TSL at 5300 MHz

SAR averaged over 1 cm ³ (1 g) of Head TSL	Condition	
SAR measured	100 mW input power	7.94 W/kg
SAR for nominal Head TSL parameters	normalized to 1W	78.7 W / kg ± 19.9 % (k=2)

SAR averaged over 10 cm ³ (10 g) of Head TSL	condition	
SAR measured	100 mW input power	2.27 W/kg
SAR for nominal Head TSL parameters	normalized to 1W	22.4 W/kg ± 19.5 % (k=2)

Head TSL parameters at 5500 MHz

The following parameters and calculations were applied.

	Temperature	Permittivity	Conductivity
Nominal Head TSL parameters	22.0 °C	35.6	4.96 mho/m
Measured Head TSL parameters	(22.0 ± 0.2) °C	34.2 ± 6 %	4.74 mho/m ± 6 %
Head TSL temperature change during test	< 0.5 °C	----	----

SAR result with Head TSL at 5500 MHz

SAR averaged over 1 cm ³ (1 g) of Head TSL	Condition	
SAR measured	100 mW input power	8.09 W/kg
SAR for nominal Head TSL parameters	normalized to 1W	80.1 W/kg ± 19.9 % (k=2)

SAR averaged over 10 cm ³ (10 g) of Head TSL	condition	
SAR measured	100 mW input power	2.29 W/kg
SAR for nominal Head TSL parameters	normalized to 1W	22.6 W/kg ± 19.5 % (k=2)

Head TSL parameters at 5600 MHz

The following parameters and calculations were applied.

	Temperature	Permittivity	Conductivity
Nominal Head TSL parameters	22.0 °C	35.5	5.07 mho/m
Measured Head TSL parameters	(22.0 ± 0.2) °C	34.1 ± 6 %	4.83 mho/m ± 6 %
Head TSL temperature change during test	< 0.5 °C	----	----

SAR result with Head TSL at 5600 MHz

SAR averaged over 1 cm ³ (1 g) of Head TSL	Condition	
SAR measured	100 mW input power	8.08 W/kg
SAR for nominal Head TSL parameters	normalized to 1W	79.9 W/kg ± 19.9 % (k=2)

SAR averaged over 10 cm ³ (10 g) of Head TSL	condition	
SAR measured	100 mW input power	2.28 W/kg
SAR for nominal Head TSL parameters	normalized to 1W	22.5 W/kg ± 19.5 % (k=2)

Head TSL parameters at 5800 MHz

The following parameters and calculations were applied.

	Temperature	Permittivity	Conductivity
Nominal Head TSL parameters	22.0 °C	35.3	5.27 mho/m
Measured Head TSL parameters	(22.0 ± 0.2) °C	33.9 ± 6 %	5.05 mho/m ± 6 %
Head TSL temperature change during test	< 0.5 °C	----	----

SAR result with Head TSL at 5800 MHz

SAR averaged over 1 cm ³ (1 g) of Head TSL	Condition	
SAR measured	100 mW input power	7.57 W/kg
SAR for nominal Head TSL parameters	normalized to 1W	74.9 W/kg ± 19.9 % (k=2)

SAR averaged over 10 cm ³ (10 g) of Head TSL	condition	
SAR measured	100 mW input power	2.13 W/kg
SAR for nominal Head TSL parameters	normalized to 1W	21.0 W/kg ± 19.5 % (k=2)

Body TSL parameters at 5200 MHz

The following parameters and calculations were applied.

	Temperature	Permittivity	Conductivity
Nominal Body TSL parameters	22.0 °C	49.0	5.30 mho/m
Measured Body TSL parameters	(22.0 ± 0.2) °C	46.9 ± 6 %	5.36 mho/m ± 6 %
Body TSL temperature change during test	< 0.5 °C	----	----

SAR result with Body TSL at 5200 MHz

SAR averaged over 1 cm ³ (1 g) of Body TSL	Condition	
SAR measured	100 mW input power	7.73 W/kg
SAR for nominal Body TSL parameters	normalized to 1W	76.6 W/kg ± 19.9 % (k=2)

SAR averaged over 10 cm ³ (10 g) of Body TSL	condition	
SAR measured	100 mW input power	2.17 W/kg
SAR for nominal Body TSL parameters	normalized to 1W	21.5 W/kg ± 19.5 % (k=2)

Body TSL parameters at 5300 MHz

The following parameters and calculations were applied.

	Temperature	Permittivity	Conductivity
Nominal Body TSL parameters	22.0 °C	48.9	5.42 mho/m
Measured Body TSL parameters	(22.0 ± 0.2) °C	46.7 ± 6 %	5.48 mho/m ± 6 %
Body TSL temperature change during test	< 0.5 °C	----	----

SAR result with Body TSL at 5300 MHz

SAR averaged over 1 cm ³ (1 g) of Body TSL	Condition	
SAR measured	100 mW input power	7.75 W/kg
SAR for nominal Body TSL parameters	normalized to 1W	76.8 W/kg ± 19.9 % (k=2)

SAR averaged over 10 cm ³ (10 g) of Body TSL	condition	
SAR measured	100 mW input power	2.18 W/kg
SAR for nominal Body TSL parameters	normalized to 1W	21.5 W/kg ± 19.5 % (k=2)

Body TSL parameters at 5500 MHz

The following parameters and calculations were applied.

	Temperature	Permittivity	Conductivity
Nominal Body TSL parameters	22.0 °C	48.6	5.65 mho/m
Measured Body TSL parameters	(22.0 ± 0.2) °C	46.3 ± 6 %	5.71 mho/m ± 6 %
Body TSL temperature change during test	< 0.5 °C	----	----

SAR result with Body TSL at 5500 MHz

SAR averaged over 1 cm ³ (1 g) of Body TSL	Condition	
SAR measured	100 mW input power	8.06 W/kg
SAR for nominal Body TSL parameters	normalized to 1W	79.8 W/kg ± 19.9 % (k=2)

SAR averaged over 10 cm ³ (10 g) of Body TSL	condition	
SAR measured	100 mW input power	2.24 W/kg
SAR for nominal Body TSL parameters	normalized to 1W	22.1 W/kg ± 19.5 % (k=2)

Body TSL parameters at 5600 MHz

The following parameters and calculations were applied.

	Temperature	Permittivity	Conductivity
Nominal Body TSL parameters	22.0 °C	48.5	5.77 mho/m
Measured Body TSL parameters	(22.0 ± 0.2) °C	46.2 ± 6 %	5.83 mho/m ± 6 %
Body TSL temperature change during test	< 0.5 °C	----	----

SAR result with Body TSL at 5600 MHz

SAR averaged over 1 cm ³ (1 g) of Body TSL	Condition	
SAR measured	100 mW input power	8.15 W/kg
SAR for nominal Body TSL parameters	normalized to 1W	80.7 W/kg ± 19.9 % (k=2)

SAR averaged over 10 cm ³ (10 g) of Body TSL	condition	
SAR measured	100 mW input power	2.26 W/kg
SAR for nominal Body TSL parameters	normalized to 1W	22.3 W/kg ± 19.5 % (k=2)

Body TSL parameters at 5800 MHz

The following parameters and calculations were applied.

	Temperature	Permittivity	Conductivity
Nominal Body TSL parameters	22.0 °C	48.2	6.00 mho/m
Measured Body TSL parameters	(22.0 ± 0.2) °C	45.9 ± 6 %	6.12 mho/m ± 6 %
Body TSL temperature change during test	< 0.5 °C	----	----

SAR result with Body TSL at 5800 MHz

SAR averaged over 1 cm ³ (1 g) of Body TSL	Condition	
SAR measured	100 mW input power	7.62 W/kg
SAR for nominal Body TSL parameters	normalized to 1W	75.5 W/kg ± 19.9 % (k=2)

SAR averaged over 10 cm ³ (10 g) of Body TSL	condition	
SAR measured	100 mW input power	2.12 W/kg
SAR for nominal Body TSL parameters	normalized to 1W	20.9 W/kg ± 19.5 % (k=2)

Appendix

Antenna Parameters with Head TSL at 5200 MHz

Impedance, transformed to feed point	53.8 Ω - 6.3 j Ω
Return Loss	- 23.0 dB

Antenna Parameters with Head TSL at 5300 MHz

Impedance, transformed to feed point	50.1 Ω + 0.5 j Ω
Return Loss	- 45.3 dB

Antenna Parameters with Head TSL at 5500 MHz

Impedance, transformed to feed point	51.0 Ω - 0.9 j Ω
Return Loss	- 37.9 dB

Antenna Parameters with Head TSL at 5600 MHz

Impedance, transformed to feed point	55.3 Ω - 0.9 j Ω
Return Loss	- 25.8 dB

Antenna Parameters with Head TSL at 5800 MHz

Impedance, transformed to feed point	53.5 Ω + 3.3 j Ω
Return Loss	- 26.7 dB

Antenna Parameters with Body TSL at 5200 MHz

Impedance, transformed to feed point	53.7 Ω - 4.8 j Ω
Return Loss	- 24.8 dB

Antenna Parameters with Body TSL at 5300 MHz

Impedance, transformed to feed point	50.2 Ω + 2.4 j Ω
Return Loss	- 32.5 dB

Antenna Parameters with Body TSL at 5500 MHz

Impedance, transformed to feed point	51.6 Ω - 1.5 j Ω
Return Loss	- 33.3 dB

Antenna Parameters with Body TSL at 5600 MHz

Impedance, transformed to feed point	57.4 Ω + 0.9 j Ω
Return Loss	- 23.2 dB

Antenna Parameters with Body TSL at 5800 MHz

Impedance, transformed to feed point	53.5 Ω + 3.2 j Ω
Return Loss	- 26.7 dB

General Antenna Parameters and Design

Electrical Delay (one direction)	1.206 ns
----------------------------------	----------

After long term use with 100W radiated power, only a slight warming of the dipole near the feedpoint can be measured.

The dipole is made of standard semirigid coaxial cable. The center conductor of the feeding line is directly connected to the second arm of the dipole. The antenna is therefore short-circuited for DC-signals. On some of the dipoles, small end caps are added to the dipole arms in order to improve matching when loaded according to the position as explained in the "Measurement Conditions" paragraph. The SAR data are not affected by this change. The overall dipole length is still according to the Standard.

No excessive force must be applied to the dipole arms, because they might bend or the soldered connections near the feedpoint may be damaged.

Additional EUT Data

Manufactured by	SPEAG
Manufactured on	September 08, 2011

DASY5 Validation Report for Head TSL

Date: 08.02.2013

Test Laboratory: SPEAG, Zurich, Switzerland

DUT: Dipole 5GHz; Type: D5GHzV2; Serial: D5GHzV2 - SN: 1120

Communication System: CW; Frequency: 5200 MHz, Frequency: 5300 MHz, Frequency: 5500 MHz, Frequency: 5600 MHz, Frequency: 5800 MHz

Medium parameters used: $f = 5200$ MHz; $\sigma = 4.47$ S/m; $\epsilon_r = 34.7$; $\rho = 1000$ kg/m³, Medium parameters used: $f = 5300$ MHz; $\sigma = 4.57$ S/m; $\epsilon_r = 34.5$; $\rho = 1000$ kg/m³, Medium parameters used: $f = 5500$ MHz; $\sigma = 4.74$ S/m; $\epsilon_r = 34.2$; $\rho = 1000$ kg/m³, Medium parameters used: $f = 5600$ MHz; $\sigma = 4.83$ S/m; $\epsilon_r = 34.1$; $\rho = 1000$ kg/m³, Medium parameters used: $f = 5800$ MHz; $\sigma = 5.05$ S/m; $\epsilon_r = 33.9$; $\rho = 1000$ kg/m³

Phantom section: Flat Section

Measurement Standard: DASY5 (IEEE/IEC/ANSI C63.19-2007)

DASY52 Configuration:

- Probe: EX3DV4 - SN3503; ConvF(5.41, 5.41, 5.41); Calibrated: 28.12.2012, ConvF(5.1, 5.1, 5.1); Calibrated: 28.12.2012, ConvF(4.91, 4.91, 4.91); Calibrated: 28.12.2012, ConvF(4.76, 4.76, 4.76); Calibrated: 28.12.2012, ConvF(4.81, 4.81, 4.81); Calibrated: 28.12.2012;
- Sensor-Surface: 1.4mm (Mechanical Surface Detection)
- Electronics: DAE4 Sn601; Calibrated: 27.06.2012
- Phantom: Flat Phantom 5.0 (front); Type: QD000P50AA; Serial: 1001
- DASY52 52.8.5(1059); SEMCAD X 14.6.8(7028)

Dipole Calibration for Head Tissue/Pin=100mW, dist=10mm, f=5200 MHz/Zoom Scan, dist=1.4mm (8x8x7)/Cube 0: Measurement grid: dx=4mm, dy=4mm, dz=1.4mm

Reference Value = 61.561 V/m; Power Drift = 0.05 dB

Peak SAR (extrapolated) = 28.8 W/kg

SAR(1 g) = 7.67 W/kg; SAR(10 g) = 2.18 W/kg

Maximum value of SAR (measured) = 17.7 W/kg

Dipole Calibration for Head Tissue/Pin=100mW, dist=10mm, f=5300 MHz/Zoom Scan, dist=1.4mm (8x8x7)/Cube 0: Measurement grid: dx=4mm, dy=4mm, dz=1.4mm

Reference Value = 62.429 V/m; Power Drift = 0.03 dB

Peak SAR (extrapolated) = 30.3 W/kg

SAR(1 g) = 7.94 W/kg; SAR(10 g) = 2.27 W/kg

Maximum value of SAR (measured) = 18.5 W/kg

Dipole Calibration for Head Tissue/Pin=100mW, dist=10mm, f=5500 MHz/Zoom Scan, dist=1.4mm (8x8x7)/Cube 0: Measurement grid: dx=4mm, dy=4mm, dz=1.4mm

Reference Value = 61.998 V/m; Power Drift = 0.08 dB

Peak SAR (extrapolated) = 32.7 W/kg

SAR(1 g) = 8.09 W/kg; SAR(10 g) = 2.29 W/kg

Maximum value of SAR (measured) = 19.3 W/kg

Dipole Calibration for Head Tissue/Pin=100mW, dist=10mm, f=5600 MHz/Zoom Scan, dist=1.4mm (8x8x7)/Cube 0: Measurement grid: dx=4mm, dy=4mm, dz=1.4mm
Reference Value = 62.540 V/m; Power Drift = 0.02 dB
Peak SAR (extrapolated) = 33.3 W/kg
SAR(1 g) = 8.08 W/kg; SAR(10 g) = 2.28 W/kg
Maximum value of SAR (measured) = 19.5 W/kg

Dipole Calibration for Head Tissue/Pin=100mW, dist=10mm, f=5800 MHz/Zoom Scan, dist=1.4mm (8x8x7)/Cube 0: Measurement grid: dx=4mm, dy=4mm, dz=1.4mm
Reference Value = 58.600 V/m; Power Drift = 0.09 dB
Peak SAR (extrapolated) = 32.9 W/kg
SAR(1 g) = 7.57 W/kg; SAR(10 g) = 2.13 W/kg
Maximum value of SAR (measured) = 18.8 W/kg

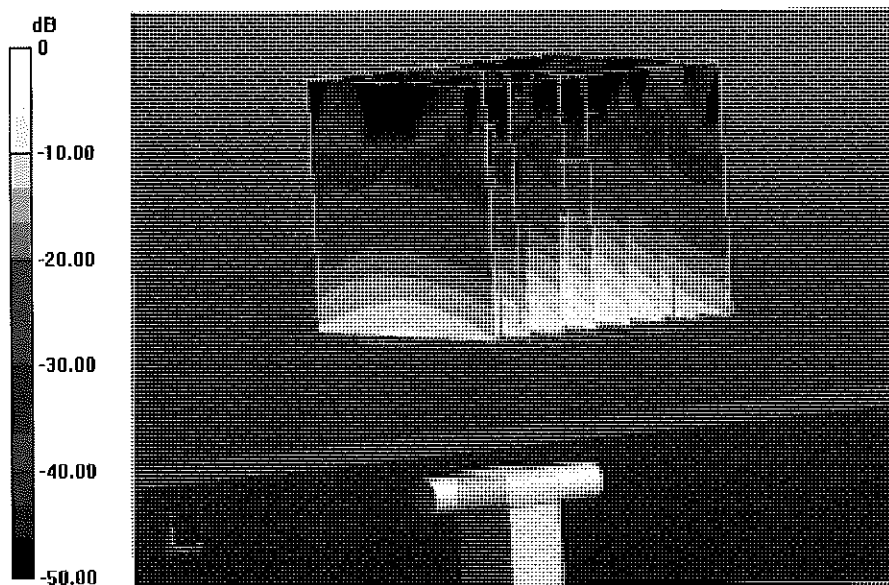

0 dB = 18.8 W/kg = 12.74 dBW/kg

Impedance Measurement Plot for Head TSL

8 Feb 2013 10:10:29

CH1 S11 1 U FS 1: 53.764 Ω -6.3086 Ω 4.8516 pF 5 200.000 000 MHz

*
De1
Cor
Avg
0
H1d

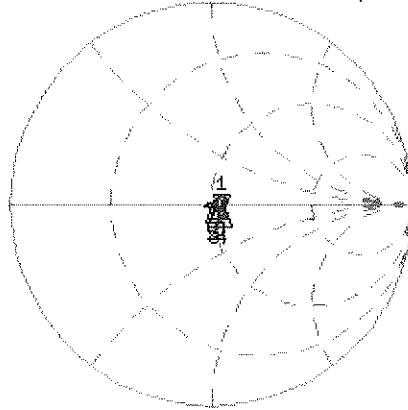

CH1 Markers
2: 50.104 Ω
0.5313 Ω
5.30000 GHz
3: 50.959 Ω
-853.52 m Ω
5.50000 GHz
4: 55.305 Ω
-902.34 m Ω
5.60000 GHz
5: 53.500 Ω
3.3027 Ω
5.80000 GHz

CH2 S11 LOG 5 dB/REF -20 dB 1: -23.013 dB 5 200.000 000 MHz

Cor
Avg
0
H1d

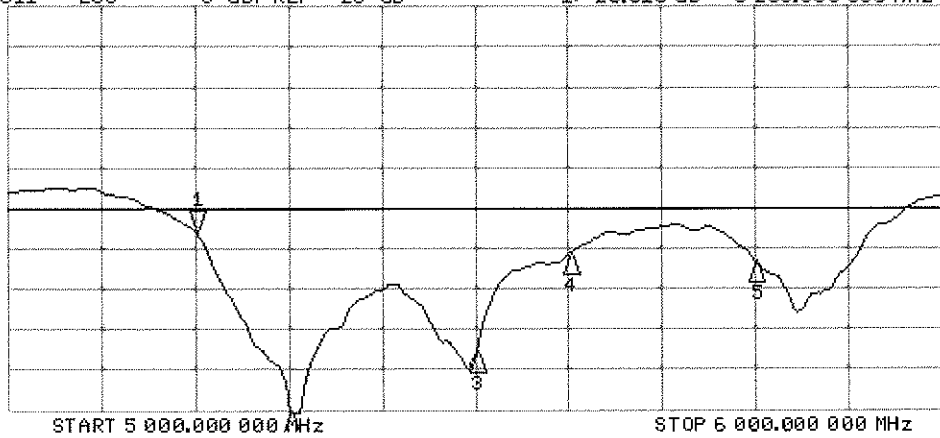

CH2 Markers
2: -45.321 dB
5.30000 GHz
3: -37.887 dB
5.50000 GHz
4: -25.835 dB
5.60000 GHz
5: -26.651 dB
5.80000 GHz

DASY5 Validation Report for Body TSL

Date: 14.02.2013

Test Laboratory: SPEAG, Zurich, Switzerland

DUT: Dipole 5GHz; Type: D5GHzV2; Serial: D5GHzV2 - SN: 1120

Communication System: CW; Frequency: 5200 MHz, Frequency: 5300 MHz, Frequency: 5500 MHz, Frequency: 5600 MHz, Frequency: 5800 MHz

Medium parameters used: $f = 5200$ MHz; $\sigma = 5.36$ S/m; $\epsilon_r = 46.9$; $\rho = 1000$ kg/m³, Medium parameters used: $f = 5300$ MHz; $\sigma = 5.48$ S/m; $\epsilon_r = 46.7$; $\rho = 1000$ kg/m³, Medium parameters used: $f = 5500$ MHz; $\sigma = 5.71$ S/m; $\epsilon_r = 46.3$; $\rho = 1000$ kg/m³, Medium parameters used: $f = 5600$ MHz; $\sigma = 5.83$ S/m; $\epsilon_r = 46.2$; $\rho = 1000$ kg/m³, Medium parameters used: $f = 5800$ MHz; $\sigma = 6.12$ S/m; $\epsilon_r = 45.9$; $\rho = 1000$ kg/m³

Phantom section: Flat Section

Measurement Standard: DASY5 (IEEE/IEC/ANSI C63.19-2007)

DASY52 Configuration:

- Probe: EX3DV4 - SN3503; ConvF(4.91, 4.91, 4.91); Calibrated: 28.12.2012, ConvF(4.67, 4.67, 4.67); Calibrated: 28.12.2012, ConvF(4.43, 4.43, 4.43); Calibrated: 28.12.2012, ConvF(4.22, 4.22, 4.22); Calibrated: 28.12.2012, ConvF(4.38, 4.38, 4.38); Calibrated: 28.12.2012;
- Sensor-Surface: 1.4mm (Mechanical Surface Detection)
- Electronics: DAE4 Sn601; Calibrated: 27.06.2012
- Phantom: Flat Phantom 5.0 (back); Type: QD000P50AA; Serial: 1002
- DASY52 52.8.5(1059); SEMCAD X 14.6.8(7028)

Dipole Calibration for Body Tissue/Pin=100mW, dist=10mm, f=5200 MHz/Zoom Scan,

dist=1.4mm (8x8x7)/Cube 0: Measurement grid: dx=4mm, dy=4mm, dz=1.4mm

Reference Value = 61.053 V/m; Power Drift = -0.08 dB

Peak SAR (extrapolated) = 31.1 W/kg

SAR(1 g) = 7.73 W/kg; SAR(10 g) = 2.17 W/kg

Maximum value of SAR (measured) = 18.2 W/kg

Dipole Calibration for Body Tissue/Pin=100mW, dist=10mm, f=5300 MHz/Zoom Scan,

dist=1.4mm (8x8x7)/Cube 0: Measurement grid: dx=4mm, dy=4mm, dz=1.4mm

Reference Value = 60.021 V/m; Power Drift = -0.02 dB

Peak SAR (extrapolated) = 32.1 W/kg

SAR(1 g) = 7.75 W/kg; SAR(10 g) = 2.18 W/kg

Maximum value of SAR (measured) = 18.5 W/kg

Dipole Calibration for Body Tissue/Pin=100mW, dist=10mm, f=5500 MHz/Zoom Scan,

dist=1.4mm (8x8x7)/Cube 0: Measurement grid: dx=4mm, dy=4mm, dz=1.4mm

Reference Value = 59.894 V/m; Power Drift = -0.02 dB

Peak SAR (extrapolated) = 35.3 W/kg

SAR(1 g) = 8.06 W/kg; SAR(10 g) = 2.24 W/kg

Maximum value of SAR (measured) = 19.4 W/kg

Dipole Calibration for Body Tissue/Pin=100mW, dist=10mm, f=5600 MHz/Zoom Scan, dist=1.4mm (8x8x7)/Cube 0: Measurement grid: dx=4mm, dy=4mm, dz=1.4mm
Reference Value = 59.730 V/m; Power Drift = -0.02 dB
Peak SAR (extrapolated) = 36.8 W/kg
SAR(1 g) = 8.15 W/kg; SAR(10 g) = 2.26 W/kg
Maximum value of SAR (measured) = 19.9 W/kg

Dipole Calibration for Body Tissue/Pin=100mW, dist=10mm, f=5800 MHz/Zoom Scan, dist=1.4mm (8x8x7)/Cube 0: Measurement grid: dx=4mm, dy=4mm, dz=1.4mm
Reference Value = 56.663 V/m; Power Drift = -0.02 dB
Peak SAR (extrapolated) = 36.4 W/kg
SAR(1 g) = 7.62 W/kg; SAR(10 g) = 2.12 W/kg
Maximum value of SAR (measured) = 19.0 W/kg

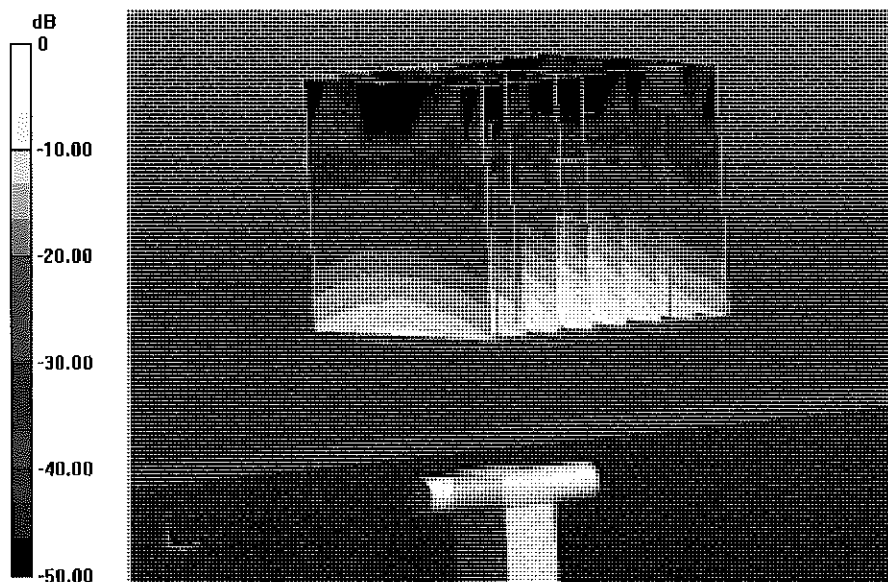

0 dB = 19.0 W/kg = 12.79 dBW/kg

Impedance Measurement Plot for Body TSL

14 Feb 2013 15:47:05

CH1 S11 1 U FS 1: 53.672 Ω -4.7539 Ω 6.4382 pF 5 200.000 000 MHz

*
De1
Cor
Avg
16
H1d

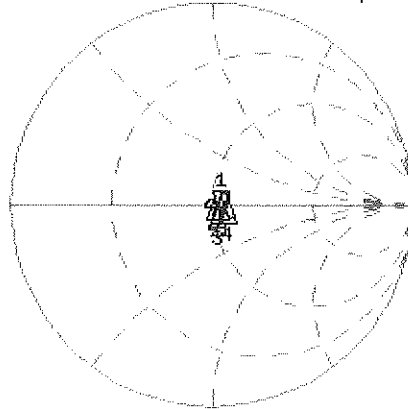

CH1 Markers
2: 50.250 Ω
2.3555 Ω
5.30000 GHz
3: 51.629 Ω
-1.4824 Ω
5.50000 GHz
4: 57.389 Ω
0.9180 Ω
5.60000 GHz
5: 53.543 Ω
3.2441 Ω
5.80000 GHz

CH2 S11 LOG 5 dB/REF -20 dB 1: -24.750 dB 5 200.000 000 MHz

Cor
Avg
16
H1d

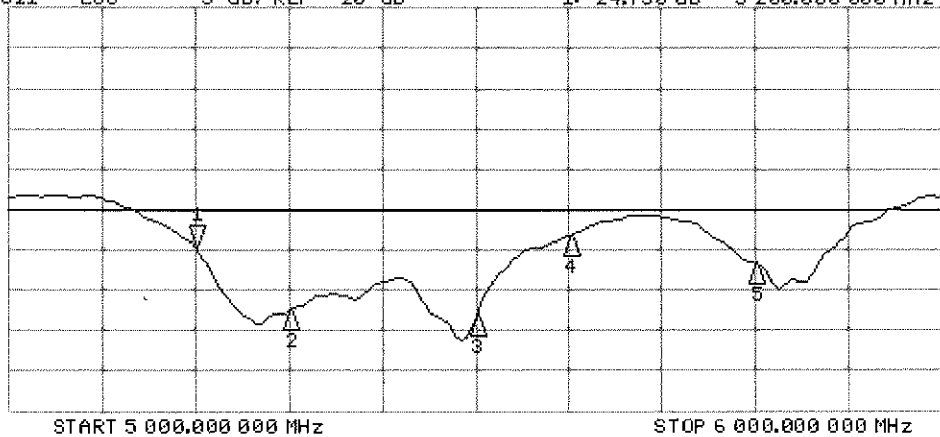

CH2 Markers
2: -32.508 dB
5.30000 GHz
3: -33.267 dB
5.50000 GHz
4: -23.183 dB
5.60000 GHz
5: -26.672 dB
5.80000 GHz



Accredited by the Swiss Accreditation Service (SAS)
The Swiss Accreditation Service is one of the signatories to the EA
Multilateral Agreement for the recognition of calibration certificates

Accreditation No.: **SCS 108**

Client **PC Test**

Certificate No: **D750V3-1054_Mar13**

CALIBRATION CERTIFICATE

Object **D750V3 - SN: 1054**

Calibration procedure(s) **QA CAL-05.v9
Calibration procedure for dipole validation kits above 700 MHz**

Calibration date: **March 18, 2013**

✓ KOK
3/22/13

This calibration certificate documents the traceability to national standards, which realize the physical units of measurements (SI).
The measurements and the uncertainties with confidence probability are given on the following pages and are part of the certificate.

All calibrations have been conducted in the closed laboratory facility: environment temperature (22 ± 3)°C and humidity < 70%.

Calibration Equipment used (M&TE critical for calibration)

Primary Standards	ID #	Cal Date (Certificate No.)	Scheduled Calibration
Power meter EPM-442A	GB37480704	01-Nov-12 (No. 217-01640)	Oct-13
Power sensor HP 8481A	US37292783	01-Nov-12 (No. 217-01640)	Oct-13
Reference 20 dB Attenuator	SN: 5058 (20k)	27-Mar-12 (No. 217-01530)	Apr-13
Type-N mismatch combination	SN: 5047.3 / 06327	27-Mar-12 (No. 217-01533)	Apr-13
Reference Probe ES3DV3	SN: 3205	28-Dec-12 (No. ES3-3205_Dec12)	Dec-13
DAE4	SN: 601	27-Jun-12 (No. DAE4-601_Jun12)	Jun-13
Secondary Standards	ID #	Check Date (in house)	Scheduled Check
Power sensor HP 8481A	MY41092317	18-Oct-02 (in house check Oct-11)	In house check: Oct-13
RF generator R&S SMT-06	100005	04-Aug-99 (in house check Oct-11)	In house check: Oct-13
Network Analyzer HP 8753E	US37390585 S4206	18-Oct-01 (in house check Oct-12)	In house check: Oct-13

Calibrated by: **Israe El-Naouq** Name: **Israe El-Naouq** Function: **Laboratory Technician**

Signature: *Israe El-Naouq*

Approved by: **Katja Pokovic** Name: **Katja Pokovic** Function: **Technical Manager**

Signature: *Katja Pokovic*

Issued: March 18, 2013

This calibration certificate shall not be reproduced except in full without written approval of the laboratory.



Accredited by the Swiss Accreditation Service (SAS)
The Swiss Accreditation Service is one of the signatories to the EA
Multilateral Agreement for the recognition of calibration certificates

Accreditation No.: **SCS 108**

Glossary:

TSL	tissue simulating liquid
ConvF	sensitivity in TSL / NORM x,y,z
N/A	not applicable or not measured

Calibration is Performed According to the Following Standards:

- a) IEEE Std 1528-2003, "IEEE Recommended Practice for Determining the Peak Spatial-Averaged Specific Absorption Rate (SAR) in the Human Head from Wireless Communications Devices: Measurement Techniques", December 2003
- b) IEC 62209-1, "Procedure to measure the Specific Absorption Rate (SAR) for hand-held devices used in close proximity to the ear (frequency range of 300 MHz to 3 GHz)", February 2005
- c) Federal Communications Commission Office of Engineering & Technology (FCC OET), "Evaluating Compliance with FCC Guidelines for Human Exposure to Radiofrequency Electromagnetic Fields; Additional Information for Evaluating Compliance of Mobile and Portable Devices with FCC Limits for Human Exposure to Radiofrequency Emissions", Supplement C (Edition 01-01) to Bulletin 65

Additional Documentation:

- d) DASY4/5 System Handbook

Methods Applied and Interpretation of Parameters:

- *Measurement Conditions:* Further details are available from the Validation Report at the end of the certificate. All figures stated in the certificate are valid at the frequency indicated.
- *Antenna Parameters with TSL:* The dipole is mounted with the spacer to position its feed point exactly below the center marking of the flat phantom section, with the arms oriented parallel to the body axis.
- *Feed Point Impedance and Return Loss:* These parameters are measured with the dipole positioned under the liquid filled phantom. The impedance stated is transformed from the measurement at the SMA connector to the feed point. The Return Loss ensures low reflected power. No uncertainty required.
- *Electrical Delay:* One-way delay between the SMA connector and the antenna feed point. No uncertainty required.
- *SAR measured:* SAR measured at the stated antenna input power.
- *SAR normalized:* SAR as measured, normalized to an input power of 1 W at the antenna connector.
- *SAR for nominal TSL parameters:* The measured TSL parameters are used to calculate the nominal SAR result.

The reported uncertainty of measurement is stated as the standard uncertainty of measurement multiplied by the coverage factor $k=2$, which for a normal distribution corresponds to a coverage probability of approximately 95%.

Measurement Conditions

DASY system configuration, as far as not given on page 1.

DASY Version	DASY5	V52.8.5
Extrapolation	Advanced Extrapolation	
Phantom	Modular Flat Phantom	
Distance Dipole Center - TSL	15 mm	with Spacer
Zoom Scan Resolution	dx, dy, dz = 5 mm	
Frequency	750 MHz \pm 1 MHz	

Head TSL parameters

The following parameters and calculations were applied.

	Temperature	Permittivity	Conductivity
Nominal Head TSL parameters	22.0 °C	41.9	0.89 mho/m
Measured Head TSL parameters	(22.0 \pm 0.2) °C	41.1 \pm 6 %	0.92 mho/m \pm 6 %
Head TSL temperature change during test	< 0.5 °C	----	----

SAR result with Head TSL

SAR averaged over 1 cm³ (1 g) of Head TSL	Condition	
SAR measured	250 mW input power	2.19 W/kg
SAR for nominal Head TSL parameters	normalized to 1W	8.50 W/kg \pm 17.0 % (k=2)

SAR averaged over 10 cm³ (10 g) of Head TSL	condition	
SAR measured	250 mW input power	1.42 W/kg
SAR for nominal Head TSL parameters	normalized to 1W	5.55 W/kg \pm 16.5 % (k=2)

Body TSL parameters

The following parameters and calculations were applied.

	Temperature	Permittivity	Conductivity
Nominal Body TSL parameters	22.0 °C	55.5	0.96 mho/m
Measured Body TSL parameters	(22.0 \pm 0.2) °C	54.2 \pm 6 %	1.00 mho/m \pm 6 %
Body TSL temperature change during test	< 0.5 °C	----	----

SAR result with Body TSL

SAR averaged over 1 cm³ (1 g) of Body TSL	Condition	
SAR measured	250 mW input power	2.26 W/kg
SAR for nominal Body TSL parameters	normalized to 1W	8.72 W/kg \pm 17.0 % (k=2)

SAR averaged over 10 cm³ (10 g) of Body TSL	condition	
SAR measured	250 mW input power	1.48 W/kg
SAR for nominal Body TSL parameters	normalized to 1W	5.75 W/kg \pm 16.5 % (k=2)

Appendix

Antenna Parameters with Head TSL

Impedance, transformed to feed point	54.4 Ω - 0.9 j Ω
Return Loss	- 27.2 dB

Antenna Parameters with Body TSL

Impedance, transformed to feed point	49.7 Ω - 2.7 j Ω
Return Loss	- 31.4 dB

General Antenna Parameters and Design

Electrical Delay (one direction)	1.034 ns
----------------------------------	----------

After long term use with 100W radiated power, only a slight warming of the dipole near the feedpoint can be measured.

The dipole is made of standard semirigid coaxial cable. The center conductor of the feeding line is directly connected to the second arm of the dipole. The antenna is therefore short-circuited for DC-signals. On some of the dipoles, small end caps are added to the dipole arms in order to improve matching when loaded according to the position as explained in the "Measurement Conditions" paragraph. The SAR data are not affected by this change. The overall dipole length is still according to the Standard.

No excessive force must be applied to the dipole arms, because they might bend or the soldered connections near the feedpoint may be damaged.

Additional EUT Data

Manufactured by	SPEAG
Manufactured on	November 08, 2011

DASY5 Validation Report for Head TSL

Date: 18.03.2013

Test Laboratory: SPEAG, Zurich, Switzerland

DUT: Dipole 750 MHz; Type: D750V3; Serial: D750V3 - SN: 1054

Communication System: CW; Frequency: 750 MHz

Medium parameters used: $f = 750 \text{ MHz}$; $\sigma = 0.92 \text{ S/m}$; $\epsilon_r = 41.1$; $\rho = 1000 \text{ kg/m}^3$

Phantom section: Flat Section

Measurement Standard: DASY5 (IEEE/IEC/ANSI C63.19-2007)

DASY52 Configuration:

- Probe: ES3DV3 - SN3205; ConvF(6.28, 6.28, 6.28); Calibrated: 28.12.2012;
- Sensor-Surface: 3mm (Mechanical Surface Detection)
- Electronics: DAE4 Sn601; Calibrated: 27.06.2012
- Phantom: Flat Phantom 4.9L; Type: QD000P49AA; Serial: 1001
- DASY52 52.8.5(1059); SEMCAD X 14.6.8(7028)

Dipole Calibration for Head Tissue/ $P_{in}=250 \text{ mW}$, $d=15\text{mm}$ /Zoom Scan (7x7x7)/Cube 0:

Measurement grid: $dx=5\text{mm}$, $dy=5\text{mm}$, $dz=5\text{mm}$

Reference Value = 52.772 V/m ; Power Drift = 0.03 dB

Peak SAR (extrapolated) = 3.33 W/kg

SAR(1 g) = 2.19 W/kg ; SAR(10 g) = 1.42 W/kg

Maximum value of SAR (measured) = 2.55 W/kg

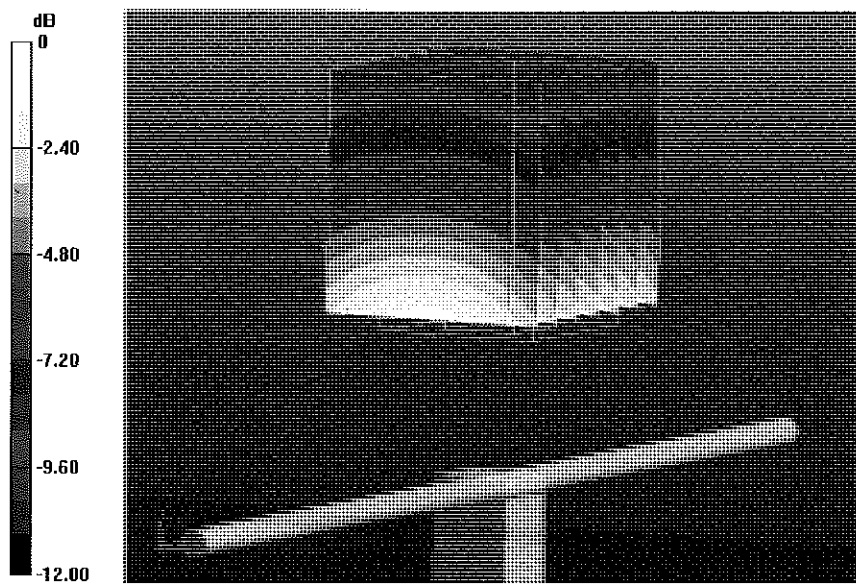

0 dB = 2.55 W/kg = 4.07 dBW/kg

Impedance Measurement Plot for Head TSL

18 Mar 2013 13:14:09

CH1 S11 1 U FS 1: 54.449 Δ -917.97 m Ω 231.17 pF 750.000 000 MHz

De1
Ca
Avg
16
H1 d

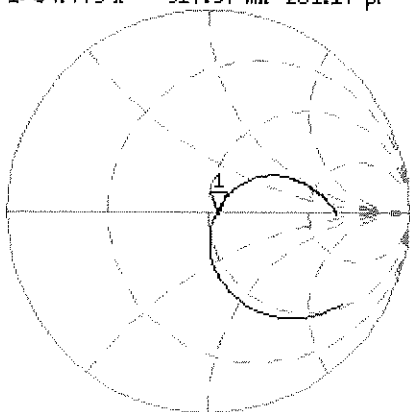

CH2 S11 LOG 5 dB/REF -20 dB 1:-27.227 dB 750.000 000 MHz

Ca
Avg
16
H1 d

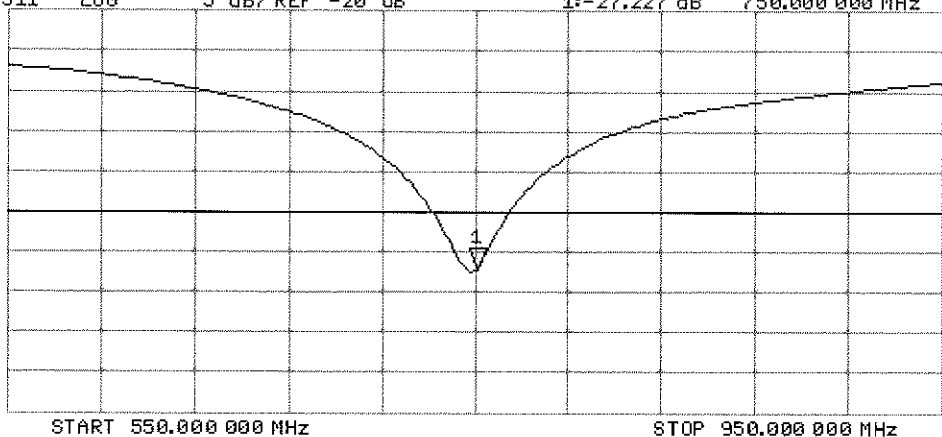

DASY5 Validation Report for Body TSL

Date: 18.03.2013

Test Laboratory: SPEAG, Zurich, Switzerland

DUT: Dipole 750 MHz; Type: D750V3; Serial: D750V3 - SN: 1054

Communication System: CW; Frequency: 750 MHz

Medium parameters used: $f = 750 \text{ MHz}$; $\sigma = 1 \text{ S/m}$; $\epsilon_r = 54.2$; $\rho = 1000 \text{ kg/m}^3$

Phantom section: Flat Section

Measurement Standard: DASY5 (IEEE/IEC/ANSI C63.19-2007)

DASY52 Configuration:

- Probe: ES3DV3 - SN3205; ConvF(6.11, 6.11, 6.11); Calibrated: 28.12.2012;
- Sensor-Surface: 3mm (Mechanical Surface Detection)
- Electronics: DAE4 Sn601; Calibrated: 27.06.2012
- Phantom: Flat Phantom 4.9L; Type: QD000P49AA; Serial: 1001
- DASY52 52.8.5(1059); SEMCAD X 14.6.8(7028)

Dipole Calibration for Body Tissue/Pin=250 mW, d=15mm/Zoom Scan (7x7x7)/Cube 0:

Measurement grid: dx=5mm, dy=5mm, dz=5mm

Reference Value = 52.772 V/m; Power Drift = 0.03 dB

Peak SAR (extrapolated) = 3.32 W/kg

SAR(1 g) = 2.26 W/kg; SAR(10 g) = 1.48 W/kg

Maximum value of SAR (measured) = 2.61 W/kg

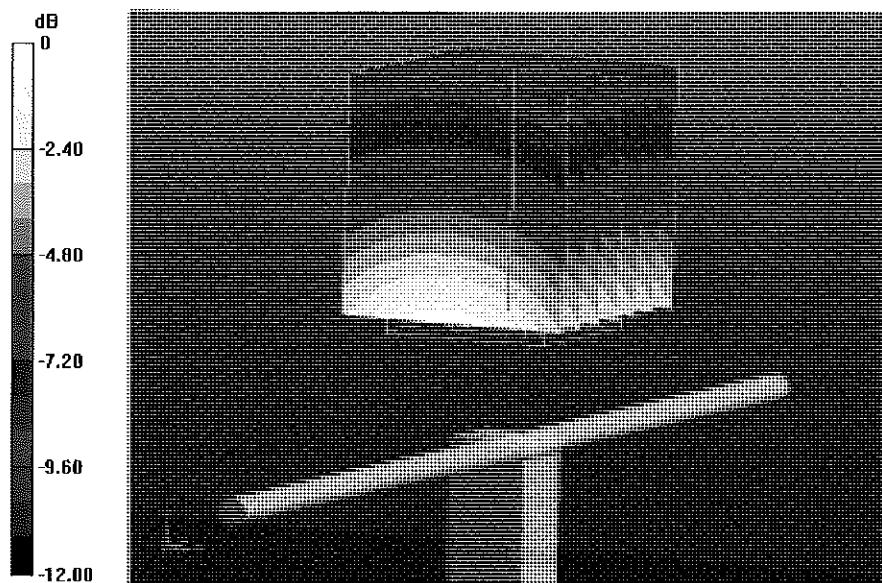

0 dB = 2.61 W/kg = 4.17 dBW/kg

Impedance Measurement Plot for Body TSL

18 Mar 2013 12:24:11

CH1 S11 1 U FS

1: 49.717 Ω -2.6553 Δ 79.890 pF

750.000 000 MHz

*
De1

CA

Avg
16

H1d

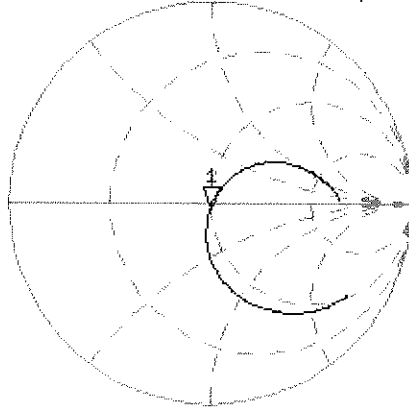

CH2 S11

LOG

5 dB/REF -20 dB

1: -31.444 dB

750.000 000 MHz

CA

Avg
16

H1d

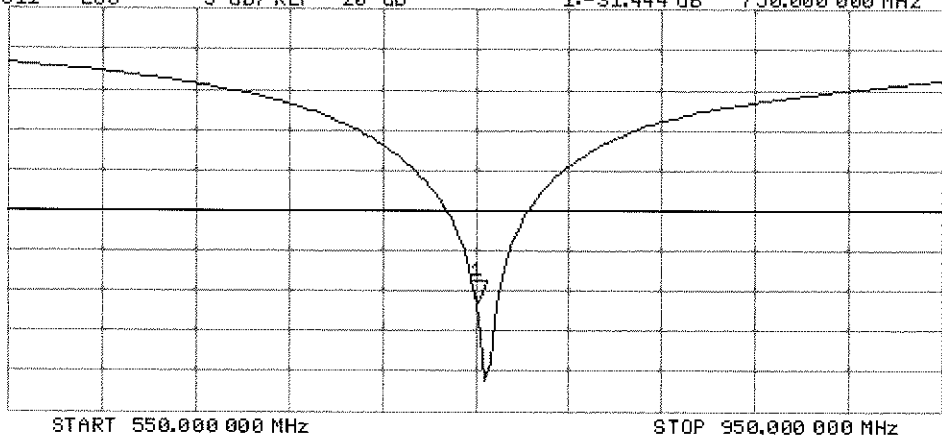



Accredited by the Swiss Accreditation Service (SAS)
The Swiss Accreditation Service is one of the signatories to the EA
Multilateral Agreement for the recognition of calibration certificates

Accreditation No.: **SCS 108**

Client **PC Test**

Certificate No: **D1900V2-5d148_Feb13**

CALIBRATION CERTIFICATE

Object **D1900V2 - SN: 5d148**

Calibration procedure(s) **QA CAL-05.v9
Calibration procedure for dipole validation kits above 700 MHz**

Calibration date: **February 06, 2013**

*KOK
2/21/13*

This calibration certificate documents the traceability to national standards, which realize the physical units of measurements (SI).
The measurements and the uncertainties with confidence probability are given on the following pages and are part of the certificate.

All calibrations have been conducted in the closed laboratory facility: environment temperature (22 ± 3)°C and humidity < 70%.

Calibration Equipment used (M&TE critical for calibration)

Primary Standards	ID #	Cal Date (Certificate No.)	Scheduled Calibration
Power meter EPM-442A	GB37480704	01-Nov-12 (No. 217-01640)	Oct-13
Power sensor HP 8481A	US37292783	01-Nov-12 (No. 217-01640)	Oct-13
Reference 20 dB Attenuator	SN: 5058 (20k)	27-Mar-12 (No. 217-01530)	Apr-13
Type-N mismatch combination	SN: 5047.3 / 06327	27-Mar-12 (No. 217-01533)	Apr-13
Reference Probe ES3DV3	SN: 3205	28-Dec-12 (No. ES3-3205_Dec12)	Dec-13
DAE4	SN: 601	27-Jun-12 (No. DAE4-601_Jun12)	Jun-13
Secondary Standards	ID #	Check Date (in house)	Scheduled Check
Power sensor HP 8481A	MY41092317	18-Oct-02 (in house check Oct-11)	In house check: Oct-13
RF generator R&S SMT-06	100005	04-Aug-99 (in house check Oct-11)	In house check: Oct-13
Network Analyzer HP 8753E	US37390585 S4206	18-Oct-01 (in house check Oct-12)	In house check: Oct-13

Calibrated by: **Leif Klysner** Name: **Leif Klysner** Function: **Laboratory Technician**

Signature: *Leif Klysner*

Approved by: **Katja Pokovic** Name: **Katja Pokovic** Technical Manager

Signature: *Katja Pokovic*

Issued: February 6, 2013

This calibration certificate shall not be reproduced except in full without written approval of the laboratory.



Accredited by the Swiss Accreditation Service (SAS)

The Swiss Accreditation Service is one of the signatories to the EA Multilateral Agreement for the recognition of calibration certificates

Accreditation No.: **SCS 108**

Glossary:

TSL	tissue simulating liquid
ConvF	sensitivity in TSL / NORM x,y,z
N/A	not applicable or not measured

Calibration is Performed According to the Following Standards:

- IEEE Std 1528-2003, "IEEE Recommended Practice for Determining the Peak Spatial-Averaged Specific Absorption Rate (SAR) in the Human Head from Wireless Communications Devices: Measurement Techniques", December 2003
- IEC 62209-1, "Procedure to measure the Specific Absorption Rate (SAR) for hand-held devices used in close proximity to the ear (frequency range of 300 MHz to 3 GHz)", February 2005
- Federal Communications Commission Office of Engineering & Technology (FCC OET), "Evaluating Compliance with FCC Guidelines for Human Exposure to Radiofrequency Electromagnetic Fields; Additional Information for Evaluating Compliance of Mobile and Portable Devices with FCC Limits for Human Exposure to Radiofrequency Emissions", Supplement C (Edition 01-01) to Bulletin 65

Additional Documentation:

- DASY4/5 System Handbook

Methods Applied and Interpretation of Parameters:

- Measurement Conditions:* Further details are available from the Validation Report at the end of the certificate. All figures stated in the certificate are valid at the frequency indicated.
- Antenna Parameters with TSL:* The dipole is mounted with the spacer to position its feed point exactly below the center marking of the flat phantom section, with the arms oriented parallel to the body axis.
- Feed Point Impedance and Return Loss:* These parameters are measured with the dipole positioned under the liquid filled phantom. The impedance stated is transformed from the measurement at the SMA connector to the feed point. The Return Loss ensures low reflected power. No uncertainty required.
- Electrical Delay:* One-way delay between the SMA connector and the antenna feed point. No uncertainty required.
- SAR measured:* SAR measured at the stated antenna input power.
- SAR normalized:* SAR as measured, normalized to an input power of 1 W at the antenna connector.
- SAR for nominal TSL parameters:* The measured TSL parameters are used to calculate the nominal SAR result.

The reported uncertainty of measurement is stated as the standard uncertainty of measurement multiplied by the coverage factor $k=2$, which for a normal distribution corresponds to a coverage probability of approximately 95%.

Measurement Conditions

DASY system configuration, as far as not given on page 1.

DASY Version	DASY5	V52.8.5
Extrapolation	Advanced Extrapolation	
Phantom	Modular Flat Phantom	
Distance Dipole Center - TSL	10 mm	with Spacer
Zoom Scan Resolution	dx, dy, dz = 5 mm	
Frequency	1900 MHz \pm 1 MHz	

Head TSL parameters

The following parameters and calculations were applied.

	Temperature	Permittivity	Conductivity
Nominal Head TSL parameters	22.0 °C	40.0	1.40 mho/m
Measured Head TSL parameters	(22.0 \pm 0.2) °C	39.4 \pm 6 %	1.38 mho/m \pm 6 %
Head TSL temperature change during test	< 0.5 °C	----	----

SAR result with Head TSL

SAR averaged over 1 cm³ (1 g) of Head TSL	Condition	
SAR measured	250 mW input power	9.87 W/kg
SAR for nominal Head TSL parameters	normalized to 1W	39.7 W/kg \pm 17.0 % (k=2)

SAR averaged over 10 cm³ (10 g) of Head TSL	condition	
SAR measured	250 mW input power	5.18 W/kg
SAR for nominal Head TSL parameters	normalized to 1W	20.8 W/kg \pm 16.5 % (k=2)

Body TSL parameters

The following parameters and calculations were applied.

	Temperature	Permittivity	Conductivity
Nominal Body TSL parameters	22.0 °C	53.3	1.52 mho/m
Measured Body TSL parameters	(22.0 \pm 0.2) °C	51.9 \pm 6 %	1.53 mho/m \pm 6 %
Body TSL temperature change during test	< 0.5 °C	----	----

SAR result with Body TSL

SAR averaged over 1 cm³ (1 g) of Body TSL	Condition	
SAR measured	250 mW input power	10.3 W/kg
SAR for nominal Body TSL parameters	normalized to 1W	40.8 W/kg \pm 17.0 % (k=2)

SAR averaged over 10 cm³ (10 g) of Body TSL	condition	
SAR measured	250 mW input power	5.45 W/kg
SAR for nominal Body TSL parameters	normalized to 1W	21.7 W/kg \pm 16.5 % (k=2)

Appendix

Antenna Parameters with Head TSL

Impedance, transformed to feed point	52.1 Ω + 5.9 j Ω
Return Loss	- 24.3 dB

Antenna Parameters with Body TSL

Impedance, transformed to feed point	48.3 Ω + 6.3 j Ω
Return Loss	- 23.6 dB

General Antenna Parameters and Design

Electrical Delay (one direction)	1.199 ns
----------------------------------	----------

After long term use with 100W radiated power, only a slight warming of the dipole near the feedpoint can be measured.

The dipole is made of standard semirigid coaxial cable. The center conductor of the feeding line is directly connected to the second arm of the dipole. The antenna is therefore short-circuited for DC-signals. On some of the dipoles, small end caps are added to the dipole arms in order to improve matching when loaded according to the position as explained in the "Measurement Conditions" paragraph. The SAR data are not affected by this change. The overall dipole length is still according to the Standard.

No excessive force must be applied to the dipole arms, because they might bend or the soldered connections near the feedpoint may be damaged.

Additional EUT Data

Manufactured by	SPEAG
Manufactured on	March 11, 2011

DASY5 Validation Report for Head TSL

Date: 06.02.2013

Test Laboratory: SPEAG, Zurich, Switzerland

DUT: Dipole 1900 MHz; Type: D1900V2; Serial: D1900V2 - SN: 5d148

Communication System: CW; Frequency: 1900 MHz

Medium parameters used: $f = 1900$ MHz; $\sigma = 1.38$ S/m; $\epsilon_r = 39.4$; $\rho = 1000$ kg/m³

Phantom section: Flat Section

Measurement Standard: DASY5 (IEEE/IEC/ANSI C63.19-2007)

DASY52 Configuration:

- Probe: ES3DV3 - SN3205; ConvF(4.98, 4.98, 4.98); Calibrated: 28.12.2012;
- Sensor-Surface: 3mm (Mechanical Surface Detection)
- Electronics: DAE4 Sn601; Calibrated: 27.06.2012
- Phantom: Flat Phantom 5.0 (front); Type: QD000P50AA; Serial: 1001
- DASY52 52.8.5(1059); SEMCAD X 14.6.8(7028)

Dipole Calibration for Head Tissue/Pin=250 mW, d=10mm/Zoom Scan (7x7x7)/Cube 0:

Measurement grid: dx=5mm, dy=5mm, dz=5mm

Reference Value = 96.534 V/m; Power Drift = 0.05 dB

Peak SAR (extrapolated) = 17.8 W/kg

SAR(1 g) = 9.87 W/kg; SAR(10 g) = 5.18 W/kg

Maximum value of SAR (measured) = 12.1 W/kg

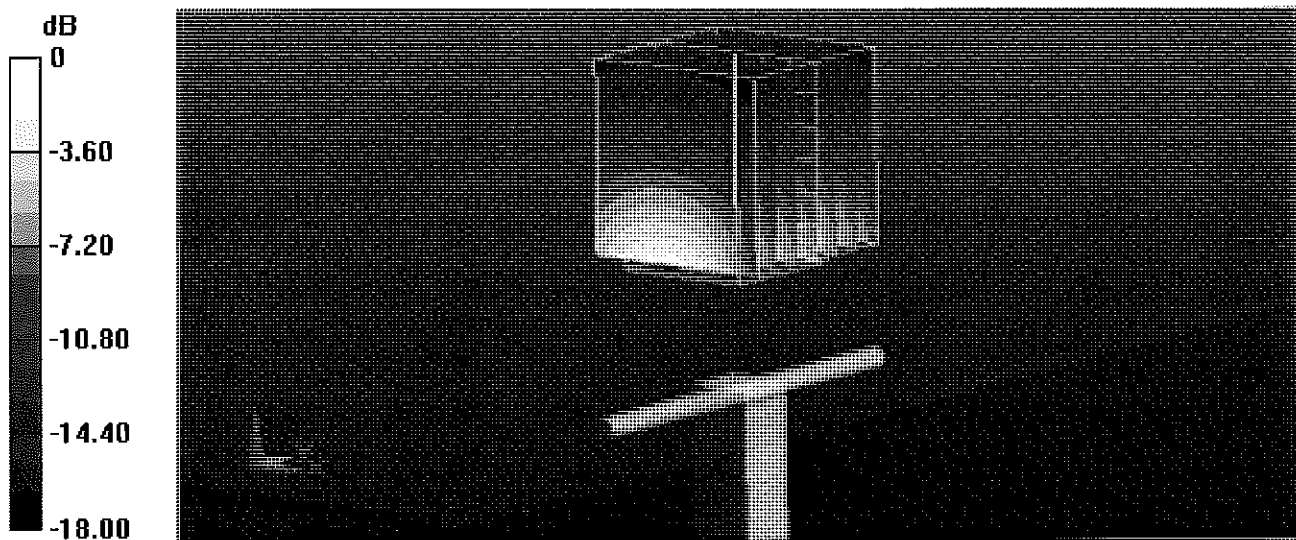

0 dB = 12.1 W/kg = 10.83 dBW/kg

Impedance Measurement Plot for Head TSL

6 Feb 2013 09:25:10

CH1 S11 1 U FS

1: 52.125 Ω 5.8711 Ω 491.80 μ H

1 900.000 000 MHz

*
Del
CA
Avg
16
H1d

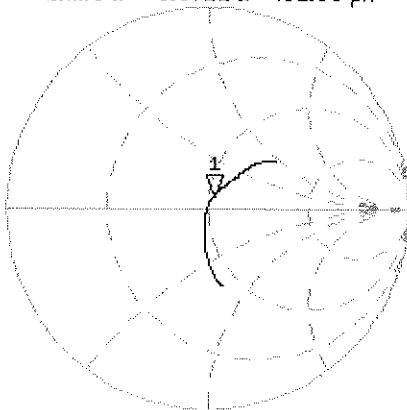

CH2 S11 LOG

5 dB/REF -20 dB

1: -24.287 dB 1 900.000 000 MHz

CA
Avg
16
H1d

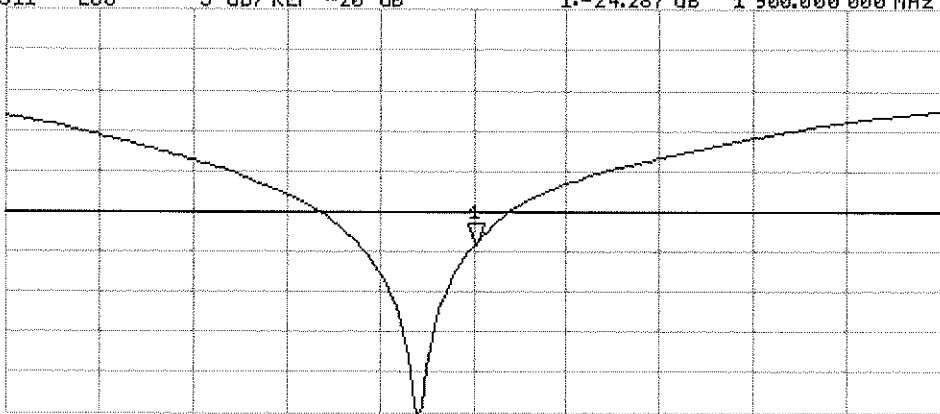

START 1 700.000 000 MHz

STOP 2 100.000 000 MHz

DASY5 Validation Report for Body TSL

Date: 06.02.2013

Test Laboratory: SPEAG, Zurich, Switzerland

DUT: Dipole 1900 MHz; Type: D1900V2; Serial: D1900V2 - SN: 5d148

Communication System: CW; Frequency: 1900 MHz

Medium parameters used: $f = 1900$ MHz; $\sigma = 1.53$ S/m; $\epsilon_r = 51.9$; $\rho = 1000$ kg/m³

Phantom section: Flat Section

Measurement Standard: DASY5 (IEEE/IEC/ANSI C63.19-2007)

DASY52 Configuration:

- Probe: ES3DV3 - SN3205; ConvF(4.6, 4.6, 4.6); Calibrated: 28.12.2012;
- Sensor-Surface: 3mm (Mechanical Surface Detection)
- Electronics: DAE4 Sn601; Calibrated: 27.06.2012
- Phantom: Flat Phantom 5.0 (back); Type: QD000P50AA; Serial: 1002
- DASY52 52.8.5(1059); SEMCAD X 14.6.8(7028)

Dipole Calibration for Body Tissue/Pin=250 mW, d=10mm/Zoom Scan (7x7x7)/Cube 0:

Measurement grid: dx=5mm, dy=5mm, dz=5mm

Reference Value = 96.534 V/m; Power Drift = -0.02 dB

Peak SAR (extrapolated) = 17.9 W/kg

SAR(1 g) = 10.3 W/kg; SAR(10 g) = 5.45 W/kg

Maximum value of SAR (measured) = 13.1 W/kg

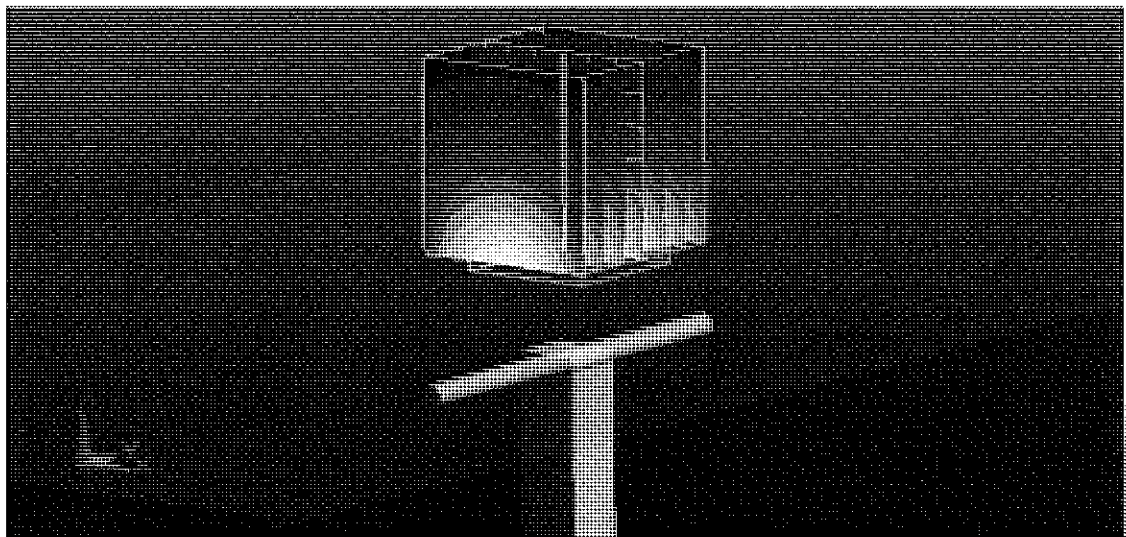
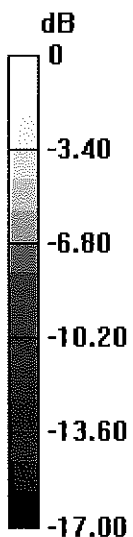

0 dB = 13.1 W/kg = 11.17 dBW/kg

Impedance Measurement Plot for Body TSL

6 Feb 2013 09:24:17

CH1 S11 1 U FS 1: 48.344 Ω 6.2715 Ω 525.34 μ H 1 900.000 000 MHz

*
De1

CA

Avg
16

H1d

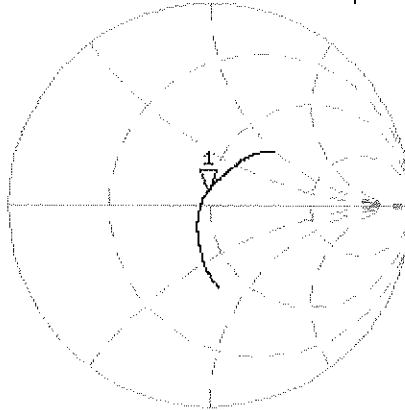

CH2 S11 LOG 5 dB/REF -20 dB 1:-23.628 dB 1 900.000 000 MHz

CA

Avg
16

H1d

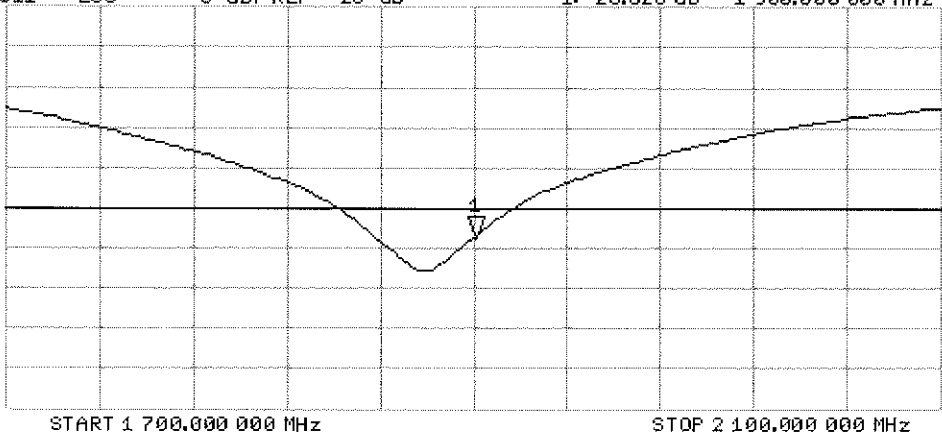



Accredited by the Swiss Accreditation Service (SAS)
The Swiss Accreditation Service is one of the signatories to the EA
Multilateral Agreement for the recognition of calibration certificates

Accreditation No.: **SCS 108**

Client **PC Test**

Certificate No: **D5GHzV2-1057_Jan13**

CALIBRATION CERTIFICATE

Object **D5GHzV2 - SN: 1057**

Calibration procedure(s) **QA CAL-22.v2
Calibration procedure for dipole validation kits between 3-6 GHz**

Calibration date: **January 11, 2013**

✓
KOK
1/29/13

This calibration certificate documents the traceability to national standards, which realize the physical units of measurements (SI).
The measurements and the uncertainties with confidence probability are given on the following pages and are part of the certificate.

All calibrations have been conducted in the closed laboratory facility: environment temperature (22 ± 3)°C and humidity < 70%.

Calibration Equipment used (M&TE critical for calibration)

Primary Standards	ID #	Cal Date (Certificate No.)	Scheduled Calibration
Power meter EPM-442A	GB37480704	01-Nov-12 (No. 217-01640)	Oct-13
Power sensor HP 8481A	US37292783	01-Nov-12 (No. 217-01640)	Oct-13
Reference 20 dB Attenuator	SN: 5058 (20k)	27-Mar-12 (No. 217-01530)	Apr-13
Type-N mismatch combination	SN: 5047.3 / 06327	27-Mar-12 (No. 217-01533)	Apr-13
Reference Probe EX3DV4	SN: 3503	28-Dec-12 (No. EX3-3503_Dec12)	Dec-13
DAE4	SN: 601	27-Jun-12 (No. DAE4-601_Jun12)	Jun-13
Secondary Standards	ID #	Check Date (in house)	Scheduled Check
Power sensor HP 8481A	MY41092317	18-Oct-02 (in house check Oct-11)	In house check: Oct-13
RF generator R&S SMT-06	100005	04-Aug-99 (in house check Oct-11)	In house check: Oct-13
Network Analyzer HP 8753E	US37390585 S4206	18-Oct-01 (in house check Oct-12)	In house check: Oct-13

Calibrated by: **Israe El-Naouq** Name: **Israe El-Naouq** Function: **Laboratory Technician** Signature: *Israe El-Naouq*

Approved by: **Katja Pokovic** Name: **Katja Pokovic** Function: **Technical Manager** Signature: *Katja Pokovic*

Issued: January 11, 2013

This calibration certificate shall not be reproduced except in full without written approval of the laboratory.



Accredited by the Swiss Accreditation Service (SAS)

The Swiss Accreditation Service is one of the signatories to the EA
Multilateral Agreement for the recognition of calibration certificates

Accreditation No.: **SCS 108**

Glossary:

TSL	tissue simulating liquid
ConvF	sensitivity in TSL / NORM x,y,z
N/A	not applicable or not measured

Calibration is Performed According to the Following Standards:

- a) IEC 62209-2, "Evaluation of Human Exposure to Radio Frequency Fields from Handheld and Body-Mounted Wireless Communication Devices in the Frequency Range of 30 MHz to 6 GHz: Human models, Instrumentation, and Procedures"; Part 2: "Procedure to determine the Specific Absorption Rate (SAR) for including accessories and multiple transmitters", March 2010
- b) Federal Communications Commission Office of Engineering & Technology (FCC OET), "Evaluating Compliance with FCC Guidelines for Human Exposure to Radiofrequency Electromagnetic Fields; Additional Information for Evaluating Compliance of Mobile and Portable Devices with FCC Limits for Human Exposure to Radiofrequency Emissions", Supplement C (Edition 01-01) to Bulletin 65

Additional Documentation:

- c) DASY4/5 System Handbook

Methods Applied and Interpretation of Parameters:

- *Measurement Conditions:* Further details are available from the Validation Report at the end of the certificate. All figures stated in the certificate are valid at the frequency indicated.
- *Antenna Parameters with TSL:* The dipole is mounted with the spacer to position its feed point exactly below the center marking of the flat phantom section, with the arms oriented parallel to the body axis.
- *Feed Point Impedance and Return Loss:* These parameters are measured with the dipole positioned under the liquid filled phantom. The impedance stated is transformed from the measurement at the SMA connector to the feed point. The Return Loss ensures low reflected power. No uncertainty required.
- *Electrical Delay:* One-way delay between the SMA connector and the antenna feed point. No uncertainty required.
- *SAR measured:* SAR measured at the stated antenna input power.
- *SAR normalized:* SAR as measured, normalized to an input power of 1 W at the antenna connector.
- *SAR for nominal TSL parameters:* The measured TSL parameters are used to calculate the nominal SAR result.

The reported uncertainty of measurement is stated as the standard uncertainty of measurement multiplied by the coverage factor $k=2$, which for a normal distribution corresponds to a coverage probability of approximately 95%.

Measurement Conditions

DASY system configuration, as far as not given on page 1.

DASY Version	DASY5	V52.8.5
Extrapolation	Advanced Extrapolation	
Phantom	Modular Flat Phantom V5.0	
Distance Dipole Center - TSL	10 mm	with Spacer
Zoom Scan Resolution	dx, dy = 4.0 mm, dz = 1.4 mm	Graded Ratio = 1.4 (Z direction)
Frequency	5200 MHz ± 1 MHz 5300 MHz ± 1 MHz 5500 MHz ± 1 MHz 5600 MHz ± 1 MHz 5800 MHz ± 1 MHz	

Head TSL parameters at 5200 MHz

The following parameters and calculations were applied.

	Temperature	Permittivity	Conductivity
Nominal Head TSL parameters	22.0 °C	36.0	4.66 mho/m
Measured Head TSL parameters	(22.0 ± 0.2) °C	34.6 ± 6 %	4.50 mho/m ± 6 %
Head TSL temperature change during test	< 0.5 °C	----	----

SAR result with Head TSL at 5200 MHz

SAR averaged over 1 cm³ (1 g) of Head TSL	Condition	
SAR measured	100 mW input power	7.66 W/kg
SAR for nominal Head TSL parameters	normalized to 1W	75.9 W/kg ± 19.9 % (k=2)

SAR averaged over 10 cm³ (10 g) of Head TSL	condition	
SAR measured	100 mW input power	2.17 W/kg
SAR for nominal Head TSL parameters	normalized to 1W	21.4 W/kg ± 19.5 % (k=2)

Head TSL parameters at 5300 MHz

The following parameters and calculations were applied.

	Temperature	Permittivity	Conductivity
Nominal Head TSL parameters	22.0 °C	35.9	4.76 mho/m
Measured Head TSL parameters	(22.0 ± 0.2) °C	34.5 ± 6 %	4.60 mho/m ± 6 %
Head TSL temperature change during test	< 0.5 °C	----	----

SAR result with Head TSL at 5300 MHz

SAR averaged over 1 cm ³ (1 g) of Head TSL	Condition	
SAR measured	100 mW input power	7.76 W/kg
SAR for nominal Head TSL parameters	normalized to 1W	76.9 W / kg ± 19.9 % (k=2)

SAR averaged over 10 cm ³ (10 g) of Head TSL	condition	
SAR measured	100 mW input power	2.22 W/kg
SAR for nominal Head TSL parameters	normalized to 1W	21.9 W/kg ± 19.5 % (k=2)

Head TSL parameters at 5500 MHz

The following parameters and calculations were applied.

	Temperature	Permittivity	Conductivity
Nominal Head TSL parameters	22.0 °C	35.6	4.96 mho/m
Measured Head TSL parameters	(22.0 ± 0.2) °C	34.2 ± 6 %	4.79 mho/m ± 6 %
Head TSL temperature change during test	< 0.5 °C	----	----

SAR result with Head TSL at 5500 MHz

SAR averaged over 1 cm ³ (1 g) of Head TSL	Condition	
SAR measured	100 mW input power	8.09 W/kg
SAR for nominal Head TSL parameters	normalized to 1W	80.1 W/kg ± 19.9 % (k=2)

SAR averaged over 10 cm ³ (10 g) of Head TSL	condition	
SAR measured	100 mW input power	2.28 W/kg
SAR for nominal Head TSL parameters	normalized to 1W	22.5 W/kg ± 19.5 % (k=2)

Head TSL parameters at 5600 MHz

The following parameters and calculations were applied.

	Temperature	Permittivity	Conductivity
Nominal Head TSL parameters	22.0 °C	35.5	5.07 mho/m
Measured Head TSL parameters	(22.0 ± 0.2) °C	34.1 ± 6 %	4.88 mho/m ± 6 %
Head TSL temperature change during test	< 0.5 °C	----	----

SAR result with Head TSL at 5600 MHz

SAR averaged over 1 cm ³ (1 g) of Head TSL	Condition	
SAR measured	100 mW input power	8.12 W/kg
SAR for nominal Head TSL parameters	normalized to 1W	80.4 W/kg ± 19.9 % (k=2)

SAR averaged over 10 cm ³ (10 g) of Head TSL	condition	
SAR measured	100 mW input power	2.30 W/kg
SAR for nominal Head TSL parameters	normalized to 1W	22.7 W/kg ± 19.5 % (k=2)

Head TSL parameters at 5800 MHz

The following parameters and calculations were applied.

	Temperature	Permittivity	Conductivity
Nominal Head TSL parameters	22.0 °C	35.3	5.27 mho/m
Measured Head TSL parameters	(22.0 ± 0.2) °C	33.8 ± 6 %	5.09 mho/m ± 6 %
Head TSL temperature change during test	< 0.5 °C	----	----

SAR result with Head TSL at 5800 MHz

SAR averaged over 1 cm ³ (1 g) of Head TSL	Condition	
SAR measured	100 mW input power	7.69 W/kg
SAR for nominal Head TSL parameters	normalized to 1W	76.1 W/kg ± 19.9 % (k=2)

SAR averaged over 10 cm ³ (10 g) of Head TSL	condition	
SAR measured	100 mW input power	2.17 W/kg
SAR for nominal Head TSL parameters	normalized to 1W	21.4 W/kg ± 19.5 % (k=2)

Body TSL parameters at 5200 MHz

The following parameters and calculations were applied.

	Temperature	Permittivity	Conductivity
Nominal Body TSL parameters	22.0 °C	49.0	5.30 mho/m
Measured Body TSL parameters	(22.0 ± 0.2) °C	47.0 ± 6 %	5.42 mho/m ± 6 %
Body TSL temperature change during test	< 0.5 °C	----	----

SAR result with Body TSL at 5200 MHz

SAR averaged over 1 cm ³ (1 g) of Body TSL	Condition	
SAR measured	100 mW input power	7.61 W/kg
SAR for nominal Body TSL parameters	normalized to 1W	75.5 W/kg ± 19.9 % (k=2)

SAR averaged over 10 cm ³ (10 g) of Body TSL	condition	
SAR measured	100 mW input power	2.13 W/kg
SAR for nominal Body TSL parameters	normalized to 1W	21.1 W/kg ± 19.5 % (k=2)

Body TSL parameters at 5300 MHz

The following parameters and calculations were applied.

	Temperature	Permittivity	Conductivity
Nominal Body TSL parameters	22.0 °C	48.9	5.42 mho/m
Measured Body TSL parameters	(22.0 ± 0.2) °C	46.8 ± 6 %	5.55 mho/m ± 6 %
Body TSL temperature change during test	< 0.5 °C	----	----

SAR result with Body TSL at 5300 MHz

SAR averaged over 1 cm ³ (1 g) of Body TSL	Condition	
SAR measured	100 mW input power	7.59 W/kg
SAR for nominal Body TSL parameters	normalized to 1W	75.3 W/kg ± 19.9 % (k=2)

SAR averaged over 10 cm ³ (10 g) of Body TSL	condition	
SAR measured	100 mW input power	2.13 W/kg
SAR for nominal Body TSL parameters	normalized to 1W	21.1 W/kg ± 19.5 % (k=2)

Body TSL parameters at 5500 MHz

The following parameters and calculations were applied.

	Temperature	Permittivity	Conductivity
Nominal Body TSL parameters	22.0 °C	48.6	5.65 mho/m
Measured Body TSL parameters	(22.0 ± 0.2) °C	46.5 ± 6 %	5.81 mho/m ± 6 %
Body TSL temperature change during test	< 0.5 °C	----	----

SAR result with Body TSL at 5500 MHz

SAR averaged over 1 cm ³ (1 g) of Body TSL	Condition	
SAR measured	100 mW input power	8.14 W/kg
SAR for nominal Body TSL parameters	normalized to 1W	80.8 W/kg ± 19.9 % (k=2)

SAR averaged over 10 cm ³ (10 g) of Body TSL	condition	
SAR measured	100 mW input power	2.26 W/kg
SAR for nominal Body TSL parameters	normalized to 1W	22.4 W/kg ± 19.5 % (k=2)

Body TSL parameters at 5600 MHz

The following parameters and calculations were applied.

	Temperature	Permittivity	Conductivity
Nominal Body TSL parameters	22.0 °C	48.5	5.77 mho/m
Measured Body TSL parameters	(22.0 ± 0.2) °C	46.3 ± 6 %	5.94 mho/m ± 6 %
Body TSL temperature change during test	< 0.5 °C	----	----

SAR result with Body TSL at 5600 MHz

SAR averaged over 1 cm ³ (1 g) of Body TSL	Condition	
SAR measured	100 mW input power	8.10 W/kg
SAR for nominal Body TSL parameters	normalized to 1W	80.3 W/kg ± 19.9 % (k=2)

SAR averaged over 10 cm ³ (10 g) of Body TSL	condition	
SAR measured	100 mW input power	2.25 W/kg
SAR for nominal Body TSL parameters	normalized to 1W	22.3 W/kg ± 19.5 % (k=2)

Body TSL parameters at 5800 MHz

The following parameters and calculations were applied.

	Temperature	Permittivity	Conductivity
Nominal Body TSL parameters	22.0 °C	48.2	6.00 mho/m
Measured Body TSL parameters	(22.0 ± 0.2) °C	46.0 ± 6 %	6.21 mho/m ± 6 %
Body TSL temperature change during test	< 0.5 °C	----	----

SAR result with Body TSL at 5800 MHz

SAR averaged over 1 cm ³ (1 g) of Body TSL	Condition	
SAR measured	100 mW input power	7.57 W/kg
SAR for nominal Body TSL parameters	normalized to 1W	75.1 W/kg ± 19.9 % (k=2)

SAR averaged over 10 cm ³ (10 g) of Body TSL	condition	
SAR measured	100 mW input power	2.09 W/kg
SAR for nominal Body TSL parameters	normalized to 1W	20.7 W/kg ± 19.5 % (k=2)

Appendix

Antenna Parameters with Head TSL at 5200 MHz

Impedance, transformed to feed point	50.5 Ω - 9.8 j Ω
Return Loss	- 20.3 dB

Antenna Parameters with Head TSL at 5300 MHz

Impedance, transformed to feed point	48.5 Ω - 4.5 j Ω
Return Loss	- 26.4 dB

Antenna Parameters with Head TSL at 5500 MHz

Impedance, transformed to feed point	50.6 Ω - 5.8 j Ω
Return Loss	- 24.8 dB

Antenna Parameters with Head TSL at 5600 MHz

Impedance, transformed to feed point	53.9 Ω - 3.8 j Ω
Return Loss	- 25.6 dB

Antenna Parameters with Head TSL at 5800 MHz

Impedance, transformed to feed point	52.5 Ω - 4.4 j Ω
Return Loss	- 26.1 dB

Antenna Parameters with Body TSL at 5200 MHz

Impedance, transformed to feed point	49.3 Ω - 7.9 j Ω
Return Loss	- 22.0 dB

Antenna Parameters with Body TSL at 5300 MHz

Impedance, transformed to feed point	48.7 Ω - 3.2 j Ω
Return Loss	- 29.2 dB

Antenna Parameters with Body TSL at 5500 MHz

Impedance, transformed to feed point	51.2 Ω - 4.8 j Ω
Return Loss	- 26.2 dB

Antenna Parameters with Body TSL at 5600 MHz

Impedance, transformed to feed point	53.6 Ω - 2.1 j Ω
Return Loss	- 27.9 dB

Antenna Parameters with Body TSL at 5800 MHz

Impedance, transformed to feed point	53.3 Ω - 2.9 j Ω
Return Loss	- 27.4 dB

General Antenna Parameters and Design

Electrical Delay (one direction)	1.202 ns
----------------------------------	----------

After long term use with 100W radiated power, only a slight warming of the dipole near the feedpoint can be measured.

The dipole is made of standard semirigid coaxial cable. The center conductor of the feeding line is directly connected to the second arm of the dipole. The antenna is therefore short-circuited for DC-signals. On some of the dipoles, small end caps are added to the dipole arms in order to improve matching when loaded according to the position as explained in the "Measurement Conditions" paragraph. The SAR data are not affected by this change. The overall dipole length is still according to the Standard.

No excessive force must be applied to the dipole arms, because they might bend or the soldered connections near the feedpoint may be damaged.

Additional EUT Data

Manufactured by	SPEAG
Manufactured on	November 27, 2006

DASY5 Validation Report for Head TSL

Date: 11.01.2013

Test Laboratory: SPEAG, Zurich, Switzerland

DUT: Dipole 5GHz; Type: D5GHzV2; Serial: D5GHzV2 - SN: 1057

Communication System: CW; Frequency: 5200 MHz, Frequency: 5300 MHz, Frequency: 5500 MHz, Frequency: 5600 MHz, Frequency: 5800 MHz

Medium parameters used: $f = 5200$ MHz; $\sigma = 4.5$ S/m; $\epsilon_r = 34.6$; $\rho = 1000$ kg/m³, Medium parameters used: $f = 5300$ MHz; $\sigma = 4.6$ S/m; $\epsilon_r = 34.5$; $\rho = 1000$ kg/m³, Medium parameters used: $f = 5500$ MHz; $\sigma = 4.79$ S/m; $\epsilon_r = 34.2$; $\rho = 1000$ kg/m³, Medium parameters used: $f = 5600$ MHz; $\sigma = 4.88$ S/m; $\epsilon_r = 34.1$; $\rho = 1000$ kg/m³, Medium parameters used: $f = 5800$ MHz; $\sigma = 5.09$ S/m; $\epsilon_r = 33.8$; $\rho = 1000$ kg/m³

Phantom section: Flat Section

Measurement Standard: DASY5 (IEEE/IEC/ANSI C63.19-2007)

DASY52 Configuration:

- Probe: EX3DV4 - SN3503; ConvF(5.41, 5.41, 5.41); Calibrated: 28.12.2012, ConvF(5.1, 5.1, 5.1); Calibrated: 28.12.2012, ConvF(4.91, 4.91, 4.91); Calibrated: 28.12.2012, ConvF(4.76, 4.76, 4.76); Calibrated: 28.12.2012, ConvF(4.81, 4.81, 4.81); Calibrated: 28.12.2012;
- Sensor-Surface: 1.4mm (Mechanical Surface Detection)
- Electronics: DAE4 Sn601; Calibrated: 27.06.2012
- Phantom: Flat Phantom 5.0 (front); Type: QD000P50AA; Serial: 1001
- DASY52 52.8.5(1059); SEMCAD X 14.6.8(7028)

Dipole Calibration for Head Tissue/Pin=100mW, dist=10mm, f=5200 MHz/Zoom Scan,

dist=1.4mm (8x8x7)/Cube 0: Measurement grid: dx=4mm, dy=4mm, dz=1.4mm

Reference Value = 63.671 V/m; Power Drift = 0.09 dB

Peak SAR (extrapolated) = 29.4 W/kg

SAR(1 g) = 7.66 W/kg; SAR(10 g) = 2.17 W/kg

Maximum value of SAR (measured) = 18.5 W/kg

Dipole Calibration for Head Tissue/Pin=100mW, dist=10mm, f=5300 MHz/Zoom Scan,

dist=1.4mm (8x8x7)/Cube 0: Measurement grid: dx=4mm, dy=4mm, dz=1.4mm

Reference Value = 63.473 V/m; Power Drift = 0.09 dB

Peak SAR (extrapolated) = 30.3 W/kg

SAR(1 g) = 7.76 W/kg; SAR(10 g) = 2.22 W/kg

Maximum value of SAR (measured) = 18.8 W/kg

Dipole Calibration for Head Tissue/Pin=100mW, dist=10mm, f=5500 MHz/Zoom Scan,

dist=1.4mm (8x8x7)/Cube 0: Measurement grid: dx=4mm, dy=4mm, dz=1.4mm

Reference Value = 63.735 V/m; Power Drift = 0.08 dB

Peak SAR (extrapolated) = 33.2 W/kg

SAR(1 g) = 8.09 W/kg; SAR(10 g) = 2.28 W/kg

Maximum value of SAR (measured) = 20.1 W/kg

Dipole Calibration for Head Tissue/Pin=100mW, dist=10mm, f=5600 MHz/Zoom Scan, dist=1.4mm (8x8x7)/Cube 0: Measurement grid: dx=4mm, dy=4mm, dz=1.4mm
Reference Value = 63.848 V/m; Power Drift = 0.09 dB
Peak SAR (extrapolated) = 33.5 W/kg
SAR(1 g) = 8.12 W/kg; SAR(10 g) = 2.3 W/kg
Maximum value of SAR (measured) = 20.2 W/kg

Dipole Calibration for Head Tissue/Pin=100mW, dist=10mm, f=5800 MHz/Zoom Scan, dist=1.4mm (8x8x7)/Cube 0: Measurement grid: dx=4mm, dy=4mm, dz=1.4mm
Reference Value = 60.467 V/m; Power Drift = 0.08 dB
Peak SAR (extrapolated) = 33.3 W/kg
SAR(1 g) = 7.69 W/kg; SAR(10 g) = 2.17 W/kg
Maximum value of SAR (measured) = 19.4 W/kg

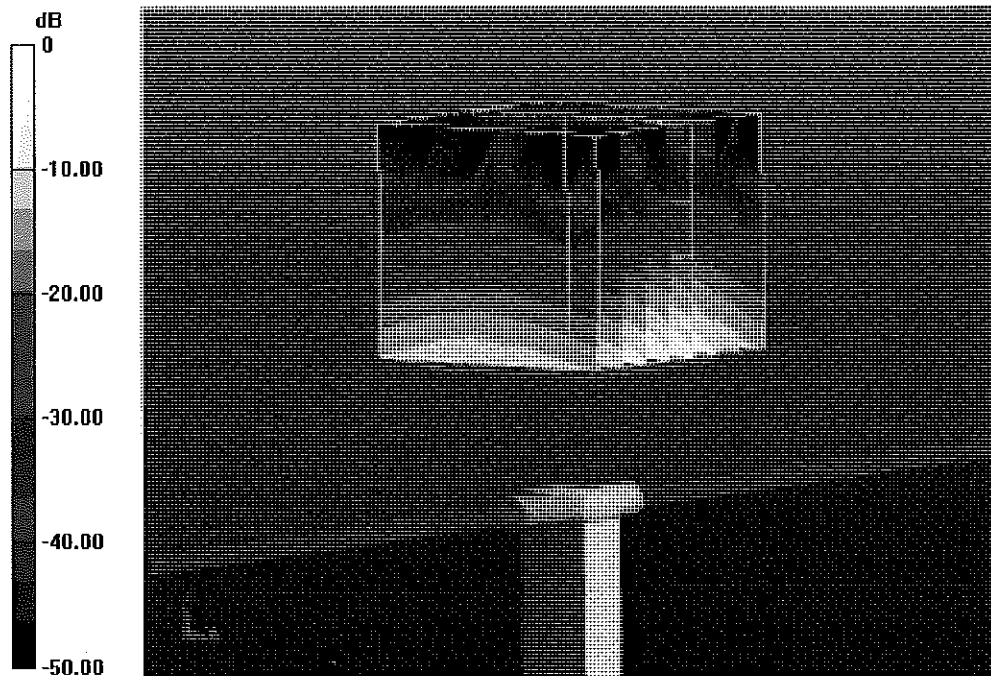

0 dB = 19.4 W/kg = 12.88 dBW/kg

Impedance Measurement Plot for Head TSL

11 Jan 2013 09:26:56

CH1 S11 1 U FS 1: 50.543 Ω -9.7754 Ω 3.1310 pF 5 200.000 000 MHz

*
De1
CA
Avg
16
H1d

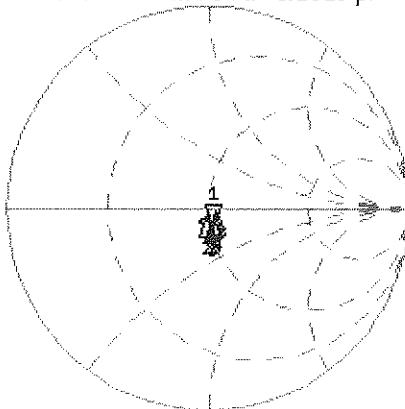

CH1 Markers

- 2: 48.508 Ω
-4.4805 Ω
5.30000 GHz
- 3: 50.617 Ω
-5.7559 Ω
5.50000 GHz
- 4: 53.891 Ω
-3.8418 Ω
5.60000 GHz
- 5: 52.500 Ω
-4.4160 Ω
5.80000 GHz

CH2 S11 LOG 5 dB/REF -20 dB 1: -20.273 dB 5 200.000 000 MHz

CA
Avg
16
H1d

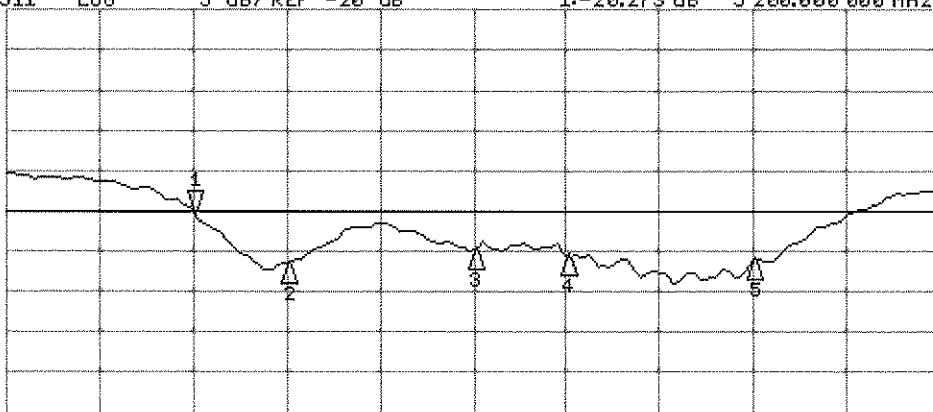

CH2 Markers

- 2: -25.396 dB
5.30000 GHz
- 3: -24.818 dB
5.50000 GHz
- 4: -25.573 dB
5.60000 GHz
- 5: -26.115 dB
5.80000 GHz

START 5 000.000 000 MHz

STOP 6 000.000 000 MHz

DASY5 Validation Report for Body TSL

Date: 10.01.2013

Test Laboratory: SPEAG, Zurich, Switzerland

DUT: Dipole 5GHz; Type: D5GHzV2; Serial: D5GHzV2 - SN: 1057

Communication System: CW; Frequency: 5200 MHz, Frequency: 5300 MHz, Frequency: 5500 MHz, Frequency: 5600 MHz, Frequency: 5800 MHz

Medium parameters used: $f = 5200$ MHz; $\sigma = 5.42$ S/m; $\epsilon_r = 47$; $\rho = 1000$ kg/m³, Medium parameters used: $f = 5300$ MHz; $\sigma = 5.55$ S/m; $\epsilon_r = 46.8$; $\rho = 1000$ kg/m³, Medium parameters used: $f = 5500$ MHz; $\sigma = 5.81$ S/m; $\epsilon_r = 46.5$; $\rho = 1000$ kg/m³, Medium parameters used: $f = 5600$ MHz; $\sigma = 5.94$ S/m; $\epsilon_r = 46.3$; $\rho = 1000$ kg/m³, Medium parameters used: $f = 5800$ MHz; $\sigma = 6.21$ S/m; $\epsilon_r = 46$; $\rho = 1000$ kg/m³

Phantom section: Flat Section

Measurement Standard: DASY5 (IEEE/IEC/ANSI C63.19-2007)

DASY52 Configuration:

- Probe: EX3DV4 - SN3503; ConvF(4.91, 4.91, 4.91); Calibrated: 28.12.2012, ConvF(4.67, 4.67, 4.67); Calibrated: 28.12.2012, ConvF(4.43, 4.43, 4.43); Calibrated: 28.12.2012, ConvF(4.22, 4.22, 4.22); Calibrated: 28.12.2012, ConvF(4.38, 4.38, 4.38); Calibrated: 28.12.2012;
- Sensor-Surface: 1.4mm (Mechanical Surface Detection)
- Electronics: DAE4 Sn601; Calibrated: 27.06.2012
- Phantom: Flat Phantom 5.0 (back); Type: QD000P50AA; Serial: 1002
- DASY52 52.8.5(1059); SEMCAD X 14.6.8(7028)

Dipole Calibration for Body Tissue/Pin=100mW, dist=10mm, f=5200 MHz/Zoom Scan, dist=1.4mm (8x8x7)/Cube 0: Measurement grid: dx=4mm, dy=4mm, dz=1.4mm

Reference Value = 59.074 V/m; Power Drift = -0.01 dB

Peak SAR (extrapolated) = 30.4 W/kg

SAR(1 g) = 7.61 W/kg; SAR(10 g) = 2.13 W/kg

Maximum value of SAR (measured) = 18.0 W/kg

Dipole Calibration for Body Tissue/Pin=100mW, dist=10mm, f=5300 MHz/Zoom Scan, dist=1.4mm (8x8x7)/Cube 0: Measurement grid: dx=4mm, dy=4mm, dz=1.4mm

Reference Value = 58.924 V/m; Power Drift = -0.00 dB

Peak SAR (extrapolated) = 30.9 W/kg

SAR(1 g) = 7.59 W/kg; SAR(10 g) = 2.13 W/kg

Maximum value of SAR (measured) = 17.9 W/kg

Dipole Calibration for Body Tissue/Pin=100mW, dist=10mm, f=5500 MHz/Zoom Scan, dist=1.4mm (8x8x7)/Cube 0: Measurement grid: dx=4mm, dy=4mm, dz=1.4mm

Reference Value = 59.561 V/m; Power Drift = -0.01 dB

Peak SAR (extrapolated) = 35.3 W/kg

SAR(1 g) = 8.14 W/kg; SAR(10 g) = 2.26 W/kg

Maximum value of SAR (measured) = 19.7 W/kg

Dipole Calibration for Body Tissue/Pin=100mW, dist=10mm, f=5600 MHz/Zoom Scan,

dist=1.4mm (8x8x7)/Cube 0: Measurement grid: dx=4mm, dy=4mm, dz=1.4mm

Reference Value = 58.884 V/m; Power Drift = -0.02 dB

Peak SAR (extrapolated) = 36.3 W/kg

SAR(1 g) = 8.1 W/kg; SAR(10 g) = 2.25 W/kg

Maximum value of SAR (measured) = 20.0 W/kg

Dipole Calibration for Body Tissue/Pin=100mW, dist=10mm, f=5800 MHz/Zoom Scan,

dist=1.4mm (8x8x7)/Cube 0: Measurement grid: dx=4mm, dy=4mm, dz=1.4mm

Reference Value = 55.753 V/m; Power Drift = -0.00 dB

Peak SAR (extrapolated) = 35.6 W/kg

SAR(1 g) = 7.57 W/kg; SAR(10 g) = 2.09 W/kg

Maximum value of SAR (measured) = 18.9 W/kg

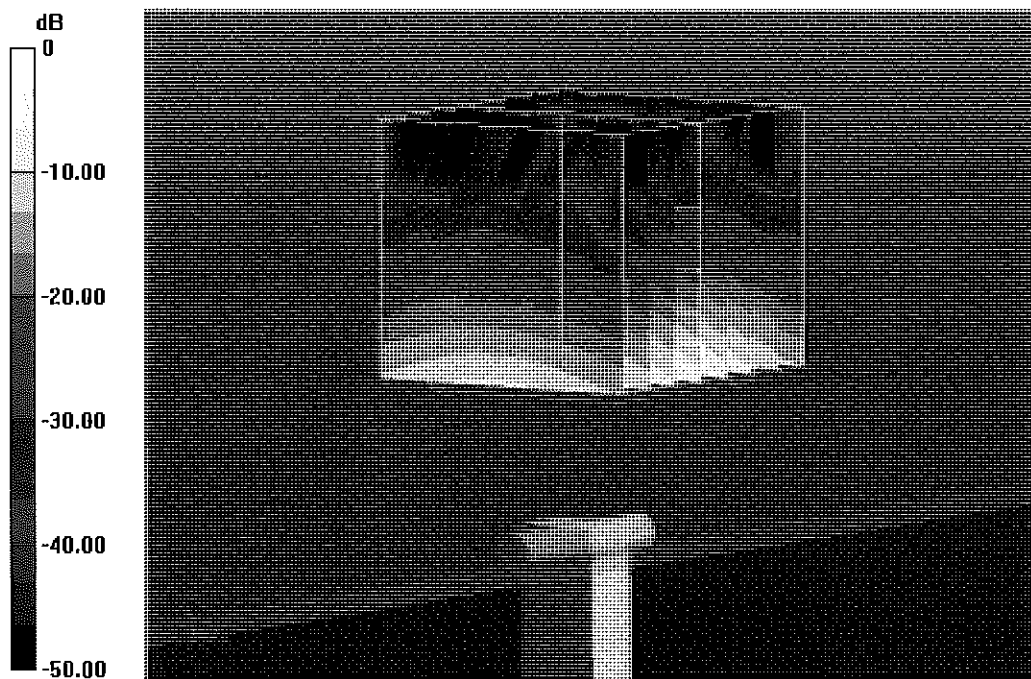

0 dB = 18.9 W/kg = 12.76 dBW/kg

Impedance Measurement Plot for Body TSL

10 Jan 2013 13:20:10

CH1 S11 1 U FS 1: 49.311 Ω -7.8789 Ω 3.8846 pF 5 200.000 000 MHz

*
Del
CA
Avg
16
H1d

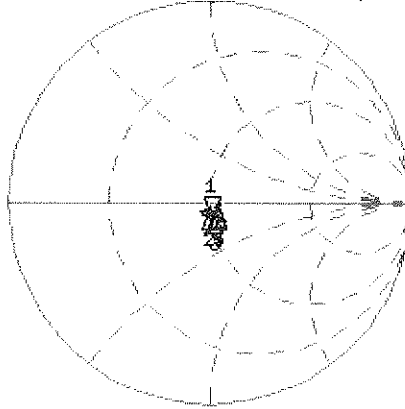

CH1 Markers
2: 48.729 Ω
-3.1895 Ω
5.30000 GHz
3: 51.209 Ω
-4.8184 Ω
5.50000 GHz
4: 53.596 Ω
-2.1113 Ω
5.60000 GHz
5: 53.314 Ω
-2.9355 Ω
5.90000 GHz

CH2 S11 LOG 5 dB/REF -20 dB 1: -22.005 dB 5 200.000 000 MHz

CA
Avg
16
H1d

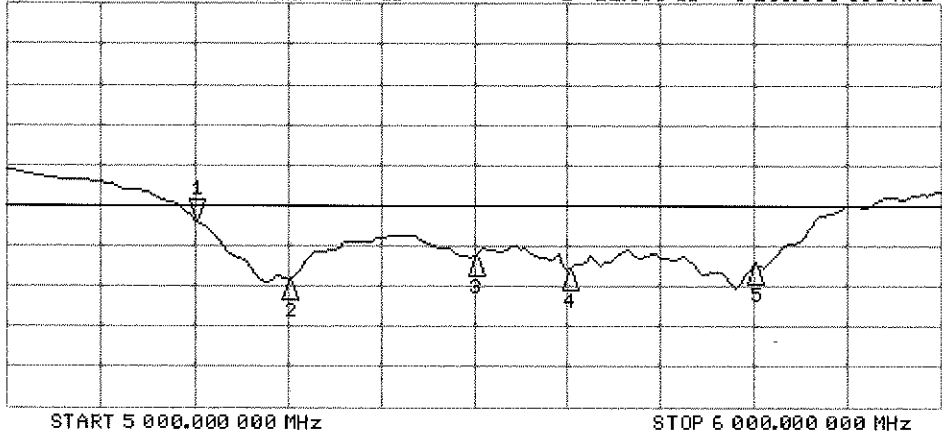

CH2 Markers
2: -29.181 dB
5.30000 GHz
3: -26.190 dB
5.50000 GHz
4: -27.903 dB
5.60000 GHz
5: -27.367 dB
5.80000 GHz

Calibration Laboratory of
Schmid & Partner
Engineering AG
Zeughausstrasse 43, 8004 Zurich, Switzerland



SCS Schweizerischer Kalibrierdienst
Service suisse d'étalonnage
Servizio svizzero di taratura
Swiss Calibration Service

Accredited by the Swiss Accreditation Service (SAS)
The Swiss Accreditation Service is one of the signatories to the EA
Multilateral Agreement for the recognition of calibration certificates

Accreditation No.: **SCS 108**

Client **PC Test**

Certificate No: **EX3-3914_Oct13**

CALIBRATION CERTIFICATE

Object **EX3DV4 - SN:3914**

Calibration procedure(s) **DIA CAL-01 v3, GA CAL-14 v4, GA CAL-23 v5, DIA CAL-25 v6
Calibration procedure for dielectric E-field probes**

Calibration date: **October 23, 2013** VCC
11/20/2013

This calibration certificate documents the traceability to national standards, which realize the physical units of measurements (SI).
The measurements and the uncertainties with confidence probability are given on the following pages and are part of the certificate.

All calibrations have been conducted in the closed laboratory facility: environment temperature (22 ± 3)°C and humidity < 70%.

Calibration Equipment used (M&TE critical for calibration)

Primary Standards	ID	Cal Date (Certificate No.)	Scheduled Calibration
Power meter E4419B	GB41293874	04-Apr-13 (No. 217-01733)	Apr-14
Power sensor E4412A	MY41498087	04-Apr-13 (No. 217-01733)	Apr-14
Reference 3 dB Attenuator	SN: S5054 (3c)	04-Apr-13 (No. 217-01737)	Apr-14
Reference 20 dB Attenuator	SN: S5277 (20x)	04-Apr-13 (No. 217-01735)	Apr-14
Reference 30 dB Attenuator	SN: S5129 (30b)	04-Apr-13 (No. 217-01738)	Apr-14
Reference Probe ES3DV2	SN: 3013	28-Dec-12 (No. ES3-3013_Dec12)	Dec-13
DAE4	SN: 660	4-Sep-13 (No. DAE4-660_Sep13)	Sep-14
Secondary Standards	ID	Check Date (in house)	Scheduled Check
RF generator HP 8648C	US3642U01700	4-Aug-99 (in house check Apr-13)	In house check: Apr-15
Network Analyzer HP 8753E	US37390585	18-Oct-01 (in house check Oct-13)	In house check: Oct-14

Calibrated by:	Name Leif Klysner	Function Laboratory Technician	Signature
Approved by:	Name Katja Pokovic	Function Technical Manager	

Issued: October 25, 2013

This calibration certificate shall not be reproduced except in full without written approval of the laboratory.

PCT # 81072



Accredited by the Swiss Accreditation Service (SAS)
 The Swiss Accreditation Service is one of the signatories to the EA
 Multilateral Agreement for the recognition of calibration certificates

Accreditation No.: **SCS 108**

Glossary:

TSL	tissue simulating liquid
NORM _{x,y,z}	sensitivity in free space
ConvF	sensitivity in TSL / NORM _{x,y,z}
DCP	diode compression point
CF	crest factor (1/duty_cycle) of the RF signal
A, B, C, D	modulation dependent linearization parameters
Polarization φ	φ rotation around probe axis
Polarization ϑ	ϑ rotation around an axis that is in the plane normal to probe axis (at measurement center), i.e., $\vartheta = 0$ is normal to probe axis
Connector Angle	information used in DASY system to align probe sensor X to the robot coordinate system

Calibration is Performed According to the Following Standards:

- a) IEEE Std 1528-2013, "IEEE Recommended Practice for Determining the Peak Spatial-Averaged Specific Absorption Rate (SAR) in the Human Head from Wireless Communications Devices: Measurement Techniques", June 2013
- b) IEC 62209-1, "Procedure to measure the Specific Absorption Rate (SAR) for hand-held devices used in close proximity to the ear (frequency range of 300 MHz to 3 GHz)", February 2005

Methods Applied and Interpretation of Parameters:

- *NORM_{x,y,z}*: Assessed for E-field polarization $\vartheta = 0$ ($f \leq 900$ MHz in TEM-cell; $f > 1800$ MHz: R22 waveguide). *NORM_{x,y,z}* are only intermediate values, i.e., the uncertainties of *NORM_{x,y,z}* does not affect the E^2 -field uncertainty inside TSL (see below *ConvF*).
- *NORM(f)_{x,y,z}* = *NORM_{x,y,z}* * *frequency_response* (see Frequency Response Chart). This linearization is implemented in DASY4 software versions later than 4.2. The uncertainty of the frequency response is included in the stated uncertainty of *ConvF*.
- *DCP_{x,y,z}*: DCP are numerical linearization parameters assessed based on the data of power sweep with CW signal (no uncertainty required). DCP does not depend on frequency nor media.
- *PAR*: PAR is the Peak to Average Ratio that is not calibrated but determined based on the signal characteristics
- *A_{x,y,z}*; *B_{x,y,z}*; *C_{x,y,z}*; *D_{x,y,z}*; *VR_{x,y,z}*; *A, B, C, D* are numerical linearization parameters assessed based on the data of power sweep for specific modulation signal. The parameters do not depend on frequency nor media. *VR* is the maximum calibration range expressed in RMS voltage across the diode.
- *ConvF and Boundary Effect Parameters*: Assessed in flat phantom using E-field (or Temperature Transfer Standard for $f \leq 800$ MHz) and inside waveguide using analytical field distributions based on power measurements for $f > 800$ MHz. The same setups are used for assessment of the parameters applied for boundary compensation (alpha, depth) of which typical uncertainty values are given. These parameters are used in DASY4 software to improve probe accuracy close to the boundary. The sensitivity in TSL corresponds to *NORM_{x,y,z}* * *ConvF* whereby the uncertainty corresponds to that given for *ConvF*. A frequency dependent *ConvF* is used in DASY version 4.4 and higher which allows extending the validity from ± 50 MHz to ± 100 MHz.
- *Spherical isotropy (3D deviation from isotropy)*: in a field of low gradients realized using a flat phantom exposed by a patch antenna.
- *Sensor Offset*: The sensor offset corresponds to the offset of virtual measurement center from the probe tip (on probe axis). No tolerance required.
- *Connector Angle*: The angle is assessed using the information gained by determining the *NORM_x* (no uncertainty required).

Probe EX3DV4

SN:3914

Manufactured: December 18, 2012
Calibrated: October 23, 2013

Calibrated for DASY/EASY Systems
(Note: non-compatible with DASY2 system!)

DASY/EASY - Parameters of Probe: EX3DV4 - SN:3914

Basic Calibration Parameters

	Sensor X	Sensor Y	Sensor Z	Unc (k=2)
Norm ($\mu\text{V}/(\text{V}/\text{m})^2$) ^A	0.47	0.49	0.51	$\pm 10.1 \%$
DCP (mV) ^B	99.2	98.9	98.2	

Modulation Calibration Parameters

UID	Communication System Name		A dB	B dB $\sqrt{\mu\text{V}}$	C	D dB	VR mV	Unc ^E (k=2)
0	CW	X	0.0	0.0	1.0	0.00	158.3	$\pm 3.0 \%$
		Y	0.0	0.0	1.0		154.6	
		Z	0.0	0.0	1.0		170.8	
10010- CAA	SAR Validation (Square, 100ms, 10ms)	X	0.71	53.3	6.1	10.00	48.4	$\pm 2.5 \%$
		Y	2.43	67.0	13.8		39.9	
		Z	4.18	68.7	13.8		45.7	
10011- CAA	UMTS-FDD (WCDMA)	X	3.05	64.4	16.5	2.91	122.4	$\pm 0.5 \%$
		Y	3.31	66.5	18.2		123.5	
		Z	3.34	66.3	17.8		136.6	
10012- CAA	IEEE 802.11b WiFi 2.4 GHz (DSSS, 1 Mbps)	X	2.49	64.8	16.1	1.87	120.6	$\pm 0.5 \%$
		Y	2.94	68.6	18.7		123.6	
		Z	2.63	65.9	17.0		135.4	
10021- DAA	GSM-FDD (TDMA, GMSK)	X	1.52	61.5	10.9	9.39	83.6	$\pm 1.2 \%$
		Y	2.22	67.4	15.0		116.0	
		Z	2.47	66.8	14.7		95.9	
10023- DAA	GPRS-FDD (TDMA, GMSK, TN 0)	X	1.73	63.3	11.9	9.57	81.5	$\pm 1.7 \%$
		Y	2.11	66.2	14.2		111.8	
		Z	2.76	69.0	16.0		93.6	
10024- DAA	GPRS-FDD (TDMA, GMSK, TN 0-1)	X	1.34	62.1	9.4	6.56	121.0	$\pm 1.2 \%$
		Y	4.24	78.6	17.9		130.0	
		Z	2.91	70.7	14.9		141.4	
10027- DAA	GPRS-FDD (TDMA, GMSK, TN 0-1-2)	X	1.25	63.5	9.7	4.80	143.5	$\pm 1.4 \%$
		Y	1.59	66.9	12.2		149.7	
		Z	2.98	71.5	14.0		123.3	
10028- DAA	GPRS-FDD (TDMA, GMSK, TN 0-1-2-3)	X	0.51	58.3	7.4	3.55	113.4	$\pm 1.2 \%$
		Y	25.43	100.0	22.6		121.3	
		Z	38.67	97.5	20.6		133.3	
10032- CAA	IEEE 802.15.1 Bluetooth (GFSK, DH5)	X	0.28	58.6	5.3	1.16	134.7	$\pm 0.9 \%$
		Y	65.75	99.6	18.6		141.3	
		Z	0.20	55.6	4.1		112.1	
10039- CAA	CDMA2000 (1xRTT, RC1)	X	4.33	64.6	17.4	4.57	113.8	$\pm 0.7 \%$
		Y	4.55	66.0	18.6		120.8	
		Z	4.85	66.2	18.4		135.9	
10062- CAA	IEEE 802.11a/h WiFi 5 GHz (OFDM, 6 Mbps)	X	9.83	67.6	20.7	8.68	109.0	$\pm 2.5 \%$
		Y	10.06	68.4	21.5		118.2	
		Z	10.66	69.2	21.7		134.0	

10081-CAA	CDMA2000 (1xRTT, RC3)	X	3.59	63.9	16.9	3.97	113.6	±0.7 %
		Y	3.84	65.6	18.2		119.6	
		Z	3.95	65.4	17.8		134.5	
10098-CAA	UMTS-FDD (HSUPA, Subtest 2)	X	4.41	65.2	17.3	3.98	126.0	±0.7 %
		Y	4.73	66.9	18.6		132.5	
		Z	4.51	65.5	17.7		105.6	
10100-CAB	LTE-FDD (SC-FDMA, 100% RB, 20 MHz, QPSK)	X	6.26	66.2	18.6	5.67	130.5	±1.2 %
		Y	6.61	67.7	19.8		139.3	
		Z	6.21	66.0	18.7		107.7	
10108-CAB	LTE-FDD (SC-FDMA, 100% RB, 10 MHz, QPSK)	X	6.13	65.8	18.6	5.80	126.3	±1.2 %
		Y	6.40	67.1	19.6		135.6	
		Z	6.10	65.5	18.5		107.4	
10110-CAB	LTE-FDD (SC-FDMA, 100% RB, 5 MHz, QPSK)	X	5.78	65.3	18.3	5.75	123.1	±1.2 %
		Y	5.97	66.3	19.2		131.5	
		Z	5.86	65.3	18.4		104.9	
10114-CAA	IEEE 802.11n (HT Greenfield, 13.5 Mbps, BPSK)	X	9.92	67.7	20.3	8.10	115.7	±2.5 %
		Y	10.25	68.7	21.2		126.8	
		Z	10.71	69.4	21.3		146.0	
10117-CAA	IEEE 802.11n (HT Mixed, 13.5 Mbps, BPSK)	X	9.95	67.8	20.3	8.07	116.6	±2.5 %
		Y	10.26	68.7	21.1		128.3	
		Z	10.70	69.4	21.3		146.9	
10151-CAB	LTE-TDD (SC-FDMA, 50% RB, 20 MHz, QPSK)	X	7.19	67.3	21.5	9.28	145.0	±2.2 %
		Y	7.40	68.3	22.4		110.8	
		Z	7.79	68.4	22.0		128.0	
10154-CAB	LTE-FDD (SC-FDMA, 50% RB, 10 MHz, QPSK)	X	5.79	65.3	18.3	5.75	124.2	±1.2 %
		Y	6.03	66.5	19.4		131.9	
		Z	6.29	66.9	19.3		149.7	
10160-CAB	LTE-FDD (SC-FDMA, 50% RB, 15 MHz, QPSK)	X	6.23	65.9	18.6	5.82	128.3	±1.2 %
		Y	6.51	67.2	19.7		136.9	
		Z	6.24	65.7	18.6		107.3	
10169-CAB	LTE-FDD (SC-FDMA, 1 RB, 20 MHz, QPSK)	X	4.83	66.0	18.9	5.73	147.5	±1.2 %
		Y	4.72	65.8	19.2		113.8	
		Z	5.03	66.1	19.1		129.7	
10172-CAB	LTE-TDD (SC-FDMA, 1 RB, 20 MHz, QPSK)	X	5.83	69.2	22.8	9.21	149.9	±1.9 %
		Y	5.81	69.4	23.4		120.3	
		Z	6.38	70.0	23.2		137.2	
10175-CAB	LTE-FDD (SC-FDMA, 1 RB, 10 MHz, QPSK)	X	4.86	66.1	18.9	5.72	149.8	±1.2 %
		Y	4.72	65.8	19.2		113.3	
		Z	5.09	66.4	19.1		126.0	
10181-CAB	LTE-FDD (SC-FDMA, 1 RB, 15 MHz, QPSK)	X	4.83	66.0	18.9	5.72	146.3	±1.2 %
		Y	4.69	65.6	19.1		112.2	
		Z	5.02	66.1	19.0		125.1	
10193-CAA	IEEE 802.11n (HT Greenfield, 6.5 Mbps, BPSK)	X	9.51	67.4	20.2	8.09	108.6	±2.5 %
		Y	9.72	68.1	20.9		118.2	
		Z	10.30	68.9	21.1		135.0	

10196-CAA	IEEE 802.11n (HT Mixed, 6.5 Mbps, BPSK)	X	9.52	67.4	20.2	8.10	111.6	±2.5 %
		Y	9.79	68.3	21.1		121.3	
		Z	10.30	68.9	21.2		139.2	
10219-CAA	IEEE 802.11n (HT Mixed, 7.2 Mbps, BPSK)	X	9.47	67.4	20.2	8.03	111.8	±2.2 %
		Y	9.67	68.3	21.0		120.0	
		Z	10.20	68.9	21.1		138.0	
10222-CAA	IEEE 802.11n (HT Mixed, 15 Mbps, BPSK)	X	9.96	67.9	20.4	8.06	118.4	±2.5 %
		Y	10.25	68.8	21.2		128.2	
		Z	10.65	69.3	21.3		144.5	
10225-CAA	UMTS-FDD (HSPA+)	X	6.96	66.7	18.9	5.97	140.0	±1.4 %
		Y	7.23	67.9	20.0		148.9	
		Z	7.03	66.4	18.9		115.6	
10237-CAB	LTE-TDD (SC-FDMA, 1 RB, 10 MHz, QPSK)	X	5.51	67.5	21.8	9.21	114.2	±1.9 %
		Y	5.82	69.4	23.4		123.0	
		Z	6.49	70.6	23.6		140.2	
10252-CAB	LTE-TDD (SC-FDMA, 50% RB, 10 MHz, QPSK)	X	6.83	67.1	21.4	9.24	136.6	±1.9 %
		Y	7.30	69.4	23.2		147.3	
		Z	7.36	68.1	22.0		117.5	
10267-CAB	LTE-TDD (SC-FDMA, 100% RB, 10 MHz, QPSK)	X	7.26	67.5	21.6	9.30	142.7	±1.9 %
		Y	7.44	68.4	22.4		110.5	
		Z	7.84	68.7	22.2		122.6	
10274-CAA	UMTS-FDD (HSUPA, Subtest 5, 3GPP Rel8.10)	X	5.86	66.2	18.2	4.87	135.4	±0.9 %
		Y	6.12	67.5	19.2		142.3	
		Z	5.91	65.9	18.2		107.6	
10275-CAA	UMTS-FDD (HSUPA, Subtest 5, 3GPP Rel8.4)	X	4.17	64.8	17.3	3.96	115.6	±0.7 %
		Y	4.42	66.4	18.5		124.6	
		Z	4.47	66.0	18.0		132.6	
10291-AAA	CDMA2000, RC3, SO55, Full Rate	X	3.36	64.7	17.1	3.46	109.4	±0.5 %
		Y	3.55	66.2	18.3		118.2	
		Z	3.60	65.6	17.7		120.9	
10292-AAA	CDMA2000, RC3, SO32, Full Rate	X	3.34	64.9	17.2	3.39	110.1	±0.5 %
		Y	3.57	66.7	18.5		121.0	
		Z	3.54	65.6	17.7		123.9	
10297-AAA	LTE-FDD (SC-FDMA, 50% RB, 20 MHz, QPSK)	X	6.14	65.8	18.6	5.81	125.1	±1.2 %
		Y	6.44	67.2	19.7		135.7	
		Z	6.52	67.0	19.3		142.2	
10311-AAA	LTE-FDD (SC-FDMA, 100% RB, 15 MHz, QPSK)	X	6.76	66.6	19.1	6.06	131.8	±1.4 %
		Y	7.03	67.8	20.0		142.5	
		Z	7.15	67.7	19.7		148.6	
10315-AAA	IEEE 802.11b WiFi 2.4 GHz (DSSS, 1 Mbps, 96pc duty cycle)	X	2.42	64.6	16.1	1.71	116.8	±0.5 %
		Y	3.00	69.3	19.0		126.9	
		Z	2.61	66.3	17.2		128.2	
10317-AAA	IEEE 802.11a WiFi 5 GHz (OFDM, 6 Mbps, 96pc duty cycle)	X	9.71	67.6	20.5	8.36	111.7	±2.5 %
		Y	9.99	68.6	21.4		122.2	
		Z	10.38	68.9	21.3		129.5	

10400-AAA	IEEE 802.11ac WiFi (20MHz, 64-QAM, 99pc duty cycle)	X	9.83	67.8	20.6	8.37	112.9	±2.5 %
		Y	10.09	68.7	21.4		123.9	
		Z	10.48	68.9	21.3		130.5	
10402-AAA	IEEE 802.11ac WiFi (80MHz, 64-QAM, 99pc duty cycle)	X	10.61	68.3	20.7	8.53	121.1	±2.5 %
		Y	11.25	70.0	21.9		135.4	
		Z	11.15	69.4	21.4		137.4	
10403-AAA	CDMA2000 (1xEV-DO, Rev. 0)	X	4.51	67.4	17.8	3.76	119.2	±0.5 %
		Y	4.91	69.5	19.3		128.3	
		Z	4.84	67.5	18.1		135.4	
10404-AAA	CDMA2000 (1xEV-DO, Rev. A)	X	4.51	67.7	18.0	3.77	117.4	±0.5 %
		Y	4.92	69.8	19.5		125.4	
		Z	4.71	67.3	18.0		131.9	

The reported uncertainty of measurement is stated as the standard uncertainty of measurement multiplied by the coverage factor $k=2$, which for a normal distribution corresponds to a coverage probability of approximately 95%.

^A The uncertainties of NormX,Y,Z do not affect the E^2 -field uncertainty inside TSL (see Pages 8 and 9).

^B Numerical linearization parameter: uncertainty not required.

^E Uncertainty is determined using the max. deviation from linear response applying rectangular distribution and is expressed for the square of the field value.

DASY/EASY - Parameters of Probe: EX3DV4 - SN:3914

Calibration Parameter Determined in Head Tissue Simulating Media

f (MHz) ^C	Relative Permittivity ^F	Conductivity (S/m) ^F	ConvF X	ConvF Y	ConvF Z	Alpha ^G	Depth ^G (mm)	Unct. (k=2)
750	41.9	0.89	9.70	9.70	9.70	0.34	1.01	± 12.0 %
835	41.5	0.90	9.34	9.34	9.34	0.67	0.67	± 12.0 %
1750	40.1	1.37	7.99	7.99	7.99	0.79	0.56	± 12.0 %
1900	40.0	1.40	7.69	7.69	7.69	0.80	0.58	± 12.0 %
2450	39.2	1.80	6.95	6.95	6.95	0.41	0.77	± 12.0 %
2600	39.0	1.96	6.79	6.79	6.79	0.40	0.82	± 12.0 %
5200	36.0	4.66	4.99	4.99	4.99	0.30	1.80	± 13.1 %
5300	35.9	4.76	4.82	4.82	4.82	0.30	1.80	± 13.1 %
5500	35.6	4.96	4.55	4.55	4.55	0.35	1.80	± 13.1 %
5600	35.5	5.07	4.37	4.37	4.37	0.35	1.80	± 13.1 %
5800	35.3	5.27	4.52	4.52	4.52	0.35	1.80	± 13.1 %

^C Frequency validity of ± 100 MHz only applies for DASY v4.4 and higher (see Page 2), else it is restricted to ± 50 MHz. The uncertainty is the RSS of the ConvF uncertainty at calibration frequency and the uncertainty for the indicated frequency band.

^F At frequencies below 3 GHz, the validity of tissue parameters (ϵ and σ) can be relaxed to ± 10% if liquid compensation formula is applied to measured SAR values. At frequencies above 3 GHz, the validity of tissue parameters (ϵ and σ) is restricted to ± 5%. The uncertainty is the RSS of the ConvF uncertainty for indicated target tissue parameters.

^G Alpha/Depth are determined during calibration. SPEAG warrants that the remaining deviation due to the boundary effect after compensation is always less than ± 1% for frequencies below 3 GHz and below ± 2% for frequencies between 3-6 GHz at any distance larger than half the probe tip diameter from the boundary.

DASY/EASY - Parameters of Probe: EX3DV4 - SN:3914

Calibration Parameter Determined in Body Tissue Simulating Media

f (MHz) ^C	Relative Permittivity ^F	Conductivity (S/m) ^F	ConvF X	ConvF Y	ConvF Z	Alpha ^G	Depth ^G (mm)	Unct. (k=2)
750	55.5	0.96	9.39	9.39	9.39	0.63	0.74	± 12.0 %
835	55.2	0.97	9.31	9.31	9.31	0.56	0.76	± 12.0 %
1750	53.4	1.49	7.89	7.89	7.89	0.32	1.03	± 12.0 %
1900	53.3	1.52	7.51	7.51	7.51	0.51	0.76	± 12.0 %
2450	52.7	1.95	7.02	7.02	7.02	0.80	0.50	± 12.0 %
2600	52.5	2.16	6.81	6.81	6.81	0.80	0.50	± 12.0 %
5200	49.0	5.30	4.52	4.52	4.52	0.35	1.90	± 13.1 %
5300	48.9	5.42	4.32	4.32	4.32	0.35	1.90	± 13.1 %
5500	48.6	5.65	4.07	4.07	4.07	0.35	1.90	± 13.1 %
5600	48.5	5.77	3.97	3.97	3.97	0.35	1.90	± 13.1 %
5800	48.2	6.00	4.14	4.14	4.14	0.40	1.90	± 13.1 %

^C Frequency validity of ± 100 MHz only applies for DASY v4.4 and higher (see Page 2), else it is restricted to ± 50 MHz. The uncertainty is the RSS of the ConvF uncertainty at calibration frequency and the uncertainty for the indicated frequency band.

^F At frequencies below 3 GHz, the validity of tissue parameters (ϵ and σ) can be relaxed to ± 10% if liquid compensation formula is applied to measured SAR values. At frequencies above 3 GHz, the validity of tissue parameters (ϵ and σ) is restricted to ± 5%. The uncertainty is the RSS of the ConvF uncertainty for indicated target tissue parameters.

^G Alpha/Depth are determined during calibration. SPEAG warrants that the remaining deviation due to the boundary effect after compensation is always less than ± 1% for frequencies below 3 GHz and below ± 2% for frequencies between 3-6 GHz at any distance larger than half the probe tip diameter from the boundary.

Frequency Response of E-Field

(TEM-Cell:ifi110 EXX, Waveguide: R22)

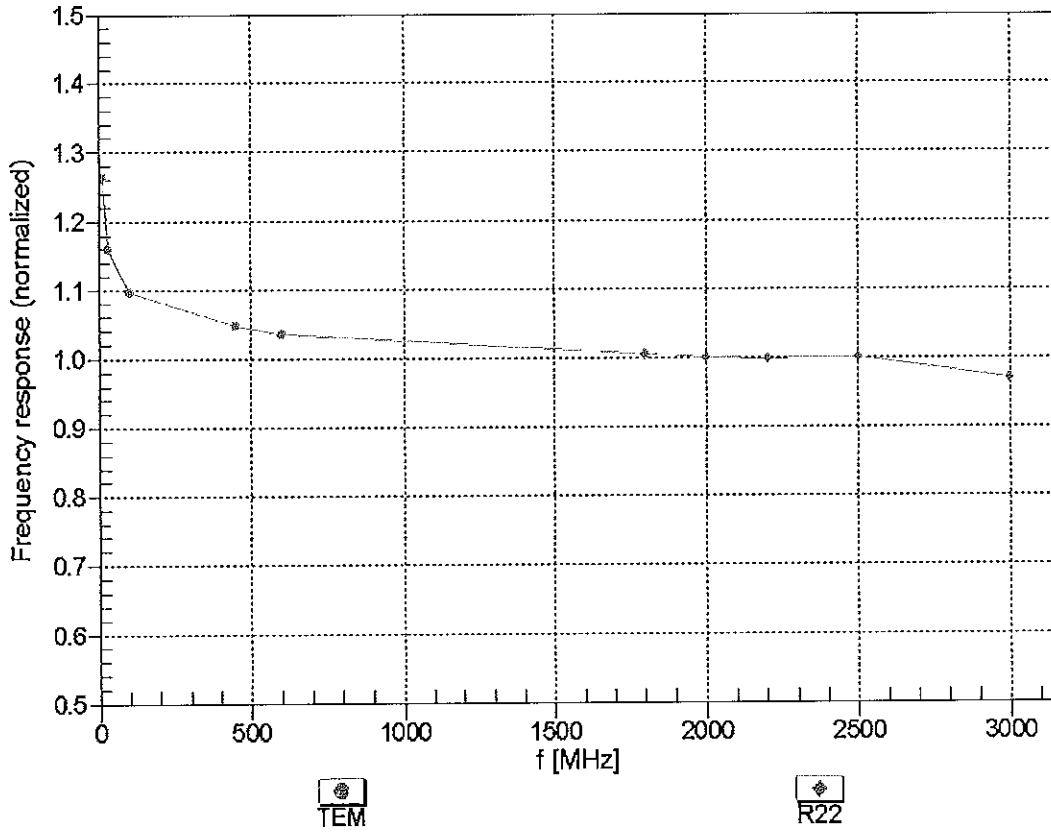

Uncertainty of Frequency Response of E-field: $\pm 6.3\%$ (k=2)

Receiving Pattern (ϕ), $\theta = 0^\circ$

f=600 MHz,TEM

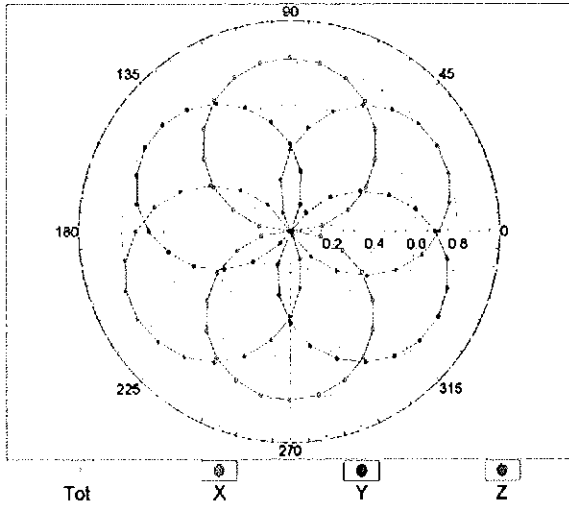

f=1800 MHz,R22

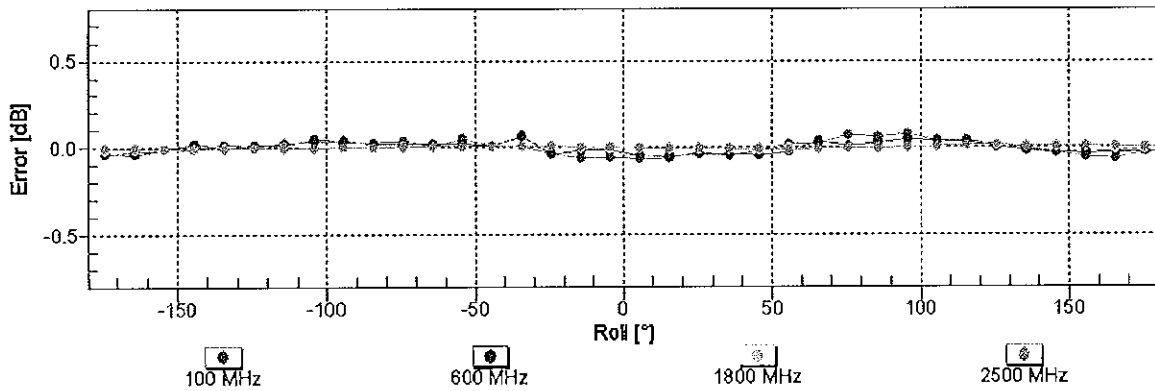
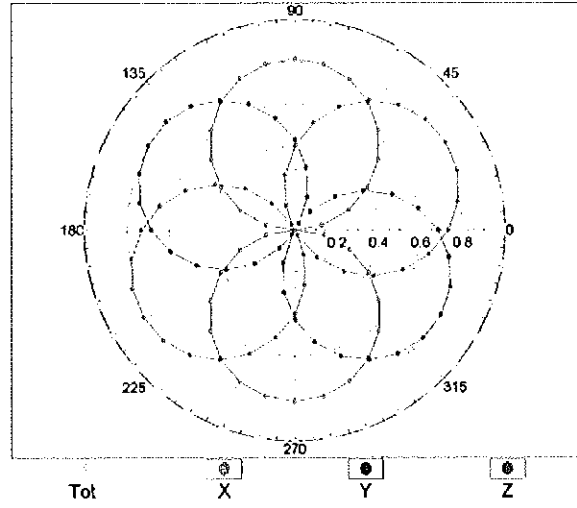

Uncertainty of Axial Isotropy Assessment: $\pm 0.5\%$ (k=2)

Dynamic Range $f(SAR_{head})$ (TEM cell , $f = 900$ MHz)

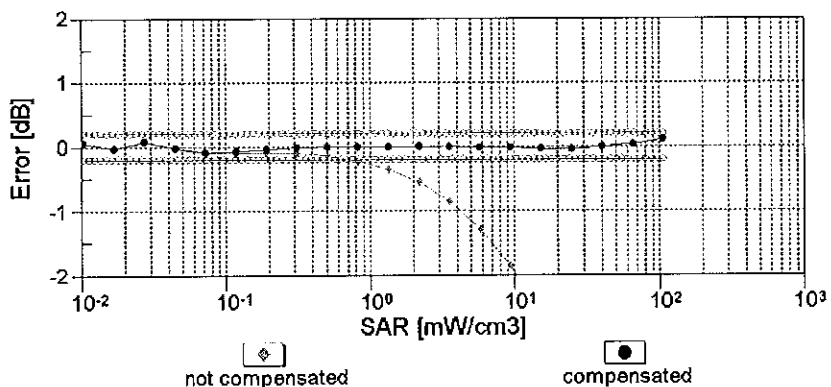
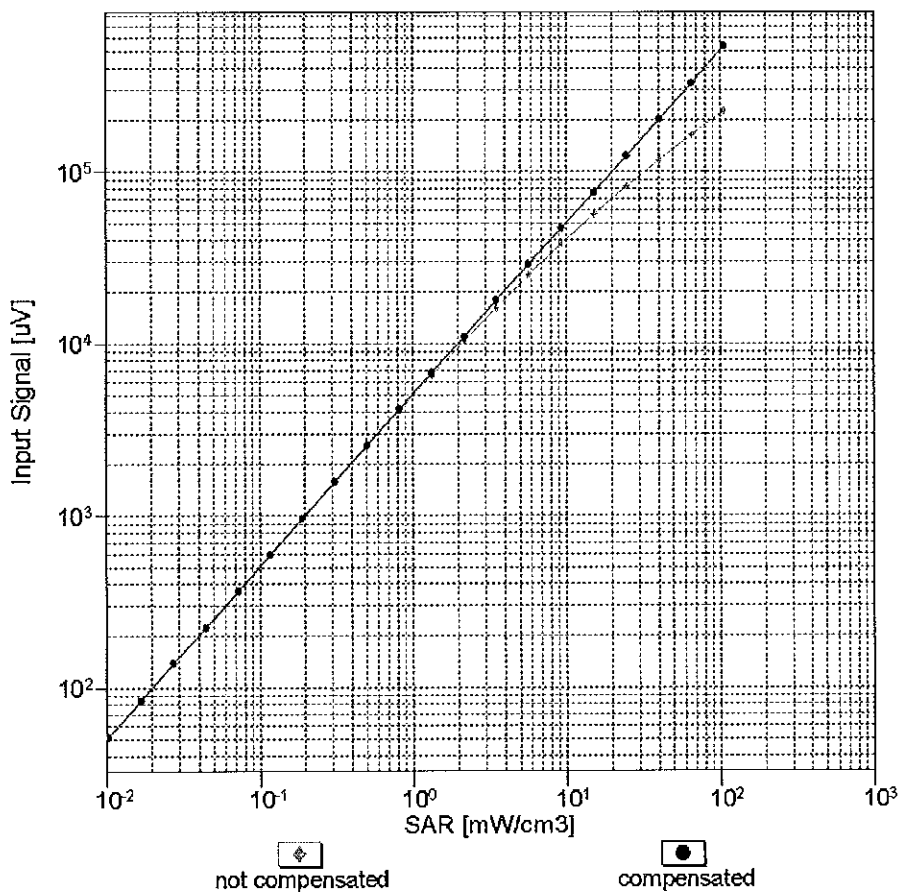

Uncertainty of Linearity Assessment: $\pm 0.6\%$ ($k=2$)

Conversion Factor Assessment

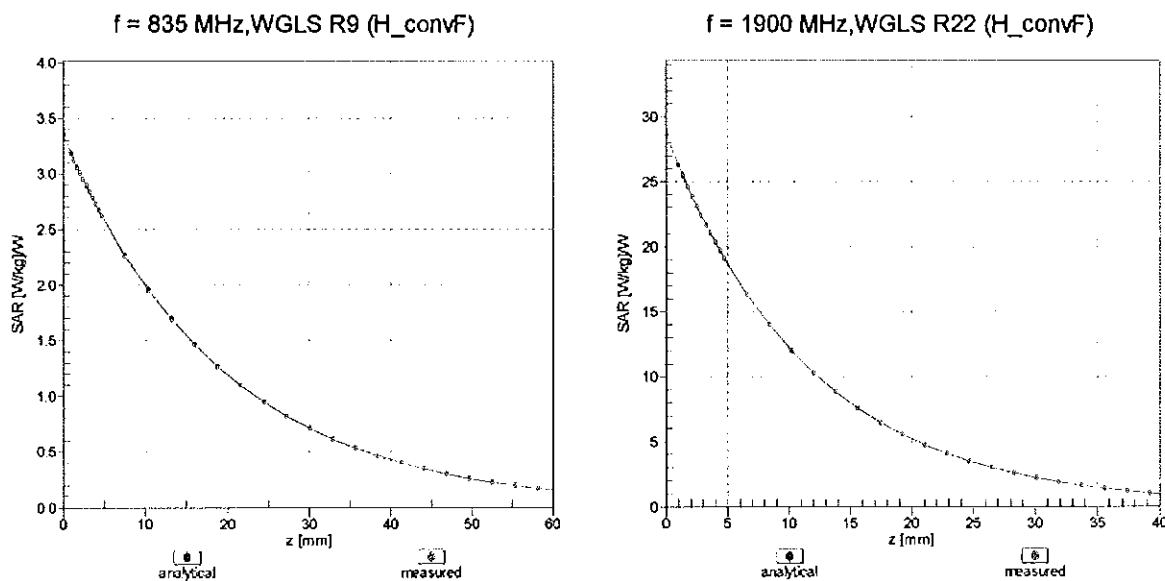

Deviation from Isotropy in Liquid

Error (ϕ, θ), f = 900 MHz

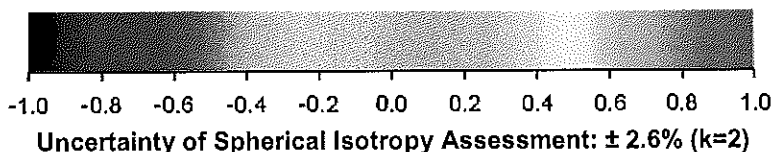
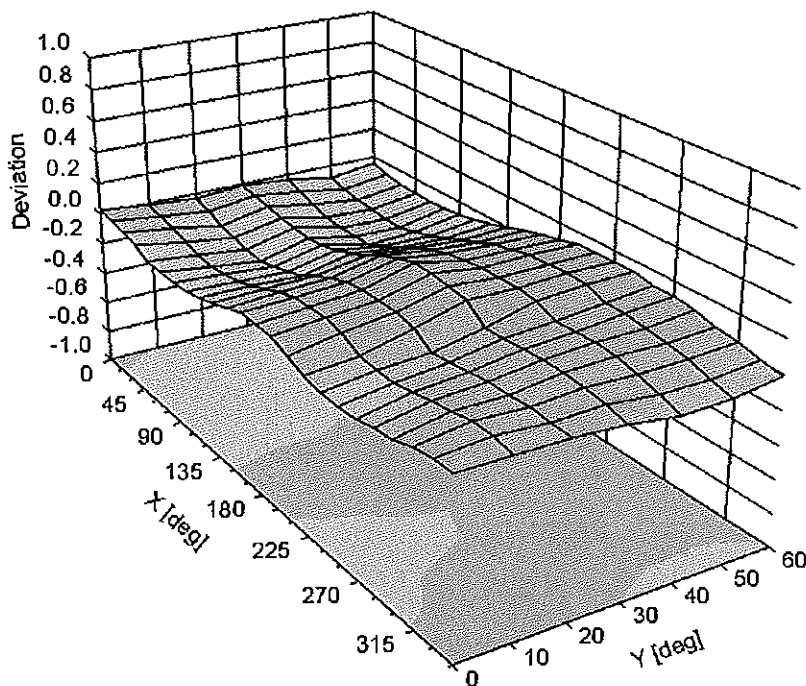

DASY/EASY - Parameters of Probe: EX3DV4 - SN:3914**Other Probe Parameters**

Sensor Arrangement	Triangular
Connector Angle (°)	-24.3
Mechanical Surface Detection Mode	enabled
Optical Surface Detection Mode	disabled
Probe Overall Length	337 mm
Probe Body Diameter	10 mm
Tip Length	9 mm
Tip Diameter	2.5 mm
Probe Tip to Sensor X Calibration Point	1 mm
Probe Tip to Sensor Y Calibration Point	1 mm
Probe Tip to Sensor Z Calibration Point	1 mm
Recommended Measurement Distance from Surface	2 mm