



SAR EVALUATION REPORT

Applicant Name:
 LG Electronics MobileComm U.S.A., Inc.
 1000 Sylvan Avenue
 Englewood Cliffs, NJ 07632
 USA

Date of Testing:
 03/30/12 - 04/19/12
Test Site/Location:
 PCTEST Lab, Columbia, MD, USA
Document Serial No.:
 0Y1204020393.ZNF

FCC ID:	ZNFAS730
APPLICANT:	LG ELECTRONICS MOBILECOMM U.S.A., INC.

DUT Type: Portable Handset
Application Type: Certification
FCC Rule Part(s): CFR §2.1093
Model(s): LG730, AS730, LG-AS730, LGAS730, LGL86C
Test Device Serial No.: Pre-Production [S/N: A0000031D1725C, A0000031D17249]

Band & Mode	Tx Frequency	Conducted Power [dBm]	SAR		
			1 gm Head (W/kg)	1 gm Body-Worn (W/kg)	1 gm Hotspot (W/kg)
Cell. CDMA/EVDO	824.70 - 848.31 MHz	24.67	0.77	0.87	1.29
PCS CDMA/EVDO	1851.25 - 1908.75 MHz	24.40	1.16	0.99	1.04
2.4 GHz WLAN	2412 - 2462 MHz	16.14	0.77	0.13	0.17
Bluetooth	2402 - 2480 MHz	9.41	N/A		
Simultaneous SAR per KDB 690783 D01:			1.54	1.12	1.42

Note: Powers in the above table represent output powers for the SAR test configurations and may not represent the highest output powers for all configurations for each mode.



This wireless portable device has been shown to be capable of compliance for localized specific absorption rate (SAR) for uncontrolled environment/general population exposure limits specified in ANSI/IEEE C95.1-1992 and has been tested in accordance with the measurement procedures specified in FCC/OET Bulletin 65 Supplement C (2001), IEEE 1528-2003 and in applicable Industry Canada Radio Standards Specifications (RSS); for North American frequency bands only.

I attest to the accuracy of data. All measurements reported herein were performed by me or were made under my supervision and are correct to the best of my knowledge and belief. I assume full responsibility for the completeness of these measurements and vouch for the qualifications of all persons taking them. Test results reported herein relate only to the item(s) tested.

PCTEST certifies that no party to this application has been subject to a denial of Federal benefits that includes FCC benefits pursuant to Section 5301 of the Anti-Drug Abuse Act of 1988, 21 U.S.C. 862.



 Randy Ortanez
 President



FCC ID: ZNFAS730		SAR EVALUATION REPORT		Reviewed by: Quality Manager
Document S/N: 0Y1204020393.ZNF	Test Dates: 03/30/12 - 04/19/12	DUT Type: Portable Handset	Page 1 of 32	

T A B L E O F C O N T E N T S

1	DEVICE UNDER TEST	3
2	INTRODUCTION	5
3	SAR MEASUREMENT SETUP	6
4	DOSIMETRIC ASSESSMENT	7
5	DEFINITION OF REFERENCE POINTS	8
6	TEST CONFIGURATION POSITIONS FOR HANDSETS	9
7	FCC RF EXPOSURE LIMITS.....	12
8	FCC MEASUREMENT PROCEDURES.....	13
9	RF CONDUCTED POWERS.....	16
10	SYSTEM VERIFICATION.....	19
11	SAR DATA SUMMARY	21
12	FCC MULTI-TX AND ANTENNA SAR CONSIDERATIONS.....	26
13	EQUIPMENT LIST.....	28
14	MEASUREMENT UNCERTAINTIES	29
15	CONCLUSION.....	30
16	REFERENCES	31

FCC ID: ZNFAS730		SAR EVALUATION REPORT	
Document S/N: 0Y1204020393.ZNF	Test Dates: 03/30/12 - 04/19/12	DUT Type: Portable Handset	Reviewed by: Quality Manager
			Page 2 of 32

1 DEVICE UNDER TEST

1.1 Device Overview

Band & Mode	Tx Frequency
Cell. CDMA/EVDO	824.70 - 848.31 MHz
PCS CDMA/EVDO	1851.25 - 1908.75 MHz
2.4 GHz WLAN	2412 - 2462 MHz
Bluetooth	2402 - 2480 MHz

1.2 DUT Antenna Locations

**Figure 1-1
DUT Antenna Locations**

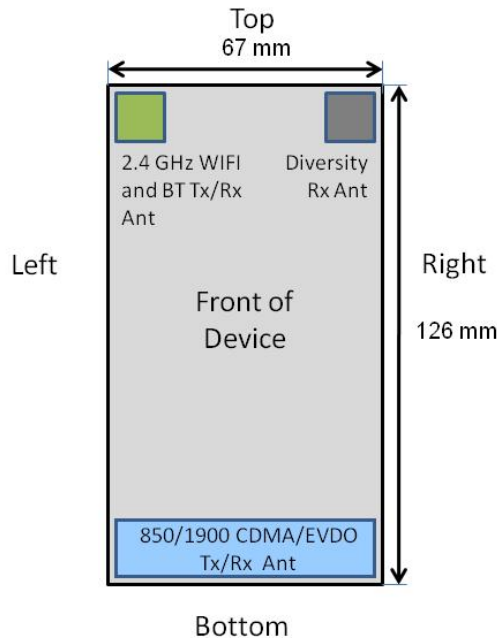

**Table 1-1
Mobile Hotspot Sides for SAR Testing**

Mobile Hotspot Sides for SAR Testing						
Mode	Back	Front	Top	Bottom	Right	Left
Cell. EVDO	Yes	Yes	No	Yes	Yes	Yes
PCS EVDO	Yes	Yes	No	Yes	Yes	Yes
2.4 GHz WLAN	Yes	Yes	Yes	No	No	Yes

Note: Particular DUT edges were not required to be evaluated for Wireless Router SAR if the edges were greater than 2.5 cm from the transmitting antenna according to FCC KDB Publication 941225 D06 guidance, page 2. The antenna document shows the distances between the transmit antennas and the edges of the device.

FCC ID: ZNFAS730	PCTEST ENGINEERING LABORATORY, INC.	SAR EVALUATION REPORT		Reviewed by: Quality Manager
Document S/N: 0Y1204020393.ZNF	Test Dates: 03/30/12 - 04/19/12	DUT Type: Portable Handset		Page 3 of 32

1.3 SAR Test Exclusions Applied

(A) WIFI/BT

The separation distance between the main antenna and the Bluetooth/WLAN antenna is 94 mm. The maximum RF Conducted Power of Bluetooth Tx is 8.732 mW (Please refer to the EMC DSS Report for a full set of Bluetooth conducted powers). The maximum RF Conducted Power of WLAN is 41.115 mW.

2.4 GHz WIFI and Bluetooth share the same antenna path and cannot transmit simultaneously.



Per KDB Publication 648474, **Bluetooth SAR was not required** based on the maximum conducted power, the Bluetooth/WLAN to main antenna separation distance and Body-SAR of the main antenna.

1.4 Power Reduction for SAR

There is no power reduction for any band/mode implemented in this device for SAR purposes.

1.5 Guidance Applied

- FCC OET Bulletin 65 Supplement C [June 2001]
- IEEE 1528-2003
- Oct 2011 TCB Workshop Notes (1x Advanced)
- FCC KDB 941225 (2G/3G and Hotspot)
- FCC KDB 248227 (802.11)
- FCC KDB 648474 (Simultaneous)

FCC ID: ZNFAS730	 PCTEST ENGINEERING LABORATORY, INC.	SAR EVALUATION REPORT	 LG	Reviewed by: Quality Manager
Document S/N: 0Y1204020393.ZNF	Test Dates: 03/30/12 - 04/19/12	DUT Type: Portable Handset		Page 4 of 32

2 INTRODUCTION

The FCC has adopted the guidelines for evaluating the environmental effects of radio frequency (RF) radiation in ET Docket 93-62 on Aug. 6, 1996 to protect the public and workers from the potential hazards of RF emissions due to FCC-regulated portable devices. [1]

The safety limits used for the environmental evaluation measurements are based on the criteria published by the American National Standards Institute (ANSI) for localized specific absorption rate (SAR) in IEEE/ANSI C95.1-1992 Standard for Safety Levels with Respect to Human Exposure to Radio Frequency Electromagnetic Fields, 3 kHz to 300 GHz [3] and Health Canada RF Exposure Guidelines Safety Code 6 [24]. The measurement procedure described in IEEE/ANSI C95.3-2002 Recommended Practice for the Measurement of Potentially Hazardous Electromagnetic Fields - RF and Microwave [4] is used for guidance in measuring the Specific Absorption Rate (SAR) due to the RF radiation exposure from the Equipment Under Test (EUT). These criteria for SAR evaluation are similar to those recommended by the International Committee for Non-Ionizing Radiation Protection (ICNIRP) in Biological Effects and Exposure Criteria for Radiofrequency Electromagnetic Fields," Report No. Vol 74. SAR is a measure of the rate of energy absorption due to exposure to an RF transmitting source. SAR values have been related to threshold levels for potential biological hazards.

2.1 SAR Definition

Specific Absorption Rate is defined as the time derivative (rate) of the incremental energy (dU) absorbed by (dissipated in) an incremental mass (dm) contained in a volume element (dV) of a given density (ρ). It is also defined as the rate of RF energy absorption per unit mass at a point in an absorbing body (see Equation 2-1).

Equation 2-1
SAR Mathematical Equation

$$SAR = \frac{d}{dt} \left(\frac{dU}{dm} \right) = \frac{d}{dt} \left(\frac{dU}{\rho dv} \right)$$



SAR is expressed in units of Watts per Kilogram (W/kg).

$$SAR = \frac{\sigma \cdot E^2}{\rho}$$

where:

- σ = conductivity of the tissue-simulating material (S/m)
- ρ = mass density of the tissue-simulating material (kg/m^3)
- E = Total RMS electric field strength (V/m)

NOTE: The primary factors that control rate of energy absorption were found to be the wavelength of the incident field in relation to the dimensions and geometry of the irradiated organism, the orientation of the organism in relation to the polarity of field vectors, the presence of reflecting surfaces, and whether conductive contact is made by the organism with a ground plane.[6]

FCC ID: ZNFAS730	 PCTEST ENGINEERING LABORATORY, INC.	SAR EVALUATION REPORT	 LG	Reviewed by: Quality Manager
Document S/N: 0Y1204020393.ZNF	Test Dates: 03/30/12 - 04/19/12	DUT Type: Portable Handset		Page 5 of 32

3 SAR MEASUREMENT SETUP

3.1 Automated SAR Measurement System

Measurements are performed using the DASY automated dosimetric SAR assessment system. The DASY is made by Schmid & Partner Engineering AG (SPEAG) in Zurich, Switzerland and consists of a high precision robotics system (Staubli), robot controller, desktop computer, near-field probe, probe alignment sensor, and the SAM phantom containing the head or body equivalent material. The robot is a six-axis industrial robot, performing precise movements to position the probe to the location (points) of maximum electromagnetic field (EMF). See www.speag.com for more information about the specification of the SAR assessment system.





Figure 3-1
SAR Measurement System



Figure 3-2
Near-Field Probe

Table 3-1
Composition of the Tissue Equivalent Matter

Frequency (MHz)	835	835	1900	1900	2450	2450
Tissue	Head	Body	Head	Body	Head	Body
Ingredients (% by weight)						
Bactericide	0.1	0.1				
DGBE			44.92	29.44	7.99	26.7
HEC	1	1				
NaCl	1.45	0.94	0.18	0.39	0.16	0.1
Sucrose	57	44.9				
Triton X-100					19.97	
Water	40.45	53.06	54.9	70.17	71.88	73.2

FCC ID: ZNFAS730	 PCTEST ENGINEERING LABORATORY, INC.	SAR EVALUATION REPORT	 LG	Reviewed by: Quality Manager
Document S/N: 0Y1204020393.ZNF	Test Dates: 03/30/12 - 04/19/12	DUT Type: Portable Handset		Page 6 of 32

4 DOSIMETRIC ASSESSMENT

4.1 Measurement Procedure

The evaluation was performed using the following procedure:

1. The SAR distribution at the exposed side of the head or body was measured at a distance no greater than 5.0 mm from the inner surface of the shell. The area covered the entire dimension of the device-head interface and the horizontal grid resolution was 15mm and 15mm for frequencies < 3 GHz in the x and y directions respectively. When applicable, for frequencies above 3 GHz, a 10 mm by 10 mm resolution was used.
2. The point SAR measurement was taken at the maximum SAR region determined from Step 1 to enable the monitoring of SAR fluctuations/drifts during the 1 gram cube evaluation. SAR at this fixed point was measured and used as a reference value.
3. Based on the area scan data, the peak area of the maximum absorption was determined by spline interpolation. Around this point, a volume of 32mm x 32mm x 30mm (fine resolution volume scan, zoom scan) was assessed by measuring at least 5 x 5 x 7 points. On this basis of this data set, the spatial peak SAR value was evaluated with the following procedure (see references or the DASY manual online for more details):
 - a. The data was extrapolated to the surface of the outer-shell of the phantom. The combined distance extrapolated was the combined distance from the center of the dipoles 2.7mm away from the tip of the probe housing plus the 1.2 mm distance between the surface and the lowest measuring point. The extrapolation was based on a least-squares algorithm. A polynomial of the fourth order was calculated through the points in the z-axis (normal to the phantom shell).
 - b. After the maximum interpolated values were calculated between the points in the cube, the SAR was averaged over the spatial volume (1g or 10g) using a 3D-Spline interpolation algorithm. The 3D-spline is composed of three one-dimensional splines with the "Not a knot" condition (in x, y, and z directions). The volume was then integrated with the trapezoidal algorithm. One thousand points (10 x 10 x 10) were obtained through interpolation, in order to calculate the averaged SAR.
 - c. All neighboring volumes were evaluated until no neighboring volume with a higher average value was found.
4. The SAR reference value, at the same location as step 2, was re-measured after the zoom scan was complete to calculate the SAR drift. If the drift deviated by more than 5%, the SAR test and drift measurements were repeated.

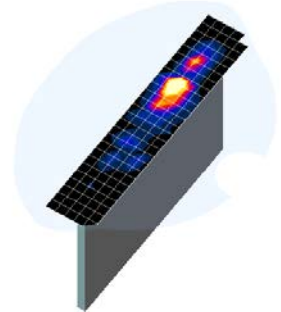



Figure 4-1
Sample SAR Area Scan

FCC ID: ZNFAS730		SAR EVALUATION REPORT		Reviewed by: Quality Manager
Document S/N: 0Y1204020393.ZNF	Test Dates: 03/30/12 - 04/19/12	DUT Type: Portable Handset		Page 7 of 32

5

DEFINITION OF REFERENCE POINTS

5.1 EAR REFERENCE POINT

Figure 5-2 shows the front, back and side views of the SAM Twin Phantom. The point “M” is the reference point for the center of the mouth, “LE” is the left ear reference point (ERP), and “RE” is the right ERP. The ERP is 15mm posterior to the entrance to the ear canal (EEC) along the B-M line (Back-Mouth), as shown in Figure 5-1. The plane passing through the two ear canals and M is defined as the Reference Plane. The line N-F (Neck-Front) is perpendicular to the reference plane and passing through the RE (or LE) is called the Reference Pivoting Line (see Figure 5-2). Line B-M is perpendicular to the N-F line. Both N-F and B-M lines are marked on the external phantom shell to facilitate handset positioning [5].

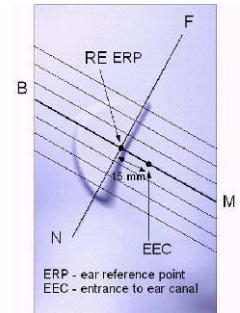

Figure 5-1
Close-Up Side view of ERP

5.2 HANDSET REFERENCE POINTS

Two imaginary lines on the handset were established: the vertical centerline and the horizontal line. The test device was placed in a normal operating position with the “test device reference point” located along the “vertical centerline” on the front of the device aligned to the “ear reference point” (See Figure 5-3). The “test device reference point” was then located at the same level as the center of the ear reference point. The test device was positioned so that the “vertical centerline” was bisecting the front surface of the handset at it’s top and bottom edges, positioning the “ear reference point” on the outer surface of the both the left and right head phantoms on the ear reference point.



Figure 5-2
Front, back and side view of SAM Twin Phantom

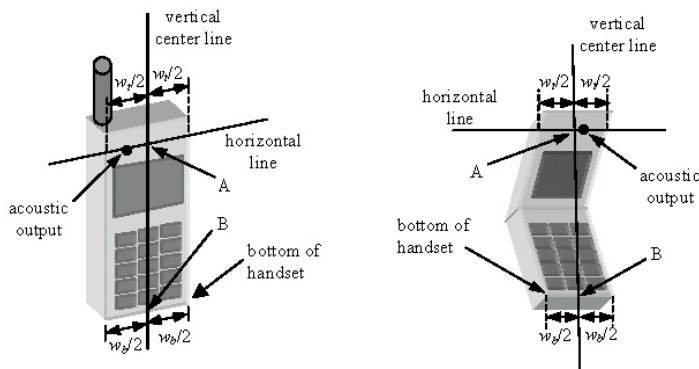

Figure 5-3
Handset Vertical Center & Horizontal Line Reference Points

FCC ID: ZNFAS730	PCTEST ENGINEERING LABORATORY, INC.	SAR EVALUATION REPORT	LG	Reviewed by: Quality Manager
Document S/N: 0Y1204020393.ZNF	Test Dates: 03/30/12 - 04/19/12	DUT Type: Portable Handset		Page 8 of 32

6 TEST CONFIGURATION POSITIONS FOR HANDSETS

6.1 Device Holder

The DASY device holder has been made out of low-loss POM material having the following dielectric parameters: relative permittivity $\epsilon = 3$ and loss tangent $\delta = 0.02$.

6.2 Positioning for Cheek/Touch

1. The test device was positioned with the handset close to the surface of the phantom such that point A is on the (virtual) extension of the line passing through points RE and LE on the phantom (see Figure 6-1), such that the plane defined by the vertical center line and the horizontal line of the phone is approximately parallel to the sagittal plane of the phantom.

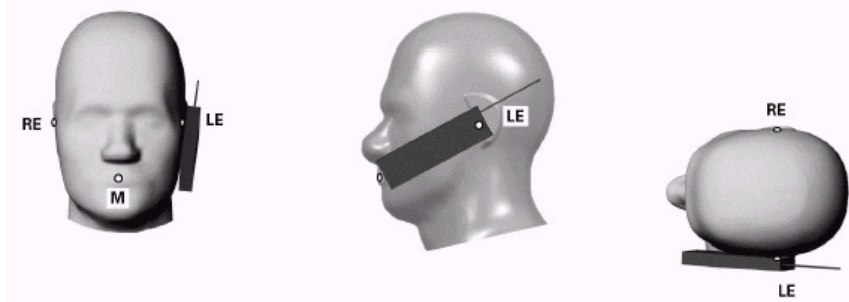



Figure 6-1 Front, Side and Top View of Cheek/Touch Position

2. The handset was translated towards the phantom along the line passing through RE & LE until the handset touches the ear.
3. While maintaining the handset in this plane, the handset was rotated around the LE-RE line until the vertical centerline was in the plane normal to MB-NF including the line MB (reference plane).
4. The phone was then rotated around the vertical centerline until the phone (horizontal line) was symmetrical with respect to the line NF.
5. While maintaining the vertical centerline in the reference plane, keeping point A on the line passing through RE and LE, and maintaining the phone contact with the ear, the handset was rotated about the line NF until any point on the handset made contact with a phantom point below the ear (cheek) (See Figure 6-2).

6.3 Positioning for Ear / 15° Tilt

With the test device aligned in the “Cheek/Touch Position”:

1. While maintaining the orientation of the phone, the phone was retracted parallel to the reference plane far enough to enable a rotation of the phone by 15degree.
2. The phone was then rotated around the horizontal line by 15 degree.
3. While maintaining the orientation of the phone, the phone was moved parallel to the reference plane until any part of the phone touches the head. (In this position, point A was located on the line RE-LE). The tilted position is obtained when the contact is on the pinna. If the contact was at any location other than the pinna, the angle of the phone would then be reduced. The tilted position was obtained when any part of the phone was in contact of the ear as well as a second part of the phone was in contact with the head (see Figure 6-2).

FCC ID: ZNFAS730		SAR EVALUATION REPORT		Reviewed by: Quality Manager
Document S/N: 0Y1204020393.ZNF	Test Dates: 03/30/12 - 04/19/12	DUT Type: Portable Handset		Page 9 of 32

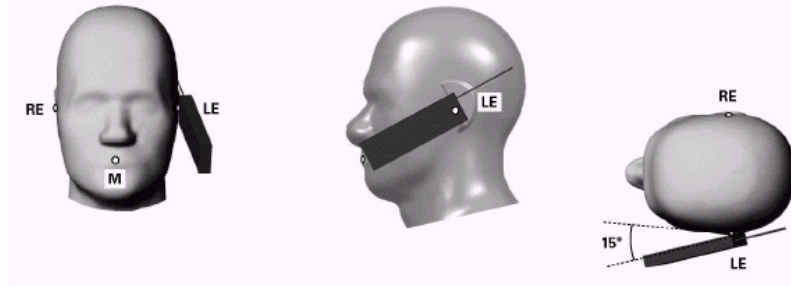

Figure 6-2 Front, Side and Top View of Ear/15° Tilt Position

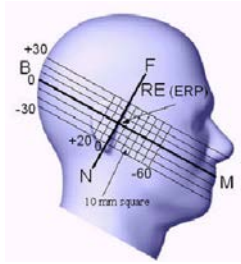

Figure 6-3 Side view w/ relevant markings



Figure 6-4 Body SAR Sample Photo (Not Actual EUT)

6.4 SAR Evaluations near the Mouth/Jaw Regions of the SAM Phantom

Antennas located near the bottom of a phone may require SAR measurements around the mouth and jaw regions of the SAM head phantom. This typically applies to clam-shell style phones that are generally longer in the unfolded normal use positions or to certain older style long rectangular phones.

Under these circumstances, the following procedures apply, adopted from the FCC guidance on SAR handsets document publication 648474. The SAR required in these regions of SAM should be measured using a flat phantom. **Rectangular shaped phones** should be positioned with its bottom edge positioned from the flat phantom with the same distance provided by the cheek touching position using SAM. The ear reference point (ERP, as defined for SAM) of the phone should be positioned ½ cm from the flat phantom shell. **Clam-shell phones** should be positioned with the hinge against a smooth edge of the flat phantom where the upper half of the phone is unfolded and extended beyond the phantom side wall. The lower half of the phone is secured in the test device holder at a fixed distance below the flat phantom determined by the minimum separation along the lower edge of the phone in the cheek touching position using SAM. Any case with substantial variation in separation distance along the lower edge of a clam shell is discussed with the FCC for best-to-use methodology.

The latest IEEE 1528 committee developments propose the usage of a tilted phantom when the antenna of the phone is mounted at the bottom or in all cases the peak absorption is in the chin region. Both SAM heads of the TwinSAM-Chin20 are rotated 20 degrees around the NF line. Each head can be removed individually from the table for emptying and cleaning.

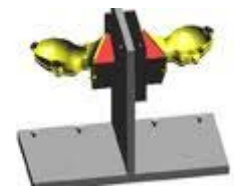



Figure 6-5 Twin SAM Chin20

6.5 Body-Worn Accessory Configurations

Body-worn operating configurations are tested with the belt-clips and holsters attached to the device and positioned against a flat phantom in a normal use configuration (see Figure 6-4). A device with a headset output is tested with a headset connected to the device.

FCC ID: ZNFAS730	 PCTEST ENGINEERING LABORATORY, INC.	SAR EVALUATION REPORT	 LG	Reviewed by: Quality Manager
Document S/N: 0Y1204020393.ZNF	Test Dates: 03/30/12 - 04/19/12	DUT Type: Portable Handset		Page 10 of 32



Accessories for Body-worn operation configurations are divided into two categories: those that do not contain metallic components and those that do contain metallic components. When multiple accessories that do not contain metallic components are supplied with the device, the device is tested with only the accessory that dictates the closest spacing to the body. Then multiple accessories that contain metallic components are tested with the device with each accessory. If multiple accessories share an identical metallic component (i.e. the same metallic belt-clip used with different holsters with no other metallic components) only the accessory that dictates the closest spacing to the body is tested.

Body-worn accessories may not always be supplied or available as options for some devices intended to be authorized for body-worn use. In this case, a test configuration with a separation distance between the back of the device and the flat phantom is used. Test position spacing was documented. Transmitters that are designed to operate in front of a person's face, as in push-to-talk configurations, are tested for SAR compliance with the front of the device positioned to face the flat phantom in head fluid. For devices that are carried next to the body such as a shoulder, waist or chest-worn transmitters, SAR compliance is tested with the accessories, including headsets and microphones, attached to the device and positioned against a flat phantom in a normal use configuration.

6.6 Wireless Router Configurations

Some battery-operated handsets have the capability to transmit and receive internet connectivity through simultaneous transmission of WIFI in conjunction with a separate licensed transmitter. The FCC has provided guidance in KDB Publication 941225 D06 where SAR test considerations for handsets ($L \times W \geq 9 \text{ cm} \times 5 \text{ cm}$) are based on a composite test separation distance of 10 mm from the front, back and edges of the device with antennas 2.5 cm or closer to the edge of the device, determined from general mixed use conditions for this type of devices. Since the hotspot SAR results may overlap with the body-worn accessory SAR requirements, the more conservative configurations can be considered, thus excluding some body-worn accessory SAR tests.

When the user enables the personal wireless router functions for the handset, actual operations include simultaneous transmission of both the WIFI transmitter and another licensed transmitter. Both transmitters often do not transmit at the same transmitting frequency and thus cannot be evaluated for SAR under actual use conditions. Therefore, SAR must be evaluated for each frequency transmission and mode separately and summed with the WIFI transmitter according to KDB 648474 publication procedures. The "Portable Hotspot" feature on the handset was NOT activated, to ensure the SAR measurements were evaluated for a single transmission frequency RF signal.

FCC ID: ZNFAS730	 PCTEST ENGINEERING LABORATORY, INC.	SAR EVALUATION REPORT	 LG	Reviewed by: Quality Manager
Document S/N: 0Y1204020393.ZNF	Test Dates: 03/30/12 - 04/19/12	DUT Type: Portable Handset		Page 11 of 32

7 FCC RF EXPOSURE LIMITS

7.1 Uncontrolled Environment

UNCONTROLLED ENVIRONMENTS are defined as locations where there is the exposure of individuals who have no knowledge or control of their exposure. The general population/uncontrolled exposure limits are applicable to situations in which the general public may be exposed or in which persons who are exposed as a consequence of their employment may not be made fully aware of the potential for exposure or cannot exercise control over their exposure. Members of the general public would come under this category when exposure is not employment-related; for example, in the case of a wireless transmitter that exposes persons in its vicinity.



7.2 Controlled Environment

CONTROLLED ENVIRONMENTS are defined as locations where there is exposure that may be incurred by persons who are aware of the potential for exposure, (i.e. as a result of employment or occupation). In general, occupational/controlled exposure limits are applicable to situations in which persons are exposed as a consequence of their employment, who have been made fully aware of the potential for exposure and can exercise control over their exposure. This exposure category is also applicable when the exposure is of a transient nature due to incidental passage through a location where the exposure levels may be higher than the general population/uncontrolled limits, but the exposed person is fully aware of the potential for exposure and can exercise control over his or her exposure by leaving the area or by some other appropriate means.

Table 7-1
SAR Human Exposure Specified in ANSI/IEEE C95.1-1992 and Health Canada Safety Code 6

HUMAN EXPOSURE LIMITS		
	UNCONTROLLED ENVIRONMENT <i>General Population</i> (W/kg) or (mW/g)	CONTROLLED ENVIRONMENT <i>Occupational</i> (W/kg) or (mW/g)
SPATIAL PEAK SAR Brain	1.6	8.0
SPATIAL AVERAGE SAR Whole Body	0.08	0.4
SPATIAL PEAK SAR Hands, Feet, Ankles, Wrists	4.0	20

1. The Spatial Peak value of the SAR averaged over any 1 gram of tissue (defined as a tissue volume in the shape of a cube) and over the appropriate averaging time.
2. The Spatial Average value of the SAR averaged over the whole body.
3. The Spatial Peak value of the SAR averaged over any 10 grams of tissue (defined as a tissue volume in the shape of a cube) and over the appropriate averaging time.

FCC ID: ZNFAS730	 PCTEST ENGINEERING LABORATORY, INC.	SAR EVALUATION REPORT	 LG	Reviewed by: Quality Manager
Document S/N: 0Y1204020393.ZNF	Test Dates: 03/30/12 - 04/19/12	DUT Type: Portable Handset		Page 12 of 32

8 FCC MEASUREMENT PROCEDURES

Power measurements were performed using a base station simulator under digital average power.

8.1 Procedures Used to Establish RF Signal for SAR

The following procedures are according to FCC KDB Publication 941225 D01 "SAR Measurement Procedures for 3G Devices" v02, October 2007.

The device was placed into a simulated call using a base station simulator in a RF shielded chamber. Establishing connections in this manner ensure a consistent means for testing SAR and are recommended for evaluating SAR [4]. Devices under test were evaluated prior to testing, with a fully charged battery and were configured to operate at maximum output power. In order to verify that the device was tested throughout the SAR test at maximum output power, the SAR measurement system measures a "point SAR" at an arbitrary reference point at the start and end of the 1 gram SAR evaluation, to assess for any power drifts during the evaluation. If the power drift deviated by more than 5%, the SAR test and drift measurements were repeated.

8.2 SAR Measurement Conditions for CDMA2000

The following procedures were performed according to FCC KDB Publication 941225 D01 "SAR Measurement Procedures for 3G Devices" v02, October 2007.

8.2.1 Output Power Verification

See 3GPP2 C.S0011/TIA-98-E as recommended by "SAR Measurement Procedures for 3G Devices" v02, October 2007. Maximum output power is verified on the High, Middle and Low channels according to procedures in section 4.4.5.2 of 3GPP2 C.S0011/TIA-98-E. SO55 tests were measured with power control bits in the "All Up" condition.

1. If the mobile station (MS) supports Reverse TCH RC 1 and Forward TCH RC 1, set up a call using Fundamental Channel Test Mode 1 (RC=1/1) with 9600 bps data rate only.
2. Under RC1, C.S0011 Table 4.4.5.2-1, Table 8-1 parameters were applied.
3. If the MS supports the RC 3 Reverse FCH, RC3 Reverse SCH₀ and demodulation of RC 3,4, or 5, set up a call using Supplemental Channel Test Mode 3 (RC 3/3) with 9600 bps Fundamental Channel and 9600 bps SCH0 data rate.
4. Under RC3, C.S0011 Table 4.4.5.2-2, Table 8-2 was applied.
5. FCHs were configured at full rate for maximum SAR with "All Up" power control bits.

Table 8-1
Parameters for Max. Power for RC1



Parameter	Units	Value
$\overline{I_{or}}$	dBm/1.23 MHz	-104
$\overline{Pilot E_c}$ $\overline{I_{or}}$	dB	-7
$\overline{Traffic E_c}$ $\overline{I_{or}}$	dB	-7.4

Table 8-2
Parameters for Max. Power for RC3

Parameter	Units	Value
$\overline{I_{or}}$	dBm/1.23 MHz	-86
$\overline{Pilot E_c}$ $\overline{I_{or}}$	dB	-7
$\overline{Traffic E_c}$ $\overline{I_{or}}$	dB	-7.4

8.2.2 CDMA2000 1x Advanced

This device additionally supports 1x Advanced. Conducted powers were measured using SO75 with RC8 on the uplink and RC11 on the downlink per Oct 2011 TCB Workshop notes. Smart blanking was disabled for all measurements. The EUT was configured with forward power control Mode 000 and reverse power control at 400 bps. Conducted powers were measured on an

FCC ID: ZNFAS730	 PCTEST ENGINEERING LABORATORY, INC.	SAR EVALUATION REPORT	 LG	Reviewed by: Quality Manager
Document S/N: 0Y1204020393.ZNF	Test Dates: 03/30/12 - 04/19/12	DUT Type: Portable Handset		Page 13 of 32

Agilent 8960 Series 10 Wireless Communications Test Set, Model E5515C using the CDMA2000 1x Advanced application, Option E1962B-410.

Based on the maximum output power measured for 1x Advanced, SAR would have to be evaluated for 1x advanced if the maximum output for 1x Advanced is more than 0.25 dB higher than the maximum measured for 1x. Also, if the measured SAR in any 1x mode exposure conditions (head, body etc.) is larger than 1.2 W/kg, the highest of those configurations above 1.2 W/kg for each exposure condition in 1x Advanced has to be repeated. All measured SAR in 1x mode higher than 1.5 W/kg must be repeated for 1x Advanced.

8.2.3 Head SAR Measurements

SAR for head exposure configurations is measured in RC3 with the DUT configured to transmit at full rate using Loopback Service Option SO55. SAR for RC1 is not required when the maximum average output of each channel is less than ¼ dB higher than that measured in RC3. Otherwise, SAR is measured on the maximum output channel in RC1 using the exposure configuration that results in the highest SAR for that channel in RC3.

8.2.4 Body SAR Measurements

SAR for body exposure configurations is measured in RC3 with the DUT configured to transmit at full rate on FCH with all other code channels disabled using TDSO / SO32. SAR for multiple code channels (FCH + SCH_n) is not required when the maximum average output of each RF channel is less than ¼ dB higher than that measured with FCH only. Otherwise, SAR is measured on the maximum output channel (FCH + SCH_n) with FCH at full rate and SCH₀ enabled at 9600 bps using the exposure configuration that results in the highest SAR for that channel with FCH only. When multiple code channels are enabled, the DUT output may shift by more than 0.5 dB and lead to higher SAR drifts and SCH dropouts. Body SAR was measured using TDSO / SO32 with power control bits in the “All Up”



Body SAR in RC1 is not required when the maximum average output of each channel is less than ¼ dB higher than that measured in RC3. Otherwise, SAR is measured on the maximum output channel in RC1; with Loopback Service Option SO55, at full rate, using the body exposure configuration that results in the highest SAR for that channel in RC3.

8.2.5 Handsets with EVDO

For handsets with Ev-Do capabilities, when the maximum average output of each channel in Rev. 0 is less than ¼ dB higher than that measured in RC3 (1x RTT), body SAR for EV-DO is not required. Otherwise, SAR for Rev. 0 is measured on the maximum output channel at 153.6 kbps using the body exposure configuration that results in the highest SAR for that channel in RC3. SAR for Rev. A is not required when the maximum average output of each channel is less than that measured in Rev. 0 or less than ¼ dB higher than that measured in RC3. Otherwise, SAR is measured on the maximum output channel for Rev. A using a Reverse Data Channel payload size of 4096 bits and a Termination Target of 16 slots defined for Subtype 2 Physical Layer configurations. A Forward Traffic Channel data rate corresponding to the 2-slot version of 307.2 kbps with the ACK Channel transmitting in all slots would be configured in the downlink for both Rev. 0 and Rev. A.

8.2.6 Body SAR Measurements for EVDO Hotspot

Hotspot Body SAR is measured using Subtype 0/1 Physical Layer configurations for Rev. 0 per KDB Publication 941225 D01 procedures for “1x Ev-Do data Devices”. SAR for Subtype 2 Physical layer configurations is not required for Rev. A when the maximum average output of each RF channels is less than that measured in Subtype 0/1 Physical layer configurations. Otherwise, SAR is measured on the maximum output channel for Rev. A using the exposure configuration that results in the highest SAR for the RF channels in Rev. 0. The AT is tested with a Reverse Data Channel rate of 153.6 kbps in Subtype 0/1 Physical Layer configurations; and a

FCC ID: ZNFAS730	 PCTEST ENGINEERING LABORATORY, INC.	SAR EVALUATION REPORT	 LG	Reviewed by: Quality Manager
Document S/N: 0Y1204020393.ZNF	Test Dates: 03/30/12 - 04/19/12	DUT Type: Portable Handset		Page 14 of 32

Reverse Data Channel payload size of 4096 bits and Termination Target of 16 slots in Subtype 2 Physical Layer configurations. Both FTAP and FETAP are configured with a Forward Traffic Channel data rate corresponding to the 2-slot version of 307.2 kbps with the ACK Channel transmitting in all slots. AT power control should be in "All Bits Up" conditions for TAP/ETAP

SAR is not required for 1x RTT for Ev-Do devices that also support 1x RTT voice and/or data operations, when the maximum average output of each channel is less than 1/4 dB higher than that measured in Subtype 0/1 Physical Layer configurations for Rev. 0. Otherwise, CDMA "Body-SAR Measurement" procedures for "CDMA 2000 1x Handsets" were applied.

8.3 SAR Testing with 802.11 Transmitters

Normal network operating configurations are not suitable for measuring the SAR of 802.11 b/g/n transmitters. Unpredictable fluctuations in network traffic and antenna diversity conditions can introduce undesirable variations in SAR results. The SAR for these devices should be measured using chipset based test mode software to ensure the results are consistent and reliable. See KDB Publication 248227 for more details.



8.3.1 General Device Setup

Chipset based test mode software is hardware dependent and generally varies among manufacturers. The device operating parameters established in test mode for SAR measurements must be identical to those programmed in production units, including output power levels, amplifier gain settings and other RF performance tuning parameters. The test frequencies should correspond to actual channel frequencies defined for domestic use. SAR for devices with switched diversity should be measured with only one antenna transmitting at a time during each SAR measurement, according to a fixed modulation and data rate. The same data pattern should be used for all measurements.

8.3.2 Frequency Channel Configurations [27]

For 2.4 GHz, the highest average RF output power channel between the low, mid and high channel at the lowest data rate was selected for SAR evaluation in 802.11b mode. 802.11g/n modes and higher data rates for 802.11b were additionally evaluated for SAR if the output power of the respective mode was 0.25 dB or higher than the powers of the SAR configurations tested in the 802.11b mode.

If the maximum extrapolated peak SAR of the zoom scan for the highest output channel was less than 1.6 W/kg or if the 1g averaged SAR was less than 0.8 W/kg, SAR testing was not required for the other test channels in the band.

FCC ID: ZNFAS730	 PCTEST ENGINEERING LABORATORY, INC.	SAR EVALUATION REPORT	 LG	Reviewed by: Quality Manager
Document S/N: 0Y1204020393.ZNF	Test Dates: 03/30/12 - 04/19/12	DUT Type: Portable Handset		Page 15 of 32

9 RF CONDUCTED POWERS

9.1 CDMA Conducted Powers

Band	Channel	Frequency	SO55 [dBm]	SO55 [dBm]	SO75 [dBm]	TDSO SO32 [dBm]	TDSO SO32 [dBm]	1x EvDO Rev. 0 [dBm]	1x EvDO Rev. A [dBm]
	F-RC	MHz	RC1	RC3	RC8 (up) / RC11 (down)	FCH+SCH	FCH	(RTAP)	(RETAP)
Cellular	1013	824.7	24.62	24.56	24.66	24.44	24.41	24.48	24.47
	384	836.52	24.80	24.67	24.68	24.53	24.47	24.58	24.57
	777	848.31	24.70	24.63	24.61	24.40	24.37	24.52	24.51
PCS	25	1851.25	24.19	24.08	24.15	24.03	24.07	24.01	24.00
	600	1880	24.30	24.20	24.24	24.10	24.03	24.06	24.05
	1175	1908.75	24.15	24.40	24.13	23.97	23.89	23.90	23.89

Note: RC1 is only applicable for IS-95 compatibility.

Per KDB Publication 941225 D01:

1. Head SAR was tested with SO55 RC3. SO55 RC1 was not required since the average output power was not more than 0.25 dB than the SO55 RC3 powers.
2. Body-Worn SAR was tested with 1x RTT with TDSO / SO32 FCH Only. Ev-Do and TDSO / SO32 FCH+SCH SAR tests were not required since the average output power was not more than 0.25 dB higher than the TDSO / SO32 FCH only powers.
3. CDMA Wireless Router SAR is measured using Subtype 0/1 Physical Layer configurations for Rev. 0 according to KDB 941225 D01 procedures for data devices. If the average output power of Subtype 2 for Rev. A is less than the Rev. 0 power levels, then Rev. A SAR is not required. Otherwise, SAR is measured on the maximum output channel for Rev. A using the exposure configuration that results in the highest SAR for that RF channel in Rev. 0. SAR is not required for 1x RTT for Ev-Do hotspot devices when the maximum average output of each channel is less than 1/4 dB higher than that measured in Subtype 0/1 Physical Layer configurations for Rev. 0.

Per Oct 2011 TCB Workshop:

1. CDMA 1X Advanced technology was not required for SAR since the maximum output powers for 1x Advanced was not more than 0.25 dB higher than the maximum measured powers for 1x and the measured SAR in any 1x mode exposure conditions was not greater than 1.2 W/kg. See Section 8.2.2 for 1x Advanced test set up.
2. CDMA 1x Advanced SO75 power measurement was used with RC8 on the uplink and RC11 on the downlink.



Figure 9-1
Power Measurement Setup

FCC ID: ZNFAS730	PCTEST ENGINEERING LABORATORY, INC.	SAR EVALUATION REPORT	LG	Reviewed by: Quality Manager
Document S/N: 0Y1204020393.ZNF	Test Dates: 03/30/12 - 04/19/12	DUT Type: Portable Handset		Page 16 of 32



9.2 WLAN Conducted Powers

Table 9-1
IEEE 802.11b Average RF Power

Freq [MHz]	Channel	Data Rate [Mbps]	Average Power (dBm)
2412	1	1	15.63
		2	15.61
		5.5	15.79
		11	15.89
2437	6	1	15.66
		2	15.67
		5.5	15.61
		11	15.57
2462	11	1	16.14
		2	15.86
		5.5	15.98
		11	16.09

Table 9-2
IEEE 802.11g Average RF Power

Freq [MHz]	Channel	Data Rate [Mbps]	Average Power (dBm)
2412	1	6	12.74
		9	12.51
		12	12.44
		18	12.38
		24	12.42
		36	12.07
		48	12.48
		54	12.83
2437	6	6	12.87
		9	12.42
		12	12.37
		18	12.31
		24	12.71
		36	12.59
		48	12.68
		54	12.56
2462	11	6	12.13
		9	12.76
		12	12.08
		18	12.37
		24	12.71
		36	12.07
		48	12.04
		54	12.05

FCC ID: ZNFAS730	 PCTEST ENGINEERING LABORATORY, INC.	SAR EVALUATION REPORT	 LG	Reviewed by: Quality Manager
Document S/N: 0Y1204020393.ZNF	Test Dates: 03/30/12 - 04/19/12	DUT Type: Portable Handset	Page 17 of 32	

**Table 9-3
IEEE 802.11n Average RF Power**



Freq [MHz]	Channel	Data Rate [Mbps]	Average Power (dBm)
2412	1	6.5/7.2	11.61
		13/14.40	11.52
		19.5/21.70	11.68
		26/28.90	11.74
		29/43.3	11.84
		52/57.80	11.56
		58.50/65	11.51
		65/72.2	11.38
2437	6	6.5/7.2	11.66
		13/14.40	11.60
		19.5/21.70	11.46
		26/28.90	11.66
		29/43.3	11.64
		52/57.80	11.75
		58.50/65	11.78
		65/72.2	11.48
2462	11	6.5/7.2	11.11
		13/14.40	11.65
		19.5/21.70	11.52
		26/28.90	11.39
		29/43.3	10.91
		52/57.80	11.47
		58.50/65	11.32
		65/72.2	11.36

Justification for reduced test configurations for WIFI channels per KDB Publication 248227 and April 2010 FCC/TCB Meeting Notes:

- For 2.4 GHz, highest average RF output power channel for the lowest data rate for IEEE 802.11b were selected for SAR evaluation. Other IEEE 802.11 modes (including 802.11g/n) were not investigated since the average output powers over all channels and data rates were not more than 0.25 dB higher than the tested channel in the lowest data rate of IEEE 802.11b mode.
- When the maximum extrapolated peak SAR of the zoom scan for the maximum output channel is <1.6 W/kg and the 1g averaged SAR is <0.8 W/kg, SAR testing on other channels is not required. Otherwise, the other default (or corresponding required) test channels were additionally tested using the lowest data rate.
- The bolded data rate and channel above were tested for SAR.



**Figure 9-2
Power Measurement Setup**

FCC ID: ZNFAS730	 PCTEST ENGINEERING LABORATORY, INC.	SAR EVALUATION REPORT	 LG	Reviewed by: Quality Manager
Document S/N: 0Y1204020393.ZNF	Test Dates: 03/30/12 - 04/19/12	DUT Type: Portable Handset	Page 18 of 32	

10 SYSTEM VERIFICATION

10.1 Tissue Verification

**Table 10-1
Measured Tissue Properties**

Calibrated for Tests Performed on:	Tissue Type	Tissue Temp During Calibration (C°)	Measured Frequency (MHz)	Measured Conductivity, σ (S/m)	Measured Dielectric Constant, ϵ	TARGET Conductivity, σ (S/m)	TARGET Dielectric Constant, ϵ	% dev σ	% dev ϵ
04/17/2012	835H	23.0	820	0.901	42.75	0.90	41.57	0.33%	2.84%
			835	0.910	42.29	0.90	41.50	1.11%	1.90%
			850	0.925	42.07	0.92	41.50	0.98%	1.37%
04/18/2012	1900H	22.9	1850	1.377	38.53	1.40	40.00	-1.64%	-3.68%
			1880	1.405	38.39	1.40	40.00	0.36%	-4.03%
			1910	1.435	38.27	1.40	40.00	2.50%	-4.32%
03/30/2012	2450H	23.6	2401	1.813	39.41	1.76	39.30	3.13%	0.29%
			2450	1.870	39.27	1.80	39.20	3.89%	0.18%
			2499	1.921	38.98	1.85	39.14	3.73%	-0.40%
04/19/2012	835B	23.5	820	0.970	52.66	0.97	55.28	0.10%	-4.75%
			835	0.984	52.57	0.97	55.20	1.44%	-4.76%
			850	0.998	52.41	0.99	55.15	1.01%	-4.98%
04/19/2012	1900B	23.1	1850	1.493	53.17	1.52	53.30	-1.78%	-0.24%
			1880	1.528	53.07	1.52	53.30	0.53%	-0.43%
			1910	1.560	52.93	1.52	53.30	2.63%	-0.69%
03/30/2012	2450B	22.2	2401	1.916	51.46	1.90	52.77	0.68%	-2.47%
			2450	1.991	51.30	1.95	52.70	2.10%	-2.66%
			2499	2.061	51.17	2.02	52.64	2.08%	-2.79%

Note: KDB Publication 450824 was ensured to be applied for probe calibration frequencies greater than or equal to 50 MHz of the DUT frequencies.



The above measured tissue parameters were used in the DASY software to perform interpolation via the DASY software to determine actual dielectric parameters at the test frequencies (per IEEE 1528 6.6.1.2). The SAR test plots may slightly differ from the table above since the DASY software rounds to three significant digits.

10.2 Measurement Procedure for Tissue verification

- 1) The network analyzer and probe system was configured and calibrated.
- 2) The probe was immersed in the sample which was placed in a nonmetallic container. Trapped air bubbles beneath the flange were minimized by placing the probe at a slight angle.
- 3) The complex admittance with respect to the probe aperture was measured
- 4) The complex relative permittivity ϵ can be calculated from the below equation (Pournaropoulos and Misra):

$$Y = \frac{j2\omega\epsilon_r\epsilon_0}{[\ln(b/a)]^2} \int_a^b \int_a^b \int_0^\pi \cos\phi' \frac{\exp[-j\omega r(\mu_0\epsilon_r'\epsilon_0)^{1/2}]}{r} d\phi'd\rho'd\rho$$

where Y is the admittance of the probe in contact with the sample, the primed and unprimed coordinates refer to source and observation points, respectively, $r^2 = \rho^2 + \rho'^2 - 2\rho\rho'\cos\phi'$, ω is the angular frequency, and $j = \sqrt{-1}$.

FCC ID: ZNFAS730	 PCTEST ENGINEERING LABORATORY, INC.	SAR EVALUATION REPORT	 LG	Reviewed by: Quality Manager
Document S/N: 0Y1204020393.ZNF	Test Dates: 03/30/12 - 04/19/12	DUT Type: Portable Handset		Page 19 of 32

10.3 Test System Verification

Prior to assessment, the system is verified to $\pm 10\%$ of the manufacturer SAR measurement on the reference dipole at the time of calibration.

**Table 10-2
System Verification Results**

System Verification TARGET & MEASURED											
Tissue Frequency (MHz)	Tissue Type	Date:	Amb. Temp (°C)	Liquid Temp (°C)	Input Power (W)	Dipole SN	Probe SN	Measured SAR _{1g} (W/kg)	1 W Target SAR _{1g} (W/kg)	1 W Normalized SAR _{1g} (W/kg)	Deviation (%)
835	Head	04/17/2012	23.1	22.4	0.100	4d026	3258	0.959	9.460	9.590	1.37%
1900	Head	04/18/2012	23.1	22.6	0.100	502	3022	3.9	39.200	39.000	-0.51%
2450	Head	03/30/2012	23.8	22.0	0.100	719	3209	5.38	53.800	53.800	0.00%
835	Body	04/19/2012	23.0	22.7	0.100	4d026	3258	1.04	9.660	10.400	7.66%
1900	Body	04/19/2012	22.1	21.8	0.100	502	3022	3.72	38.900	37.200	-4.37%
2450	Body	03/30/2012	24.2	22.1	0.100	719	3209	5.52	51.300	55.200	7.60%

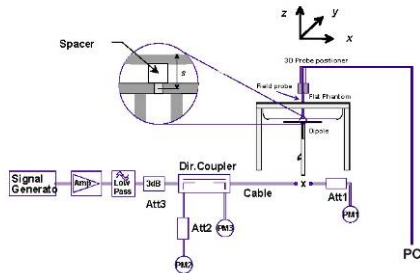

**Figure 10-1
System Verification Setup Diagram**



**Figure 10-2
System Verification Setup Photo**

FCC ID: ZNFAS730	PCTEST ENGINEERING LABORATORY, INC.	SAR EVALUATION REPORT	LG	Reviewed by: Quality Manager
Document S/N: 0Y1204020393.ZNF	Test Dates: 03/30/12 - 04/19/12	DUT Type: Portable Handset		Page 20 of 32

11 SAR DATA SUMMARY



11.1 Standalone Head SAR Data

**Table 11-1
Cell. CDMA Head SAR Results**

MEASUREMENT RESULTS								
FREQUENCY		Mode/Band	Conducted Power [dBm]	Power Drift [dB]	Side	Test Position	Device Serial Number	SAR (1g)
MHz	Ch.							(W/kg)
836.52	384	Cell. CDMA	24.67	-0.02	Right	Touch	A0000031D1725C	0.765
836.52	384	Cell. CDMA	24.67	-0.03	Right	Tilt	A0000031D1725C	0.435
836.52	384	Cell. CDMA	24.67	0.06	Left	Touch	A0000031D1725C	0.651
836.52	384	Cell. CDMA	24.67	0.01	Left	Tilt	A0000031D1725C	0.405
ANSI / IEEE C95.1 1992 - SAFETY LIMIT Spatial Peak Uncontrolled Exposure/General Population					Head 1.6 W/kg (mW/g) averaged over 1 gram			

**Table 11-2
PCS CDMA Head SAR Results**

MEASUREMENT RESULTS								
FREQUENCY		Mode/Band	Conducted Power [dBm]	Power Drift [dB]	Side	Test Position	Device Serial Number	SAR (1g)
MHz	Ch.							(W/kg)
1880.00	600	PCS CDMA	24.20	-0.03	Right	Touch	A0000031D1725C	0.501
1880.00	600	PCS CDMA	24.20	-0.05	Right	Tilt	A0000031D1725C	0.313
1851.25	25	PCS CDMA	24.08	-0.01	Left	Touch	A0000031D1725C	0.874
1880.00	600	PCS CDMA	24.20	-0.08	Left	Touch	A0000031D1725C	0.901
1908.75	1175	PCS CDMA	24.40	-0.09	Left	Touch	A0000031D1725C	1.160
1880.00	600	PCS CDMA	24.20	-0.17	Left	Tilt	A0000031D1725C	0.339
ANSI / IEEE C95.1 1992 - SAFETY LIMIT Spatial Peak Uncontrolled Exposure/General Population					Head 1.6 W/kg (mW/g) averaged over 1 gram			

FCC ID: ZNFAS730	 PCTEST ENGINEERING LABORATORY, INC.	SAR EVALUATION REPORT	 LG	Reviewed by: Quality Manager
Document S/N: 0Y1204020393.ZNF	Test Dates: 03/30/12 - 04/19/12	DUT Type: Portable Handset		Page 21 of 32

**Table 11-3
2.4 GHz WLAN Head SAR Results**

MEASUREMENT RESULTS										
FREQUENCY		Mode	Service	Conducted Power [dBm]	Power Drift [dB]	Side	Test Position	Device Serial Number	Data Rate (Mbps)	SAR (1g)
MHz	Ch.									(W/kg)
2462	11	IEEE 802.11b	DSSS	16.14	0.07	Right	Touch	A0000031D17249	1	0.771
2462	11	IEEE 802.11b	DSSS	16.14	-0.01	Right	Tilt	A0000031D17249	1	0.435
2462	11	IEEE 802.11b	DSSS	16.14	0.03	Left	Touch	A0000031D17249	1	0.335
2462	11	IEEE 802.11b	DSSS	16.14	0.00	Left	Tilt	A0000031D17249	1	0.265
ANSI / IEEE C95.1 1992 - SAFETY LIMIT Spatial Peak Uncontrolled Exposure/General Population						Head 1.6 W/kg (mW/g) averaged over 1 gram				

11.2 Standalone Body-Worn SAR Data



**Table 11-4
Licensed Transmitter Body-Worn SAR Results**

MEASUREMENT RESULTS									
FREQUENCY		Mode	Service	Conducted Power [dBm]	Power Drift [dB]	Spacing	Device Serial Number	Side	SAR (1g)
MHz	Ch.								(W/kg)
824.70	1013	Cell. CDMA	TDSO / SO32	24.41	0.03	1.0 cm	A0000031D1725C	back	0.765
836.52	384	Cell. CDMA	TDSO / SO32	24.47	0.01	1.0 cm	A0000031D1725C	back	0.868
848.31	777	Cell. CDMA	TDSO / SO32	24.37	0.02	1.0 cm	A0000031D1725C	back	0.716
1851.25	25	PCS CDMA	TDSO / SO32	24.07	-0.08	1.0 cm	A0000031D1725C	back	0.868
1880.00	600	PCS CDMA	TDSO / SO32	24.03	0.16	1.0 cm	A0000031D1725C	back	0.850
1908.75	1175	PCS CDMA	TDSO / SO32	23.89	0.19	1.0 cm	A0000031D1725C	back	0.990
ANSI / IEEE C95.1 1992 - SAFETY LIMIT Spatial Peak Uncontrolled Exposure/General Population						Body 1.6 W/kg (mW/g) averaged over 1 gram			

**Table 11-5
WLAN Body-Worn SAR Results**

MEASUREMENT RESULTS										
FREQUENCY		Mode	Service	Conducted Power [dBm]	Power Drift [dB]	Spacing	Device Serial Number	Data Rate (Mbps)	Side	SAR (1g)
MHz	Ch.									(W/kg)
2462	11	IEEE 802.11b	DSSS	16.14	-0.14	1.0 cm	A0000031D17249	1	back	0.127
ANSI / IEEE C95.1 1992 - SAFETY LIMIT Spatial Peak Uncontrolled Exposure/General Population						Body 1.6 W/kg (mW/g) averaged over 1 gram				



Note: For IEEE 802.11b mode, Hotspot SAR Data was considered to determine body-worn SAR compliance per FCC KDB Publication 941225 D06.

FCC ID: ZNFAS730	 PCTEST ENGINEERING LABORATORY, INC.	SAR EVALUATION REPORT		Reviewed by: Quality Manager
Document S/N: 0Y1204020393.ZNF	Test Dates: 03/30/12 - 04/19/12	DUT Type: Portable Handset		Page 22 of 32

11.3 Standalone Wireless Router SAR Data

Table 11-6
Licensed Transmitter Hotspot SAR Data

MEASUREMENT RESULTS									
FREQUENCY		Mode	Service	Conducted Power [dBm]	Power Drift [dB]	Spacing	Device Serial Number	Side	SAR (1g)
MHz	Ch.								(W/kg)
824.70	1013	Cell. CDMA	EVDO Rev. 0	24.48	0.10	1.0 cm	A0000031D1725C	back	1.160
836.52	384	Cell. CDMA	EVDO Rev. 0	24.58	-0.01	1.0 cm	A0000031D1725C	back	1.290
848.31	777	Cell. CDMA	EVDO Rev. 0	24.52	0.09	1.0 cm	A0000031D1725C	back	1.210
824.70	1013	Cell. CDMA	EVDO Rev. 0	24.48	0.00	1.0 cm	A0000031D1725C	front	0.862
836.52	384	Cell. CDMA	EVDO Rev. 0	24.58	-0.01	1.0 cm	A0000031D1725C	front	1.030
848.31	777	Cell. CDMA	EVDO Rev. 0	24.52	0.04	1.0 cm	A0000031D1725C	front	0.985
836.52	384	Cell. CDMA	EVDO Rev. 0	24.58	0.00	1.0 cm	A0000031D1725C	bottom	0.121
824.70	1013	Cell. CDMA	EVDO Rev. 0	24.48	0.02	1.0 cm	A0000031D1725C	right	0.805
836.52	384	Cell. CDMA	EVDO Rev. 0	24.58	-0.07	1.0 cm	A0000031D1725C	right	0.979
848.31	777	Cell. CDMA	EVDO Rev. 0	24.52	0.12	1.0 cm	A0000031D1725C	right	0.920
824.70	1013	Cell. CDMA	EVDO Rev. 0	24.48	0.09	1.0 cm	A0000031D1725C	left	0.774
836.52	384	Cell. CDMA	EVDO Rev. 0	24.58	0.03	1.0 cm	A0000031D1725C	left	0.933
848.31	777	Cell. CDMA	EVDO Rev. 0	24.52	0.03	1.0 cm	A0000031D1725C	left	0.870
1851.25	25	PCS CDMA	EVDO Rev. 0	24.01	0.08	1.0 cm	A0000031D1725C	back	0.871
1880.00	600	PCS CDMA	EVDO Rev. 0	24.06	-0.07	1.0 cm	A0000031D1725C	back	0.830
1908.75	1175	PCS CDMA	EVDO Rev. 0	23.90	-0.02	1.0 cm	A0000031D1725C	back	0.944
1851.25	25	PCS CDMA	EVDO Rev. 0	24.01	0.05	1.0 cm	A0000031D1725C	front	0.947
1880.00	600	PCS CDMA	EVDO Rev. 0	24.06	0.00	1.0 cm	A0000031D1725C	front	0.904
1908.75	1175	PCS CDMA	EVDO Rev. 0	23.90	0.06	1.0 cm	A0000031D1725C	front	1.040
1880.00	600	PCS CDMA	EVDO Rev. 0	24.06	0.12	1.0 cm	A0000031D1725C	bottom	0.582
1880.00	600	PCS CDMA	EVDO Rev. 0	24.06	-0.02	1.0 cm	A0000031D1725C	right	0.205
1880.00	600	PCS CDMA	EVDO Rev. 0	24.06	-0.14	1.0 cm	A0000031D1725C	left	0.585
ANSI / IEEE C95.1 1992 - SAFETY LIMIT						Body			
Spatial Peak						1.6 W/kg (mW/g)			
Uncontrolled Exposure/General Population						averaged over 1 gram			

FCC ID: ZNFAS730	 PCTEST ENGINEERING LABORATORY, INC.	SAR EVALUATION REPORT		Reviewed by: Quality Manager
Document S/N: 0Y1204020393.ZNF	Test Dates: 03/30/12 - 04/19/12	DUT Type: Portable Handset		Page 23 of 32

**Table 11-7
WLAN Hotspot SAR Data**

MEASUREMENT RESULTS										
FREQUENCY		Mode	Service	Conducted Power [dBm]	Power Drift [dB]	Spacing	Device Serial Number	Data Rate (Mbps)	Side	SAR (1g)
MHz	Ch.									(W/kg)
2462	11	IEEE 802.11b	DSSS	16.14	-0.14	1.0 cm	A0000031D17249	1	back	0.127
2462	11	IEEE 802.11b	DSSS	16.14	-0.15	1.0 cm	A0000031D17249	1	front	0.165
2462	11	IEEE 802.11b	DSSS	16.14	-0.01	1.0 cm	A0000031D17249	1	top	0.096
2462	11	IEEE 802.11b	DSSS	16.14	-0.11	1.0 cm	A0000031D17249	1	left	0.122
ANSI / IEEE C95.1 1992 - SAFETY LIMIT Spatial Peak Uncontrolled Exposure/General Population						Body 1.6 W/kg (mW/g) averaged over 1 gram				



11.4 SAR Test Notes

General Notes:

1. The test data reported are the worst-case SAR value with the position set in a typical configuration. Test procedures used were according to FCC/OET Bulletin 65, Supplement C [June 2001].
2. Batteries are fully charged for all readings. The standard battery was used.
3. Tissue parameters and temperatures are listed on the SAR plots.
4. Liquid tissue depth was at least 15.0 cm. To confirm the proper SAR liquid depth, the z-axis plots from the system verifications were included since the system verifications were performed using the same liquid, probe and DAE as the SAR tests in the same time period.
5. The manufacturer has confirmed that the device(s) tested have the same physical, mechanical and thermal characteristics and are within operational tolerances expected for production units
6. Per FCC/OET Bulletin 65 Supplement C and Public Notice DA-02-1438, if the SAR measured at the middle channel for each test configuration is at least 3.0 dB lower than the SAR limit, testing at the high and low channels is optional for such test configuration(s).

CDMA Notes:

1. Head SAR for CDMA2000 mode was tested under RC3/SO55 per KDB Publication 941225 D01.
2. Body-Worn SAR was tested with 1x RTT with TDSO / SO32 FCH Only. Ev-Do and TDSO / SO32 FCH+SCH SAR tests were not required since the average output power was not more than 0.25 dB higher than the TDSO / SO32 FCH only powers.
3. Device was tested using a fixed spacing for body-worn accessory testing. A separation distance of 10 mm was considered because the manufacturer has determined that there will be body-worn accessories available in the marketplace for users to support this separation distance.
4. CDMA 1X Advanced was not required for SAR testing since the maximum output powers for 1x Advanced was not more than 0.25 dB higher than the maximum measured powers for 1x and the measured SAR in any 1x mode exposure conditions was not greater than 1.2 W/kg.
5. CDMA Wireless Router SAR is measured using Subtype 0/1 Physical Layer configurations for Rev. 0 according to KDB 941225 D01 procedures for data devices. If the average output power of Subtype 2 for Rev. A is less than the Rev. 0 power levels, then Rev. A SAR is not required. Otherwise, SAR is measured on the maximum output channel for Rev. A using the exposure configuration that results in the highest SAR for that RF channel in Rev. 0. SAR is not required for

FCC ID: ZNFAS730	 PCTEST ENGINEERING LABORATORY, INC.	SAR EVALUATION REPORT		Reviewed by: Quality Manager
Document S/N: 0Y1204020393.ZNF	Test Dates: 03/30/12 - 04/19/12	DUT Type: Portable Handset		Page 24 of 32



1x RTT for Ev-Do hotspot devices when the maximum average output of each channel is less than 1/4 dB higher than that measured in Subtype 0/1 Physical Layer configurations for Rev. 0.

WLAN Notes:

1. Justification for reduced test configurations for WIFI channels per KDB Publication 248227 and April 2010 FCC/TCB Meeting Notes for 2.4 GHz WIFI: Highest average RF output power channel for the lowest data rate was selected for SAR evaluation in 802.11b. Other IEEE 802.11 modes (including 802.11g/n) were not investigated since the average output powers over all channels and data rates were not more than 0.25 dB higher than the tested channel in the lowest data rate of IEEE 802.11b mode.
2. WLAN transmission was verified using an uncalibrated spectrum analyzer.
3. When the maximum extrapolated peak SAR of the zoom scan for the maximum output channel is <1.6 W/kg and the 1g averaged SAR is <0.8 W/kg, SAR testing on other channels is not required. Otherwise, the other default (or corresponding required) test channels were additionally tested using the lowest data rate.
4. Per FCC KDB Publication 941225 D06, when the same wireless modes and device transmission configurations are required for body-worn accessories and hotspot mode, it is not necessary to additionally test body-worn accessory SAR for the same device orientation. Therefore, the hotspot data for the back side configuration additionally shows body-worn compliance at the same distance.

Hotspot Notes:

1. Top Edge for the licensed transmitter was not tested since the antenna distance from the edge was greater than 2.5 cm per FCC KDB Publication 941225 D06 guidance (see Section 1.2).
2. Bottom Edge and Right Edge for the WLAN transmitter were not tested since the antenna distance from the edge was greater than 2.5 cm per FCC KDB Publication 941225 D06 (see Section 1.2).
3. During SAR Testing for the Wireless Router conditions per KDB 941225 D06, the actual Portable Hotspot operation (with actual simultaneous transmission of a transmitter with WIFI) was not activated (See Section 6.6.)

FCC ID: ZNFAS730		SAR EVALUATION REPORT		Reviewed by: Quality Manager
Document S/N: 0Y1204020393.ZNF	Test Dates: 03/30/12 - 04/19/12	DUT Type: Portable Handset	Page 25 of 32	

12 FCC MULTI-TX AND ANTENNA SAR CONSIDERATIONS

12.1 Introduction

The following procedures adopted from “FCC SAR Considerations for Cell Phones with Multiple Transmitters” FCC KDB Publication 648474 are applicable to handsets with built-in unlicensed transmitters such as 802.11b/g/n and Bluetooth devices which may simultaneously transmit with the licensed transmitter.

12.2 FCC Power Tables & Conditions

	2.45	5.15 - 5.35	5.47 - 5.85	GHz
P_{Ref}	12	6	5	mW

Device output power should be rounded to the nearest mW to compare with values specified in this table.



Figure 12-1
Output Power Thresholds for Unlicensed Transmitters

	Individual Transmitter	Simultaneous Transmission
Licensed Transmitters	<u>Routine evaluation required</u>	SAR not required: <u>Unlicensed only</u>
Unlicensed Transmitters	<p><u>When there is no simultaneous transmission –</u></p> <ul style="list-style-type: none"> output $\leq 60/f$: SAR not required output $> 60/f$: stand-alone SAR required <p><u>When there is simultaneous transmission –</u></p> <p><u>Stand-alone SAR not required when</u></p> <ul style="list-style-type: none"> output $\leq 2 \cdot P_{Ref}$ and antenna is ≥ 5.0 cm from other antennas output $\leq P_{Ref}$ and antenna is ≥ 2.5 cm from other antennas output $\leq P_{Ref}$ and antenna is < 2.5 cm from other antennas, each with either output power $\leq P_{Ref}$ or 1-g SAR < 1.2 W/kg <p><u>Otherwise stand-alone SAR is required</u></p> <p><u>When stand-alone SAR is required</u></p> <ul style="list-style-type: none"> test SAR on highest output channel for each wireless mode and exposure condition if SAR for highest output channel is $> 50\%$ of SAR limit, evaluate all channels according to normal procedures 	<ul style="list-style-type: none"> when stand-alone 1-g SAR is not required and antenna is ≥ 5 cm from other antennas <p><u>Licensed & Unlicensed</u></p> <ul style="list-style-type: none"> when the sum of the 1-g SAR is < 1.6 W/kg for all simultaneous transmitting antennas when SAR to peak location separation ratio of simultaneous transmitting antenna pair is < 0.3 <p>SAR required:</p> <p><u>Licensed & Unlicensed</u></p> <p>antenna pairs with SAR to peak location separation ratio ≥ 0.3; test is only required for the configuration that results in the highest SAR in stand-alone configuration for each wireless mode and exposure condition</p> <p>Note: simultaneous transmission exposure conditions for head and body can be different for different style phones; therefore, different test requirements may apply</p>

Figure 12-2
SAR Evaluation Requirements for Multiple Transmitter Handsets

According to Figure 12-1 and Figure 12-2, simultaneous transmission analysis of SAR may be required for this device for the licensed and unlicensed transmitters. Possible simultaneous transmissions for this device were numerically summed using stand-alone SAR data and are shown in the following tables.

Per KDB Publication 648474, standalone Bluetooth SAR tests were not required. Standalone SAR tests for WLAN were required. See Section 1.3(A) for more information.

FCC ID: ZNFAS730	 PCTEST ENGINEERING LABORATORY, INC.	SAR EVALUATION REPORT		Reviewed by: Quality Manager
Document S/N: 0Y1204020393.ZNF	Test Dates: 03/30/12 - 04/19/12	DUT Type: Portable Handset		Page 26 of 32

12.3 Head SAR Simultaneous Transmission Analysis

Table 12-1
Simultaneous Transmission Scenario (Held to Ear)

Simult Tx	Configuration	Cell. CDMA SAR (W/kg)	2.4 GHz WLAN SAR (W/kg)	Σ SAR (W/kg)	Simult Tx	Configuration	PCS CDMA SAR (W/kg)	2.4 GHz WLAN SAR (W/kg)	Σ SAR (W/kg)
Head SAR	Right Cheek	0.765	0.771	1.536	Head SAR	Right Cheek	0.501	0.771	1.272
	Right Tilt	0.435	0.435	0.870		Right Tilt	0.313	0.435	0.748
	Left Cheek	0.651	0.335	0.986		Left Cheek	1.160	0.335	1.495
	Left Tilt	0.405	0.265	0.670		Left Tilt	0.339	0.265	0.604

The above tables represent a held to ear voice call potentially simultaneously operating with 2.4 GHz WLAN.

12.4 Body-Worn Simultaneous Transmission Analysis

Table 12-2
Simultaneous Transmission Scenario (Body-Worn at 1.0 cm)

Configuration	Mode	CDMA SAR (W/kg)	2.4 GHz WLAN SAR (W/kg)	Σ SAR (W/kg)
Back Side	Cell. CDMA	0.868	0.127	0.995
Back Side	PCS CDMA	0.990	0.127	1.117

The above tables represent a body-worn voice call potentially simultaneously operating with 2.4 GHz WLAN.

12.5 Hotspot SAR Simultaneous Transmission Analysis



Table 12-3
Simultaneous Transmission Scenario (Hotspot at 1.0 cm)

Simult Tx	Configuration	Cell. EVDO SAR (W/kg)	2.4 GHz WLAN SAR (W/kg)	Σ SAR (W/kg)	Simult Tx	Configuration	PCS EVDO SAR (W/kg)	2.4 GHz WLAN SAR (W/kg)	Σ SAR (W/kg)
Body SAR	Back	1.290	0.127	1.417	Body SAR	Back	0.944	0.127	1.071
	Front	1.030	0.165	1.195		Front	1.040	0.165	1.205
	Top	-	0.096	0.096		Top	-	0.096	0.096
	Bottom	0.121	-	0.121		Bottom	0.582	-	0.582
	Right	0.979	-	0.979		Right	0.205	-	0.205
	Left	0.933	0.122	1.055		Left	0.585	0.122	0.707

Note: Per FCC KDB Publication 941225 D06, the edges with antennas more than 2.5 cm are not required to be evaluated for SAR ("-"). The above tables represent a portable hotspot condition.

12.6 Simultaneous Transmission Conclusion



The above numerical summed SAR was below the SAR limit. Therefore, the above analysis is sufficient to determine that simultaneous transmission cases will not exceed the SAR limit. No volumetric SAR summation is required per FCC KDB Publication 648474.

FCC ID: ZNFAS730	 PCTEST ENGINEERING LABORATORY, INC.	SAR EVALUATION REPORT		Reviewed by: Quality Manager
Document S/N: 0Y1204020393.ZNF	Test Dates: 03/30/12 - 04/19/12	DUT Type: Portable Handset		Page 27 of 32

13 EQUIPMENT LIST

Manufacturer	Model	Description	Cal Date	Cal Interval	Cal Due	Serial Number
Agilent	85070E	Dielectric Probe Kit	3/8/2012	Annual	3/8/2013	MY44300633
Agilent	8594A	(9kHz-2.9GHz) Spectrum Analyzer	N/A		N/A	3051A00187
Agilent	8648D	(9kHz-4GHz) Signal Generator	10/10/2011	Annual	10/10/2012	3613A00315
Agilent	8753E	(30kHz-6GHz) Network Analyzer	4/4/2012	Annual	4/4/2013	JP38020182
Agilent	E5515C	Wireless Communications Test Set	10/10/2011	Annual	10/10/2012	GB46110872
Agilent	E5515C	Wireless Communications Test Set	10/20/2011	Annual	10/20/2012	GB46310798
Agilent	E5515C	Wireless Communications Test Set	10/14/2011	Annual	10/14/2012	GB41450275
Agilent	E5515C	Wireless Communications Test Set	2/14/2012	Annual	2/14/2013	GB43304447
Agilent	E5515C	Wireless Communications Test Set	2/12/2012	Annual	2/12/2013	GB45360985
Agilent	E5515C	Wireless Communications Test Set	2/14/2012	Annual	2/14/2013	GB43163447
Agilent	E5515C	Wireless Communications Test Set	2/9/2012	Annual	2/9/2013	GB43460554
Amplifier Research	551G4	5W, 800MHz-4.2GHz	CBT	N/A	N/A	21910
Anritsu	MA2411B	Pulse Sensor	10/13/2011	Annual	10/13/2012	1027293
Anritsu	MA2481A	Power Sensor	2/14/2012	Annual	2/14/2013	5318
Anritsu	MA2481A	Power Sensor	2/14/2012	Annual	2/14/2013	5442
Anritsu	MA2481A	Power Sensor	2/14/2012	Annual	2/14/2013	5821
Anritsu	MA2481A	Power Sensor	2/14/2012	Annual	2/14/2013	8013
Anritsu	MA2481A	Power Sensor	2/14/2012	Annual	2/14/2013	2400
Anritsu	ML2438A	Power Meter	2/14/2012	Annual	2/14/2013	1190013
Anritsu	ML2438A	Power Meter	2/14/2012	Annual	2/14/2013	98150041
Anritsu	ML2438A	Power Meter	10/13/2011	Annual	10/13/2012	1070030
Anritsu	ML2495A	Power Meter	10/13/2011	Annual	10/13/2012	1039008
Anritsu	MT8820C	Radio Communication Tester	11/11/2011	Annual	11/11/2012	6200901190
Control Company	36934-158	Wall-Mounted Thermometer	1/4/2012	Biennial	1/4/2014	122014497
Control Company	61220-416	Long-Stem Thermometer	2/15/2011	Biennial	2/15/2013	111331322
Control Company	61220-416	Long-Stem Thermometer	3/16/2011	Biennial	3/16/2013	111391601
Control Company	61220-416	Long-Stem Thermometer	7/1/2011	Biennial	7/1/2013	111642941
Control Company	61220-416	Long-Stem Thermometer	10/12/2011	Biennial	10/12/2013	111860820
Gigatronics	80701A	(0.05-18GHz) Power Sensor	10/12/2011	Annual	10/12/2012	1833460
Gigatronics	8651A	Universal Power Meter	10/12/2011	Annual	10/12/2012	8650319
Intelligent Weigh	PD-3000	Electronic Balance	3/27/2012	Annual	3/27/2013	11081534
MCL	BW-N6W5+	6dB Attenuator	CBT	N/A	N/A	1139
MiniCircuits	SLP-2400+	Low Pass Filter	CBT	N/A	N/A	R8979500903
Mini-Circuits	BW-N20W5+	DC to 18 GHz Precision Fixed 20 dB Attenuator	CBT	N/A	N/A	N/A
Mini-Circuits	NLP-1200+	Low Pass Filter DC to 1000 MHz	CBT	N/A	N/A	N/A
Mini-Circuits	NLP-2950+	Low Pass Filter DC to 2700 MHz	CBT	N/A	N/A	N/A
Narda	4014C-6	4 - 8 GHz SMA 6 dB Directional Coupler	CBT	N/A	N/A	N/A
Narda	4772-3	Attenuator (3dB)	CBT	N/A	N/A	9406
Narda	BW-S3W2	Attenuator (3dB)	CBT	N/A	N/A	120
Pasternack	PE2208-6	Bidirectional Coupler	6/3/2011	Annual	6/3/2012	N/A
Pasternack	PE2209-10	Bidirectional Coupler	6/3/2011	Annual	6/3/2012	N/A
Rohde & Schwarz	CMU200	Base Station Simulator	6/1/2011	Annual	6/1/2012	833855/0010
Rohde & Schwarz	NRVD	Dual Channel Power Meter	4/8/2011	Biennial	4/8/2013	101695
Seekonk	NC-100	Torque Wrench (8" lb)	11/29/2011	Triennial	11/29/2014	21053
Seekonk	NC-100	Torque Wrench (8" lb)	3/5/2012	Triennial	3/5/2015	N/A
Seekonk	NC-100	Torque Wrench (8" lb)	3/5/2012	Triennial	3/5/2015	N/A
SPEAG	D1900V2	1900 MHz SAR Dipole	2/22/2012	Annual	2/22/2013	502
SPEAG	D2450V2	2450 MHz SAR Dipole	8/19/2011	Annual	8/19/2012	719
SPEAG	D835V2	835 MHz SAR Dipole	8/15/2011	Annual	8/15/2012	4d026
SPEAG	DAE4	Dasy Data Acquisition Electronics	4/20/2011	Annual	4/20/2012	665
SPEAG	DAE4	Dasy Data Acquisition Electronics	5/19/2011	Annual	5/19/2012	859
SPEAG	DAE4	Dasy Data Acquisition Electronics	1/18/2012	Annual	1/18/2013	1272
Speag	DAK-3.5	Dielectric Assessment Kit	12/1/2011	Annual	12/1/2012	1031
SPEAG	ES3DV2	SAR Probe	8/25/2011	Annual	8/25/2012	3022
SPEAG	ES3DV3	SAR Probe	3/16/2012	Annual	3/16/2013	3209
SPEAG	ES3DV3	SAR Probe	2/21/2012	Annual	2/21/2013	3258
VWR	36934-158	Wall-Mounted Thermometer	1/21/2011	Biennial	1/21/2013	111286445
VWR	36934-158	Wall-Mounted Thermometer	5/26/2010	Biennial	5/26/2012	101718589
VWR	36934-158	Wall-Mounted Thermometer	1/21/2011	Biennial	1/21/2013	111286454
VWR	36934-158	Wall-Mounted Thermometer	9/30/2011	Biennial	9/30/2013	111859323

Note: CBT (Calibrated Before Testing). Prior to testing, the measurement paths containing a cable, attenuator, coupler, amplifier or filter were connected to a calibrated source (i.e. a signal generator) to determine the losses of the measurement path. The power meter offset was then adjusted to compensate for the measurement system losses. This level offset is stored within the power meter before measurements are made. This calibration verification procedure applies to the system verification and output power measurements. The calibrated reading is then taken directly from the power meter after compensation of the losses for all final power measurements.



FCC ID: ZNFAS730	 PCTEST Engineering Laboratory, Inc.	SAR EVALUATION REPORT	 LG	Reviewed by: Quality Manager
Document S/N: 0Y1204020393.ZNF	Test Dates: 03/30/12 - 04/19/12	DUT Type: Portable Handset		Page 28 of 32

14 MEASUREMENT UNCERTAINTIES

Applicable for frequencies less than 3000 MHz.

a	b	c	d	e= f(d,k)	f	g	h = c x f/e	i = c x g/e	k	
Uncertainty Component	IEEE 1528 Sec.	Tol. (± %)	Prob. Dist.	Div.	c _i 1gm	c _i 10 gms	1gm u _i (± %)	10gms u _i (± %)	v _i	
Measurement System										
Probe Calibration	E.2.1	6.0	N	1	1.0	1.0	6.0	6.0	∞	
Axial Isotropy	E.2.2	0.25	N	1	0.7	0.7	0.2	0.2	∞	
Hemishperical Isotropy	E.2.2	1.3	N	1	1.0	1.0	1.3	1.3	∞	
Boundary Effect	E.2.3	0.4	N	1	1.0	1.0	0.4	0.4	∞	
Linearity	E.2.4	0.3	N	1	1.0	1.0	0.3	0.3	∞	
System Detection Limits	E.2.5	5.1	N	1	1.0	1.0	5.1	5.1	∞	
Readout Electronics	E.2.6	1.0	N	1	1.0	1.0	1.0	1.0	∞	
Response Time	E.2.7	0.8	R	1.73	1.0	1.0	0.5	0.5	∞	
Integration Time	E.2.8	2.6	R	1.73	1.0	1.0	1.5	1.5	∞	
RF Ambient Conditions	E.6.1	3.0	R	1.73	1.0	1.0	1.7	1.7	∞	
Probe Positioner Mechanical Tolerance	E.6.2	0.4	R	1.73	1.0	1.0	0.2	0.2	∞	
Probe Positioning w/ respect to Phantom	E.6.3	2.9	R	1.73	1.0	1.0	1.7	1.7	∞	
Extrapolation, Interpolation & Integration algorithms for Max. SAR Evaluation	E.5	1.0	R	1.73	1.0	1.0	0.6	0.6	∞	
Test Sample Related										
Test Sample Positioning	E.4.2	6.0	N	1	1.0	1.0	6.0	6.0	287	
Device Holder Uncertainty	E.4.1	3.32	R	1.73	1.0	1.0	1.9	1.9	∞	
Output Power Variation - SAR drift measurement	6.6.2	5.0	R	1.73	1.0	1.0	2.9	2.9	∞	
Phantom & Tissue Parameters										
Phantom Uncertainty (Shape & Thickness tolerances)	E.3.1	4.0	R	1.73	1.0	1.0	2.3	2.3	∞	
Liquid Conductivity - deviation from target values	E.3.2	5.0	R	1.73	0.64	0.43	1.8	1.2	∞	
Liquid Conductivity - measurement uncertainty	E.3.3	3.8	N	1	0.64	0.43	2.4	1.6	6	
Liquid Permittivity - deviation from target values	E.3.2	5.0	R	1.73	0.60	0.49	1.7	1.4	∞	
Liquid Permittivity - measurement uncertainty	E.3.3	4.5	N	1	0.60	0.49	2.7	2.2	6	
Combined Standard Uncertainty (k=1)							RSS	12.1	11.7	299
Expanded Uncertainty (95% CONFIDENCE LEVEL)							k=2	24.2	23.5	

The above measurement uncertainties are according to IEEE Std. 1528-2003



FCC ID: ZNFAS730	 PCTEST ENGINEERING LABORATORY, INC.	SAR EVALUATION REPORT		Reviewed by: Quality Manager
Document S/N: 0Y1204020393.ZNF	Test Dates: 03/30/12 - 04/19/12	DUT Type: Portable Handset		Page 29 of 32

15 CONCLUSION

15.1 Measurement Conclusion



The SAR evaluation indicates that the EUT complies with the RF radiation exposure limits of the FCC and Industry Canada, with respect to all parameters subject to this test. These measurements were taken to simulate the RF effects of RF exposure under worst-case conditions. Precise laboratory measures were taken to assure repeatability of the tests. The results and statements relate only to the item(s) tested.

Please note that the absorption and distribution of electromagnetic energy in the body are very complex phenomena that depend on the mass, shape, and size of the body, the orientation of the body with respect to the field vectors, and the electrical properties of both the body and the environment. Other variables that may play a substantial role in possible biological effects are those that characterize the environment (e.g. ambient temperature, air velocity, relative humidity, and body insulation) and those that characterize the individual (e.g. age, gender, activity level, debilitation, or disease). Because various factors may interact with one another to vary the specific biological outcome of an exposure to electromagnetic fields, any protection guide should consider maximal amplification of biological effects as a result of field-body interactions, environmental conditions, and physiological variables. [3]



FCC ID: ZNFAS730	 PCTEST ENGINEERING LABORATORY, INC.	SAR EVALUATION REPORT	 LG	Reviewed by: Quality Manager
Document S/N: 0Y1204020393.ZNF	Test Dates: 03/30/12 - 04/19/12	DUT Type: Portable Handset		Page 30 of 32

16 REFERENCES

- [1] Federal Communications Commission, ET Docket 93-62, Guidelines for Evaluating the Environmental Effects of Radiofrequency Radiation, Aug. 1996.
- [2] ANSI/IEEE C95.1-2005, American National Standard safety levels with respect to human exposure to radio frequency electromagnetic fields, 3kHz to 300GHz, New York: IEEE, 2006.
- [3] ANSI/IEEE C95.1-1992, American National Standard safety levels with respect to human exposure to radio frequency electromagnetic fields, 3kHz to 300GHz, New York: IEEE, Sept. 1992.
- [4] ANSI/IEEE C95.3-2002, IEEE Recommended Practice for the Measurement of Potentially Hazardous Electromagnetic Fields - RF and Microwave, New York: IEEE, December 2002.
- [5] Federal Communications Commission, OET Bulletin 65 (Edition 97-01), Supplement C (Edition 01-01), Evaluating Compliance with FCC Guidelines for Human Exposure to Radiofrequency Electromagnetic Fields, June 2001.
- [6] IEEE Standards Coordinating Committee 34 – IEEE Std. 1528-2003, Recommended Practice for Determining the Peak Spatial-Average Specific Absorption Rate (SAR) in the Human Body Due to Wireless Communications Devices.
- [7] NCRP, National Council on Radiation Protection and Measurements, Biological Effects and Exposure Criteria for RadioFrequency Electromagnetic Fields, NCRP Report No. 86, 1986. Reprinted Feb. 1995.
- [8] T. Schmid, O. Egger, N. Kuster, Automated E-field scanning system for dosimetric assessments, IEEE Transaction on Microwave Theory and Techniques, vol. 44, Jan. 1996, pp. 105-113.
- [9] K. Pokovic, T. Schmid, N. Kuster, Robust setup for precise calibration of E-field probes in tissue simulating liquids at mobile communications frequencies, ICECOM97, Oct. 1997, pp. 120-124.
- [10] K. Pokovic, T. Schmid, and N. Kuster, E-field Probe with improved isotropy in brain simulating liquids, Proceedings of the ELMAR, Zadar, Croatia, June 23-25, 1996, pp. 172-175.
- [11] Schmid & Partner Engineering AG, Application Note: Data Storage and Evaluation, June 1998, p2.
- [12] V. Hombach, K. Meier, M. Burkhardt, E. Kuhn, N. Kuster, The Dependence of EM Energy Absorption upon Human Head Modeling at 900 MHz, IEEE Transaction on Microwave Theory and Techniques, vol. 44 no. 10, Oct. 1996, pp. 1865-1873.
- [13] N. Kuster and Q. Balzano, Energy absorption mechanism by biological bodies in the near field of dipole antennas above 300MHz, IEEE Transaction on Vehicular Technology, vol. 41, no. 1, Feb. 1992, pp. 17-23.
- [14] G. Hartsgrove, A. Kraszewski, A. Surowiec, Simulated Biological Materials for Electromagnetic Radiation Absorption Studies, University of Ottawa, Bioelectromagnetics, Canada: 1987, pp. 29-36.
- [15] Q. Balzano, O. Garay, T. Manning Jr., Electromagnetic Energy Exposure of Simulated Users of Portable Cellular Telephones, IEEE Transactions on Vehicular Technology, vol. 44, no.3, Aug. 1995.
- [16] W. Gander, Computermathematick, Birkhaeuser, Basel, 1992.
- [17] W.H. Press, S.A. Teukolsky, W.T. Vetterling, and B.P. Flannery, Numerical Recipes in C, The Art of Scientific Computing, Second edition, Cambridge University Press, 1992.

FCC ID: ZNFAS730	 PCTEST ENGINEERING LABORATORY, INC.	SAR EVALUATION REPORT	 LG	Reviewed by: Quality Manager
Document S/N: 0Y1204020393.ZNF	Test Dates: 03/30/12 - 04/19/12	DUT Type: Portable Handset		Page 31 of 32

- [18] Federal Communications Commission, OET Bulletin 65, Evaluating Compliance with FCC Guidelines for Human Exposure to Radiofrequency Electromagnetic Fields. Supplement C, Dec. 1997.
- [19] N. Kuster, R. Kastle, T. Schmid, Dosimetric evaluation of mobile communications equipment with known precision, IEEE Transaction on Communications, vol. E80-B, no. 5, May 1997, pp. 645-652.
- [20] CENELEC CLC/SC111B, European Prestandard (prENV 50166-2), Human Exposure to Electromagnetic Fields High-frequency: 10kHz-300GHz, Jan. 1995.
- [21] Prof. Dr. Niels Kuster, ETH, Eidgenössische Technische Hochschule Zürich, Dosimetric Evaluation of the Cellular Phone.
- [22] IEC 62209-1, Human exposure to radio frequency fields from hand-held and body-mounted wireless communication devices - Human models, instrumentation, and procedures - Part 1: Procedure to determine the specific absorption rate (SAR) for hand-held devices used in close proximity to the ear (frequency range of 300 MHz to 3 GHz), Feb. 2005.
- [23] Industry Canada RSS-102 Radio Frequency Exposure Compliance of Radiocommunication Apparatus (All Frequency Bands) Issue 4, March 2010.
- [24] Health Canada Safety Code 6 Limits of Human Exposure to Radio Frequency Electromagnetic Fields in the Frequency Range from 3 kHz – 300 GHz, 2009
- [25] FCC Public Notice DA-02-1438. Office of Engineering and Technology Announces a Transition Period for the Phantom Requirements of Supplement C to OET Bulletin 65, June 19, 2002
- [26] FCC SAR Measurement Procedures for 3G Devices KDB Publication 941225
- [27] SAR Measurement procedures for IEEE 802.11a/b/g KDB Publication 248227
- [28] FCC SAR Considerations for Handsets with Multiple Transmitters and Antennas, KDB Publication 648474
- [29] FCC Application Note for SAR Probe Calibration and System Verification Consideration for Measurements at 150 MHz – 3 GHz, KDB Publication 450824
- [30] FCC SAR Evaluation Considerations for Laptop Computers with Antennas Built-in on Display Screens, KDB Publication 616217
- [31] FCC SAR Measurement Requirements for 3 – 6 GHz, KDB Publication 865664
- [32] FCC Mobile Portable RF Exposure Procedure, KDB Publication 447498
- [33] FCC SAR Procedures for Dongle Transmitters, KDB Publication 447498
- [34] Anexo à Resolução No. 533, de 10 de Setembro de 2009.
- [35] FCC SAR Test Considerations for LTE Handsets and Data Modems, KDB Publication 941225.
- [36] IEC 62209-2, Human exposure to radio frequency fields from hand-held and body-mounted wireless communication devices - Human models, instrumentation, and procedures - Part 2: Procedure to determine the specific absorption rate (SAR) for wireless communication devices used in close proximity to the human body (frequency range of 30 MHz to 6 GHz), Mar. 2010.
- [37] FCC Hot Spot SAR v01, KDB Publication 941225 D06.

FCC ID: ZNFAS730		SAR EVALUATION REPORT		Reviewed by: Quality Manager
Document S/N: 0Y1204020393.ZNF	Test Dates: 03/30/12 - 04/19/12	DUT Type: Portable Handset	Page 32 of 32	

APPENDIX A: SAR TEST DATA

PCTEST ENGINEERING LABORATORY, INC.

DUT: ZNFAS730; Type: Portable Handset; Serial: A0000031D1725C

Communication System: Cellular CDMA; Frequency: 836.52 MHz; Duty Cycle: 1:1
Medium: 835 Head Medium parameters used (interpolated):
 $f = 836.52 \text{ MHz}$; $\sigma = 0.912 \text{ mho/m}$; $\epsilon_r = 42.3$; $\rho = 1000 \text{ kg/m}^3$
Phantom section: Right Section

Test Date: 04-17-2012; Ambient Temp: 23.1 °C; Tissue Temp: 22.4 °C

Probe: ES3DV3 - SN3258; ConvF(6.01, 6.01, 6.01); Calibrated: 2/21/2012
Sensor-Surface: 4mm (Mechanical Surface Detection)
Electronics: DAE4 Sn1272; Calibrated: 1/18/2012
Phantom: SAM Sub; Type: SAM 4.0; Serial: TP-1403

Measurement SW: DASY4, V4.7 Build 80; Postprocessing SW: SEMCAD, V1.8 Build 186

Mode: Cellular CDMA, Right Head, Touch, Mid.ch

Area Scan (8x12x1): Measurement grid: dx=15mm, dy=15mm

Zoom Scan (5x5x7)/Cube 0: Measurement grid: dx=8mm, dy=8mm, dz=5mm

Reference Value = 30.9 V/m; Power Drift = -0.019 dB

Peak SAR (extrapolated) = 0.954 W/kg

SAR(1 g) = 0.765 mW/g; SAR(10 g) = 0.569 mW/g

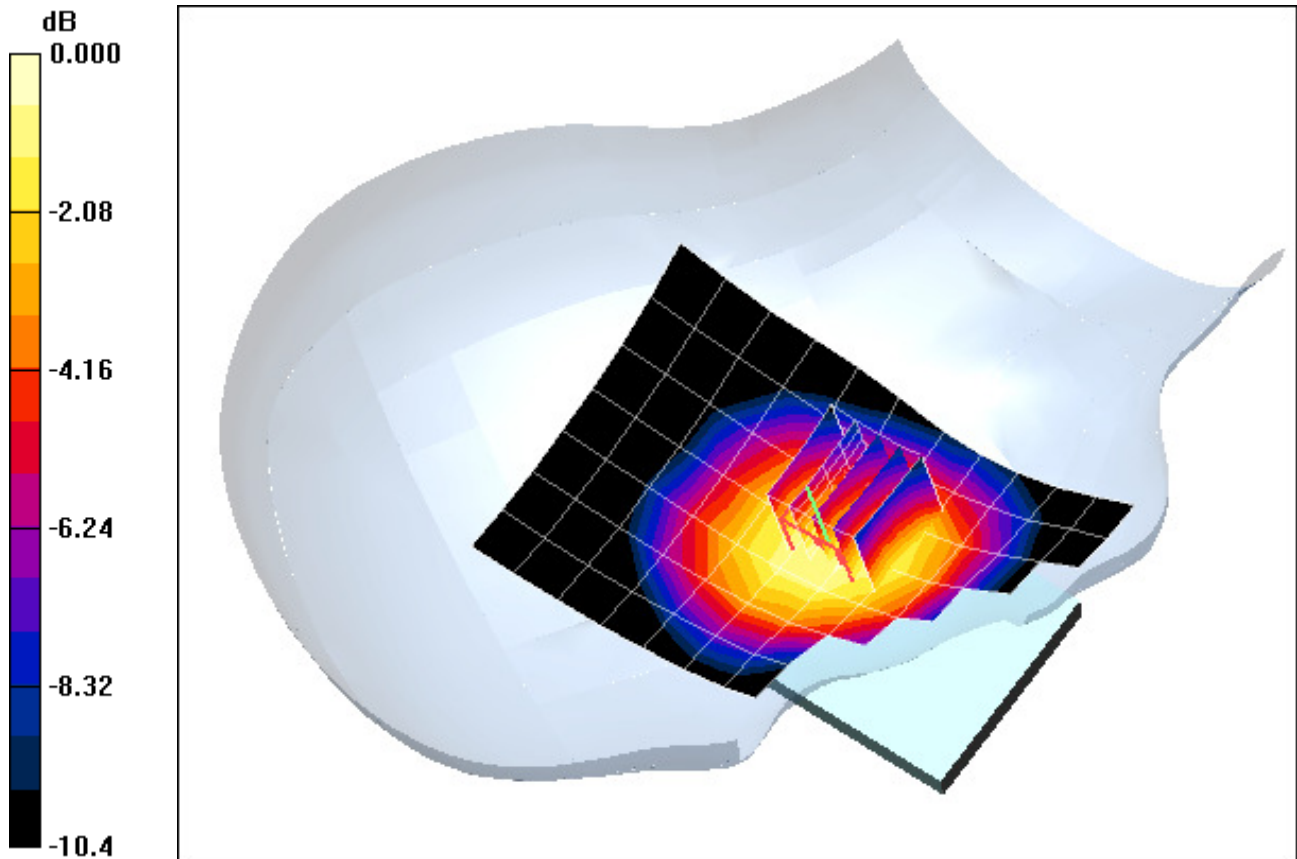

0 dB = 0.805mW/g

PCTEST ENGINEERING LABORATORY, INC.

DUT: ZNFAS730; Type: Portable Handset; Serial: A0000031D1725C

Communication System: Cellular CDMA; Frequency: 836.52 MHz; Duty Cycle: 1:1
Medium: 835 Head Medium parameters used (interpolated):
 $f = 836.52 \text{ MHz}$; $\sigma = 0.912 \text{ mho/m}$; $\epsilon_r = 42.3$; $\rho = 1000 \text{ kg/m}^3$
Phantom section: Right Section

Test Date: 04-17-2012; Ambient Temp: 23.1°C; Tissue Temp: 22.4°C

Probe: ES3DV3 - SN3258; ConvF(6.01, 6.01, 6.01); Calibrated: 2/21/2012
Sensor-Surface: 4mm (Mechanical Surface Detection)
Electronics: DAE4 Sn1272; Calibrated: 1/18/2012
Phantom: SAM Sub; Type: SAM 4.0; Serial: TP-1403
Measurement SW: DASY4, V4.7 Build 80; Postprocessing SW: SEMCAD, V1.8 Build 186

Mode: Cellular CDMA, Right Head, Tilt, Mid.ch

Area Scan (8x12x1): Measurement grid: dx=15mm, dy=15mm

Zoom Scan (5x5x7)/Cube 0: Measurement grid: dx=8mm, dy=8mm, dz=5mm

Reference Value = 23.4 V/m; Power Drift = -0.027 dB

Peak SAR (extrapolated) = 0.523 W/kg

SAR(1 g) = 0.435 mW/g; SAR(10 g) = 0.338 mW/g

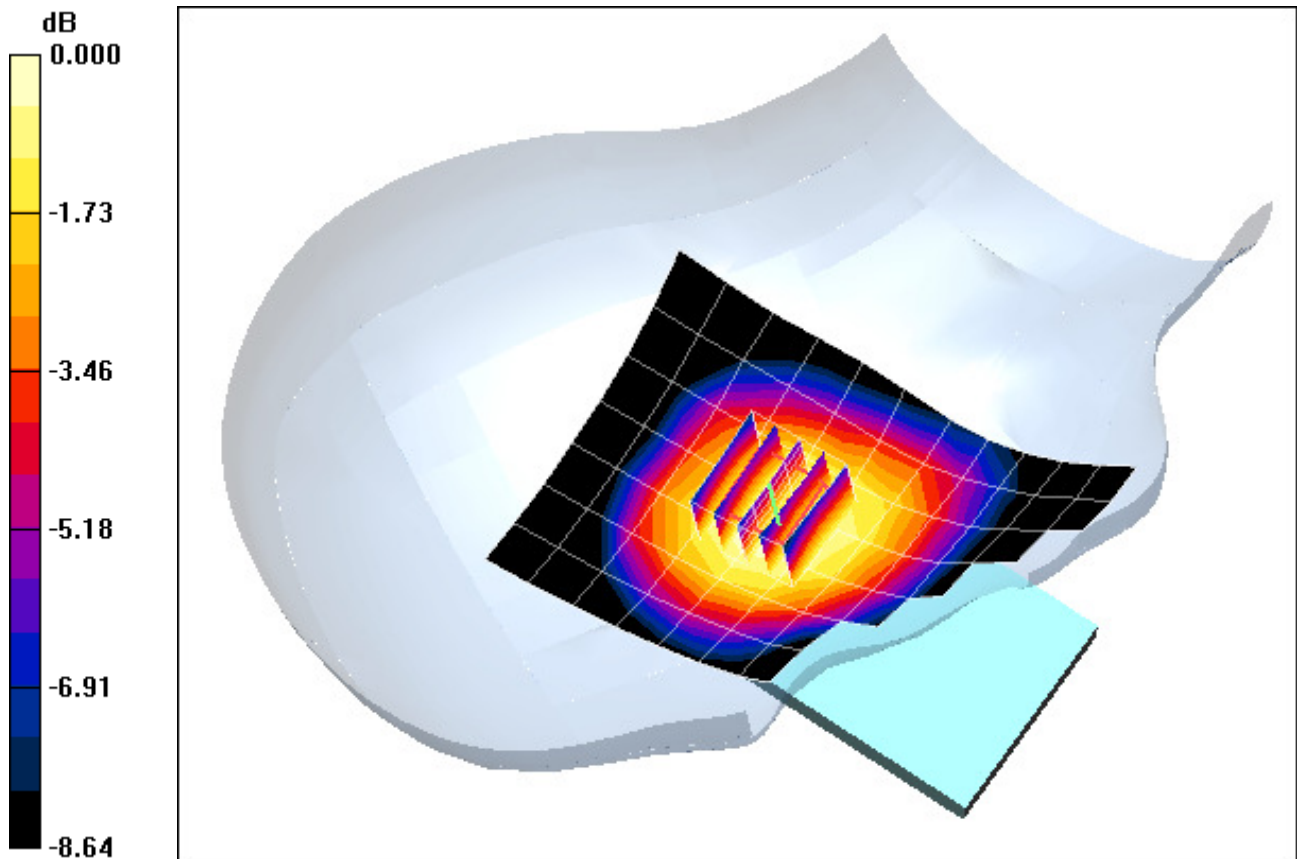

0 dB = 0.452mW/g

PCTEST ENGINEERING LABORATORY, INC.

DUT: ZNFAS730; Type: Portable Handset; Serial: A0000031D1725C

Communication System: Cellular CDMA; Frequency: 836.52 MHz; Duty Cycle: 1:1
Medium: 835 Head Medium parameters used (interpolated):
 $f = 836.52 \text{ MHz}$; $\sigma = 0.912 \text{ mho/m}$; $\epsilon_r = 42.3$; $\rho = 1000 \text{ kg/m}^3$
Phantom section: Left Section

Test Date: 04-17-2012; Ambient Temp: 23.1 °C; Tissue Temp: 22.4 °C

Probe: ES3DV3 - SN3258; ConvF(6.01, 6.01, 6.01); Calibrated: 2/21/2012

Sensor-Surface: 4mm (Mechanical Surface Detection)

Electronics: DAE4 Sn1272; Calibrated: 1/18/2012

Phantom: SAM Sub; Type: SAM 4.0; Serial: TP-1403

Measurement SW: DASY4, V4.7 Build 80; Postprocessing SW: SEMCAD, V1.8 Build 186

Mode: Cellular CDMA, Left Head, Touch, Mid.ch

Area Scan (8x12x1): Measurement grid: dx=15mm, dy=15mm

Zoom Scan (5x5x7)/Cube 0: Measurement grid: dx=8mm, dy=8mm, dz=5mm

Reference Value = 28.0 V/m; Power Drift = 0.058 dB

Peak SAR (extrapolated) = 0.791 W/kg

SAR(1 g) = 0.651 mW/g; SAR(10 g) = 0.493 mW/g

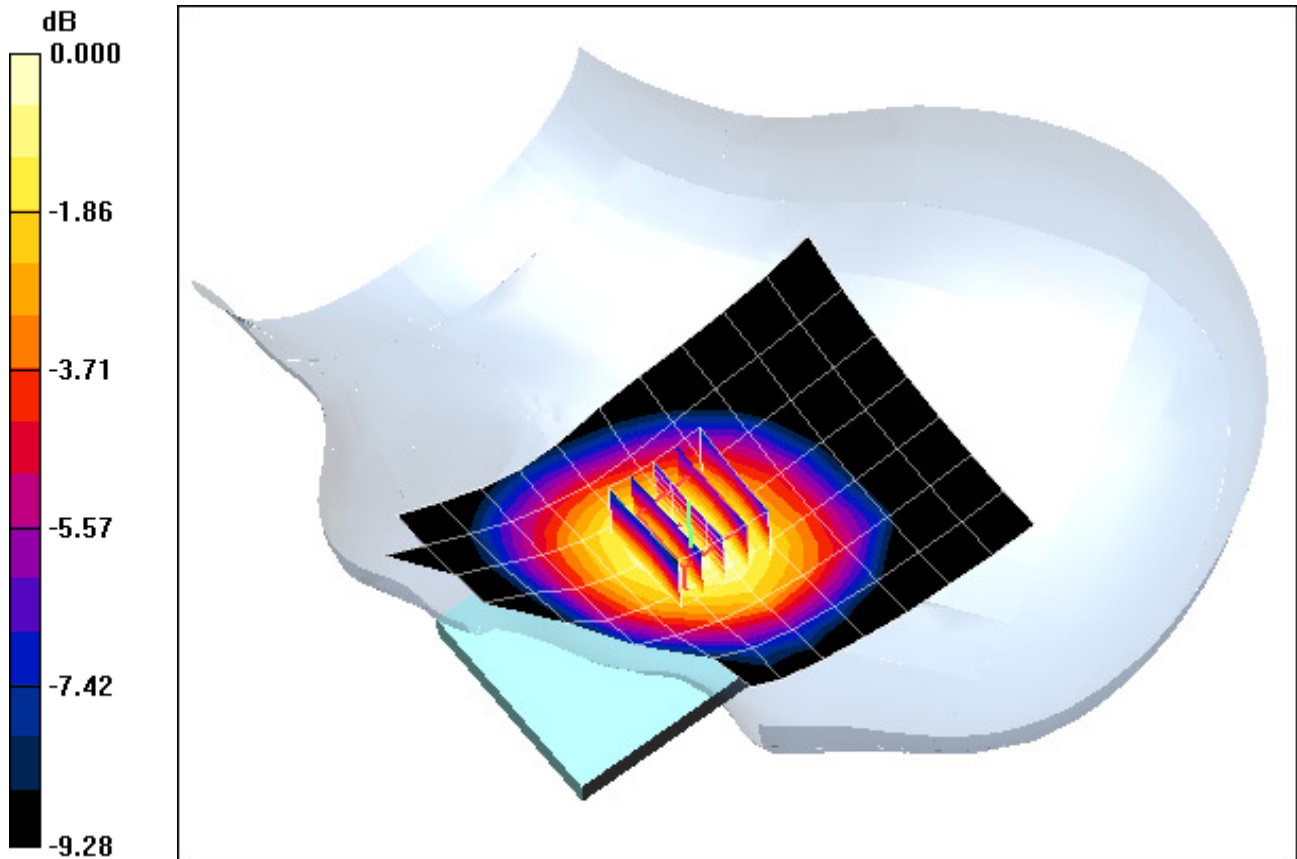

0 dB = 0.697mW/g

PCTEST ENGINEERING LABORATORY, INC.

DUT: ZNFAS730; Type: Portable Handset; Serial: A0000031D1725C

Communication System: Cellular CDMA; Frequency: 836.52 MHz; Duty Cycle: 1:1
Medium: 835 Head Medium parameters used (interpolated):
 $f = 836.52 \text{ MHz}$; $\sigma = 0.912 \text{ mho/m}$; $\epsilon_r = 42.3$; $\rho = 1000 \text{ kg/m}^3$
Phantom section: Left Section

Test Date: 04-17-2012; Ambient Temp: 23.1 °C; Tissue Temp: 22.4 °C

Probe: ES3DV3 - SN3258; ConvF(6.01, 6.01, 6.01); Calibrated: 2/21/2012

Sensor-Surface: 4mm (Mechanical Surface Detection)

Electronics: DAE4 Sn1272; Calibrated: 1/18/2012

Phantom: SAM Sub; Type: SAM 4.0; Serial: TP-1403

Measurement SW: DASY4, V4.7 Build 80; Postprocessing SW: SEMCAD, V1.8 Build 186

Mode: Cellular CDMA, Left Head, Tilt, Mid.ch

Area Scan (8x12x1): Measurement grid: dx=15mm, dy=15mm

Zoom Scan (5x5x7)/Cube 0: Measurement grid: dx=8mm, dy=8mm, dz=5mm

Reference Value = 22.4 V/m; Power Drift = 0.006 dB

Peak SAR (extrapolated) = 0.488 W/kg

SAR(1 g) = 0.405 mW/g; SAR(10 g) = 0.316 mW/g

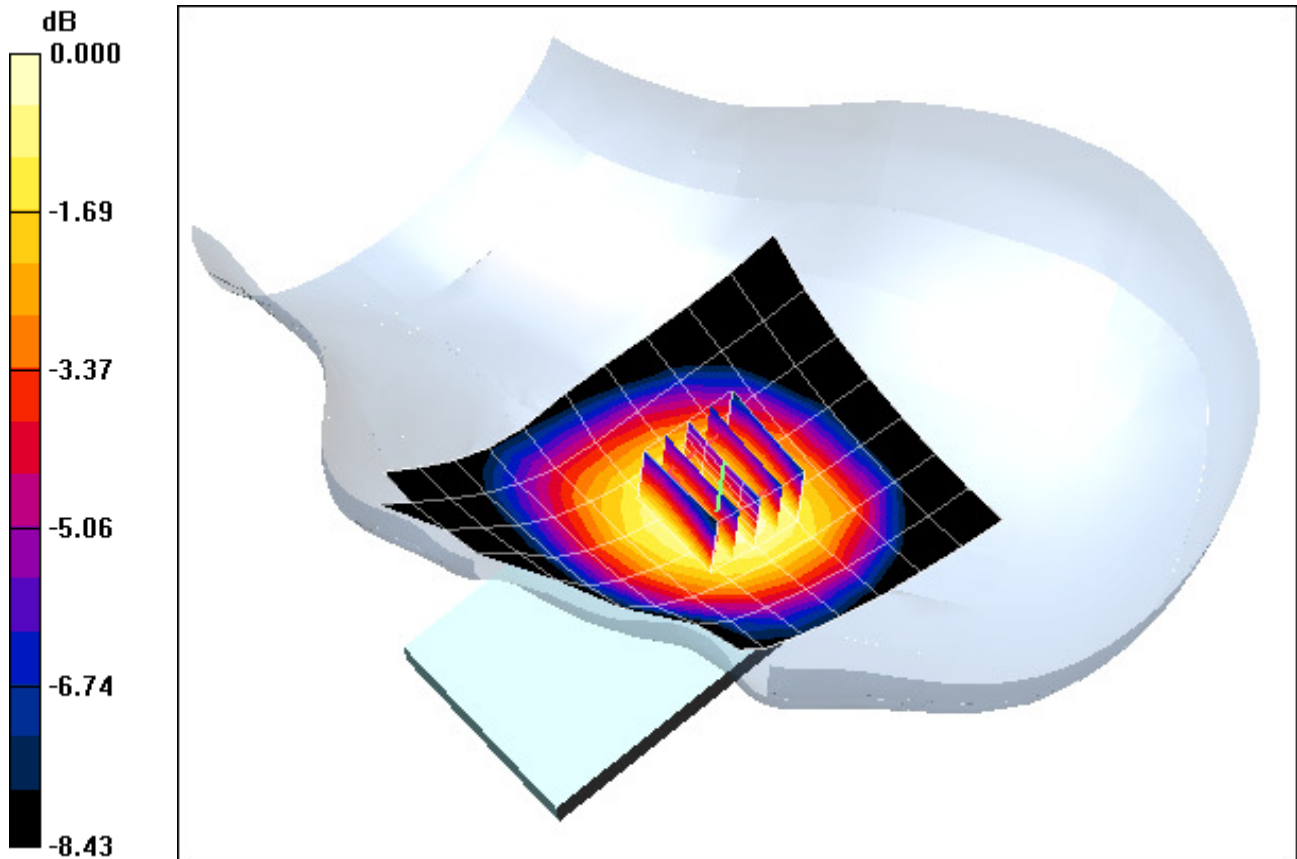

0 dB = 0.420mW/g

PCTEST ENGINEERING LABORATORY, INC.

DUT: ZNFAS730; Type: Portable Handset; Serial: A0000031D1725C

Communication System: PCS CDMA; Frequency: 1880 MHz; Duty Cycle: 1:1

Medium: 1900 Head Medium parameters used:

$f = 1880 \text{ MHz}$; $\sigma = 1.41 \text{ mho/m}$; $\epsilon_r = 38.4$; $\rho = 1000 \text{ kg/m}^3$

Phantom section: Right Section

Test Date: 04-18-2012; Ambient Temp: 23.1°C; Tissue Temp: 22.6°C

Probe: ES3DV2 - SN3022; ConvF(4.98, 4.98, 4.98); Calibrated: 8/25/2011

Sensor-Surface: 4mm (Mechanical Surface Detection)

Electronics: DAE4 Sn859; Calibrated: 5/19/2011

Phantom: SAM with CRP; Type: SAM; Serial: TP1375

Measurement SW: DASY4, V4.7 Build 80; Postprocessing SW: SEMCAD, V1.8 Build 186

Mode: PCS CDMA, Right Head, Touch, Mid.ch

Area Scan (8x12x1): Measurement grid: dx=15mm, dy=15mm

Zoom Scan (5x5x7)/Cube 0: Measurement grid: dx=8mm, dy=8mm, dz=5mm

Reference Value = 20.5 V/m; Power Drift = -0.029 dB

Peak SAR (extrapolated) = 0.762 W/kg

SAR(1 g) = 0.501 mW/g; SAR(10 g) = 0.315 mW/g

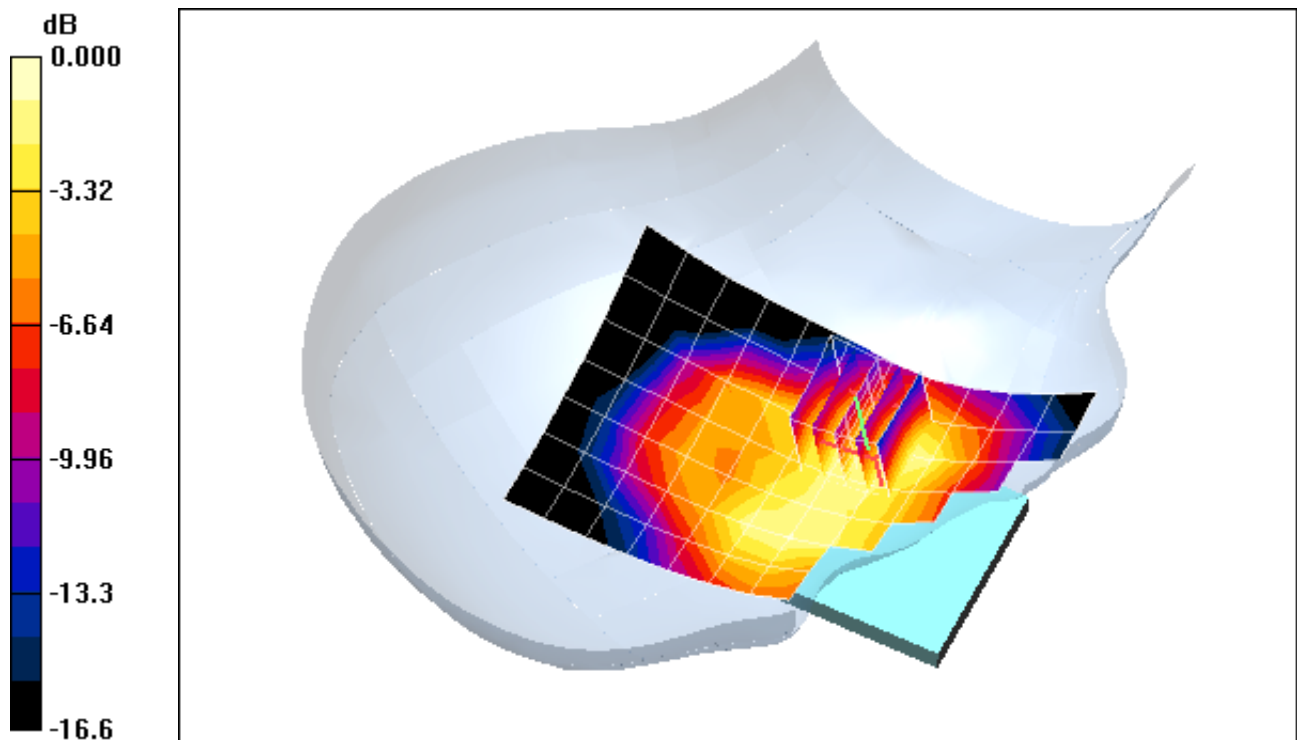

0 dB = 0.537mW/g

PCTEST ENGINEERING LABORATORY, INC.

DUT: ZNFAS730; Type: Portable Handset; Serial: A0000031D1725C

Communication System: PCS CDMA; Frequency: 1880 MHz; Duty Cycle: 1:1

Medium: 1900 Head Medium parameters used:

$f = 1880 \text{ MHz}$; $\sigma = 1.41 \text{ mho/m}$; $\epsilon_r = 38.4$; $\rho = 1000 \text{ kg/m}^3$

Phantom section: Right Section

Test Date: 04-18-2012; Ambient Temp: 23.1°C; Tissue Temp: 22.6°C

Probe: ES3DV2 - SN3022; ConvF(4.98, 4.98, 4.98); Calibrated: 8/25/2011

Sensor-Surface: 4mm (Mechanical Surface Detection)

Electronics: DAE4 Sn859; Calibrated: 5/19/2011

Phantom: SAM with CRP; Type: SAM; Serial: TP1375

Measurement SW: DASY4, V4.7 Build 80; Postprocessing SW: SEMCAD, V1.8 Build 186

Mode: PCS CDMA, Right Head, Tilt, Mid.ch

Area Scan (8x12x1): Measurement grid: dx=15mm, dy=15mm

Zoom Scan (5x5x7)/Cube 0: Measurement grid: dx=8mm, dy=8mm, dz=5mm

Reference Value = 15.9 V/m; Power Drift = -0.047 dB

Peak SAR (extrapolated) = 0.506 W/kg

SAR(1 g) = 0.313 mW/g; SAR(10 g) = 0.189 mW/g

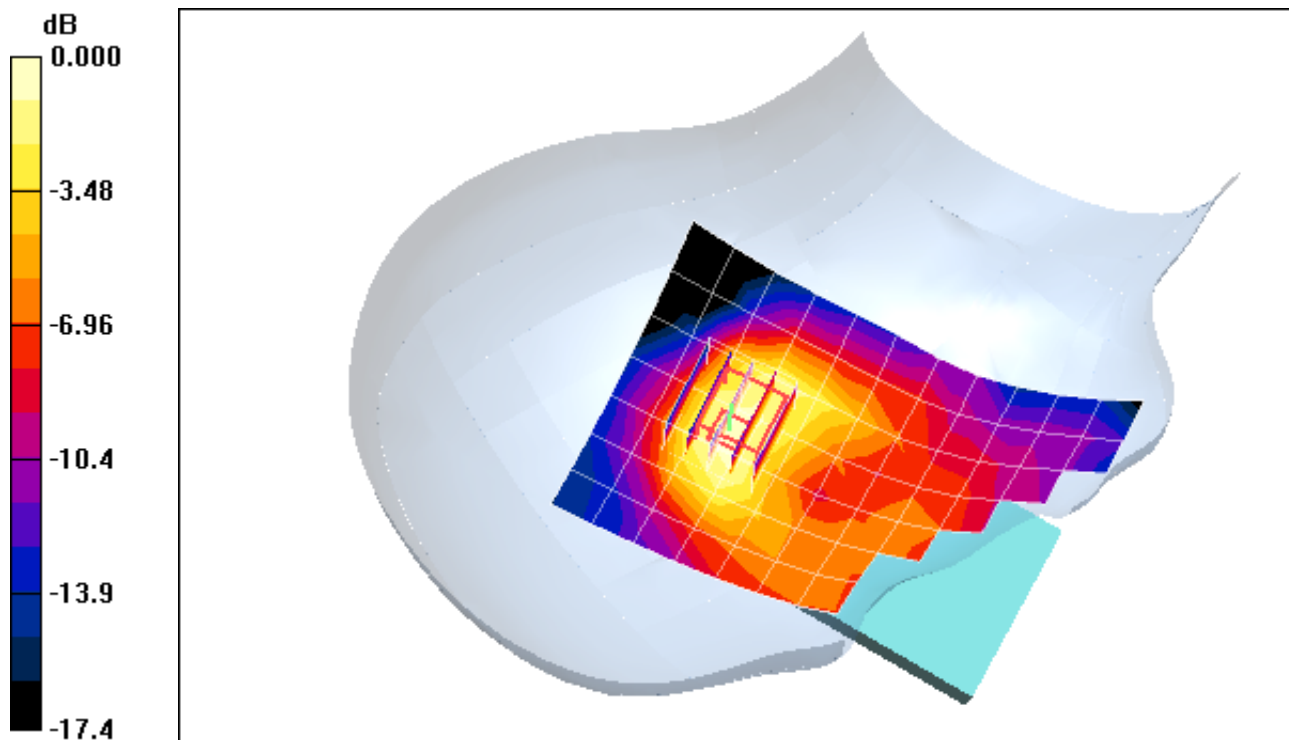

0 dB = 0.342mW/g

PCTEST ENGINEERING LABORATORY, INC.

DUT: ZNFAS730; Type: Portable Handset; Serial: A0000031D1725C

Communication System: PCS CDMA; Frequency: 1908.75 MHz; Duty Cycle: 1:1

Medium: 1900 Head Medium parameters used (interpolated):

$f = 1908.75 \text{ MHz}$; $\sigma = 1.43 \text{ mho/m}$; $\epsilon_r = 38.3$; $\rho = 1000 \text{ kg/m}^3$

Phantom section: Left Section

Test Date: 04-18-2012; Ambient Temp: 23.1°C; Tissue Temp: 22.6°C

Probe: ES3DV2 - SN3022; ConvF(4.98, 4.98, 4.98); Calibrated: 8/25/2011

Sensor-Surface: 4mm (Mechanical Surface Detection)

Electronics: DAE4 Sn859; Calibrated: 5/19/2011

Phantom: SAM with CRP; Type: SAM; Serial: TP1375

Measurement SW: DASY4, V4.7 Build 80; Postprocessing SW: SEMCAD, V1.8 Build 186

Mode: PCS CDMA, Left Head, Touch, High.ch

Area Scan (8x12x1): Measurement grid: dx=15mm, dy=15mm

Zoom Scan (5x5x7)/Cube 0: Measurement grid: dx=8mm, dy=8mm, dz=5mm

Reference Value = 32.8 V/m; Power Drift = -0.087 dB

Peak SAR (extrapolated) = 1.87 W/kg

SAR(1 g) = 1.16 mW/g; SAR(10 g) = 0.691 mW/g

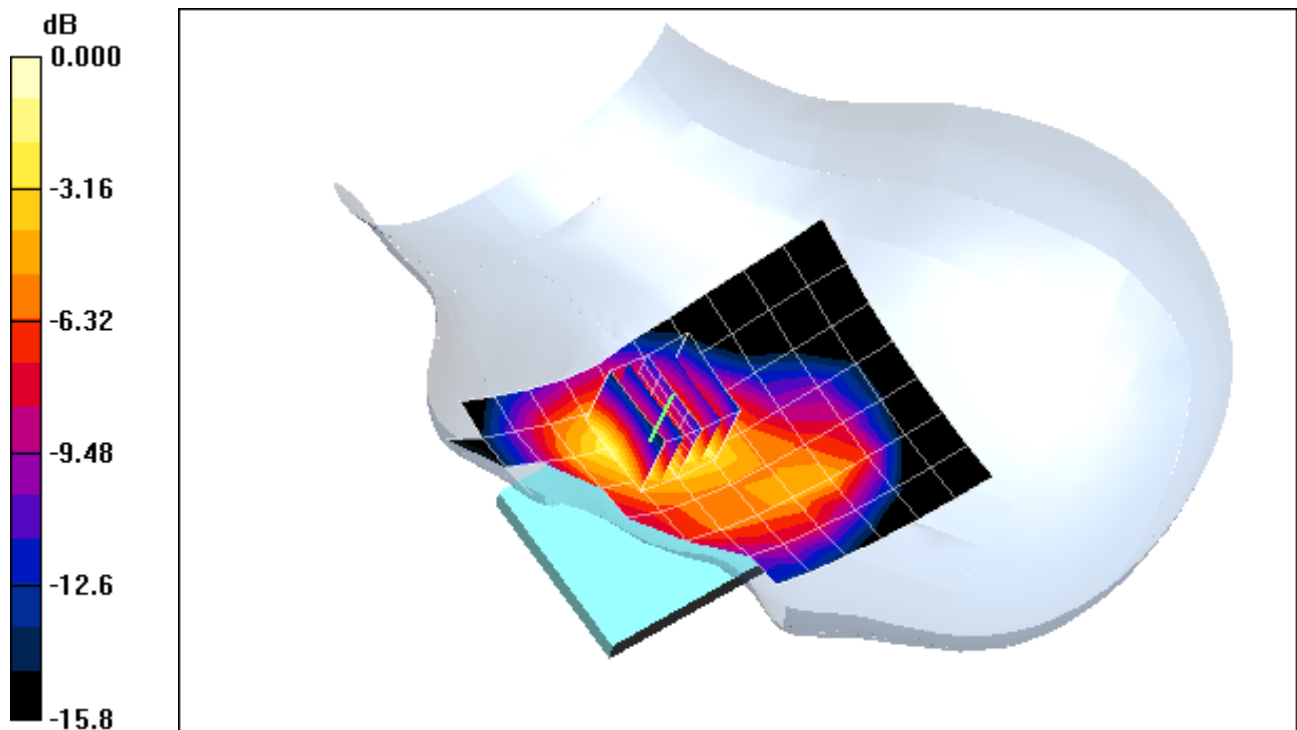

0 dB = 1.28mW/g

PCTEST ENGINEERING LABORATORY, INC.

DUT: ZNFAS730; Type: Portable Handset; Serial: A0000031D1725C

Communication System: PCS CDMA; Frequency: 1880 MHz; Duty Cycle: 1:1

Medium: 1900 Head Medium parameters used:

$f = 1880 \text{ MHz}$; $\sigma = 1.41 \text{ mho/m}$; $\epsilon_r = 38.4$; $\rho = 1000 \text{ kg/m}^3$

Phantom section: Left Section

Test Date: 04-18-2012; Ambient Temp: 23.1°C; Tissue Temp: 22.6°C

Probe: ES3DV2 - SN3022; ConvF(4.98, 4.98, 4.98); Calibrated: 8/25/2011

Sensor-Surface: 4mm (Mechanical Surface Detection)

Electronics: DAE4 Sn859; Calibrated: 5/19/2011

Phantom: SAM with CRP; Type: SAM; Serial: TP1375

Measurement SW: DASY4, V4.7 Build 80; Postprocessing SW: SEMCAD, V1.8 Build 186

Mode: PCS CDMA, Left Head, Tilt, Mid.ch

Area Scan (8x12x1): Measurement grid: dx=15mm, dy=15mm

Zoom Scan (5x5x7)/Cube 0: Measurement grid: dx=8mm, dy=8mm, dz=5mm

Reference Value = 17.2 V/m; Power Drift = -0.165 dB

Peak SAR (extrapolated) = 0.509 W/kg

SAR(1 g) = 0.339 mW/g; SAR(10 g) = 0.220 mW/g

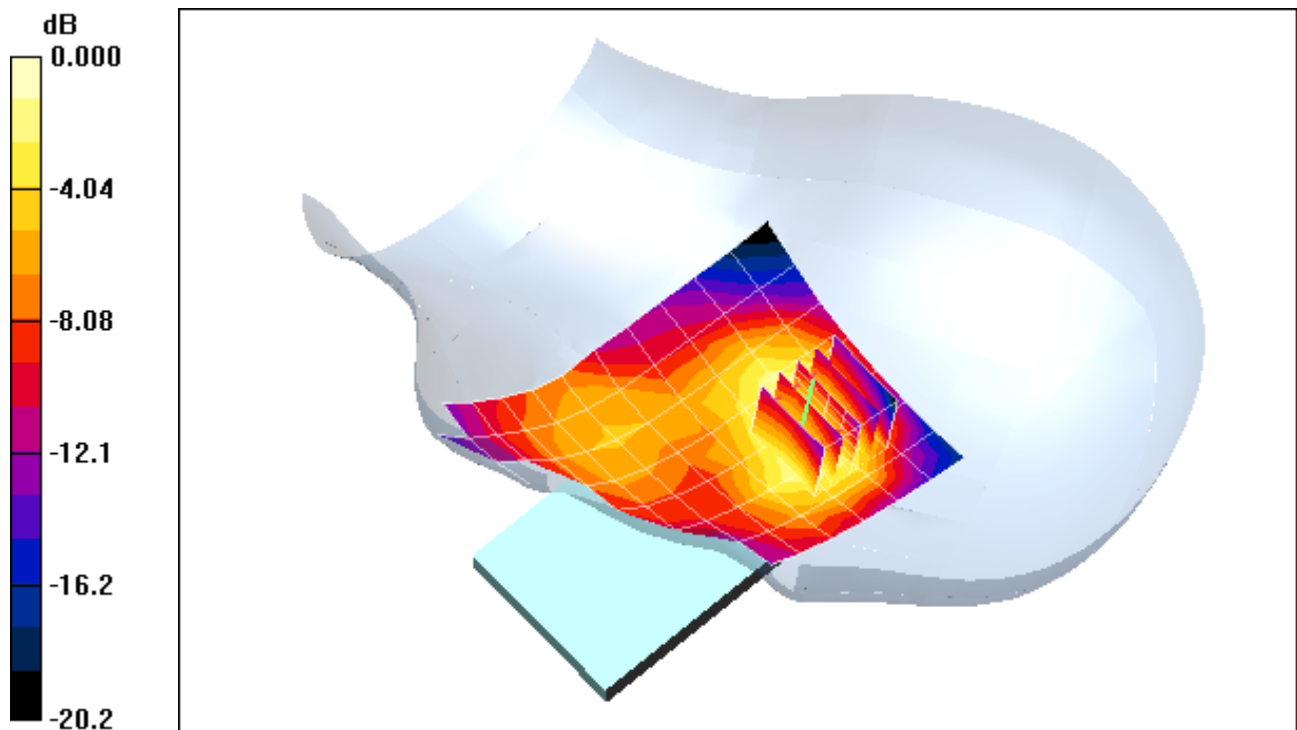

0 dB = 0.359mW/g

PCTEST ENGINEERING LABORATORY, INC.

DUT: ZNFAS730; Type: Portable Handset; Serial: A0000031D17249

Communication System: IEEE 802.11b; Frequency: 2462 MHz; Duty Cycle: 1:1

Medium: 2450 Head Medium parameters used (interpolated):

$f = 2462 \text{ MHz}$; $\sigma = 1.88 \text{ mho/m}$; $\epsilon_r = 39.2$; $\rho = 1000 \text{ kg/m}^3$

Phantom section: Right Section

Test Date: 03-30-2012; Ambient Temp: 23.8°C; Tissue Temp: 22.0°C

Probe: ES3DV3 - SN3209; ConvF(4.46, 4.46, 4.46); Calibrated: 3/16/2012

Sensor-Surface: 3mm (Mechanical Surface Detection)

Electronics: DAE4 Sn665; Calibrated: 4/20/2011

Phantom: SAM Main; Type: SAM 4.0; Serial: TP-1114

Measurement SW: DASY4, V4.7 Build 80; Postprocessing SW: SEMCAD, V1.8 Build 186

Mode: IEEE 802.11b, Right Head, Touch, Ch 11, 1 Mbps

Area Scan (7x14x1): Measurement grid: dx=15mm, dy=15mm

Zoom Scan (5x5x7)/Cube 0: Measurement grid: dx=8mm, dy=8mm, dz=5mm

Reference Value = 19.7 V/m; Power Drift = 0.072 dB

Peak SAR (extrapolated) = 1.59 W/kg

SAR(1 g) = 0.771 mW/g; SAR(10 g) = 0.367 mW/g

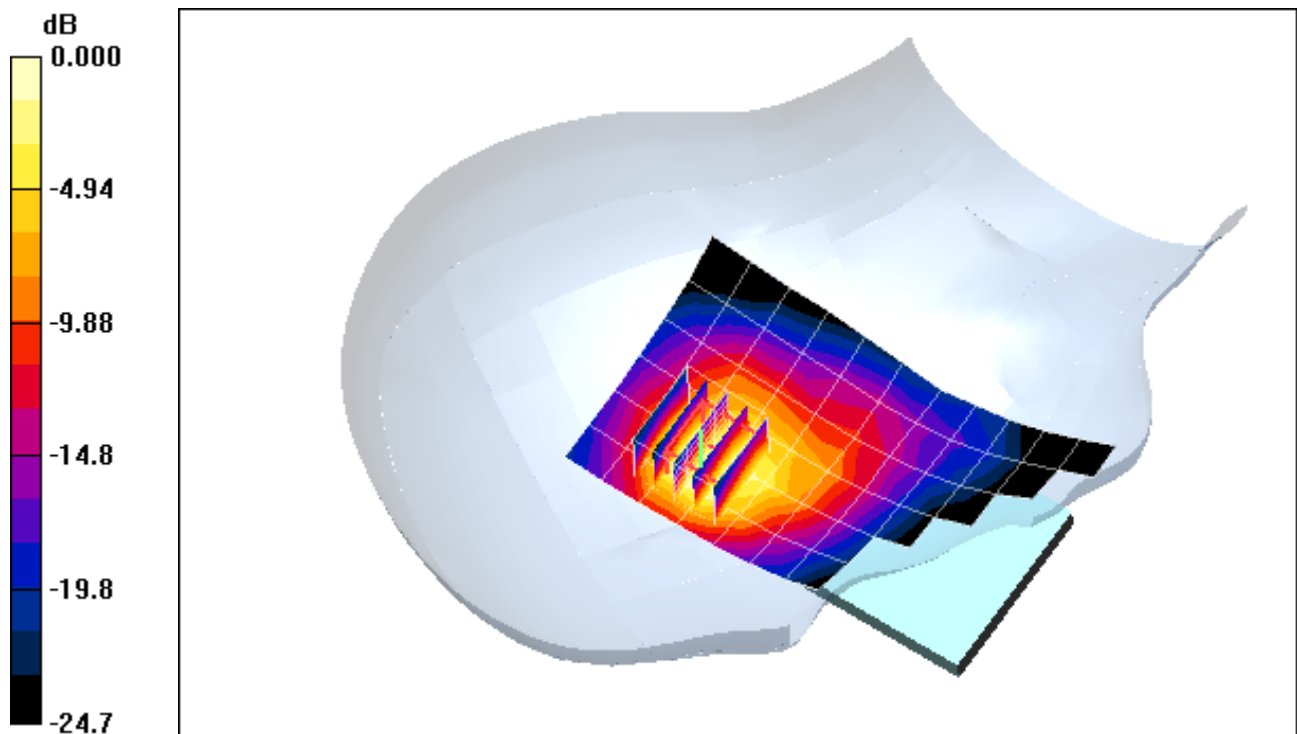

0 dB = 1.01mW/g

PCTEST ENGINEERING LABORATORY, INC.

DUT: ZNFAS730; Type: Portable Handset; Serial: A0000031D17249

Communication System: IEEE 802.11b; Frequency: 2462 MHz; Duty Cycle: 1:1

Medium: 2450 Head Medium parameters used (interpolated):

$f = 2462 \text{ MHz}$; $\sigma = 1.88 \text{ mho/m}$; $\epsilon_r = 39.2$; $\rho = 1000 \text{ kg/m}^3$

Phantom section: Right Section

Test Date: 03-30-2012; Ambient Temp: 23.8°C; Tissue Temp: 22.0°C

Probe: ES3DV3 - SN3209; ConvF(4.46, 4.46, 4.46); Calibrated: 3/16/2012

Sensor-Surface: 3mm (Mechanical Surface Detection)

Electronics: DAE4 Sn665; Calibrated: 4/20/2011

Phantom: SAM Main; Type: SAM 4.0; Serial: TP-1114

Measurement SW: DASY4, V4.7 Build 80; Postprocessing SW: SEMCAD, V1.8 Build 186

Mode: IEEE 802.11b, Right Head, Tilt, Ch 11, 1 Mbps

Area Scan (7x14x1): Measurement grid: dx=15mm, dy=15mm

Zoom Scan (5x5x7)/Cube 0: Measurement grid: dx=8mm, dy=8mm, dz=5mm

Reference Value = 14.6 V/m; Power Drift = -0.014 dB

Peak SAR (extrapolated) = 0.908 W/kg

SAR(1 g) = 0.435 mW/g; SAR(10 g) = 0.210 mW/g

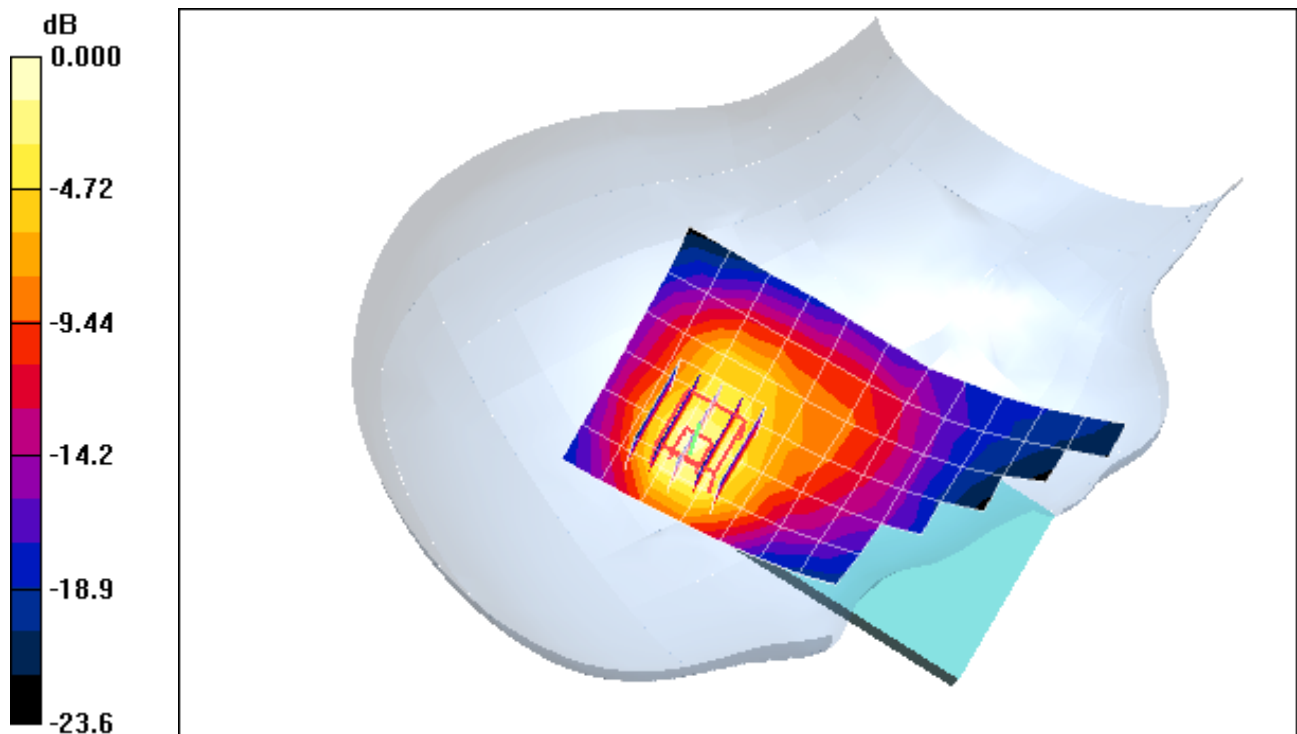

0 dB = 0.561mW/g

PCTEST ENGINEERING LABORATORY, INC.

DUT: ZNFAS730; Type: Portable Handset; Serial: A0000031D17249

Communication System: IEEE 802.11b; Frequency: 2462 MHz; Duty Cycle: 1:1

Medium: 2450 Head Medium parameters used (interpolated):

$f = 2462 \text{ MHz}$; $\sigma = 1.88 \text{ mho/m}$; $\epsilon_r = 39.2$; $\rho = 1000 \text{ kg/m}^3$

Phantom section: Left Section

Test Date: 03-30-2012; Ambient Temp: 23.8°C; Tissue Temp: 22.0°C

Probe: ES3DV3 - SN3209; ConvF(4.46, 4.46, 4.46); Calibrated: 3/16/2012

Sensor-Surface: 3mm (Mechanical Surface Detection)

Electronics: DAE4 Sn665; Calibrated: 4/20/2011

Phantom: SAM Main; Type: SAM 4.0; Serial: TP-1114

Measurement SW: DASY4, V4.7 Build 80; Postprocessing SW: SEMCAD, V1.8 Build 186

Mode: IEEE 802.11b, Left Head, Touch, Ch 11, 1 Mbps

Area Scan (7x11x1): Measurement grid: dx=15mm, dy=15mm

Zoom Scan (5x5x7)/Cube 0: Measurement grid: dx=8mm, dy=8mm, dz=5mm

Reference Value = 13.5 V/m; Power Drift = 0.031 dB

Peak SAR (extrapolated) = 0.583 W/kg

SAR(1 g) = 0.335 mW/g; SAR(10 g) = 0.192 mW/g

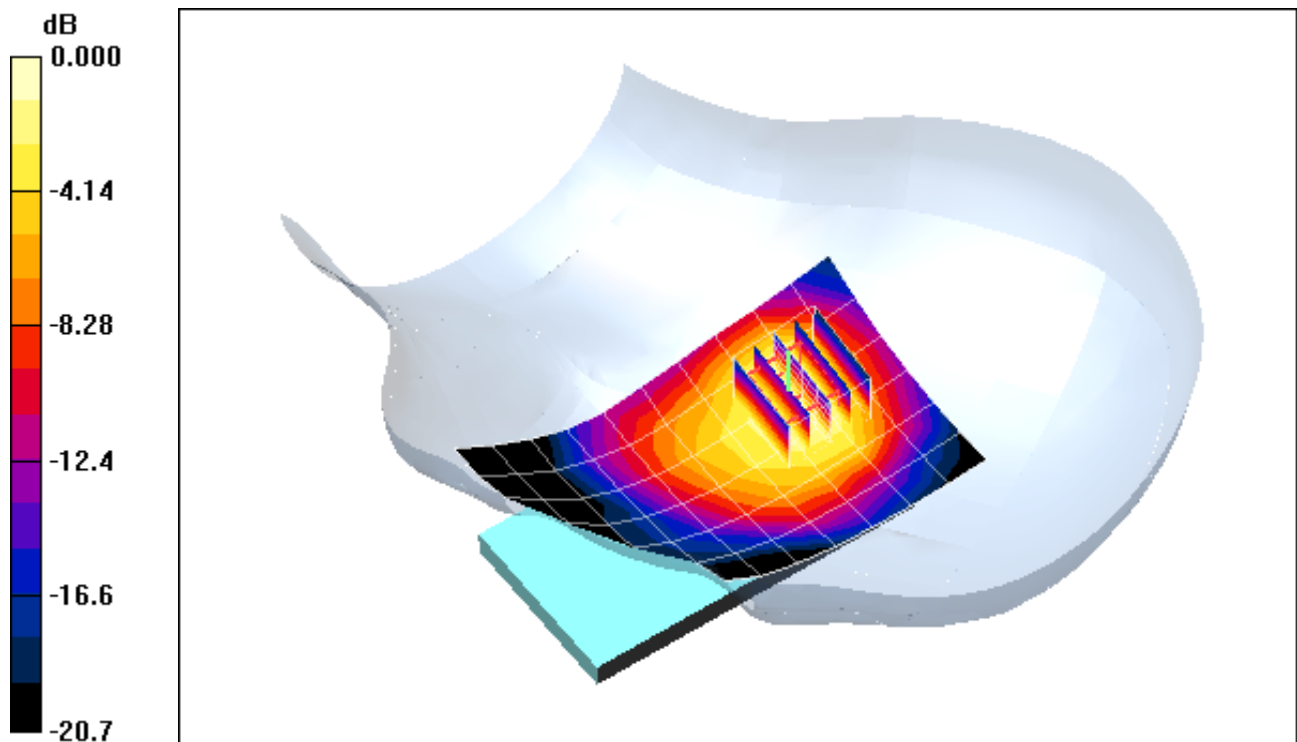

0 dB = 0.406mW/g

PCTEST ENGINEERING LABORATORY, INC.

DUT: ZNFAS730; Type: Portable Handset; Serial: A0000031D17249

Communication System: IEEE 802.11b; Frequency: 2462 MHz; Duty Cycle: 1:1

Medium: 2450 Head Medium parameters used (interpolated):

$f = 2462 \text{ MHz}$; $\sigma = 1.88 \text{ mho/m}$; $\epsilon_r = 39.2$; $\rho = 1000 \text{ kg/m}^3$

Phantom section: Left Section

Test Date: 03-30-2012; Ambient Temp: 23.8°C; Tissue Temp: 22.0°C

Probe: ES3DV3 - SN3209; ConvF(4.46, 4.46, 4.46); Calibrated: 3/16/2012

Sensor-Surface: 3mm (Mechanical Surface Detection)

Electronics: DAE4 Sn665; Calibrated: 4/20/2011

Phantom: SAM Main; Type: SAM 4.0; Serial: TP-1114

Measurement SW: DASY4, V4.7 Build 80; Postprocessing SW: SEMCAD, V1.8 Build 186

Mode: IEEE 802.11b, Left Head, Tilt, Ch 11, 1 Mbps

Area Scan (7x11x1): Measurement grid: dx=15mm, dy=15mm

Zoom Scan (5x5x7)/Cube 0: Measurement grid: dx=8mm, dy=8mm, dz=5mm

Reference Value = 12.6 V/m; Power Drift = 0.002 dB

Peak SAR (extrapolated) = 0.489 W/kg

SAR(1 g) = 0.265 mW/g; SAR(10 g) = 0.144 mW/g

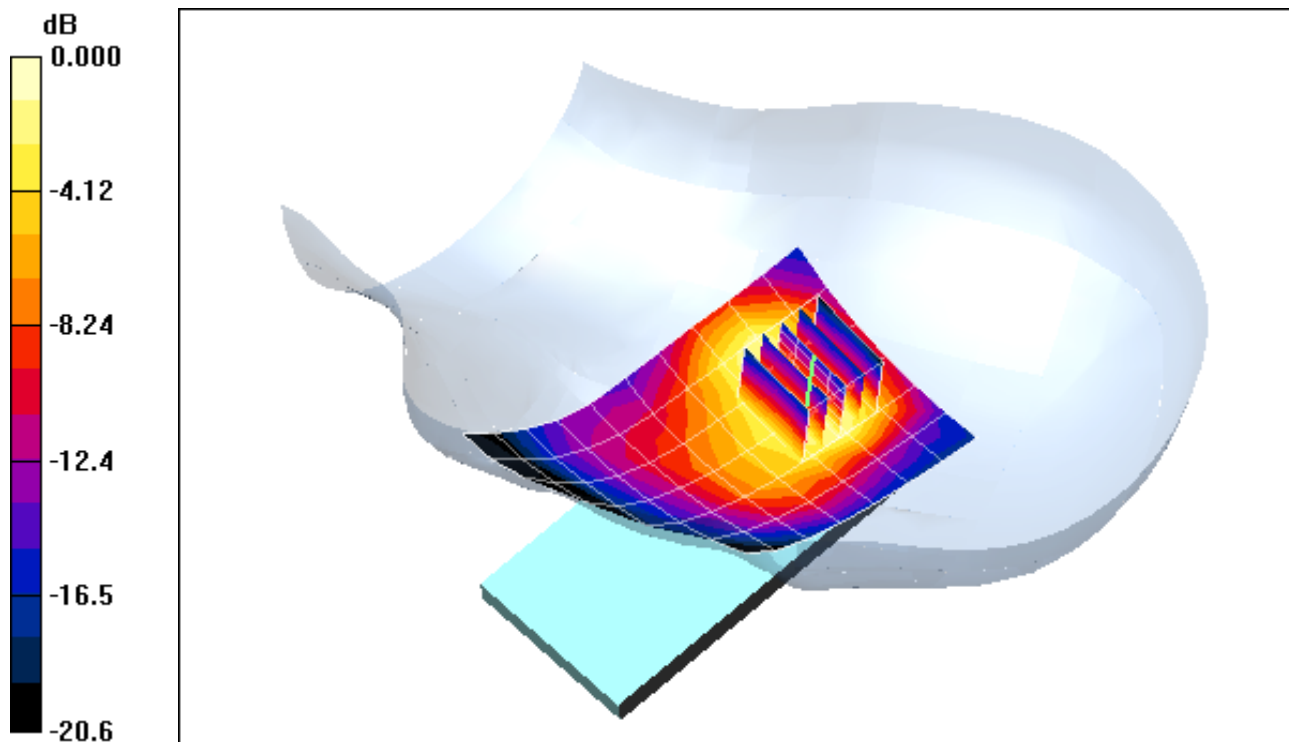

0 dB = 0.327mW/g

PCTEST ENGINEERING LABORATORY, INC.

DUT: ZNFAS730; Type: Portable Handset; Serial: A0000031D1725C

Communication System: Cellular CDMA; Frequency: 836.52 MHz; Duty Cycle: 1:1

Medium: 835 Body Medium parameters used (interpolated):

$f = 836.52 \text{ MHz}$; $\sigma = 0.985 \text{ mho/m}$; $\epsilon_r = 52.6$; $\rho = 1000 \text{ kg/m}^3$

Phantom section: Flat Section; Space: 1.0 cm

Test Date: 04-19-2012; Ambient Temp: 23.0°C; Tissue Temp: 22.7°C

Probe: ES3DV3 - SN3258; ConvF(6.06, 6.06, 6.06); Calibrated: 2/21/2012

Sensor-Surface: 4mm (Mechanical Surface Detection)

Electronics: DAE4 Sn1272; Calibrated: 1/18/2012

Phantom: SAM Main; Type: SAM 4.0; Serial: TP-1406

Measurement SW: DASY4, V4.7 Build 80; Postprocessing SW: SEMCAD, V1.8 Build 186

Mode: Cellular EVDO, Body SAR, Back side, Mid.ch

Area Scan (7x12x1): Measurement grid: dx=15mm, dy=15mm

Zoom Scan (5x5x7)/Cube 0: Measurement grid: dx=8mm, dy=8mm, dz=5mm

Reference Value = 39.2 V/m; Power Drift = -0.006 dB

Peak SAR (extrapolated) = 1.59 W/kg

SAR(1 g) = 1.29 mW/g; SAR(10 g) = 0.978 mW/g

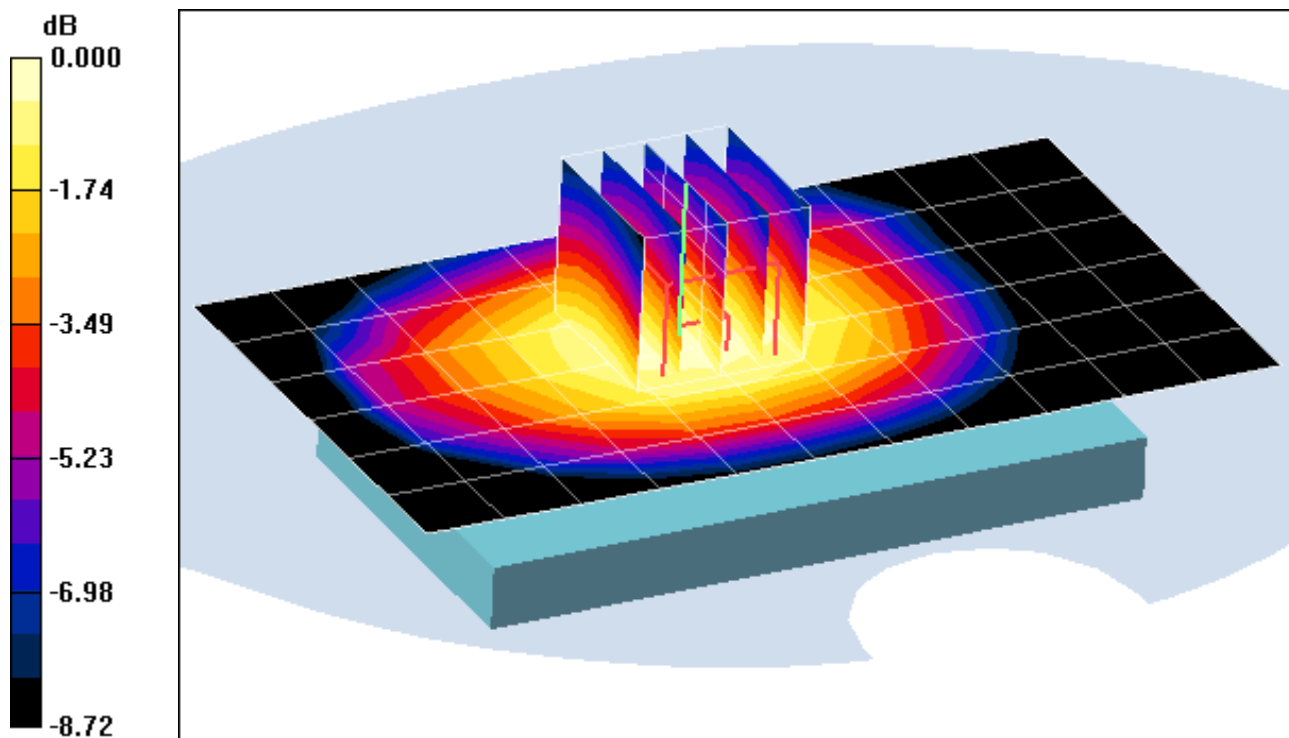

0 dB = 1.35mW/g

PCTEST ENGINEERING LABORATORY, INC.

DUT: ZNFAS730; Type: Portable Handset; Serial: A0000031D1725C

Communication System: Cellular CDMA; Frequency: 836.52 MHz; Duty Cycle: 1:1

Medium: 835 Body Medium parameters used (interpolated):

$f = 836.52 \text{ MHz}$; $\sigma = 0.985 \text{ mho/m}$; $\epsilon_r = 52.6$; $\rho = 1000 \text{ kg/m}^3$

Phantom section: Flat Section; Space: 1.0 cm

Test Date: 04-19-2012; Ambient Temp: 23.0°C; Tissue Temp: 22.7°C

Probe: ES3DV3 - SN3258; ConvF(6.06, 6.06, 6.06); Calibrated: 2/21/2012

Sensor-Surface: 4mm (Mechanical Surface Detection)

Electronics: DAE4 Sn1272; Calibrated: 1/18/2012

Phantom: SAM Main; Type: SAM 4.0; Serial: TP-1406

Measurement SW: DASY4, V4.7 Build 80; Postprocessing SW: SEMCAD, V1.8 Build 186

Mode: Cellular EVDO, Body SAR, Front side, Mid.ch

Area Scan (7x12x1): Measurement grid: dx=15mm, dy=15mm

Zoom Scan (5x5x7)/Cube 0: Measurement grid: dx=8mm, dy=8mm, dz=5mm

Reference Value = 35.1 V/m; Power Drift = -0.006 dB

Peak SAR (extrapolated) = 1.24 W/kg

SAR(1 g) = 1.03 mW/g; SAR(10 g) = 0.793 mW/g

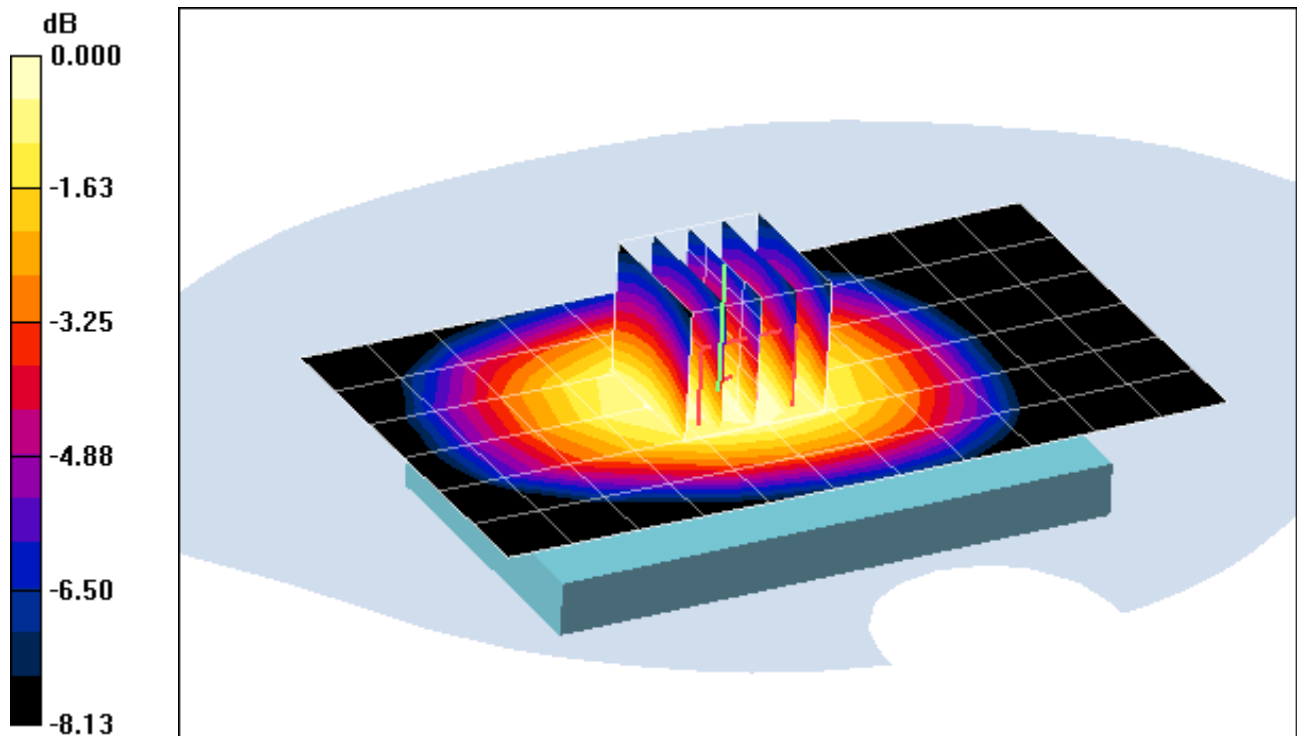

0 dB = 1.08mW/g

PCTEST ENGINEERING LABORATORY, INC.

DUT: ZNFAS730; Type: Portable Handset; Serial: A0000031D1725C

Communication System: Cellular CDMA; Frequency: 836.52 MHz; Duty Cycle: 1:1

Medium: 835 Body Medium parameters used (interpolated):

$f = 836.52 \text{ MHz}$; $\sigma = 0.985 \text{ mho/m}$; $\epsilon_r = 52.6$; $\rho = 1000 \text{ kg/m}^3$

Phantom section: Flat Section; Space: 1.0 cm

Test Date: 04-19-2012; Ambient Temp: 23.0°C; Tissue Temp: 22.7°C

Probe: ES3DV3 - SN3258; ConvF(6.06, 6.06, 6.06); Calibrated: 2/21/2012

Sensor-Surface: 4mm (Mechanical Surface Detection)

Electronics: DAE4 Sn1272; Calibrated: 1/18/2012

Phantom: SAM Main; Type: SAM 4.0; Serial: TP-1406

Measurement SW: DASY4, V4.7 Build 80; Postprocessing SW: SEMCAD, V1.8 Build 186

Mode: Cellular EVDO, Body SAR, Bottom Edge, Mid.ch

Area Scan (5x7x1): Measurement grid: dx=15mm, dy=15mm

Zoom Scan (5x5x7)/Cube 0: Measurement grid: dx=8mm, dy=8mm, dz=5mm

Reference Value = 12.3 V/m; Power Drift = -0.002 dB

Peak SAR (extrapolated) = 0.222 W/kg

SAR(1 g) = 0.121 mW/g; SAR(10 g) = 0.071 mW/g

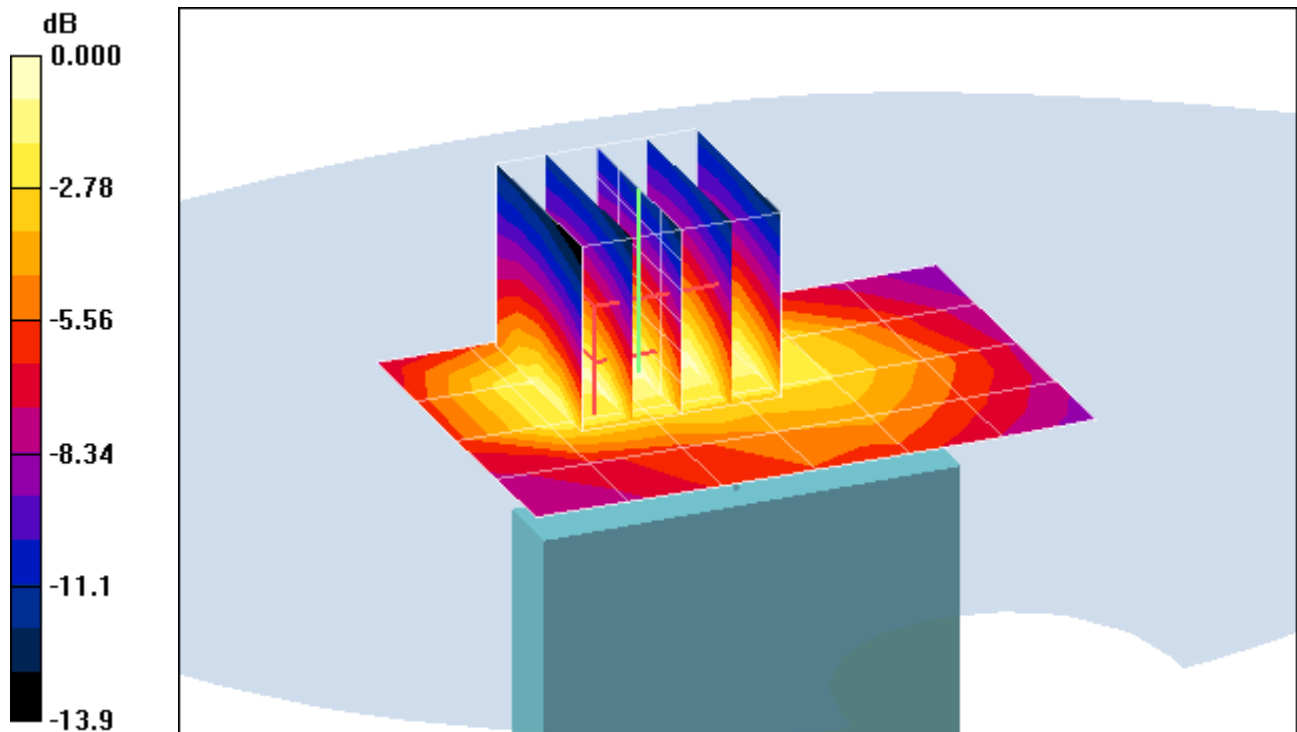

0 dB = 0.131mW/g

PCTEST ENGINEERING LABORATORY, INC.

DUT: ZNFAS730; Type: Portable Handset; Serial: A0000031D1725C

Communication System: Cellular CDMA; Frequency: 836.52 MHz; Duty Cycle: 1:1

Medium: 835 Body Medium parameters used (interpolated):

$f = 836.52 \text{ MHz}$; $\sigma = 0.985 \text{ mho/m}$; $\epsilon_r = 52.6$; $\rho = 1000 \text{ kg/m}^3$

Phantom section: Flat Section; Space: 1.0 cm

Test Date: 04-19-2012; Ambient Temp: 23.0°C; Tissue Temp: 22.7°C

Probe: ES3DV3 - SN3258; ConvF(6.06, 6.06, 6.06); Calibrated: 2/21/2012

Sensor-Surface: 4mm (Mechanical Surface Detection)

Electronics: DAE4 Sn1272; Calibrated: 1/18/2012

Phantom: SAM Main; Type: SAM 4.0; Serial: TP-1406

Measurement SW: DASY4, V4.7 Build 80; Postprocessing SW: SEMCAD, V1.8 Build 186

Mode: Cellular EVDO, Body SAR, Right Edge, Mid.ch

Area Scan (5x13x1): Measurement grid: dx=15mm, dy=15mm

Zoom Scan (5x5x7)/Cube 0: Measurement grid: dx=8mm, dy=8mm, dz=5mm

Reference Value = 34.8 V/m; Power Drift = -0.067 dB

Peak SAR (extrapolated) = 1.35 W/kg

SAR(1 g) = 0.979 mW/g; SAR(10 g) = 0.681 mW/g

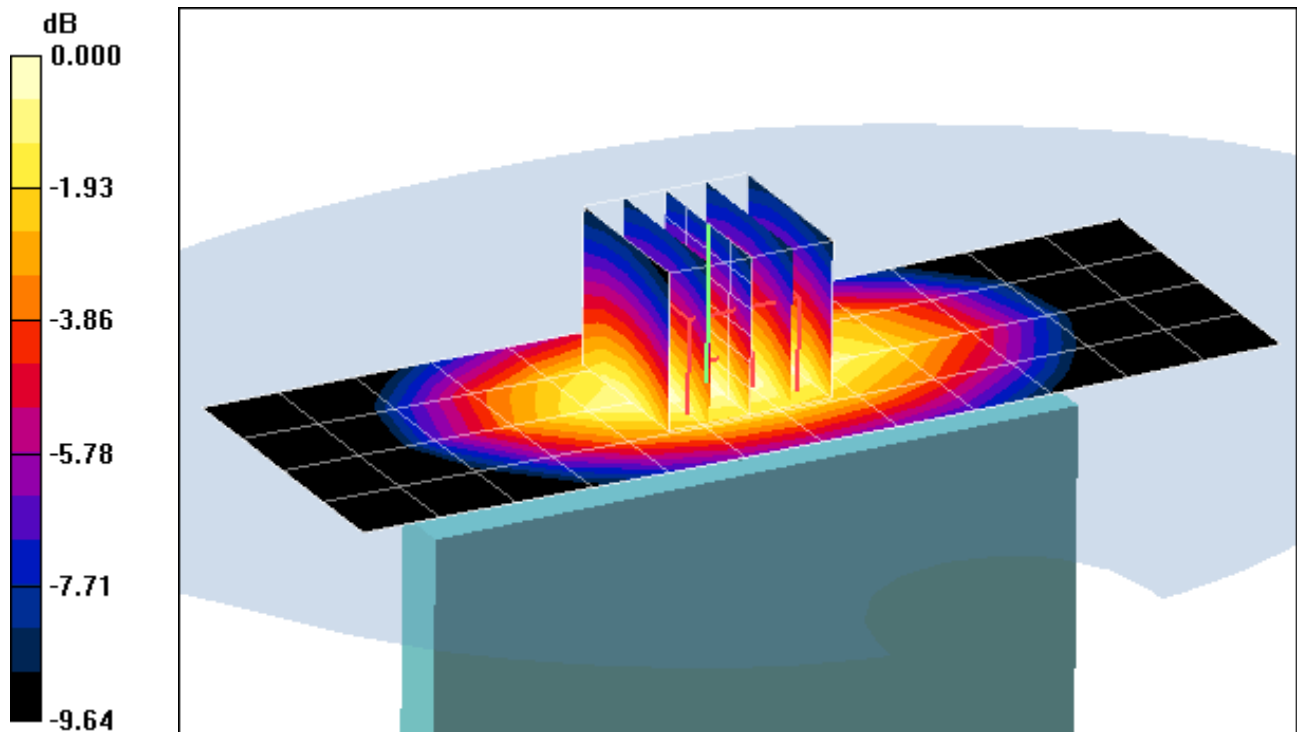

0 dB = 1.05mW/g

PCTEST ENGINEERING LABORATORY, INC.

DUT: ZNFAS730; Type: Portable Handset; Serial: A0000031D1725C

Communication System: Cellular CDMA; Frequency: 836.52 MHz; Duty Cycle: 1:1

Medium: 835 Body Medium parameters used (interpolated):

$f = 836.52 \text{ MHz}$; $\sigma = 0.985 \text{ mho/m}$; $\epsilon_r = 52.6$; $\rho = 1000 \text{ kg/m}^3$

Phantom section: Flat Section; Space: 1.0 cm

Test Date: 04-19-2012; Ambient Temp: 23.0°C; Tissue Temp: 22.7°C

Probe: ES3DV3 - SN3258; ConvF(6.06, 6.06, 6.06); Calibrated: 2/21/2012

Sensor-Surface: 4mm (Mechanical Surface Detection)

Electronics: DAE4 Sn1272; Calibrated: 1/18/2012

Phantom: SAM Main; Type: SAM 4.0; Serial: TP-1406

Measurement SW: DASY4, V4.7 Build 80; Postprocessing SW: SEMCAD, V1.8 Build 186

Mode: Cellular EVDO, Body SAR, Left Edge, Mid.ch

Area Scan (5x13x1): Measurement grid: dx=15mm, dy=15mm

Zoom Scan (5x5x7)/Cube 0: Measurement grid: dx=8mm, dy=8mm, dz=5mm

Reference Value = 34.1 V/m; Power Drift = 0.027 dB

Peak SAR (extrapolated) = 1.29 W/kg

SAR(1 g) = 0.933 mW/g; SAR(10 g) = 0.646 mW/g

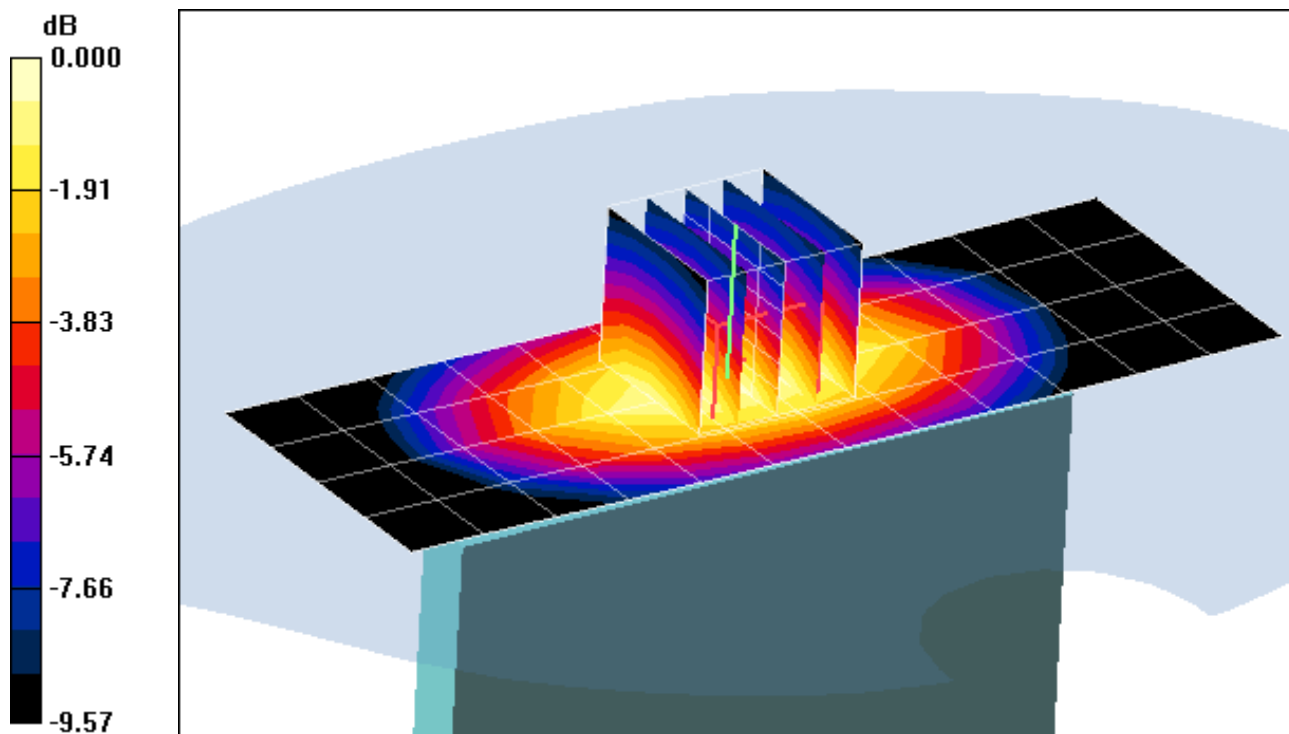

0 dB = 0.997mW/g

PCTEST ENGINEERING LABORATORY, INC.

DUT: ZNFAS730; Type: Portable Handset; Serial: A0000031D1725C

Communication System: PCS CDMA; Frequency: 1908.75 MHz; Duty Cycle: 1:1

Medium: 1900 Body Medium parameters used (interpolated):

$f = 1908.75 \text{ MHz}$; $\sigma = 1.56 \text{ mho/m}$; $\epsilon_r = 52.93$; $\rho = 1000 \text{ kg/m}^3$

Phantom section: Flat Section; Space: 1.0 cm

Test Date: 04-19-2012; Ambient Temp: 22.1°C; Tissue Temp: 21.8°C

Probe: ES3DV2 - SN3022; ConvF(4.41, 4.41, 4.41); Calibrated: 8/25/2011

Sensor-Surface: 4mm (Mechanical Surface Detection)

Electronics: DAE4 Sn859; Calibrated: 5/19/2011

Phantom: SAM Sub Dasy B; Type: SAM 5.0; Serial: TP-1626

Measurement SW: DASY4, V4.7 Build 80; Postprocessing SW: SEMCAD, V1.8 Build 186

Mode: PCS CDMA, Body SAR, Back side, High.ch

Area Scan (8x12x1): Measurement grid: dx=15mm, dy=15mm

Zoom Scan (5x5x7)/Cube 0: Measurement grid: dx=8mm, dy=8mm, dz=5mm

Reference Value = 27.5 V/m; Power Drift = 0.194 dB

Peak SAR (extrapolated) = 1.54 W/kg

SAR(1 g) = 0.990 mW/g; SAR(10 g) = 0.631 mW/g

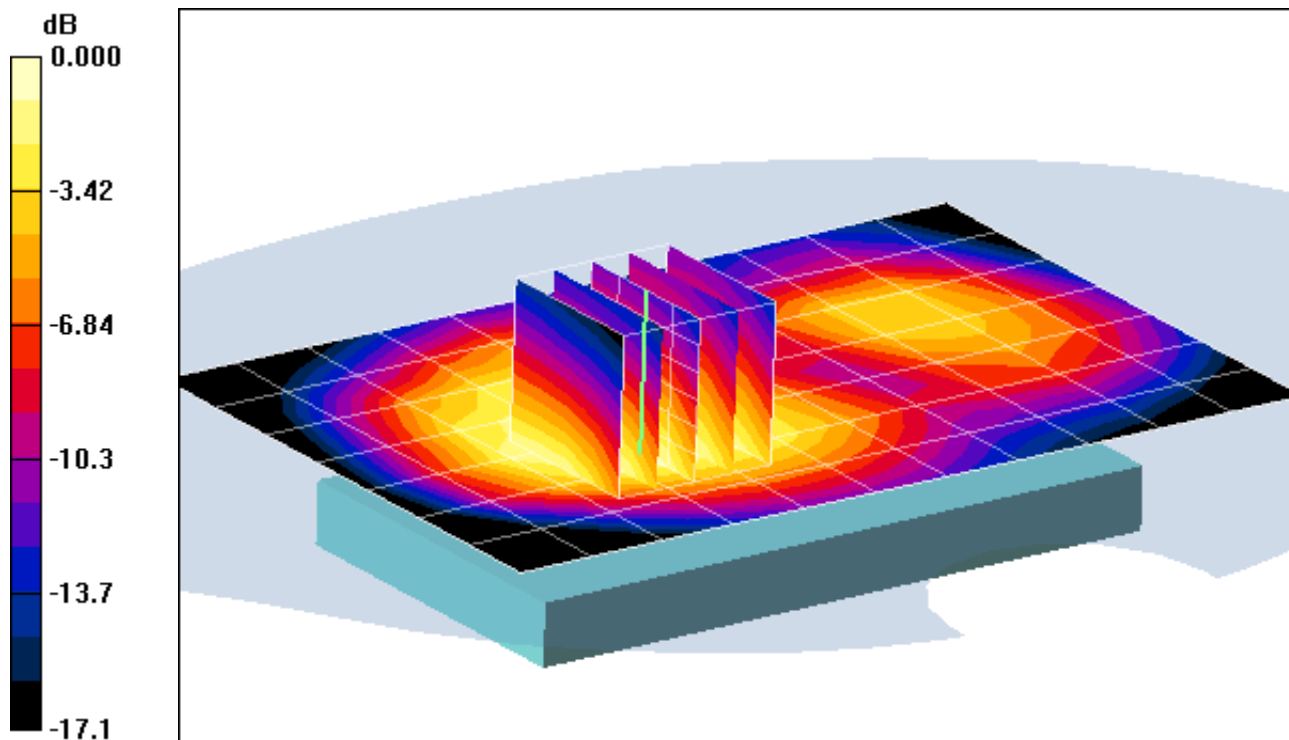

0 dB = 1.06mW/g

PCTEST ENGINEERING LABORATORY, INC.

DUT: ZNFAS730; Type: Portable Handset; Serial: A0000031D1725C

Communication System: PCS CDMA; Frequency: 1908.75 MHz; Duty Cycle: 1:1

Medium: 1900 Body Medium parameters used (interpolated):

$f = 1908.75 \text{ MHz}$; $\sigma = 1.56 \text{ mho/m}$; $\epsilon_r = 52.94$; $\rho = 1000 \text{ kg/m}^3$

Phantom section: Flat Section; Space: 1.0 cm

Test Date: 04-19-2012; Ambient Temp: 22.1°C; Tissue Temp: 21.8°C

Probe: ES3DV2 - SN3022; ConvF(4.41, 4.41, 4.41); Calibrated: 8/25/2011

Sensor-Surface: 4mm (Mechanical Surface Detection)

Electronics: DAE4 Sn859; Calibrated: 5/19/2011

Phantom: SAM Sub Dasy B; Type: SAM 5.0; Serial: TP-1626

Measurement SW: DASY4, V4.7 Build 80; Postprocessing SW: SEMCAD, V1.8 Build 186

Mode: PCS EVDO, Body SAR, Front side, High.ch

Area Scan (8x12x1): Measurement grid: dx=15mm, dy=15mm

Zoom Scan (5x5x7)/Cube 0: Measurement grid: dx=8mm, dy=8mm, dz=5mm

Reference Value = 28.9 V/m; Power Drift = 0.056 dB

Peak SAR (extrapolated) = 1.61 W/kg

SAR(1 g) = 1.04 mW/g; SAR(10 g) = 0.652 mW/g

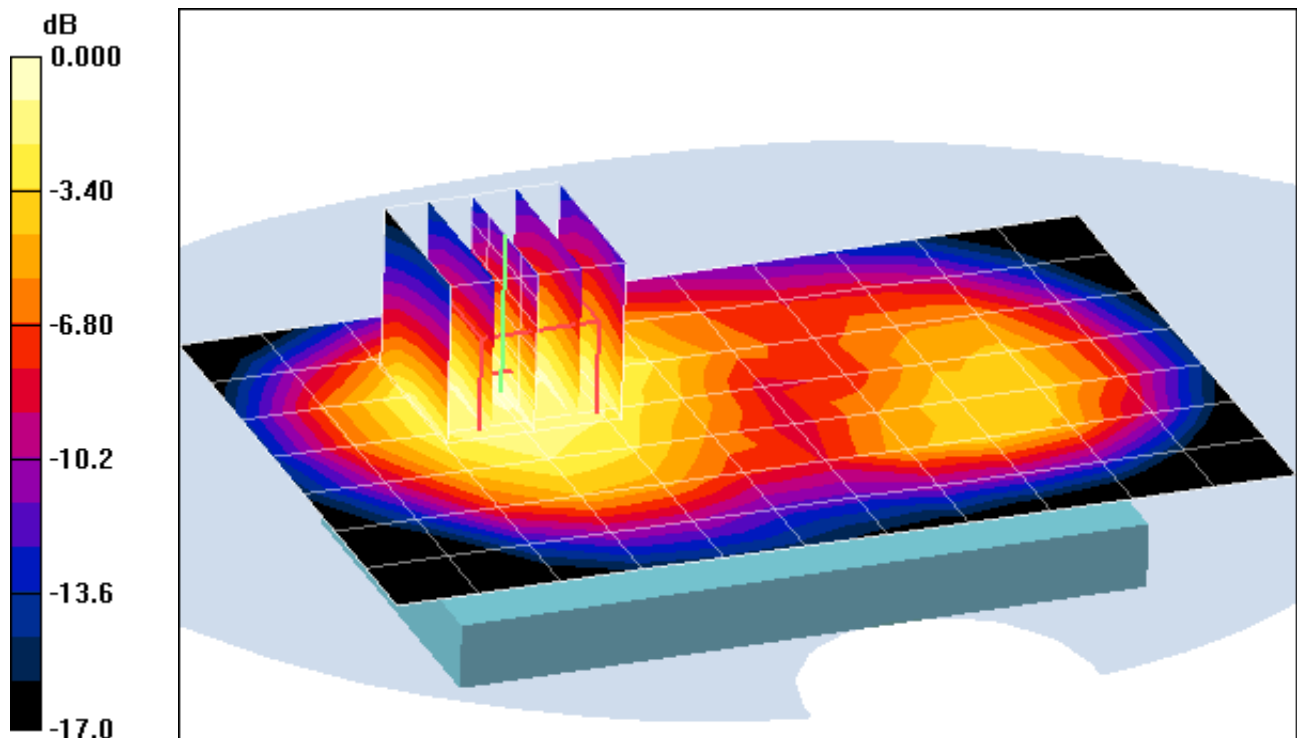

0 dB = 1.12mW/g

PCTEST ENGINEERING LABORATORY, INC.

DUT: ZNFAS730; Type: Portable Handset; Serial: A0000031D1725C

Communication System: PCS CDMA; Frequency: 1880 MHz; Duty Cycle: 1:1

Medium: 1900 Body Medium parameters used:

$f = 1880 \text{ MHz}$; $\sigma = 1.53 \text{ mho/m}$; $\epsilon_r = 53.1$; $\rho = 1000 \text{ kg/m}^3$

Phantom section: Flat Section; Space: 1.0 cm

Test Date: 04-19-2012; Ambient Temp: 22.1°C; Tissue Temp: 21.8°C

Probe: ES3DV2 - SN3022; ConvF(4.41, 4.41, 4.41); Calibrated: 8/25/2011

Sensor-Surface: 4mm (Mechanical Surface Detection)

Electronics: DAE4 Sn859; Calibrated: 5/19/2011

Phantom: SAM Sub Dasy B; Type: SAM 5.0; Serial: TP-1626

Measurement SW: DASY4, V4.7 Build 80; Postprocessing SW: SEMCAD, V1.8 Build 186

Mode: PCS EVDO, Body SAR, Bottom Edge, Mid.ch

Area Scan (5x7x1): Measurement grid: dx=15mm, dy=15mm

Zoom Scan (5x5x7)/Cube 0: Measurement grid: dx=8mm, dy=8mm, dz=5mm

Reference Value = 20.6 V/m; Power Drift = 0.115 dB

Peak SAR (extrapolated) = 0.972 W/kg

SAR(1 g) = 0.582 mW/g; SAR(10 g) = 0.328 mW/g

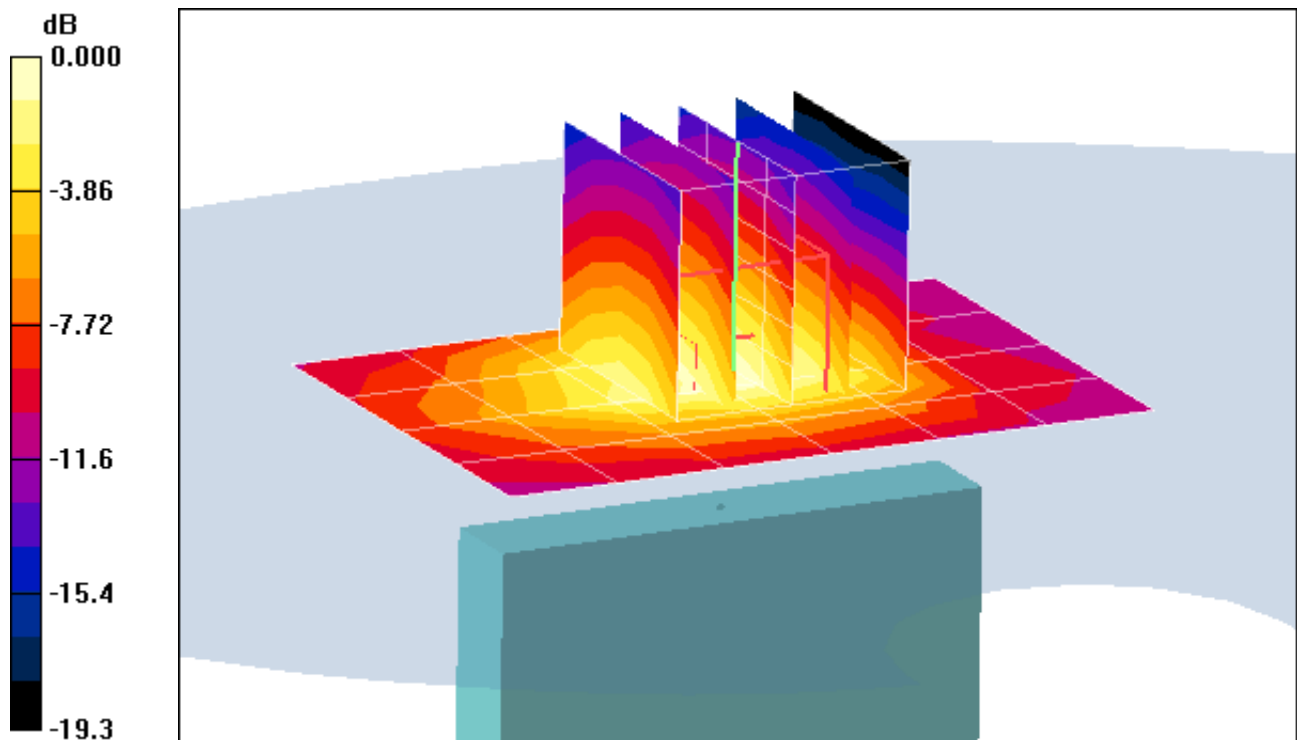

0 dB = 0.640mW/g

PCTEST ENGINEERING LABORATORY, INC.

DUT: ZNFAS730; Type: Portable Handset; Serial: A0000031D1725C

Communication System: PCS CDMA; Frequency: 1880 MHz; Duty Cycle: 1:1

Medium: 1900 Body Medium parameters used:

$f = 1880 \text{ MHz}$; $\sigma = 1.53 \text{ mho/m}$; $\epsilon_r = 53.1$; $\rho = 1000 \text{ kg/m}^3$

Phantom section: Flat Section; Space: 1.0 cm

Test Date: 04-19-2012; Ambient Temp: 22.1°C; Tissue Temp: 21.8°C

Probe: ES3DV2 - SN3022; ConvF(4.41, 4.41, 4.41); Calibrated: 8/25/2011

Sensor-Surface: 4mm (Mechanical Surface Detection)

Electronics: DAE4 Sn859; Calibrated: 5/19/2011

Phantom: SAM Sub Dasy B; Type: SAM 5.0; Serial: TP-1626

Measurement SW: DASY4, V4.7 Build 80; Postprocessing SW: SEMCAD, V1.8 Build 186

Mode: PCS EVDO, Body SAR, Right Edge, Mid.ch

Area Scan (5x13x1): Measurement grid: dx=15mm, dy=15mm

Zoom Scan (5x5x7)/Cube 0: Measurement grid: dx=8mm, dy=8mm, dz=5mm

Reference Value = 12.4 V/m; Power Drift = -0.018 dB

Peak SAR (extrapolated) = 0.317 W/kg

SAR(1 g) = 0.205 mW/g; SAR(10 g) = 0.124 mW/g

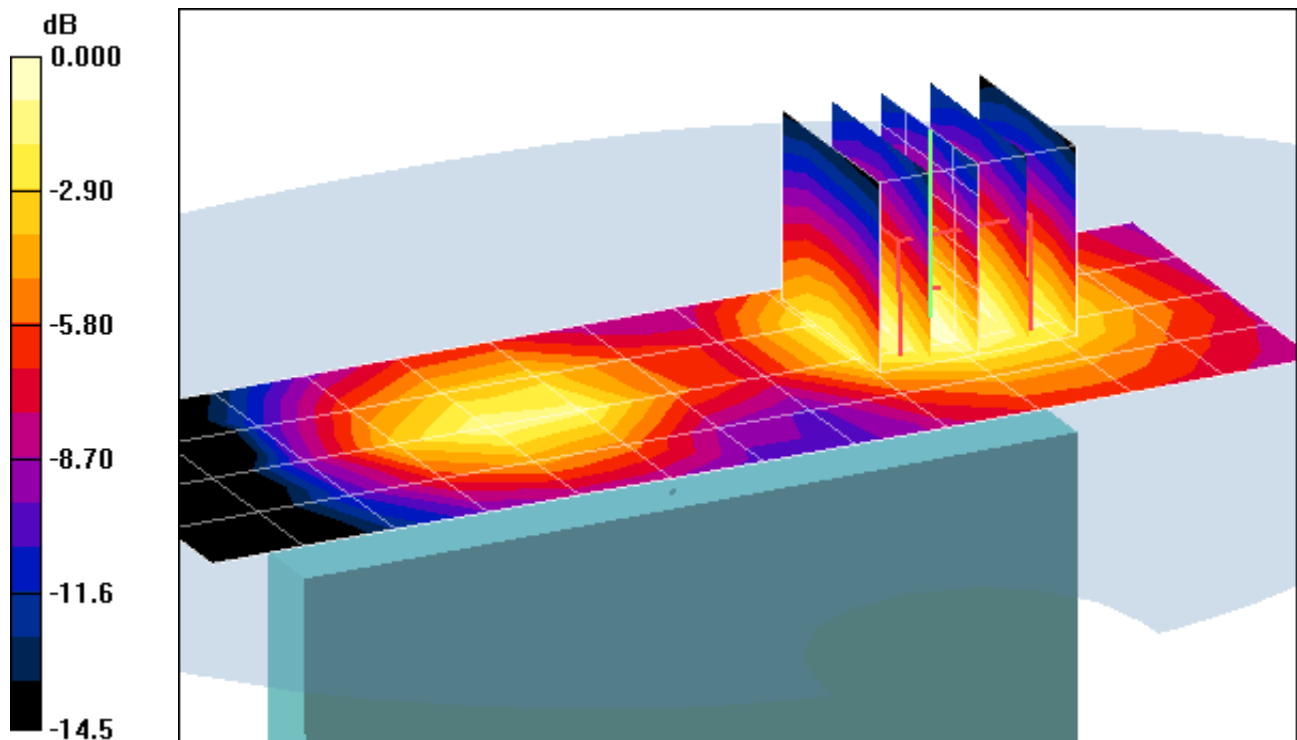

0 dB = 0.222mW/g

PCTEST ENGINEERING LABORATORY, INC.

DUT: ZNFAS730; Type: Portable Handset; Serial: A0000031D1725C

Communication System: PCS CDMA; Frequency: 1880 MHz; Duty Cycle: 1:1

Medium: 1900 Body Medium parameters used:

$f = 1880 \text{ MHz}$; $\sigma = 1.53 \text{ mho/m}$; $\epsilon_r = 53.1$; $\rho = 1000 \text{ kg/m}^3$

Phantom section: Flat Section; Space: 1.0 cm

Test Date: 04-19-2012; Ambient Temp: 22.1°C; Tissue Temp: 21.8°C

Probe: ES3DV2 - SN3022; ConvF(4.41, 4.41, 4.41); Calibrated: 8/25/2011

Sensor-Surface: 4mm (Mechanical Surface Detection)

Electronics: DAE4 Sn859; Calibrated: 5/19/2011

Phantom: SAM Sub Dasy B; Type: SAM 5.0; Serial: TP-1626

Measurement SW: DASY4, V4.7 Build 80; Postprocessing SW: SEMCAD, V1.8 Build 186

Mode: PCS EVDO, Body SAR, Left Edge, Mid.ch

Area Scan (5x13x1): Measurement grid: dx=15mm, dy=15mm

Zoom Scan (5x5x7)/Cube 0: Measurement grid: dx=8mm, dy=8mm, dz=5mm

Reference Value = 20.4 V/m; Power Drift = -0.136 dB

Peak SAR (extrapolated) = 0.939 W/kg

SAR(1 g) = 0.585 mW/g; SAR(10 g) = 0.344 mW/g

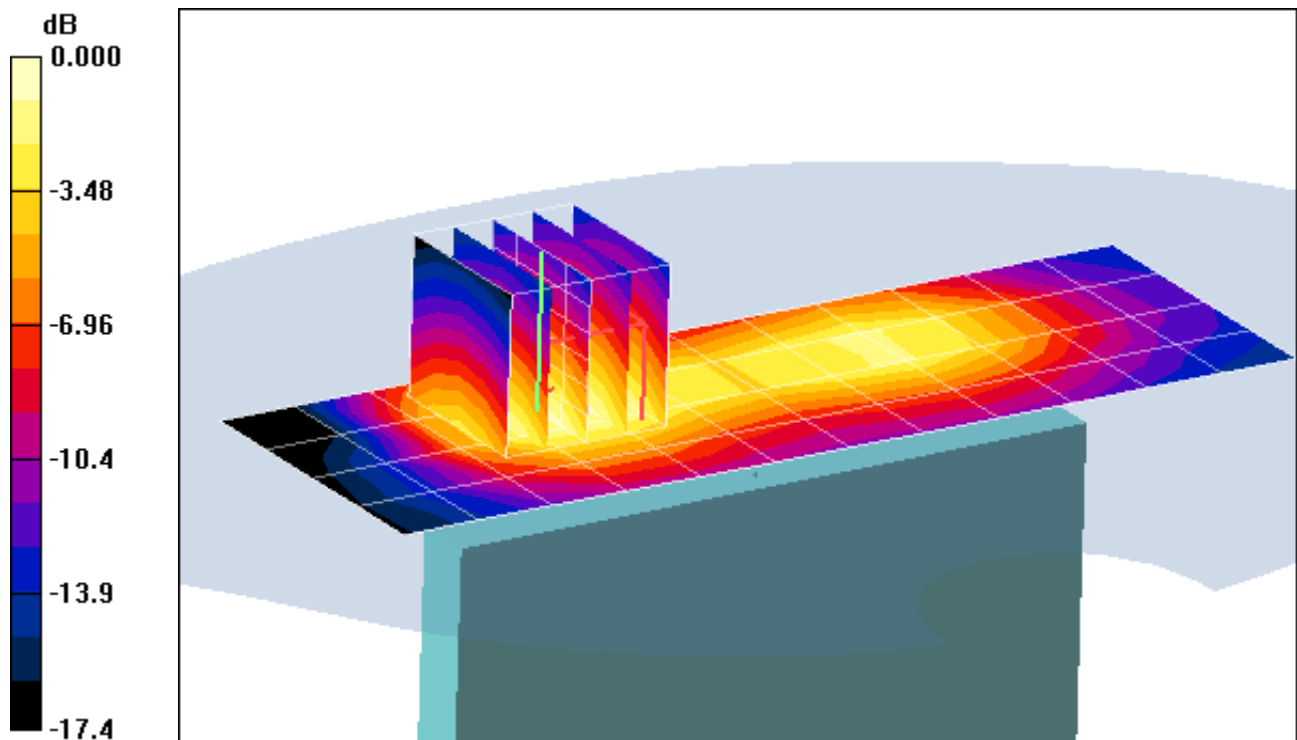

0 dB = 0.642mW/g

PCTEST ENGINEERING LABORATORY, INC.

DUT: ZNFAS730; Type: Portable Handset; Serial: A0000031D17249

Communication System: IEEE 802.11b; Frequency: 2462 MHz; Duty Cycle: 1:1

Medium: 2450 Body Medium parameters used (interpolated):

$f = 2462 \text{ MHz}$; $\sigma = 2.01 \text{ mho/m}$; $\epsilon_r = 51.3$; $\rho = 1000 \text{ kg/m}^3$

Phantom section: Flat Section; Space: 1.0 cm

Test Date: 03-30-2012; Ambient Temp: 24.2°C; Tissue Temp: 22.1°C

Probe: ES3DV3 - SN3209; ConvF(4.23, 4.23, 4.23); Calibrated: 3/16/2012

Sensor-Surface: 3mm (Mechanical Surface Detection)

Electronics: DAE4 Sn665; Calibrated: 4/20/2011

Phantom: SAM Sub; Type: SAM 4.0; Serial: TP-1357

Measurement SW: DASY4, V4.7 Build 80; Postprocessing SW: SEMCAD, V1.8 Build 186

Mode: IEEE 802.11b, Body SAR, Ch 11, 1 Mbps, Back Side

Area Scan (7x12x1): Measurement grid: dx=15mm, dy=15mm

Zoom Scan (5x5x7)/Cube 0: Measurement grid: dx=8mm, dy=8mm, dz=5mm

Reference Value = 8.26 V/m; Power Drift = -0.135 dB

Peak SAR (extrapolated) = 0.303 W/kg

SAR(1 g) = 0.127 mW/g; SAR(10 g) = 0.064 mW/g

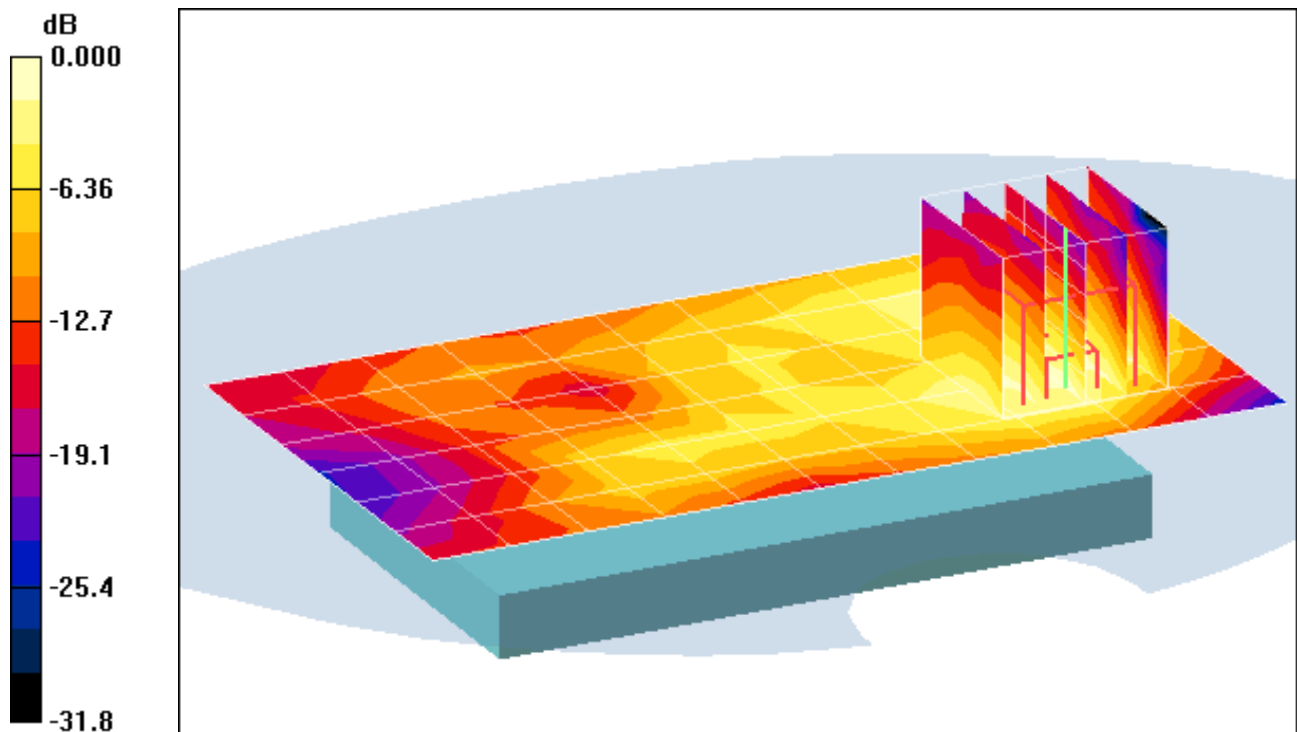

0 dB = 0.167mW/g

PCTEST ENGINEERING LABORATORY, INC.

DUT: ZNFAS730; Type: Portable Handset; Serial: A0000031D17249

Communication System: IEEE 802.11b; Frequency: 2462 MHz; Duty Cycle: 1:1

Medium: 2450 Body Medium parameters used (interpolated):

$f = 2462 \text{ MHz}$; $\sigma = 2.01 \text{ mho/m}$; $\epsilon_r = 51.3$; $\rho = 1000 \text{ kg/m}^3$

Phantom section: Flat Section; Space: 1.0 cm

Test Date: 03-30-2012; Ambient Temp: 24.2°C; Tissue Temp: 22.1°C

Probe: ES3DV3 - SN3209; ConvF(4.23, 4.23, 4.23); Calibrated: 3/16/2012

Sensor-Surface: 3mm (Mechanical Surface Detection)

Electronics: DAE4 Sn665; Calibrated: 4/20/2011

Phantom: SAM Sub; Type: SAM 4.0; Serial: TP-1357

Measurement SW: DASY4, V4.7 Build 80; Postprocessing SW: SEMCAD, V1.8 Build 186

Mode: IEEE 802.11b, Body SAR, Ch 11, 1 Mbps, Front Side

Area Scan (7x12x1): Measurement grid: dx=15mm, dy=15mm

Zoom Scan (5x5x7)/Cube 0: Measurement grid: dx=8mm, dy=8mm, dz=5mm

Reference Value = 9.53 V/m; Power Drift = -0.145 dB

Peak SAR (extrapolated) = 0.309 W/kg

SAR(1 g) = 0.165 mW/g; SAR(10 g) = 0.089 mW/g

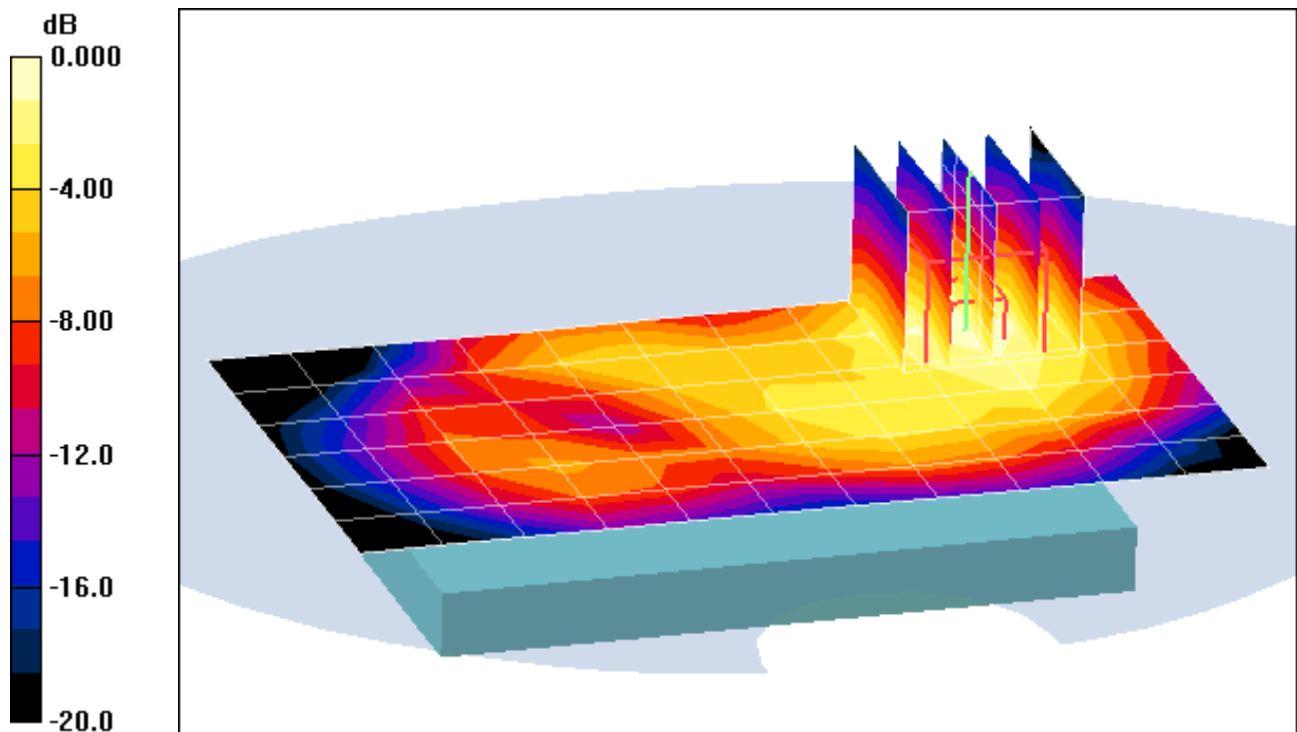

0 dB = 0.205mW/g

PCTEST ENGINEERING LABORATORY, INC.

DUT: ZNFAS730; Type: Portable Handset; Serial: A0000031D17249

Communication System: IEEE 802.11b; Frequency: 2462 MHz; Duty Cycle: 1:1

Medium: 2450 Body Medium parameters used (interpolated):

$f = 2462 \text{ MHz}$; $\sigma = 2.01 \text{ mho/m}$; $\epsilon_r = 51.3$; $\rho = 1000 \text{ kg/m}^3$

Phantom section: Flat Section; Space: 1.0 cm

Test Date: 03-30-2012; Ambient Temp: 24.2°C; Tissue Temp: 22.1°C

Probe: ES3DV3 - SN3209; ConvF(4.23, 4.23, 4.23); Calibrated: 3/16/2012

Sensor-Surface: 3mm (Mechanical Surface Detection)

Electronics: DAE4 Sn665; Calibrated: 4/20/2011

Phantom: SAM Sub; Type: SAM 4.0; Serial: TP-1357

Measurement SW: DASY4, V4.7 Build 80; Postprocessing SW: SEMCAD, V1.8 Build 186

Mode: IEEE 802.11b, Body SAR, Ch 11, 1 Mbps, Top Edge

Area Scan (5x7x1): Measurement grid: dx=15mm, dy=15mm

Zoom Scan (5x5x7)/Cube 0: Measurement grid: dx=8mm, dy=8mm, dz=5mm

Reference Value = 7.13 V/m; Power Drift = -0.009 dB

Peak SAR (extrapolated) = 0.185 W/kg

SAR(1 g) = 0.096 mW/g; SAR(10 g) = 0.051 mW/g

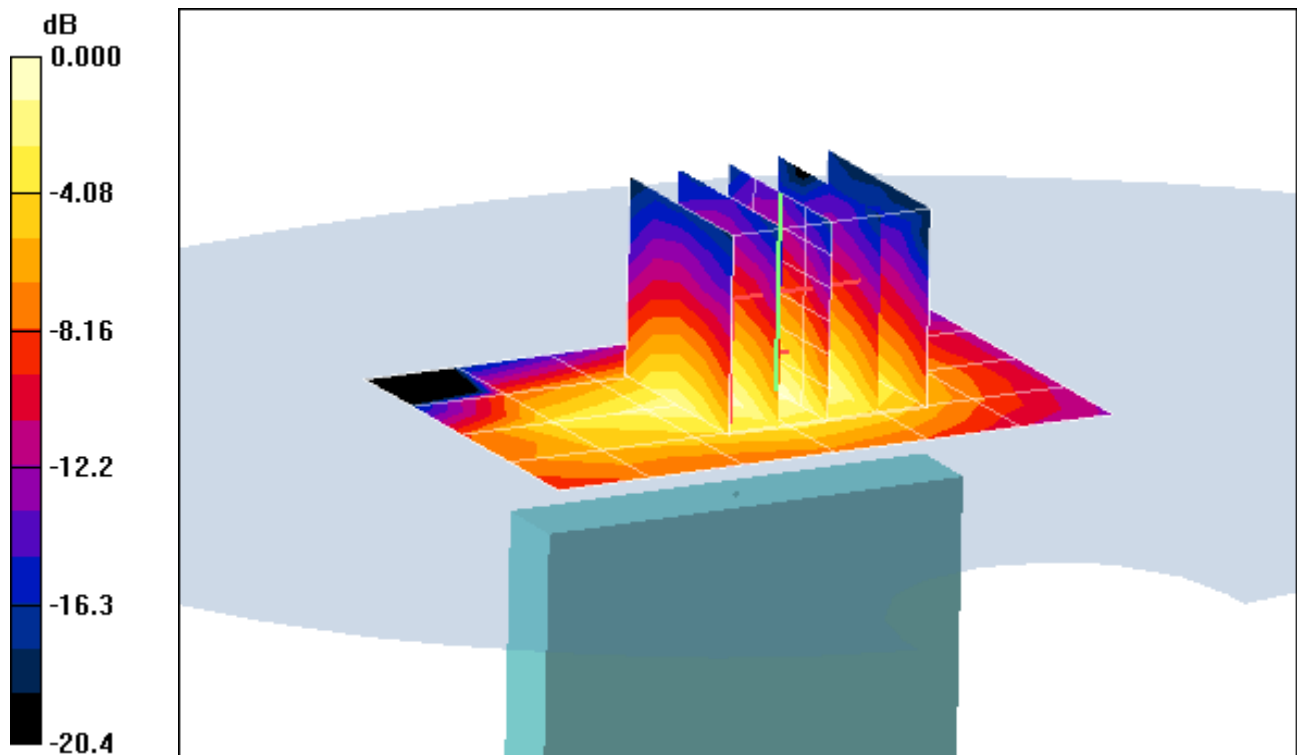

0 dB = 0.120mW/g

PCTEST ENGINEERING LABORATORY, INC.

DUT: ZNFAS730; Type: Portable Handset; Serial: A0000031D17249

Communication System: IEEE 802.11b; Frequency: 2462 MHz; Duty Cycle: 1:1

Medium: 2450 Body Medium parameters used (interpolated):

$f = 2462 \text{ MHz}$; $\sigma = 2.01 \text{ mho/m}$; $\epsilon_r = 51.3$; $\rho = 1000 \text{ kg/m}^3$

Phantom section: Flat Section; Space: 1.0 cm

Test Date: 03-30-2012; Ambient Temp: 24.2°C; Tissue Temp: 22.1°C

Probe: ES3DV3 - SN3209; ConvF(4.23, 4.23, 4.23); Calibrated: 3/16/2012

Sensor-Surface: 3mm (Mechanical Surface Detection)

Electronics: DAE4 Sn665; Calibrated: 4/20/2011

Phantom: SAM Sub; Type: SAM 4.0; Serial: TP-1357

Measurement SW: DASY4, V4.7 Build 80; Postprocessing SW: SEMCAD, V1.8 Build 186

Mode: IEEE 802.11b, Body SAR, Ch 11, 1 Mbps, Left Edge

Area Scan (5x13x1): Measurement grid: dx=15mm, dy=15mm

Zoom Scan (5x5x7)/Cube 0: Measurement grid: dx=8mm, dy=8mm, dz=5mm

Reference Value = 8.12 V/m; Power Drift = -0.110 dB

Peak SAR (extrapolated) = 0.238 W/kg

SAR(1 g) = 0.122 mW/g; SAR(10 g) = 0.062 mW/g

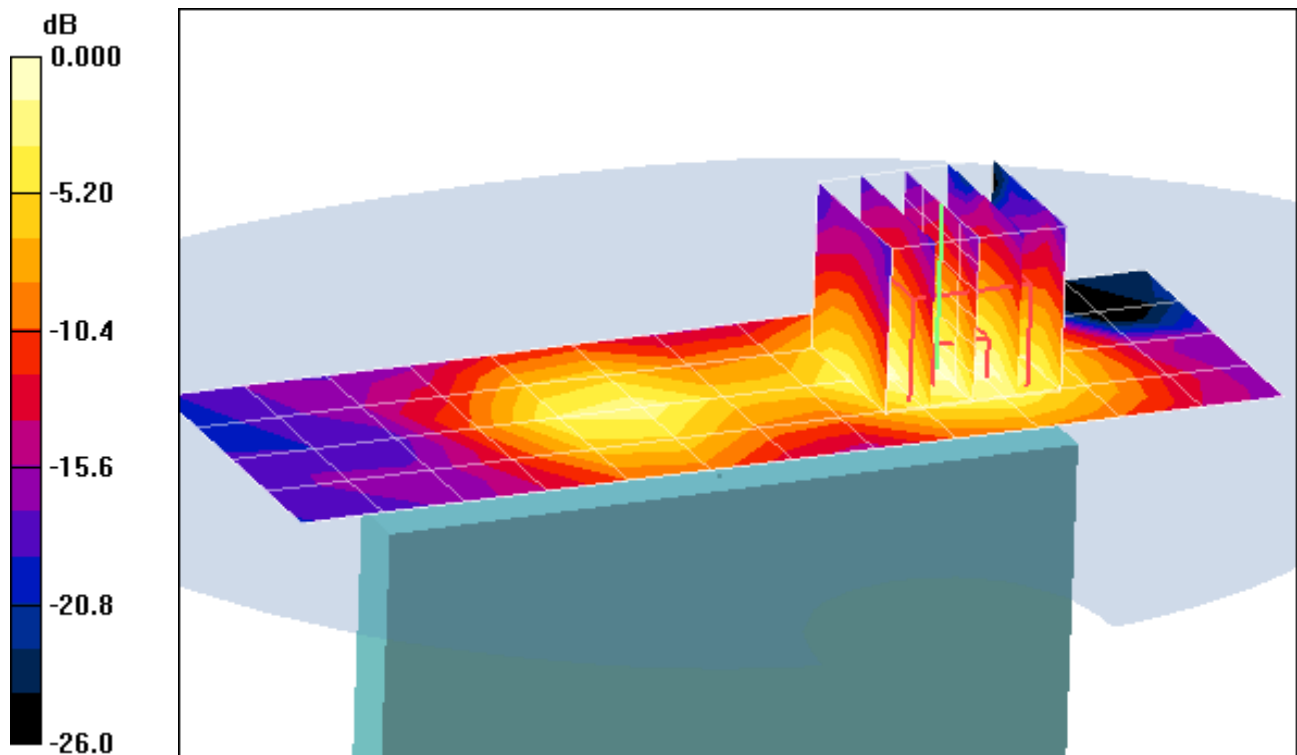

0 dB = 0.153mW/g

APPENDIX B: SYSTEM VERIFICATION

PCTEST ENGINEERING LABORATORY, INC.

DUT: Dipole 835 MHz; Type: D835V2; Serial: 4d026

Communication System: CW; Frequency: 835 MHz; Duty Cycle: 1:1

Medium: 835 Head Medium parameters used:

$f = 835 \text{ MHz}$; $\sigma = 0.91 \text{ mho/m}$; $\epsilon_r = 42.3$; $\rho = 1000 \text{ kg/m}^3$

Phantom section: Flat Section; Space: 1.5 cm

Test Date: 04-17-2012; Ambient Temp: 23.1°C; Tissue Temp: 22.4°C

Probe: ES3DV3 - SN3258; ConvF(6.01, 6.01, 6.01); Calibrated: 2/21/2012

Sensor-Surface: 4mm (Mechanical Surface Detection)

Electronics: DAE4 Sn1272; Calibrated: 1/18/2012

Phantom: SAM Sub; Type: SAM 4.0; Serial: TP-1403

Measurement SW: DASY4, V4.7 Build 80; Postprocessing SW: SEMCAD, V1.8 Build 186

835MHz System Verification

Area Scan (7x13x1): Measurement grid: dx=15mm, dy=15mm

Zoom Scan (5x5x7)/Cube 0: Measurement grid: dx=8mm, dy=8mm, dz=5mm

Input Power: 20.0 dBm (100 mW)

SAR(1 g) = 0.959 mW/g; SAR(10 g) = 0.625 mW/g

Deviation: 1.37%

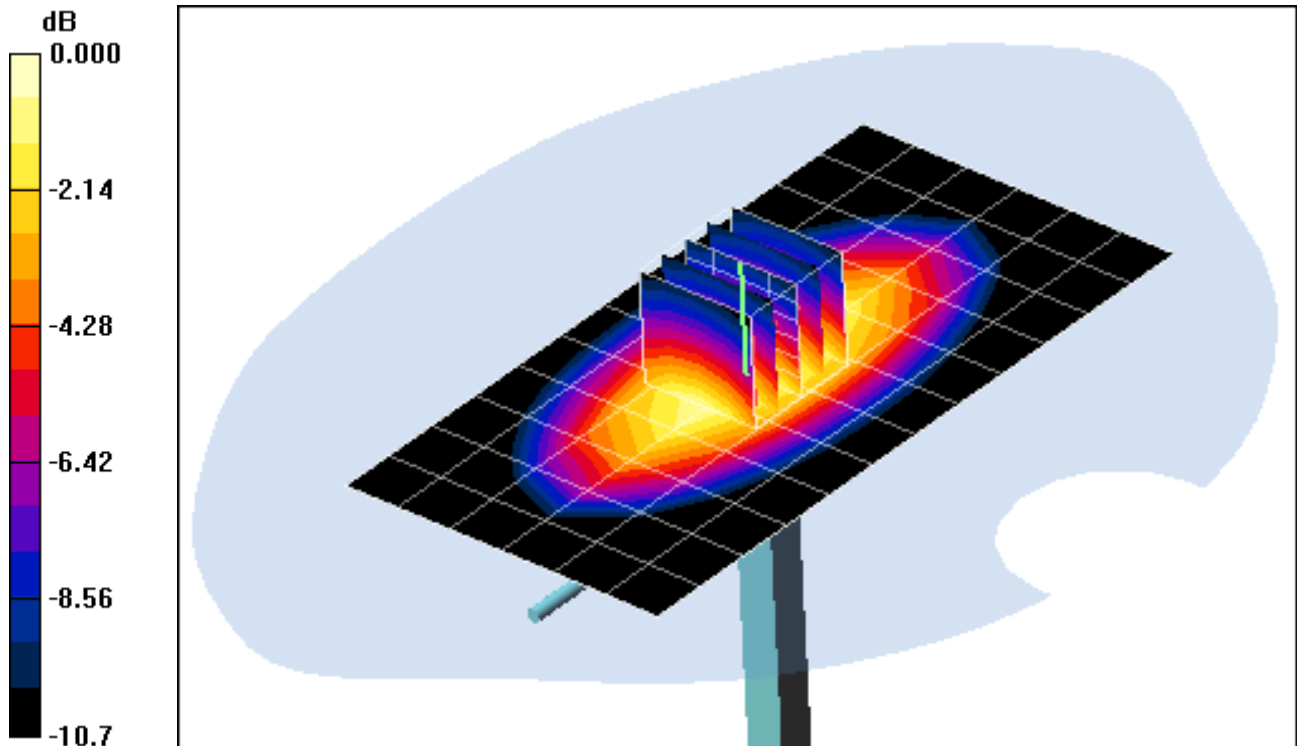

0 dB = 1.04mW/g

PCTEST ENGINEERING LABORATORY, INC.

DUT: Dipole 835 MHz; Type: D835V2; Serial: 4d026

Communication System: CW; Frequency: 835 MHz; Duty Cycle: 1:1

Medium: 835 Head Medium parameters used:

$f = 835 \text{ MHz}$; $\sigma = 0.91 \text{ mho/m}$; $\epsilon_r = 42.3$; $\rho = 1000 \text{ kg/m}^3$

Phantom section: Flat Section; Space: 1.5 cm

Test Date: 04-17-2012; Ambient Temp: 23.1°C; Tissue Temp: 22.4°C

Probe: ES3DV3 - SN3258; ConvF(6.01, 6.01, 6.01); Calibrated: 2/21/2012

Sensor-Surface: 4mm (Mechanical Surface Detection)

Electronics: DAE4 Sn1272; Calibrated: 1/18/2012

Phantom: SAM Sub; Type: SAM 4.0; Serial: TP-1403

Measurement SW: DASY4, V4.7 Build 80; Postprocessing SW: SEMCAD, V1.8 Build 186

835MHz System Verification

Area Scan (7x13x1): Measurement grid: dx=15mm, dy=15mm

Zoom Scan (5x5x7)/Cube 0: Measurement grid: dx=8mm, dy=8mm, dz=5mm

Input Power: 20.0 dBm (100 mW)

SAR(1 g) = 0.959 mW/g; SAR(10 g) = 0.625 mW/g

Deviation: 1.37%

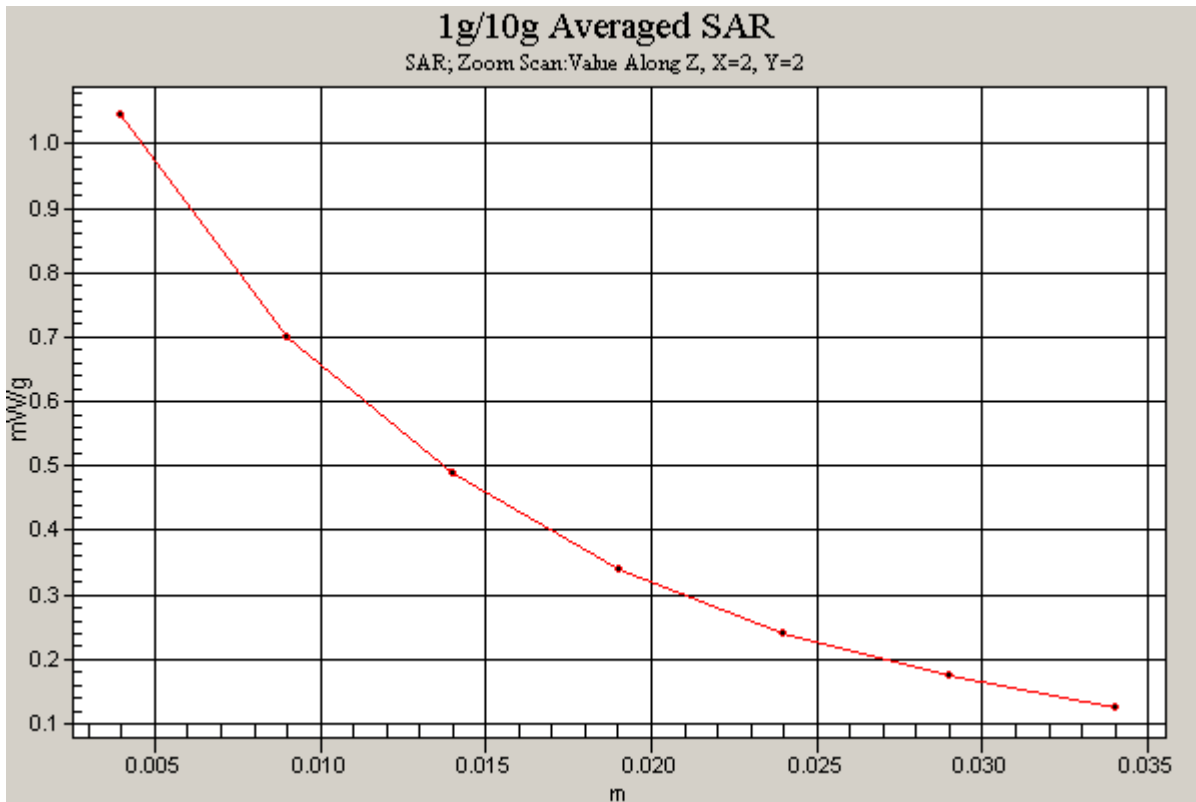

PCTEST ENGINEERING LABORATORY, INC.

DUT: SAR Dipole 1900 MHz; Type: D1900V2; Serial: 502

Communication System: CW; Frequency: 1900 MHz; Duty Cycle: 1:1

Medium: 1900 Head Medium parameters used (interpolated):

$f = 1900 \text{ MHz}$; $\sigma = 1.43 \text{ mho/m}$; $\epsilon_r = 38.3$; $\rho = 1000 \text{ kg/m}^3$

Phantom section: Flat Section; Space: 1.0 cm

Test Date: 04-18-2012; Ambient Temp: 23.1°C; Tissue Temp: 22.6°C

Probe: ES3DV2 - SN3022; ConvF(4.98, 4.98, 4.98); Calibrated: 8/25/2011

Sensor-Surface: 4mm (Mechanical Surface Detection)

Electronics: DAE4 Sn859; Calibrated: 5/19/2011

Phantom: SAM with CRP; Type: SAM; Serial: TP1375

Measurement SW: DASY4, V4.7 Build 80; Postprocessing SW: SEMCAD, V1.8 Build 186

1900MHz System Verification

Area Scan (5x7x1): Measurement grid: dx=15mm, dy=15mm

Zoom Scan (5x5x7)/Cube 0: Measurement grid: dx=8mm, dy=8mm, dz=5mm

Input Power = 20 dBm (100 mW)

SAR(1 g) = 3.9 mW/g; SAR(10 g) = 2.03 mW/g

Deviation = -0.51%

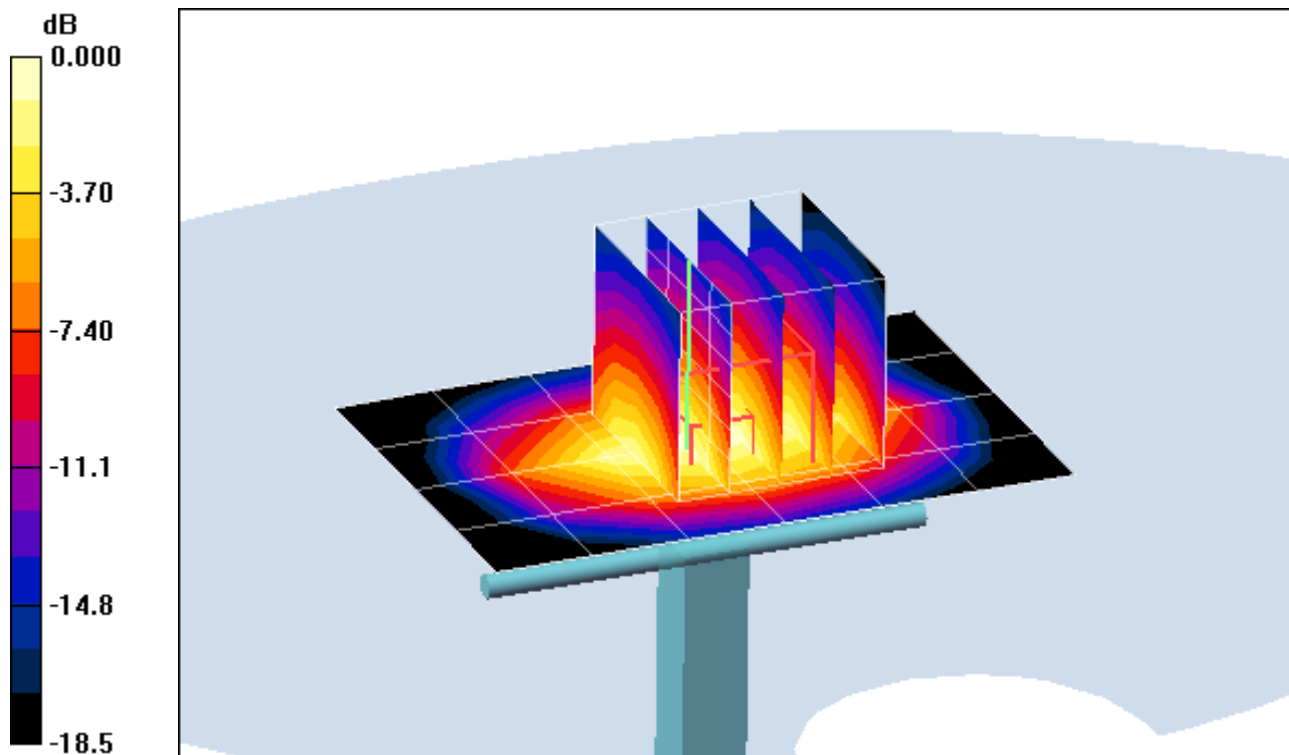

0 dB = 4.29mW/g

PCTEST ENGINEERING LABORATORY, INC.

DUT: SAR Dipole 1900 MHz; Type: D1900V2; Serial: 502

Communication System: CW; Frequency: 1900 MHz; Duty Cycle: 1:1

Medium: 1900 Head Medium parameters used (interpolated):

$f = 1900 \text{ MHz}$; $\sigma = 1.43 \text{ mho/m}$; $\epsilon_r = 38.3$; $\rho = 1000 \text{ kg/m}^3$

Phantom section: Flat Section; Space: 1.0 cm

Test Date: 04-18-2012; Ambient Temp: 23.1°C; Tissue Temp: 22.6°C

Probe: ES3DV2 - SN3022; ConvF(4.98, 4.98, 4.98); Calibrated: 8/25/2011

Sensor-Surface: 4mm (Mechanical Surface Detection)

Electronics: DAE4 Sn859; Calibrated: 5/19/2011

Phantom: SAM with CRP; Type: SAM; Serial: TP1375

Measurement SW: DASY4, V4.7 Build 80; Postprocessing SW: SEMCAD, V1.8 Build 186

1900MHz System Verification

Area Scan (5x7x1): Measurement grid: dx=15mm, dy=15mm

Zoom Scan (5x5x7)/Cube 0: Measurement grid: dx=8mm, dy=8mm, dz=5mm

Input Power = 20 dBm (100 mW)

SAR(1 g) = 3.9 mW/g; SAR(10 g) = 2.03 mW/g

Deviation = -0.51%

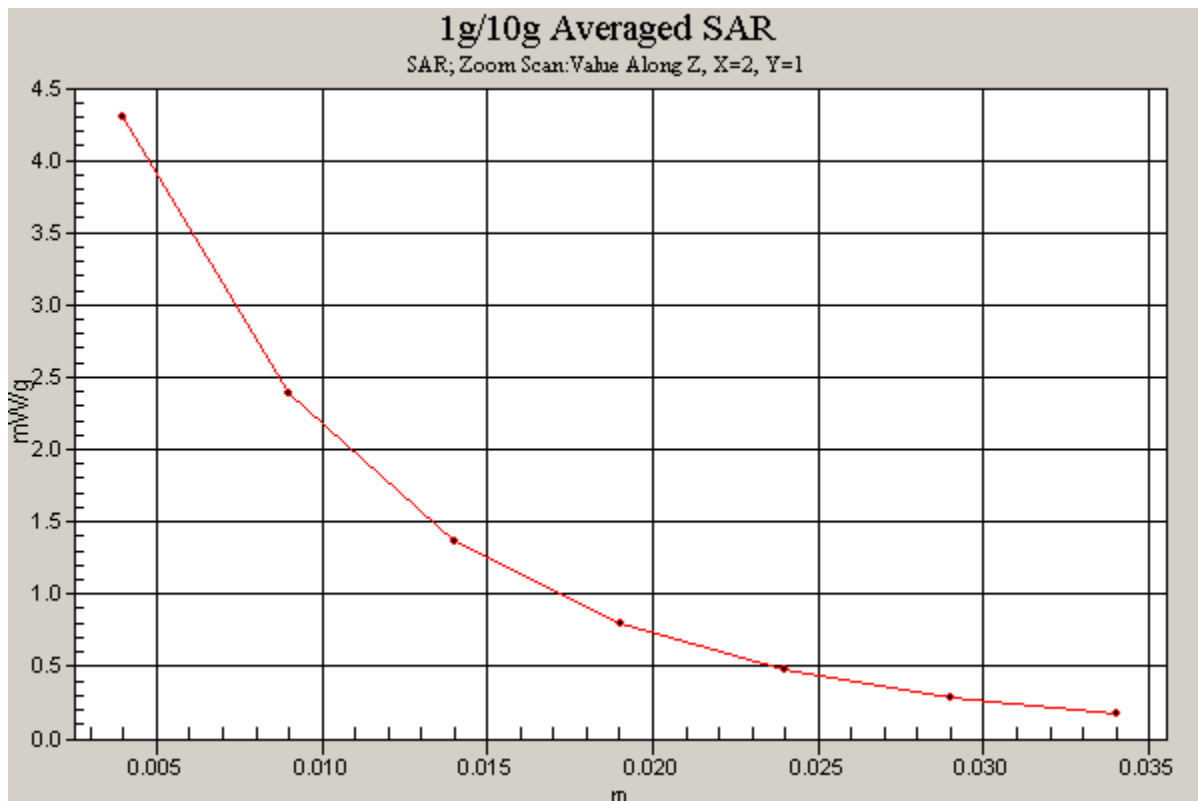

PCTEST ENGINEERING LABORATORY, INC.

DUT: SAR Dipole 2450 MHz; Type: D2450V2; Serial: 719

Communication System: CW; Frequency: 2450 MHz; Duty Cycle: 1:1

Medium: 2450 Head Medium parameters used:

$f = 2450 \text{ MHz}$; $\sigma = 1.87 \text{ mho/m}$; $\epsilon_r = 39.3$; $\rho = 1000 \text{ kg/m}^3$

Phantom section: Flat Section; Space: 1.0 cm

Test Date: 03-30-2012; Ambient Temp: 23.8°C; Tissue Temp: 22.0°C

Probe: ES3DV3 - SN3209; ConvF(4.46, 4.46, 4.46); Calibrated: 3/16/2012

Sensor-Surface: 3mm (Mechanical Surface Detection)

Electronics: DAE4 Sn665; Calibrated: 4/20/2011

Phantom: SAM Main; Type: SAM 4.0; Serial: TP-1114

Measurement SW: DASY4, V4.7 Build 80; Postprocessing SW: SEMCAD, V1.8 Build 186

2450MHz System Verification

Area Scan (5x7x1): Measurement grid: dx=15mm, dy=15mm

Zoom Scan (5x5x7)/Cube 0: Measurement grid: dx=8mm, dy=8mm, dz=5mm

Input Power = 20 dBm (100 mW)

SAR(1 g) = 5.38 mW/g; SAR(10 g) = 2.44 mW/g

Deviation = 0.00%

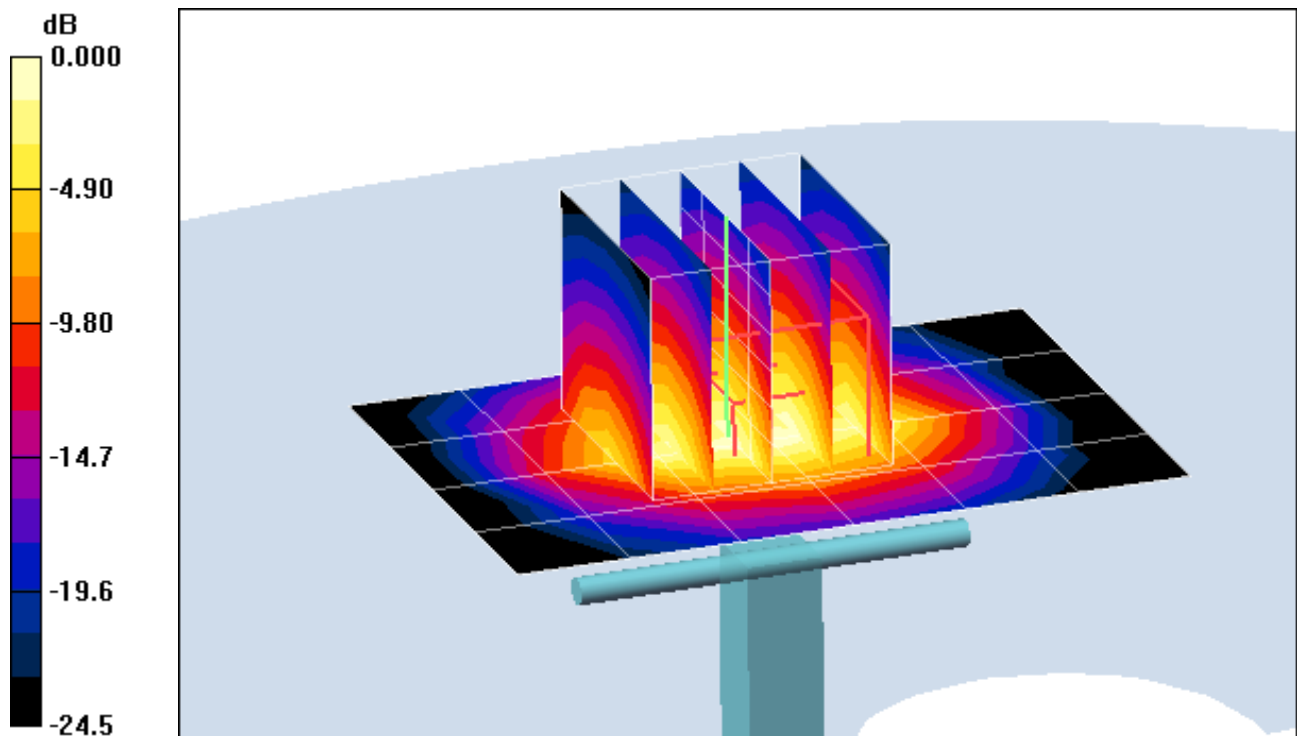

0 dB = 6.95mW/g

PCTEST ENGINEERING LABORATORY, INC.

DUT: SAR Dipole 2450 MHz; Type: D2450V2; Serial: 719

Communication System: CW; Frequency: 2450 MHz; Duty Cycle: 1:1

Medium: 2450 Head Medium parameters used:

$f = 2450 \text{ MHz}$; $\sigma = 1.87 \text{ mho/m}$; $\epsilon_r = 39.3$; $\rho = 1000 \text{ kg/m}^3$

Phantom section: Flat Section; Space: 1.0 cm

Test Date: 03-30-2012; Ambient Temp: 23.8°C; Tissue Temp: 22.0°C

Probe: ES3DV3 - SN3209; ConvF(4.46, 4.46, 4.46); Calibrated: 3/16/2012

Sensor-Surface: 3mm (Mechanical Surface Detection)

Electronics: DAE4 Sn665; Calibrated: 4/20/2011

Phantom: SAM Main; Type: SAM 4.0; Serial: TP-1114

Measurement SW: DASY4, V4.7 Build 80; Postprocessing SW: SEMCAD, V1.8 Build 186

2450MHz System Verification

Area Scan (5x7x1): Measurement grid: dx=15mm, dy=15mm

Zoom Scan (5x5x7)/Cube 0: Measurement grid: dx=8mm, dy=8mm, dz=5mm

Input Power = 20 dBm (100 mW)

SAR(1 g) = 5.38 mW/g; SAR(10 g) = 2.44 mW/g

Deviation = 0.00%

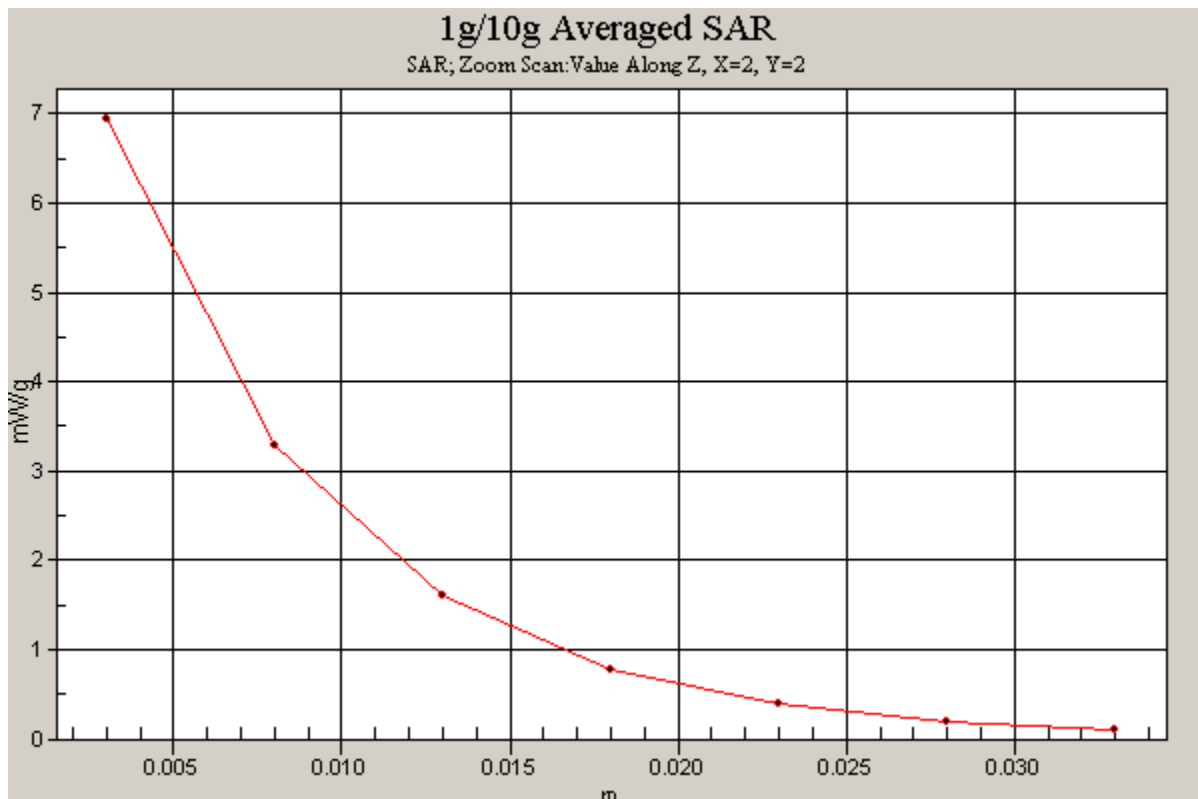

PCTEST ENGINEERING LABORATORY, INC.

DUT: Dipole 835 MHz; Type: D835V2; Serial: 4d026

Communication System: CW; Frequency: 835 MHz; Duty Cycle: 1:1

Medium: 835 Body Medium parameters used:

$f = 835 \text{ MHz}$; $\sigma = 0.984 \text{ mho/m}$; $\epsilon_r = 52.6$; $\rho = 1000 \text{ kg/m}^3$

Phantom section: Flat Section; Space: 1.5 cm

Test Date: 04-19-2012; Ambient Temp: 23.0°C; Tissue Temp: 22.7°C

Probe: ES3DV3 - SN3258; ConvF(6.06, 6.06, 6.06); Calibrated: 2/21/2012

Sensor-Surface: 4mm (Mechanical Surface Detection)

Electronics: DAE4 Sn1272; Calibrated: 1/18/2012

Phantom: SAM Main; Type: SAM 4.0; Serial: TP-1406

Measurement SW: DASY4, V4.7 Build 80; Postprocessing SW: SEMCAD, V1.8 Build 186

835MHz System Verification

Area Scan (7x13x1): Measurement grid: dx=15mm, dy=15mm

Zoom Scan (5x5x7)/Cube 0: Measurement grid: dx=8mm, dy=8mm, dz=5mm

Input Power: 20.0 dBm (100 mW)

SAR(1 g) = 1.04 mW/g; SAR(10 g) = 0.677 mW/g

Deviation: 7.66%

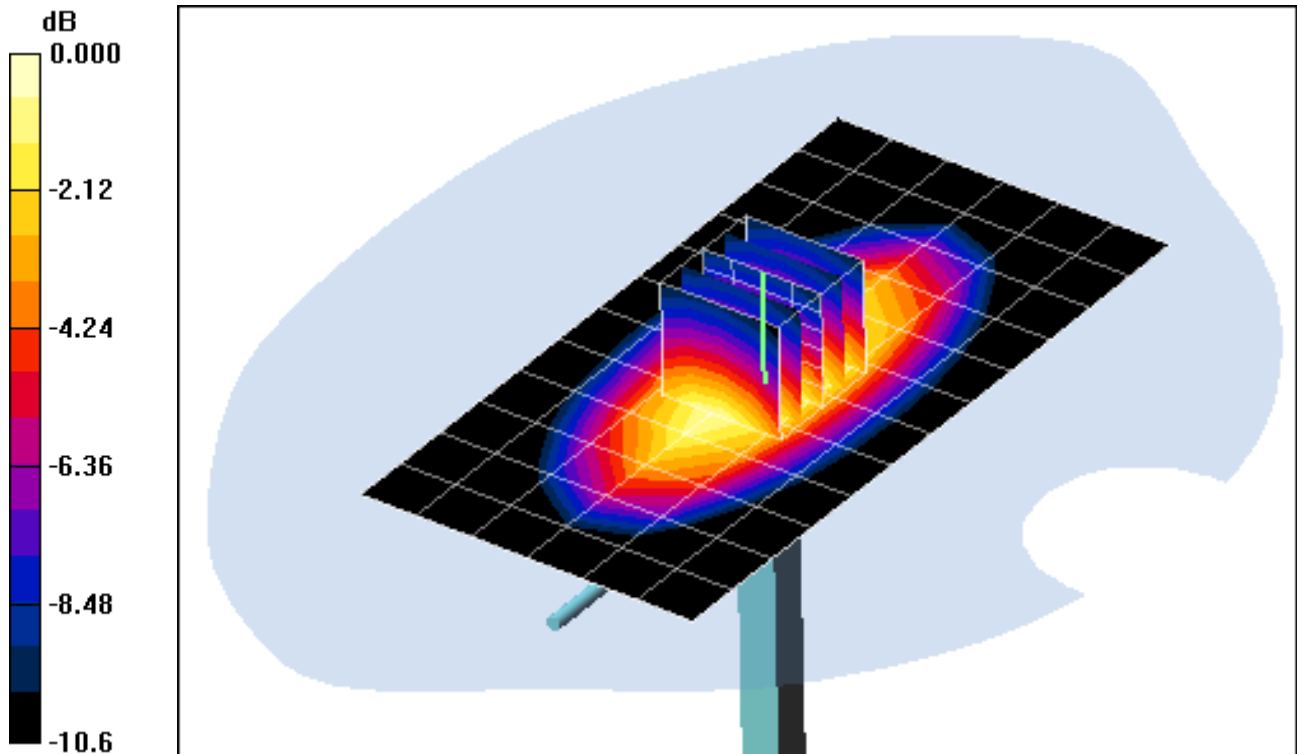

0 dB = 1.11mW/g

PCTEST ENGINEERING LABORATORY, INC.

DUT: Dipole 835 MHz; Type: D835V2; Serial: 4d026

Communication System: CW; Frequency: 835 MHz; Duty Cycle: 1:1

Medium: 835 Body Medium parameters used:

$f = 835 \text{ MHz}$; $\sigma = 0.984 \text{ mho/m}$; $\epsilon_r = 52.6$; $\rho = 1000 \text{ kg/m}^3$

Phantom section: Flat Section; Space: 1.5 cm

Test Date: 04-19-2012; Ambient Temp: 23.0°C; Tissue Temp: 22.7°C

Probe: ES3DV3 - SN3258; ConvF(6.06, 6.06, 6.06); Calibrated: 2/21/2012

Sensor-Surface: 4mm (Mechanical Surface Detection)

Electronics: DAE4 Sn1272; Calibrated: 1/18/2012

Phantom: SAM Main; Type: SAM 4.0; Serial: TP-1406

Measurement SW: DASY4, V4.7 Build 80; Postprocessing SW: SEMCAD, V1.8 Build 186

835MHz System Verification

Area Scan (7x13x1): Measurement grid: dx=15mm, dy=15mm

Zoom Scan (5x5x7)/Cube 0: Measurement grid: dx=8mm, dy=8mm, dz=5mm

Input Power: 20.0 dBm (100 mW)

SAR(1 g) = 1.04 mW/g; SAR(10 g) = 0.677 mW/g

Deviation: 7.66%

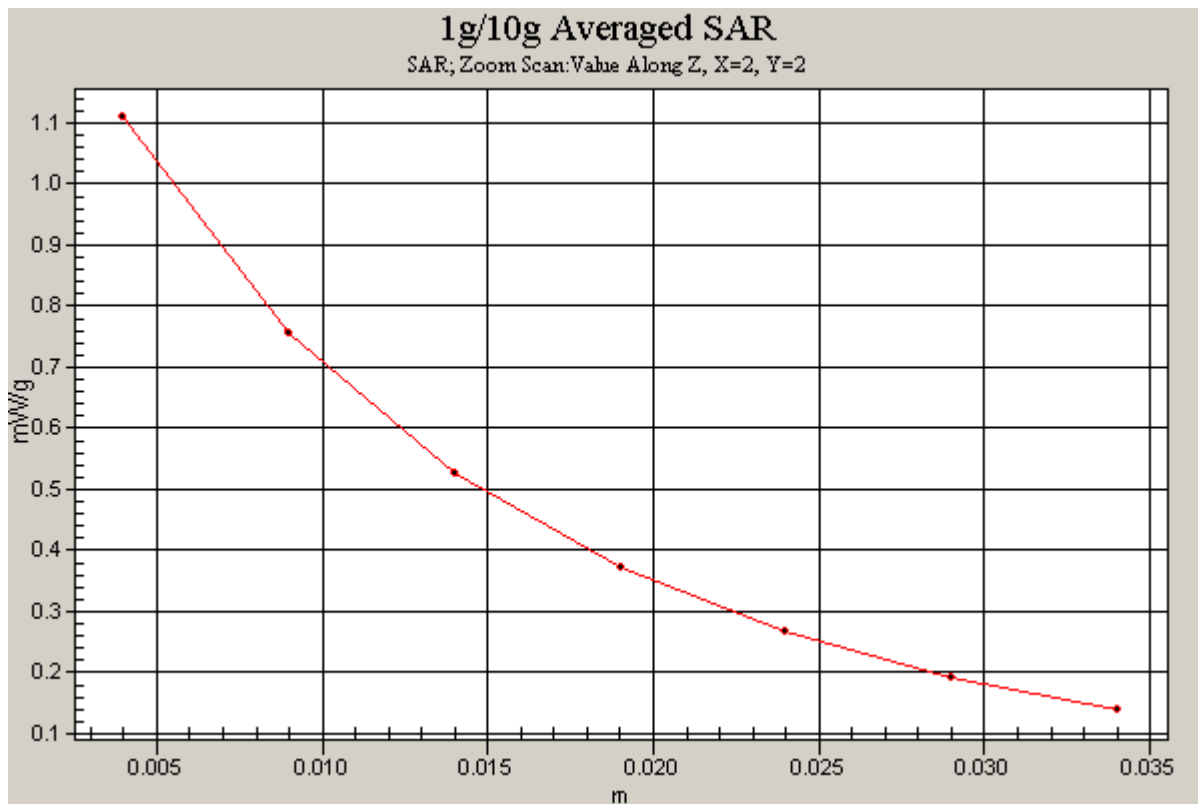

PCTEST ENGINEERING LABORATORY, INC.

DUT: SAR Dipole 1900 MHz; Type: D1900V2; Serial: 502

Communication System: CW; Frequency: 1900 MHz; Duty Cycle: 1:1

Medium: 1900 Body Medium parameters used (interpolated):

$f = 1900 \text{ MHz}$; $\sigma = 1.55 \text{ mho/m}$; $\epsilon_r = 53$; $\rho = 1000 \text{ kg/m}^3$

Phantom section: Flat Section; Space: 1.0 cm

Test Date: 04-19-2012; Ambient Temp: 22.1°C; Tissue Temp: 21.8°C

Probe: ES3DV2 - SN3022; ConvF(4.41, 4.41, 4.41); Calibrated: 8/25/2011

Sensor-Surface: 4mm (Mechanical Surface Detection)

Electronics: DAE4 Sn859; Calibrated: 5/19/2011

Phantom: SAM Sub Dasy B; Type: SAM 5.0; Serial: TP-1626

Measurement SW: DASY4, V4.7 Build 80; Postprocessing SW: SEMCAD, V1.8 Build 186

1900MHz System Verification

Area Scan (5x7x1): Measurement grid: dx=15mm, dy=15mm

Zoom Scan (5x5x7)/Cube 0: Measurement grid: dx=8mm, dy=8mm, dz=5mm

Input Power = 20 dBm (100 mW)

SAR(1 g) = 3.72 mW/g; SAR(10 g) = 1.96 mW/g

Deviation = -4.37%

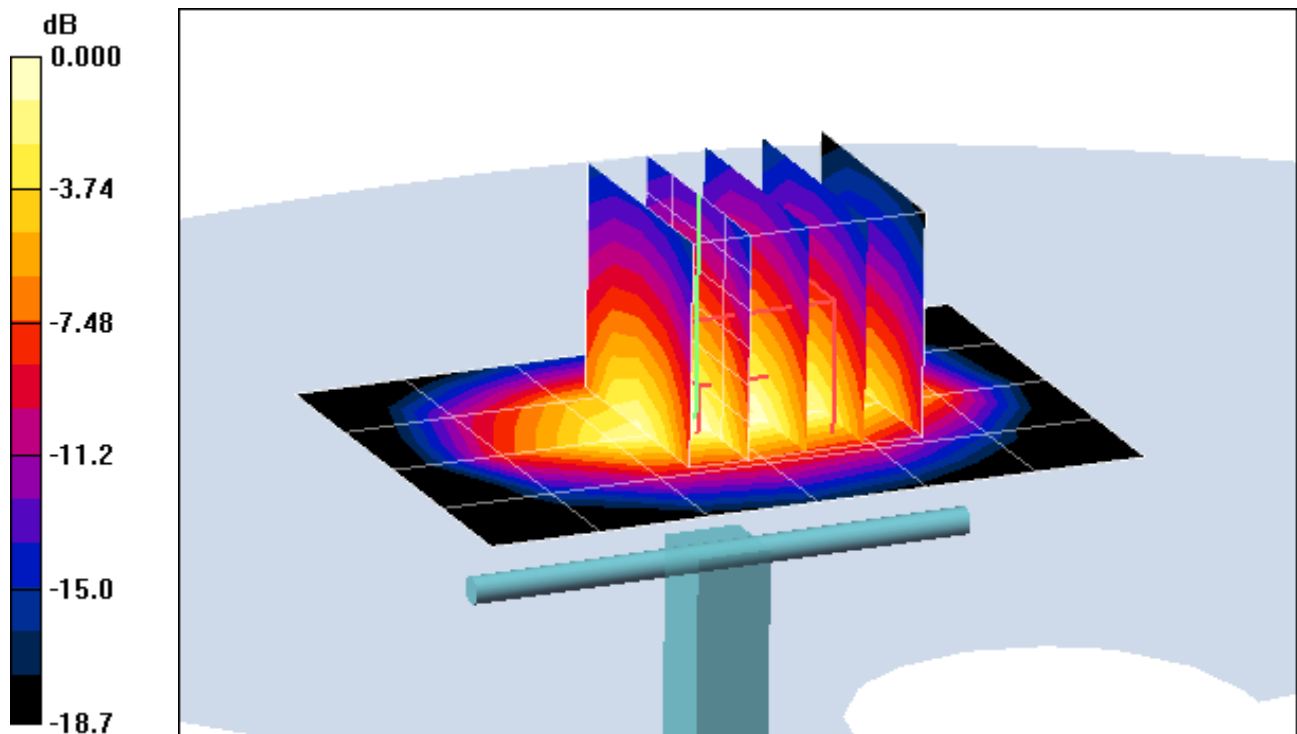

0 dB = 4.14mW/g

PCTEST ENGINEERING LABORATORY, INC.

DUT: SAR Dipole 1900 MHz; Type: D1900V2; Serial: 502

Communication System: CW; Frequency: 1900 MHz; Duty Cycle: 1:1

Medium: 1900 Body Medium parameters used (interpolated):

$f = 1900 \text{ MHz}$; $\sigma = 1.55 \text{ mho/m}$; $\epsilon_r = 53$; $\rho = 1000 \text{ kg/m}^3$

Phantom section: Flat Section; Space: 1.0 cm

Test Date: 04-19-2012; Ambient Temp: 22.1°C; Tissue Temp: 21.8°C

Probe: ES3DV2 - SN3022; ConvF(4.41, 4.41, 4.41); Calibrated: 8/25/2011

Sensor-Surface: 4mm (Mechanical Surface Detection)

Electronics: DAE4 Sn859; Calibrated: 5/19/2011

Phantom: SAM Sub Dasy B; Type: SAM 5.0; Serial: TP-1626

Measurement SW: DASY4, V4.7 Build 80; Postprocessing SW: SEMCAD, V1.8 Build 186

1900MHz System Verification

Area Scan (5x7x1): Measurement grid: dx=15mm, dy=15mm

Zoom Scan (5x5x7)/Cube 0: Measurement grid: dx=8mm, dy=8mm, dz=5mm

Input Power = 20 dBm (100 mW)

SAR(1 g) = 3.72 mW/g; SAR(10 g) = 1.96 mW/g

Deviation = -4.37%

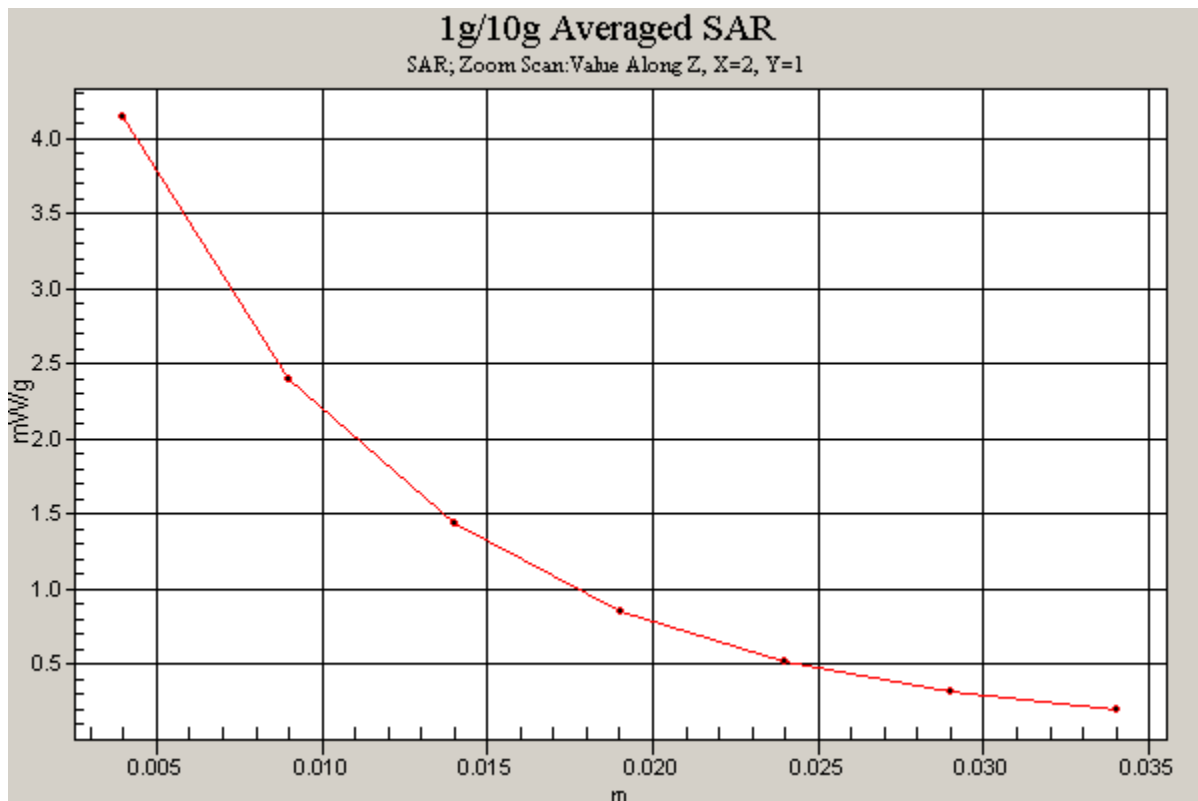

PCTEST ENGINEERING LABORATORY, INC.

DUT: SAR Dipole 2450 MHz; Type: D2450V2; Serial: 719

Communication System: CW; Frequency: 2450 MHz; Duty Cycle: 1:1

Medium: 2450 Body Medium parameters used:

$f = 2450 \text{ MHz}$; $\sigma = 1.99 \text{ mho/m}$; $\epsilon_r = 51.3$; $\rho = 1000 \text{ kg/m}^3$

Phantom section: Flat Section; Space: 1.0 cm

Test Date: 03-30-2012; Ambient Temp: 24.2°C; Tissue Temp: 22.1°C

Probe: ES3DV3 - SN3209; ConvF(4.23, 4.23, 4.23); Calibrated: 3/16/2012

Sensor-Surface: 3mm (Mechanical Surface Detection)

Electronics: DAE4 Sn665; Calibrated: 4/20/2011

Phantom: SAM Sub; Type: SAM 4.0; Serial: TP-1357

Measurement SW: DASY4, V4.7 Build 80; Postprocessing SW: SEMCAD, V1.8 Build 186

2450MHz System Verification

Area Scan (5x7x1): Measurement grid: dx=15mm, dy=15mm

Zoom Scan (5x5x7)/Cube 0: Measurement grid: dx=8mm, dy=8mm, dz=5mm

Input Power = 20 dBm (100 mW)

SAR(1 g) = 5.52 mW/g; SAR(10 g) = 2.52 mW/g

Deviation = 7.60%

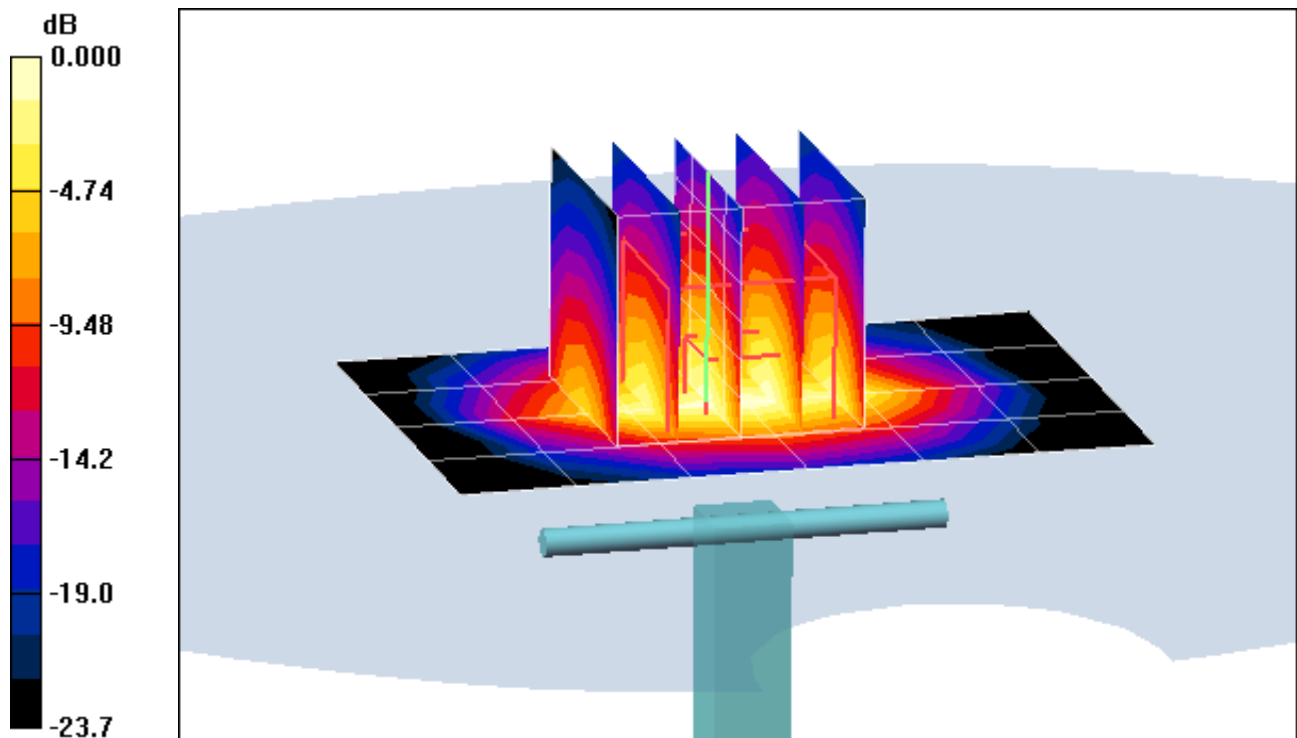

0 dB = 7.14mW/g

PCTEST ENGINEERING LABORATORY, INC.

DUT: SAR Dipole 2450 MHz; Type: D2450V2; Serial: 719

Communication System: CW; Frequency: 2450 MHz; Duty Cycle: 1:1

Medium: 2450 Body Medium parameters used:

$f = 2450 \text{ MHz}$; $\sigma = 1.99 \text{ mho/m}$; $\epsilon_r = 51.3$; $\rho = 1000 \text{ kg/m}^3$

Phantom section: Flat Section; Space: 1.0 cm

Test Date: 03-30-2012; Ambient Temp: 24.2°C; Tissue Temp: 22.1°C

Probe: ES3DV3 - SN3209; ConvF(4.23, 4.23, 4.23); Calibrated: 3/16/2012

Sensor-Surface: 3mm (Mechanical Surface Detection)

Electronics: DAE4 Sn665; Calibrated: 4/20/2011

Phantom: SAM Sub; Type: SAM 4.0; Serial: TP-1357

Measurement SW: DASY4, V4.7 Build 80; Postprocessing SW: SEMCAD, V1.8 Build 186

2450MHz System Verification

Area Scan (5x7x1): Measurement grid: dx=15mm, dy=15mm

Zoom Scan (5x5x7)/Cube 0: Measurement grid: dx=8mm, dy=8mm, dz=5mm

Input Power = 20 dBm (100 mW)

SAR(1 g) = 5.52 mW/g; SAR(10 g) = 2.52 mW/g

Deviation = 7.60%

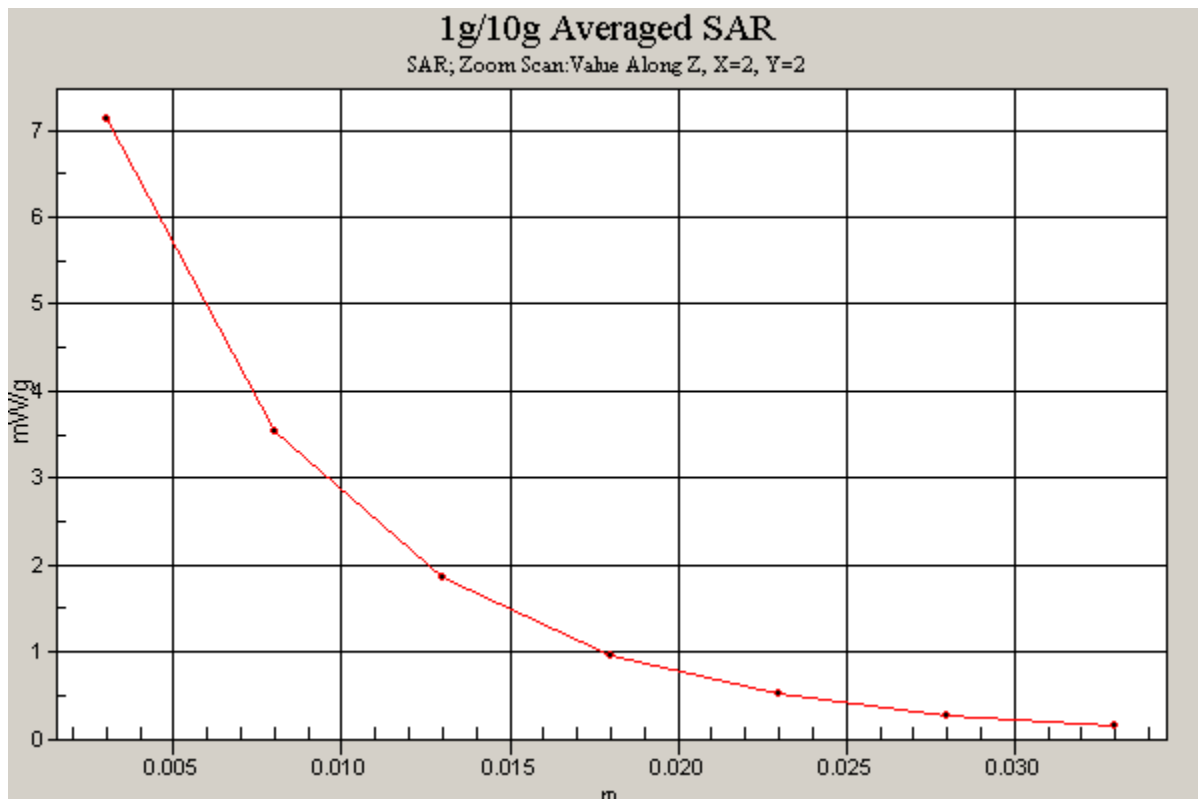

APPENDIX C: PROBE CALIBRATION



Accredited by the Swiss Accreditation Service (SAS)

Accreditation No.: **SCS 108**

The Swiss Accreditation Service is one of the signatories to the EA
Multilateral Agreement for the recognition of calibration certificates

Client **PC Test**

Certificate No: **D835V2-4d026_Aug11**

CALIBRATION CERTIFICATE

Object **D835V2 - SN: 4d026**

Calibration procedure(s) **QA CAL-05.v8
Calibration procedure for dipole validation kits above 700 MHz**

Calibration date: **August 15, 2011**

✓ KOK
9/16/11

This calibration certificate documents the traceability to national standards, which realize the physical units of measurements (SI).
The measurements and the uncertainties with confidence probability are given on the following pages and are part of the certificate.

All calibrations have been conducted in the closed laboratory facility: environment temperature (22 ± 3)°C and humidity < 70%.

Calibration Equipment used (M&TE critical for calibration)

Primary Standards	ID #	Cal Date (Certificate No.)	Scheduled Calibration
Power meter EPM-442A	GB37480704	06-Oct-10 (No. 217-01266)	Oct-11
Power sensor HP 8481A	US37292783	06-Oct-10 (No. 217-01266)	Oct-11
Reference 20 dB Attenuator	SN: S5086 (20b)	29-Mar-11 (No. 217-01367)	Apr-12
Type-N mismatch combination	SN: 5047.2 / 06327	29-Mar-11 (No. 217-01371)	Apr-12
Reference Probe ES3DV3	SN: 3205	29-Apr-11 (No. ES3-3205_Apr11)	Apr-12
DAE4	SN: 601	04-Jul-11 (No. DAE4-601_Jul11)	Jul-12
Secondary Standards	ID #	Check Date (in house)	Scheduled Check
Power sensor HP 8481A	MY41092317	18-Oct-02 (in house check Oct-09)	In house check: Oct-11
RF generator R&S SMT-06	100005	04-Aug-99 (in house check Oct-09)	In house check: Oct-11
Network Analyzer HP 8753E	US37390585 S4206	18-Oct-01 (in house check Oct-10)	In house check: Oct-11

Calibrated by: **Claudio Leubler** **Laboratory Technician**

Signature

Approved by: **Katja Pokovic** **Technical Manager**

Issued: August 15, 2011

This calibration certificate shall not be reproduced except in full without written approval of the laboratory.



Accredited by the Swiss Accreditation Service (SAS)

Accreditation No.: **SCS 108**

The Swiss Accreditation Service is one of the signatories to the EA
Multilateral Agreement for the recognition of calibration certificates

Glossary:

TSL	tissue simulating liquid
ConvF	sensitivity in TSL / NORM x,y,z
N/A	not applicable or not measured

Calibration is Performed According to the Following Standards:

- IEEE Std 1528-2003, "IEEE Recommended Practice for Determining the Peak Spatial-Averaged Specific Absorption Rate (SAR) in the Human Head from Wireless Communications Devices: Measurement Techniques", December 2003
- IEC 62209-1, "Procedure to measure the Specific Absorption Rate (SAR) for hand-held devices used in close proximity to the ear (frequency range of 300 MHz to 3 GHz)", February 2005
- Federal Communications Commission Office of Engineering & Technology (FCC OET), "Evaluating Compliance with FCC Guidelines for Human Exposure to Radiofrequency Electromagnetic Fields; Additional Information for Evaluating Compliance of Mobile and Portable Devices with FCC Limits for Human Exposure to Radiofrequency Emissions", Supplement C (Edition 01-01) to Bulletin 65

Additional Documentation:

- DASY4/5 System Handbook

Methods Applied and Interpretation of Parameters:

- Measurement Conditions:** Further details are available from the Validation Report at the end of the certificate. All figures stated in the certificate are valid at the frequency indicated.
- Antenna Parameters with TSL:** The dipole is mounted with the spacer to position its feed point exactly below the center marking of the flat phantom section, with the arms oriented parallel to the body axis.
- Feed Point Impedance and Return Loss:** These parameters are measured with the dipole positioned under the liquid filled phantom. The impedance stated is transformed from the measurement at the SMA connector to the feed point. The Return Loss ensures low reflected power. No uncertainty required.
- Electrical Delay:** One-way delay between the SMA connector and the antenna feed point. No uncertainty required.
- SAR measured:** SAR measured at the stated antenna input power.
- SAR normalized:** SAR as measured, normalized to an input power of 1 W at the antenna connector.
- SAR for nominal TSL parameters:** The measured TSL parameters are used to calculate the nominal SAR result.

Measurement Conditions

DASY system configuration, as far as not given on page 1.

DASY Version	DASY5	V52.6.2
Extrapolation	Advanced Extrapolation	
Phantom	Modular Flat Phantom	
Distance Dipole Center - TSL	15 mm	with Spacer
Zoom Scan Resolution	dx, dy, dz = 5 mm	
Frequency	835 MHz \pm 1 MHz	

Head TSL parameters

The following parameters and calculations were applied.

	Temperature	Permittivity	Conductivity
Nominal Head TSL parameters	22.0 °C	41.5	0.90 mho/m
Measured Head TSL parameters	(22.0 \pm 0.2) °C	41.1 \pm 6 %	0.89 mho/m \pm 6 %
Head TSL temperature change during test	< 0.5 °C	----	----

SAR result with Head TSL

SAR averaged over 1 cm ³ (1 g) of Head TSL	Condition	
SAR measured	250 mW input power	2.35 mW / g
SAR for nominal Head TSL parameters	normalized to 1W	9.46 mW / g \pm 17.0 % (k=2)

SAR averaged over 10 cm ³ (10 g) of Head TSL	condition	
SAR measured	250 mW input power	1.54 mW / g
SAR for nominal Head TSL parameters	normalized to 1W	6.19 mW / g \pm 16.5 % (k=2)

Body TSL parameters

The following parameters and calculations were applied.

	Temperature	Permittivity	Conductivity
Nominal Body TSL parameters	22.0 °C	55.2	0.97 mho/m
Measured Body TSL parameters	(22.0 \pm 0.2) °C	53.4 \pm 6 %	0.99 mho/m \pm 6 %
Body TSL temperature change during test	< 0.5 °C	----	----

SAR result with Body TSL

SAR averaged over 1 cm ³ (1 g) of Body TSL	Condition	
SAR measured	250 mW input power	2.47 mW / g
SAR for nominal Body TSL parameters	normalized to 1W	9.66 mW / g \pm 17.0 % (k=2)

SAR averaged over 10 cm ³ (10 g) of Body TSL	condition	
SAR measured	250 mW input power	1.63 mW / g
SAR for nominal Body TSL parameters	normalized to 1W	6.42 mW / g \pm 16.5 % (k=2)

Appendix

Antenna Parameters with Head TSL

Impedance, transformed to feed point	53.4 Ω - 3.1 j Ω
Return Loss	- 27.0 dB

Antenna Parameters with Body TSL

Impedance, transformed to feed point	49.3 Ω - 5.4 j Ω
Return Loss	- 25.3 dB

General Antenna Parameters and Design

Electrical Delay (one direction)	1.389 ns
----------------------------------	----------

After long term use with 100W radiated power, only a slight warming of the dipole near the feedpoint can be measured.

The dipole is made of standard semirigid coaxial cable. The center conductor of the feeding line is directly connected to the second arm of the dipole. The antenna is therefore short-circuited for DC-signals.

No excessive force must be applied to the dipole arms, because they might bend or the soldered connections near the feedpoint may be damaged.

Additional EUT Data

Manufactured by	SPEAG
Manufactured on	December 17, 2004

DASY5 Validation Report for Head TSL

Date: 15.08.2011

Test Laboratory: SPEAG, Zurich, Switzerland

DUT: Dipole 835 MHz; Type: D835V2; Serial: D835V2 - SN: 4d026

Communication System: CW; Frequency: 835 MHz

Medium parameters used: $f = 835$ MHz; $\sigma = 0.89$ mho/m; $\epsilon_r = 41.1$; $\rho = 1000$ kg/m³

Phantom section: Flat Section

Measurement Standard: DASY5 (IEEE/IEC/ANSI C63.19-2007)

DASY52 Configuration:

- Probe: ES3DV3 - SN3205; ConvF(6.07, 6.07, 6.07); Calibrated: 29.04.2011
- Sensor-Surface: 3mm (Mechanical Surface Detection)
- Electronics: DAE4 Sn601; Calibrated: 04.07.2011
- Phantom: Flat Phantom 4.9L; Type: QD000P49AA; Serial: 1001
- DASY52 52.6.2(482); SEMCAD X 14.4.5(3634)

Dipole Calibration for Head Tissue/Pin=250 mW, d=15mm/Zoom Scan (7x7x7)/Cube 0:

Measurement grid: dx=5mm, dy=5mm, dz=5mm

Reference Value = 57.042 V/m; Power Drift = 0.02 dB

Peak SAR (extrapolated) = 3.480 W/kg

SAR(1 g) = 2.35 mW/g; SAR(10 g) = 1.54 mW/g

Maximum value of SAR (measured) = 2.719 mW/g

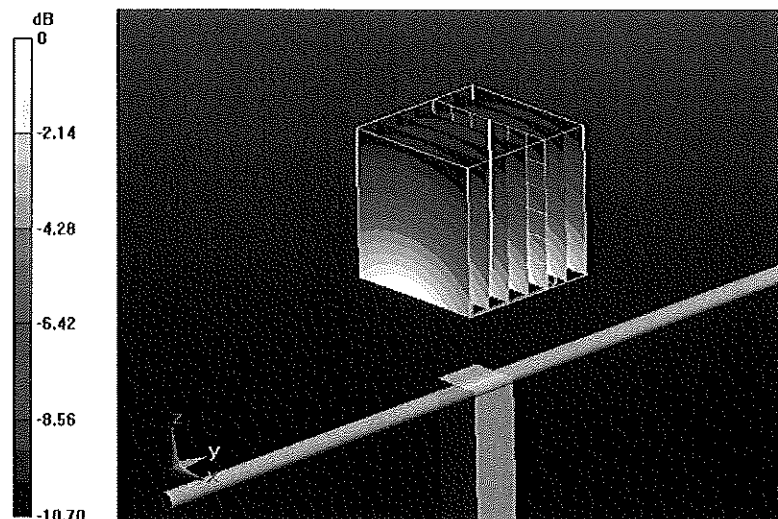

0 dB = 2.720mW/g

Impedance Measurement Plot for Head TSL

15 Aug 2011 10:13:08

CH1 S11 1 U FS 1: 53.387 Ω 3: 1935 Ω 61.416 pF 835.000 000 MHz

*
De1
CA
Avg
16
H1 d

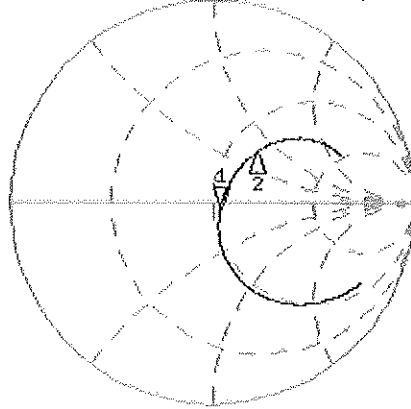

CH1 Markers
2: 65.559 Ω
35.387 Ω
900.000 MHz

CH2 S11 LOG 5 dB/REF -20 dB 1: -27.040 dB 835.000 000 MHz

CA
Avg
16
H1 d

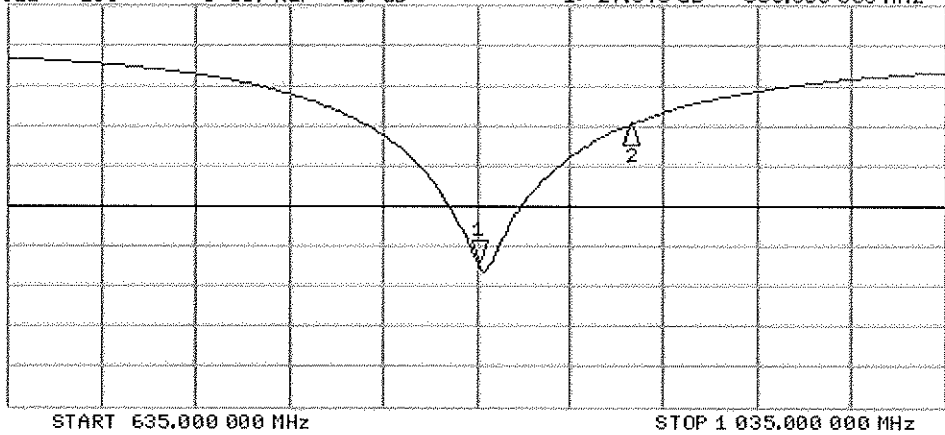

CH2 Markers
2: -9.9002 dB
900.000 MHz

DASY5 Validation Report for Body TSL

Date: 15.08.2011

Test Laboratory: SPEAG, Zurich, Switzerland

~~DUT: Dipole 835 MHz; Type: D835V2; Serial: D835V2 - SN: 4d026~~

Communication System: CW; Frequency: 835 MHz

Medium parameters used: $f = 835$ MHz; $\sigma = 0.99$ mho/m; $\epsilon_r = 53.4$; $\rho = 1000$ kg/m³

Phantom section: Flat Section

Measurement Standard: DASY5 (IEEE/IEC/ANSI C63.19-2007)

DASY52 Configuration:

- Probe: ES3DV3 - SN3205; ConvF(6.02, 6.02, 6.02); Calibrated: 29.04.2011
- Sensor-Surface: 3mm (Mechanical Surface Detection)
- Electronics: DAE4 Sn601; Calibrated: 04.07.2011
- Phantom: Flat Phantom 4.9L; Type: QD000P49AA; Serial: 1001
- DASY52 52.6.2(482); SEMCAD X 14.4.5(3634)

Dipole Calibration for Body Tissue/Pin=250 mW, d=15mm/Zoom Scan (7x8x7)/Cube 0:

Measurement grid: dx=5mm, dy=5mm, dz=5mm

Reference Value = 54.889 V/m; Power Drift = 0.03 dB

Peak SAR (extrapolated) = 3.598 W/kg

SAR(1 g) = 2.47 mW/g; SAR(10 g) = 1.63 mW/g

Maximum value of SAR (measured) = 2.854 mW/g

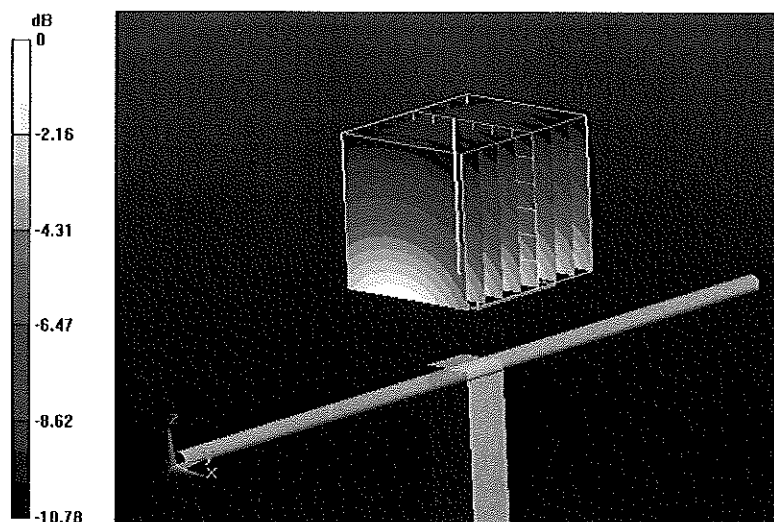

0 dB = 2.850mW/g

Impedance Measurement Plot for Body TSL

15 Aug 2011 14:17:58

CH1 S11 1 U FS 1: 49.320 Ω 5: 3828 Ω 95.410 pF 835.000 000 MHz

*
Del
Cor
Avg
16
H1 d

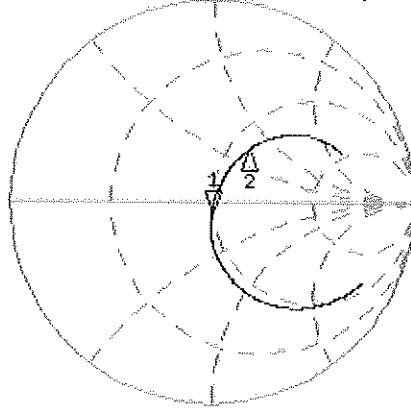

CH1 Markers
2: 60.363 Ω
33.563 Ω
900.000 MHz

CH2 S11 LOG 5 dB/REF -20 dB 1: -25.262 dB 835.000 000 MHz

Cor
Avg
16
H1 d

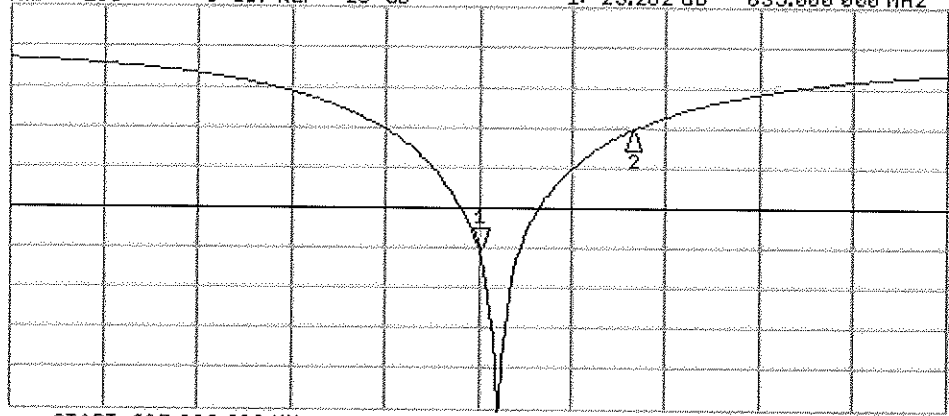

CH2 Markers
2: -10.327 dB
900.000 MHz

START 635.000 028 MHz

STOP 1 035.000 000 MHz



Accredited by the Swiss Accreditation Service (SAS)

Accreditation No.: **SCS 108**

The Swiss Accreditation Service is one of the signatories to the EA
 Multilateral Agreement for the recognition of calibration certificates

Client **PC Test**

Certificate No: **D1900V2-502_Feb12**

CALIBRATION CERTIFICATE

Object **D1900V2 - SN: 502**

Calibration procedure(s) **QA CAL-05.v8
 Calibration procedure for dipole validation kits above 700 MHz**

Calibration date: **February 22, 2012**

*KOK
2/27/12*

This calibration certificate documents the traceability to national standards, which realize the physical units of measurements (SI).
 The measurements and the uncertainties with confidence probability are given on the following pages and are part of the certificate.

All calibrations have been conducted in the closed laboratory facility: environment temperature (22 ± 3)°C and humidity < 70%.

Calibration Equipment used (M&TE critical for calibration)

Primary Standards	ID #	Cal Date (Certificate No.)	Scheduled Calibration
Power meter EPM-442A	GB37480704	05-Oct-11 (No. 217-01451)	Oct-12
Power sensor HP 8481A	US37292783	05-Oct-11 (No. 217-01451)	Oct-12
Reference 20 dB Attenuator	SN: 5086 (20g)	29-Mar-11 (No. 217-01368)	Apr-12
Type-N mismatch combination	SN: 5047.2 / 06327	29-Mar-11 (No. 217-01371)	Apr-12
Reference Probe ES3DV3	SN: 3205	30-Dec-11 (No. ES3-3205_Dec11)	Dec-12
DAE4	SN: 601	04-Jul-11 (No. DAE4-601_Jul11)	Jul-12
Secondary Standards	ID #	Check Date (in house)	Scheduled Check
Power sensor HP 8481A	MY41092317	18-Oct-02 (in house check Oct-11)	In house check: Oct-13
RF generator R&S SMT-06	100005	04-Aug-99 (in house check Oct-11)	In house check: Oct-13
Network Analyzer HP 8753E	US37390585 S4206	18-Oct-01 (in house check Oct-11)	In house check: Oct-12

Calibrated by:	Name Israe El-Naouq	Function Laboratory Technician	Signature <i>Israe El-Naouq</i>
Approved by:	Name Katja Pokovic	Function Technical Manager	Signature <i>Katja Pokovic</i>

Issued: February 22, 2012

This calibration certificate shall not be reproduced except in full without written approval of the laboratory.



Accredited by the Swiss Accreditation Service (SAS)

Accreditation No.: **SCS 108**

The Swiss Accreditation Service is one of the signatories to the EA
Multilateral Agreement for the recognition of calibration certificates

Glossary:

TSL	tissue simulating liquid
ConvF	sensitivity in TSL / NORM x,y,z
N/A	not applicable or not measured

Calibration is Performed According to the Following Standards:

- a) IEEE Std 1528-2003, "IEEE Recommended Practice for Determining the Peak Spatial-Averaged Specific Absorption Rate (SAR) in the Human Head from Wireless Communications Devices: Measurement Techniques", December 2003
- b) IEC 62209-1, "Procedure to measure the Specific Absorption Rate (SAR) for hand-held devices used in close proximity to the ear (frequency range of 300 MHz to 3 GHz)", February 2005
- c) Federal Communications Commission Office of Engineering & Technology (FCC OET), "Evaluating Compliance with FCC Guidelines for Human Exposure to Radiofrequency Electromagnetic Fields; Additional Information for Evaluating Compliance of Mobile and Portable Devices with FCC Limits for Human Exposure to Radiofrequency Emissions", Supplement C (Edition 01-01) to Bulletin 65

Additional Documentation:

- d) DAS4/5 System Handbook

Methods Applied and Interpretation of Parameters:

- *Measurement Conditions:* Further details are available from the Validation Report at the end of the certificate. All figures stated in the certificate are valid at the frequency indicated.
- *Antenna Parameters with TSL:* The dipole is mounted with the spacer to position its feed point exactly below the center marking of the flat phantom section, with the arms oriented parallel to the body axis.
- *Feed Point Impedance and Return Loss:* These parameters are measured with the dipole positioned under the liquid filled phantom. The impedance stated is transformed from the measurement at the SMA connector to the feed point. The Return Loss ensures low reflected power. No uncertainty required.
- *Electrical Delay:* One-way delay between the SMA connector and the antenna feed point. No uncertainty required.
- *SAR measured:* SAR measured at the stated antenna input power.
- *SAR normalized:* SAR as measured, normalized to an input power of 1 W at the antenna connector.
- *SAR for nominal TSL parameters:* The measured TSL parameters are used to calculate the nominal SAR result.

Measurement Conditions

DASY system configuration, as far as not given on page 1.

DASY Version	DASY5	V52.8.0
Extrapolation	Advanced Extrapolation	
Phantom	Modular Flat Phantom	
Distance Dipole Center - TSL	10 mm	with Spacer
Zoom Scan Resolution	dx, dy, dz = 5 mm	
Frequency	1900 MHz \pm 1 MHz	

Head TSL parameters

The following parameters and calculations were applied.

	Temperature	Permittivity	Conductivity
Nominal Head TSL parameters	22.0 °C	40.0	1.40 mho/m
Measured Head TSL parameters	(22.0 \pm 0.2) °C	40.4 \pm 6 %	1.40 mho/m \pm 6 %
Head TSL temperature change during test	< 0.5 °C	----	----

SAR result with Head TSL

SAR averaged over 1 cm ³ (1 g) of Head TSL	Condition	
SAR measured	250 mW input power	9.79 mW / g
SAR for nominal Head TSL parameters	normalized to 1W	39.2 mW /g \pm 17.0 % (k=2)

SAR averaged over 10 cm ³ (10 g) of Head TSL	condition	
SAR measured	250 mW input power	5.17 mW / g
SAR for nominal Head TSL parameters	normalized to 1W	20.7 mW /g \pm 16.5 % (k=2)

Body TSL parameters

The following parameters and calculations were applied.

	Temperature	Permittivity	Conductivity
Nominal Body TSL parameters	22.0 °C	53.3	1.52 mho/m
Measured Body TSL parameters	(22.0 \pm 0.2) °C	53.0 \pm 6 %	1.56 mho/m \pm 6 %
Body TSL temperature change during test	< 0.5 °C	----	----

SAR result with Body TSL

SAR averaged over 1 cm ³ (1 g) of Body TSL	Condition	
SAR measured	250 mW input power	9.88 mW / g
SAR for nominal Body TSL parameters	normalized to 1W	38.9 mW / g \pm 17.0 % (k=2)

SAR averaged over 10 cm ³ (10 g) of Body TSL	condition	
SAR measured	250 mW input power	5.17 mW / g
SAR for nominal Body TSL parameters	normalized to 1W	20.5 mW / g \pm 16.5 % (k=2)

Appendix

Antenna Parameters with Head TSL

Impedance, transformed to feed point	51.7 Ω + 7.2 j Ω
Return Loss	- 22.8 dB

Antenna Parameters with Body TSL

Impedance, transformed to feed point	47.2 Ω + 7.6 j Ω
Return Loss	- 21.6 dB

General Antenna Parameters and Design

Electrical Delay (one direction)	1.206 ns
----------------------------------	----------

After long term use with 100W radiated power, only a slight warming of the dipole near the feedpoint can be measured.

The dipole is made of standard semirigid coaxial cable. The center conductor of the feeding line is directly connected to the second arm of the dipole. The antenna is therefore short-circuited for DC-signals. On some of the dipoles, small end caps are added to the dipole arms in order to improve matching when loaded according to the position as explained in the "Measurement Conditions" paragraph. The SAR data are not affected by this change. The overall dipole length is still according to the Standard.

No excessive force must be applied to the dipole arms, because they might bend or the soldered connections near the feedpoint may be damaged.

Additional EUT Data

Manufactured by	SPEAG
Manufactured on	November 14, 1998

DASY5 Validation Report for Head TSL

Date: 22.02.2012

Test Laboratory: SPEAG, Zurich, Switzerland

DUT: Dipole 1900 MHz; Type: D1900V2; Serial: D1900V2 - SN: 502

Communication System: CW; Frequency: 1900 MHz

Medium parameters used: $f = 1900$ MHz; $\sigma = 1.4$ mho/m; $\epsilon_r = 40.4$; $\rho = 1000$ kg/m³

Phantom section: Flat Section

Measurement Standard: DASY5 (IEEE/IEC/ANSI C63.19-2007)

DASY52 Configuration:

- Probe: ES3DV3 - SN3205; ConvF(5.01, 5.01, 5.01); Calibrated: 30.12.2011
- Sensor-Surface: 3mm (Mechanical Surface Detection)
- Electronics: DAE4 Sn601; Calibrated: 04.07.2011
- Phantom: Flat Phantom 5.0 (front); Type: QD000P50AA; Serial: 1001
- DASY52 52.8.0(692); SEMCAD X 14.6.4(4989)

Dipole Calibration for Head Tissue/Pin=250 mW, d=10mm/Zoom Scan (7x7x7)/Cube 0:

Measurement grid: dx=5mm, dy=5mm, dz=5mm

Reference Value = 96.315 V/m; Power Drift = 0.03 dB

Peak SAR (extrapolated) = 17.4000

SAR(1 g) = 9.79 mW/g; SAR(10 g) = 5.17 mW/g

Maximum value of SAR (measured) = 12.015 mW/g

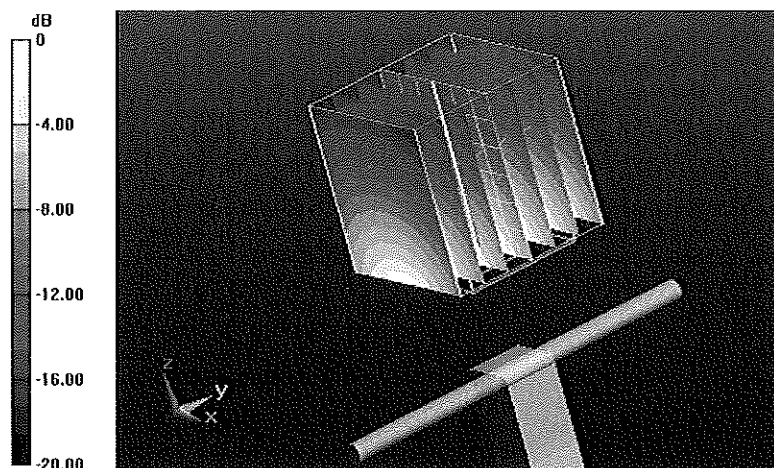

0 dB = 12.020mW/g = 21.60 dB mW/g

Impedance Measurement Plot for Head TSL

22 Feb 2012 09:44:49

CH1 S11 1 u FS 2: 51.697 Ω 7.1936 Ω 601.74 μ H 1 900.000 000 MHz

*
De1
Cor
Avg
9
H1d

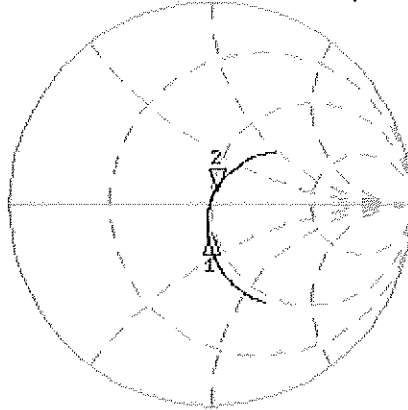

CH1 Markers
1: 46.764 Ω
-14.023 Ω
1.00000 GHz

CH2 S11 LOG 5 dB/REF -20 dB 2: -22.806 dB 1 900.000 000 MHz

Cor
Avg
9
H1d

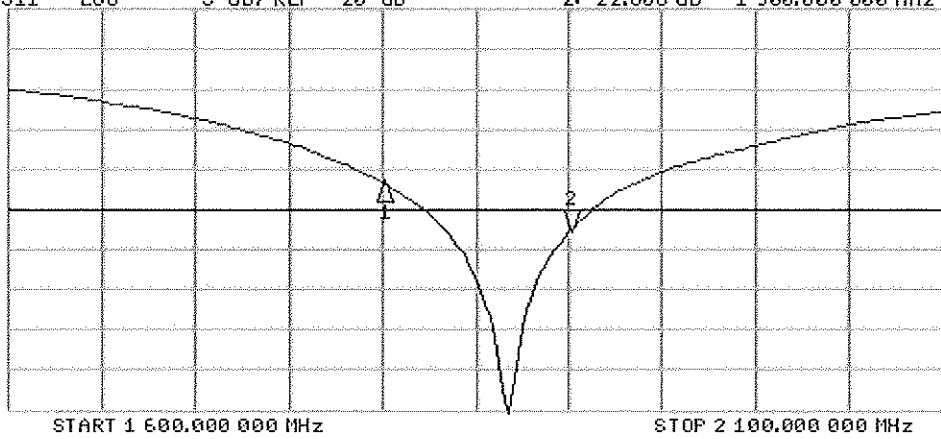

CH2 Markers
1: -16.642 dB
1.00000 GHz

DASY5 Validation Report for Body TSL

Date: 22.02.2012

Test Laboratory: SPEAG, Zurich, Switzerland

DUT: Dipole 1900 MHz; Type: D1900V2; Serial: D1900V2 - SN: 502

Communication System: CW; Frequency: 1900 MHz

Medium parameters used: $f = 1900$ MHz; $\sigma = 1.56$ mho/m; $\epsilon_r = 53$; $\rho = 1000$ kg/m³

Phantom section: Flat Section

Measurement Standard: DASY5 (IEEE/IEC/ANSI C63.19-2007)

DASY52 Configuration:

- Probe: ES3DV3 - SN3205; ConvF(4.62, 4.62, 4.62); Calibrated: 30.12.2011
- Sensor-Surface: 3mm (Mechanical Surface Detection)
- Electronics: DAE4 Sn601; Calibrated: 04.07.2011
- Phantom: Flat Phantom 5.0 (back); Type: QD000P50AA; Serial: 1002
- DASY52 52.8.0(692); SEMCAD X 14.6.4(4989)

Dipole Calibration for Body Tissue/Pin=250 mW, d=10mm/Zoom Scan (7x7x7)/Cube 0:

Measurement grid: dx=5mm, dy=5mm, dz=5mm

Reference Value = 93.607 V/m; Power Drift = 0.0093 dB

Peak SAR (extrapolated) = 17.4260

SAR(1 g) = 9.88 mW/g; SAR(10 g) = 5.17 mW/g

Maximum value of SAR (measured) = 12.532 mW/g

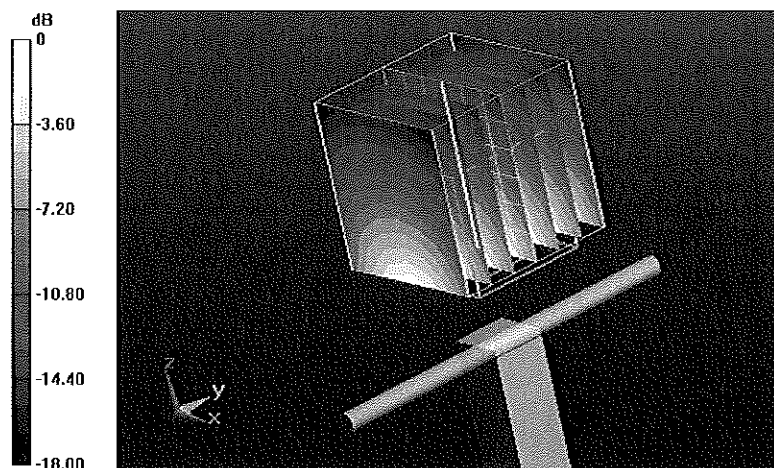

0 dB = 12.530mW/g = 21.96 dB mW/g

Impedance Measurement Plot for Body TSL

22 Feb 2012 09:44:23

[CH1] S11 1 U FS 2:47.184 Ω 2:6.133 Ω -637.73 μ H 1.900.000.000 MHz

*
Del
Cor
Avg
16
H1d

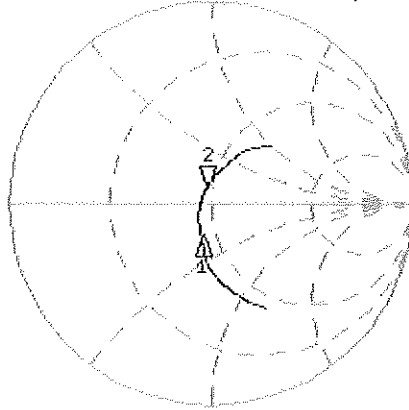

CH1 Markers
1: 43.225 Ω
-14.492 Ω
1.80000 GHz

CH2 S11 LOG 5 dB/REF -20 dB 2:-21.590 dB 1.900.000.000 MHz

Cor
Avg
16
H1d

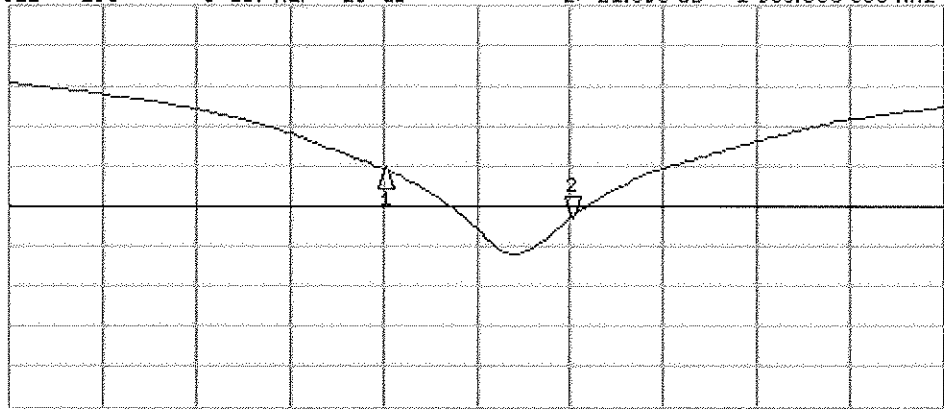

CH2 Markers
1:-15.413 dB
1.80000 GHz

START 1.600.000.000 MHz

STOP 2.000.000.000 MHz



Accredited by the Swiss Accreditation Service (SAS)

Accreditation No.: **SCS 108**

The Swiss Accreditation Service is one of the signatories to the EA
Multilateral Agreement for the recognition of calibration certificates

Client **PC Test**

Certificate No: **D2450V2-719_Aug11**

CALIBRATION CERTIFICATE

Object **D2450V2 - SN: 719**

Calibration procedure(s) **QA CAL-05.v8
Calibration procedure for dipole validation kits above 700 MHz**

Calibration date: **August 19, 2011**

✓ KOK
9/6/11

This calibration certificate documents the traceability to national standards, which realize the physical units of measurements (SI).
The measurements and the uncertainties with confidence probability are given on the following pages and are part of the certificate.

All calibrations have been conducted in the closed laboratory facility: environment temperature (22 ± 3)°C and humidity < 70%.

Calibration Equipment used (M&TE critical for calibration)

Primary Standards	ID #	Cal Date (Certificate No.)	Scheduled Calibration
Power meter EPM-442A	GB37480704	06-Oct-10 (No. 217-01266)	Oct-11
Power sensor HP 8481A	US37292783	06-Oct-10 (No. 217-01266)	Oct-11
Reference 20 dB Attenuator	SN: S5086 (20b)	29-Mar-11 (No. 217-01367)	Apr-12
Type-N mismatch combination	SN: 5047.2 / 06327	29-Mar-11 (No. 217-01371)	Apr-12
Reference Probe ES3DV3	SN: 3205	29-Apr-11 (No. ES3-3205_Apr11)	Apr-12
DAE4	SN: 601	04-Jul-11 (No. DAE4-601_Jul11)	Jul-12
Secondary Standards	ID #	Check Date (in house)	Scheduled Check
Power sensor HP 8481A	MY41092317	18-Oct-02 (in house check Oct-09)	In house check: Oct-11
RF generator R&S SMT-06	100005	04-Aug-99 (in house check Oct-09)	In house check: Oct-11
Network Analyzer HP 8753E	US37390585 S4206	18-Oct-01 (in house check Oct-10)	In house check: Oct-11

Calibrated by: **Claudio Leubler** **Laboratory Technician**

Signature

Approved by: **Katja Pokovic** **Technical Manager**

Issued: August 22, 2011

This calibration certificate shall not be reproduced except in full without written approval of the laboratory.



The Swiss Accreditation Service is one of the signatories to the EA Multilateral Agreement for the recognition of calibration certificates

Glossary:

TSL	tissue simulating liquid
ConvF	sensitivity in TSL / NORM x,y,z
N/A	not applicable or not measured

Calibration is Performed According to the Following Standards:

- a) IEEE Std 1528-2003, "IEEE Recommended Practice for Determining the Peak Spatial-Averaged Specific Absorption Rate (SAR) in the Human Head from Wireless Communications Devices: Measurement Techniques", December 2003
- b) IEC 62209-1, "Procedure to measure the Specific Absorption Rate (SAR) for hand-held devices used in close proximity to the ear (frequency range of 300 MHz to 3 GHz)", February 2005
- c) Federal Communications Commission Office of Engineering & Technology (FCC OET), "Evaluating Compliance with FCC Guidelines for Human Exposure to Radiofrequency Electromagnetic Fields; Additional Information for Evaluating Compliance of Mobile and Portable Devices with FCC Limits for Human Exposure to Radiofrequency Emissions", Supplement C (Edition 01-01) to Bulletin 65

Additional Documentation:

- d) DAS4/5 System Handbook

Methods Applied and Interpretation of Parameters:

- *Measurement Conditions:* Further details are available from the Validation Report at the end of the certificate. All figures stated in the certificate are valid at the frequency indicated.
- *Antenna Parameters with TSL:* The dipole is mounted with the spacer to position its feed point exactly below the center marking of the flat phantom section, with the arms oriented parallel to the body axis.
- *Feed Point Impedance and Return Loss:* These parameters are measured with the dipole positioned under the liquid filled phantom. The impedance stated is transformed from the measurement at the SMA connector to the feed point. The Return Loss ensures low reflected power. No uncertainty required.
- *Electrical Delay:* One-way delay between the SMA connector and the antenna feed point. No uncertainty required.
- *SAR measured:* SAR measured at the stated antenna input power.
- *SAR normalized:* SAR as measured, normalized to an input power of 1 W at the antenna connector.
- *SAR for nominal TSL parameters:* The measured TSL parameters are used to calculate the nominal SAR result.

Measurement Conditions

DASY system configuration, as far as not given on page 1.

DASY Version	DASY5	V52.6.2
Extrapolation	Advanced Extrapolation	
Phantom	Modular Flat Phantom	
Distance Dipole Center - TSL	10 mm	with Spacer
Zoom Scan Resolution	dx, dy, dz = 5 mm	
Frequency	2450 MHz \pm 1 MHz	

Head TSL parameters

The following parameters and calculations were applied.

	Temperature	Permittivity	Conductivity
Nominal Head TSL parameters	22.0 °C	39.2	1.80 mho/m
Measured Head TSL parameters	(22.0 \pm 0.2) °C	38.4 \pm 6 %	1.85 mho/m \pm 6 %
Head TSL temperature change during test	< 0.5 °C	----	----

SAR result with Head TSL

SAR averaged over 1 cm ³ (1 g) of Head TSL	Condition	
SAR measured	250 mW input power	13.7 mW / g
SAR for nominal Head TSL parameters	normalized to 1W	53.8 mW / g \pm 17.0 % (k=2)

SAR averaged over 10 cm ³ (10 g) of Head TSL	condition	
SAR measured	250 mW input power	6.35 mW / g
SAR for nominal Head TSL parameters	normalized to 1W	25.2 mW / g \pm 16.5 % (k=2)

Body TSL parameters

The following parameters and calculations were applied.

	Temperature	Permittivity	Conductivity
Nominal Body TSL parameters	22.0 °C	52.7	1.95 mho/m
Measured Body TSL parameters	(22.0 \pm 0.2) °C	51.8 \pm 6 %	2.02 mho/m \pm 6 %
Body TSL temperature change during test	< 0.5 °C	----	----

SAR result with Body TSL

SAR averaged over 1 cm ³ (1 g) of Body TSL	Condition	
SAR measured	250 mW input power	13.1 mW / g
SAR for nominal Body TSL parameters	normalized to 1W	51.3 mW / g \pm 17.0 % (k=2)

SAR averaged over 10 cm ³ (10 g) of Body TSL	condition	
SAR measured	250 mW input power	6.07 mW / g
SAR for nominal Body TSL parameters	normalized to 1W	24.1 mW / g \pm 16.5 % (k=2)

Appendix

Antenna Parameters with Head TSL

Impedance, transformed to feed point	53.2 Ω + 3.6 j Ω
Return Loss	- 26.6 dB

Antenna Parameters with Body TSL

Impedance, transformed to feed point	49.6 Ω + 4.3 j Ω
Return Loss	- 27.3 dB

General Antenna Parameters and Design

Electrical Delay (one direction)	1.149 ns
----------------------------------	----------

After long term use with 100W radiated power, only a slight warming of the dipole near the feedpoint can be measured.

The dipole is made of standard semirigid coaxial cable. The center conductor of the feeding line is directly connected to the second arm of the dipole. The antenna is therefore short-circuited for DC-signals.

No excessive force must be applied to the dipole arms, because they might bend or the soldered connections near the feedpoint may be damaged.

Additional EUT Data

Manufactured by	SPEAG
Manufactured on	September 10, 2002

DASY5 Validation Report for Head TSL

Date: 18.08.2011

Test Laboratory: SPEAG, Zurich, Switzerland

~~DUT: Dipole 2450 MHz; Type: D2450V2; Serial: D2450V2 - SN: 719~~

Communication System: CW; Frequency: 2450 MHz

Medium parameters used: $f = 2450$ MHz; $\sigma = 1.85$ mho/m; $\epsilon_r = 38.4$; $\rho = 1000$ kg/m³

Phantom section: Flat Section

Measurement Standard: DASY5 (IEEE/IEC/ANSI C63.19-2007)

DASY52 Configuration:

- Probe: ES3DV3 - SN3205; ConvF(4.45, 4.45, 4.45); Calibrated: 29.04.2011
- Sensor-Surface: 3mm (Mechanical Surface Detection)
- Electronics: DAE4 Sn601; Calibrated: 04.07.2011
- Phantom: Flat Phantom 5.0 (front); Type: QD000P50AA; Serial: 1001
- DASY52 52.6.2(482); SEMCAD X 14.4.5(3634)

Dipole Calibration for Head Tissue/Pin=250 mW, d=10mm/Zoom Scan (7x7x7)/Cube 0:

Measurement grid: dx=5mm, dy=5mm, dz=5mm

Reference Value = 101.4 V/m; Power Drift = 0.06 dB

Peak SAR (extrapolated) = 28.234 W/kg

SAR(1 g) = 13.7 mW/g; SAR(10 g) = 6.35 mW/g

Maximum value of SAR (measured) = 17.657 mW/g

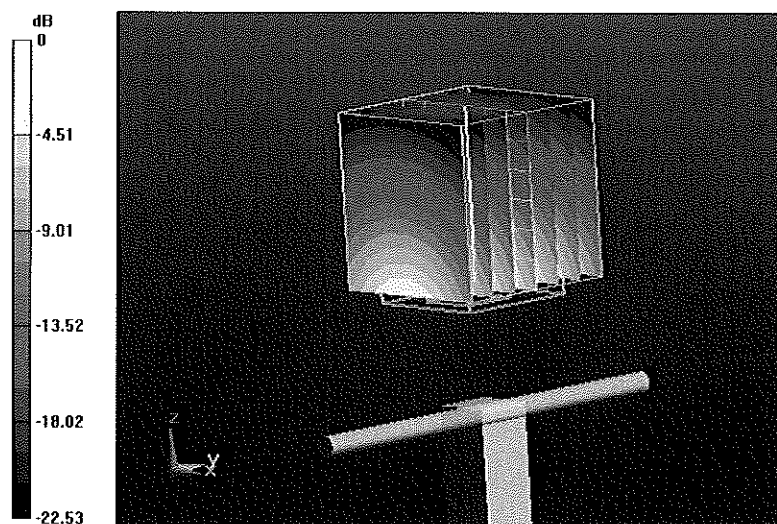

0 dB = 17.660mW/g

Impedance Measurement Plot for Head TSL

18 Aug 2011 10:43:30

CH1 S11 1 U FS 1:53.248 μ 3.5703 μ 231.93 pF 2 450.000 000 MHz

*
Del
CA

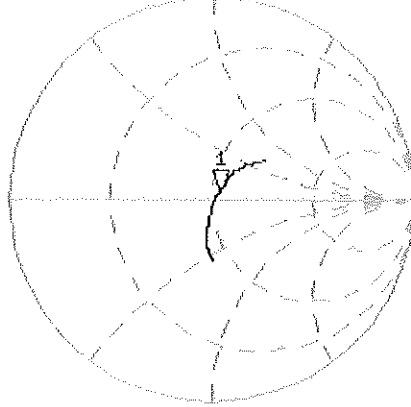

Avg
16

HI d

CH2 S11 LOG 5 dB/REF -20 dB 1:-26.606 dB 2 450.000 000 MHz

CA

Avg
16

HI d

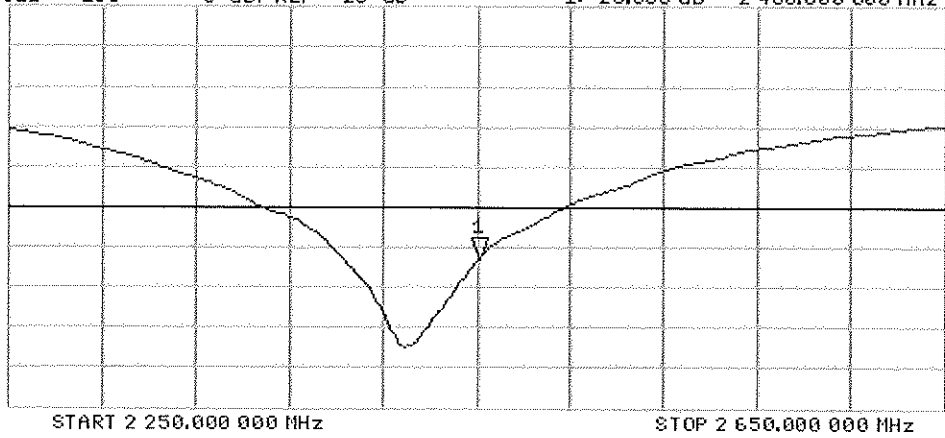

DASY5 Validation Report for Body TSL

Date: 19.08.2011

Test Laboratory: SPEAG, Zurich, Switzerland

~~DUT: Dipole 2450 MHz; Type: D2450V2; Serial: D2450V2 - SN: 719~~

Communication System: CW; Frequency: 2450 MHz

Medium parameters used: $f = 2450$ MHz; $\sigma = 2.02$ mho/m; $\epsilon_r = 51.8$; $\rho = 1000$ kg/m³

Phantom section: Flat Section

Measurement Standard: DASY5 (IEEE/IEC/ANSI C63.19-2007)

DASY52 Configuration:

- Probe: ES3DV3 - SN3205; ConvF(4.26, 4.26, 4.26); Calibrated: 29.04.2011
- Sensor-Surface: 3mm (Mechanical Surface Detection)
- Electronics: DAE4 Sn601; Calibrated: 04.07.2011
- Phantom: Flat Phantom 5.0 (back); Type: QD000P50AA; Serial: 1002
- DASY52 52.6.2(482); SEMCAD X 14.4.5(3634)

Dipole Calibration for Body Tissue/Pin=250 mW, d=10mm/Zoom Scan (7x7x7)/Cube 0:

Measurement grid: dx=5mm, dy=5mm, dz=5mm

Reference Value = 95.948 V/m; Power Drift = 0.01 dB

Peak SAR (extrapolated) = 26.876 W/kg

SAR(1 g) = 13.1 mW/g; SAR(10 g) = 6.07 mW/g

Maximum value of SAR (measured) = 17.309 mW/g

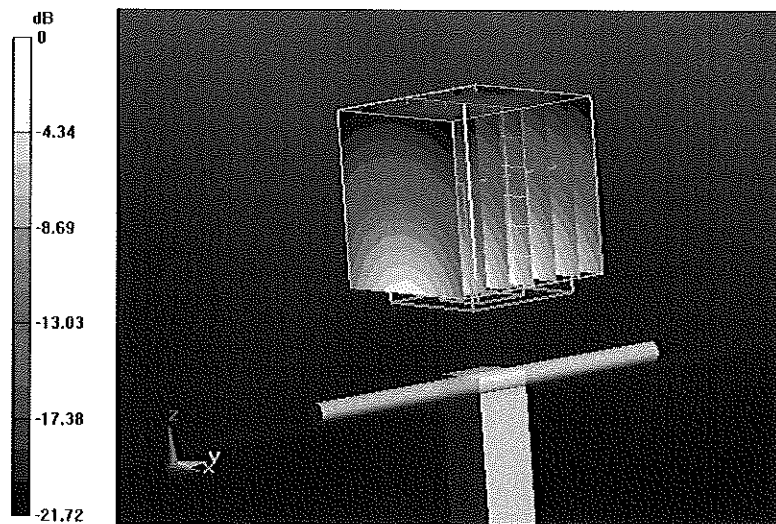

0 dB = 17.310mW/g

Impedance Measurement Plot for Body TSL

18 Aug 2011 10:49:46

[CH1] S11 1 U FS 1: 49.582 μ 4.2578 μ 276.59 pH 2 450.000 000 MHz

*
De1
CA

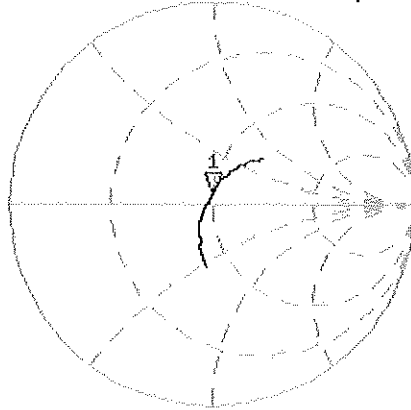

Avg
16

H1 d

CH2 S11 LOG 5 dB/REF -20 dB 1:-27.342 dB 2 450.000 000 MHz

CA

Avg
16

H1 d

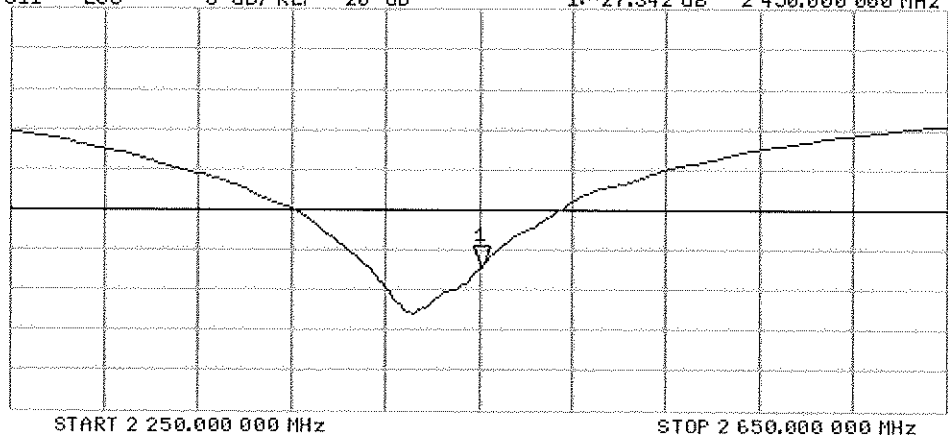



Accredited by the Swiss Accreditation Service (SAS)
The Swiss Accreditation Service is one of the signatories to the EA
Multilateral Agreement for the recognition of calibration certificates

Accreditation No.: SCS 108

Client **PC Test**

Certificate No: **ES3-3022_Aug11**

CALIBRATION CERTIFICATE

Object **ES3DV2 - SN:3022**

Calibration procedure(s) **QA CAL-01.v8, QA CAL-12.v7, QA CAL-23.v4, QA CAL-25.v4
Calibration procedure for dosimetric E-field probes**

Calibration date: **August 25, 2011**

*✓KOK
9/6/11*

This calibration certificate documents the traceability to national standards, which realize the physical units of measurements (SI).
The measurements and the uncertainties with confidence probability are given on the following pages and are part of the certificate.

All calibrations have been conducted in the closed laboratory facility: environment temperature (22 ± 3)°C and humidity < 70%.

Calibration Equipment used (M&TE critical for calibration)

Primary Standards	ID	Cal Date (Certificate No.)	Scheduled Calibration
Power meter E4419B	GB41293874	31-Mar-11 (No. 217-01372)	Apr-12
Power sensor E4412A	MY41498087	31-Mar-11 (No. 217-01372)	Apr-12
Reference 3 dB Attenuator	SN: S5054 (3c)	29-Mar-11 (No. 217-01369)	Apr-12
Reference 20 dB Attenuator	SN: S5086 (20b)	29-Mar-11 (No. 217-01367)	Apr-12
Reference 30 dB Attenuator	SN: S5129 (30b)	29-Mar-11 (No. 217-01370)	Apr-12
Reference Probe ES3DV2	SN: 3013	29-Dec-10 (No. ES3-3013_Dec10)	Dec-11
DAE4	SN: 654	3-May-11 (No. DAE4-654_May11)	May-12
Secondary Standards	ID	Check Date (in house)	Scheduled Check
RF generator HP 8648C	US3642U01700	4-Aug-99 (in house check Oct-09)	In house check: Oct-11
Network Analyzer HP 8753E	US37390585	18-Oct-01 (in house check Oct-10)	In house check: Oct-11

Calibrated by:	Name Claudio Leubler	Function Laboratory Technician	Signature
Approved by:	Katja Pokovic	Technical Manager	

Issued: August 27, 2011

This calibration certificate shall not be reproduced except in full without written approval of the laboratory.



Accredited by the Swiss Accreditation Service (SAS)

Accreditation No.: SCS 108

The Swiss Accreditation Service is one of the signatories to the EA
Multilateral Agreement for the recognition of calibration certificates

Glossary:

TSL	tissue simulating liquid
NORM _{x,y,z}	sensitivity in free space
ConvF	sensitivity in TSL / NORM _{x,y,z}
DCP	diode compression point
CF	crest factor (1/duty_cycle) of the RF signal
A, B, C	modulation dependent linearization parameters
Polarization φ	φ rotation around probe axis
Polarization ϑ	ϑ rotation around an axis that is in the plane normal to probe axis (at measurement center), i.e., $\vartheta = 0$ is normal to probe axis

Calibration is Performed According to the Following Standards:

- IEEE Std 1528-2003, "IEEE Recommended Practice for Determining the Peak Spatial-Averaged Specific Absorption Rate (SAR) in the Human Head from Wireless Communications Devices: Measurement Techniques", December 2003
- IEC 62209-1, "Procedure to measure the Specific Absorption Rate (SAR) for hand-held devices used in close proximity to the ear (frequency range of 300 MHz to 3 GHz)", February 2005

Methods Applied and Interpretation of Parameters:

- NORM_{x,y,z}**: Assessed for E-field polarization $\vartheta = 0$ ($f \leq 900$ MHz in TEM-cell; $f > 1800$ MHz: R22 waveguide). NORM_{x,y,z} are only intermediate values, i.e., the uncertainties of NORM_{x,y,z} does not affect the E²-field uncertainty inside TSL (see below ConvF).
- NORM(f)_{x,y,z} = NORM_{x,y,z} * frequency_response** (see Frequency Response Chart). This linearization is implemented in DASY4 software versions later than 4.2. The uncertainty of the frequency response is included in the stated uncertainty of ConvF.
- DCP_{x,y,z}**: DCP are numerical linearization parameters assessed based on the data of power sweep with CW signal (no uncertainty required). DCP does not depend on frequency nor media.
- PAR**: PAR is the Peak to Average Ratio that is not calibrated but determined based on the signal characteristics
- A_{x,y,z}; B_{x,y,z}; C_{x,y,z}; VR_{x,y,z}; A, B, C** are numerical linearization parameters assessed based on the data of power sweep for specific modulation signal. The parameters do not depend on frequency nor media. VR is the maximum calibration range expressed in RMS voltage across the diode.
- ConvF and Boundary Effect Parameters**: Assessed in flat phantom using E-field (or Temperature Transfer Standard for $f \leq 800$ MHz) and inside waveguide using analytical field distributions based on power measurements for $f > 800$ MHz. The same setups are used for assessment of the parameters applied for boundary compensation (alpha, depth) of which typical uncertainty values are given. These parameters are used in DASY4 software to improve probe accuracy close to the boundary. The sensitivity in TSL corresponds to NORM_{x,y,z} * ConvF whereby the uncertainty corresponds to that given for ConvF. A frequency dependent ConvF is used in DASY version 4.4 and higher which allows extending the validity from ± 50 MHz to ± 100 MHz.
- Spherical isotropy (3D deviation from isotropy)**: in a field of low gradients realized using a flat phantom exposed by a patch antenna.
- Sensor Offset**: The sensor offset corresponds to the offset of virtual measurement center from the probe tip (on probe axis). No tolerance required.

Probe ES3DV2

SN:3022

Manufactured: April 15, 2003
Calibrated: August 25, 2011

Calibrated for DASY/EASY Systems
(Note: non-compatible with DASY2 system!)

DASY/EASY - Parameters of Probe: ES3DV2 - SN:3022

Basic Calibration Parameters

	Sensor X	Sensor Y	Sensor Z	Unc (k=2)
Norm ($\mu\text{V}/(\text{V/m})^2$) ^A	1.00	1.04	0.99	$\pm 10.1 \%$
DCP (mV) ^B	99.5	97.7	99.2	

Modulation Calibration Parameters

UID	Communication System Name	PAR		A dB	B dB	C dB	VR mV	Unc ^E (k=2)
10000	CW	0.00	X	0.00	0.00	1.00	133.2	$\pm 2.7 \%$
			Y	0.00	0.00	1.00	130.0	
			Z	0.00	0.00	1.00	133.9	

The reported uncertainty of measurement is stated as the standard uncertainty of measurement multiplied by the coverage factor k=2, which for a normal distribution corresponds to a coverage probability of approximately 95%.

^A The uncertainties of NormX,Y,Z do not affect the E²-field uncertainty inside TSL (see Pages 5 and 6).

^B Numerical linearization parameter: uncertainty not required.

^E Uncertainty is determined using the max. deviation from linear response applying rectangular distribution and is expressed for the square of the field value.

DASY/EASY - Parameters of Probe: ES3DV2 - SN:3022

Calibration Parameter Determined in Head Tissue Simulating Media

f (MHz) ^C	Relative Permittivity ^F	Conductivity (S/m) ^F	ConvF X	ConvF Y	ConvF Z	Alpha	Depth (mm)	Unct. (k=2)
750	41.9	0.89	6.27	6.27	6.27	0.80	1.13	± 12.0 %
835	41.5	0.90	6.05	6.05	6.05	0.80	1.14	± 12.0 %
1750	40.1	1.37	5.20	5.20	5.20	0.59	1.39	± 12.0 %
1900	40.0	1.40	4.98	4.98	4.98	0.66	1.30	± 12.0 %
2450	39.2	1.80	4.30	4.30	4.30	0.58	1.41	± 12.0 %
2600	39.0	1.96	4.20	4.20	4.20	0.58	1.43	± 12.0 %

^C Frequency validity of ± 100 MHz only applies for DASY v4.4 and higher (see Page 2), else it is restricted to ± 50 MHz. The uncertainty is the RSS of the ConvF uncertainty at calibration frequency and the uncertainty for the indicated frequency band.

^F At frequencies below 3 GHz, the validity of tissue parameters (ϵ and σ) can be relaxed to ± 10% if liquid compensation formula is applied to measured SAR values. At frequencies above 3 GHz, the validity of tissue parameters (ϵ and σ) is restricted to ± 5%. The uncertainty is the RSS of the ConvF uncertainty for indicated target tissue parameters.

DASY/EASY - Parameters of Probe: ES3DV2- SN:3022

Calibration Parameter Determined in Body Tissue Simulating Media

f (MHz) ^C	Relative Permittivity ^F	Conductivity (S/m) ^F	ConvF X	ConvF Y	ConvF Z	Alpha	Depth (mm)	Unct. (k=2)
450	56.7	0.94	6.93	6.93	6.93	0.07	1.00	± 13.4 %
750	55.5	0.96	6.11	6.11	6.11	0.80	1.18	± 12.0 %
835	55.2	0.97	6.06	6.06	6.06	0.80	1.20	± 12.0 %
1640	53.8	1.40	5.07	5.07	5.07	0.70	1.32	± 12.0 %
1750	53.4	1.49	4.64	4.64	4.64	0.67	1.35	± 12.0 %
1900	53.3	1.52	4.41	4.41	4.41	0.54	1.56	± 12.0 %
2450	52.7	1.95	4.01	4.01	4.01	0.66	1.19	± 12.0 %
2600	52.5	2.16	3.90	3.90	3.90	0.54	1.45	± 12.0 %

^C Frequency validity of ± 100 MHz only applies for DASY v4.4 and higher (see Page 2), else it is restricted to ± 50 MHz. The uncertainty is the RSS of the ConvF uncertainty at calibration frequency and the uncertainty for the indicated frequency band.

^F At frequencies below 3 GHz, the validity of tissue parameters (ϵ and σ) can be relaxed to ± 10% if liquid compensation formula is applied to measured SAR values. At frequencies above 3 GHz, the validity of tissue parameters (ϵ and σ) is restricted to ± 5%. The uncertainty is the RSS of the ConvF uncertainty for indicated target tissue parameters.

Frequency Response of E-Field

(TEM-Cell: ifi110 EXX, Waveguide: R22)

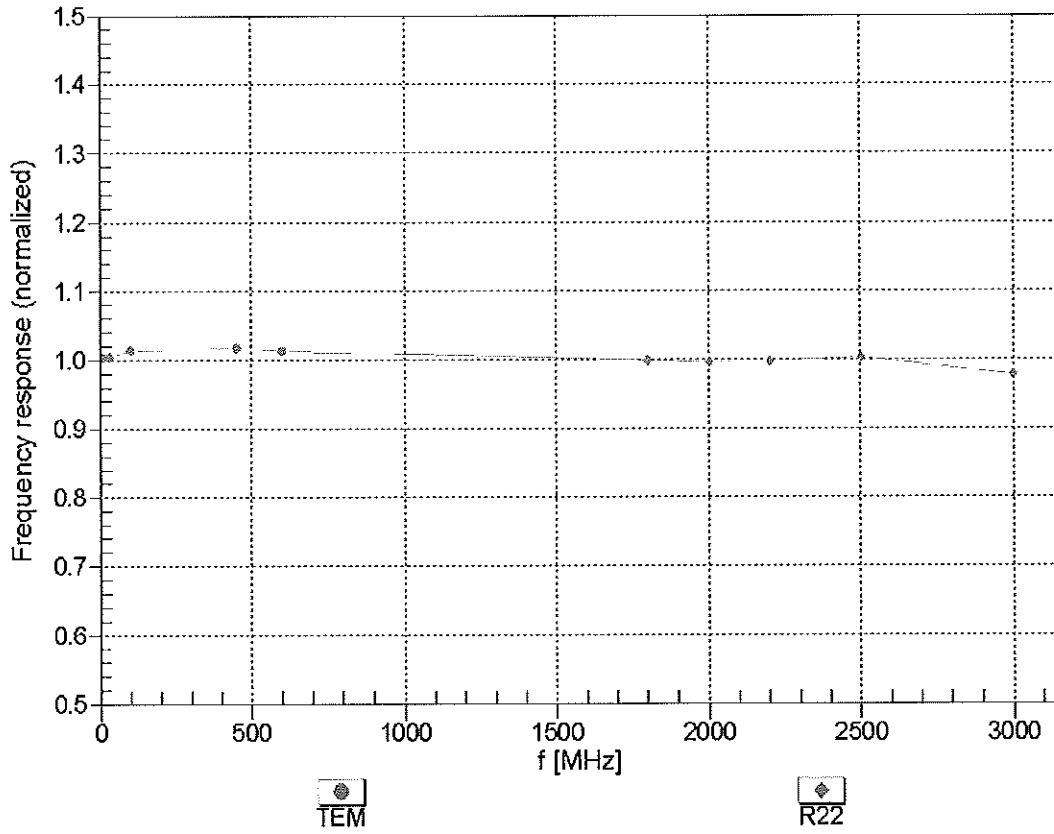

Uncertainty of Frequency Response of E-field: $\pm 6.3\%$ (k=2)

Receiving Pattern (ϕ), $\vartheta = 0^\circ$

f=600 MHz, TEM

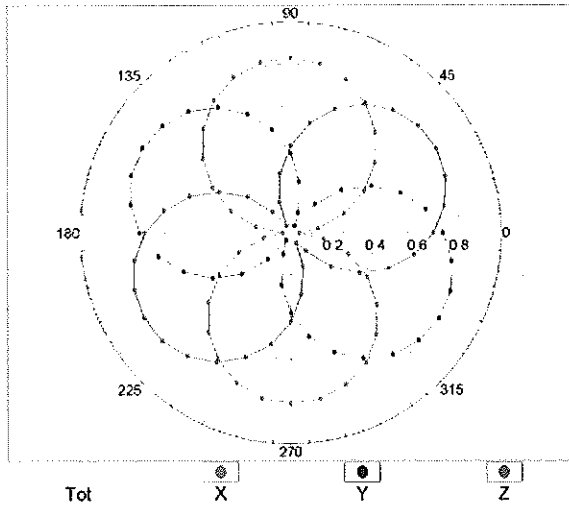

f=1800 MHz, R22

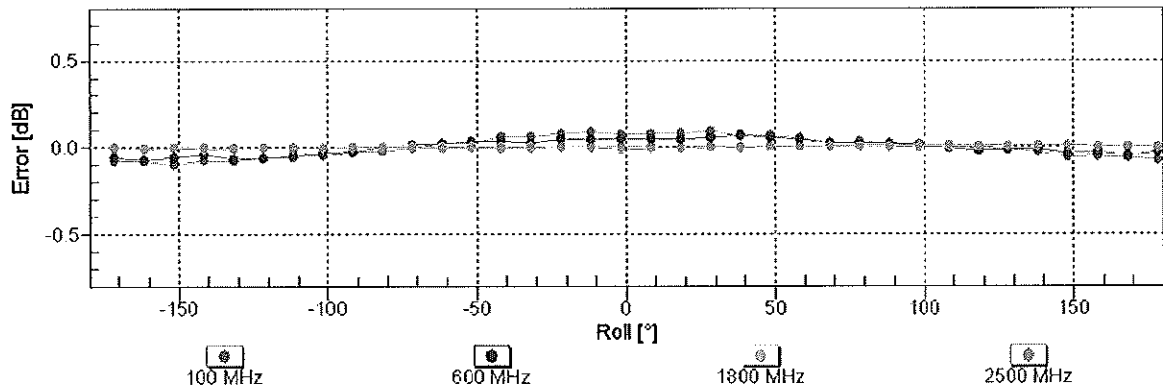
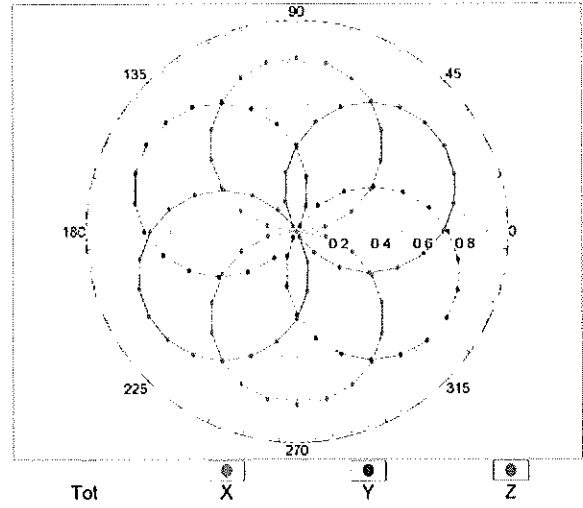

Uncertainty of Axial Isotropy Assessment: $\pm 0.5\%$ (k=2)

Dynamic Range $f(SAR_{head})$ (TEM cell , $f = 900$ MHz)

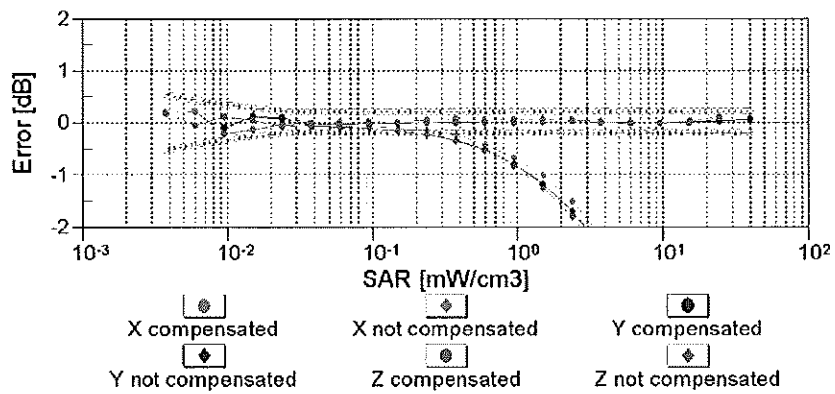
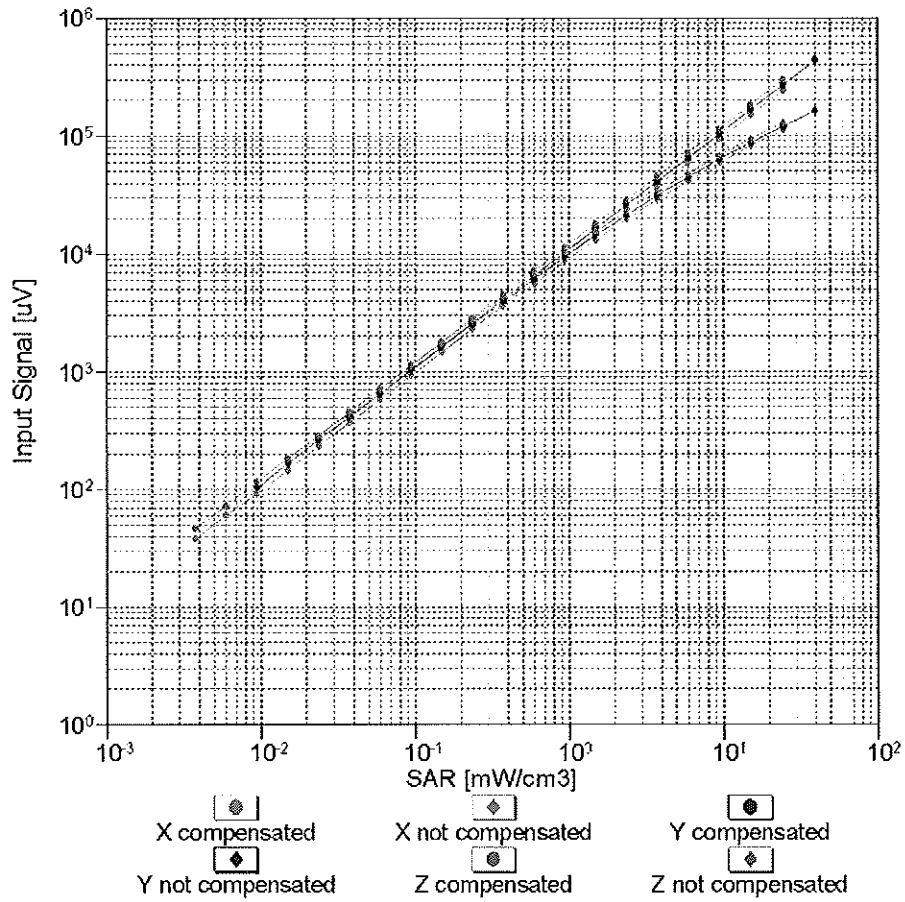

Uncertainty of Linearity Assessment: $\pm 0.6\%$ ($k=2$)

Conversion Factor Assessment

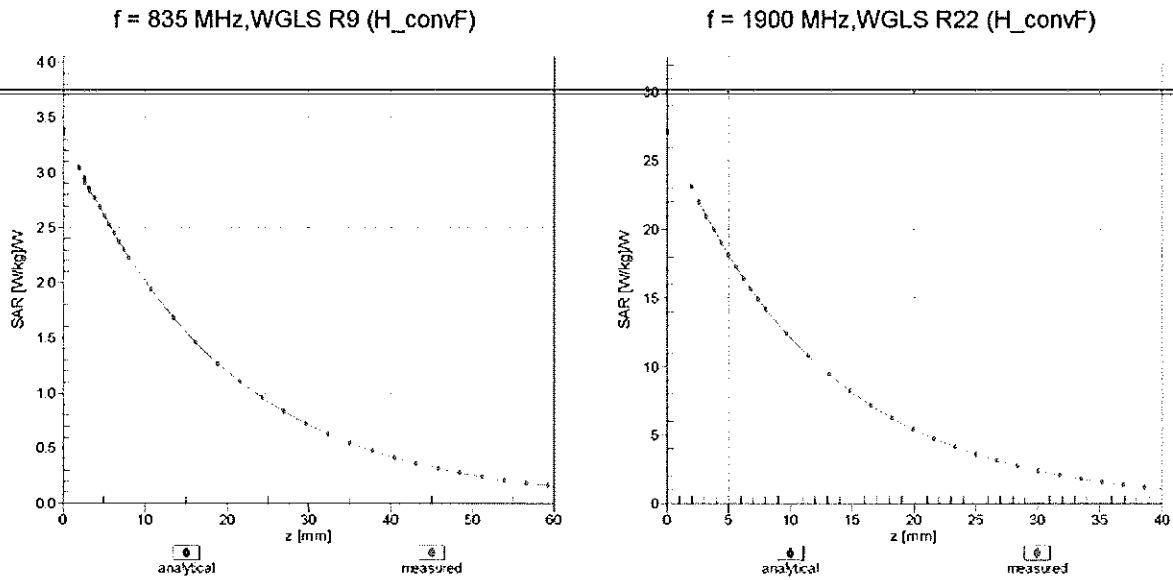

Deviation from Isotropy in Liquid Error (ϕ, θ), f = 900 MHz

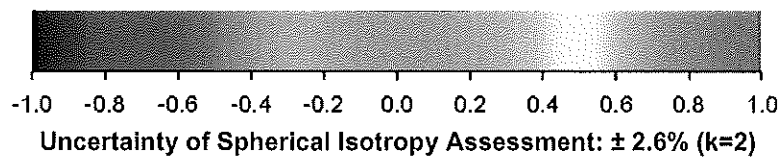
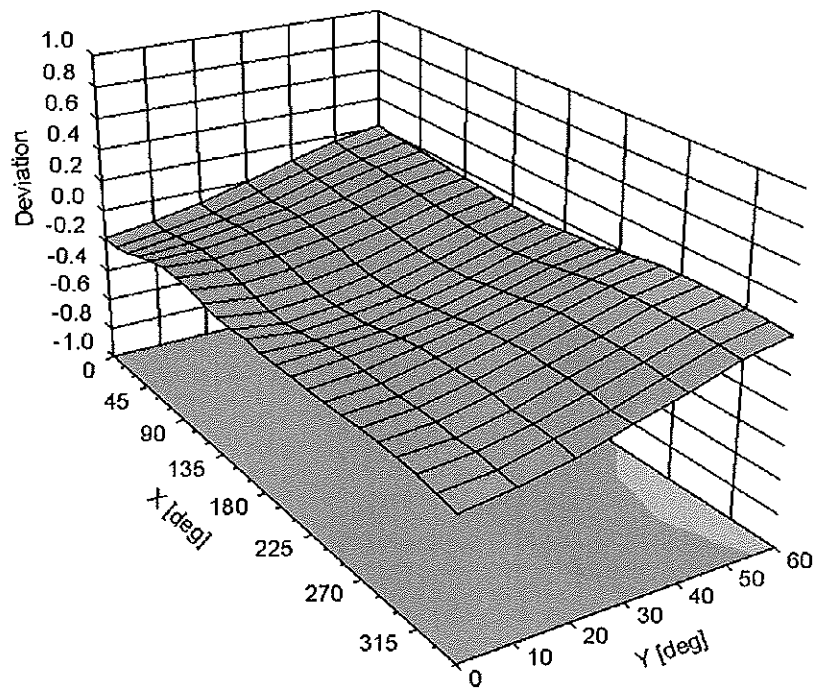

DASY/EASY - Parameters of Probe: ES3DV2 - SN:3022

Other Probe Parameters

Sensor Arrangement	Triangular
Connector Angle (°)	Not applicable
Mechanical Surface Detection Mode	enabled
Optical Surface Detection Mode	disabled
Probe Overall Length	337 mm
Probe Body Diameter	10 mm
Tip Length	10 mm
Tip Diameter	4 mm
Probe Tip to Sensor X Calibration Point	2 mm
Probe Tip to Sensor Y Calibration Point	2 mm
Probe Tip to Sensor Z Calibration Point	2 mm
Recommended Measurement Distance from Surface	3 mm

Additional Conversion Factors

for Dosimetric E-Field Probe

Type:

ES3DV2

Serial Number:

3022

Place of Assessment:

Zurich

Date of Assessment:

August 29, 2011

Probe Calibration Date:

August 25, 2011

Schmid & Partner Engineering AG hereby certifies that conversion factor(s) of this probe have been evaluated on the date indicated above. The assessment was performed using the FDTD numerical code SEMCAD of Schmid & Partner Engineering AG. The evaluation is coupled with measured conversion factors (probe calibration date indicated above). The uncertainty of the numerical assessment is based on the extrapolation from measured value at 835 MHz or at 1750 MHz.

Assessed by:

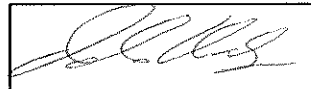

Dosimetric E-Field Probe ES3DV2 SN:3022

Conversion factor (\pm standard deviation)

550 \pm 50 MHz *ConvF* 6.57 \pm 7%

$\epsilon_r = 56.3 \pm 5\%$
 $\sigma = 0.95 \pm 5\%$ mho/m
 (body tissue)

650 \pm 50 MHz *ConvF* 6.16 \pm 7%

$\epsilon_r = 55.9 \pm 5\%$
 $\sigma = 0.95 \pm 5\%$ mho/m
 (body tissue)

Important Note:

For numerically assessed probe conversion factors, parameters Alpha and Delta in the DASY software must have the following entries: Alpha = 0 and Delta = 1.

Please see also DASY Manual.



Accredited by the Swiss Accreditation Service (SAS)
 The Swiss Accreditation Service is one of the signatories to the EA
 Multilateral Agreement for the recognition of calibration certificates

Accreditation No.: **SCS 108**

Client **PC Test**

Certificate No: **ES3-3209_Mar12**

CALIBRATION CERTIFICATE

Object **ES3DV3 - SN:3209**

Calibration procedure(s) **QA CAL-01.v8, QA CAL-12.v7, QA CAL-23.v4, QA CAL-25.v4
 Calibration procedure for dosimetric E-field probes**

Calibration date: **March 16, 2012**

*KOK
4/15/12*

This calibration certificate documents the traceability to national standards, which realize the physical units of measurements (SI).
 The measurements and the uncertainties with confidence probability are given on the following pages and are part of the certificate.

All calibrations have been conducted in the closed laboratory facility: environment temperature (22 ± 3)°C and humidity < 70%.

Calibration Equipment used (M&TE critical for calibration)

Primary Standards	ID	Cal Date (Certificate No.)	Scheduled Calibration
Power meter E4419B	GB41293874	31-Mar-11 (No. 217-01372)	Apr-12
Power sensor E4412A	MY41498087	31-Mar-11 (No. 217-01372)	Apr-12
Reference 3 dB Attenuator	SN: S5054 (3c)	29-Mar-11 (No. 217-01369)	Apr-12
Reference 20 dB Attenuator	SN: S5086 (20b)	29-Mar-11 (No. 217-01367)	Apr-12
Reference 30 dB Attenuator	SN: S5129 (30b)	29-Mar-11 (No. 217-01370)	Apr-12
Reference Probe ES3DV2	SN: 3013	29-Dec-11 (No. ES3-3013_Dec11)	Dec-12
DAE4	SN: 654	3-May-11 (No. DAE4-654_May11)	May-12
Secondary Standards	ID	Check Date (in house)	Scheduled Check
RF generator HP 8648C	US3642U01700	4-Aug-99 (in house check Apr-11)	In house check: Apr-13
Network Analyzer HP 8753E	US37390585	18-Oct-01 (in house check Oct-11)	In house check: Oct-12

Calibrated by:	Name Jeton Kastrati	Function Laboratory Technician	Signature
Approved by:	Name Katja Pokovic	Function Technical Manager	Signature

Issued: March 19, 2012

This calibration certificate shall not be reproduced except in full without written approval of the laboratory.



Accredited by the Swiss Accreditation Service (SAS)
 The Swiss Accreditation Service is one of the signatories to the EA
 Multilateral Agreement for the recognition of calibration certificates

Accreditation No.: **SCS 108**

Glossary:

TSL	tissue simulating liquid
NORM _{x,y,z}	sensitivity in free space
ConvF	sensitivity in TSL / NORM _{x,y,z}
DCP	diode compression point
CF	crest factor (1/duty_cycle) of the RF signal
A, B, C	modulation dependent linearization parameters
Polarization ϕ	ϕ rotation around probe axis
Polarization ϑ	ϑ rotation around an axis that is in the plane normal to probe axis (at measurement center), i.e., $\vartheta = 0$ is normal to probe axis

Calibration is Performed According to the Following Standards:

- a) IEEE Std 1528-2003, "IEEE Recommended Practice for Determining the Peak Spatial-Averaged Specific Absorption Rate (SAR) in the Human Head from Wireless Communications Devices: Measurement Techniques", December 2003
- b) IEC 62209-1, "Procedure to measure the Specific Absorption Rate (SAR) for hand-held devices used in close proximity to the ear (frequency range of 300 MHz to 3 GHz)", February 2005

Methods Applied and Interpretation of Parameters:

- *NORM_{x,y,z}*: Assessed for E-field polarization $\vartheta = 0$ ($f \leq 900$ MHz in TEM-cell; $f > 1800$ MHz: R22 waveguide). *NORM_{x,y,z}* are only intermediate values, i.e., the uncertainties of *NORM_{x,y,z}* does not affect the E^2 -field uncertainty inside TSL (see below *ConvF*).
- *NORM(f)_{x,y,z}* = *NORM_{x,y,z}* * *frequency_response* (see Frequency Response Chart). This linearization is implemented in DASY4 software versions later than 4.2. The uncertainty of the frequency response is included in the stated uncertainty of *ConvF*.
- *DCP_{x,y,z}*: DCP are numerical linearization parameters assessed based on the data of power sweep with CW signal (no uncertainty required). DCP does not depend on frequency nor media.
- *PAR*: PAR is the Peak to Average Ratio that is not calibrated but determined based on the signal characteristics
- *A_{x,y,z}*; *B_{x,y,z}*; *C_{x,y,z}*; *VR_{x,y,z}*; *A, B, C* are numerical linearization parameters assessed based on the data of power sweep for specific modulation signal. The parameters do not depend on frequency nor media. *VR* is the maximum calibration range expressed in RMS voltage across the diode.
- *ConvF and Boundary Effect Parameters*: Assessed in flat phantom using E-field (or Temperature Transfer Standard for $f \leq 800$ MHz) and inside waveguide using analytical field distributions based on power measurements for $f > 800$ MHz. The same setups are used for assessment of the parameters applied for boundary compensation (alpha, depth) of which typical uncertainty values are given. These parameters are used in DASY4 software to improve probe accuracy close to the boundary. The sensitivity in TSL corresponds to *NORM_{x,y,z}* * *ConvF* whereby the uncertainty corresponds to that given for *ConvF*. A frequency dependent *ConvF* is used in DASY version 4.4 and higher which allows extending the validity from ± 50 MHz to ± 100 MHz.
- *Spherical isotropy (3D deviation from isotropy)*: in a field of low gradients realized using a flat phantom exposed by a patch antenna.
- *Sensor Offset*: The sensor offset corresponds to the offset of virtual measurement center from the probe tip (on probe axis). No tolerance required.

Probe ES3DV3

SN:3209

Manufactured: October 14, 2008
Calibrated: March 16, 2012

Calibrated for DASY/EASY Systems
(Note: non-compatible with DASY2 system!)

DASY/EASY - Parameters of Probe: ES3DV3 - SN:3209

Basic Calibration Parameters

	Sensor X	Sensor Y	Sensor Z	Unc (k=2)
Norm ($\mu V/(V/m)^2$) ^A	1.36	1.34	1.15	± 10.1 %
DCP (mV) ^B	98.2	97.4	98.7	

Modulation Calibration Parameters

UID	Communication System Name	PAR		A dB	B dB	C dB	VR mV	Unc ^E (k=2)
10000	CW	0.00	X	0.00	0.00	1.00	119.2	±3.5 %
			Y	0.00	0.00	1.00	89.3	
			Z	0.00	0.00	1.00	111.5	

The reported uncertainty of measurement is stated as the standard uncertainty of measurement multiplied by the coverage factor k=2, which for a normal distribution corresponds to a coverage probability of approximately 95%.

^A The uncertainties of NormX,Y,Z do not affect the E²-field uncertainty inside TSL (see Pages 5 and 6).

^B Numerical linearization parameter: uncertainty not required.

^E Uncertainty is determined using the max. deviation from linear response applying rectangular distribution and is expressed for the square of the field value.

DASY/EASY - Parameters of Probe: ES3DV3 - SN:3209

Calibration Parameter Determined in Head Tissue Simulating Media

f (MHz) ^C	Relative Permittivity ^F	Conductivity (S/m) ^F	ConvF X	ConvF Y	ConvF Z	Alpha	Depth (mm)	Unct. (k=2)
750	41.9	0.89	6.47	6.47	6.47	0.37	1.61	± 12.0 %
835	41.5	0.90	6.22	6.22	6.22	0.24	2.24	± 12.0 %
1640	40.3	1.29	5.38	5.38	5.38	0.41	1.56	± 12.0 %
1750	40.1	1.37	5.26	5.26	5.26	0.41	1.60	± 12.0 %
1900	40.0	1.40	5.15	5.15	5.15	0.80	1.16	± 12.0 %
2450	39.2	1.80	4.46	4.46	4.46	0.64	1.39	± 12.0 %
2600	39.0	1.96	4.30	4.30	4.30	0.69	1.42	± 12.0 %

^C Frequency validity of ± 100 MHz only applies for DASY v4.4 and higher (see Page 2), else it is restricted to ± 50 MHz. The uncertainty is the RSS of the ConvF uncertainty at calibration frequency and the uncertainty for the indicated frequency band.

^F At frequencies below 3 GHz, the validity of tissue parameters (ϵ and σ) can be relaxed to ± 10% if liquid compensation formula is applied to measured SAR values. At frequencies above 3 GHz, the validity of tissue parameters (ϵ and σ) is restricted to ± 5%. The uncertainty is the RSS of the ConvF uncertainty for indicated target tissue parameters.

DASY/EASY - Parameters of Probe: ES3DV3 - SN:3209

Calibration Parameter Determined in Body Tissue Simulating Media

f (MHz) ^C	Relative Permittivity ^F	Conductivity (S/m) ^F	ConvF X	ConvF Y	ConvF Z	Alpha	Depth (mm)	Unct. (k=2)
450	56.7	0.94	7.11	7.11	7.11	0.07	1.00	± 13.4 %
750	55.5	0.96	6.23	6.23	6.23	0.54	1.40	± 12.0 %
835	55.2	0.97	6.13	6.13	6.13	0.24	2.27	± 12.0 %
1640	53.8	1.40	5.21	5.21	5.21	0.72	1.29	± 12.0 %
1750	53.4	1.49	4.83	4.83	4.83	0.59	1.44	± 12.0 %
1900	53.3	1.52	4.63	4.63	4.63	0.57	1.50	± 12.0 %
2450	52.7	1.95	4.23	4.23	4.23	0.80	1.00	± 12.0 %
2600	52.5	2.16	4.02	4.02	4.02	0.62	0.90	± 12.0 %

^C Frequency validity of ± 100 MHz only applies for DASY v4.4 and higher (see Page 2), else it is restricted to ± 50 MHz. The uncertainty is the RSS of the ConvF uncertainty at calibration frequency and the uncertainty for the indicated frequency band.

^F At frequencies below 3 GHz, the validity of tissue parameters (ϵ and σ) can be relaxed to ± 10% if liquid compensation formula is applied to measured SAR values. At frequencies above 3 GHz, the validity of tissue parameters (ϵ and σ) is restricted to ± 5%. The uncertainty is the RSS of the ConvF uncertainty for indicated target tissue parameters.

Frequency Response of E-Field

(TEM-Cell:ifi110 EXX, Waveguide: R22)

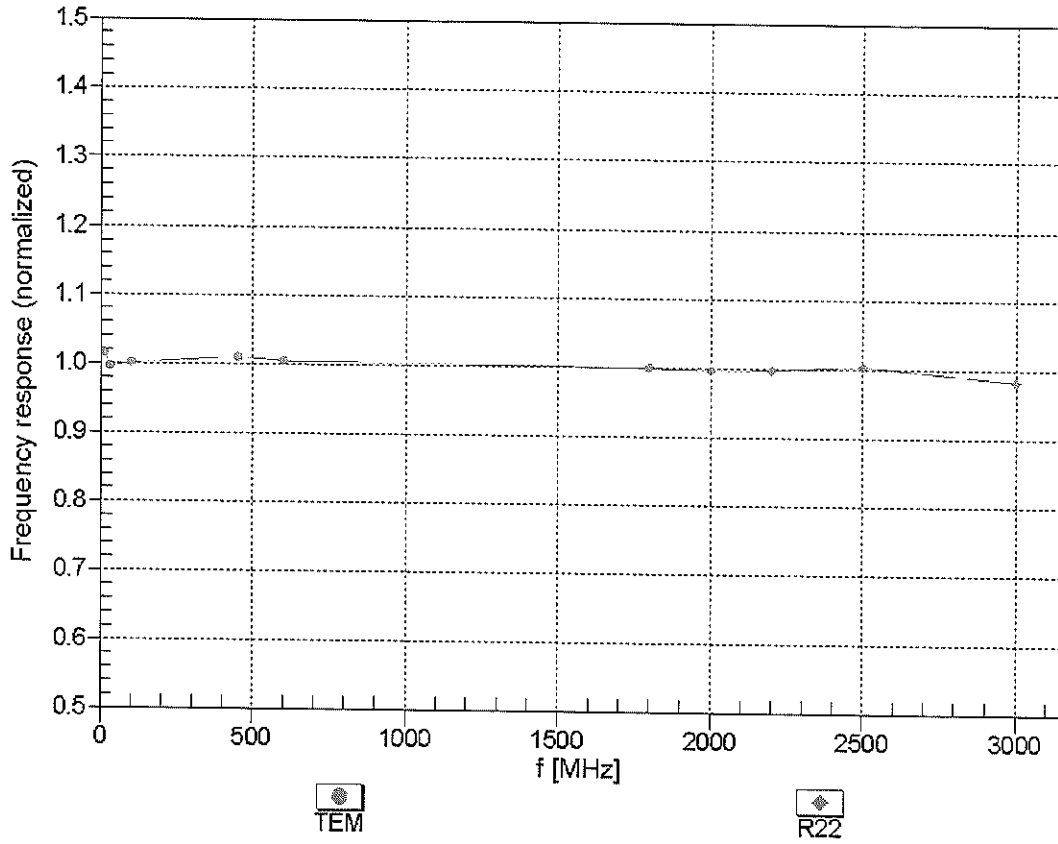

Uncertainty of Frequency Response of E-field: $\pm 6.3\%$ ($k=2$)

Receiving Pattern (ϕ), $\theta = 0^\circ$

f=600 MHz, TEM

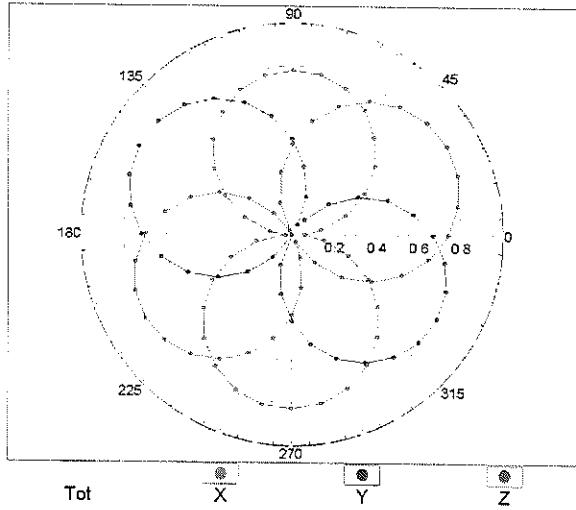

f=1800 MHz, R22

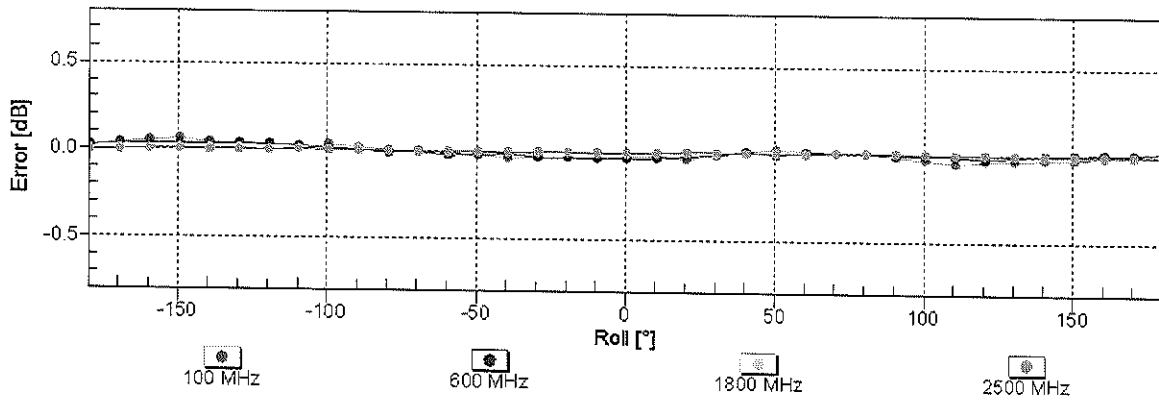
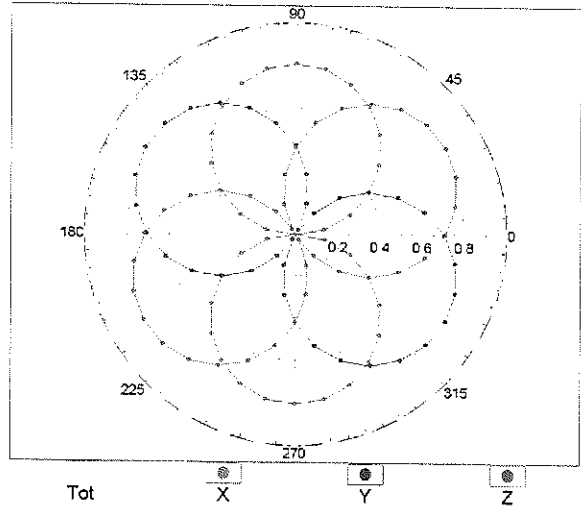

Uncertainty of Axial Isotropy Assessment: $\pm 0.5\%$ (k=2)

Dynamic Range f(SAR_{head}) (TEM cell , f = 900 MHz)

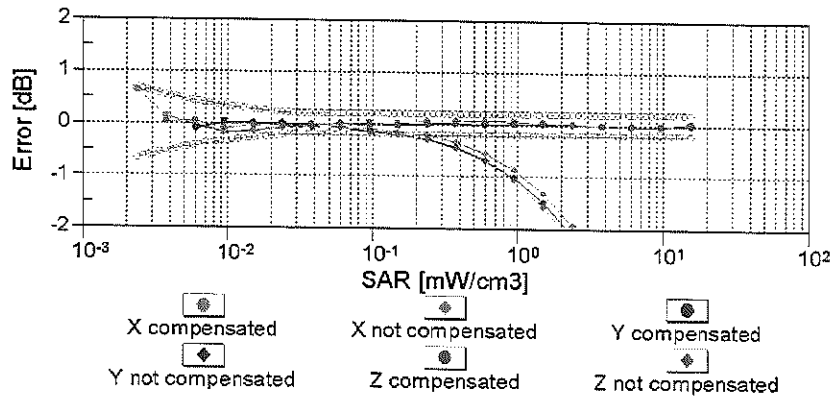
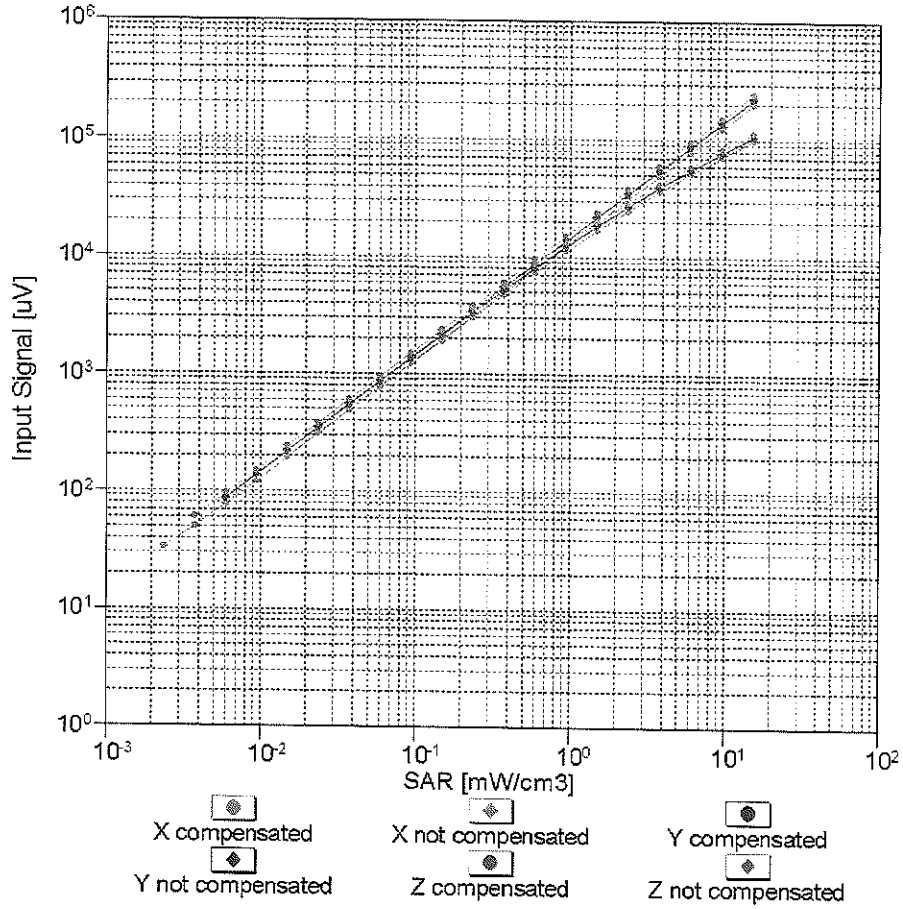

Uncertainty of Linearity Assessment: ± 0.6% (k=2)

Conversion Factor Assessment

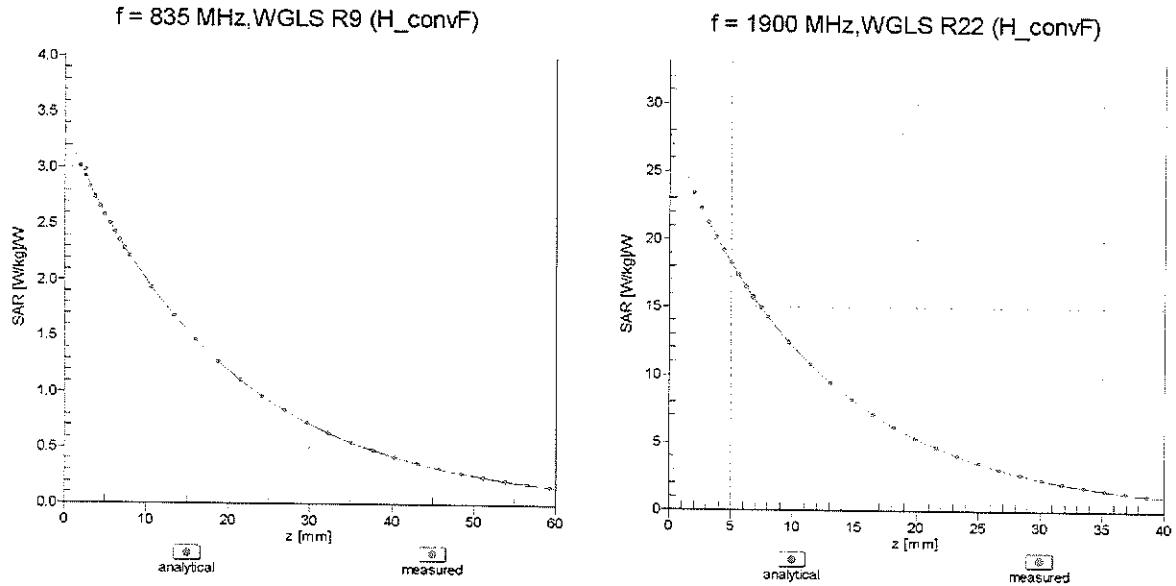

Deviation from Isotropy in Liquid Error (ϕ, θ), f = 900 MHz

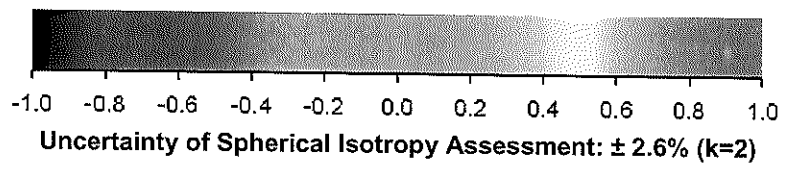
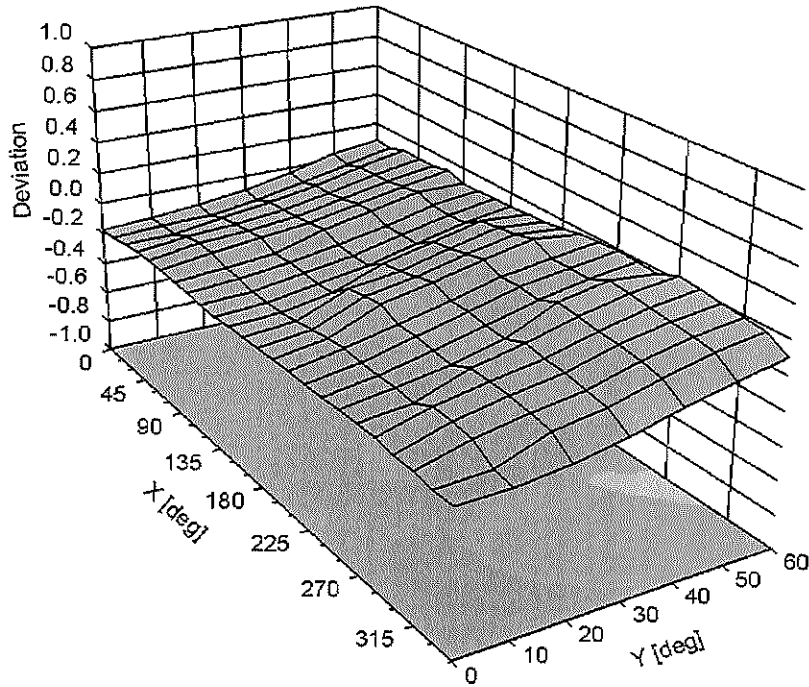

DASY/EASY - Parameters of Probe: ES3DV3 - SN:3209**Other Probe Parameters**

Sensor Arrangement	Triangular
Connector Angle (°)	Not applicable
Mechanical Surface Detection Mode	enabled
Optical Surface Detection Mode	disabled
Probe Overall Length	337 mm
Probe Body Diameter	10 mm
Tip Length	10 mm
Tip Diameter	4 mm
Probe Tip to Sensor X Calibration Point	2 mm
Probe Tip to Sensor Y Calibration Point	2 mm
Probe Tip to Sensor Z Calibration Point	2 mm
Recommended Measurement Distance from Surface	3 mm



Accredited by the Swiss Accreditation Service (SAS)
The Swiss Accreditation Service is one of the signatories to the EA
Multilateral Agreement for the recognition of calibration certificates

Accreditation No.: **SCS 108**

Client **PC Test**

Certificate No: **ES3-3258_Feb12**

CALIBRATION CERTIFICATE

Object **ES3DV3 - SN:3258**

Calibration procedure(s) **QA CAL-01.v8, QA CAL-23.v4, QA CAL-25.v4
Calibration procedure for dosimetric E-field probes**

Calibration date: **February 21, 2012**

This calibration certificate documents the traceability to national standards, which realize the physical units of measurements (SI).
The measurements and the uncertainties with confidence probability are given on the following pages and are part of the certificate.

All calibrations have been conducted in the closed laboratory facility: environment temperature (22 ± 3)°C and humidity < 70%.

Calibration Equipment used (M&TE critical for calibration)

*KOK
2/27/12*

Primary Standards	ID	Cal Date (Certificate No.)	Scheduled Calibration
Power meter E4419B	GB41293874	31-Mar-11 (No. 217-01372)	Apr-12
Power sensor E4412A	MY41498087	31-Mar-11 (No. 217-01372)	Apr-12
Reference 3 dB Attenuator	SN: S5054 (3c)	29-Mar-11 (No. 217-01369)	Apr-12
Reference 20 dB Attenuator	SN: S5086 (20b)	29-Mar-11 (No. 217-01367)	Apr-12
Reference 30 dB Attenuator	SN: S5129 (30b)	29-Mar-11 (No. 217-01370)	Apr-12
Reference Probe ES3DV2	SN: 3013	29-Dec-11 (No. ES3-3013_Dec11)	Dec-12
DAE4	SN: 654	3-May-11 (No. DAE4-654_May11)	May-12
Secondary Standards	ID	Check Date (in house)	Scheduled Check
RF generator HP 8648C	US3642U01700	4-Aug-99 (in house check Apr-11)	In house check: Apr-13
Network Analyzer HP 8753E	US37390585	18-Oct-01 (in house check Oct-11)	In house check: Oct-12

Calibrated by:	Name Claudio Leubler	Function Laboratory Technician	Signature
Approved by:	Katja Pokovic	Technical Manager	

Issued: February 23, 2012

This calibration certificate shall not be reproduced except in full without written approval of the laboratory.



Accredited by the Swiss Accreditation Service (SAS)
The Swiss Accreditation Service is one of the signatories to the EA
Multilateral Agreement for the recognition of calibration certificates

Accreditation No.: SCS 108

Glossary:

TSL	tissue simulating liquid
NORM _{x,y,z}	sensitivity in free space
ConvF	sensitivity in TSL / NORM _{x,y,z}
DCP	diode compression point
CF	crest factor (1/duty_cycle) of the RF signal
A, B, C	modulation dependent linearization parameters
Polarization φ	φ rotation around probe axis
Polarization ϑ	ϑ rotation around an axis that is in the plane normal to probe axis (at measurement center), i.e., $\vartheta = 0$ is normal to probe axis

Calibration is Performed According to the Following Standards:

- IEEE Std 1528-2003, "IEEE Recommended Practice for Determining the Peak Spatial-Averaged Specific Absorption Rate (SAR) in the Human Head from Wireless Communications Devices: Measurement Techniques", December 2003
- IEC 62209-1, "Procedure to measure the Specific Absorption Rate (SAR) for hand-held devices used in close proximity to the ear (frequency range of 300 MHz to 3 GHz)", February 2005

Methods Applied and Interpretation of Parameters:

- NORM_{x,y,z}**: Assessed for E-field polarization $\vartheta = 0$ ($f \leq 900$ MHz in TEM-cell; $f > 1800$ MHz: R22 waveguide). NORM_{x,y,z} are only intermediate values, i.e., the uncertainties of NORM_{x,y,z} does not affect the E²-field uncertainty inside TSL (see below ConvF).
- NORM(f)_{x,y,z} = NORM_{x,y,z} * frequency_response** (see Frequency Response Chart). This linearization is implemented in DASY4 software versions later than 4.2. The uncertainty of the frequency response is included in the stated uncertainty of ConvF.
- DCP_{x,y,z}**: DCP are numerical linearization parameters assessed based on the data of power sweep with CW signal (no uncertainty required). DCP does not depend on frequency nor media.
- PAR**: PAR is the Peak to Average Ratio that is not calibrated but determined based on the signal characteristics
- A_{x,y,z}; B_{x,y,z}; C_{x,y,z}; VR_{x,y,z}; A, B, C** are numerical linearization parameters assessed based on the data of power sweep for specific modulation signal. The parameters do not depend on frequency nor media. VR is the maximum calibration range expressed in RMS voltage across the diode.
- ConvF and Boundary Effect Parameters**: Assessed in flat phantom using E-field (or Temperature Transfer Standard for $f \leq 800$ MHz) and inside waveguide using analytical field distributions based on power measurements for $f > 800$ MHz. The same setups are used for assessment of the parameters applied for boundary compensation (alpha, depth) of which typical uncertainty values are given. These parameters are used in DASY4 software to improve probe accuracy close to the boundary. The sensitivity in TSL corresponds to NORM_{x,y,z} * ConvF whereby the uncertainty corresponds to that given for ConvF. A frequency dependent ConvF is used in DASY version 4.4 and higher which allows extending the validity from ± 50 MHz to ± 100 MHz.
- Spherical isotropy (3D deviation from isotropy)**: in a field of low gradients realized using a flat phantom exposed by a patch antenna.
- Sensor Offset**: The sensor offset corresponds to the offset of virtual measurement center from the probe tip (on probe axis). No tolerance required.

Probe ES3DV3

SN:3258

Manufactured: January 25, 2010
Calibrated: February 21, 2012

Calibrated for DASY/EASY Systems
(Note: non-compatible with DASY2 system!)

DASY/EASY - Parameters of Probe: ES3DV3 - SN:3258

Basic Calibration Parameters

	Sensor X	Sensor Y	Sensor Z	Unc (k=2)
Norm ($\mu\text{V}/(\text{V}/\text{m})^2$) ^A	1.29	1.18	1.23	$\pm 10.1 \%$
DCP (mV) ^B	101.6	105.0	100.8	

Modulation Calibration Parameters

UID	Communication System Name	PAR		A dB	B dB	C dB	VR mV	Unc ^E (k=2)
10000	CW	0.00	X	0.00	0.00	1.00	115.9	$\pm 3.0 \%$
			Y	0.00	0.00	1.00	107.9	
			Z	0.00	0.00	1.00	115.8	

The reported uncertainty of measurement is stated as the standard uncertainty of measurement multiplied by the coverage factor k=2, which for a normal distribution corresponds to a coverage probability of approximately 95%.

^A The uncertainties of NormX,Y,Z do not affect the E²-field uncertainty inside TSL (see Pages 5 and 6).

^B Numerical linearization parameter: uncertainty not required.

^E Uncertainty is determined using the max. deviation from linear response applying rectangular distribution and is expressed for the square of the field value.

DASY/EASY - Parameters of Probe: ES3DV3 - SN:3258

Calibration Parameter Determined in Head Tissue Simulating Media

f (MHz) ^C	Relative Permittivity ^F	Conductivity (S/m) ^F	ConvF X	ConvF Y	ConvF Z	Alpha	Depth (mm)	Unct. (k=2)
750	41.9	0.89	6.26	6.26	6.26	0.43	1.49	± 12.0 %
835	41.5	0.90	6.01	6.01	6.01	0.45	1.48	± 12.0 %
1640	40.3	1.29	5.46	5.46	5.46	0.61	1.30	± 12.0 %
1750	40.1	1.37	5.30	5.30	5.30	0.67	1.30	± 12.0 %
1900	40.0	1.40	5.17	5.17	5.17	0.79	1.23	± 12.0 %
2450	39.2	1.80	4.46	4.46	4.46	0.67	1.40	± 12.0 %
2600	39.0	1.96	4.31	4.31	4.31	0.80	1.33	± 12.0 %

^C Frequency validity of ± 100 MHz only applies for DASY v4.4 and higher (see Page 2), else it is restricted to ± 50 MHz. The uncertainty is the RSS of the ConvF uncertainty at calibration frequency and the uncertainty for the indicated frequency band.

^F At frequencies below 3 GHz, the validity of tissue parameters (ϵ and σ) can be relaxed to ± 10% if liquid compensation formula is applied to measured SAR values. At frequencies above 3 GHz, the validity of tissue parameters (ϵ and σ) is restricted to ± 5%. The uncertainty is the RSS of the ConvF uncertainty for indicated target tissue parameters.

DASY/EASY - Parameters of Probe: ES3DV3 - SN:3258

Calibration Parameter Determined in Body Tissue Simulating Media

f (MHz) ^C	Relative Permittivity ^F	Conductivity (S/m) ^F	ConvF X	ConvF Y	ConvF Z	Alpha	Depth (mm)	Unct. (k=2)
750	55.5	0.96	6.21	6.21	6.21	0.80	1.13	± 12.0 %
835	55.2	0.97	6.06	6.06	6.06	0.50	1.46	± 12.0 %
1640	53.8	1.40	5.45	5.45	5.45	0.80	1.23	± 12.0 %
1750	53.4	1.49	4.99	4.99	4.99	0.60	1.48	± 12.0 %
1900	53.3	1.52	4.70	4.70	4.70	0.56	1.57	± 12.0 %
2450	52.7	1.95	4.28	4.28	4.28	0.80	1.08	± 12.0 %
2600	52.5	2.16	4.05	4.05	4.05	0.80	1.02	± 12.0 %

^C Frequency validity of ± 100 MHz only applies for DASY v4.4 and higher (see Page 2), else it is restricted to ± 50 MHz. The uncertainty is the RSS of the ConvF uncertainty at calibration frequency and the uncertainty for the indicated frequency band.

^F At frequencies below 3 GHz, the validity of tissue parameters (ϵ and σ) can be relaxed to ± 10% if liquid compensation formula is applied to measured SAR values. At frequencies above 3 GHz, the validity of tissue parameters (ϵ and σ) is restricted to ± 5%. The uncertainty is the RSS of the ConvF uncertainty for indicated target tissue parameters.

Frequency Response of E-Field

(TEM-Cell:ifi110 EXX, Waveguide: R22)

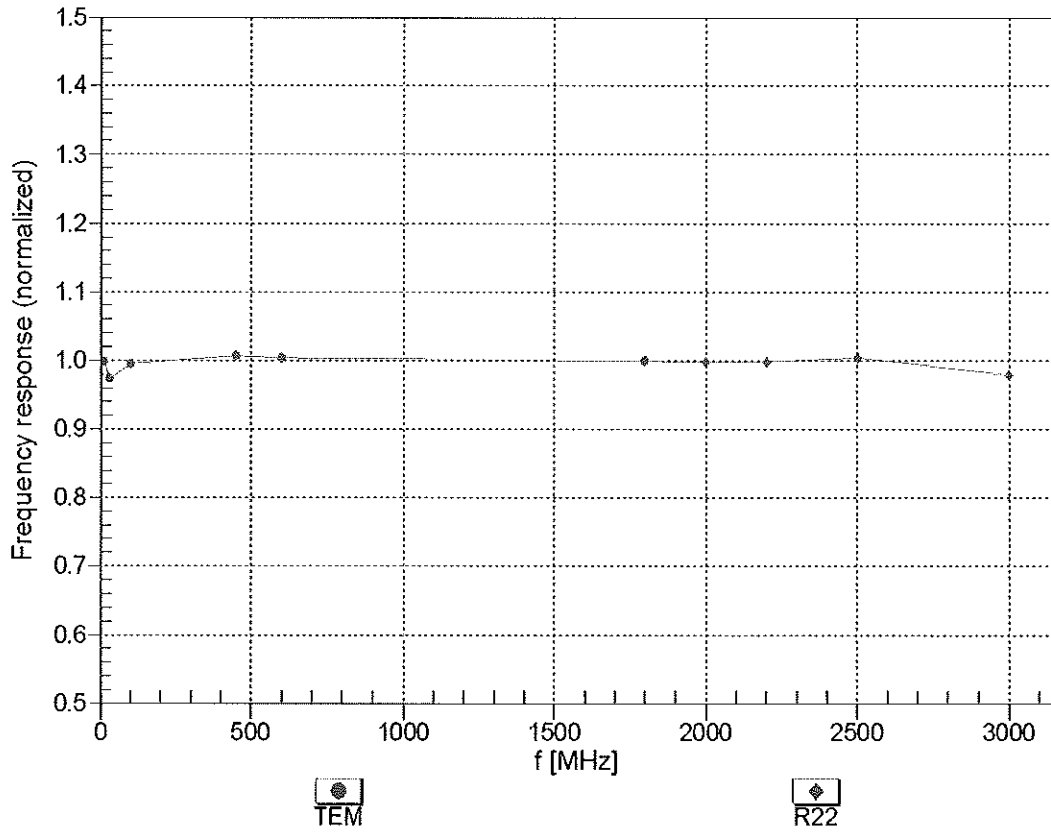

Uncertainty of Frequency Response of E-field: $\pm 6.3\%$ (k=2)

Receiving Pattern (ϕ), $\theta = 0^\circ$

f=600 MHz,TEM

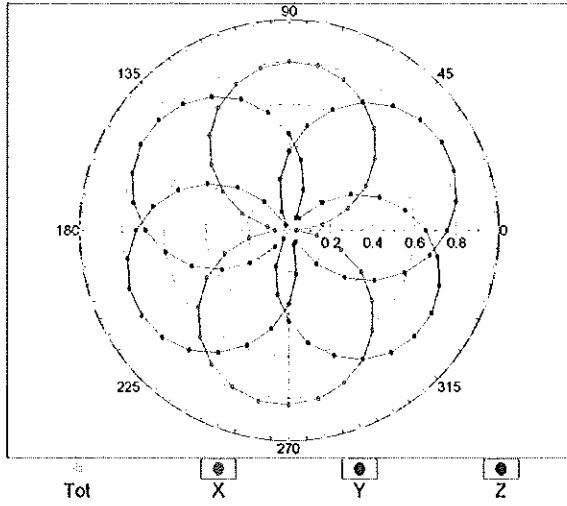

f=1800 MHz,R22

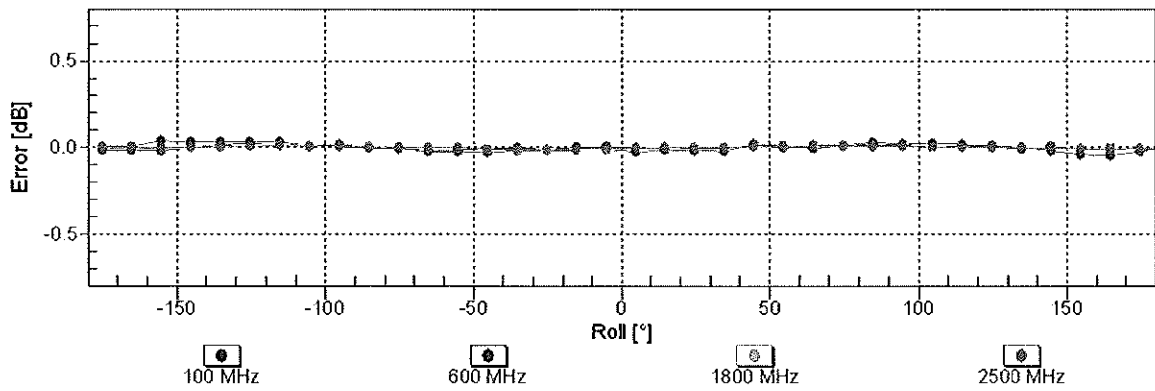
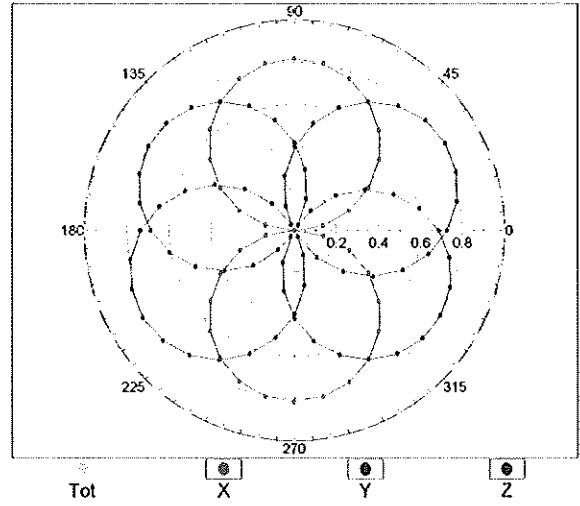

Uncertainty of Axial Isotropy Assessment: $\pm 0.5\%$ ($k=2$)

Dynamic Range $f(SAR_{head})$ (TEM cell , $f = 900$ MHz)

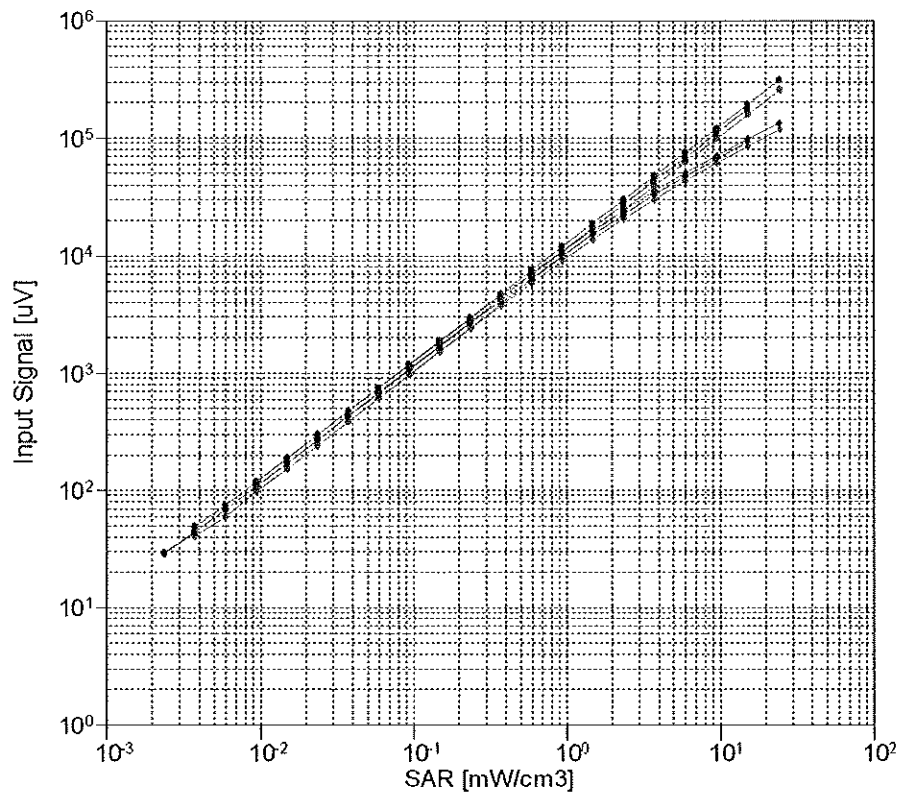

X compensated	X not compensated	Y compensated
Y not compensated	Z compensated	Z not compensated

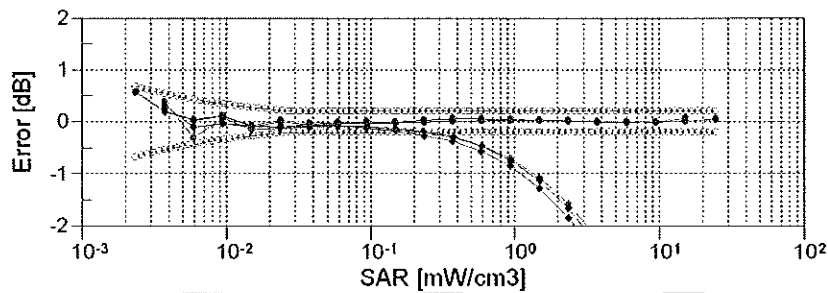

X compensated	X not compensated	Y compensated
Y not compensated	Z compensated	Z not compensated

Uncertainty of Linearity Assessment: $\pm 0.6\%$ ($k=2$)

Conversion Factor Assessment

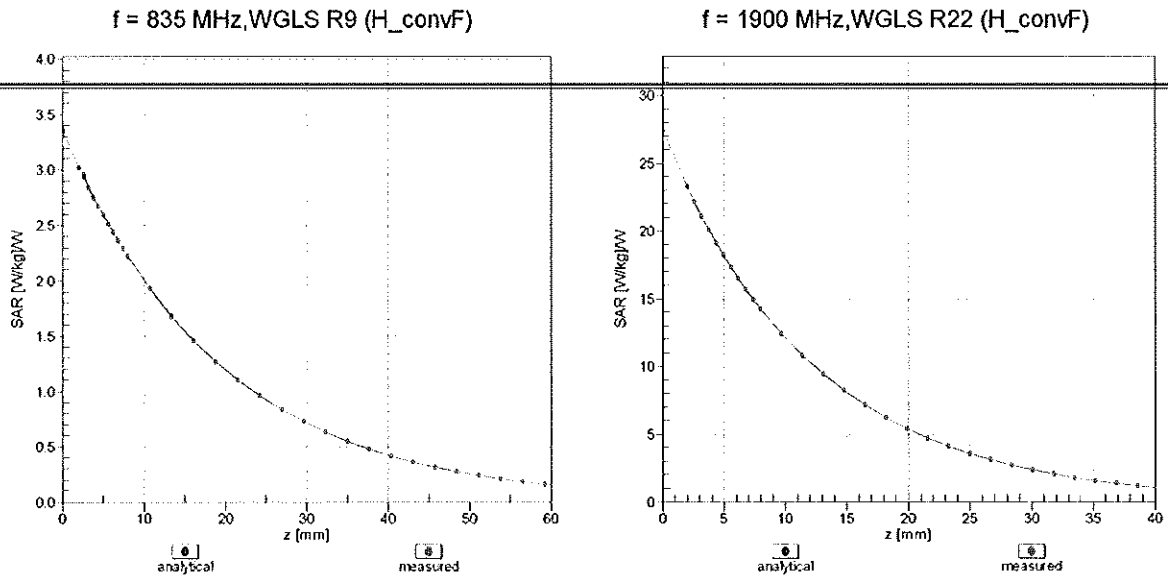

Deviation from Isotropy in Liquid Error (ϕ, θ), f = 900 MHz

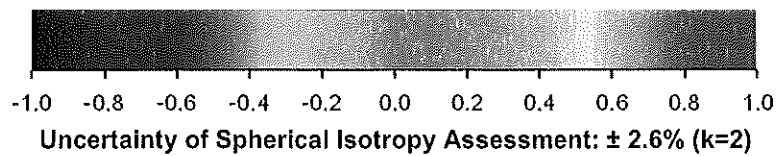
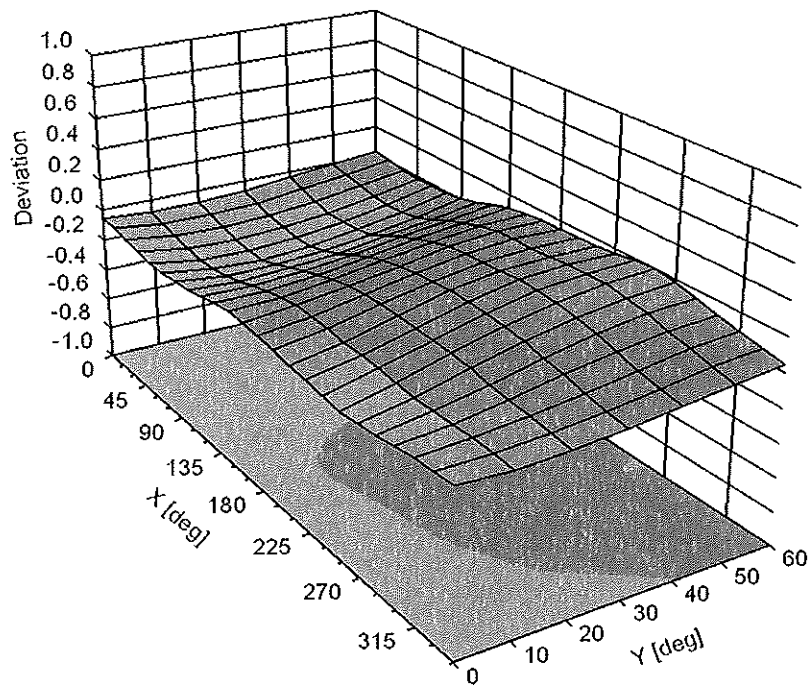

DASY/EASY - Parameters of Probe: ES3DV3 - SN:3258

Other Probe Parameters

Sensor Arrangement	Triangular
Connector Angle (°)	Not applicable
Mechanical Surface Detection Mode	enabled
Optical Surface Detection Mode	disabled
Probe Overall Length	337 mm
Probe Body Diameter	10 mm
Tip Length	10 mm
Tip Diameter	4 mm
Probe Tip to Sensor X Calibration Point	2 mm
Probe Tip to Sensor Y Calibration Point	2 mm
Probe Tip to Sensor Z Calibration Point	2 mm
Recommended Measurement Distance from Surface	3 mm