



## SAR Test Report

Product Name : Tablet PC  
Model No. : TC978, Le Pan S  
FCC ID : ZDRTC978

Applicant : Matsunichi Digital Development (Shenzhen) Co., Ltd  
Address : F/22, Matsunichi Building, No.9996, Shennan Boulevard,  
Nanshan District, Shenzhen, China

Date of Receipt : 27/06/2012  
Date of Test : 28/06/2012  
Issued Date : 29/06/2012  
Report No. : 126S072R-HP-US-P03V01  
Report Version : V1.1

The test results relate only to the samples tested.

The test report shall not be reproduced except in full without the written approval of Quietek Corporation.

## Test Report Certification

Issued Date: 29/06/2012

Report No.: 126S072R-HP-US-P03V01



Product Name : Tablet PC

Applicant : Matsunichi Digital Development (Shenzhen) Co., Ltd

Address : F/22, Matsunichi Building, No.9996, Shennan Boulevard,  
Nanshan District, Shenzhen, China

Manufacturer : Guangzhou Singulargold Electronics Co., Ltd

Address : No.6, Lianhua yan Road, Science City, Guangzhou Hi-Tech  
Industrial Development Zone, Guangzhou, China

Model No. : TC978, Le Pan S

FCC ID : ZDRTC978

Brand Name : Le Pan

EUT Voltage : DC 5V

Applicable Standard : FCC Oet65 Supplement C June 2001  
IEEE Std. 1528-2003,47CFR § 2.1093

Test Result : Max. SAR Measurement (1g)  
**0.406W/kg**

Performed Location : Suzhou EMC Laboratory  
No.99 Hongye Rd., Suzhou Industrial Park Loufeng  
Hi-Tech Development Zone., Suzhou, China  
TEL: +86-512-6251-5088 / FAX: +86-512-6251-5098  
FCC Registration Number: 800392

Documented By : Alice Ni  
(Engineering ADM: Alice Ni)

Reviewed By : Robin Wu  
(Engineering Supervisor: Robin Wu)

Approved By : Marlin Chen  
(Manager: Marlin Chen)

## Laboratory Information

We, **Quietek Corporation**, are an independent EMC and safety consultancy that was established the whole facility in our laboratories. The test facility has been accredited/accepted(audited or listed) by the following related bodies in compliance with ISO 17025, EN 45001 and specified testing scope:

|                      |          |                       |
|----------------------|----------|-----------------------|
| <b>Taiwan R.O.C.</b> | <b>:</b> | <b>BSMI, NCC, TAF</b> |
| <b>Germany</b>       | <b>:</b> | <b>TUV Rheinland</b>  |
| <b>Norway</b>        | <b>:</b> | <b>Nemko, DNV</b>     |
| <b>USA</b>           | <b>:</b> | <b>FCC, NVLAP</b>     |
| <b>Japan</b>         | <b>:</b> | <b>VCCI</b>           |
| <b>China</b>         | <b>:</b> | <b>CNAS</b>           |

The related certificate for our laboratories about the test site and management system can be downloaded from Quietek Corporation's Web Site :<http://www.quietek.com/tw/ctg/cts/accreditations.htm>

The address and introduction of Quietek Corporation's laboratories can be founded in our Web site :  
<http://www.quietek.com/>

If you have any comments, Please don't hesitate to contact us. Our contact information is as below:

### **HsinChu Testing Laboratory :**

No.75-2, 3rd Lin, Wangye Keng, Yonghxing Tsuen, Qionglin Shiang, Hsinchu County 307, Taiwan, R.O.C.  
TEL:+886-3-592-8858 / FAX:+886-3-592-8859                      E-Mail : [service@quietek.com](mailto:service@quietek.com)

### **LinKou Testing Laboratory :**

No.5-22, Ruishukeng, Linkou Dist., New Taipei City 24451, Taiwan, R.O.C.  
TEL : 886-2-8601-3788 / FAX : 886-2-8601-3789                      E-Mail : [service@quietek.com](mailto:service@quietek.com)

### **Suzhou Testing Laboratory :**

No.99 Hongye Rd., Suzhou Industrial Park Loufeng Hi-Tech Development Zone., SuZhou, China  
TEL : +86-512-6251-5088 / FAX : 86-512-6251-5098                      E-Mail : [service@quietek.com](mailto:service@quietek.com)

## TABLE OF CONTENTS

| Description  | Page      |
|--|-----------|
| <b>1. General Information .....</b>                                  | <b>6</b>  |
| 1.1. EUT DESCRIPTION.....  | 6         |
| 1.2. TEST ENVIRONMENT .....  | 7         |
| <b>2. SAR Measurement System .....</b>                               | <b>8</b>  |
| 2.1. DASY5 SYSTEM DESCRIPTION .....                                  | 8         |
| 2.1.1. Applications .....  | 9         |
| 2.1.2. Area Scans .....  | 9         |
| 2.1.3. Zoom Scan (Cube Scan Averaging) .....                         | 9         |
| 2.1.4. Uncertainty of Inter-/Extrapolation and Averaging .....       | 9         |
| 2.2. DASY5 E-FIELD PROBE.....  | 10        |
| 2.2.1. Isotropic E-Field Probe Specification .....                   | 10        |
| 2.3. BOUNDARY DETECTION UNIT AND PROBE MOUNTING DEVICE .....         | 11        |
| 2.4. DATA ACQUISITION ELECTRONICS (DAE) AND MEASUREMENT SERVER ..... | 11        |
| 2.5. ROBOT.....  | 12        |
| 2.6. LIGHT BEAM UNIT .....   | 12        |
| 2.7. DEVICE HOLDER .....   | 13        |
| 2.8. SAM TWIN PHANTOM.....   | 13        |
| <b>3. Tissue Simulating Liquid .....</b>                             | <b>14</b> |
| 3.1. THE COMPOSITION OF THE TISSUE SIMULATING LIQUID .....           | 14        |
| 3.2. TISSUE CALIBRATION RESULT .....                                 | 15        |
| 3.3. TISSUE DIELECTRIC PARAMETERS FOR HEAD AND BODY PHANTOMS .....   | 16        |
| <b>4. SAR Measurement Procedure .....</b>                            | <b>17</b> |
| 4.1. SAR SYSTEM VALIDATION .....                                     | 17        |
| 4.1.1. Validation Dipoles .....                                      | 17        |
| 4.1.2. Validation Result .....                                       | 18        |
| 4.2. SAR MEASUREMENT PROCEDURE .....                                 | 19        |
| <b>5. SAR Exposure Limits .....</b>                                  | <b>20</b> |
| <b>6. Test Equipment List.....</b>                                   | <b>21</b> |
| <b>7. Measurement Uncertainty.....</b>                               | <b>22</b> |
| <b>8. Conducted Power Measurement .....</b>                          | <b>23</b> |
| <b>9. Test Results.....</b>  | <b>24</b> |

9.1. SAR TEST RESULTS SUMMARY .....24

**Appendix A. SAR System Validation Data .....26**

**Appendix B. SAR measurement Data .....27**

**Appendix C. Test Setup Photographs & EUT Photographs .....36**

**Appendix D. Probe Calibration Data .....43**

**Appendix E. Dipole Calibration Data.....54**

**Appendix F. DAE Calibration Data.....62**

## 1. General Information

### 1.1. EUT Description

|                                |   |
|--------------------------------|---|
| Product Name                   | Tablet PC                                     |
| Model No.                      | TC978, Le Pan S                               |
| Hardware Version               | R007  |
| Software Version               | 17.92   |
| Device Category                | Portable                                      |
| <b>Wi-Fi</b>                   |   |
| Frequency Range                | 802.11b/g/n(20MHz): 2412 - 2462 MHz           |
| Channel Number                 | 802.11b/g/n(20MHz): 11                        |
| Type of Modulation             | 802.11b: DSSS; 802.11g/n: OFDM                |
| Data Rate                      | 802.11b: 1/2/5.5/11 Mbps                      |
|                                | 802.11g: 6/9/12/18/24/36/48/54 Mbps           |
|                                | 802.11n: up to 65 Mbps                        |
| Peak Antenna Gain              | 2.67dBi                                       |
| Max. Output Power<br>(Average) | 802.11b: 19.75dBm                             |
|                                | 802.11g: 18.54dBm                             |
|                                | 802.11n(20MHz): 18.74dBm                      |
| <b>Bluetooth</b>               |   |
| Bluetooth Frequency            | 2402~2480MHz                                  |
| Bluetooth Version              | V4.0  |
| Type of modulation             | FHSS  |
| Data Rate                      | 1Mbps(GFSK), 2Mbps(Pi/4 DQPSK), 3Mbps (8DPSK) |
| Peak Antenna Gain              | 2.67dBi                                       |
| <b>Component</b>               |   |
| Battery #1                     | M/N: WD4585170P-2P                            |
|                                | Rated Voltage and Capacitance: 3.7V/6800mAh   |
| Battery #2                     | M/N: E438483-2P                               |
|                                | Rated Voltage and Capacitance: 3.7V/6800mAh   |

Note: They are only for different marketing requirement.

**1.2. Test Environment**

Ambient conditions in the laboratory:

| <b>Items</b>     | <b>Required</b> | <b>Actual</b> |
|------------------|-----------------|---------------|
| Temperature (°C) | 18-25           | 21.5± 2       |
| Humidity (%RH)   | 30-70           | 52            |

## 2. SAR Measurement System

### 2.1. DASY5 System Description

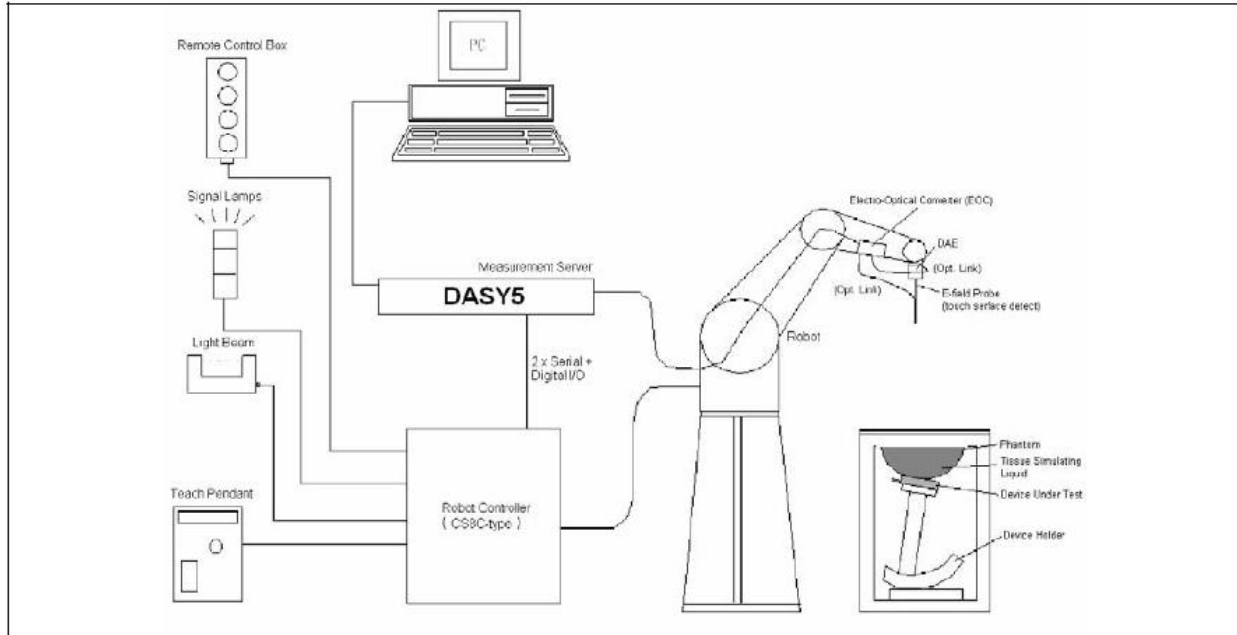

The DASY5 system for performing compliance tests consists of the following items:

- A standard high precision 6-axis robot with controller, teach pendant and software. An arm extension for accommodating the data acquisition electronics (DAE).
- A data acquisition electronics (DAE) which performs the signal amplification, signal multiplexing, AD-conversion, offset measurements, mechanical surface detection, collision detection, etc. The unit is battery powered with standard or rechargeable batteries. The signal is optically transmitted to the EOC.
- The Electro-optical converter (EOC) performs the conversion from optical to electrical signals for the digital communication to the DAE. To use optical surface detection, a special version of the EOC is required. The EOC signal is transmitted to the measurement server.
- The Light Beam used is for probe alignment. This improves the (absolute) accuracy of the probe positioning.
- A computer running WinXP and the DASY5 software.
- Remote control and teach pendant as well as additional circuitry for robot safety such as warning lamps, etc.
- The phantom, the device holder and other accessories according to the targeted measurement.



**2.1.1. Applications**

Predefined procedures and evaluations for automated compliance testing with all worldwide standards, e.g., IEEE 1528, OET 65, IEC 62209-1, IEC 62209-2, EN 50360, EN 50383 and others.

**2.1.2. Area Scans**

Area scans are defined prior to the measurement process being executed with a user defined variable spacing between each measurement point (integral) allowing low uncertainty measurements to be conducted. Scans defined for FCC applications utilize a 10mm<sup>2</sup> step integral, with 1mm interpolation used to locate the peak SAR area used for zoom scan assessments.

When an Area Scan has measured all reachable points, it computes the field maxima found in the scanned area, within a range of the global maximum. The range (in dB) is specified in the standards for compliance testing. For example, a 2 dB range is required in IEEE 1528-2003, EN 50361 and IEC 62209 standards, whereby 3 dB is a requirement when compliance is assessed in accordance with the ARIB standard (Japan).

**2.1.3. Zoom Scan (Cube Scan Averaging)**

Zoom Scans are used to assess the peak spatial SAR values within a cubic averaging volume containing 1 g and 10 g of simulated tissue. A density of 1000 kg/m<sup>3</sup> is used to represent the head and body tissue density and not the phantom liquid density, in order to be consistent with the definition of the liquid dielectric properties, i.e. the side length of the 1 g cube is 10mm, with the side length of the 10 g cube 21,5mm.

The zoom scan integer steps can be user defined so as to reduce uncertainty, but normal practice for typical test applications utilize a physical step of 7x7x7 (5mmx5mmx5mm) providing a volume of 30mm in the X & Y axis, and 30mm in the Z axis.

**2.1.4. Uncertainty of Inter-/Extrapolation and Averaging**

In order to evaluate the uncertainty of the interpolation, extrapolation and averaged SAR calculation algorithms of the Postprocessor, DASY5 allows the generation of measurement grids which are artificially predefined by analytically based test functions. Therefore, the grids of area scans and zoom scans can be filled with uncertainty test data, according to the SAR benchmark functions of IEEE 1528. The three analytical functions shown in equations as below are used to describe the possible range of the expected SAR distributions for the tested handsets. The field gradients are covered by the spatially flat distribution f1, the spatially steep distribution f3 and f2 accounts for H-field cancellation on the phantom/tissue surface.

$$f_1(x, y, z) = Ae^{-\frac{z}{2a}} \cos^2 \left( \frac{\pi \sqrt{x'^2 + y'^2}}{2 \cdot 5a} \right)$$

$$f_2(x, y, z) = Ae^{-\frac{z}{a}} \frac{a^2}{a^2 + x'^2} \left( 3 - e^{-\frac{2z}{a}} \right) \cos^2 \left( \frac{\pi y'}{2 \cdot 3a} \right)$$

$$f_3(x, y, z) = A \frac{a^2}{\frac{a^2}{4} + x'^2 + y'^2} \left( e^{-\frac{2z}{a}} + \frac{a^2}{2(a + 2z)^2} \right)$$

**2.2. DASY5 E-Field Probe**

The SAR measurement is conducted with the dosimetric probe manufactured by SPEAG. The probe is specially designed and calibrated for use in liquid with high permittivity. The dosimetric probe has special calibration in liquid at different frequency. SPEAG conducts the probe calibration in compliance with international and national standards (e.g. IEEE 1528, EN 62209-1, IEC 62209, etc.) under ISO 17025. The calibration data are in Appendix D.

**2.2.1. Isotropic E-Field Probe Specification**

|                      |  |   |
|----------------------|--|---|
| <b>Model</b>         | EX3DV4   |   |
| <b>Construction</b>  | Symmetrical design with triangular core Built-in shielding against static charges PEEK enclosure material (resistant to organic solvents, e.g., DGBE)  |   |
| <b>Frequency</b>     | 10 MHz to 6 GHz<br>Linearity: ± 0.2 dB (30 MHz to 6 GHz)   |  |
| <b>Directivity</b>   | ± 0.3 dB in HSL (rotation around probe axis)<br>± 0.5 dB in tissue material (rotation normal to probe axis)  |   |
| <b>Dynamic Range</b> | 10 µW/g to 100 mW/g<br>Linearity: ± 0.2 dB (noise: typically < 1 µW/g)   |   |
| <b>Dimensions</b>    | Overall length: 330 mm (Tip: 20 mm)<br>Tip diameter: 2.5 mm (Body: 12 mm)<br>Typical distance from probe tip to dipole centers: 1 mm   |   |
| <b>Application</b>   | High precision dosimetric measurements in any exposure scenario (e.g., very strong gradient fields). Only probe which enables compliance testing for frequencies up to 6 GHz with precision of better 30%. |   |

**2.3. Boundary Detection Unit and Probe Mounting Device**

The DASY probes use a precise connector and an additional holder for the probe, consisting of a plastic tube and a flexible silicon ring to center the probe. The connector at the DAE is flexibly mounted and held in the default position with magnets and springs. Two switching systems in the connector mount detect frontal and lateral probe collisions and trigger the necessary software response.

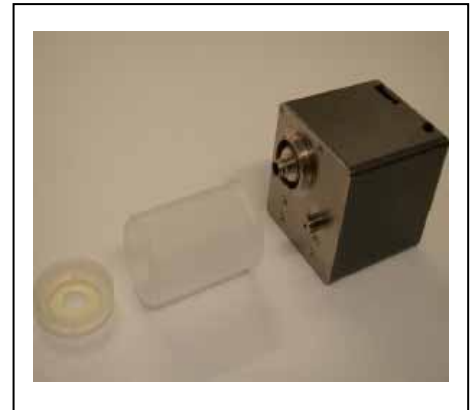

**2.4. DATA Acquisition Electronics (DAE) and Measurement Server**

The data acquisition electronics (DAE) consists of a highly sensitive electrometer-grade preamplifier with auto-zeroing, a channel and gain-switching multiplexer, a fast 16 bit AD-converter and a command decoder and control logic unit.

Transmission to the measurement server is accomplished through an optical downlink for data and status information as well as an optical uplink for commands and the clock.

The input impedance of the DAE4 is 200M Ohm; the inputs are symmetrical and floating. Common mode rejection is above 80dB.

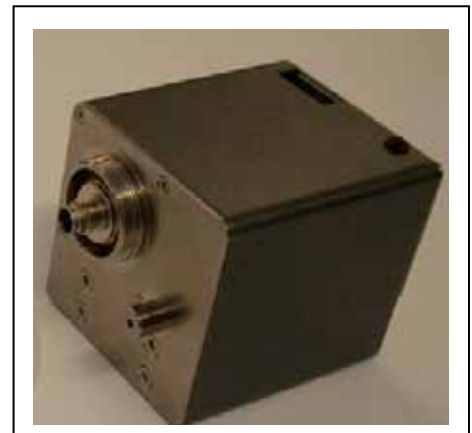

The DASY5 measurement server is based on a PC/104 CPU board with a 400MHz intel ULV Celeron, 128MB chipdisk and 128MB RAM. The necessary circuits for communication with the DAE electronics box, as well as the 16 bit AD converter system for optical detection and digital I/O interface are contained on the DASY5 I/O board, which is directly connected to the PC/104 bus of the CPU board.



**2.5. Robot**

The DASY5 system uses the high precision robots TX90 XL type out of the newer series from Stäubli SA (France). For the 6-axis controller DASY5 system, the CS8C robot controller version from Stäubli is used.

The XL robot series have many features that are important for our application:

- High precision (repeatability 0.02 mm)
- High reliability (industrial design)
- Jerk-free straight movements
- Low ELF interference (the closed metallic construction shields against motor control fields)
- 6-axis controller



**2.6. Light Beam Unit**

The light beam switch allows automatic "tooling" of the probe. During the process, the actual position of the probe tip with respect to the robot arm is measured, as well as the probe length and the horizontal probe offset. The software then corrects all movements, such that the robot coordinates are valid for the probe tip.

The repeatability of this process is better than 0.1 mm. If a position has been taught with an aligned probe, the same position will be reached with another aligned probe within 0.1 mm, even if the other probe has different dimensions. During probe rotations, the probe tip will keep its actual position.



## 2.7. Device Holder

The DASY5 device holder is designed to cope with different positions given in the standard. It has two scales for the device rotation (with respect to the body axis) and the device inclination (with respect to the line between the ear reference points). The rotation center for both scales is the ear reference point (EPR).

Thus the device needs no repositioning when changing the angles.

The DASY5 device holder has been made out of low-loss POM material having the following dielectric parameters: relative permittivity  $\epsilon_r = 3$  and loss tangent  $\delta = 0.02$ . The amount of dielectric material has been reduced in the closest vicinity of the device, since measurements have suggested that the influence of the clamp on the test results could thus be lowered.



## 2.8. SAM Twin Phantom

The SAM twin phantom is a fiberglass shell phantom with 2mm shell thickness (except the ear region where shell thickness increases to 6mm). It has three measurement areas:

- Left head
- Right head
- Flat phantom



The bottom plate contains three pair of bolts for locking the device holder. The device holder positions are adjusted to the standard measurement positions in the three sections. A white cover is provided to tap the phantom during off-periods to prevent water evaporation and changes in the liquid parameters. On the phantom top, three reference markers are provided to identify the phantom position with respect to the robot.

### 3. Tissue Simulating Liquid

#### 3.1. The composition of the tissue simulating liquid

| <b>INGREDIENT (% Weight)</b> | <b>2450MHz Body</b> |
|------------------------------|---------------------|
| <b>Water</b>                 | 73.2                |
| <b>Salt</b>                  | 0.04                |
| <b>Sugar</b>                 | 0.00                |
| <b>HEC</b>                   | 0.00                |
| <b>Preventol</b>             | 0.00                |
| <b>DGBE</b>                  | 26.7                |

**3.2. Tissue Calibration Result**

The dielectric parameters of the liquids were verified prior to the SAR evaluation using DASY5 Dielectric Probe Kit and Agilent Vector Network Analyzer E5071C

| <b>Body Tissue Simulant Measurement</b> |                                 |                        |                      |                   |
|---|---------------------------------|------------------------|----------------------|-------------------|
| Frequency [MHz]                         | Description                     | Dielectric Parameters  |                      | Tissue Temp. [°C] |
|   |                                 | $\epsilon_r$           | $\sigma$ [s/m]       |                   |
| 2450MHz                                 | Reference result<br>± 5% window | 52.7<br>50.07 to 55.34 | 1.95<br>1.85 to 2.05 | N/A               |
|   | 28-06-2012                      | 52.63                  | 2.00                 | 21.0              |

**3.3. Tissue Dielectric Parameters for Head and Body Phantoms**

The head tissue dielectric parameters recommended by the IEEE SCC-34/SC-2 in P1528 have been incorporated in the following table. These head parameters are derived from planar layer models simulating the highest expected SAR for the dielectric properties and tissue thickness variations in a human head. Other head and body tissue parameters that have not been specified in P1528 are derived from the tissue dielectric parameters computed from the 4-Cole-Cole equations described in Reference [12] and extrapolated according to the head parameters specified in P1528.

| Target Frequency<br>(MHz) | Head         |                | Body         |                |
|---------------------------|--------------|----------------|--------------|----------------|
|                           | $\epsilon_r$ | $\sigma$ (S/m) | $\epsilon_r$ | $\sigma$ (S/m) |
| 150                       | 52.3         | 0.76           | 61.9         | 0.80           |
| 300                       | 45.3         | 0.87           | 58.2         | 0.92           |
| 450                       | 43.5         | 0.87           | 56.7         | 0.94           |
| 835                       | 41.5         | 0.90           | 55.2         | 0.97           |
| 900                       | 41.5         | 0.97           | 55.0         | 1.05           |
| 915                       | 41.5         | 0.98           | 55.0         | 1.06           |
| 1450                      | 40.5         | 1.20           | 54.0         | 1.30           |
| 1610                      | 40.3         | 1.29           | 53.8         | 1.40           |
| 1800 – 2000               | 40.0         | 1.40           | 53.3         | 1.52           |
| <b>2450</b>               | 39.2         | 1.80           | <b>52.7</b>  | <b>1.95</b>    |
| 3000                      | 38.5         | 2.40           | 52.0         | 2.73           |
| 5800                      | 35.3         | 5.27           | 48.2         | 6.00           |

( $\epsilon_r$  = relative permittivity,  $\sigma$  = conductivity and  $\rho = 1000 \text{ kg/m}^3$ )



## 4. SAR Measurement Procedure

### 4.1. SAR System Validation

#### 4.1.1. Validation Dipoles

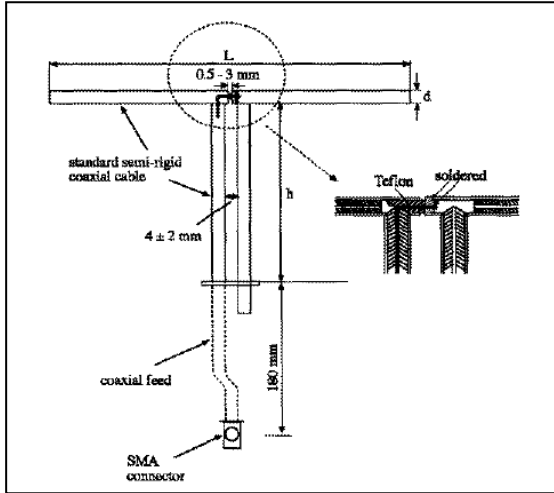

The dipoles used is based on the IEEE-1528 standard, and is complied with mechanical and electrical specifications in line with the requirements of both IEEE and FCC Supplement C. the table below provides details for the mechanical and electrical specifications for the dipoles.

| Frequency | L (mm) | h (mm) | d (mm) |
|-----------|--------|--------|--------|
| 2450MHz   | 51.5   | 30.4   | 3.6    |

**4.1.2. Validation Result**

| <b>System Performance Check at 2450MHz for Body</b>      |                               |                        |                        |                   |
|--|-------------------------------|------------------------|------------------------|-------------------|
| <b>Validation Dipole: D2450V2, SN: 839</b>               |                               |                        |                        |                   |
| Frequency [MHz]  | Description                   | SAR [w/kg] 1g          | SAR [w/kg] 10g         | Tissue Temp. [°C] |
| 2450 MHz   | Reference result ± 10% window | 48.7<br>43.83 to 53.57 | 22.8<br>20.52 to 25.08 | N/A               |
|  | 28-06-2012                    | 49.20                  | 22.56                  | 21.0              |
| Note: All SAR values are normalized to 1W forward power. |                               |                        |                        |                   |

#### 4.2. SAR Measurement Procedure

The DASY5 calculates SAR using the following equation,

$$SAR = \frac{\sigma |E|^2}{\rho}$$

$\sigma$ : represents the simulated tissue conductivity

$\rho$ : represents the tissue density

The EUT is set to transmit at the required power in line with product specification, at each frequency relating to the LOW, MID, and HIGH channel settings.

Pre-scans are made on the device to establish the location for the transmitting antenna, using a large area scan in either air or tissue simulation fluid.

The EUT is placed against the Universal Phantom where the maximum area scan dimensions are larger than the physical size of the resonating antenna. When the scan size is not large enough to cover the peak SAR distribution, it is modified by either extending the area scan size in both the X and Y directions, or the device is shifted within the predefined area.

The area scan is then run to establish the peak SAR location (interpolated resolution set at  $1\text{mm}^2$ ) which is then used to orient the center of the zoom scan. The zoom scan is then executed and the 1g and 10g averages are derived from the zoom scan volume (interpolated resolution set at  $1\text{mm}^3$ ).

## 5. SAR Exposure Limits

SAR assessments have been made in line with the requirements of IEEE-1528, FCC Supplement C, and comply with ANSI/IEEE C95.1-1992 “Uncontrolled Environments” limits. These limits apply to a location which is deemed as “Uncontrolled Environment” which can be described as a situation where the general public may be exposed to an RF source with no prior knowledge or control over their exposure.

### Limits for General Population/Uncontrolled Exposure (W/kg)

| Type Exposure  | Uncontrolled Environment Limit |
|--|--------------------------------|
| Spatial Peak SAR (1g cube tissue for brain or body)      | 1.60 W/kg                      |
| Spatial Average SAR (whole body)                         | 0.08 W/kg                      |
| Spatial Peak SAR (10g for hands, feet, ankles and wrist) | 4.00 W/kg                      |

## 6. Test Equipment List

| Instrument                  | Manufacturer | Model No.     | Serial No.      | Cali. Due Date |
|-----------------------------|--------------|---------------|-----------------|----------------|
| Stäubli Robot TX60L         | Stäubli      | TX60L         | F10/5C90A1/A/01 | only once      |
| Controller                  | Stäubli      | SP1           | S-0034          | only once      |
| Dipole Validation Kits      | Speag        | D2450V2       | 839             | 2013.02.23     |
| SAM Twin Phantom            | Speag        | SAM           | TP-1561/1562    | N/A            |
| Device Holder               | Speag        | SD 000 H01 HA | N/A             | N/A            |
| Data Acquisition Electronic | Speag        | DAE4          | 1220            | 2013.01.23     |
| E-Field Probe               | Speag        | EX3DV4        | 3710            | 2013.03.12     |
| SAR Software                | Speag        | DASY5         | V5.2 Build 162  | N/A            |
| Power Amplifier             | Mini-Circuit | ZHL-42        | D051404-28      | N/A            |
| Directional Coupler         | Agilent      | 778D          | 20160           | N/A            |
| Vector Network              | Agilent      | E5071C        | MY48367267      | 2013.04.10     |
| Signal Generator            | Agilent      | E4438C        | MY49070163      | 2013.04.18     |
| Power Meter                 | Anritsu      | ML2495A       | 0905006         | 2013.01.12     |
| Wide Bandwidth Sensor       | Anritsu      | MA2411B       | 0846014         | 2013.01.12     |

**7. Measurement Uncertainty**

| <b>DASY5 Uncertainty</b>   |               |             |      |         |          |                |                 |                       |
|--|---------------|-------------|------|---------|----------|----------------|-----------------|-----------------------|
| Measurement uncertainty for 300 MHz to 3 GHz averaged over 1 gram / 10 gram. |               |             |      |         |          |                |                 |                       |
| Error Description  | Uncert. value | Prob. Dist. | Div. | (ci) 1g | (ci) 10g | Std. Unc. (1g) | Std. Unc. (10g) | (vi) V <sub>eff</sub> |
| <b>Measurement System</b>  |               |             |      |         |          |                |                 |                       |
| Probe Calibration  | ±6.0%         | N           | 1    | 1       | 1        | ±6.0%          | ±6.0%           | ∞                     |
| Axial Isotropy   | ±4.7%         | R           | √3   | 0.7     | 0.7      | ±1.9%          | ±1.9%           | ∞                     |
| Hemispherical Isotropy   | ±9.6%         | R           | √3   | 0.7     | 0.7      | ±3.9%          | ±3.9%           | ∞                     |
| Boundary Effects   | ±1.0%         | R           | √3   | 1       | 1        | ±0.6%          | ±0.6%           | ∞                     |
| Linearity  | ±4.7%         | R           | √3   | 1       | 1        | ±2.7%          | ±2.7%           | ∞                     |
| System Detection Limits  | ±1.0%         | R           | √3   | 1       | 1        | ±0.6%          | ±0.6%           | ∞                     |
| Readout Electronics  | ±0.3%         | N           | 1    | 1       | 1        | ±0.3%          | ±0.3%           | ∞                     |
| Response Time  | ±0.8%         | R           | √3   | 1       | 1        | ±0.5%          | ±0.5%           | ∞                     |
| Integration Time   | ±2.6%         | R           | √3   | 1       | 1        | ±1.5%          | ±1.5%           | ∞                     |
| RF Ambient Noise   | ±3.0%         | R           | √3   | 1       | 1        | ±1.7%          | ±1.7%           | ∞                     |
| RF Ambient Reflections   | ±3.0%         | R           | √3   | 1       | 1        | ±1.7%          | ±1.7%           | ∞                     |
| Probe Positioner   | ±0.4%         | R           | √3   | 1       | 1        | ±0.2%          | ±0.2%           | ∞                     |
| Probe Positioning  | ±2.9%         | R           | √3   | 1       | 1        | ±1.7%          | ±1.7%           | ∞                     |
| Max. SAR Eval.   | ±1.0%         | R           | √3   | 1       | 1        | ±0.6%          | ±0.6%           | ∞                     |
| <b>Test Sample Related</b>   |               |             |      |         |          |                |                 |                       |
| Device Positioning   | ±2.9%         | N           | 1    | 1       | 1        | ±2.9%          | ±2.9%           | 145                   |
| Device Holder  | ±3.6%         | N           | 1    | 1       | 1        | ±3.6%          | ±3.6%           | 5                     |
| Power Drift  | ±5.0%         | R           | √3   | 1       | 1        | ±2.9%          | ±2.9%           | ∞                     |
| <b>Phantom and Setup</b>   |               |             |      |         |          |                |                 |                       |
| Phantom Uncertainty  | ±4.0%         | R           | √3   | 1       | 1        | ±2.3%          | ±2.3%           | ∞                     |
| Liquid Conductivity (target)   | ±5.0%         | R           | √3   | 0.64    | 0.43     | ±1.8%          | ±1.2%           | ∞                     |
| Liquid Conductivity (meas.)  | ±2.5%         | N           | 1    | 0.64    | 0.43     | ±1.6%          | ±1.1%           | ∞                     |
| Liquid Permittivity (target)   | ±5.0%         | R           | √3   | 0.6     | 0.49     | ±1.7%          | ±1.4%           | ∞                     |
| Liquid Permittivity (meas.)  | ±2.5%         | N           | 1    | 0.6     | 0.49     | ±1.5%          | ±1.2%           | ∞                     |
| <b>Combined Std. Uncertainty</b>   |               |             |      |         |          | ±10.9%         | ±10.7%          | 387                   |
| <b>Expanded STD Uncertainty</b>  |               |             |      |         |          | ±21.9%         | ±21.4%          |                       |

## 8. Conducted Power Measurement

### Wi-Fi output power

| Test Mode      | Data Rate (Mbps) | Channel No. | Frequency (MHz) | Average Power (dBm) |
|----------------|------------------|-------------|-----------------|---------------------|
| 802.11b        | 1                | 01          | 2412            | 19.52               |
|                |                  | 06          | 2437            | 19.71               |
|                |                  | 11          | 2462            | 19.75               |
| 802.11g        | 6                | 01          | 2412            | 18.45               |
|                |                  | 06          | 2437            | 18.54               |
|                |                  | 11          | 2462            | 18.46               |
| 802.11n(20MHz) | 6.5              | 01          | 2412            | 18.11               |
|                |                  | 06          | 2437            | 18.74               |
|                |                  | 11          | 2462            | 18.38               |

## **9. Test Results**

### **9.1. SAR Test Results Summary**

#### **9.1.1. Test position and configuration**

Body SAR was performed with the device configured in the positions according to FCC OET65. SAR test was performed with the device 0mm (touch) from the phantom for the worst case due to antenna position. Test Position: bottom, primary landscape, primary portrait. Please refer to the test photograph for details.

#### **9.1.2. Co-located SAR**

Bluetooth output power is less than Pref, and shares the same antenna with WLAN, they cannot transmit simultaneously. Therefore, standalone SAR and simultaneous SAR for Bluetooth is not required.

#### **9.1.3. Referenced Documents**

FCC KDB 248227 D01 and KDB 447498 D01 and KDB 616217 D03



**9.1.4. Test Result**

| SAR MEASUREMENT   |                     |           |      |                                |                           |                           |                  |                 |
|---|---------------------|-----------|------|--------------------------------|---------------------------|---------------------------|------------------|-----------------|
| Ambient Temperature (°C) : 21.5 ±2  |                     |           |      |                                | Relative Humidity (%): 52 |                           |                  |                 |
| Liquid Temperature (°C) : 21.0 ±2   |                     |           |      |                                | Depth of Liquid (cm):>15  |                           |                  |                 |
| Product: Tablet PC  |                     |           |      |                                |                           |                           |                  |                 |
| Test Mode: 802.11b  |                     |           |      |                                |                           |                           |                  |                 |
| Test Position<br>Body   | Antenna<br>Position | Frequency |      | Separation<br>Distance<br>(mm) | Average<br>Power<br>(dBm) | Power<br>Drift<br>(<±0.2) | SAR 1g<br>(W/kg) | Limit<br>(W/kg) |
|   |                     | Channel   | MHz  |                                |                           |                           |                  |                 |
| Bottom  | Fixed               | 1         | 2412 | 0                              | 19.52                     | 0.09                      | 0.370            | 1.6             |
| Bottom  | Fixed               | 6         | 2437 | 0                              | 19.71                     | 0.05                      | 0.402            | 1.6             |
| Bottom  | Fixed               | 11        | 2462 | 0                              | 19.75                     | 0.18                      | 0.406            | 1.6             |
| Primary landscape   | Fixed               | 11        | 2462 | 0                              | 19.75                     | -0.12                     | 0.227            | 1.6             |
| Primary portrait  | Fixed               | 11        | 2462 | 0                              | 19.75                     | 0.18                      | 0.082            | 1.6             |
| Bottom<br>(With Battery #2)   | Fixed               | 11        | 2462 | 0                              | 19.75                     | 0.10                      | 0.355            | 1.6             |
| Test Mode: 802.11g  |                     |           |      |                                |                           |                           |                  |                 |
| Bottom  | Fixed               | 6         | 2437 | 0                              | 19.52                     | 0.10                      | 0.214            | 1.6             |
| Test Mode: 802.11n(20MHz)   |                     |           |      |                                |                           |                           |                  |                 |
| Bottom  | Fixed               | 6         | 2437 | 0                              | 19.52                     | -0.14                     | 0.228            | 1.6             |
| Note: when the 1-g SAR is 0.8 W/kg, testing for low and high channel is optional. |                     |           |      |                                |                           |                           |                  |                 |

## Appendix A. SAR System Validation Data

Date/Time: 28-06-2012

Test Laboratory: QuieTek Lab

System Check Body 2450MHz

**DUT: Dipole 2450 MHz D2450V2; Type: D2450V2**

Communication System: CW; Communication System Band: D2450 (2450.0 MHz); Duty Cycle: 1:1;

Frequency: 2450 MHz; Medium parameters used:  $f = 2450$  MHz;  $\sigma = 2$  mho/m;  $\epsilon_r = 52.63$ ;  $\rho = 1000$  kg/m<sup>3</sup> ;

Phantom section: Flat Section ; Input Power=250mW

Ambient temperature ( ): 21.5, Liquid temperature ( ): 21.0

DASY5 Configuration:

- Probe: EX3DV4 - SN3710; ConvF(6.98, 6.98, 6.98); Calibrated: 12/03/2012;
- Sensor-Surface: 4mm (Mechanical Surface Detection)
- Electronics: DAE4 Sn1220; Calibrated: 23/01/2012
- Phantom: SAM1; Type: SAM; Serial: TP1561
- Measurement SW: DASY52, Version 52.8 (1); SEMCAD X Version 14.6.5 (6469)

**Configuration/System Check Body 2450MHz/Area Scan (7x11x1):** Measurement grid: dx=10mm, dy=10mm, Maximum value of SAR (measured) = 13.5 mW/g

**Configuration/System Check Body 2450MHz/Zoom Scan (7x7x7)/Cube 0:** Measurement grid: dx=5mm, dy=5mm, dz=5mm, Reference Value = 81.585 V/m; Power Drift = 0.17 dB

Peak SAR (extrapolated) = 25.479 mW/g

**SAR(1 g) = 12.3 mW/g; SAR(10 g) = 5.64 mW/g** Maximum value of SAR (measured) = 14.1 mW/g

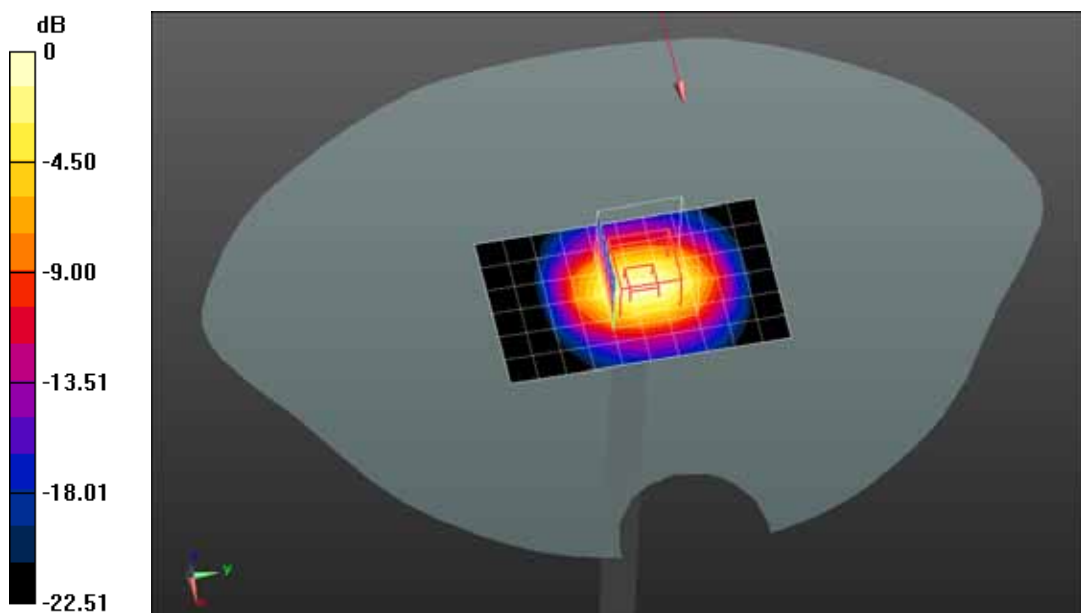

0 dB = 14.1 mW/g = 22.98 dB mW/g

## Appendix B. SAR measurement Data

Date/Time: 28-06-2012

Test Laboratory: QuieTek Lab

802.11b 2412MHz-Bottom

**DUT: Tablet PC; Type: TC978**

Communication System: Wi-Fi; Communication System Band: 802.11b; Duty Cycle: 1:1; Frequency: 2412 MHz; Medium parameters used:  $f = 2412$  MHz;  $\sigma = 1.95$  mho/m;  $\epsilon_r = 52.76$ ;  $\rho = 1000$  kg/m<sup>3</sup>; Phantom section: Flat Section

Ambient temperature ( ): 21.5, Liquid temperature ( ): 21.0

DASY5 Configuration:

- Probe: EX3DV4 - SN3710; ConvF(6.98, 6.98, 6.98); Calibrated: 12/03/2012;
- Sensor-Surface: 4mm (Mechanical Surface Detection)
- Electronics: DAE4 Sn1220; Calibrated: 23/01/2012
- Phantom: SAM1; Type: SAM; Serial: TP1561
- Measurement SW: DASY52, Version 52.8 (1); SEMCAD X Version 14.6.5 (6469)

**Configuration/802.11b Low-Bottom/Area Scan (7x8x1):** Measurement grid: dx=20mm, dy=20mm

Maximum value of SAR (measured) = 0.294 mW/g

**Configuration/802.11b Low-Bottom/Zoom Scan (5x5x7)/Cube 0:** Measurement grid: dx=8mm, dy=8mm, dz=5mm, Reference Value = 13.303 V/m; Power Drift = 0.09 dB

Peak SAR (extrapolated) = 0.839 mW/g

**SAR(1 g) = 0.370 mW/g; SAR(10 g) = 0.162 mW/g** Maximum value of SAR (measured) = 0.395 mW/g

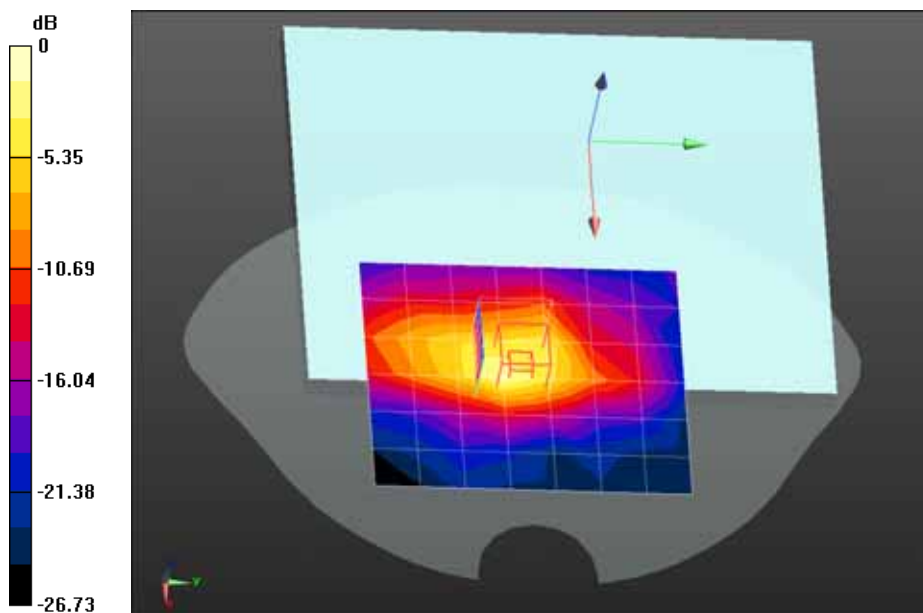

0 dB = 0.395 mW/g = -8.07 dB mW/g

Date/Time: 28-06-2012

Test Laboratory: QuieTek Lab

802.11b 2437MHz-Bottom

**DUT: Tablet PC; Type: TC978**

Communication System: Wi-Fi; Communication System Band: 802.11b; Duty Cycle: 1:1; Frequency: 2437 MHz; Medium parameters used:  $f = 2437$  MHz;  $\sigma = 1.98$  mho/m;  $\epsilon_r = 52.68$ ;  $\rho = 1000$  kg/m<sup>3</sup>; Phantom section: Flat Section

Ambient temperature ( ): 21.5, Liquid temperature ( ): 21.0

DASY5 Configuration:

- Probe: EX3DV4 - SN3710; ConvF(6.98, 6.98, 6.98); Calibrated: 12/03/2012;
- Sensor-Surface: 4mm (Mechanical Surface Detection)
- Electronics: DAE4 Sn1220; Calibrated: 23/01/2012
- Phantom: SAM1; Type: SAM; Serial: TP1561
- Measurement SW: DASY52, Version 52.8 (1); SEMCAD X Version 14.6.5 (6469)

**Configuration/802.11b Mid-Bottom/Area Scan (7x8x1):** Measurement grid: dx=20mm, dy=20mm

Maximum value of SAR (measured) = 0.294 mW/g

**Configuration/802.11b Mid-Bottom/Zoom Scan (5x5x7)/Cube 0:** Measurement grid: dx=8mm, dy=8mm, dz=5mm, Reference Value = 13.934 V/m; Power Drift = 0.05 dB

Peak SAR (extrapolated) = 0.936 mW/g

**SAR(1 g) = 0.402 mW/g; SAR(10 g) = 0.173 mW/g** Maximum value of SAR (measured) = 0.427 mW/g

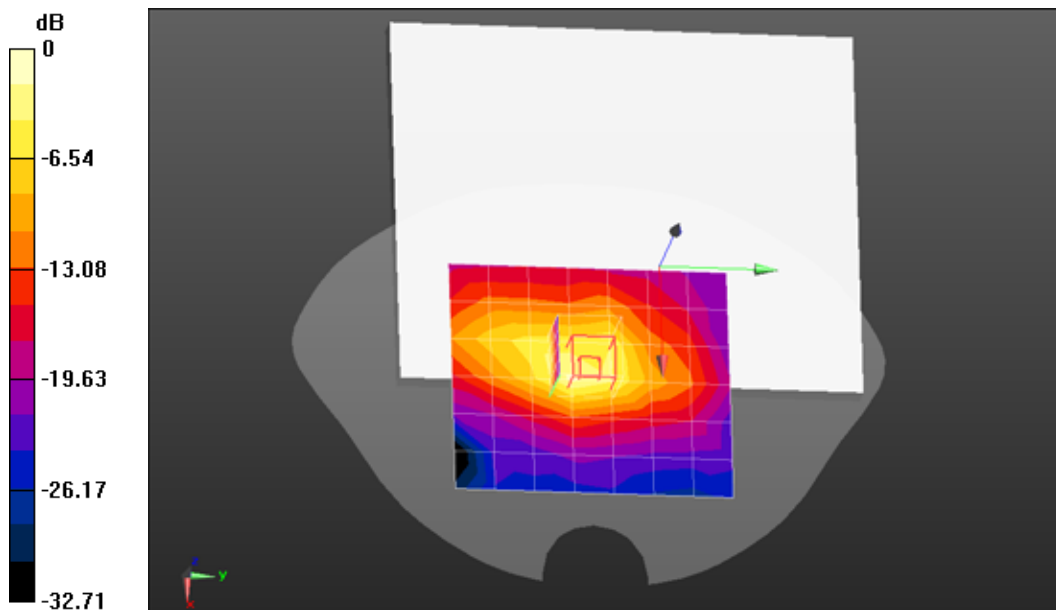

0 dB = 0.427 mW/g = -7.39 dB mW/g

Date/Time: 28-06-2012

Test Laboratory: QuieTek Lab

802.11b 2462MHz-Bottom

**DUT: Tablet PC; Type: TC978**

Communication System: Wi-Fi; Communication System Band: 802.11b; Duty Cycle: 1:1; Frequency: 2462 MHz; Medium parameters used:  $f = 2462$  MHz;  $\sigma = 2.02$  mho/m;  $\epsilon_r = 52.58$ ;  $\rho = 1000$  kg/m<sup>3</sup>; Phantom section: Flat Section

Ambient temperature ( ): 21.5, Liquid temperature ( ): 21.0

DASY5 Configuration:

- Probe: EX3DV4 - SN3710; ConvF(6.98, 6.98, 6.98); Calibrated: 12/03/2012;
- Sensor-Surface: 4mm (Mechanical Surface Detection)
- Electronics: DAE4 Sn1220; Calibrated: 23/01/2012
- Phantom: SAM1; Type: SAM; Serial: TP1561
- Measurement SW: DASY52, Version 52.8 (1); SEMCAD X Version 14.6.5 (6469)

**Configuration/802.11b High-Bottom/Area Scan (7x8x1):** Measurement grid: dx=20mm, dy=20mm

Maximum value of SAR (measured) = 0.300 mW/g

**Configuration/802.11b High-Bottom/Zoom Scan (5x5x7)/Cube 0:** Measurement grid: dx=8mm, dy=8mm, dz=5mm, Reference Value = 12.792 V/m; Power Drift = 0.18 dB

Peak SAR (extrapolated) = 0.951 mW/g

**SAR(1 g) = 0.406 mW/g; SAR(10 g) = 0.175 mW/g** Maximum value of SAR (measured) = 0.454 mW/g

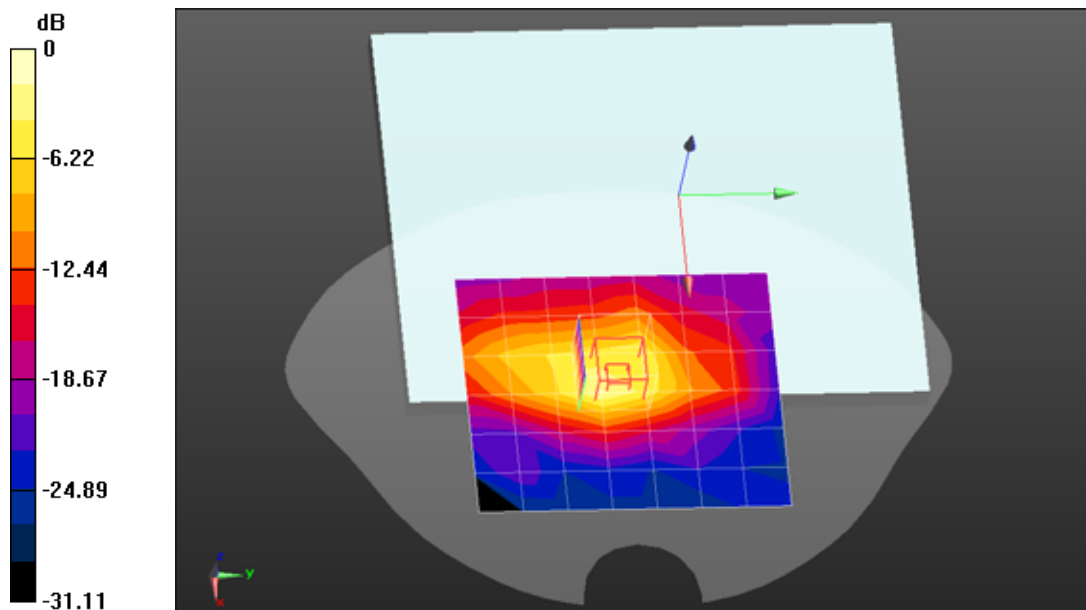

0 dB = 0.454 mW/g = -6.86 dB mW/g

Z-Axis Plot

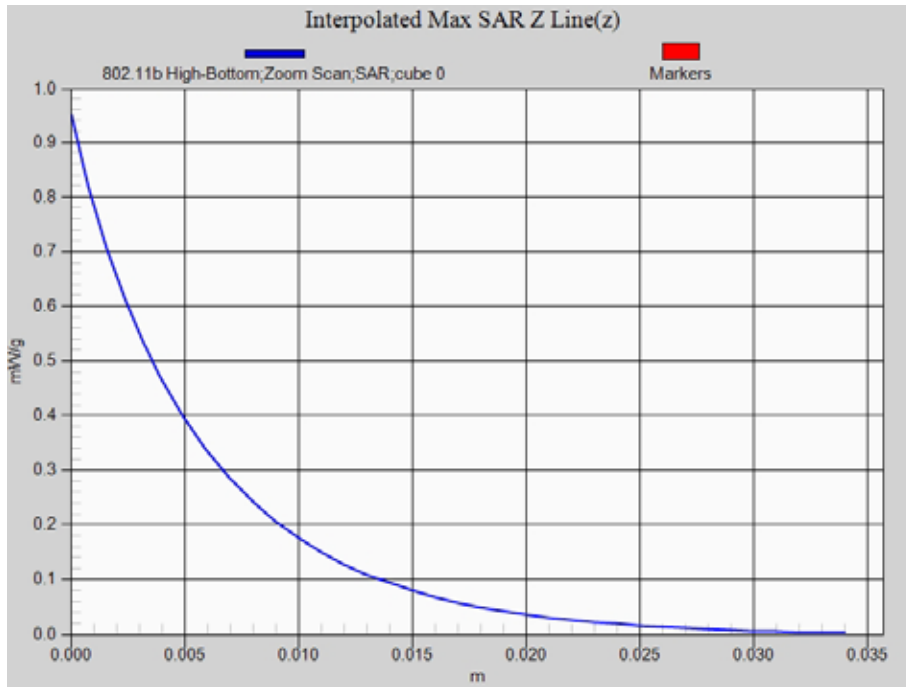

Date/Time: 28-06-2012

Test Laboratory: QuieTek Lab

802.11b 2462MHz-Primary landscape

**DUT: Tablet PC; Type: TC978**

Communication System: Wi-Fi; Communication System Band: 802.11b; Duty Cycle: 1:1; Frequency: 2462 MHz; Medium parameters used:  $f = 2462$  MHz;  $\sigma = 2.02$  mho/m;  $\epsilon_r = 52.58$ ;  $\rho = 1000$  kg/m<sup>3</sup>; Phantom section: Flat Section

Ambient temperature ( ): 21.5, Liquid temperature ( ): 21.0

DASY5 Configuration:

- Probe: EX3DV4 - SN3710; ConvF(6.98, 6.98, 6.98); Calibrated: 12/03/2012;
- Sensor-Surface: 4mm (Mechanical Surface Detection)
- Electronics: DAE4 Sn1220; Calibrated: 23/01/2012
- Phantom: SAM1; Type: SAM; Serial: TP1561
- Measurement SW: DASY52, Version 52.8 (1); SEMCAD X Version 14.6.5 (6469)

**Configuration/802.11b High-Primary landscape/Area Scan (7x8x1):** Measurement grid: dx=20mm, dy=20mm

Maximum value of SAR (measured) = 0.176 mW/g

**Configuration/802.11b High-Primary landscape/Zoom Scan (5x5x7)/Cube 0:** Measurement grid: dx=8mm, dy=8mm, dz=5mm, Reference Value = 5.705 V/m; Power Drift = -0.12 dB

Peak SAR (extrapolated) = 0.524 mW/g

**SAR(1 g) = 0.227 mW/g; SAR(10 g) = 0.097 mW/g** Maximum value of SAR (measured) = 0.257 mW/g

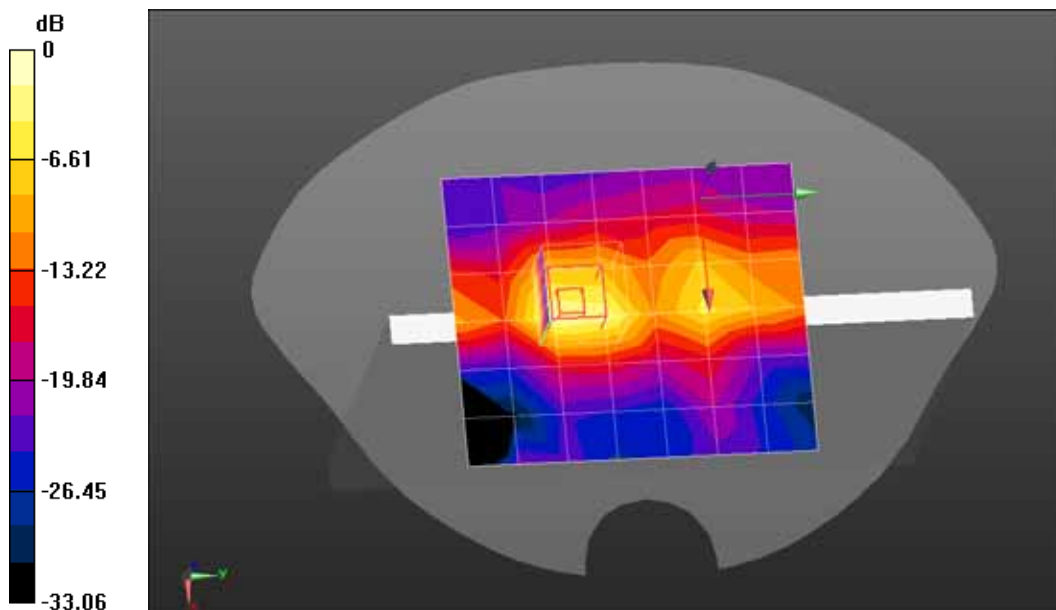

0 dB = 0.257 mW/g = -11.80 dB mW/g

Date/Time: 28-06-2012

Test Laboratory: QuieTek Lab

802.11b 2462MHz-Primary portrait

**DUT: Tablet PC; Type: TC978**

Communication System: Wi-Fi; Communication System Band: 802.11b; Duty Cycle: 1:1; Frequency: 2462 MHz; Medium parameters used:  $f = 2462$  MHz;  $\sigma = 2.02$  mho/m;  $\epsilon_r = 52.58$ ;  $\rho = 1000$  kg/m<sup>3</sup>; Phantom section: Flat Section

Ambient temperature ( ): 21.5, Liquid temperature ( ): 21.0

DASY5 Configuration:

- Probe: EX3DV4 - SN3710; ConvF(6.98, 6.98, 6.98); Calibrated: 12/03/2012;
- Sensor-Surface: 4mm (Mechanical Surface Detection)
- Electronics: DAE4 Sn1220; Calibrated: 23/01/2012
- Phantom: SAM1; Type: SAM; Serial: TP1561
- Measurement SW: DASY52, Version 52.8 (1); SEMCAD X Version 14.6.5 (6469)

**Configuration/802.11b High-Primary portrait/Area Scan (7x8x1):** Measurement grid: dx=20mm, dy=20mm

Maximum value of SAR (measured) = 0.0892 mW/g

**Configuration/802.11b High-Primary portrait/Zoom Scan (5x5x7)/Cube 0:** Measurement grid: dx=8mm, dy=8mm, dz=5mm, Reference Value = 6.651 V/m; Power Drift = 0.18 dB

Peak SAR (extrapolated) = 0.160 mW/g

**SAR(1 g) = 0.082 mW/g; SAR(10 g) = 0.040 mW/g** Maximum value of SAR (measured) = 0.0930 mW/g

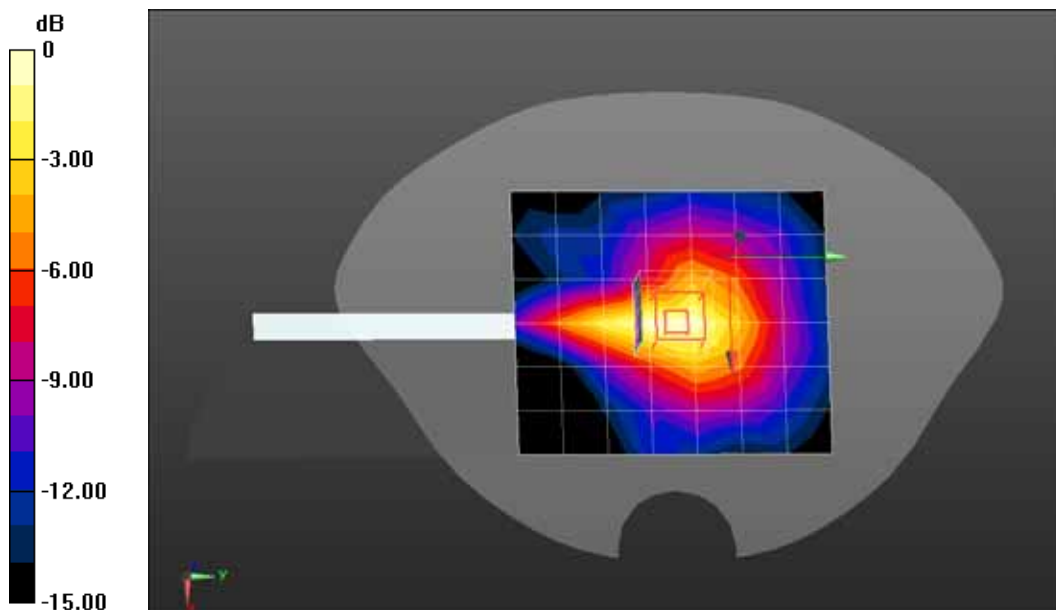

0 dB = 0.0930 mW/g = -20.63 dB mW/g



Date/Time: 28-06-2012

Test Laboratory: QuieTek Lab

802.11b 2462MHz-Bottom(with battery #2)

**DUT: Tablet PC; Type: TC978**

Communication System: Wi-Fi; Communication System Band: 802.11b; Duty Cycle: 1:1; Frequency: 2462 MHz; Medium parameters used:  $f = 2462$  MHz;  $\sigma = 2.02$  mho/m;  $\epsilon_r = 52.58$ ;  $\rho = 1000$  kg/m<sup>3</sup>; Phantom section: Flat Section

Ambient temperature ( ): 21.5, Liquid temperature ( ): 21.0

DASY5 Configuration:

- Probe: EX3DV4 - SN3710; ConvF(6.98, 6.98, 6.98); Calibrated: 12/03/2012;
- Sensor-Surface: 4mm (Mechanical Surface Detection)
- Electronics: DAE4 Sn1220; Calibrated: 23/01/2012
- Phantom: SAM1; Type: SAM; Serial: TP1561
- Measurement SW: DASY52, Version 52.8 (1); SEMCAD X Version 14.6.5 (6469)

**Configuration/802.11b High-Bottom/Area Scan (7x8x1):** Measurement grid: dx=20mm, dy=20mm

Maximum value of SAR (measured) = 0.318 mW/g

**Configuration/802.11b High-Bottom/Zoom Scan (5x5x7)/Cube 0:** Measurement grid: dx=8mm, dy=8mm, dz=5mm, Reference Value = 13.577 V/m; Power Drift = 0.10 dB

Peak SAR (extrapolated) = 0.809 mW/g

**SAR(1 g) = 0.355 mW/g; SAR(10 g) = 0.159 mW/g** Maximum value of SAR (measured) = 0.365 mW/g

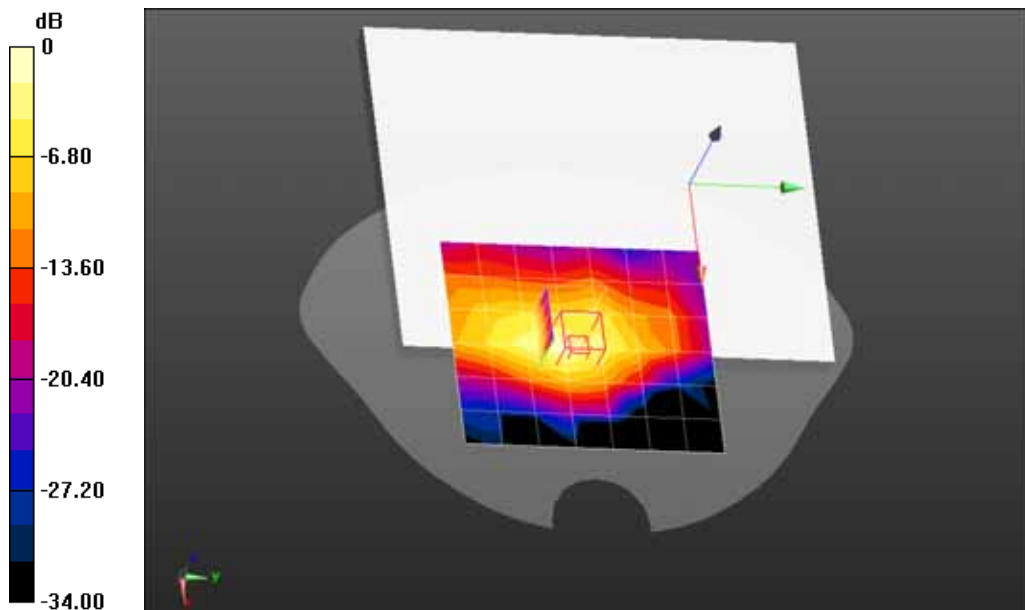

0 dB = 0.365 mW/g = -8.75 dB mW/g

Date/Time: 28-06-2012

Test Laboratory: QuieTek Lab

802.11g 2437MHz-Bottom

**DUT: Tablet PC; Type: TC978**

Communication System: Wi-Fi; Communication System Band: 802.11b; Duty Cycle: 1:1; Frequency: 2437 MHz; Medium parameters used:  $f = 2437$  MHz;  $\sigma = 1.98$  mho/m;  $\epsilon_r = 52.68$ ;  $\rho = 1000$  kg/m<sup>3</sup>; Phantom section: Flat Section

Ambient temperature ( ): 21.5, Liquid temperature ( ): 21.0

DASY5 Configuration:

- Probe: EX3DV4 - SN3710; ConvF(6.98, 6.98, 6.98); Calibrated: 12/03/2012;
- Sensor-Surface: 4mm (Mechanical Surface Detection)
- Electronics: DAE4 Sn1220; Calibrated: 23/01/2012
- Phantom: SAM1; Type: SAM; Serial: TP1561
- Measurement SW: DASY52, Version 52.8 (1); SEMCAD X Version 14.6.5 (6469)

**Configuration/802.11g Mid-Bottom/Area Scan (7x8x1):** Measurement grid: dx=20mm, dy=20mm

Maximum value of SAR (measured) = 0.123 mW/g

**Configuration/802.11g Mid-Bottom/Zoom Scan (5x5x7)/Cube 0:** Measurement grid: dx=8mm, dy=8mm, dz=5mm, Reference Value = 9.969 V/m; Power Drift = 0.10 dB

Peak SAR (extrapolated) = 0.498 mW/g

**SAR(1 g) = 0.214 mW/g; SAR(10 g) = 0.094 mW/g** Maximum value of SAR (measured) = 0.228 mW/g

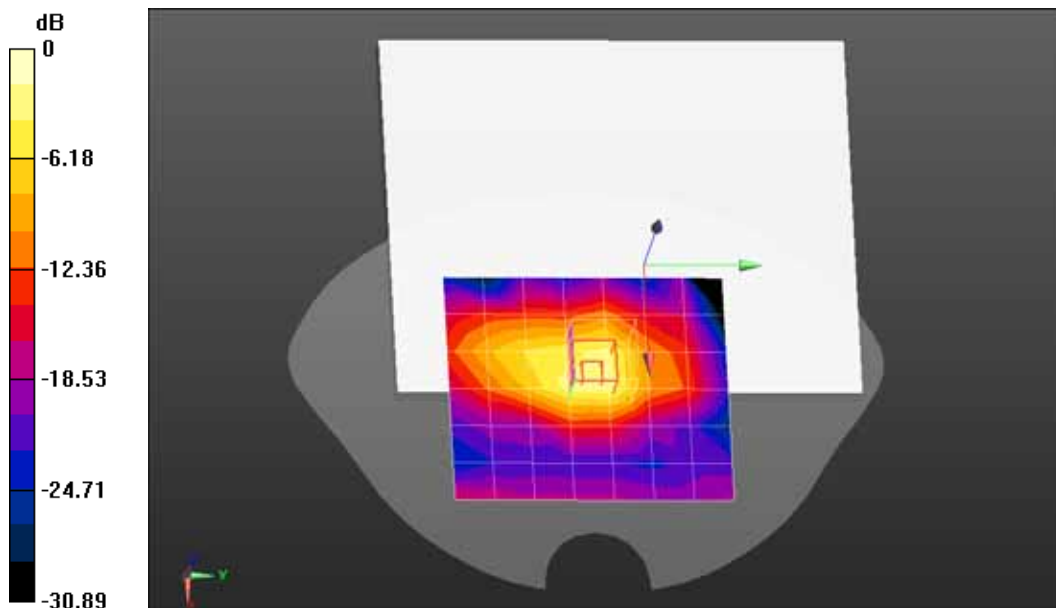

0 dB = 0.228 mW/g = -12.84 dB mW/g

Date/Time: 28-06-2012

Test Laboratory: QuieTek Lab

802.11n(20MHz) 2437MHz-Bottom

**DUT: Tablet PC; Type: TC978**

Communication System: Wi-Fi; Communication System Band: 802.11n(20MHz); Duty Cycle: 1:1; Frequency: 2437 MHz; Medium parameters used:  $f = 2437$  MHz;  $\sigma = 1.98$  mho/m;  $\epsilon_r = 52.68$ ;  $\rho = 1000$  kg/m<sup>3</sup>; Phantom section: Flat Section

Ambient temperature ( ): 21.5, Liquid temperature ( ): 21.0

DASY5 Configuration:

- Probe: EX3DV4 - SN3710; ConvF(6.98, 6.98, 6.98); Calibrated: 12/03/2012;
- Sensor-Surface: 4mm (Mechanical Surface Detection)
- Electronics: DAE4 Sn1220; Calibrated: 23/01/2012
- Phantom: SAM1; Type: SAM; Serial: TP1561
- Measurement SW: DASY52, Version 52.8 (1); SEMCAD X Version 14.6.5 (6469)

**Configuration/802.11n(20MHz) Mid-Bottom/Area Scan (7x8x1):** Measurement grid: dx=20mm, dy=20mm

Maximum value of SAR (measured) = 0.188 mW/g

**Configuration/802.11n(20MHz) Mid-Bottom/Zoom Scan (5x5x7)/Cube 0:** Measurement grid: dx=8mm, dy=8mm, dz=5mm, Reference Value = 11.601 V/m; Power Drift = -0.14 dB

Peak SAR (extrapolated) = 0.530 mW/g

**SAR(1 g) = 0.228 mW/g; SAR(10 g) = 0.102 mW/g** Maximum value of SAR (measured) = 0.235 mW/g

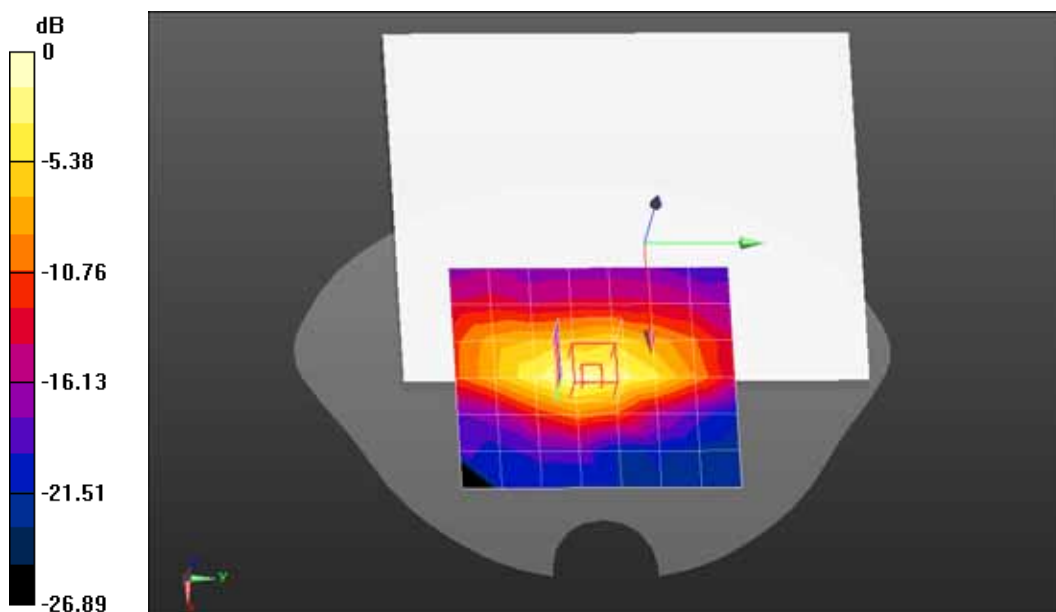

0 dB = 0.235 mW/g = -12.58 dB mW/g

**Appendix C. Test Setup Photographs & EUT Photographs**  
**Antenna to Antenna/User Separation Distances**

**Bottom of the Tablet**

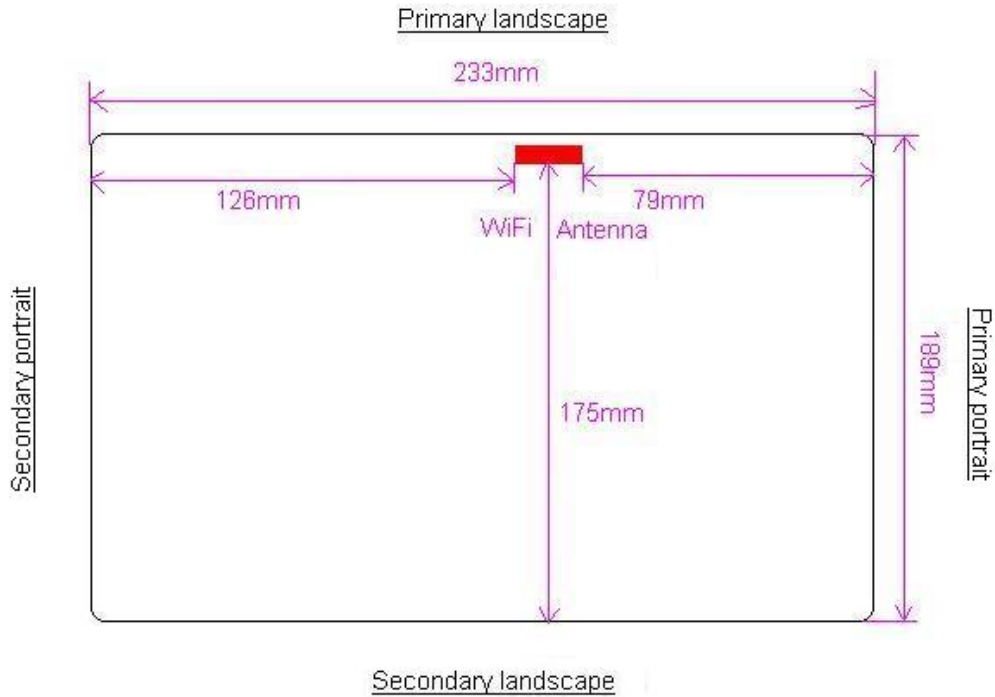

|  |  |
|--|--|
| <p>Antenna-to-user separation distances:</p> | <p><b>WiFi Antenna</b></p> <p>Tablet-Bottom face: 5mm from WiFi Antenna-to-user</p> <p>Tablet-Edges with the following configurations</p> <ul style="list-style-type: none"> <li>● Primary landscape: 3mm from WiFi Antenna-to-user</li> <li>● Secondary landscape: 175mm from WiFi Antenna-to-user</li> <li>● Primary portrait: 189mm from WiFi Antenna-to-user</li> <li>● Secondary portrait: 126mm from WiFi Antenna-to-user</li> </ul> |
|--|--|

**Test Setup Photographs**  
Bottom Touch



Primary landscape Touch

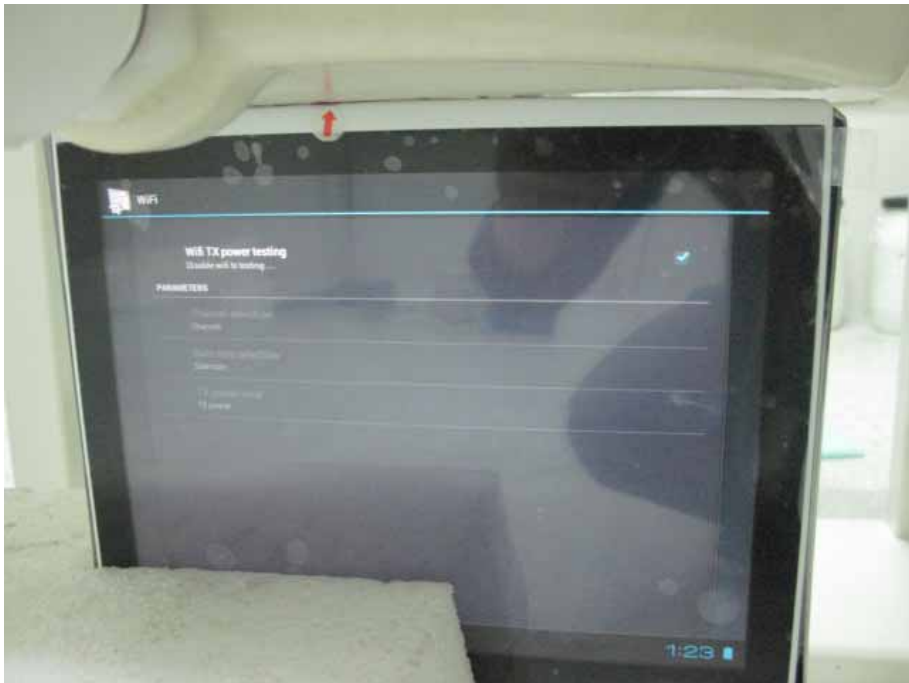

Primary portrait Touch



**Depth of the liquid in the phantom – Zoom in**

Note: The position used in the measurements were according to IEEE 1528 - 2003

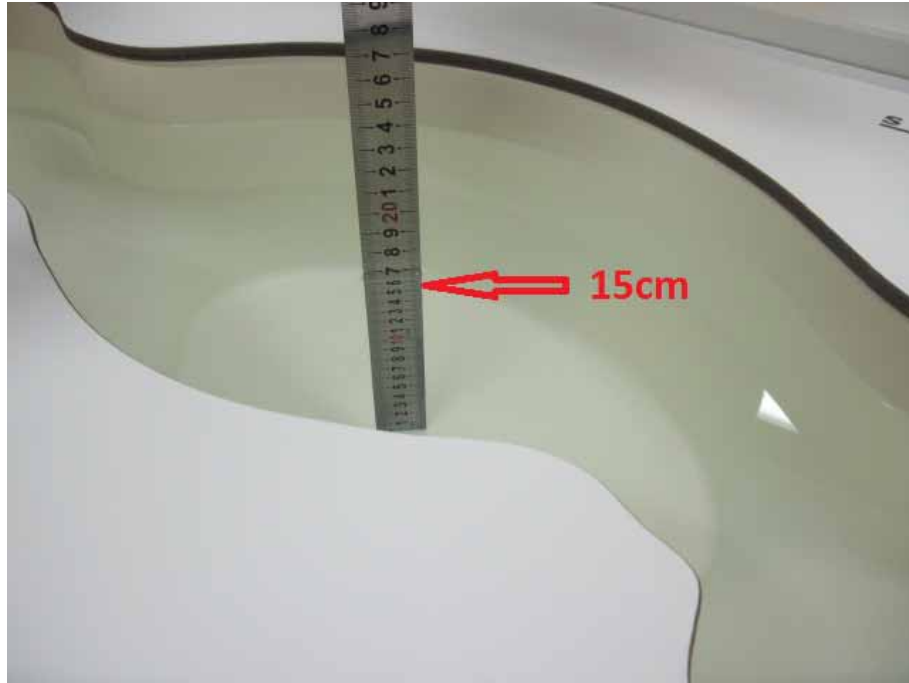

EUT Photographs

(1) EUT Photo



(2) EUT Photo





(3) EUT Photo(with battery #1)



(4) EUT Photo(with battery #2)



(5) EUT Photo

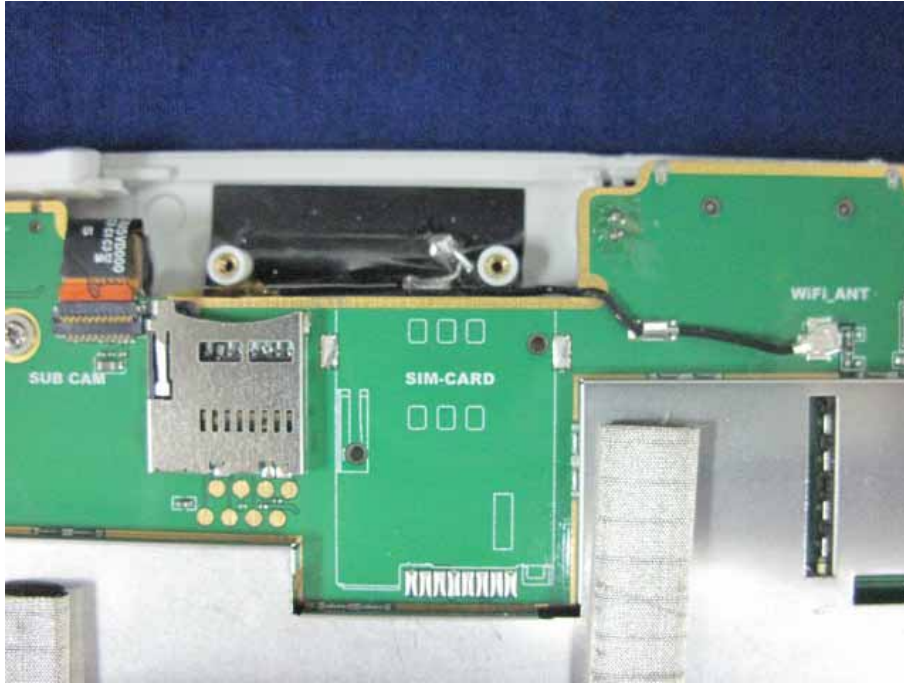

**Appendix D. Probe Calibration Data**

**Calibration Laboratory of  
Schmid & Partner  
Engineering AG**  
Zeughausstrasse 43, 8004 Zurich, Switzerland



**S** Schweizerischer Kalibrierdienst  
**C** Service suisse d'étalonnage  
**S** Servizio svizzero di taratura  
**S** Swiss Calibration Service

Accredited by the Swiss Accreditation Service (SAS)  
The Swiss Accreditation Service is one of the signatories to the EA  
Multilateral Agreement for the recognition of calibration certificates

Accreditation No.: **SCS 108**

Client **Quietek-CN (Auden)**

Certificate No: **EX3-3710\_Mar12**

**CALIBRATION CERTIFICATE**

Object: **EX3DV4 - SN:3710**

Calibration procedure(s): **QA CAL-01.v8, QA CAL-12.v7, QA CAL-14.v3, QA CAL-23.v4, QA CAL-25.v4  
Calibration procedure for dosimetric E-field probes**

Calibration date: **March 12, 2012**

This calibration certificate documents the traceability to national standards, which realize the physical units of measurements (SI). The measurements and the uncertainties with confidence probability are given on the following pages and are part of the certificate.

All calibrations have been conducted in the closed laboratory facility: environment temperature (22 ± 3)°C and humidity < 70%.

Calibration Equipment used (M&TE critical for calibration)

| Primary Standards          | ID              | Cal Date (Certificate No.)        | Scheduled Calibration  |
|----------------------------|-----------------|-----------------------------------|------------------------|
| Power meter E4419B         | GB41293874      | 31-Mar-11 (No. 217-01372)         | Apr-12                 |
| Power sensor E4412A        | MY41498087      | 31-Mar-11 (No. 217-01372)         | Apr-12                 |
| Reference 3 dB Attenuator  | SN: S5054 (3c)  | 29-Mar-11 (No. 217-01369)         | Apr-12                 |
| Reference 20 dB Attenuator | SN: S5086 (20b) | 29-Mar-11 (No. 217-01367)         | Apr-12                 |
| Reference 30 dB Attenuator | SN: S5129 (30b) | 29-Mar-11 (No. 217-01370)         | Apr-12                 |
| Reference Probe ES3DV2     | SN: 3013        | 29-Dec-11 (No. ES3-3013_Dec11)    | Dec-12                 |
| DAE4                       | SN: 654         | 3-May-11 (No. DAE4-654_May11)     | May-12                 |
| Secondary Standards        | ID              | Check Date (in house)             | Scheduled Check        |
| RF generator HP 8648C      | US3642U01700    | 4-Aug-99 (in house check Apr-11)  | In house check: Apr-13 |
| Network Analyzer HP 8753E  | US37390585      | 18-Oct-01 (in house check Oct-11) | In house check: Oct-12 |

|                | Name           | Function              | Signature |
|----------------|----------------|-----------------------|-----------|
| Calibrated by: | Jeton Kastrati | Laboratory Technician |           |
| Approved by:   | Katja Pokovic  | Technical Manager     |           |

Issued: March 13, 2012

This calibration certificate shall not be reproduced except in full without written approval of the laboratory.

**Calibration Laboratory of  
Schmid & Partner  
Engineering AG**  
Zeughausstrasse 43, 8004 Zurich, Switzerland



**S** Schweizerischer Kalibrierdienst  
**S** Service suisse d'étalonnage  
**S** Servizio svizzero di taratura  
**S** Swiss Calibration Service

Accredited by the Swiss Accreditation Service (SAS)

Accreditation No.: **SCS 108**

The Swiss Accreditation Service is one of the signatories to the EA  
Multilateral Agreement for the recognition of calibration certificates

### Glossary:

|                          |   |
|--------------------------|---|
| TSL                      | tissue simulating liquid  |
| NORM <sub>x,y,z</sub>    | sensitivity in free space   |
| ConvF                    | sensitivity in TSL / NORM <sub>x,y,z</sub>  |
| DCP                      | diode compression point   |
| CF                       | crest factor (1/duty_cycle) of the RF signal  |
| A, B, C                  | modulation dependent linearization parameters   |
| Polarization $\varphi$   | $\varphi$ rotation around probe axis  |
| Polarization $\vartheta$ | $\vartheta$ rotation around an axis that is in the plane normal to probe axis (at measurement center),<br>i.e., $\vartheta = 0$ is normal to probe axis |

### Calibration is Performed According to the Following Standards:

- IEEE Std 1528-2003, "IEEE Recommended Practice for Determining the Peak Spatial-Averaged Specific Absorption Rate (SAR) in the Human Head from Wireless Communications Devices: Measurement Techniques", December 2003
- IEC 62209-1, "Procedure to measure the Specific Absorption Rate (SAR) for hand-held devices used in close proximity to the ear (frequency range of 300 MHz to 3 GHz)", February 2005

### Methods Applied and Interpretation of Parameters:

- NORM<sub>x,y,z</sub>**: Assessed for E-field polarization  $\vartheta = 0$  ( $f \leq 900$  MHz in TEM-cell;  $f > 1800$  MHz: R22 waveguide). NORM<sub>x,y,z</sub> are only intermediate values, i.e., the uncertainties of NORM<sub>x,y,z</sub> does not affect the E<sup>2</sup>-field uncertainty inside TSL (see below ConvF).
- NORM(f)<sub>x,y,z</sub> = NORM<sub>x,y,z</sub> \* frequency\_response** (see Frequency Response Chart). This linearization is implemented in DASY4 software versions later than 4.2. The uncertainty of the frequency response is included in the stated uncertainty of ConvF.
- DCP<sub>x,y,z</sub>**: DCP are numerical linearization parameters assessed based on the data of power sweep with CW signal (no uncertainty required). DCP does not depend on frequency nor media.
- PAR**: PAR is the Peak to Average Ratio that is not calibrated but determined based on the signal characteristics
- A<sub>x,y,z</sub>; B<sub>x,y,z</sub>; C<sub>x,y,z</sub>; VR<sub>x,y,z</sub>; A, B, C** are numerical linearization parameters assessed based on the data of power sweep for specific modulation signal. The parameters do not depend on frequency nor media. VR is the maximum calibration range expressed in RMS voltage across the diode.
- ConvF and Boundary Effect Parameters**: Assessed in flat phantom using E-field (or Temperature Transfer Standard for  $f \leq 800$  MHz) and inside waveguide using analytical field distributions based on power measurements for  $f > 800$  MHz. The same setups are used for assessment of the parameters applied for boundary compensation (alpha, depth) of which typical uncertainty values are given. These parameters are used in DASY4 software to improve probe accuracy close to the boundary. The sensitivity in TSL corresponds to NORM<sub>x,y,z</sub> \* ConvF whereby the uncertainty corresponds to that given for ConvF. A frequency dependent ConvF is used in DASY version 4.4 and higher which allows extending the validity from  $\pm 50$  MHz to  $\pm 100$  MHz.
- Spherical isotropy (3D deviation from isotropy)**: in a field of low gradients realized using a flat phantom exposed by a patch antenna.
- Sensor Offset**: The sensor offset corresponds to the offset of virtual measurement center from the probe tip (on probe axis). No tolerance required.

EX3DV4 – SN:3710

March 12, 2012

# Probe EX3DV4

## SN:3710

|               |                   |
|---------------|-------------------|
| Manufactured: | July 21, 2009     |
| Repaired:     | February 21, 2012 |
| Calibrated:   | March 12, 2012    |

Calibrated for DASY/EASY Systems  
(Note: non-compatible with DASY2 system!)

EX3DV4- SN:3710

March 12, 2012

## DASY/EASY - Parameters of Probe: EX3DV4 - SN:3710

### Basic Calibration Parameters

|   | Sensor X | Sensor Y | Sensor Z | Unc (k=2)     |
|---|----------|----------|----------|---------------|
| Norm ( $\mu\text{V}/(\text{V}/\text{m})^2$ ) <sup>A</sup> | 0.51     | 0.56     | 0.44     | $\pm 10.1 \%$ |
| DCP (mV) <sup>B</sup>                                     | 101.3    | 98.9     | 100.9    |               |

### Modulation Calibration Parameters

| UID   | Communication System Name | PAR  |   | A<br>dB | B<br>dB | C<br>dB | VR<br>mV | Unc <sup>E</sup><br>(k=2) |
|-------|---------------------------|------|---|---------|---------|---------|----------|---------------------------|
| 10000 | CW                        | 0.00 | X | 0.00    | 0.00    | 1.00    | 114.4    | $\pm 2.2 \%$              |
|       |                           |      | Y | 0.00    | 0.00    | 1.00    | 94.4     |                           |
|       |                           |      | Z | 0.00    | 0.00    | 1.00    | 114.2    |                           |

The reported uncertainty of measurement is stated as the standard uncertainty of measurement multiplied by the coverage factor k=2, which for a normal distribution corresponds to a coverage probability of approximately 95%.

<sup>A</sup> The uncertainties of NormX,Y,Z do not affect the E<sup>2</sup>-field uncertainty inside TSL (see Pages 5 and 6).

<sup>B</sup> Numerical linearization parameter: uncertainty not required.

<sup>E</sup> Uncertainty is determined using the max. deviation from linear response applying rectangular distribution and is expressed for the square of the field value.

## DASY/EASY - Parameters of Probe: EX3DV4 - SN:3710

### Calibration Parameter Determined in Head Tissue Simulating Media

| f (MHz) <sup>C</sup> | Relative Permittivity <sup>F</sup> | Conductivity (S/m) <sup>F</sup> | ConvF X | ConvF Y | ConvF Z | Alpha | Depth (mm) | Unct. (k=2) |
|----------------------|------------------------------------|---------------------------------|---------|---------|---------|-------|------------|-------------|
| 450                  | 43.5                               | 0.87                            | 9.61    | 9.61    | 9.61    | 0.12  | 1.00       | ± 13.4 %    |
| 750                  | 41.9                               | 0.89                            | 9.51    | 9.51    | 9.51    | 0.24  | 1.16       | ± 12.0 %    |
| 835                  | 41.5                               | 0.90                            | 9.18    | 9.18    | 9.18    | 0.22  | 1.15       | ± 12.0 %    |
| 900                  | 41.5                               | 0.97                            | 8.97    | 8.97    | 8.97    | 0.19  | 1.35       | ± 12.0 %    |
| 1810                 | 40.0                               | 1.40                            | 8.32    | 8.32    | 8.32    | 0.79  | 0.60       | ± 12.0 %    |
| 1900                 | 40.0                               | 1.40                            | 8.16    | 8.16    | 8.16    | 0.72  | 0.66       | ± 12.0 %    |
| 2450                 | 39.2                               | 1.80                            | 7.25    | 7.25    | 7.25    | 0.36  | 0.91       | ± 12.0 %    |
| 2600                 | 39.0                               | 1.96                            | 6.96    | 6.96    | 6.96    | 0.39  | 0.95       | ± 12.0 %    |
| 3500                 | 37.9                               | 2.91                            | 6.80    | 6.80    | 6.80    | 0.33  | 1.09       | ± 13.1 %    |
| 5200                 | 36.0                               | 4.66                            | 5.21    | 5.21    | 5.21    | 0.35  | 1.80       | ± 13.1 %    |
| 5500                 | 35.6                               | 4.96                            | 4.95    | 4.95    | 4.95    | 0.35  | 1.80       | ± 13.1 %    |
| 5800                 | 35.3                               | 5.27                            | 4.56    | 4.56    | 4.56    | 0.45  | 1.80       | ± 13.1 %    |

<sup>C</sup> Frequency validity of ± 100 MHz only applies for DASY v4.4 and higher (see Page 2), else it is restricted to ± 50 MHz. The uncertainty is the RSS of the ConvF uncertainty at calibration frequency and the uncertainty for the indicated frequency band.

<sup>F</sup> At frequencies below 3 GHz, the validity of tissue parameters ( $\epsilon$  and  $\sigma$ ) can be relaxed to ± 10% if liquid compensation formula is applied to measured SAR values. At frequencies above 3 GHz, the validity of tissue parameters ( $\epsilon$  and  $\sigma$ ) is restricted to ± 5%. The uncertainty is the RSS of the ConvF uncertainty for indicated target tissue parameters.

EX3DV4--SN:3710

March 12, 2012

## DASY/EASY - Parameters of Probe: EX3DV4 - SN:3710

### Calibration Parameter Determined in Body Tissue Simulating Media

| f (MHz) <sup>C</sup> | Relative Permittivity <sup>F</sup> | Conductivity (S/m) <sup>F</sup> | ConvF X | ConvF Y | ConvF Z | Alpha | Depth (mm) | Unct. (k=2) |
|----------------------|------------------------------------|---------------------------------|---------|---------|---------|-------|------------|-------------|
| 450                  | 56.7                               | 0.94                            | 10.69   | 10.69   | 10.69   | 0.06  | 1.00       | ± 13.4 %    |
| 750                  | 55.5                               | 0.96                            | 9.33    | 9.33    | 9.33    | 0.43  | 0.86       | ± 12.0 %    |
| 835                  | 55.2                               | 0.97                            | 9.13    | 9.13    | 9.13    | 0.63  | 0.70       | ± 12.0 %    |
| 900                  | 55.0                               | 1.05                            | 9.04    | 9.04    | 9.04    | 0.39  | 0.88       | ± 12.0 %    |
| 1810                 | 53.3                               | 1.52                            | 7.73    | 7.73    | 7.73    | 0.33  | 1.10       | ± 12.0 %    |
| 1900                 | 53.3                               | 1.52                            | 7.43    | 7.43    | 7.43    | 0.42  | 0.90       | ± 12.0 %    |
| 2450                 | 52.7                               | 1.95                            | 6.98    | 6.98    | 6.98    | 0.79  | 0.59       | ± 12.0 %    |
| 2600                 | 52.5                               | 2.16                            | 6.68    | 6.68    | 6.68    | 0.79  | 0.52       | ± 12.0 %    |
| 3500                 | 51.3                               | 3.31                            | 6.23    | 6.23    | 6.23    | 0.36  | 1.13       | ± 13.1 %    |
| 5200                 | 49.0                               | 5.30                            | 4.20    | 4.20    | 4.20    | 0.50  | 1.90       | ± 13.1 %    |
| 5500                 | 48.6                               | 5.65                            | 3.82    | 3.82    | 3.82    | 0.50  | 1.90       | ± 13.1 %    |
| 5800                 | 48.2                               | 6.00                            | 3.89    | 3.89    | 3.89    | 0.60  | 1.90       | ± 13.1 %    |

<sup>C</sup> Frequency validity of ± 100 MHz only applies for DASY v4.4 and higher (see Page 2), else it is restricted to ± 50 MHz. The uncertainty is the RSS of the ConvF uncertainty at calibration frequency and the uncertainty for the indicated frequency band.

<sup>F</sup> At frequencies below 3 GHz, the validity of tissue parameters ( $\epsilon$  and  $\sigma$ ) can be relaxed to ± 10% if liquid compensation formula is applied to measured SAR values. At frequencies above 3 GHz, the validity of tissue parameters ( $\epsilon$  and  $\sigma$ ) is restricted to ± 5%. The uncertainty is the RSS of the ConvF uncertainty for indicated target tissue parameters.



EX3DV4- SN:3710

March 12, 2012

### Frequency Response of E-Field (TEM-Cell:ifi110 EXX, Waveguide: R22)

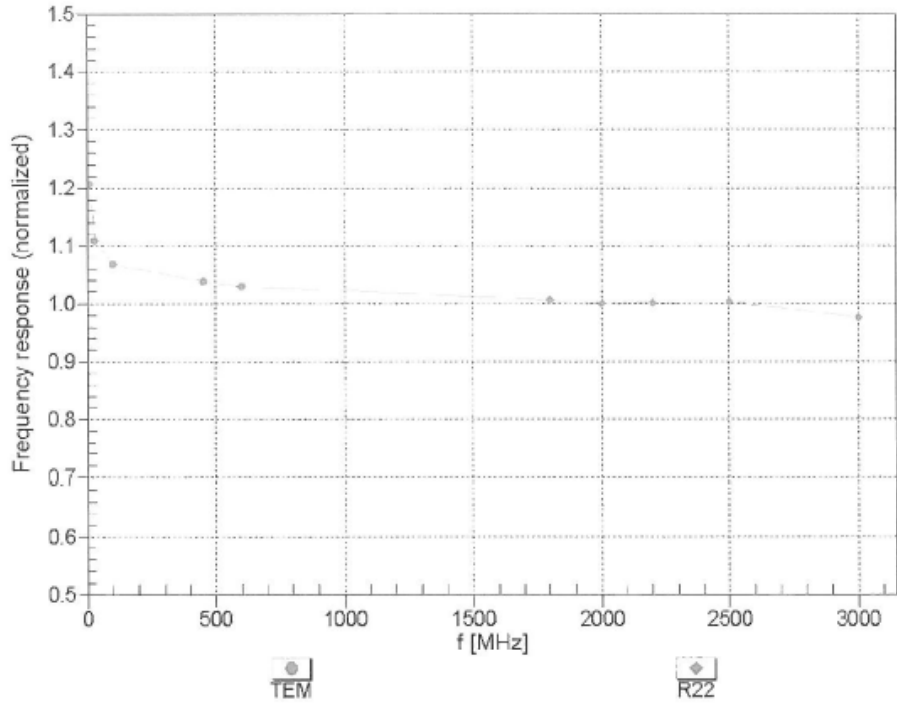

Uncertainty of Frequency Response of E-field:  $\pm 6.3\%$  (k=2)

EX3DV4- SN:3710

March 12, 2012

Receiving Pattern ( $\phi$ ),  $\vartheta = 0^\circ$

f=600 MHz,TEM

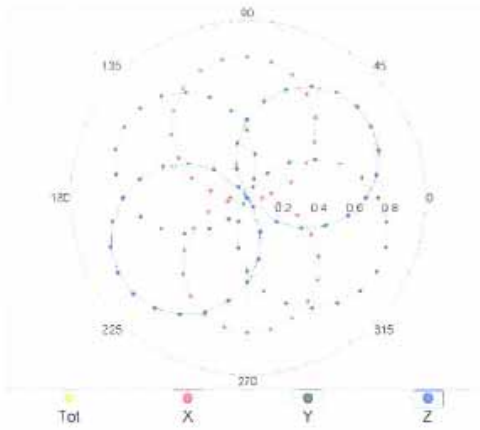

f=1800 MHz,R22

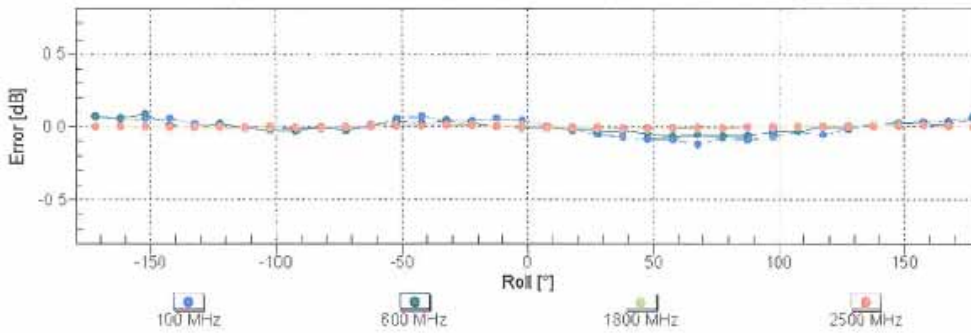
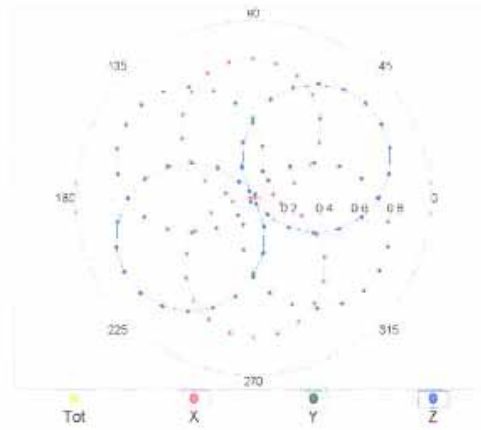

Uncertainty of Axial Isotropy Assessment:  $\pm 0.5\%$  (k=2)

EX3DV4-- SN:3710

March 12, 2012

### Dynamic Range f(SAR<sub>head</sub>) (TEM cell , f = 900 MHz)

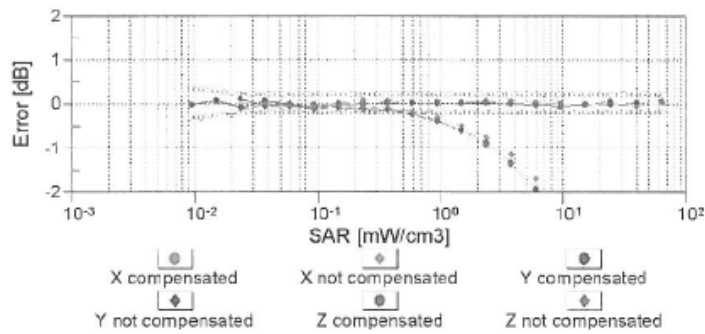
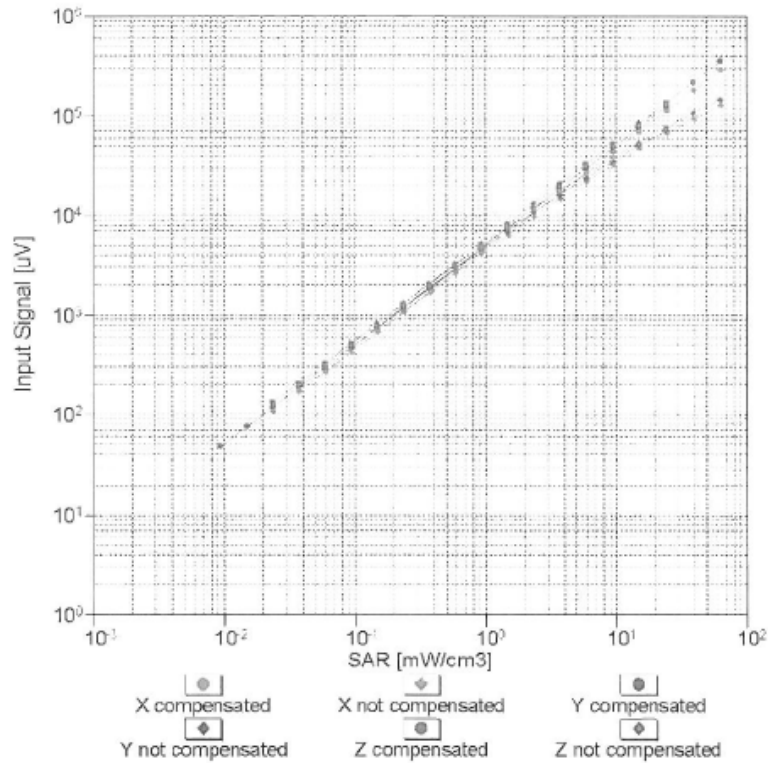

Uncertainty of Linearity Assessment: ± 0.6% (k=2)

EX3DV4-SN:3710

March 12, 2012

### Conversion Factor Assessment

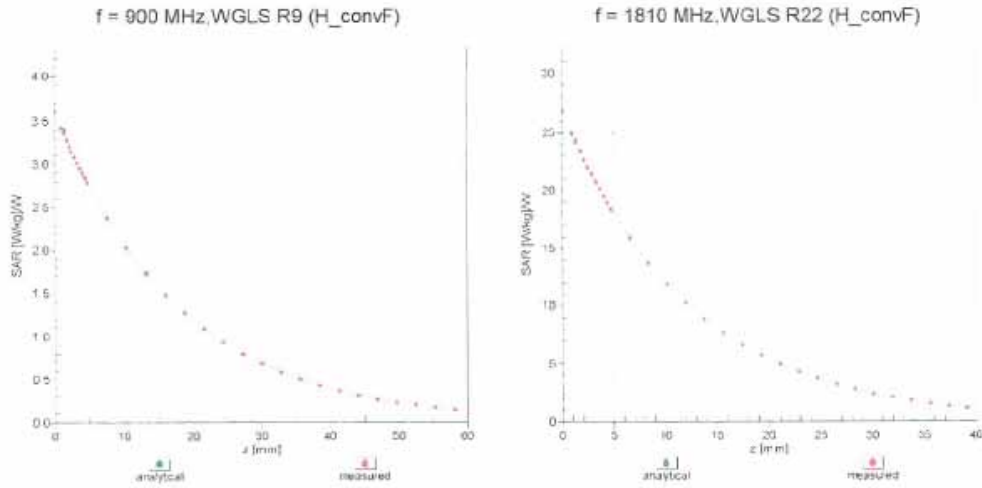

### Deviation from Isotropy in Liquid Error ( $\phi, \theta$ ), f = 900 MHz

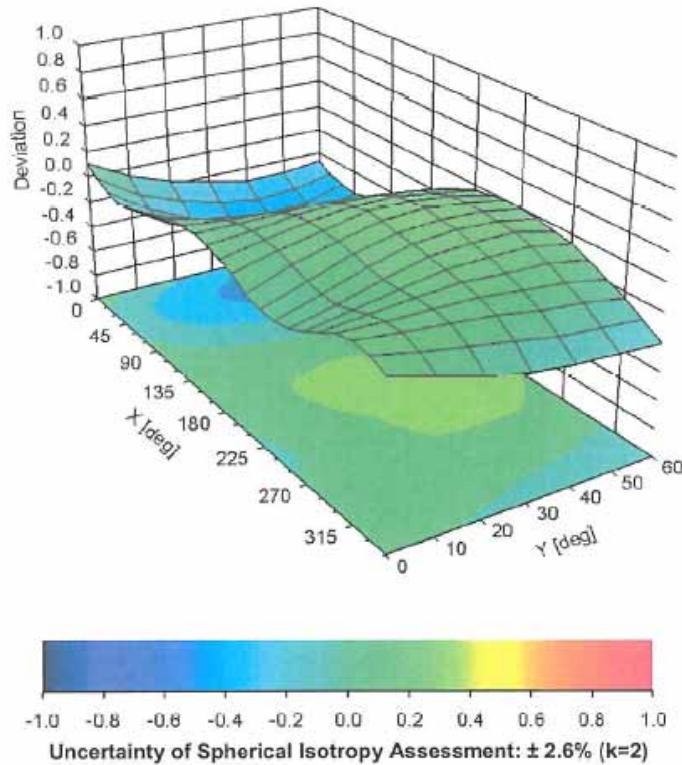

EX3DV4- SN:3710

March 12, 2012

**DASY/EASY - Parameters of Probe: EX3DV4 - SN:3710**

**Other Probe Parameters**

|   |                |
|---|----------------|
| Sensor Arrangement                            | Triangular     |
| Connector Angle (°)                           | Not applicable |
| Mechanical Surface Detection Mode             | enabled        |
| Optical Surface Detection Mode                | disabled       |
| Probe Overall Length                          | 337 mm         |
| Probe Body Diameter                           | 10 mm          |
| Tip Length                                    | 9 mm           |
| Tip Diameter                                  | 2.5 mm         |
| Probe Tip to Sensor X Calibration Point       | 1 mm           |
| Probe Tip to Sensor Y Calibration Point       | 1 mm           |
| Probe Tip to Sensor Z Calibration Point       | 1 mm           |
| Recommended Measurement Distance from Surface | 2 mm           |

**Appendix E. Dipole Calibration Data**

**Calibration Laboratory of  
Schmid & Partner  
Engineering AG**  
Zeughausstrasse 43, 8004 Zurich, Switzerland



**S** Schweizerischer Kalibrierdienst  
**C** Service suisse d'étalonnage  
**S** Servizio svizzero di taratura  
**S** Swiss Calibration Service

Accredited by the Swiss Accreditation Service (SAS)  
The Swiss Accreditation Service is one of the signatories to the EA  
Multilateral Agreement for the recognition of calibration certificates

Accreditation No.: **SCS 108**

Client **Quietek-CN (Auden)**

Certificate No: **D2450V2-839\_Feb12**

| CALIBRATION CERTIFICATE  |  |                                   |                           |                   |      |                            |                       |                      |            |                           |        |                       |            |                           |        |                            |                |                           |        |                             |                    |                           |        |                        |          |                                |        |      |         |                                |        |                     |      |                       |                 |                       |            |                                   |                        |                         |        |                                   |                        |                           |                  |                                   |                        |
|--|--|-----------------------------------|---------------------------|-------------------|------|----------------------------|-----------------------|----------------------|------------|---------------------------|--------|-----------------------|------------|---------------------------|--------|----------------------------|----------------|---------------------------|--------|-----------------------------|--------------------|---------------------------|--------|------------------------|----------|--------------------------------|--------|------|---------|--------------------------------|--------|---------------------|------|-----------------------|-----------------|-----------------------|------------|-----------------------------------|------------------------|-------------------------|--------|-----------------------------------|------------------------|---------------------------|------------------|-----------------------------------|------------------------|
| Object   | D2450V2 - SN: 839  |                                   |                           |                   |      |                            |                       |                      |            |                           |        |                       |            |                           |        |                            |                |                           |        |                             |                    |                           |        |                        |          |                                |        |      |         |                                |        |                     |      |                       |                 |                       |            |                                   |                        |                         |        |                                   |                        |                           |                  |                                   |                        |
| Calibration procedure(s)   | QA CAL-05.v8<br>Calibration procedure for dipole validation kits above 700 MHz |                                   |                           |                   |      |                            |                       |                      |            |                           |        |                       |            |                           |        |                            |                |                           |        |                             |                    |                           |        |                        |          |                                |        |      |         |                                |        |                     |      |                       |                 |                       |            |                                   |                        |                         |        |                                   |                        |                           |                  |                                   |                        |
| Calibration date:  | February 23, 2012  |                                   |                           |                   |      |                            |                       |                      |            |                           |        |                       |            |                           |        |                            |                |                           |        |                             |                    |                           |        |                        |          |                                |        |      |         |                                |        |                     |      |                       |                 |                       |            |                                   |                        |                         |        |                                   |                        |                           |                  |                                   |                        |
| <p>This calibration certificate documents the traceability to national standards, which realize the physical units of measurements (SI). The measurements and the uncertainties with confidence probability are given on the following pages and are part of the certificate.</p> <p>All calibrations have been conducted in the closed laboratory facility: environment temperature (22 ± 3)°C and humidity &lt; 70%.</p> <p>Calibration Equipment used (M&amp;TE critical for calibration)</p> <table border="1"> <thead> <tr> <th>Primary Standards</th> <th>ID #</th> <th>Cal Date (Certificate No.)</th> <th>Scheduled Calibration</th> </tr> </thead> <tbody> <tr> <td>Power meter EPM-442A</td> <td>GB37480704</td> <td>05-Oct-11 (No. 217-01451)</td> <td>Oct-12</td> </tr> <tr> <td>Power sensor HP 8481A</td> <td>US37292783</td> <td>05-Oct-11 (No. 217-01451)</td> <td>Oct-12</td> </tr> <tr> <td>Reference 20 dB Attenuator</td> <td>SN: 5086 (20g)</td> <td>29-Mar-11 (No. 217-01368)</td> <td>Apr-12</td> </tr> <tr> <td>Type N mismatch combination</td> <td>SN: 5017.2 / 06327</td> <td>29-Mar-11 (No. 217-01371)</td> <td>Apr-12</td> </tr> <tr> <td>Reference Probe ES3DV3</td> <td>SN: 3205</td> <td>30-Dec-11 (No. ES3-3205_Dec11)</td> <td>Dec-12</td> </tr> <tr> <td>DAE4</td> <td>SN: 601</td> <td>04-Jul-11 (No. DAE4-601_Jul11)</td> <td>Jul-12</td> </tr> </tbody> </table><br><table border="1"> <thead> <tr> <th>Secondary Standards</th> <th>ID #</th> <th>Check Date (in house)</th> <th>Scheduled Check</th> </tr> </thead> <tbody> <tr> <td>Power sensor HP 8481A</td> <td>MY41092317</td> <td>18-Oct-02 (in house check Oct-11)</td> <td>In house check: Oct-13</td> </tr> <tr> <td>RF generator R&amp;S SMT-06</td> <td>100005</td> <td>04-Aug-99 (in house check Oct-11)</td> <td>In house check: Oct-13</td> </tr> <tr> <td>Network Analyzer HP 8753E</td> <td>US37390585 S4206</td> <td>18-Oct-01 (in house check Oct-11)</td> <td>In house check: Oct-12</td> </tr> </tbody> </table> |  |                                   |                           | Primary Standards | ID # | Cal Date (Certificate No.) | Scheduled Calibration | Power meter EPM-442A | GB37480704 | 05-Oct-11 (No. 217-01451) | Oct-12 | Power sensor HP 8481A | US37292783 | 05-Oct-11 (No. 217-01451) | Oct-12 | Reference 20 dB Attenuator | SN: 5086 (20g) | 29-Mar-11 (No. 217-01368) | Apr-12 | Type N mismatch combination | SN: 5017.2 / 06327 | 29-Mar-11 (No. 217-01371) | Apr-12 | Reference Probe ES3DV3 | SN: 3205 | 30-Dec-11 (No. ES3-3205_Dec11) | Dec-12 | DAE4 | SN: 601 | 04-Jul-11 (No. DAE4-601_Jul11) | Jul-12 | Secondary Standards | ID # | Check Date (in house) | Scheduled Check | Power sensor HP 8481A | MY41092317 | 18-Oct-02 (in house check Oct-11) | In house check: Oct-13 | RF generator R&S SMT-06 | 100005 | 04-Aug-99 (in house check Oct-11) | In house check: Oct-13 | Network Analyzer HP 8753E | US37390585 S4206 | 18-Oct-01 (in house check Oct-11) | In house check: Oct-12 |
| Primary Standards  | ID #   | Cal Date (Certificate No.)        | Scheduled Calibration     |                   |      |                            |                       |                      |            |                           |        |                       |            |                           |        |                            |                |                           |        |                             |                    |                           |        |                        |          |                                |        |      |         |                                |        |                     |      |                       |                 |                       |            |                                   |                        |                         |        |                                   |                        |                           |                  |                                   |                        |
| Power meter EPM-442A   | GB37480704   | 05-Oct-11 (No. 217-01451)         | Oct-12                    |                   |      |                            |                       |                      |            |                           |        |                       |            |                           |        |                            |                |                           |        |                             |                    |                           |        |                        |          |                                |        |      |         |                                |        |                     |      |                       |                 |                       |            |                                   |                        |                         |        |                                   |                        |                           |                  |                                   |                        |
| Power sensor HP 8481A  | US37292783   | 05-Oct-11 (No. 217-01451)         | Oct-12                    |                   |      |                            |                       |                      |            |                           |        |                       |            |                           |        |                            |                |                           |        |                             |                    |                           |        |                        |          |                                |        |      |         |                                |        |                     |      |                       |                 |                       |            |                                   |                        |                         |        |                                   |                        |                           |                  |                                   |                        |
| Reference 20 dB Attenuator   | SN: 5086 (20g)   | 29-Mar-11 (No. 217-01368)         | Apr-12                    |                   |      |                            |                       |                      |            |                           |        |                       |            |                           |        |                            |                |                           |        |                             |                    |                           |        |                        |          |                                |        |      |         |                                |        |                     |      |                       |                 |                       |            |                                   |                        |                         |        |                                   |                        |                           |                  |                                   |                        |
| Type N mismatch combination  | SN: 5017.2 / 06327   | 29-Mar-11 (No. 217-01371)         | Apr-12                    |                   |      |                            |                       |                      |            |                           |        |                       |            |                           |        |                            |                |                           |        |                             |                    |                           |        |                        |          |                                |        |      |         |                                |        |                     |      |                       |                 |                       |            |                                   |                        |                         |        |                                   |                        |                           |                  |                                   |                        |
| Reference Probe ES3DV3   | SN: 3205   | 30-Dec-11 (No. ES3-3205_Dec11)    | Dec-12                    |                   |      |                            |                       |                      |            |                           |        |                       |            |                           |        |                            |                |                           |        |                             |                    |                           |        |                        |          |                                |        |      |         |                                |        |                     |      |                       |                 |                       |            |                                   |                        |                         |        |                                   |                        |                           |                  |                                   |                        |
| DAE4   | SN: 601  | 04-Jul-11 (No. DAE4-601_Jul11)    | Jul-12                    |                   |      |                            |                       |                      |            |                           |        |                       |            |                           |        |                            |                |                           |        |                             |                    |                           |        |                        |          |                                |        |      |         |                                |        |                     |      |                       |                 |                       |            |                                   |                        |                         |        |                                   |                        |                           |                  |                                   |                        |
| Secondary Standards  | ID #   | Check Date (in house)             | Scheduled Check           |                   |      |                            |                       |                      |            |                           |        |                       |            |                           |        |                            |                |                           |        |                             |                    |                           |        |                        |          |                                |        |      |         |                                |        |                     |      |                       |                 |                       |            |                                   |                        |                         |        |                                   |                        |                           |                  |                                   |                        |
| Power sensor HP 8481A  | MY41092317   | 18-Oct-02 (in house check Oct-11) | In house check: Oct-13    |                   |      |                            |                       |                      |            |                           |        |                       |            |                           |        |                            |                |                           |        |                             |                    |                           |        |                        |          |                                |        |      |         |                                |        |                     |      |                       |                 |                       |            |                                   |                        |                         |        |                                   |                        |                           |                  |                                   |                        |
| RF generator R&S SMT-06  | 100005   | 04-Aug-99 (in house check Oct-11) | In house check: Oct-13    |                   |      |                            |                       |                      |            |                           |        |                       |            |                           |        |                            |                |                           |        |                             |                    |                           |        |                        |          |                                |        |      |         |                                |        |                     |      |                       |                 |                       |            |                                   |                        |                         |        |                                   |                        |                           |                  |                                   |                        |
| Network Analyzer HP 8753E  | US37390585 S4206   | 18-Oct-01 (in house check Oct-11) | In house check: Oct-12    |                   |      |                            |                       |                      |            |                           |        |                       |            |                           |        |                            |                |                           |        |                             |                    |                           |        |                        |          |                                |        |      |         |                                |        |                     |      |                       |                 |                       |            |                                   |                        |                         |        |                                   |                        |                           |                  |                                   |                        |
| Calibrated by:   | Name<br>Israe El-Naouq   | Function<br>Laboratory Technician | Signature<br>             |                   |      |                            |                       |                      |            |                           |        |                       |            |                           |        |                            |                |                           |        |                             |                    |                           |        |                        |          |                                |        |      |         |                                |        |                     |      |                       |                 |                       |            |                                   |                        |                         |        |                                   |                        |                           |                  |                                   |                        |
| Approved by:   | Katja Pokovic  | Technical Manager                 |                           |                   |      |                            |                       |                      |            |                           |        |                       |            |                           |        |                            |                |                           |        |                             |                    |                           |        |                        |          |                                |        |      |         |                                |        |                     |      |                       |                 |                       |            |                                   |                        |                         |        |                                   |                        |                           |                  |                                   |                        |
|  |  |                                   | Issued: February 23, 2012 |                   |      |                            |                       |                      |            |                           |        |                       |            |                           |        |                            |                |                           |        |                             |                    |                           |        |                        |          |                                |        |      |         |                                |        |                     |      |                       |                 |                       |            |                                   |                        |                         |        |                                   |                        |                           |                  |                                   |                        |
| This calibration certificate shall not be reproduced except in full without written approval of the laboratory.  |  |                                   |                           |                   |      |                            |                       |                      |            |                           |        |                       |            |                           |        |                            |                |                           |        |                             |                    |                           |        |                        |          |                                |        |      |         |                                |        |                     |      |                       |                 |                       |            |                                   |                        |                         |        |                                   |                        |                           |                  |                                   |                        |

**Calibration Laboratory of  
Schmid & Partner  
Engineering AG**  
Zeughausstrasse 43, 8004 Zurich, Switzerland



**S** Schweizerischer Kalibrierdienst  
**C** Service suisse d'étalonnage  
**S** Servizio svizzero di taratura  
**S** Swiss Calibration Service

Accredited by the Swiss Accreditation Service (SAS)  
The Swiss Accreditation Service is one of the signatories to the EA  
Multilateral Agreement for the recognition of calibration certificates

Accreditation No.: **SCS 108**

**Glossary:**

|       |                                 |
|-------|---------------------------------|
| TSL   | tissue simulating liquid        |
| ConvF | sensitivity in TSL / NORM x,y,z |
| N/A   | not applicable or not measured  |

**Calibration is Performed According to the Following Standards:**

- a) IEEE Std 1528-2003, "IEEE Recommended Practice for Determining the Peak Spatial-Averaged Specific Absorption Rate (SAR) in the Human Head from Wireless Communications Devices: Measurement Techniques", December 2003
- b) IEC 62209-1, "Procedure to measure the Specific Absorption Rate (SAR) for hand-held devices used in close proximity to the ear (frequency range of 300 MHz to 3 GHz)", February 2005
- c) Federal Communications Commission Office of Engineering & Technology (FCC OET), "Evaluating Compliance with FCC Guidelines for Human Exposure to Radiofrequency Electromagnetic Fields; Additional Information for Evaluating Compliance of Mobile and Portable Devices with FCC Limits for Human Exposure to Radiofrequency Emissions", Supplement C (Edition 01-01) to Bulletin 65

**Additional Documentation:**

- d) DASY4/5 System Handbook

**Methods Applied and Interpretation of Parameters:**

- *Measurement Conditions:* Further details are available from the Validation Report at the end of the certificate. All figures stated in the certificate are valid at the frequency indicated.
- *Antenna Parameters with TSL:* The dipole is mounted with the spacer to position its feed point exactly below the center marking of the flat phantom section, with the arms oriented parallel to the body axis.
- *Feed Point Impedance and Return Loss:* These parameters are measured with the dipole positioned under the liquid filled phantom. The impedance stated is transformed from the measurement at the SMA connector to the feed point. The Return Loss ensures low reflected power. No uncertainty required.
- *Electrical Delay:* One-way delay between the SMA connector and the antenna feed point. No uncertainty required.
- *SAR measured:* SAR measured at the stated antenna input power.
- *SAR normalized:* SAR as measured, normalized to an input power of 1 W at the antenna connector.
- *SAR for nominal TSL parameters:* The measured TSL parameters are used to calculate the nominal SAR result.

**Measurement Conditions**

DASY system configuration, as far as not given on page 1.

|                              |                        |             |
|------------------------------|------------------------|-------------|
| DASY Version                 | DASY5                  | V52.8.0     |
| Extrapolation                | Advanced Extrapolation |             |
| Phantom                      | Modular Flat Phantom   |             |
| Distance Dipole Center - TSL | 10 mm                  | with Spacer |
| Zoom Scan Resolution         | dx, dy, dz = 5 mm      |             |
| Frequency                    | 2450 MHz ± 1 MHz       |             |

**Head TSL parameters**

The following parameters and calculations were applied.

|   | Temperature     | Permittivity | Conductivity     |
|---|-----------------|--------------|------------------|
| Nominal Head TSL parameters             | 22.0 °C         | 39.2         | 1.80 mho/m       |
| Measured Head TSL parameters            | (22.0 ± 0.2) °C | 38.9 ± 6 %   | 1.86 mho/m ± 6 % |
| Head TSL temperature change during test | < 0.5 °C        | ----         | ----             |

**SAR result with Head TSL**

| SAR averaged over 1 cm <sup>3</sup> (1 g) of Head TSL | Condition          |                                   |
|---|--------------------|-----------------------------------|
| SAR measured  | 250 mW input power | 13.2 mW / g                       |
| SAR for nominal Head TSL parameters                   | normalized to 1W   | <b>51.9 mW / g ± 17.0 % (k=2)</b> |

| SAR averaged over 10 cm <sup>3</sup> (10 g) of Head TSL | condition          |                                   |
|---|--------------------|-----------------------------------|
| SAR measured  | 250 mW input power | 6.09 mW / g                       |
| SAR for nominal Head TSL parameters                     | normalized to 1W   | <b>24.1 mW / g ± 16.5 % (k=2)</b> |

**Body TSL parameters**

The following parameters and calculations were applied.

|   | Temperature     | Permittivity | Conductivity     |
|---|-----------------|--------------|------------------|
| Nominal Body TSL parameters             | 22.0 °C         | 52.7         | 1.95 mho/m       |
| Measured Body TSL parameters            | (22.0 ± 0.2) °C | 52.3 ± 6 %   | 2.02 mho/m ± 6 % |
| Body TSL temperature change during test | < 0.5 °C        | ----         | ----             |

**SAR result with Body TSL**

| SAR averaged over 1 cm <sup>3</sup> (1 g) of Body TSL | Condition          |                                   |
|---|--------------------|-----------------------------------|
| SAR measured  | 250 mW input power | 12.4 mW / g                       |
| SAR for nominal Body TSL parameters                   | normalized to 1W   | <b>48.7 mW / g ± 17.0 % (k=2)</b> |

| SAR averaged over 10 cm <sup>3</sup> (10 g) of Body TSL | condition          |                                   |
|---|--------------------|-----------------------------------|
| SAR measured  | 250 mW input power | 5.76 mW / g                       |
| SAR for nominal Body TSL parameters                     | normalized to 1W   | <b>22.8 mW / g ± 16.5 % (k=2)</b> |



**Appendix**

**Antenna Parameters with Head TSL**

|                                      |                                |
|--------------------------------------|--------------------------------|
| Impedance, transformed to feed point | 55.7 $\Omega$ - 1.0 j $\Omega$ |
| Return Loss                          | - 25.2 dB                      |

**Antenna Parameters with Body TSL**

|                                      |                                |
|--------------------------------------|--------------------------------|
| Impedance, transformed to feed point | 52.1 $\Omega$ + 1.0 j $\Omega$ |
| Return Loss                          | - 32.9 dB                      |

**General Antenna Parameters and Design**

|                                  |          |
|----------------------------------|----------|
| Electrical Delay (one direction) | 1.160 ns |
|----------------------------------|----------|

After long term use with 100W radiated power, only a slight warming of the dipole near the feedpoint can be measured.

The dipole is made of standard semirigid coaxial cable. The center conductor of the feeding line is directly connected to the second arm of the dipole. The antenna is therefore short-circuited for DC-signals. On some of the dipoles, small end caps are added to the dipole arms in order to improve matching when loaded according to the position as explained in the "Measurement Conditions" paragraph. The SAR data are not affected by this change. The overall dipole length is still according to the Standard.

No excessive force must be applied to the dipole arms, because they might bend or the soldered connections near the feedpoint may be damaged.

**Additional EUT Data**

|                 |               |
|-----------------|---------------|
| Manufactured by | SPEAG         |
| Manufactured on | July 20, 2009 |

## DASY5 Validation Report for Head TSL

Date: 23.02.2012

Test Laboratory: SPEAG, Zurich, Switzerland

**DUT: Dipole 2450 MHz; Type: D2450V2; Serial: D2450V2 - SN: 839**

Communication System: CW; Frequency: 2450 MHz

Medium parameters used:  $f = 2450$  MHz;  $\sigma = 1.86$  mho/m;  $\epsilon_r = 38.9$ ;  $\rho = 1000$  kg/m<sup>3</sup>

Phantom section: Flat Section

Measurement Standard: DASY5 (IEEE/IEC/ANSI C63.19-2007)

DASY52 Configuration:

- Probe: ES3DV3 - SN3205; ConvF(4.45, 4.45, 4.45); Calibrated: 30.12.2011
- Sensor-Surface: 3mm (Mechanical Surface Detection)
- Electronics: DAE4 Sn601; Calibrated: 04.07.2011
- Phantom: Flat Phantom 5.0 (front); Type: QD000P50AA; Serial: 1001
- DASY52 52.8.0(692); SEMCAD X 14.6.4(4989)

### Dipole Calibration for Head Tissue/Pin=250 mW, d=10mm/Zoom Scan (7x7x7)/Cube 0:

Measurement grid: dx=5mm, dy=5mm, dz=5mm

Reference Value = 98.155 V/m; Power Drift = 0.08 dB

Peak SAR (extrapolated) = 27.8700

**SAR(1 g) = 13.2 mW/g; SAR(10 g) = 6.09 mW/g**

Maximum value of SAR (measured) = 16.839 mW/g

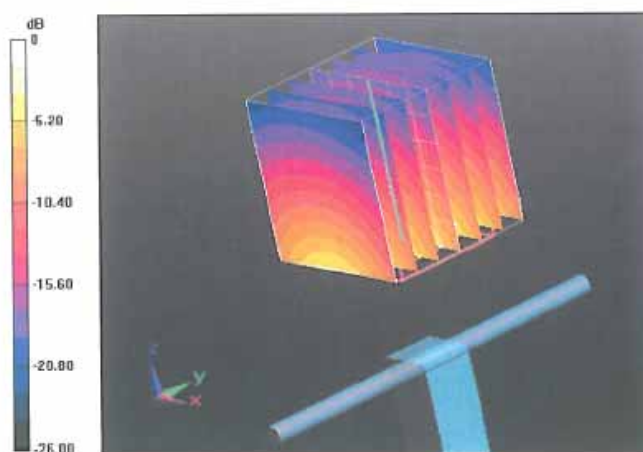

0 dB = 16.840mW/g = 24.53 dB mW/g

Impedance Measurement Plot for Head TSL

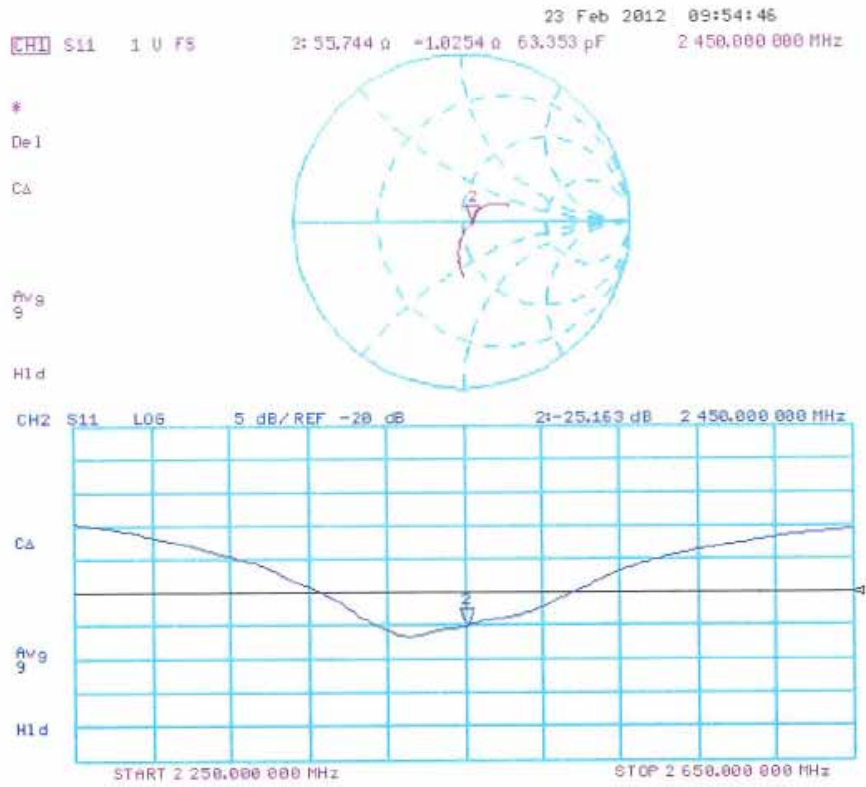

## DASY5 Validation Report for Body TSL

Date: 23.02.2012

Test Laboratory: SPEAG, Zurich, Switzerland

**DUT: Dipole 2450 MHz; Type: D2450V2; Serial: D2450V2 - SN: 839**

Communication System: CW; Frequency: 2450 MHz

Medium parameters used:  $f = 2450$  MHz;  $\sigma = 2.02$  mho/m;  $\epsilon_r = 52.3$ ;  $\rho = 1000$  kg/m<sup>3</sup>

Phantom section: Flat Section

Measurement Standard: DASY5 (IEEE/IEC/ANSI C63.19-2007)

DASY52 Configuration:

- Probe: ES3DV3 - SN3205; ConvF(4.26, 4.26, 4.26); Calibrated: 30.12.2011
- Sensor-Surface: 3mm (Mechanical Surface Detection)
- Electronics: DAE4 Sn601; Calibrated: 04.07.2011
- Phantom: Flat Phantom 5.0 (back); Type: QD000P50AA; Serial: 1002
- DASY52 52.8.0(692); SEMCAD X 14.6.4(4989)

### Dipole Calibration for Body Tissue/Pin=250 mW, d=10mm/Zoom Scan (7x7x7)/Cube 0:

Measurement grid: dx=5mm, dy=5mm, dz=5mm

Reference Value = 93.056 V/m; Power Drift = 0.0053 dB

Peak SAR (extrapolated) = 25.2250

**SAR(1 g) = 12.4 mW/g; SAR(10 g) = 5.76 mW/g**

Maximum value of SAR (measured) – 16.258 mW/g

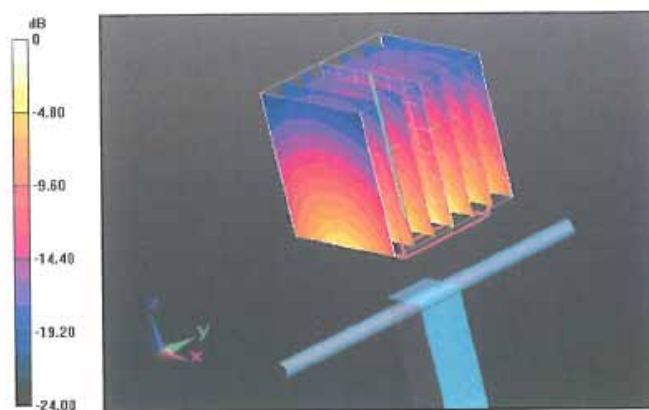

0 dB = 16.260mW/g = 24.22 dB mW/g

Impedance Measurement Plot for Body TSL

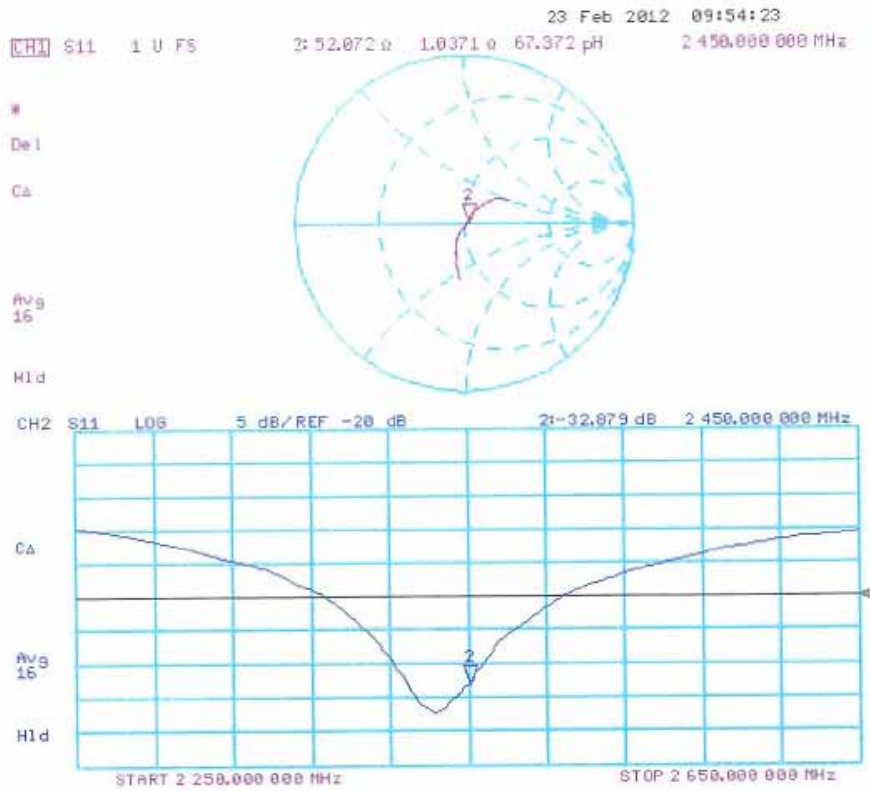

**Appendix F. DAE Calibration Data**

Calibration Laboratory of  
Schmid & Partner  
Engineering AG  
Zeughausstrasse 43, 8004 Zurich, Switzerland



S Schweizerischer Kalibrierdienst  
C Service suisse d'étalonnage  
S Servizio svizzero di taratura  
S Swiss Calibration Service

Accredited by the Swiss Accreditation Service (SAS)  
The Swiss Accreditation Service is one of the signatories to the EA  
Multilateral Agreement for the recognition of calibration certificates

Accreditation No.: **SCS 108**

Client **Quietek-CN (Auden)**

Certificate No: **DAE4-1220\_Jan12**

| CALIBRATION CERTIFICATE  |   |                            |                          |                   |      |                            |                       |                               |             |                      |        |                     |      |                       |                 |                     |                    |                            |                        |
|--|---|----------------------------|--------------------------|-------------------|------|----------------------------|-----------------------|-------------------------------|-------------|----------------------|--------|---------------------|------|-----------------------|-----------------|---------------------|--------------------|----------------------------|------------------------|
| Object   | DAE4 - SD 000 D04 BJ - SN: 1220   |                            |                          |                   |      |                            |                       |                               |             |                      |        |                     |      |                       |                 |                     |                    |                            |                        |
| Calibration procedure(s)   | QA CAL-06.v24<br>Calibration procedure for the data acquisition electronics (DAE) |                            |                          |                   |      |                            |                       |                               |             |                      |        |                     |      |                       |                 |                     |                    |                            |                        |
| Calibration date:  | January 23, 2012  |                            |                          |                   |      |                            |                       |                               |             |                      |        |                     |      |                       |                 |                     |                    |                            |                        |
| <p>This calibration certificate documents the traceability to national standards, which realize the physical units of measurements (SI). The measurements and the uncertainties with confidence probability are given on the following pages and are part of the certificate.</p> <p>All calibrations have been conducted in the closed laboratory facility: environment temperature (22 ± 3)°C and humidity &lt; 70%.</p> <p>Calibration Equipment used (M&amp;TE critical for calibration)</p> <table border="1"> <thead> <tr> <th>Primary Standards</th> <th>ID #</th> <th>Cal Date (Certificate No.)</th> <th>Scheduled Calibration</th> </tr> </thead> <tbody> <tr> <td>Keithley Multimeter Type 2001</td> <td>SN: 0810278</td> <td>28-Sep-11 (No:11450)</td> <td>Sep-12</td> </tr> <tr> <th>Secondary Standards</th> <th>ID #</th> <th>Check Date (in house)</th> <th>Scheduled Check</th> </tr> <tr> <td>Calibrator Box V2.1</td> <td>SE UWS 053 AA 1001</td> <td>05-Jan-12 (in house check)</td> <td>In house check: Jan-13</td> </tr> </tbody> </table> |   |                            |                          | Primary Standards | ID # | Cal Date (Certificate No.) | Scheduled Calibration | Keithley Multimeter Type 2001 | SN: 0810278 | 28-Sep-11 (No:11450) | Sep-12 | Secondary Standards | ID # | Check Date (in house) | Scheduled Check | Calibrator Box V2.1 | SE UWS 053 AA 1001 | 05-Jan-12 (in house check) | In house check: Jan-13 |
| Primary Standards  | ID #  | Cal Date (Certificate No.) | Scheduled Calibration    |                   |      |                            |                       |                               |             |                      |        |                     |      |                       |                 |                     |                    |                            |                        |
| Keithley Multimeter Type 2001  | SN: 0810278   | 28-Sep-11 (No:11450)       | Sep-12                   |                   |      |                            |                       |                               |             |                      |        |                     |      |                       |                 |                     |                    |                            |                        |
| Secondary Standards  | ID #  | Check Date (in house)      | Scheduled Check          |                   |      |                            |                       |                               |             |                      |        |                     |      |                       |                 |                     |                    |                            |                        |
| Calibrator Box V2.1  | SE UWS 053 AA 1001  | 05-Jan-12 (in house check) | In house check: Jan-13   |                   |      |                            |                       |                               |             |                      |        |                     |      |                       |                 |                     |                    |                            |                        |
| Calibrated by:   | Name<br>Dominique Steffen   | Function<br>Technician     | Signature<br>            |                   |      |                            |                       |                               |             |                      |        |                     |      |                       |                 |                     |                    |                            |                        |
| Approved by:   | Fin Bomholt   | R&D Director               |                          |                   |      |                            |                       |                               |             |                      |        |                     |      |                       |                 |                     |                    |                            |                        |
|  |   |                            | Issued: January 23, 2012 |                   |      |                            |                       |                               |             |                      |        |                     |      |                       |                 |                     |                    |                            |                        |
| This calibration certificate shall not be reproduced except in full without written approval of the laboratory.  |   |                            |                          |                   |      |                            |                       |                               |             |                      |        |                     |      |                       |                 |                     |                    |                            |                        |

**Calibration Laboratory of**  
 Schmid & Partner  
 Engineering AG  
 Zeughausstrasse 43, 8004 Zurich, Switzerland



**S** Schweizerischer Kalibrierdienst  
**S** Service suisse d'étalonnage  
**C** Servizio svizzero di taratura  
**S** Swiss Calibration Service

Accredited by the Swiss Accreditation Service (SAS)  
 The Swiss Accreditation Service is one of the signatories to the EA  
 Multilateral Agreement for the recognition of calibration certificates

Accreditation No.: **SCS 108**

## Glossary

DAE data acquisition electronics  
 Connector angle information used in DASY system to align probe sensor X to the robot coordinate system.

## Methods Applied and Interpretation of Parameters

- *DC Voltage Measurement:* Calibration Factor assessed for use in DASY system by comparison with a calibrated instrument traceable to national standards. The figure given corresponds to the full scale range of the voltmeter in the respective range.
- *Connector angle:* The angle of the connector is assessed measuring the angle mechanically by a tool inserted. Uncertainty is not required.
- The following parameters as documented in the Appendix contain technical information as a result from the performance test and require no uncertainty.
  - *DC Voltage Measurement Linearity:* Verification of the Linearity at +10% and -10% of the nominal calibration voltage. Influence of offset voltage is included in this measurement.
  - *Common mode sensitivity:* Influence of a positive or negative common mode voltage on the differential measurement.
  - *Channel separation:* Influence of a voltage on the neighbor channels not subject to an input voltage.
  - *AD Converter Values with inputs shorted:* Values on the internal AD converter corresponding to zero input voltage
  - *Input Offset Measurement:* Output voltage and statistical results over a large number of zero voltage measurements.
  - *Input Offset Current:* Typical value for information; Maximum channel input offset current, not considering the input resistance.
  - *Input resistance:* Typical value for information: DAE input resistance at the connector, during internal auto-zeroing and during measurement.
  - *Low Battery Alarm Voltage:* Typical value for information. Below this voltage, a battery alarm signal is generated.
  - *Power consumption:* Typical value for information. Supply currents in various operating modes.

**DC Voltage Measurement**

A/D - Converter Resolution nominal

High Range: 1LSB = 6.1 $\mu$ V, full range = -100...+300 mV

Low Range: 1LSB = 61nV, full range = -1.....+3mV

DASY measurement parameters: Auto Zero Time: 3 sec; Measuring time: 3 sec

| Calibration Factors | X                        | Y                        | Z                        |
|---------------------|--------------------------|--------------------------|--------------------------|
| High Range          | 405.267 $\pm$ 0.1% (k=2) | 404.990 $\pm$ 0.1% (k=2) | 404.221 $\pm$ 0.1% (k=2) |
| Low Range           | 3.97762 $\pm$ 0.7% (k=2) | 3.99629 $\pm$ 0.7% (k=2) | 3.98707 $\pm$ 0.7% (k=2) |

**Connector Angle**

|   |                          |
|---|--------------------------|
| Connector Angle to be used in DASY system | 176.5 $\pm$ 1 $^{\circ}$ |
|---|--------------------------|



## Appendix

### 1. DC Voltage Linearity

| High Range        | Reading ( $\mu$ V) | Difference ( $\mu$ V) | Error (%) |
|-------------------|--------------------|-----------------------|-----------|
| Channel X + Input | 199991.77          | -2.52                 | -0.00     |
| Channel X + Input | 20001.19           | 1.01                  | 0.01      |
| Channel X - Input | -19996.52          | 3.93                  | -0.02     |
| Channel Y + Input | 199992.70          | -2.15                 | -0.00     |
| Channel Y + Input | 19999.00           | -1.14                 | -0.01     |
| Channel Y - Input | -19999.75          | 0.71                  | -0.00     |
| Channel Z + Input | 199991.55          | -3.11                 | -0.00     |
| Channel Z + Input | 19999.33           | -0.76                 | -0.00     |
| Channel Z - Input | -20001.23          | -0.67                 | 0.00      |

| Low Range         | Reading ( $\mu$ V) | Difference ( $\mu$ V) | Error (%) |
|-------------------|--------------------|-----------------------|-----------|
| Channel X + Input | 1999.14            | -1.60                 | -0.08     |
| Channel X + Input | 201.79             | 0.59                  | 0.29      |
| Channel X - Input | -198.19            | 0.48                  | -0.24     |
| Channel Y + Input | 1999.56            | -0.99                 | -0.05     |
| Channel Y + Input | 200.20             | -0.96                 | -0.48     |
| Channel Y - Input | -199.38            | -0.54                 | 0.27      |
| Channel Z + Input | 2000.07            | -0.52                 | -0.03     |
| Channel Z + Input | 200.32             | -0.83                 | -0.41     |
| Channel Z - Input | -199.60            | -0.78                 | 0.39      |

### 2. Common mode sensitivity

DASY measurement parameters: Auto Zero Time: 3 sec; Measuring time: 3 sec

|           | Common mode Input Voltage (mV) | High Range Average Reading ( $\mu$ V) | Low Range Average Reading ( $\mu$ V) |
|-----------|--------------------------------|---------------------------------------|--------------------------------------|
| Channel X | 200                            | 10.22                                 | 8.65                                 |
|           | - 200                          | -6.99                                 | -8.91                                |
| Channel Y | 200                            | -10.43                                | -11.02                               |
|           | - 200                          | 7.95                                  | 9.22                                 |
| Channel Z | 200                            | 14.25                                 | 13.66                                |
|           | - 200                          | -15.77                                | -14.99                               |

### 3. Channel separation

DASY measurement parameters: Auto Zero Time: 3 sec; Measuring time: 3 sec

|           | Input Voltage (mV) | Channel X ( $\mu$ V) | Channel Y ( $\mu$ V) | Channel Z ( $\mu$ V) |
|-----------|--------------------|----------------------|----------------------|----------------------|
| Channel X | 200                | -                    | -1.62                | -2.79                |
| Channel Y | 200                | 8.07                 | -                    | -2.95                |
| Channel Z | 200                | 7.90                 | 6.93                 | -                    |

**4. AD-Converter Values with inputs shorted**

DASY measurement parameters: Auto Zero Time: 3 sec; Measuring time: 3 sec

|           | High Range (LSB) | Low Range (LSB) |
|-----------|------------------|-----------------|
| Channel X | 15896            | 16218           |
| Channel Y | 16012            | 15924           |
| Channel Z | 15702            | 15710           |

**5. Input Offset Measurement**

DASY measurement parameters: Auto Zero Time: 3 sec; Measuring time: 3 sec

Input 10MΩ

|           | Average (μV) | min. Offset (μV) | max. Offset (μV) | Std. Deviation (μV) |
|-----------|--------------|------------------|------------------|---------------------|
| Channel X | 0.67         | -0.77            | 1.84             | 0.43                |
| Channel Y | -1.44        | -2.35            | -0.02            | 0.39                |
| Channel Z | -0.81        | -1.60            | 0.01             | 0.37                |

**6. Input Offset Current**

Nominal Input circuitry offset current on all channels: <25fA

**7. Input Resistance** (Typical values for information)

|           | Zeroing (kOhm) | Measuring (MOhm) |
|-----------|----------------|------------------|
| Channel X | 200            | 200              |
| Channel Y | 200            | 200              |
| Channel Z | 200            | 200              |

**8. Low Battery Alarm Voltage** (Typical values for information)

| Typical values | Alarm Level (VDC) |
|----------------|-------------------|
| Supply (+ Vcc) | +7.9              |
| Supply (- Vcc) | -7.6              |

**9. Power Consumption** (Typical values for information)

| Typical values | Switched off (mA) | Stand by (mA) | Transmitting (mA) |
|----------------|-------------------|---------------|-------------------|
| Supply (+ Vcc) | +0.01             | +6            | +14               |
| Supply (- Vcc) | -0.01             | -8            | -9                |