



Test Report No.: RF190418W001-5



# FCC TEST REPORT (PART 27)

Applicant:	Corporativo Lanix S.A. de C.V.
Address:	Carretera Internacional Hermosillo-Nogales Km 8.5, Hermosillo Sonora, Mexico

Manufacturer or Supplier:	Corporativo Lanix S.A. de C.V.
Address:	Carretera Internacional Hermosillo-Nogales Km 8.5, Hermosillo Sonora, Mexico
Product:	smartphone
Brand Name:	LANIX
Model Name:	Ilium M9s
FCC ID:	ZC4M9S
Date of tests:	Apr. 19, 2019 ~ May. 28, 2019

The tests have been carried out according to the requirements of the following standard:

- FCC Part 27, Subpart C, L     ANSI/TIA/EIA-603- D
- FCC Part 2                       ANSI/TIA/EIA-603-E     ANSI C63.26-2015

CONCLUSION: The submitted sample was found to COMPLY with the test requirement

Prepared by Alex Chen Engineer / Mobile Department	Approved by Luke Lu Manager / Mobile Department
Date: May. 29, 2019	Date: May. 29, 2019

This report is governed by, and incorporates by reference, CPS Conditions of Service as posted at the date of issuance of this report at <http://www.bureauveritas.com/home/about-us/our-business/cps/about-us/terms-conditions> and is intended for your exclusive use. Any copying or replication of this report to or for any other person or entity, or use of our name or trademark, is permitted only with our prior written permission. This report sets forth our findings solely with respect to the test samples identified herein. The results set forth in this report are not indicative or representative of the quality or characteristics of the lot from which a test sample was taken or any similar or identical product unless specifically and expressly noted. Our report includes all of the tests requested by you and the results thereof based upon the information that you provided to us. Measurement uncertainty is only provided upon request for accredited tests. You have 60 days from date of issuance of this report to notify us of any material error or omission caused by our negligence or if you require measurement uncertainty; provided, however, that such notice shall be in writing and shall specifically address the issue you wish to raise. A failure to raise such issue within the prescribed time shall constitute your unqualified acceptance of the completeness of this report, the tests conducted and the correctness of the report contents.



# TABLE OF CONTENTS

RELEASE CONTROL RECORD .....	4
<b>1 SUMMARY OF TEST RESULTS .....</b>	<b>5</b>
1.1 MEASUREMENT UNCERTAINTY .....	5
1.2 TEST SITE AND INSTRUMENTS .....	6
<b>2 GENERAL INFORMATION.....</b>	<b>7</b>
2.1 GENERAL DESCRIPTION OF EUT.....	7
2.2 CONFIGURATION OF SYSTEM UNDER TEST .....	10
2.3 DESCRIPTION OF SUPPORT UNITS .....	11
2.4 DESCRIPTION OF TEST MODES.....	11
2.5 GENERAL DESCRIPTION OF APPLIED STANDARDS .....	16
<b>3 TEST TYPES AND RESULTS .....</b>	<b>17</b>
3.1 OUTPUT POWER MEASUREMENT .....	17
3.1.1 LIMITS OF OUTPUT POWER MEASUREMENT .....	17
3.1.2 TEST PROCEDURES .....	17
3.1.3 TEST SETUP .....	18
3.1.4 TEST RESULTS .....	19
3.2 FREQUENCY STABILITY MEASUREMENT .....	32
3.2.1 LIMITS OF FREQUENCY STABILITY MEASUREMENT .....	32
3.2.2 TEST PROCEDURE .....	32
3.2.3 TEST SETUP .....	32
3.2.4 TEST RESULTS .....	33
3.3 OCCUPIED BANDWIDTH MEASUREMENT .....	44
3.3.1 LIMITS OF OCCUPIED BANDWIDTH MEASUREMENT .....	44
3.3.2 TEST SETUP .....	44
3.3.3 TEST PROCEDURES .....	44
3.3.4 TEST RESULTS .....	45
3.4 PEAK TO AVERAGE RATIO .....	51
3.4.1 LIMITS OF PEAK TO AVERAGE RATIO MEASUREMENT .....	51
3.4.2 TEST SETUP .....	51
3.4.3 TEST PROCEDURES .....	51
3.4.4 TEST RESULTS .....	52
3.5 BAND EDGE MEASUREMENT .....	60
3.5.1 LIMITS OF BAND EDGE MEASUREMENT .....	60
3.5.2 TEST SETUP .....	60
3.5.3 TEST PROCEDURES .....	61
3.5.4 TEST RESULTS .....	62
3.6 CONDUCTED SPURIOUS EMISSIONS.....	83
3.6.1 LIMITS OF CONDUCTED SPURIOUS EMISSIONS MEASUREMENT .....	83
3.6.2 TEST PROCEDURE .....	83
3.6.3 TEST SETUP .....	83
3.6.4 TEST RESULTS .....	84
3.7 RADIATED EMISSION MEASUREMENT .....	95
3.7.1 LIMITS OF RADIATED EMISSION MEASUREMENT .....	95
3.7.2 TEST PROCEDURES .....	95
3.7.3 DEVIATION FROM TEST STANDARD .....	95
3.7.4 TEST SETUP .....	96
3.7.5 TEST RESULTS .....	98



Test Report No.: RF190418W001-5

4	INFORMATION ON THE TESTING LABORATORIES .....	134
5	APPENDIX A – MODIFICATIONS RECORDERS FOR ENGINEERING CHANGES TO THE EUT BY THE LAB .....	135



Test Report No.: RF190418W001-5

## RELEASE CONTROL RECORD

ISSUE NO.	REASON FOR CHANGE	DATE ISSUED
RF190418W001-5	Original release	May. 29, 2019



# 1 SUMMARY OF TEST RESULTS

The EUT has been tested according to the following specifications:

APPLIED STANDARD: FCC Part 27 & Part 2			
STANDARD SECTION	TEST TYPE AND LIMIT	RESULT	REMARK
2.1046 27.50(d)(4)	Maximum Peak Output Power	PASS	Meet the requirement of limit.
2.1055 27.54	Frequency Stability	PASS	Meet the requirement of limit.
2.1049 27.53(h)	Occupied Bandwidth	PASS	Meet the requirement of limit.
27.50(d)(5)	Peak to average ratio	PASS	Meet the requirement of limit.
27.53(h)	Band Edge Measurements	PASS	Meet the requirement of limit.
2.1051 27.53(h)	Conducted Spurious Emissions	PASS	Meet the requirement of limit.
2.1053 27.53(h)	Radiated Spurious Emissions	PASS	Meet the requirement of limit. Minimum passing margin is -7.01dB at 34.850MHz.

## 1.1 MEASUREMENT UNCERTAINTY

Where relevant, the following measurement uncertainty levels have been estimated for tests performed on the EUT as specified in CISPR 16-4-2:

MEASUREMENT	UNCERTAINTY
Maximum Peak Output Power	±1dB
Frequency Stability	±39.27Hz
Radiated emissions	±4.48dB
Conducted emissions	±2 dB
Occupied Channel Bandwidth	±21.7KHz
Band Edge Measurements	±4.48dB
Peak to average ratio	±0.76dB

This uncertainty represents an expanded uncertainty expressed at approximately the 95% confidence level using a coverage factor of k=2.



## 1.2 TEST SITE AND INSTRUMENTS

Equipment	Manufacturer	Model No.	Serial No.	Last Cal.	Next Cal.
MXE EMI Receiver	KEYSIGHT	N9038A-544	MY54450026	Feb. 26, 19	Feb. 25, 20
EXA Signal Analyzer	KEYSIGHT	N9010A-526	MY54510322	Feb. 26, 19	Feb. 25, 20
Bilog Antenna 1	ETS-LINDGREN	3143B	00161964	Feb. 26, 19	Feb. 25, 20
Bilog Antenna 2	ETS-LINDGREN	3143B	00161965	Feb. 26, 19	Feb. 25, 20
Horn Antenna 1	ETS-LINDGREN	3117	00168728	Feb. 26, 19	Feb. 25, 20
Horn Antenna 2	ETS-LINDGREN	3117	00168692	Nov. 30, 18	Nov. 29, 19
Loop antenna	Daze	ZN30900A	0708	Oct. 23, 18	Oct. 22, 19
Horn Antenna (18GHz-40GHz)	N/A	QWH-SL-18-40-K-SG/QMS-00361	15433	Nov. 21, 18	Nov. 20, 19
Radio Communication Analyzer	ANRITSU	MT8820C	6201465426	Feb. 26, 19	Feb. 25, 20
Signal Pre-Amplifier	EMSI	EMC 9135	980249	Jul. 09, 18	Jul. 08, 19
Signal Pre-Amplifier	EMSI	EMC 012645B	980257	Jul. 09, 18	Jul. 08, 19
Signal Pre-Amplifier	EMSI	EMC 184045B	980259	Jul. 09, 18	Jul. 08, 19
3m Semi-anechoic Chamber	ETS-LINDGREN	9m*6m*6m	Euroshieldpn-CT0001143-1216	Feb. 26, 19	Feb. 25, 20
Test Software	E3	V 9.160323	N/A	N/A	N/A
Test Software	ADT	ADT_Radiated_V7.6.15.9.2	N/A	N/A	N/A
10dB Attenuator	JFW/USA	50HF-010-SM A	1505	Jul. 09, 18	Jul. 08, 19
Power Meter	Anritsu	ML2495A	1506002	Feb. 26, 19	Feb. 25, 20
Power Sensor	Anritsu	MA2411B	1339352	Feb. 26, 19	Feb. 25, 20
Humid & Temp Programmable Tester	Juyi	ITH-120-45-CP-AR	IAA1504-001	Jul. 09, 18	Jul. 08, 19
MXG Analog Microwave Signal Generator	KEYSIGHT	N5183A	MY50143024	Feb. 26, 19	Feb. 25, 20

- NOTE:**
1. The calibration interval of the above test instruments is 12 months or 24 months and the calibrations are traceable to CEPREI/CHINA, GRGT/CHINA and NIM/CHINA.
  2. The test was performed in 3m Semi-anechoic Chamber and RF Oven Room.
  3. The horn antenna is used only for the measurement of emission frequency above 1GHz if tested.
  4. The FCC Site Registration No. is 525120; The Designation No. is CN1171.



## 2 GENERAL INFORMATION

### 2.1 GENERAL DESCRIPTION OF EUT

<b>PRODUCT</b>	smartphone		
<b>BRAND NAME</b>	LANIX		
<b>MODEL NAME</b>	Ilium M9s		
<b>POWER SUPPLY</b>	5.0Vdc (adapter or host equipment) 3.85Vdc (Li-ion, battery)		
<b>MODULATION TECHNOLOGY</b>	<b>WCDMA IV</b>	BPSK, QPSK	
	<b>LTE</b>	QPSK, 16QAM	
<b>FREQUENCY RANGE</b>	<b>WCDMA IV</b>	1712.4MHz ~ 1752.6MHz	
	<b>LTE Band 4 Channel Bandwidth: 1.4MHz</b>	1710.7MHz ~ 1754.3MHz	
	<b>LTE Band 4 Channel Bandwidth: 3MHz</b>	1711.5MHz ~ 1753.5MHz	
	<b>LTE Band 4 Channel Bandwidth: 5MHz</b>	1712.5MHz ~ 1752.5MHz	
	<b>LTE Band 4 Channel Bandwidth: 10MHz</b>	1715.0MHz ~ 1750.0MHz	
	<b>LTE Band 4 Channel Bandwidth: 15MHz</b>	1717.5MHz ~ 1747.5MHz	
	<b>LTE Band 4 Channel Bandwidth: 20MHz</b>	1720.0MHz ~ 1745.0MHz	
	<b>LTE Band 12 Channel Bandwidth: 1.4MHz</b>	699.7MHz ~ 715.3MHz	
	<b>LTE Band 12 Channel Bandwidth: 3MHz</b>	700.5MHz ~ 714.5MHz	
	<b>LTE Band 12 Channel Bandwidth: 5MHz</b>	701.5MHz ~ 713.5MHz	
	<b>LTE Band 12 Channel Bandwidth: 10MHz</b>	704.0MHz ~ 711.0MHz	
	<b>EMISSION DESIGNATOR</b>	<b>WCDMA IV</b>	4M16F9W
		<b>LTE Band 4 Channel Bandwidth: 1.4MHz</b>	QPSK: 1M09G7D
16QAM: 1M09W7D			
<b>LTE Band 4 Channel Bandwidth: 3MHz</b>		QPSK: 2M69G7D	
		16QAM: 2M69W7D	
<b>LTE Band 4 Channel Bandwidth: 5MHz</b>		QPSK: 4M47G7D	
		16QAM: 4M47W7D	
<b>LTE Band 4 Channel Bandwidth: 10MHz</b>		QPSK: 8M95G7D	
	16QAM: 8M94W7D		
<b>LTE Band 4 Channel Bandwidth: 15MHz</b>	QPSK: 13M4G7D		
	16QAM: 13M4W7D		



Test Report No.: RF190418W001-5

<b>EMISSION DESIGNATOR</b>	<b>LTE Band 4 Channel Bandwidth: 20MHz</b>	QPSK: 17M9G7D 16QAM: 17M9W7D	
	<b>LTE Band 12 Channel Bandwidth: 1.4MHz</b>	QPSK: 1M09G7D 16QAM: 1M09W7D	
	<b>LTE Band 12 Channel Bandwidth: 3MHz</b>	QPSK: 2M69G7D 16QAM: 2M69W7D	
	<b>LTE Band 12 Channel Bandwidth: 5MHz</b>	QPSK: 4M48G7D 16QAM: 4M48W7D	
	<b>LTE Band 12 Channel Bandwidth: 10MHz</b>	QPSK: 8M98G7D 16QAM: 8M96W7D	
	<b>MAX. ERP/EIRP POWER</b>	<b>WCDMA IV</b>	64mW
<b>LTE Band 4 Channel Bandwidth: 1.4MHz</b>		68mW	
<b>LTE Band 4 Channel Bandwidth: 3MHz</b>		69mW	
<b>LTE Band 4 Channel Bandwidth: 5MHz</b>		69mW	
<b>LTE Band 4 Channel Bandwidth: 10MHz</b>		75mW	
<b>LTE Band 4 Channel Bandwidth: 15MHz</b>		68mW	
<b>LTE Band 4 Channel Bandwidth: 20MHz</b>		60mW	
<b>LTE Band 12 Channel Bandwidth: 1.4MHz</b>		55mW	
<b>LTE Band 12 Channel Bandwidth: 3MHz</b>		57mW	
<b>LTE Band 12 Channel Bandwidth: 5MHz</b>		58mW	
<b>LTE Band 12 Channel Bandwidth: 10MHz</b>		51mW	
<b>ANTENNA TYPE</b>		Fixed Internal Antenna	
<b>ANTENNA GAIN</b>		0.4dBi for WCDMA IV / LTE Band 4 -1.5dBi for LTE Band 12	
<b>HW VERSION</b>	V0.10		
<b>SW VERSION</b>	Ilium M9s_SW_01_V01		
<b>ACCESSORY DEVICE</b>	Refer to note as below		
<b>DATA CABLE</b>	USB cable: non-shielded, detachable, 1.0m Earphone cable: non-shielded, detachable, 1.2m		

**NOTE:**

1. For a more detailed features description, please refer to the manufacturer's specifications or the user's manual.





**Test Report No.: RF190418W001-5**

2. The EUT was powered by the following adapter:

ADAPTER	
BRAND:	Ianix
MODEL:	Ilium M9s-C
INPUT:	AC 100-240V, 250mA
OUTPUT:	DC 5V, 1550mA

3. The EUT matched the following USB cable and Earphone:

USB CABLE	
BRAND:	Ianix
MODEL:	M9s
SIGNAL LINE:	1.0 meter

EARPHONE	
BRAND:	Ianix
MODEL:	M9s
SIGNAL LINE:	1.2 meter

4. For the test results, the EUT had been tested with all conditions. But only the worst case was shown in test report.

## 2.2 CONFIGURATION OF SYSTEM UNDER TEST

### FOR RADIATION EMISSION TEST

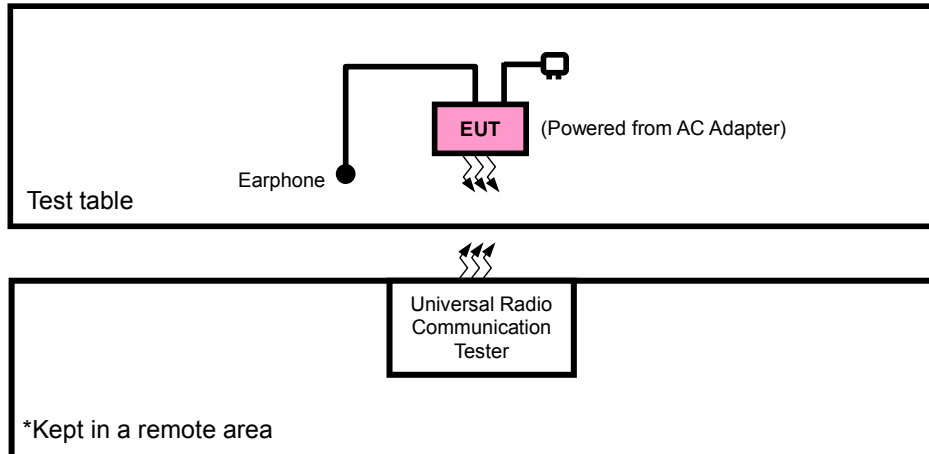

### FOR CONDUCTED & E.R.P./E.I.R.P TEST

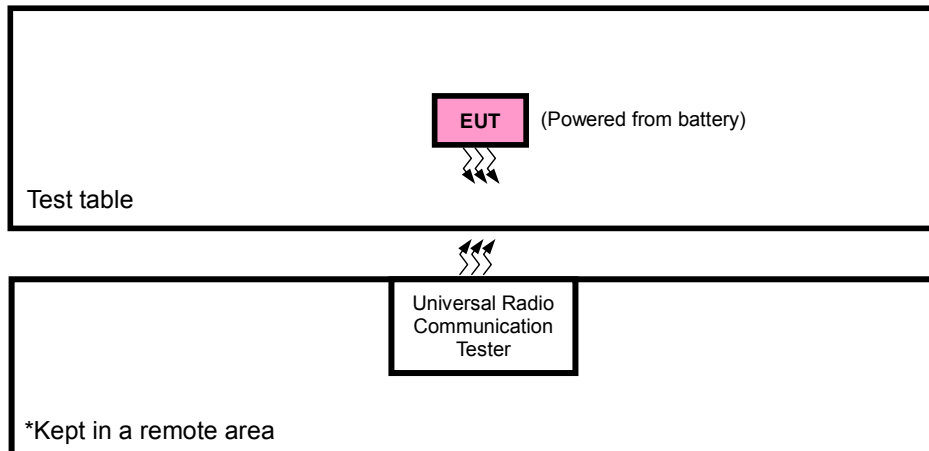



### 2.3 DESCRIPTION OF SUPPORT UNITS

The EUT has been tested as an independent unit together with other necessary accessories or support units. The following support units or accessories were used to form a representative test configuration during the tests.

NO.	PRODUCT	BRAND	MODEL NO.	SERIAL NO.	FCC ID
1	DC source	LONG WEI	PS-6403D	010934269	N/A
2	PC	HP	A6608CN	3CR83825X3	N/A

NO.	SIGNAL CABLE DESCRIPTION OF THE ABOVE SUPPORT UNITS
1	DC Line: Unshielded, Detachable 1.0m
2	AC Line: Unshielded, Detachable 1.5m

**NOTE:**

1. All power cords of the above support units are non shielded (1.8m).

### 2.4 DESCRIPTION OF TEST MODES

Pre-Scan has been conducted to determine the worst-case mode from all possible combinations between available modulations, data rates, XYZ axis and antenna ports. The worst case in ERP/EIRP and radiated emission was found when positioned on X-plane for WCDMA/LTE. Following channel(s) was (were) selected for the final test as listed below:

EUT CONFIGURE MODE	DESCRIPTION
A	EUT + Adapter + USB Cable + Earphone with WCDMA or LTE link
B	EUT + Battery with WCDMA or LTE link

#### WCDMA MODE

EUT CONFIGURE MODE	TEST ITEM	AVAILABLE CHANNEL	TESTED CHANNEL	MODE
B	EIRP	1312 to 1513	1312, 1413, 1513	WCDMA
B	FREQUENCY STABILITY	1312 to 1513	1312, 1513	WCDMA
B	OCCUPIED BANDWIDTH	1312 to 1513	1312, 1413, 1513	WCDMA
B	BAND EDGE	1312 to 1513	1312, 1513	WCDMA
B	PEAK TO AVERAGE RATIO	1312 to 1513	1312, 1413, 1513	WCDMA
B	CONDUCTED EMISSION	1312 to 1513	1312, 1413, 1513	WCDMA
A	RADIATED EMISSION	1312 to 1513	1312, 1413, 1513	WCDMA



Test Report No.: RF190418W001-5

LTE BAND 4

EUT CONFIGURE MODE	TEST ITEM	AVAILABLE CHANNEL	TESTED CHANNEL	CHANNEL BANDWIDTH	MODULATION	MODE
B	EIRP	19957 to 20393	19957, 20175, 20393	1.4MHz	QPSK, 16QAM	1 RB / 0 RB Offset
		19965 to 20385	19965, 20175, 20385	3MHz	QPSK, 16QAM	1 RB / 0 RB Offset
		19975 to 20375	19975, 20175, 20375	5MHz	QPSK, 16QAM	1 RB / 0 RB Offset
		20000 to 20350	20000, 20175, 20350	10MHz	QPSK, 16QAM	1 RB / 0 RB Offset
		20025 to 20325	20025, 20175, 20325	15MHz	QPSK, 16QAM	1 RB / 0 RB Offset
		20050 to 20300	20050, 20175, 20300	20MHz	QPSK, 16QAM	1 RB / 0 RB Offset
B	FREQUENCY STABILITY	19957 to 20393	19957, 20393	1.4MHz	QPSK	1 RB / 0 RB Offset
		19965 to 20385	19965, 20385	3MHz	QPSK	1 RB / 0 RB Offset
		19975 to 20375	19975, 20375	5MHz	QPSK	1 RB / 0 RB Offset
		20000 to 20350	20000, 20350	10MHz	QPSK	1 RB / 0 RB Offset
		20025 to 20325	20025, 20325	15MHz	QPSK	1 RB / 0 RB Offset
		20050 to 20300	20050, 20300	20MHz	QPSK	1 RB / 0 RB Offset
B	OCCUPIED BANDWIDTH	19957 to 20393	19957, 20175, 20393	1.4MHz	QPSK, 16QAM	6 RB / 0 RB Offset
		19965 to 20385	19965, 20175, 20385	3MHz	QPSK, 16QAM	15 RB / 0 RB Offset
		19975 to 20375	19975, 20175, 20375	5MHz	QPSK, 16QAM	25 RB / 0 RB Offset
		20000 to 20350	20000, 20175, 20350	10MHz	QPSK, 16QAM	50 RB / 0 RB Offset
		20025 to 20325	20025, 20175, 20325	15MHz	QPSK, 16QAM	75 RB / 0 RB Offset
		20050 to 20300	20050, 20175, 20300	20MHz	QPSK, 16QAM	100 RB / 0 RB Offset
B	PEAK TO AVERAGE RATIO	19957 to 20393	19957, 20175, 20393	1.4MHz	QPSK, 16QAM	1 RB / 0 RB Offset
		19965 to 20385	19965, 20175, 20385	3MHz	QPSK, 16QAM	1 RB / 0 RB Offset
		19975 to 20375	19975, 20175, 20375	5MHz	QPSK, 16QAM	1 RB / 0 RB Offset
		20000 to 20350	20000, 20175, 20350	10MHz	QPSK, 16QAM	1 RB / 0 RB Offset
		20025 to 20325	20025, 20175, 20325	15MHz	QPSK, 16QAM	1 RB / 0 RB Offset
		20050 to 20300	20050, 20175, 20300	20MHz	QPSK, 16QAM	1 RB / 0 RB Offset
B	BAND EDGE	19957 to 20393	19957	1.4MHz	QPSK, 16QAM	1 RB / 0 RB Offset 6 RB / 0 RB Offset
			20393	1.4MHz	QPSK, 16QAM	1 RB / 5 RB Offset 6 RB / 0 RB Offset
		19965 to 20385	19965	3MHz	QPSK, 16QAM	1 RB / 0 RB Offset 15 RB / 0 RB Offset
			20385	3MHz	QPSK, 16QAM	1 RB / 14 RB Offset 15 RB / 0 RB Offset
		19975 to 20375	19975	5MHz	QPSK, 16QAM	1 RB / 0 RB Offset 25 RB / 0 RB Offset
			20375	5MHz	QPSK, 16QAM	1 RB / 24 RB Offset 25 RB / 0 RB Offset
		20000 to 20350	20000	10MHz	QPSK, 16QAM	1 RB / 0 RB Offset 50 RB / 0 RB Offset
			20350	10MHz	QPSK, 16QAM	1 RB / 49 RB Offset 50 RB / 0 RB Offset



Test Report No.: RF190418W001-5

B	BAND EDGE	20025 to 20325	20025	15MHz	QPSK, 16QAM	1 RB / 0 RB Offset
						75 RB / 0 RB Offset
		20050 to 20300	20325	15MHz	QPSK, 16QAM	1 RB / 74 RB Offset
						75 RB / 0 RB Offset
			20050	20MHz	QPSK, 16QAM	1 RB / 0 RB Offset
						100 RB / 0 RB Offset
	20300	20MHz	QPSK, 16QAM	1 RB / 99 RB Offset		
				100 RB / 0 RB Offset		
B	CONDCUDED EMISSION	19957 to 20393	19957, 20175, 20393	1.4MHz	QPSK	1 RB / 0 RB Offset
		19965 to 20385	19965, 20175, 20385	3MHz	QPSK	1 RB / 0 RB Offset
		19975 to 20375	19975, 20175, 20375	5MHz	QPSK	1 RB / 0 RB Offset
		20000 to 20350	20000, 20175, 20350	10MHz	QPSK	1 RB / 0 RB Offset
		20025 to 20325	20025, 20175, 20325	15MHz	QPSK	1 RB / 0 RB Offset
		20050 to 20300	20050, 20175, 20300	20MHz	QPSK	1 RB / 0 RB Offset
A	RADIATED EMISSION	19957 to 20393	20175	1.4MHz	QPSK	1 RB / 0 RB Offset
		19965 to 20385	19965, 20175, 20385	3MHz	QPSK	1 RB / 0 RB Offset
		19975 to 20375	20175	5MHz	QPSK	1 RB / 0 RB Offset
		20000 to 20350	20175	10MHz	QPSK	1 RB / 0 RB Offset
		20025 to 20325	20175	15MHz	QPSK	1 RB / 0 RB Offset
		20050 to 20300	20175	20MHz	QPSK	1 RB / 0 RB Offset

**Note:** This device was tested under all bandwidths, RB configurations and modulations. The worst case was found in QPSK modulation.



Test Report No.: RF190418W001-5

LTE BAND 12

EUT CONFIGURE MODE	TEST ITEM	AVAILABLE CHANNEL	TESTED CHANNEL	CHANNEL BANDWIDTH	MODULATION	MODE		
B	ERP	23017 to 23173	23017, 23095 , 23173	1.4MHz	QPSK,16QAM	1 RB / 0 RB Offset		
		23025 to 23165	23025, 23095 ,23165	3MHz	QPSK,16QAM	1 RB / 0 RB Offset		
		23035 to 23155	23035, 23095 ,23155	5MHz	QPSK,16QAM	1 RB / 0 RB Offset		
		23060 to 23130	23060, 23095 ,23130	10MHz	QPSK,16QAM	1 RB / 0 RB Offset		
B	FREQUENCY STABILITY	23017 to 23173	23017, 23173	1.4MHz	QPSK	1 RB / 0 RB Offset		
		23025 to 23165	23025, 23165	3MHz	QPSK	1 RB / 0 RB Offset		
		23035 to 23155	23035, 23155	5MHz	QPSK	1 RB / 0 RB Offset		
		23060 to 23130	23060, 23130	10MHz	QPSK	1 RB / 0 RB Offset		
B	OCCUPIED BANDWIDTH	23017 to 23173	23017, 23095 , 23173	1.4MHz	QPSK,16QAM	6 RB / 0 RB Offset		
		23025 to 23165	23025, 23095 ,23165	3MHz	QPSK,16QAM	15 RB / 0 RB Offset		
		23035 to 23155	23035, 23095 ,23155	5MHz	QPSK,16QAM	25 RB / 0 RB Offset		
		23060 to 23130	23060, 23095 ,23130	10MHz	QPSK,16QAM	50 RB / 0 RB Offset		
B	PEAK TO AVERAGE RATIO	23017 to 23173	23017, 23095 , 23173	1.4MHz	QPSK, 16QAM	1 RB / 0 RB Offset		
		23025 to 23165	23025, 23095 ,23165	3MHz	QPSK, 16QAM	1 RB / 0 RB Offset		
		23035 to 23155	23035, 23095 ,23155	5MHz	QPSK, 16QAM	1 RB / 0 RB Offset		
		23060 to 23130	23060, 23095 ,23130	10MHz	QPSK, 16QAM	1 RB / 0 RB Offset		
B	BAND EDGE	23017 to 23173	23017	1.4MHz	QPSK, 16QAM	1 RB / 0 RB Offset		
			23173	1.4MHz	QPSK, 16QAM	6 RB / 0 RB Offset		
		23025 to 23165	23025	3MHz	QPSK, 16QAM	1 RB / 5 RB Offset		
			23165	3MHz	QPSK, 16QAM	6 RB / 0 RB Offset		
		23035 to 23155	23035	5MHz	QPSK, 16QAM	1 RB / 0 RB Offset		
			23155	5MHz	QPSK, 16QAM	15 RB / 0 RB Offset		
		23060 to 23130	23060	10MHz	QPSK, 16QAM	1 RB / 14 RB Offset		
			23130	10MHz	QPSK, 16QAM	15 RB / 0 RB Offset		
		B	CONDCUETED EMISSION	23017 to 23173	23017, 23095 , 23173	1.4MHz	QPSK	1 RB / 0 RB Offset
				23025 to 23165	23025, 23095 ,23165	3MHz	QPSK	1 RB / 0 RB Offset
				23035 to 23155	23035, 23095 ,23155	5MHz	QPSK	1 RB / 0 RB Offset
				23060 to 23130	23060, 23095 ,23130	10MHz	QPSK	1 RB / 0 RB Offset
A	RADIATED EMISSION	23017 to 23173	23095	1.4MHz	QPSK	1 RB / 0 RB Offset		
		23025 to 23165	23025, 23095 ,23165	3MHz	QPSK	1 RB / 0 RB Offset		
		23035 to 23155	23095	5MHz	QPSK	1 RB / 0 RB Offset		
		23060 to 23130	23095	10MHz	QPSK	1 RB / 0 RB Offset		

**Note:** This device was tested under all bandwidths, RB configurations and modulations. The worst case was found in QPSK modulation.



Test Report No.: RF190418W001-5

**TEST CONDITION:**

TEST ITEM	ENVIRONMENTAL CONDITIONS	INPUT POWER	TESTED BY
EIRP(ERP)	24deg. C, 60%RH	3.85Vdc from Battery	Star Le
FREQUENCY STABILITY	24deg. C, 61%RH	DC 3.5V/3.8V/4.2V	Rain Wang
OCCUPIED BANDWIDTH	24deg. C, 61%RH	3.85Vdc from Battery	Rain Wang
PEAK TO AVERAGE RATIO	24deg. C, 61%RH	3.85Vdc from Battery	Rain Wang
BAND EDGE	24deg. C, 61%RH	3.85Vdc from Battery	Rain Wang
CONDCUDED EMISSION	24deg. C, 61%RH	3.85Vdc from Battery	Rain Wang
RADIATED EMISSION	24deg. C, 60%RH	5Vdc from adapter	Star Le



Test Report No.: RF190418W001-5

## 2.5 GENERAL DESCRIPTION OF APPLIED STANDARDS

The EUT is a RF product. According to the specifications of the manufacturer, it must comply with the requirements of the following standards:

**FCC 47 CFR Part 2**

**FCC 47 CFR Part 27**

**KDB 971168 D01 Power Meas License Digital Systems v03r01**

**ANSI/TIA/EIA-603-D**

**ANSI/TIA/EIA-603-E**

**ANSI C63.26-2015**

**NOTE:** All test items have been performed and recorded as per the above standards.





### 3 TEST TYPES AND RESULTS

#### 3.1 OUTPUT POWER MEASUREMENT

##### 3.1.1 LIMITS OF OUTPUT POWER MEASUREMENT

Fixed, mobile, and portable (hand-held) stations operating in the 1710–1755 MHz band are limited to 1 watt EIRP.

Portable stations (hand-held devices) operating in the 699-716 MHz bands are limited to 3 watts ERP.

##### 3.1.2 TEST PROCEDURES

###### EIRP / ERP MEASUREMENT:

- a. The EUT was set up for the maximum power with LTE link data modulation. The power was measured with R&S Spectrum Analyzer. All measurements were done at 3 channels (low, middle and high operational frequency range). RBW and VBW is 10MHz for LTE.
- b. E.I.R.P power measurement. In the semi-anechoic chamber, EUT placed on the 0.8m height of Turn Table, rotated the table around 360 degrees to search the maximum radiation power and receiver antenna shall be rotated vertical and horizontal polarization and moved height from 1m to 4m to find the maximum polar radiated power. The “Read Value” is the spectrum reading the maximum power value.
- c. The substitution horn antenna is substituted for EUT at the same position and signals generator export the CW signal to the substitution antenna via a TX cable. Rotated the Turn Table and moved receiving antenna to find the maximum radiation power. Adjust output power level of S.G to get a Value of spectrum reading equal to “Read Value” of step a. Record the power level of S.G
- d.  $EIRP = \text{Output power level of S.G} - \text{TX cable loss} + \text{Antenna gain of substitution horn}$
- e.  $E.R.P = E.I.R.P - 2.15 \text{ dB}$

###### CONDUCTED POWER MEASUREMENT:

- a. The EUT was set up for the maximum power with LTE link data modulation and link up with simulator.
- b. Set the EUT to transmit under low, middle and high channel and record the power level shown on simulator.

### 3.1.3 TEST SETUP

**EIRP / ERP Measurement:**

<Radiated Emission below or equal 1 GHz>

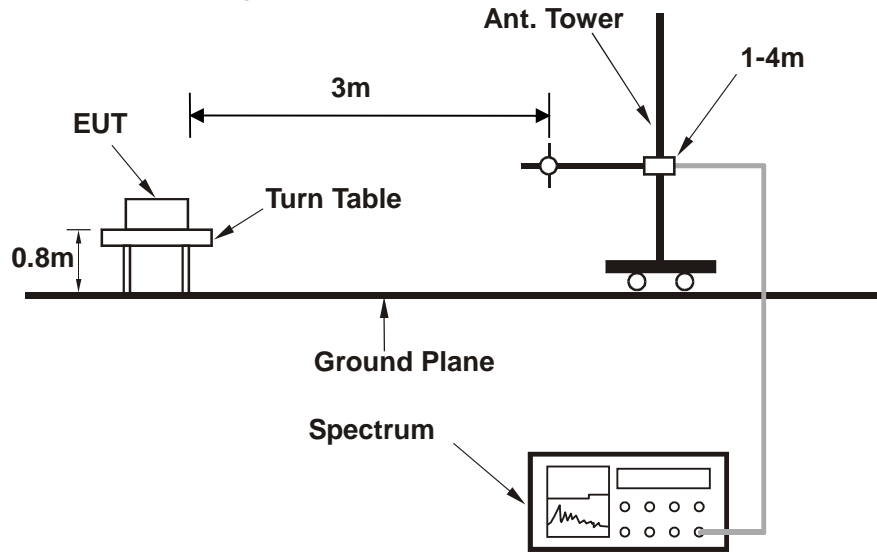

<Radiated Emission above 1 GHz>

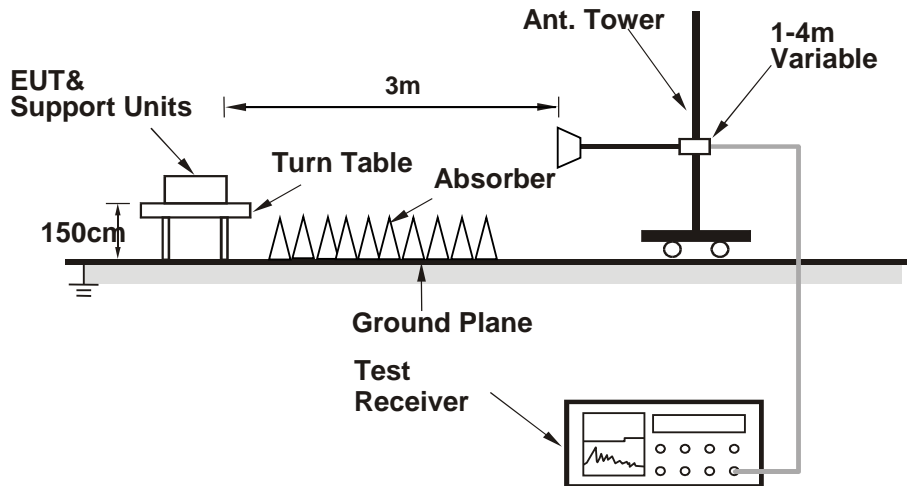

For the actual test configuration, please refer to the attached file (Test Setup Photo).

**CONDUCTED POWER MEASUREMENT:**

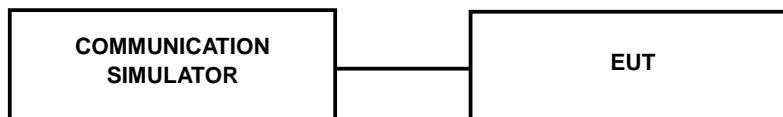



Test Report No.: RF190418W001-5

### 3.1.4 TEST RESULTS

#### AVERAGE CONDUCTED OUTPUT POWER (dBm)

Band	WCDMA IV		
Channel	1312	1413	1513
Frequency (MHz)	1712.4	1732.6	1752.6
RMC 12.2K	22.76	22.77	22.72
HSPA			
HSDPA Subtest-1	21.88	21.89	21.84
HSDPA Subtest-2	21.81	21.82	21.77
HSDPA Subtest-3	21.27	21.28	21.23
HSDPA Subtest-4	21.23	21.24	21.19
DC-HSDPA Subtest-1	21.84	21.85	21.80
DC-HSDPA Subtest-2	21.78	21.79	21.74
DC-HSDPA Subtest-3	21.23	21.24	21.19
DC-HSDPA Subtest-4	21.20	21.21	21.16
HSUPA Subtest-1	21.83	21.84	21.79
HSUPA Subtest-2	19.91	19.92	19.87
HSUPA Subtest-3	20.78	20.79	20.74
HSUPA Subtest-4	19.86	19.87	19.82
HSUPA Subtest-5	21.77	21.78	21.73
HSPA+ Subtest-1	21.45	21.46	21.41



Test Report No.: RF190418W001-5

LTE Band 4							
BW	Modulation	RB Size	RB Offset	Low CH 19957	Mid CH 20175	High CH 20393	MPR
				Frequency 1710.7 MHz	Frequency 1732.5 MHz	Frequency 1754.3 MHz	
1.4MHz	QPSK	1	0	22.01	22.02	22.09	0
		1	2	21.92	21.93	22.00	0
		1	5	21.82	21.83	21.90	0
		3	0	21.99	22.00	22.07	0
		3	1	21.90	21.91	21.98	0
		3	3	21.80	21.81	21.88	0
	16QAM	6	0	20.99	21.00	21.07	1
		1	0	21.40	21.41	21.48	1
		1	2	21.37	21.38	21.45	1
		1	5	21.23	21.24	21.31	1
		3	0	21.39	21.40	21.47	1
		3	1	21.36	21.37	21.44	1
		3	3	21.22	21.23	21.30	1
		6	0	20.21	20.22	20.29	2
BW	Modulation	RB Size	RB Offset	Low CH 19965	Mid CH 20175	High CH 20385	MPR
				Frequency 1711.5 MHz	Frequency 1732.5 MHz	Frequency 1753.5 MHz	
3 MHz	QPSK	1	0	22.02	22.03	22.10	0
		1	7	21.93	21.94	22.01	0
		1	14	21.83	21.84	21.91	0
		8	0	21.17	21.18	21.25	1
		8	3	21.04	21.05	21.12	1
		8	7	21.08	21.09	21.16	1
		15	0	21.00	21.01	21.08	1
	16QAM	1	0	21.41	21.42	21.49	1
		1	7	21.38	21.39	21.46	1
		1	14	21.24	21.25	21.32	1
		8	0	20.19	20.20	20.27	2
		8	3	20.14	20.15	20.22	2
		8	7	20.17	20.18	20.25	2
		15	0	20.22	20.23	20.30	2



Test Report No.: RF190418W001-5

LTE Band 4							
BW	Modulation	RB Size	RB Offset	Low CH 19975	Mid CH 20175	High CH 20375	MPR
				Frequency 1712.5 MHz	Frequency 1732.5 MHz	Frequency 1752.5 MHz	
5 MHz	QPSK	1	0	22.05	22.06	22.13	0
		1	12	21.96	21.97	22.04	0
		1	24	21.86	21.87	21.94	0
		12	0	21.20	21.21	21.28	1
		12	6	21.07	21.08	21.15	1
		12	13	21.11	21.12	21.19	1
		25	0	21.03	21.04	21.11	1
	16QAM	1	0	21.44	21.45	21.52	1
		1	12	21.41	21.42	21.49	1
		1	24	21.27	21.28	21.35	1
		12	0	20.22	20.23	20.30	2
		12	6	20.17	20.18	20.25	2
		12	13	20.20	20.21	20.28	2
		25	0	20.25	20.26	20.33	2
BW	Modulation	RB Size	RB Offset	Low CH 20000	Mid CH 20175	High CH 20350	MPR
				Frequency 1715 MHz	Frequency 1732.5 MHz	Frequency 1750 MHz	
10 MHz	QPSK	1	0	22.09	22.10	22.17	0
		1	24	22.00	22.01	22.08	0
		1	49	21.90	21.91	21.98	0
		25	0	21.24	21.25	21.32	1
		25	12	21.11	21.12	21.19	1
		25	25	21.15	21.16	21.23	1
		50	0	21.07	21.08	21.15	1
	16QAM	1	0	21.48	21.49	21.56	1
		1	24	21.45	21.46	21.53	1
		1	49	21.31	21.32	21.39	1
		25	0	20.26	20.27	20.34	2
		25	12	20.21	20.22	20.29	2
		25	25	20.24	20.25	20.32	2
		50	0	20.29	20.30	20.37	2



Test Report No.: RF190418W001-5

LTE Band 4							
BW	Modulation	RB Size	RB Offset	Low CH 20025	Mid CH 20175	High CH 20325	MPR
				Frequency 1717.5 MHz	Frequency 1732.5 MHz	Frequency 1747.5 MHz	
15 MHz	QPSK	1	0	22.15	22.16	22.23	0
		1	37	22.06	22.07	22.14	0
		1	74	21.96	21.97	22.04	0
		36	0	21.30	21.31	21.38	1
		36	19	21.17	21.18	21.25	1
		36	39	21.21	21.22	21.29	1
		75	0	21.13	21.14	21.21	1
	16QAM	1	0	21.54	21.55	21.62	1
		1	37	21.51	21.52	21.59	1
		1	74	21.37	21.38	21.45	1
		36	0	20.32	20.33	20.40	2
		36	19	20.27	20.28	20.35	2
		36	39	20.30	20.31	20.38	2
		75	0	20.35	20.36	20.43	2
BW	Modulation	RB Size	RB Offset	Low CH 20050	Mid CH 20175	High CH 20300	MPR
				Frequency 1720 MHz	Frequency 1732.5 MHz	Frequency 1745 MHz	
20MHz	QPSK	1	0	22.18	22.19	22.26	0
		1	50	22.09	22.10	22.17	0
		1	99	21.99	22.00	22.07	0
		50	0	21.33	21.34	21.41	1
		50	25	21.20	21.21	21.28	1
		50	50	21.24	21.25	21.32	1
		100	0	21.16	21.17	21.24	1
	16QAM	1	0	21.57	21.58	21.65	1
		1	50	21.54	21.55	21.62	1
		1	99	21.40	21.41	21.48	1
		50	0	20.35	20.36	20.43	2
		50	25	20.30	20.31	20.38	2
		50	50	20.33	20.34	20.41	2
		100	0	20.38	20.39	20.46	2



Test Report No.: RF190418W001-5

LTE Band 12							
BW	Modulation	RB Size	RB Offset	Low CH 23017	Mid CH 23095	High CH 23173	MPR
				Frequency 699.7 MHz	Frequency 707.5 MHz	Frequency 715.3 MHz	
1.4 MHz	QPSK	1	0	21.93	21.96	21.91	0
		1	2	21.91	21.94	21.89	0
		1	5	21.87	21.90	21.85	0
		3	0	21.91	21.94	21.89	0
		3	1	21.89	21.92	21.87	0
		3	3	21.85	21.88	21.83	0
	16QAM	6	0	21.10	21.13	21.08	1
		1	0	21.12	21.15	21.10	1
		1	2	21.09	21.12	21.07	1
		1	5	21.07	21.10	21.05	1
		3	0	21.11	21.14	21.09	1
		3	1	21.08	21.11	21.06	1
		3	3	21.06	21.09	21.04	1
		6	0	20.18	20.21	20.16	2
LTE Band 12							
BW	Modulation	RB Size	RB Offset	Low CH 23025	Mid CH 23095	High CH 23165	MPR
				Frequency 700.5 MHz	Frequency 707.5 MHz	Frequency 714.5 MHz	
3 MHz	QPSK	1	0	21.97	22.00	21.95	0
		1	7	21.95	21.98	21.93	0
		1	14	21.91	21.94	21.89	0
		8	0	21.24	21.27	21.22	1
		8	3	21.20	21.23	21.18	1
		8	7	21.17	21.20	21.15	1
		15	0	21.14	21.17	21.12	1
	16QAM	1	0	21.16	21.19	21.14	1
		1	7	21.13	21.16	21.11	1
		1	14	21.11	21.14	21.09	1
		8	0	20.43	20.46	20.41	2
		8	3	20.40	20.43	20.38	2
		8	7	20.31	20.34	20.29	2
		15	0	20.22	20.25	20.20	2



Test Report No.: RF190418W001-5

LTE Band 12							
BW	Modulation	RB Size	RB Offset	Low CH 23035	Mid CH 23095	High CH 23155	MPR
				Frequency 701.5 MHz	Frequency 707.5 MHz	Frequency 713.5 MHz	
5 MHz	QPSK	1	0	22.03	22.06	22.01	0
		1	12	22.01	22.04	21.99	0
		1	24	21.97	22.00	21.95	0
		12	0	21.30	21.33	21.28	1
		12	6	21.26	21.29	21.24	1
		12	13	21.23	21.26	21.21	1
		25	0	21.20	21.23	21.18	1
	16QAM	1	0	21.22	21.25	21.20	1
		1	12	21.19	21.22	21.17	1
		1	24	21.17	21.20	21.15	1
		12	0	20.49	20.52	20.47	2
		12	6	20.46	20.49	20.44	2
		12	13	20.37	20.40	20.35	2
		25	0	20.28	20.31	20.26	2
LTE Band 12							
BW	Modulation	RB Size	RB Offset	Low CH 23060	Mid CH 23095	High CH 23130	MPR
				Frequency 704 MHz	Frequency 707.5 MHz	Frequency 711 MHz	
10 MHz	QPSK	1	0	22.06	22.09	22.04	0
		1	24	22.04	22.07	22.02	0
		1	49	22.00	22.03	21.98	0
		25	0	21.33	21.36	21.31	1
		25	12	21.29	21.32	21.27	1
		25	25	21.26	21.29	21.24	1
		50	0	21.23	21.26	21.21	1
	16QAM	1	0	21.25	21.28	21.23	1
		1	24	21.22	21.25	21.20	1
		1	49	21.20	21.23	21.18	1
		25	0	20.52	20.55	20.50	2
		25	12	20.49	20.52	20.47	2
		25	25	20.40	20.43	20.38	2
		50	0	20.31	20.34	20.29	2





Test Report No.: RF190418W001-5

**EIRP / ERP**

**WCDMA IV**

Channel	Frequency (MHz)	SPA LVL (dBm)	Correction Factor(dB)	EIRP(dBm)	EIRP(mW)	Polarization (H/V)
1312	1712.40	-29.26	41.39	12.13	16.33	H
1413	1732.60	-28.58	41.36	12.78	18.97	H
1513	1752.60	-28.87	42.63	13.76	23.76	H
1312	1712.40	-26.35	44.17	17.82	60.48	V
1413	1732.60	-26.12	44.20	18.08	<b>64.27</b>	V
1513	1752.60	-27.24	44.35	17.11	61.45	V

**REMARKS:** 1. EIRP Output Power (dBm) = SPA LVL (dBm) + Correction Factor (dB).  
 2. Correction factor (dB) = Free Space Loss + Antenna Factor + Cable Loss

**LTE BAND 4**

**CHANNEL BANDWIDTH: 1.4MHz QPSK**

Channel	Frequency (MHz)	SPA LVL (dBm)	Correction Factor(dB)	EIRP(dBm)	EIRP(mW)	Polarization (H/V)	LIMIT (W)
19957	1710.7	-28.83	41.29	12.46	17.64	H	1
20175	1732.5	-30.03	41.36	11.33	13.58	H	1
20393	1754.3	-28.90	42.74	13.84	24.20	H	1
19957	1710.7	-25.90	44.25	18.35	<b>68.31</b>	V	1
20175	1732.5	-25.96	44.20	18.24	66.68	V	1
20393	1754.3	-26.07	44.09	18.02	63.31	V	1

**CHANNEL BANDWIDTH: 1.4MHz 16QAM**

Channel	Frequency (MHz)	SPA LVL (dBm)	Correction Factor(dB)	EIRP(dBm)	EIRP(mW)	Polarization (H/V)	LIMIT (W)
19957	1710.7	-29.70	41.29	11.59	14.43	H	1
20175	1732.5	-30.96	41.36	10.40	10.96	H	1
20393	1754.3	-29.86	42.74	12.88	19.40	H	1
19957	1710.7	-26.77	44.25	17.48	55.91	V	1
20175	1732.5	-26.89	44.20	17.31	53.83	V	1
20393	1754.3	-27.03	44.09	17.06	50.76	V	1



Test Report No.: RF190418W001-5

**LTE BAND 4**

**CHANNEL BANDWIDTH: 3MHz QPSK**

Channel	Frequency (MHz)	SPA LVL (dBm)	Correction Factor(dB)	EIRP(dBm)	EIRP(mW)	Polarization (H/V)	LIMIT (W)
19965	1711.5	-28.81	41.27	12.46	17.61	H	1
20175	1732.5	-30.09	41.36	11.27	13.40	H	1
20385	1753.5	-28.85	42.76	13.91	24.59	H	1
19965	1711.5	-25.88	44.26	18.38	<b>68.90</b>	V	1
20175	1732.5	-26.02	44.20	18.18	65.77	V	1
20385	1753.5	-26.02	44.23	18.21	66.25	V	1

**CHANNEL BANDWIDTH: 3MHz 16QAM**

Channel	Frequency (MHz)	SPA LVL (dBm)	Correction Factor(dB)	EIRP(dBm)	EIRP(mW)	Polarization (H/V)	LIMIT (W)
19965	1711.5	-29.88	41.27	11.39	13.76	H	1
20175	1732.5	-30.98	41.36	10.38	10.91	H	1
20385	1753.5	-29.84	42.76	12.92	19.57	H	1
19965	1711.5	-26.95	44.26	17.31	53.85	V	1
20175	1732.5	-26.91	44.20	17.29	53.58	V	1
20385	1753.5	-27.01	44.23	17.22	52.75	V	1

**LTE BAND 4**

**CHANNEL BANDWIDTH: 5MHz QPSK**

Channel	Frequency (MHz)	SPA LVL (dBm)	Correction Factor(dB)	EIRP(dBm)	EIRP(mW)	Polarization (H/V)	LIMIT (W)
19975	1712.5	-28.87	41.39	12.52	17.86	H	1
20175	1732.5	-30.04	41.36	11.32	13.55	H	1
20375	1752.5	-28.80	42.63	13.83	24.15	H	1
19975	1712.5	-25.94	44.17	18.23	66.47	V	1
20175	1732.5	-25.97	44.20	18.23	66.53	V	1
20375	1752.5	-25.97	44.35	18.38	<b>68.79</b>	V	1



Test Report No.: RF190418W001-5

**CHANNEL BANDWIDTH: 5MHz 16QAM**

Channel	Frequency (MHz)	SPA LVL (dBm)	Correction Factor(dB)	EIRP(dBm)	EIRP(mW)	Polarization (H/V)	LIMIT (W)
19975	1712.5	-29.70	41.39	11.69	14.75	H	1
20175	1732.5	-31.06	41.36	10.30	10.72	H	1
20375	1752.5	-29.90	42.63	12.73	18.75	H	1
19975	1712.5	-26.77	44.17	17.40	54.90	V	1
20175	1732.5	-26.99	44.20	17.21	52.60	V	1
20375	1752.5	-27.07	44.35	17.28	53.39	V	1

**LTE BAND 4**

**CHANNEL BANDWIDTH: 10MHz QPSK**

Channel	Frequency (MHz)	SPA LVL (dBm)	Correction Factor(dB)	EIRP(dBm)	EIRP(mW)	Polarization (H/V)	LIMIT (W)
20000	1715.0	-28.68	41.49	12.81	19.08	H	1
20175	1732.5	-28.75	41.36	12.61	18.24	H	1
20350	1750.0	-28.62	42.28	13.66	23.24	H	1
20000	1715.0	-25.75	44.06	18.31	67.81	V	1
20175	1732.5	-25.82	44.20	18.38	68.87	V	1
20350	1750.0	-25.69	44.43	18.74	<b>74.82</b>	V	1

**CHANNEL BANDWIDTH: 10MHz 16QAM**

Channel	Frequency (MHz)	SPA LVL (dBm)	Correction Factor(dB)	EIRP(dBm)	EIRP(mW)	Polarization (H/V)	LIMIT (W)
20000	1715.0	-29.83	41.49	11.66	14.64	H	1
20175	1732.5	-31.08	41.36	10.28	10.67	H	1
20350	1750.0	-29.83	42.28	12.45	17.59	H	1
20000	1715.0	-26.90	44.06	17.16	52.04	V	1
20175	1732.5	-27.01	44.20	17.19	52.36	V	1
20350	1750.0	-27.00	44.43	17.43	55.34	V	1



Test Report No.: RF190418W001-5

LTE BAND 4

CHANNEL BANDWIDTH: 15MHz QPSK

Channel	Frequency (MHz)	SPA LVL (dBm)	Correction Factor(dB)	EIRP(dBm)	EIRP(mW)	Polarization (H/V)	LIMIT (W)
20025	1717.5	-28.69	41.34	12.65	18.40	H	1
20175	1732.5	-30.05	41.36	11.31	13.52	H	1
20325	1747.5	-28.74	42.09	13.35	21.61	H	1
20025	1717.5	-25.76	44.04	18.28	67.36	V	1
20175	1732.5	-25.98	44.20	18.22	66.37	V	1
20325	1747.5	-25.91	44.22	18.31	<b>67.69</b>	V	1

CHANNEL BANDWIDTH: 15MHz 16QAM

Channel	Frequency (MHz)	SPA LVL (dBm)	Correction Factor(dB)	EIRP(dBm)	EIRP(mW)	Polarization (H/V)	LIMIT (W)
20025	1717.5	-29.55	41.34	11.79	15.09	H	1
20175	1732.5	-30.92	41.36	10.44	11.07	H	1
20325	1747.5	-29.59	42.09	12.50	17.77	H	1
20025	1717.5	-26.62	44.04	17.42	55.26	V	1
20175	1732.5	-26.85	44.20	17.35	54.33	V	1
20325	1747.5	-26.76	44.22	17.46	55.65	V	1

LTE BAND 4

CHANNEL BANDWIDTH: 20MHz QPSK

Channel	Frequency (MHz)	SPA LVL (dBm)	Correction Factor(dB)	EIRP(dBm)	EIRP(mW)	Polarization (H/V)	LIMIT (W)
20050	1720.0	-29.27	41.28	12.01	15.89	H	1
20175	1732.5	-30.50	41.36	10.86	12.19	H	1
20300	1745.0	-29.32	41.96	12.64	18.35	H	1
20050	1720.0	-26.34	44.14	17.80	<b>60.19</b>	V	1
20175	1732.5	-26.43	44.20	17.77	59.79	V	1
20300	1745.0	-26.49	43.88	17.39	54.85	V	1



Test Report No.: RF190418W001-5

**CHANNEL BANDWIDTH: 20MHz 16QAM**

Channel	Frequency (MHz)	SPA LVL (dBm)	Correction Factor(dB)	EIRP(dBm)	EIRP(mW)	Polarization (H/V)	LIMIT (W)
20050	1720.0	-30.20	41.28	11.08	12.83	H	1
20175	1732.5	-31.57	41.36	9.79	9.53	H	1
20300	1745.0	-30.15	41.96	11.81	15.16	H	1
20050	1720.0	-27.27	44.14	16.87	48.58	V	1
20175	1732.5	-27.50	44.20	16.70	46.73	V	1
20300	1745.0	-27.32	43.88	16.56	45.31	V	1

**REMARKS:** 1. EIRP Output Power (dBm) = SPA LVL (dBm) + Correction Factor (dB).  
 2. Correction factor (dB) = Free Space Loss + Antenna Factor + Cable Loss

**LTE BAND 12**

**CHANNEL BANDWIDTH: 1.4MHz QPSK**

Channel	Frequency (MHz)	SPA LVL (dBm)	Correction Factor(dB)	ERP(dBm)	ERP(mW)	Polarization (H/V)	LIMIT (W)
23017	699.7	-14.03	32.77	16.59	45.60	H	3
23095	707.5	-14.18	33.23	16.90	48.98	H	3
23173	715.3	-13.60	33.14	17.39	<b>54.80</b>	H	3
23017	699.7	-18.38	32.42	11.89	15.44	V	3
23095	707.5	-18.80	32.60	11.65	14.62	V	3
23173	715.3	-19.11	32.19	10.93	12.38	V	3

**CHANNEL BANDWIDTH: 1.4MHz 16QAM**

Channel	Frequency (MHz)	SPA LVL (dBm)	Correction Factor(dB)	ERP(dBm)	ERP(mW)	Polarization (H/V)	LIMIT (W)
23017	699.7	-14.86	32.77	15.76	37.67	H	3
23095	707.5	-15.20	33.23	15.88	38.73	H	3
23173	715.3	-14.70	33.14	16.29	42.54	H	3
23017	699.7	-19.21	32.42	11.06	12.75	V	3
23095	707.5	-19.82	32.60	10.63	11.56	V	3
23173	715.3	-20.21	32.19	9.83	9.61	V	3



Test Report No.: RF190418W001-5

LTE BAND 12

CHANNEL BANDWIDTH: 3MHz QPSK

Channel	Frequency (MHz)	SPA LVL (dBm)	Correction Factor(dB)	ERP(dBm)	ERP(mW)	Polarization (H/V)	LIMIT (W)
23025	700.5	-13.84	32.63	16.64	46.14	H	3
23095	707.5	-14.12	33.23	16.96	49.66	H	3
23165	714.5	-13.47	33.21	17.59	<b>57.35</b>	H	3
23025	700.5	-18.19	32.33	11.99	15.80	V	3
23095	707.5	-18.74	32.60	11.71	14.83	V	3
23165	714.5	-18.98	32.30	11.17	13.09	V	3

CHANNEL BANDWIDTH: 3MHz 16QAM

Channel	Frequency (MHz)	SPA LVL (dBm)	Correction Factor(dB)	ERP(dBm)	ERP(mW)	Polarization (H/V)	LIMIT (W)
23025	700.5	-14.99	32.63	15.49	35.41	H	3
23095	707.5	-15.22	33.23	15.86	38.55	H	3
23165	714.5	-14.63	33.21	16.43	43.90	H	3
23025	700.5	-19.34	32.33	10.84	12.13	V	3
23095	707.5	-19.84	32.60	10.61	11.51	V	3
23165	714.5	-20.14	32.30	10.01	10.03	V	3

LTE BAND 12

CHANNEL BANDWIDTH: 5MHz QPSK

Channel	Frequency (MHz)	SPA LVL (dBm)	Correction Factor(dB)	ERP(dBm)	ERP(mW)	Polarization (H/V)	LIMIT (W)
23035	701.5	-13.85	32.53	16.53	44.93	H	3
23095	707.5	-14.19	33.23	16.89	48.84	H	3
23155	713.5	-13.54	33.29	17.60	<b>57.50</b>	H	3
23035	701.5	-18.20	32.25	11.90	15.50	V	3
23095	707.5	-18.81	32.60	11.64	14.59	V	3
23155	713.5	-19.05	32.39	11.19	13.14	V	3



Test Report No.: RF190418W001-5

**CHANNEL BANDWIDTH: 5MHz 16QAM**

Channel	Frequency (MHz)	SPA LVL (dBm)	Correction Factor(dB)	ERP(dBm)	ERP(mW)	Polarization (H/V)	LIMIT (W)
23035	701.5	-14.71	32.53	15.67	36.86	H	3
23095	707.5	-15.06	33.23	16.02	39.98	H	3
23155	713.5	-14.39	33.29	16.75	47.28	H	3
23035	701.5	-19.06	32.25	11.04	12.72	V	3
23095	707.5	-19.68	32.60	10.77	11.94	V	3
23155	713.5	-19.90	32.39	10.34	10.80	V	3

**LTE BAND 12**

**CHANNEL BANDWIDTH: 10MHz QPSK**

Channel	Frequency (MHz)	SPA LVL (dBm)	Correction Factor(dB)	ERP(dBm)	ERP(mW)	Polarization (H/V)	LIMIT (W)
23060	704.0	-14.43	32.68	16.10	40.77	H	3
23095	707.5	-14.64	33.23	16.44	44.06	H	3
23130	711.0	-14.12	33.39	17.12	<b>51.49</b>	H	3
23060	704.0	-18.78	32.37	11.44	13.93	V	3
23095	707.5	-19.26	32.60	11.19	13.15	V	3
23130	711.0	-19.63	32.56	10.78	11.95	V	3

**CHANNEL BANDWIDTH: 10MHz 16QAM**

Channel	Frequency (MHz)	SPA LVL (dBm)	Correction Factor(dB)	ERP(dBm)	ERP(mW)	Polarization (H/V)	LIMIT (W)
23060	704.0	-15.36	32.68	15.17	32.91	H	3
23095	707.5	-15.71	33.23	15.37	34.43	H	3
23130	711.0	-14.95	33.39	16.29	42.53	H	3
23060	704.0	-19.71	32.37	10.51	11.24	V	3
23095	707.5	-20.33	32.60	10.12	10.28	V	3
23130	711.0	-20.46	32.56	9.95	9.87	V	3

**REMARKS:** 1. ERP Output Power (dBm) = SPA LVL (dBm) + Correction Factor (dB) -2.15(dB).  
 2. Correction factor (dB) = Free Space Loss + Antenna Factor + Cable Loss

## 3.2 FREQUENCY STABILITY MEASUREMENT

### 3.2.1 LIMITS OF FREQUENCY STABILITY MEASUREMENT

The frequency stability shall be sufficient to ensure that the fundamental emissions stay within the authorized bands of operation.

### 3.2.2 TEST PROCEDURE

- a. Device is placed at the oven room. The oven room could control the temperatures and humidity. Power warm up is at least 15 min and power applied should perform before recording frequency error.
- b. EUT is connected the external power supply to control the DC input power. The test voltage range is from minimum to maximum working voltage. Each step shall be record the frequency error rate.
- c. The temperature range step is 10 degrees in this test items. All temperature levels shall be hold the  $\pm 0.5^{\circ}\text{C}$  during the measurement testing. The each temperature step shall be at least 0.5 hours, consider the EUT could be test under the stability condition.

**NOTE:** The frequency error was recorded frequency error from the communication simulator.

### 3.2.3 TEST SETUP

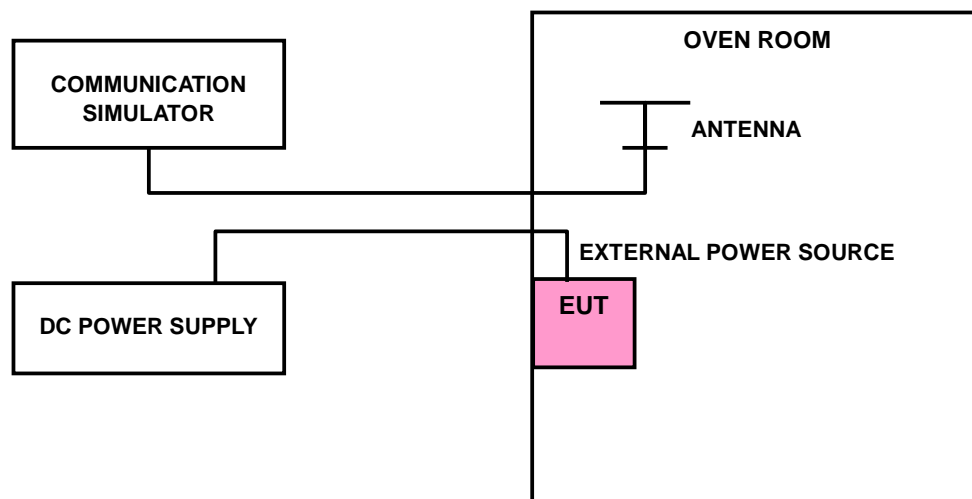





### 3.2.4 TEST RESULTS

#### WCDMA BAND IV

##### FREQUENCY ERROR VS. VOLTAGE

VOLTAGE (Volts)	FREQUENCY ERROR (ppm)		LIMIT (ppm)
	Low Channel	High Channel	
3.8	0.0018	0.0019	2.5
3.5	-0.0023	-0.0023	2.5
4.2	0.0019	0.0021	2.5

**NOTE:** The applicant defined the normal working voltage of the battery is from 3.5Vdc to 4.2Vdc.

##### FREQUENCY ERROR vs. TEMPERATURE.

TEMP. (°C)	FREQUENCY ERROR (ppm)		LIMIT (ppm)
	Low Channel	High Channel	
-30	-0.0126	-0.0121	2.5
-20	-0.0113	-0.0108	2.5
-10	-0.0106	-0.0101	2.5
0	-0.0088	-0.0085	2.5
10	-0.0064	-0.0061	2.5
20	-0.0052	-0.0050	2.5
30	-0.0039	-0.0037	2.5
40	-0.0035	-0.0033	2.5
50	-0.0029	-0.0028	2.5



**LTE BAND 4**

**FREQUENCY ERROR VS. VOLTAGE**

VOLTAGE (Volts)	1.4MHz		LIMIT (ppm)
	FREQUENCY ERROR (ppm)		
	Low Channel	High Channel	
3.8	0.0011	0.0011	2.5
3.5	-0.0016	-0.0016	2.5
4.2	0.0009	0.0010	2.5

**NOTE:** The applicant defined the normal working voltage of the battery is from 3.5Vdc to 4.2Vdc.

**FREQUENCY ERROR vs. TEMPERATURE.**

TEMP. (°C)	1.4MHz		LIMIT (ppm)
	FREQUENCY ERROR (ppm)		
	Low Channel	High Channel	
-30	-0.0062	-0.0054	2.5
-20	-0.0055	-0.0049	2.5
-10	-0.0045	-0.0043	2.5
0	-0.0040	-0.0035	2.5
10	-0.0029	-0.0031	2.5
20	-0.0025	-0.0025	2.5
30	-0.0020	-0.0014	2.5
40	-0.0010	-0.0009	2.5
50	-0.0004	-0.0002	2.5



Test Report No.: RF190418W001-5

**FREQUENCY ERROR VS. VOLTAGE**

VOLTAGE (Volts)	3MHz		LIMIT (ppm)
	FREQUENCY ERROR (ppm)		
	Low Channel	High Channel	
3.8	0.0008	0.0010	2.5
3.5	-0.0008	-0.0011	2.5
4.2	0.0009	0.0010	2.5

**NOTE:** The applicant defined the normal working voltage of the battery is from 3.5Vdc to 4.2Vdc.

**FREQUENCY ERROR vs. TEMPERATURE.**

TEMP. (°C)	3MHz		LIMIT (ppm)
	FREQUENCY ERROR (ppm)		
	Low Channel	High Channel	
-30	-0.0054	-0.0055	2.5
-20	-0.0050	-0.0049	2.5
-10	-0.0044	-0.0041	2.5
0	-0.0037	-0.0036	2.5
10	-0.0028	-0.0027	2.5
20	-0.0019	-0.0022	2.5
30	-0.0016	-0.0018	2.5
40	-0.0008	-0.0010	2.5
50	-0.0002	-0.0004	2.5



Test Report No.: RF190418W001-5

**FREQUENCY ERROR VS. VOLTAGE**

VOLTAGE (Volts)	5MHz		LIMIT (ppm)
	FREQUENCY ERROR (ppm)		
	Low Channel	High Channel	
3.8	0.0011	0.0010	2.5
3.5	-0.0010	-0.0013	2.5
4.2	0.0010	0.0010	2.5

**NOTE:** The applicant defined the normal working voltage of the battery is from 3.5Vdc to 4.2Vdc.

**FREQUENCY ERROR vs. TEMPERATURE.**

TEMP. (°C)	5MHz		LIMIT (ppm)
	FREQUENCY ERROR (ppm)		
	Low Channel	High Channel	
-30	-0.0060	-0.0050	2.5
-20	-0.0056	-0.0043	2.5
-10	-0.0049	-0.0041	2.5
0	-0.0039	-0.0033	2.5
10	-0.0035	-0.0026	2.5
20	-0.0027	-0.0023	2.5
30	-0.0017	-0.0014	2.5
40	-0.0010	-0.0008	2.5
50	-0.0003	-0.0002	2.5



Test Report No.: RF190418W001-5

### FREQUENCY ERROR VS. VOLTAGE

VOLTAGE (Volts)	10MHz		LIMIT (ppm)
	FREQUENCY ERROR (ppm)		
	Low Channel	High Channel	
3.8	0.0009	0.0013	2.5
3.5	-0.0013	-0.0014	2.5
4.2	0.0010	0.0009	2.5

**NOTE:** The applicant defined the normal working voltage of the battery is from 3.5Vdc to 4.2Vdc.

### FREQUENCY ERROR vs. TEMPERATURE.

TEMP. (°C)	10MHz		LIMIT (ppm)
	FREQUENCY ERROR (ppm)		
	Low Channel	High Channel	
-30	-0.0054	-0.0055	2.5
-20	-0.0049	-0.0045	2.5
-10	-0.0042	-0.0039	2.5
0	-0.0033	-0.0031	2.5
10	-0.0026	-0.0024	2.5
20	-0.0019	-0.0019	2.5
30	-0.0013	-0.0014	2.5
40	-0.0009	-0.0008	2.5
50	-0.0002	-0.0003	2.5



Test Report No.: RF190418W001-5

**FREQUENCY ERROR VS. VOLTAGE**

VOLTAGE (Volts)	15MHz		LIMIT (ppm)
	FREQUENCY ERROR (ppm)		
	Low Channel	High Channel	
3.8	0.0009	0.0010	2.5
3.5	-0.0014	-0.0013	2.5
4.2	0.0009	0.0010	2.5

**NOTE:** The applicant defined the normal working voltage of the battery is from 3.5Vdc to 4.2Vdc.

**FREQUENCY ERROR vs. TEMPERATURE.**

TEMP. (°C)	15MHz		LIMIT (ppm)
	FREQUENCY ERROR (ppm)		
	Low Channel	High Channel	
-30	-0.0055	-0.0051	2.5
-20	-0.0049	-0.0045	2.5
-10	-0.0044	-0.0039	2.5
0	-0.0033	-0.0031	2.5
10	-0.0027	-0.0025	2.5
20	-0.0021	-0.0020	2.5
30	-0.0014	-0.0013	2.5
40	-0.0008	-0.0009	2.5
50	-0.0002	-0.0003	2.5



Test Report No.: RF190418W001-5

**FREQUENCY ERROR VS. VOLTAGE**

VOLTAGE (Volts)	20MHz		LIMIT (ppm)
	FREQUENCY ERROR (ppm)		
	Low Channel	High Channel	
3.8	0.0010	0.0014	2.5
3.5	-0.0016	-0.0015	2.5
4.2	0.0008	0.0013	2.5

**NOTE:** The applicant defined the normal working voltage of the battery is from 3.5Vdc to 4.2Vdc.

**FREQUENCY ERROR vs. TEMPERATURE.**

TEMP. (°C)	20MHz		LIMIT (ppm)
	FREQUENCY ERROR (ppm)		
	Low Channel	High Channel	
-30	-0.0047	-0.0044	2.5
-20	-0.0042	-0.0042	2.5
-10	-0.0040	-0.0034	2.5
0	-0.0033	-0.0027	2.5
10	-0.0025	-0.0022	2.5
20	-0.0019	-0.0018	2.5
30	-0.0011	-0.0008	2.5
40	-0.0005	-0.0003	2.5
50	-0.0002	0.0004	2.5



**LTE BAND 12**

**FREQUENCY ERROR VS. VOLTAGE**

VOLTAGE (Volts)	1.4MHz		LIMIT (ppm)
	FREQUENCY ERROR (ppm)		
	Low Channel	High Channel	
3.8	0.0018	0.0028	2.5
3.5	-0.0021	-0.0023	2.5
4.2	0.0019	0.0021	2.5

**NOTE:** The applicant defined the normal working voltage of the battery is from 3.5Vdc to 4.2Vdc.

**FREQUENCY ERROR vs. TEMPERATURE.**

TEMP. (°C)	1.4MHz		LIMIT (ppm)
	FREQUENCY ERROR (ppm)		
	Low Channel	High Channel	
-30	-0.0146	-0.0141	2.5
-20	-0.0133	-0.0124	2.5
-10	-0.0117	-0.0106	2.5
0	-0.0097	-0.0091	2.5
10	-0.0077	-0.0079	2.5
20	-0.0060	-0.0071	2.5
30	-0.0047	-0.0048	2.5
40	-0.0027	-0.0028	2.5
50	-0.0010	-0.0015	2.5





Test Report No.: RF190418W001-5

**FREQUENCY ERROR VS. VOLTAGE**

VOLTAGE (Volts)	3MHz		LIMIT (ppm)
	FREQUENCY ERROR (ppm)		
	Low Channel	High Channel	
3.8	0.0020	0.0020	2.5
3.5	-0.0027	-0.0021	2.5
4.2	0.0020	0.0018	2.5

**NOTE:** The applicant defined the normal working voltage of the battery is from 3.5Vdc to 4.2Vdc.

**FREQUENCY ERROR vs. TEMPERATURE.**

TEMP. (°C)	3MHz		LIMIT (ppm)
	FREQUENCY ERROR (ppm)		
	Low Channel	High Channel	
-30	-0.0149	-0.0145	2.5
-20	-0.0139	-0.0130	2.5
-10	-0.0103	-0.0103	2.5
0	-0.0083	-0.0080	2.5
10	-0.0063	-0.0061	2.5
20	-0.0052	-0.0048	2.5
30	-0.0019	-0.0021	2.5
40	-0.0008	-0.0010	2.5
50	0.0007	0.0006	2.5



Test Report No.: RF190418W001-5

**FREQUENCY ERROR VS. VOLTAGE**

VOLTAGE (Volts)	5MHz		LIMIT (ppm)
	FREQUENCY ERROR (ppm)		
	Low Channel	High Channel	
3.8	0.0023	0.0024	2.5
3.5	-0.0022	-0.0025	2.5
4.2	0.0023	0.0020	2.5

**NOTE:** The applicant defined the normal working voltage of the battery is from 3.5Vdc to 4.2Vdc.

**FREQUENCY ERROR vs. TEMPERATURE.**

TEMP. (°C)	5MHz		LIMIT (ppm)
	FREQUENCY ERROR (ppm)		
	Low Channel	High Channel	
-30	-0.0137	-0.0143	2.5
-20	-0.0116	-0.0124	2.5
-10	-0.0106	-0.0110	2.5
0	-0.0091	-0.0093	2.5
10	-0.0075	-0.0073	2.5
20	-0.0062	-0.0060	2.5
30	-0.0045	-0.0048	2.5
40	-0.0025	-0.0026	2.5
50	-0.0006	-0.0007	2.5



Test Report No.: RF190418W001-5

**FREQUENCY ERROR VS. VOLTAGE**

VOLTAGE (Volts)	10MHz		LIMIT (ppm)
	FREQUENCY ERROR (ppm)		
	Low Channel	High Channel	
3.8	0.0021	0.0022	2.5
3.5	-0.0024	-0.0023	2.5
4.2	0.0019	0.0018	2.5

**NOTE:** The applicant defined the normal working voltage of the battery is from 3.5Vdc to 4.2Vdc.

**FREQUENCY ERROR vs. TEMPERATURE.**

TEMP. (°C)	10MHz		LIMIT (ppm)
	FREQUENCY ERROR (ppm)		
	Low Channel	High Channel	
-30	-0.0150	-0.0138	2.5
-20	-0.0139	-0.0119	2.5
-10	-0.0120	-0.0089	2.5
0	-0.0108	-0.0075	2.5
10	-0.0077	-0.0065	2.5
20	-0.0058	-0.0049	2.5
30	-0.0048	-0.0033	2.5
40	-0.0033	-0.0023	2.5
50	-0.0013	-0.0014	2.5

### 3.3 OCCUPIED BANDWIDTH MEASUREMENT

#### 3.3.1 LIMITS OF OCCUPIED BANDWIDTH MEASUREMENT

The width of a frequency band such that, below the lower and above the upper frequency limits, the mean powers emitted are each equal to a specified percentage 0.5 %of the total mean power of a given emission.

#### 3.3.2 TEST SETUP

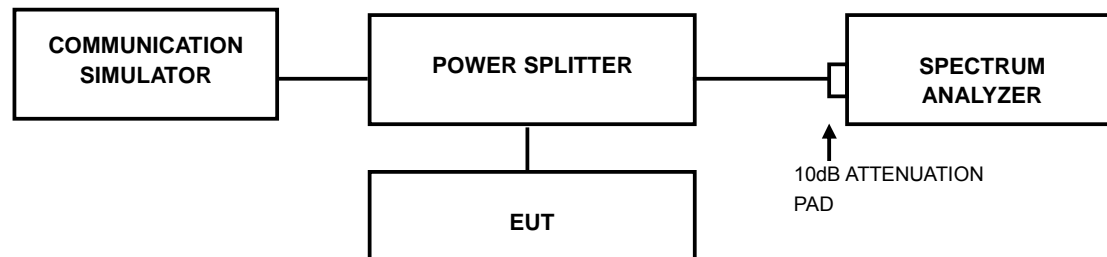

#### 3.3.3 TEST PROCEDURES

- The conducted occupied bandwidth used the power splitter via EUT RF power connector between simulation base station and spectrum analyzer.
- Use OBW measurement function of Spectrum analyzer to measure 99 % occupied bandwidth.



### 3.3.4 TEST RESULTS

#### WCDMA BAND IV

Channel	FREQ. (MHz)	99% Occupied Bandwidth (MHz)	Channel	FREQ. (MHz)	26dB Bandwidth (MHz)
		WCDMA			WCDMA
1312	1712.40	4.15	1312	1712.40	4.70
1413	1732.60	4.14	1413	1732.60	4.87
1513	1752.60	4.16	1513	1752.60	4.70

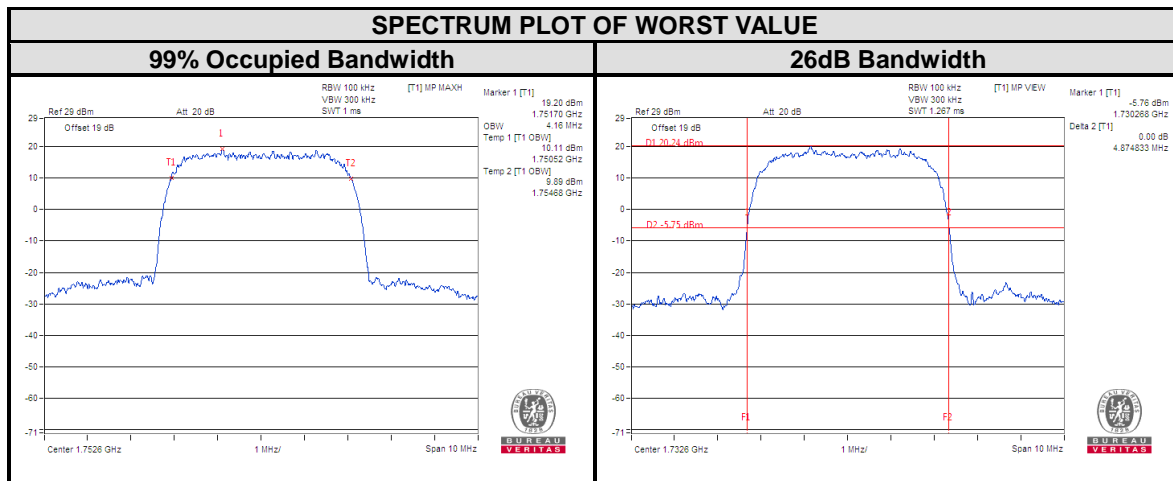



Test Report No.: RF190418W001-5

LTE BAND 4

CHANNEL BANDWIDTH: 1.4MHz				CHANNEL BANDWIDTH: 3MHz			
CHANNEL	Frequency (MHz)	99% OCCUPIED Bandwidth (MHz)		CHANNEL	Frequency (MHz)	99% OCCUPIED Bandwidth (MHz)	
		QPSK	16QAM			QPSK	16QAM
19957	1710.7	1.09	1.09	19965	1711.5	2.69	2.69
20175	1732.5	1.09	1.09	20175	1732.5	2.68	2.69
20393	1754.3	1.09	1.08	20385	1753.5	2.68	2.69

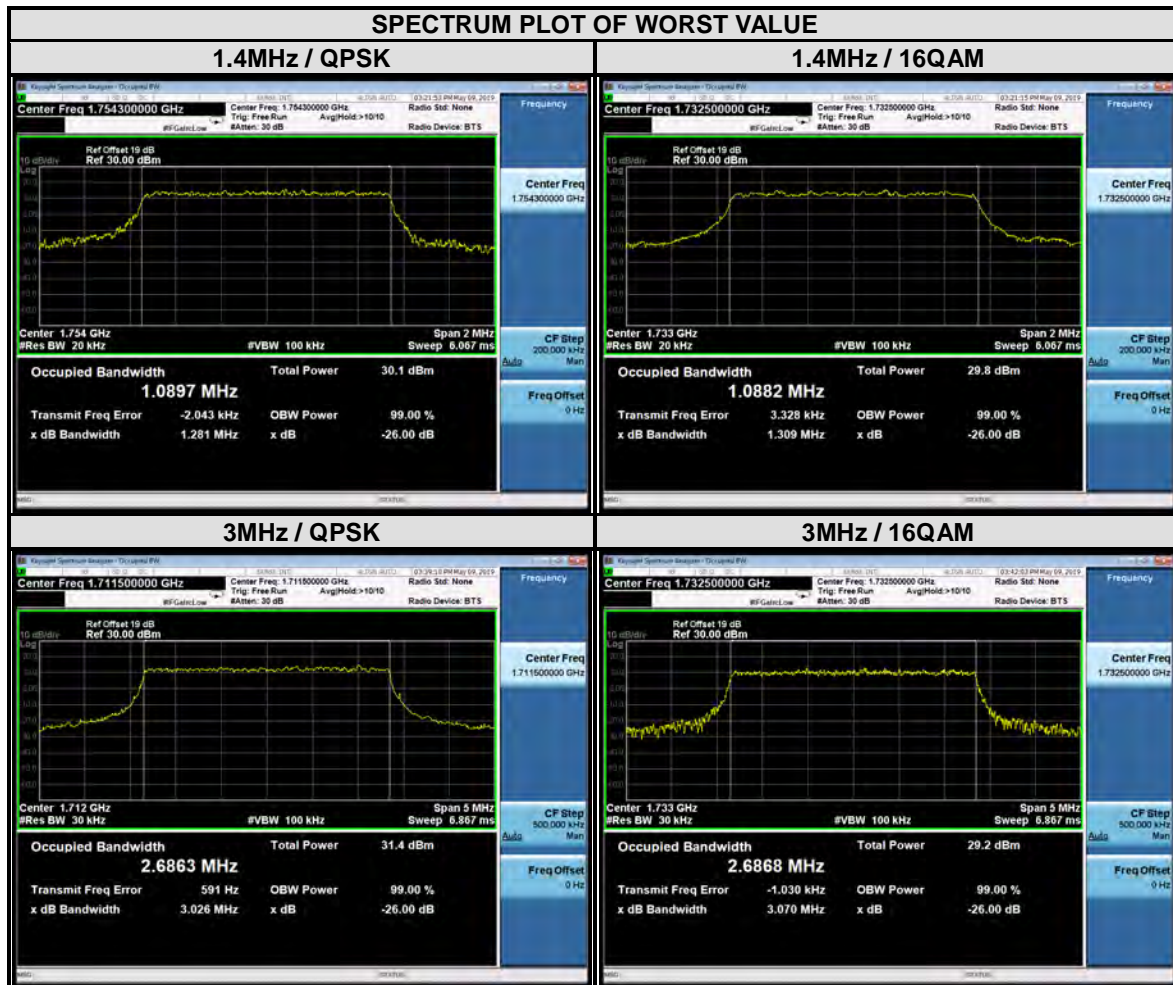



Test Report No.: RF190418W001-5

LTE BAND 4

CHANNEL BANDWIDTH: 5MHz				CHANNEL BANDWIDTH: 10MHz			
CHANNEL	Frequency (MHz)	99% OCCUPIED Bandwidth (MHz)		CHANNEL	Frequency (MHz)	99% OCCUPIED Bandwidth (MHz)	
		QPSK	16QAM			QPSK	16QAM
19975	1712.5	4.47	4.47	20000	1715	8.94	8.92
20175	1732.5	4.47	4.47	20175	1732.5	8.95	8.94
20375	1752.5	4.47	4.47	20350	1750	8.94	8.93

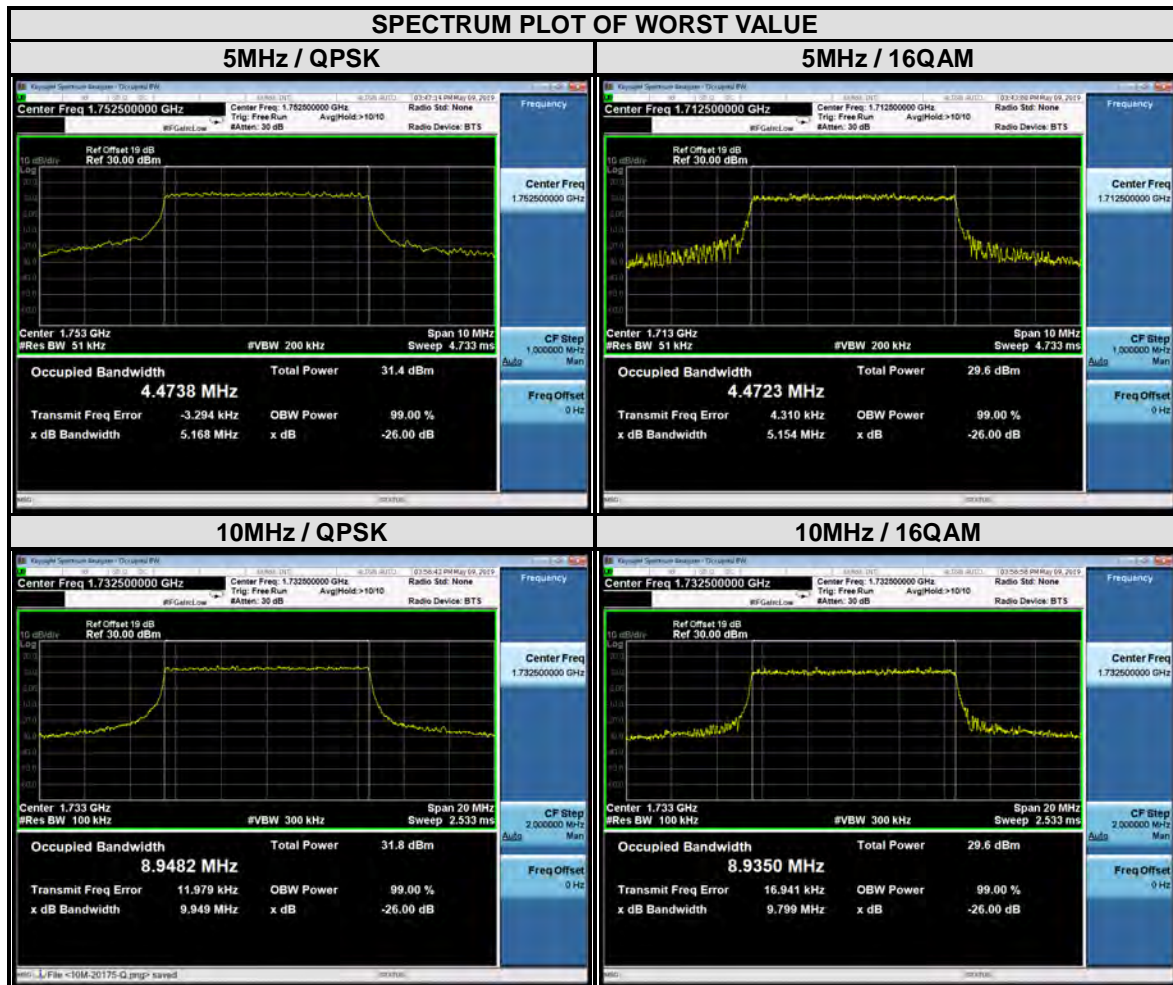



Test Report No.: RF190418W001-5

LTE BAND 4

CHANNEL BANDWIDTH: 15MHz				CHANNEL BANDWIDTH: 20MHz			
CHANNEL	FREQUENCY (MHz)	99% OCCUPIED BANDWIDTH (MHz)		CHANNEL	FREQUENCY (MHz)	99% OCCUPIED BANDWIDTH (MHz)	
		QPSK	16QAM			QPSK	16QAM
20025	1717.5	13.44	13.40	20050	1720	17.91	17.87
20175	1732.5	13.39	13.40	20175	1732.5	17.84	17.91
20325	1747.5	13.44	13.41	20300	1745	17.91	17.91







Test Report No.: RF190418W001-5

LTE BAND 12

CHANNEL BANDWIDTH: 1.4MHz				CHANNEL BANDWIDTH: 3MHz			
CHANNEL	FREQUENCY (MHz)	99% OCCUPIED BANDWIDTH (MHz)		CHANNEL	FREQUENCY (MHz)	99% OCCUPIED BANDWIDTH (MHz)	
		QPSK	16QAM			QPSK	16QAM
23017	699.7	1.09	1.09	23025	700.5	2.68	2.69
23095	707.5	1.09	1.09	23095	707.5	2.69	2.69
23173	715.3	1.09	1.09	23165	714.5	2.69	2.69

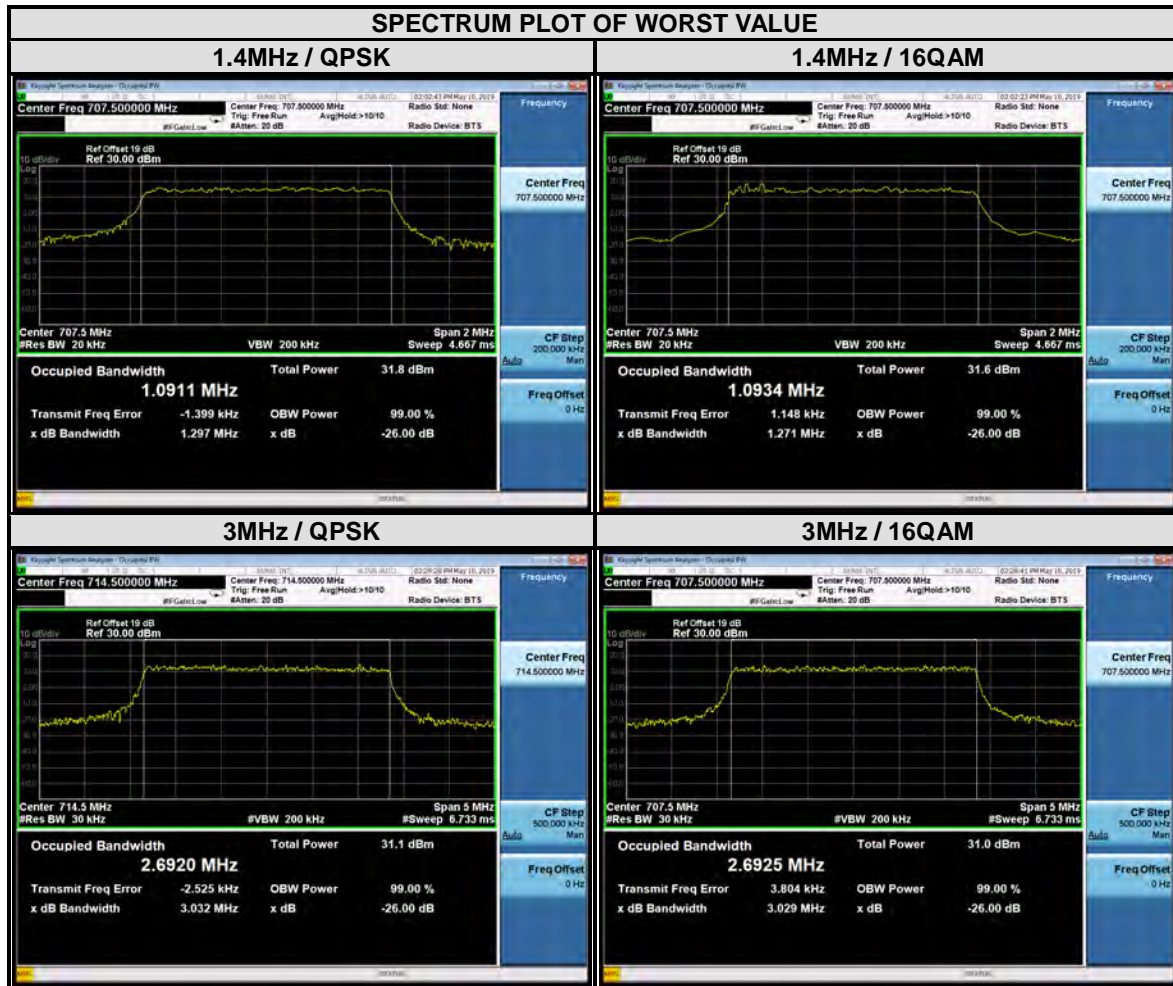



LTE BAND 12

CHANNEL BANDWIDTH: 5MHz				CHANNEL BANDWIDTH: 10MHz			
CHANNEL	Frequency (MHz)	99% OCCUPIED Bandwidth (MHz)		CHANNEL	Frequency (MHz)	99% OCCUPIED Bandwidth (MHz)	
		QPSK	16QAM			QPSK	16QAM
23035	701.5	4.47	4.47	23060	704	8.96	8.93
23095	707.5	4.48	4.48	23095	707.5	8.98	8.96
23155	713.5	4.47	4.47	23130	711	8.94	8.91

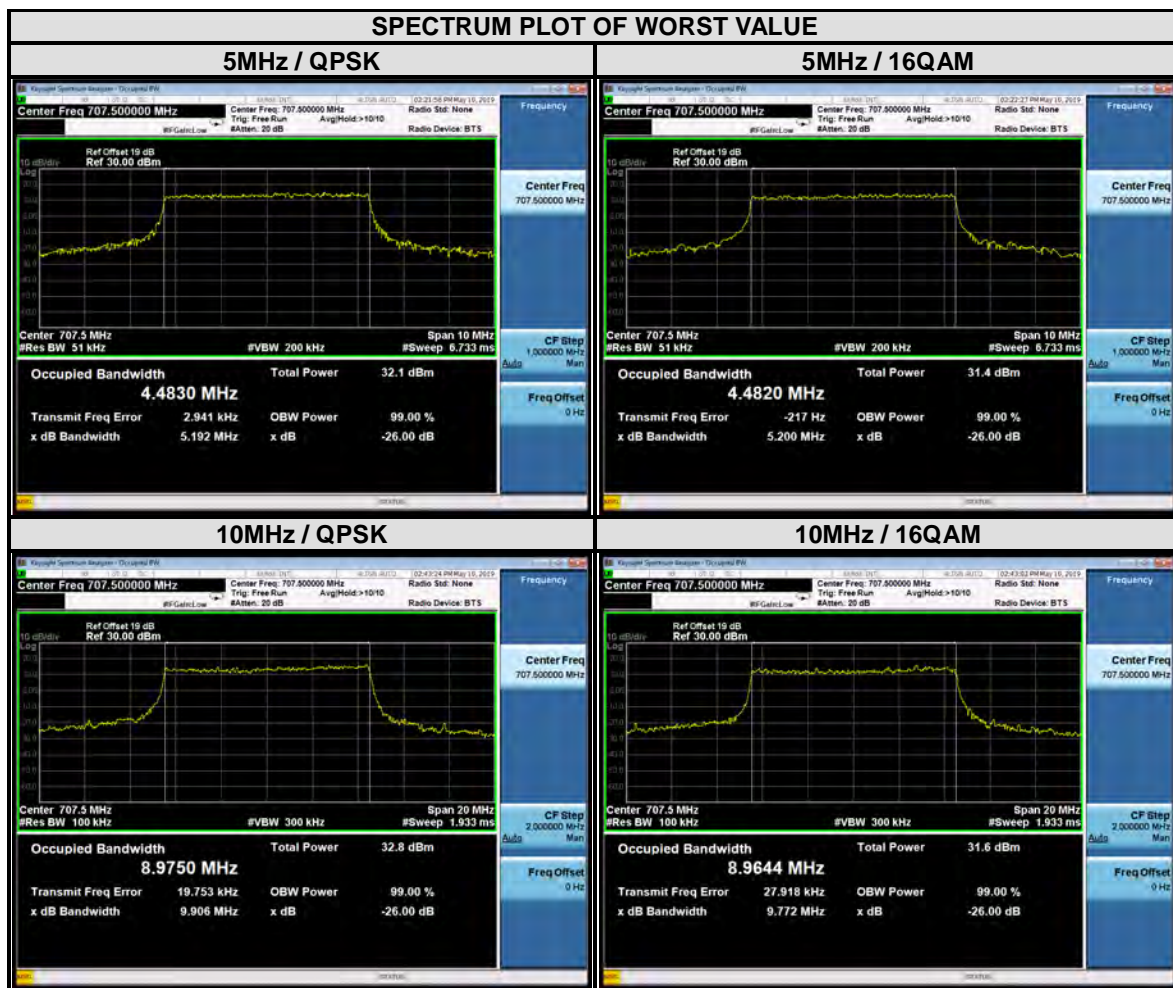

### 3.4 PEAK TO AVERAGE RATIO

#### 3.4.1 LIMITS OF PEAK TO AVERAGE RATIO MEASUREMENT

In measuring transmissions in this band using an average power technique, the peak to-average ratio (PAR) of the transmission may not exceed 13 dB

#### 3.4.2 TEST SETUP

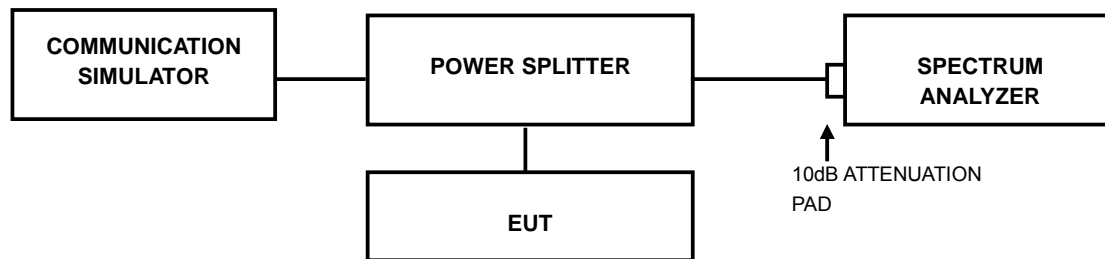

#### 3.4.3 TEST PROCEDURES

1. Set resolution/measurement bandwidth  $\geq$  signal's occupied bandwidth;
2. Set the number of counts to a value that stabilizes the measured CCDF curve;
3. Record the maximum PAPR level associated with a probability of 0.1%.



Test Report No.: RF190418W001-5

### 3.4.4 TEST RESULTS

#### WCDMA Band IV

CHANNEL	FREQUENCY (MHz)	PEAK TO AVERAGE RATIO (dB)
1312	1712.4	2.71

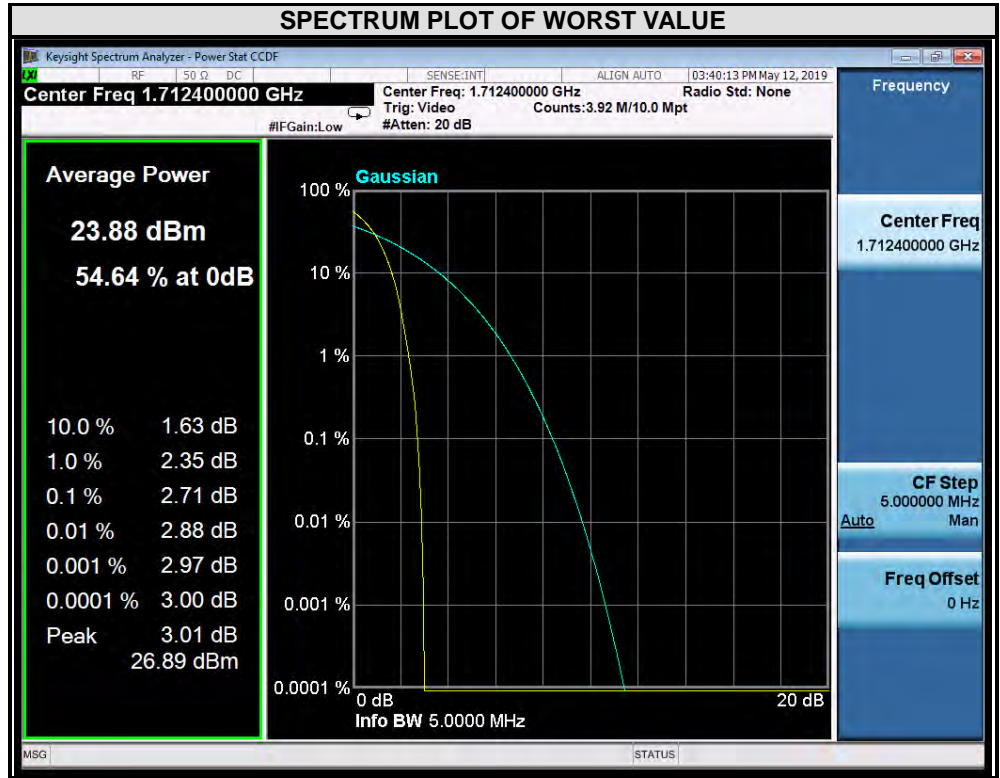



Test Report No.: RF190418W001-5

CHANNEL	FREQUENCY (MHz)	PEAK TO AVERAGE RATIO (dB)
1413	1732.6	2.87

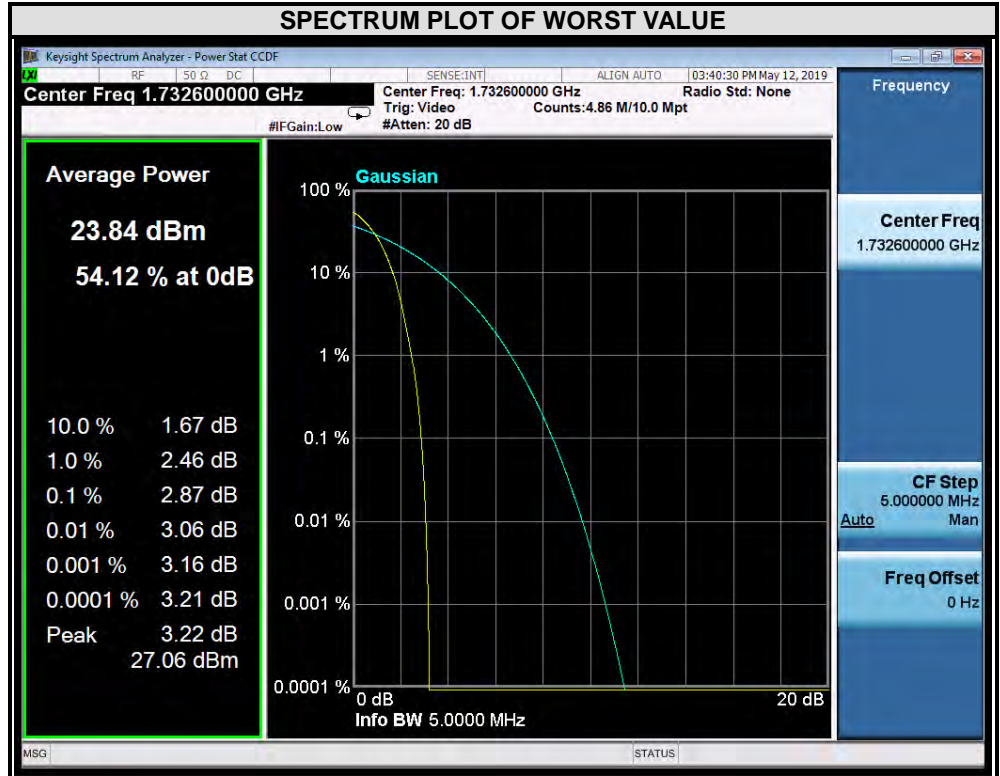



Test Report No.: RF190418W001-5

CHANNEL	FREQUENCY (MHz)	PEAK TO AVERAGE RATIO (dB)
1513	1752.6	2.60

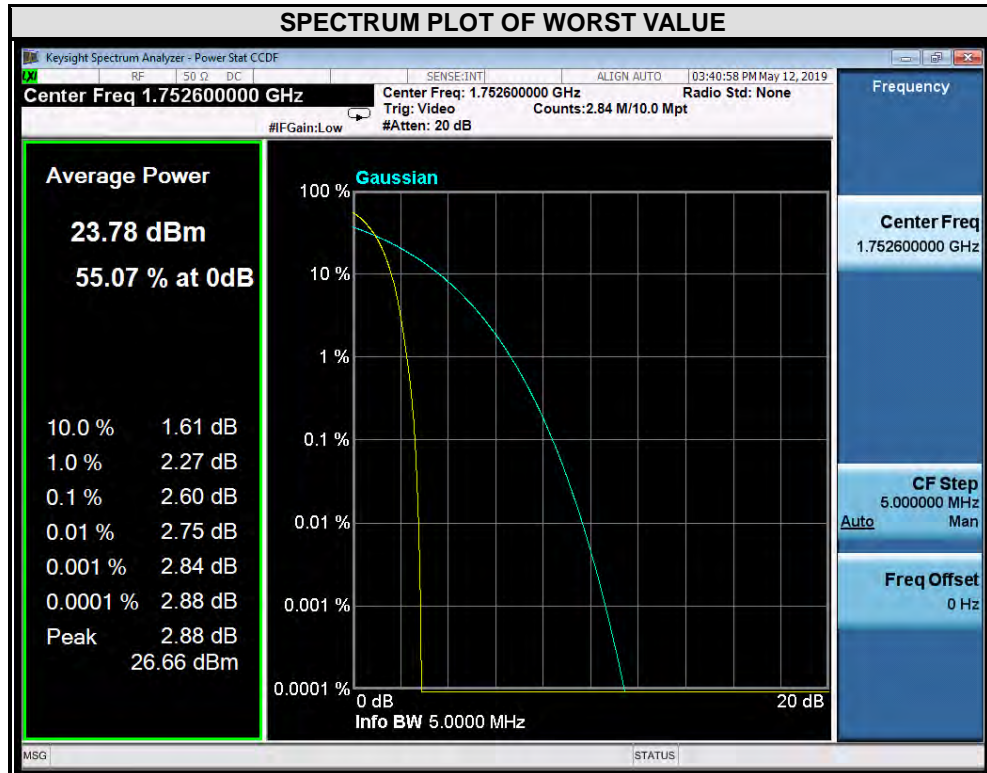



Test Report No.: RF190418W001-5

LTE BAND 4

CHANNEL BANDWIDTH: 1.4MHz				CHANNEL BANDWIDTH: 3MHz			
CHANNEL	FREQUENCY (MHz)	PEAK TO AVERAGE RATIO (dB)		CHANNEL	FREQUENCY (MHz)	PEAK TO AVERAGE RATIO (dB)	
		QPSK	16QAM			QPSK	16QAM
19957	1710.7	4.99	6.00	19965	1711.5	5.11	5.88
20175	1732.5	5.29	6.17	20175	1732.5	5.34	6.16
20393	1754.3	5.24	5.81	20385	1753.5	4.79	5.61

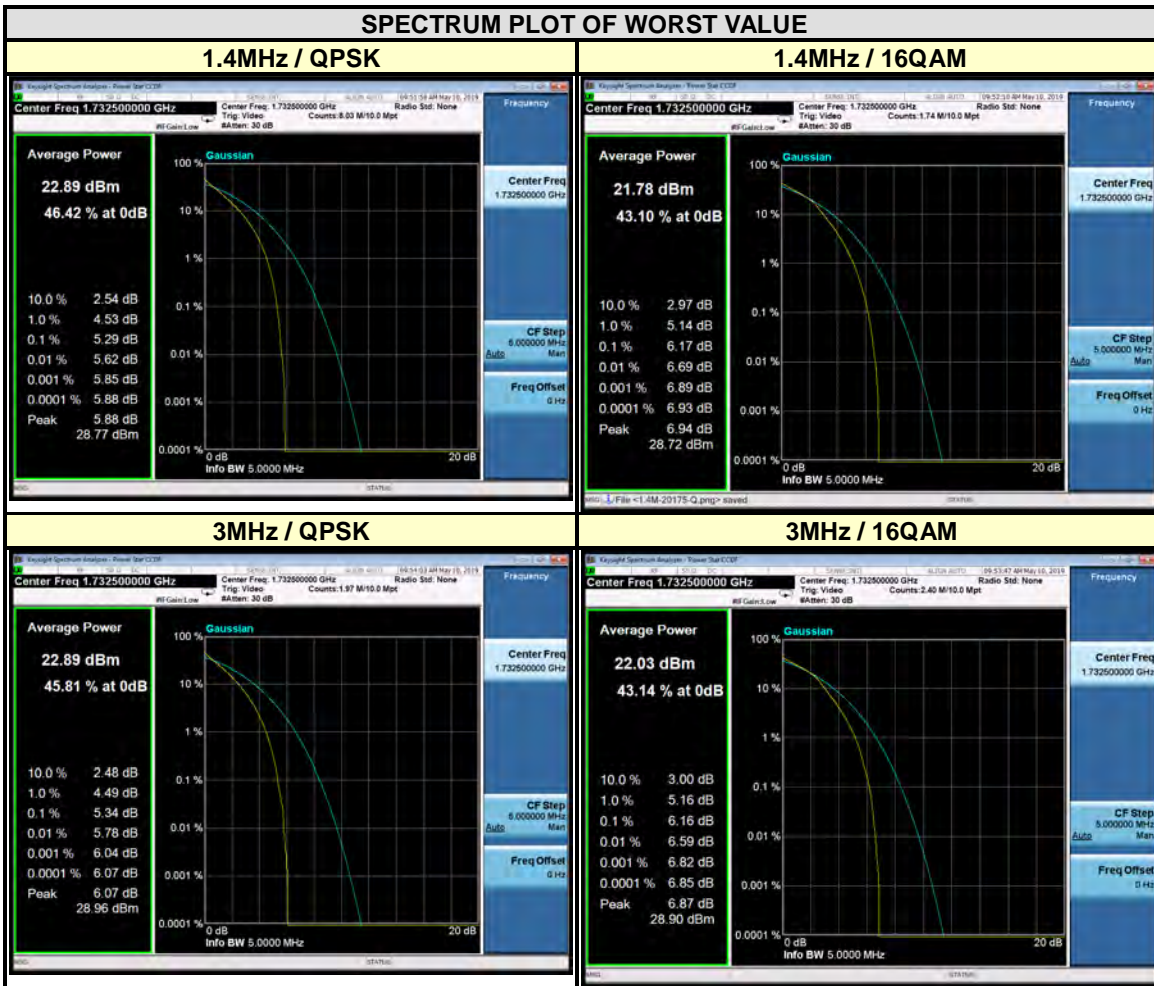



Test Report No.: RF190418W001-5

CHANNEL BANDWIDTH: 5MHz				CHANNEL BANDWIDTH: 10MHz			
CHANNEL	FREQUENCY (MHz)	PEAK TO AVERAGE RATIO (dB)		CHANNEL	FREQUENCY (MHz)	PEAK TO AVERAGE RATIO (dB)	
		QPSK	16QAM			QPSK	16QAM
19975	1712.5	5.31	5.99	20000	1715	5.11	5.84
20175	1732.5	5.46	6.18	20175	1732.5	5.30	6.05
20375	1752.5	5.07	5.83	20350	1750	4.66	5.47

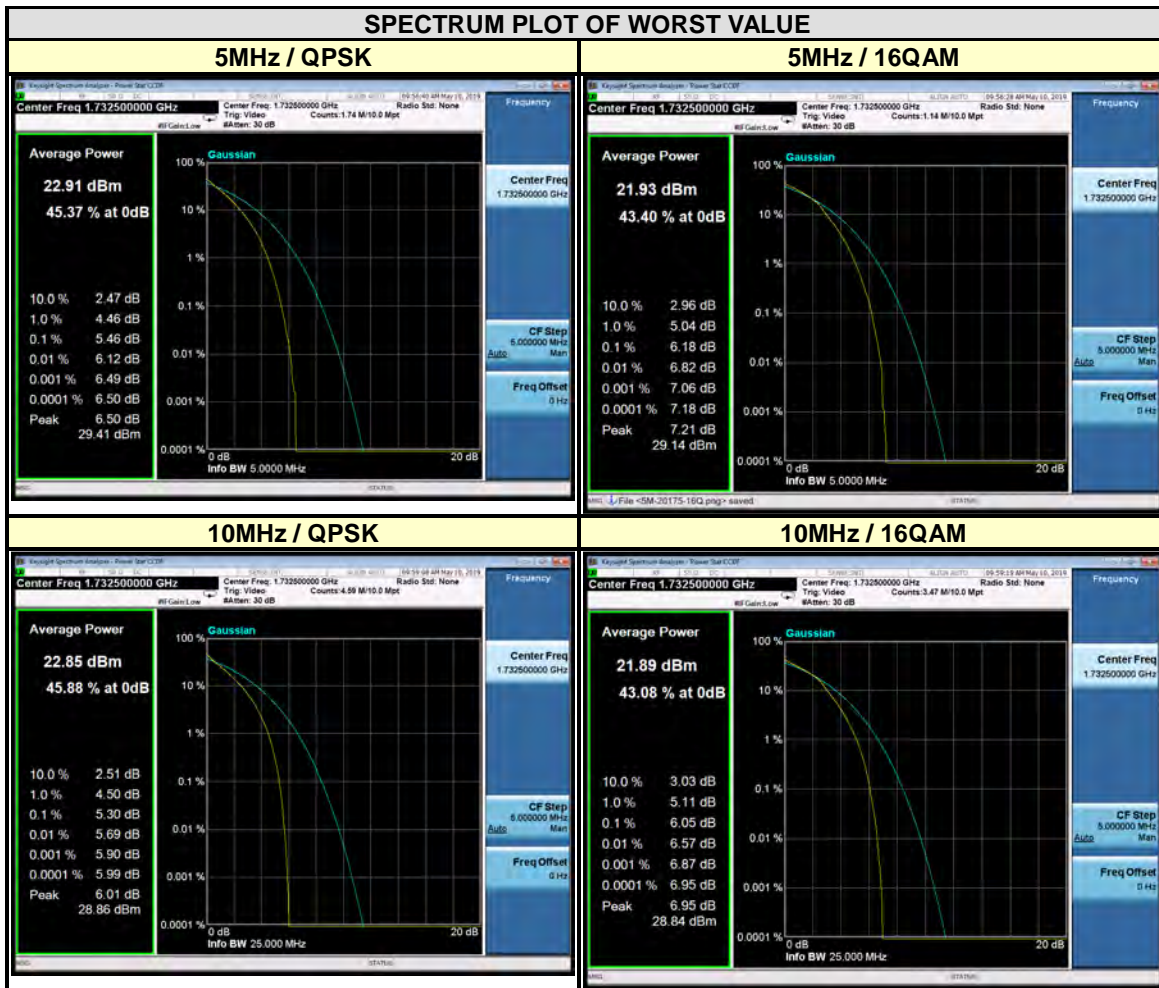





Test Report No.: RF190418W001-5

CHANNEL BANDWIDTH: 15MHz				CHANNEL BANDWIDTH: 20MHz			
CHANNEL	FREQUENCY (MHz)	PEAK TO AVERAGE RATIO (dB)		CHANNEL	FREQUENCY (MHz)	PEAK TO AVERAGE RATIO (dB)	
		QPSK	16QAM			QPSK	16QAM
20025	1717.5	5.25	5.99	20050	1720	5.42	6.13
20175	1732.5	5.36	6.13	20175	1732.5	5.42	6.14
20325	1747.5	5.02	5.69	20300	1745	5.21	5.90

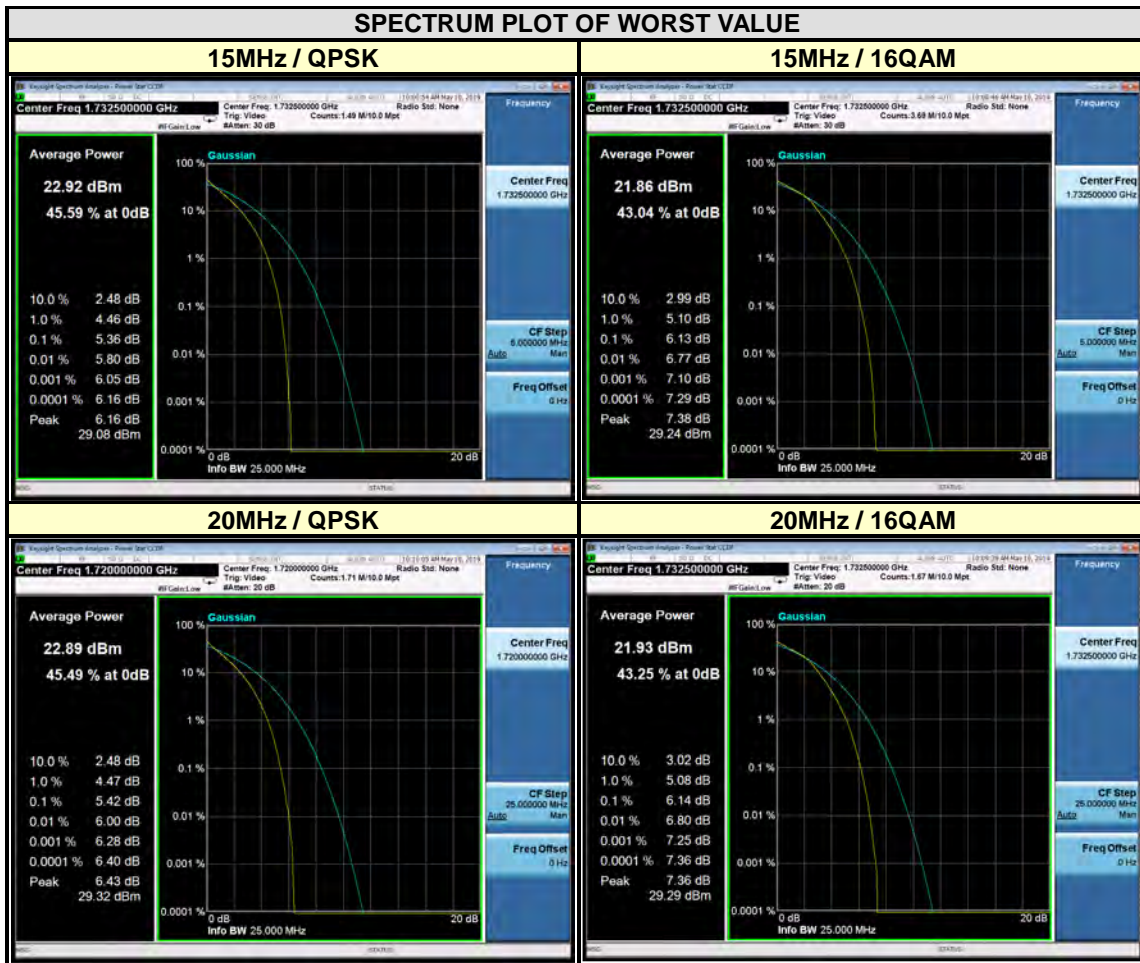



LTE BAND 12

CHANNEL BANDWIDTH: 1.4MHz				CHANNEL BANDWIDTH: 3MHz			
CHANNEL	FREQUENCY (MHz)	PEAK TO AVERAGE RATIO (dB)		CHANNEL	FREQUENCY (MHz)	PEAK TO AVERAGE RATIO (dB)	
		QPSK	16QAM			QPSK	16QAM
23017	699.7	5.61	6.42	23025	700.5	5.56	6.22
23095	707.5	6.16	6.40	23095	707.5	5.46	5.95
23173	715.3	4.58	5.63	23165	714.5	5.03	5.84

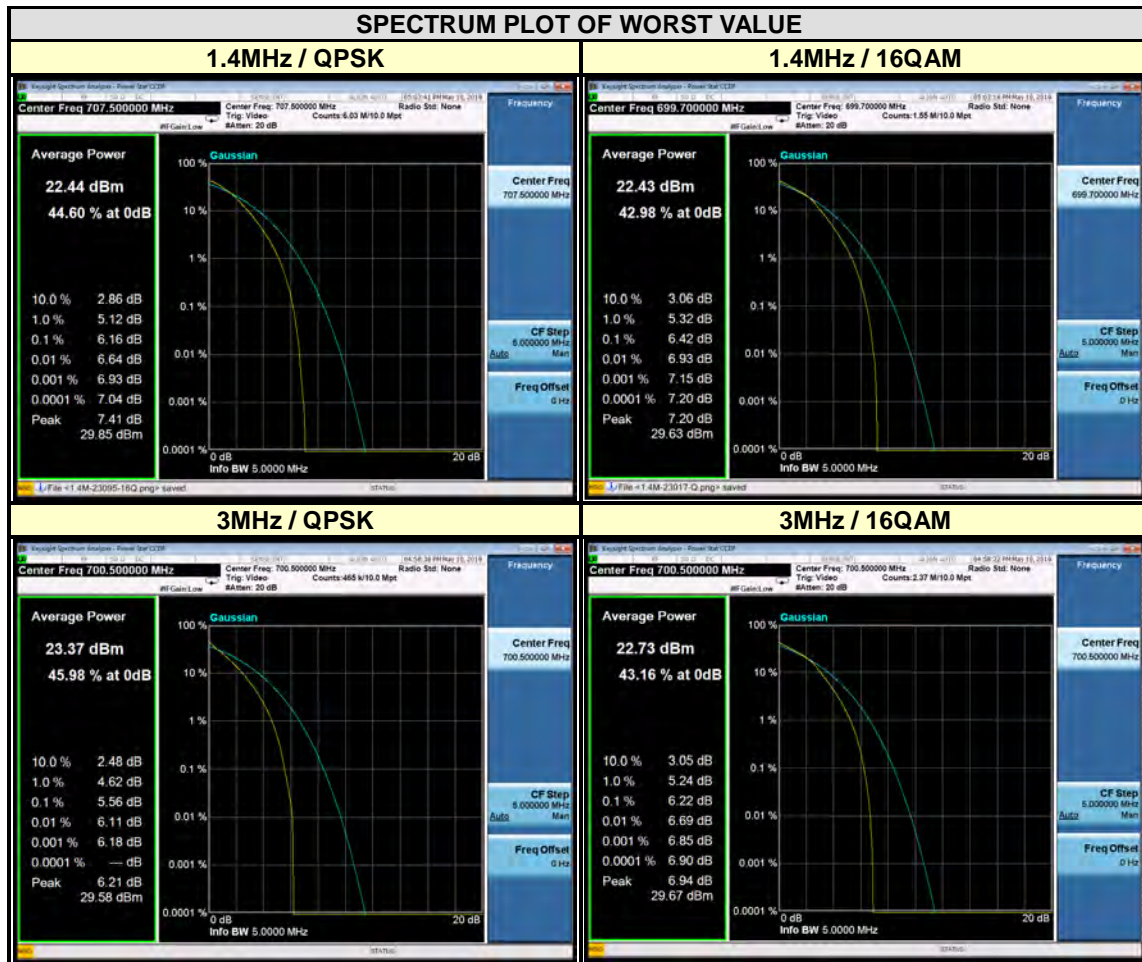



Test Report No.: RF190418W001-5

CHANNEL BANDWIDTH: 5MHz				CHANNEL BANDWIDTH: 10MHz			
CHANNEL	FREQUENCY (MHz)	PEAK TO AVERAGE RATIO (dB)		CHANNEL	FREQUENCY (MHz)	PEAK TO AVERAGE RATIO (dB)	
		QPSK	16QAM			QPSK	16QAM
23035	701.5	5.43	6.14	23060	704	5.59	6.28
23095	707.5	5.54	6.21	23095	707.5	5.56	6.32
23155	713.5	5.35	6.10	23130	711	5.36	6.20

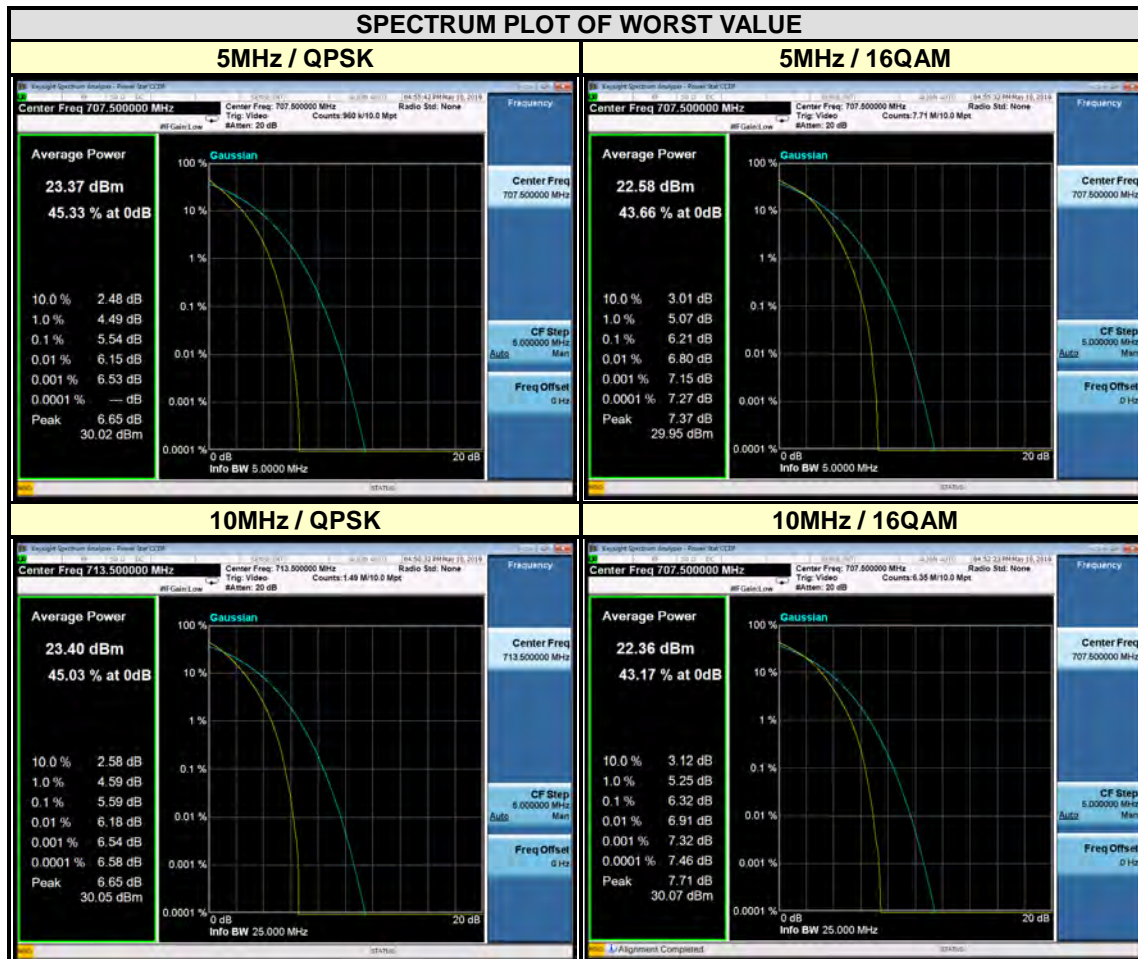

### 3.5 BAND EDGE MEASUREMENT

#### 3.5.1 LIMITS OF BAND EDGE MEASUREMENT

The power of any emission outside a licensee's frequency band(s) of operation shall be attenuated below the transmitter power (P) within the licensed band(s) of operation, measured in watts, by at least  $43 + 10 \log (P)$  dB. Compliance with this provision is based on the use of measurement instrumentation employing a resolution bandwidth of 100 kilohertz or greater.

However, in the 100 kilohertz bands immediately outside and adjacent to a licensee's frequency block, a resolution bandwidth of at least 30 kHz may be employed.

#### 3.5.2 TEST SETUP

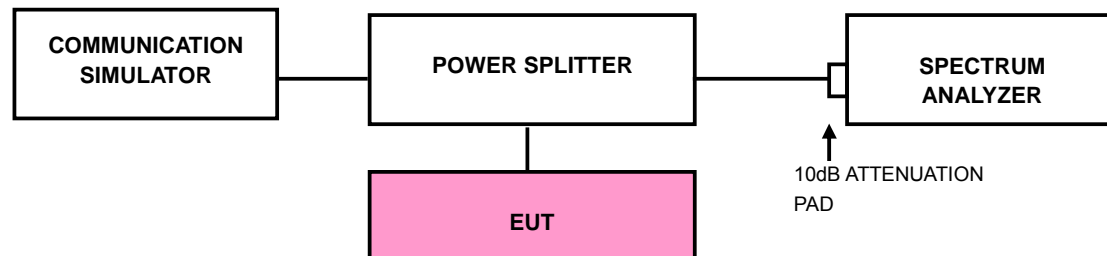



### 3.5.3 TEST PROCEDURES

- a. The EUT was set up for the maximum peak power with LTE link data modulation. The power was measured with R&S Spectrum Analyzer. All measurements were done at 2 channels (low and high operational frequency range.).
- b. The band edge measurement used the power splitter via EUT RF power connector between simulation base station and spectrum analyzer.
- c. The center frequency of spectrum is the band edge frequency and span is 10MHz. RBW of the spectrum is 100kHz and VBW of the spectrum is 300kHz (WCDMA).
- d. The center frequency of spectrum is the band edge frequency and span is 1~5 MHz. RBW of the spectrum is 20kHz and VBW of the spectrum is 100 kHz. (LTE bandwidth 1.4MHz)
- e. The center frequency of spectrum is the band edge frequency and span is 1~5 MHz. RBW of the spectrum is 30kHz and VBW of the spectrum is 100kHz. (LTE bandwidth 3MHz)
- f. The center frequency of spectrum is the band edge frequency and span is 1~5 MHz. RBW of the spectrum is 50kHz and VBW of the spectrum is 200kHz. (LTE bandwidth 5MHz)
- g. The center frequency of spectrum is the band edge frequency and span is 1~5 MHz. RBW of the spectrum is 100kHz and VBW of the spectrum is 300kHz. (LTE bandwidth 10MHz)
- h. The center frequency of spectrum is the band edge frequency and span is 1~5 MHz. RBW of the spectrum is 200kHz and VBW of the spectrum is 1MHz. (LTE bandwidth 15MHz)
- i. The center frequency of spectrum is the band edge frequency and span is 1~5 MHz. RBW of the spectrum is 200kHz and VBW of the spectrum is 1MHz. (LTE bandwidth 20MHz)
- j. Record the max trace plot into the test report.



Test Report No.: RF190418W001-5

### 3.5.4 TEST RESULTS

#### WCDMA BAND 4

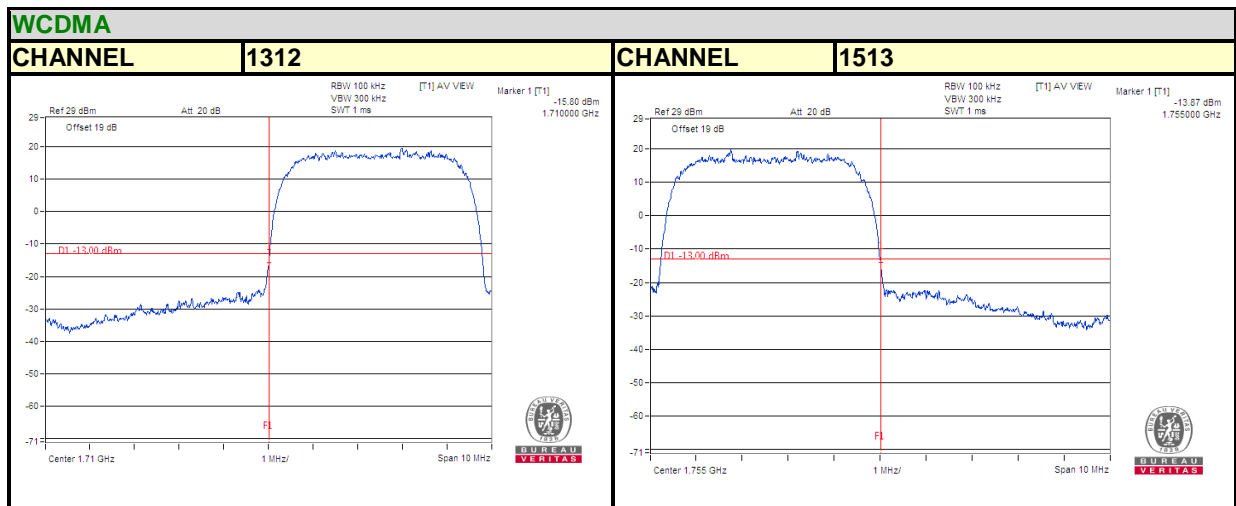



Test Report No.: RF190418W001-5

LTE BAND 4

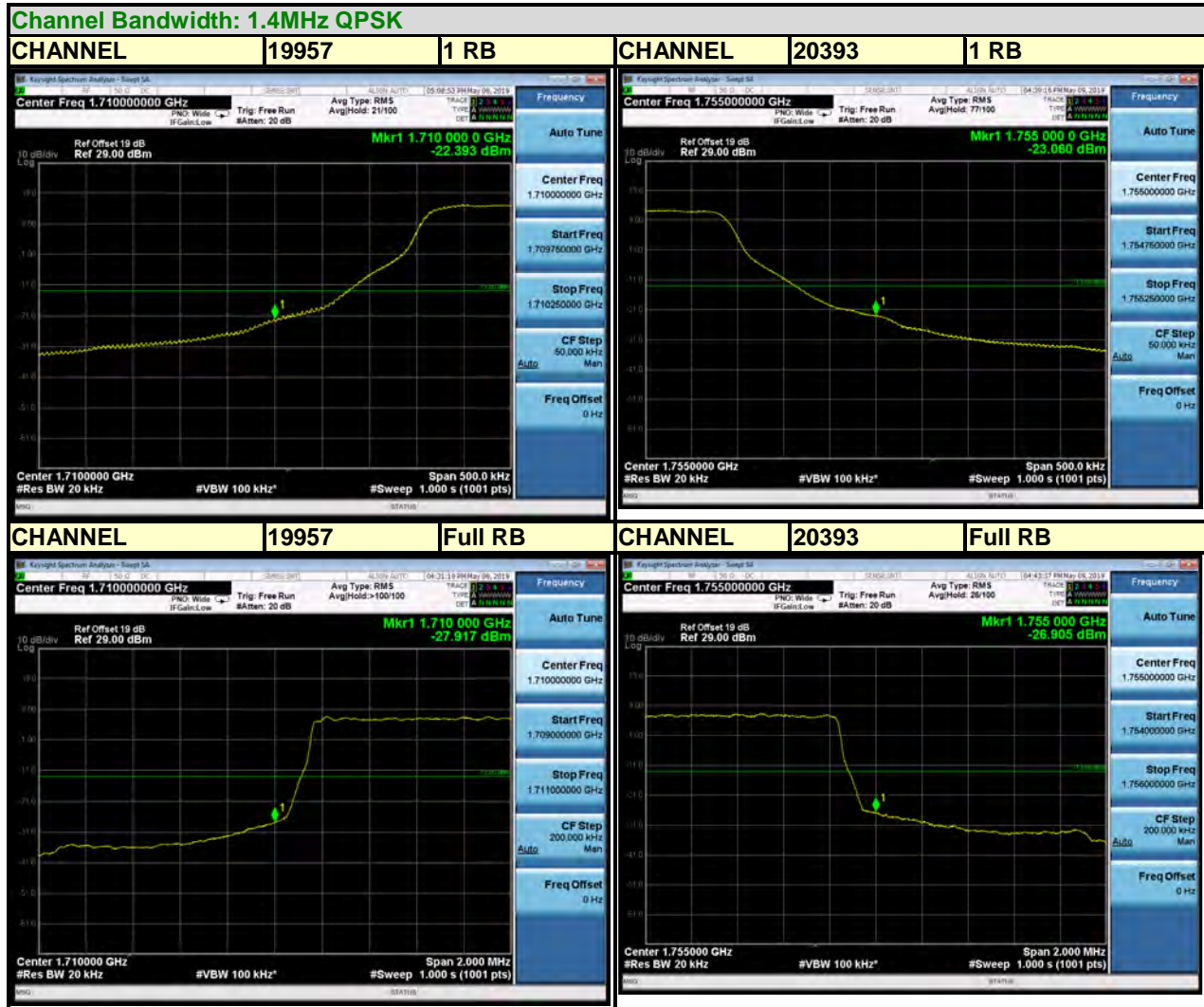



Test Report No.: RF190418W001-5

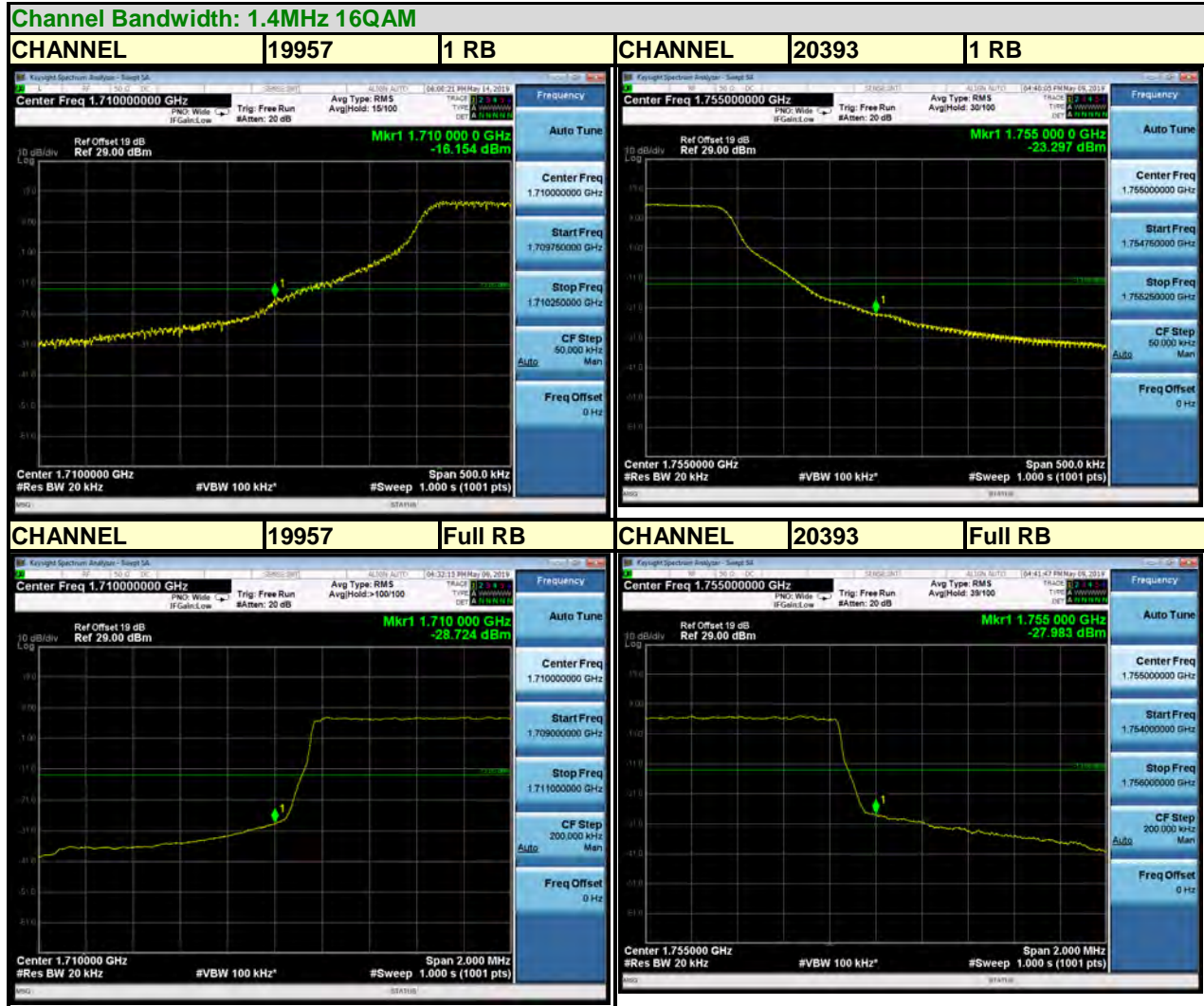





Test Report No.: RF190418W001-5

LTE BAND 4

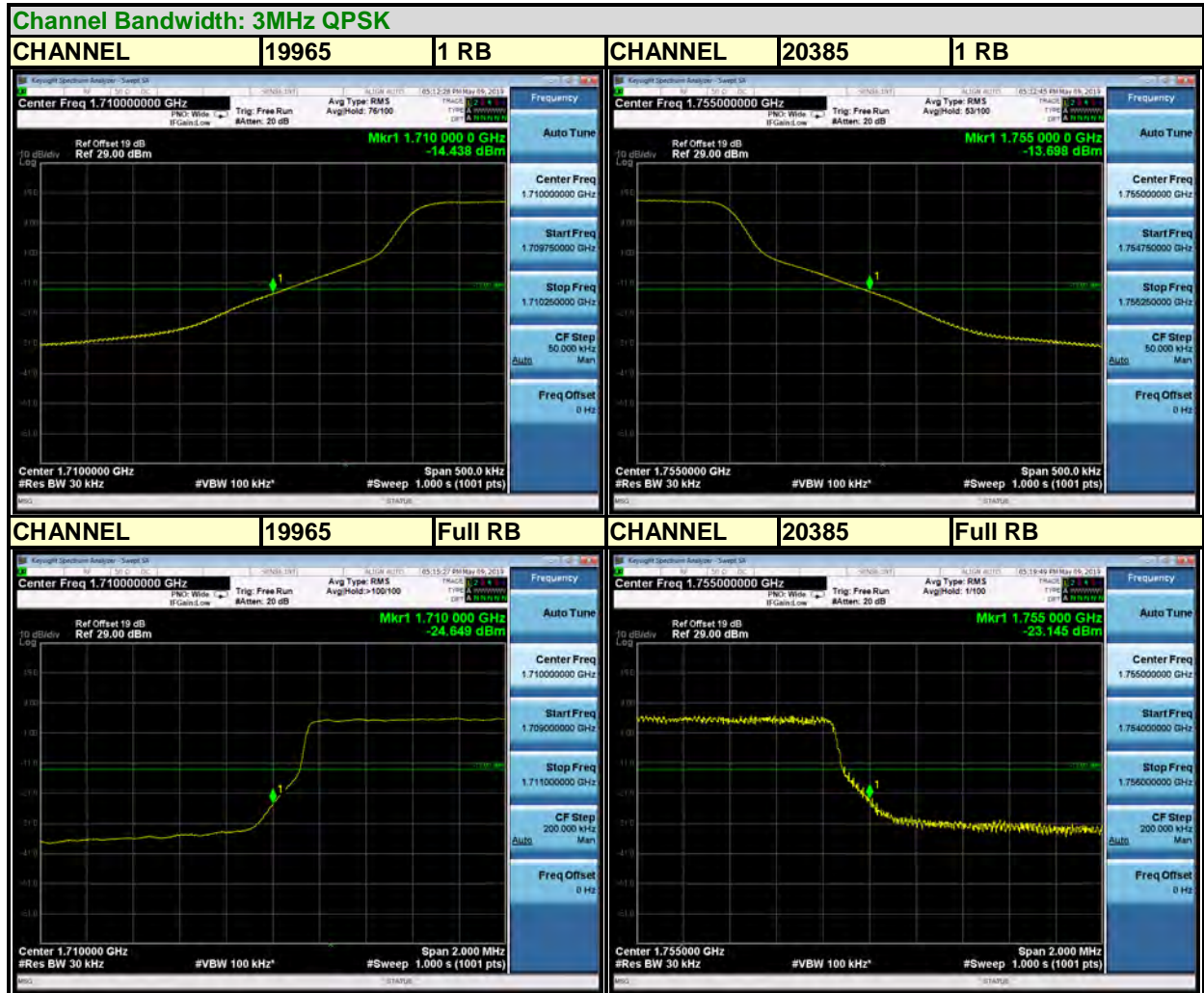



Test Report No.: RF190418W001-5

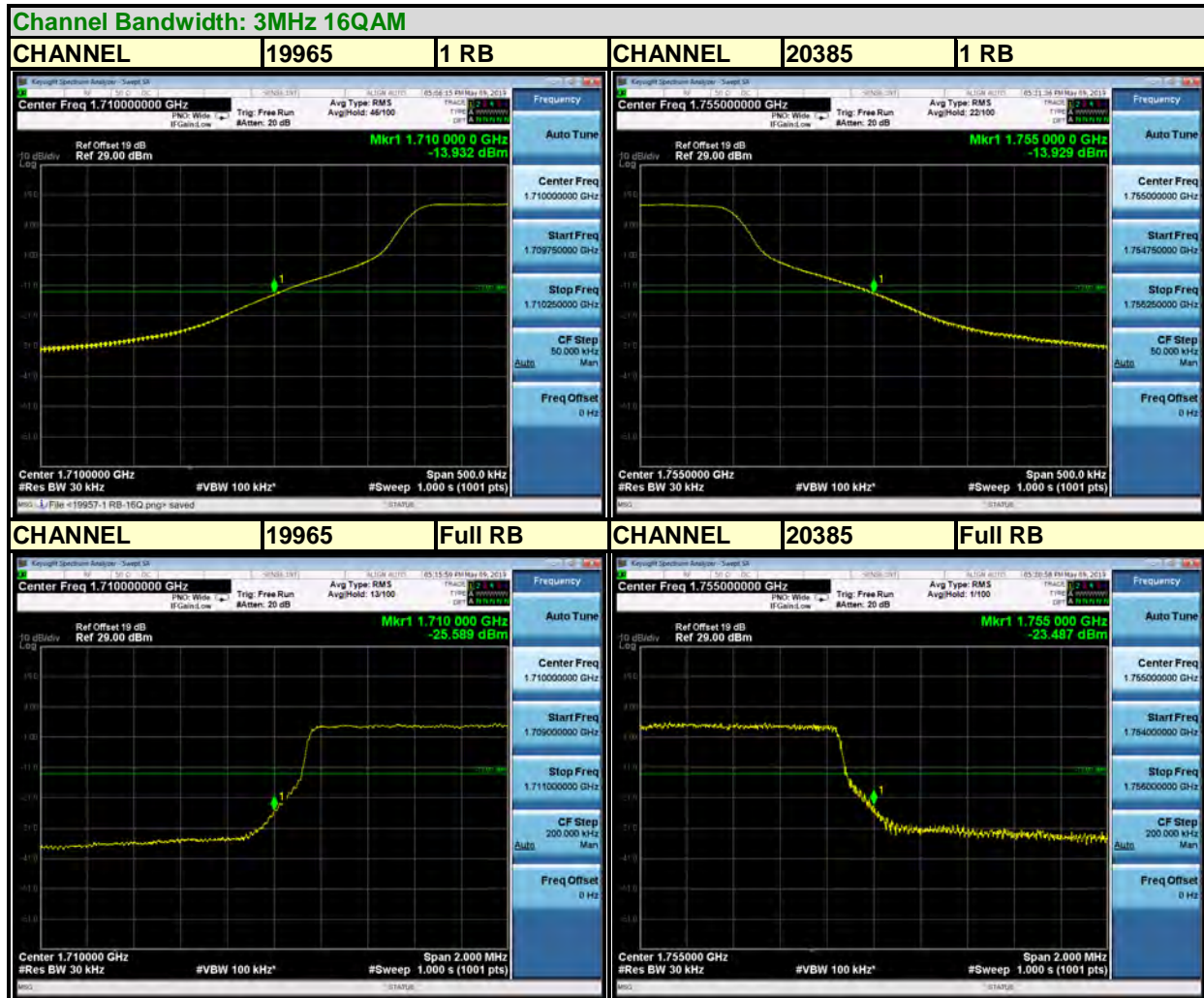



Test Report No.: RF190418W001-5

LTE BAND 4

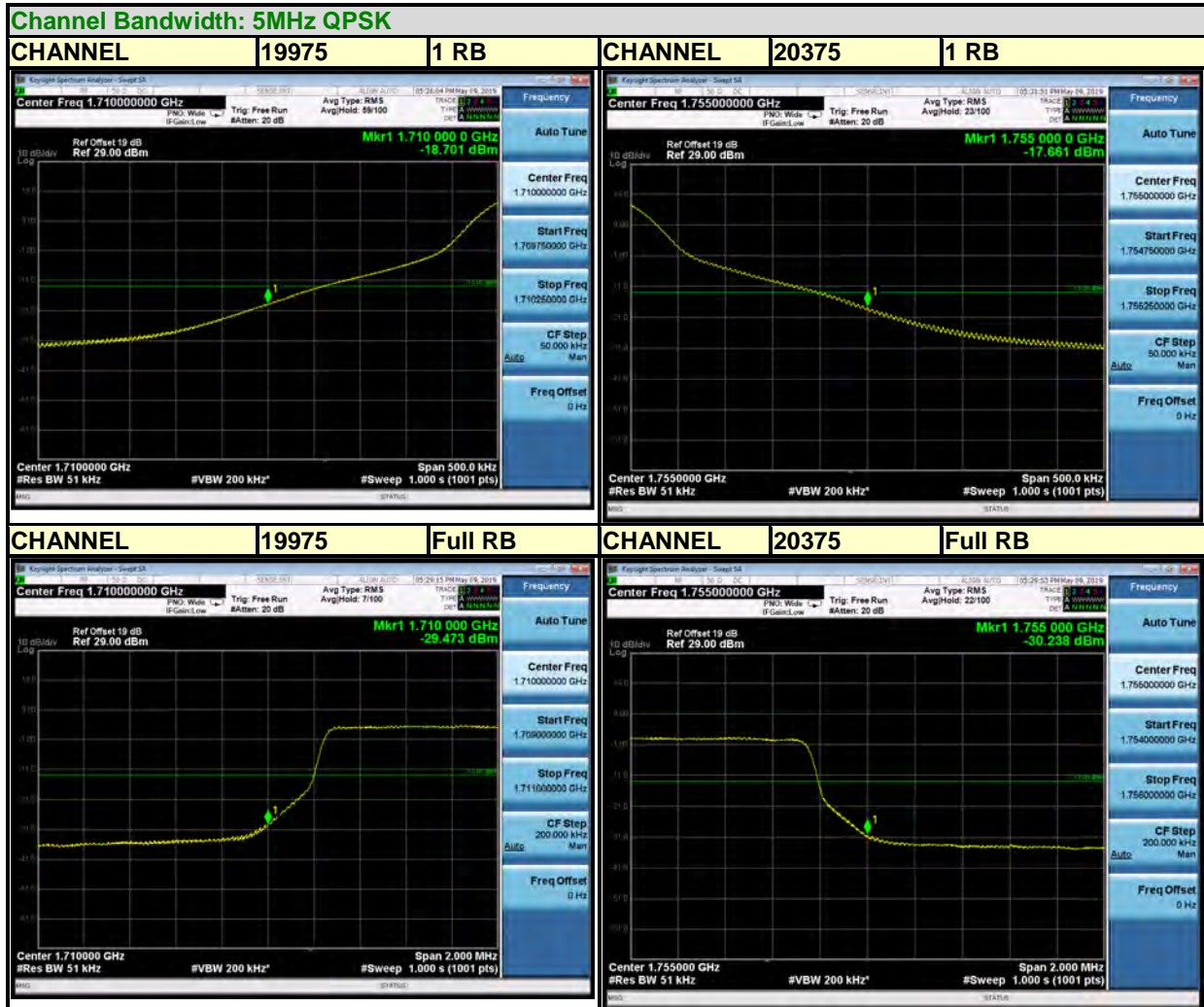



Test Report No.: RF190418W001-5

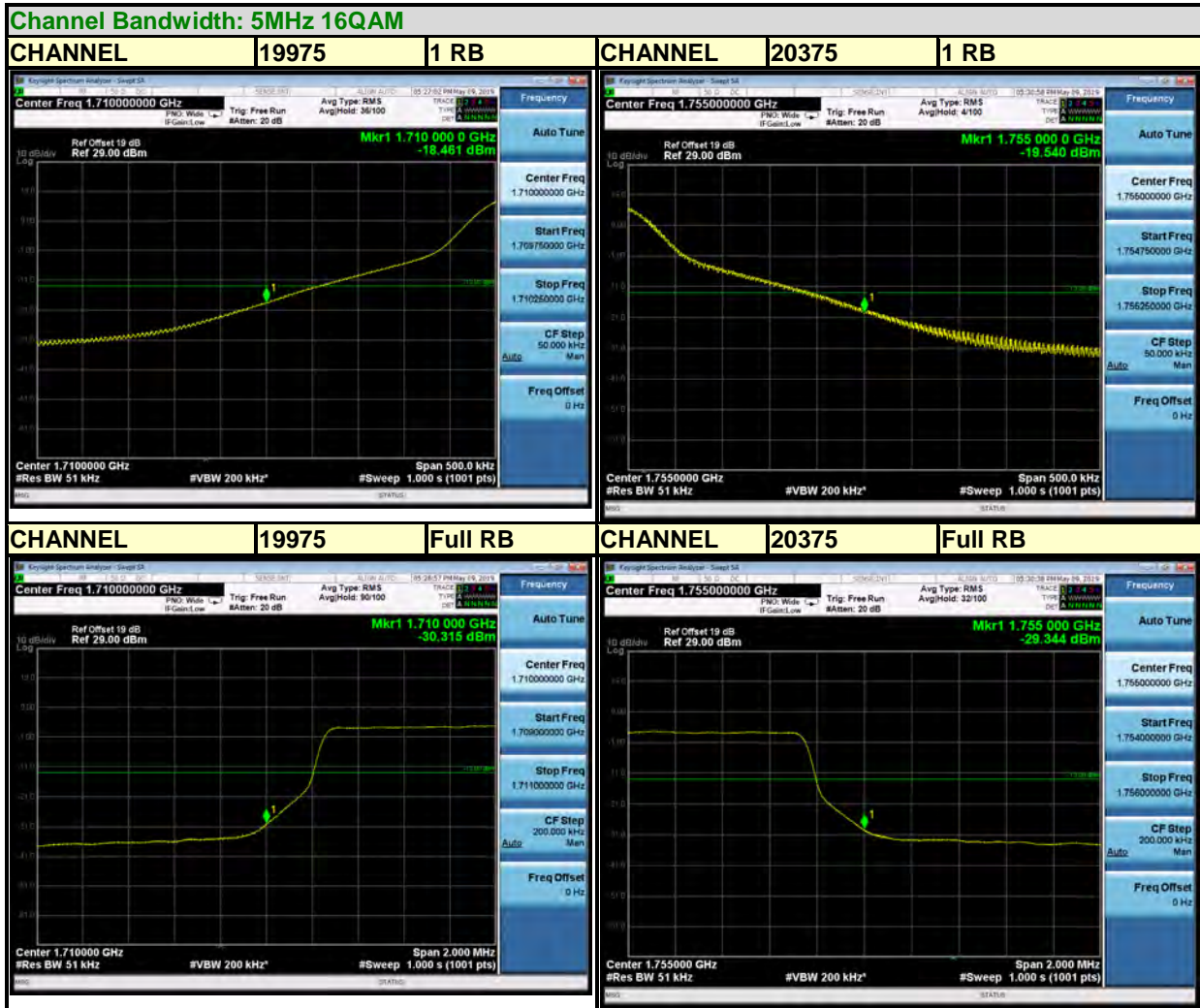



Test Report No.: RF190418W001-5

LTE BAND 4

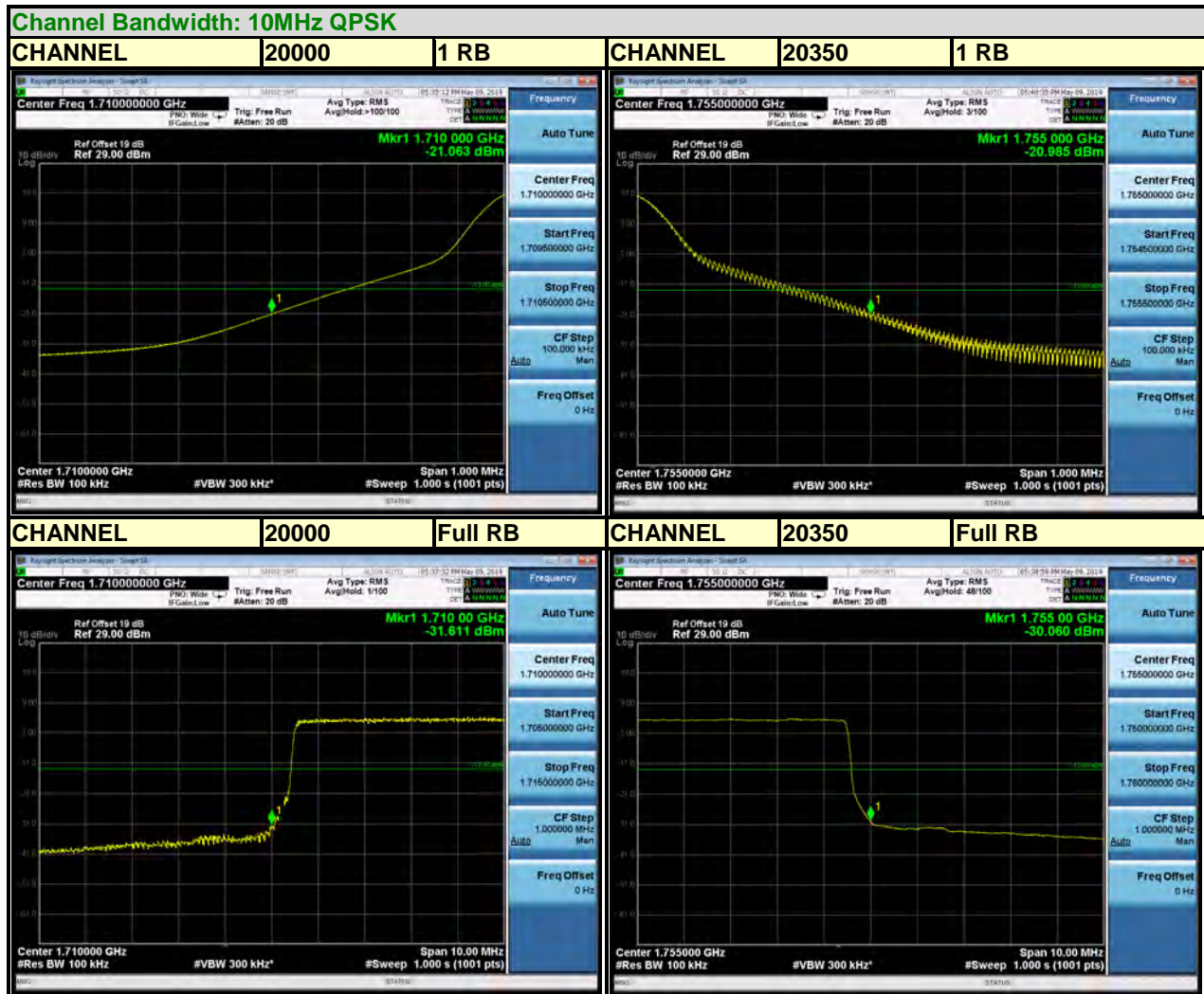



Test Report No.: RF190418W001-5

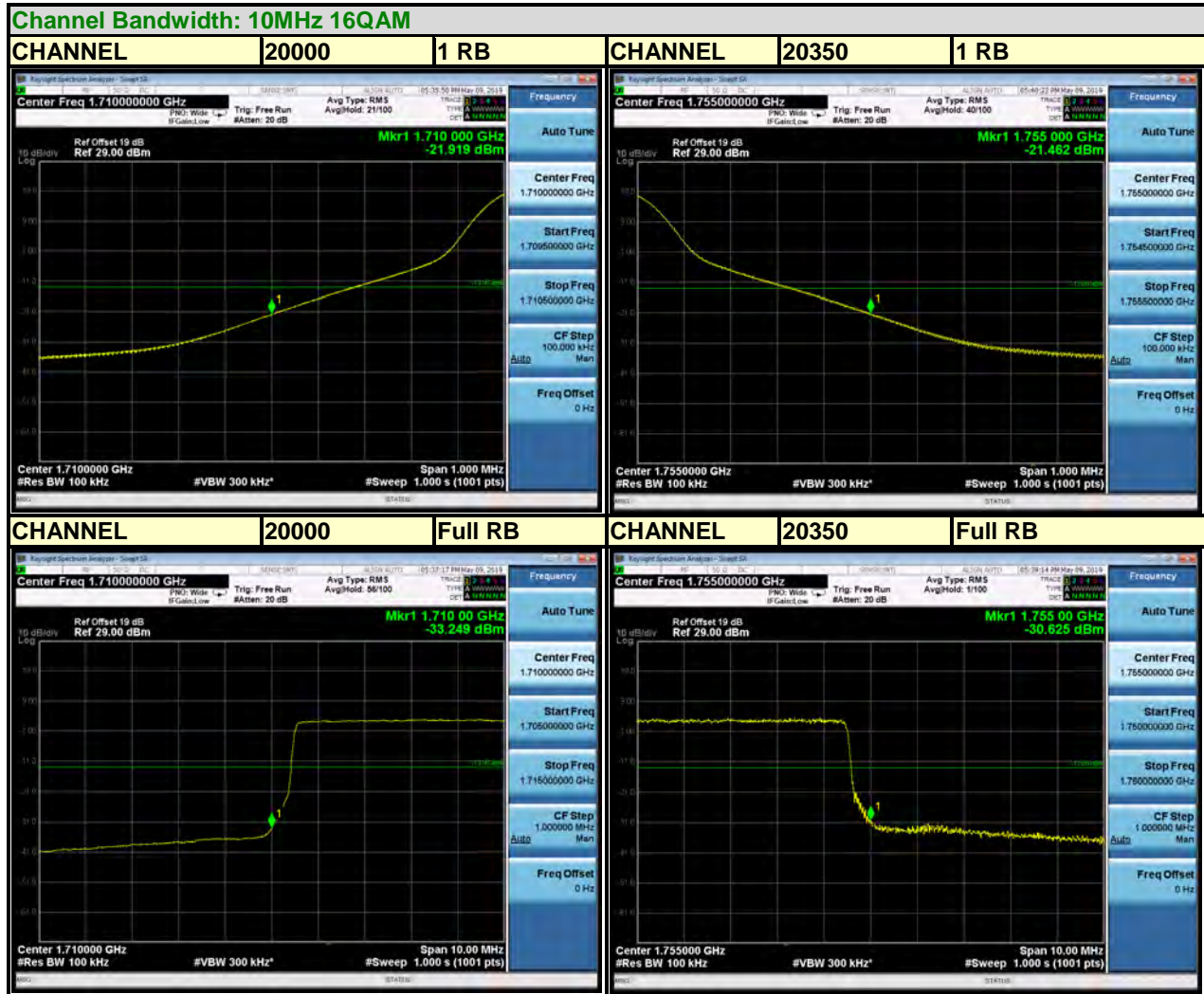



Test Report No.: RF190418W001-5

LTE BAND 4

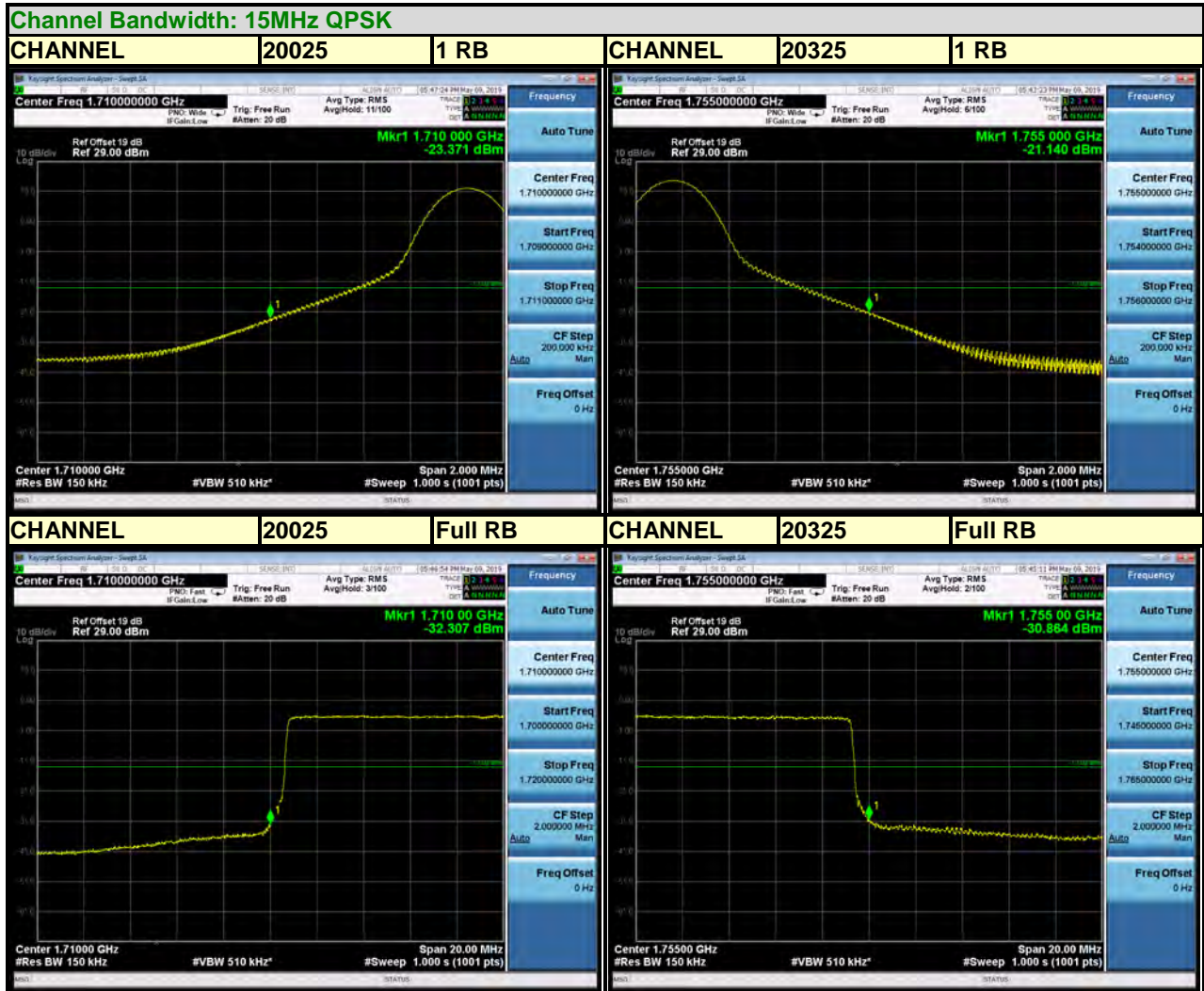



Test Report No.: RF190418W001-5

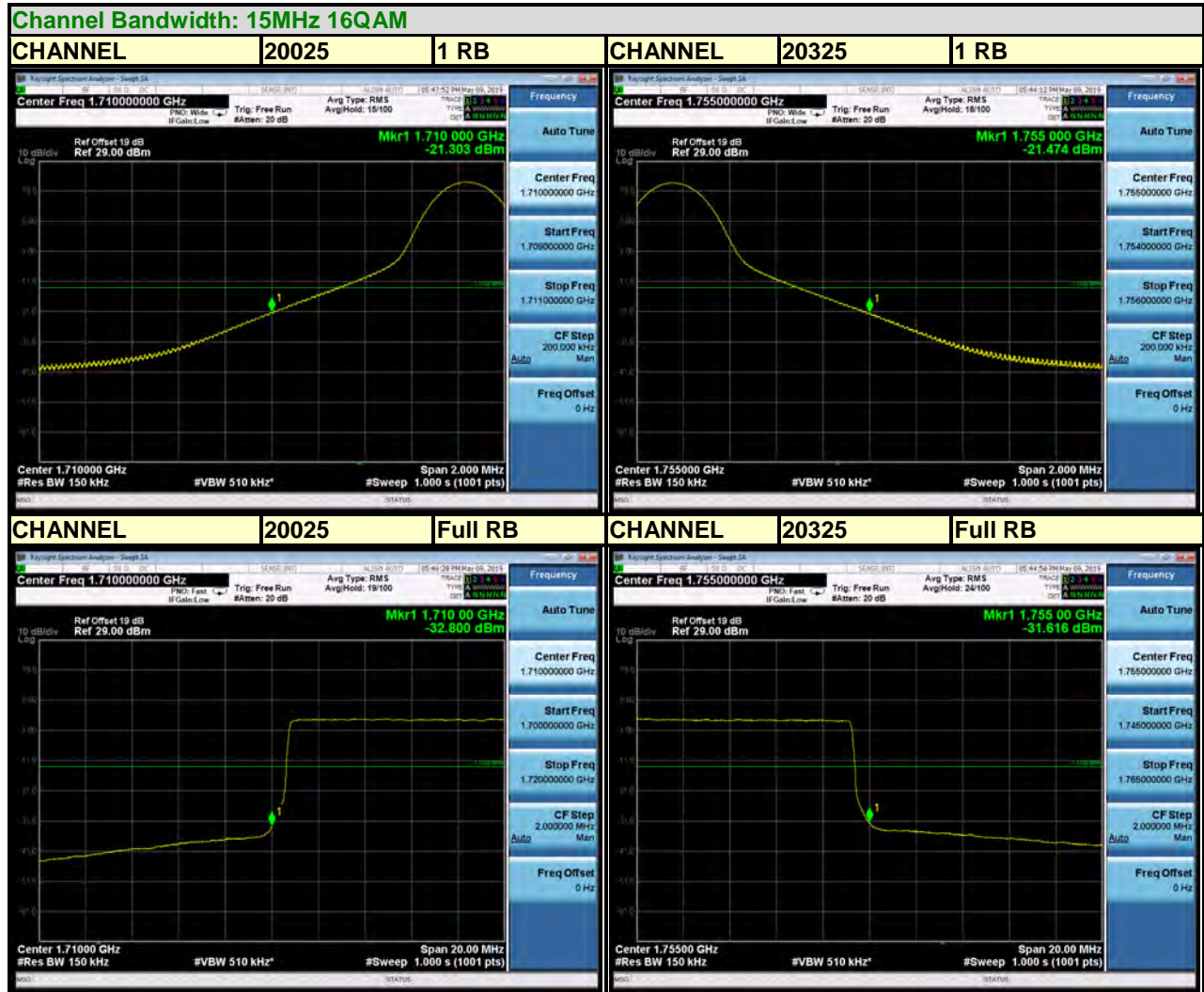





Test Report No.: RF190418W001-5

LTE BAND 4





Test Report No.: RF190418W001-5

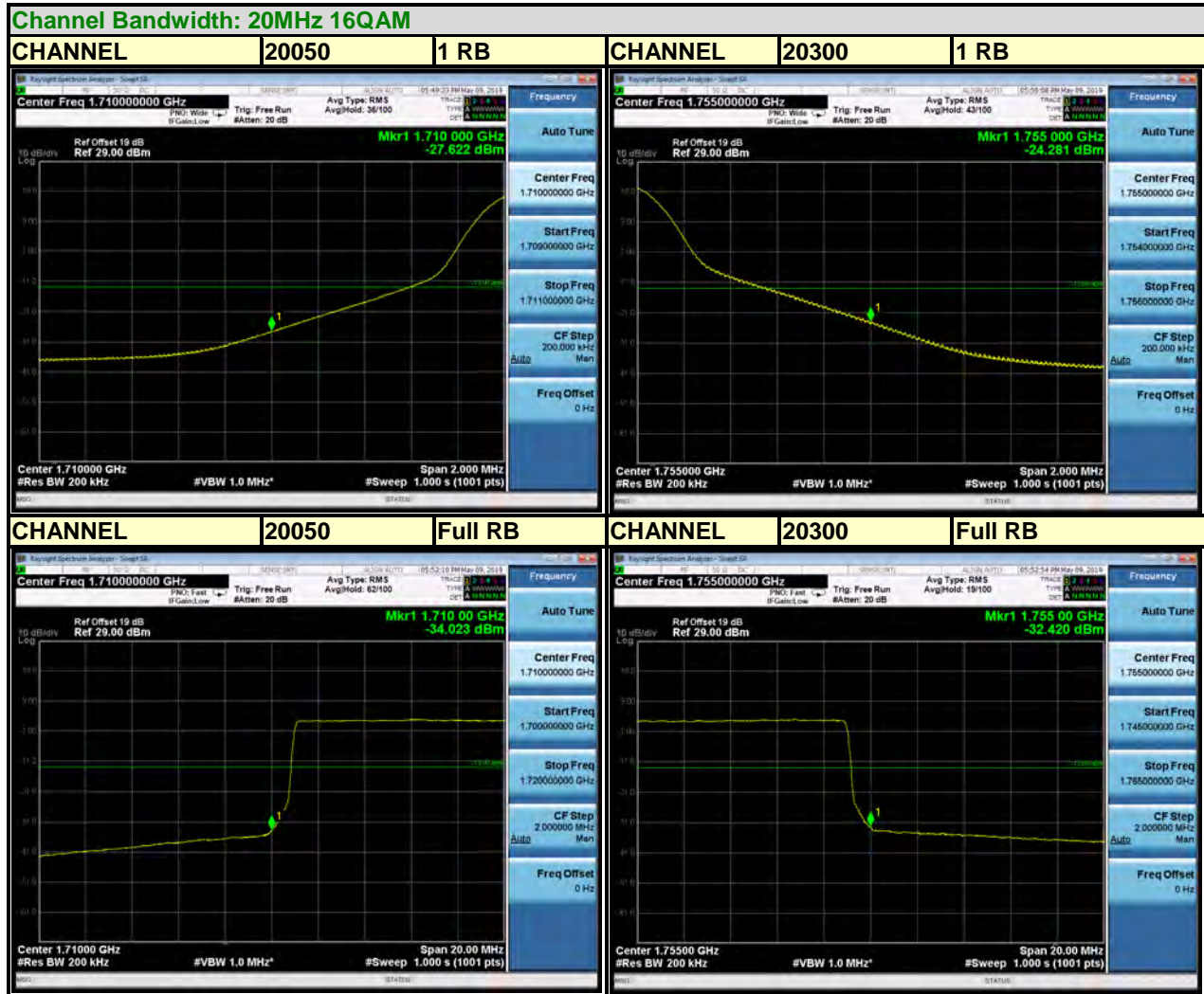



Test Report No.: RF190418W001-5

LTE BAND 12

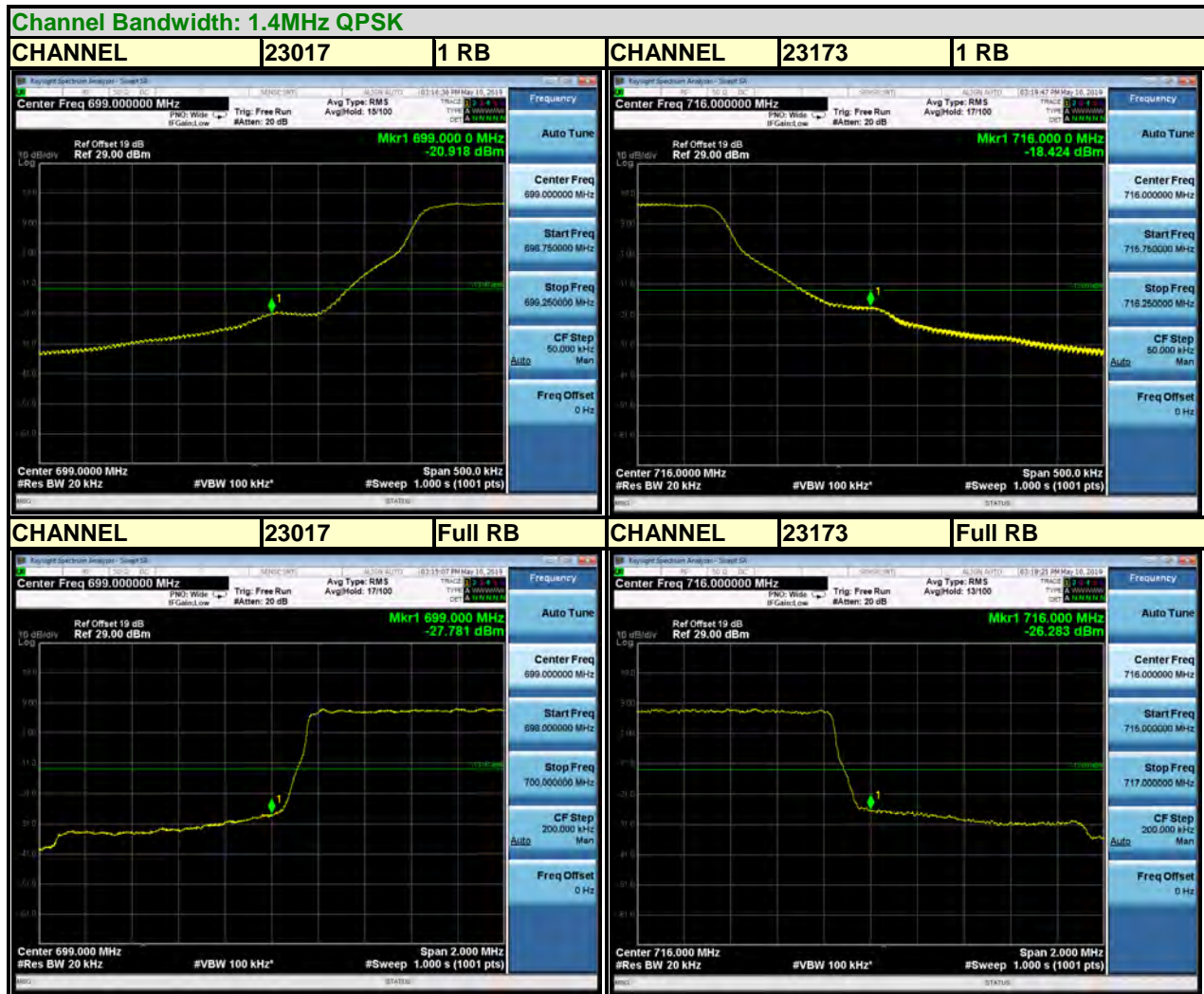



Test Report No.: RF190418W001-5

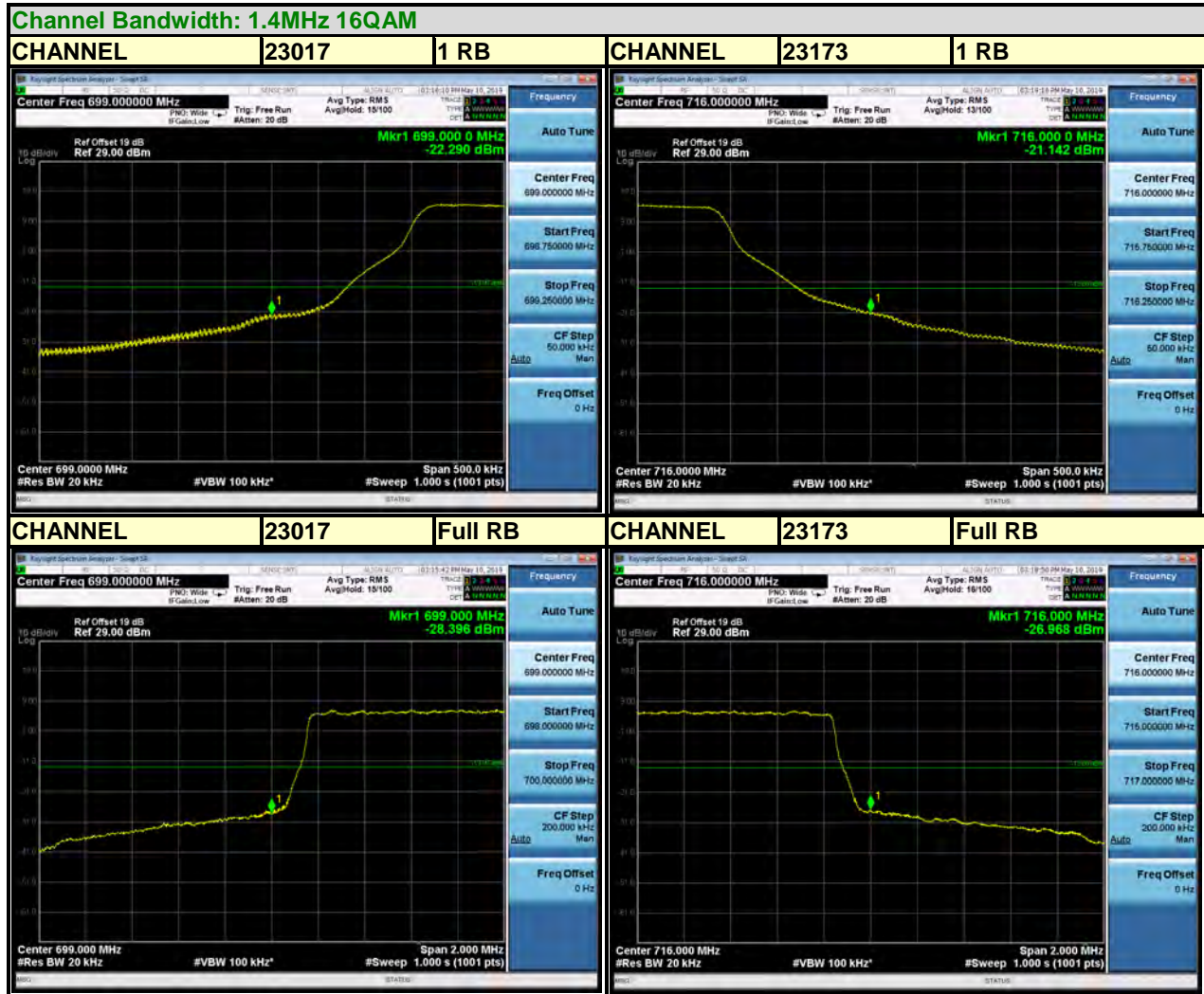



Test Report No.: RF190418W001-5

LTE BAND 12

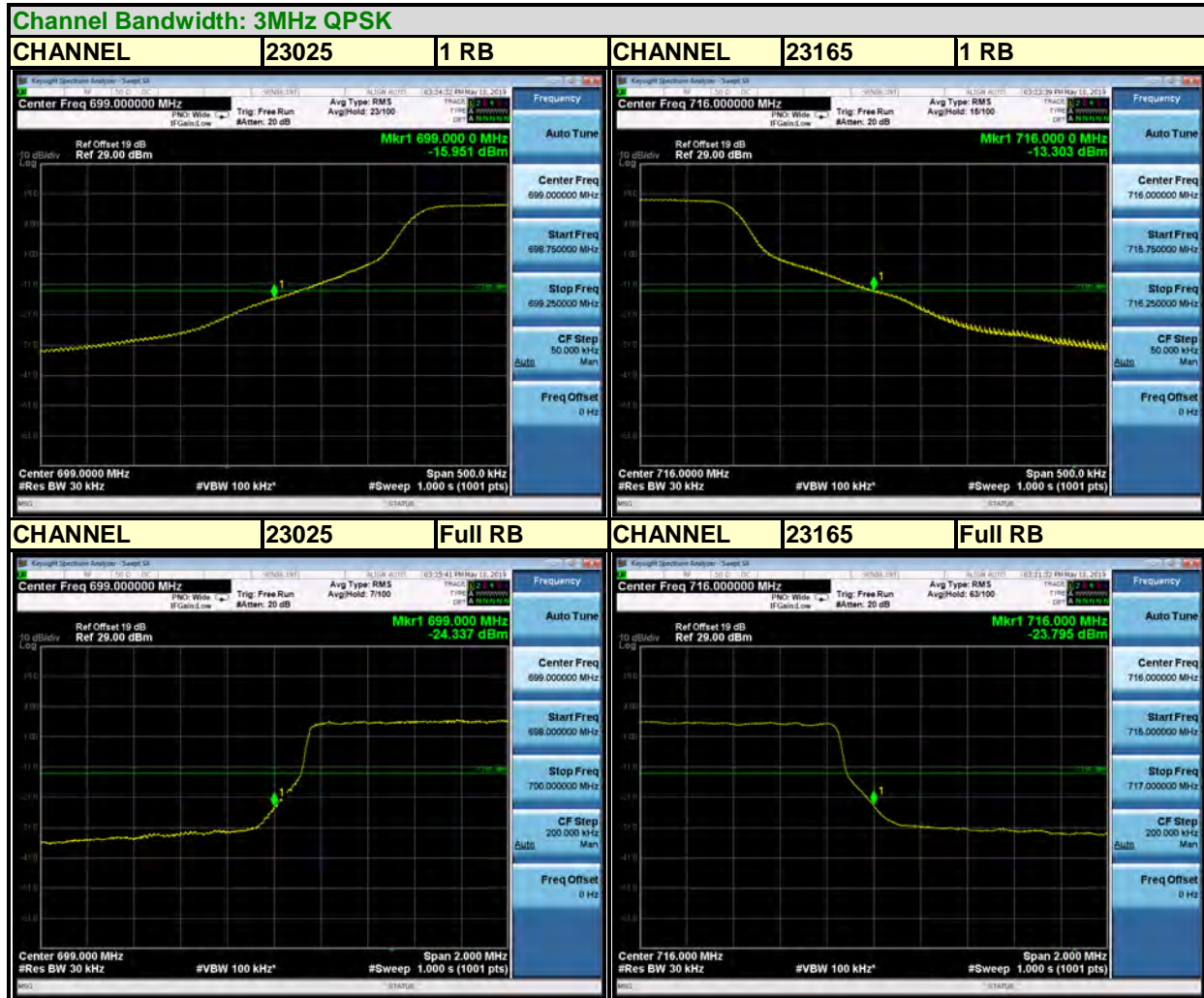



Test Report No.: RF190418W001-5





Test Report No.: RF190418W001-5

LTE BAND 12

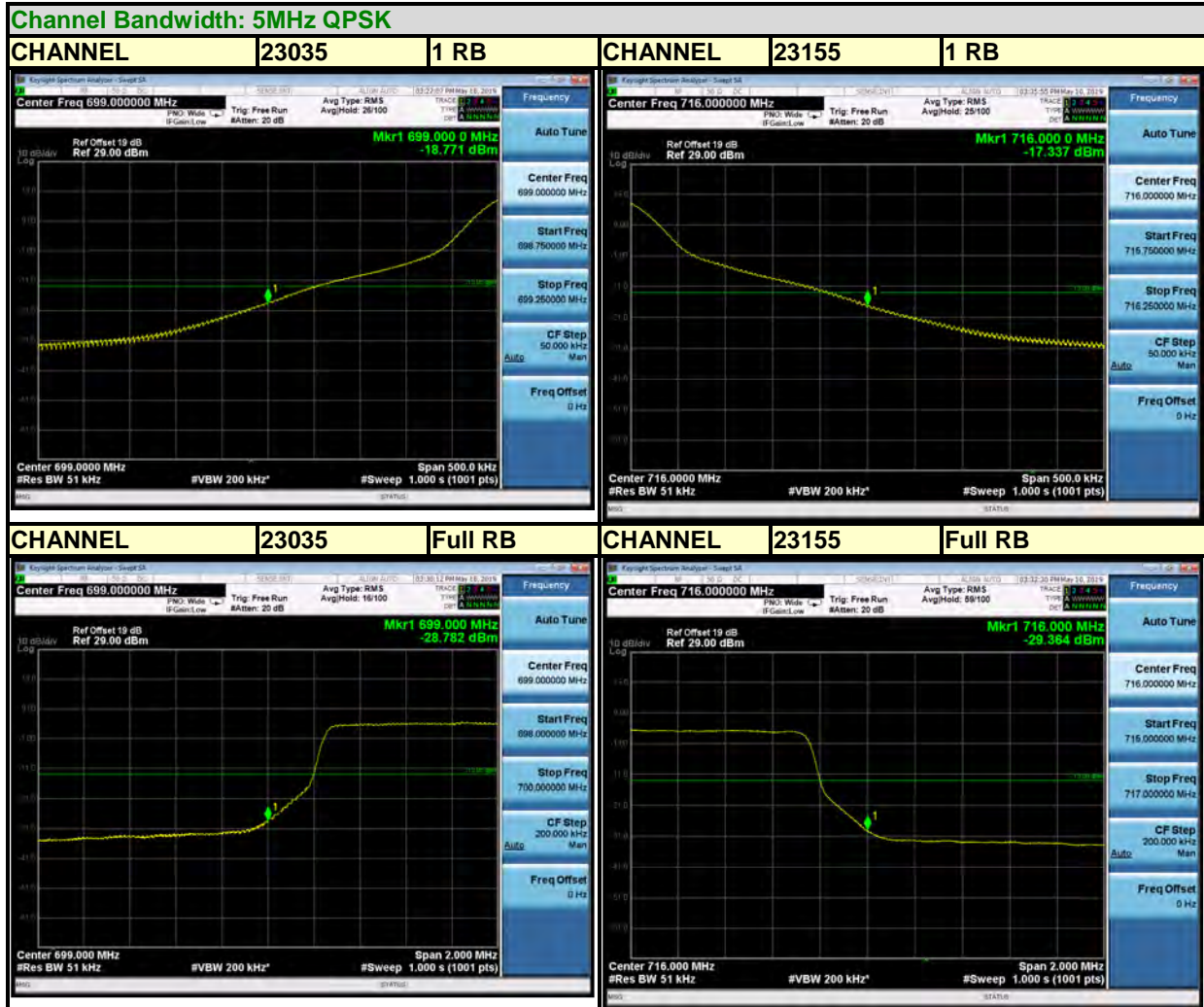



Test Report No.: RF190418W001-5

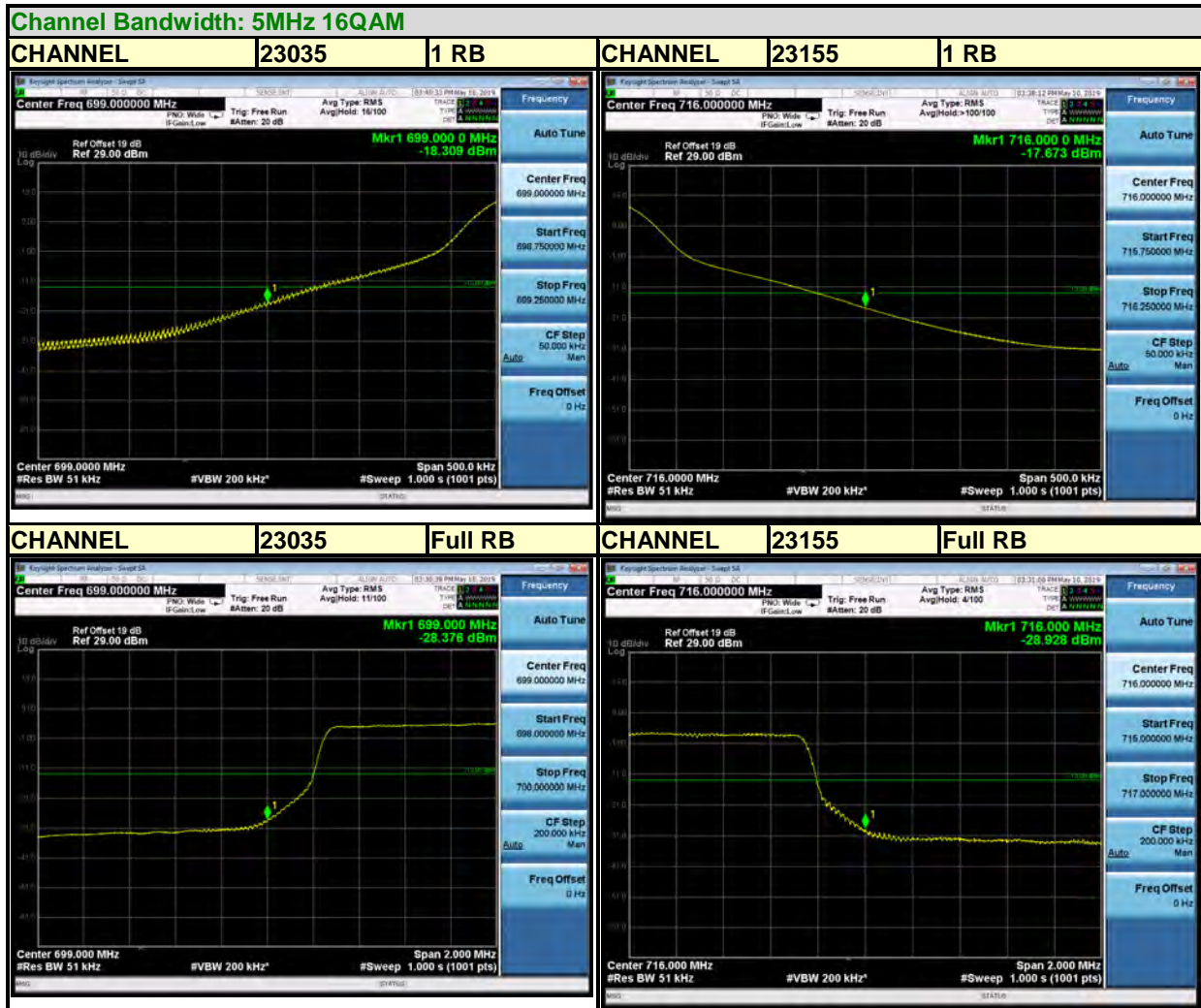





Test Report No.: RF190418W001-5

LTE BAND 12

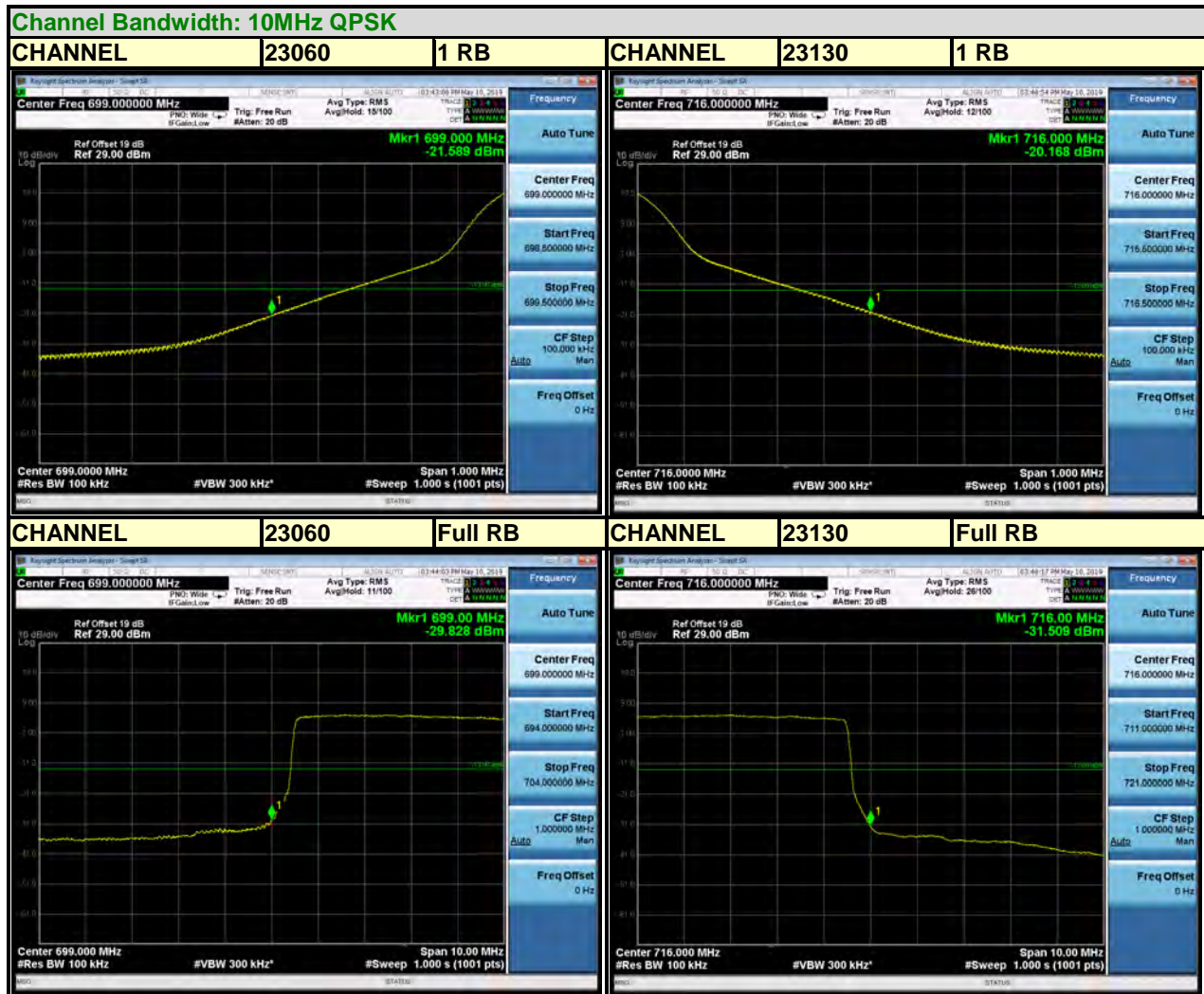



Test Report No.: RF190418W001-5

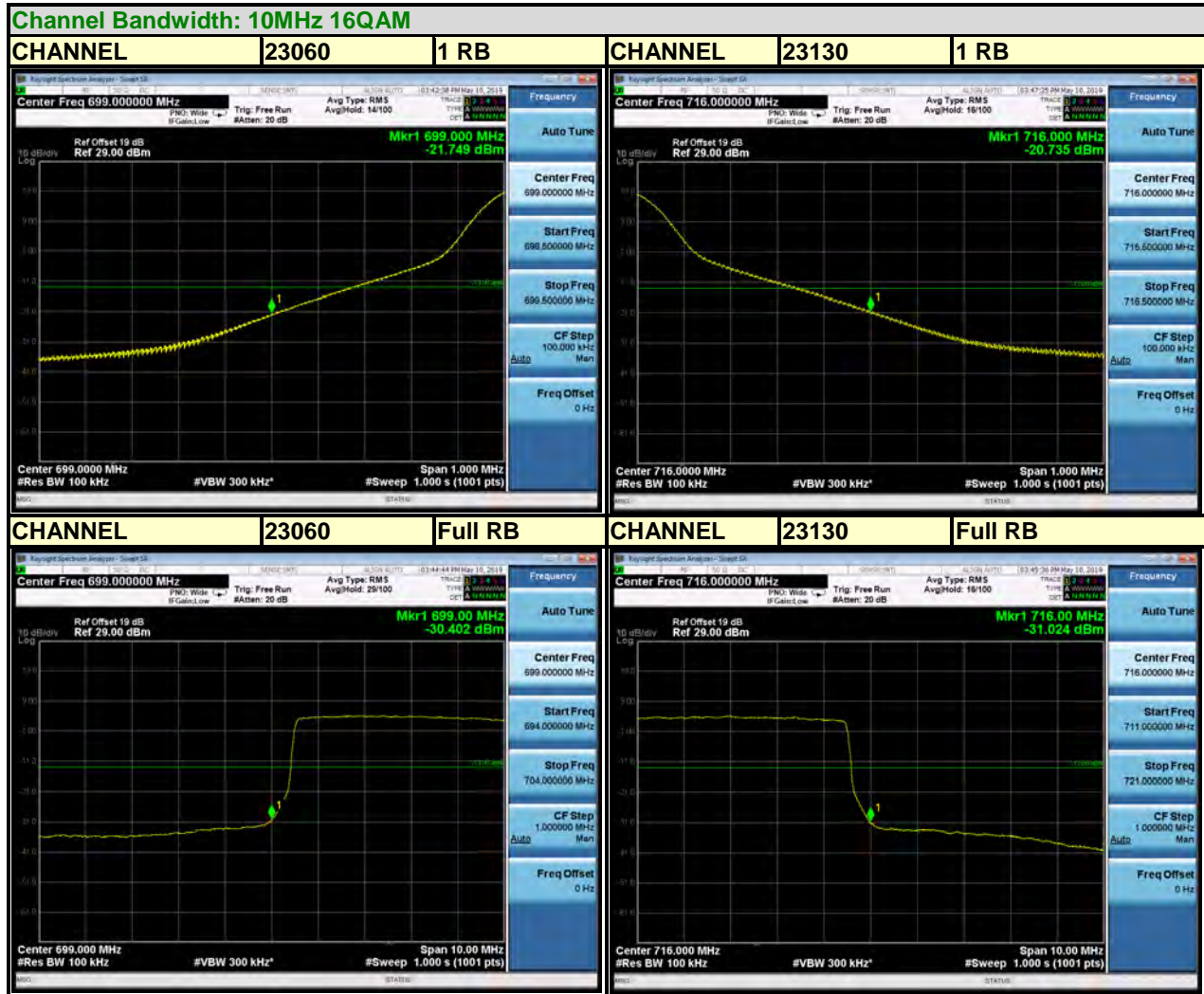

### 3.6 CONDUCTED SPURIOUS EMISSIONS

#### 3.6.1 LIMITS OF CONDUCTED SPURIOUS EMISSIONS MEASUREMENT

The power of any emission outside a licensee's frequency block shall be attenuated below the transmitter power (P) by at least  $43 + 10 \log_{10}(P)$  dB. The limit of emission equal to  $-13\text{dBm}$

#### 3.6.2 TEST PROCEDURE

- a. The EUT makes a phone call to the communication simulator. All measurements were done at middle operational frequency range.
- b. Measuring frequency range is from 30 MHz to 19.1GHz for WCDMA Band 4 & LTE Band 4 and 30 MHz to 9GHz for LTE Band 12. 10dB attenuation pad is connected with spectrum. RBW=1MHz and VBW=3MHz are used for conducted emission measurement.

#### 3.6.3 TEST SETUP

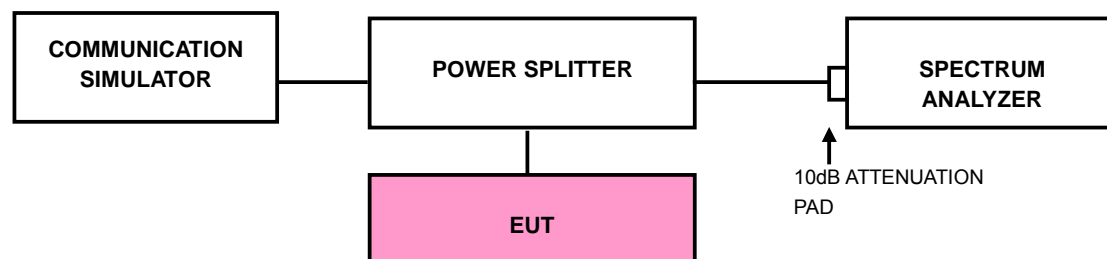



Test Report No.: RF190418W001-5

### 3.6.4 TEST RESULTS

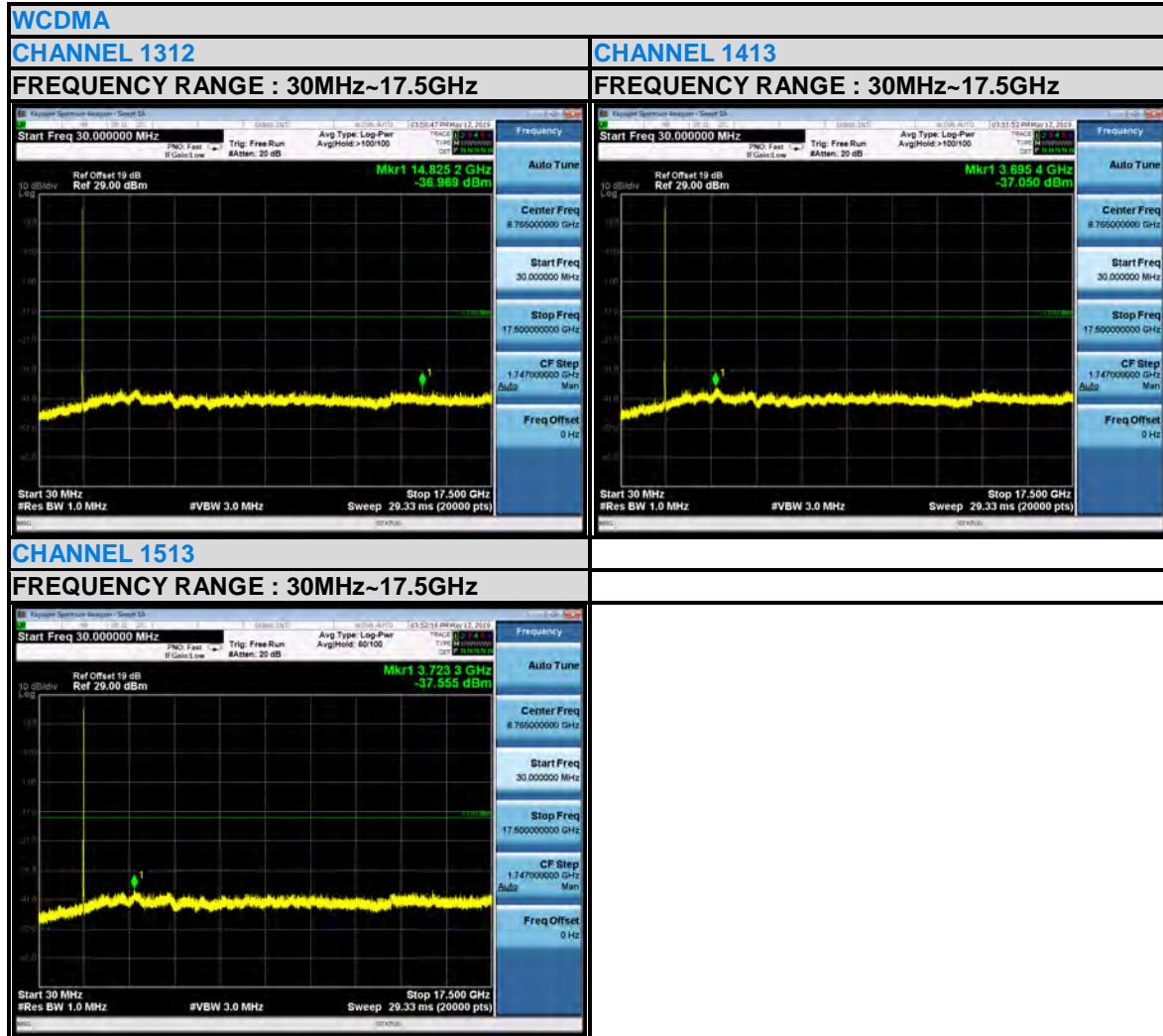



Test Report No.: RF190418W001-5

LTE BAND 4

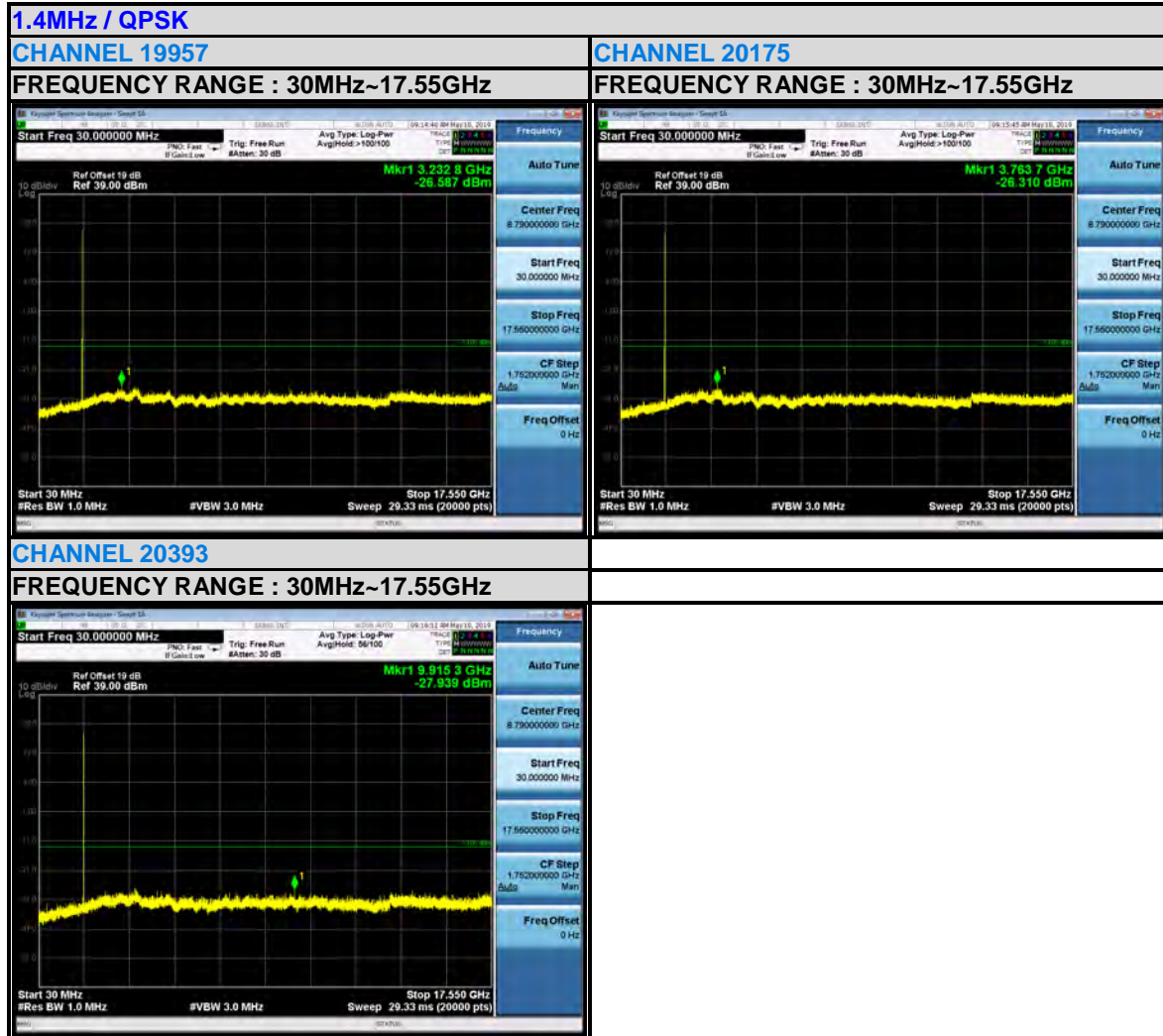



Test Report No.: RF190418W001-5





Test Report No.: RF190418W001-5





Test Report No.: RF190418W001-5







Test Report No.: RF190418W001-5





Test Report No.: RF190418W001-5





LTE BAND 12

1.4MHz / QPSK

CHANNEL 23017

FREQUENCY RANGE : 30MHz~7.16GHz



CHANNEL 23095

FREQUENCY RANGE : 30MHz~7.16GHz

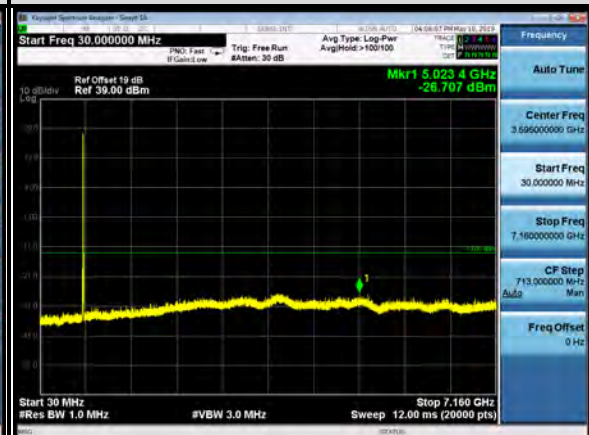

CHANNEL 23173

FREQUENCY RANGE : 30MHz~7.16GHz

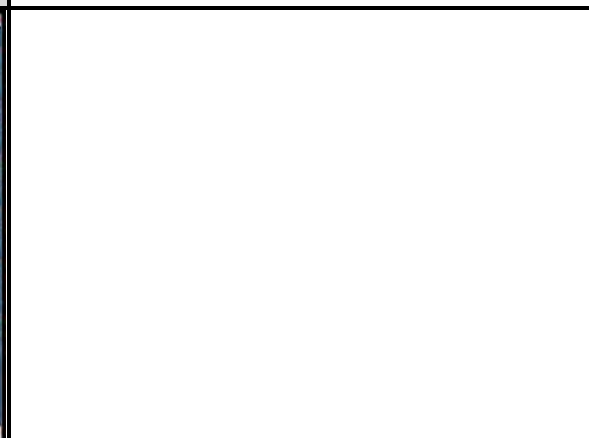
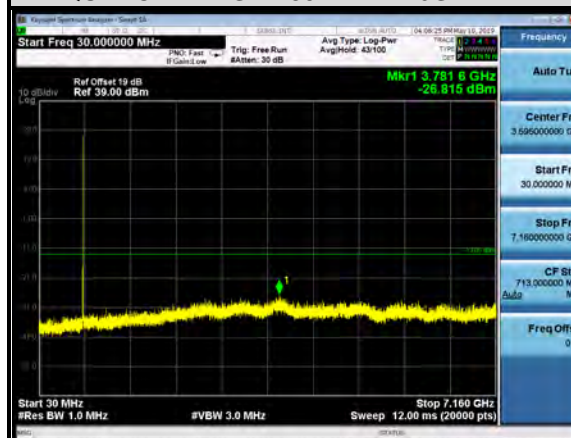



Test Report No.: RF190418W001-5

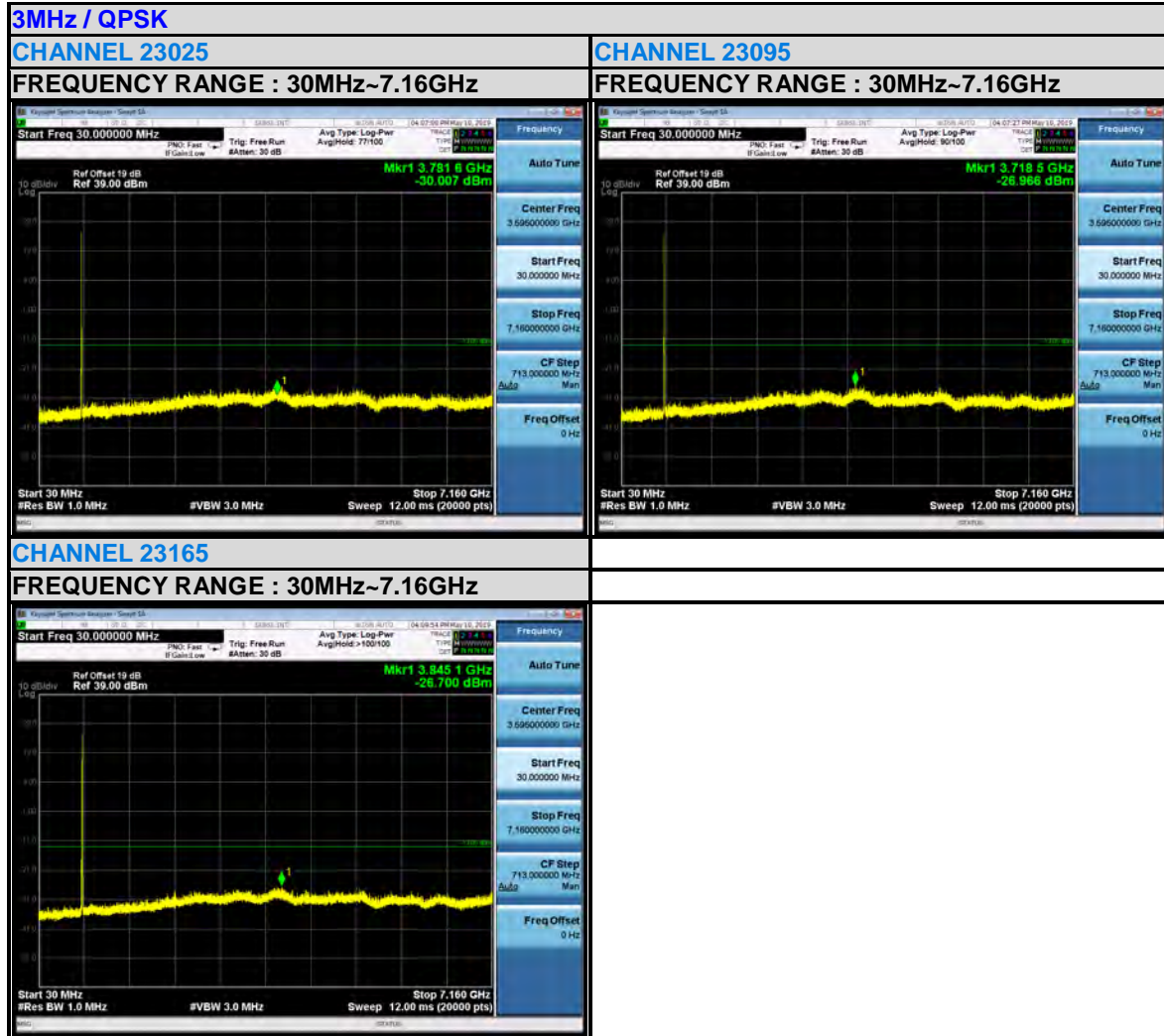



Test Report No.: RF190418W001-5

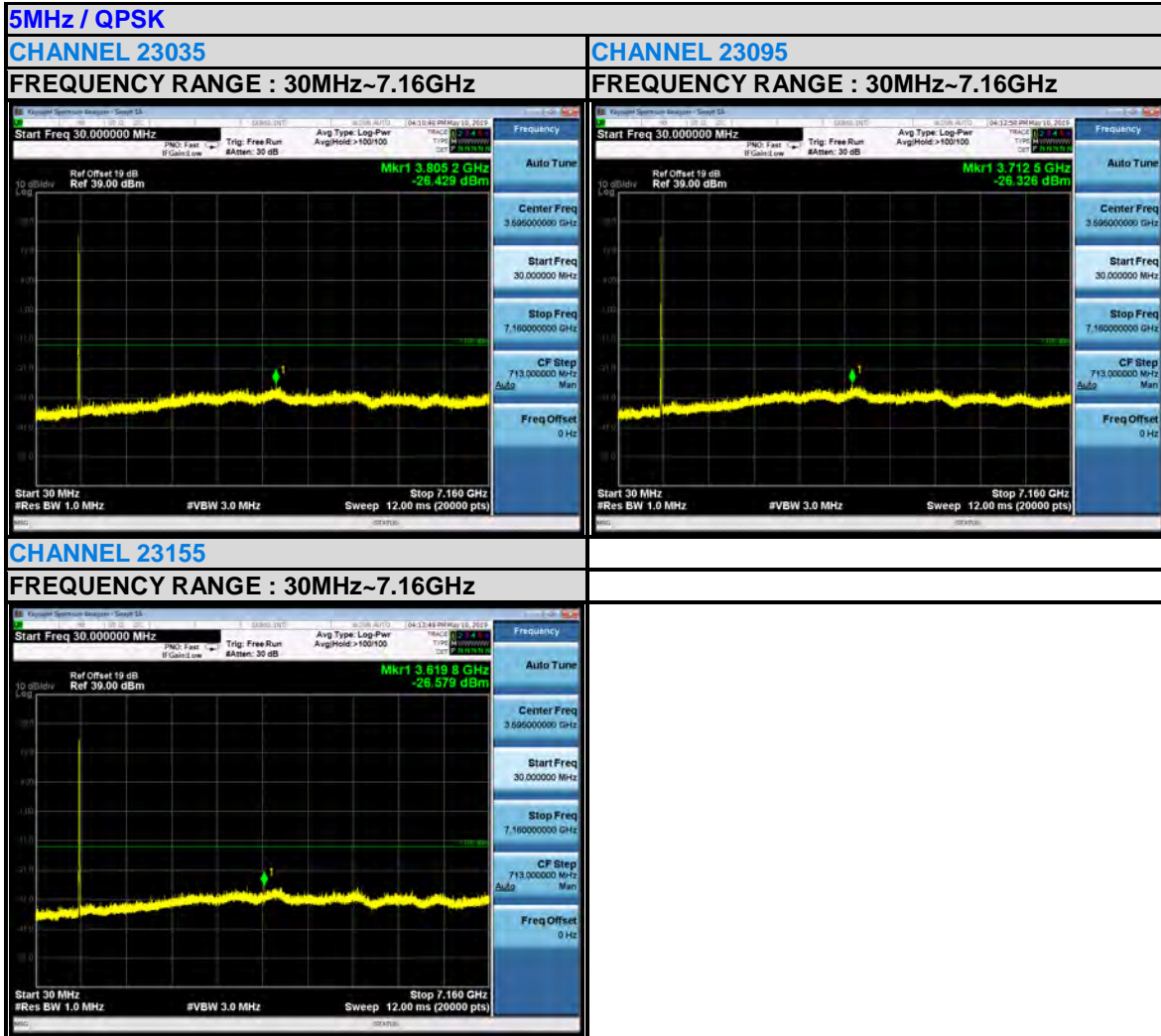



Test Report No.: RF190418W001-5

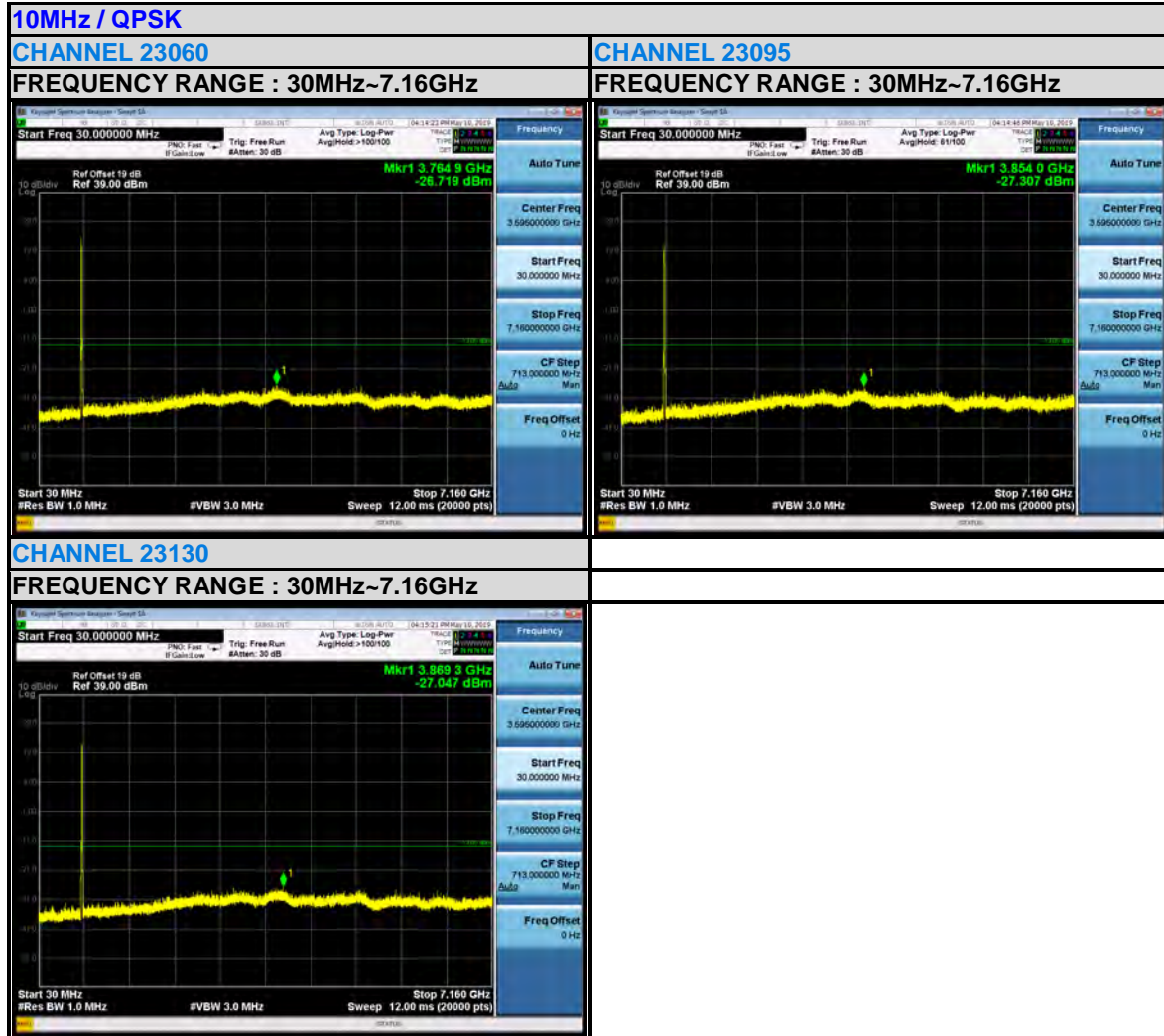



### 3.7 RADIATED EMISSION MEASUREMENT

#### 3.7.1 LIMITS OF RADIATED EMISSION MEASUREMENT

The power of any emission outside a licensee's frequency block shall be attenuated below the transmitter power (P) by at least  $43 + 10 \log_{10}(P)$  dB. The limit of emission equal to  $-13\text{dBm}$

#### 3.7.2 TEST PROCEDURES

- a. Substitution method is used for E.I.R.P measurement. In the semi-anechoic chamber, EUT placed on the 0.8m height of Turn Table, rotated the table around 360 degrees to search the maximum radiation power and receiver antenna shall be rotated vertical and horizontal polarization and moved height from 1m to 4m to find the maximum polar radiated power. The "Read Value" is the spectrum reading the maximum power value.
- b. The substitution horn antenna is substituted for EUT at the same position and signals generator export the CW signal to the substitution antenna via a TX cable. Rotated the Turn Table and moved receiving antenna to find the maximum radiation power. Adjust output power level of S.G to get a Value of spectrum reading equal to "Read Value" of step a. Record the power level of S.G
- c.  $\text{EIRP} = \text{Output power level of S.G} - \text{TX cable loss} + \text{Antenna gain of substitution horn}$ .
- d. E.R.P power can be calculated form E.I.R.P power by subtracting the gain of dipole,  $\text{E.R.P power} = \text{E.I.P.R power} - 2.15\text{dBi}$ .

**NOTE:** The resolution bandwidth of spectrum analyzer is 1 MHz and the video bandwidth is 3 MHz.

#### 3.7.3 DEVIATION FROM TEST STANDARD

No deviation

### 3.7.4 TEST SETUP

<Below 30MHz>

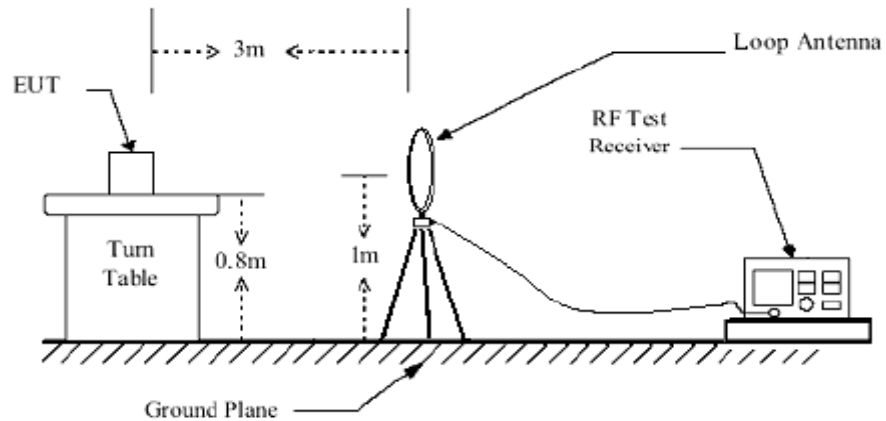

< Frequency Range 30MHz~1GHz >

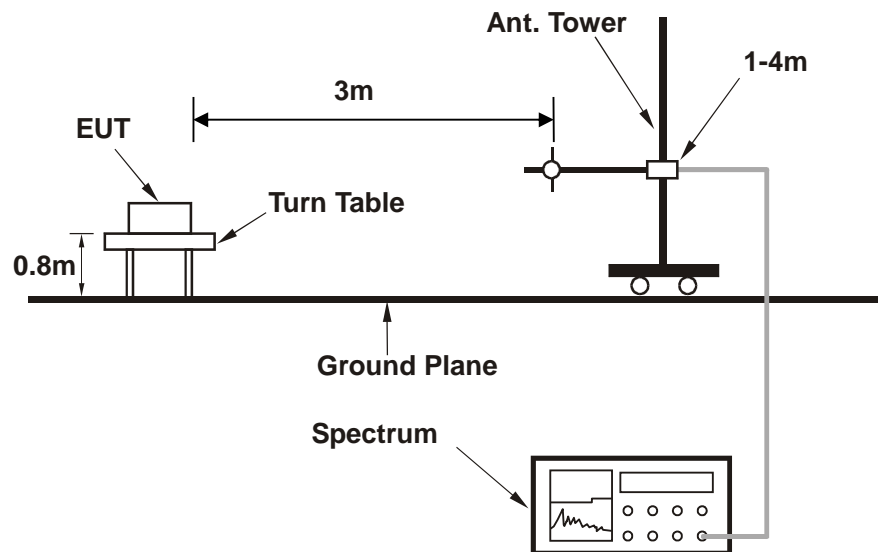



< Frequency Range above 1GHz >

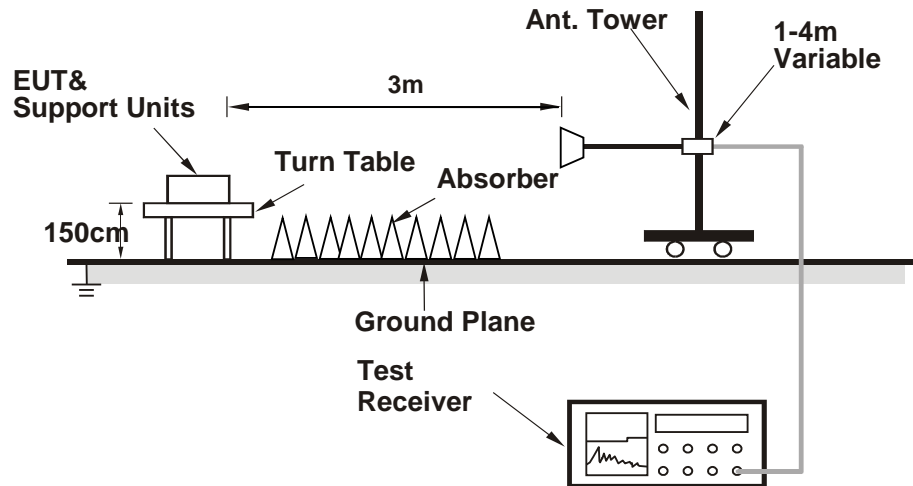

For the actual test configuration, please refer to the attached file (Test Setup Photo).



Test Report No.: RF190418W001-5

### 3.7.5 TEST RESULTS

#### BELOW 1GHz WORST-CASE DATA

**9 KHz – 30 MHz data:** the amplitude of spurious emissions attenuated more than 20 dB below the permissible value is not required in the report.

**30 MHz – 1GHz data:**

**LTE BAND 4:**

**CHANNEL BANDWIDTH: 3MHz / QPSK**

<b>MODE</b>	TX channel 20175	<b>FREQUENCY RANGE</b>	Below 1000MHz
<b>ENVIRONMENTAL CONDITIONS</b>	23deg. C, 70%RH	<b>INPUT POWER</b>	DC 5V from adapter
<b>TESTED BY</b>	Star Le		
<b>ANTENNA POLARITY &amp; TEST DISTANCE: HORIZONTAL AT 3 M</b>			

	Freq	Level	Read Level	Limit Line	Over Limit	Factor	Remark	Pol/Phase
	MHz	dBm/m	dBm	dBm/m	dB	dB/m		
1 PP	34.850	-31.52	-45.91	-13.00	-18.52	14.39	Peak	Horizontal
2	87.230	-39.83	-48.22	-13.00	-26.83	8.39	Peak	Horizontal
3	99.840	-39.64	-49.32	-13.00	-26.64	9.68	Peak	Horizontal
4	195.870	-38.02	-48.72	-13.00	-25.02	10.70	Peak	Horizontal
5	227.880	-39.35	-51.38	-13.00	-26.35	12.03	Peak	Horizontal
6	297.720	-43.93	-57.98	-13.00	-30.93	14.05	Peak	Horizontal

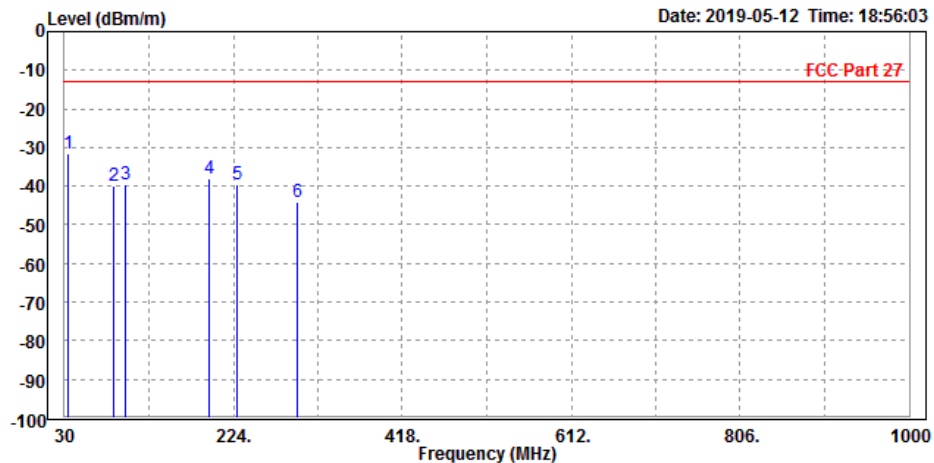



Test Report No.: RF190418W001-5

<b>MODE</b>	TX channel 20175	<b>FREQUENCY RANGE</b>	Below 1000MHz
<b>ENVIRONMENTAL CONDITIONS</b>	23deg. C, 70%RH	<b>INPUT POWER</b>	DC 5V from adapter
<b>TESTED BY</b>	Star Le		
<b>ANTENNA POLARITY &amp; TEST DISTANCE: VERTICAL AT 3 M</b>			

	Freq	Level	Read Level	Limit Line	Over Limit	Factor	Remark	Pol/Phase
	MHz	dBm/m	dBm	dBm/m	dB	dB/m		
1 PP	34.850	-20.01	-34.12	-13.00	-7.01	14.11	Peak	Vertical
2	85.290	-28.03	-36.49	-13.00	-15.03	8.46	Peak	Vertical
3	95.960	-29.46	-38.78	-13.00	-16.46	9.32	Peak	Vertical
4	193.930	-42.92	-53.60	-13.00	-29.92	10.68	Peak	Vertical
5	416.060	-44.03	-61.55	-13.00	-31.03	17.52	Peak	Vertical
6	705.120	-42.82	-65.84	-13.00	-29.82	23.02	Peak	Vertical

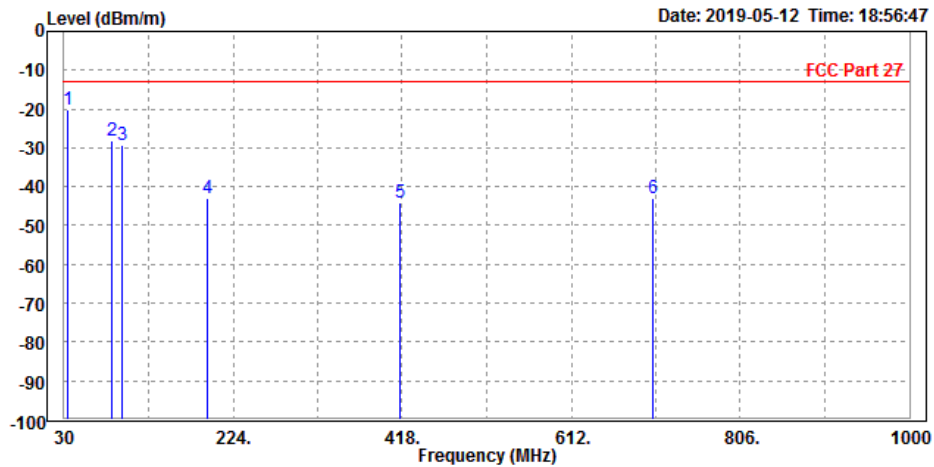



Test Report No.: RF190418W001-5

**ABOVE 1GHz**

**Note:** For higher frequency, the emission is too low to be detected.

**WCDMA Band IV:**

**CH 1312**

<b>MODE</b>	TX channel 1312	<b>FREQUENCY RANGE</b>	Above 1000MHz
<b>ENVIRONMENTAL CONDITIONS</b>	23deg. C, 70%RH	<b>INPUT POWER</b>	DC 5V from adapter
<b>TESTED BY</b>	Star Le		
<b>ANTENNA POLARITY &amp; TEST DISTANCE: HORIZONTAL AT 3 M</b>			

	Freq	Level	Read Level	Limit Line	Over Limit	Factor	Remark	Pol/Phase
	MHz	dBm/m	dBm	dBm/m	dB	dB/m		
1	3418.000	-58.40	-60.25	-13.00	-45.40	1.85	Peak	Horizontal
2 PP	5137.000	-55.78	-64.32	-13.00	-42.78	8.54	Peak	Horizontal

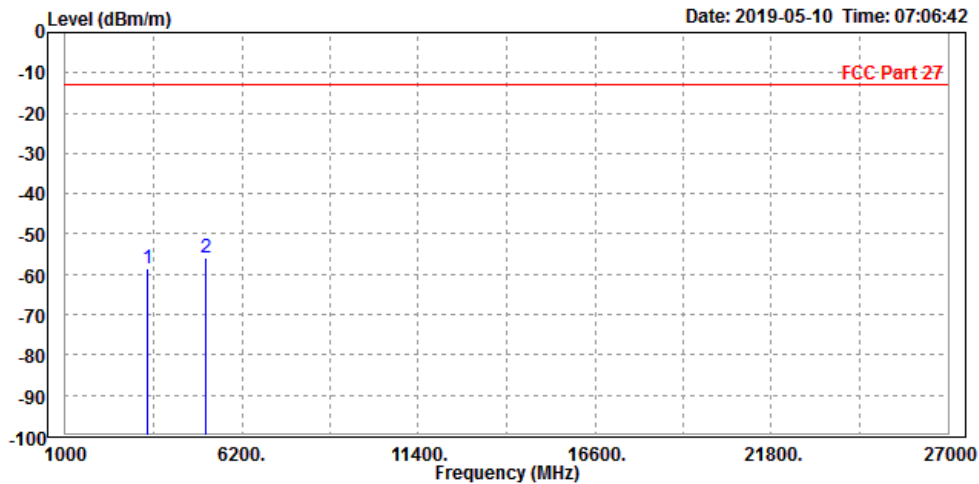



Test Report No.: RF190418W001-5

<b>MODE</b>	TX channel 1312	<b>FREQUENCY RANGE</b>	Above 1000MHz
<b>ENVIRONMENTAL CONDITIONS</b>	23deg. C, 70%RH	<b>INPUT POWER</b>	DC 5V from adapter
<b>TESTED BY</b>	Star Le		
<b>ANTENNA POLARITY &amp; TEST DISTANCE: VERTICAL AT 3 M</b>			

	Freq	Level	Read Level	Limit Line	Over Limit	Factor	Remark	Pol/Phase
	MHz	dBm/m	dBm	dBm/m	dB	dB/m		
1	3418.000	-56.48	-58.95	-13.00	-43.48	2.47	Peak	Vertical
2 PP	5137.000	-54.43	-62.42	-13.00	-41.43	7.99	Peak	Vertical

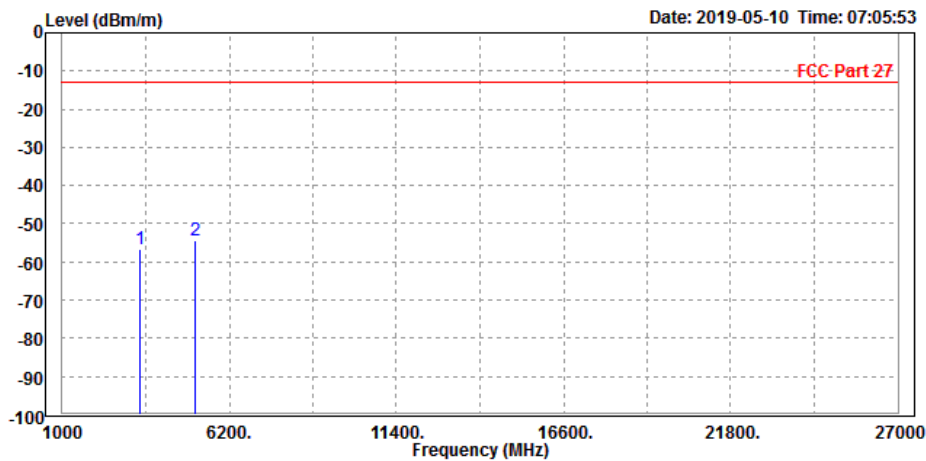



Test Report No.: RF190418W001-5

CH 1413

MODE	TX channel 1413	FREQUENCY RANGE	Above 1000MHz
ENVIRONMENTAL CONDITIONS	23deg. C, 70%RH	INPUT POWER	DC 5V from adapter
TESTED BY	Star Le		
<b>ANTENNA POLARITY &amp; TEST DISTANCE: HORIZONTAL AT 3 M</b>			

	Freq	Level	Read Level	Limit Line	Over Limit	Factor	Remark	Pol/Phase
	MHz	dBm/m	dBm	dBm/m	dB	dB/m		
1	3470.000	-60.10	-62.15	-13.00	-47.10	2.05	Peak	Horizontal
2 PP	5197.000	-56.34	-64.95	-13.00	-43.34	8.61	Peak	Horizontal

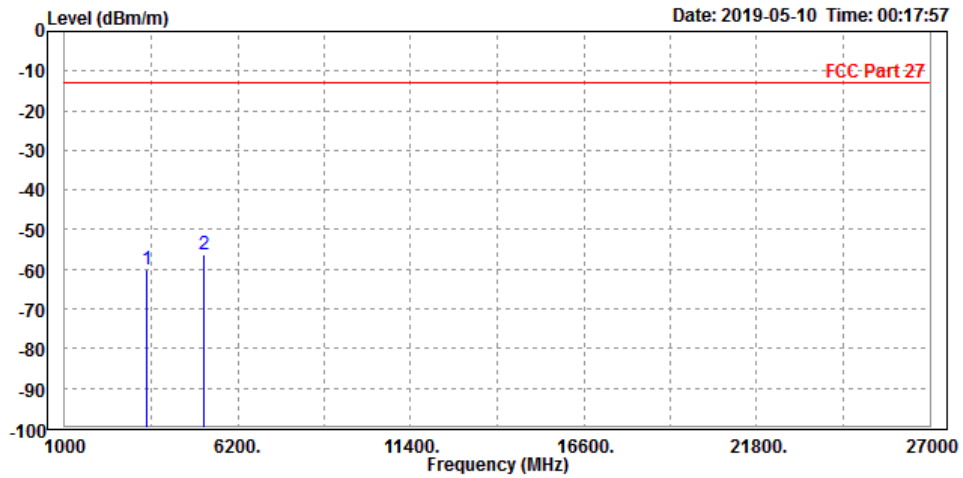



Test Report No.: RF190418W001-5

<b>MODE</b>	TX channel 1413	<b>FREQUENCY RANGE</b>	Above 1000MHz
<b>ENVIRONMENTAL CONDITIONS</b>	23deg. C, 70%RH	<b>INPUT POWER</b>	DC 5V from adapter
<b>TESTED BY</b>	Star Le		
<b>ANTENNA POLARITY &amp; TEST DISTANCE: VERTICAL AT 3 M</b>			

	Freq	Read Level	Limit Level	Over Limit	Factor	Remark	Pol/Phase
	MHz	dBm/m	dBm	dBm/m	dB	dB/m	
1	3470.000	-55.69	-58.22	-13.00	-42.69	2.53 Peak	Vertical
2 PP	5197.000	-54.18	-62.16	-13.00	-41.18	7.98 Peak	Vertical

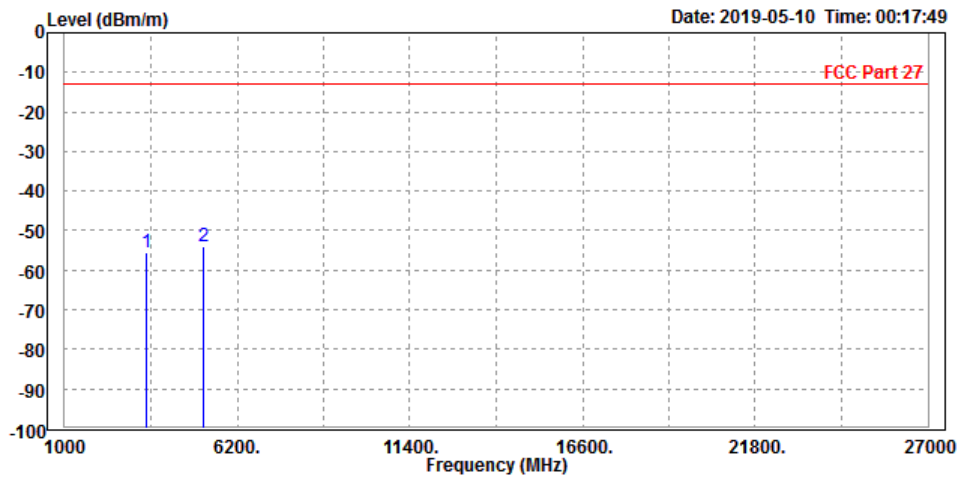



Test Report No.: RF190418W001-5

CH 1513

MODE	TX channel 1513	FREQUENCY RANGE	Above 1000MHz
ENVIRONMENTAL CONDITIONS	23deg. C, 70%RH	INPUT POWER	DC 5V from adapter
TESTED BY	Star Le		
<b>ANTENNA POLARITY &amp; TEST DISTANCE: HORIZONTAL AT 3 M</b>			

	Freq	Read Level	Limit Level	Over Line	Over Limit	Factor	Remark	Pol/Phase
	MHz	dBm/m	dBm	dBm/m	dB	dB/m		
1	3505.000	-57.29	-59.48	-13.00	-44.29	2.19	Peak	Horizontal
2 PP	5257.000	-54.86	-63.54	-13.00	-41.86	8.68	Peak	Horizontal

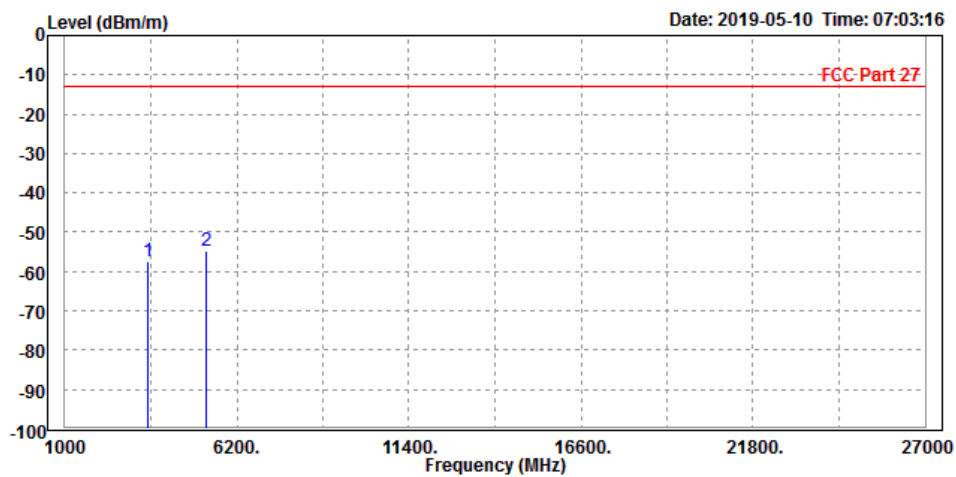





Test Report No.: RF190418W001-5

<b>MODE</b>	TX channel 1513	<b>FREQUENCY RANGE</b>	Above 1000MHz
<b>ENVIRONMENTAL CONDITIONS</b>	23deg. C, 70%RH	<b>INPUT POWER</b>	DC 5V from adapter
<b>TESTED BY</b>	Star Le		
<b>ANTENNA POLARITY &amp; TEST DISTANCE: VERTICAL AT 3 M</b>			

	Freq	Level	Read Level	Limit Line	Over Limit	Factor	Remark	Pol/Phase
	MHz	dBm/m	dBm	dBm/m	dB	dB/m		
1	3505.000	-55.61	-58.21	-13.00	-42.61	2.60	Peak	Vertical
2 PP	5257.000	-53.38	-61.36	-13.00	-40.38	7.98	Peak	Vertical

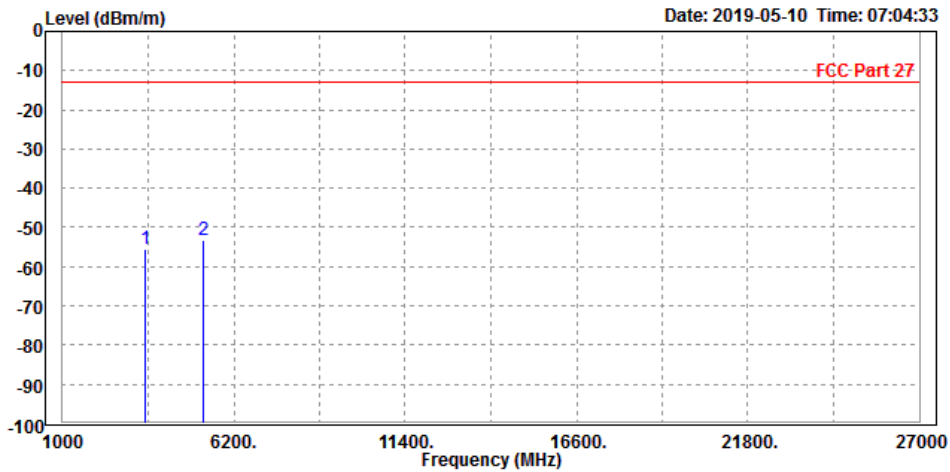



Test Report No.: RF190418W001-5

LTE BAND 4

CHANNEL BANDWIDTH: 1.4MHz / QPSK

MODE	TX channel 20175	FREQUENCY RANGE	Above 1000MHz
ENVIRONMENTAL CONDITIONS	23deg. C, 70%RH	INPUT POWER	DC 5V from adapter
TESTED BY	Star Le		
<b>ANTENNA POLARITY &amp; TEST DISTANCE: HORIZONTAL AT 3 M</b>			

	Freq	Level	Read Level	Limit Line	Over Limit	Factor	Remark	Pol/Phase
	MHz	dBm/m	dBm	dBm/m	dB	dB/m		
1	3470.000	-58.19	-60.24	-13.00	-45.19	2.05	Peak	Horizontal
2 PP	5197.000	-54.97	-63.58	-13.00	-41.97	8.61	Peak	Horizontal

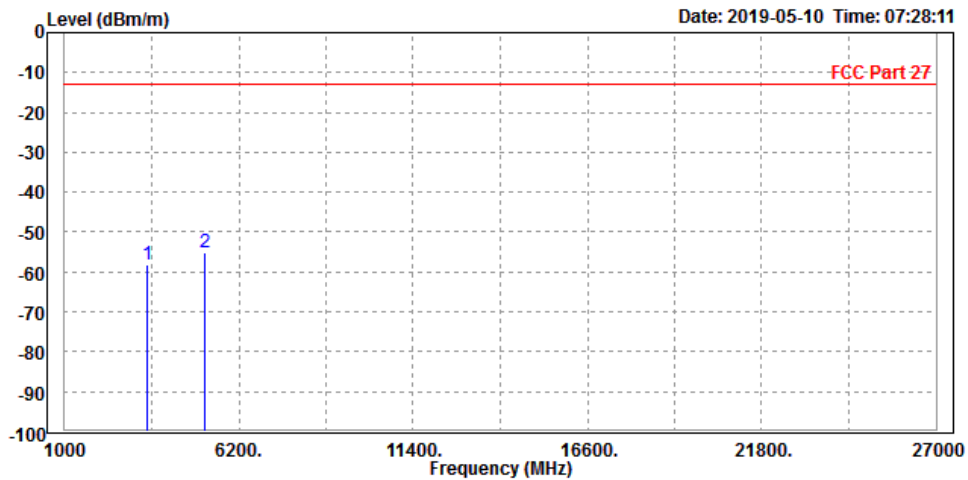



Test Report No.: RF190418W001-5

<b>MODE</b>	TX channel 20175	<b>FREQUENCY RANGE</b>	Above 1000MHz
<b>ENVIRONMENTAL CONDITIONS</b>	23deg. C, 70%RH	<b>INPUT POWER</b>	DC 5V from adapter
<b>TESTED BY</b>	Star Le		
<b>ANTENNA POLARITY &amp; TEST DISTANCE: VERTICAL AT 3 M</b>			

	Freq	Level	Read Level	Limit Line	Over Limit	Factor	Remark	Pol/Phase
	MHz	dBm/m	dBm	dBm/m	dB	dB/m		
1	PP 3470.000	-54.22	-56.75	-13.00	-41.22	2.53	Peak	Vertical
2	5197.000	-54.47	-62.45	-13.00	-41.47	7.98	Peak	Vertical

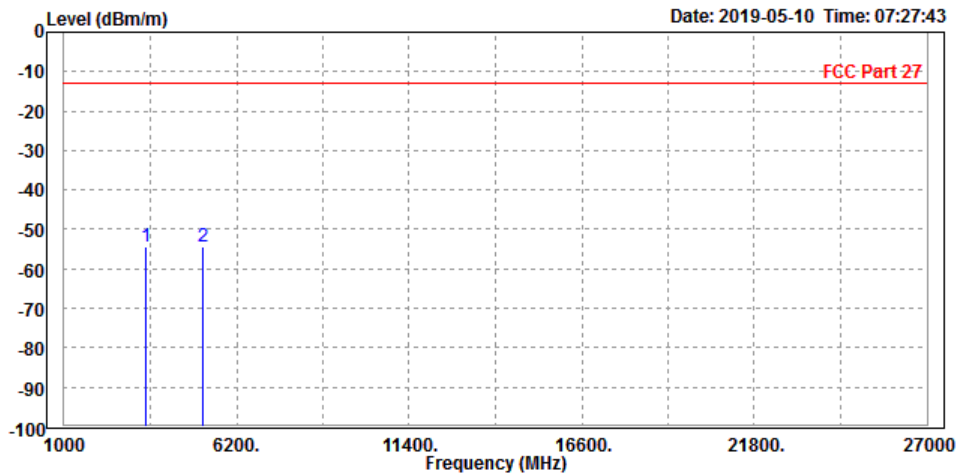



Test Report No.: RF190418W001-5

CHANNEL BANDWIDTH: 3MHz / QPSK

CH 19965

<b>MODE</b>	TX channel 19965	<b>FREQUENCY RANGE</b>	Above 1000MHz
<b>ENVIRONMENTAL CONDITIONS</b>	23deg. C, 70%RH	<b>INPUT POWER</b>	DC 5V from adapter
<b>TESTED BY</b>	Star Le		
<b>ANTENNA POLARITY &amp; TEST DISTANCE: HORIZONTAL AT 3 M</b>			

	Freq	Level	Read Level	Limit Line	Over Limit	Factor	Remark	Pol/Phase
	MHz	dBm/m	dBm	dBm/m	dB	dB/m		
1	3418.000	-58.86	-60.71	-13.00	-45.86	1.85	Peak	Horizontal
2 PP	5132.000	-53.86	-62.39	-13.00	-40.86	8.53	Peak	Horizontal

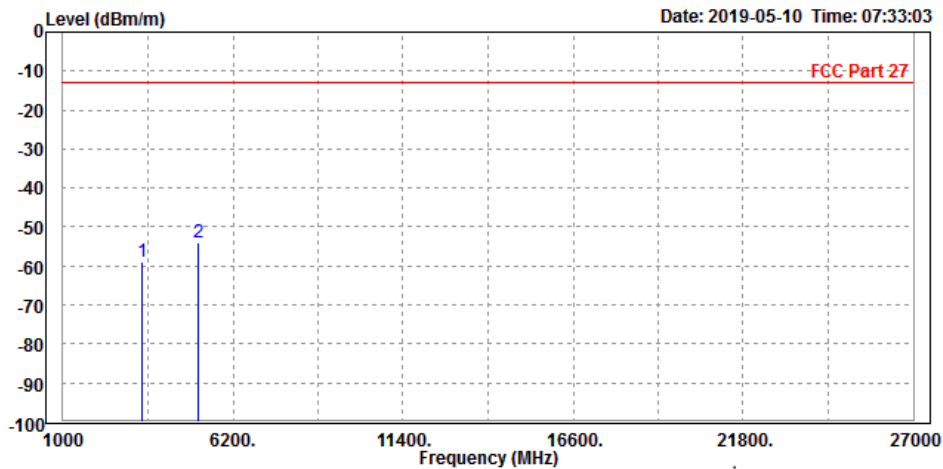



Test Report No.: RF190418W001-5

<b>MODE</b>	TX channel 19965	<b>FREQUENCY RANGE</b>	Above 1000MHz
<b>ENVIRONMENTAL CONDITIONS</b>	23deg. C, 70%RH	<b>INPUT POWER</b>	DC 5V from adapter
<b>TESTED BY</b>	Star Le		
<b>ANTENNA POLARITY &amp; TEST DISTANCE: VERTICAL AT 3 M</b>			

	Freq	Level	Read Level	Limit Line	Over Limit	Factor	Remark	Pol/Phase
	MHz	dBm/m	dBm	dBm/m	dB	dB/m		
1	3418.000	-54.17	-56.64	-13.00	-41.17	2.47	Peak	Vertical
2 PP	5132.000	-53.06	-61.05	-13.00	-40.06	7.99	Peak	Vertical

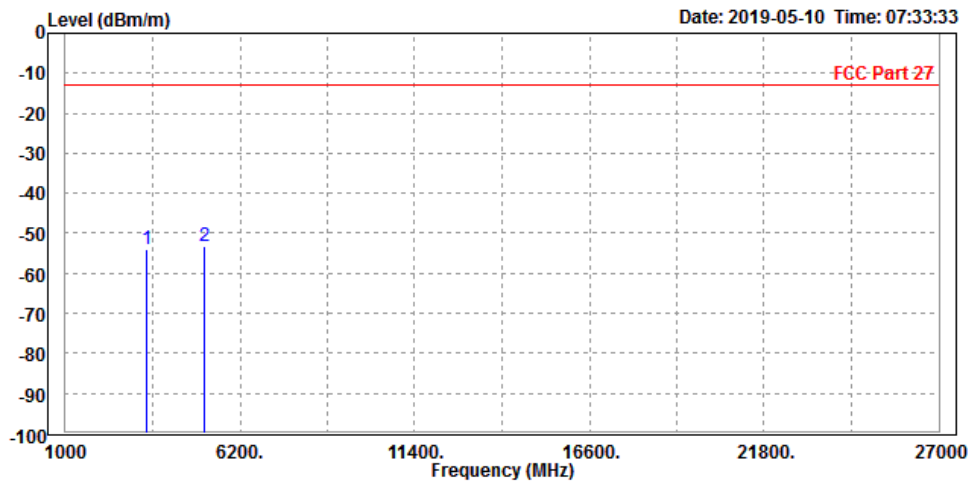



Test Report No.: RF190418W001-5

CH 20175

<b>MODE</b>	TX channel 20175	<b>FREQUENCY RANGE</b>	Above 1000MHz
<b>ENVIRONMENTAL CONDITIONS</b>	23deg. C, 70%RH	<b>INPUT POWER</b>	DC 5V from adapter
<b>TESTED BY</b>	Star Le		
<b>ANTENNA POLARITY &amp; TEST DISTANCE: HORIZONTAL AT 3 M</b>			

	Freq	Level	Read Level	Limit Line	Over Limit	Factor	Remark	Pol/Phase
	MHz	dBm/m	dBm	dBm/m	dB	dB/m		
1	3470.000	-56.74	-58.79	-13.00	-43.74	2.05	Peak	Horizontal
2 PP	5197.000	-53.87	-62.48	-13.00	-40.87	8.61	Peak	Horizontal

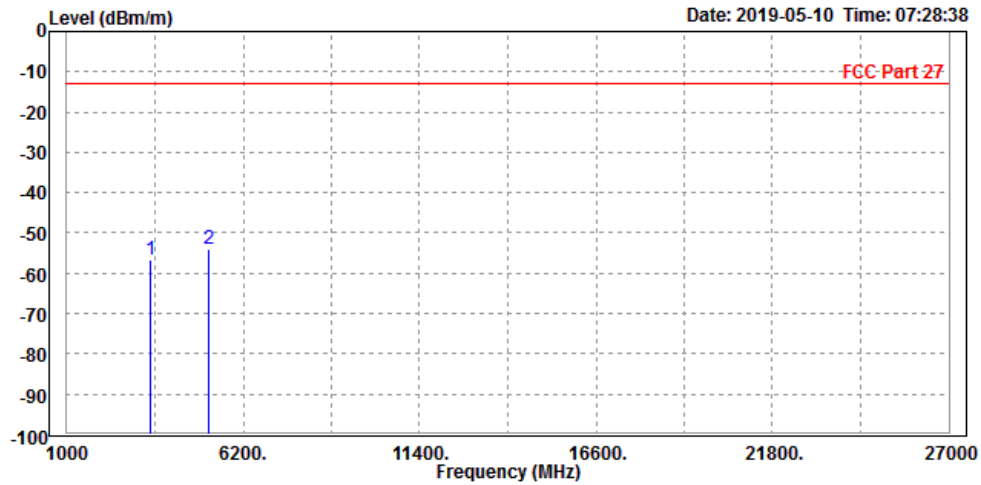



Test Report No.: RF190418W001-5

<b>MODE</b>	TX channel 20175	<b>FREQUENCY RANGE</b>	Above 1000MHz
<b>ENVIRONMENTAL CONDITIONS</b>	23deg. C, 70%RH	<b>INPUT POWER</b>	DC 5V from adapter
<b>TESTED BY</b>	Star Le		
<b>ANTENNA POLARITY &amp; TEST DISTANCE: VERTICAL AT 3 M</b>			

	Freq	Level	Read Level	Limit Line	Over Limit	Factor	Remark	Pol/Phase
	MHz	dBm/m	dBm	dBm/m	dB	dB/m		
1	3470.000	-53.89	-56.42	-13.00	-40.89	2.53	Peak	Vertical
2 PP	5197.000	-51.17	-59.15	-13.00	-38.17	7.98	Peak	Vertical

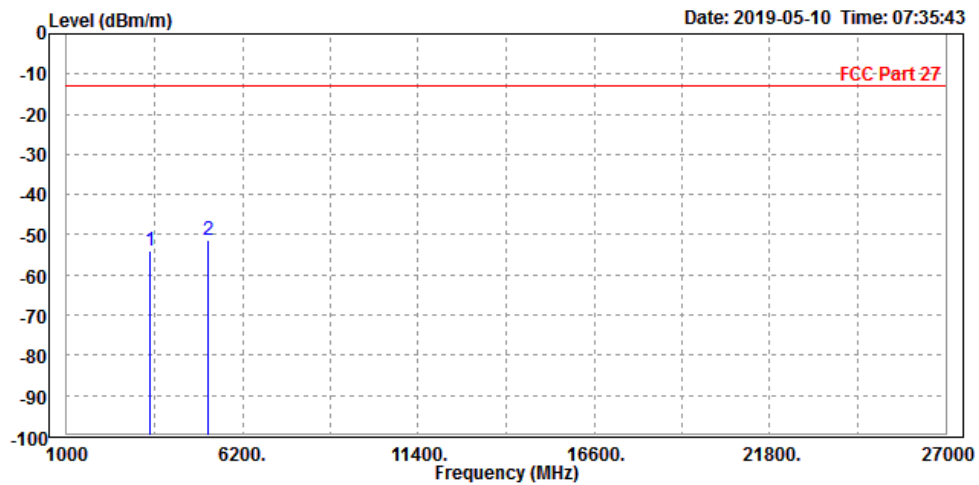



Test Report No.: RF190418W001-5

CH 20385

<b>MODE</b>	TX channel 20385	<b>FREQUENCY RANGE</b>	Above 1000MHz
<b>ENVIRONMENTAL CONDITIONS</b>	23deg. C, 70%RH	<b>INPUT POWER</b>	DC 5V from adapter
<b>TESTED BY</b>	Star Le		
<b>ANTENNA POLARITY &amp; TEST DISTANCE: HORIZONTAL AT 3 M</b>			

	Freq	Level	Read Level	Limit Line	Over Limit	Factor	Remark	Pol/Phase
	MHz	dBm/m	dBm	dBm/m	dB	dB/m		
1	3502.000	-58.14	-60.31	-13.00	-45.14	2.17	Peak	Horizontal
2 PP	5266.000	-54.90	-63.59	-13.00	-41.90	8.69	Peak	Horizontal

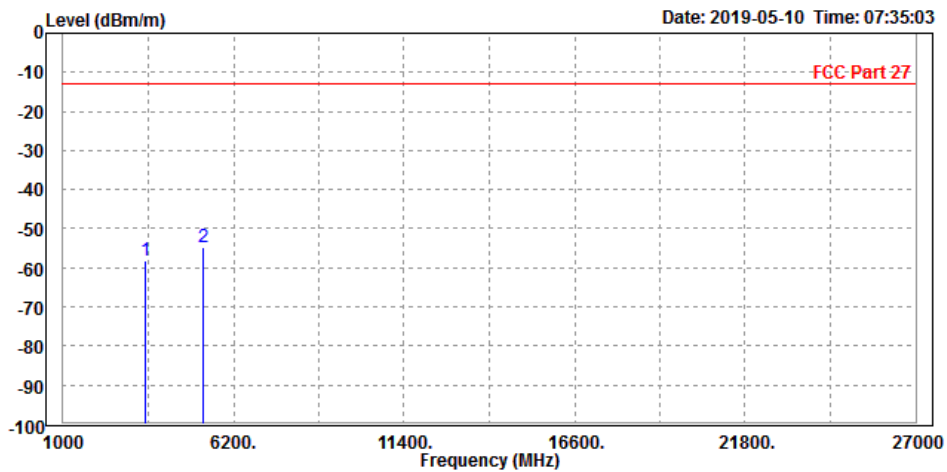





Test Report No.: RF190418W001-5

<b>MODE</b>	TX channel 20385	<b>FREQUENCY RANGE</b>	Above 1000MHz
<b>ENVIRONMENTAL CONDITIONS</b>	23deg. C, 70%RH	<b>INPUT POWER</b>	DC 5V from adapter
<b>TESTED BY</b>	Star Le		
<b>ANTENNA POLARITY &amp; TEST DISTANCE: VERTICAL AT 3 M</b>			

	Freq	Level	Read Level	Limit Line	Over Limit	Factor	Remark	Pol/Phase
	MHz	dBm/m	dBm	dBm/m	dB	dB/m		
1	3502.000	-53.90	-56.48	-13.00	-40.90	2.58	Peak	Vertical
2 PP	5266.000	-52.36	-60.34	-13.00	-39.36	7.98	Peak	Vertical

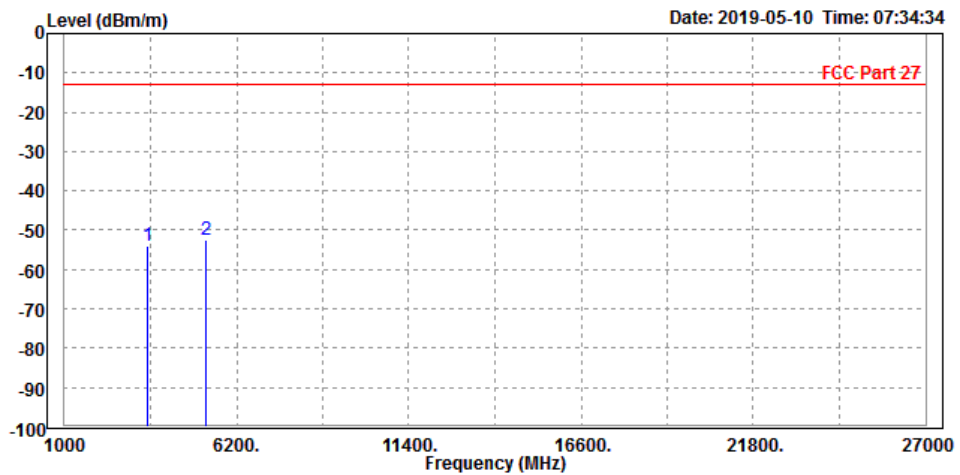



Test Report No.: RF190418W001-5

**CHANNEL BANDWIDTH: 5MHz / QPSK**

<b>MODE</b>	TX channel 20175	<b>FREQUENCY RANGE</b>	Above 1000MHz
<b>ENVIRONMENTAL CONDITIONS</b>	23deg. C, 70%RH	<b>INPUT POWER</b>	DC 5V from adapter
<b>TESTED BY</b>	Star Le		
<b>ANTENNA POLARITY &amp; TEST DISTANCE: HORIZONTAL AT 3 M</b>			

	Freq	Level	Read Level	Limit Line	Over Limit	Factor	Remark	Pol/Phase
	MHz	dBm/m	dBm	dBm/m	dB	dB/m		
1	3470.000	-58.23	-60.28	-13.00	-45.23	2.05	Peak	Horizontal
2 PP	5197.000	-54.81	-63.42	-13.00	-41.81	8.61	Peak	Horizontal

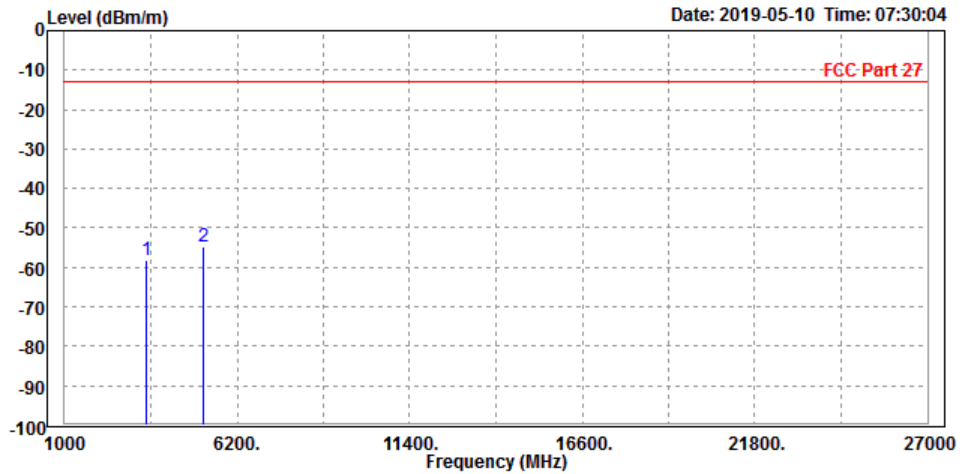



Test Report No.: RF190418W001-5

<b>MODE</b>	TX channel 20175	<b>FREQUENCY RANGE</b>	Above 1000MHz
<b>ENVIRONMENTAL CONDITIONS</b>	23deg. C, 70%RH	<b>INPUT POWER</b>	DC 5V from adapter
<b>TESTED BY</b>	Star Le		
<b>ANTENNA POLARITY &amp; TEST DISTANCE: VERTICAL AT 3 M</b>			

	Freq	Level	Read Level	Limit Line	Over Limit	Factor	Remark	Pol/Phase
	MHz	dBm/m	dBm	dBm/m	dB	dB/m		
1	3470.000	-54.33	-56.86	-13.00	-41.33	2.53	Peak	Vertical
2	PP 5197.000	-53.61	-61.59	-13.00	-40.61	7.98	Peak	Vertical

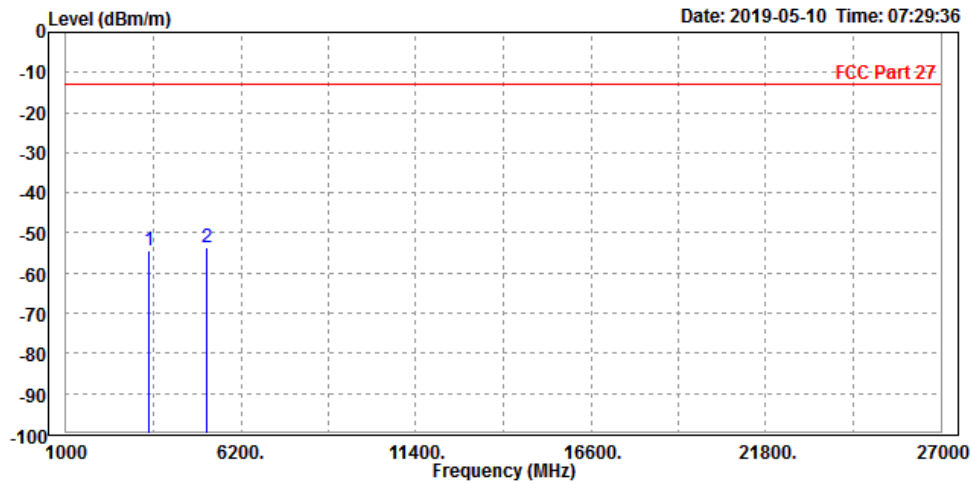



Test Report No.: RF190418W001-5

**CHANNEL BANDWIDTH: 10MHz / QPSK**

<b>MODE</b>	TX channel 20175	<b>FREQUENCY RANGE</b>	Above 1000MHz
<b>ENVIRONMENTAL CONDITIONS</b>	23deg. C, 70%RH	<b>INPUT POWER</b>	DC 5V from adapter
<b>TESTED BY</b>	Star Le		
<b>ANTENNA POLARITY &amp; TEST DISTANCE: HORIZONTAL AT 3 M</b>			

	Freq	Level	Read Level	Limit Line	Over Limit	Factor	Remark	Pol/Phase
	MHz	dBm/m	dBm	dBm/m	dB	dB/m		
1	3470.000	-54.05	-56.10	-13.00	-41.05	2.05	Peak	Horizontal
2	PP 5197.000	-51.60	-60.21	-13.00	-38.60	8.61	Peak	Horizontal

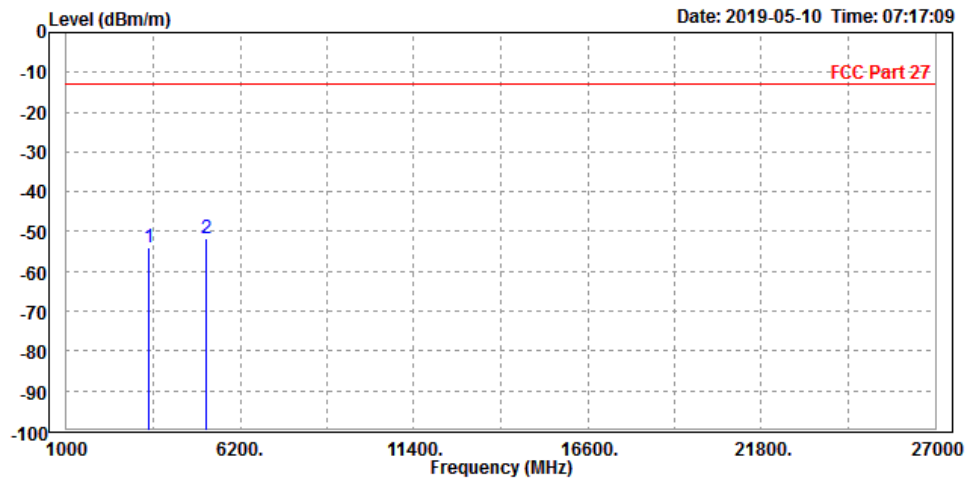



Test Report No.: RF190418W001-5

<b>MODE</b>	TX channel 20175	<b>FREQUENCY RANGE</b>	Above 1000MHz
<b>ENVIRONMENTAL CONDITIONS</b>	23deg. C, 70%RH	<b>INPUT POWER</b>	DC 5V from adapter
<b>TESTED BY</b>	Star Le		
<b>ANTENNA POLARITY &amp; TEST DISTANCE: VERTICAL AT 3 M</b>			

	Freq	Level	Read Level	Limit Line	Over Limit	Factor	Remark	Pol/Phase
	MHz	dBm/m	dBm	dBm/m	dB	dB/m		
1	PP 3470.000	-53.11	-55.64	-13.00	-40.11	2.53	Peak	Vertical
2	5197.000	-54.37	-62.35	-13.00	-41.37	7.98	Peak	Vertical

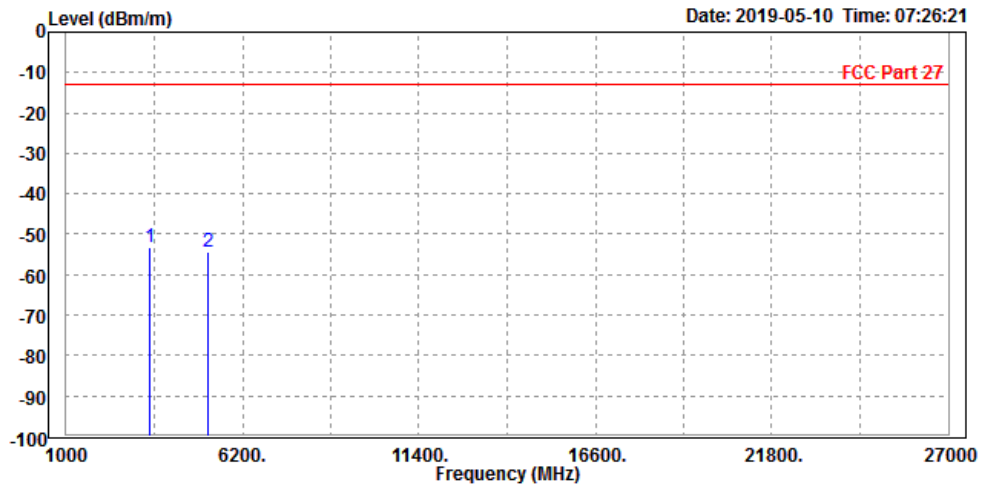



Test Report No.: RF190418W001-5

**CHANNEL BANDWIDTH: 15MHz / QPSK**

<b>MODE</b>	TX channel 20175	<b>FREQUENCY RANGE</b>	Above 1000MHz
<b>ENVIRONMENTAL CONDITIONS</b>	23deg. C, 70%RH	<b>INPUT POWER</b>	DC 5V from adapter
<b>TESTED BY</b>	Star Le		
<b>ANTENNA POLARITY &amp; TEST DISTANCE: HORIZONTAL AT 3 M</b>			

	Freq	Level	Read Level	Limit Line	Over Limit	Factor	Remark	Pol/Phase
	MHz	dBm/m	dBm	dBm/m	dB	dB/m		
1	3470.000	-58.27	-60.32	-13.00	-45.27	2.05	Peak	Horizontal
2 PP	5197.000	-54.55	-63.16	-13.00	-41.55	8.61	Peak	Horizontal

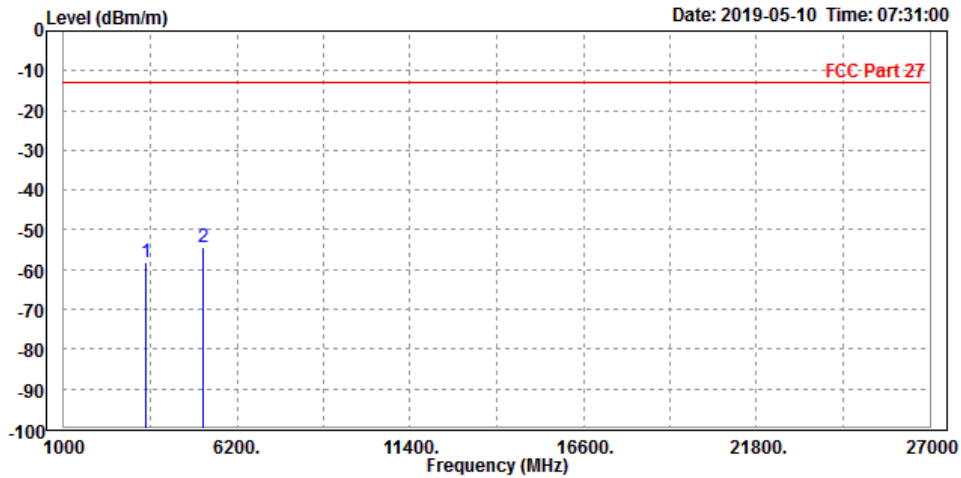



Test Report No.: RF190418W001-5

<b>MODE</b>	TX channel 20175	<b>FREQUENCY RANGE</b>	Above 1000MHz
<b>ENVIRONMENTAL CONDITIONS</b>	23deg. C, 70%RH	<b>INPUT POWER</b>	DC 5V from adapter
<b>TESTED BY</b>	Star Le		
<b>ANTENNA POLARITY &amp; TEST DISTANCE: VERTICAL AT 3 M</b>			

	Freq	Level	Read Level	Limit Line	Over Limit	Factor	Remark	Pol/Phase
	MHz	dBm/m	dBm	dBm/m	dB	dB/m		
1	3470.000	-54.22	-56.75	-13.00	-41.22	2.53	Peak	Vertical
2	PP 5197.000	-53.97	-61.95	-13.00	-40.97	7.98	Peak	Vertical

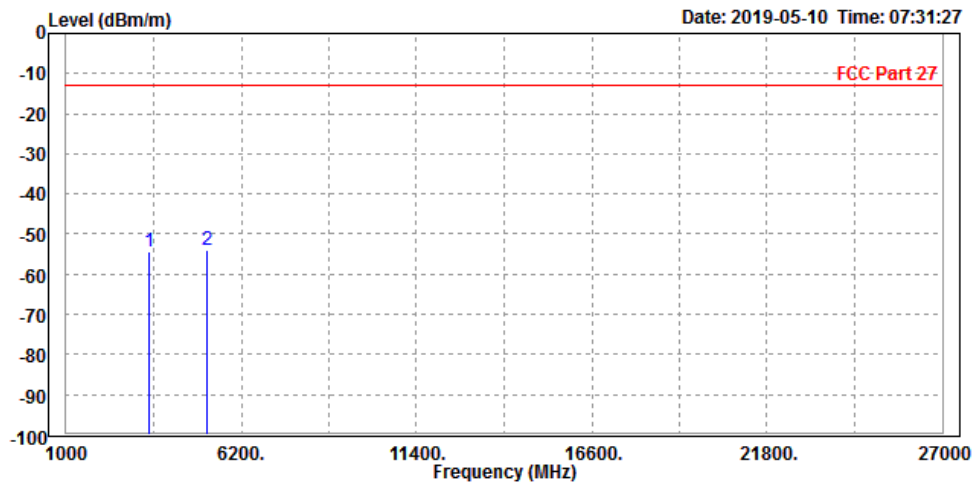



Test Report No.: RF190418W001-5

**CHANNEL BANDWIDTH: 20MHz / QPSK**

<b>MODE</b>	TX channel 20175	<b>FREQUENCY RANGE</b>	Above 1000MHz
<b>ENVIRONMENTAL CONDITIONS</b>	23deg. C, 70%RH	<b>INPUT POWER</b>	DC 5V from adapter
<b>TESTED BY</b>	Star Le		
<b>ANTENNA POLARITY &amp; TEST DISTANCE: HORIZONTAL AT 3 M</b>			

	Freq	Level	Read Level	Limit Line	Over Limit	Factor	Remark	Pol/Phase
	MHz	dBm/m	dBm	dBm/m	dB	dB/m		
1	3470.000	-57.84	-59.89	-13.00	-44.84	2.05	Peak	Horizontal
2 PP	5197.000	-54.50	-63.11	-13.00	-41.50	8.61	Peak	Horizontal

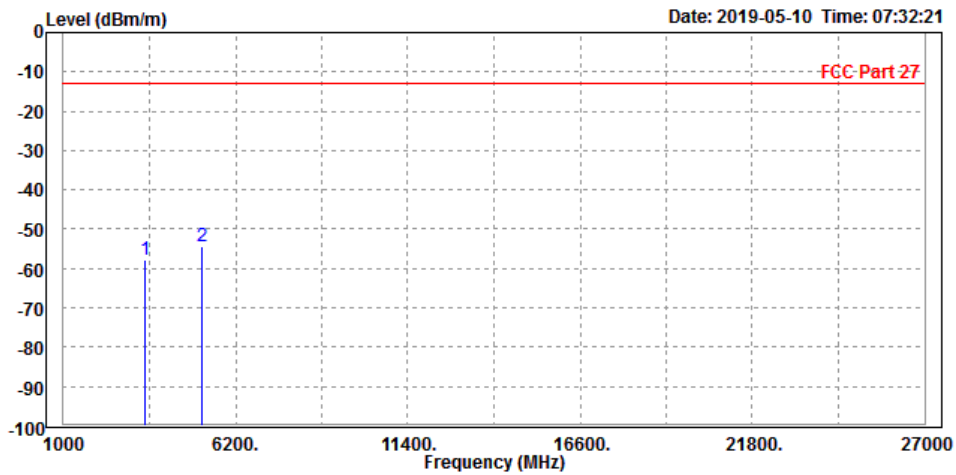





Test Report No.: RF190418W001-5

<b>MODE</b>	TX channel 20175	<b>FREQUENCY RANGE</b>	Above 1000MHz
<b>ENVIRONMENTAL CONDITIONS</b>	23deg. C, 70%RH	<b>INPUT POWER</b>	DC 5V from adapter
<b>TESTED BY</b>	Star Le		
<b>ANTENNA POLARITY &amp; TEST DISTANCE: VERTICAL AT 3 M</b>			

	Freq	Level	Read Level	Limit Line	Over Limit	Factor	Remark	Pol/Phase
	MHz	dBm/m	dBm	dBm/m	dB	dB/m		
1	3470.000	-54.88	-57.41	-13.00	-41.88	2.53	Peak	Vertical
2 PP	5197.000	-52.27	-60.25	-13.00	-39.27	7.98	Peak	Vertical

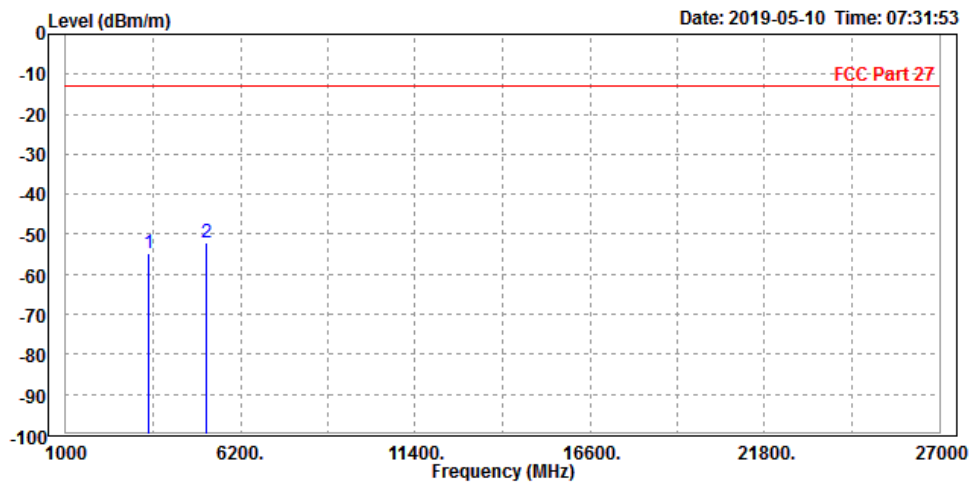



Test Report No.: RF190418W001-5

LTE BAND 12

CHANNEL BANDWIDTH: 1.4MHz / QPSK

MODE	TX channel 23095	FREQUENCY RANGE	Above 1000MHz
ENVIRONMENTAL CONDITIONS	23deg. C, 70%RH	INPUT POWER	DC 5V from adapter
TESTED BY	Tony		
<b>ANTENNA POLARITY &amp; TEST DISTANCE: HORIZONTAL AT 3 M</b>			

	Freq	Level	Read Level	Limit Line	Over Limit	Factor	Remark	Pol/Phase
	MHz	dBm/m	dBm	dBm/m	dB	dB/m		
1 PP	1416.000	-67.48	-60.76	-13.00	-54.48	-6.72	Peak	Horizontal
2	2122.500	-67.94	-66.01	-13.00	-54.94	-1.93	Peak	Horizontal

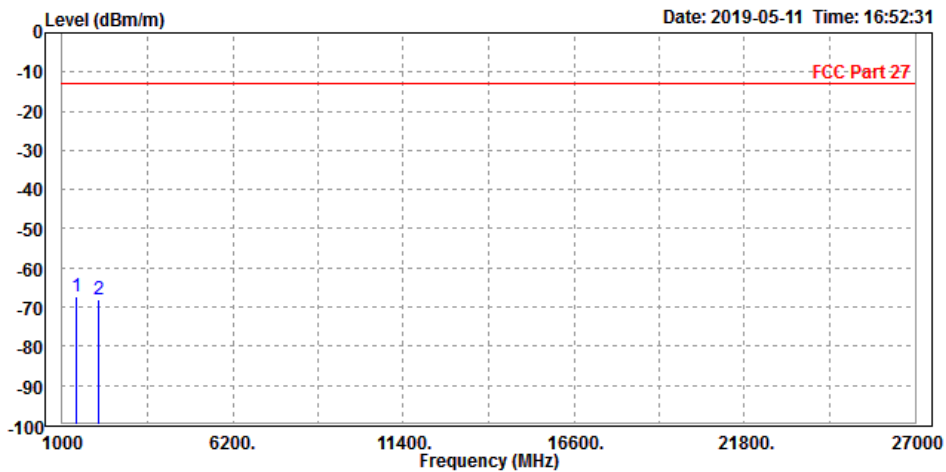



Test Report No.: RF190418W001-5

<b>MODE</b>	TX channel 23095	<b>FREQUENCY RANGE</b>	Above 1000MHz
<b>ENVIRONMENTAL CONDITIONS</b>	23deg. C, 70%RH	<b>INPUT POWER</b>	DC 5V from adapter
<b>TESTED BY</b>	Tony		
<b>ANTENNA POLARITY &amp; TEST DISTANCE: VERTICAL AT 3 M</b>			

	Freq	Level	Read Level	Limit Line	Over Limit	Factor	Remark	Pol/Phase
	MHz	dBm/m	dBm	dBm/m	dB	dB/m		
1	1416.000	-67.11	-61.67	-13.00	-54.11	-5.44	Peak	Vertical
2	PP 2122.500	-65.90	-65.66	-13.00	-52.90	-0.24	Peak	Vertical

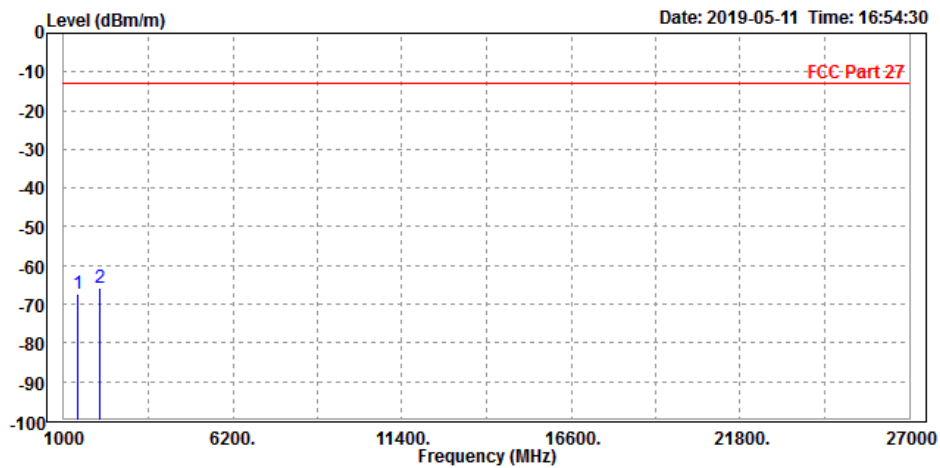



Test Report No.: RF190418W001-5

CHANNEL BANDWIDTH: 3MHz / QPSK

CH 23025

MODE	TX channel 23025	FREQUENCY RANGE	Above 1000MHz
ENVIRONMENTAL CONDITIONS	23deg. C, 70%RH	INPUT POWER	DC 5V from adapter
TESTED BY	Tony		
<b>ANTENNA POLARITY &amp; TEST DISTANCE: HORIZONTAL AT 3 M</b>			

	Freq	Level	Read Level	Limit Line	Over Limit	Factor	Remark	Pol/Phase
	MHz	dBm/m	dBm	dBm/m	dB	dB/m		
1	PP 1390.000	-64.85	-57.97	-13.00	-51.85	-6.88	Peak	Horizontal
2	2101.500	-66.60	-64.65	-13.00	-53.60	-1.95	Peak	Horizontal

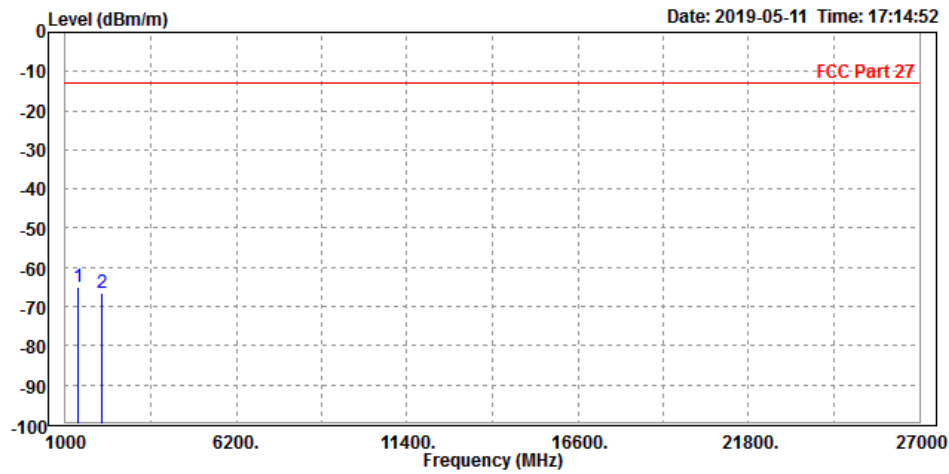



Test Report No.: RF190418W001-5

<b>MODE</b>	TX channel 23025	<b>FREQUENCY RANGE</b>	Above 1000MHz
<b>ENVIRONMENTAL CONDITIONS</b>	23deg. C, 70%RH	<b>INPUT POWER</b>	DC 5V from adapter
<b>TESTED BY</b>	Tony		
<b>ANTENNA POLARITY &amp; TEST DISTANCE: VERTICAL AT 3 M</b>			

	Freq	Level	Read Level	Limit Line	Over Limit	Factor	Remark	Pol/Phase
	MHz	dBm/m	dBm	dBm/m	dB	dB/m		
1	1390.000	-66.11	-60.51	-13.00	-53.11	-5.60	Peak	Vertical
2	PP 2101.500	-65.24	-64.99	-13.00	-52.24	-0.25	Peak	Vertical

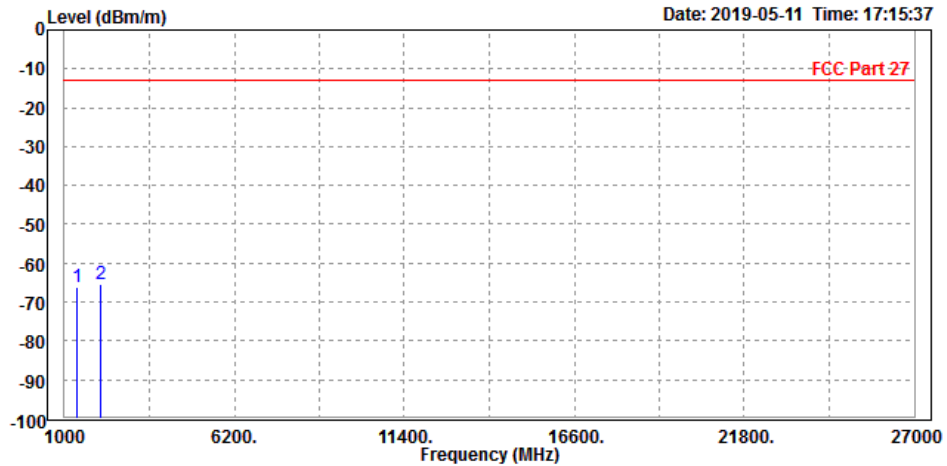



Test Report No.: RF190418W001-5

CH 23095

MODE	TX channel 23095	FREQUENCY RANGE	Above 1000MHz
ENVIRONMENTAL CONDITIONS	23deg. C, 70%RH	INPUT POWER	DC 5V from adapter
TESTED BY	Tony		
<b>ANTENNA POLARITY &amp; TEST DISTANCE: HORIZONTAL AT 3 M</b>			

	Freq	Level	Read Level	Limit Line	Over Limit	Factor	Remark	Pol/Phase
	MHz	dBm/m	dBm	dBm/m	dB	dB/m		
1	PP 1416.000	-57.25	-50.53	-13.00	-44.25	-6.72	Peak	Horizontal
2	2122.500	-67.13	-65.20	-13.00	-54.13	-1.93	Peak	Horizontal

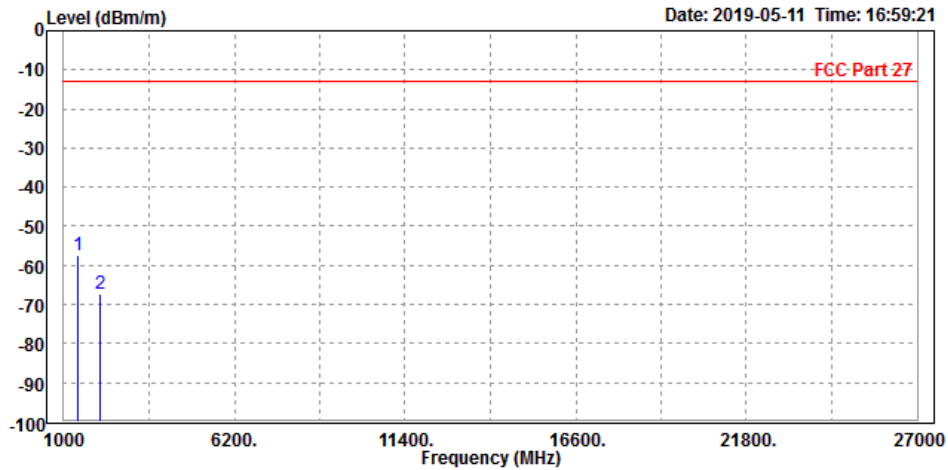



Test Report No.: RF190418W001-5

<b>MODE</b>	TX channel 23095	<b>FREQUENCY RANGE</b>	Above 1000MHz
<b>ENVIRONMENTAL CONDITIONS</b>	23deg. C, 70%RH	<b>INPUT POWER</b>	DC 5V from adapter
<b>TESTED BY</b>	Tony		
<b>ANTENNA POLARITY &amp; TEST DISTANCE: VERTICAL AT 3 M</b>			

	Freq	Level	Read Level	Limit Line	Over Limit	Factor	Remark	Pol/Phase
	MHz	dBm/m	dBm	dBm/m	dB	dB/m		
1	1416.000	-69.45	-64.01	-13.00	-56.45	-5.44	Peak	Vertical
2 PP	2122.500	-64.80	-64.56	-13.00	-51.80	-0.24	Peak	Vertical

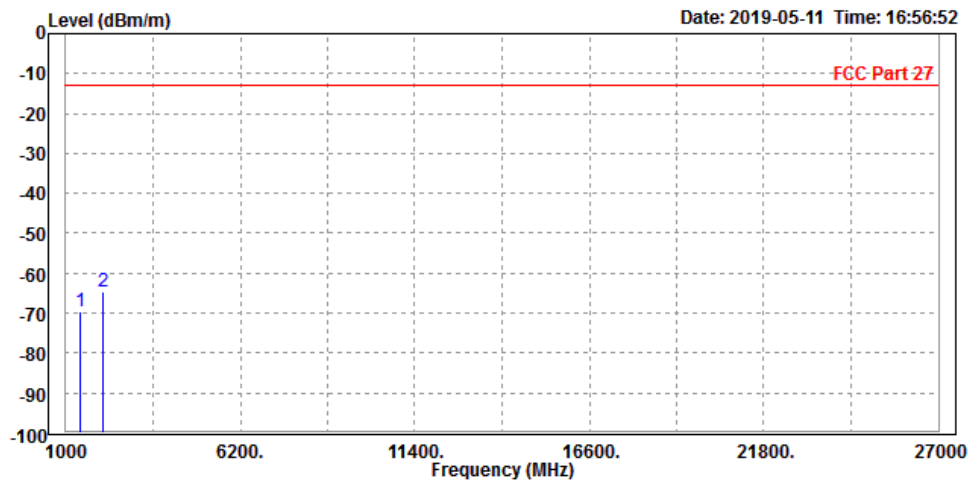



Test Report No.: RF190418W001-5

CH 23165

<b>MODE</b>	TX channel 23165	<b>FREQUENCY RANGE</b>	Above 1000MHz
<b>ENVIRONMENTAL CONDITIONS</b>	23deg. C, 70%RH	<b>INPUT POWER</b>	DC 5V from adapter
<b>TESTED BY</b>	Tony		
<b>ANTENNA POLARITY &amp; TEST DISTANCE: HORIZONTAL AT 3 M</b>			

	Freq	Level	Read Level	Limit Line	Over Limit	Factor	Remark	Pol/Phase
	MHz	dBm/m	dBm	dBm/m	dB	dB/m		
1	PP 1416.000	-61.37	-54.65	-13.00	-48.37	-6.72	Peak	Horizontal
2	2143.500	-66.63	-64.71	-13.00	-53.63	-1.92	Peak	Horizontal

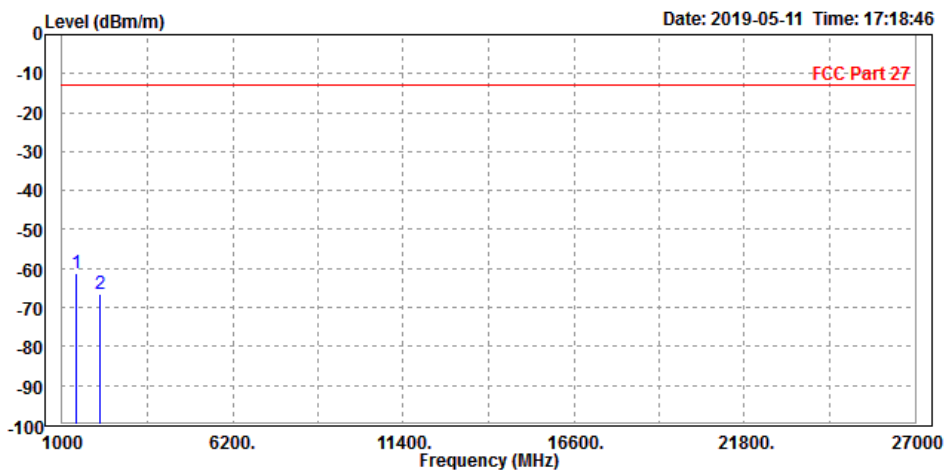





Test Report No.: RF190418W001-5

<b>MODE</b>	TX channel 23165	<b>FREQUENCY RANGE</b>	Above 1000MHz
<b>ENVIRONMENTAL CONDITIONS</b>	23deg. C, 70%RH	<b>INPUT POWER</b>	DC 5V from adapter
<b>TESTED BY</b>	Tony		
<b>ANTENNA POLARITY &amp; TEST DISTANCE: VERTICAL AT 3 M</b>			

	Freq	Level	Read Level	Limit Line	Over Limit	Factor	Remark	Pol/Phase
	MHz	dBm/m	dBm	dBm/m	dB	dB/m		
1	1416.000	-68.56	-63.12	-13.00	-55.56	-5.44	Peak	Vertical
2 PP	2143.500	-65.31	-65.07	-13.00	-52.31	-0.24	Peak	Vertical

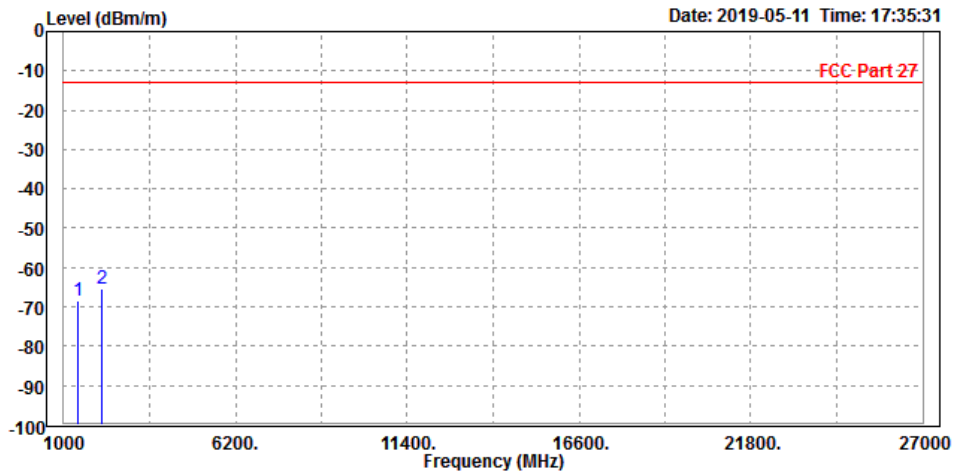



Test Report No.: RF190418W001-5

**CHANNEL BANDWIDTH: 5MHz / QPSK**

<b>MODE</b>	TX channel 23095	<b>FREQUENCY RANGE</b>	Above 1000MHz
<b>ENVIRONMENTAL CONDITIONS</b>	23deg. C, 70%RH	<b>INPUT POWER</b>	DC 5V from adapter
<b>TESTED BY</b>	Tony		
<b>ANTENNA POLARITY &amp; TEST DISTANCE: HORIZONTAL AT 3 M</b>			

	Freq	Read Level	Limit Level	Over Limit	Factor	Remark	Pol/Phase
	MHz	dBm/m	dBm	dBm/m	dB	dB/m	
1 PP	1416.000	-59.00	-52.28	-13.00	-46.00	-6.72 Peak	Horizontal
2	2122.500	-67.39	-65.46	-13.00	-54.39	-1.93 Peak	Horizontal

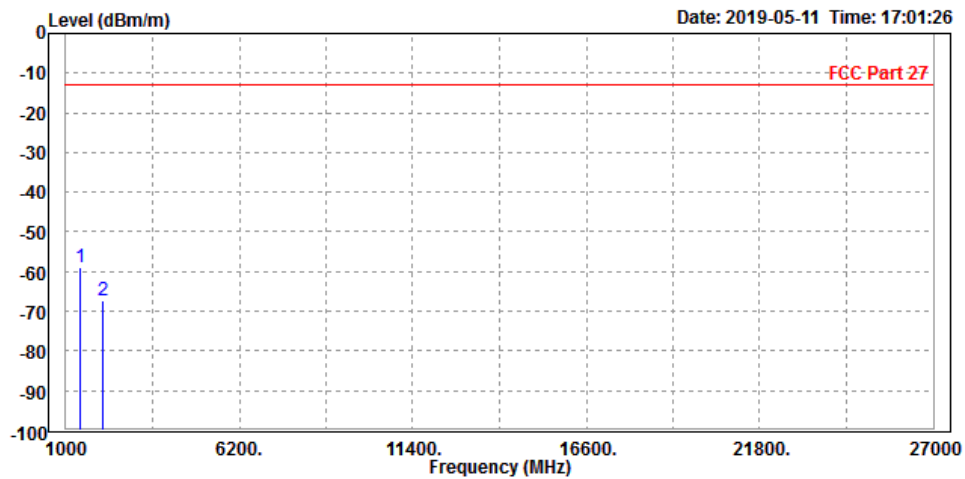



Test Report No.: RF190418W001-5

<b>MODE</b>	TX channel 23095	<b>FREQUENCY RANGE</b>	Above 1000MHz
<b>ENVIRONMENTAL CONDITIONS</b>	23deg. C, 70%RH	<b>INPUT POWER</b>	DC 5V from adapter
<b>TESTED BY</b>	Tony		
<b>ANTENNA POLARITY &amp; TEST DISTANCE: VERTICAL AT 3 M</b>			

	Freq	Level	Read Level	Limit Line	Over Limit	Factor	Remark	Pol/Phase
	MHz	dBm/m	dBm	dBm/m	dB	dB/m		
1	1416.000	-68.47	-63.03	-13.00	-55.47	-5.44	Peak	Vertical
2 PP	2122.500	-65.74	-65.50	-13.00	-52.74	-0.24	Peak	Vertical

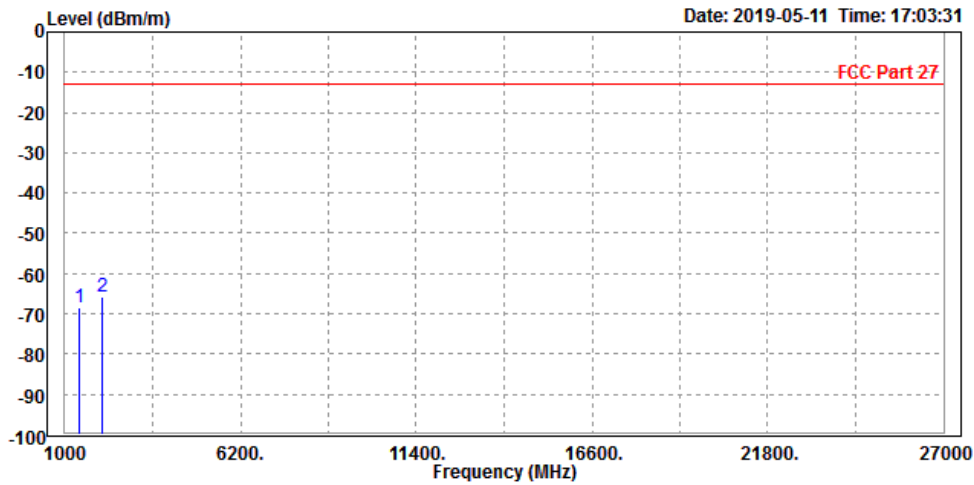



Test Report No.: RF190418W001-5

**CHANNEL BANDWIDTH: 10MHz / QPSK**

<b>MODE</b>	TX channel 23095	<b>FREQUENCY RANGE</b>	Above 1000MHz
<b>ENVIRONMENTAL CONDITIONS</b>	23deg. C, 70%RH	<b>INPUT POWER</b>	DC 5V from adapter
<b>TESTED BY</b>	Tony		
<b>ANTENNA POLARITY &amp; TEST DISTANCE: HORIZONTAL AT 3 M</b>			

	Freq	Level	Read Level	Limit Line	Over Limit	Factor	Remark	Pol/Phase
	MHz	dBm/m	dBm	dBm/m	dB	dB/m		
1	PP 1416.000	-66.23	-59.51	-13.00	-53.23	-6.72	Peak	Horizontal
2	2122.500	-67.19	-65.26	-13.00	-54.19	-1.93	Peak	Horizontal

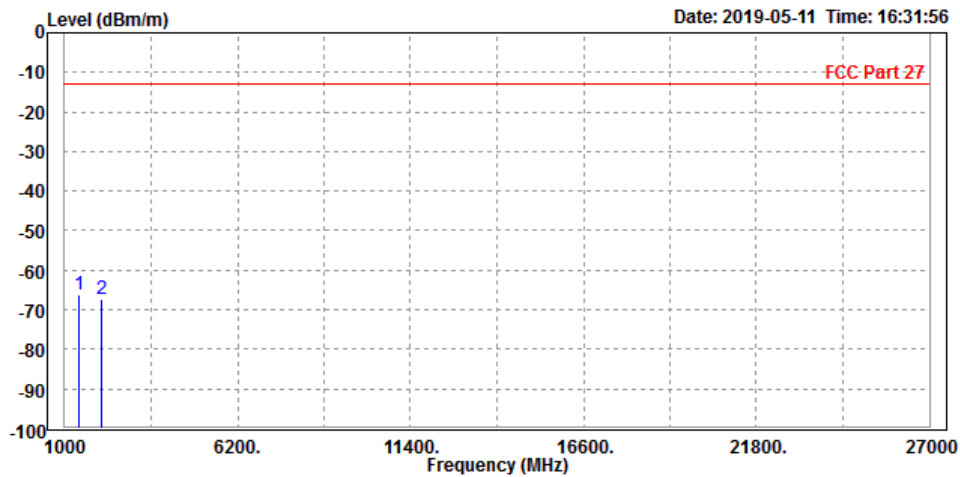



Test Report No.: RF190418W001-5

<b>MODE</b>	TX channel 23095	<b>FREQUENCY RANGE</b>	Above 1000MHz
<b>ENVIRONMENTAL CONDITIONS</b>	23deg. C, 70%RH	<b>INPUT POWER</b>	DC 5V from adapter
<b>TESTED BY</b>	Tony		
<b>ANTENNA POLARITY &amp; TEST DISTANCE: VERTICAL AT 3 M</b>			

	Freq	Level	Read Level	Limit Line	Over Limit	Factor	Remark	Pol/Phase
	MHz	dBm/m	dBm	dBm/m	dB	dB/m		
1	1416.000	-64.40	-58.96	-13.00	-51.40	-5.44	Peak	Vertical
2	PP 2122.500	-63.09	-62.85	-13.00	-50.09	-0.24	Peak	Vertical

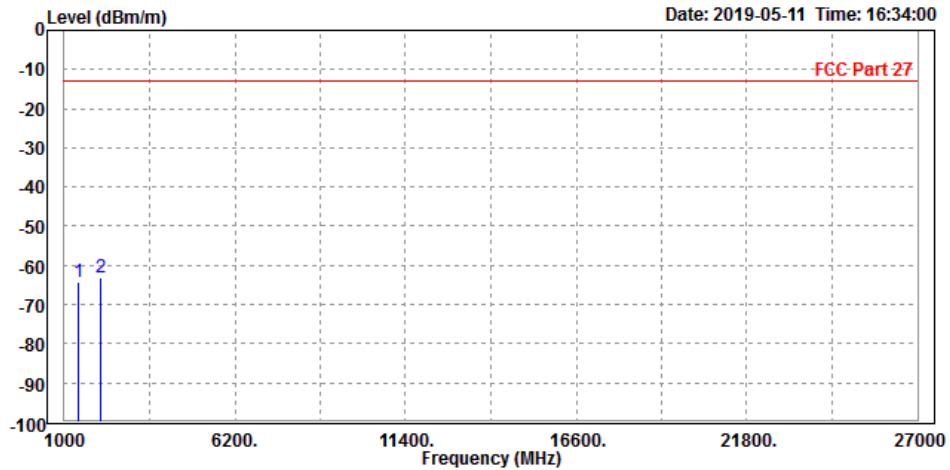



Test Report No.: RF190418W001-5

#### 4 INFORMATION ON THE TESTING LABORATORIES

We, BV 7LAYERS COMMUNICATIONS TECHNOLOGY (SHENZHEN) CO. LTD., were founded in 2015 to provide our best service in EMC, Radio, Telecom and Safety consultation. Our laboratories are accredited and approved according to ISO/IEC 17025.

If you have any comments, please feel free to contact us at the following:

**Shenzhen EMC/RF Lab:**

Tel: +86-755-88696566

Fax: +86-755-88696577

**Email:** [customerservice.dg@cn.bureauveritas.com](mailto:customerservice.dg@cn.bureauveritas.com)

**Web Site:** [www.adt.com.tw](http://www.adt.com.tw)

The address and road map of all our labs can be found in our web site also.



Test Report No.: RF190418W001-5

## 5 APPENDIX A – MODIFICATIONS RECORDERS FOR ENGINEERING CHANGES TO THE EUT BY THE LAB

No modifications were made to the EUT by the lab during the test.

---END---