



TEST REPORT

REPORT NUMBER: B16X50266-SAR-Rev3

ON

Type of Equipment: Tablet

Type of Designation: Ilium Pad L8X

Manufacturer: Corporativo Lanix S.A.de C.V.

ACCORDING TO

ANSI C95.1-2006

IEEE 1528-2013

China Telecommunication Technology Labs.

Month date, year

Aug 22,2016

Signature

A handwritten signature in black ink, appearing to be 'Zhang Yan'.

Zhang Yan

Director

Note:

The test results in this test report relate only to the devices specified in this report. This report shall not be reproduced except in full without the written approval of China Telecommunication Technology Labs.

Report No.: B16X50266-SAR-Rev3

FCC ID: ZC4L8X

Report Date: 2016-08-22

Test Firm Name: China Telecommunication Technology Labs

FCC Registration Number: 840587

Statement

The measurements shown in this report were made in accordance with the procedures described on test pages. The sample tested was found to comply with the requirements defined in the applied rules.

CONTENTS

1. TEST LABORATORY	5
1.1. TESTING LOCATION	5
1.2. TESTING ENVIRONMENT.....	5
1.3. PROJECT DATA	5
1.4. SIGNATURE	5
2. STATEMENT OF COMPLIANCE	6
3. CLIENT INFORMATION	17
3.1. APPLICANT INFORMATION.....	17
3.2. MANUFACTURER INFORMATION.....	17
4. EQUIPMENT UNDER TEST (EUT) AND ANCILLARY EQUIPMENT (AE).....	18
4.1. ABOUT EUT	18
4.2. INTERNAL IDENTIFICATION OF EUT USED DURING THE TEST.....	20
4.3. INTERNAL IDENTIFICATION OF AE USED DURING THE TEST	20
5. TEST METHODOLOGY	21
5.1. APPLICABLE LIMIT REGULATIONS.....	21
5.2. APPLICABLE MEASUREMENT STANDARDS	21
6. SPECIFIC ABSORPTION RATE (SAR)	22
6.1. INTRODUCTION.....	22
6.2. SAR DEFINITION	22
7. SAR MEASUREMENT SETUP.....	23
7.1. MEASUREMENT SET-UP	23
7.2. DASY5 E-FIELD PROBE SYSTEM.....	24
7.3. E-FIELD PROBE CALIBRATION.....	24
7.4. OTHER TEST EQUIPMENT	25
7.4.1. DATA ACQUISITION ELECTRONICS(DAE).....	25

Report No.: B16X50266-SAR-Rev3

7.4.2. ROBOT.....	26
7.4.3. MEASUREMENT SERVER.....	26
7.4.4. DEVICE HOLDER FOR PHANTOM	27
7.4.5. PHANTOM.....	28
8. POSITION OF THE WIRELESS DEVICE IN RELATION TO THE PHANTOM.....	29
8.1. GENERAL CONSIDERATIONS	29
8.2. BODY-WORN DEVICE	30
8.3. DESKTOP DEVICE	30
8.4. DUT SETUP PHOTOS.....	32
9. TISSUE SIMULATING LIQUIDS	38
9.1. EQUIVALENT TISSUES.....	38
9.2. DIELECTRIC PERFORMANCE.....	40
10. SYSTEM VALIDATION.....	45
10.1. SYSTEM VALIDATION.....	45
10.2. SYSTEM SETUP	45
11. MEASUREMENT PROCEDURES.....	48
11.1. TESTS TO BE PERFORMED	48
11.2. MEASUREMENT PROCEDURE.....	49
11.3. POWER DRIFT.....	50
12. CONDUCTED OUTPUT POWER	51
13. MEASUREMENT UNCERTAINTY	72
14. MAIN TEST INSTRUMENTS.....	74
ANNEX A. GRAPH RESULTS.....	75
ANNEX B. SYSTEM VALIDATION RESULTS	209

1. Test Laboratory

1.1. Testing Location

Company Name:	China Telecommunication Technology Labs.
Address:	No. 11, Yue Tan Nan Jie, Xi Cheng District, Beijing, P. R. China
Postal Code:	401336
Telephone:	0086-23-88069965
Fax:3	0086-23-88608777
Email:	liguoqing@chinattl.com

1.2. Testing Environment

Normal Temperature:	15-35°C
Relative Humidity:	20-75%
Ambient noise & Reflection:	< 0.012 W/kg

1.3. Project Data

Testing Start Date:	2016-06-30
Testing End Date:	2016-07-19

1.4. Signature

李国庆

2016-08-22

Li Guoqing
(Prepared this test report)

Date

邹东屹

2016-08-22

Zou Dongyi
(Reviewed this test report)

Date

何桂立

2016-08-22

He Guili
Director of the laboratory
(Approved this test report)

Date

2. Statement of Compliance

The maximum results of Specific Absorption Rate (SAR) found during testing for Ilium Pad L8X are as follows (with expanded uncertainty 22.4%)

Table 2.1: Max. SAR Measured(1g)

Band	Position	SAR 1g (W/Kg)
GSM850	Head	0.00863
	Body	0.63266
GSM1900	Head	0.00914
	Body	0.32090
WCDMA Band II	Head	0.05656
	Body	0.56052
WCDMA Band V	Head	0.01107
	Body	0.20608
LTE Band II	Head	0.04563
	Body	0.39473
LTE Band IV	Head	0.00809
	Body	0.27974
LTE Band VII	Head	0.02254
	Body	0.64787
LTE Band XVII	Head	0.00650
	Body	0.15729
WIFI	Head	0.08300
	Body	0.74970
Bluetooth	Head	0.16080
	Body	0.00804

Table 2.2: The maximum of SAR values

	Maximum SAR value for Head	Maximum SAR value for Body
GSM	0.00914	0.63266
WCDMA	0.05656	0.56052
LTE	0.04563	0.64787
WIFI	0.08300	0.74970
Bluetooth	0.16080	0.00804

The SAR values found for the Mobile Phone are below the maximum recommended levels of 1.6 W/Kg as averaged over any 1g tissue according to the ANSI C95.1-2006.

The measurement together with the test system set-up is described in chapter 7 of this test report. A detailed description of the equipment under test can be found in chapter 3 of this test report.

The maximum SAR value is obtained at the case of (Table 2.2), and the values are:**0.74970 (1g)**.

Report No.: B16X50266-SAR-Rev3

The sample has two antennas. One is main antenna for GSM/WCDMA/LTE, and the other is for BT/Wifi.
So simultaneous transmission is GSM/WCDMA/LTE and BT/Wifi.

Table 2.3: Simultaneous SAR (1g)

Test Position		GSM 850	GSM 1900	WCD MA Band II	WCD MA Band V	LTE Band II	LTE Band IV	LTE Band VII	LTE Band XVII	WIFI	BT note	SUM	
Head	Left	Cheek	0.0086	0.0025	0.0566	0.0111	0.0250	0.0073	0.0118	0.0032	0.0808	0.1608	0.2174
		Tilt 15°	0.0050	0.0021	0.0426	0.0099	0.0110	0.0047	0.0118	0.0035	0.0830	0.1608	0.2034
	Right	Cheek	0.0054	0.0091	0.0529	0.0096	0.0456	0.0081	0.0225	0.0065	0.0250	0.1608	0.2137
		Tilt 15°	0.0058	0.0030	0.0071	0.0079	0.0174	0.0064	0.0129	0.0039	0.0250	0.1608	0.1782
Body	Ground Side		0.6327	0.3209	0.5605	0.2061	0.3947	0.2797	0.6479	0.1573	0.7497	0.0080	1.3976
	Phantom Side		0.0453	0.0387	0.0586	0.0289	0.0293	0.0508	0.5791	0.0169	0.1035	0.0080	0.6826
	Left		0.0113	0.0136	0.0101	0.0011	0.0078	0.0083	0.0614	0.0006	0.0077	0.0080	0.0694
	Right		0.0020	0.0136	0.0152	0.0012	0.0074	0.0034	0.0194	0.0008	0.0182	0.0080	0.0376
	Bottom		0.0640	0.0827	0.1454	0.0244	0.0739	0.0531	0.1701	0.0074	0.0017	0.0080	0.1781
	Top		0.0007	0.0010	0.0045	0.0011	0.0017	0.0010	0.0022	0.0007	0.2287	0.0080	0.2332

According to the above table, The maximum GSM/WCDMA/LTE value is 0.6479 W/Kg(1g), The maximum Wi-Fi value is 0.7497 W/Kg(1g), 0.6479 W/Kg+0.7497 W/Kg=1.3976 W/Kg(1g) are less than 1.6W/Kg(1g). So no simultaneous multi-band transmission test is required.

Report No.: B16X50266-SAR-Rev3

Table 2.4: SAR Values(GSM 835 MHz Band - Head)

Frequency		Side	Test Position	Maximum allowed Power (dBm)	Measured average power (dBm)	Scaling factor	Measured SAR(1g) (W/kg)	Reported SAR(1g)(W/kg)	Power Drift (dB)
MHz	Ch.								
824.2	128	Left	Touch	32	31.7	1.07	0.00805	0.00863	+0.16
824.2	128	Left	Tilt	32	31.7	1.07	0.00469	0.00503	-0.13
824.2	128	Right	Touch	32	31.7	1.07	0.00506	0.00542	-0.13
824.2	128	Right	Tilt	32	31.7	1.07	0.00540	0.00579	-0.15
848.8	251	Left	Touch	32	31.3	1.17	0.00552	0.00649	+0.14
836.6	190	Left	Touch	32	31.4	1.15	0.00524	0.00602	+0.13

Table 2.5: SAR Values(GSM 835 MHz Band - Body)

Frequency		Mode (number of timeslots)	Test Position	Maximum allowed Power (dBm)	Measured average power (dBm)	Scaling factor	Measured SAR(1g) (W/kg)	Reported SAR(1g)(W/kg)	Power Drift (dB)
MHz	Ch.								
824.2	128	GPRS-4TS	Ground	30	29.0	1.26	0.409	0.51490	+0.15
824.2	128	GPRS-4TS	Phantom	30	29.0	1.26	0.036	0.04532	+0.09
824.2	128	GPRS-4TS	Left	30	29.0	1.26	0.00896	0.01128	+0.08
824.2	128	GPRS-4TS	Right	30	29.0	1.26	0.00158	0.00199	+0.12
824.2	128	GPRS-4TS	Bottom	30	29.0	1.26	0.064	0.08057	-0.08
824.2	128	GPRS-4TS	Top	30	29.0	1.26	0.00065	0.00082	+0.15
848.8	251	GPRS-4TS	Ground	30	28.7	1.35	0.469	0.63266	+0.12
836.6	190	GPRS-4TS	Ground	30	28.7	1.35	0.428	0.57736	-0.12
848.8	251	Headset	Ground	32	31.3	1.17	0.133	0.15626	0.00
848.8	251	EGPRS-4TS	Ground	30	28.7	1.35	0.301	0.40604	+0.14

Report No.: B16X50266-SAR-Rev3

Table 2.6: SAR Values(GSM 1900 MHz Band - Head)

Frequency		Side	Test Position	Maximum allowed Power (dBm)	Measured average power (dBm)	Scaling factor	Measured SAR(1g) (W/kg)	Reported SAR(1g)(W/kg)	Power Drift (dB)
MHz	Ch.								
1850.2	512	Left	Touch	29.5	28.9	1.15	0.0022	0.00253	-0.17
1850.2	512	Left	Tilt	29.5	28.9	1.15	0.0018	0.00207	+0.12
1850.2	512	Right	Touch	29.5	28.9	1.15	0.0047	0.00540	+0.07
1850.2	512	Right	Tilt	29.5	28.9	1.15	0.0026	0.00299	+0.09
1909.8	810	Right	Touch	29.5	28.7	1.20	0.0076	0.00914	+0.14
1880	661	Right	Touch	29.5	28.6	1.23	0.0039	0.00480	-0.10

Table 2.7: SAR Values(GSM 1900 MHz Band - Body)

Frequency		Mode (number of timeslots)	Test Position	Maximum allowed Power (dBm)	Measured average power (dBm)	Scaling factor	Measured SAR(1g) (W/kg)	Reported SAR(1g)(W/kg)	Power Drift (dB)
MHz	Ch.								
1850.2	512	GPRS-4TS	Ground	27	26.8	1.05	0.295	0.30890	+0.07
1850.2	512	GPRS-4TS	Phantom	27	26.8	1.05	0.037	0.03874	+0.09
1850.2	512	GPRS-4TS	Left	27	26.8	1.05	0.013	0.01361	+0.12
1850.2	512	GPRS-4TS	Right	27	26.8	1.05	0.013	0.01361	+0.09
1850.2	512	GPRS-4TS	Bottom	27	26.8	1.05	0.079	0.08272	+0.16
1850.2	512	GPRS-4TS	Top	27	26.8	1.05	0.000921	0.00096	+0.11
1909.8	810	GPRS-4TS	Ground	27	26.7	1.07	0.283	0.30324	+0.13
1880	661	GPRS-4TS	Ground	27	26.5	1.12	0.286	0.32090	+0.09
1850.2	512	Headset	Ground	29.5	28.9	1.15	0.263	0.30196	+0.17
1850.2	512	EGPRS-4TS	Ground	27	26.8	1.05	0.151	0.15811	-0.12

Report No.: B16X50266-SAR-Rev3

Table 2.8: SAR Values(WCDMA Band II- Head)

Frequency		Side	Test Position	Maximum allowed Power (dBm)	Measured average power (dBm)	Scaling factor	Measured SAR(1g) (W/kg)	Reported SAR(1g)(W/kg)	Power Drift (dB)
MHz	Ch.								
1907.6	9538	Left	Touch	23	22.95	1.01	0.056	0.05656	+0.04
1907.6	9538	Left	Tilt	23	22.95	1.01	0.041	0.04264	+0.05
1907.6	9538	Right	Touch	23	22.95	1.01	0.040	0.04040	+0.14
1907.6	9538	Right	Tilt	23	22.95	1.01	0.00707	0.00714	-0.06
1880	9400	Right	Touch	23	22.66	1.08	0.049	0.05292	+0.12
1852.4	9262	Right	Touch	23	22.86	1.03	0.0358	0.03687	-0.07

Table 2.9: SAR Values(WCDMA Band II - Body)

Frequency		Mode (number of timeslots)	Test Position	Maximum allowed Power (dBm)	Measured average power (dBm)	Scaling factor	Measured SAR(1g) (W/kg)	Reported SAR(1g)(W/kg)	Power Drift (dB)
MHz	Ch.								
1907.6	9538	Band 2	Ground	23	22.95	1.01	0.514	0.51914	+0.15
1907.6	9538	Band 2	Phantom	23	22.95	1.01	0.058	0.05858	+0.13
1907.6	9538	Band 2	Left	23	22.95	1.01	0.010	0.01010	+0.01
1907.6	9538	Band 2	Right	23	22.95	1.01	0.015	0.01515	+0.12
1907.6	9538	Band 2	Bottom	23	22.95	1.01	0.144	0.14544	-0.15
1907.6	9538	Band 2	Top	23	22.95	1.01	0.00444	0.00448	+0.09
1852.4	9262	Band 2	Ground	23	22.86	1.03	0.506	0.52118	+0.04
1880	9400	Band 2	Ground	23	22.66	1.08	0.519	0.56052	+0.06
1880	9400	Headset	Ground	23	22.66	1.08	0.490	0.52920	+0.08

Report No.: B16X50266-SAR-Rev3

Table 2.10: SAR Values(WCDMA Band V - Head)

Frequency		Side	Test Position	Maximum allowed Power (dBm)	Measured average power (dBm)	Scaling factor	Measured SAR(1g) (W/kg)	Reported SAR(1g)(W/kg)	Power Drift (dB)
MHz	Ch.								
826.4	4132	Left	Touch	23	22.53	1.11	0.00997	0.01107	+0.06
826.4	4132	Left	Tilt	23	22.53	1.11	0.00891	0.00989	+0.20
826.4	4132	Right	Touch	23	22.53	1.11	0.00866	0.00961	+0.02
826.4	4132	Right	Tilt	23	22.53	1.11	0.00715	0.00794	-0.06
846.4	4233	Right	Touch	23	22.51	1.12	0.00822	0.00921	+0.04
836.4	4182	Right	Touch	23	22.48	1.13	0.00336	0.00380	-0.11

Table 2.11: SAR Values(WCDMA Band V - Body)

Frequency		Mode (number of timeslots)	Test Position	Maximum allowed Power (dBm)	Measured average power (dBm)	Scaling factor	Measured SAR(1g) (W/kg)	Reported SAR(1g)(W/kg)	Power Drift (dB)
MHz	Ch.								
826.4	4132	Band 5	Ground	23	22.53	1.11	0.151	0.16761	+0.04
826.4	4132	Band 5	Phantom	23	22.53	1.11	0.026	0.02886	+0.02
826.4	4132	Band 5	Left	23	22.53	1.11	0.00096	0.00107	+0.10
826.4	4132	Band 5	Right	23	22.53	1.11	0.00107	0.00119	-0.05
826.4	4132	Band 5	Bottom	23	22.53	1.11	0.022	0.02442	+0.02
826.4	4132	Band 5	Top	23	22.53	1.11	0.001	0.00111	+0.05
846.4	4233	Band 5	Ground	23	22.51	1.12	0.182	0.20384	+0.09
836.4	4182	Band 5	Ground	23	22.48	1.13	0.167	0.18871	+0.11
846.4	4233	Headset	Ground	23	22.51	1.12	0.184	0.20608	+0.03

Report No.: B16X50266-SAR-Rev3

Table 2.12: SAR Values(LTE Band II - Head)

Frequency		Side	Test Position	Maximum allowed Power (dBm)	Measured average power (dBm)	Scaling factor	Measured SAR(1g) (W/kg)	Reported SAR(1g)(W/kg)	Power Drift (dB)
MHz	Ch.								
18900	1880	Left	Touch	23	22.64	1.09	0.023	0.02499	+0.09
18900	1880	Left	Tilt	23	22.64	1.09	0.0101	0.01097	+0.18
18900	1880	Right	Touch	23	22.64	1.09	0.042	0.04563	+0.15
18900	1880	Right	Tilt	23	22.64	1.09	0.016	0.01738	+0.14
19100	1900	Right	Touch	23	22.60	1.10	0.017	0.01864	+0.12
18700	1860	Right	Touch	23	22.34	1.16	0.00138	0.00161	-0.15

Table 2.13: SAR Values(LTE Band II - Body)

Frequency		Mode (number of timeslots)	Test Position	Maximum allowed Power (dBm)	Measured average power (dBm)	Scaling factor	Measured SAR(1g) (W/kg)	Reported SAR(1g)(W/kg)	Power Drift (dB)
MHz	Ch.								
18900	1880	QPSK 20MHz 1RB	Ground	23	22.64	1.09	0.218	0.23684	+0.15
18900	1880	QPSK 20MHz 1RB	Phantom	23	22.64	1.09	0.027	0.02933	+0.14
18900	1880	QPSK 20MHz 1RB	Left	23	22.64	1.09	0.00716	0.00778	+0.11
18900	1880	QPSK 20MHz 1RB	Right	23	22.64	1.09	0.00678	0.00737	+0.06
18900	1880	QPSK 20MHz 1RB	Bottom	23	22.64	1.09	0.068	0.07388	+0.16
18900	1880	QPSK 20MHz 1RB	Top	23	22.64	1.09	0.00159	0.00173	+0.13
19100	1900	QPSK 20MHz 1RB	Ground	23	22.60	1.1	0.360	0.39473	+0.07
18700	1860	QPSK 20MHz 1RB	Ground	23	22.34	1.16	0.328	0.38183	+0.12

Report No.: B16X50266-SAR-Rev3

Table 2.14: SAR Values(LTE Band IV - Head)

Frequency		Side	Test Position	Maximum allowed Power (dBm)	Measured average power (dBm)	Scaling factor	Measured SAR(1g) (W/kg)	Reported SAR(1g)(W/kg)	Power Drift (dB)
MHz	Ch.								
19965	1711.5	Left	Touch	23	22.28	1.18	0.00617	0.00728	-0.12
19965	1711.5	Left	Tilt	23	22.28	1.18	0.00397	0.00469	-0.13
19965	1711.5	Right	Touch	23	22.28	1.18	0.00624	0.00737	+0.17
19965	1711.5	Right	Tilt	23	22.28	1.18	0.00539	0.00636	+0.10
20385	1753.5	Right	Touch	23	21.94	1.28	0.00634	0.00809	+0.13
20175	1732.5	Right	Touch	23	21.96	1.27	0.0028	0.00356	-0.12
20300	1745	Right	Touch	23	21.43	1.44	0.00468	0.00672	+0.07

Table 2.15: SAR Values(LTE Band IV - Body)

Frequency		Mode (number of timeslots)	Test Position	Maximum allowed Power (dBm)	Measured average power (dBm)	Scaling factor	Measured SAR(1g) (W/kg)	Reported SAR(1g)(W/kg)	Power Drift (dB)
MHz	Ch.								
19965	1711.5	16QAM 3MHz 1RB	Ground	23	22.28	1.18	0.237	0.27974	+0.08
19965	1711.5	16QAM 3MHz 1RB	Phantom	23	22.28	1.18	0.043	0.05075	+0.18
19965	1711.5	16QAM 3MHz 1RB	Left	23	22.28	1.18	0.007	0.00826	+0.08
19965	1711.5	16QAM 3MHz 1RB	Right	23	22.28	1.18	0.00284	0.00335	+0.13
19965	1711.5	16QAM 3MHz 1RB	Bottom	23	22.28	1.18	0.045	0.05311	+0.13
19965	1711.5	16QAM 3MHz 1RB	Top	23	22.28	1.18	0.000818	0.00097	+0.06
20385	1753.5	16QAM 3MHz 1RB	Ground	23	21.94	1.28	0.205	0.26167	-0.11
20175	1732.5	16QAM 3MHz 1RB	Ground	23	21.96	1.27	0.183	0.23252	+0.08
20050	1720	16QAM 20MHz 1RB	Ground	23	21.67	1.36	0.182	0.24721	+0.10

Report No.: B16X50266-SAR-Rev3

Table 2.16: SAR Values(LTE Band VII - Head)

Frequency		Side	Test Position	Maximum allowed Power (dBm)	Measured average power (dBm)	Scaling factor	Measured SAR(1g) (W/kg)	Reported SAR(1g)(W/kg)	Power Drift (dB)
MHz	Ch.								
20775	2502.5	Left	Touch	23	22.68	1.08	0.011	0.01184	-0.09
20775	2502.5	Left	Tilt	23	22.68	1.08	0.011	0.01184	-0.11
20775	2502.5	Right	Touch	23	22.68	1.08	0.0181	0.01948	-0.12
20775	2502.5	Right	Tilt	23	22.68	1.08	0.012	0.01292	+0.14
21425	2567.5	Right	Touch	23	21.56	1.39	0.011	0.01532	+0.12
21100	2535	Right	Touch	23	21.26	1.49	0.0151	0.02254	-0.08
20850	2510	Right	Touch	23	22.59	1.10	0.0146	0.01605	-0.12

Table 2.17: SAR Values(LTE Band VII - Body)

Frequency		Mode (number of timeslots)	Test Position	Maximum allowed Power (dBm)	Measured average power (dBm)	Scaling factor	Measured SAR(1g) (W/kg)	Reported SAR(1g)(W/kg)	Power Drift (dB)
MHz	Ch.								
20775	2502.5	QPSK 5MHz 1RB	Ground	23	22.68	1.08	0.576	0.62004	+0.09
20775	2502.5	QPSK 5MHz 1RB	Phantom	23	22.68	1.08	0.538	0.57914	-0.12
20775	2502.5	QPSK 5MHz 1RB	Left	23	22.68	1.08	0.057	0.06136	+0.13
20775	2502.5	QPSK 5MHz 1RB	Right	23	22.68	1.08	0.018	0.01938	+0.07
20775	2502.5	QPSK 5MHz 1RB	Bottom	23	22.68	1.08	0.158	0.17008	+0.16
20775	2502.5	QPSK 5MHz 1RB	Top	23	22.68	1.08	0.00204	0.00220	+0.16
21425	2567.5	QPSK 5MHz 1RB	Ground	23	21.56	1.39	0.269	0.37476	+0.06
21100	2535	QPSK 5MHz 1RB	Ground	23	21.26	1.49	0.434	0.64787	+0.11
20850	2510	QPSK 20MHz 1RB	Ground	23	22.59	1.10	0.588	0.64622	-0.14

Report No.: B16X50266-SAR-Rev3

Table 2.18: SAR Values(LTE Band XVII - Head)

Frequency		Side	Test Position	Maximum allowed Power (dBm)	Measured average power (dBm)	Scaling factor	Measured SAR(1g) (W/kg)	Reported SAR(1g)(W/kg)	Power Drift (dB)
MHz	Ch.								
23825	713.5	Left	Touch	23	22.19	1.21	0.00266	0.00321	-0.04
23825	713.5	Left	Tilt	23	22.19	1.21	0.00292	0.00352	+0.16
23825	713.5	Right	Touch	23	22.19	1.21	0.00451	0.00543	+0.09
23825	713.5	Right	Tilt	23	22.19	1.21	0.00323	0.00389	+0.11
23790	710	Right	Touch	23	22.02	1.25	0.00200	0.00251	-0.11
23755	706.5	Right	Touch	23	21.64	1.37	0.00186	0.00254	+0.19
23800	711	Right	Touch	23	21.60	1.38	0.00471	0.00650	+0.13

Table 2.19: SAR Values(LTE Band XVII - Body)

Frequency		Mode (number of timeslots)	Test Position	Maximum allowed Power (dBm)	Measured average power (dBm)	Scaling factor	Measured SAR(1g) (W/kg)	Reported SAR(1g)(W/kg)	Power Drift (dB)
MHz	Ch.								
23825	713.5	QPSK 5MHz 1RB	Ground	23	22.19	1.21	0.091	0.10966	-0.03
23825	713.5	QPSK 5MHz 1RB	Phantom	23	22.19	1.21	0.014	0.01687	-0.03
23825	713.5	QPSK 5MHz 1RB	Left	23	22.19	1.21	0.00048	0.00058	+0.08
23825	713.5	QPSK 5MHz 1RB	Right	23	22.19	1.21	0.00069	0.00083	+0.15
23825	713.5	QPSK 5MHz 1RB	Bottom	23	22.19	1.21	0.00616	0.00742	+0.17
23825	713.5	QPSK 5MHz 1RB	Top	23	22.19	1.21	0.00064	0.00077	+0.16
23790	710	QPSK 5MHz 1RB	Ground	23	22.02	1.25	0.109	0.13659	+0.06
23755	706.5	QPSK 5MHz 1RB	Ground	23	21.64	1.37	0.115	0.15729	+0.07
23780	709	QPSK 10MHz 1RB	Ground	23	21.75	1.33	0.075	0.10001	+0.02

Report No.: B16X50266-SAR-Rev3

Table 2.20: SAR Values(WIFI - Head)

Frequency		Side	Test Position	Maximum allowed Power (dBm)	Measured average power (dBm)	Scaling factor	Measured SAR(1g) (W/kg)	Reported SAR(1g)(W/kg)	Power Drift (dB)
MHz	Ch.								
2442	7	Left	Touch	23	22.44	1.14	0.071	0.0808	+0.07
2442	7	Left	Tilt	23	22.44	1.14	0.073	0.0830	+0.03
2442	7	Right	Touch	23	22.44	1.14	0.022	0.0250	+0.15
2442	7	Right	Tilt	23	22.44	1.14	0.022	0.0250	-0.04

Table 2.21: SAR Values(WIFI - Body)

Frequency		Mode (number of timeslots)	Test Position	Maximum allowed Power (dBm)	Measured average power (dBm)	Scaling factor	Measured SAR(1g) (W/kg)	Reported SAR(1g)(W/kg)	Power Drift (dB)
MHz	Ch.								
2442	7	WI-FI	Ground	23	22.44	1.14	0.6590	0.7497	+0.09
2442	7	WI-FI	Phantom	23	22.44	1.14	0.0910	0.1035	+0.12
2442	7	WI-FI	Left	23	22.44	1.14	0.0068	0.0077	+0.19
2442	7	WI-FI	Right	23	22.44	1.14	0.0160	0.0182	+0.14
2442	7	WI-FI	Bottom	23	22.44	1.14	0.0015	0.0017	+0.05
2442	7	WI-FI	Top	23	22.44	1.14	0.2010	0.2287	+0.15

Note: The distance between the EUT and the phantom bottom is 0mm.

3. Client Information

3.1. Applicant Information

Company Name:	Corporativo Lanix S.A.de C.V.
Address /Post:	Carretera Internacional Hermosillo – Nogals Km 8.5 Hermosillo, Sonora, Mexico
City:	Sonora
Country:	Mexico
Telephone:	005216621090811
Fax:	N/A
Email:	Oguzman@lanix.com
Contact Person:	Oscar Guzman

3.2. Manufacturer Information

Company Name:	Corporativo Lanix S.A.de C.V.
Address /Post:	Carretera Internacional Hermosillo – Nogals Km 8.5 Hermosillo, Sonora, Mexico
City:	Sonora
Country:	Mexico
Telephone:	005216621090811
Fax:	N/A
Email:	Oguzman@lanix.com
Contact Person:	Oscar Guzman

4. Equipment Under Test (EUT) and Ancillary Equipment (AE)

4.1. About EUT

Description:	Tablet
Model name:	Ilium Pad L8X
Operation Model(s):	GSM 850/1900, WCDMA Band II/V, LTE Band II/IV/VII/XVII, WIFI, Bluetooth
Tx Frequency:	824.2~848.6MHz,1850.2~1909.8MHz(GSM) 826~847MHz,1852~1908MHz(WCDMA) 706~714MHz,1860~1900MHz,1711~1754MHz, 2502~2568MHz(LTE) 2412~2472MHz (Wi-Fi) 2402~2480MHz (BT)
GPRS Multislot Class:	12
Operation mode:	B
Test device Production information:	Production unit
Device type:	Portable device
Antenna type:	Inner antenna
Accessories/Body-worn configurations:	Headset
Hotspot mode:	Support simultaneous transmission of hotspot and voice (or data)
Dimensions:	20.7cm×12.3cm

Report No.: B16X50266-SAR-Rev3



Picture 4-1: Constituents of the sample

4.2. Internal Identification of EUT used during the test

EUT ID*	SN or IMEI	HW Version	SW Version	Date of receipt
S8	IMEI:358067070000770	U357A_V1.0	Ilium Pad L8X_TELCEL_SW _01	2016-6-30

*EUT ID: is used to identify the test sample in the lab internally.

4.3. Internal Identification of AE used during the test

AE ID*	Description	Model	SN	Manufacturer
B01	Battery	N/A	N/A	N/A
A01	Headset	N/A	N/A	N/A

*AE ID: is used to identify the test sample in the lab internally.

5. TEST METHODOLOGY

5.1. Applicable Limit Regulations

ANSI C95.1–2006: IEEE Standard for Safety Levels with Respect to Human Exposure to Radio Frequency Electromagnetic Fields, 3 kHz to 300 GHz.

It specifies the maximum exposure limit of **1.6 W/kg** as averaged over any 1 gram of tissue for portable devices being used within 20 cm of the user in the uncontrolled environment.

5.2. Applicable Measurement Standards

IEEE 1528–2013: Recommended Practice for Determining the Peak Spatial-Average Specific Absorption Rate (SAR) in the Human Body Due to Wireless Communications Devices:
Experimental Techniques.

OET Bulletin 65 (Edition 97-01) and Supplement C(Edition 01-01): Additional Information for Evaluating Compliance of Mobile and Portable Devices with FCC Limits.

KDB648474 D01 SAR Handsets Multi Xmitter and Ant, v01r05: SAR Evaluation Considerations for Handsets with Multiple Transmitters and Antennas.

KDB941225 D03: Recommended SAR Test Reduction Procedures for GSM/GPRS/EDGE

6. Specific Absorption Rate (SAR)

6.1. Introduction

SAR is related to the rate at which energy is absorbed per unit mass in an object exposed to a radio field. The SAR distribution in a biological body is complicated and is usually carried out by experimental techniques or numerical modeling. The standard recommends limits for two tiers of groups, occupational/controlled and general population/uncontrolled, based on a person's awareness and ability to exercise control over his or her exposure. In general, occupational/controlled exposure limits are higher than the limits for general population/uncontrolled.

6.2. SAR Definition

The SAR definition is the time derivative (rate) of the incremental energy (dW) absorbed by (dissipated in) an incremental mass (dm) contained in a volume element (dv) of a given density (ρ). The equation description is as below:

$$SAR = \frac{d}{dt} \left(\frac{dW}{dm} \right) = \frac{d}{dt} \left(\frac{dW}{\rho dv} \right)$$

SAR is expressed in units of Watts per kilogram (W/kg)

SAR measurement can be either related to the temperature elevation in tissue by

$$SAR = c \left(\frac{\delta T}{\delta t} \right)$$

Where: C is the specific heat capacity, δT is the temperature rise and δt is the exposure duration, or related to the electrical field in the tissue by

$$SAR = \frac{\sigma |E|^2}{\rho}$$

Where: σ is the conductivity of the tissue, ρ is the mass density of tissue and E is the RMS electrical field strength.

However for evaluating SAR of low power transmitter, electrical field measurement is typically applied.

7. SAR MEASUREMENT SETUP

7.1. Measurement Set-up

The DASY5 system for performing compliance tests is illustrated above graphically. This system consists of the following items:

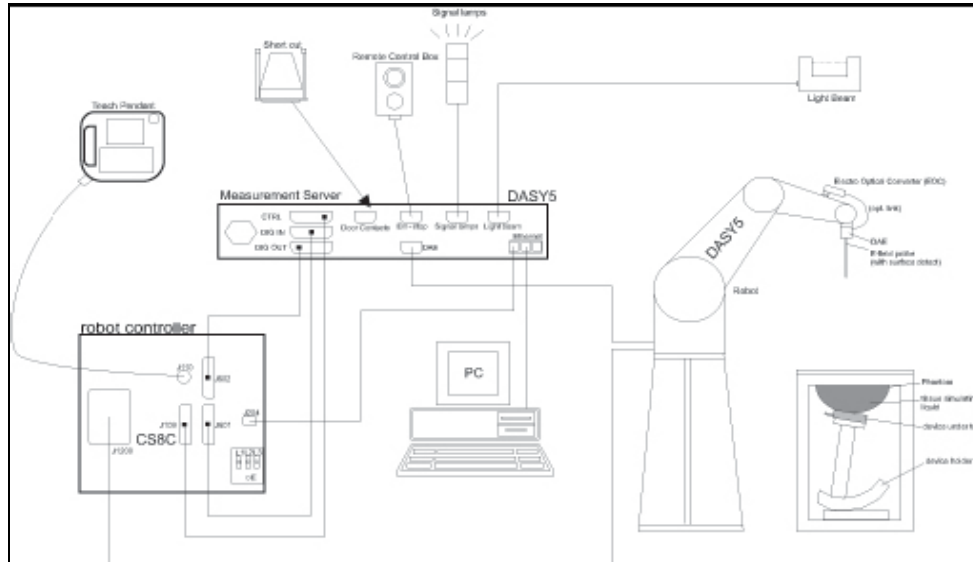

Picture 7-1 SAR Lab Test Measurement Set-up

- A standard high precision 6-axis robot (Stäubli TX=RX family) with controller, teach pendant and software. An arm extension for accommodating the data acquisition electronics (DAE).
- An isotropic field probe optimized and calibrated for the targeted measurement.
- A data acquisition electronics (DAE) which performs the signal amplification, signal multiplexing, AD-conversion, offset measurements, mechanical surface detection, collision detection, etc. The unit is battery powered with standard or rechargeable batteries. The signal is optically transmitted to the EOC.
- The Electro-optical converter (EOC) performs the conversion from optical to electrical signals for the digital communication to the DAE. To use optical surface detection, a special version of the EOC is required. The EOC signal is transmitted to the measurement server.
- The function of the measurement server is to perform the time critical tasks such as signal filtering, control of the robot operation and fast movement interrupts.
- The Light Beam used is for probe alignment. This improves the (absolute) accuracy of the probe positioning.
- A computer running WinXP and the DASY5 software.
- Remote control and teach pendant as well as additional circuitry for robot safety such as
- warning lamps, etc.
- The phantom, the device holder and other accessories according to the targeted measurement.

7.2. DASY5 E-field Probe System

The SAR measurements were conducted with the dosimetric probe designed in the classical triangular configuration and optimized for dosimetric evaluation. The probe is constructed using the thick film technique; with printed resistive lines on ceramic substrates. The probe is equipped with an optical multifiber line ending at the front of the probe tip. It is connected to the EOC box on the robot arm and provides an automatic detection of the phantom surface. Half of the fibers are connected to a pulsed infrared transmitter, the other half to a synchronized receiver. As the probe approaches the surface, the reflection from the surface produces a coupling from the transmitting to the receiving fibers. This reflection increases first during the approach, reaches maximum and then decreases. If the probe is flatly touching the surface, the coupling is zero. The distance of the coupling maximum to the surface is independent of the surface reflectivity and largely independent of the surface to probe angle. The DASY5 software reads the reflection during a software approach and looks for the maximum using 2nd ord curve fitting. The approach is stopped at reaching the maximum.

Probe Specifications:

Model: EX3DV4
Frequency 10MHz — 5.8GHz(EX3DV4)
Range:
Calibration: In head and body simulating tissue at
 Frequencies from 750 up to 5800MHz
Linearity: ± 0.2 dB(30 MHz to 5.8 GHz) for EX3DV3
Picture 7-2 Near-field Probe



Dynamic Range: 10 mW/kg — 100W/kg
Probe Length: 337 mm
Probe Tip
Length: 9 mm
Body Diameter: 10 mm
Tip Diameter: 2.5 mm (3.9 mm for EX3DV4)
Tip-Center: 1 mm (2.0mm for EX3DV4)
Application: SAR Dosimetry Testing
 Compliance tests of mobile phones
 Dosimetry in strong gradient fields



Picture 7-3 E-field Probe

7.3. E-field Probe Calibration

Each E-Probe/Probe Amplifier combination has unique calibration parameters. A TEM cell calibration procedure is conducted to determine the proper amplifier settings to enter in the probe parameters. The amplifier settings are determined for a given frequency by subjecting the probe to a known E-field density (1 mW/cm²) using an RF Signal generator, TEM cell, and RF Power Meter.

The free space E-field from amplified probe outputs is determined in a test chamber. This

Report No.: B16X50266-SAR-Rev3

calibration can be performed in a TEM cell if the frequency is below 1 GHz and in a waveguide or other methodologies above 1 GHz for free space. For the free space calibration, the probe is placed in the volumetric center of the cavity and at the proper orientation with the field. The probe is then rotated 360 degrees until the three channels show the maximum reading. The power density readings equate to 1 mW/cm²:

E-field temperature correlation calibration is performed in a flat phantom filled with the appropriate simulated brain tissue. The E-field in the medium correlates with the temperature rise in the dielectric medium. For temperature correlation calibration a RF transparent thermistor-based temperature probe is used in conjunction with the E-field probe.

$$SAR = C \frac{\Delta T}{\Delta t}$$

Where:

Δt = Exposure time (30 seconds),

C = Heat capacity of tissue (brain or muscle),

ΔT = Temperature increase due to RF exposure.

$$SAR = \frac{|E|^2 \cdot \sigma}{\rho}$$

Where:

σ = Simulated tissue conductivity,

ρ = Tissue density (kg/m³).

7.4. Other Test Equipment

7.4.1. Data Acquisition Electronics(DAE)

The data acquisition electronics consist of a highly sensitive electrometer-grade preamplifier with auto-zeroing, a channel and gain-switching multiplexer, a fast 16 bit AD-converter and a command decoder with a control logic unit. Transmission to the measurement server is accomplished through an optical downlink for data and status information, as well as an optical uplink for commands and the clock.

The mechanical probe mounting device includes two different sensor systems for frontal and sideways probe contacts. They are used for mechanical surface detection and probe collision detection.

The input impedance of the DAE is 200 MOhm; the inputs are symmetrical and floating. Common mode rejection is above 80 dB.



Picture7-4: DAE

7.4.2. Robot

The SPEAG DASY system uses the high precision robots (DASY5: TX90) type from Stäubli SA (France). For the 6-axis controller system, the robot controller version from Stäubli is used. The Stäubli robot series have many features that are important for our application:

- High precision (repeatability 0.02mm)
- High reliability (industrial design)
- Low maintenance costs (virtually maintenance free due to direct drive gears; no belt drives)
- Jerk-free straight movements (brushless synchron motors; no stepper motors)
- Low ELF interference (motor control fields shielded via the closed metallic construction shields)



Picture7-5: DASY 5

7.4.3. Measurement Server

The Measurement server is based on a PC/104 CPU board with CPU (DASY5: 400 MHz, Intel Celeron), chipdisk (DASY5: 128MB), RAM (DASY5: 128MB). The necessary circuits for communication with the DAE electronic box, as well as the 16 bit AD converter system for optical detection and digital I/O interface are contained on the DASY I/O board, which is directly connected to the PC/104 bus of the CPU board.

The measurement server performs all real-time data evaluation of field measurements and surface detection, controls robot movements and handles safety operation. The PC operating system cannot interfere with these time critical processes. All connections are supervised by a watchdog, and disconnection of any of the cables to the measurement server will automatically disarm the robot and disable all program-controlled robot movements. Furthermore, the measurement server is equipped with an expansion port which is

Report No.: B16X50266-SAR-Rev3

reserved for future applications. Please note that this expansion port does not have a standardized pinout, and therefore only devices provided by SPEAG can be connected. Devices from any other supplier could seriously damage the measurement server.



Picture 7-6: Server for DASY 5

7.4.4. Device Holder for Phantom

The SAR in the phantom is approximately inversely proportional to the square of the distance between the source and the liquid surface. For a source at 5mm distance, a positioning uncertainty of $\pm 0.5\text{mm}$ would produce a SAR uncertainty of $\pm 20\%$. Accurate device positioning is therefore crucial for accurate and repeatable measurements. The positions in which the devices must be measured are defined by the standards.

The DASY device holder is designed to cope with the different positions given in the standard. It has two scales for device rotation (with respect to the body axis) and device inclination (with respect to the line between the ear reference points). The rotation centers for both scales is the ear reference point (ERP). Thus the device needs no repositioning when changing the angles.

The DASY device holder is constructed of low-loss POM material having the following dielectric parameters:

relative permittivity $\epsilon = 3$ and loss tangent $\delta = 0.02$. The amount of dielectric material has been reduced in the closest vicinity of the device, since measurements have suggested that the influence of the clamp on the test results could thus be lowered.

<Laptop Extension Kit>

The extension is lightweight and made of POM, acrylic glass and foam. It fits easily on the upper part of the Mounting Device in place of the phone positioner. The extension is fully compatible with the Twin-SAM and ELI phantoms.



Picture7-7: Device Holder

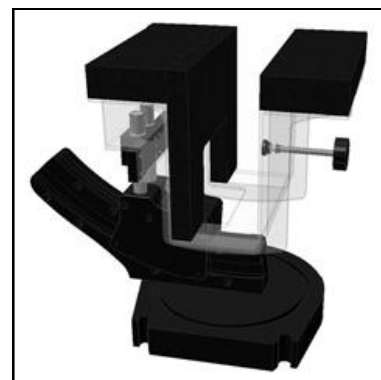

Picture 7-8: Laptop Extension Kit

Report No.: B16X50266-SAR-Rev3**7.4.5. Phantom**

The SAM Twin Phantom V4.0 is constructed of a fiberglass shell integrated in a table. The shape of the shell is based on data from an anatomical study designed to

Represent the 90th percentile of the population. The phantom enables the dissymmetric evaluation of SAR for both left and right handed handset usage, as well as body-worn usage using the flat phantom region. Reference markings on the Phantom allow the complete setup of all predefined phantom positions and measurement grids by manually teaching three points in the robot. The shell phantom has a 2mm shell thickness (except the ear region where shell thickness increases to 6 mm).

Shell Thickness: 2 ± 0.2 mm

Filling Volume: Approx. 25 liters

Dimensions: 810 x 1000 x 500 mm (H x L x W)

Available: Special



Picture 7-9: SAM Twin Phantom

8. Position of the wireless device in relation to the phantom

8.1. General considerations

This standard specifies two handset test positions against the head phantom – the “cheek” position and the “tilt” position.

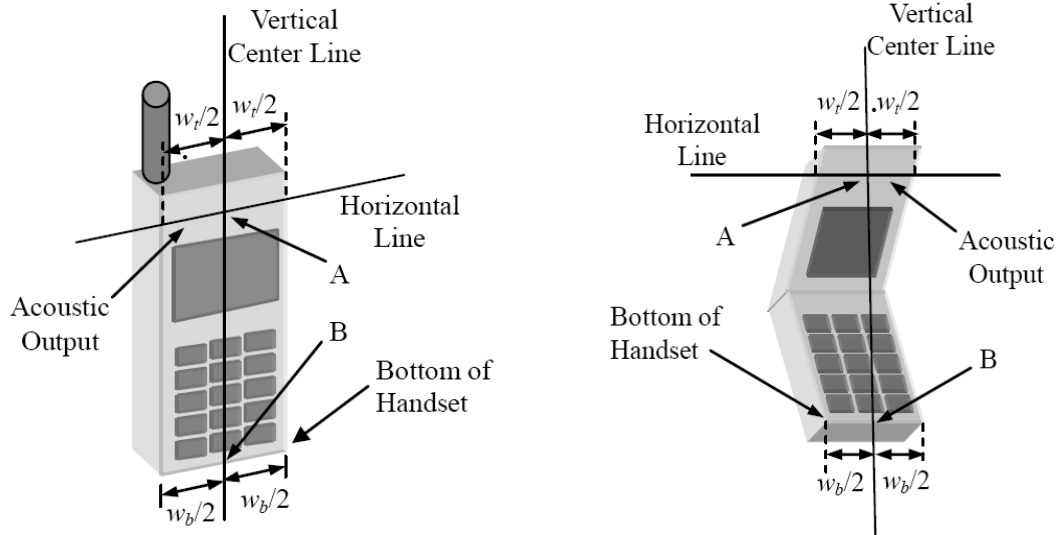

- w_t Width of the handset at the level of the acoustic
- w_b Width of the bottom of the handset
- A Midpoint of the width w_t of the handset at the level of the acoustic output
- B Midpoint of the width w_b of the bottom of the handset

Picture 8-1 Typical “fixed” case handset Picture 8-2 Typical “clam-shell” case handset

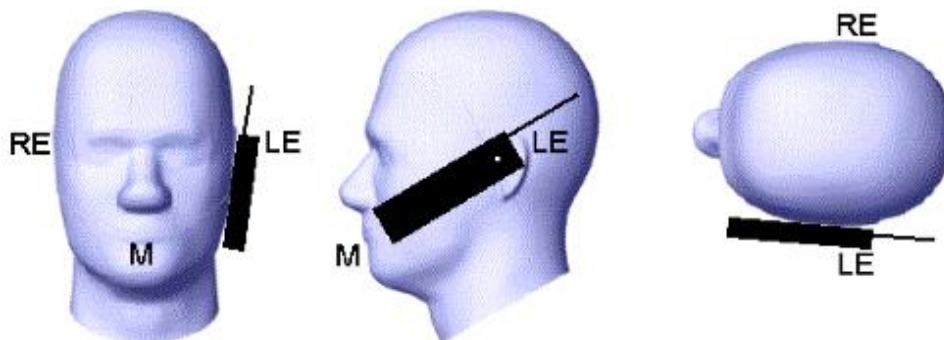

Picture 8-3 Cheek position of the wireless device on the left side of SAM

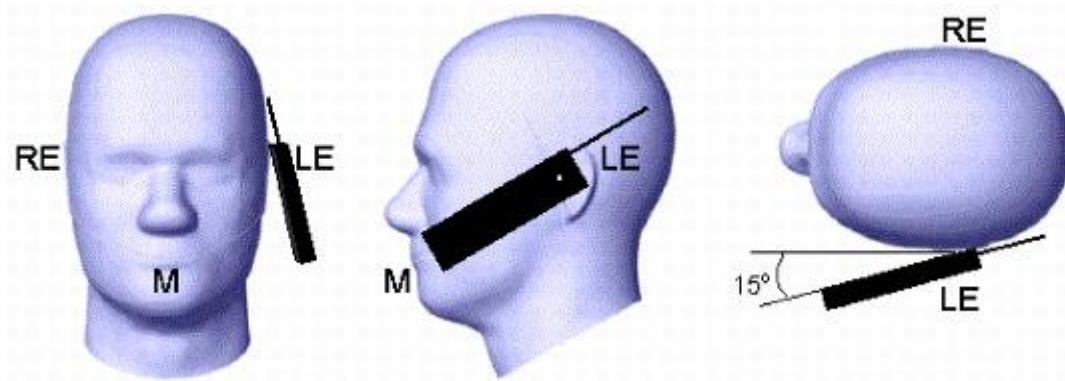

Picture 8-4 Tilt position of the wireless device on the left side of SAM

8.2. Body-worn device

A typical example of a body-worn device is a mobile phone, wireless enabled PDA or other battery operated wireless device with the ability to transmit while mounted on a person's body using a carry accessory approved by the wireless device manufacturer.

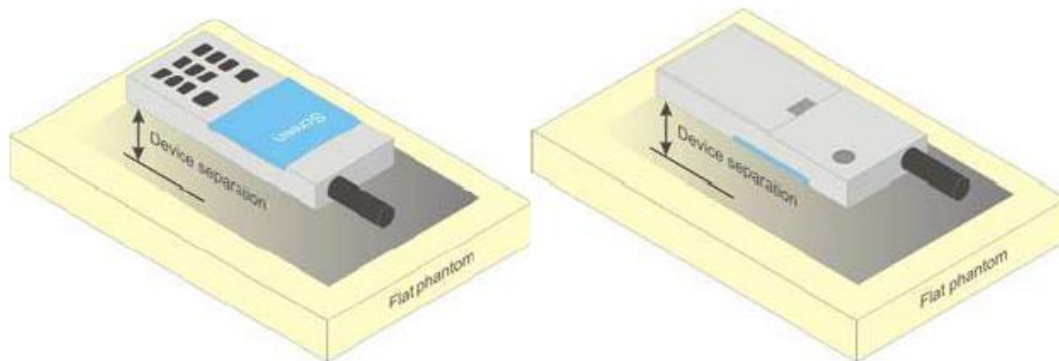

Picture 8-5 Test positions for body-worn devices

8.3. Desktop device

A typical example of a desktop device is a wireless enabled desktop computer placed on a table or desk when used.

The DUT shall be positioned at the distance and in the orientation to the phantom that corresponds to the intended use as specified by the manufacturer in the user instructions. For devices that employ an external antenna with variable positions, tests shall be performed for all antenna positions specified. Picture 8-6 shows positions for desktop device SAR tests. If the intended use is not specified, the device shall be tested directly against the flat phantom.

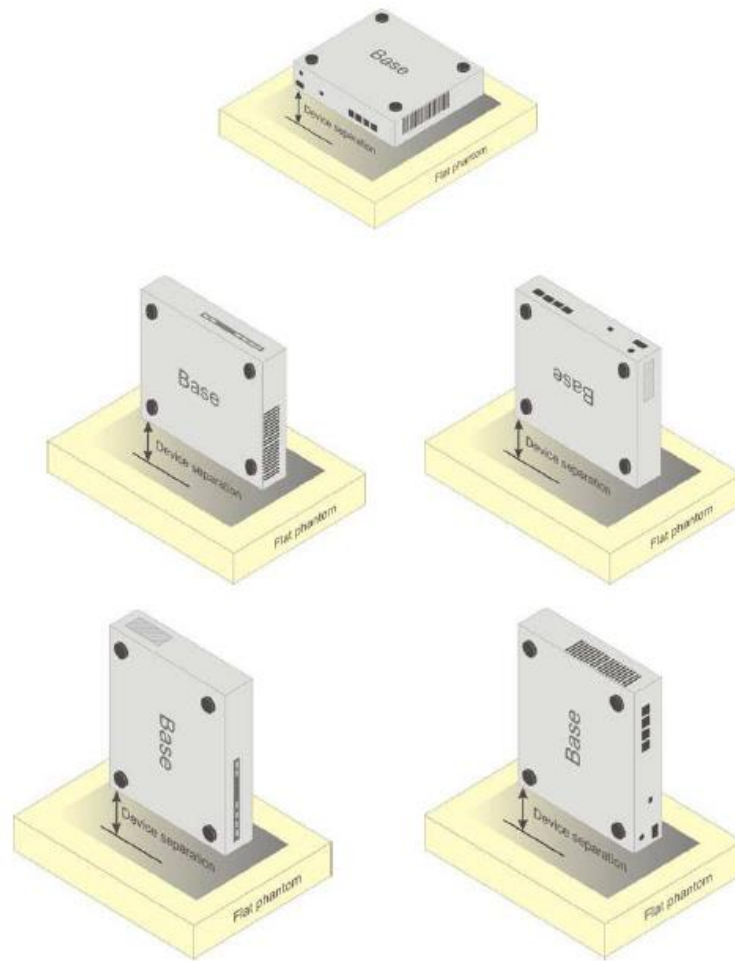

Picture 8-6 Test positions for desktop devices

8.4. DUT Setup Photos

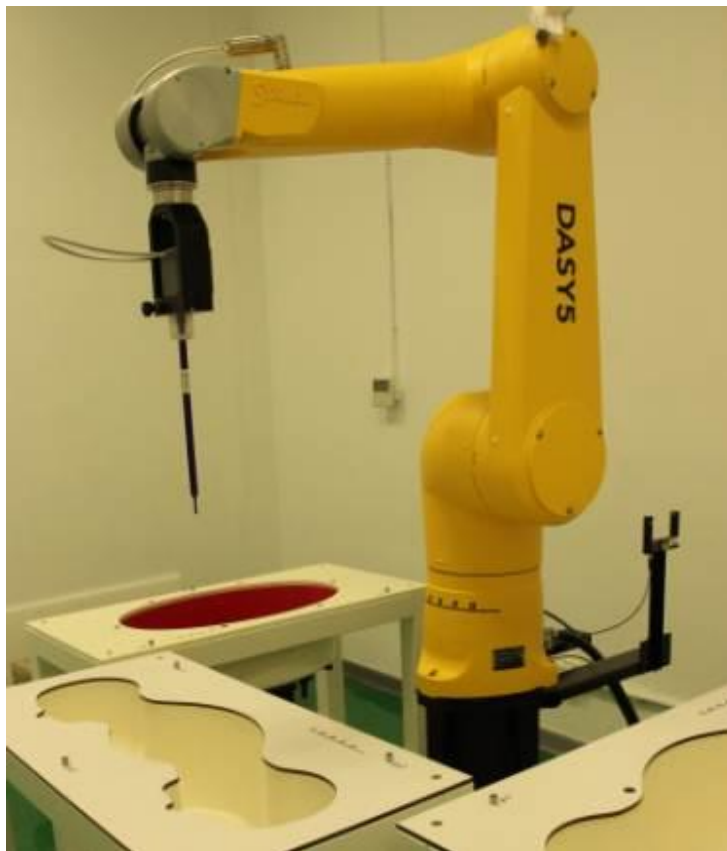

Picture 8-7: Specific Absorption Rate Test Layout



Picture 8-8: Left Head Touch Cheek Position



Picture 8-9: Left Head Tilt 15° Position

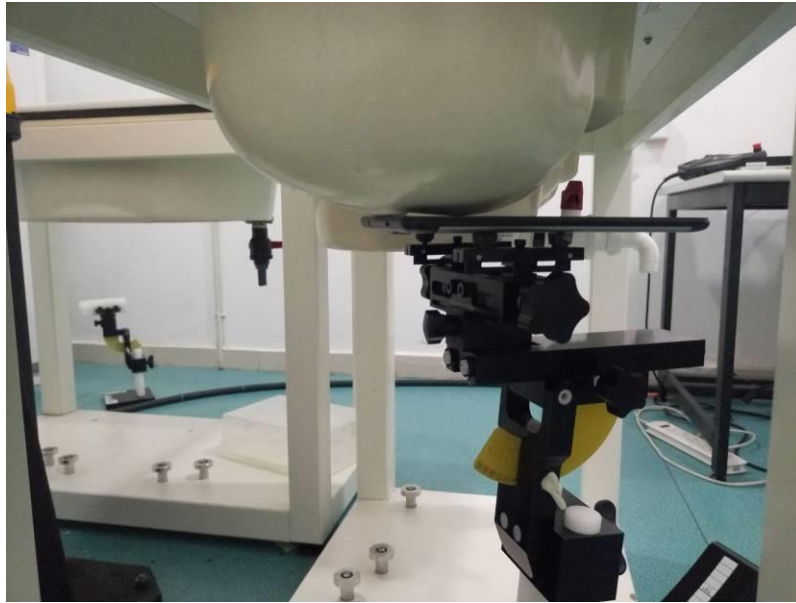

Picture 8-10: Right Head Touch Cheek Position



Picture 8-11: Right Head Tilt 15° Position

Test positions for body:

According to the antenna position, the Body SAR is tested at the following 6 test positions all with the distance =0 mm between the EUT and the phantom bottom :



Picture 8-12: Toward Phantom (0mm)



Picture 8-13: Toward Ground (0mm)



Picture 8-14: Left (0mm)



Picture 8-15: Right (0mm)



Picture 8-16: Bottom (0mm)

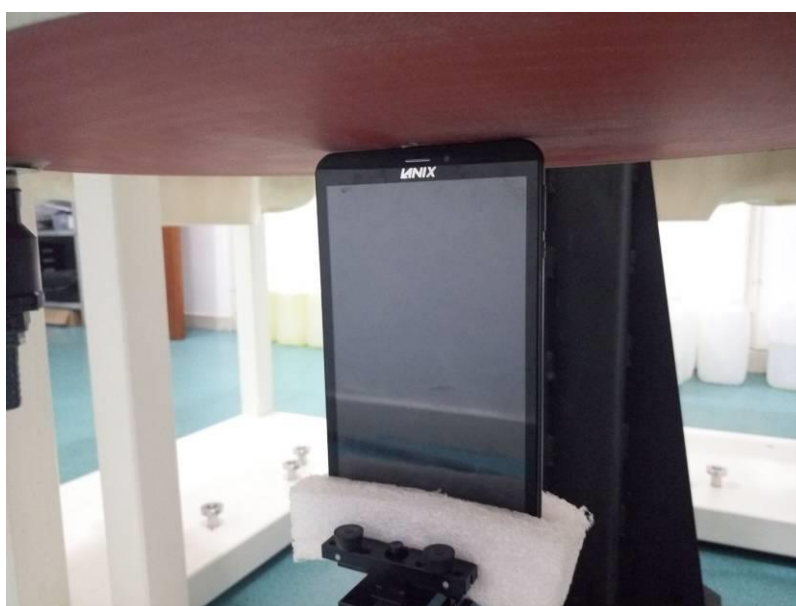

Picture 8-17: Bottom (0mm)

9. Tissue Simulating Liquids

9.1. Equivalent Tissues

The liquid used for the frequency range of 800-3000 MHz consisted of water, sugar, salt and Cellulose. The liquid has been previously proven to be suited for worst-case. The Table 3 and 4 shows the detail solution. It's satisfying the latest tissue dielectric parameters requirements proposed by the IEEE 1528 and IEC 62209.

Table 9.1. Composition of the Head Tissue Equivalent Matter

Frequency (MHz)	750	850	1750	1900	2450	2600
	Head	Head	Head	Head	Head	Head
Ingredients (% by weight)						
Water	40.41	40.92	52.64	54.90	58.79	58.23
Sugar	56.94	57.1	/	/	/	/
Salt	1.55	1.48	0.36	0.18	0.06	0.07
Preventol	0.1	0.1	/	/	/	/
Cellulose	1.0	0.4	/	/	/	/
Clycol Monobutyl	/	/	47.00	44.92	41.15	41.70
Dielectric Parameters Target Value	f=750MHz $\epsilon=41.68$ $\sigma=0.897$	f=850MHz $\epsilon=41.5$ $\sigma=0.916$	f=1800MHz $\epsilon=40.0$ $\sigma=1.40$	f=1900MHz $\epsilon=40.0$ $\sigma=1.40$	f=2450MHz $\epsilon=39.2$ $\sigma=1.80$	f=2600MHz $\epsilon=39.0$ $\sigma=1.96$

Table 9.2. Composition of the Body Tissue Equivalent Matter

Frequency (MHz)	750	850	1750	1900	2450	2600
	Body	Body	Body	Body	Body	Body
Ingredients (% by weight)						
Water	52.45	56.0	40.5	40.5	73.02	72.64
Sugar	44.95	41.76	58.0	58.0	/	/
Salt	1.5	0.76	0.5	0.5	0.16	0.13
Preventol	0.1	0.27	0.5	0.5	/	/
Cellulose	1.0	1.21	0.5	0.5	/	/
Clycol Monobutyl	/	/	/	/	26.82	27.23
Dielectric Parameters Target Value	f=750MHz $\epsilon=55.3$ $\sigma=0.97$	f=850MHz $\epsilon=55.0$ $\sigma=0.99$	f=1800MHz $\epsilon=53.3$ $\sigma=1.52$	f=1900MHz $\epsilon=53.3$ $\sigma=1.52$	f=2450MHz $\epsilon=52.7$ $\sigma=1.95$	f=2600MHz $\epsilon=39.0$ $\sigma=1.96$

Table 9.3. Targets for tissue simulating liquid

Frequency (MHz)	Liquid Type	Conductivity (σ)	$\pm 5\%$ Range	Permittivity (ϵ)	$\pm 5\%$ Range
750	Head	0.897	0.85~0.94	41.68	39.60~43.76
850	Head	0.92	0.87~0.97	41.5	39.4~43.6
1750	Head	1.40	1.33~1.47	40.0	38.0~42.0
1900	Head	1.40	1.33~1.47	40.0	38.0~42.0
2450	Head	1.80	1.71~1.89	39.2	37.2~41.2
2600	Head	1.96	1.86~2.06	39.0	37.05~40.95
750	Body	0.97	0.92~1.02	55.3	52.54~58.07
850	Body	0.99	0.94~1.04	55.2	52.4~57.9
1750	Body	1.52	1.44~1.59	53.3	50.6~55.9
1900	Body	1.52	1.44~1.59	53.3	50.6~55.9
2450	Body	1.95	1.85~2.05	52.7	50.06~55.34
2600	Body	2.01	1.91~2.11	52.5	49.88~55.13

9.2. Dielectric Performance

Table 9.4: Dielectric Performance of Tissue Simulating Liquid

Measurement Value						
Liquid Temperature: 22.5°C						
Type	Frequency	Permittivity ϵ	Drift (%)	Conductivity σ	Drift (%)	Test Date
Head	750	42.47	+1.89%	0.896	-0.11%	2016-7-08
Head	850	42.01	+1.23%	0.920	+0.44%	2016-7-06
Head	1750	40.24	+0.60%	1.380	-1.43%	2016-7-11
Head	1900	40.62	+1.48%	1.388	-0.86%	2016-7-05
Head	2450	39.59	+0.99%	1.819	+1.06%	2016-7-15
Head	2600	39.25	+0.64%	1.884	-3.88%	2016-7-10
Body	750	54.08	-2.21%	0.981	+1.75%	2016-7-08
Body	850	55.33	+0.24%	0.994	+0.40%	2016-7-06
Body	1750	52.96	-0.64%	1.480	-2.63%	2016-7-11
Body	1900	53.83	+0.99%	1.509	-0.72%	2016-7-04
Body	2450	52.14	-1.06%	1.944	-0.31%	2016-7-15
Body	2600	52.13	-0.07%	2.032	+1.09%	2016-7-09

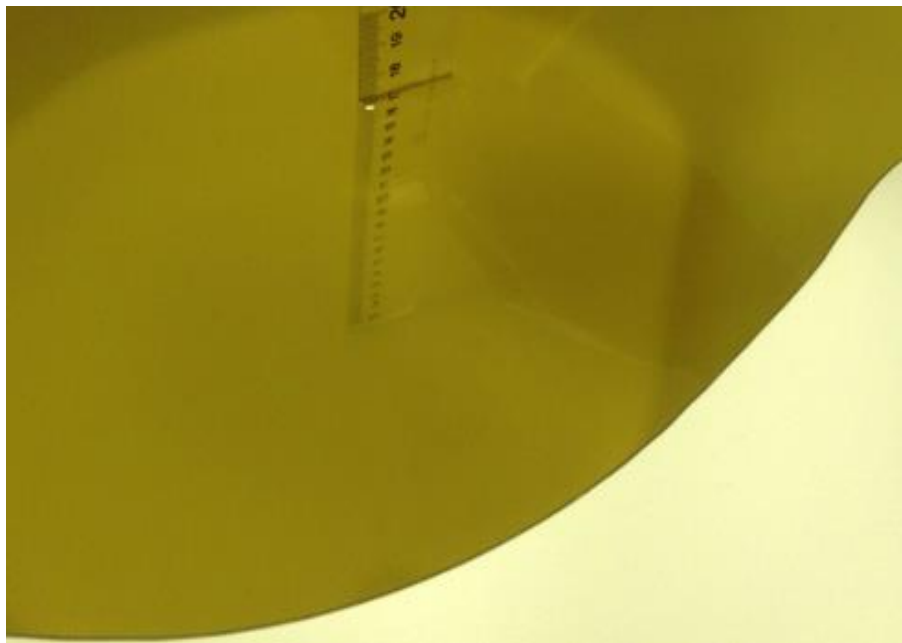

Picture 9-1: Liquid depth in the Flat Phantom (750/850/900 MHz Head)



Picture 9-2: Liquid depth in the Flat Phantom (1900 MHz Head)



Picture 9-3: Liquid depth in the Flat Phantom (2300 MHz Head)

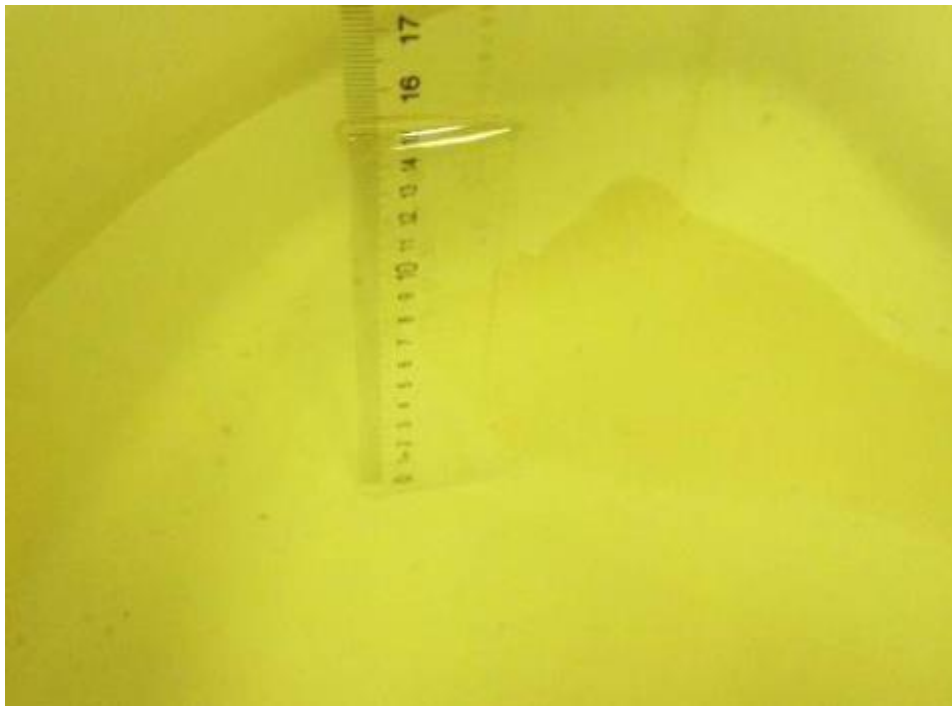

Picture 9-4: Liquid depth in the Flat Phantom (2450 MHz Head)

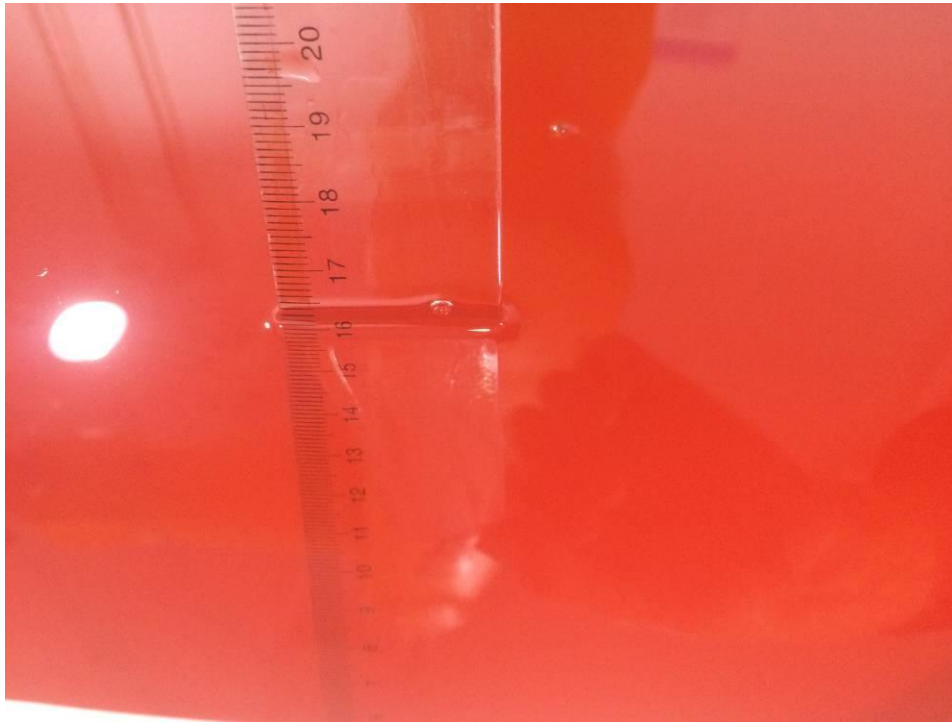

Picture 9-5: Liquid depth in the Flat Phantom (750/850/900 MHz Body)

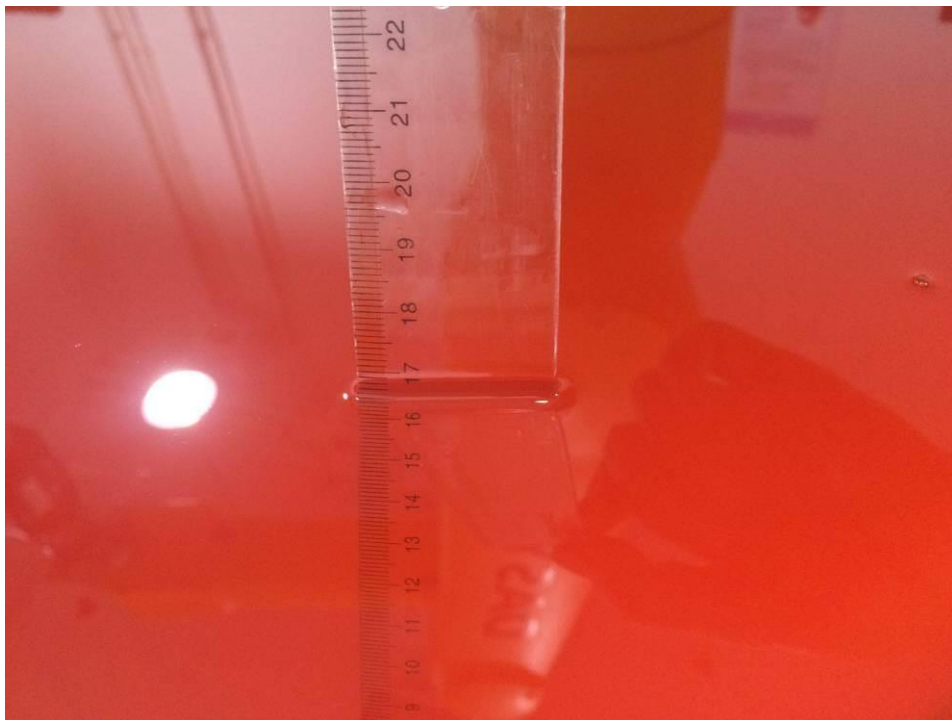

Picture 9-6: Liquid depth in the Flat Phantom (1900 MHz Body)

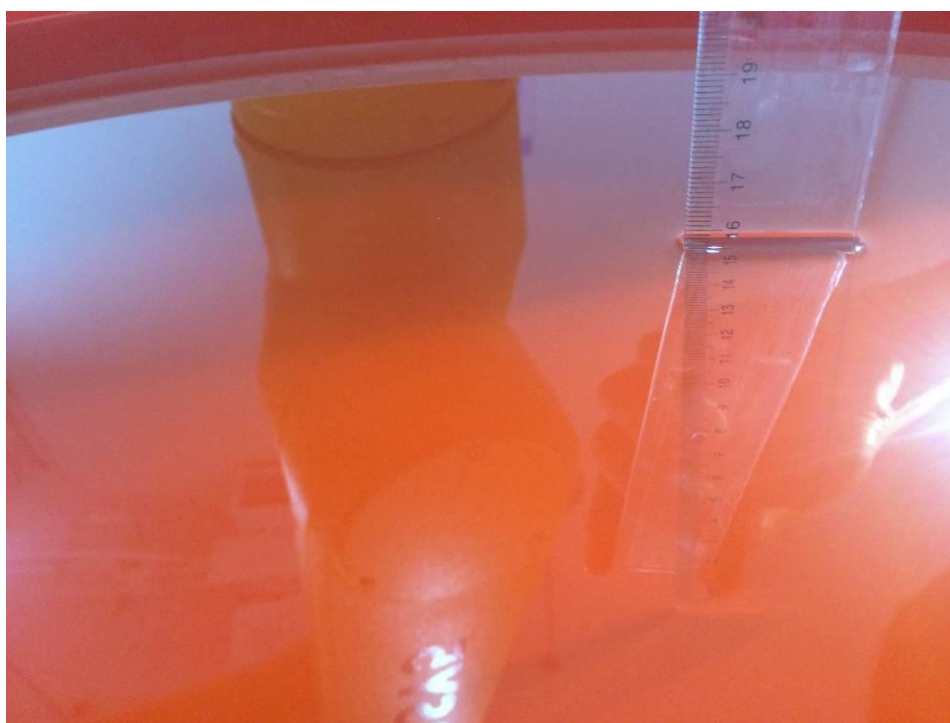

Picture 9-7: Liquid depth in the Flat Phantom (2300 MHz Body)



Picture 9-8: Liquid depth in the Flat Phantom (2450 MHz Body)

10. System Validation

10.1. System Validation

Each DASY system is equipped with one or more system validation kits. These units, together with the predefined measurement procedures within the DASY software, enable the user to conduct the system performance check and system validation. System validation kit includes a dipole, tripod holder to fix it underneath the flat phantom and a corresponding distance holder.

10.2. System Setup

In the simplified setup for system evaluation, the DUT is replaced by a calibrated dipole and the power source is replaced by a continuous wave that comes from a signal generator. The calibrated dipole must be placed beneath the flat phantom section of the SAM twin phantom with the correct distance holder. The distance holder should touch the phantom surface with a light pressure at the reference marking and be oriented parallel to the long side of the phantom. The equipment setup is shown below:

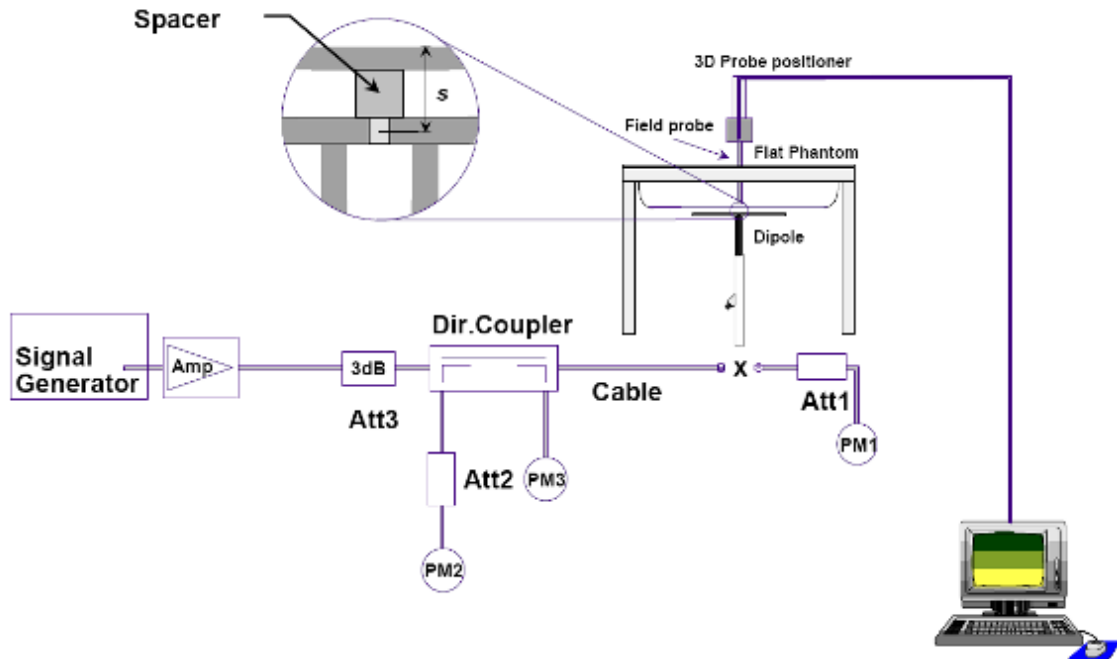

Picture 10-1 System Setup for System Evaluation

The output power on dipole port must be calibrated to 24 dBm (250mW) before dipole is connected.

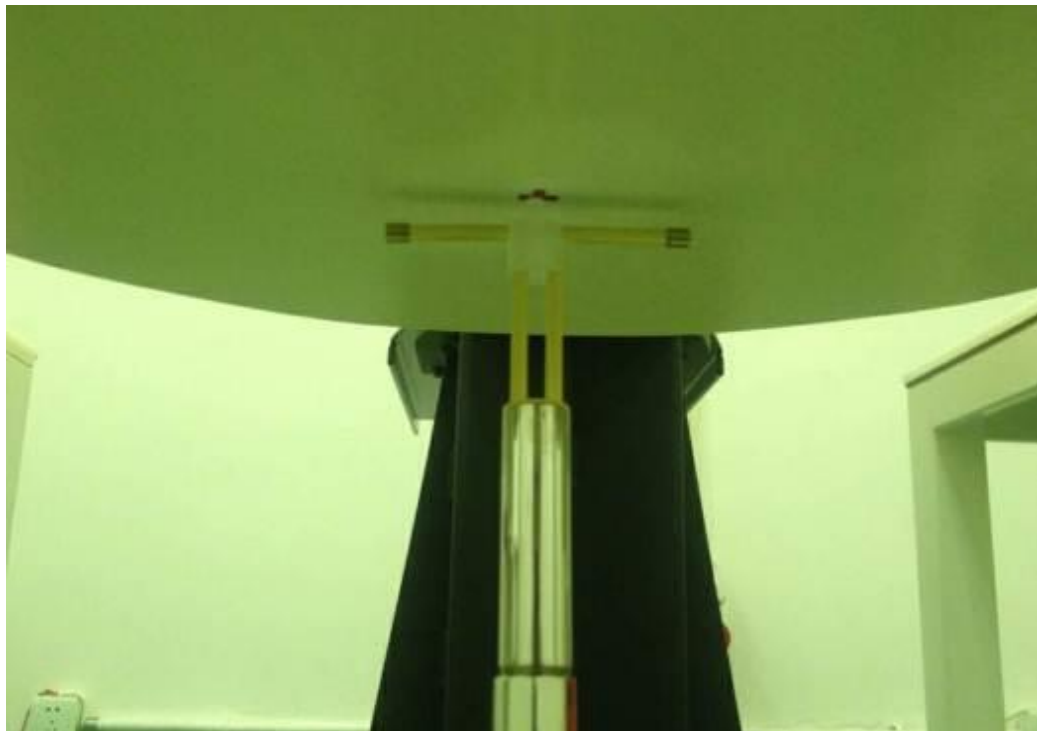

Picture 10-2 Photo of Dipole Setup

Table 10.1: System Validation of Head

Verification Results							
Input power level: 250mW							
Frequency	Target value (W/kg)		Measured value (W/kg)		Deviation		Test date
	10 g Average	1 g Average	10 g Average	1 g Average	10 g Average	1 g Average	
750	1.38	2.06	1.33	2.06	-3.62%	0%	2016-7-08
835	1.55	2.33	1.53	2.34	-1.29%	+0.43%	2016-7-06
1750	4.97	9.23	4.83	9.05	-2.82%	-1.95%	2016-7-11
1900	5.19	9.97	4.95	9.56	-4.62%	-4.11%	2016-7-05
2450	6.14	13.10	6.16	13.50	+0.33%	+3.05%	2016-7-15
2600	6.25	14	6.42	14.60	+2.72%	+4.29%	2016-7-10

Table 10.2: System Validation of Body

Verification Results							
Input power level: 250mW							
Frequency	Target value (W/kg)		Measured value (W/kg)		Deviation		Test date
	10 g Average	1 g Average	10 g Average	1 g Average	10 g Average	1 g Average	
750	1.368	2.24	1.52	2.39	+11.1%	+6.70%	2016-7-08
835	1.61	2.41	1.57	2.37	-2.48%	-1.66%	2016-7-06
1750	5.23	9.65	5.25	9.82	+0.38%	+1.76%	2016-7-11
1900	5.34	10.20	4.96	9.49	-7.12%	-6.96%	2016-7-04
2450	6.14	13.20	6.10	12.80	-0.65%	-3.03%	2016-7-15
2600	6.25	14.2	6.15	13.5	-1.60%	-4.93%	2016-7-09

11. Measurement Procedures

11.1. Tests to be performed

In order to determine the highest value of the peak spatial-average SAR of a handset, all device positions, configurations and operational modes shall be tested for each frequency band according to steps 1 to 3 below. A flowchart of the test process is shown in Picture 19

Step 1: The tests described in 11.2 shall be performed at the channel that is closest to the centre of the transmit frequency band (f_c) for:

- a) all device positions (cheek and tilt, for both left and right sides of the SAM phantom, as described in Chapter 8),
- b) all configurations for each device position in a), e.g., antenna extended and retracted, and
- c) all operational modes, e.g., analogue and digital, for each device position in a) and configuration in b) in each frequency band.

If more than three frequencies need to be tested according to 11.1 (i.e., $N_c > 3$), then all frequencies, configurations and modes shall be tested for all of the above test conditions.

Step 2: For the condition providing highest peak spatial-average SAR determined in Step 1, perform all tests described in 11.2 at all other test frequencies, i.e., lowest and highest frequencies. In addition, for all other conditions (device position, configuration and operational mode) where the peak spatial-average SAR value determined in Step 1 is within 3 dB of the applicable SAR limit, it is recommended that all other test frequencies shall be tested as well.

Step 3: Examine all data to determine the highest value of the peak spatial-average SAR found in Steps 1 to 2.

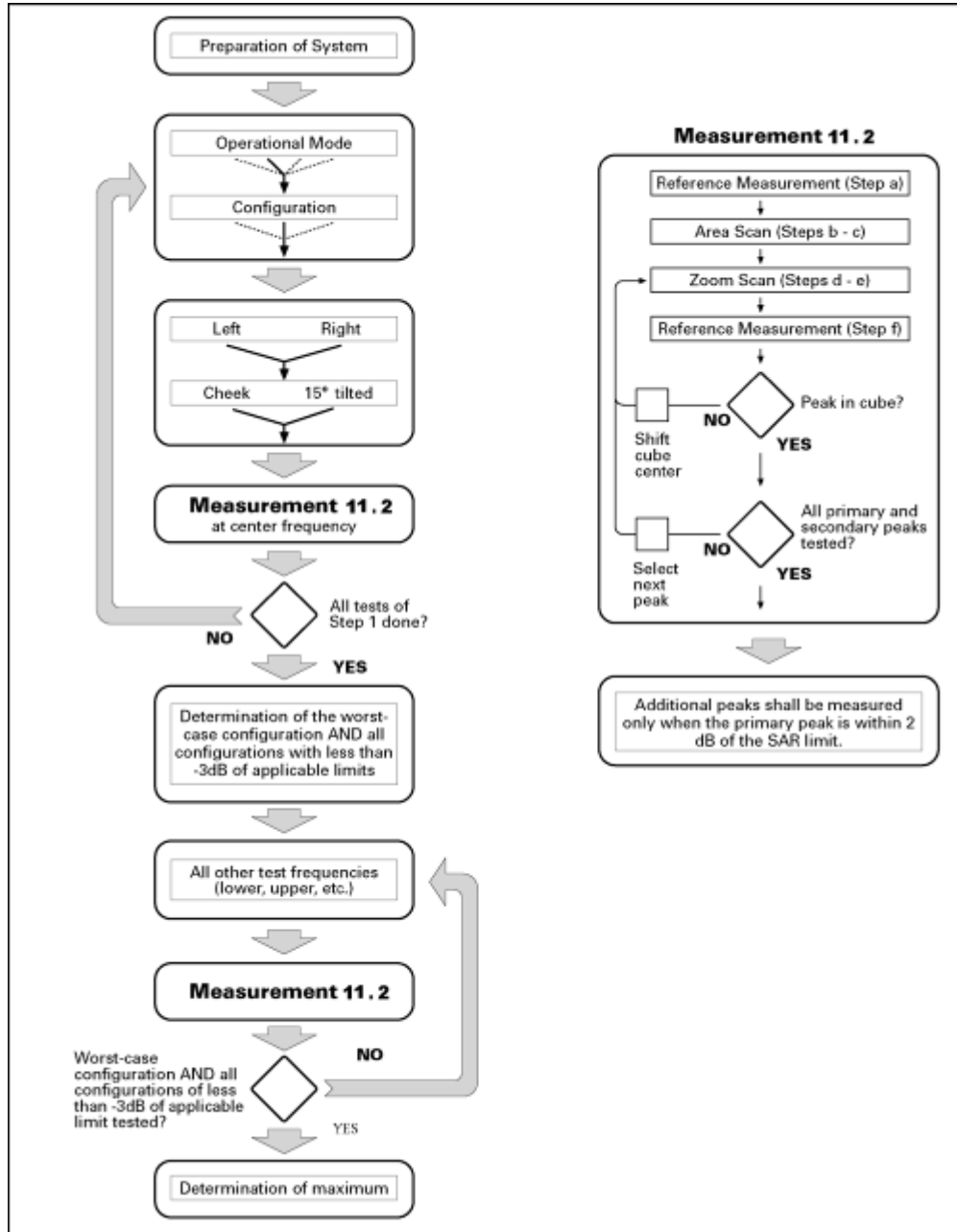

Picture 11-1 Block diagram of the tests to be performed

11.2. Measurement procedure

The following procedure shall be performed for each of the test conditions (see Picture 19) described in 11.1:

- a) Measure the local SAR at a test point within 8 mm or less in the normal direction from the inner surface of the phantom.
- b) Measure the two-dimensional SAR distribution within the phantom (area scan procedure). The boundary of the measurement area shall not be closer than 20 mm from the phantom side walls. The distance between the measurement points should enable the detection of the location of local maximum with an accuracy of better than half the linear dimension of the tissue cube after interpolation. A maximum grid spacing of 20

Report No.: B16X50266-SAR-Rev3

mm for frequencies below 3 GHz and $(60/f \text{ [GHz]})$ mm for frequencies of 3GHz and greater is recommended. The maximum distance between the geometrical centre of the probe detectors and the inner surface of the phantom shall be 5 mm for frequencies below 3 GHz and $\delta \ln(2)/2$ mm for frequencies of 3 GHz and greater, where δ is the plane wave skin depth and $\ln(x)$ is the natural logarithm. The maximum variation of the sensor-phantom surface shall be ± 1 mm for frequencies below 3 GHz and ± 0.5 mm for frequencies of 3 GHz and greater. At all measurement points the angle of the probe with respect to the line normal to the surface should be less than 5° . If this cannot be achieved for a measurement distance to the phantom inner surface shorter than the probe diameter, additional uncertainty evaluation is needed.

c) From the scanned SAR distribution, identify the position of the maximum SAR value, in addition identify the positions of any local maxima with SAR values within 2 dB of the maximum value that are not within the zoom-scan volume; additional peaks shall be measured only when the primary peak is within 2 dB of the SAR limit. This is consistent with the 2 dB threshold already stated;

d) Measure the three-dimensional SAR distribution at the local maxima locations identified in step c). The horizontal grid step shall be $(24 / f[\text{GHz}])$ mm or less but not more than 8 mm. The minimum zoom size of 30 mm by 30 mm and 30 mm for frequencies below 3 GHz. For higher frequencies, the minimum zoom size of 22 mm by 22 mm and 22 mm. The grid step in the vertical direction shall be $(8-f[\text{GHz}])$ mm or less but not more than 5 mm, if uniform spacing is used. If variable spacing is used in the vertical direction, the maximum spacing between the two closest measured points to the phantom shell shall be $(12 / f[\text{GHz}])$ mm or less but not more than 4 mm, and the spacing between further points shall increase by an incremental factor not exceeding 1.5. When variable spacing is used, extrapolation routines shall be tested with the same spacing as used in measurements. The maximum distance between the geometrical centre of the probe detectors and the inner surface of the phantom shall be 5 mm for frequencies below 3 GHz and $\delta \ln(2)/2$ mm for frequencies of 3 GHz and greater, where δ is the plane wave skin depth and $\ln(x)$ is the natural logarithm. Separate grids shall be centered on each of the local SAR maxima found in step c). Uncertainties due to field distortion between the media boundary and the dielectric enclosure of the probe should also be minimized, which is achieved if the distance between the phantom surface and physical tip of the probe is larger than probe tip diameter. Other methods may utilize correction procedures for these boundary effects that enable high precision measurements closer than half the probe diameter. For all measurement points, the angle of the probe with respect to the flat phantom surface shall be less than 5° . If this cannot be achieved an additional uncertainty evaluation is needed.

e) Use post processing (e.g. interpolation and extrapolation) procedures to determine the local SAR values at the spatial resolution needed for mass averaging.

11.3. Power Drift

To control the output power stability during the SAR test, DASY5 system calculates the power drift by measuring the E-field at the same location at the beginning and at the end of the measurement for each test position. These drift values can be found in Table 13.1 to Table 13.10 labeled as: (Power Drift [dB]). This ensures that the power drift during one measurement is within 5%.

12. Conducted Output Power

12.1. Manufacturing tolerance

Table 12.1: GSM Speech

GSM 835			
Channel	Channel 251	Channel 190	Channel 128
Maximum Target Value (dBm)	31±1.0	31±1.0	31±1.0
PCS 1900			
Channel	Channel 810	Channel 661	Channel 512
Maximum Target Value (dBm)	28.5±1.0	28.5±1.0	28.5±1.0

Table 12.2: GPRS/E-GPRS

GSM 850 GPRS				
Channel		251	190	128
1 Txslots	Maximum Target Value (dBm)	31.0±1.0	31.0±1.0	31.0±1.0
2 Txslots	Maximum Target Value (dBm)	31.0±1.0	31.0±1.0	31.0±1.0
3 Txslots	Maximum Target Value (dBm)	30.0±1.0	30.0±1.0	30.0±1.0
4 Txslots	Maximum Target Value (dBm)	29.0±1.0	29.0±1.0	29.0±1.0
GSM 850 E-GPRS GMSK				
Channel		251	190	128
1 Txslots	Maximum Target Value (dBm)	31.0±1.0	31.0±1.0	31.0±1.0
2 Txslots	Maximum Target Value (dBm)	31.0±1.0	31.0±1.0	31.0±1.0
3 Txslots	Maximum Target Value (dBm)	30.0±1.0	30.0±1.0	30.0±1.0
4 Txslots	Maximum Target Value (dBm)	29.0±1.0	29.0±1.0	29.0±1.0
GSM 850 E-GPRS 8PSK				
Channel		251	190	128
1 Txslots	Maximum Target Value (dBm)	27.0±1.0	27.0±1.0	27.0±1.0
2 Txslots	Maximum Target Value (dBm)	26.0±1.0	26.0±1.0	26.0±1.0
3 Txslots	Maximum Target Value (dBm)	24.0±1.0	24.0±1.0	24.0±1.0

Report No.: B16X50266-SAR-Rev3

4 Txslots	Maximum Target Value (dBm)	23.0±1.0	23.0±1.0	23.0±1.0
GSM 1900 GPRS				
Channel		810	661	512
1 Txslots	Maximum Target Value (dBm)	28.5±1.0	28.5±1.0	28.5±1.0
2 Txslots	Maximum Target Value (dBm)	28.5±1.0	28.5±1.0	28.5±1.0
3 Txslots	Maximum Target Value (dBm)	27.5±1.0	27.5±1.0	27.5±1.0
4 Txslots	Maximum Target Value (dBm)	26.0±1.0	26.0±1.0	26.0±1.0
GSM 1900 E-GPRS GMSK				
Channel		810	661	512
1 Txslots	Maximum Target Value (dBm)	28.5±1.0	28.5±1.0	28.5±1.0
2 Txslots	Maximum Target Value (dBm)	28.5±1.0	28.5±1.0	28.5±1.0
3 Txslots	Maximum Target Value (dBm)	27.5±1.0	27.5±1.0	27.5±1.0
4 Txslots	Maximum Target Value (dBm)	26.0±1.0	26.0±1.0	26.0±1.0
GSM 1900 E-GPRS 8PSK				
Channel		810	661	512
1 Txslots	Maximum Target Value (dBm)	26.0±1.0	26.0±1.0	26.0±1.0
2 Txslots	Maximum Target Value (dBm)	25.0±1.0	25.0±1.0	25.0±1.0
3 Txslots	Maximum Target Value (dBm)	23.0±1.0	23.0±1.0	23.0±1.0
4 Txslots	Maximum Target Value (dBm)	21.0±1.0	21.0±1.0	21.0±1.0

Table 12.3: WCDMA

WCDMA Band V			
Channel	Channel 4132	Channel 4182	Channel 4233
Maximum Target Value (dBm)	22.0 ±1.0	22.0 ±1.0	22.0 ±1.0
WCDMA Band II			
Channel	Channel 9262	Channel 9400	Channel 9538
Maximum Target Value (dBm)	22.0 ±1.0	22.0 ±1.0	22.0 ±1.0

Table 12.4: HSDPA

WCDMA Band V				
Channel		4132	4182	4233
1	Maximum Target Value (dBm)	22.0 ±1.0	22.0 ±1.0	22.0 ±1.0
2	Maximum Target Value (dBm)	22.0 ±1.0	22.0 ±1.0	22.0 ±1.0
3	Maximum Target Value (dBm)	22.0 ±1.0	22.0 ±1.0	22.0 ±1.0
4	Maximum Target Value (dBm)	22.0 ±1.0	22.0 ±1.0	22.0 ±1.0
WCDMA Band II				
Channel		9262	9400	9538
1	Maximum Target Value (dBm)	22.0 ±1.0	22.0 ±1.0	22.0 ±1.0
2	Maximum Target Value (dBm)	22.0 ±1.0	22.0 ±1.0	22.0 ±1.0
3	Maximum Target Value (dBm)	22.0 ±1.0	22.0 ±1.0	22.0 ±1.0
4	Maximum Target Value (dBm)	22.0 ±1.0	22.0 ±1.0	22.0 ±1.0

Table 12.5: HSUPA

WCDMA Band V				
Channel		4132	4182	4233
1	Maximum Target Value (dBm)	22.0 ±1	22.0 ±1	22.0 ±1
2	Maximum Target Value (dBm)	22.0 ±1	22.0 ±1	22.0 ±1
3	Maximum Target Value (dBm)	22.0 ±1	22.0 ±1	22.0 ±1
4	Maximum Target Value (dBm)	22.0 ±1	22.0 ±1	22.0 ±1
5	Maximum Target Value (dBm)	22.0 ±1	22.0 ±1	22.0 ±1
WCDMA Band II				
Channel		9262	9400	9538
1	Maximum Target Value (dBm)	22.0 ±1	22.0 ±1	22.0 ±1
2	Maximum Target Value (dBm)	22.0 ±1	22.0 ±1	22.0 ±1
3	Maximum Target Value (dBm)	22.0 ±1	22.0 ±1	22.0 ±1
4	Maximum Target Value (dBm)	22.0 ±1	22.0 ±1	22.0 ±1
5	Maximum Target Value (dBm)	22.0 ±1	22.0 ±1	22.0 ±1

Table 12.6: LTE

LTE Band 2				
Bnadwith	Channel	18607	18900	19193
1.4	Maximum Target Value (dBm)	21.0 ±2	21.0 ±2	21.0 ±2
		18615	18900	19185
3	Maximum Target Value (dBm)	21.0 ±2	21.0 ±2	21.0 ±2
		18625	18900	19175
5	Maximum Target Value (dBm)	21.0 ±2	21.0 ±2	21.0 ±2
		18650	18900	19150
10	Maximum Target Value (dBm)	21.0 ±2	21.0 ±2	21.0 ±2
		18675	18900	19125
15	Maximum Target Value (dBm)	21.0 ±2	21.0 ±2	21.0 ±2
		18700	18900	19100
20	Maximum Target Value (dBm)	21.0 ±2	21.0 ±2	21.0 ±2
LTE Band 4				
Bnadwith	Channel	19957	20175	20393
1.4	Maximum Target Value (dBm)	21.0 ±2	21.0 ±2	21.0 ±2
		19965	20175	20385
3	Maximum Target Value (dBm)	21.0 ±2	21.0 ±2	21.0 ±2
		19975	20175	20375
5	Maximum Target Value (dBm)	21.0 ±2	21.0 ±2	21.0 ±2
		20000	20175	20350
10	Maximum Target Value (dBm)	21.0 ±2	21.0 ±2	21.0 ±2
		20025	20175	20325
15	Maximum Target Value (dBm)	21.0 ±2	21.0 ±2	21.0 ±2
		20050	20175	20300
20	Maximum Target Value (dBm)	21.0 ±2	21.0 ±2	21.0 ±2

LTE Band 7				
Bnadwith	Channel	20775	21100	21425
5	Maximum Target Value (dBm)	21.0 ±2	21.0 ±2	21.0 ±2
		20800	21100	21400
10	Maximum Target Value (dBm)	21.0 ±2	21.0 ±2	21.0 ±2
		20825	21100	21375
15	Maximum Target Value (dBm)	21.0 ±2	21.0 ±2	21.0 ±2
		20850	21100	21350
20	Maximum Target Value (dBm)	21.0 ±2	21.0 ±2	21.0 ±2
LTE Band 17				
Bnadwith	Channel	23775	23790	23825
5	Maximum Target Value (dBm)	21.0 ±2	21.0 ±2	21.0 ±2
		23780	23790	23800
10	Maximum Target Value (dBm)	21.0 ±2	21.0 ±2	21.0 ±2

Table 12.7: WiFi

WiFi 802.11b			
Channel	Channel 1	Channel 6	Channel 11
Maximum Target Value (dBm)	22.0±1	22.0±1	22.0±1
WiFi 802.11g			
Channel	Channel 1	Channel 6	Channel 11
Maximum Target Value (dBm)	21.0±1	21.0±1	21.0±1
WiFi 802.11n 20MHz			
Channel	Channel 1	Channel 6	Channel 11
Maximum Target Value (dBm)	20.6±1	20.6±1	20.6±1
WiFi 802.11n 40MHz			
Channel	Channel 1	Channel 6	Channel 11
Maximum Target Value (dBm)	19.5±2	19.5±2	19.5±2

12.2. GSM Measurement result

During the process of testing, the EUT was controlled via R&S Digital Radio Communication tester (Ilium Pad L8X) to ensure the maximum power transmission and proper modulation. This result contains conducted output power for the EUT. In all cases, the measured peak output power should be greater and within 5% than EMI measurement.

Table 12.8: The conducted power measurement results for GSM850/1900

GSM 850MHz	Average Conducted Power (dBm)		
	Channel 251(848.8MHz)	Channel 190(836.6MHz)	Channel 128(824.2MHz)
	31.3	31.4	31.7
GSM 1900MHz	Average Conducted Power (dBm)		
	Channel 810 (1909.8MHz)	Channel 661(1880MHz)	Channel 512(1850.2MHz)
	28.7	28.6	28.9

Report No.: B16X50266-SAR-Rev3

Table 12.9: The average conducted power measurement results for GPRS and EGPRS

GSM 850 GPRS(GMSK)	Measured Power (dBm)			calculation	Averaged Power (dBm)		
	251	190	128		251	190	128
1 Txslot	31.3	31.4	31.7	-9.03dB	22.27	22.37	22.67
2 Txslots	31.0	31.0	31.3	-6.02dB	24.98	24.98	25.28
3 Txslots	29.7	29.7	30.0	-4.26dB	25.44	25.44	25.74
4 Txslots	28.7	28.7	29.0	-3.01dB	25.69	25.69	25.99
GSM 850 EGPRS(GMSK)	Measured Power (dBm)			calculation	Averaged Power (dBm)		
	251	190	128		251	190	128
1 Txslot	31.3	31.4	31.7	-9.03dB	22.27	22.37	22.67
2 Txslots	31.0	31.0	31.3	-6.02dB	24.98	24.98	25.28
3 Txslots	29.7	29.8	30.0	-4.26dB	25.44	25.54	25.74
4 Txslots	28.7	28.7	29.0	-3.01dB	25.69	25.69	25.99
GSM 850 EGPRS(8PSK)	Measured Power (dBm)			calculation	Averaged Power (dBm)		
	251	190	128		251	190	128
1 Txslot	27.19	27.32	27.28	-9.03dB	18.16	18.29	18.25
2 Txslots	26.17	26.23	26.32	-6.02dB	20.15	20.21	20.30
3 Txslots	24.31	24.25	24.18	-4.26dB	20.05	19.99	19.92
4 Txslots	23.42	23.28	23.35	-3.01dB	20.41	20.27	20.34
DCS1900 GPRS (GMSK)	Measured Power (dBm)			calculation	Averaged Power (dBm)		
	810	661	512		810	661	512
1 Txslot	28.8	28.6	28.9	-9.03dB	19.77	19.57	19.87
2 Txslots	28.7	28.6	28.8	-6.02dB	22.68	22.58	22.78
3 Txslots	27.7	27.7	27.8	-4.26dB	23.44	23.44	23.54
4 Txslots	26.7	26.5	26.8	-3.01dB	23.69	23.49	23.79
DCS1900 EGPRS(GMSK)	Measured Power (dBm)			calculation	Averaged Power (dBm)		
	810	661	512		810	661	512
1 Txslot	28.8	28.6	28.9	-9.03dB	19.77	19.57	19.87
2 Txslots	28.7	28.6	28.8	-6.02dB	22.68	22.58	22.78
3 Txslots	27.7	27.7	27.8	-4.26dB	23.44	23.44	23.54
4 Txslots	26.6	26.5	26.8	-3.01dB	23.59	23.49	23.79
DCS1900 EGPRS(8PSK)	Measured Power (dBm)			calculation	Averaged Power (dBm)		
	810	661	512		810	661	512
1 Txslot	26.15	26.29	26.07	-9.03dB	17.12	17.26	17.04
2 Txslots	25.13	25.10	25.04	-6.02dB	19.11	19.08	19.02
3 Txslots	23.05	23.08	23.02	-4.26dB	18.79	18.82	18.76
4 Txslots	21.80	21.93	21.88	-3.01dB	18.79	18.92	18.87

NOTES:

1) Division Factors

To average the power, the division factor is as follows:

1TX-slot = 1 transmit time slot out of 8 time slots=> conducted power divided by (8/1) => -9.03dB

2TX-slots = 2 transmit time slots out of 8 time slots=> conducted power divided by (8/2) => -6.02dB

Report No.: B16X50266-SAR-Rev3

3TX-slots = 3 transmit time slots out of 8 time slots=> conducted power divided by (8/3) => -4.26dB

4TX-slots = 4 transmit time slots out of 8 time slots=> conducted power divided by (8/4) => -3.01dB

According to the conducted power as above, the body measurements are performed with 4Txslots for 850MHz, 1900MHz.

12.3. WCDMA Measurement result

Table 12.10 The conducted Power for WCDMA

Item	band	WCDMA BAND II result(dBm)		
	ARFCN	9262 (1852.4MHz)	9400 (1880MHz)	9538 (1907.6MHz)
WCDMA	\	22.66	22.86	22.95
HSDPA(QPSK)	1	21.67	21.98	21.88
	2	21.62	21.81	21.78
	3	20.55	20.68	20.66
	4	20.56	20.58	20.70
HSUPA(QPSK)	1	20.51	19.90	20.43
	2	20.52	19.92	19.23
	3	20.54	19.93	19.14
	4	20.53	20.01	19.30
	5	20.50	19.97	20.64
Item	band	WCDMA BAND V result(dBm)		
	ARFCN	4132 (826.4MHz)	4182 (836.4MHz)	4233 (846.4MHz)
WCDMA	\	22.53	22.51	22.48
HSDPA(QPSK)	1	21.30	21.31	21.21
	2	21.44	21.49	21.46
	3	20.46	20.45	20.34
	4	20.48	20.49	20.35
HSUPA(QPSK)	1	20.44	20.41	20.35
	2	20.47	20.44	20.34
	3	20.49	20.45	20.33
	4	20.45	20.43	20.37
	5	20.48	20.42	20.36

Note: HSDPA/HSUPA/HSPA+ body SAR are not required, because maximum average output power of each RF channel with HSDPA/HSUPA/HSPA+ active is not 1/4 dB higher than that measured without HSDPA/HSUPA and the maximum SAR for WCDMA I and WCDMA VIII are not above 75% of the SAR limit.

12.4. LTE Measurement result

Table 12.11 The conducted Power for LTE

Band2						
Bandwidth	Mode	RB Size	RB Offset	Actual output power(dBm)		
				Channel 18625 1852.5MHz	Channel 18900 1880MHz	Channel 19175 1907.5MHz
5MHz	QPSK	1	0	22.55	22.36	22.49
		1	13	22.24	22.15	22.51
		1	24	22.50	22.40	22.49
		12	0	21.54	21.47	21.51
		12	6	21.39	21.32	21.48
		12	13	21.49	21.49	21.50
		25	0	21.47	21.40	21.42
	16QAM	1	0	21.73	21.47	21.29
		1	13	21.63	21.44	21.29
		1	24	21.69	21.42	21.31
		12	0	20.57	20.45	20.47
		12	6	20.51	20.44	20.48
		12	13	20.54	20.43	20.45
		25	0	20.44	20.35	20.43
Bandwidth	Mode	RB Size	RB Offset	Actual output power(dBm)		
				Channel 18650 1855MHz	Channel 18900 1880MHz	Channel 19150 1905MHz
10MHz	QPSK	1	0	22.15	22.12	22.29
		1	25	22.31	22.21	22.52
		1	49	22.08	22.04	22.12
		25	0	21.49	21.43	21.37
		25	13	21.55	21.49	21.46
		25	25	21.44	21.37	21.32
		50	0	21.46	21.42	21.44
	16QAM	1	0	21.36	21.28	21.85
		1	25	21.53	21.38	21.86
		1	49	21.30	21.23	21.73
		25	0	20.57	20.41	20.49
		25	13	20.64	20.49	20.51
		25	25	20.52	20.4	20.43
		50	0	20.48	20.38	20.42

Report No.: B16X50266-SAR-Rev3

Bandwidth	Mode	RB Size	RB Offset	Actual output power(dBm)		
				Channel 18675 1857.5MHz	Channel 18900 1880MHz	Channel 19125 1902.5MHz
15MHz	QPSK	1	0	22.43	22.25	22.48
		1	38	22.33	22.14	22.39
		1	74	22.21	22.30	22.36
		36	0	21.43	21.52	21.64
		36	18	21.35	21.46	21.60
		36	39	21.30	21.53	21.57
		75	0	21.46	21.48	21.61
	16QAM	1	0	21.64	21.63	21.93
		1	38	21.57	21.54	21.88
		1	74	21.47	21.67	21.86
		36	0	20.57	20.51	20.60
		36	18	20.51	20.45	20.56
		36	39	20.48	20.54	20.55
		75	0	20.54	20.52	20.55
Bandwidth	Mode	RB Size	RB Offset	Actual output power(dBm)		
				Channel 18700 1860MHz	Channel 18900 1880MHz	Channel 19100 1900MHz
20MHz	QPSK	1	0	22.23	21.95	22.59
		1	50	22.17	21.96	22.61
		1	99	22.34	22.64	22.60
		50	0	21.44	21.48	21.52
		50	25	21.35	21.39	21.48
		50	50	21.47	21.52	21.49
		100	0	21.21	21.45	21.51
	16QAM	1	0	21.31	21.84	21.65
		1	50	21.20	21.68	21.74
		1	99	21.03	21.79	21.72
		50	0	20.48	20.38	20.48
		50	25	20.34	20.28	20.56
		50	50	20.26	20.35	20.57
		100	0	20.05	20.33	20.53
Bandwidth	Mode	RB Size	RB	Actual output power(dBm)		

Report No.: B16X50266-SAR-Rev3

			Offset	Channel 18607 1850.7MHz	Channel 18900 1880MHz	Channel 19193 1909.3MHz
1.4MHz	QPSK	1	0	22.59	22.60	22.52
		1	2	22.61	22.59	22.58
		1	5	22.60	22.62	22.54
		3	0	21.58	21.59	21.56
		3	1	21.59	21.60	21.57
		3	2	21.59	21.58	21.53
		6	0	21.57	21.59	21.55
	16QAM	1	0	21.58	21.36	21.37
		1	2	21.64	21.47	21.43
		1	5	21.59	21.41	21.41
		3	0	20.57	20.42	20.44
		3	1	20.59	20.48	20.48
		3	2	20.63	20.40	20.41
		6	0	20.53	20.37	20.45
Bandwidth	Mode	RB Size	RB Offset	Actual output power(dBm)		
				Channel 18615 1851.5MHz	Channel 18900 1880MHz	Channel 19185 1908.5MHz
3MHz	QPSK	1	0	22.56	22.59	22.48
		1	8	22.58	22.58	22.53
		1	14	22.52	22.57	22.51
		8	0	21.54	21.53	21.51
		8	4	21.57	21.55	21.54
		8	7	21.55	21.51	20.50
		15	0	21.52	21.49	21.48
	16QAM	1	0	21.56	21.37	21.76
		1	8	21.57	21.39	21.80
		1	14	21.54	21.36	21.77
		8	0	20.48	20.41	20.51
		8	4	20.49	20.45	20.54
		8	7	20.45	20.37	20.49
		15	0	20.44	20.38	20.46

Report No.: B16X50266-SAR-Rev3

Band4						
Bandwidth	Mode	RB Size	RB Offset	Actual output power(dBm)		
				Channel 19975 1712.5MHz	Channel 20175 1732.5MHz	Channel 20375 1752.5MHz
5MHz	QPSK	1	0	21.87	21.77	21.85
		1	13	21.45	21.27	21.43
		1	24	21.71	21.43	21.86
		12	0	21.47	21.35	21.59
		12	6	21.26	21.23	21.47
		12	13	21.40	21.28	21.58
		25	0	21.43	21.29	21.54
	16QAM	1	0	22.07	21.79	21.71
		1	13	21.68	21.30	21.28
		1	24	21.91	21.47	21.72
		12	0	21.54	21.50	21.63
		12	6	21.39	21.36	21.45
		12	13	21.47	21.42	21.56
		25	0	21.40	21.28	21.54
Bandwidth	Mode	RB Size	RB Offset	Actual output power(dBm)		
				Channel 20000 1715MHz	Channel 20175 1732.5MHz	Channel 20350 1750MHz
10MHz	QPSK	1	0	21.35	21.27	21.31
		1	25	21.51	21.26	21.37
		1	49	21.26	20.85	21.40
		25	0	21.33	21.15	21.15
		25	13	21.46	21.24	21.21
		25	25	21.20	20.81	21.30
		50	0	21.45	21.23	21.36
	16QAM	1	0	21.46	21.24	21.78
		1	25	21.60	21.23	21.84
		1	49	21.36	20.84	21.83
		25	0	21.30	21.20	21.46
		25	13	21.43	21.21	21.49
		25	25	21.31	20.81	21.51
		50	0	21.42	21.22	21.45
Bandwidth	Mode	RB Size	RB Offset	Actual output power(dBm)		

Report No.: B16X50266-SAR-Rev3

				Channel 20025 1717.5MHz	Channel 20175 1732.5MHz	Channel 20325 1747.5MHz
15MHz	QPSK	1	0	21.65	21.66	21.49
		1	38	21.52	21.24	21.30
		1	74	21.62	21.02	21.63
		36	0	21.55	21.48	21.44
		36	18	21.48	21.31	21.31
		36	39	21.51	21.20	21.55
		75	0	21.53	21.24	21.45
	16QAM	1	0	21.74	21.92	21.97
		1	38	21.62	21.54	21.79
		1	74	21.69	21.36	22.06
		36	0	21.57	21.55	21.49
		36	18	21.50	21.41	21.41
		36	39	21.54	21.37	21.51
		75	0	21.51	21.22	21.42
Bandwidth	Mode	RB Size	RB Offset	Actual output power(dBm)		
				Channel 20050 1720MHz	Channel 20175 1732.5MHz	Channel 20300 1745MHz
20MHz	QPSK	1	0	21.73	21.70	21.48
		1	50	21.54	21.18	21.20
		1	99	21.41	21.00	21.50
		50	0	21.60	21.61	21.44
		50	25	21.51	21.12	21.19
		50	50	21.47	21.01	21.49
		100	0	21.54	21.26	21.31
	16QAM	1	0	21.85	22.13	21.69
		1	50	21.67	21.65	21.43
		1	99	21.52	21.53	21.71
		50	0	21.63	22.04	21.54
		50	25	21.52	21.59	21.34
		50	50	21.44	21.35	21.44
		100	0	21.50	21.24	21.31
Bandwidth	Mode	RB Size	RB Offset	Actual output power(dBm)		

Report No.: B16X50266-SAR-Rev3

				Channel 19965 1711.5MHz	Channel 20175 1732.5MHz	Channel 20385 1753.5MHz
3MHz	QPSK	1	0	21.83	21.83	21.85
		1	8	21.87	21.66	21.92
		1	14	21.80	21.67	21.85
		8	0	21.70	21.80	21.84
		8	4	21.82	21.67	21.90
		8	7	21.72	21.65	21.82
		15	0	21.75	21.74	21.83
	16QAM	1	0	22.25	21.92	21.81
		1	8	22.28	21.96	21.94
		1	14	22.25	21.77	21.79
		8	0	21.90	21.85	21.76
		8	4	21.95	21.63	21.80
		8	7	21.81	21.67	21.74
		15	0	21.85	21.65	21.81
Bandwidth	Mode	RB Size	RB Offset	Actual output power(dBm)		
				Channel 19957 1710.7MHz	Channel 20175 1732.5MHz	Channel 20393 1754.3MHz
1.4MHz	QPSK	1	0	21.85	21.81	21.85
		1	2	21.90	21.77	21.91
		1	5	21.87	21.76	21.86
		3	0	21.84	21.79	21.84
		3	1	21.91	21.74	21.89
		3	2	21.86	21.73	21.86
		6	0	21.85	21.74	21.89
	16QAM	1	0	21.94	21.80	21.79
		1	2	22.00	21.74	21.85
		1	5	21.95	21.75	21.81
		3	0	21.91	21.72	21.75
		3	1	21.97	21.69	21.81
		3	2	21.92	21.68	21.78
		6	0	21.85	21.64	21.82

Report No.: B16X50266-SAR-Rev3

Band7						
Bandwidth	Mode	RB Size	RB Offset	Actual output power(dBm)		
				Channel 20775 2502.5MHz	Channel 21100 2535MHz	Channel 21425 2567.5MHz
5MHz	QPSK	1	0	22.15	21.21	21.00
		1	13	21.69	20.81	20.31
		1	24	22.68	21.56	20.26
		12	0	20.94	20.02	19.83
		12	6	20.57	19.84	19.52
		12	13	20.95	20.07	19.47
		25	0	20.83	19.85	19.41
	16QAM	1	0	21.47	20.34	20.06
		1	13	21.07	19.98	20.38
		1	24	21.58	20.41	20.44
		12	0	20.28	19.11	19.14
		12	6	19.96	19.01	19.03
		12	13	20.42	19.19	19.02
		25	0	20.03	19.01	19.05
Bandwidth	Mode	RB Size	RB Offset	Actual output power(dBm)		
				Channel 20800 2505MHz	Channel 21100 2535MHz	Channel 21400 2565MHz
10MHz	QPSK	1	0	21.52	20.82	20.86
		1	25	21.71	20.91	20.99
		1	49	21.61	20.81	20.37
		25	0	20.69	19.94	20.62
		25	13	20.79	20.00	20.77
		25	25	20.74	19.93	20.18
		50	0	20.77	19.87	20.03
	16QAM	1	0	20.71	19.77	20.13
		1	25	20.95	19.95	20.32
		1	49	20.91	19.73	19.75
		25	0	19.83	19.02	19.23
		25	13	19.96	19.05	19.36
		25	25	19.90	19.01	19.08
		50	0	19.88	19.02	19.04
Bandwidth	Mode	RB Size	RB Offset	Actual output power(dBm)		

Report No.: B16X50266-SAR-Rev3

				Channel 20825 2507.5MHz	Channel 21100 2535MHz	Channel 21375 2562.5MHz
15MHz	QPSK	1	0	21.67	20.99	20.88
		1	38	21.71	20.93	20.97
		1	74	21.77	20.97	20.67
		36	0	20.59	20.07	20.07
		36	18	20.68	20.04	20.12
		36	39	20.74	20.07	19.95
		75	0	20.69	20.00	20.02
	16QAM	1	0	20.65	20.40	20.06
		1	38	20.71	20.35	20.28
		1	74	20.85	20.41	20.27
		36	0	19.88	19.08	19.04
		36	18	19.95	19.15	19.12
		36	39	20.01	19.02	19.11
		75	0	19.87	19.02	19.03
Bandwidth	Mode	RB Size	RB Offset	Actual output power(dBm)		
				Channel 20850 2510MHz	Channel 21100 2535MHz	Channel 21350 2560MHz
20MHz	QPSK	1	0	22.55	22.45	22.54
		1	50	22.58	22.53	22.57
		1	99	22.59	22.55	22.57
		50	0	21.95	21.92	21.96
		50	25	21.93	21.99	22.00
		50	50	21.97	21.91	21.94
		100	0	21.88	21.96	21.95
	16QAM	1	0	22.04	22.26	22.01
		1	50	22.10	22.41	22.04
		1	99	22.13	22.38	22.12
		50	0	20.93	20.90	21.03
		50	25	20.88	20.86	21.05
		50	50	20.91	20.92	20.98
		100	0	20.85	20.88	20.95

Report No.: B16X50266-SAR-Rev3

Band17						
Bandwidth	Mode	RB Size	RB Offset	Actual output power(dBm)		
				Channel 23755 706.5MHz	Channel 23790 710MHz	Channel 23825 713.5MHz
5MHz	QPSK	1	0	21.64	22.02	22.19
		1	13	21.21	21.49	21.45
		1	24	21.71	21.89	21.46
		12	0	20.55	20.84	20.88
		12	6	20.39	20.38	20.66
		12	13	20.60	20.69	20.64
		25	0	20.46	20.46	20.71
	16QAM	1	0	21.07	21.07	21.28
		1	13	20.65	20.65	20.53
		1	24	21.16	21.16	20.59
		12	0	19.81	19.97	20.17
		12	6	19.61	19.53	19.75
		12	13	19.78	20.04	19.73
		25	0	19.67	19.67	19.94
Bandwidth	Mode	RB Size	RB Offset	Actual output power(dBm)		
				Channel 23780 709MHz	Channel 23790 710MHz	Channel 23800 711MHz
10MHz	QPSK	1	0	21.75	21.55	21.60
		1	25	21.47	21.47	21.55
		1	49	21.42	21.29	21.27
		25	0	21.07	20.91	20.86
		25	13	20.62	20.65	20.74
		25	25	20.60	20.61	20.63
		50	0	20.74	20.72	20.71
	16QAM	1	0	21.08	20.82	21.34
		1	25	20.76	20.66	21.26
		1	49	20.79	20.55	20.84
		25	0	20.02	19.99	20.15
		25	13	19.84	19.81	20.02
		25	25	19.87	19.77	19.84
		50	0	19.91	19.93	19.91

12.5. WIFI Measurement result

Table 12.12 The average conducted power for Wi-Fi

802.11b (dBm)

Channel\data rate	1Mbps	2Mbps	5.5Mbps	11Mbps
1	22.11	22.03	21.87	22.01
6	22.26	22.25	22.44	22.37
11	21.14	21.12	20.86	21.09

802.11g (dBm)

Channel\data rate	6Mbps	9Mbps	12Mbps	18Mbps	24Mbps	36Mbps	48Mbps	54Mbps
1	21.30	21.15	20.09	20.81	21.27	21.31	21.18	21.39
6	21.44	20.89	20.95	20.57	21.01	21.13	20.77	20.96
11	20.53	20.50	20.32	20.14	20.51	20.32	20.63	20.31

20M 802.11n (dBm)

Channel\data rate	MCS0	MCS1	MCS2	MCS3	MCS4	MCS5	MCS6	MCS7
1	21.42	21.31	21.20	21.26	21.23	21.03	21.06	21.12
6	21.05	20.98	21.01	21.02	20.99	20.94	21.05	20.77
11	20.62	20.63	20.57	20.50	20.61	20.30	20.74	20.40

40M 802.11n (dBm)

Channel\data rate	MCS0	MCS1	MCS2	MCS3	MCS4	MCS5	MCS6	MCS7
1	21.45	21.15	21.09	21.08	21.42	21.43	21.11	21.00
6	20.53	20.42	20.33	20.47	20.74	20.72	19.49	19.47
11	20.29	20.34	20.27	20.33	20.32	20.33	20.32	20.50

Note: According to the EN62479,Wi-Fi/BT SAR testing is required, when conducted power of Wi-Fi/BT > 20mW.

12.6. BT Measurement result

Table12.13: The output power of BT antenna

GFSK

Channel	Ch 0 2402 MHz	Ch 39 2441 MHz	Ch 78 2480 MHz
Peak Conducted Output Power(dBm)	4.34	5.28	5.83

$\pi/4$ DQPSK

Channel	Ch 0 2402 MHz	Ch 39 2441 MHz	Ch 78 2480 MHz
Peak Conducted Output Power(dBm)	3.19	4.37	4.48

8DPSK

Channel	Ch 0 2402 MHz	Ch 39 2441 MHz	Ch 78 2480 MHz
Peak Conducted Output Power(dBm)	3.39	4.58	4.81

Note:BT standalone SAR are not required, because maximum average output power is less than 10mW.

When the standalone SAR test exclusion is applied to an antenna that transmits simultaneously with other antennas, the standalone SAR must be estimated according to the following to determine simultaneous transmission SAR test exclusion:

$$(\text{max. power of channel, including tune-up tolerance, mW})/(\text{min. test separation distance, mm}) \cdot [\sqrt{f(\text{GHz})}/x]$$

W/kg for test separation distances ≤ 50 mm;

where $x = 7.5$ for 1-g SAR, and $x = 18.75$ for 10-g SAR.

SAR head value of BT is 0.1608 W/Kg. SAR body value of BT is 0.00804 W/Kg.

13. Measurement Uncertainty

Measurement uncertainty evaluation for SAR test

Error Description	Unc. value, ±%	Prob. Dist.	Div.	c _i 1g	c _i 10g	Std.Unc. ±%,1g	Std.Unc. ±%,10g	V _i V _{eff}
Measurement System								
Probe Calibration	6.0	N	1	1	1	6.0	6.0	∞
Axial Isotropy	0.5	R	$\sqrt{3}$	0.7	0.7	0.2	0.2	∞
Hemispherical Isotropy	2.6	R	$\sqrt{3}$	0.7	0.7	1.1	1.1	∞
Boundary Effects	0.8	R	$\sqrt{3}$	1	1	0.5	0.5	∞
Linearity	0.6	R	$\sqrt{3}$	1	1	0.3	0.3	∞
System Detection Limits	1.0	R	$\sqrt{3}$	1	1	0.6	0.6	∞
Readout Electronics	0.7	N	1	1	1	0.7	0.7	∞
Response Time	0	R	$\sqrt{3}$	1	1	0	0	∞
Integration Time	2.6	R	$\sqrt{3}$	1	1	1.5	1.5	∞
RF Ambient Noise	3.0	R	$\sqrt{3}$	1	1	1.7	1.7	∞
RF Ambient Reflections	3.0	R	$\sqrt{3}$	1	1	1.7	1.7	∞
Probe Positioner	1.5	R	$\sqrt{3}$	1	1	0.9	0.9	∞
Probe Positioning	2.9	R	$\sqrt{3}$	1	1	1.7	1.7	∞
Max. SAR Eval.	1.0	R	$\sqrt{3}$	1	1	0.6	0.6	∞
Test Sample Related								
Device Positioning	2.9	N	1	1	1	2.9	2.9	145
Device Holder	3.6	N	1	1	1	3.6	3.6	5
Phantom and Setup								
Phantom Uncertainty	4.0	R	$\sqrt{3}$	1	1	2.3	2.3	∞
Liquid Conductivity (target)	5.0	R	$\sqrt{3}$	0.64	0.43	1.8	1.2	∞
Liquid Conductivity (meas.)	2.5	N	1	0.64	0.43	1.6	1.1	∞
Liquid Permittivity (target)	5.0	R	$\sqrt{3}$	0.6	0.49	1.7	1.4	∞
Liquid Permittivity (meas.)	2.5	N	1	0.6	0.49	1.5	1.2	∞

Report No.: B16X50266-SAR-Rev3

Measurement uncertainty evaluation for system validation

Error Description	Unc. value, ±%	Prob. Dist.	Div.	c _i 1g	c _i 10g	Std.Unc. ±%,1g	Std.Unc. ±%,10g	V _i V _{eff}
Measurement System								
Probe Calibration	6.0	N	1	1	1	6.0	6.0	∞
Axial Isotropy	0.5	R	$\sqrt{3}$	0.7	0.7	0.2	0.2	∞
Hemispherical Isotropy	2.6	R	$\sqrt{3}$	0.7	0.7	1.1	1.1	∞
Boundary Effects	0.8	R	$\sqrt{3}$	1	1	0.5	0.5	∞
Linearity	0.6	R	$\sqrt{3}$	1	1	0.3	0.3	∞
System Detection Limits	1.0	R	$\sqrt{3}$	1	1	0.6	0.6	∞
Readout Electronics	0.7	N	1	1	1	0.7	0.7	∞
Response Time	0	R	$\sqrt{3}$	1	1	0	0	∞
Integration Time	2.6	R	$\sqrt{3}$	1	1	1.5	1.5	∞
RF Ambient Noise	3.0	R	$\sqrt{3}$	1	1	1.7	1.7	∞
RF Ambient Reflections	3.0	R	$\sqrt{3}$	1	1	1.7	1.7	∞
Probe Positioner	1.5	R	$\sqrt{3}$	1	1	0.9	0.9	∞
Probe Positioning	2.9	R	$\sqrt{3}$	1	1	1.7	1.7	∞
Max. SAR Eval.	1.0	R	$\sqrt{3}$	1	1	0.6	0.6	∞
Diople								
Power Drift	5.0	R	$\sqrt{3}$	1	1	2.9	2.9	∞
Dipole Positioning	2.0	N	1	1	1	2.0	2.0	∞
Dipole Input Power	5.0	N	1	1	1	5.0	5.0	∞
Phantom and Setup								
Phantom Uncertainty	4.0	R	$\sqrt{3}$	1	1	2.3	2.3	∞
Liquid Conductivity (target)	5.0	R	$\sqrt{3}$	0.64	0.43	1.8	1.2	∞
Liquid Conductivity (meas.)	2.5	N	1	0.64	0.43	1.6	1.1	∞
Liquid Permittivity (target)	5.0	R	$\sqrt{3}$	0.6	0.49	1.7	1.4	∞
Liquid Permittivity (meas.)	2.5	N	1	0.6	0.49	1.5	1.2	∞
Combined Std Uncertainty								
						±11.2%	±10.9%	387
Expanded Std Uncertainty								
						±22.4%	±21.8%	

14. MAIN TEST INSTRUMENTS

Table 15.1: List of Main Instruments

No.	Name	Type	Serial Number	Calibration Date	Valid Period
1	Radio Communication Analyzer	CMU200	122816	2016-03-05	2017-03-04
		CMW500	152395	2016-03-05	2017-03-04
2	Signal Generator	N5181A	MY50143363	2016-03-05	2017-03-04
3	Power Sensor	E8481H	MY51020011	2016-03-05	2017-03-04
4	Power Amplifier	ZHL	QA1202003	NA	NA
5	Attenuator	8491A	MY39267989	NA	NA
6	Probe kit	85070E	3G-S-00139	NA	NA
7	Network Analyzer	E5071C	US39175666	2016-03-05	2017-03-04
8	Power Meter	N1914A	MY50001660	2016-03-05	2017-03-04
9	Probe	EX3DV4	3844	2016-04-15	2017-04-14
10	DAE	DAE4	1329	2015-11-11	2016-11-10
11	Dipole	D750V3	1037	2016-03-29	2017-03-28
		D835V2	4d135	2016-03-29	2017-03-28
		D1750V2	1063	2016-03-30	2017-03-29
		D1900V2	5d153	2016-03-30	2017-03-29
		D2450V2	886	2016-04-01	2017-03-31
		D2600V2	1045	2016-03-31	2017-03-30

END OF REPORT BODY

ANNEX A. GRAPH RESULTS

GSM850 Left Check Low

Date/Time: 2016/7/7

Electronics: DAE4 Sn1329

Medium: Head 850MHz

Medium parameters used (interpolated): $f = 824.2$ MHz; $\sigma = 0.897$ S/m; $\epsilon_r = 42.304$; $\rho = 1000$ kg/m³

Ambient Temperature: 22.5°C Liquid Temperature: 22.5°C

Communication System: GSM 850MHz; Frequency: 824.2 MHz; Duty Cycle: 1:8.3

Probe: EX3DV4 - SN3844ConvF(9.57, 9.57, 9.57);

Low Cheek Left GSM 850/Area Scan (11x16x1): Measurement grid: dx=15mm, dy=15mm

Maximum value of SAR (measured) = 0.00944 W/kg

Low Cheek Left GSM 850/Zoom Scan (7x7x7)/Cube 0: Measurement grid: dx=5mm, dy=5mm, dz=5mm

Reference Value = 2.055 V/m; Power Drift = 0.16 dB

Peak SAR (extrapolated) = 0.0410 W/kg

SAR(1 g) = 0.00805 W/kg; SAR(10 g) = 0.00627 W/kg.

Maximum value of SAR (measured) = 0.0145 W/kg

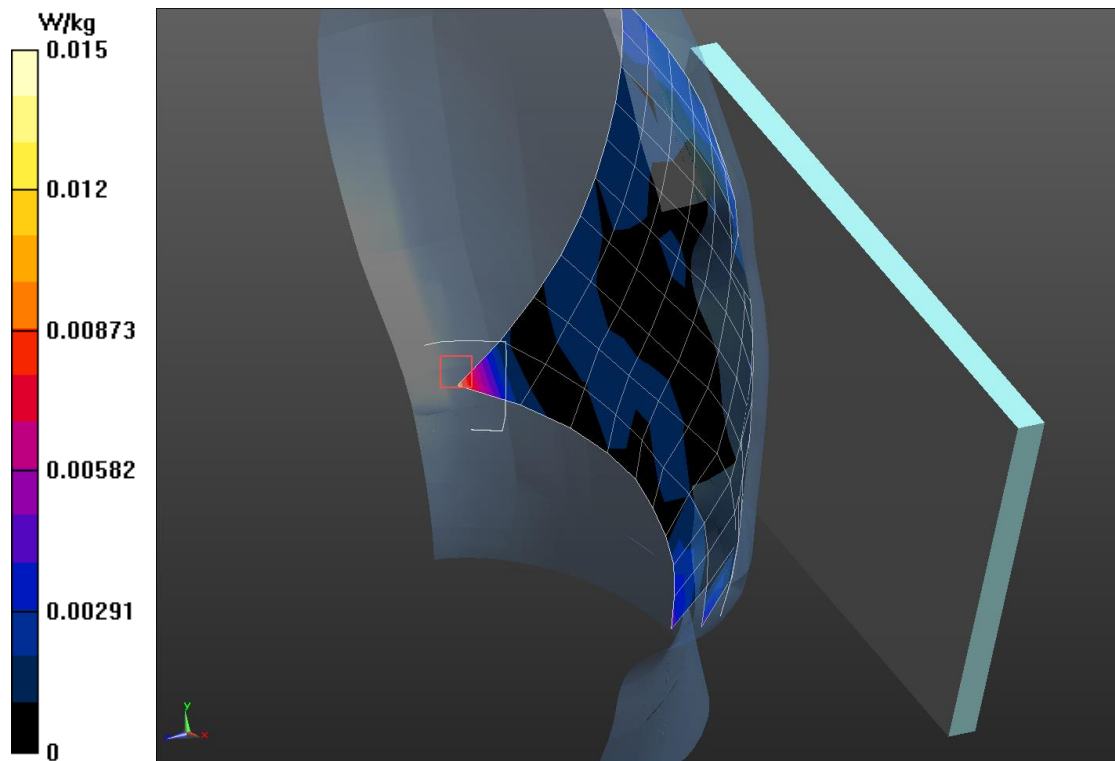

GSM850 Left Tilt Low

Date/Time: 2016/7/7

Electronics: DAE4 Sn1329

Medium: Head 850MHz

Medium parameters used (interpolated): $f = 824.2$ MHz; $\sigma = 0.897$ S/m; $\epsilon_r = 42.304$; $\rho = 1000$ kg/m³

Ambient Temperature: 22.5°C Liquid Temperature: 22.5°C

Communication System: GSM 850MHz; Frequency: 824.2 MHz; Duty Cycle: 1:8.3

Probe: EX3DV4 - SN3844ConvF(9.57, 9.57, 9.57);

Low Tilt Left GSM 850/Area Scan (11x16x1): Measurement grid: dx=15mm, dy=15mm

Maximum value of SAR (measured) = 0.00420 W/kg

Low Tilt Left GSM 850/Zoom Scan (7x7x7)/Cube 0: Measurement grid: dx=5mm, dy=5mm, dz=5mm

Reference Value = 2.237 V/m; Power Drift = -0.13 dB

Peak SAR (extrapolated) = 0.00532 W/kg

SAR(1 g) = 0.00469 W/kg; SAR(10 g) = 0.00434 W/kg

Maximum value of SAR (measured) = 0.00530 W/kg

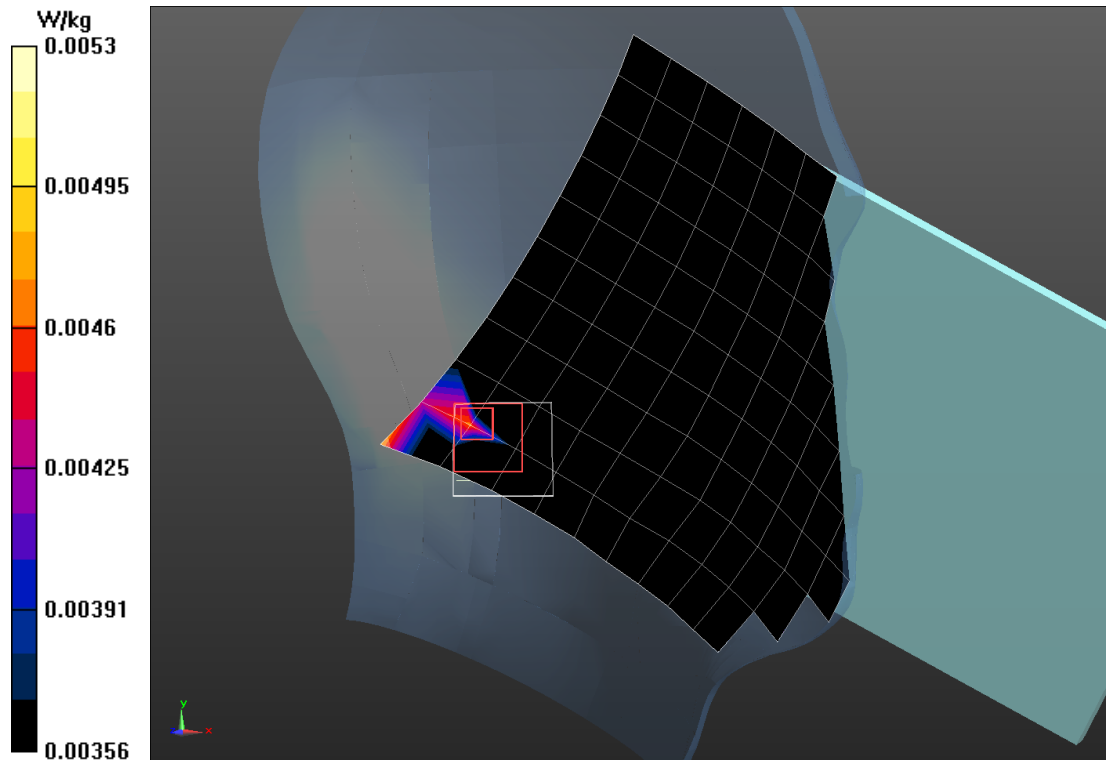

GSM850Right Check Low

Date/Time: 2016/7/7

Electronics: DAE4 Sn1329

Medium: Head 850MHz

Medium parameters used (interpolated): $f = 824.2$ MHz; $\sigma = 0.897$ S/m; $\epsilon_r = 42.304$; $\rho = 1000$ kg/m³

Ambient Temperature:22.5°C Liquid Temperature:22.5°C

Communication System: GSM 850MHz; Frequency: 824.2 MHz; Duty Cycle: 1:8.3

Probe: EX3DV4 - SN3844ConvF(9.57, 9.57, 9.57);

Low Cheek Right GSM 850/Area Scan (11x16x1): Measurement grid: dx=15mm, dy=15mm

Maximum value of SAR (measured) = 0.00458 W/kg

Low Cheek Right GSM 850/Zoom Scan (7x7x4)/Cube 0: Measurement grid: dx=5mm, dy=5mm, dz=5mm

Reference Value = 1.932 V/m; Power Drift = -0.13 dB

Peak SAR (extrapolated) = 0.0120 W/kg

SAR(1 g) = 0.00506 W/kg; SAR(10 g) = 0.00344 W/kg

Maximum value of SAR (measured) = 0.00514 W/kg

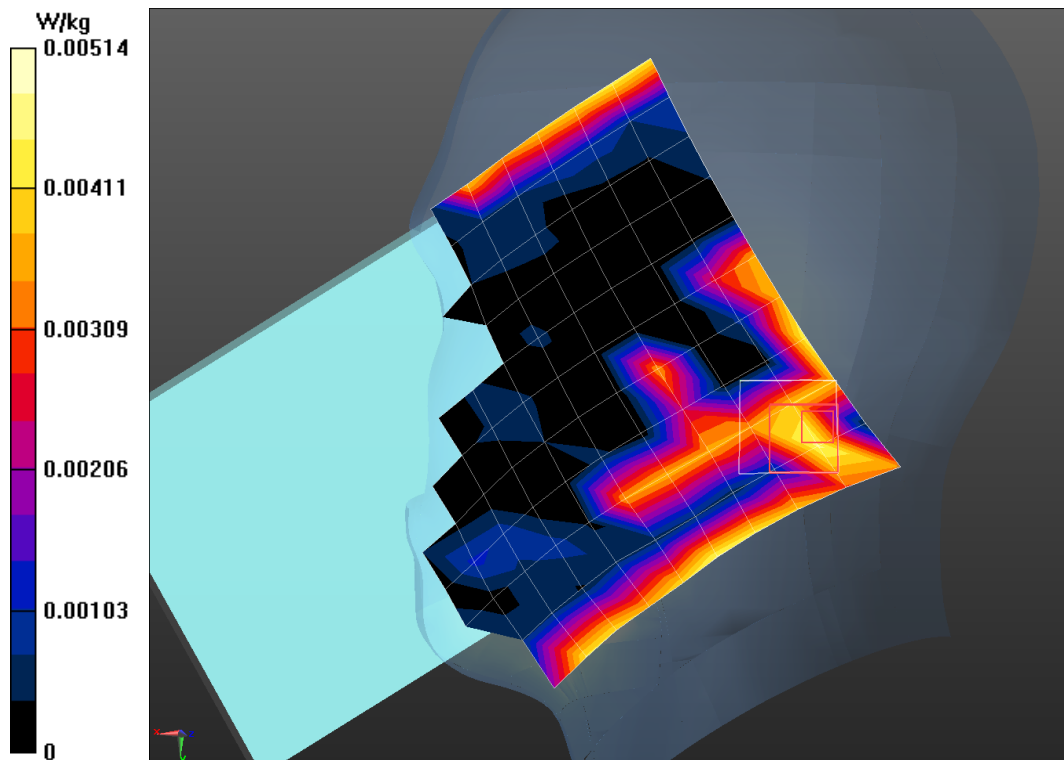

GSM850 Right Tilt Low

Date/Time: 2016/7/7

Electronics: DAE4 Sn1329

Medium: Head 850MHz

Medium parameters used (interpolated): $f = 824.2$ MHz; $\sigma = 0.897$ S/m; $\epsilon_r = 42.304$; $\rho = 1000$ kg/m³

Ambient Temperature: 22.5°C Liquid Temperature: 22.5°C

Communication System: GSM 850MHz; Frequency: 824.2 MHz; Duty Cycle: 1:8.3

Probe: EX3DV4 - SN3844ConvF(9.57, 9.57, 9.57);

Low Tilt Right GSM 850/Area Scan (11x16x1): Measurement grid: dx=15mm, dy=15mm

Maximum value of SAR (measured) = 0.00510 W/kg

Low Tilt Right GSM 850/Zoom Scan (7x7x4)/Cube 0: Measurement grid: dx=5mm, dy=5mm, dz=5mm

Reference Value = 2.207 V/m; Power Drift = -0.15 dB

Peak SAR (extrapolated) = 0.0390 W/kg

SAR(1 g) = 0.0054 W/kg; SAR(10 g) = 0.00468 W/kg

Maximum value of SAR (measured) = 0.00629 W/kg

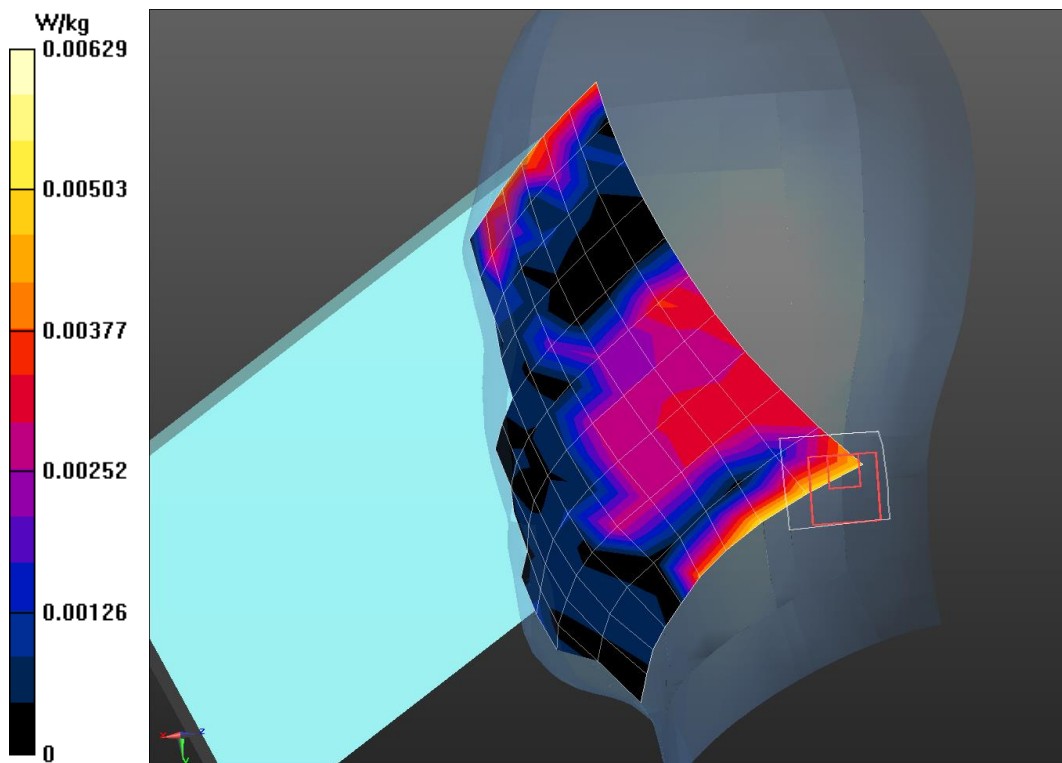

GSM850 Left Check High

Date/Time: 2016/7/7

Electronics: DAE4 Sn1329

Medium: Head 850MHz

Medium parameters used: $f = 849$ MHz; $\sigma = 0.919$ S/m; $\epsilon_r = 42.018$; $\rho = 1000$ kg/m³

Ambient Temperature: 22.5°C Liquid Temperature: 22.5°C

Communication System: GSM 850MHz; Frequency: 848.6 MHz; Duty Cycle: 1:8.3

Probe: EX3DV4 - SN3844ConvF(9.57, 9.57, 9.57);

High Cheek Left GSM 850/Area Scan (11x16x1): Measurement grid: dx=15mm, dy=15mm

Maximum value of SAR (measured) = 0.00381 W/kg

High Cheek Left GSM 850/Zoom Scan (7x7x7)/Cube 0: Measurement grid: dx=5mm, dy=5mm, dz=5mm

Reference Value = 1.507 V/m; Power Drift = 0.14 dB

Peak SAR (extrapolated) = 0.0100 W/kg

SAR(1 g) = 0.00552 W/kg; SAR(10 g) = 0.00411 W/kg

Maximum value of SAR (measured) = 0.00619 W/kg

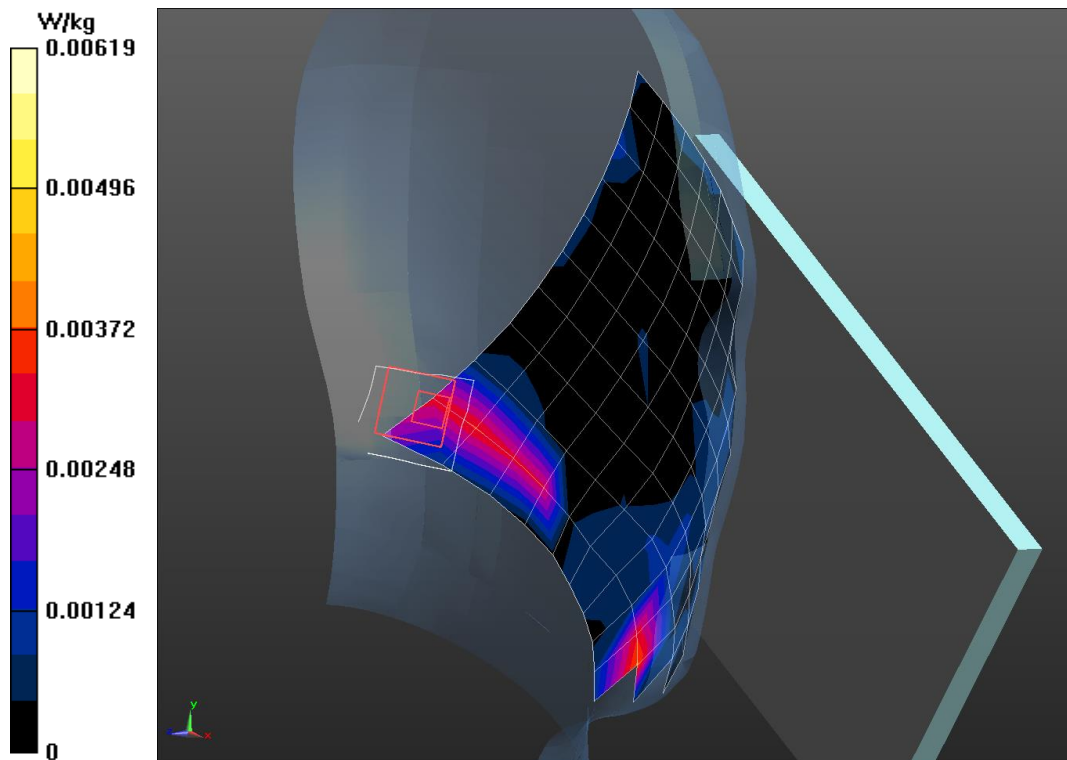

GSM850 Left Check Middle

Date/Time: 2016/7/7

Electronics: DAE4 Sn1329

Medium: Head 850MHz

Medium parameters used: $f = 837$ MHz; $\sigma = 0.909$ S/m; $\epsilon_r = 42.151$; $\rho = 1000$ kg/m³

Ambient Temperature: 22.5°C Liquid Temperature: 22.5°C

Communication System: GSM 850MHz; Frequency: 836.8 MHz; Duty Cycle: 1:8.3

Probe: EX3DV4 - SN3844ConvF(9.57, 9.57, 9.57);

Middle Cheek Left GSM 850/Area Scan (11x16x1): Measurement grid: dx=15mm, dy=15mm

Maximum value of SAR (measured) = 0.00730 W/kg

Middle Cheek Left GSM 850/Zoom Scan (7x7x7)/Cube 0: Measurement grid: dx=5mm, dy=5mm, dz=5mm

Reference Value = 0.7130 V/m; Power Drift = 0.13 dB

Peak SAR (extrapolated) = 0.0100 W/kg

SAR(1 g) = 0.00524 W/kg; SAR(10 g) = 0.00358

Maximum value of SAR (measured) = 0.00975 W/kg

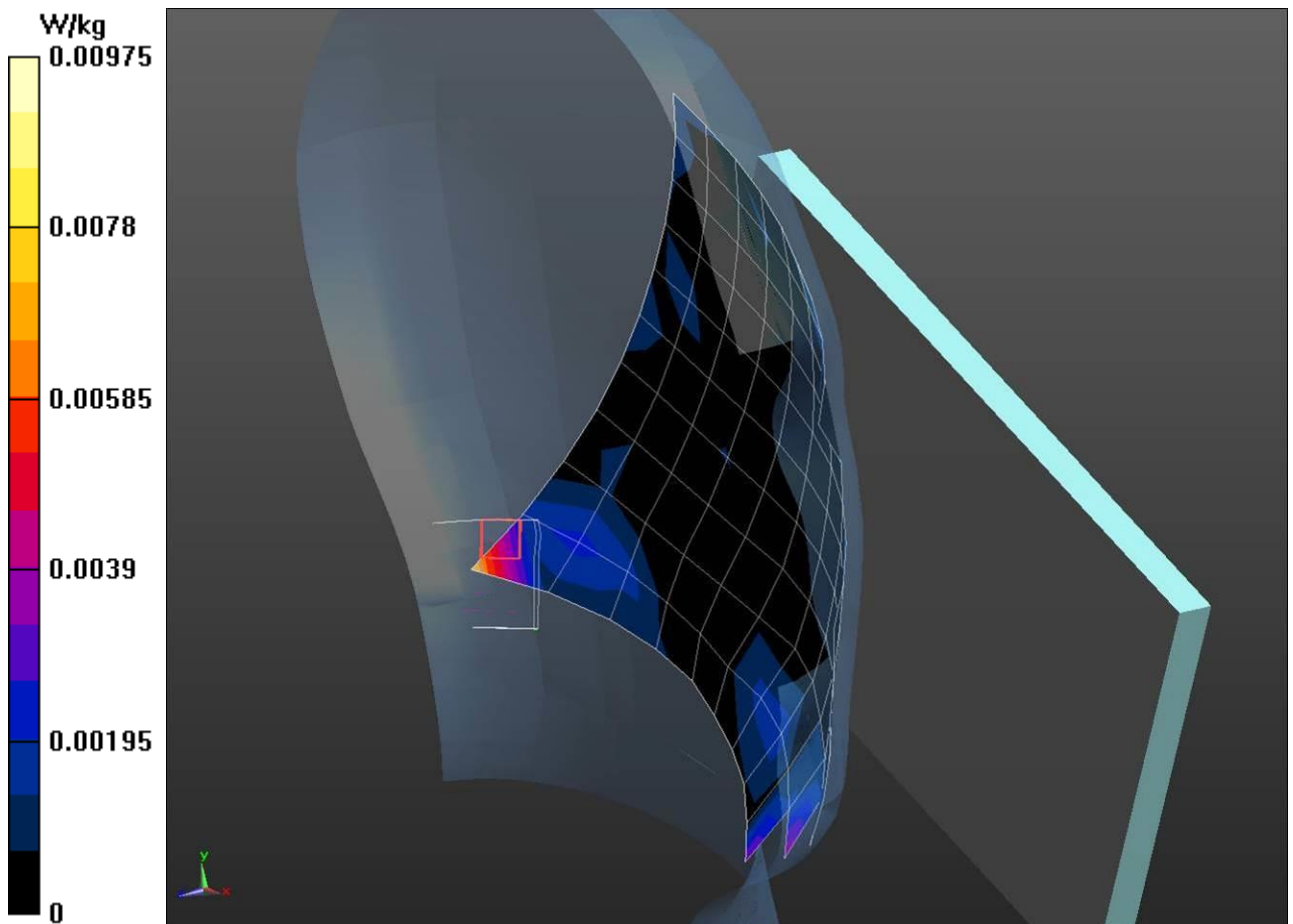

GSM850 Body Toward Ground GPRS 4TS Low

Date/Time: 2016/7/7

Electronics: DAE4 Sn1329

Medium: Body 850MHz

Medium parameters used (interpolated): $f = 824.2$ MHz; $\sigma = 0.969$ S/m; $\epsilon_r = 55.591$; $\rho = 1000$ kg/m³

Ambient Temperature: 22.5°C Liquid Temperature: 22.5°C

Communication System: GPRS 850MHz 4TS; Frequency: 824.2 MHz; Duty Cycle: 1:2.0

Probe: EX3DV4 - SN3844ConvF(9.99, 9.99, 9.99);

Low Toward Ground GPRS 850 4TS/Area Scan (15x24x1): Measurement grid: dx=10mm, dy=10mm

Maximum value of SAR (measured) = 0.449 W/kg

Low Toward Ground GPRS 850 4TS/Zoom Scan (7x7x7)/Cube 0: Measurement grid: dx=5mm, dy=5mm, dz=5mm

Reference Value = 0.9820 V/m; Power Drift = 0.15 dB

Peak SAR (extrapolated) = 1.57 W/kg

SAR(1 g) = 0.409 W/kg; SAR(10 g) = 0.159 W/kg

Maximum value of SAR (measured) = 0.473 W/kg

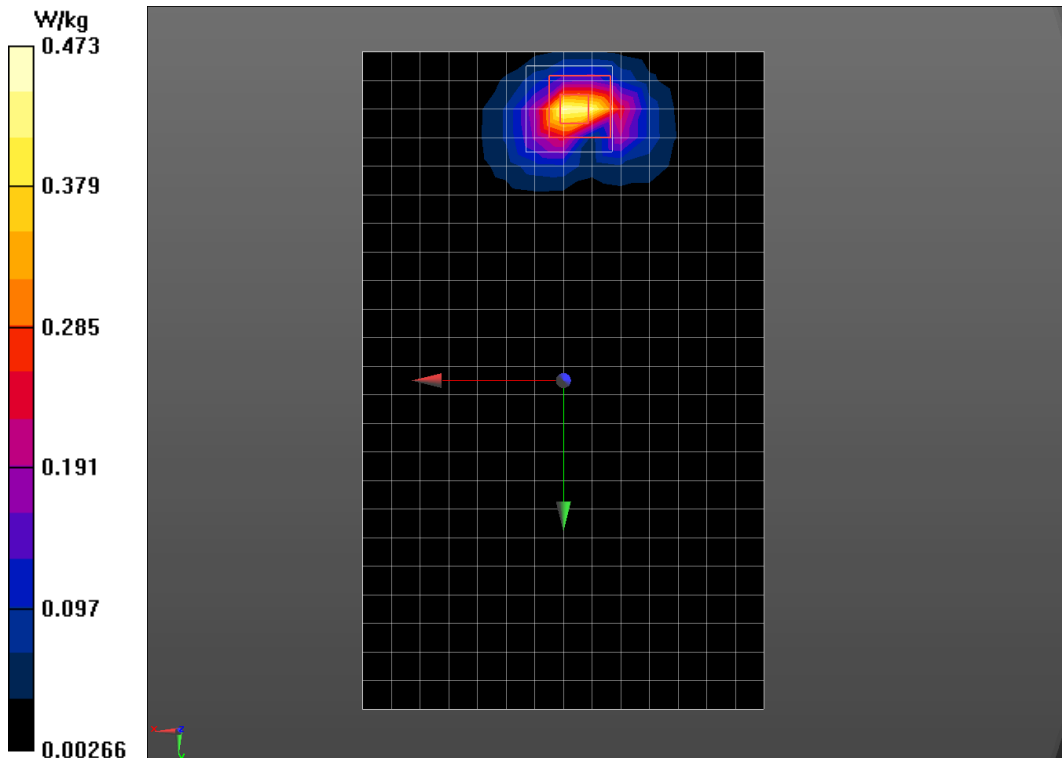

GSM850 Body Toward Phantom GPRS 4TS Low

Date/Time: 2016/7/7

Electronics: DAE4 Sn1329

Medium: Body 850MHz

Medium parameters used (interpolated): $f = 824.2$ MHz; $\sigma = 0.969$ S/m; $\epsilon_r = 55.591$; $\rho = 1000$ kg/m³

Ambient Temperature: 22.5°C Liquid Temperature: 22.5°C

Communication System: GPRS 850MHz 4TS; Frequency: 824.2 MHz; Duty Cycle: 1:2.0

Probe: EX3DV4 - SN3844ConvF(9.99, 9.99, 9.99);

Low Toward Phantom GPRS 850 4TS/Area Scan (15x24x1): Measurement grid:

$dx=10$ mm, $dy=10$ mm

Maximum value of SAR (measured) = 0.0408 W/kg

Low Toward Phantom GPRS 850 4TS/Zoom Scan (7x7x7)/Cube 0: Measurement grid:

$dx=5$ mm, $dy=5$ mm, $dz=5$ mm

Reference Value = 0 V/m; Power Drift = 0.09 dB

Peak SAR (extrapolated) = 0.0830 W/kg

SAR(1 g) = 0.036 W/kg; SAR(10 g) = 0.019 W/kg

Maximum value of SAR (measured) = 0.0405 W/kg

