

EDIFIER

iF355BT

Portable Multimedia Speaker

User manual

Page1 Important safety instructions

WARNING: To reduce the risk of fire or electric shock, do not expose this apparatus to rain or moisture.

Thank you for purchasing this Edifier product. For generations, Edifier tries to provide powered speaker products to satisfy the need of our end customers, even the most demanding ones. This product can add to your home entertainment, personal computer, and mini home theater great sound performance. Please read this manual carefully to obtain the best of this system.



The lightning flash with arrowhead inside the triangle, is intended to alert the user to the presence of un-insulated dangerous voltage within the product's enclosure that may be of a sufficient magnitude to constitute a risk of electric shock to persons.

To prevent the risk of electric shock, do not remove cover (or back). No user-serviceable Parts inside. Refer servicing to qualified Service personnel only.

The exclamation point inside the triangle is intended to alert the user to the presence of important operating and maintenance (servicing) instructions in the literature accompanying the product.

1. Read these instructions.
2. Keep these instructions.
3. Heed all warnings.
4. Follow all instructions.
5. Do not use this apparatus near water.
6. Clean only with dry cloth.
7. Do not block any ventilation openings. Install in accordance with the manufacturer's instructions.
8. Do not install near any heat sources such as radiators, heat registers, stoves, or other apparatus (including amplifiers) that produce heat.
9. Do not defeat the safety purpose of the polarized or grounding-type plug. A polarized plug has two blades with one wider than the other. A grounding type plug has two blades and a third grounding prong. The wide blade or the third prong are provided for your safety. If the provided plug does not fit into your outlet, consult an electrician for replacement of the obsolete outlet.
10. Protect the power cord from being walked on or pinched particularly at plugs, convenience receptacles, and the point where they exit from the apparatus.
11. Only use attachments/accessories specified by the manufacturer.
12. Unplug this apparatus during lightning storms or when unused for long periods of time.
13. Refer all servicing to qualified service personnel. Servicing is required when the apparatus has been damaged in any way, such as power-supply cord or plug is damaged, liquid has been spilled or objects have fallen into the apparatus, the apparatus has been exposed to rain or moisture, does not operate normally, or has been dropped.
14. The MAINS plug or an appliance coupler is used as the disconnect device, the disconnect device shall remain readily operable.

Note: There is a built-in rechargeable lithium-ion battery in the speaker. Danger of explosion if disassemble the speaker. The speaker shall not be placed close to excessive heat such as fire or the like.

Page2 Important safety instructions

Note: The marking is located on the bottom enclosure of the speaker. There is a rechargeable Li-ion battery in the remote control.

The battery shall not be exposed to excessive heat such as sunshine, fire or the like. Danger of explosion if the battery is incorrectly replaced.

Replace only with the same or equivalent type.

The MAINS plug or an appliance coupler is used as the disconnect device, the disconnect device shall remain readily operable.

FCC Caution:

"Changes or modifications not expressly approved by the part responsible for compliance could void the user's authority to operate the equipment."

FCC statement:

"This device complies with Part 15 of the FCC Rules. Operation is subject to the following two conditions:

- (1) this device may not cause harmful interference, and
- (2) this device must accept any interference received, including interference that may cause undesired operation."

"This equipment has been tested and found to comply with the limits for a Class B digital device, pursuant to part 15 of the FCC Rules.

These limits are designed to provide reasonable protection against harmful interference in a residential installation. This equipment generates, uses and can radiate radio frequency energy and, if not installed and used in accordance with the instructions, may cause harmful interference to radio communications. However, there is no guarantee that interference will not occur in a particular installation.

If this equipment does cause harmful interference to radio or television reception, which can be determined by turning the equipment off and on, the user is encouraged to try to correct the interference by one or more of the following measures:

- Reorient or relocate the receiving antenna.
- Increase the separation between the equipment and receiver.
- Connect the equipment into an outlet on a circuit different from that to which the receiver is connected.
- Consult the dealer or an experienced radio/TV technician for help."

IC statement:

This device complies with Industry Canada license-exempt RSS standard(s). Operation is subject to the following two conditions:

- (1) this device may not cause interference, and
- (2) this device must accept any interference, including interference that may cause undesired operation of the device.

This Class **【B】** digital apparatus complies with Canadian ICES-003.

Cet appareil s'accorde avec Industrie Canada licence-exempte RSS standard.

- (1) cet appareil ne peut pas causer l'intervention, et
 - (2) cet appareil doit accepter de l'intervention, y compris l'intervention qui peut causer l'opération non désirée de.
- Cet appareil numérique de la classe B est conforme à la norme NMB-003 du Canada.



Use only with the cart, stand, tripod, bracket, or table specified by the manufacturer, or sold with the apparatus. When a cart is used, use caution when moving the cart/apparatus combination to avoid injury from tip-over.



Correct Disposal of this product. This marking indicates that this product should not be disposed with other household wastes throughout the EU. To prevent possible harm to the environment or human health from uncontrolled waste disposal, recycle it responsibly to promote the sustainable reuse of material resources. To return your used device, please use the return and collection systems or contact the retailer where the product was purchased. They can take this product for environmental safe recycling.

Page 3 Unpack the box

Box contents:

Charge Instructions: Connect the speaker (DC IN connector port on the rear panel) to the outlet with the attached power adapter. Charge speaker for approximately 3~5 hours before the first use.



iF355BT



Remote control battery



Power adapter



3.5mm ~ 3.5mm audio cable



Remote control



User Manual

Page 4 Illustrations

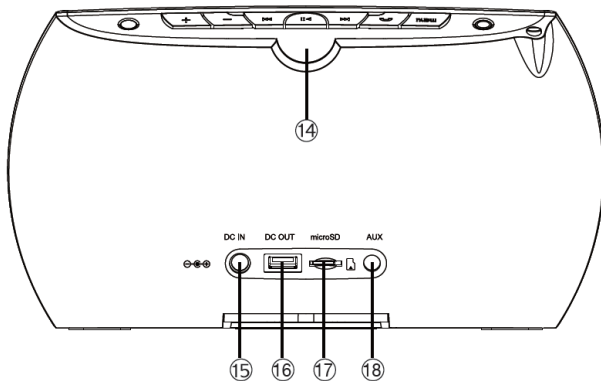
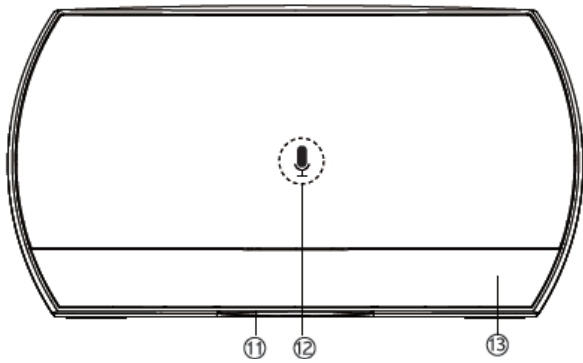
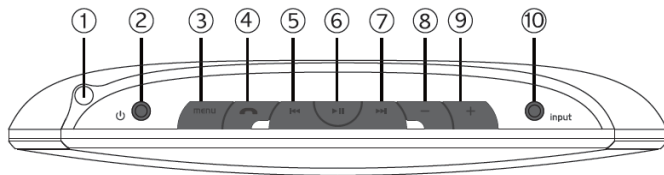

1. FM Antenna
2. Standby/ON
3. Menu
4. Selection/Setting/Phone call function button
5. Previous track/folder
6. Play/Pause (mute in FM mode)
7. Next track/folder
8. Volume down
9. Volume up
10. Audio input selection
11. Swivel Stand
12. Microphone
13. Display screen
14. Remote control slot
15. Power adapter connector port
16. Power out (to charge mobile devices)
17. microSD card slot
18. AUX input port

Page 5 Illustrations

Remote control

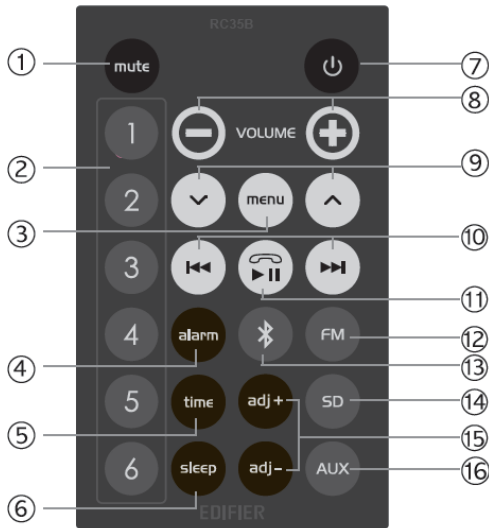

- 1. Mute
- 2. Numeric keys
- 3. Menu
- 4. Alarm clock setting
- 5. Time setting
- 6. Sleep time setting
- 7. On/Off
- 8. Volume adjustment
- 9. Previous/Next item
- 10. Previous/Next track/folder
- 11. Phone call function/Play/Pause/Select
- 12. FM radio input selector
- 13. Bluetooth input selector
- 14. microSD card input selector
- 15. Adjustment
- 16. AUX input selector

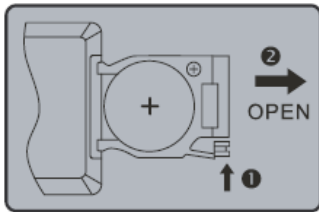

Battery loading:

Please refer to the illustration to open the battery compartment, insert the CR 2025 battery and close the compartment.

Note:

- 1. Do not place the remote control in places that are hot and humid.
- 2. Do not charge the battery.
- 3. Remove the battery when unused for long period of time.
- 4. The battery should not be exposed to excessive heat such as direct sun, fire or similar.

Page 6 Operational guide

Open the stand

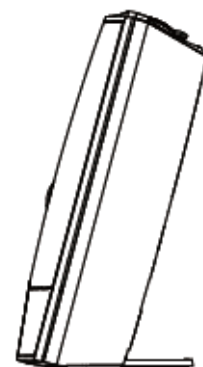

Note: In battery power supply mode (disconnected power adapter), if there is no operation after 48 hours from turning off the speaker, using the remote control to turn the speaker on is not available, please press the power button (on the top of speaker) to power on.



Caution

- 1. Do not change the built-in battery of the speaker, please ask a qualified service personnel for assistance if there is a need to change the battery.

2. Please dispose of defective batteries correctly, at a local recycling center.
3. The battery should not be exposed to excessive heat such as direct sun, fire or similar.

Page 7 Power

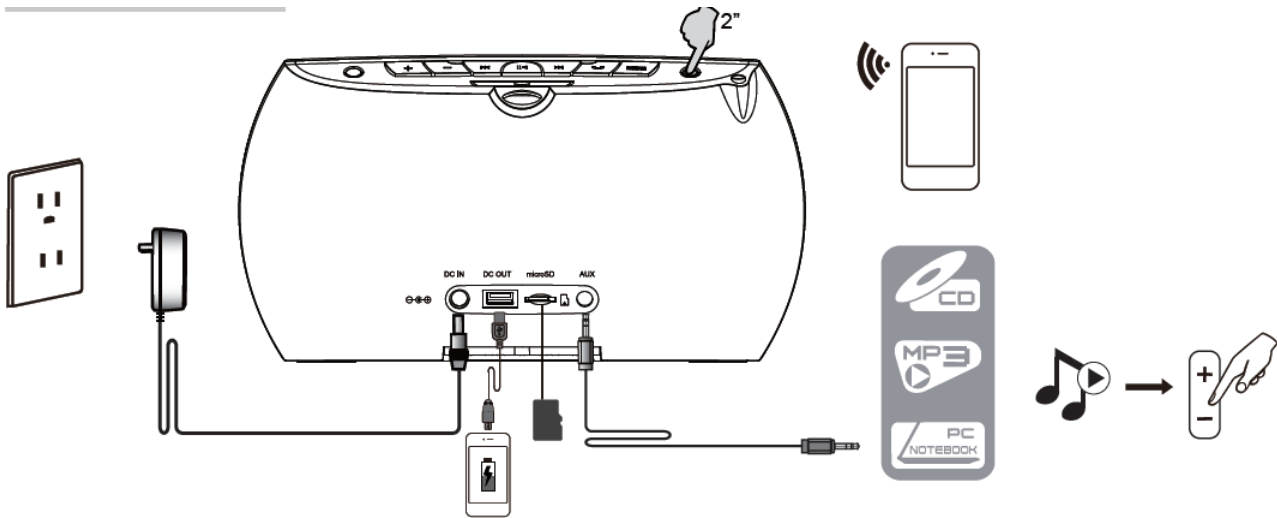

1. Connect the power adapter to the rear panel of the speaker, and then to the wall socket.
2. Press and hold key approximately 2 seconds to turn on the speaker (press and hold it again to power off the speaker).

USB DC output

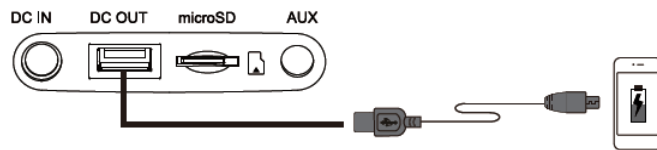

This system can provide maximum 500mA/5V DC power supply to charge a mobile device.
 → Connect the “DC OUT” to your device with a USB cable (not included in box) for power supply or charging.

Page 8 Operational guide

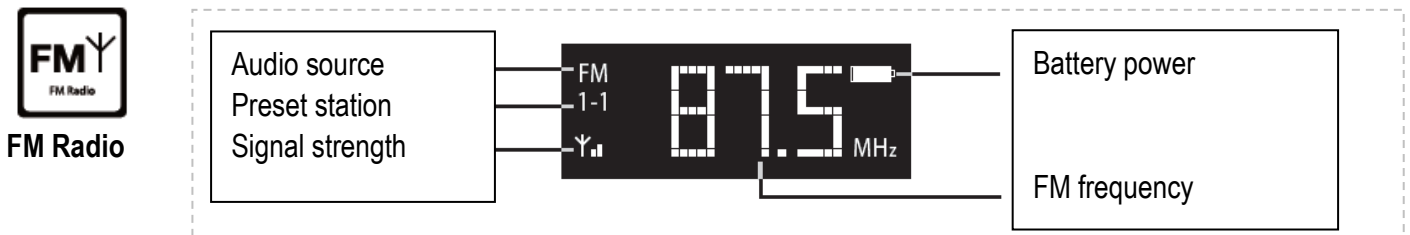

Select FM radio



→ Press “input” button (on the top of speaker) or “FM” key (on the remote control) to select FM mode, extend the antenna for better signal.

Select FM region



→ Press “MENU” twice to access to FM region selection;
 → Press to select FM region:
 EUROPE-CHINA-JAPAN-USA-AUS-WIDE

Page 9 Operational guide

Auto search & store presets



- 1 Press “MENU” once to access to auto search, the SCREEN display “AUTO”;
- 2 Press ▶|| to enable system to start auto search and store the radio station as presets.
→ 4 preset groups, 6 preset stations per group (1-1, 1-2...4-1, 4-6), 24 presets in total.

Manual search & store presets

- 1 Press ∨/∧ (on remote control) manually tune to a higher / lower frequency in increments/ decrements of 0.1MHz per operation.
- 2 When you find the frequency to set, press & hold a number 1~6 for 2 seconds to assign the radio stations.
→ Selecting group: press FM key (on remote control)

Page 10 Operational guide



- 1 Press “input” key (on the top of speaker) or “AUX” key (on remote control) to access to AUX mode.
- 2 Connect the speaker to your audio device (PC sound card, CD/MP3/MP4 player, mobile phone, etc.) with the 3.5mm audio cable.
- 3 Play the music in connected device and adjust the volume to a desired level.

Page 11 Operational guide

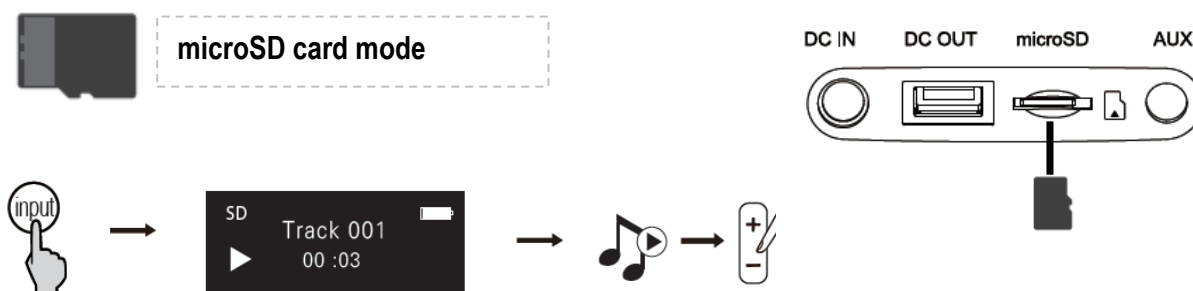

- 1 Press “input” key (on the top of speaker) or “SD” key (on remote control) to access to microSD card mode.
- 2 Insert the microSD card (Max. 32GB, supports MP3/WMA format) into the slot.
- 3 The system will play the music in the microSD card, adjust the volume to a desired level.

Previous/Next track:  Press ◀▶

Previous/Next folder:  Press and hold ◀▶ for 2 seconds

Bluetooth®

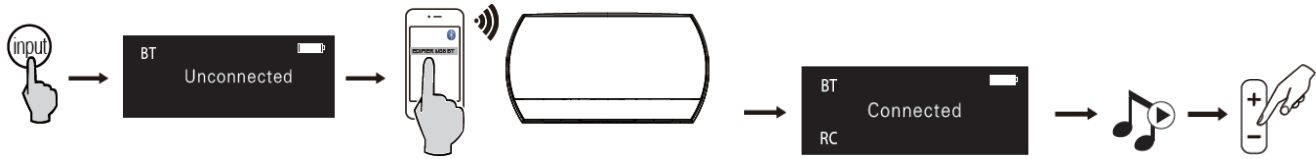

- ❶ Press “input” or key to access to Bluetooth mode.
- ❷ Set your device (mobile phone, tablet device, MP3/MP4 player, etc.) to search and select “EDIFIER iF355BT”.
- ❸ Pair your device with “EDIFIER iF355BT”.
- ❹ When the connection is made, the screen will display “Connected”
- ❺ Play the music and adjust the volume to a desired level.

Bluetooth speaker phone

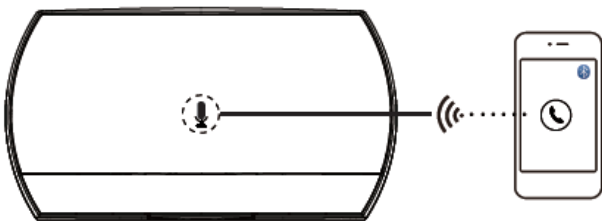

EDIFIER iF355BT can be used as a wireless speakerphone.
 Note: The built-in microphone only works when your phone is connected via Bluetooth.

Answer incoming phone call---- Press or once

Hang up (end) the phone call ----Press or once (during the phone call)

Decline (reject) the incoming phone call ----Press & hold or

Switch conversation to your mobile phone from the “EDIFIER iF355BT” ----Press & hold or

While in Bluetooth mode (without phone call), press & hold this key to disconnect Bluetooth.

Note: Bluetooth connectivity and compatibility may be different between different source devices, depending on the software versions of source devices.

Note: 1. Incoming and outgoing calls will interrupt audio playback.

2. To enjoy the full Bluetooth functions of this product, please ensure your mobile device has A2DP & AVRCP profile.

3. PIN code for connection is “0000” if needed.

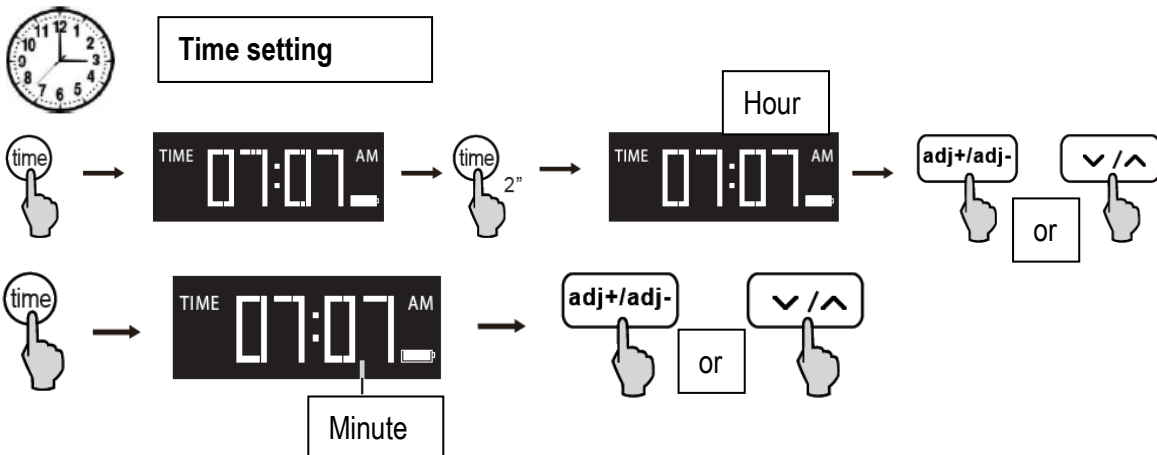

- ❶ Using the remote control, press “time” key once, the screen will display the current time.
- ❷ Press & hold “time” key approximately 2 seconds, the hour number will blink, press “adj+/adj-” or √/∧ to adjust hour;
- ❸ press “time” key again, the minute number will blink, press “adj+/adj-” or √/∧ to adjust minute. The time will be saved after approximately 2 seconds.

Note: The time is 12-hour time format, and it will switch between AM and PM when adjusting time.

Page 14 Operational guide



- ❶ Press “alarm” key once, the screen will display the alarm setting.
- ❷ Press and hold “alarm” key to access to alarm setting.
- ❸ Press “alarm” key to select “alarm number – alarm on/off – alarm time – alarm source – alarm volume”.

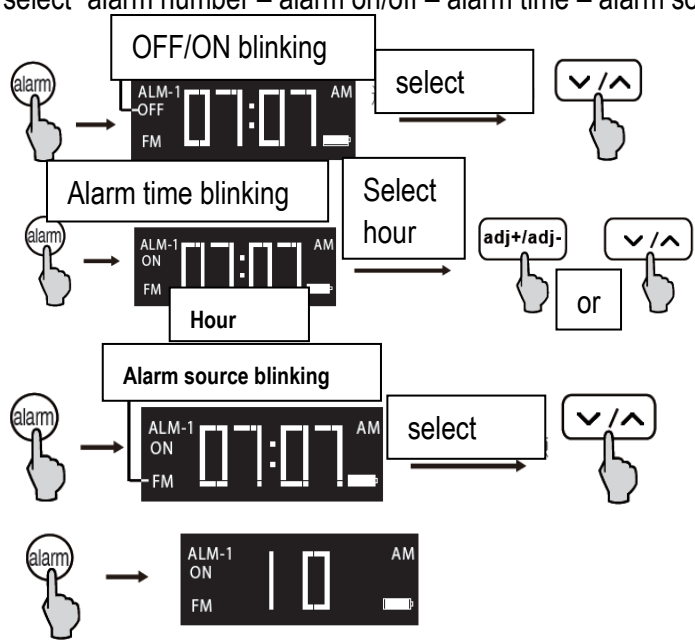

- ❹ Press √/∧ to adjust settings.
- Note:
- There are 5 available alarm settings available.
 - Available alarm source: FM, microSD
 - Alarm volume: 10~30

Page 15 Operational guide

Alarm snooze / disable



Alarm functions:

- When alarm sound is activated, touch any key on the top of the speaker, to snooze the alarm for 10 minutes.

- During snooze mode, a “zZZ” icon and current time will be displayed.
- If no key is pressed within 5 minutes during alarm activation, the alarm will go into a default sequence of: Alarm- Snooze -Alarm- Snooze -Alarm-Power off;
- CANCEL ALARM: press “⏻”, the speaker will resume playback of the alarm source and the “zZZ” icon will not be displayed.

.....

Sleep time setting

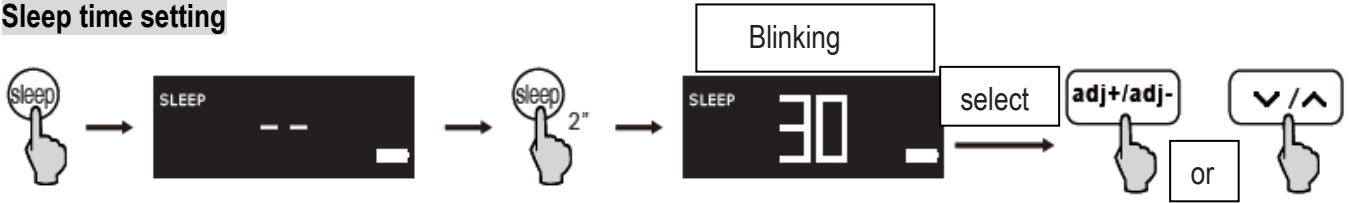

- 1 Press “sleep” key, the screen will display “SLEEP --”.
- 2 Press & hold “sleep” key to enter a sleep time setting, “--” blinks.
- 3 press “adj+/adj-” or v/^ to adjust sleep time.

Note: Sleep setting is the time specified for music to play before the system automatically powering off. Press ⏻ to power on the system.

Page 16 Specifications

Power output:	RMS 6W × 2 (THD+N=10%, f ₀ =1 KHz)
Signal to noise ratio:	≥85dBA
Frequency response:	75Hz~20KHz (+/-11dB)
Input type:	Bluetooth/FM/microSD/AUX
Input sensitivity:	550mV ± 50mV
Adjustment:	Buttons on speaker, remote control
Speaker unit:	2¾ inch (70mm), magnetically shielded, 8Ω
Dimension:	290(W) × 157(H) × 81(D) mm
Weight (net/gross):	Approx. 1.15kg /1.45kg

Page 17 Troubleshooting

- Switch the system off then on and reconnect to the audio source.
- Ensure Bluetooth function is enabled compatible on your Bluetooth devices.
- Move the devices closer and retry the connection.
- Try another Bluetooth device for connection.
- Please check if power is connected, and if the wall outlet is switched on.
- Please switch the system off then on and reconnect to the audio source.
- Please check if the system is in STBY.
- Please check if the master volume is turned to minimum.
- Please check if the audio input cable is connected correctly.
- Please check if there is signal from audio source.
- Keep a 0.2 ~1m distance between the speaker system and monitor or TV set to avoid magnetic interference.

If you have any further questions or concerns regarding EDIFIER Products...

Asia, Europe, Oceania:

📞 Please visit our website at: www.edifier.com, or email EDIFIER Support for further assistance at: main@edifier.com,

➔ Dear Customer, thank you for purchasing this EDIFIER product. For the EDIFIER warranty applicable for this product, we refer you to the Edifier website www.edifier-international.com/warranty-terms.

Canada/USA/Mexico: www.edifier.ca, Email: service@edifier.ca

☎ If you prefer, you may contact us by phone, Toll Free: 1-877-EDIFIER (334-3437) in Canada, 1-800-688-7406 in US.

South America: Please visit www.edifier.com (English) or www.edifierla.com (Spanish/Portuguese) for detailed local contact information.