

Global EMC Inc. Labs

EMC & RF Test Report

As per

RSS 210 Issue 8:2010

&

FCC Part 15 Subpart C:2010

Unlicensed Intentional Radiators

On the

Wireless Video Transmitter



Ashwani Malhotra
Global EMC Inc.
180 Brodie Dr, Unit 2
Richmond Hill, ON L4B 3K8
Canada
Ph: (905) 883-3919

Testing produced for



See Appendix A for full customer & EUT details.





Client	Minewise Technology Ltd.	
Product	Z6X-DVLINK / 9978A-DVLINK	
Standard(s)	RSS 210 Issue 8:2010 / FCC Part 15 Subpart C 15:2010	

Table of Contents

Table of Contents	2
Report Scope	3
Summary	4
Test Results Summary	5
Justifications, Descriptions, or Deviations.....	6
Applicable Standards, Specifications and Methods.....	7
Sample calculation(s).....	8
Document Revision Status.....	8
Definitions and Acronyms	9
Testing Facility	10
Calibrations and Accreditations	10
Testing Environmental Conditions and Dates	11
Detailed Test Results Section	12
Spurious Radiated Emissions.....	13
6dB Bandwidth of Digitally Modulated Systems	25
Maximum Peak Envelope Conducted Power	29
Antenna Spurious Conducted Emissions (-20 dbc Requirement).....	32
Power Spectral Density.....	36
Maximum Permissible Exposure	38
Appendix A – EUT Summary.....	39
Appendix B – EUT and Test Setup Photographs.....	40

Client	Minewise Technology Ltd.	
Product	Z6X-DVLINK / 9978A-DVLINK	
Standard(s)	RSS 210 Issue 8:2010 / FCC Part 15 Subpart C 15:2010	

Report Scope

This report addresses the EMC certification testing and test results of the DVLINK (Wireless video monitoring system), herein referred to as EUT (Equipment Under Test) performed at Global EMC Labs.

The EUT was tested for compliance against the following standards:

RSS 210 Issue 8:2010 / FCC Part 15 Subpart C 15:2010

Test procedures, results, justifications, and engineering considerations, if any, follow later in this report.

The results contained in this report relate only to the item(s) tested.

This report does not imply product endorsement by A2LA or any other accreditation agency, any government, or Global EMC Inc.

Opinions/interpretations expressed in this report, if any, are outside the scope of Global EMC Inc accreditation. Any opinions expressed do not necessarily reflect the opinions of Global EMC Inc, unless otherwise stated.

Client	Minewise Technology Ltd.	
Product	Z6X-DVLINK / 9978A-DVLINK	
Standard(s)	RSS 210 Issue 8:2010 / FCC Part 15 Subpart C 15:2010	

Summary

The results contained in this report relate only to the item(s) tested.

EUT FCC Certification #, FCC ID:	Z6X-DVLINK
EUT Industry Canada Certification #, IC:	9978A-DVLINK
EUT Passed all tests performed.	Yes (see test results summary)
Tests conducted by	Ashwani Malhotra

Client	Minewise Technology Ltd.	
Product	Z6X-DVLINK / 9978A-DVLINK	
Standard(s)	RSS 210 Issue 8:2010 / FCC Part 15 Subpart C 15:2010	

Test Results Summary

Standard/Method	Description	Class/Limit	Result
FCC 15.203	Antenna Requirement	Permanently mounted.	Pass See Justification
FCC 15.205 RSS 210 (Table 1)	Restricted Bands for intentional operation	QuasiPeak Average	Pass
FCC 15.207	Power line conducted emissions	QuasiPeak Average	N/A
FCC 15.209 RSS-210 (Table 2)	Spurious Radiated emissions	QuasiPeak Average	Pass
FCC 15.247(a)2 RSS-210 A8.2(a)	6 dB Bandwidth	> 500 kHz	Pass
FCC 15.247(b)2 RSS-210 A8.4(4)	Max output power	< 27.85 dbm (30 dbm – 2.15db)	Pass
FCC 15.247(b)(4) RSS-210 A8.4(5)	Antenna Gain	8.15 dBi	Pass
FCC 15.247(d) RSS-210 A8.5	Antenna conducted spurious	< 20 dBc	Pass
FCC 15.247(e) RSS-210 A8.2(b)	Spectral Density	< 8 dBm (3 kHz BW)	Pass
FCC 15.247(i) IC Safety code 6	Maximum Permissible Exposure	> 20.0 cm separation.	Pass See justification and calculations
Overall Result			PASS

All tests were performed by Ashwani Malhotra

If the product as tested or otherwise complies with the specification, the EUT is deemed to comply with the requirement and is deemed a 'PASS' grade. If not 'FAIL' grade will be issued. Note that 'PASS' / 'FAIL' grade is independent of any measurement uncertainties. A 'PASS' / 'FAIL' grade within measurement uncertainty is marked with a '*'.

Client	Minewise Technology Ltd.	
Product	Z6X-DVLINK / 9978A-DVLINK	
Standard(s)	RSS 210 Issue 8:2010 / FCC Part 15 Subpart C 15:2010	

Justifications, Descriptions, or Deviations

The following justifications for tests not performed or deviations from the above listed specifications apply:

For the Antenna requirement specified in FCC 15.203 (RSS 210 section 5.5), the unit a permanently connected antenna with a gain of 8.15 dBi.

For the Restricted Bands of operation, the EUT is designed to only operate between 902 – 928 MHz.

For maximum permissible exposure, this device operates at less than 27.85 dbm at 902 – 928.0 MHz and is operated at greater than 20 cm from the body. No testing is required, however worst case calculated exposure compliance follows later in this report.

The EUT is not a hybrid system and FCC 15.247 (f) does not apply to it. However the 15.247 (d) requirement of power density were met and are detailed later in this test report.

EUT has no power line ports. It is used in underground mines and draws power from a DC battery or a DC power source. No AC-DC adaptor is supplied with the device, hence no conducted emissions testing was performed.

A 14db pad was used on the transmitter output to comply with the FCC requirements.

Client	Minewise Technology Ltd.	
Product	Z6X-DVLINK / 9978A-DVLINK	
Standard(s)	RSS 210 Issue 8:2010 / FCC Part 15 Subpart C 15:2010	

Applicable Standards, Specifications and Methods

- ANSI C63.4:2003 - Methods of Measurement of Radio-Noise Emissions from Low-Voltage Electrical and Electronic Equipment in the Range of 9 kHz to 40 GHz
- ANSI C63.10:2009 - American national standard for testing unlicensed wireless devices
- CFR 47 FCC 15 - Code of Federal Regulations – Radio Frequency Devices
- CISPR 22:1997 - Information technology equipment – Radio disturbance characteristics – Limits and methods of measurement
- ICES-003:2004 - Digital Apparatus - Spectrum Management and Telecommunications Policy Interference-Causing Equipment Standard
- ISO 17025:2005 - General Requirements for the competence of testing and calibration laboratories
- RSS 210:2010 - Issue 8: Spectrum Management and Telecommunications Policy. Radio Standards Specification Low Power License-Exempt Radio communication Devices

Client	Minewise Technology Ltd.	
Product	Z6X-DVLINK / 9978A-DVLINK	
Standard(s)	RSS 210 Issue 8:2010 / FCC Part 15 Subpart C 15:2010	

Sample calculation(s)

Margin = limit – (received signal + antenna factor + cable loss – pre-amp gain)

Margin = 50.5dBuV/m – (50dBuV + 10dB + 2.5dB – 20dB)

Margin = 8.5 dB

Document Revision Status

Revision 1 - Nov 2, 2011 – Initial report release.

Revision 2 - Dec 2, 2011 – Updated power spectral density plot.

This report replaces the Revision 1 issued on Nov 2, 2011 in its entirety.

Client	Minewise Technology Ltd.	
Product	Z6X-DVLINK / 9978A-DVLINK	
Standard(s)	RSS 210 Issue 8:2010 / FCC Part 15 Subpart C 15:2010	

Definitions and Acronyms

The following definitions and acronyms are applicable in this report.
See also ANSI C63.14.

AE – Auxillary Equipment.

BW – Bandwidth. Unless otherwise stated, this is refers to the 6 dB bandwidth.

EMC – Electro-Magnetic Compatibility

EMI – Electro-Magnetic Immunity

EUT – Equipment Under Test

ITE – Information Technology Equipment with a primary function(s) of entry, storage, display, retrieval, transmission, processing, switching, or control, of data.

LISN – Line impedance stabilization network

NCR – No Calibration Required

RF – Radio Frequency

Client	Minewise Technology Ltd.	
Product	Z6X-DVLINK / 9978A-DVLINK	
Standard(s)	RSS 210 Issue 8:2010 / FCC Part 15 Subpart C 15:2010	

Testing Facility

Testing for EMC on the EUT was carried out at Global EMC labs in Toronto, Ontario, Canada. The testing lab consists of a 3m semi-anechoic chamber calibrated to be able to allow measurements on an EUT with a maximum width or length of up to 2m and height up to 3m. The chamber is equipped with a turn table that is capable of testing devices up to 3300lb in weight. This facility is capable of testing products that are rated for 120 Vac and 240Vac single phase, or 208 Vac 3 phase input. DC capability is also available. The chamber is equipped with an antenna mast that controls polarization and height from the control room adjoining the shielded chamber. Radiated emissions measurements are performed using a Bilog, and Horn antenna where applicable. Conducted emissions, unless otherwise stated, are performed using a LISN.

Calibrations and Accreditations

The measurement site used is registered with Federal Communications Commission (FCC) and Industry Canada (IC). This site is calibrated for Normalized Site Attenuation (NSA) using test procedures outlined in ANSI C63.4 “Methods of Measurement of Radio-Noise Emissions from Low-Voltage Electrical and Electronic Equipment in the Range of 9 kHz to 40 GHz”. The semi-anechoic chamber is lined with ferrite tiles and absorption cones to minimize any undesired reflections. All measuring equipment is calibrated on an annual or bi-annual basis as listed for each respective test.

Client	Minewise Technology Ltd.	
Product	Z6X-DVLINK / 9978A-DVLINK	
Standard(s)	RSS 210 Issue 8:2010 / FCC Part 15 Subpart C 15:2010	

Testing Environmental Conditions and Dates

Following were the environmental conditions in the facility during time of testing –

Date	Test	Init.	Temperature (°C)	Humidity (%)	Pressure (kPa)
Oct 21 – 25, 2011	All	AM	22.5 – 24.2 °C	39.1%-43.2%	100.0 -100.7 kPa

Client	Minewise Technology Ltd.	
Product	Z6X-DVLINK / 9978A-DVLINK	
Standard(s)	RSS 210 Issue 8:2010 / FCC Part 15 Subpart C 15:2010	

Detailed Test Results Section

Client	Minewise Technology Ltd.	
Product	Z6X-DVLINK / 9978A-DVLINK	
Standard(s)	RSS 210 Issue 8:2010 / FCC Part 15 Subpart C 15:2010	

Spurious Radiated Emissions

Purpose

The purpose of this test is to ensure that the RF energy unintentionally emitted from the EUT does not exceed the limits listed below as defined in the applicable test standard, as measured from a receiving antenna. This helps protect broadcast radio services such as television, FM radio, pagers, cellular telephones, emergency services, and so on, from unwanted interference.

Limit(s) and Method

The limits, as defined in 15.247(d) for unintentional radiated emissions apply for those emissions that fall in the restricted bands, as defined in Section 15.205(a). These emissions must comply with the radiated emission limits specified in Section 15.209(a).

All unintentional emissions must also meet the ‘Spurious Conducted Emissions’ requirements of -20 dBc or greater. See also ‘Spurious Conducted Emissions’ for further details.

30 MHz – 88 MHz, 100 uV/m (40.0 dBuV/m¹) at 3 m
88 MHz – 216 MHz, 150 uV/m (43.5 dBuV/m¹) at 3 m
216 MHz – 960 MHz, 200 uV/m (46.4 dBuV/m¹) at 3 m
Above 960 MHz, 500 uV/m (54.0 dBuV/m¹) at 3 m
Above 1000 MHz, 500 uV/m (54.0 dBuV/m²) at 3m

¹Limit is with 120 kHz measurement bandwidth and a using a Quasi Peak detector.

²Limit is with 1 MHz measurement bandwidth and using an Average detector, scanned in accordance with 15.33 to above the 10th harmonic.

Client	Minewise Technology Ltd.	
Product	Z6X-DVLINK / 9978A-DVLINK	
Standard(s)	RSS 210 Issue 8:2010 / FCC Part 15 Subpart C 15:2010	

Typical Radiated Emissions Setup

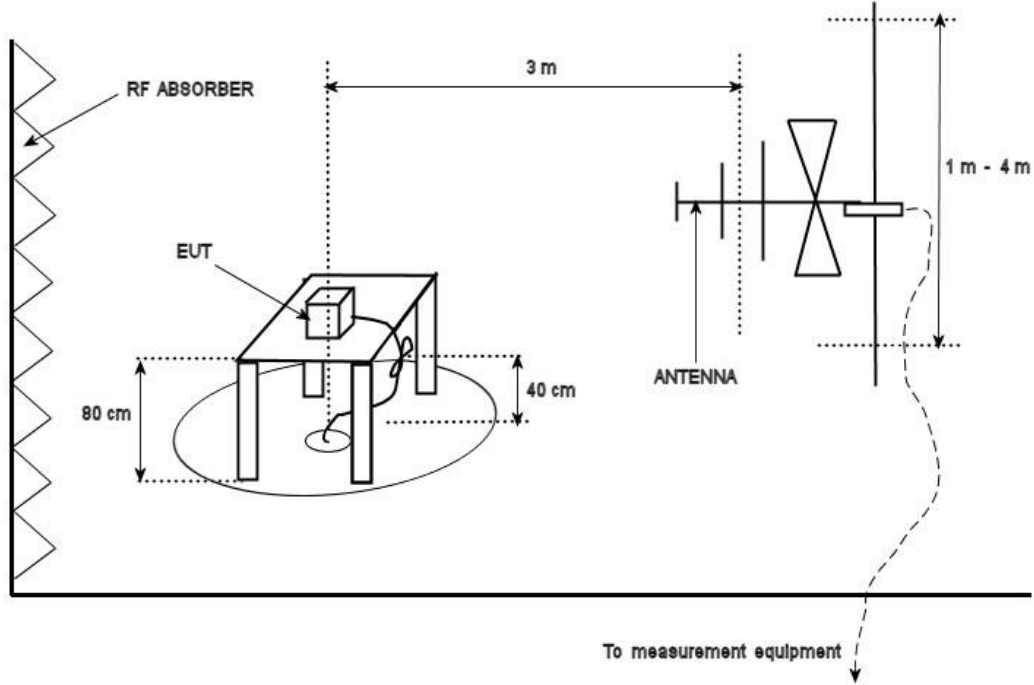

Client	Minewise Technology Ltd.	
Product	Z6X-DVLINK / 9978A-DVLINK	
Standard(s)	RSS 210 Issue 8:2010 / FCC Part 15 Subpart C 15:2010	

Measurement Uncertainty

The expanded measurement uncertainty is calculated in accordance with CISPR 16-4-2 and is +/-4.4 dB with a 'k=2' coverage factor and a 95% confidence level.

Preliminary Graphs

Note the graphs shown below are for graphical illustration only. For final measurements with the appropriate detector, please refer to the final measurement table where applicable. The graph shown below is a maximized peak measurement graph, measured with a resolution bandwidth greater than the final required detector and over a full 0-360 rotation. This peaking process is done as a worst case measurement. This process enables the detection of frequencies of concern for final measurement, and provides considerable time savings.

In accordance with FCC Part 15, Subpart A, Section 15.33, the device was scanned to a minimum of a 10 GHz.

Client	Minewise Technology Ltd.	
Product	Z6X-DVLINK / 9978A-DVLINK	
Standard(s)	RSS 210 Issue 8:2010 / FCC Part 15 Subpart C 15:2010	

30MHz – 1 GHz
Vertical – Peak Emissions Graph

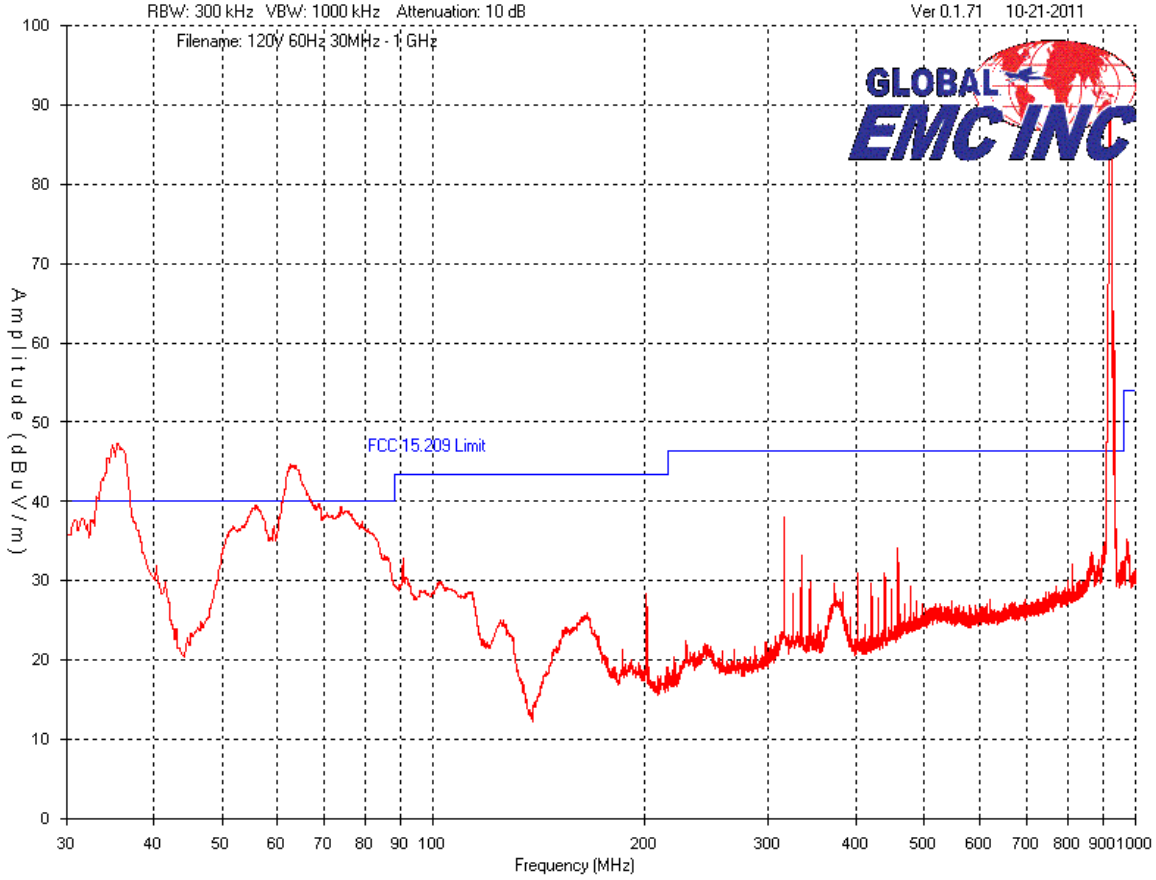

Client	Minewise Technology Ltd.	
Product	Z6X-DVLINK / 9978A-DVLINK	
Standard(s)	RSS 210 Issue 8:2010 / FCC Part 15 Subpart C 15:2010	

30MHz – 1 GHz
Horizontal – Peak Emissions Graph

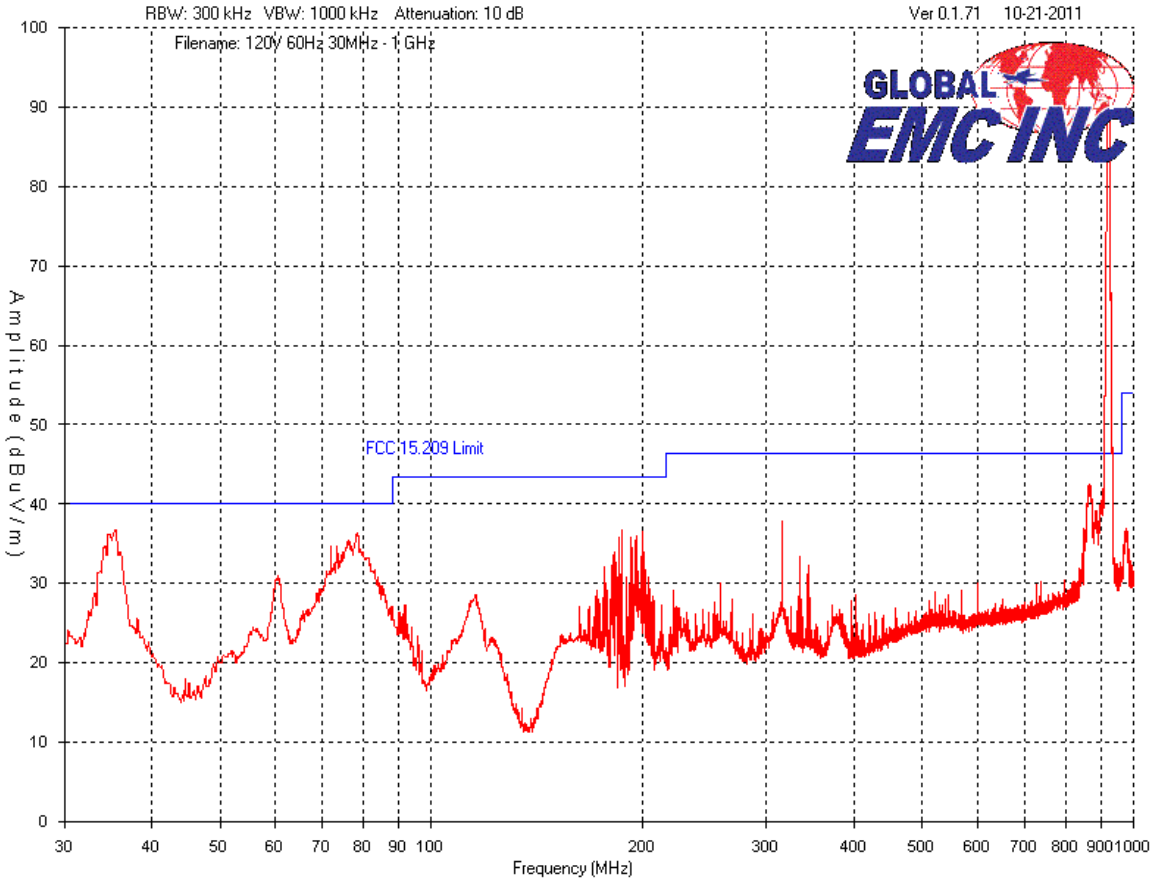

Client	Minewise Technology Ltd.	
Product	Z6X-DVLINK / 9978A-DVLINK	
Standard(s)	RSS 210 Issue 8:2010 / FCC Part 15 Subpart C 15:2010	

1 – 1.5GHz
Vertical – Peak Emissions Graph

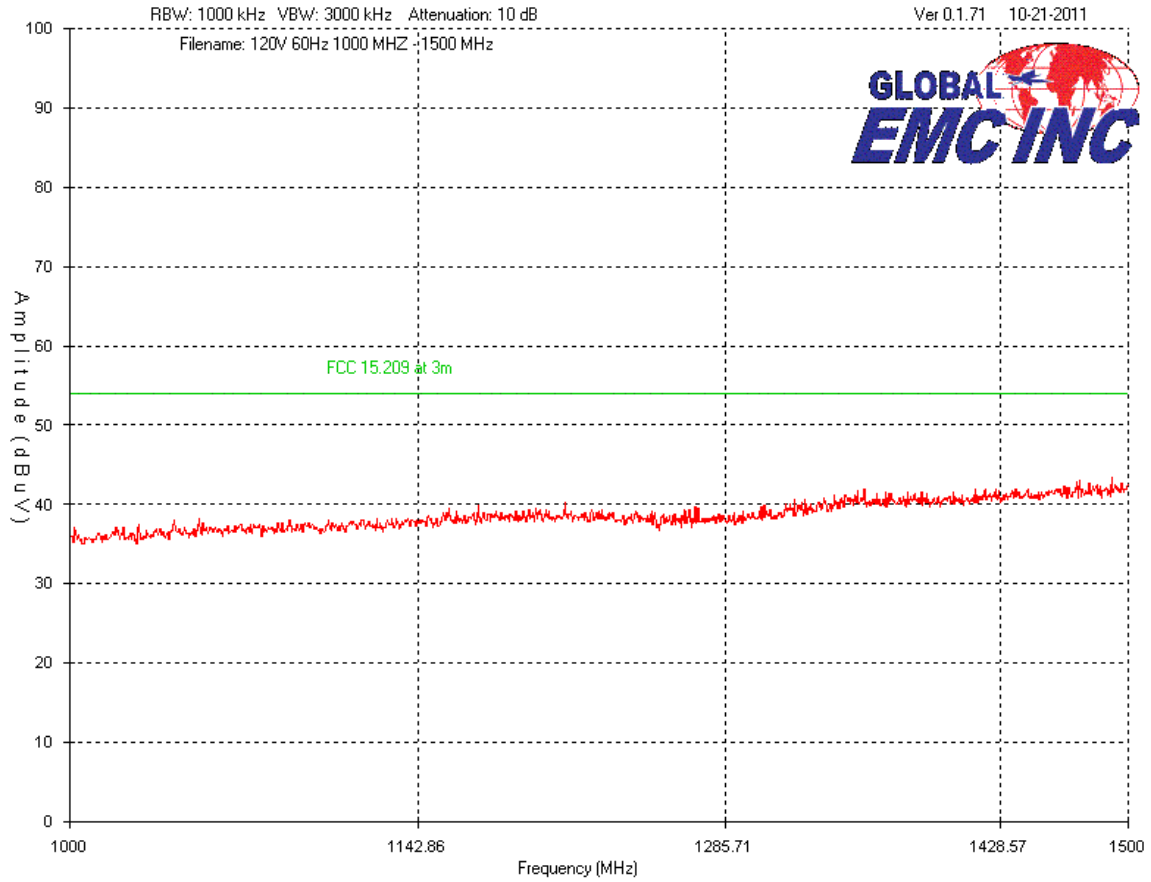

Client	Minewise Technology Ltd.	
Product	Z6X-DVLINK / 9978A-DVLINK	
Standard(s)	RSS 210 Issue 8:2010 / FCC Part 15 Subpart C 15:2010	

1 – 1.5GHz
Horizontal – Peak Emissions Graph

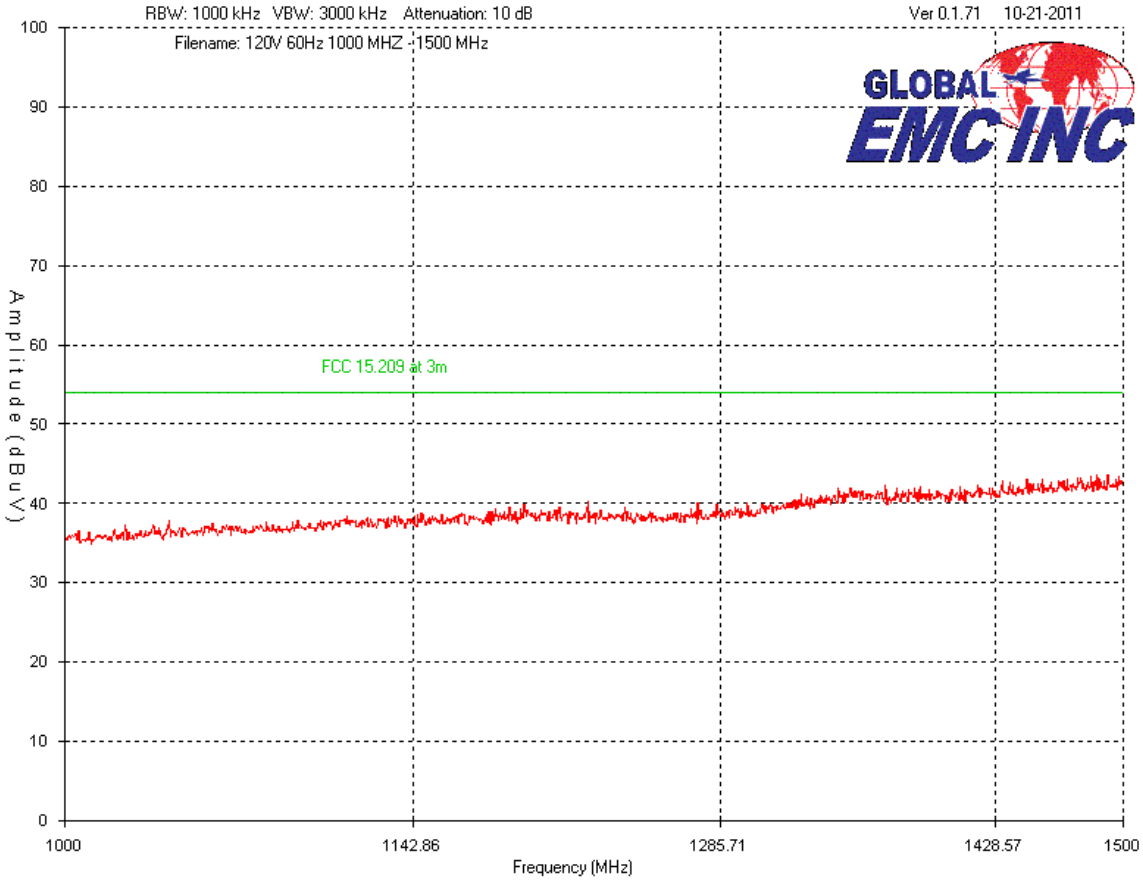

Client	Minewise Technology Ltd.	
Product	Z6X-DVLINK / 9978A-DVLINK	
Standard(s)	RSS 210 Issue 8:2010 / FCC Part 15 Subpart C 15:2010	

1.5-5 GHz
Vertical – Peak Emissions Graph

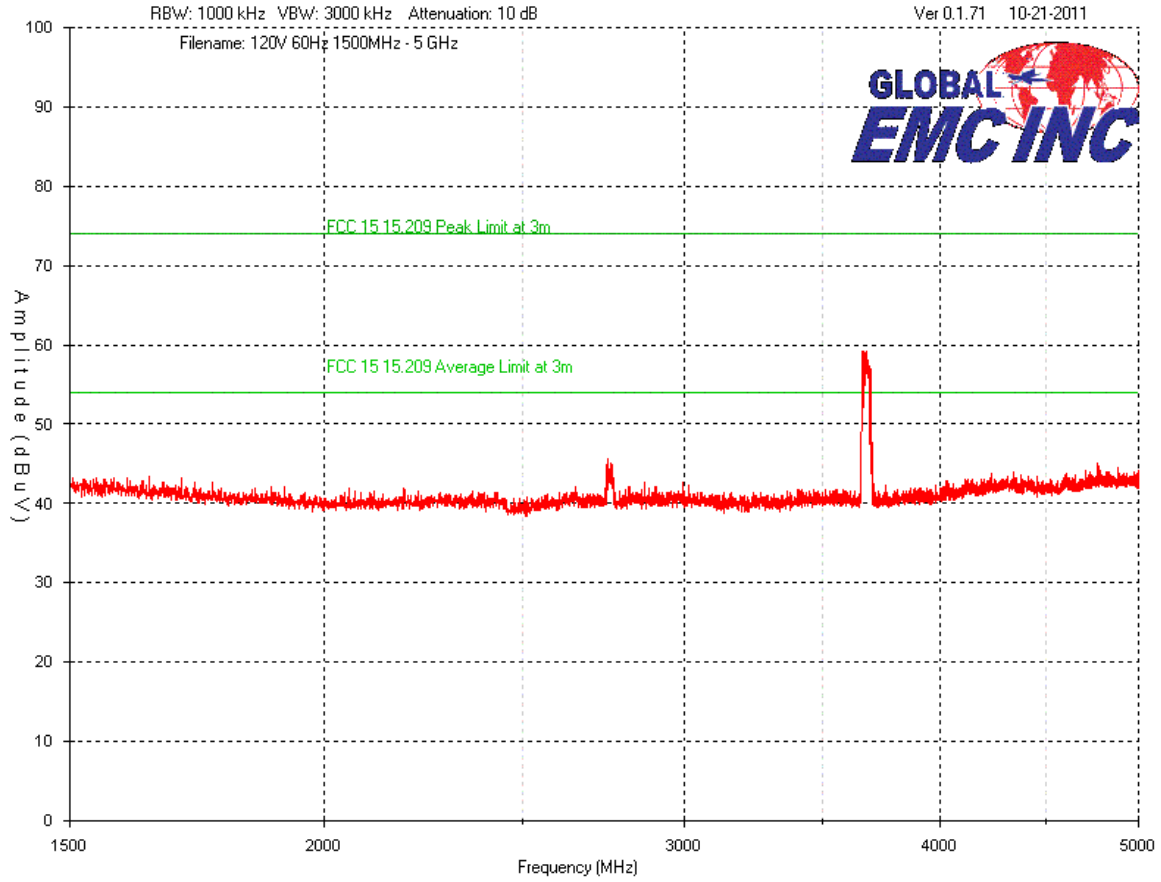

Client	Minewise Technology Ltd.	
Product	Z6X-DVLINK / 9978A-DVLINK	
Standard(s)	RSS 210 Issue 8:2010 / FCC Part 15 Subpart C 15:2010	

1.5-5 GHz
Horizontal – Peak Emissions Graph

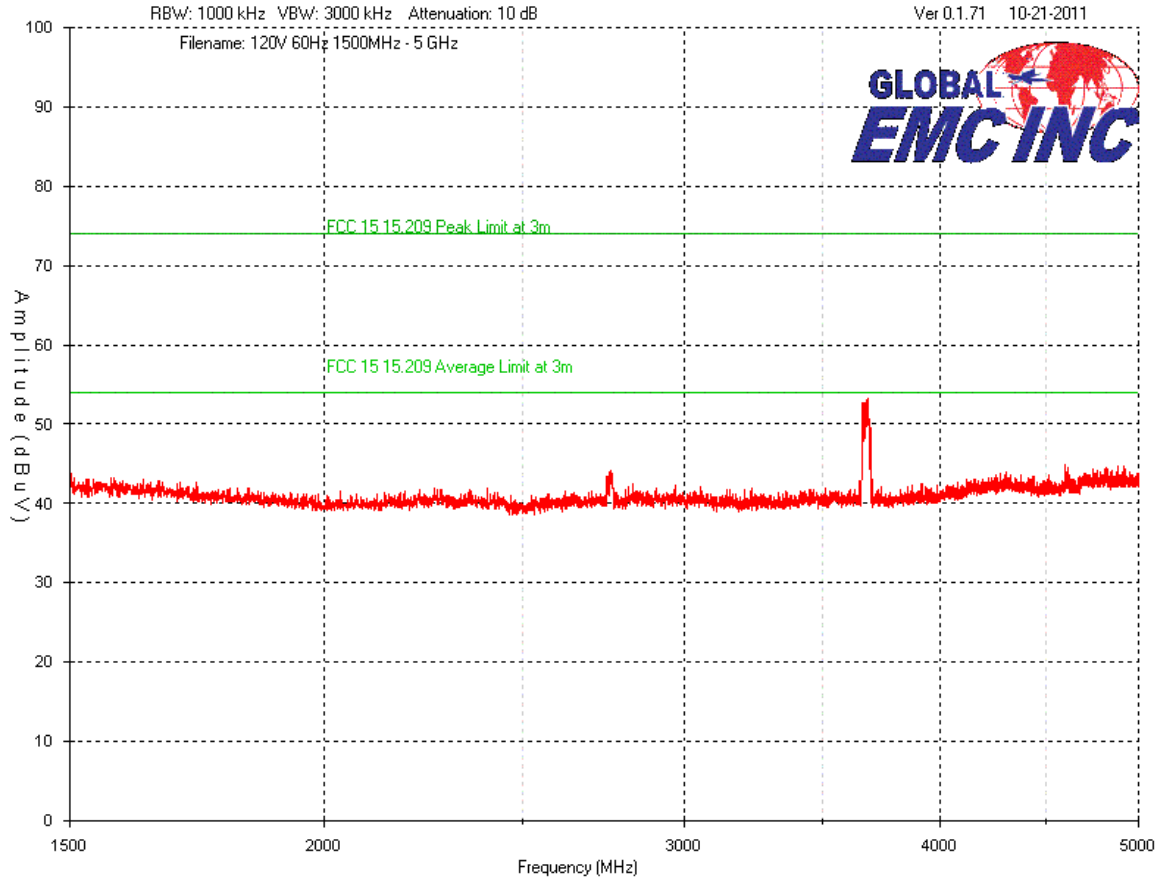

Client	Minewise Technology Ltd.	
Product	Z6X-DVLINK / 9978A-DVLINK	
Standard(s)	RSS 210 Issue 8:2010 / FCC Part 15 Subpart C 15:2010	

Final Measurements

Note:

1. In accordance with 15.247(d), only radiated emissions exceeding the 15.209 limit that occur within the bands listed in 15.205, need to be verified with a quasi-peak detector or an average detector.
2. EUT operates on only one channel hence no lo, mid or hi channel testing was performed.

The requirement of -20dBc is verified by the conducted method; please see ‘Spurious Antenna Conducted Emissions’ section of this report.

Some of the frequencies shown on the peak graph do not fall within a restricted band as listed in FCC 15.205 and does not need to be verified.

None of the unintentional radiated emissions that fall outside of the restricted bands exceeded the -20dBc requirement.

The following measurements were made at the harmonics shown in the above graphs.

See ‘Spurious Antenna Conducted Emissions’ measurements for -20 dBc requirements.

Client	Minewise Technology Ltd.	
Product	Z6X-DVLINK / 9978A-DVLINK	
Standard(s)	RSS 210 Issue 8:2010 / FCC Part 15 Subpart C 15:2010	

Radiated Emissions Measurements

RF Transmitter

Frequency (MHz)	Detector	Antenna Polarity	Reading (dbuV)	Antenna factor (db)	Cable Loss (db)	Preamp gain (db)	Level (dbuV/m)	FCC 15 15.209 AVG/QP 3m Limit (dbuV/m)	FCC 15 15.209 QP 3m Margin (dbuV)
3665.23	Avg	Vert	44.6	32	1	-35.9	41.7	54	12.3
3686.23	Avg	Horz	44	32.1	1	-35.9	41.2	54	12.8
37.50	QP	Vert	53.2	14.1	0.3	-30.1	37.5	40	2.5
902.00	QP	Vert	27	22.7	1.5	-29.8	21.4	54	32.6
928.00	QP	Vert	53.4	22.7	1.5	-29.8	47.8	54	6.2
315.76	QP	Vert	53.8	14.1	0.6	-30.4	38.1	46.4	8.3

Note: 62.5 MHz is shown to be exceeding the limits however it does not fall under the restricted bands per 15.205.

Client	Minewise Technology Ltd.	
Product	Z6X-DVLINK / 9978A-DVLINK	
Standard(s)	RSS 210 Issue 8:2010 / FCC Part 15 Subpart C 15:2010	

Test Equipment List

Equipment	Model No.	Manufacturer	Last calibration date	Next calibration due date	Asset #
IFR Spectrum Analyzer	AN940	IFR	12/29/2009	12/29/2011	GEMC 6350
BiLog Antenna	3142-C	ETS	2011-01-17	2013-01-17	GEMC 136
Attenuator 3 dB	FP-50-3	Trilithic	NCR	NCR	GEMC 40
Chase Preamp 9kHz - 2 GHz	CPA9231A	Chase	8/25/2010	8/25/2012	GEMC 6403
Q-Par 1.5-18 GHz Horn	6878/24	Q-par	8/25/2010	8/25/2012	GEMC 65
1-26G pre-amp	HP 8449B	HP	8/25/2010	8/25/2012	GEMC 68
RF Cable 7m	LMR-400-7M-50OHM-MN-MN	LexTec	NCR	NCR	GEMC 28
RF Cable 1m	LMR-400-1M-50OHM-MN-MN	LexTec	NCR	NCR	GEMC 29
RF Cable 0.5M	LMR-400-0.5M-50OHM-MN-MN	LexTec	NCR	NCR	GEMC 31

This report module is based on GEMC template "FCC - 15.209 - Radiated Emissions_Rev1.doc"

Client	Minewise Technology Ltd.	
Product	Z6X-DVLINK / 9978A-DVLINK	
Standard(s)	RSS 210 Issue 8:2010 / FCC Part 15 Subpart C 15:2010	

6dB Bandwidth of Digitally Modulated Systems

Purpose

The purpose of this test is to ensure that the bandwidth occupied exceeds a stated minimum. This helps ensure the utilization of the frequency allocation is sufficiently wide. This also helps prevent corruption of data by ensuring adequate data separation to distinguish the reception of the intended information.

Limits

Systems using digital modulation techniques may operate in the 902 - 928 MHz, 2400 - 2483.5 MHz, and 5725 - 5850 MHz bands. The minimum 6 dB bandwidth shall be at least 500 kHz. This should be measured with a 100 kHz RBW and a 300 kHz VBW.

Results

The EUT passed. The 6 dB BW measured was 8.49 MHz.

Client	Minewise Technology Ltd.	
Product	Z6X-DVLINK / 9978A-DVLINK	
Standard(s)	RSS 210 Issue 8:2010 / FCC Part 15 Subpart C 15:2010	

Graph(s)

The graphs shown below show the channel spacing during the operation of the device. This is measured by a max hold on the spectrum analyzer. This measurement is a peak measurement. Max hold is performed for a duration of not less than 1 minute.

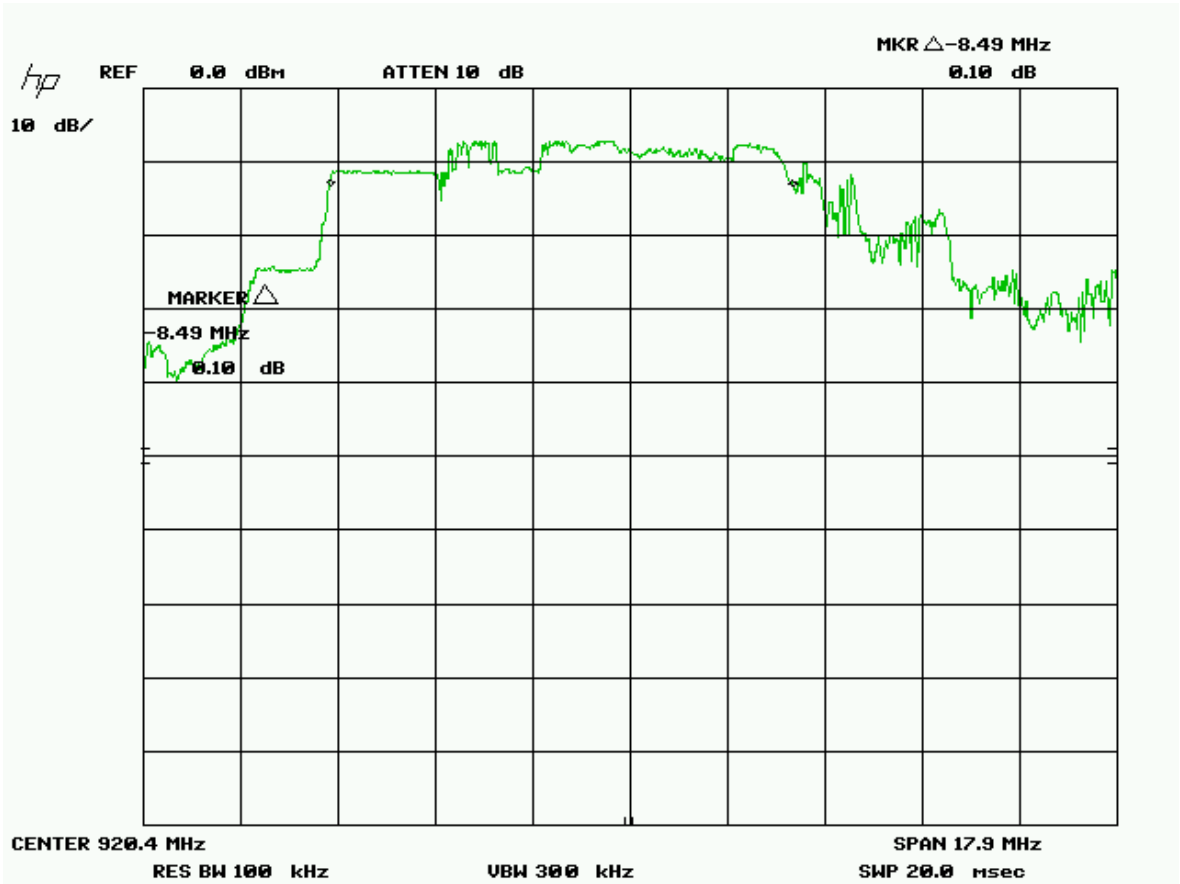

Note: See ‘Appendix B – EUT & Test Setup Photographs’ for photos showing the test set-up.

Client	Minewise Technology Ltd.	
Product	Z6X-DVLINK / 9978A-DVLINK	
Standard(s)	RSS 210 Issue 8:2010 / FCC Part 15 Subpart C 15:2010	

20 db Bandwidth

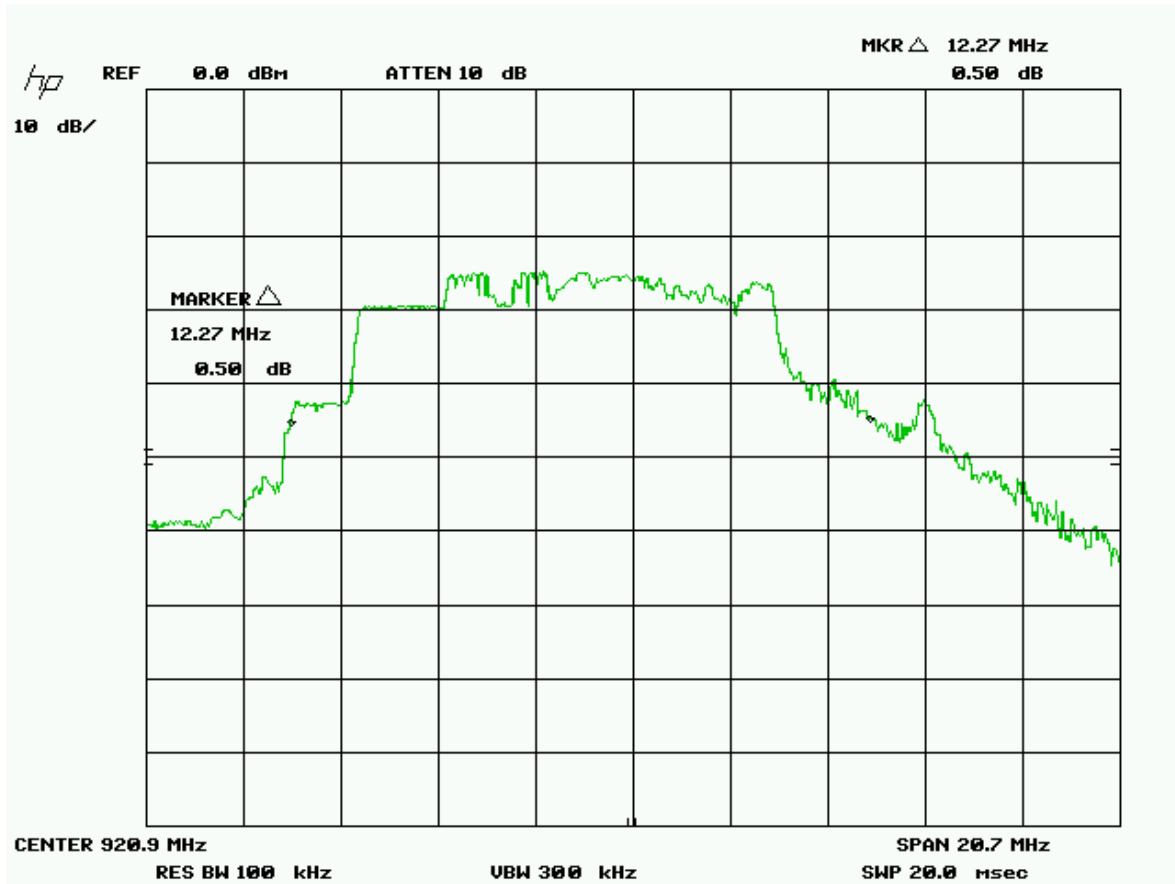

Client	Minewise Technology Ltd.	
Product	Z6X-DVLINK / 9978A-DVLINK	
Standard(s)	RSS 210 Issue 8:2010 / FCC Part 15 Subpart C 15:2010	

Test Equipment List

Equipment	Model No.	Manufacturer	Last calibration date	Next calibration due date	Asset #
Attenuator 20 dB	FP-50-20	Trilithic	NCR	NCR	GEMC 43
IFR Spectrum Analyzer	AN940	IFR	12/29/2009	12/29/2011	GEMC 6350
RF Cable 0.5M	LMR-400-0.5M-50OHM-MN-MN	LexTec	NCR	NCR	GEMC 31
RF Cable 1m	LMR-400-1M-50OHM-MN-MN	LexTec	NCR	NCR	GEMC 29
Power Attenuator 20 dB	25-A-FFN-20	Bird / Hutton	NCR	NCR	GEMC 49

This report module is based on GEMC template "FCC – Power Line Conducted Emissions Class B_Rev1"

Client	Minewise Technology Ltd.	
Product	Z6X-DVLINK / 9978A-DVLINK	
Standard(s)	RSS 210 Issue 8:2010 / FCC Part 15 Subpart C 15:2010	

Maximum Peak Envelope Conducted Power

Purpose

The purpose of this test is to ensure that the maximum power conducted to the radiating element does not exceed the limits specified. This ensures that if the end-user replaces the antenna, that the maximum power does not exceed an amount which may create an excessive power level.

Limits

The limits are defined in 15.247(b).

For systems using digital modulation in the 902-928 MHz, 2400-2483.5 MHz, and 5725-5850 MHz bands, the peak limit is 1 watt.

Results

The EUT passed. The peak power measured was 16.39 dbm (43.55 mW).

Client	Minewise Technology Ltd.	
Product	Z6X-DVLINK / 9978A-DVLINK	
Standard(s)	RSS 210 Issue 8:2010 / FCC Part 15 Subpart C 15:2010	

Table(s)

The tables shown below shows the peak power output of the device during the antenna conducted measurement during transmit operation of the EUT.



Note:

1. Since the antenna used in the system is 8.15 dbi gain, the maximum power allowed for this transmitter is 27.85 dbm.
2. See ‘Appendix B – EUT & Test Setup Photographs’ for photos showing the test set-up.

Test Equipment List

Equipment	Model No.	Manufacturer	Last calibration	Next calibration	Asset #
-----------	-----------	--------------	------------------	------------------	---------

Client	Minewise Technology Ltd.	
Product	Z6X-DVLINK / 9978A-DVLINK	
Standard(s)	RSS 210 Issue 8:2010 / FCC Part 15 Subpart C 15:2010	

			date	due date	
IFR Spectrum Analyzer	AN940	IFR	12/29/2009	12/29/2011	GEMC 6350
BiLog Antenna	3142-C	ETS	01/17/2011	01/17/2013	GEMC 137
RF Cable 1m	LMR-400-1M-50OHM-MN-MN	LexTec	NCR	NCR	GEMC 29
Power Attenuator 10 dB	25-A-FFN-10	Bird / Hutton	NCR	NCR	GEMC 49

This report module is based on GEMC template "FCC – Power Line Conducted Emissions Class B_Rev1"

Client	Minewise Technology Ltd.	
Product	Z6X-DVLINK / 9978A-DVLINK	
Standard(s)	RSS 210 Issue 8:2010 / FCC Part 15 Subpart C 15:2010	

Antenna Spurious Conducted Emissions (-20 dbc Requirement)

Purpose

The purpose of this test is to ensure that the maximum power conducted to the radiating element at frequencies outside of the authorized spectrum does not exceed the limits specified. This ensures that the only the intended signal is delivered to the radiating element.

Limits

The limits are defined in 15.247(d). In any 100 kHz band, the peak spurious harmonics emissions must be at least 20 dB below the fundamental. Spurious Conducted emissions are to be evaluated up to the 10th harmonic. This -20 dBc requirement also applies at the 'band edge' or 2.4 GHz and 2.4835 GHz.

Results

The EUT passed the limits. Low, middle and high band was measured. The worst case for each mode is presented as a graph for the spectrum. The -20 dBc requirement is shown for the lower band edge at 2.4 GHz in the low band. The -20 dBc requirement is also shown for the higher band edge at 2.4835 GHz in the high band.

Graph(s)

The graphs shown below shows the peak power output of the device during the antenna conducted measurement during transmit operation of the EUT.

Client	Minewise Technology Ltd.	
Product	Z6X-DVLINK / 9978A-DVLINK	
Standard(s)	RSS 210 Issue 8:2010 / FCC Part 15 Subpart C 15:2010	

9 kHz – 2.5 GHz

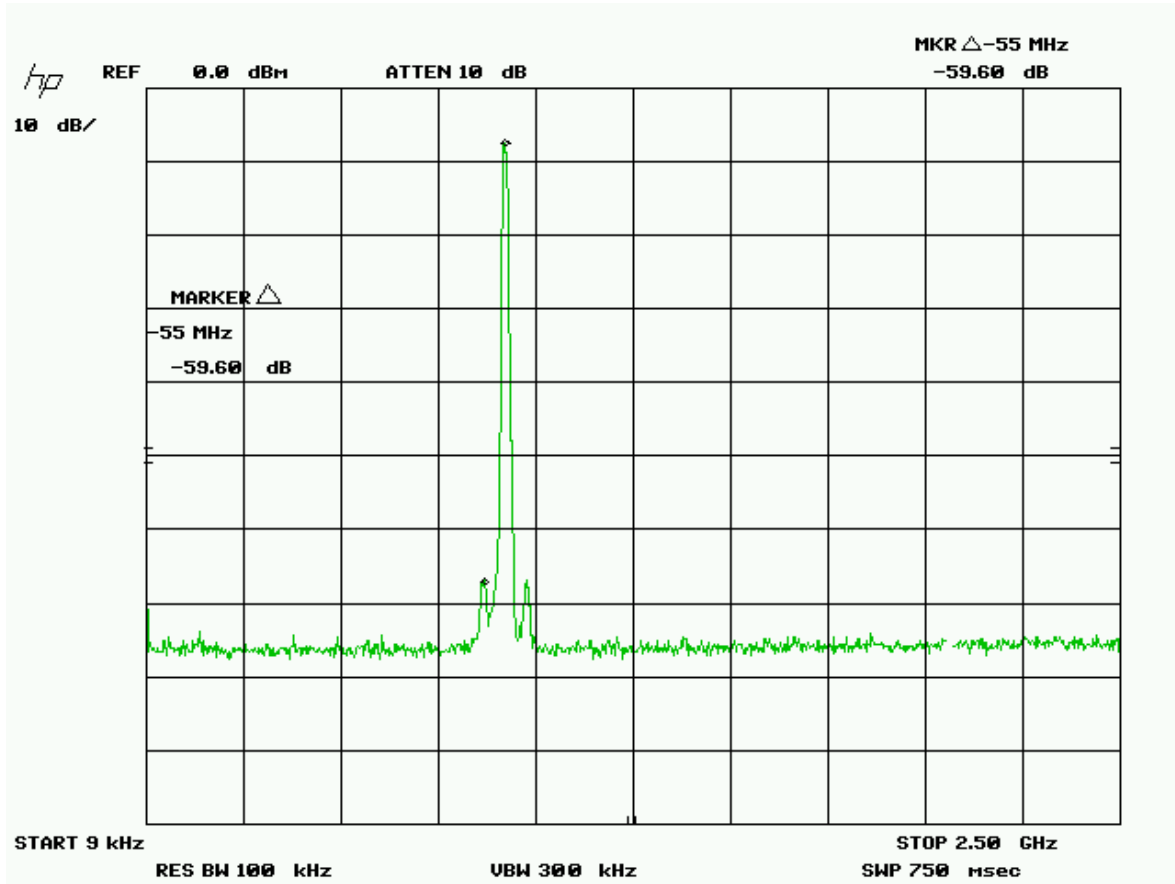

Client	Minewise Technology Ltd.	
Product	Z6X-DVLINK / 9978A-DVLINK	
Standard(s)	RSS 210 Issue 8:2010 / FCC Part 15 Subpart C 15:2010	

2 GHz – 10 GHz

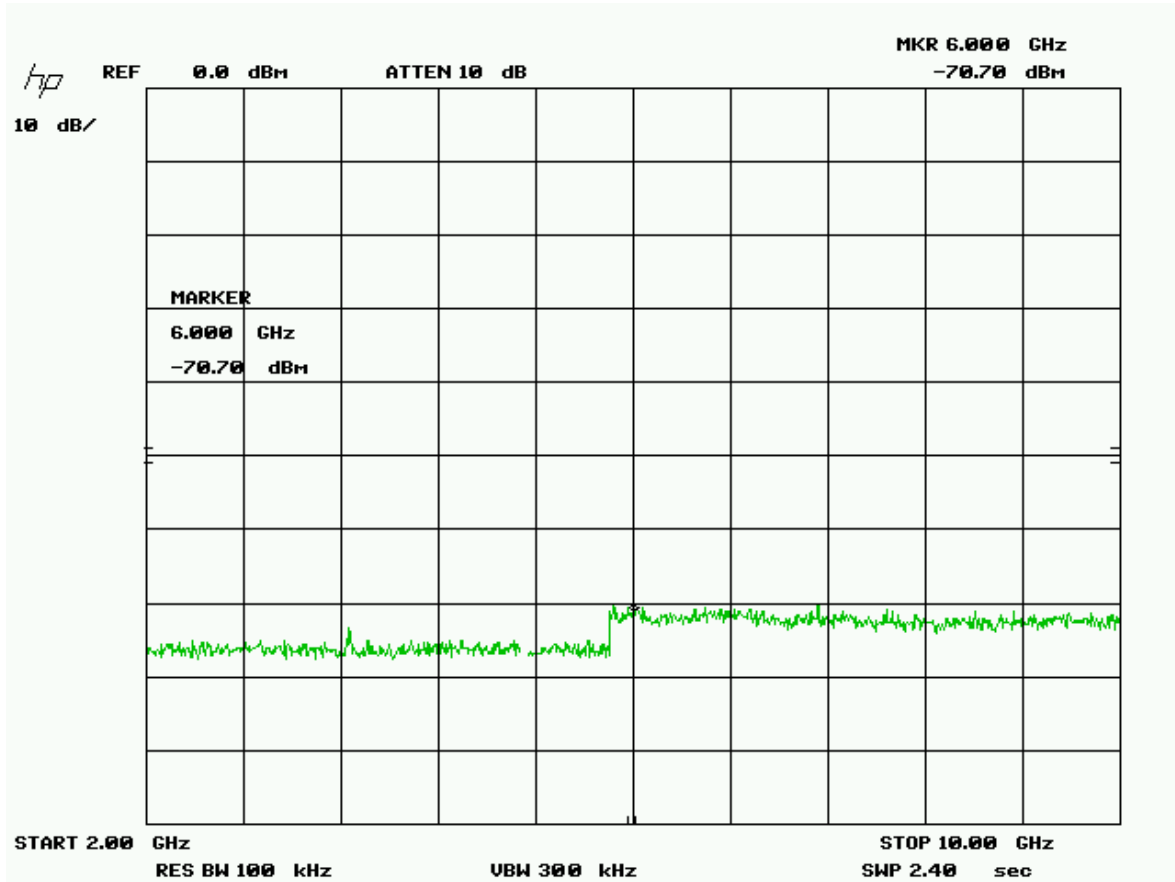

Client	Minewise Technology Ltd.	
Product	Z6X-DVLINK / 9978A-DVLINK	
Standard(s)	RSS 210 Issue 8:2010 / FCC Part 15 Subpart C 15:2010	

The plots show raw data and no correction factors are applied. They simply show a 20dbc differential between the peak and the band edge

Note: See ‘Appendix B – EUT & Test Setup Photographs’ for photos showing the test set-up.

Test Equipment List

Equipment	Model No.	Manufacturer	Last calibration date	Next calibration due date	Asset #
Attenuator 1 dB	FP-50-1	Trilithic	NCR	NCR	GEMC 38
Attenuator 3 dB	FP-50-3	Trilithic	NCR	NCR	GEMC 40
Attenuator 6 dB	FP-50-6	Trilithic	NCR	NCR	GEMC 41
Attenuator 10 dB	FP-50-10	Trilithic	NCR	NCR	GEMC 42
Attenuator 20 dB	FP-50-20	Trilithic	NCR	NCR	GEMC 43
Spectrum Analyzer	AN940	IFR	Dec 29, 2009	Dec 29, 2011	GEMC 6350
RF Cable 1m	LMR-400-1M-50OHM-MN-MN	LexTec	NCR	NCR	GEMC 29
Power Attenuator 20 dB	25-A-FFN-20	Bird / Hutton	NCR	NCR	GEMC 49

This report module is based on GEMC template “FCC – Power Line Conducted Emissions Class B_Rev1”

Client	Minewise Technology Ltd.	
Product	Z6X-DVLINK / 9978A-DVLINK	
Standard(s)	RSS 210 Issue 8:2010 / FCC Part 15 Subpart C 15:2010	

Power Spectral Density

Purpose

The purpose of this test is to ensure that the maximum power spectral density to the radiating element does not exceed the limits specified. This ensures that the modulation is significantly wide enough, or low enough in power that it will allow for co-operation of other wireless devices operating within this frequency allocation.

Limits

The limits are defined in 15.247(e).

For digitally modulated systems, the power spectral density conducted from the intentional radiator to the antenna shall not be greater than 8 dBm in any 3 kHz band during any time interval of continuous transmission.

Results

The EUT met the requirement of 8dbm in 3 kHz BW. The worst case value recorded was 3.8 dbm.

Graph(s)

The graphs shown below show the power spectral density of the device during the conducted measurement operation of the EUT.

Client	Minewise Technology Ltd.	
Product	Z6X-DVLINK / 9978A-DVLINK	
Standard(s)	RSS 210 Issue 8:2010 / FCC Part 15 Subpart C 15:2010	

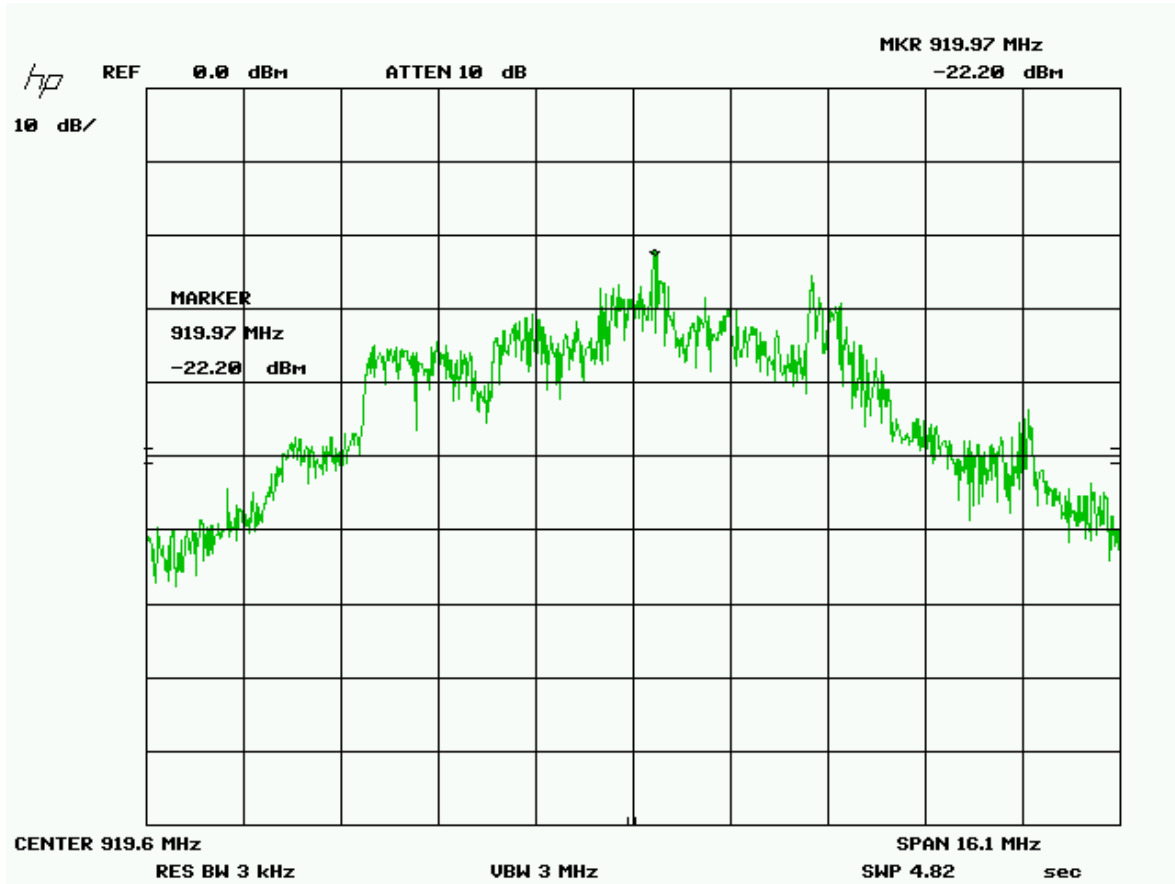

Note: See 'Appendix B – EUT & Test Setup Photographs' for photos showing the test set-up.

Test Equipment List

Equipment	Model No.	Manufacturer	Last calibration date	Next calibration due date	Asset #
Spectrum Analyzer	AN940	IFR	Dec 29, 2009	Dec 29, 2011	GEMC 6350
RF Cable 1m	LMR-400-1M-50OHM-MN-MN	LexTec	NCR	NCR	GEMC 29
Power Attenuator 20 dB	25-A-FFN-20	Bird / Hutton	NCR	NCR	GEMC 49

This report module is based on GEMC template "FCC – Power Line Conducted Emissions Class B_Rev1"

Client	Minewise Technology Ltd.	
Product	Z6X-DVLINK / 9978A-DVLINK	
Standard(s)	RSS 210 Issue 8:2010 / FCC Part 15 Subpart C 15:2010	

Maximum Permissible Exposure

Purpose

The purpose of this test is to ensure that the RF energy intentionally transmitted, in terms of power density emitted from the EUT at a stated operating distance does not exceed the limits listed below as defined in the applicable test standard, as calculated based upon readings obtained during testing. This helps protect human exposure to excessive RF fields.

Limit(s) and Method

The limits, as defined in FCC 15.247(i) and FCC 1.1310 Table 1 (B) limits for general public exposure was applied. The limit for the frequency range of 1.5 GHz to 100 GHz was applied. This is a limit of 1.0 mW/cm². The distance used for calculations was 20cm.

Results

The EUT passed the requirements. The worst case calculated power density was 0.062 mW/cm², this is significantly under the 1.0 mW/cm² requirement.

Calculations

Method 1 (conducted power)

$$P_d = (P_t * G) / (4 * \pi * R^2)$$

Where $P_t = 16.39$ dbm or 43.55 mW as per Peak power conducted output

Where $G = 8.55$ dBi, or numerically 7.16

Where $R = 20$ cm

$$P_d = (43.55 \times 7.16) / (4 \times \pi \times 20\text{cm}^2)$$

$$P_d = 311 \text{ mW} / 5026.54 \text{ cm}^2$$

$$P_d = 0.062 \text{ mW/cm}^2$$

Client	Minewise Technology Ltd.	
Product	Z6X-DVLINK / 9978A-DVLINK	
Standard(s)	RSS 210 Issue 8:2010 / FCC Part 15 Subpart C 15:2010	

Appendix A – EUT Summary

General EUT Description

EUT Details	
Manufacturer	Minewise Technology Ltd.
EUT Model number	DVLink
Equipment Category	Wireless video monitoring system
Basic EUT Functionality	EUT is installed in a commercial environment and video is monitored on the receiver.
Input Voltage and Frequency	24Vdc, 1A (to be supplied by end user). No AC/DC adaptor is sold with the unit.
Connectors available on EUT	None for RF, 1 for power 1 for video camera.
Peripherals Required for Test	None.
Release type	Final
Intentional Radiator Frequency	920 MHz (902 MHz – 928 MHz band per 15.247)

Note the EUT is considered to have been received the date of the commencement of the first test, unless otherwise stated. For a close-up picture of the EUT, see ‘Appendix B – EUT & Test Setup Photographs’.

Client	Minewise Technology Ltd.	
Product	Z6X-DVLINK / 9978A-DVLINK	
Standard(s)	RSS 210 Issue 8:2010 / FCC Part 15 Subpart C 15:2010	

Appendix B – EUT and Test Setup Photographs

Client	Minewise Technology Ltd.	
Product	Z6X-DVLINK / 9978A-DVLINK	
Standard(s)	RSS 210 Issue 8:2010 / FCC Part 15 Subpart C 15:2010	



Figure 1 – Radiated emission setup

Client	Minewise Technology Ltd.	
Product	Z6X-DVLINK / 9978A-DVLINK	
Standard(s)	RSS 210 Issue 8:2010 / FCC Part 15 Subpart C 15:2010	

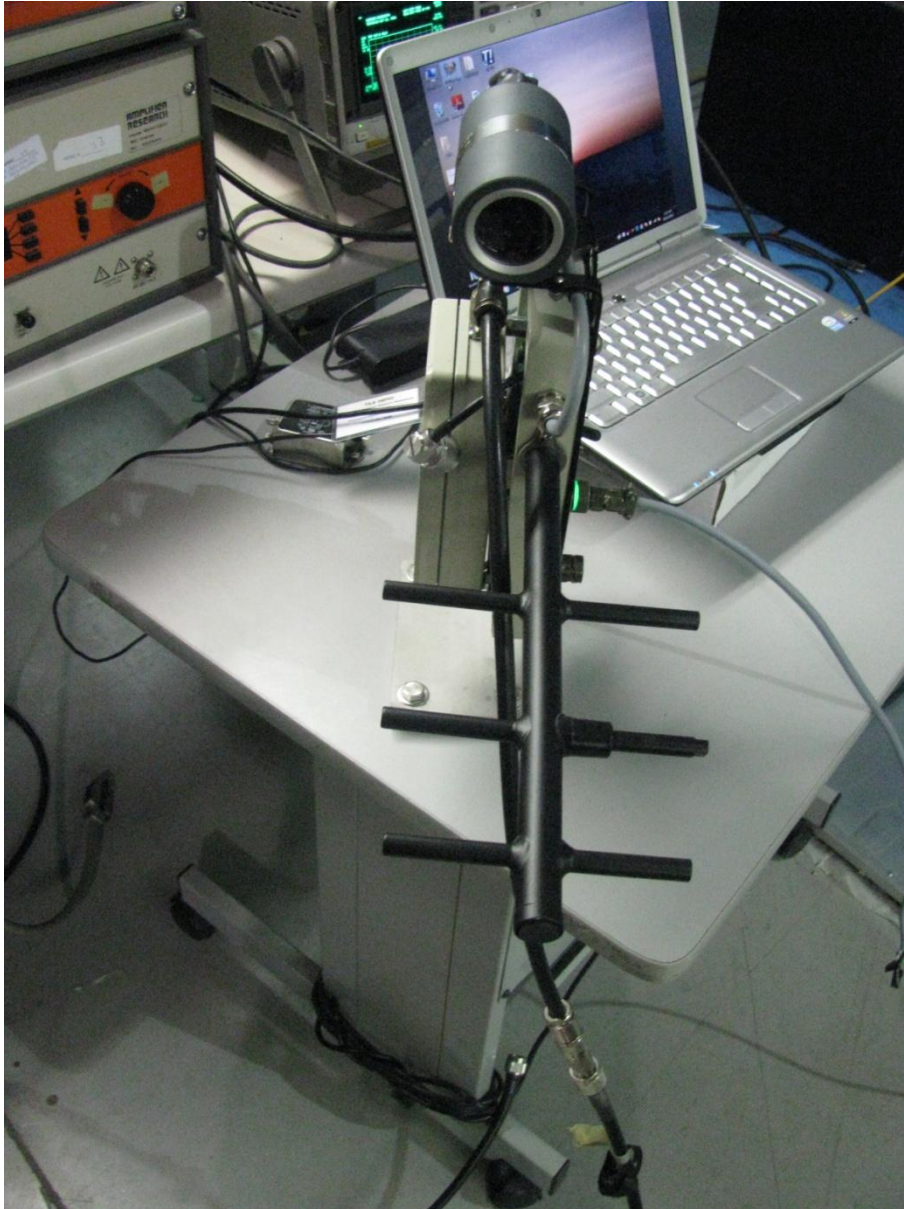

Figure 2 – Conducted power output setup

Note: These photos are for information purposes only. Also refer to PDF files that are separate from this test report.