

**Grandstream Networks, Inc.**

---

**GSC36XX Series**

**FHD Infrared Weatherproof, IP Dome/Box Camera**

**User Manual**



**GSC3610**



**GSC3615**



## **COPYRIGHT**

©2020 Grandstream Networks, Inc. <http://www.grandstream.com>

All rights reserved. Information in this document is subject to change without notice. Reproduction or transmittal of the entire or any part, in any form or by any means, electronic or print, for any purpose without the express written permission of Grandstream Networks, Inc. is not permitted.

The latest electronic version of this guide is available for download here:

<http://www.grandstream.com/support>

Grandstream is a registered trademark and Grandstream logo is trademark of Grandstream Networks, Inc. in the United States, Europe and other countries.

## **CAUTION**

Changes or modifications to this product not expressly approved by Grandstream, or operation of this product in any way other than as detailed by this guide, could void your manufacturer warranty.

## **WARNING**

Please do not use a different power adaptor with devices as it may cause damage to the products and void the manufacturer warranty.



## FCC Caution

This device complies with part 15 of the FCC Rules. Operation is subject to the following two conditions:

(1) This device may not cause harmful interference, and (2) this device must accept any interference received, including interference that may cause undesired operation.

**Note:** This equipment has been tested and found to comply with the limits for a Class B digital device, pursuant to part 15 of the FCC Rules. These limits are designed to provide reasonable protection against harmful interference in a residential installation. This equipment generates uses and can radiate radio frequency energy and, if not installed and used in accordance with the instructions, may cause harmful interference to radio communications. However, there is no guarantee that interference will not occur in a particular installation. If this equipment does cause harmful interference to radio or television reception, which can be determined by turning the equipment off and on, the user is encouraged to try to correct the interference by one or more of the following measures:

- Reorient or relocate the receiving antenna.
- Increase the separation between the equipment and receiver.
- Connect the equipment into an outlet on a circuit different from that to which the receiver is connected.
- Consult the dealer or an experienced radio/TV technician for help.



## GNU GPL INFORMATION

GSC3610/GSC3615 firmware contains third-party software licensed under the GNU General Public License (GPL). Grandstream uses software under the specific terms of the GPL. Please see the GNU General Public License (GPL) for the exact terms and conditions of the license.

Grandstream GNU GPL related source code can be downloaded from Grandstream web site from:

[http://www.grandstream.com/sites/default/files/Resources/GSC36XX\\_gpl.zip](http://www.grandstream.com/sites/default/files/Resources/GSC36XX_gpl.zip)



## Table of Contents

<b>DOCUMENT PURPOSE .....</b>	<b>9</b>
<b>CHANGE LOG .....</b>	<b>10</b>
Firmware Version 1.0.1.3.....	10
<b>WELCOME .....</b>	<b>11</b>
<b>PRODUCT OVERVIEW .....</b>	<b>12</b>
Feature Highlights .....	12
GSC3610/GSC3615 Technical Specifications.....	12
<b>GETTING STARTED.....</b>	<b>14</b>
Equipment Packaging.....	14
Powering and Connecting the GSC36XX.....	15
<i>Option A (Recommended)</i> .....	15
<i>Option B</i> .....	15
<b>HARDWARE INSTALLATION .....</b>	<b>16</b>
Mounting GSC3610 .....	16
Mounting GSC3615.....	17
<b>GSC36XX APPLICATION SCENARIOS .....</b>	<b>18</b>
<i>LAN without Internet</i> .....	18
<i>LAN with Internet</i> .....	19
<b>GSC3610/GSC3615 WEB GUI .....</b>	<b>20</b>
Web GUI Settings.....	21
<b>GSC36XX SETTINGS.....</b>	<b>23</b>
Live View Page.....	23
System Settings.....	24
<i>Date &amp; Time Settings</i> .....	24
<i>Network Settings</i> .....	24
<i>Access Settings</i> .....	26
<i>User Management</i> .....	30



Account.....	31
<i>Account 1 - 4</i> .....	31
Phone Settings .....	35
<i>Phone Settings</i> .....	35
<i>Account [1-4] White List</i> .....	37
Video & Audio Settings .....	37
<i>Video Settings</i> .....	38
<i>OSD Settings</i> .....	39
<i>CMOS Settings</i> .....	40
<i>Audio Settings</i> .....	41
<i>Privacy Masks</i> .....	42
Alarm Settings .....	42
<i>Alarm Events Config</i> .....	42
<i>Alarm Schedule Settings</i> .....	43
<i>Alarm Action Settings</i> .....	45
<i>Alarm Phone List</i> .....	46
Email & FTP Settings .....	46
<i>Email Settings</i> .....	46
<i>FTP &amp; Center Storage</i> .....	48
Maintenance Settings .....	48
<i>Upgrade</i> .....	49
<i>Reboot &amp; Reset</i> .....	51
<i>Debug Log</i> .....	51
<i>Data Maintenance</i> .....	51
<i>Event Notification</i> .....	52
<i>Certificates</i> .....	53
Status.....	54
<i>Account Status</i> .....	54
<i>System Info</i> .....	55
<i>Network Info</i> .....	56
<b>EXPERIENCING THE GSC3610/GSC3615.....</b>	<b>57</b>



## Table of Tables

Table 1: GSC3610/GSC3615 Features in a Glance .....	12
Table 2: GSC3610/GSC3615 Technical Specifications.....	12
Table 3: Equipment Packaging .....	14
Table 4: GSC3610/GSC3615 WEB GUI Sections .....	22
Table 5: Date & Time.....	24
Table 6: Basic Settings.....	25
Table 7: Access Settings .....	27
Table 8: User Management.....	30
Table 9: SIP Account Basic & Advanced Settings.....	32
Table 10: Phone Settings .....	35
Table 11: White List .....	37
Table 12: Video Settings .....	38
Table 13: OSD Settings.....	40
Table 14: CMOS Settings.....	41
Table 15: Audio Settings.....	41
Table 16: Motion Detection.....	43
Table 17: Alarm Actions.....	45
Table 18: Alarm Phone List .....	46
Table 19: Email Settings - SMTP .....	47
Table 20: Picture Storage Settings.....	48
Table 21: Upgrade.....	50
Table 22: Reset & Reboot .....	51
Table 23 : Log Manager Settings .....	53
Table 24: System Info.....	56
Table 25: Network Info .....	56

## Table of Figures

Figure 1: GSC3610/GSC3615 Package Content.....	14
Figure 2: RJ45 plug installation.....	15
Figure 3: Mounting GSC3610 .....	16
Figure 4: Mounting GSC3615 .....	17
Figure 5: GSC3610/GSC3615 Working in LAN .....	18
Figure 6: GSC36XX working with Internet .....	19
Figure 7: GS_Search tool.....	20
Figure 8: GSC36XX Login Page .....	20
Figure 9: GSC3610/GSC3615 WEB GUI.....	21
Figure 10: Live View.....	23



Figure 11: Date & Time Page .....	24
Figure 12: Basic Settings Page .....	25
Figure 13: Access Settings Page .....	26
Figure 14: MJPEG Authentication Mode .....	28
Figure 15: RTSP steam display using VLC .....	29
Figure 16: User Management Page .....	30
Figure 17: Password Recovery Email .....	30
Figure 18: SIP Account Settings Page .....	31
Figure 19: Phone Settings Page .....	35
Figure 20: White List Page .....	37
Figure 21: Video Settings Page .....	38
Figure 22: OSD Settings Page .....	40
Figure 23: CMOS Settings Page .....	40
Figure 24: Audio Settings Page .....	41
Figure 25: Privacy Masks Configuration Page .....	42
Figure 26: Events Page .....	42
Figure 27: Region Config .....	43
Figure 28: Alarm Schedule .....	44
Figure 29: Edit Schedule .....	44
Figure 30: Alarm Action .....	45
Figure 31: Edit Alarm Action .....	45
Figure 32: Alarm Phone List .....	46
Figure 33: Email Settings - SMTP Page .....	47
Figure 34: Picture Storage Settings .....	48
Figure 35: Upgrade Page .....	49
Figure 36: Reset & Reboot Page .....	51
Figure 37: Debug Log Page .....	51
Figure 38: Data Maintenance Page .....	52
Figure 39: Log Manager Page .....	52
Figure 40: Upload Certificate files .....	53
Figure 41: Trusted CA Certificates .....	54
Figure 42: Custom certificate .....	54
Figure 43: System Info Page .....	55
Figure 44: System Info Page .....	55
Figure 45: Network Info Page .....	56





## DOCUMENT PURPOSE

This document describes how to configure the GSC3610/GSC3615 via web UI menu to fully manipulate device's features. Please visit <http://www.grandstream.com/support> to download the latest "GSC36XX User Manual".

This guide covers following topics:

- [Product Overview](#)
- [Getting Started](#)
- [Hardware Installation](#)
- [GSC3610/GSC3615 Web GUI](#)
- [GSC36XX Settings](#)
- [Experiencing the GSC3610/GSC3615](#)



## CHANGE LOG

This section documents significant changes from previous versions of user manual for GSC36XX Series. Only major new features or major document updates are listed here. Minor updates for corrections or editing are not documented here.

### **Firmware Version 1.0.1.3**

- This is the initial version.



## WELCOME

Thank you for purchasing Grand stream's GSC36XX FHD IP Box Camera, the innovative powerful weatherproof infrared next generation network camera. The GSC3610 is a ceiling-mounted fixed dome IP camera with a 3.6mm lens - making it an ideal device for wide-angle monitoring of nearby subjects in environments such as banks, hotels, retail stores, offices, warehouses, and building entrances. Meanwhile the GSC3615 is a wall-mounted bullet IP camera with a 3.6mm lens - making it ideal for wide-angle monitoring of nearby subjects in environments such as banks, hotels, retail, offices, warehouses, and building entrances. Both devices support motion detection and smart infrared technology for white balance and exposure to monitor activity at night in outdoor or dark enclosed spaces. The GSC3610/GSC3615 can be managed with GSURF Pro, Grandstream's free video management software, along with other ONVIF-compliant video management systems. It pairs with Grandstream's video phones and GSC3570 HD intercom and facility control station for active end-point monitoring and facility control. By adding weatherproof capabilities, this is an ideal device for increasing security and facility management in any indoor or outdoor area.

Designed for both indoor and outdoor environment, the GSC36XX series of IP Cameras ensures ease of use, integration and deployment, with multilingual graphical user interface, provides powerful solution to professional surveillance applications.

This manual will help you to learn how to operate and manage your GSC3610/GSC3615 FHD Infrared Weatherproof, IP Box Camera and make the best use of it.





# PRODUCT OVERVIEW

## Feature Highlights

The following table contains the major features of the GSC3610/GSC3615:

**Table 1: GSC3610/GSC3615 Features in a Glance**

<p><b>GSC3610</b></p> 	<ul style="list-style-type: none"> <li>• Motion detection</li> <li>• Smart infrared technology for optimal white balance and exposure</li> <li>• Built-in PoE to power the device and provide a network connection</li> <li>• Alert notifications via outbound voice or video call &amp; email screenshot</li> <li>• IP66-level weatherproof capability</li> </ul>
<p><b>GSC3615</b></p> 	

## GSC3610/GSC3615 Technical Specifications

The following table resumes all the technical specifications including the protocols / standards supported, voice codecs, telephony features, languages and upgrade/provisioning settings for GSC3610/GSC3615.

**Table 2: GSC3610/GSC3615 Technical Specifications**

<b>Network Protocol</b>	SIP RFC3261, TCP/IP/UDP, RTP/RTCP, HTTP/HTTPS, ARP, ICMP, DNS (A record, SRV, NAPTR), DHCP, SSH, TFTP, NTP, STUN, SIMPLE, LLDP-MED, 802.1x, TLS, SRTP
<b>Image Sensor Resolution</b>	1/2.9" CMOS Sensor, 1920(H)*1080(V)
<b>Video Compression</b>	H.264/H.265/JPEG/MJPEG
<b>Supported Maximum Video Resolution and Frame Rate</b>	Primary Stream:1920*1080 Secondary Stream: 640*480
<b>Video Output</b>	Network
<b>Audio</b>	1 x 3.5mm Line-In Port; 1 x 3.5mm Line-Out Port



<b>Scanning System</b>	Progressive
<b>Image Configuration</b>	Saturation/Brightness/Contrast/Sharpness, White Balance
<b>Focal Length</b>	Fixed 3.6mm
<b>Infrared LED</b>	2x LED, up to 20M, Auto Control
<b>Ethernet</b>	One RJ-45 (10/100Base-T) Port with PoE
<b>ONVIF</b>	Yes, Profile S
<b>Day/Night</b>	Color/ Black &White (IR-CUT)
<b>Motion Detection</b>	Supported
<b>Language Supported</b>	Multi-Language
<b>Privacy Mask</b>	4 Rectangular Zone
<b>Weatherproof Grade</b>	Metal, IP66-level weatherproof capability
<b>Power</b>	DC12V±10%,1A (Power Adapter NOT Included) PoE: Support IEEE 802.3af
<b>Temperature / Humidity</b>	-20 °C ~ 50 °C, RH95% Max
<b>Weight and Dimensions</b>	109 x 93mm, 390g
<b>Compliance</b>	FCC, CE, RCM, IC



## GETTING STARTED

This chapter provides basic installation instructions including the list of the packaging contents and also information for obtaining the best performance with the GSC3610/GSC3615.

### Equipment Packaging

**Table 3: Equipment Packaging**

GSC3610/GSC3615
<ul style="list-style-type: none"> <li>• 1x GSC3610/GSC3615 Main Case.</li> <li>• 1x Drill Template</li> <li>• 1x Hex Key</li> <li>• 1x Waterproof RJ45 Socket (5 pieces)</li> <li>• 3x Wall Anchors and Screws</li> <li>• 1x Quick Installation Guide.</li> </ul>

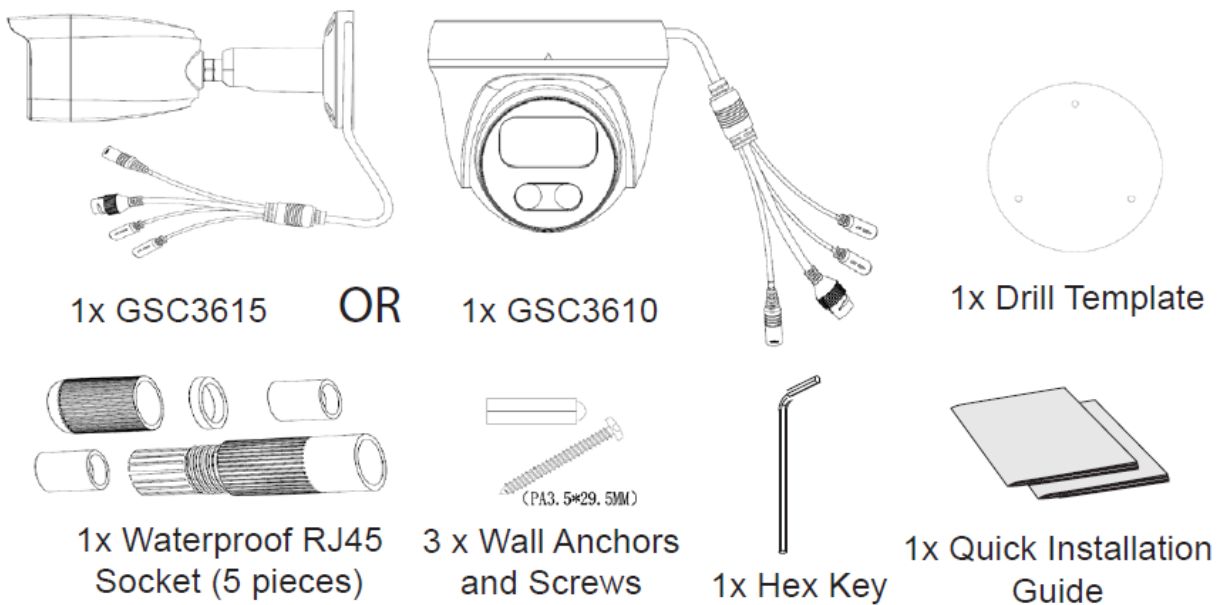

**Figure 1: GSC3610/GSC3615 Package Content**

**Note:** Check the package before installation. If you find anything missing, contact your system administrator.

## Powering and Connecting the GSC36XX

The GSC3610/GSC3615 can be powered either using the right PSU (DC12V, 1A) or using a PoE switch, please refer to illustration below to do the wiring and connect the waterproof RJ45 socket:

### Option A (Recommended)

1. Based on T-568B (see diagram below) to install the RJ45 plug, tighten the connector using the provided waterproof socket.

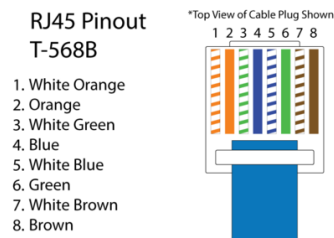

2. Connect other end of the cable into a switch supporting Power over Ethernet.

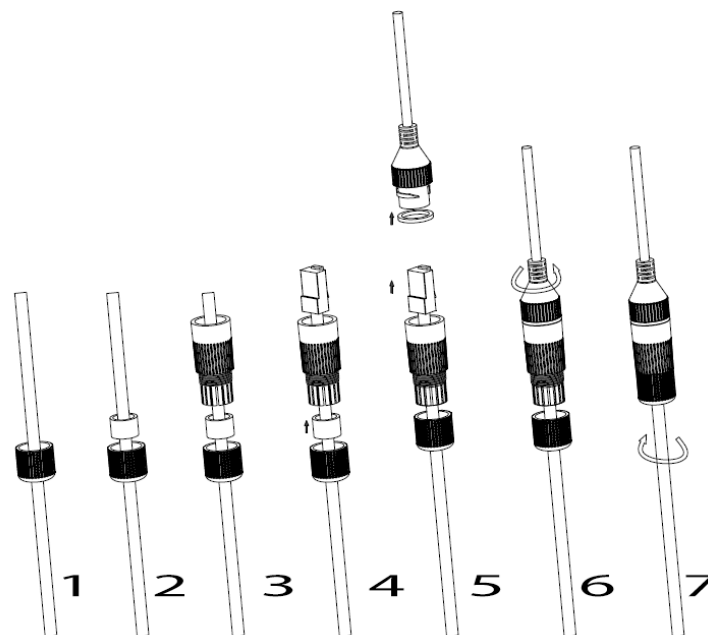

Figure 2: RJ45 plug installation

### Option B

1. Wire the cable and connect it to a network switch as in the figure above.
2. Connect a 12VDC, 1A (minimum) Power Adapter (not provided) to the power socket of the GSC3610 tail cable. Make sure the polarity "+" (center) and "-" (outside) are correctly connected.

## HARDWARE INSTALLATION

### Mounting GSC3610

**Step 1:** Use supplied drill template to drill holes at ceiling. Select appropriate anchors or screws based on ceiling material.

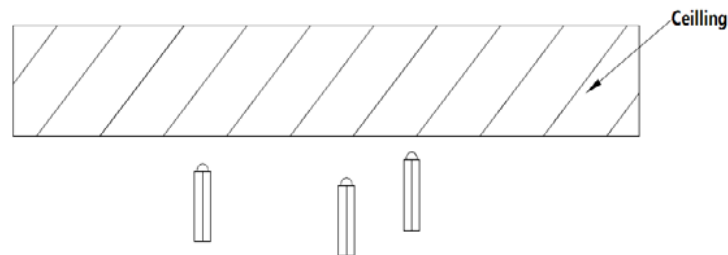

**Step 2:** Remove the top cover of the camera by turning it counterclockwise as shown in the figure below. Refer to the arrow and small notch on the machine body as shown below to align the machine cover.

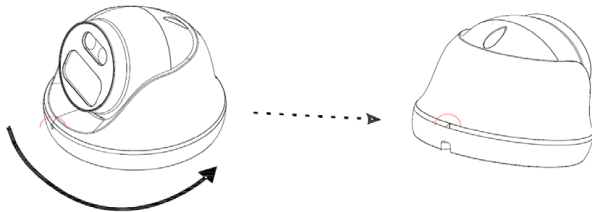

**Step 3:** Place the cable into the groove of camera cover, mount the cover into ceiling using provided screws as shown in below diagram. Leave the connectors of cable dangling outside the cover.

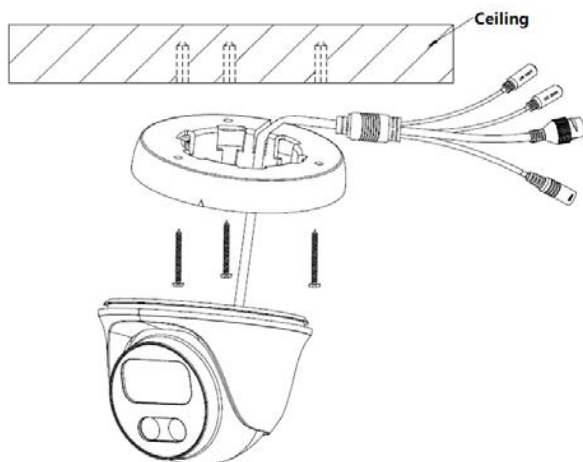

**Step 4:** Hold the body of camera and align to the notch as shown in the diagram, then push the body of camera into the cover of camera already mounted at the ceiling.

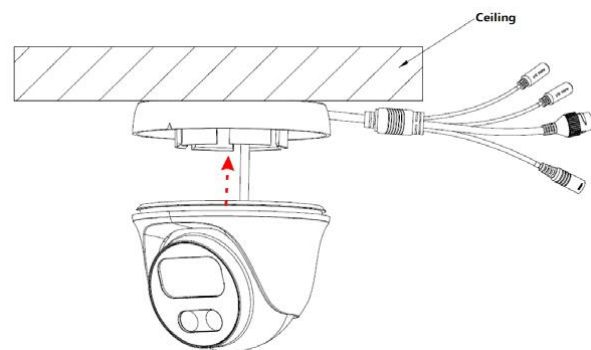

**Step 5:** Rotate the body of camera to snap to the self-locking bracket.

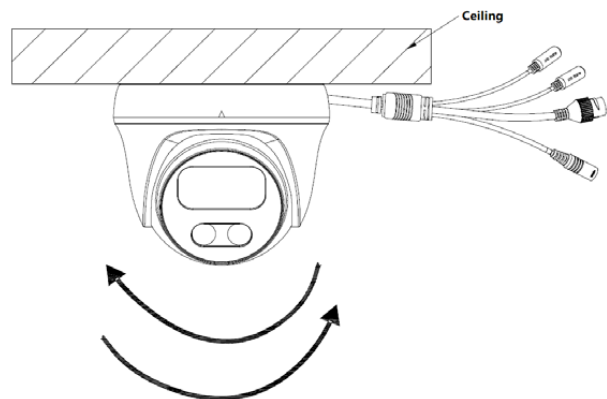

Figure 3: Mounting GSC3610





## Mounting GSC3615

**Step 1:** Use supplied drill template to drill holes at ceiling. Select appropriate anchors or screws based on ceiling material.

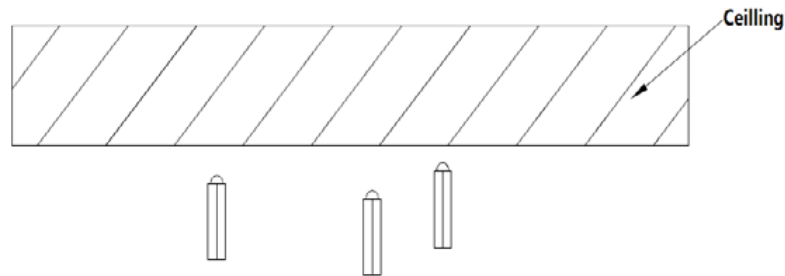

**Step 2:**

Place the cable into the groove of camera mounting base, mount the base at wall using provided screws as shown in below diagram. Leave the connectors of cable dangling outside the cover.

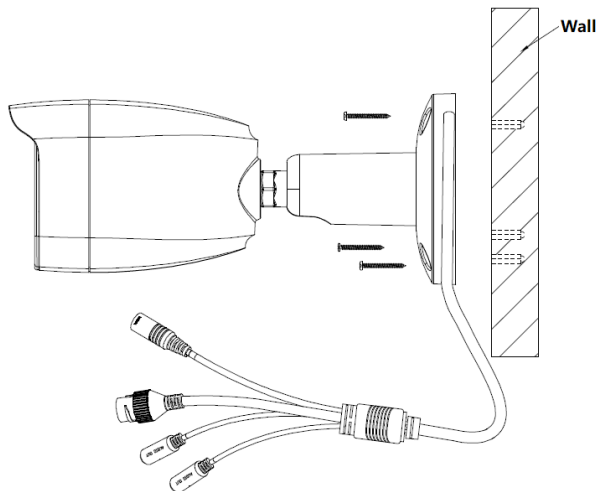

**Step 3:** Use the provided hex key to lose the fix screw, rotate and adjust the camera to the appropriate angle and position.

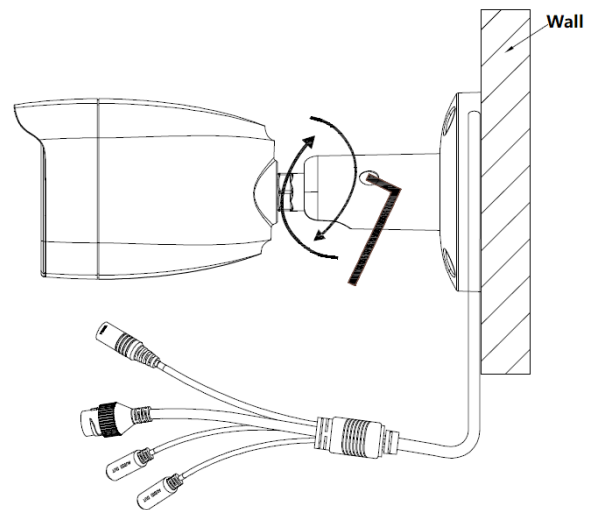

**Step 4:** Hold the body of camera and align to the notch as shown in the diagram, then push the body of camera into the cover of camera already mounted at the ceiling.

Figure 4: Mounting GSC3615

## GSC36XX APPLICATION SCENARIOS

GSC36XX is very versatile infrared IP Camera, it can be used in a lot of scenarios.

### LAN without Internet

For multi-room or a bigger space, multiple GSC36XX might be required. User can establish a local area network using PoE switch.

If remote access required, a router with internet access may add in.

#### **Equipment List:**

1. Several GSC36XX
2. Ethernet cables
3. Switch (Static IP required to configure to IP Cameras)
4. PoE Switch (Optional, better solution)

**Note:** If remote access to the cameras required to view the LIVE video stream, then broadband Internet is required and more equipment required:

5. Router (if DHCP configured than static IP is not required although still recommended)
6. iPhone or Android phone. (Application like “IP Cam Viewer”)

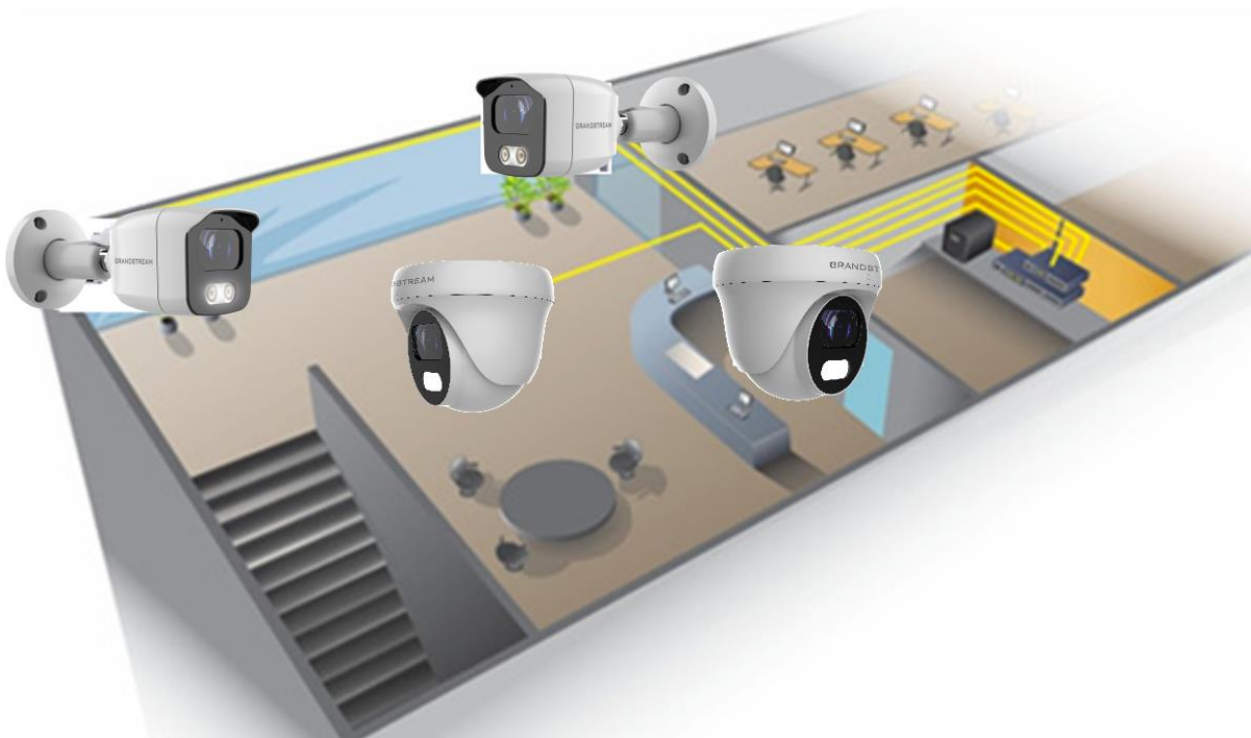

Figure 5: GSC3610/GSC3615 Working in LAN

## LAN with Internet

For multi-room or a bigger space, with Internet access and local video recording required, following list is recommended:

### Equipment List:

1. Several GSC36XX
2. Ethernet cables
3. Switch (PoE Switch recommended)
4. Router
5. Broadband Internet Access (FiOS, Cable or DSL)
6. iPhone or Android phone. (Application like "IP Cam Viewer")
7. VMS GSurf\_Pro Remote Access (Optional)

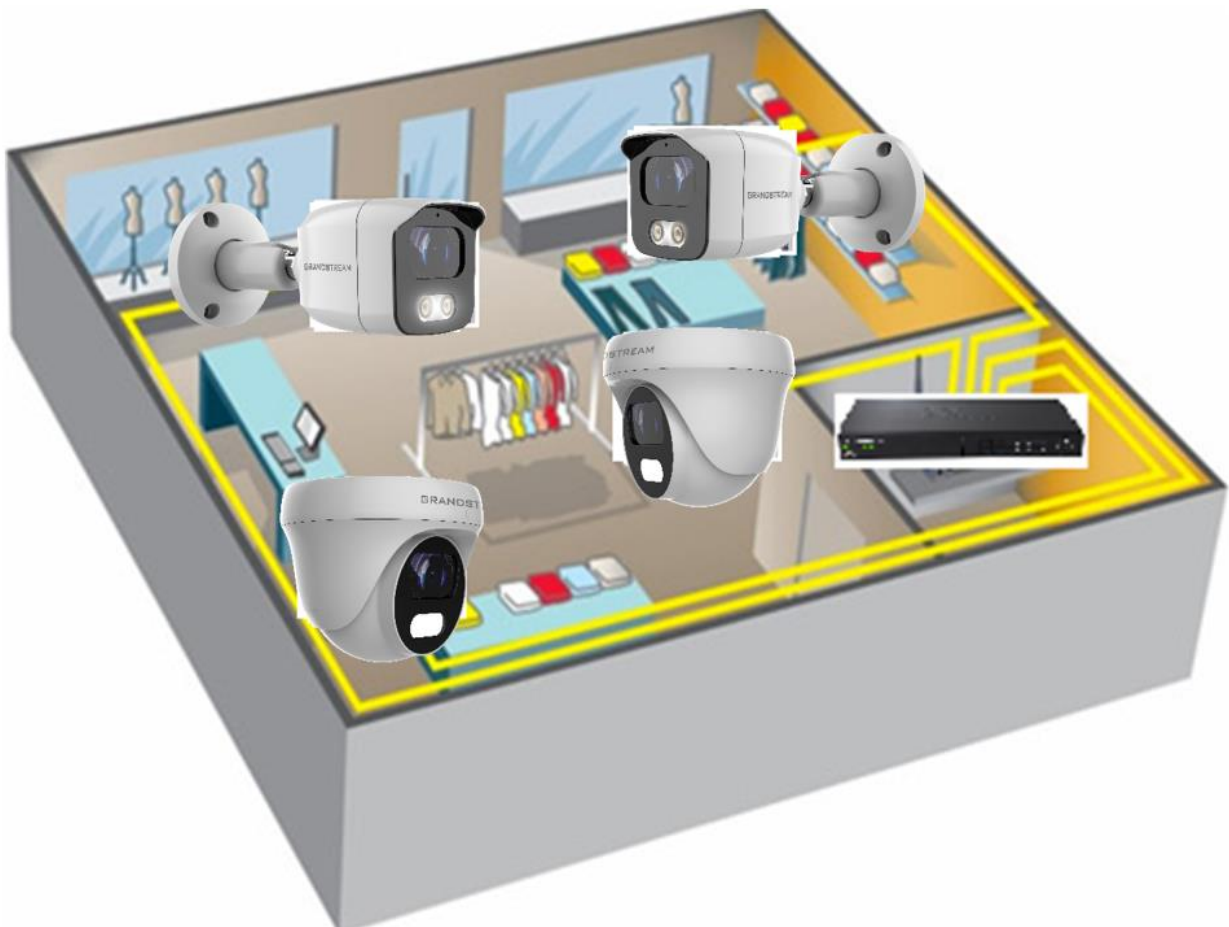

Figure 6: GSC36XX working with Internet



## GSC3610/GSC3615 Web GUI

Note the below requirement to access/configure the GSC36XX:

- Internet Browser like Firefox, Chrome, Microsoft Internet Explorer or Edge.
- DHCP server enabled on the network.

Double check the requirements then follow the below steps to access the GSC36XX WEB configuration page:

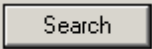
1. Download and install GS\_Search tool from the link below:  
[http://www.grandstream.com/products/tools/surveillance/GS\\_Search.zip](http://www.grandstream.com/products/tools/surveillance/GS_Search.zip)
2. Run the Grandstream GS\_Search tool.
3. Click on  button to start device detection.
4. The detected devices will appear in the output field as below.

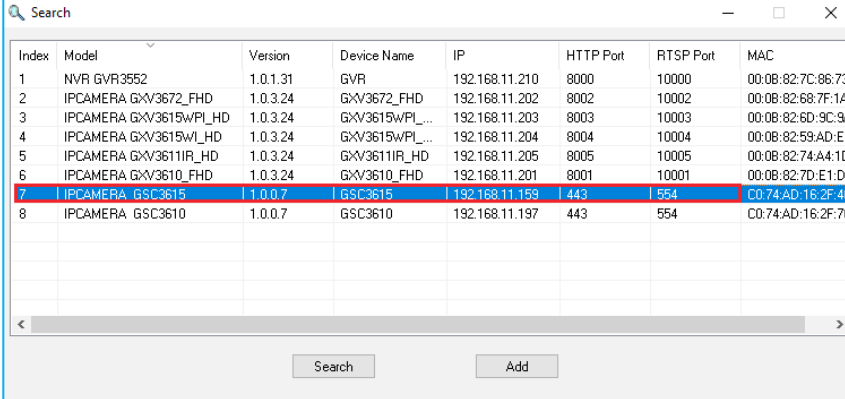

Index	Model	Version	Device Name	IP	HTTP Port	RTSP Port	MAC
1	NVR GVR3552	1.0.1.31	GVR	192.168.11.210	8000	10000	00:08:82:7C:86:73
2	IPCAMERA GXV3672_FHD	1.0.3.24	GXV3672_FHD	192.168.11.202	8002	10002	00:08:82:68:7F:1A
3	IPCAMERA GXV3615WPL_HD	1.0.3.24	GXV3615WPL_...	192.168.11.203	8003	10003	00:08:82:6D:9C:98
4	IPCAMERA GXV3615WPL_HD	1.0.3.24	GXV3615WPL_...	192.168.11.204	8004	10004	00:08:82:59:AD:EF
5	IPCAMERA GXV3611IR_HD	1.0.3.24	GXV3611IR_HD	192.168.11.205	8005	10005	00:08:82:74:A4:1D
6	IPCAMERA GXV3610_FHD	1.0.3.24	GXV3610_FHD	192.168.11.201	8001	10001	00:08:82:7D:E1:D7
7	IPCAMERA GSC3615	1.0.0.7	GSC3615	192.168.11.159	443	554	C0:74:AD:16:2F:4C
8	IPCAMERA GSC3610	1.0.0.7	GSC3610	192.168.11.197	443	554	C0:74:AD:16:2F:7C

**Figure 7: GS\_Search tool**

5. Double click on the detected device. The default browser (Chrome in this example) will open to display the camera's login web interface.

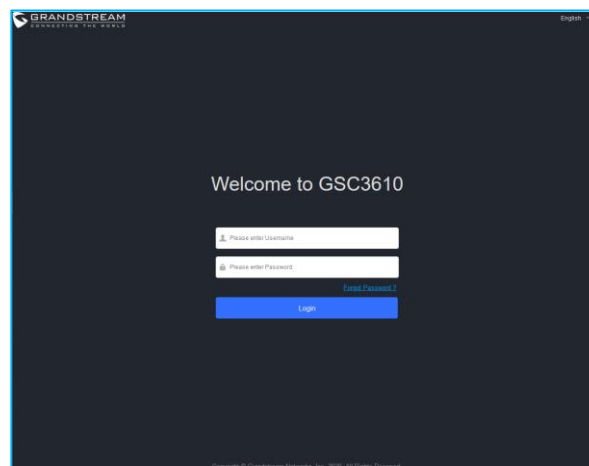

**Figure 8: GSC36XX Login Page**



- When clicking on the “Language” drop down, supported languages will be displayed. Click to select the related webpage display language. (Current firmware supports only English as default and simplified Chinese).

6. Access using Default Username “admin” and password “admin”

## Web GUI Settings





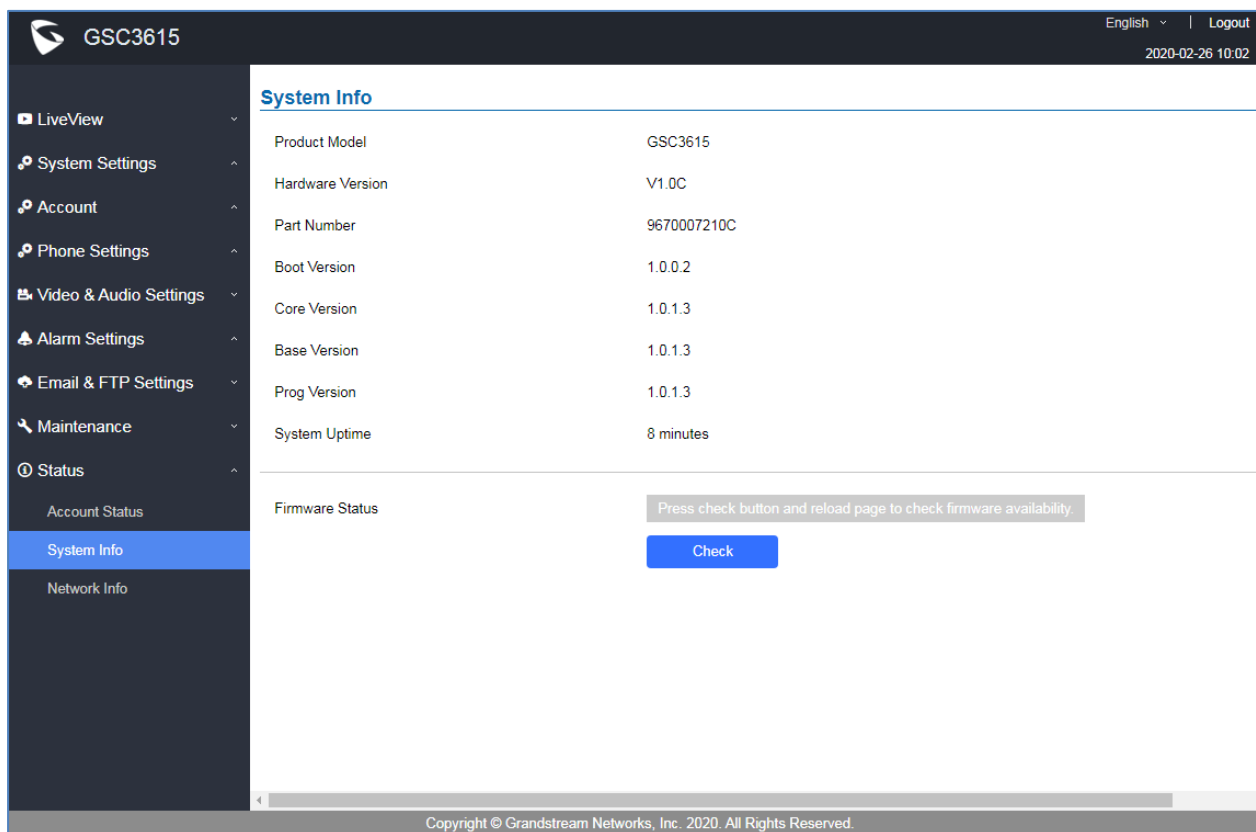



The GSC3610/GSC3615 embedded Web server responds to HTTP/HTTPS GET/POST requests. Embedded HTML pages allow users to configure the application phone through a Web browser such as Microsoft’s IE, Mozilla, Firefox, Google Chrome and etc.

- Once logged in successfully to the GSC36XX, the browser will display the GUI as shown below:



**Figure 9: GSC3610/GSC3615 WEB GUI**

**Table 4: GSC3610/GSC3615 WEB GUI Sections**

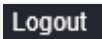
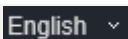
Fields	Description
<b>LiveView</b>	Access to live view stream page.
	Play/Stop Live View
	Play the primary stream.
	Play the secondary stream.
	Zoom in/out
	Mute/Un-Mute
	Start/Stop Talking
	Capture a screenshot
	Start/Stop Recording
	Set up "Record Path" and "Capture Path"
<b>System Settings</b>	Access to "System Settings" page.
<b>Account</b>	Access to "Account" configuration page.
<b>Phone Settings</b>	Access to "Phone Settings" configuration page.
<b>Video &amp; Audio Settings</b>	Access to "Video & Audio settings" page.
<b>Alarm Settings</b>	Access to "Alarm settings" page.
<b>Email &amp; FTP Settings</b>	Access to "Email & FTP Settings" page.
<b>Maintenance</b>	Access to "Maintenance" page.
<b>Status</b>	Click to enter "Status" page.
<b>Display Performance</b>	BRIGHTNESS CONTRAST SATURATION SHARP
<b>Date &amp; Time</b>	Displays the current Date & Time
	Logout from the web page.
	Select the webpage language.



## GSC36XX SETTINGS

### Live View Page

This page allows users to view the live video of the GSC3610/GSC3615.

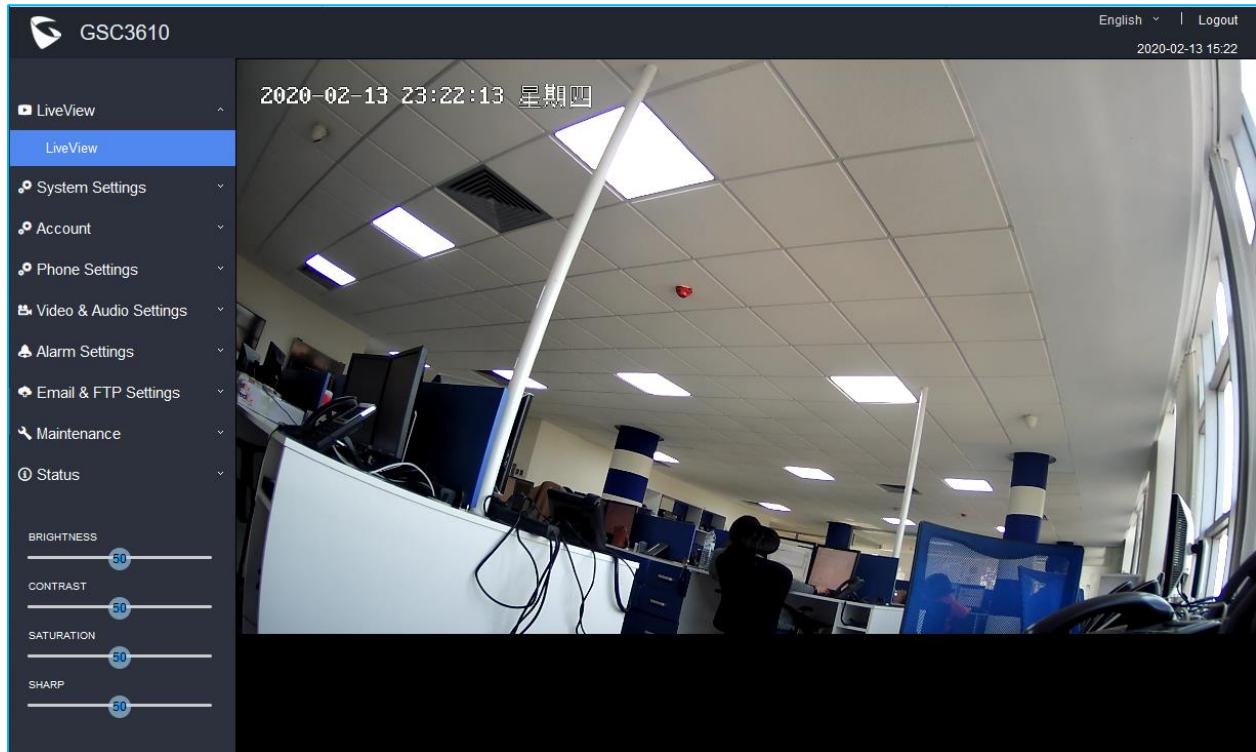

Figure 10: Live View

Two streams are available:

- **Primary video stream:** 1920\*1080 resolution, recommended for continuous full HD recording
- **Secondary video stream:** 640\*480 resolution, recommended for SIP/VoIP video calls

**Note:** Make sure to download/Install the browser video plugin to have access to the Live View and video stream tools.



## System Settings

This page allows users to configure date and time, network settings as well as access method to the GSC36XX and password for accessing the Web GUI.

### Date & Time Settings

This page allows users to adjust system date and time.

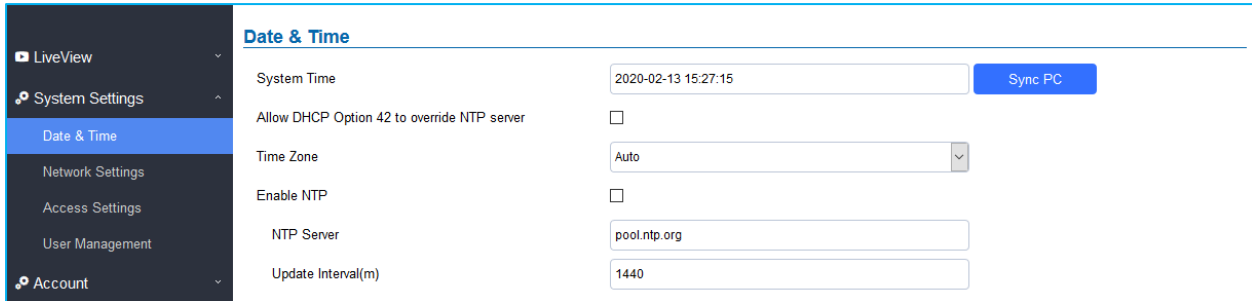

**Figure 11: Date & Time Page**

**Table 5: Date & Time**

<b>System Time</b>	Displays the current system time.
<b>Allow DHCP Option 42 to override NTP server</b>	Defines whether DHCP Option 42 should override NTP server or not. When enabled, DHCP Option 42 will override the NTP server if it is set up on the LAN. The default setting is “Yes”.
<b>Sync PC</b>	Clicks to synchronize current time with the computer.
<b>Time Zone</b>	Selects from drop down menu the preferred time zone. Default is “Auto”
<b>Enable NTP</b>	Enables NTP to synchronize device time.
<b>NTP Server</b>	Configures the domain name of NTP server. Default is “pool.ntp.org”
<b>Update Interval</b>	Configures the Interval (in minutes) to retrieve updates from the NTP server.

### Network Settings

This page allows users to set either a static or DHCP IP address to access the unit.





- LiveView
- System Settings
- Date & Time
- Network Settings
- Access Settings
- User Management
- Account
- Phone Settings
- Video & Audio Settings
- Alarm Settings
- Email & FTP Settings
- Maintenance
- Status

### Basic Settings

---

#### IP Address Config

IP Address Mode  DHCP  Static IP

IP Address

Subnet Mask

Gateway

---

#### DNS Config

DNS Address Type  Dynamic DNS  Static DNS

DNS Server 1

DNS Server 2

---

#### LLDP Config

Enable LLDP  Disable  Enable

Layer 2 QoS 802.1Q/VLAN Tag

Layer 2 QoS 802.1p Priority Value

**Figure 12: Basic Settings Page**

**Table 6: Basic Settings**

<b>IP Address Mode</b>	Selects DHCP or Static IP. Default DHCP. (Static recommended)
<b>IP Address</b>	Configures the Static IP of the GSC36XX.
<b>Subnet Mask</b>	Configures the Associated Subnet Mask.
<b>Gateway</b>	Configures the Gateway IP address.
<b>DNS Address Type</b>	Specifies the DNS type used: Dynamic DNS or Static DNS.
<b>DNS Server 1</b>	Configures DNS Server 1 IP address.
<b>DNS Server 2</b>	Configures DNS Server 2 IP address.
<b>Enable LLDP</b>	Controls the LLDP (Link Layer Discovery Protocol) service. The default setting is “Enabled”.
<b>Layer 2 QoS 802.1Q/VLAN Tag</b>	Assigns the VLAN Tag of the Layer 2 QoS packets. Default value is 0.
<b>Layer 2 QoS 802.1p Priority Value</b>	Assigns the priority value of the Layer2 QoS packets. Default value is 0.



### Notes:

- If the device is behind SOHO (Small Office Home Office) router with port forwarding configured for remote access, static IP should be used to avoid IP address changes after router reboot.
- TCP port above 5000 is suggested to Port forward HTTP for remote access, due to some ISP would block port 80 for inbound traffic. For example, change the default HTTP port from 80 to 8088, to make sure the TCP port will not be blocked.
- In addition to HTTP port, RTSP port is also required to configure via port forwarding, so that the remote party can view the video stream.
- If the default TCP port 80 is changed to port “A”, then RTSP port should be “2000+A” (changed from default TCP 554). Both TCP port “A” and “2000+A” should be configured for port forwarding in the router. For example, of the HTTP port is changed to 8088, the RTSP port should be 10088, both TCP ports 8088 and 10088 should be configured for port forwarding to have remote GSC36XX access: 8088 for web portal, and 10088 for video streaming.

### Access Settings

This page configures the GSC36XX access control parameters.

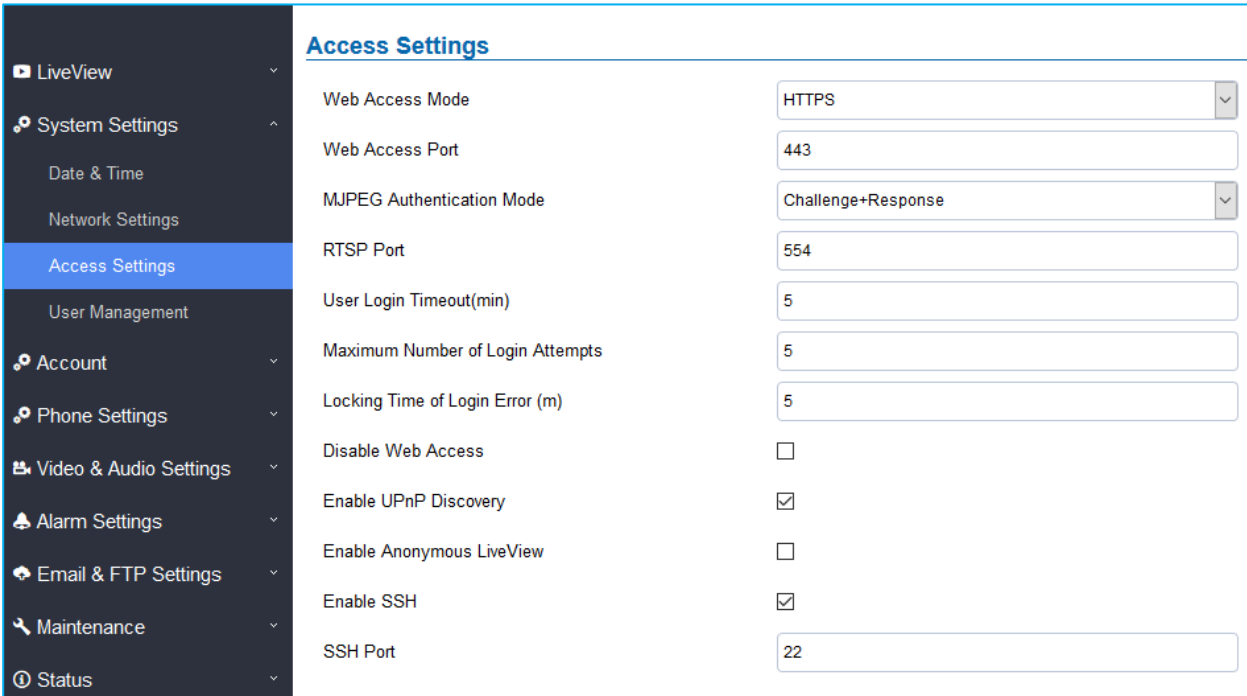

Access Settings	
Web Access Mode	HTTPS
Web Access Port	443
MJPEG Authentication Mode	Challenge+Response
RTSP Port	554
User Login Timeout(min)	5
Maximum Number of Login Attempts	5
Locking Time of Login Error (m)	5
Disable Web Access	<input type="checkbox"/>
Enable UPnP Discovery	<input checked="" type="checkbox"/>
Enable Anonymous LiveView	<input type="checkbox"/>
Enable SSH	<input checked="" type="checkbox"/>
SSH Port	22

Figure 13: Access Settings Page



**Table 7: Access Settings**

<b>Web Access Mode</b>	Selects the access mode to the Web GUI either HTTP or HTTPS.
<b>Web Access Port</b>	Specifies the TCP port for Web Access, default 443.
<b>MJPEG Authentication Mode</b>	<p>Allows 3<sup>rd</sup> party system integrator or developers to implement related application for users. By default, this feature is disabled and use more secured “Challenge+Response” mode.</p> <p>If enabled, user can send HTTP API with correct credentials to retrieve MJPEG video stream or JPEG snapshot from GSC.</p> <p>Notes:</p> <p>1- The MJPEG stream can be retrieved via the following URL HTML based →  <b>http(s)://admin:password@IP_GSC3610:Port/jpeg/mjpeg.html</b>            Stream → <b>http(s)://admin:password@ip:port/jpeg/stream</b></p> <p>2- The MJPEG stream retrieved via the methods above is running on the background and cannot be tuned. If users want more flexibility, they can use the three configurable video streams as shown on <b>[Retrieving Video Streams]</b></p>
<b>RTSP Port</b>	Specifies RTSP port for media stream, default TCP port 554.
<b>User Login Timeout(min)</b>	If no action is made within this time the GSC36XX will logout from the Web GUI, range is between 3 and 60. Default is 5.
<b>Maximum Number of Login Attempts</b>	Specifies the allowed login times error limit, if the unsuccessful login attempts exceed this value, the GSC36XX webGUI will be locked for the time specified in Login Error Lock Time. Default is 5.
<b>Locking Time of Login Error (m)</b>	Specifies how long the GSC36XX is locked before a new login attempt is allowed. Default is 5.
<b>Disable Web Access</b>	<p>Allow or deny the web access to the GSC36XX. (HTTP API do not take effect when this option is enabled).</p> <p><b>Note:</b> If both WebUI and SSH are disabled, GSC36XX will get blocked and not be able to be accessed. Only two ways to get it back:</p> <ol style="list-style-type: none"> <li>1. Re-provisioned by ITSP or Service Provider (by adjusting the related parameters)</li> <li>2. Hard Reset (GSC36XX has to be offline and uninstalled to perform this hard reset).</li> </ol>
<b>Enable UPnP Discovery</b>	UPnP (or mDNS) function for local discovery. Default setting is enabled.



<b>Enable Anonymous LiveView</b>	<p>1. When enabled, user can display the camera stream from without admin credentials using the following URL scheme:  <a href="http(s)://GSC3610_IP:port/videoview.html">http(s)://GSC3610_IP:port/videoview.html</a></p> <p>1. User can also retrieve a real-time snapshot without admin credentials using the following URL:  <a href="http(s)://IP:port/anonymous/snapshot/view.html">http(s)://IP:port/anonymous/snapshot/view.html</a></p> <p>Or with:  <a href="https://IP_GSC3610:Port/anonymous/snapshot/view.jpg">https://IP_GSC3610:Port/anonymous/snapshot/view.jpg</a></p> <p>2. To retrieve video stream via RTSP, users can use the following format: <code>rtsp://IP_GSC3610:Port/X</code> where X=0,4 for 1<sup>st</sup>, 2<sup>nd</sup> streams, respectively.</p>
<b>Enable SSH</b>	Allows SSH access for remote secured configuration purposes (restart, upgrade, provision...)
<b>SSH Port</b>	Specifies the SSH port. Default setting is 22.

## Retrieving Video Streams

### RTSP Stream

To retrieve video stream via RTSP, users can use the following format:

[rtsp://admin:password@IP\\_GSC36XX:Port/X](rtsp://admin:password@IP_GSC36XX:Port/X) where X=0,4,8 for 1<sup>st</sup>, 2<sup>nd</sup> streams respectively

### MJPEG Stream

The GSC36XX supports MJPEG Stream live viewing via HTTP API commands, this can be used without installing the Live view browser plugin. Users can deploy two methods to retrieve MJPEG stream depending on *MJPEG Authentication Mode*, which can be set under following path:

**Web UI → System Settings → Access Settings**

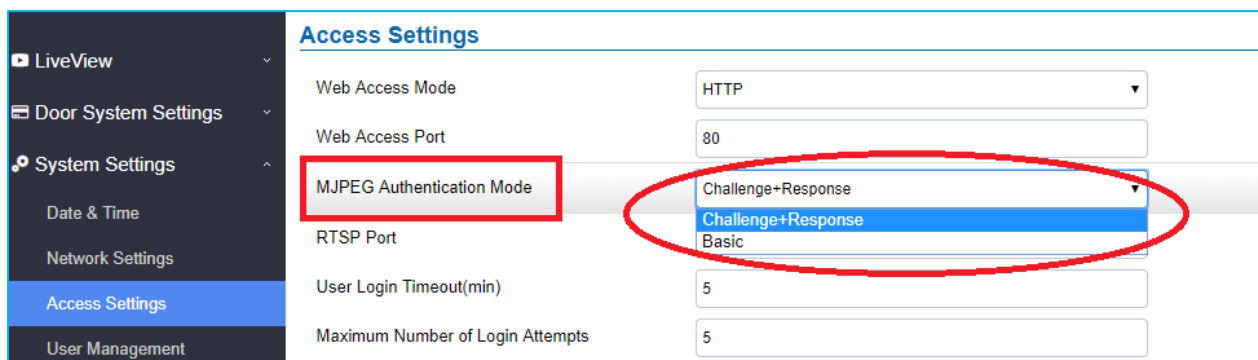

**Figure 14: MJPEG Authentication Mode**



#### A. “Challenge+Response” MJPEG Authentication Mode:

In order to get live view stream using MJPEG stream over HTTP command on this mode, please follow below steps:

1. In browser type in **http(s)://IP\_Address\_GSC36XX:Port/jpeg/mjpeg.html**

**Example:** <https://192.168.5.146/jpeg/mjpeg.html>

2. The browser will pop up the window above asking for credentials, user needs to enter admin credential.
3. The browser will show MJPEG stream (720p).

#### B. “Basic” MJPEG Authentication Mode:

Please follow below steps in order to take a snapshot via HTTP commands:

1. In browser type in: **http(s)://admin:password@IP\_Address\_GSC:Port/jpeg/mjpeg.html**

**Example:** <https://admin:admin@192.168.5.157:443/jpeg/mjpeg.html>

2. The browser will show MJPEG stream (720p).

**Note:** Similar command can be applied to open source application like **VLC MediaPlayer** to retrieve H.264 video stream with better quality: **rtsp://admin:password@IP\_GSC36XX:Port/X**

Where **X=0,4** corresponded to **1<sup>st</sup>, 2<sup>nd</sup>** video stream

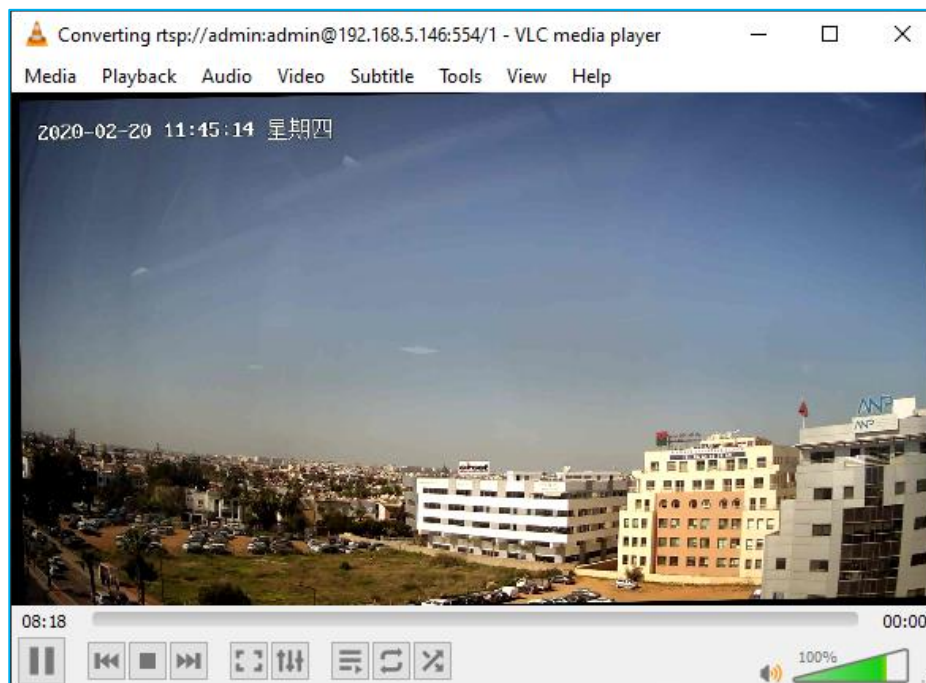

Figure 15: RTSP steam display using VLC



## User Management

This page allows users to configure the password for administrator. Since this is a door system which must be a secure product, the use is only limited to administrator.

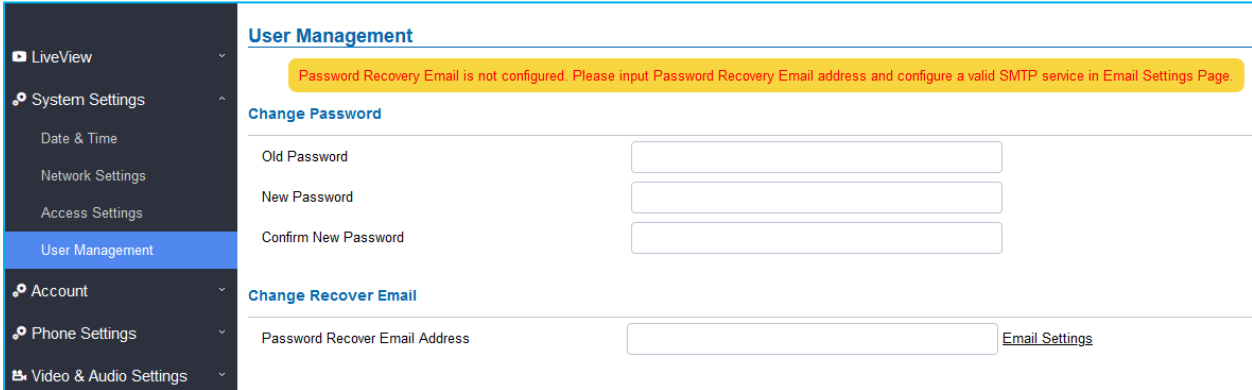

Figure 16: User Management Page

Table 8: User Management

<b>Old Password</b>	Old password must be entered to change new password.
<b>New Password</b>	Fill in the revised new password in this field.
<b>Confirm User Password</b>	Re-enter the new password for verification, must match.
<b>Password Recovery Email Address</b>	This option is <b>highly recommended</b> , as if the password is lost, you can recover it on the configured Email address. <b>Note:</b> Make sure to configure SMTP Email Settings under “ <b>Email Settings</b> ”

**Note:**

- When trying to change the password, users need to set the “Password Recovery Email” which should be a valid Email account configurable under “**Email & FTP Settings → Email Settings**” to retrieve the email before the new admin password take effect as displayed on the following screenshot.

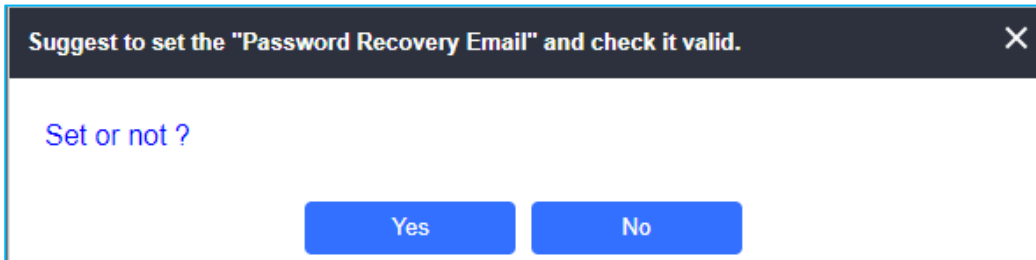

Figure 17: Password Recovery Email



## Account

The GSC36XX supports 4 SIP accounts and 4 lines, this section covers the configuration of basic and advanced sip settings for each account.

### Account 1 - 4

This page allows the administrator to configure the SIP account basic and advanced settings for each SIP account:

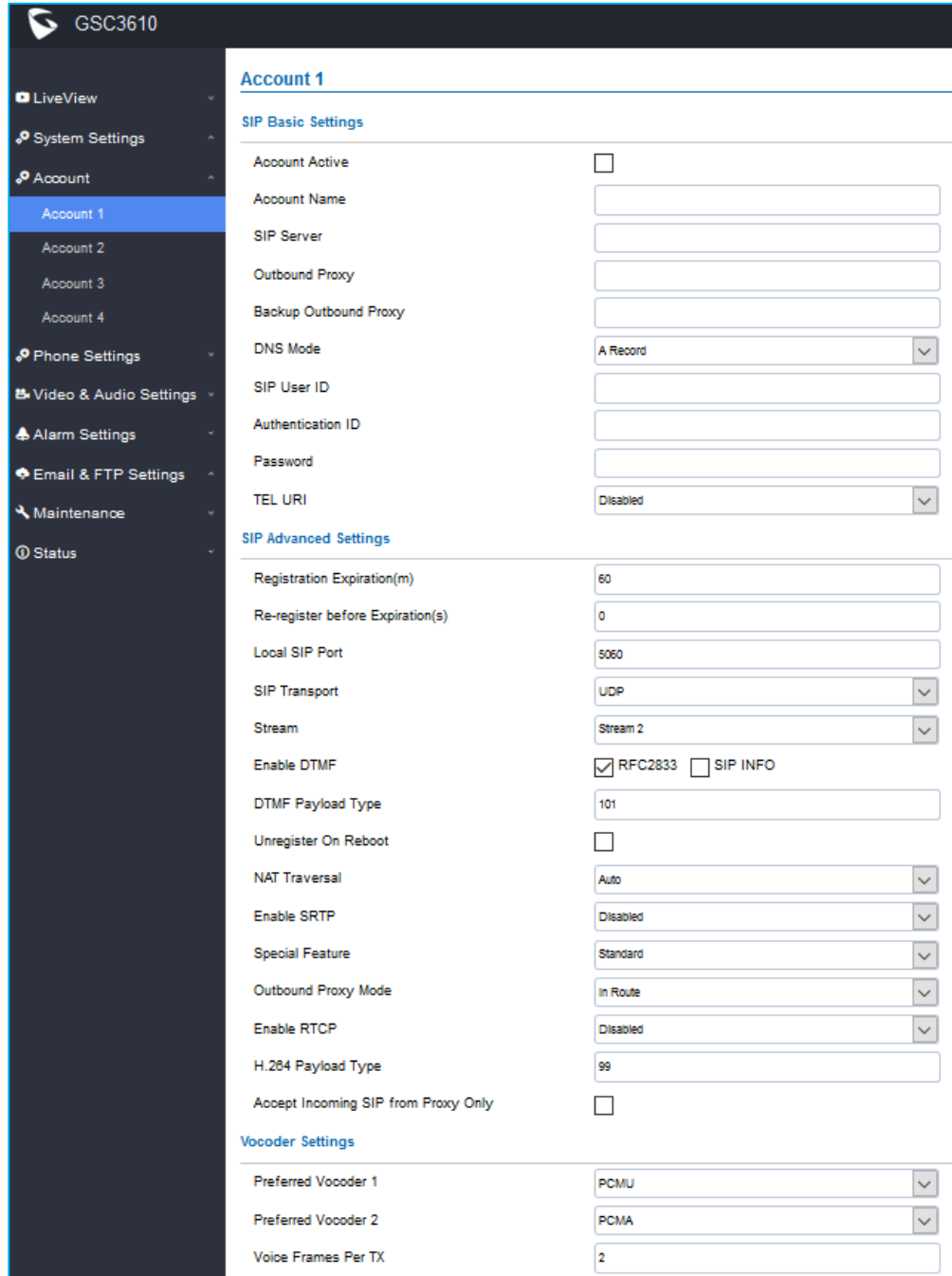

**GSC3610**

**Account 1**

**SIP Basic Settings**

Account Active	<input type="checkbox"/>
Account Name	<input type="text"/>
SIP Server	<input type="text"/>
Outbound Proxy	<input type="text"/>
Backup Outbound Proxy	<input type="text"/>
DNS Mode	A Record
SIP User ID	<input type="text"/>
Authentication ID	<input type="text"/>
Password	<input type="text"/>
TEL URI	Disabled

**SIP Advanced Settings**

Registration Expiration(m)	60
Re-register before Expiration(s)	0
Local SIP Port	5060
SIP Transport	UDP
Stream	Stream 2
Enable DTMF	<input checked="" type="checkbox"/> RFC2833 <input type="checkbox"/> SIP INFO
DTMF Payload Type	101
Unregister On Reboot	<input type="checkbox"/>
NAT Traversal	Auto
Enable SRTP	Disabled
Special Feature	Standard
Outbound Proxy Mode	In Route
Enable RTCP	Disabled
H.264 Payload Type	99
Accept Incoming SIP from Proxy Only	<input type="checkbox"/>

**Voocoder Settings**

Preferred Voocoder 1	PCMU
Preferred Voocoder 2	PCMA
Voice Frames Per TX	2

Figure 18: SIP Account Settings Page

**Table 9: SIP Account Basic & Advanced Settings**

SIP Basic Settings	
<b>Account Active</b>	This field indicates whether the account is active. Default setting is "Yes".
<b>Account Name</b>	Configures the SIP account name used for identification.
<b>SIP Server</b>	Configures the FQDN or IP of the SIP server from VoIP service provider or local IPPBX.
<b>Outbound Proxy</b>	Configures the IP address or the domain name of the outbound proxy, media gateway, or session border controller. It is used by the GSC for firewall or NAT penetration in different network environments. If a symmetric NAT is detected, STUN will not work and only an outbound proxy can provide a solution.
<b>Backup Outbound Proxy</b>	Configures the backup outbound proxy to be used when the "Outbound Proxy" registration fails. By default, this field is left empty.
<b>DNS Mode</b>	Configure which DNS mode will be used to translate the SIP Server FQDN (Default value is <b>A Record</b> ): <ul style="list-style-type: none"> <li>• <b>A Record.</b></li> <li>• <b>SRV.</b></li> <li>• <b>NAPTR/SRV.</b></li> </ul>
<b>SIP User ID</b>	Configures the SIP username or telephone number from ITSP. <b>Note:</b> Letters, digits and special characters including @ are supported.
<b>Authenticate ID</b>	Configures the Authenticate ID used by SIP proxy.
<b>Password</b>	Sets the Authenticate password used by SIP proxy. <b>Note:</b> For security reasons, the SIP password is invisible on the web UI.
<b>TEL URI</b>	Select "User=Phone" or "Enabled" from the dropdown list. If the SIP account has an assigned PSTN telephone number, this field should be set to "User=Phone". Then a "User=Phone" parameter will be attached to the Request-Line and "TO" header in the SIP request to indicate the E.164 number. If set to "Enable", "Tel:" will be used instead of "SIP:" in the SIP request. The default setting is "Disable".
SIP Advanced Settings	
<b>Registration Expiration (m)</b>	Sets the registration expiration time. Default setting is 60 minutes. Valid range is from 1 to 64800 minutes.
<b>Re-register before Expiration (s)</b>	Specifies the time frequency (in seconds) that the GSC36XX sends re-registration request before the Register Expiration. The default value is 0. Range is from 0-64800 seconds.





<b>Local SIP Port</b>	Sets the local SIP port. Default setting is 5060 for Account 1, 5062 for Account 2, 5064 for Account 3, 5066 for Account 4.
<b>SIP Transport</b>	Chooses the SIP transport protocol. UDP, TCP or TCP/TLS. Default setting is UDP.
<b>Stream</b>	Select the Video stream to be used by the GSC36XX when call is made from this SIP Account. Default is Stream 2.
<b>Enable DTMF</b>	Specifies the mechanism to transmit DTMF digits. There are 2 supported modes: <ul style="list-style-type: none"> <li>• <b>RFC2833</b> sends DTMF with RTP packet. Users can check the RTP packet to see the DTMFs sent as well as the number pressed.</li> <li>• <b>SIP INFO</b> uses SIP INFO to carry DTMF. Default setting is "RFC2833"</li> </ul>
<b>DTMF Payload Type</b>	Configures the payload type for DTMF using RFC2833. Default value is 101. Range: 96~127.
<b>Unregister On Reboot</b>	Allows the SIP user's registration information to be cleared when the GSC reboots. The SIP REGISTER message will contain "Expires: 0" to unbind the connection.
<b>NAT Traversal</b>	This parameter configures whether the NAT traversal mechanism is activated. Users could select the mechanism from No, STUN, Keep-alive, UPnP, Auto. The default setting is "No". If set to "STUN" and STUN server is configured, the GSC will route according to the STUN server. If NAT type is Full Cone, Restricted Cone or Port-Restricted Cone, the unit will try to use public IP addresses and port number in all the SIP&SDP messages. The GSC will send empty SDP packet to the SIP server periodically to keep the NAT port open if it is configured to be "Keep-alive". Configure this to be "No" if an outbound proxy is used. "STUN" cannot be used if the detected NAT is symmetric NAT. If the firewall and the SIP device behind the firewall are both able to use UPNP, it can be set to "UPNP". Both parties will negotiate to use which port to allow SIP through.
<b>Enable SRTP</b>	Enable SRTP mode based on your selection from the drop-down menu. The default setting is "Disabled", the two other modes are "Enabled but Not Forced" and "Enabled and Forced".
<b>Special Feature</b>	Configures GSC settings to meet different vendors' server requirements. Users can choose from Standard, Broadsoft or Telefonica Spain.



	The default setting is “Standard”.
<b>Outbound Proxy Mode</b>	<p><b>In route:</b> outbound proxy FQDN is placed in route header. This is used for the SIP Extension to notify the SIP server that the device is behind a NAT/Firewall.</p> <p><b>Always sent to:</b> SIP messages will always be sent to Outbound proxy.</p> <p><b>Not in route:</b> remove the Route header from SIP requests.</p>
<b>Enable RTCP</b>	<p>This option allows 3rd party Service Provider or Cloud Solution to monitor the operation status of the GSC36XX by using related SIP Calls.</p> <p>By default, it is disabled. Users can choose either RTCP or RTCP-XR.</p>
<b>H.264 Payload Type</b>	The H.264 payload type can now be configured to be compatible with 3rd party video phones, as well as other advanced SIP settings, to easy system integration process. Default is 99.
<b>Accept Incoming SIP from Proxy Only</b>	When set to “Yes”, the SIP address of the Request URL in the incoming SIP message will be checked. If it does not match the SIP server address of the account, the call will be rejected. The default setting is disabled.
<b>Vocoder Settings</b>	
<b>Preferred Vocoder 1</b>	Select audio codec to prioritize. Supported codecs are: PCMU and PCMA.
<b>Preferred Vocoder 2</b>	Select the second audio codec PCMU or PCMA.
<b>Voice Frame Per TX</b>	Configures the number of voice frames transmitted per packet. When configuring this, it should be noted that the “ptime” value for the SDP will change with different configurations here. This value is related to the codec used and the actual frames transmitted during the in-payload call. For end users, it is recommended to use the default setting, as incorrect settings may influence the audio quality. Range is from 1-64. The default setting is 2.



## Phone Settings

The phone settings allow users to configure the GSC36XX phone settings and the White list for all the SIP accounts.

### Phone Settings

This page allows users to configure the GSC36XX phone settings.

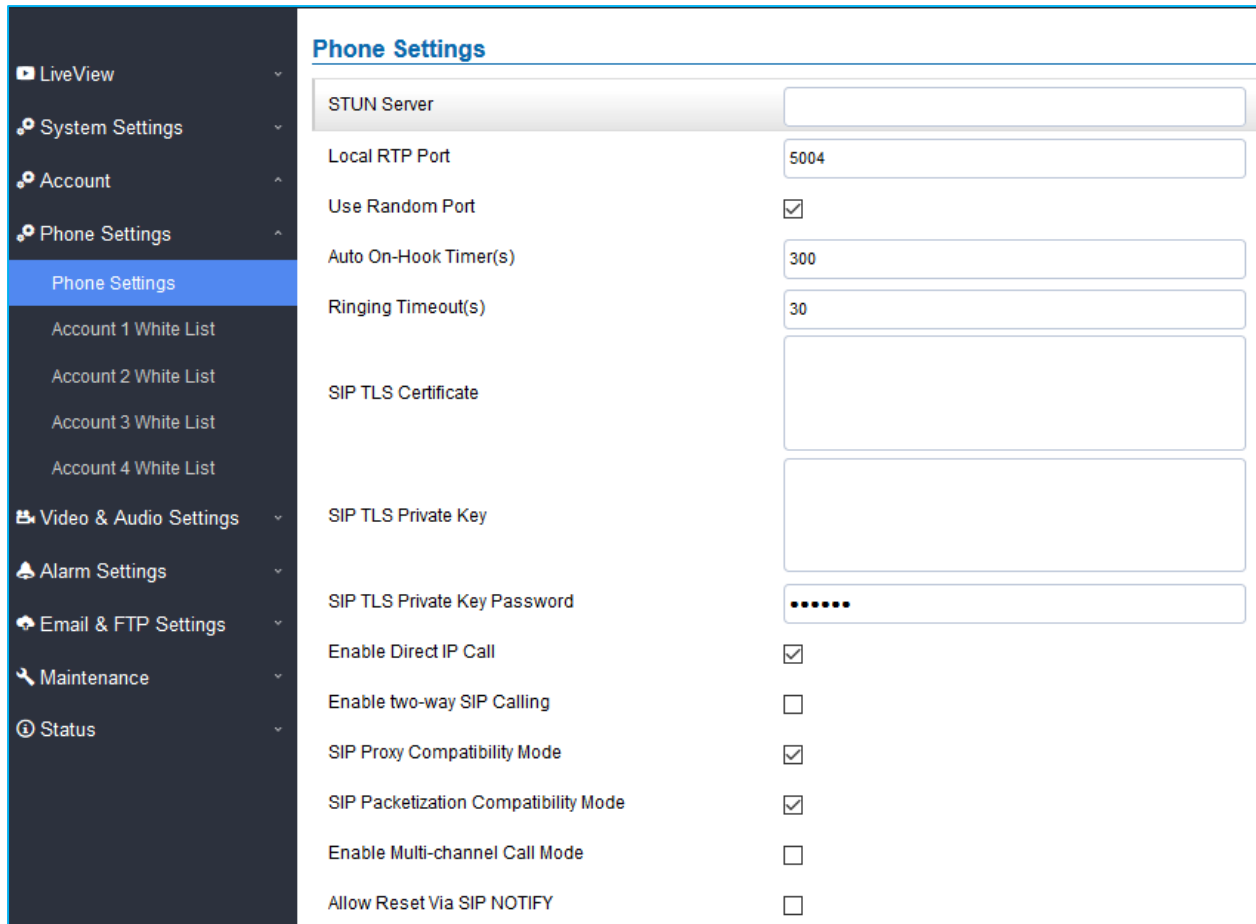

Phone Settings	
STUN Server	<input type="text"/>
Local RTP Port	<input type="text" value="5004"/>
Use Random Port	<input checked="" type="checkbox"/>
Auto On-Hook Timer(s)	<input type="text" value="300"/>
Ringing Timeout(s)	<input type="text" value="30"/>
SIP TLS Certificate	<input type="text"/>
SIP TLS Private Key	<input type="text"/>
SIP TLS Private Key Password	<input type="password" value="....."/>
Enable Direct IP Call	<input checked="" type="checkbox"/>
Enable two-way SIP Calling	<input type="checkbox"/>
SIP Proxy Compatibility Mode	<input checked="" type="checkbox"/>
SIP Packetization Compatibility Mode	<input checked="" type="checkbox"/>
Enable Multi-channel Call Mode	<input type="checkbox"/>
Allow Reset Via SIP NOTIFY	<input type="checkbox"/>

**Figure 19: Phone Settings Page**

**Table 10: Phone Settings**

<b>STUN Server</b>	Configures the STUN server FQDN or IP. If the device is behind a non-symmetric router, STUN server can help to penetrate & resolve NAT issues.
<b>Local RTP Port</b>	Sets the local RTP port for media. Default setting is 5004. Range between 1024~65400.



<b>Use Random Port</b>	<p>Forces the GSC36XX to use random ports for both SIP and RTP messages. This is usually necessary when multiple units are behind the same full cone NAT. The default setting is “Disabled”</p> <p><b>Note:</b> This parameter must be set to “Disabled” for Direct IP Calling to work.</p>
<b>Auto On-Hook Timer</b>	<p>Configures the auto on-hook timer (in seconds) for automatic disconnecting the SIP call. Default setting is 300. Range between 0~65535.</p>
<b>Ring Timeout(s)</b>	<p>Specifies the Ring timeout, when no reply is returned from the called party after exceeding this field, the GSC36XX will hang up the call. The value is in the range of 0s – 90s. By default, it is “30” seconds.</p>
<b>SIP TLS Certificate</b>	<p>Input the TLS certificate here for encryption.</p>
<b>SIP TLS Private Key</b>	<p>Input private key here for TLS security protection.</p>
<b>SIP TLS Private Key Password</b>	<p>Specifies the password for SIP TLS private Key.</p>
<b>Enable Direct IP Call</b>	<p>Accepts peer-to-peer IP call (over UDP only) without SIP server. Default is “Enabled”.</p>
<b>Enable two-way SIP Calling</b>	<p>Allows the user to enable/disable the alarm sound during a SIP call triggered by doorbell pressing.</p>
<b>SIP Proxy Compatibility Mode</b>	<p>Enables more proxy compatibility with cost of bandwidth, the SIP call will send audio no matter what.</p>
<b>SIP Packetization Compatibility Mode</b>	<p>When enabled, the GSC36XX will have in SDP “packetization-mode = 0”. This is required when the device is interacting with legacy video phones that only accepts this value to decode the RTP.</p>
<b>Enable Multi-channel Call Mode</b>	<p>This feature allows the device to receive multiple calls at the same time, with one active and others on hold (up to 4 calls maximum).</p>
<b>Allow Reset Via SIP NOTIFY</b>	<p>Allows to factory reset the devices directly through SIP Notify.</p> <p>If “Allow Reset Via SIP NOTIFY” is “check”, then once the GSC3610/3615 receives the SIP NOTIFY from the SIP server with Event: reset, the device will perform a factory reset after authentication.</p> <p>This authentication can be either with:</p> <ul style="list-style-type: none"> <li>• The admin password if no SIP account is configured on the unit.</li> <li>• The SIP User ID and Password credentials of the SIP account if configured on the unit.</li> </ul> <p>Default is unchecked (disabled).</p>



## Account [1-4] White List

This page allows users to configure the white list per account, which is a phone number or extension list that can call the GSC36XX. (The call will be automatically answered when calling from a phone set on the white list, and all other inbound calls will be blocked), the user can configure up to 30 white phone numbers per SIP account. Moreover, besides numbers associated to active cards, and numbers on the "Number Called When Doorbell Pressed" setting, all whitelisted numbers can open door remotely by using the respective PIN code.

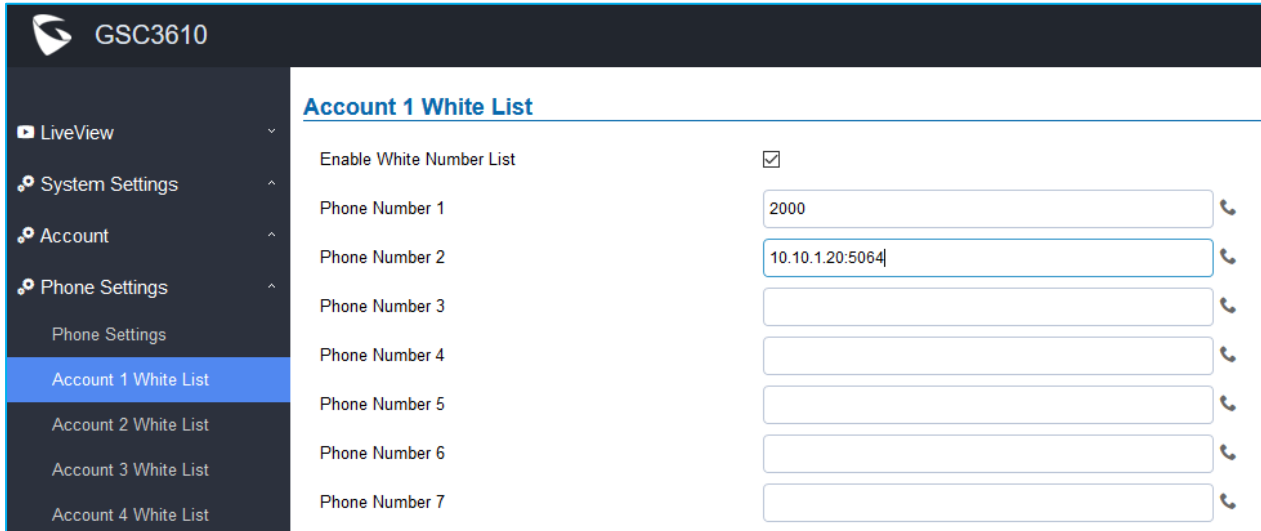

Figure 20: White List Page

The table below gives a brief overview of the options:

Table 11: White List

<b>Enable White Number List</b>	Enables the White List feature.
<b>Phone Number 1 -30</b>	<p>Adds a new phone number (or IP address) to the white list.</p> <p><b>Notes:</b></p> <ul style="list-style-type: none"> <li>When using IP addresses, the port number should be appended (default 5060).</li> <li>Only the whitelisted numbers/IPs can open door remotely using PIN Code when calling GSC36XX.</li> </ul>

## Video & Audio Settings

The audio and videos settings allow users to configure the video / audio codecs, videos resolution, CMOS settings and audio related settings.



## Video Settings

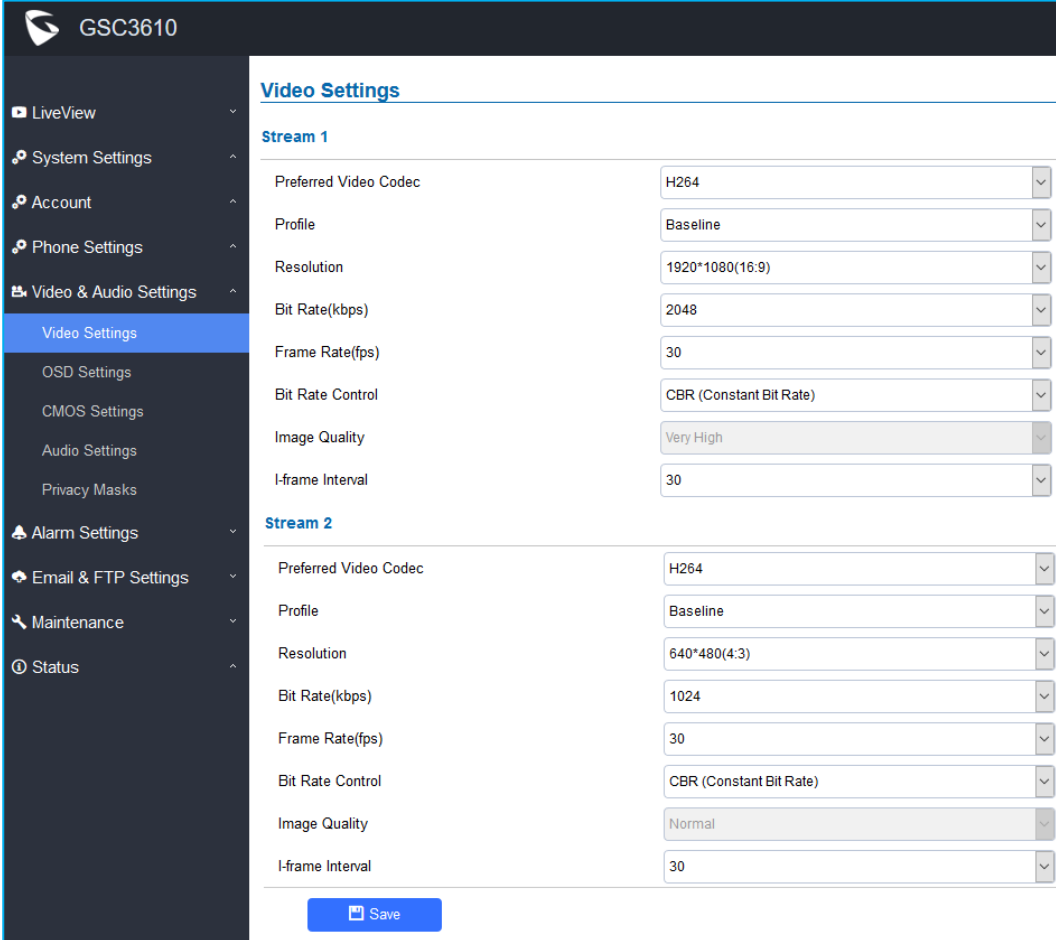

**GSC3610**

**Video Settings**

**Stream 1**

Preferred Video Codec: H264

Profile: Baseline

Resolution: 1920\*1080(16.9)

Bit Rate(kbps): 2048

Frame Rate(fps): 30

Bit Rate Control: CBR (Constant Bit Rate)

Image Quality: Very High

I-frame Interval: 30

**Stream 2**

Preferred Video Codec: H264

Profile: Baseline

Resolution: 640\*480(4.3)

Bit Rate(kbps): 1024

Frame Rate(fps): 30

Bit Rate Control: CBR (Constant Bit Rate)

Image Quality: Normal

I-frame Interval: 30

[Save](#)

Figure 21: Video Settings Page

Table 12: Video Settings

Stream 1	
<b>Preferred Video Codec</b>	Selects the videos codecs, the codecs supported are H.264, H.265 and MJPEG. Default setting is H.264.
<b>Profile</b>	Selects the H.264/H.265 profile. Three profiles are available for H.264: Baseline, Main Profile and High Profile. And one profile for H.265: Hvc Main
<b>Resolution</b>	Specifies the resolution in pixels used at video image.
<b>Bit Rate(kbps)</b>	Selects the video bit rate or bandwidth used.
<b>Frame Rate(fps)</b>	Selects the maximum frame rate used (more data if big frame used).
<b>Bit Rate Control</b>	Selects the constantly bit rate, or variable bit rate.
<b>Image Quality</b>	Selects the image quality used when Variable Bit Rate used.
<b>I-frame Interval</b>	Configures the I-frame interval (suggested 2~3 times of frame rate).



Stream 2	
<b>Preferred Video Codec</b>	Selects the videos codecs, the codecs supported are H.264, H.265 and MJPEG. Default setting is H.264.
<b>Profile</b>	Selects the H.264/H.265 profile. Three profiles are available for H.264: Baseline, Main Profile and High Profile. And one profile for H.265: HECV Main
<b>Resolution</b>	Specifies the resolution in pixels used at video image.
<b>Bit Rate(kbps)</b>	Selects the video bit rate or bandwidth used.
<b>Frame Rate(fps)</b>	Selects the maximum frame rate used (more data if big frame used).
<b>Bit Rate Control</b>	Selects the constantly bit rate, or variable bit rate.
<b>Image Quality</b>	Selects the image quality used when Variable Bit Rate used.
<b>I-frame Interval</b>	Configures the I-frame interval (suggested 2~3 times of frame rate).

**Notes:**

- H.264 suggested if the GSC36XX needs to be viewed via Internet.
- For definition of Baseline, Main Profile and High profile of H.264 please refer to: [H.264 Profiles](#)
- If MJPEG is selected, reduce the frame rate to the minimal value to save bandwidth and get better image.
- Grandstream GSC36XX provides two video streams, users can use them with flexibility. For example, the high-resolution stream for local recording, another low or high resolution for SIP video phone call or remote smartphone monitoring application, or vice versa depending application scenarios.
- Use below link to calculate bandwidth and storage before installation  
<http://www.grandstream.com/support/tools/bandwidth-storage-calc>

**OSD Settings**

OSD Settings (On Screen Display) allow the users to Display time stamp and text on the video screen.



### OSD Settings

Display Time	<input checked="" type="checkbox"/>
Display Text	<input type="checkbox"/>
OSD Text	<input type="text"/>
OSD Date/Time Position	Top Left <span style="float: right;">▼</span>
OSD Text Position	Top Left <span style="float: right;">▼</span>

**Figure 22: OSD Settings Page**

**Table 13: OSD Settings**

<b>Display Time</b>	When checked, time will be displayed inside the video image.
<b>Display Text</b>	When checked, inputted text on “OSD Test” will be displayed on the video image.
<b>OSD Text</b>	Input a text (to identify the GSC36XX) it will be shown on the screen.
<b>OSD Date/Time Position</b>	Show the Date/Time position on the screen.
<b>OSD Text Position</b>	Show the text position on the screen.

## CMOS Settings

This page configures the CMOS parameters for different scenarios.

### CMOS Settings

Mode	Normal <span style="float: right;">▼</span>
Power Frequency	Indoor (60Hz Power Frequency) <span style="float: right;">▼</span>
Shutter Speed	Auto <span style="float: right;">▼</span>
Flip	NONE <span style="float: right;">▼</span>
IR CUT Setting	Manual <span style="float: right;">▼</span>
Daytime/Night Model	Daytime <span style="float: right;">▼</span>

**Figure 23: CMOS Settings Page**



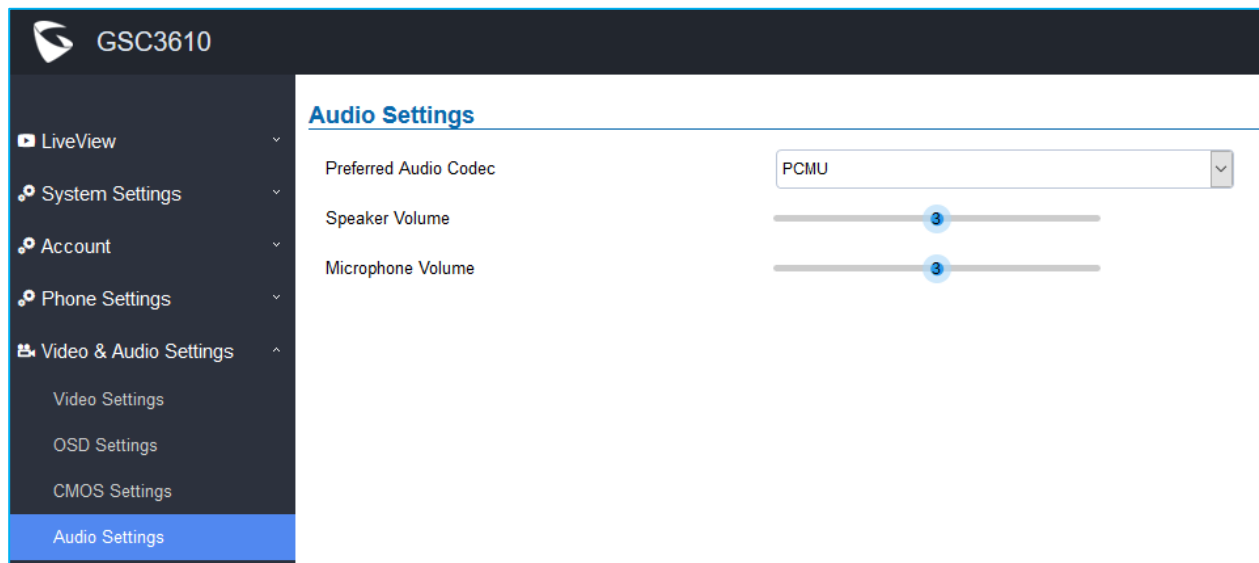

**Table 14: CMOS Settings**

<b>Mode</b>	Pull down to choose “Normal, Low Light, WDR” for different light condition. Default “Normal”.
<b>Power Frequency</b>	Select correct light condition for the scene monitored: Outdoor, Indoor 50Hz power frequency (Europe, China, etc.) or 60Hz power frequency (US, Japan, etc.).
<b>Shutter Speed</b>	Camera Shutter Speed. There are 10 options, with Auto, 1/30 (slowest), 1/60, 1/125, 1/250, 1/500, 1/1000, 1/2000, 1/5000 and 1/10000 (fastest)
<b>Flip</b>	Pull down to choose to flip video either vertically, horizontal or both
<b>IR CUT Setting</b>	Set Manual or Automatic (IR Sensor control) to switch the mechanical IR_CUT.
<b>Daytime/Night Model</b>	Select either Daytime or Night Model

## Audio Settings

This page allows users to configure the audio settings.

**Figure 24: Audio Settings Page**
**Table 15: Audio Settings**

<b>Preferred Audio Codec</b>	Configures the audio codec. Two codecs are available: PCMU and PCMA.
<b>Speaker Volume</b>	Adjusts the speaker volume connected.
<b>Microphone Volume</b>	Adjusts the Mic volume.



## Privacy Masks

This page allows users to configure privacy masks up to 4 different regions by selecting different regions requiring privacy mask as displayed on the following figure.

When privacy mask enabled, the video at related region will be masked by black color and no video displayed inside that mask.

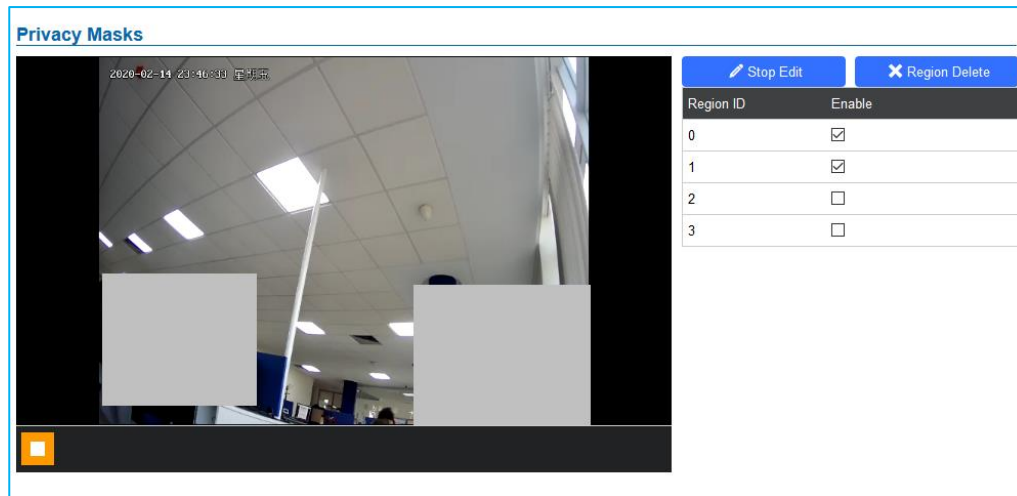

Figure 25: Privacy Masks Configuration Page

- Click **“Start Edit”** then long press and slide to identify a region
- Select a preconfigured region then Click **“Region Delete”** to remove it.

## Alarm Settings

This page allows users to configure alarm schedule and alarm actions.

### Alarm Events Config

This page allows users to configure GSC36XX events to trigger programmed actions within predefined schedule.

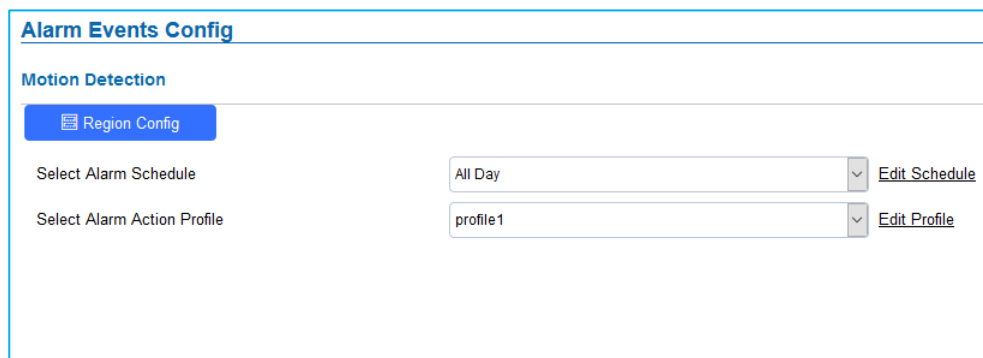
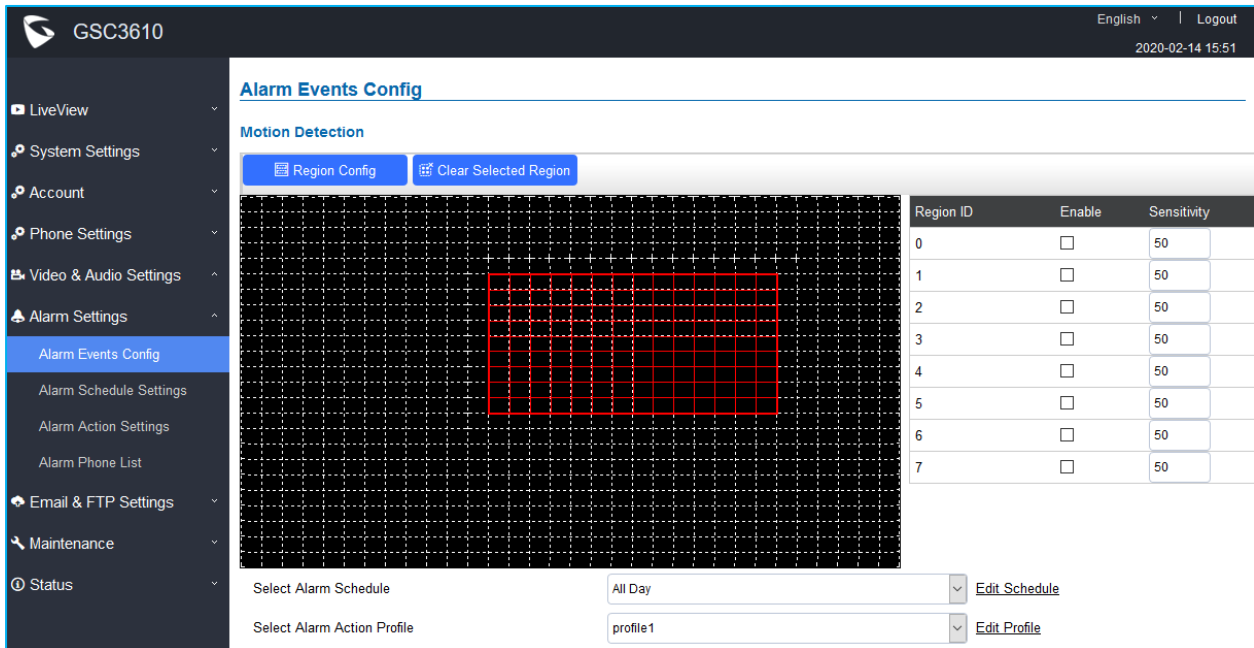

Figure 26: Events Page



## Motion Detection

Users can select a specific region to trigger the alarm using motion detection.



Region ID	Enable	Sensitivity
0	<input type="checkbox"/>	50
1	<input type="checkbox"/>	50
2	<input type="checkbox"/>	50
3	<input type="checkbox"/>	50
4	<input type="checkbox"/>	50
5	<input type="checkbox"/>	50
6	<input type="checkbox"/>	50
7	<input type="checkbox"/>	50

Figure 27: Region Config

Table 16: Motion Detection





















<b>Region Config</b>	Configures the motion detection region. First click to access the Region Config menu and second click to quit.
<b>Clear Selected Region</b>	Selects a zone on the screen then click on “Clear” to delete the region.
<b>Sensitivity</b>	Specifies the region sensitivity (value between 0-100%).
<b>Select Alarm Schedule</b>	Selects the alarm schedule.
<b>Select Alarm Action Profile</b>	Selects the programmed Alarm Action profile.

## Alarm Schedule Settings



This page specifies the configuration of Alarm Schedule.

**Note:** Schedule must be configured first to allow the alarm to take the related action.



Alarm Schedule Settings																																																																																																																																																																																																																								
No.	Schedule Name	Detail	Edit																																																																																																																																																																																																																					
1	schedule1																																																																																																																																																																																																																							
<table border="1"> <tr> <td></td> <td>0</td><td>1</td><td>2</td><td>3</td><td>4</td><td>5</td><td>6</td><td>7</td><td>8</td><td>9</td><td>10</td><td>11</td><td>12</td><td>13</td><td>14</td><td>15</td><td>16</td><td>17</td><td>18</td><td>19</td><td>20</td><td>21</td><td>22</td><td>23</td><td>0</td> </tr> <tr> <td>Sun</td> <td colspan="24">[Green bar]</td> </tr> <tr> <td>Mon</td> <td></td><td></td><td></td><td></td><td></td><td></td><td></td><td></td><td></td><td></td><td></td><td></td><td></td><td></td><td></td><td></td><td></td><td></td><td></td><td></td><td></td><td></td><td></td><td></td><td></td><td></td> </tr> <tr> <td>Tue</td> <td></td><td></td><td></td><td></td><td></td><td></td><td></td><td></td><td></td><td></td><td></td><td></td><td></td><td></td><td></td><td></td><td></td><td></td><td></td><td></td><td></td><td></td><td></td><td></td><td></td><td></td> </tr> <tr> <td>Wed</td> <td></td><td></td><td></td><td></td><td></td><td></td><td></td><td></td><td></td><td></td><td></td><td></td><td></td><td></td><td></td><td></td><td></td><td></td><td></td><td></td><td></td><td></td><td></td><td></td><td></td><td></td> </tr> <tr> <td>Thu</td> <td></td><td></td><td></td><td></td><td></td><td></td><td></td><td></td><td></td><td></td><td></td><td></td><td></td><td></td><td></td><td></td><td></td><td></td><td></td><td></td><td></td><td></td><td></td><td></td><td></td><td></td> </tr> <tr> <td>Fri</td> <td></td><td></td><td></td><td></td><td></td><td></td><td></td><td></td><td></td><td></td><td></td><td></td><td></td><td></td><td></td><td></td><td></td><td></td><td></td><td></td><td></td><td></td><td></td><td></td><td></td><td></td> </tr> <tr> <td>Sat</td> <td></td><td></td><td></td><td></td><td></td><td></td><td></td><td></td><td></td><td></td><td></td><td></td><td></td><td></td><td></td><td></td><td></td><td></td><td></td><td></td><td></td><td></td><td></td><td></td><td></td><td></td> </tr> </table>					0	1	2	3	4	5	6	7	8	9	10	11	12	13	14	15	16	17	18	19	20	21	22	23	0	Sun	[Green bar]																								Mon																											Tue																											Wed																											Thu																											Fri																											Sat																										
	0	1	2	3	4	5	6	7	8	9	10	11	12	13	14	15	16	17	18	19	20	21	22	23	0																																																																																																																																																																																															
Sun	[Green bar]																																																																																																																																																																																																																							
Mon																																																																																																																																																																																																																								
Tue																																																																																																																																																																																																																								
Wed																																																																																																																																																																																																																								
Thu																																																																																																																																																																																																																								
Fri																																																																																																																																																																																																																								
Sat																																																																																																																																																																																																																								
2	schedule2																																																																																																																																																																																																																							
3	schedule3																																																																																																																																																																																																																							
4	schedule4																																																																																																																																																																																																																							
5	schedule5																																																																																																																																																																																																																							
6	schedule6																																																																																																																																																																																																																							
7	schedule7																																																																																																																																																																																																																							
8	schedule8																																																																																																																																																																																																																							
9	schedule9																																																																																																																																																																																																																							
10	schedule10																																																																																																																																																																																																																							

**Figure 28: Alarm Schedule**

GSC36XX supports up to 10 alarm schedules to be configured, with time span specified by users. Users can view the schedule details by clicking  or edit the alarm schedule by clicking  button. Usually the 24 hours' span is 00:00 ~ 23:59, which is 24 hours' format. Note that it is possible to copy the configuration to different date during the schedule programming using the banner at the bottom.

**Modify Schedule** ✕

Schedule Name:

<b>Sun</b>	Period1	00	:	00	-	23	:	59
Mon	Period2	00	:	00	-	00	:	00
Tue	Period3	00	:	00	-	00	:	00
Wed	Period4	00	:	00	-	00	:	00
Thu	Period5	00	:	00	-	00	:	00
Fri	Period6	00	:	00	-	00	:	00
Sat	Period7	00	:	00	-	00	:	00
	Period8	00	:	00	-	00	:	00

Copy  Sun  Mon  Tue  Wed  Thu  Fri  Sat  Select All

**Figure 29: Edit Schedule**



## Alarm Action Settings

This page specifies the configuration of Profile used by the Alarm Actions. A Profile is required before the Alarm Action can take effect.

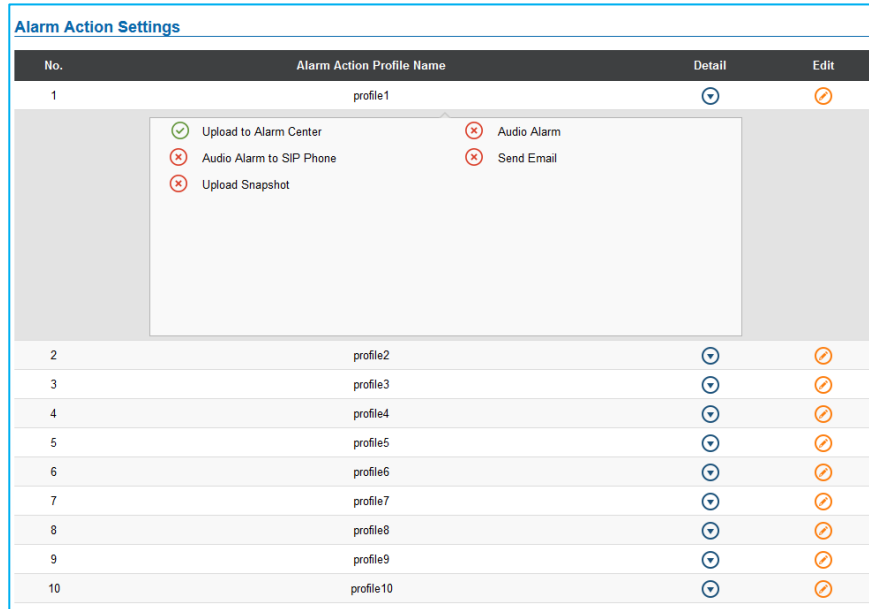

Figure 30: Alarm Action

User can edit the alarm action by clicking  button, the following window will popup.

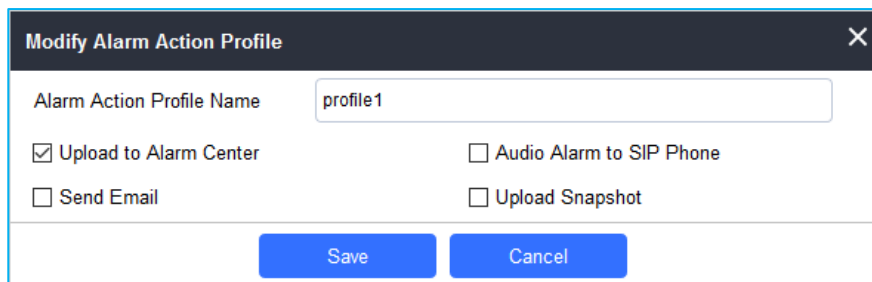

Figure 31: Edit Alarm Action

Table 17: Alarm Actions

<b>Upload to Alarm Center</b>	If selected, the Gsurf will popup alarm window and sound alarm in the computer speaker.
<b>Audio Alarm to SIP Phone</b>	If selected, GSC36XX will call pre-configured (video or audio) phone and will play sound alarm.
<b>Send Email</b>	If selected, an email with snapshot will be sent to the pre-configured email destination.
<b>Upload Snapshot</b>	If selected, snapshots at the moment where the event is triggered will be sent to preconfigured destination (e.g.: FTP or email).



## Alarm Phone List

This page allows users to configure the Alarm Phone List, which are phone numbers or extensions list that the GSC36XX will call out when event is triggered.

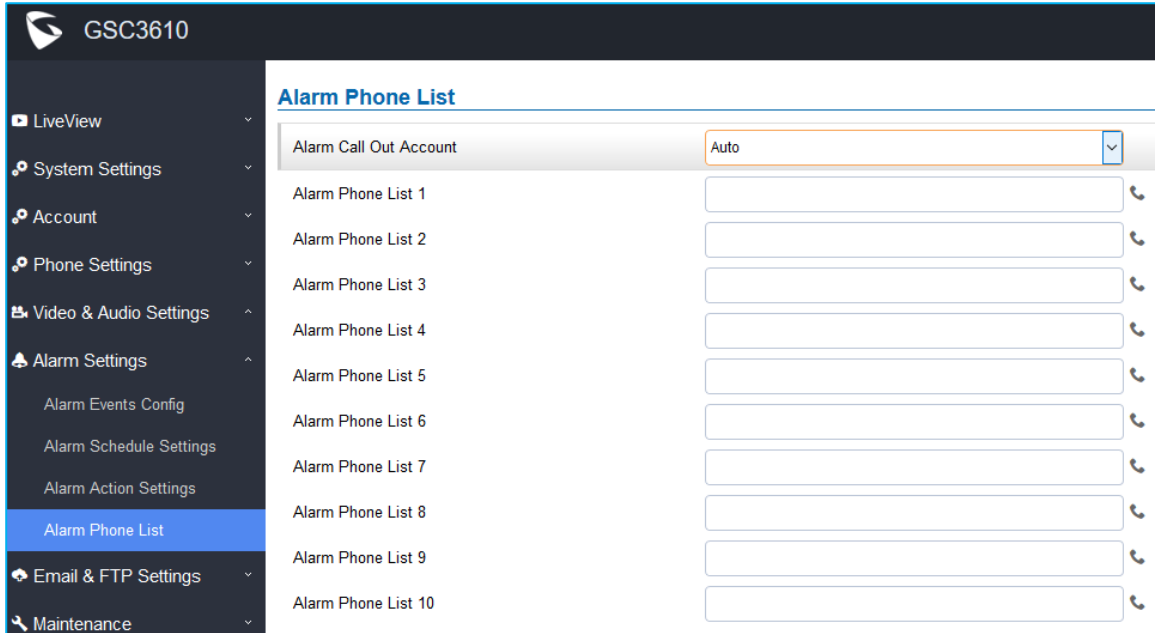

**Figure 32: Alarm Phone List**

**Table 18: Alarm Phone List**

<b>Alarm Call Out Account</b>	Select the SIP Account to be used by the GSC36XX when alarm out is triggered.
<b>Alarm Phone List 1-10</b>	Add or delete number from the phone alarm list. (When IP address is used then the port needs to be appended, example: 192.168.1.12:5060).

Once the event is triggered the GSC36XX will call the first number, once time out is reached and no answer is returned from the first number, the GSC3610 will try the next number on the list and so on. Once the remote phone answers the call, an alarm will be played to notify users that an event is triggered.

## Email & FTP Settings

This page contains Email and FTP Settings.

### Email Settings

This page allows users to configure email client to send out an email when the alarm is triggered.



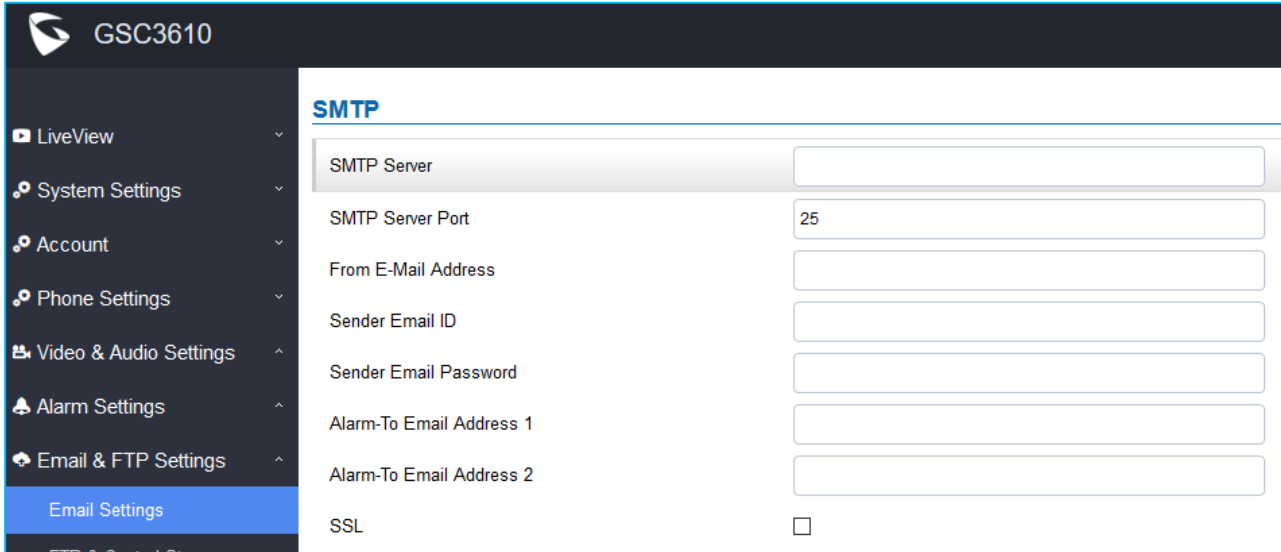

**Figure 33: Email Settings - SMTP Page**

**Table 19: Email Settings - SMTP**

<b>SMTP Server</b>	Configures the SMTP Email Server IP or Domain Name.
<b>SMTP Server Port</b>	Specifies the Port number used by server to send email.
<b>From E-mail address</b>	Specifies email address of alarm email sending from, usually client email ID.
<b>Sender Email ID</b>	Specifies sender's User ID or account ID in the email system used.
<b>Sender Email Password</b>	Specifies sender's password of the email account.
<b>Alarm-To Email Address 1</b>	Specifies the 1 <sup>st</sup> email address to receive the alarm email.
<b>Alarm-To Email Address 2</b>	Specifies the 2 <sup>nd</sup> email address to receive the alarm email.
<b>SSL</b>	Check if the SMTP email server requires SSL.

**Notes:**

- Click "Save" to save the email configuration information.
- Click "Email Test" after configuration, if settings are correct, a test email will send out and "E-mail test successfully" message on the top page will appear.



## FTP & Center Storage

This page allows users to configure the FTP Settings in order to upload capture images.

**Table 20: Picture Storage Settings**

<b>Storage Server Type</b>	Selects whether to upload pictures to Central Storage or upload them to the FTP server.
<b>FTP Server</b>	Configures the IP address of the FTP server when selected to upload images to.
<b>FTP Server Port</b>	Specifies the FTP address port.
<b>FTP Username</b>	Specifies the FTP server account name.
<b>FTP Password</b>	Specifies the FTP server password.
<b>FTP Path</b>	Specifies the storage path.
<b>FTP Test</b>	Click to test the connection with FTP server.

**Snapshot Storage Settings**

Storage Server Type	<input type="text" value="FTP"/>
FTP Server	<input type="text"/>
FTP Server Port	<input type="text" value="21"/>
FTP User Name	<input type="text"/>
FTP Password	<input type="password"/>
FTP Path	<input type="text" value="/"/>

**Figure 34: Picture Storage Settings**

### Notes:

- If the connection to the FTP server is successful, a “.txt” file containing a success message will be uploaded to the FTP server. And the following message will pop up on the Web GUI FTP test successfully.
- Central Storage will store screenshots locally.

## Maintenance Settings

This page shows the GSC36XX Maintenance parameters.





## Upgrade

This page contains the upgrade and provisioning parameters of the GSC36XX.

GSC3610

- LiveView
- System Settings
- Account
- Phone Settings
- Video & Audio Settings
- Alarm Settings
- Email & FTP Settings
- Maintenance
  - Upgrade
  - Reboot & Reset
  - Debug Log
  - Data Maintenance
  - Event Notification
  - Certificates
- Status

### Upgrade

#### Firmware

Upgrade Via	HTTP
Firmware Server Path	fm.grandstream.com/gs
HTTP/HTTPS User Name	
HTTP/HTTPS Password	
Firmware File Prefix	
Firmware File Postfix	

#### Config

Upgrade Via	HTTPS
Config Server Path	fm.grandstream.com/gs
HTTP/HTTPS User Name	
HTTP/HTTPS Password	
Config File Prefix	
Config File Postfix	
XML Config File Password	

Validate Server Certificates	<input type="checkbox"/>
Enable DHCP Option 66 Override Server	<input checked="" type="checkbox"/>
Zero Config	<input checked="" type="checkbox"/>
Enable DHCP Option 120 Override SIP Server	<input type="checkbox"/>
Automatic Upgrade	<input type="radio"/> No <input checked="" type="radio"/> Yes, check for every <input type="text" value="10080"/> minute(s) <input type="radio"/> Yes, check for every day <input type="radio"/> Yes, check for every week
Randomized Automatic Upgrade	<input type="checkbox"/>
Hour of the Day (0-23)	Start <input type="text" value="1"/> End <input type="text" value="23"/>
Day of the Week (0-6)	<input type="text" value="1"/>

Figure 35: Upgrade Page

**Table 21: Upgrade**

Firmware	
<b>Upgrade Via</b>	Selects the upgrade method (TFTP, HTTP, or HTTPS).
<b>Firmware Server Path</b>	Configures the IP address or the FQDN of the upgrade server.
<b>HTTP/HTTPS Username</b>	The username for the HTTP/HTTPS server.
<b>HTTP/HTTPS Password</b>	The password for the HTTP/HTTPS server.
<b>Firmware File Prefix</b>	Enables your ITSP to lock configuration updates. If configured, only the firmware file with the matching encrypted prefix will be downloaded and flashed into the phone.
<b>Firmware File Postfix</b>	Enables your ITSP to lock firmware updates. If configured, only the firmware with the matching encrypted postfix will be downloaded and flashed into the phone.
Config	
<b>Upgrade via</b>	Selects the upgrade method (TFTP, HTTP, and HTTPS).
<b>Config Server Path</b>	Configures the IP address or the FQDN of the configuration server.
<b>HTTP/HTTPS Username</b>	The username for the HTTP/HTTPS server.
<b>HTTP/HTTPS Password</b>	The password for the HTTP/HTTPS server.
<b>Config File Prefix</b>	Enables your ITSP to lock configuration updates. If configured, only the configuration file with the matching encrypted prefix will be downloaded and flashed into the phone.
<b>Config File Postfix</b>	Enables your ITSP to lock configuration updates. If configured, only the configuration file with the matching encrypted postfix will be downloaded and flashed into the phone.
<b>XML Config File Password</b>	Specifies the password for the configuration file.
<b>Validate Server Certificate</b>	Enable this option in order to validate certificate with trusted ones during TLS connection.
<b>Enable DHCP Option 66 Override Server</b>	Activates DHCP option 66 to override upgrade/config servers.
<b>Zero Config</b>	Enables Zero Config feature for auto provisioning.
<b>Enable DHCP Option 120 Override SIP Server</b>	Enables DHCP Option 120 from local server to override the SIP Server on the phone. The default setting is enabled.
<b>Automatic Upgrade</b>	Enables automatic upgrade and provisioning. Set schedule for provisioning for either every X minute, every day or every week. Default is No.



**Randomized Automatic Upgrade**

Enable and define the start/End hours of the day and days of the week where the GSC36XX will randomly checking for update.

## Reboot & Reset

This page allows user to reboot and reset the GSC36XX.

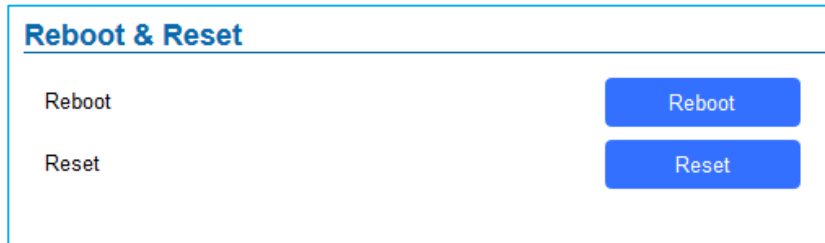

**Figure 36: Reset & Reboot Page**

**Table 22: Reset & Reboot**

<b>Reboot</b>	When clicked, the GSC36XX will restart (soft reboot).
<b>Reset</b>	Restore Factory Default Settings

## Debug Log

This page allows user to configure SYSLOG to collect information to help troubleshooting issues with GSC36XX.

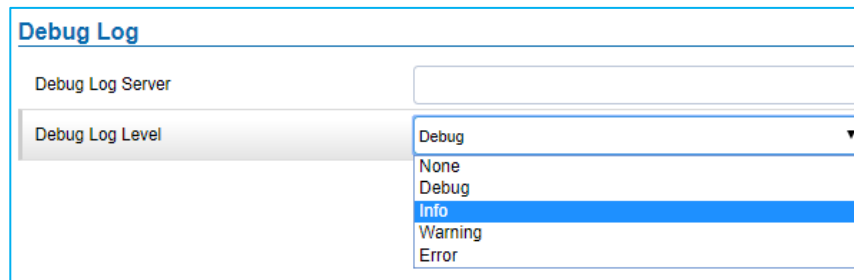

**Figure 37: Debug Log Page**

- Five levels of Debugging are available, None, Debug, Info, Warning, Error.
- Once the Syslog Server and the level entered, press “Save” and then Reboot the device to apply the settings.

## Data Maintenance

This page allows users to manage the GSC36XX configuration file by importing/exporting configuration files.



**Data Maintenance**

Data Type: System Config Data(Password not included) Export

Import: Import

**Figure 38: Data Maintenance Page**

**Notes:**

- Click on Export to save the GSC36XX configuration in a predefined directory.
- Users can either select to include all the passwords (SIP, FTP, Remotes access...) on the configuration files exported or not including the passwords as displayed on the previous figure.

**Event Notification**

This page allows users to configure the event notification details that will be used by GSC36XX to communicate to an HTTP server to log the events. When the feature is enabled and configured, all the event logs will be uploaded to server:

**Event Notification**

Enable Event Notification:

Via Type: HTTP

HTTP/HTTPS Server:

HTTP/HTTPS Server Username:

HTTP/HTTPS Server Password:

URL Template:

Template Variables:

- \$(MAC)* : MAC Address
- \$(TYPE)* : Event Type
- \$(WARNING\_MSG)* : Event Message
- \$(DATE)* : Date & Time
- \$(CARDID)* : Card Number\*
- \$(SIPNUM)* : Sip Number

Template Samples:

- 1: {"mac":"\$(MAC)","content":"\$(WARNING\_MSG)"}
- 2: <body><mac>\$(MAC)</mac><content>\$(WARNING\_MSG)</content></body>
- 3: mac=\$(MAC)&content=\$(WARNING\_MSG)

**Figure 39: Log Manager Page**



**Table 23 : Log Manager Settings**

<b>Enable Event Notification</b>	Enables Event Notification feature
<b>Via Type</b>	Choose which protocol will be used to connect to the logs server (HTTP or HTTPS).
<b>HTTP/HTTPS Server</b>	Enter the IP address of domain name for the logs server.
<b>HTTP Server Username</b>	Configure the username of your HTTP(s) server
<b>HTTP Server Password</b>	Configure the password of your HTTP(s) server
<b>URL Template</b>	<p>Specify the template for the event log messages that will be sent to the server, users can use the following variables to customize the message:</p> <ul style="list-style-type: none"> <li>• <code>\${MAC}</code> : MAC Address</li> <li>• <code>\${TYPE}</code> : Event Type</li> <li>• <code>\${WARNING_MSG}</code> : Event Message</li> <li>• <code>\${DATE}</code> : Date &amp; Time</li> <li>• <code>\${CARDID}</code> : Card Number</li> <li>• <code>\${SIPNUM}</code> : SIP Number</li> </ul>

- User can test the configuration by clicking on  button at the bottom

## Certificates

This page allows users to upload up to 6 Trusted CA certificate files which will be trusted by the GSC36XX during SSL exchange. Also, users are allowed to configure the device with custom certificate signed by custom CA certificate under the Custom Certificate section.

Certificates		
<b>Trusted CA Certificates</b>		
No.	Issued By	Expiration
1		
2		
3		
4		
5		
6		
<b>Custom Certificate</b>		
No.	Issued By	Expiration
1		

**Figure 40: Upload Certificate files**

In order to upload your Trusted CA certificate, you may proceed as follows:

- Click on  button to upload a file and some related information to the uploaded file will be displayed, such as “**Issued by**” and “**Expiration date**”.





Trusted CA Certificates			
No.	Issued By	Expiration	
1	-	2018-07-17 15:46:03	 
2			 

Figure 41: Trusted CA Certificates

- Users could press  to delete one of the files.

In order to upload your Custom certificate, you may proceed as follows:

- Click on  button to upload a file and some related information to the uploaded file will be displayed, such as “**Issued by**” and “**Expiration date**”.



Custom Certificate			
No.	Issued By	Expiration	
1			 

Figure 42: Custom certificate

## Status

This page displays GSC36XX system and network information.

### Account Status

This page displays of configured accounts’ SIP user ID, SIP server as well as the SIP Registration status, from Account 1 to Account 4.

#### Notes:

- When the SIP account is registered, the SIP Registration status display will be **Online**
- When SIP account is unregistered, the SIP Registration status display will be **Offline**



Account Status			
Account	SIP User ID	SIP Server	SIP Registration Status
Account 1	3000	192.168.5.100	Offline
Account 2	3001	192.168.5.100	Online
Account 3	3002	192.168.5.187	Offline
Account 4	3003	192.168.5.187	Offline

Figure 43: System Info Page

## System Info

This page displays information such as the product model, the hardware version, firmware...

System Info	
Product Model	GSC3610
Hardware Version	V1.0C
Part Number	9670007110C
Boot Version	1.0.0.2
Core Version	1.0.1.3
Base Version	1.0.1.3
Prog Version	1.0.1.3
System Uptime	17 minutes
Firmware Status	<div style="border: 1px solid gray; padding: 2px; text-align: center;">           Press check button and reload page to check firmware availability.         </div> <div style="text-align: center; margin-top: 5px;"> <input type="button" value="Check"/> </div>

Figure 44: System Info Page



**Table 24: System Info**

<b>Product Model</b>	Displays the Product Model.
<b>Hardware Version</b>	Displays the Hardware Version.
<b>Part Number</b>	Displays the Part Number.
<b>Boot Version</b>	Displays the Boot Version.
<b>Core Version</b>	Displays the Core Version.
<b>Base Version</b>	Displays the Base Version.
<b>Prog Version</b>	Displays the Prog Version.
<b>System Up Time</b>	Displays the time since the first boot of the GSC36XX.
<b>Firmware Status</b>	Click the  button to check whether the firmware in the firmware server has an updated version, if so, update immediately.

## Network Info

This page displays the network system information of GSC36XX.

Network Info	
MAC Address	C0:74:AD:16:2F:53
IP Address Mode	DHCP
IP Address	192.168.0.160
Subnet Mask	255.255.0.0
Gateway	0.0.0.0
DNS Server 1	0.0.0.0
DNS Server 2	0.0.0.0

**Figure 45: Network Info Page**
**Table 25: Network Info**

<b>MAC Address</b>	Displays the GSC MAC Address.
<b>IP Address Mode</b>	Displays the IP address mode used.
<b>IP Address</b>	Displays the IP address of the GSC36XX.
<b>Subnet Mask</b>	Displays the Subnet Mask used.
<b>Gateway</b>	Displays the GSC36XX Gateway.
<b>DNS Server 1</b>	Displays the Preferred DNS Server.
<b>DNS Server 2</b>	Displays the secondary DNS Server.





## EXPERIENCING THE GSC3610/GSC3615

Please visit our website: <http://www.grandstream.com> to receive the most up- to-date updates on firmware releases, additional features, FAQs, documentation and news on new products.

We encourage you to browse our [product related documentation](#), [FAQs](#) and [User and Developer Forum](#) for answers to your general questions. If you have purchased our products through a Grandstream Certified Partner or Reseller, please contact them directly for immediate support.

Our technical support staff is trained and ready to answer all of your questions. Contact a technical support member or [submit a trouble ticket online](#) to receive in-depth support.

