

NUVO®

Whole Home Audio

Player Portfolio Audio System



Product Manual

Includes:

- NVP100-xx Single Zone Player
- NVP200-xx Single Zone Player
- NVGW100-xx Wireless Gateway
- NVP3100-xx Three Zone Player
- NVP3500-xx Three Zone Player
- NVP300-xx Single Zone Pre-Amplifier

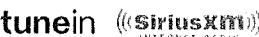

Direct Stream

Table of Contents

Introduction	Page 3
NVP100-xx Single Zone Player Front and Back Panel Features	Page 4
NVP200-xx Single Zone Player Front and Back Panel Features	Page 5
NVP3100-xx Triple Zone Player Front and Back Panel Features	Page 6
NVP3500-xx Triple Zone Player Front and Back Panel Features	Page 7
NVP300-xx Single Zone Pre-Amplifier Front and Back Panel Features	Page 8
1. Setup/Installation	
1.1 Network Requirements	Page 9
1.2 Connecting the Gateway to the Network	Page 9
1.3 Hardwiring the Players Directly to the Network	Page 10
1.4 Installing the NVP3100-xx and NVP3500-xx Triple Zone Players	Page 11
1.5 Connecting the Speakers to the NVP100-xx and NVP200-xx Single Zone Players.....	Page 12
1.6 Connecting the Speakers to the NVP3100-xx and NVP3500-xx Triple Zone Players.....	Page 12
2. Setting Up a System from the iOS or Android App	
2.1 New System Setup	Page 13
2.2 Adding Zones to an Existing System	Page 16
2.3 Adding Additional Gateways to an Existing System	Page 17
3. Using the iOS and Android Control App	
3.1 The Dashboard	Page 18
3.2 Music Selection	Page 18
3.3 Bluetooth® Playback	Page 19
3.4 Line In	Page 19
3.5 Direct Stream	Page 20
4. The Settings Menu	
4.1 Zones	Page 21
4.2 Gateways	Page 23
4.3 Controller.....	Page 24
4.4 Add a NuVo Component.....	Page 24
4.5 Music Library	Page 24
4.6 Music Services.....	Page 25
4.7 System	Page 26
4.8 International.....	Page 27
4.9 Help	Page 27
5. The Music Share Software	Page 28
6. Troubleshooting	
6.1 Front Panel LEDs	Page 30
6.2 Not Connected	Page 30
6.3 Restoring Defaults	Page 31
6.4 System Diagnostics.....	Page 32
6.5 Advanced Network Management	Page 33
7. Specifications	Page 34

The NuVo Wireless Audio System Product Manual

Introduction

Welcome to the exciting world of the NuVo Player Portfolio Audio System. Now your favorite music, in any room you want it, anytime you want it, is as close as the touch of a button on any of your Apple or Android Wi-Fi enabled portable devices. True high fidelity music, from your own personal library or streaming from the Internet, is more affordable and accessible than you ever imagined.

This is your guide to quickly and easily filling a home with music.

The NuVo Wireless Audio System

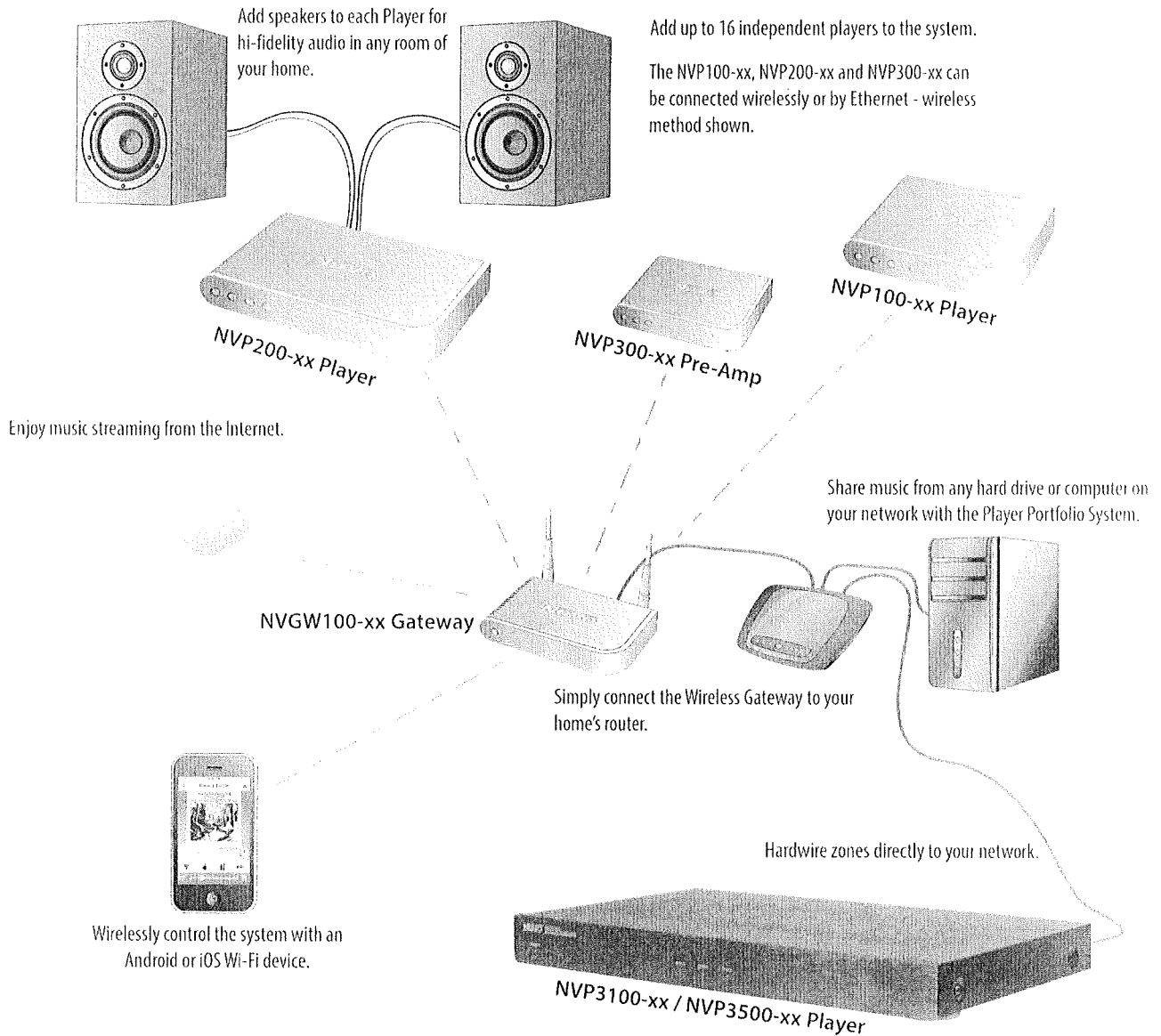

NVP100-xx Single Zone Player Front Panel Features (Wireless or Ethernet Connectivity)

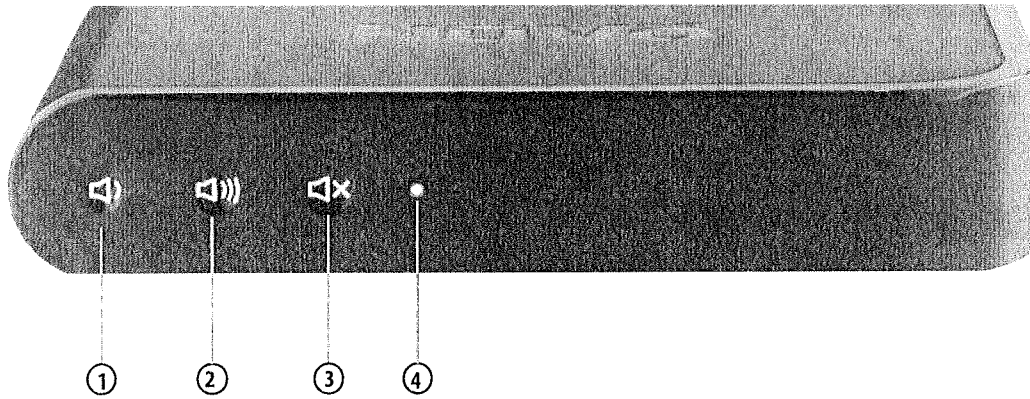

1. **Volume Down:** Press to decrease audio volume.
2. **Volume Up:** Press to increase audio volume.
3. **Mute:** Press to mute/un-mute audio.
4. **LED Indicator:** Indicates status of NVP100-xx (see table in section 6.1 for details).

NVP100-xx Single Zone Player Back Panel Features (Wireless or Ethernet Connectivity)

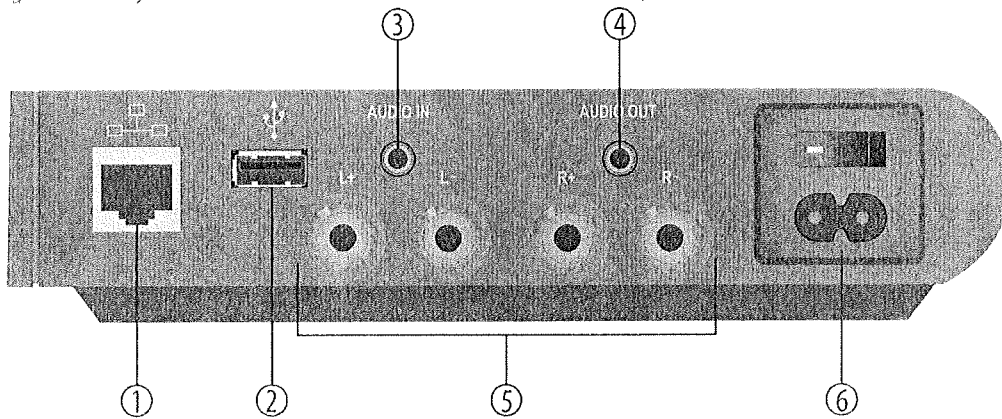

1. **Ethernet:** This RJ45 port allows for a wired connection directly to the NVGW100-xx Gateway or directly to the network router.
2. **USB:** A USB storage device can share music content with the NuVo Player Portfolio Audio System through this port.
3. **Audio In:** This 3.5mm stereo input will accept any analog line level audio signal. The local audio source is amplified by the local player, as well as providing it as an additional source selection in any other associated audio zones within the NuVo Player Portfolio Audio System.
4. **Audio Out*:** This 3.5mm stereo output provides the local line level audio signal to an additional amplifier, powered subwoofer, or headphones.
5. **Speaker Outputs*:** These binding posts provide an amplified audio signal to any connected speakers. The maximum output of the P100 is 40 Watts at 8 Ohm stereo.
6. **AC:** The switchable universal power supply will accept any incoming AC voltage worldwide.

* If the audio output of a video device is the source, there will be no perceptible delay in audio if a single player zone is selected. If two or more player zones are playing the audio from the video source an audio buffer will be engaged which will add a delay between the audio and video source.

***Not all USB drives are supported natively by the USB port as current draw is limited to XX amps. If a device that exceeds this is used, an external power supply must be used.

NVP200-xx Single Zone Player Front Panel Features (Wireless or Ethernet Connectivity)

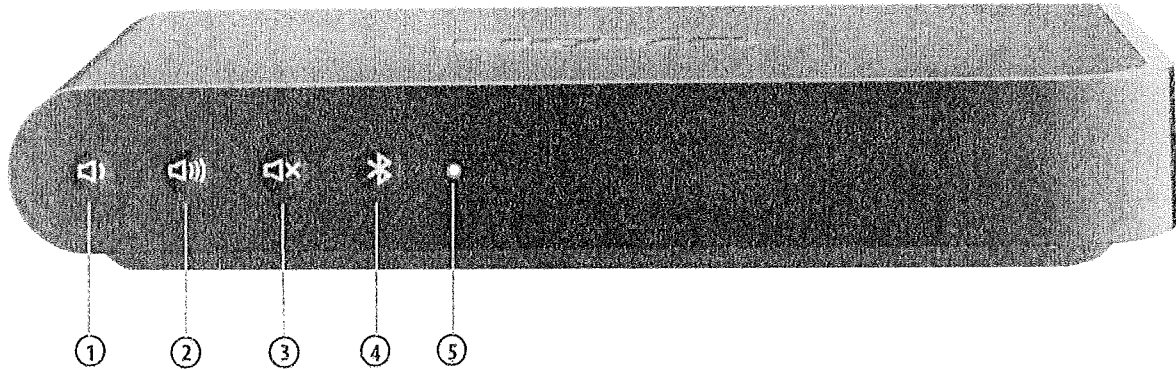

1. **Volume Down:** Press to decrease audio volume.
2. **Volume Up:** Press to increase audio volume.
3. **Mute:** Press to mute/un-mute audio.
4. **Bluetooth:** Press to cause the NVP200-xx to change to the next paired device in the list. Press and hold to break any current connections, become discoverable, and accept pairing requests.
5. **LED Indicator:** Indicates status of NVP200-xx (see table in section 6.1 for details).

NVP200-xx Single Zone Player Back Panel Features (Wireless or Ethernet Connectivity)

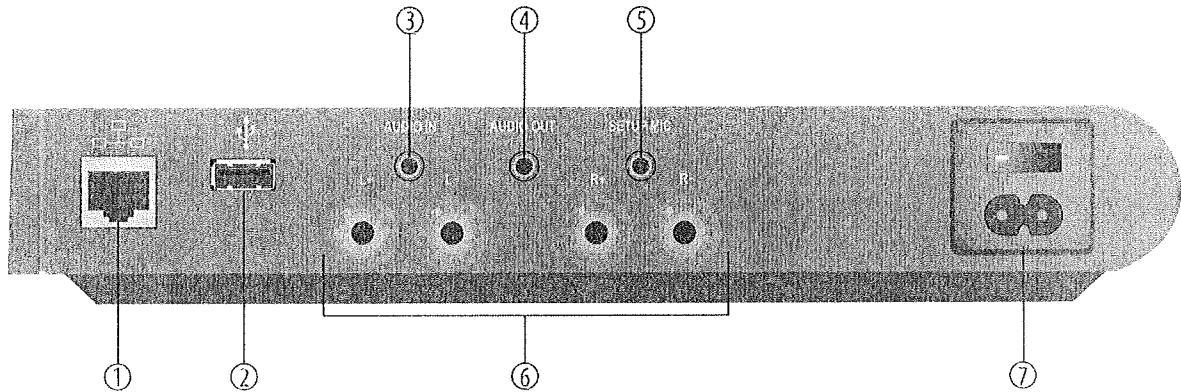

1. **Ethernet:** This RJ45 port allows for a wired connection directly to the NVGW100-xx Gateway or directly to the network router.
2. **USB:** A USB storage device can share music content with the NuVo Player Portfolio Audio System through this port.
3. **Audio In:** This 3.5mm stereo input will accept any analog line level audio signal. The local audio source is amplified by the local Player, as well as providing it as an additional source selection in any other associated audio zones within the NuVo Player Portfolio Audio System.
4. **Audio Out*:** This 3.5mm stereo output provides the local line level audio signal to an additional amplifier, powered subwoofer, or headphones.
5. **Setup Mic:** This 3.5mm input is for use with future software upgrades.
6. **Speaker Outputs*:** These binding posts provide an amplified local audio signal to any connected speakers. The maximum output of the P200 is 120 Watts at 8 Ohm stereo.
7. **AC:** The switchable universal power supply will accept any incoming AC voltage worldwide.

* If the audio output of a video device is the source, there will be no perceptible delay in audio if a single player zone is selected. If two or more player zones are playing the audio from the video source an audio buffer will be engaged which will add a delay between the audio and video source.

***Not all USB drives are supported natively by the USB port as current draw is limited to XX amps. If a device that exceeds this is used, an external power supply must be used.

NVP3100-xx Triple Zone Player Front Panel Features (Ethernet Connectivity)

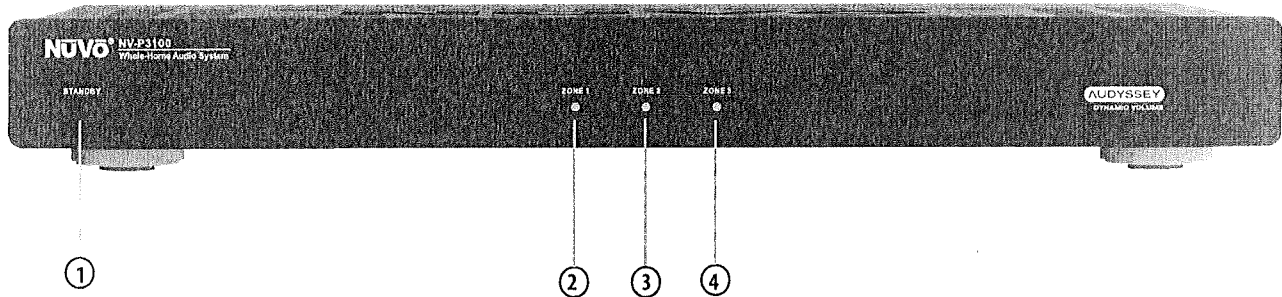

1. **Standby LED Indicator:** Indicates whether the NVP3100-xx is powered on, and whether it is in active or standby mode.
2. **Zone 1 LED Indicator:** Indicates status of NVP3100-xx Zone 1 (see table in section 6.1 for details).
3. **Zone 2 LED Indicator:** Indicates status of NVP3100-xx Zone 2 (see table in section 6.1 for details).
4. **Zone 3 LED Indicator:** Indicates status of NVP3100-xx Zone 3 (see table in section 6.1 for details).

NVP3100-xx Zone Player Back Panel Features (Ethernet Connectivity)

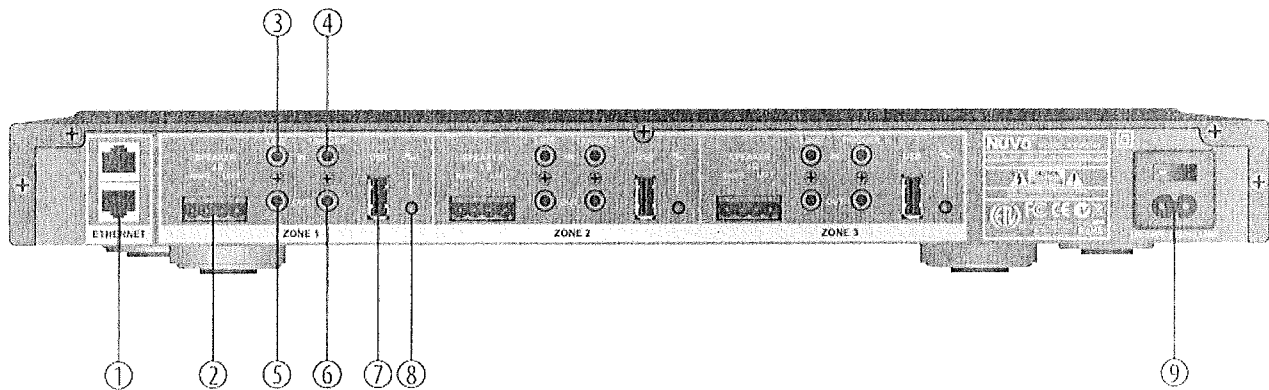

1. **Ethernet:** The NVP3100-xx is designed to connect directly to the network LAN. The second port enables multiple NVP3100-xx to share the same network connection within one system.
2. **Speaker Outputs*:** This modular connection provides a maximum 40 Watts stereo amplified signal to the connected speakers. Each zone represents an independent output.
3. **Line In:** This 3.5mm stereo input will accept any analog line level audio signal. The local audio source is amplified by the local Player, as well as providing it as an additional source selection in any other associated audio zones within the NuVo Player Portfolio Audio System. Each zone represents an independent input.
4. **Trigger In:** This optional input is for a 3-12 volt input trigger (for possible use with a future firmware release).
5. **Line Out*:** This 3.5mm stereo output provides the local line level audio signal to an additional amplifier, powered subwoofer, or headphones. Each zone represents an independent output.
6. **Trigger Out:** This 3.5mm output acts as a voltage (5V, 20mA) trigger for external equipment, to turn on an external amp when audio is present on the zone.
7. **USB:** A USB storage drive can share music content with the NuVo Player Portfolio Audio System through this port. Each zone represents an independent input.
8. **Setup:** This button is used for each of the zone sections in the setup process to associate the zone control with the network.

* If the audio output of a video device is the source, there will be no perceptible delay in audio if a single player zone is selected. If two or more player zones are playing the audio from the video source an audio buffer will be engaged which will add a delay between the audio and video source.

***Not all USB drives are supported natively by the USB port as current draw is limited to XX amps. If a device that exceeds this is used, an external power supply must be used.

NVP3500-xx Triple Zone Player Front Panel (Ethernet Connectivity—B&O ICEpower Amplification)

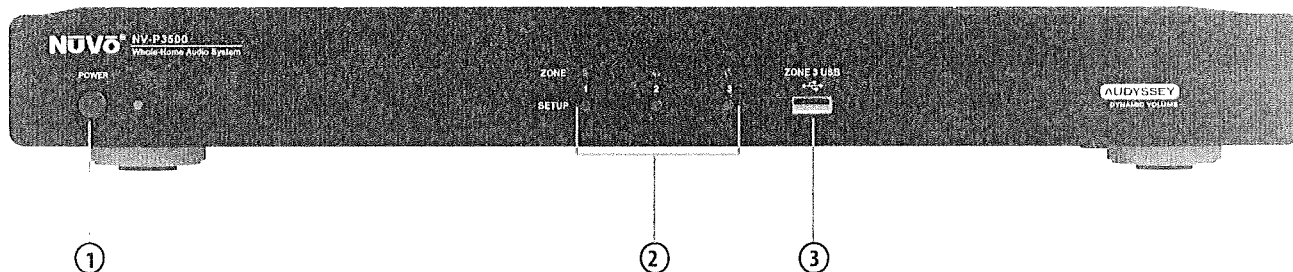

1. **Power Button:** The Power button toggles the power on and off to the NVP3500-xx component. It is also used in the reset procedure for each of the zones.
2. **Setup Buttons:** Each of the three zones housed in the NVP3500-xx have a separate setup button used in the initial system setup process. These buttons are also used in the zone reset procedure. When the system is set up, each zone has an associated LED that indicates that zone's power status (see table in section 6.1 for details).
3. **Zone 3 USB***:** The USB input can be used to add digital music files to the system's music library. When a USB hard drive is inserted into the input, the system will recognize the drive, scan the files and automatically add them to the library.

NVP3500-xx Zone Player Back Panel Features (Ethernet Connectivity—B&O ICEpower Amplification)

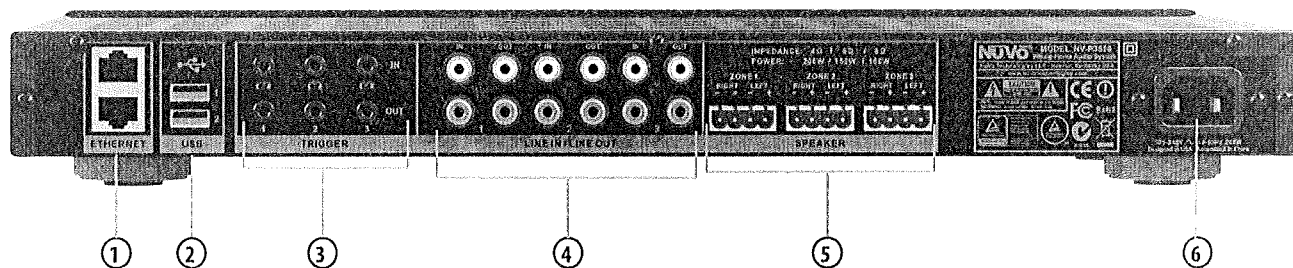

1. **Ethernet:** The NVP3500-xx is designed to connect directly to the network LAN. The second port enables multiple Players to share the same network connection within one system.
2. **Zone 1 and Zone 2 USB:** Any USB storage device can share music content with the NuVo Player Portfolio Audio System through these ports. Each port can accept a separate drive.
3. **Trigger In:** These optional inputs are for 3-12 volt input triggers (for possible use with a future firmware release).
Trigger Out: These 3.5mm outputs act as a voltage (5V, 20mA) trigger for external equipment, to turn on an external amp when audio is present on the zone.
4. **Line In/Line Out*:** Each of the three zones have an independent RCA line input for a local analog audio source, and RCA audio output for use with an additional amplifier or subwoofer.
5. **Speaker Outputs***:** Each of the three zones has a modular connector that provides a maximum 200 Watts @ 4 Ohm output.
6. **AC:** The universal power supply will accept any incoming AC voltage worldwide.

* If the audio output of a video device is the source, there will be no perceptible delay in audio if a single player zone is selected. If two or more player zones are playing the audio from the video source an audio buffer will be engaged which will add a delay between the audio and video source.

** High end Bang & Olufsen ICEpower Amplifiers are used in the P3500 for amplification*.

***Not all USB drives are supported natively by the USB port as current draw is limited to XX amps. If a device that exceeds this is used, an external power supply must be used.

NVP300-xx Zone Player Front Panel Features (Wireless or Ethernet Connectivity)

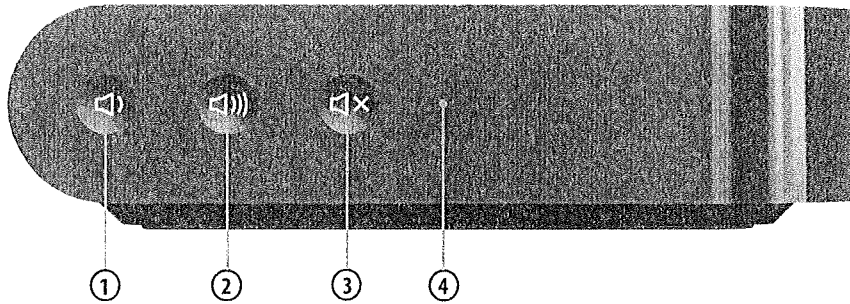

1. **Volume Down:** Press to decrease audio volume.
2. **Volume Up:** Press to increase audio volume.
3. **Mute:** Press to mute/un-mute audio.
4. **LED Indicator:** Indicates status of NVP300 (see table in section 6.1 for details).

NVP300-xx Zone Player Back Panel Features (Wireless or Ethernet Connectivity)

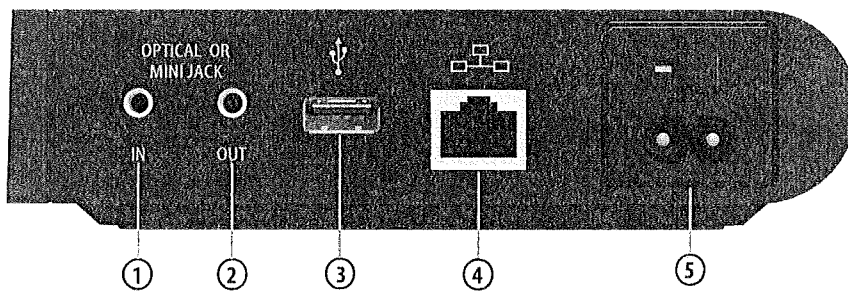

1. **Audio In:** This is a combination 3.5mm stereo line level and mini TOSLINK optical input. This input will automatically decipher the difference between an analog line level input and TOSLINK optical input. To connect to the TOSLINK input use a standard TOSLINK cable with the supplied TOSLINK mini- adapters or use a TOSLINK to TOSLINK mini cable. The line input is available to any player zone within the NuVo Wireless Audio System.
2. **Audio Out*:** This is a combination 3.5mm stereo line level and mini TOSLINK optical output. This 3.5mm stereo output provides the local line level audio signal to an additional amplifier, powered subwoofer, or headphones. To connect to the TOSLINK input use a standard TOSLINK cable with the supplied TOSLINK mini- adapters or use a TOSLINK to TOSLINK mini cable.
3. **USB***:** Any USB storage device can share music content with the NuVo Player Portfolio Audio System through this port.
4. **Ethernet:** This RJ45 port allows for a wired connection directly to the GW100 Gateway or directly to the network router.
5. **AC:** The switchable universal power supply will accept any incoming AC voltage worldwide.

* If the audio output of a video device is the source, there will be no perceptible delay in audio if a single player zone is selected. If two or more player zones are playing the audio from the video source an audio buffer will be engaged which will add a delay between the audio and video source.

***Not all USB drives are supported natively by the USB port as current draw is limited to XX amps. If a device that exceeds this is used, an external power supply must be used.

1. Setup/Installation

1.1 Network Requirements

A live Internet connection is necessary for complete setup, operation, and music enjoyment of your NuVo Player Portfolio Audio System. Once the system is set up and running, Internet is not necessary for listening to music streaming from a network source. For wired Ethernet connectivity a minimum 100mb wired network is necessary for proper communication. This should not be a problem. Today's network routers are designed to operate in the Gigabyte range. If this is not the case, you should update the installation's network equipment before you proceed with the setup. **The NuVo Player Portfolio Audio System uses the most advanced dual band 802.11N wireless communication available for the most robust operation. To insure that all components are compatible and communicating correctly, it is strongly suggested network routers using the older 802.11G protocol are upgraded.**

1.2 Connecting the Gateway to the Network

The NVGW100-xx Gateway is the wireless communication point for the NuVo Player Portfolio System's wireless capable components. It requires a standard Ethernet CAT5 or 6 (four twisted pair) wire connection to the home's network. It should be a standard EIA/TIA 568A or 568B network termination if you choose to terminate the cable to a specific length, as shown in fig. 1, or simply use a pre-terminated "network" cable (a cable is included in the package for this purpose), as shown in fig. 2. Note this is a straight-through connection. You should never connect the Gateway using a "crossover" style cable.

Fig. 1

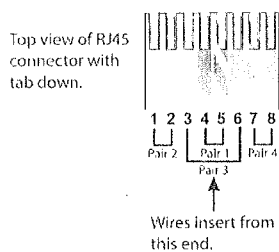
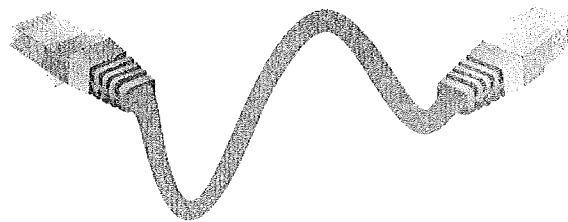

Fig. 1: EIA 568A and 568B wiring scheme for CAT5 Cable

Pin # 568A	Pin # 568B
1. Green Stripe	1. Orange Stripe
2. Green	2. Orange
3. Orange Stripe	3. Green Stripe
4. Blue	4. Blue
5. Blue Stripe	5. Blue Stripe
6. Orange	6. Green
7. Brown Stripe	7. Brown Stripe
8. Brown	8. Brown

Note: Colors listed as "stripe" are a white wire with a colored stripe.

Fig. 2



Make sure that the installation's router is connected to the network modem (this is generally supplied by the Internet Service Provider, ISP) with a single CAT5 network cable. The Gateway has five Ethernet ports and acts as a standard Ethernet switch. Simply connect the included cable, or any Ethernet cable with a standard RJ45 modular plug, into one of the five ports on the back of the Gateway and connect the other end into an available port on the back of the installation's router, as shown in fig. 3.

Fig. 3

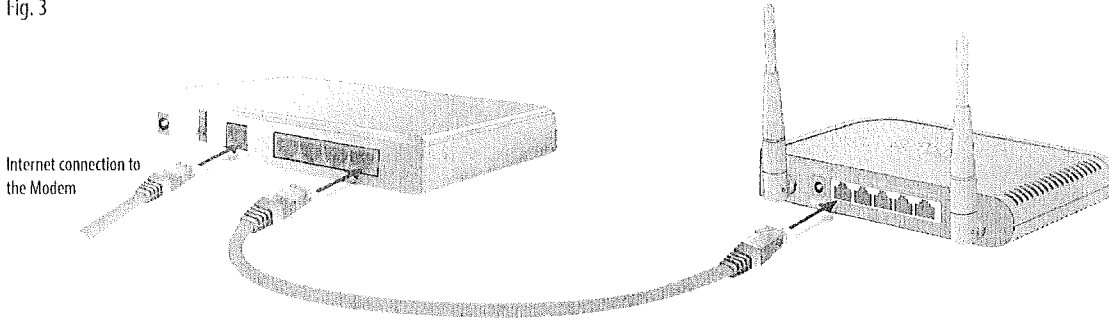

A network switch can also be used for the connection to the Gateway, provided the switch is connected to the Internet through the network's router. Once you have made the necessary connections, you are ready to continue with each audio zone setup.

1.3 Hardwiring the Players Directly to the Network

In lieu of using WiFi to connect to wireless capable components, Ethernet may be used as an alternative (P100-xx, P200-xx and P300-xx) through thru its embedded Ethernet Port. This port allows a standard four twisted pair wire, either CAT5 or CAT6, terminated with a modular RJ45 plug to "hardwire" the units directly to the system's Gateway or network router, as shown in fig 4. Once the player is connected to the network via the Gateway or directly to the home's router, the actual network connection will be completed from the control app on the desired control device, **see 2.2 Advanced Setup.**

Fig. 4

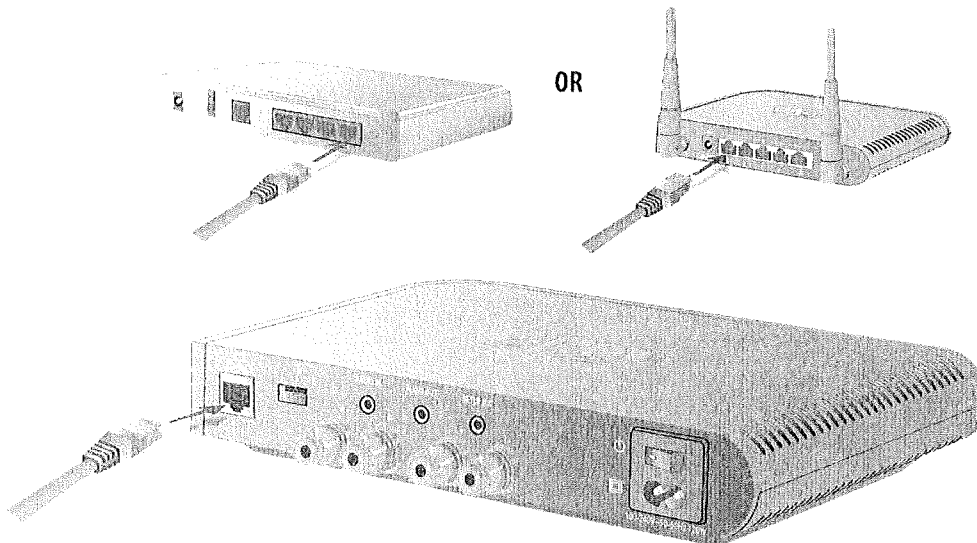

1.4 Installing the NVP3100-xx and NVP3500-xx Zone Players

If you are installing the NVP3100-xx or NVP3500-xx rack mount component, the network connection is completed by connecting one of the NVP3100-xx (or NVP3500-xx) two Ethernet ports directly to the home's network using a standard Ethernet cable. Either of the two Ethernet ports will communicate when connected, as shown in fig. 5. The second port is used for daisy chaining multiple P3100 or P3500 units for more audio zones, as shown in fig. 6. **Note that the NVP3100-xx and NVP3500-xx are not wireless devices and do not use the Gateway for communication.**

Fig. 5

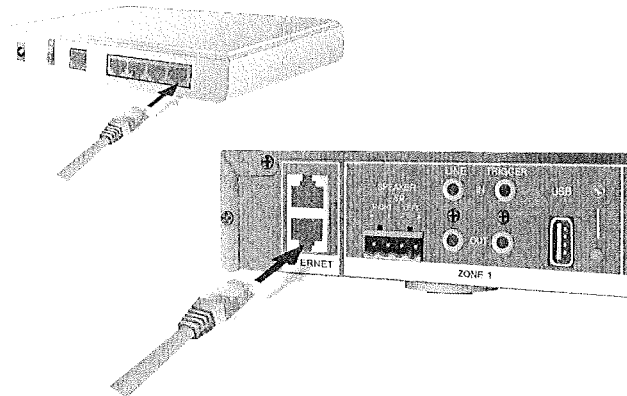

Example shown in fig. 5 and 6 using the NVP3100-cc Player

Fig. 6

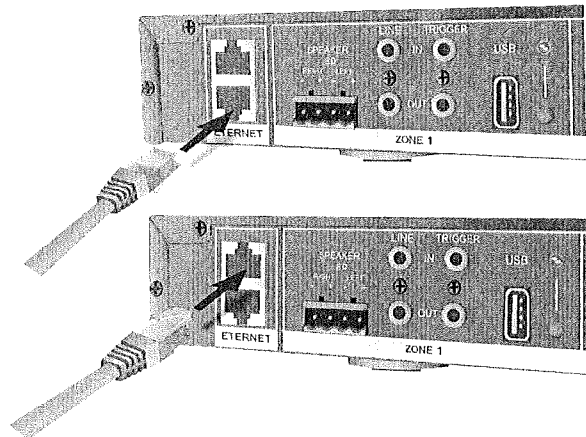

7.5 Connecting Speakers to the NVP100-xx and NVP200-xx

The NVP100-xx and NVP200-xx zone players are equipped with "5-way" binding posts for connecting the amplified audio signal to speakers. These can be bookshelf, floor standing, or installed in the wall or ceiling. 16 gauge speaker wire is recommended for this purpose. The binding posts provide five different methods for terminating the wire. The post can be unscrewed to expose a hole for the speaker wire. Strip about 1/4 inch of insulation from the inner conductor wire and insert it into the hole. Screw the post back in until it firmly secures the wire, as shown in fig 7. The alternative methods are to terminate the speaker wire into "banana" plugs and insert those into the end of the binding posts, as shown in fig. 8. Spade, Pin and wrapping are alternative connection methods. **Be careful to keep the positive and negative speaker connections consistent at both ends. Crossing the left and right terminations will inhibit the audio quality from the amplifier.**

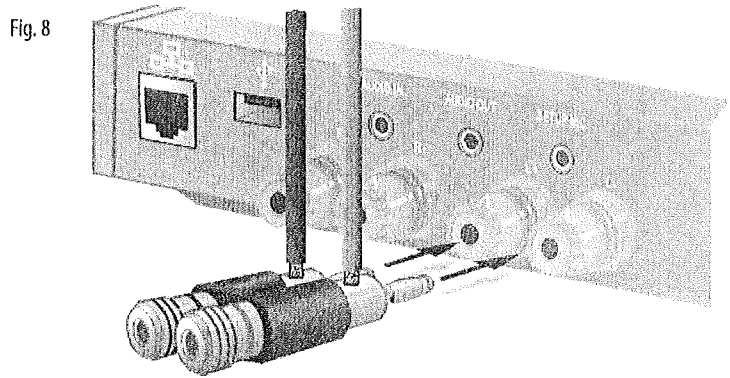
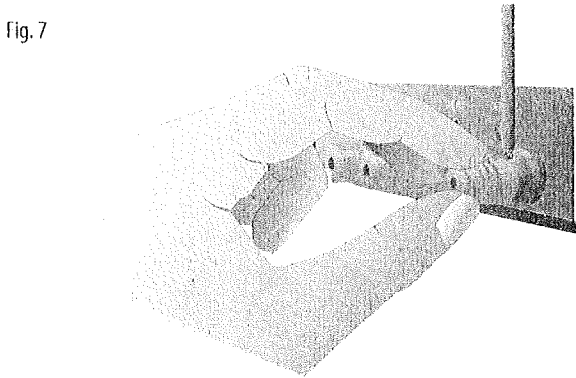

7.6 Connecting Speakers to the NVP3100-xx and NVP3500-xx

The P3100 and P3500 zone players have three separate zone "euro" style speaker connectors. The speaker wire is terminated into this modular plug and then inserted into the appropriate zone output on the back panel of the P3100, as shown in fig. 9. **It is only necessary to strip about 1/8 inch of the insulation from the inner conductor for these plugs. Be careful not to let the exposed speaker wires touch. This will short the connection and could damage the amplifier.**

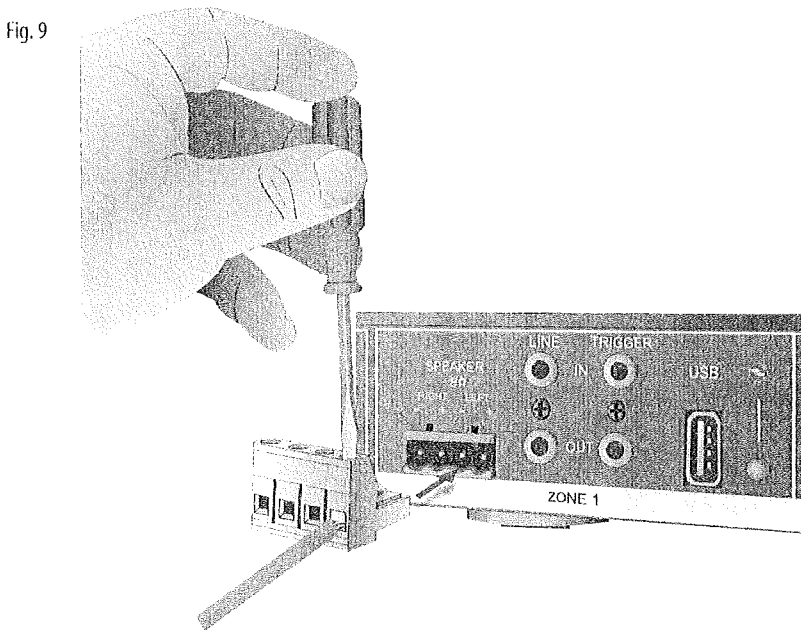

Example shown using the NVP3100-xx Player



2. Setting Up a System from the iOS or Android App

Once you have connected the system to the local network you are ready to begin adding components in their desired locations, naming those locations for local control and creating your multi-zone music system. The process is easily done from any iPod Touch, iPhone, iPad, or Android device using the NuVo Wireless Audio System app.

2.1 New Wireless System Setup

Download the app to your device from the iTunes App Store or the Google Play Marketplace. Make sure your device is connected to the same network as the NuVo Player Portfolio Audio System. Open the app and select "Setup a new system" from the initial screen, as shown in fig. 10. "Set up my new system" is used to connect a new iOS or Android device to an existing system. **Note that the iOS app will not run on older iOS devices that cannot support iOS5 or later versions.**

Fig. 10

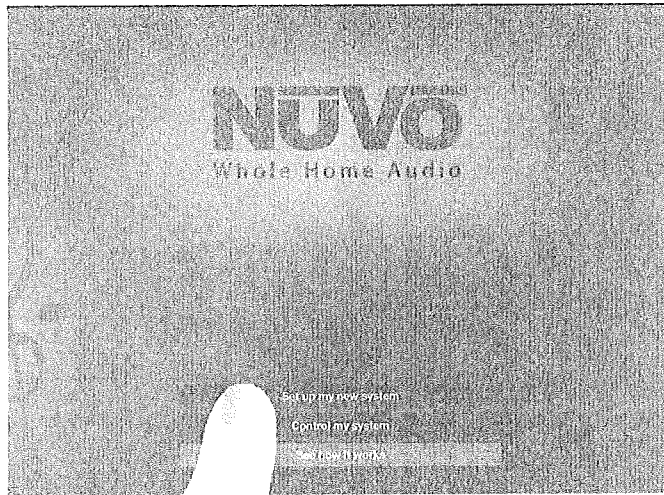
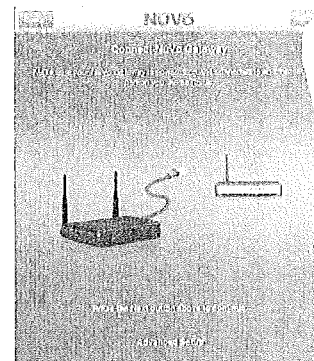
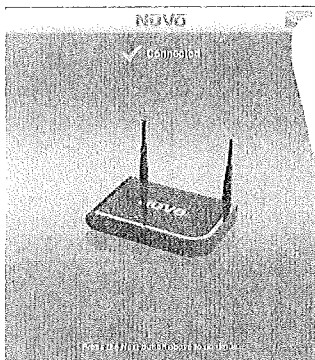

Fig. 11



You should already have connected your Gateway to the home's network. If not, make sure that connection is made, **see section 1.2, Connecting the Gateway to the Network**. When the Gateway and home router connection is made, simply touch "Next", as shown in fig. 11.

Fig. 12



The app will indicate that the Gateway is connected to the network. Touch "Next" to proceed to the individual zone player setup, as shown in fig. 12.

The next step is to place your first component in its desired location. When it is plugged in and powered on, the front LED light will flash white while the player is booting up. When it is ready the front panel LED will be solid green. Touch the "Next" button to proceed to the next step, as shown in fig. 13.

Fig. 13

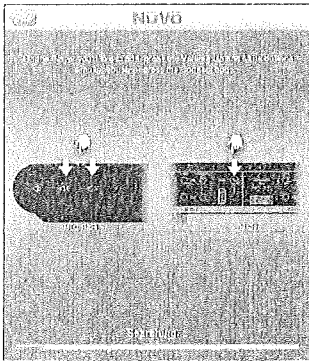
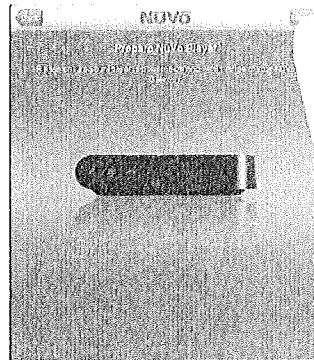

Each player is assigned a network ID as well as a NuVo System ID. This process is completed by simultaneously pressing the Volume UP and Mute buttons (located on the front panel of the NVP100-xx or NVP200-xx players), or by pressing the Zone Setup button (located on the back panel of the NVP3100-xx player, or the front panel of the NVP3500-xx), as shown in fig. 14. Note that the NVP3100-xx and NVP3500-xx support three individual zones in the system. Each zone output section has its own setup button, requiring this process to be repeated for each zone.

Fig. 14

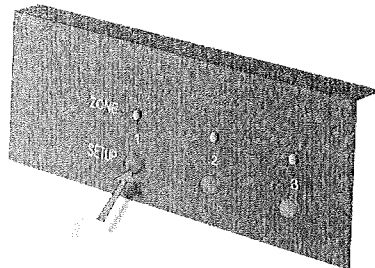
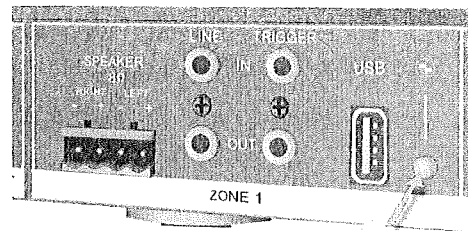
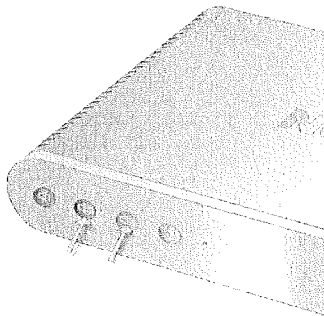
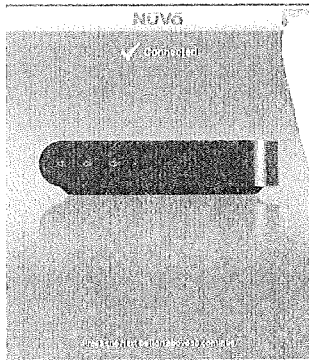
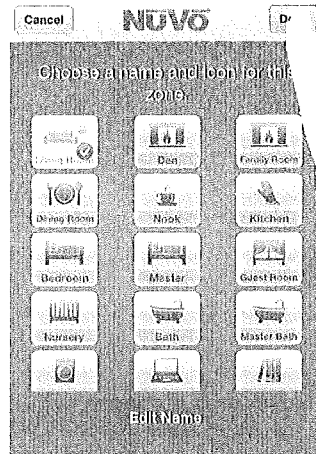

Fig. 15



While the connection is being made, the front panel LED will flash. The app will indicate when the connection is complete and the LED will be solid white. Touch "Next" to proceed, as shown in fig. 15.

Fig. 16



Choose a zone icon for the device. Then you use the "Edit Name" button to give the zone a customized name. When the selection is complete, touch the "Done" button, as shown in fig. 16.

Fig. 17

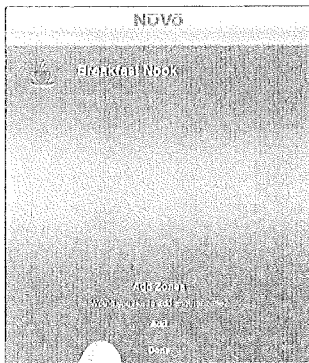

The "Add" button will repeat the setup process for the next zone. If you have completed the setup on all of the desired zones, touch the "Done" button. The app will go to the home screen, referred to as the Dashboard view, as shown in fig. 18. From there any zone can be selected for music playback, and you are ready to enjoy music anywhere in the home.

Fig. 18

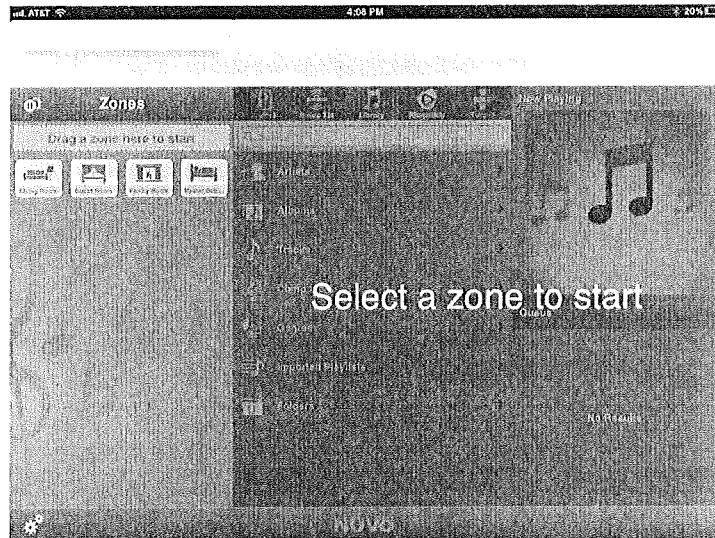

2.2 Adding Zones to an Existing System

Once a system is set up, adding additional NVP100-xx, NVP200-xx, P3100, NVP3500-xx or NVP300-xx zone players is easily done.

Fig. 19

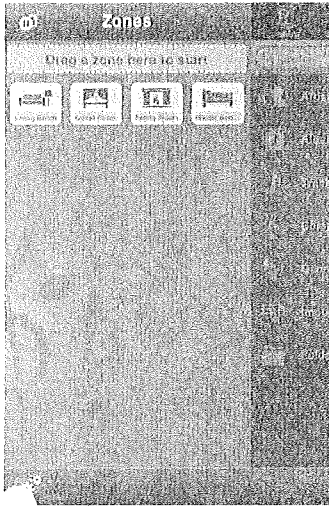

To do this, go to the "Settings" button at the bottom of the Dashboard, which is the section of the app defined by the zone icons, as shown in fig. 19.

Fig. 20

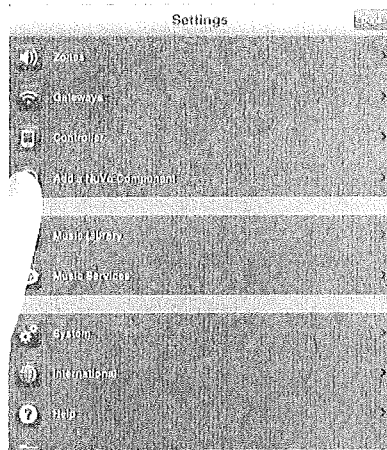

Touch the "Add a NuVo Component" button as shown in fig. 20. This will take you to the zone setup procedure described in section 2.1 New Wireless System Setup.

From this point the setup is identical to the process covered in section 2.1, **New System Setup**.

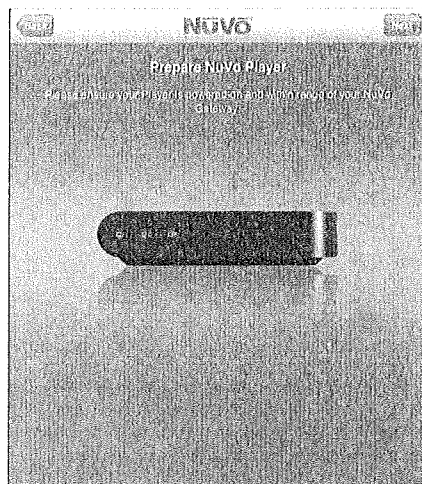

2.3 Adding Additional Gateways to an Existing System

Up to two additional Gateways can be added to a system when additional Wi-Fi range is needed. Additional Gateways must be hardwired to the network along with the original Gateway. This can be done by plugging the new Gateway(s) into the first Gateway, into the installation's router, or a switch from the router. When a new Gateway is added to the system, go to the Settings menu and select "Add a NuVo Component", as shown in fig. 21. The control app will recognize that a new Gateway has been added and the next step is to touch "Add Gateway(s)", as shown in fig. 22.

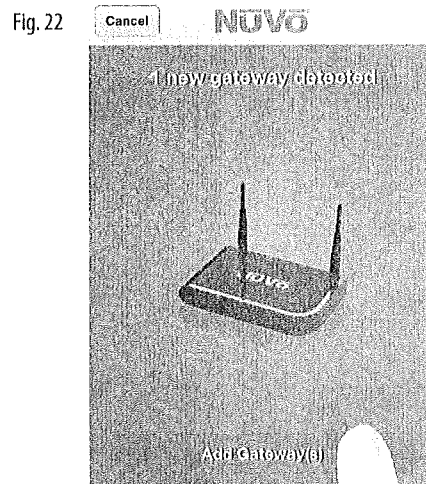
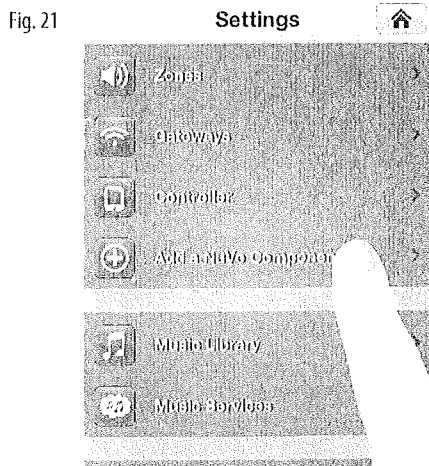

The next step will join the new Gateway to the system, as shown in fig. 23. When the process is complete, the app will indicate that the Gateway has been successfully added, as shown in fig. 24.

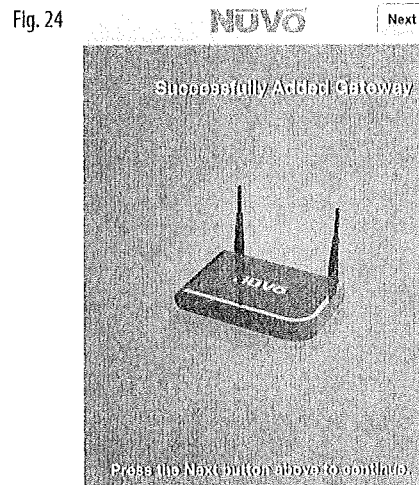
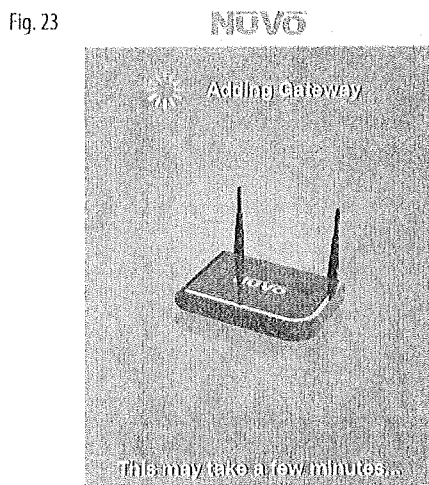

The zones in the system will connect to the best Gateway signal at startup, depending on their location.