



FCC RADIO TEST REPORT

FCC ID : YUATLDPM01D1
Equipment : Enterprise Access Router
Brand Name : Teldat
Model Name : TLDPM01D1, TLDPM02D1
Applicant : Teldat S.A.
Parque Tecnologico de Madrid, Tres Cantos 28760 Madrid
Manufacturer : Teldat S.A.
Parque Tecnologico de Madrid, Tres Cantos 28760 Madrid
Factory : CastleNet Tech Inc.
No.64, Chung-Shan Rd., Tu-Cheng Dist., New Taipei 23680, Taiwan
Standard : 47 CFR FCC Part 15.247

The product was received on Mar. 26, 2019, and testing was started from Mar. 26, 2019 and completed on Jun. 13, 2019. We, SPORTON INTERNATIONAL INC. EMC & Wireless Communications Laboratory, would like to declare that the tested sample has been evaluated in accordance with the procedures given in ANSI C63.10-2013 and shown compliance with the applicable technical standards.

The report must not be used by the client to claim product certification, approval, or endorsement by TAF or any agency of government.

The test results in this report apply exclusively to the tested model / sample. Without written approval of SPORTON INTERNATIONAL INC. EMC & Wireless Communications Laboratory, the test report shall not be reproduced except in full.

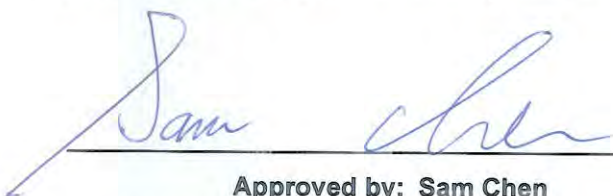
Approved by: Sam Chen

SPORTON INTERNATIONAL INC. EMC & Wireless Communications Laboratory
No. 52, Huaya 1st Rd., Guishan Dist., Taoyuan City, Taiwan (R.O.C.)



Table of Contents

History of this test report.....3

Summary of Test Result.....4

1 General Description5

1.1 Information.....5

1.2 Applicable Standards8

1.3 Testing Location Information.....8

1.4 Measurement Uncertainty8

2 Test Configuration of EUT9

2.1 Test Channel Mode9

2.2 The Worst Case Measurement Configuration.....10

2.3 EUT Operation during Test11

2.4 Accessories12

2.5 Support Equipment.....12

2.6 Test Setup Diagram14

3 Transmitter Test Result17

3.1 AC Power-line Conducted Emissions17

3.2 DTS Bandwidth19

3.3 Maximum Conducted Output Power20

3.4 Power Spectral Density23

3.5 Emissions in Non-restricted Frequency Bands25

3.6 Emissions in Restricted Frequency Bands.....26

4 Test Equipment and Calibration Data30

Appendix A. Test Results of AC Power-line Conducted Emissions

Appendix B. Test Results of DTS Bandwidth

Appendix C. Test Results of Maximum Conducted Output Power

Appendix D. Test Results of Power Spectral Density

Appendix E. Test Results of Emissions in Non-restricted Frequency Bands

Appendix F. Test Results of Emissions in Restricted Frequency Bands

Appendix G. Test Results of Radiated Emission Co-location

Appendix H. Test Photos

Photographs of EUT v02



Summary of Test Result

Report Clause	Ref Std. Clause	Test Items	Result (PASS/FAIL)	Remark
1.1.2	15.203	Antenna Requirement	PASS	-
3.1	15.207	AC Power-line Conducted Emissions	PASS	-
3.2	15.247(a)	DTS Bandwidth	PASS	-
3.3	15.247(b)	Maximum Conducted Output Power	PASS	-
3.4	15.247(e)	Power Spectral Density	PASS	-
3.5	15.247(d)	Emissions in Non-restricted Frequency Bands	PASS	-
3.6	15.247(d)	Emissions in Restricted Frequency Bands	PASS	-

Declaration of Conformity:

The test results with all measurement uncertainty excluded are presented in accordance with the regulation limits or requirements declared by manufacturers.

Comments and Explanations:

- 1.The test configuration, test mode and test software were written in this test report are declared by the manufacturer.
- 2.The declared of product specification for EUT presented in the report are provided by the manufacturer, and the manufacturer takes all the responsibilities for the accuracy of product specification.

Reviewed by: **Sam Chen**

Report Producer: **Viola Huang**



1 General Description

1.1 Information

1.1.1 RF General Information

Frequency Range (MHz)	IEEE Std. 802.11	Ch. Frequency (MHz)	Channel Number
2400-2483.5	b, g, n (HT20), VHT20	2412-2462	1-11 [11]

Band	Mode	BWch (MHz)	Nant
2.4-2.4835GHz	802.11b	20	2TX
2.4-2.4835GHz	802.11g	20	2TX
2.4-2.4835GHz	802.11n HT20	20	2TX
2.4-2.4835GHz	VHT20	20	2TX

Note:

- 11b mode uses a combination of DSSS-DBPSK, DQPSK, CCK modulation.
- 11g, HT20 use a combination of OFDM-BPSK, QPSK, 16QAM, 64QAM modulation.
- VHT20 use a combination of OFDM-BPSK, QPSK, 16QAM, 64QAM, 256QAM modulation.
- BWch is the nominal channel bandwidth.
- Nss-Min is the minimum number of spatial streams.
- Nant is the number of outputs. e.g., 2(2,3) means have 2 outputs for port 2 and port 3. 2 means have 2 outputs for port 1 and port 2.
- The EUT contains a certified RF module (FCC ID: N7NEM7455).



1.1.2 Antenna Information

For WLAN antenna

Ant.	Port	Brand	Model Name	Antenna Type	Connector	Gain (dBi)
1	1	WALSIN	RFMTA441122IMLB701	PIFA Antenna	I-PEX	Note1
2	2	WALSIN	RFMTA441110IMLB701	PIFA Antenna	I-PEX	

For WWAN antenna

Ant.	Port	Brand	Model Name	Antenna Type	Connector	Gain (dBi)
3	1	WALSIN	RFDP A222200SMTB803	Dipole Antenna	SMA Plug	Note1
4	2	WALSIN	RFDP A222200SMTB803	Dipole Antenna	SMA Plug	

For GPS antenna

Ant.	Port	Brand	Model Name	Antenna Type	Connector	Gain (dBi)
5	1	ANTENNAE2J	2J660B-2J409-250RG17 4LL-C20N-C04N-ETXES	Combined Antenna	SMA	2.20

Note1:

WLAN antenna Gain (dBi)				
Ant.	Port	2.4GHz	5G Band 1	5G Band 4
1	1	3.28	4.58	4.06
2	2	3.28	4.58	4.06

WWAN antenna Gain (dBi)					
Ant.	Port	698MHz~960MHz	1400MHz~1500MHz	1710MHz~2170MHz	2300MHz~2690MHz
3	1	2.06	4.03	4.99	3.69
4	2	2.06	4.03	4.99	3.69

Note2: The above information was declared by manufacturer.

Note3: Ant.1 and Ant. 2 for wifi antenna, Ant.3 and Ant.4 for WWAN antenna, Ant. 5 for GPS antenna.

For wifi function (2TX/2RX):

Port 1 and Port 2 can be used as transmitting/receiving antenna.

Port 1 and Port 2 can could transmit/receive simultaneously.

For WWAN function (1TX/2RX):

Port 1 and Port 2 can be used as transmitting/receiving antenna.

Port 1 and Port 2 can could receive simultaneously.

The EUT supports the antenna with TX diversity functions.

Both Port 1 and Port 2 support transmit functions, but only one of them will be used at one time.

For GPS function (1RX):

Only Port 1 can be used as receiving antenna.



1.1.3 Mode Test Duty Cycle

Mode	DC	DCF(dB)	T(s)	VBW(Hz) ≥ 1/T
802.11b	0.995	0.022	n/a (DC>=0.98)	n/a (DC>=0.98)
802.11g	0.962	0.168	2.07m	1k
VHT20	0.984	0.07	n/a (DC>=0.98)	n/a (DC>=0.98)

Note:

- ◆ DC is Duty Cycle.
- ◆ DCF is Duty Cycle Factor.

1.1.4 EUT Operational Condition

EUT Power Type	From Power Adapter			
Beamforming Function	<input checked="" type="checkbox"/>	With beamforming for 802.11ac in 5GHz	<input type="checkbox"/>	Without beamforming
Function	<input checked="" type="checkbox"/>	Point-to-multipoint	<input type="checkbox"/>	Point-to-point
Test Software Version	QCA Radio Control Toolkit v3.0.298.0			

Note: The above information was declared by manufacturer.

1.1.5 Table for Multiple Listing

The model names in the following table are all refer to the identical product.

Brand Name	EUT	Model Name	SKU	Description
Teldat	1	TLDPM01D1	SKU 2	Wi-Fi
	2	TLDPM02D1	SKU 2	Wi-Fi + LTE EM7455

From the above models, model: TLDPM02D1 was selected as representative model for the test and its data was recorded in this report.

1.1.6 Table of WWAN module function

Model Name	FCC ID	Module	Function
EM7455	N7NEM7455	1	LTE: B13 & WCDMA: B4



1.2 Applicable Standards

According to the specifications of the manufacturer, the EUT must comply with the requirements of the following standards:

- ◆ 47 CFR FCC Part 15
- ◆ ANSI C63.10-2013
- ◆ FCC KDB 558074 D01 v05r02
- ◆ FCC KDB 662911 D01 v02r01

1.3 Testing Location Information

Testing Location		
<input type="checkbox"/>	HWA YA	ADD : No. 52, Huaya 1st Rd., Guishan Dist., Taoyuan City, Taiwan (R.O.C.) TEL : 886-3-327-3456 FAX : 886-3-327-0973
<input checked="" type="checkbox"/>	JHUBEI	ADD : No.8, Lane 724, Bo-ai St., Jhubei City, HsinChu County 302, Taiwan, R.O.C. TEL : 886-3-656-9065 FAX : 886-3-656-9085

Test Condition	Test Site No.	Test Engineer	Test Environment	Test Date
RF Conducted	TH01-CB	Welson Chen	22~24°C / 54~56%	Mar. 28, 2019 ~ May 21, 2019
Radiated below 1GHz	03CH06-CB	Cola Fan	22~24°C / 50~60%	May 14, 2019~Jun. 13, 2019
Radiated above 1GHz	03CH04-CB	Welson Chen	21~23°C / 53~55%	Mar. 26, 2019 ~ May 21, 2019
AC Conduction	CO02-CB	Deven Huang	24~25°C / 59~61%	May 10, 2019

Test site Designation No. TW0006 with FCC.

Test site registered number IC 4086B with Industry Canada.

1.4 Measurement Uncertainty

ISO/IEC 17025 requires that an estimate of the measurement uncertainties associated with the emissions test results be included in the report. The measurement uncertainties given below are based on a 95% confidence level (based on a coverage factor (k=2))

Test Items	Uncertainty	Remark
Conducted Emission (150kHz ~ 30MHz)	2.0 dB	Confidence levels of 95%
Radiated Emission (30MHz ~ 1,000MHz)	3.4 dB	Confidence levels of 95%
Radiated Emission (1GHz ~ 18GHz)	3.8 dB	Confidence levels of 95%
Radiated Emission (18GHz ~ 40GHz)	4.7 dB	Confidence levels of 95%
Conducted Emission	1.7 dB	Confidence levels of 95%
Output Power Measurement	1.33 dB	Confidence levels of 95%
Power Density Measurement	1.27 dB	Confidence levels of 95%
Bandwidth Measurement	9.74 x10 ⁻⁸	Confidence levels of 95%



2 Test Configuration of EUT

2.1 Test Channel Mode

Mode	PowerSetting
802.11b_Nss1,(1Mbps)_2TX	-
2412MHz	22
2437MHz	22
2462MHz	21.5
802.11g_Nss1,(6Mbps)_2TX	-
2412MHz	20.5
2437MHz	22
2462MHz	21
VHT20_Nss1,(MCS0)_2TX	-
2412MHz	21.5
2437MHz	22
2457MHz	21.5
2462MHz	18.5

Note:

- ♦ VHT20 covers HT20, due to same modulation. The power setting for 802.11n HT20 is the same or lower than 802.11ac VHT20.



2.2 The Worst Case Measurement Configuration

The Worst Case Mode for Following Conformance Tests	
Tests Item	AC power-line conducted emissions
Condition	AC power-line conducted measurement for line and neutral
Operating Mode	Normal Link
1	EUT 2 + GPS + WiFi + Fiber Mode + Sim card 1 + LTE B13 (EM7455)
2	EUT 2 + GPS + WiFi + WAN Mode + Sim card 1 + LTE B13 (EM7455)
Mode 2 has been evaluated to be the worst case among Mode 1~2, thus measurement for Mode 3 will follow this same test mode.	
3	EUT 2 + GPS + WiFi + WAN Mode + Sim card 1 + WCDMA B4 (EM7455)
Mode 2 has been evaluated to be the worst case among Mode 1~3, thus measurement for Mode 4 will follow this same test mode.	
4	EUT 2 + GPS + WiFi + WAN Mode + Sim card 2 + LTE B13 (EM7455)
Mode 4 generated the worst test result, so it was recorded in this report.	

The Worst Case Mode for Following Conformance Tests	
Tests Item	DTS Bandwidth Maximum Conducted Output Power Power Spectral Density Emissions in Non-restricted Frequency Bands
Test Condition	Conducted measurement at transmit chains



The Worst Case Mode for Following Conformance Tests	
Tests Item	Emissions in Restricted Frequency Bands
Test Condition	Radiated measurement If EUT consist of multiple antenna assembly (multiple antenna are used in EUT regardless of spatial multiplexing MIMO configuration), the radiated test should be performed with highest antenna gain of each antenna type.
Operating Mode < 1GHz	Normal Link
1	EUT 2 + GPS + WiFi + Fiber Mode + Sim card 1 + LTE B13 (EM7455)
2	EUT 2 + GPS + WiFi + WAN Mode + Sim card 1 + LTE B13 (EM7455)
Mode 1 has been evaluated to be the worst case among Mode 1~2, thus measurement for Mode 3 will follow this same test mode.	
3	EUT 2 + GPS + WiFi + Fiber Mode + Sim card 1 + WCDMA B4 (EM7455)
Mode 1 has been evaluated to be the worst case among Mode 1~3, thus measurement for Mode 4 will follow this same test mode.	
4	EUT 2 + GPS + WiFi + Fiber Mode + Sim card 2 + LTE B13 (EM7455)
Mode 1 generated the worst test result, so it was recorded in this report.	
Operating Mode > 1GHz	CTX

The Worst Case Mode for Following Conformance Tests	
Tests Item	Simultaneous Transmission Analysis - Radiated Emission Co-location
Test Condition	Radiated measurement
Operating Mode	Normal Link
1	WLAN 2.4GHz + WLAN 5GHz
Refer to Appendix G for Radiated Emission Co-location.	

The Worst Case Mode for Following Conformance Tests	
Tests Item	Simultaneous Transmission Analysis - Co-location RF Exposure Evaluation
Operating Mode	
1	WLAN 2.4GHz + WLAN 5GHz + WCDMA B4 (EM7455)
2	WLAN 2.4GHz + WLAN 5GHz + LTE B13 (EM7455)
Refer to Sporton Test Report No.: FA932105 for Co-location RF Exposure Evaluation.	

Note: The EUT only uses in Z axis.

2.3 EUT Operation during Test

For CTX Mode:

The EUT was programmed to be in continuously transmitting mode.

For Normal Link:

During the test, the EUT operation to normal function.



2.4 Accessories

Accessories				
Power	Brand Name	Model Name	Rating	Remark
Adapter	AtechOEM	A0403TD-120033	Input: 100-240Vac ~ 50-60Hz, 1.2A Output: 12Vdc, 3.34A	DC Power cable: Non-shielded, 1.6m
Others				
Power cable*1: Non-shielded, 1.5m				
RJ-45 cable*1: Non-shielded, 2m				

2.5 Support Equipment

For AC Conduction (For WAN Mode):

Support Equipment				
No.	Equipment	Brand Name	Model Name	FCC ID
A	WAN1 NB	DELL	E6430	N/A
B	WAN2 NB	DELL	E6430	N/A
C	2.4G NB	DELL	E6430	N/A
D	5G NB	DELL	E6430	N/A
E	LAN NB	DELL	E6430	N/A
F	LTE Base station	Anritsu	MT8820C	N/A
G	GPS simulator	WELNAVIGATE	GS-100	N/A
H	SIM card	N/A	N/A	N/A

For Radiated (below 1GHz / For Fiber Mode):

Support Equipment				
No.	Equipment	Brand Name	Model Name	FCC ID
A	Fiber1 NB	DELL	E4300	N/A
B	Fiber2 NB	DELL	E4300	N/A
C	LAN NB	DELL	E4300	N/A
D	2.4G NB	DELL	E4300	N/A
E	5G NB	DELL	E4300	N/A
F	Media converter	TRON OPTO	TN1000SFP	N/A
G	Media converter	TRON OPTO	TN1000SFP	N/A
H	SIM card	Anritsu	N/A	N/A
I	LTE base station	Anritsu	MT8820C	N/A
J	GPS simulator	WELNAVIGATE	GS-100	N/A



For RF Conducted and Radiated (above 1GHz):

Support Equipment				
No.	Equipment	Brand Name	Model Name	FCC ID
A	NB	DELL	E4300	N/A

2.6 Test Setup Diagram

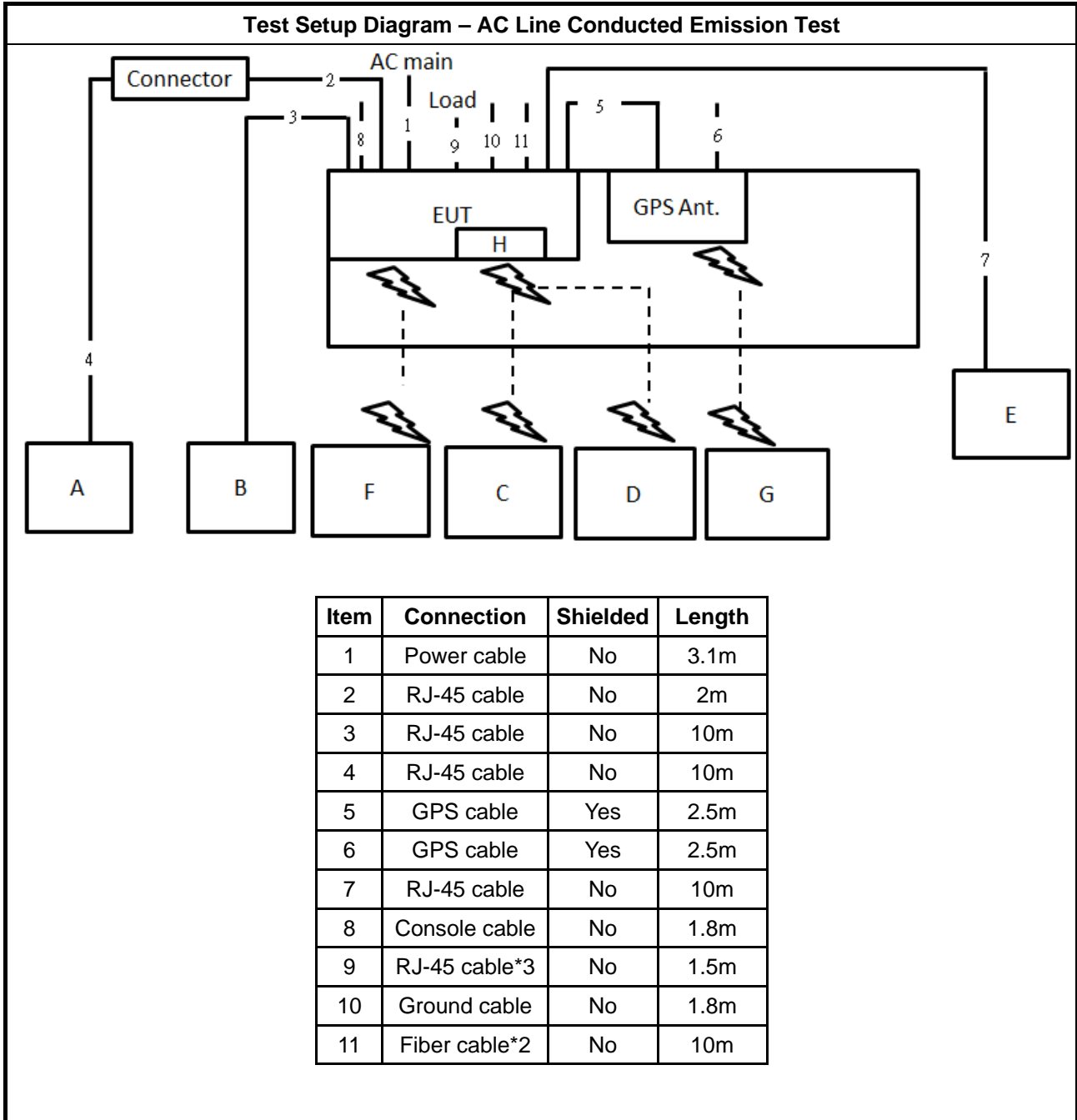



Test Setup Diagram - Radiated Test < 1GHz

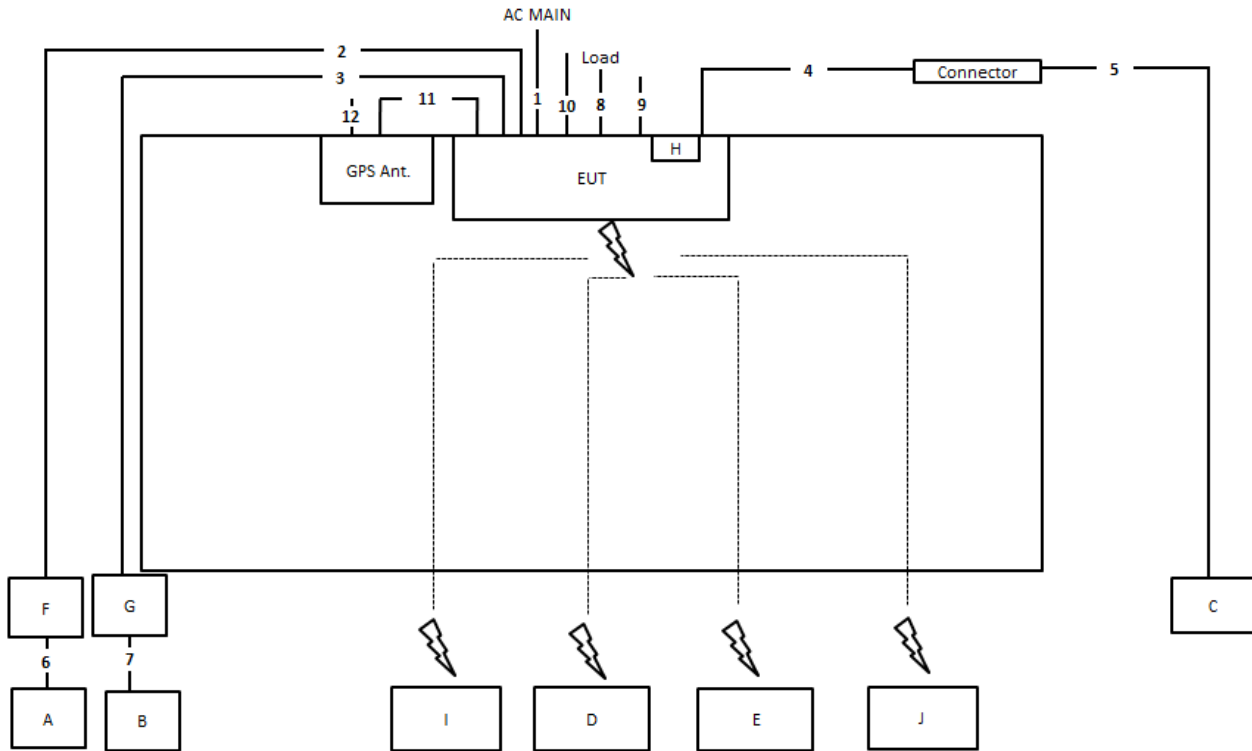

Item	Connection	Shielded	Length
1	Power cable	No	3.1m
2	Fiber cable	No	10m
3	Fiber cable	No	10m
4	RJ-45 cable	No	2m
5	RJ-45 cable	No	10m
6	RJ-45 cable	No	1.5m
7	RJ-45 cable	No	1.5m
8	RJ-45 cable*5	No	1.5m
9	Ground cable	No	1.5m
10	Console cable	No	1.8m
11	GPS cable	Yes	2.5m
12	GPS cable	Yes	2.5m



Test Setup Diagram - Radiated Test > 1GHz

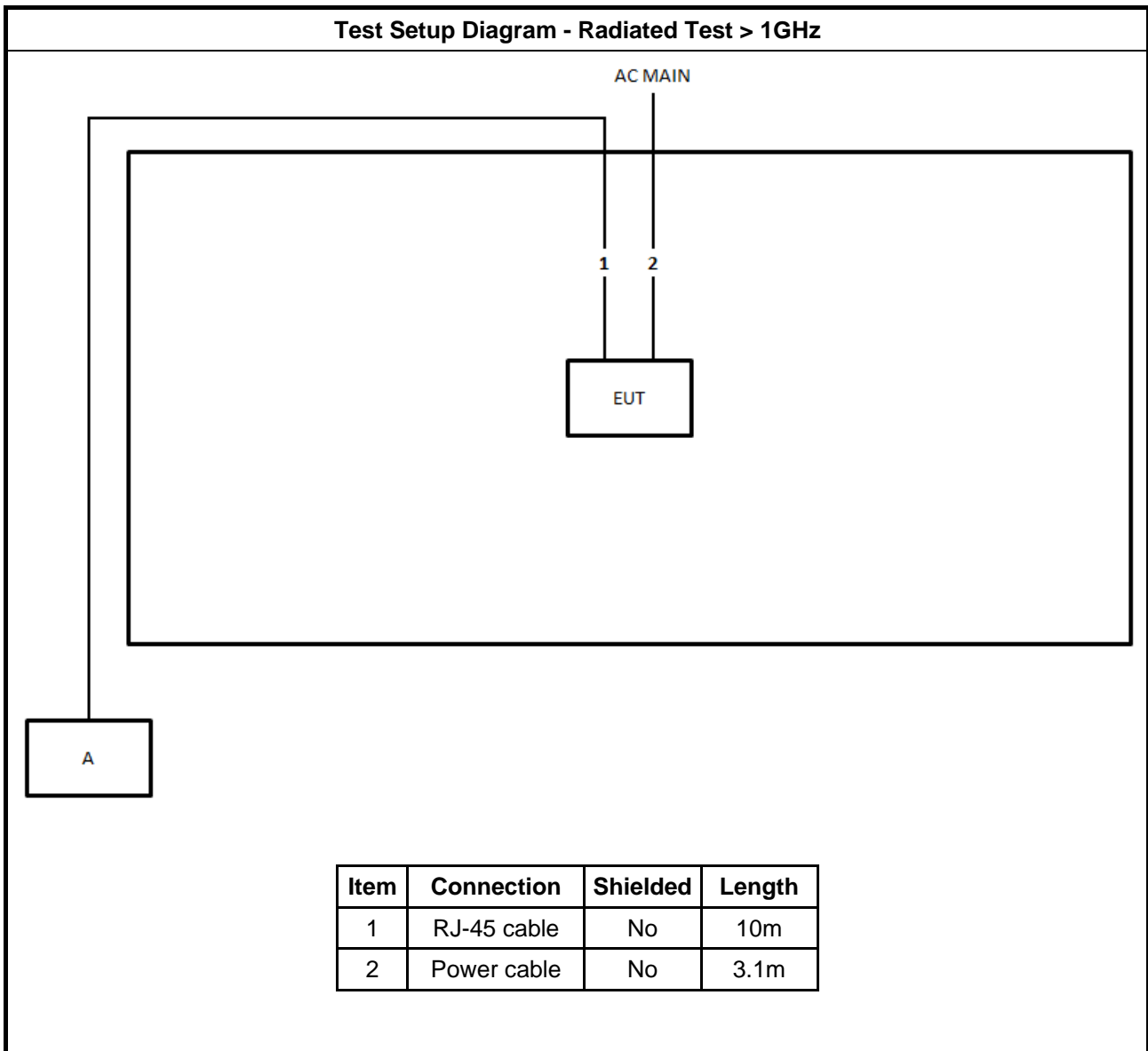

Item	Connection	Shielded	Length
1	RJ-45 cable	No	10m
2	Power cable	No	3.1m



3 Transmitter Test Result

3.1 AC Power-line Conducted Emissions

3.1.1 AC Power-line Conducted Emissions Limit

AC Power-line Conducted Emissions Limit		
Frequency Emission (MHz)	Quasi-Peak	Average
0.15-0.5	66 - 56 *	56 - 46 *
0.5-5	56	46
5-30	60	50

Note 1: * Decreases with the logarithm of the frequency.

3.1.2 Measuring Instruments

Refer a test equipment and calibration data table in this test report.

3.1.3 Test Procedures

Test Method
<input checked="" type="checkbox"/> Refer as ANSI C63.10-2013, clause 6.2 for AC power-line conducted emissions.

3.1.4 Test Setup

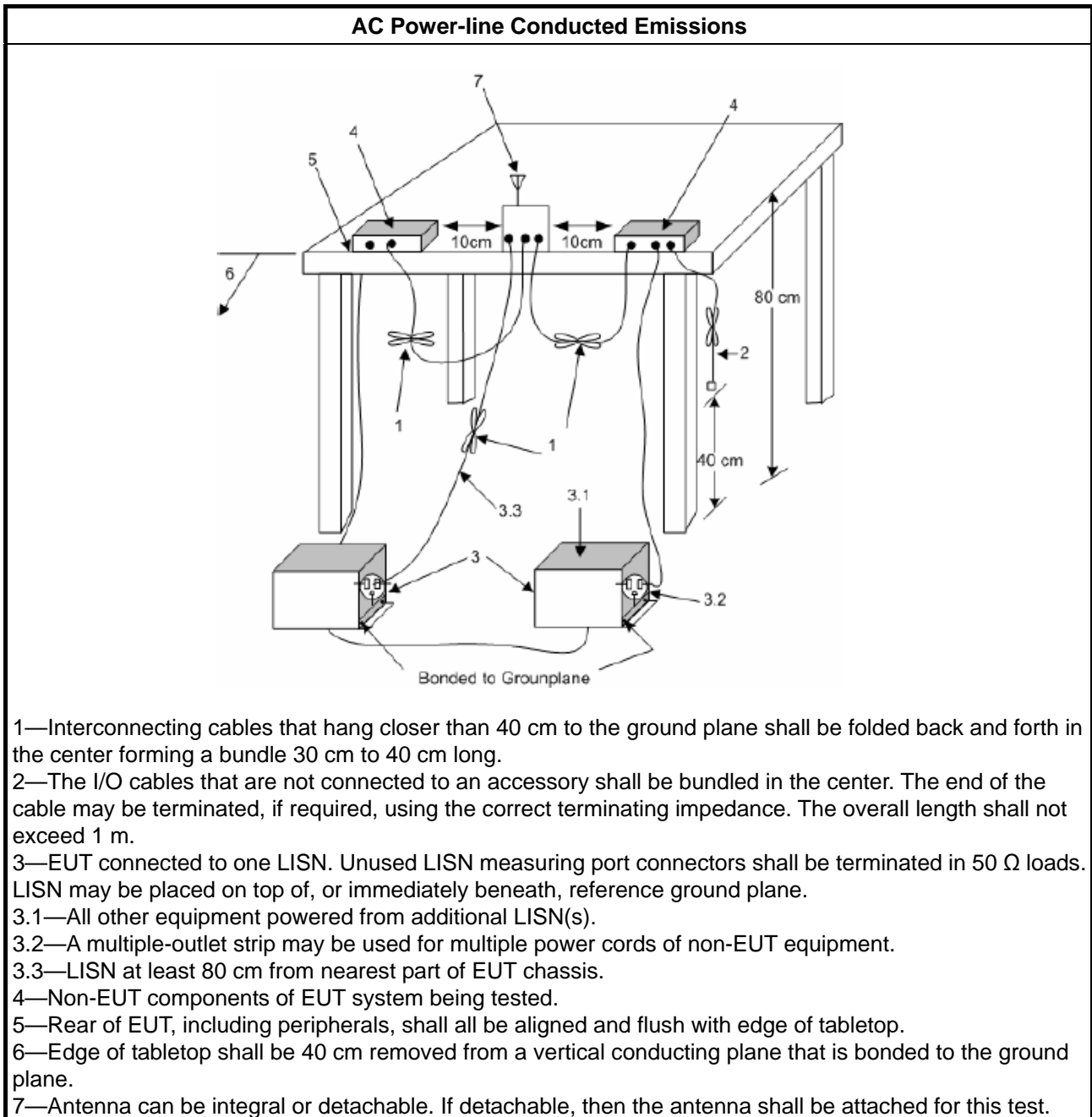

3.1.5 Test Result of AC Power-line Conducted Emissions

Refer as Appendix A

3.2 DTS Bandwidth

3.2.1 6dB Bandwidth Limit

6dB Bandwidth Limit
Systems using digital modulation techniques:
<ul style="list-style-type: none"> ▪ 6 dB bandwidth \geq 500 kHz.

3.2.2 Measuring Instruments

Refer a test equipment and calibration data table in this test report.

3.2.3 Test Procedures

Test Method
<ul style="list-style-type: none"> ▪ For the emission bandwidth shall be measured using one of the options below:
<input checked="" type="checkbox"/> Refer as FCC KDB 558074, clause 8.2 & C63.10 clause 11.8.1 Option 1 for 6 dB bandwidth measurement.
<input type="checkbox"/> Refer as FCC KDB 558074, clause 8.2 & C63.10 clause 11.8.2 Option 2 for 6 dB bandwidth measurement.
<input type="checkbox"/> Refer as ANSI C63.10, clause 6.9.1 for occupied bandwidth testing.

3.2.4 Test Setup

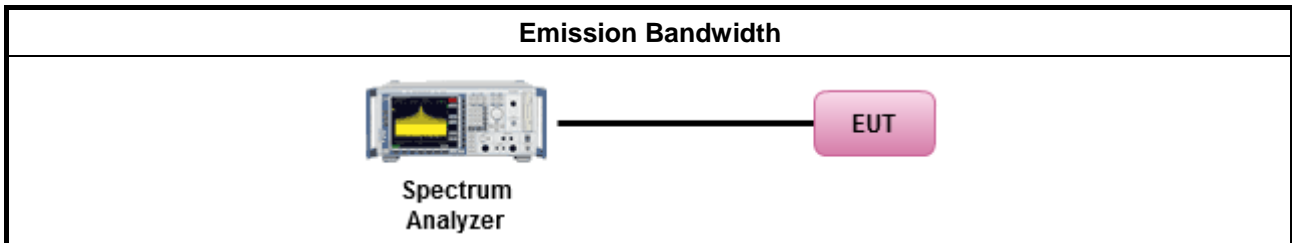

3.2.5 Test Result of Emission Bandwidth

Refer as Appendix B



3.3 Maximum Conducted Output Power

3.3.1 Maximum Conducted Output Power Limit

Maximum Conducted Output Power Limit	
	<ul style="list-style-type: none">▪ If $G_{TX} \leq 6$ dBi, then $P_{Out} \leq 30$ dBm (1 W)
	<ul style="list-style-type: none">▪ Point-to-multipoint systems (P2M): If $G_{TX} > 6$ dBi, then $P_{Out} = 30 - (G_{TX} - 6)$ dBm
	<ul style="list-style-type: none">▪ Point-to-point systems (P2P): If $G_{TX} > 6$ dBi, then $P_{Out} = 30 - (G_{TX} - 6)/3$ dBm
	<ul style="list-style-type: none">▪ Smart antenna system (SAS):
	<ul style="list-style-type: none">- Single beam: If $G_{TX} > 6$ dBi, then $P_{Out} = 30 - (G_{TX} - 6)/3$ dBm
	<ul style="list-style-type: none">- Overlap beam: If $G_{TX} > 6$ dBi, then $P_{Out} = 30 - (G_{TX} - 6)/3$ dBm
	<ul style="list-style-type: none">- Aggregate power on all beams: If $G_{TX} > 6$ dBi, then $P_{Out} = 30 - (G_{TX} - 6)/3 + 8$ dB dBm
P_{Out} = maximum peak conducted output power or maximum conducted output power in dBm, G_{TX} = the maximum transmitting antenna directional gain in dBi.	

3.3.2 Measuring Instruments

Refer a test equipment and calibration data table in this test report.



3.3.3 Test Procedures

Test Method	
<ul style="list-style-type: none"> ▪ Maximum Peak Conducted Output Power 	
	<input type="checkbox"/> Refer as FCC KDB 558074, clause 8.3.1.1 & C63.10 clause 11.9.1.1 (RBW ≥ EBW method).
	<input type="checkbox"/> Refer as FCC KDB 558074, clause 8.3.1.3 & C63.10 clause 11.9.1.3 (peak power meter).
<ul style="list-style-type: none"> ▪ Maximum Conducted Output Power 	
[duty cycle ≥ 98% or external video / power trigger]	
	<input type="checkbox"/> Refer as FCC KDB 558074, clause 8.3.2.2 & C63.10 clause 11.9.2.2.2 Method AVGSA-1.
	<input type="checkbox"/> Refer as FCC KDB 558074, clause 8.3.2.2 & C63.10 clause 11.9.2.2.3 Method AVGSA-1A. (alternative)
duty cycle < 98% and average over on/off periods with duty factor	
	<input type="checkbox"/> Refer as FCC KDB 558074, clause 8.3.2.2 & C63.10 clause 11.9.2.2.4 Method AVGSA-2.
	<input type="checkbox"/> Refer as FCC KDB 558074, clause 8.3.2.2 & C63.10 clause 11.9.2.2.5 Method AVGSA-2A (alternative)
	<input type="checkbox"/> Refer as FCC KDB 558074, clause 8.3.2.2 & C63.10 clause 11.9.2.2.6 Method AVGSA-3
	<input type="checkbox"/> Refer as FCC KDB 558074, clause 8.3.2.2 & C63.10 clause 11.9.2.2.7 Method AVGSA-3A (alternative)
Measurement using a power meter (PM)	
	<input checked="" type="checkbox"/> Refer as FCC KDB 558074, clause 8.3.2.3 & C63.10 clause 11.9.2.3.1 Method AVGPM (using an RF average power meter).
	<input type="checkbox"/> Refer as FCC KDB 558074, clause 8.3.2.3 & C63.10 clause 11.9.2.3.2 Method AVGPM-G (using an gate RF average power meter).
<ul style="list-style-type: none"> ▪ For conducted measurement. 	
	<ul style="list-style-type: none"> ▪ If the EUT supports multiple transmit chains using options given below: Refer as FCC KDB 662911, In-band power measurements. Using the measure-and-sum approach, measured all transmit ports individually. Sum the power (in linear power units e.g., mW) of all ports for each individual sample and save them.
	<ul style="list-style-type: none"> ▪ If multiple transmit chains, EIRP calculation could be following as methods: $P_{total} = P_1 + P_2 + \dots + P_n$ (calculated in linear unit [mW] and transfer to log unit [dBm]) $EIRP_{total} = P_{total} + DG$

3.3.4 Test Setup

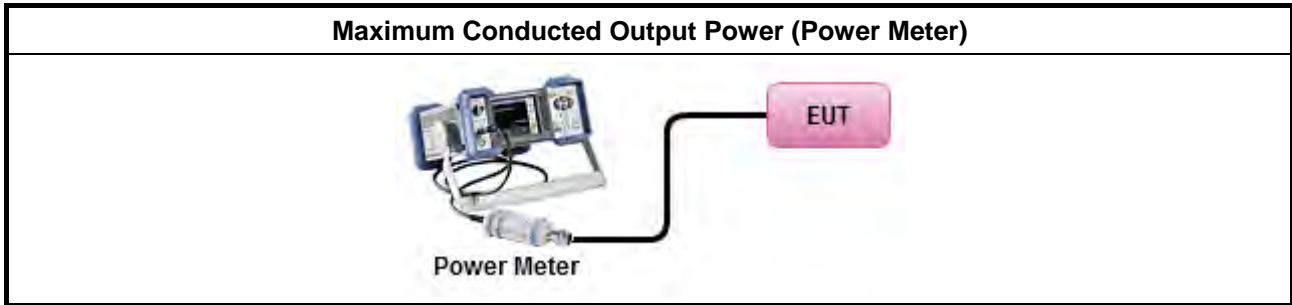

3.3.5 Test Result of Maximum Conducted Output Power

Refer as Appendix C



3.4 Power Spectral Density

3.4.1 Power Spectral Density Limit

Power Spectral Density Limit
<ul style="list-style-type: none"> ▪ Power Spectral Density (PSD) \leq 8 dBm/3kHz

3.4.2 Measuring Instruments

Refer a test equipment and calibration data table in this test report.

3.4.3 Test Procedures

Test Method				
<ul style="list-style-type: none"> ▪ Peak power spectral density procedures that the same method as used to determine the conducted output power. If maximum peak conducted output power was measured to demonstrate compliance to the output power limit, then the peak PSD procedure below (Method PKPSD) shall be used. If maximum conducted output power was measured to demonstrate compliance to the output power limit, then one of the average PSD procedures shall be used, as applicable based on the following criteria (the peak PSD procedure is also an acceptable option). 				
<input checked="" type="checkbox"/> Refer as FCC KDB 558074, clause 8.4 & C63.10 clause 11.10.2 Method PKPSD. [duty cycle \geq 98% or external video / power trigger]				
<input type="checkbox"/> Refer as FCC KDB 558074, clause 8.4 & C63.10 clause 11.10.3 Method AVGPSD-1.				
<input type="checkbox"/> Refer as FCC KDB 558074, clause 8.4 & C63.10 clause 11.10.5 Method AVGPSD-2.				
<input type="checkbox"/> Refer as FCC KDB 558074, clause 8.4 & C63.10 clause 11.10.7 Method AVGPSD-3. duty cycle < 98% and average over on/off periods with duty factor				
<input type="checkbox"/> Refer as FCC KDB 558074, clause 8.4 & C63.10 clause 11.10.4 Method AVGPSD-1A. (alternative).				
<input type="checkbox"/> Refer as FCC KDB 558074, clause 8.4 & C63.10 clause 11.10.6 Method AVGPSD-2A. (alternative)				
<input type="checkbox"/> Refer as FCC KDB 558074, clause 8.4 & C63.10 clause 11.10.8 Method AVGPSD-3A. (alternative)				
<ul style="list-style-type: none"> ▪ For conducted measurement. 				
<ul style="list-style-type: none"> ▪ If The EUT supports multiple transmit chains using options given below: <table border="1" style="width: 100%; border-collapse: collapse;"> <tbody> <tr> <td style="width: 20px; text-align: center;"><input checked="" type="checkbox"/></td> <td>Option 1: Measure and sum the spectra across the outputs. Refer as FCC KDB 662911, In-band power spectral density (PSD). Sample all transmit ports simultaneously using a spectrum analyzer for each transmit port. Where the trace bin-by-bin of each transmit port summing can be performed. (i.e., in the first spectral bin of output 1 is summed with that in the first spectral bin of output 2 and that from the first spectral bin of output 3, and so on up to the NTX output to obtain the value for the first frequency bin of the summed spectrum.). Add up the amplitude (power) values for the different transmit chains and use this as the new data trace.</td> </tr> <tr> <td style="text-align: center;"><input type="checkbox"/></td> <td>Option 2: Measure and sum spectral maxima across the outputs. With this technique, spectra are measured at each output of the device at the required resolution bandwidth. The maximum value (peak) of each spectrum is determined. These maximum values are then summed mathematically in linear power units across the outputs. These operations shall be performed separately over frequency spans that have different out-of-band or spurious emission limits,</td> </tr> </tbody> </table> 	<input checked="" type="checkbox"/>	Option 1: Measure and sum the spectra across the outputs. Refer as FCC KDB 662911, In-band power spectral density (PSD). Sample all transmit ports simultaneously using a spectrum analyzer for each transmit port. Where the trace bin-by-bin of each transmit port summing can be performed. (i.e., in the first spectral bin of output 1 is summed with that in the first spectral bin of output 2 and that from the first spectral bin of output 3, and so on up to the NTX output to obtain the value for the first frequency bin of the summed spectrum.). Add up the amplitude (power) values for the different transmit chains and use this as the new data trace.	<input type="checkbox"/>	Option 2: Measure and sum spectral maxima across the outputs. With this technique, spectra are measured at each output of the device at the required resolution bandwidth. The maximum value (peak) of each spectrum is determined. These maximum values are then summed mathematically in linear power units across the outputs. These operations shall be performed separately over frequency spans that have different out-of-band or spurious emission limits,
<input checked="" type="checkbox"/>	Option 1: Measure and sum the spectra across the outputs. Refer as FCC KDB 662911, In-band power spectral density (PSD). Sample all transmit ports simultaneously using a spectrum analyzer for each transmit port. Where the trace bin-by-bin of each transmit port summing can be performed. (i.e., in the first spectral bin of output 1 is summed with that in the first spectral bin of output 2 and that from the first spectral bin of output 3, and so on up to the NTX output to obtain the value for the first frequency bin of the summed spectrum.). Add up the amplitude (power) values for the different transmit chains and use this as the new data trace.			
<input type="checkbox"/>	Option 2: Measure and sum spectral maxima across the outputs. With this technique, spectra are measured at each output of the device at the required resolution bandwidth. The maximum value (peak) of each spectrum is determined. These maximum values are then summed mathematically in linear power units across the outputs. These operations shall be performed separately over frequency spans that have different out-of-band or spurious emission limits,			



Option 3: Measure and add $10 \log(N)$ dB, where N is the number of transmit chains. Refer as FCC KDB 662911, In-band power spectral density (PSD). Performed at each transmit chains and each transmit chains shall be compared with the limit have been reduced with $10 \log(N)$. Or each transmit chains shall be add $10 \log(N)$ to compared with the limit.

3.4.4 Test Setup

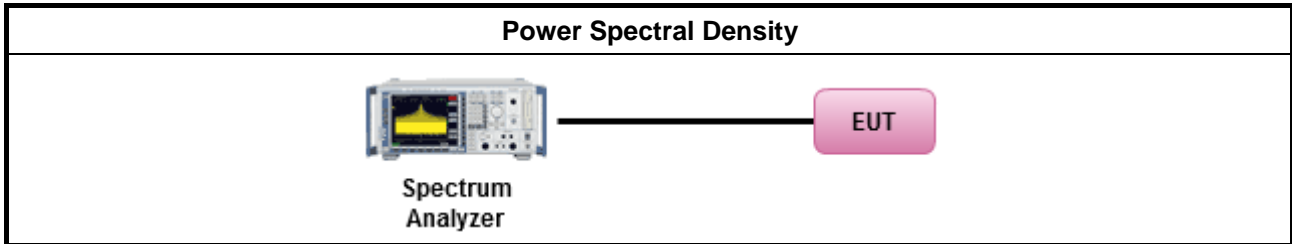

3.4.5 Test Result of Power Spectral Density

Refer as Appendix D

3.5 Emissions in Non-restricted Frequency Bands

3.5.1 Emissions in Non-restricted Frequency Bands Limit

Un-restricted Band Emissions Limit	
RF output power procedure	Limit (dBc)
Peak output power procedure	20
Average output power procedure	30

Note 1: If the peak output power procedure is used to measure the fundamental emission power to demonstrate compliance to requirements, then the peak conducted output power measured within any 100 kHz outside the authorized frequency band shall be attenuated by at least 20 dB relative to the maximum measured in-band peak PSD level.

Note 2: If the average output power procedure is used to measure the fundamental emission power to demonstrate compliance to requirements, then the power in any 100 kHz outside of the authorized frequency band shall be attenuated by at least 30 dB relative to the maximum measured in-band average PSD level.

3.5.2 Measuring Instruments

Refer a test equipment and calibration data table in this test report.

3.5.3 Test Procedures

Test Method
<ul style="list-style-type: none"> Refer as FCC KDB 558074, clause 8.5 for unwanted emissions into non-restricted bands.

3.5.4 Test Setup

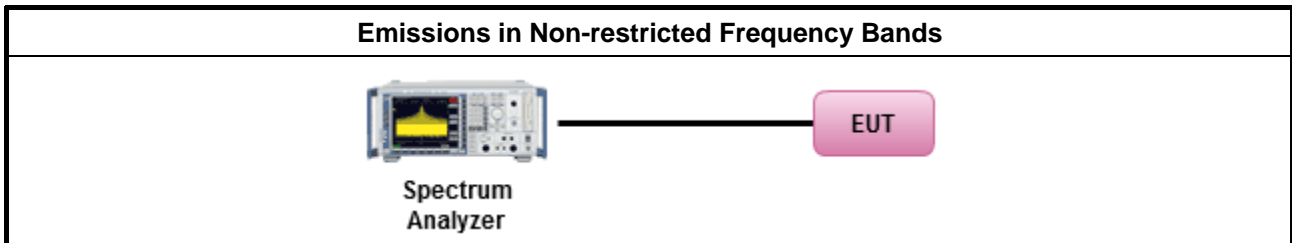

3.5.5 Test Result of Emissions in Non-restricted Frequency Bands

Refer as Appendix E



3.6 Emissions in Restricted Frequency Bands

3.6.1 Emissions in Restricted Frequency Bands Limit

Restricted Band Emissions Limit			
Frequency Range (MHz)	Field Strength (uV/m)	Field Strength (dBuV/m)	Measure Distance (m)
0.009~0.490	2400/F(kHz)	48.5 - 13.8	300
0.490~1.705	24000/F(kHz)	33.8 - 23	30
1.705~30.0	30	29	30
30~88	100	40	3
88~216	150	43.5	3
216~960	200	46	3
Above 960	500	54	3

Note 1: Test distance for frequencies at or above 30 MHz, measurements may be performed at a distance other than the limit distance provided they are not performed in the near field and the emissions to be measured can be detected by the measurement equipment. When performing measurements at a distance other than that specified, the results shall be extrapolated to the specified distance using an extrapolation factor of 20 dB/decade (inverse of linear distance for field-strength measurements, inverse of linear distance-squared for power-density measurements).

Note 2: Test distance for frequencies at below 30 MHz, measurements may be performed at a distance closer than the EUT limit distance; however, an attempt should be made to avoid making measurements in the near field. When performing measurements below 30 MHz at a closer distance than the limit distance, the results shall be extrapolated to the specified distance by either making measurements at a minimum of two or more distances on at least one radial to determine the proper extrapolation factor or by using the square of an inverse linear distance extrapolation factor (40 dB/decade). The test report shall specify the extrapolation method used to determine compliance of the EUT.

Note 3: Using the distance of 1m during the test for above 18 GHz, and the test value to correct for the distance factor at 3m.

3.6.2 Measuring Instruments

Refer a test equipment and calibration data table in this test report.



3.6.3 Test Procedures

Test Method	
<ul style="list-style-type: none"> ▪ The average emission levels shall be measured in [duty cycle \geq 98 or duty factor]. 	
<ul style="list-style-type: none"> ▪ Refer as ANSI C63.10, clause 6.10.3 band-edge testing shall be performed at the lowest frequency channel and highest frequency channel within the allowed operating band. 	
<ul style="list-style-type: none"> ▪ For the transmitter unwanted emissions shall be measured using following options below: 	
	<ul style="list-style-type: none"> ▪ Refer as FCC KDB 558074, clause 8.6 for unwanted emissions into restricted bands.
	<input type="checkbox"/> Refer as FCC KDB 558074, clause 8.6 & C63.10 clause 11.12.2.5.1(trace averaging for duty cycle \geq 98%).
	<input type="checkbox"/> Refer as FCC KDB 558074, clause 8.6 & C63.10 clause 11.12.2.5.2(trace averaging + duty factor).
	<input checked="" type="checkbox"/> Refer as FCC KDB 558074, clause 8.6 & C63.10 clause 11.12.2.5.3(Reduced VBW \geq 1/T).
	<input type="checkbox"/> Refer as ANSI C63.10, clause 11.12.2.5.3 (Reduced VBW). VBW \geq 1/T, where T is pulse time.
	<input type="checkbox"/> Refer as ANSI C63.10, clause 7.5 average value of pulsed emissions.
	<input checked="" type="checkbox"/> Refer as FCC KDB 558074, clause 8.6 & C63.10 clause 11.12.2.4 measurement procedure peak limit.
<ul style="list-style-type: none"> ▪ For the transmitter band-edge emissions shall be measured using following options below: 	
	<ul style="list-style-type: none"> ▪ Refer as FCC KDB 558074 clause 8.7 & C63.10 clause 11.13.1, When the performing peak or average radiated measurements, emissions within 2 MHz of the authorized band edge may be measured using the marker-delta method described below.
	<ul style="list-style-type: none"> ▪ Refer as FCC KDB 558074, clause 8.7 (ANSI C63.10, clause 6.10.6) for marker-delta method for band-edge measurements.
	<ul style="list-style-type: none"> ▪ Refer as FCC KDB 558074, clause 8.7 for narrower resolution bandwidth (100kHz) using the band power and summing the spectral levels (i.e., 1 MHz).
	<ul style="list-style-type: none"> ▪ For conducted unwanted emissions into restricted bands (absolute emission limits). Devices with multiple transmit chains using options given below: (1) Measure and sum the spectra across the outputs or (2) Measure and add 10 log(N) dB
	<ul style="list-style-type: none"> ▪ For FCC KDB 662911 The methodology described here may overestimate array gain, thereby resulting in apparent failures to satisfy the out-of-band limits even if the device is actually compliant. In such cases, compliance may be demonstrated by performing radiated tests around the frequencies at which the apparent failures occurred.

3.6.4 Test Setup

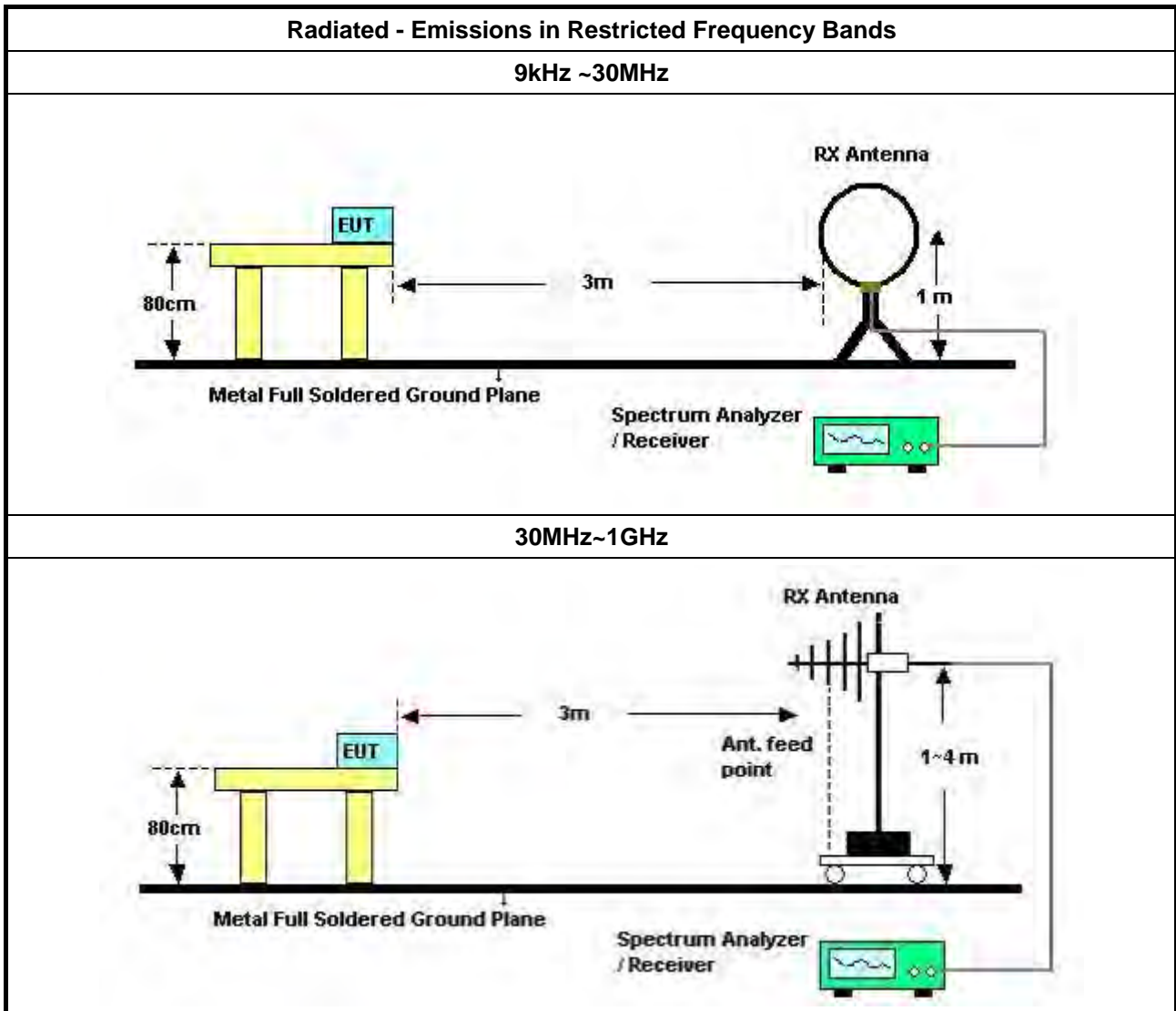

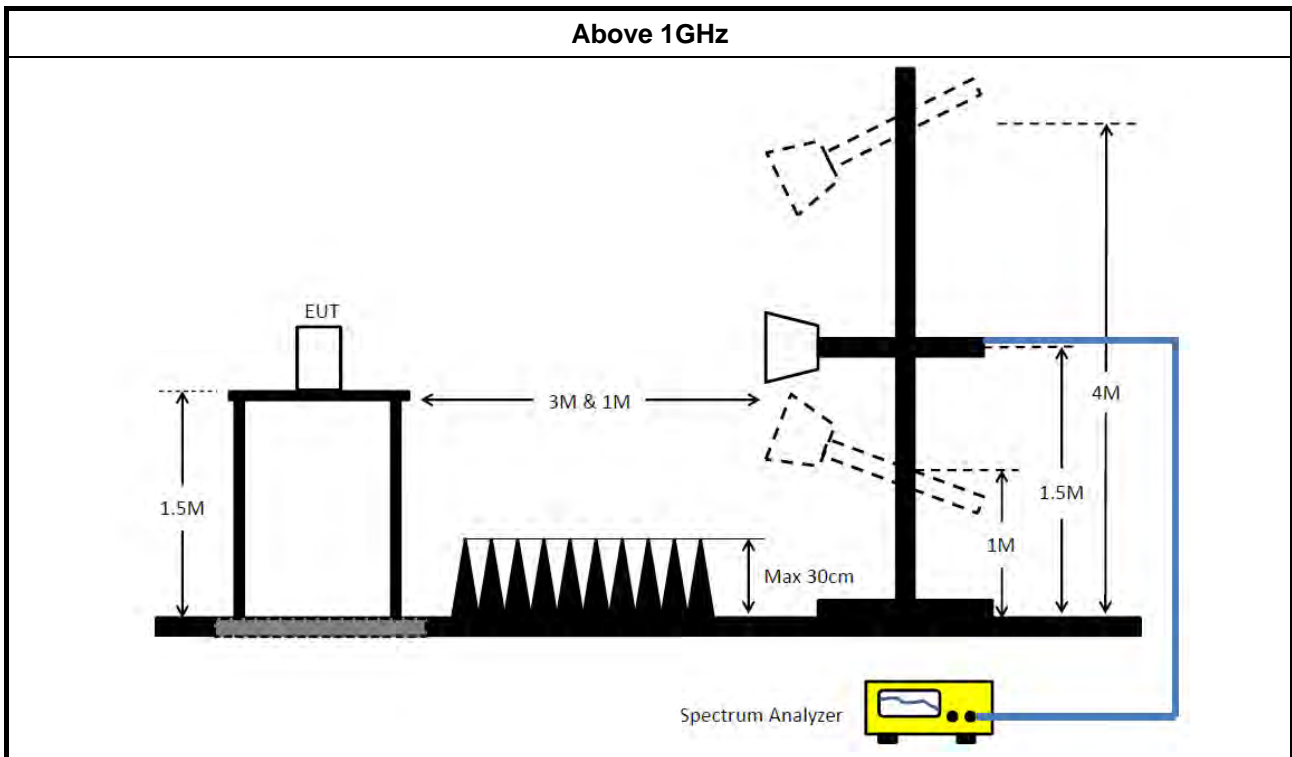

3.6.5 Measurement Results Calculation

The measured Level is calculated using:

Corrected Reading: Antenna Factor + Cable Loss + Read Level - Preamp Factor = Level.

3.6.6 Emissions in Restricted Frequency Bands (Below 30MHz)

All amplitude of spurious emissions that are attenuated by more than 20 dB below the permissible value has no need to be reported.

The radiated emissions were investigated from 9 kHz or the lowest frequency generated within the device, up to the 10 harmonic or 40 GHz, whichever is appropriate.

3.6.7 Test Result of Emissions in Restricted Frequency Bands

Refer as Appendix F



4 Test Equipment and Calibration Data

Instrument	Manufacturer	Model No.	Serial No.	Characteristics	Calibration Date	Calibration Due Date	Remark
LISN	Schwarzbeck	NSLK 8127	8127650	9kHz ~ 30MHz	Nov. 21, 2018	Nov. 20, 2019	Conduction (CO02-CB)
LISN	Schwarzbeck	NSLK 8127	8127478	9kHz ~ 30MHz	Nov. 05, 2018	Nov. 04, 2019	Conduction (CO02-CB)
EMI Receiver	Agilent	N9038A	MY52260140	9kHz ~ 8.4GHz	Jan. 16, 2019	Jan. 15, 2020	Conduction (CO02-CB)
COND Cable	Woken	Cable	2	0.15MHz ~ 30MHz	Nov. 06, 2018	Nov. 05, 2019	Conduction (CO02-CB)
Software	Audix	E3	6.120210n	-	N.C.R.	N.C.R.	Conduction (CO02-CB)
Bilog Antenna with 6 dB attenuator	TESEQ & EMCI	CBL6112D & N-6-06	37878 & AT-N0606	20MHz ~ 2GHz	Aug. 04, 2018	Aug. 03, 2019	Radiation (03CH06-CB)
Loop Antenna	Teseq	HLA 6120	24155	9kHz - 30 MHz	Mar. 29, 2019	Mar. 28, 2020	Radiation (03CH06-CB)
Horn Antenna	ETS · Lindgren	3115	00143147	750MHz~18GHz	Oct. 26, 2018	Oct. 25, 2019	Radiation (03CH04-CB)
Horn Antenna	SCHWARZBECK	BBHA 9170	BBHA9170507	15GHz ~ 40GHz	Jun. 07, 2018	Jun. 06, 2019	Radiation (03CH04-CB)
Pre-Amplifier	Agilent	310N	187290	0.1MHz ~ 1GHz	May 07, 2019	May 06, 2020	Radiation (03CH06-CB)
Pre-Amplifier	Agilent	83017A	MY53270063	0.5GHz ~ 26.5GHz	Mar. 19, 2019	Mar. 18, 2020	Radiation (03CH04-CB)
Amplifier	MITEQ	TTA1840-35-H G	1864479	18GHz ~ 40GHz	Jul. 04, 2018	Jul. 03, 2019	Radiation (03CH04-CB)
Spectrum Analyzer	R&S	FSP40	100142	9kHz~40GHz	Dec. 26, 2018	Dec. 25, 2019	Radiation (03CH04-CB)
Spectrum analyzer	R&S	FSP40	100080	9kHz~40GHz	Oct. 03, 2018	Oct. 02, 2019	Radiation (03CH06-CB)
EMI Test Receiver	R&S	ESCS	100359	9kHz ~ 2.75GHz	Jul. 03, 2018	Jul. 02, 2019	Radiation (03CH06-CB)
RF Cable-low	HUBER+SUHNER	RG402	Low Cable-05+24	30MHz~1GHz	Oct. 08, 2018	Oct. 07, 2019	Radiation (03CH06-CB)
RF Cable-high	Woken	RG402	High Cable-21	1GHz - 18GHz	Oct. 08, 2018	Oct. 07, 2019	Radiation (03CH04-CB)
RF Cable-high	Woken	RG402	High Cable-21+22	1GHz - 18GHz	Oct. 08, 2018	Oct. 07, 2019	Radiation (03CH04-CB)
RF Cable-high	Woken	RG402	High Cable-40G#1	18GHz ~ 40 GHz	Jul. 27, 2018	Jul. 26, 2019	Radiation (03CH04-CB)



Instrument	Manufacturer	Model No.	Serial No.	Characteristics	Calibration Date	Calibration Due Date	Remark
RF Cable-high	Woken	RG402	High Cable-40G#2	18GHz ~ 40 GHz	Jul. 27, 2018	Jul. 26, 2019	Radiation (03CH04-CB)
Spectrum analyzer	R&S	FSV40	100979	9kHz~40GHz	Feb. 25, 2019	Feb. 24, 2020	Conducted (TH01-CB)
RF Cable-high	Woken	RG402	High Cable-06	1 GHz – 26.5 GHz	Oct. 08, 2018	Oct. 07, 2019	Conducted (TH01-CB)
RF Cable-high	Woken	RG402	High Cable-07	1 GHz –26.5 GHz	Oct. 08, 2018	Oct. 07, 2019	Conducted (TH01-CB)
RF Cable-high	Woken	RG402	High Cable-08	1 GHz –26.5 GHz	Oct. 08, 2018	Oct. 07, 2019	Conducted (TH01-CB)
RF Cable-high	Woken	RG402	High Cable-09	1 GHz –26.5 GHz	Oct. 08, 2018	Oct. 07, 2019	Conducted (TH01-CB)
RF Cable-high	Woken	RG402	High Cable-10	1 GHz –26.5 GHz	Oct. 08, 2018	Oct. 07, 2019	Conducted (TH01-CB)
RF Cable-high	Woken	RG402	High Cable-28	1 GHz –26.5 GHz	Nov. 19, 2018	Nov. 18, 2019	Conducted (TH01-CB)
Power Sensor	Agilent	E9327A	US40442088	50MHz~18GHz	Jan. 15, 2019	Jan. 14, 2020	Conducted (TH01-CB)
Power Meter	Agilent	E4416A	GB41291199	50MHz~18GHz	Jan. 15, 2019	Jan. 14, 2020	Conducted (TH01-CB)

Note: Calibration Interval of instruments listed above is one year.

N.C.R. means Non-Calibration required.



AC Power-line Conducted Emissions Result

Appendix A

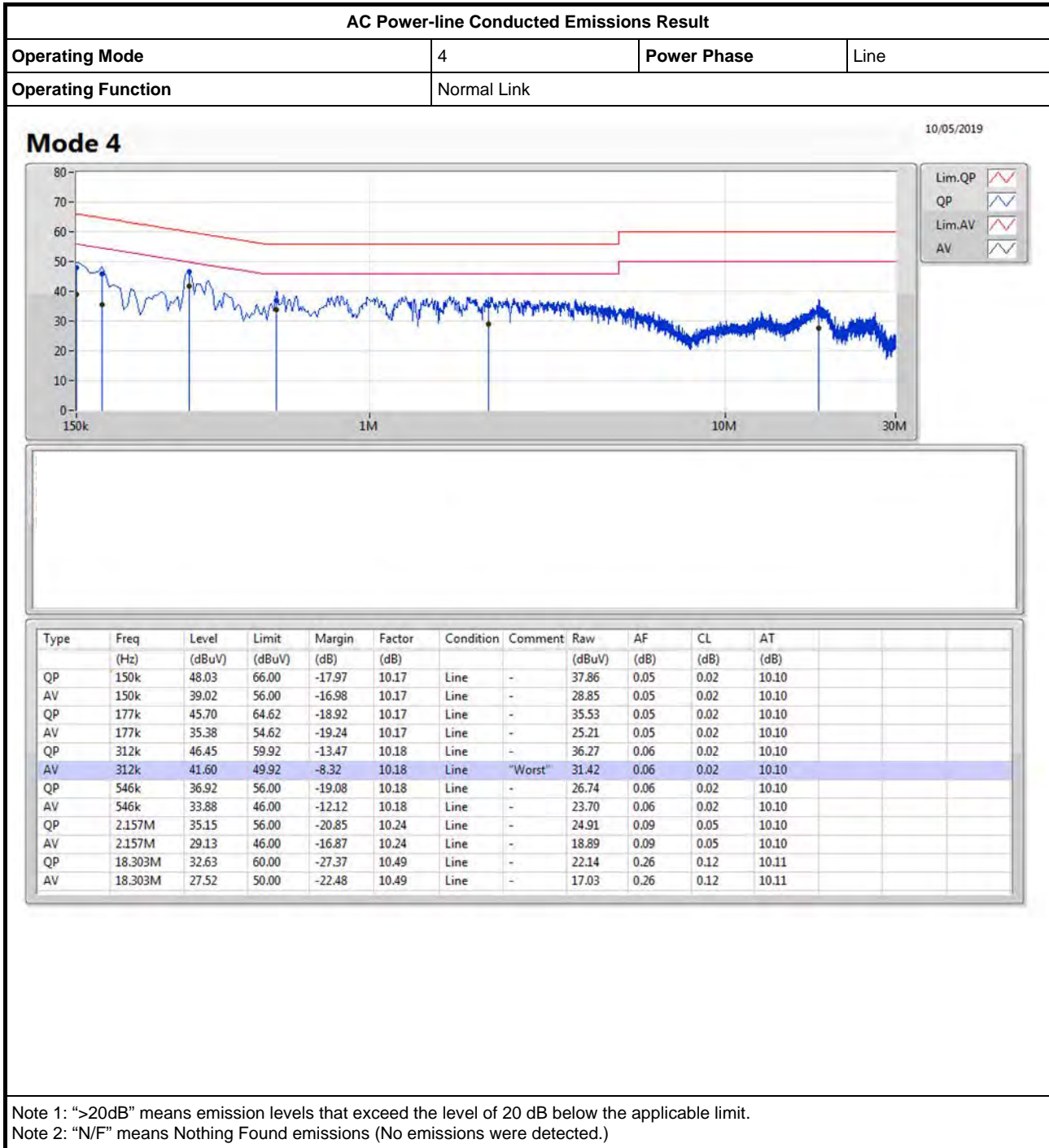



AC Power-line Conducted Emissions Result

Appendix A





Summary

Mode	Max-N dB (Hz)	Max-OBW (Hz)	ITU-Code	Min-N dB (Hz)	Min-OBW (Hz)
2.4-2.4835GHz	-	-	-	-	-
802.11b_Nss1,(1Mbps)_2TX	8.075M	12.844M	12M8G1D	7.575M	12.594M
802.11g_Nss1,(6Mbps)_2TX	16.35M	16.417M	16M4D1D	16.325M	16.392M
VHT20_Nss1,(MCS0)_2TX	17.6M	17.641M	17M6D1D	17.175M	17.591M

Max-N dB = Maximum 6dB down bandwidth; **Max-OBW** = Maximum 99% occupied bandwidth;
Min-N dB = Minimum 6dB down bandwidth; **Min-OBW** = Minimum 99% occupied bandwidth;

Result

Mode	Result	Limit (Hz)	Port 1-N dB (Hz)	Port 1-OBW (Hz)	Port 2-N dB (Hz)	Port 2-OBW (Hz)
802.11b_Nss1,(1Mbps)_2TX	-	-	-	-	-	-
2412MHz	Pass	500k	7.575M	12.744M	7.575M	12.669M
2437MHz	Pass	500k	7.575M	12.794M	7.6M	12.594M
2462MHz	Pass	500k	7.575M	12.844M	8.075M	12.819M
802.11g_Nss1,(6Mbps)_2TX	-	-	-	-	-	-
2412MHz	Pass	500k	16.325M	16.392M	16.325M	16.417M
2437MHz	Pass	500k	16.325M	16.392M	16.325M	16.417M
2462MHz	Pass	500k	16.325M	16.392M	16.35M	16.392M
VHT20_Nss1,(MCS0)_2TX	-	-	-	-	-	-
2412MHz	Pass	500k	17.575M	17.641M	17.575M	17.591M
2437MHz	Pass	500k	17.575M	17.616M	17.55M	17.616M
2462MHz	Pass	500k	17.175M	17.591M	17.6M	17.591M

Port X-N dB = Port X 6dB down bandwidth; **Port X-OBW** = Port X 99% occupied bandwidth;

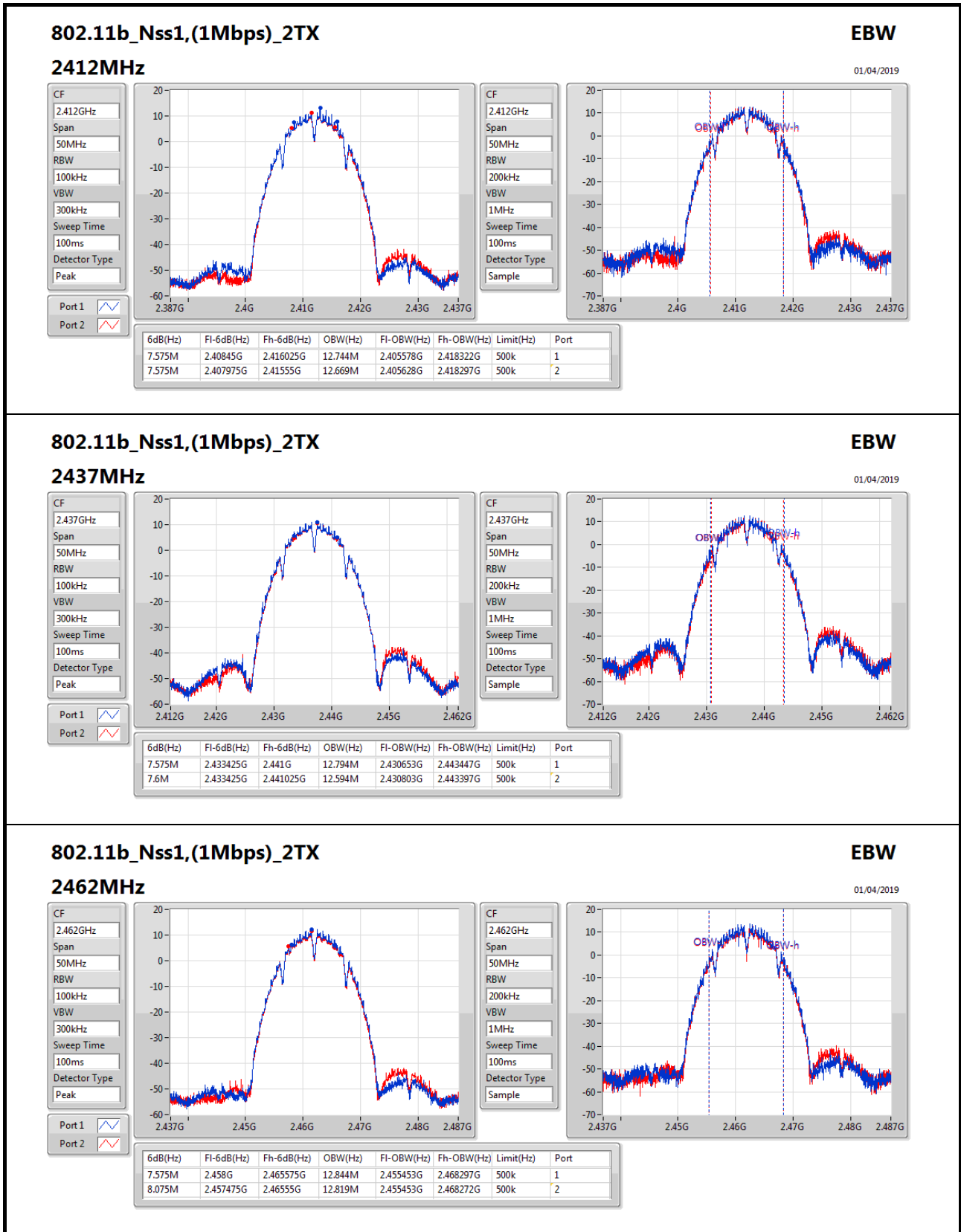

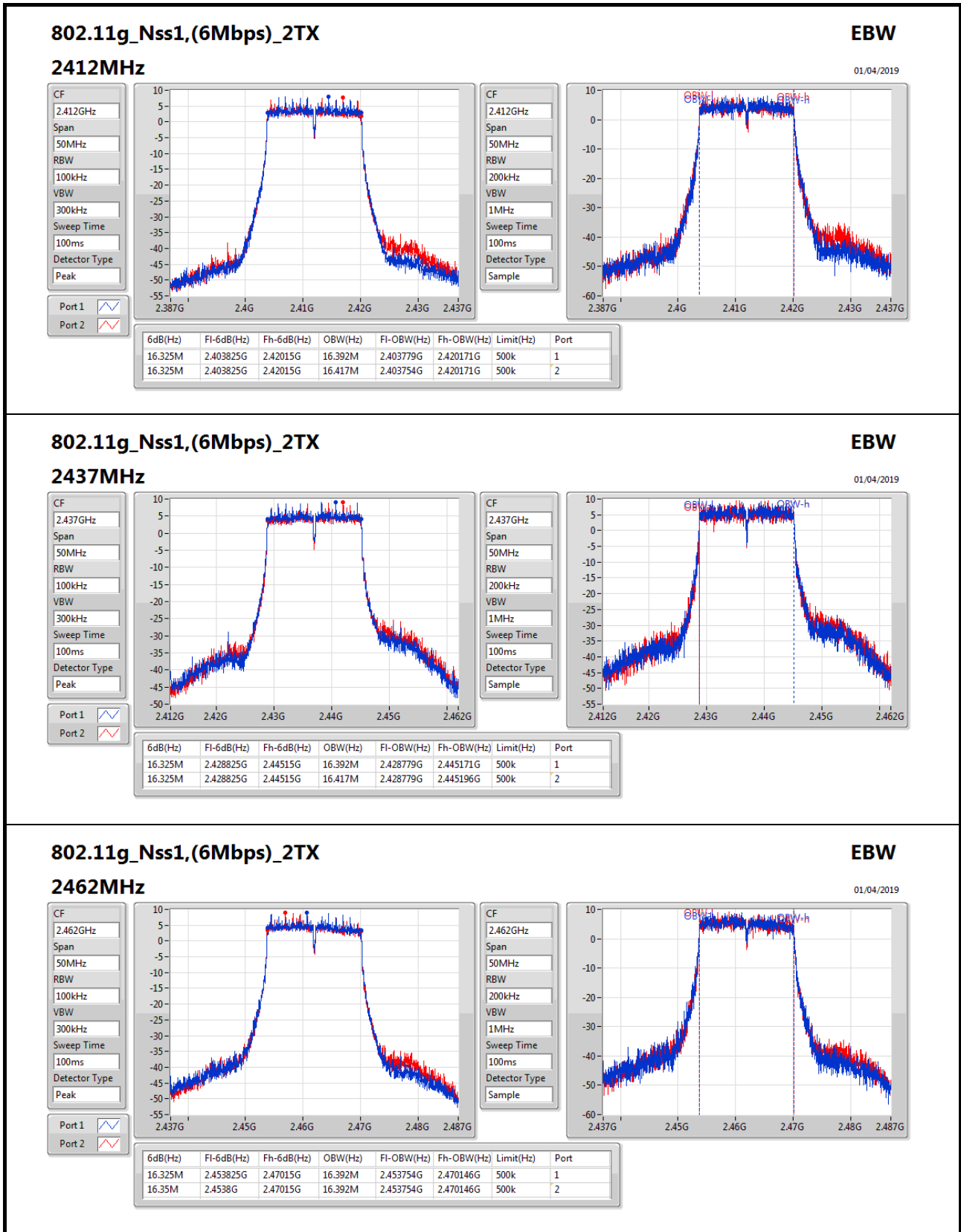

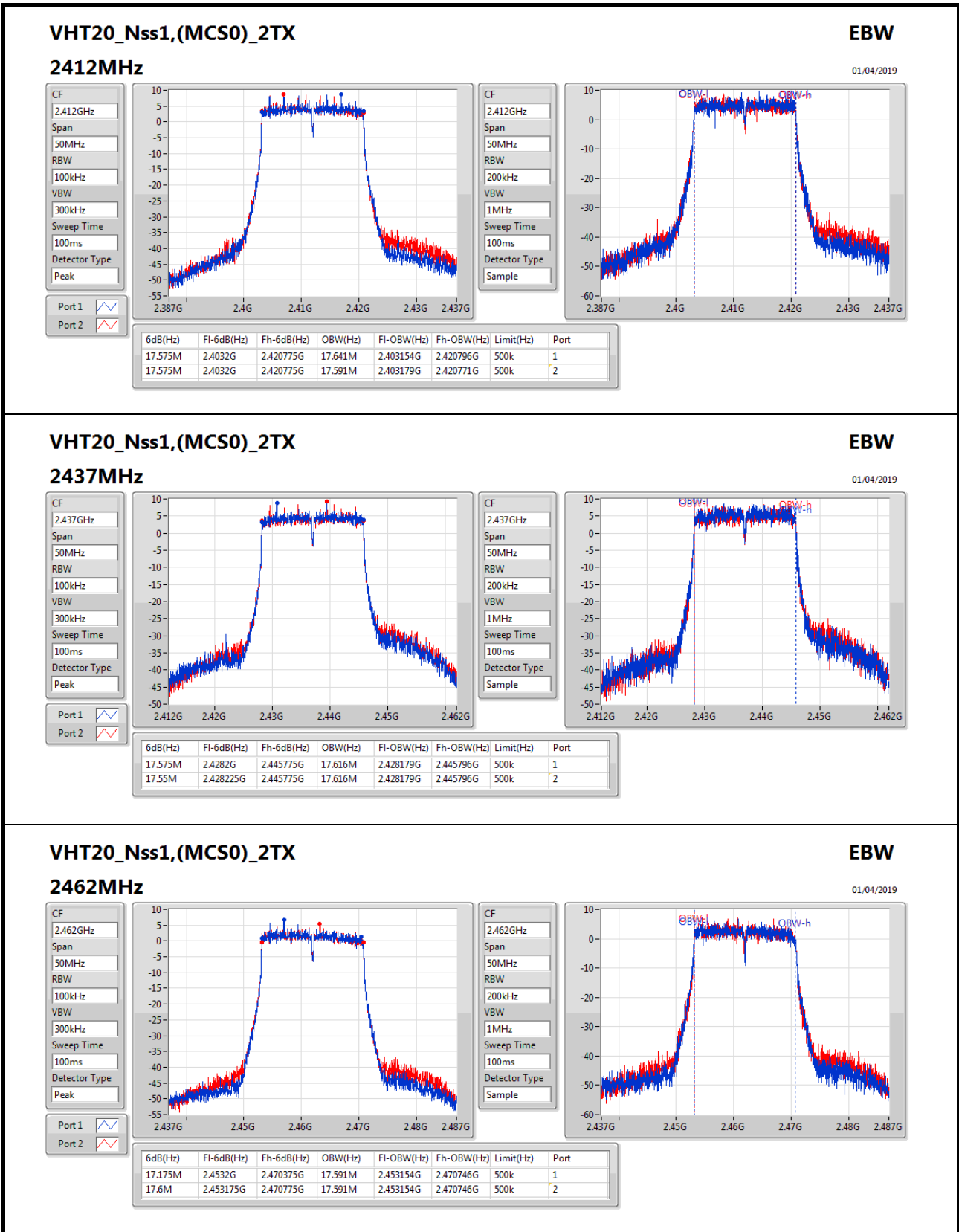
VHT20_Nss1,(MCS0)_2TX
EBW

01/04/2019

2462MHz

CF: 2.462GHz

Span: 50MHz

RBW: 100kHz

VBW: 300kHz

Sweep Time: 100ms

Detector Type: Peak

CF: 2.462GHz

Span: 50MHz

RBW: 200kHz

VBW: 1MHz

Sweep Time: 100ms

Detector Type: Sample



AV Power Result

Appendix C

Summary

Mode	Total Power (dBm)	Total Power (W)
2.4-2.4835GHz	-	-
802.11b_Nss1,(1Mbps)_2TX	24.73	0.29717
802.11g_Nss1,(6Mbps)_2TX	24.55	0.28510
VHT20_Nss1,(MCS0)_2TX	24.64	0.29107

Result

Mode	Result	DG (dBi)	Port 1 (dBm)	Port 2 (dBm)	Total Power (dBm)	Power Limit (dBm)
802.11b_Nss1,(1Mbps)_2TX	-	-	-	-	-	-
2412MHz	Pass	3.28	21.89	21.44	24.68	30.00
2437MHz	Pass	3.28	21.57	21.53	24.56	30.00
2462MHz	Pass	3.28	21.90	21.54	24.73	30.00
802.11g_Nss1,(6Mbps)_2TX	-	-	-	-	-	-
2412MHz	Pass	3.28	20.41	20.18	23.31	30.00
2437MHz	Pass	3.28	21.52	21.56	24.55	30.00
2462MHz	Pass	3.28	21.27	21.08	24.19	30.00
VHT20_Nss1,(MCS0)_2TX	-	-	-	-	-	-
2412MHz	Pass	3.28	21.36	21.19	24.29	30.00
2437MHz	Pass	3.28	21.69	21.41	24.56	30.00
2457MHz	Pass	3.28	21.60	21.66	24.64	30.00
2462MHz	Pass	3.28	18.74	18.73	21.75	30.00

DG = Directional Gain; Port X = Port X output power

Note : Conducted average output power is for reference only



PSD Result

Appendix D

Summary

Mode	PD (dBm/RBW)
2.4-2.4835GHz	-
802.11b_Nss1,(1Mbps)_2TX	-3.97
802.11g_Nss1,(6Mbps)_2TX	-3.95
VHT20_Nss1,(MCS0)_2TX	-4.60

RBW=3kHz.

Result

Mode	Result	DG (dBi)	Port 1 (dBm/RBW)	Port 2 (dBm/RBW)	PD (dBm/RBW)	PD Limit (dBm/RBW)
802.11b_Nss1,(1Mbps)_2TX	-	-	-	-	-	-
2412MHz	Pass	6.29	-7.81	-7.25	-4.52	7.71
2437MHz	Pass	6.29	-7.68	-7.68	-4.80	7.71
2462MHz	Pass	6.29	-6.55	-7.12	-3.97	7.71
802.11g_Nss1,(6Mbps)_2TX	-	-	-	-	-	-
2412MHz	Pass	6.29	-7.30	-8.67	-6.08	7.71
2437MHz	Pass	6.29	-5.19	-7.17	-3.95	7.71
2462MHz	Pass	6.29	-7.09	-6.86	-5.27	7.71
VHT20_Nss1,(MCS0)_2TX	-	-	-	-	-	-
2412MHz	Pass	6.29	-6.92	-7.78	-5.04	7.71
2437MHz	Pass	6.29	-6.88	-7.40	-4.60	7.71
2462MHz	Pass	6.29	-9.89	-9.77	-7.69	7.71

DG = Directional Gain; RBW=3kHz;

PD = trace bin-by-bin of each transmits port summing can be performed maximum power density; **Port X** = Port Xpower density;

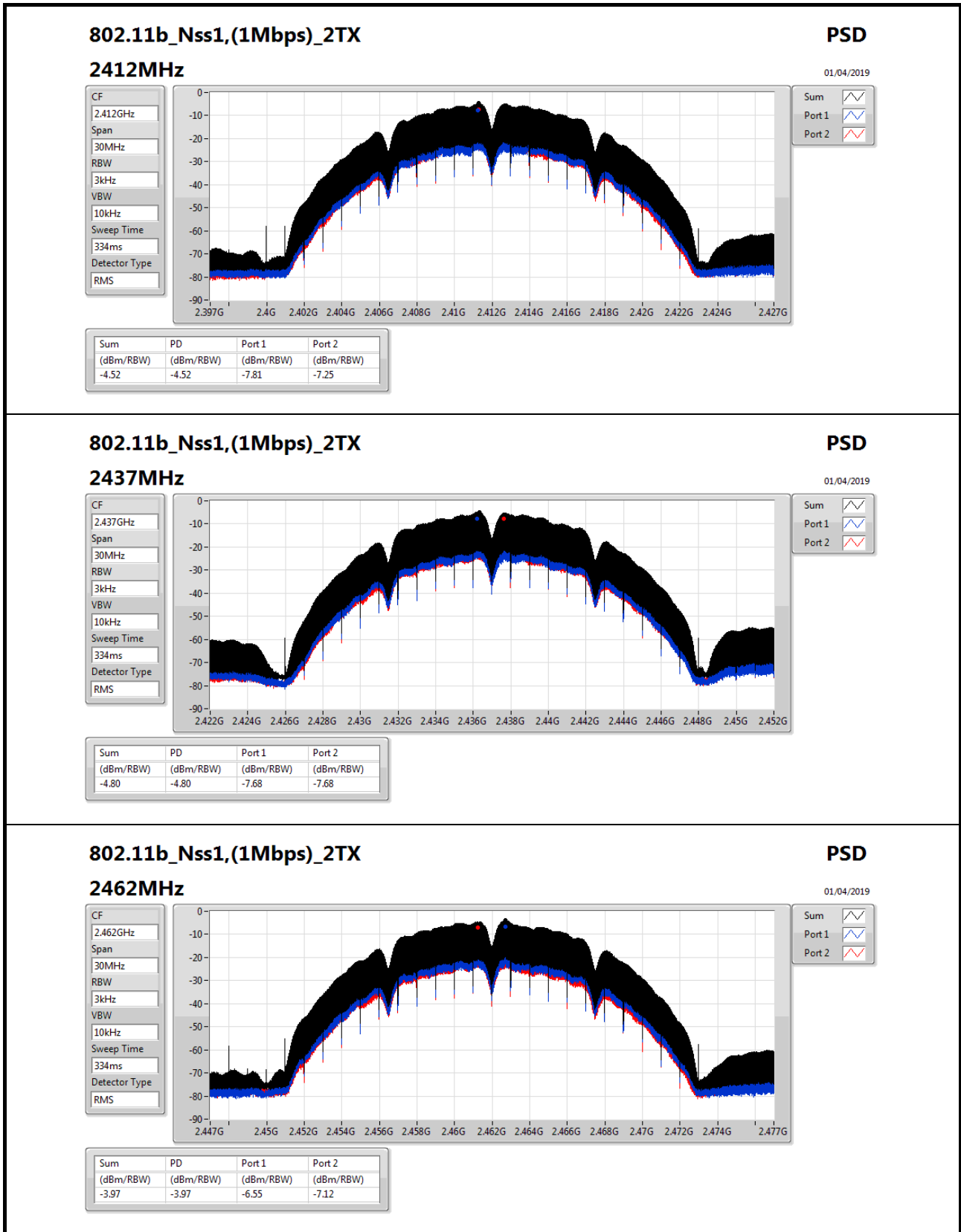

802.11b_Nss1,(1Mbps)_2TX

2462MHz

PSD

01/04/2019

CF
2.462GHz

Span
30MHz

RBW
3kHz

VBW
10kHz

Sweep Time
334ms

Detector Type
RMS



Sum 

Port 1 

Port 2 

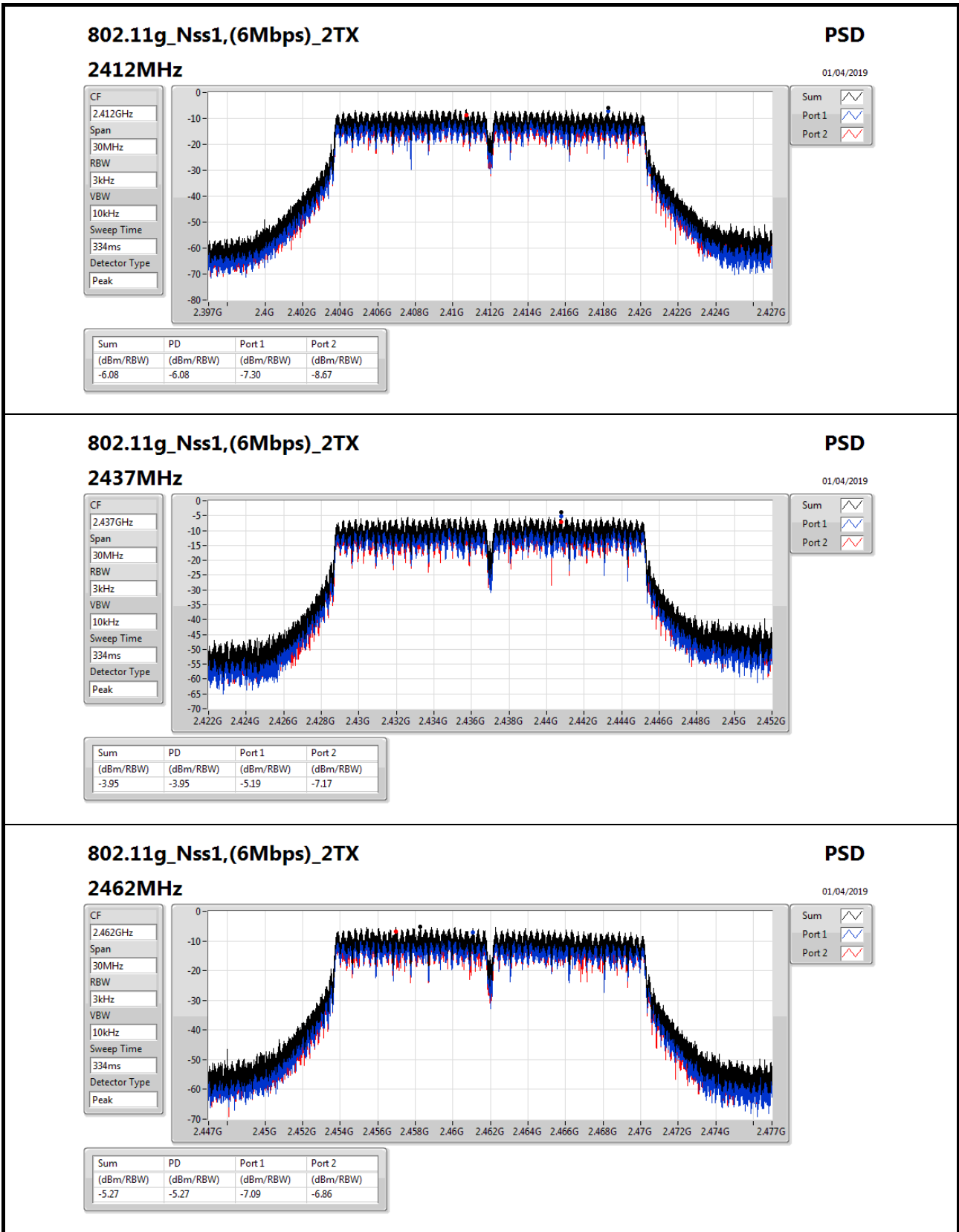

802.11g_Nss1,(6Mbps)_2TX

2462MHz

PSD

01/04/2019

CF
2.462GHz

Span
30MHz

RBW
3kHz

VBW
10kHz

Sweep Time
334ms

Detector Type
Peak



Sum 

Port 1 

Port 2 

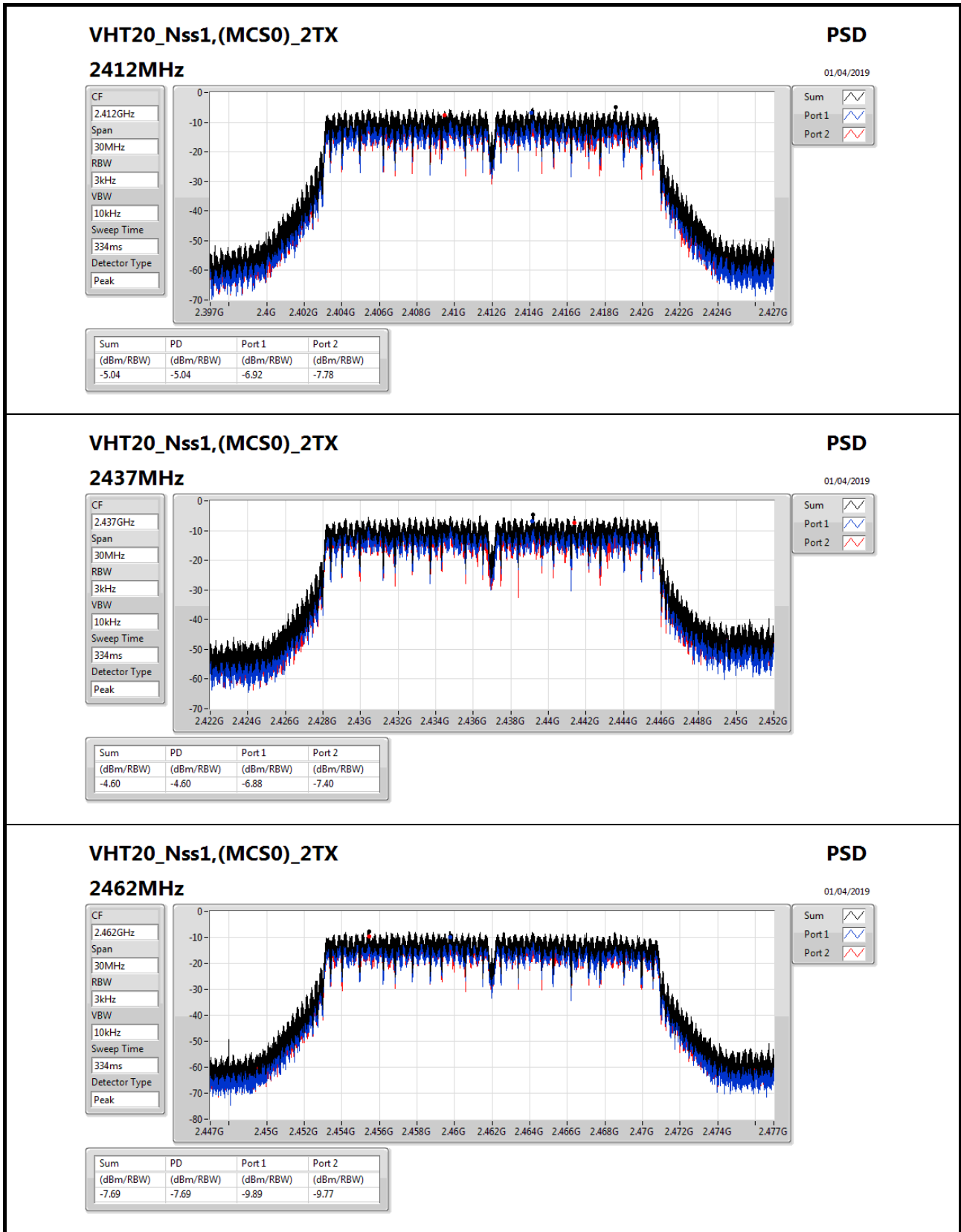

VHT20_Nss1,(MCS0)_2TX

2462MHz

PSD

01/04/2019

CF
2.462GHz

Span
30MHz

RBW
3kHz

VBW
10kHz

Sweep Time
334ms

Detector Type
Peak



Sum 

Port 1 

Port 2 



Summary

Mode	Result	Ref (Hz)	Ref (dBm)	Limit (dBm)	Freq (Hz)	Level (dBm)	Freq (Hz)	Level (dBm)	Freq (Hz)	Level (dBm)	Freq (Hz)	Level (dBm)	Port
2.4-2.4835GHz	-	-	-	-	-	-	-	-	-	-	-	-	-
802.11b_Nss1,(1Mbps)_2TX	Pass	2.41248G	11.77	-18.23	852.78M	-45.01	2.39592G	-42.69	2.48668G	-44.22	15.2761G	-35.08	1
802.11g_Nss1,(6Mbps)_2TX	Pass	2.44075G	8.61	-21.39	698.71M	-45.20	2.3991G	-43.77	2.50968G	-44.38	17.65018G	-34.83	2
VHT20_Nss1,(MCS0)_2TX	Pass	2.44079G	8.36	-21.64	753.17M	-45.52	2.39534G	-44.31	2.51126G	-43.63	15.25644G	-34.52	2

Result

Mode	Result	Ref (Hz)	Ref (dBm)	Limit (dBm)	Freq (Hz)	Level (dBm)	Freq (Hz)	Level (dBm)	Freq (Hz)	Level (dBm)	Freq (Hz)	Level (dBm)	Port
802.11b_Nss1,(1Mbps)_2TX	-	-	-	-	-	-	-	-	-	-	-	-	-
2412MHz	Pass	2.41248G	11.77	-18.23	852.78M	-45.01	2.39592G	-42.69	2.48668G	-44.22	15.2761G	-35.08	1
2412MHz	Pass	2.41248G	11.77	-18.23	707.45M	-44.57	2.39382G	-43.73	2.49102G	-43.98	17.64457G	-35.74	2
2437MHz	Pass	2.41248G	11.77	-18.23	2.14826G	-45.03	2.3918G	-44.64	2.50266G	-44.46	14.6299G	-35.85	1
2437MHz	Pass	2.41248G	11.77	-18.23	2.0571G	-44.10	2.39164G	-45.30	2.4881G	-44.10	23.36483G	-35.67	2
2462MHz	Pass	2.41248G	11.77	-18.23	1.98516G	-45.63	2.3932G	-44.43	2.48638G	-44.33	15.30701G	-35.13	1
2462MHz	Pass	2.41248G	11.77	-18.23	876.08M	-44.81	2.39362G	-43.65	2.497G	-44.03	17.68109G	-35.93	2
802.11g_Nss1,(6Mbps)_2TX	-	-	-	-	-	-	-	-	-	-	-	-	-
2412MHz	Pass	2.44075G	8.61	-21.39	220.48M	-44.73	2.39998G	-37.27	2.51142G	-43.42	17.6558G	-35.38	1
2412MHz	Pass	2.44075G	8.61	-21.39	832.69M	-44.95	2.39988G	-36.89	2.4847G	-43.89	14.96986G	-34.96	2
2437MHz	Pass	2.44075G	8.61	-21.39	848.41M	-44.67	2.39976G	-44.02	2.51616G	-44.00	24.74995G	-36.13	1
2437MHz	Pass	2.44075G	8.61	-21.39	698.71M	-45.20	2.3991G	-43.77	2.50968G	-44.38	17.65018G	-34.83	2
2462MHz	Pass	2.44075G	8.61	-21.39	908.41M	-44.87	2.39998G	-44.58	2.48558G	-41.36	15.28172G	-35.07	1
2462MHz	Pass	2.44075G	8.61	-21.39	910.16M	-45.19	2.3901G	-43.91	2.48358G	-41.17	17.67547G	-35.55	2
VHT20_Nss1,(MCS0)_2TX	-	-	-	-	-	-	-	-	-	-	-	-	-
2412MHz	Pass	2.44079G	8.36	-21.64	866.76M	-44.30	2.3999G	-35.41	2.5218G	-43.68	15.34353G	-34.71	1
2412MHz	Pass	2.44079G	8.36	-21.64	741.52M	-44.63	2.397G	-35.85	2.50842G	-43.80	15.27049G	-35.91	2
2437MHz	Pass	2.44079G	8.36	-21.64	825.11M	-45.05	2.39966G	-42.99	2.49642G	-43.92	17.60804G	-36.10	1
2437MHz	Pass	2.44079G	8.36	-21.64	753.17M	-45.52	2.39534G	-44.31	2.51126G	-43.63	15.25644G	-34.52	2
2462MHz	Pass	2.44079G	8.36	-21.64	2.08564G	-45.11	2.39372G	-45.12	2.4848G	-43.46	17.63895G	-35.67	1
2462MHz	Pass	2.44079G	8.36	-21.64	766.28M	-44.94	2.39744G	-45.13	2.48474G	-41.52	14.65238G	-35.39	2

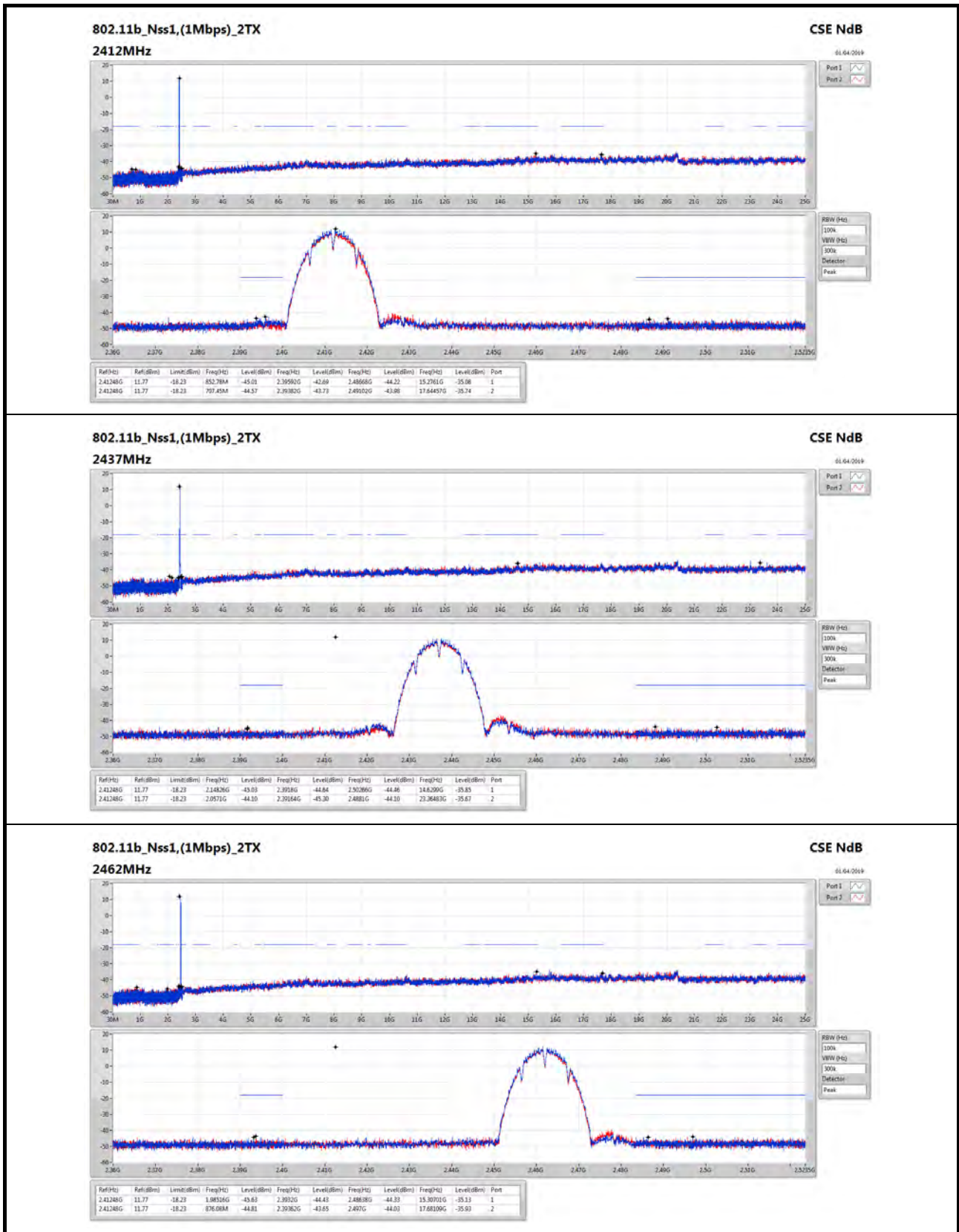

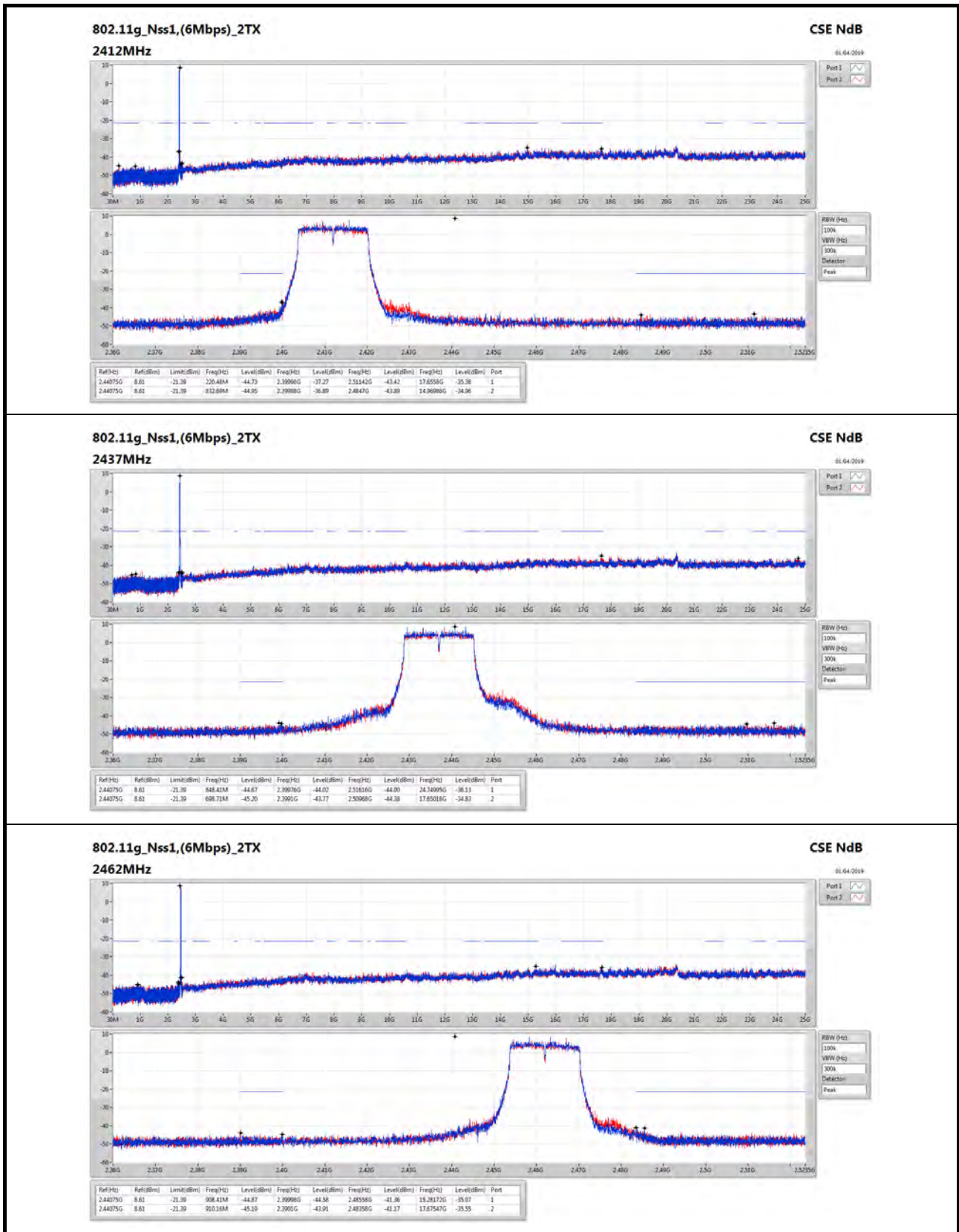

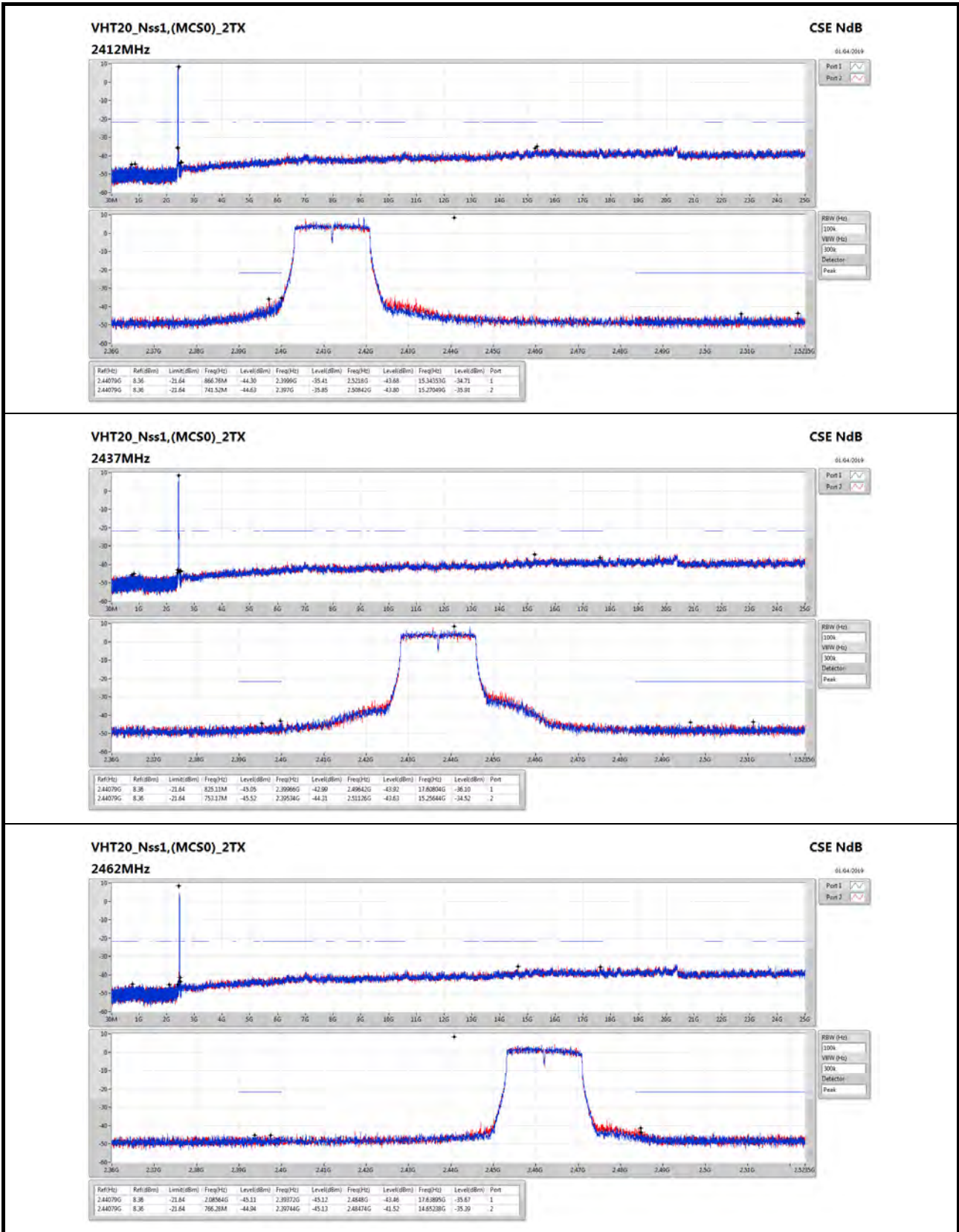

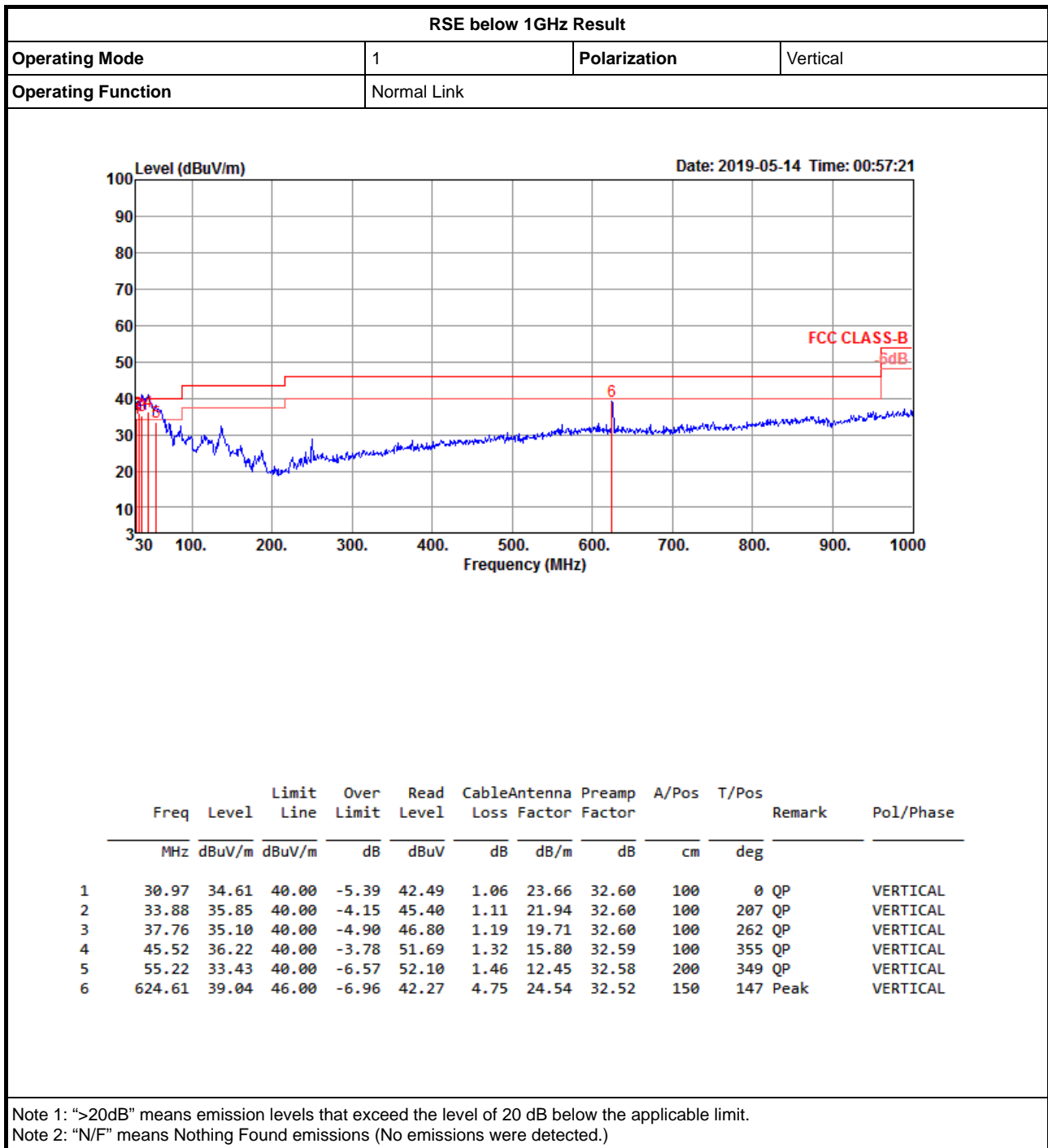

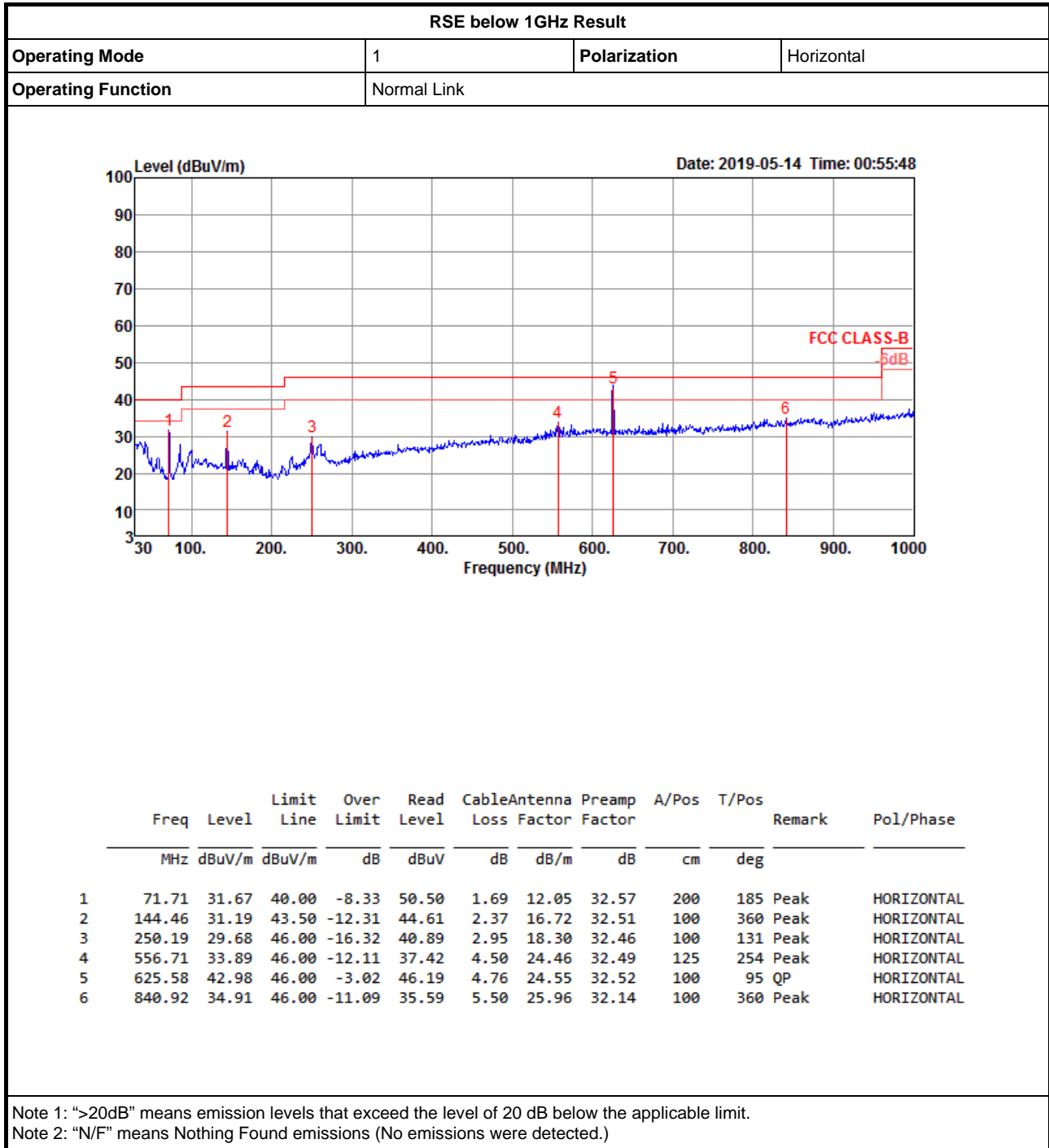



RSE TX above 1GHz Result

Appendix F.2

Summary

Mode	Result	Type	Freq (Hz)	Level (dBuV/m)	Limit (dBuV/m)	Margin (dB)	Factor (dB)	Dist (m)	Condition	Azimuth (°)	Height (m)	Comments
2.4-2.4835GHz	-	-	-	-	-	-	-	-	-	-	-	-
802.11g_Nss1,(6Mbps)_2TX	Pass	AV	2.4848G	53.77	54.00	-0.23	33.36	3	Horizontal	66	1.27	-



RSE TX above 1GHz Result

Appendix F.2

802.11b_Nss1,(1Mbps)_2TX

29/03/2019

2412MHz_TX

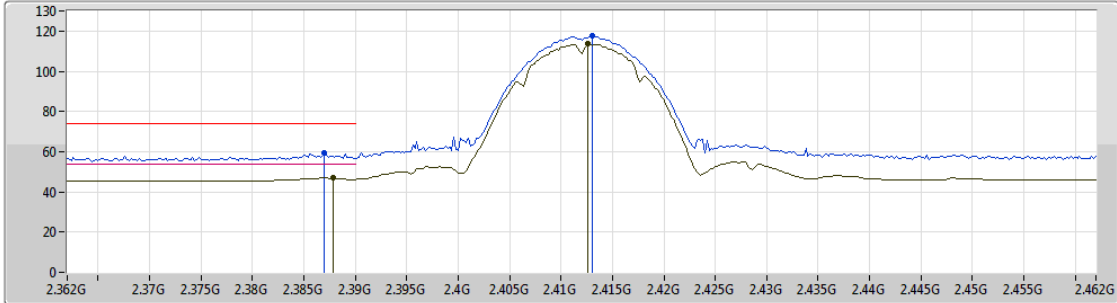

EUT_Z_2TX
Setting 22
04-E-2
FSP(100304)

Type	Freq (Hz)	Level (dBuV/m)	Limit (dBuV/m)	Margin (dB)	Factor (dB)	Dist (m)	Condition	Azimuth (°)	Height (m)	Comments
PK	2.387G	59.58	74.00	-14.42	33.07	3	Vertical	122	2.51	-
AV	2.3878G	46.94	54.00	-7.06	33.08	3	Vertical	122	2.51	-
PK	2.413G	117.56	Inf	-Inf	33.14	3	Vertical	122	2.51	-
AV	2.4126G	113.52	Inf	-Inf	33.14	3	Vertical	122	2.51	-



802.11b_Nss1,(1Mbps)_2TX

29/03/2019

2412MHz_TX

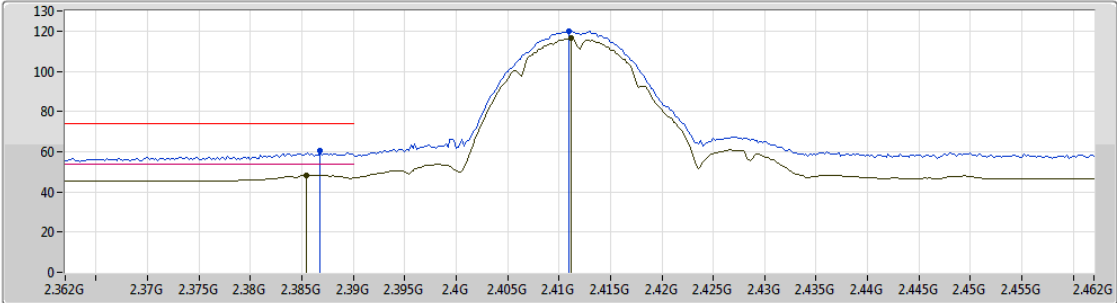

EUT_Z_2TX
Setting 22
04-E-2
FSP(100304)

Type	Freq (Hz)	Level (dBuV/m)	Limit (dBuV/m)	Margin (dB)	Factor (dB)	Dist (m)	Condition	Azimuth (°)	Height (m)	Comments
PK	2.3868G	60.67	74.00	-13.33	33.07	3	Horizontal	303	1.03	-
AV	2.3854G	48.34	54.00	-5.66	33.07	3	Horizontal	303	1.03	-
PK	2.411G	120.14	Inf	-Inf	33.12	3	Horizontal	303	1.03	-
AV	2.4112G	116.35	Inf	-Inf	33.12	3	Horizontal	303	1.03	-



802.11b_Nss1,(1Mbps)_2TX

29/03/2019

2412MHz_TX

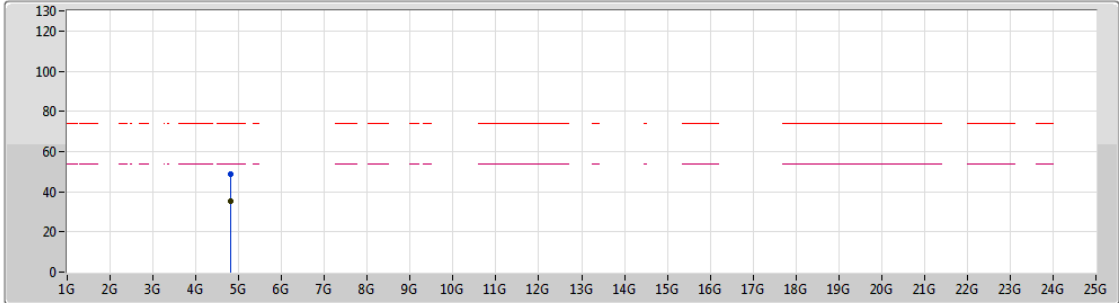

Legend for the spectrum plot:

- Lim.PK (Red dashed line)
- PK (Blue line with peak marker)
- Lim.AV (Magenta dashed line)
- AV (Black line with average marker)

EUT_Z_2TX
Setting 22
04-E-2
FSP(100304)

Type	Freq (Hz)	Level (dBuV/m)	Limit (dBuV/m)	Margin (dB)	Factor (dB)	Dist (m)	Condition	Azimuth (°)	Height (m)	Comments
PK	4.81932G	48.73	74.00	-25.27	7.14	3	Vertical	183	1.50	-
AV	4.82406G	35.13	54.00	-18.87	7.16	3	Vertical	183	1.50	-



802.11b_Nss1,(1Mbps)_2TX

29/03/2019

2412MHz_TX

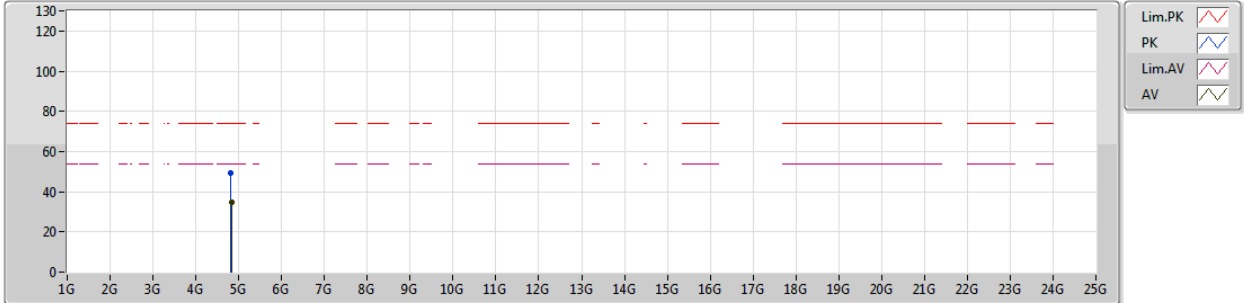

EUT_Z_2TX
Setting 22
04-E-2
FSP(100304)

Type	Freq (Hz)	Level (dBuV/m)	Limit (dBuV/m)	Margin (dB)	Factor (dB)	Dist (m)	Condition	Azimuth (°)	Height (m)	Comments
PK	4.82082G	49.17	74.00	-24.83	7.14	3	Horizontal	157	1.52	-
AV	4.83696G	34.81	54.00	-19.19	7.21	3	Horizontal	157	1.52	-



RSE TX above 1GHz Result

Appendix F.2

802.11b_Nss1,(1Mbps)_2TX

29/03/2019

2437MHz_TX

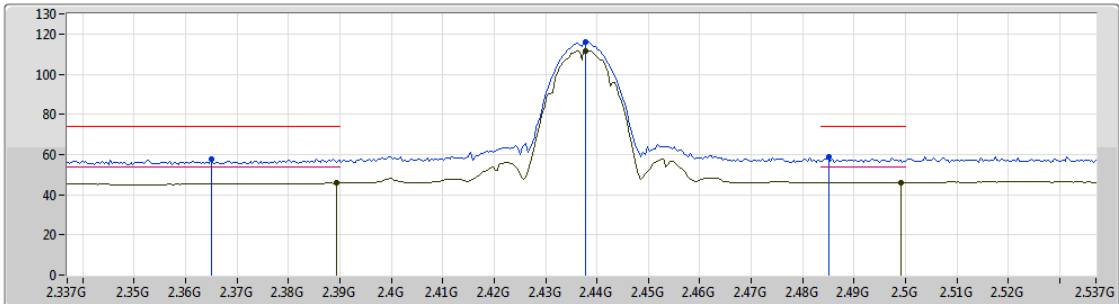

EUT_Z_2TX
Setting 22
04-E-2
FSP(100304)

Type	Freq (Hz)	Level (dBuV/m)	Limit (dBuV/m)	Margin (dB)	Factor (dB)	Dist (m)	Condition	Azimuth (°)	Height (m)	Comments
PK	2.365G	57.70	74.00	-16.30	33.06	3	Vertical	231	2.95	-
AV	2.3894G	45.74	54.00	-8.26	33.08	3	Vertical	231	2.95	-
PK	2.4378G	115.94	Inf	-Inf	33.22	3	Vertical	231	2.95	-
AV	2.4378G	111.74	Inf	-Inf	33.22	3	Vertical	231	2.95	-
PK	2.485G	58.56	74.00	-15.44	33.36	3	Vertical	231	2.95	-
AV	2.499G	46.15	54.00	-7.85	33.41	3	Vertical	231	2.95	-



802.11b_Nss1,(1Mbps)_2TX

29/03/2019

2437MHz_TX

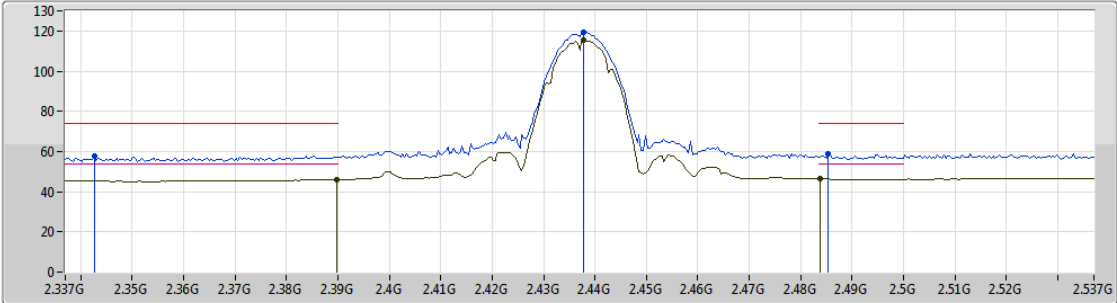

EUT_Z_2TX
Setting 22
04-E-2
FSP(100304)

Type	Freq (Hz)	Level (dBuV/m)	Limit (dBuV/m)	Margin (dB)	Factor (dB)	Dist (m)	Condition	Azimuth (°)	Height (m)	Comments
PK	2.3426G	57.88	74.00	-16.12	33.04	3	Horizontal	53	1.19	-
AV	2.3898G	45.94	54.00	-8.06	33.08	3	Horizontal	53	1.19	-
PK	2.4378G	119.32	Inf	-Inf	33.22	3	Horizontal	53	1.19	-
AV	2.4378G	115.22	Inf	-Inf	33.22	3	Horizontal	53	1.19	-
PK	2.4854G	58.92	74.00	-15.08	33.36	3	Horizontal	53	1.19	-
AV	2.4838G	46.34	54.00	-7.66	33.36	3	Horizontal	53	1.19	-



802.11b_Nss1,(1Mbps)_2TX

29/03/2019

2437MHz_TX

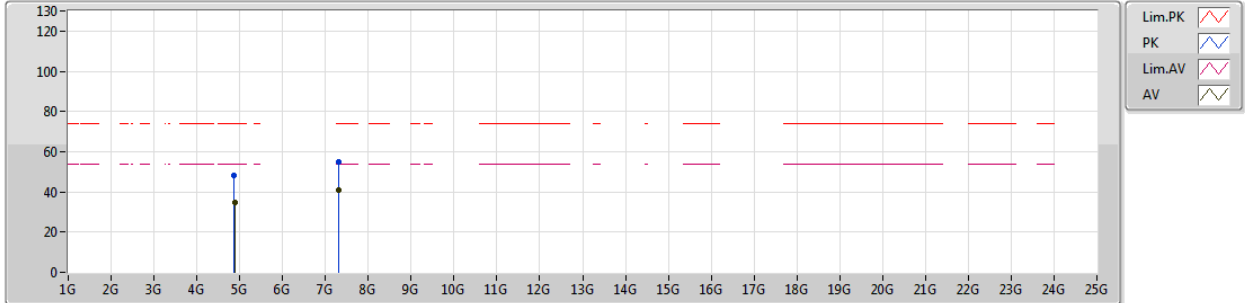

EUT_Z_2TX
Setting 22
04-E-2
FSP(100304)

Type	Freq (Hz)	Level (dBuV/m)	Limit (dBuV/m)	Margin (dB)	Factor (dB)	Dist (m)	Condition	Azimuth (°)	Height (m)	Comments
PK	4.87316G	48.05	74.00	-25.95	7.37	3	Vertical	77	1.50	-
AV	4.88684G	34.54	54.00	-19.46	7.44	3	Vertical	77	1.50	-
PK	7.29846G	54.89	74.00	-19.11	12.51	3	Vertical	287	1.50	-
AV	7.30128G	40.74	54.00	-13.26	12.51	3	Vertical	287	1.50	-



RSE TX above 1GHz Result

Appendix F.2

802.11b_Nss1,(1Mbps)_2TX

29/03/2019

2437MHz_TX

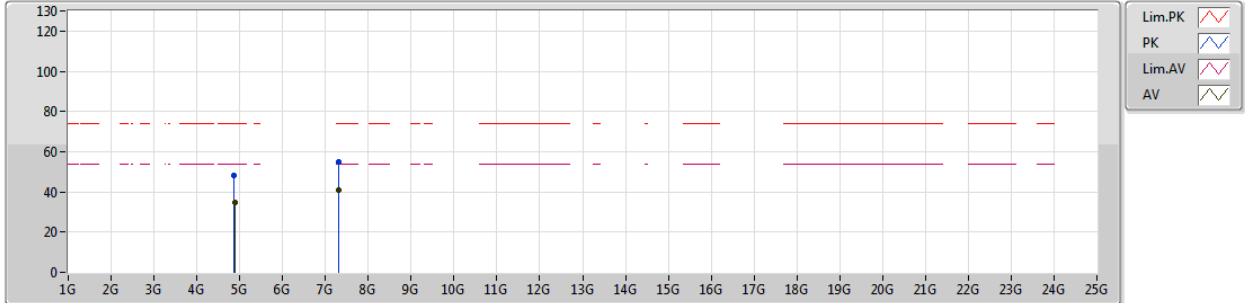

EUT_Z_2TX
Setting 22
04-E-2
FSP(100304)

Type	Freq (Hz)	Level (dBuV/m)	Limit (dBuV/m)	Margin (dB)	Factor (dB)	Dist (m)	Condition	Azimuth (°)	Height (m)	Comments
PK	4.87718G	48.10	74.00	-25.90	7.38	3	Horizontal	154	2.10	-
AV	4.87868G	34.55	54.00	-19.45	7.40	3	Horizontal	154	2.10	-
PK	7.31748G	55.07	74.00	-18.93	12.51	3	Horizontal	298	2.46	-
AV	7.29714G	40.68	54.00	-13.32	12.50	3	Horizontal	298	2.46	-



802.11b_Nss1,(1Mbps)_2TX

29/03/2019

2462MHz_TX

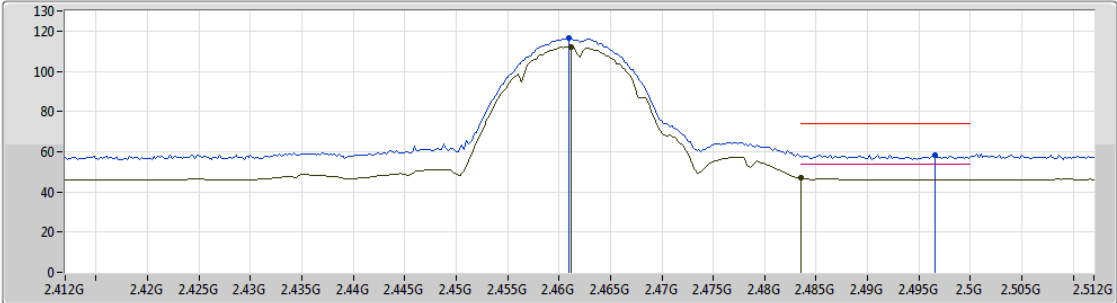

EUT_Z_2TX
Setting 22
04-E-2
FSP(100304)

Type	Freq (Hz)	Level (dBuV/m)	Limit (dBuV/m)	Margin (dB)	Factor (dB)	Dist (m)	Condition	Azimuth (°)	Height (m)	Comments
PK	2.461G	116.67	Inf	-Inf	33.28	3	Vertical	134	2.79	-
AV	2.4612G	112.30	Inf	-Inf	33.28	3	Vertical	134	2.79	-
PK	2.4966G	58.44	74.00	-15.56	33.40	3	Vertical	134	2.79	-
AV	2.4835G	46.80	54.00	-7.20	33.36	3	Vertical	134	2.79	-

802.11b_Nss1,(1Mbps)_2TX

29/03/2019

2462MHz_TX

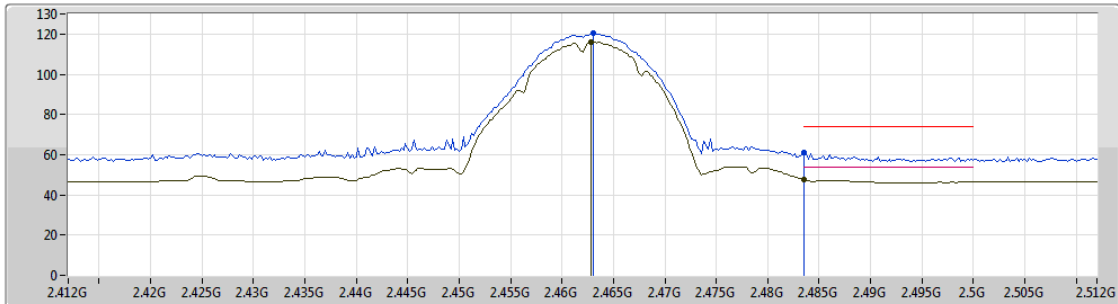

EUT_Z_2TX
Setting 22
04-E-2
FSP(100304)

Type	Freq (Hz)	Level (dBuV/m)	Limit (dBuV/m)	Margin (dB)	Factor (dB)	Dist (m)	Condition	Azimuth (°)	Height (m)	Comments
PK	2.463G	120.47	Inf	-Inf	33.30	3	Horizontal	64	1.50	-
AV	2.4628G	116.03	Inf	-Inf	33.30	3	Horizontal	64	1.50	-
PK	2.4835G	60.80	74.00	-13.20	33.36	3	Horizontal	64	1.50	-
AV	2.4835G	47.78	54.00	-6.22	33.36	3	Horizontal	64	1.50	-



802.11b_Nss1,(1Mbps)_2TX

29/03/2019

2462MHz_TX

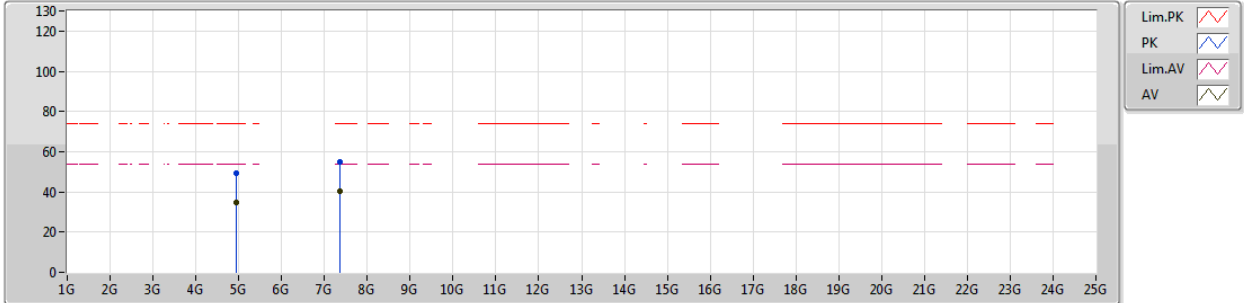

EUT_Z_2TX
Setting 22
04-E-2
FSP(100304)

Type	Freq (Hz)	Level (dBuV/m)	Limit (dBuV/m)	Margin (dB)	Factor (dB)	Dist (m)	Condition	Azimuth (°)	Height (m)	Comments
PK	4.93354G	49.15	74.00	-24.85	7.61	3	Vertical	240	1.59	-
AV	4.93444G	34.69	54.00	-19.31	7.61	3	Vertical	240	1.59	-
PK	7.37226G	54.87	74.00	-19.13	12.51	3	Vertical	35	1.78	-
AV	7.371G	40.51	54.00	-13.49	12.51	3	Vertical	35	1.78	-



802.11b_Nss1,(1Mbps)_2TX

29/03/2019

2462MHz_TX

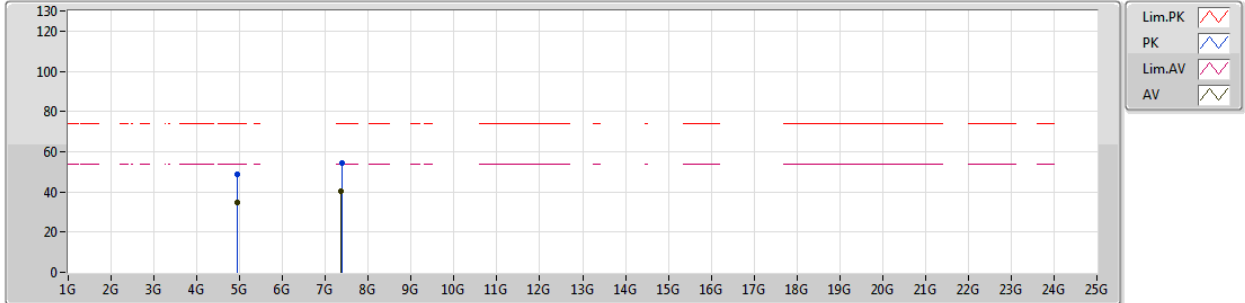

EUT_Z_2TX
Setting 22
04-E-2
FSP(100304)

Type	Freq (Hz)	Level (dBuV/m)	Limit (dBuV/m)	Margin (dB)	Factor (dB)	Dist (m)	Condition	Azimuth (°)	Height (m)	Comments
PK	4.93468G	48.71	74.00	-25.29	7.61	3	Horizontal	70	1.50	-
AV	4.93186G	34.77	54.00	-19.23	7.60	3	Horizontal	70	1.50	-
PK	7.37604G	54.41	74.00	-19.59	12.50	3	Horizontal	34	1.31	-
AV	7.37106G	40.51	54.00	-13.49	12.51	3	Horizontal	34	1.31	-



802.11g_Nss1,(6Mbps)_2TX

29/03/2019

2412MHz_TX

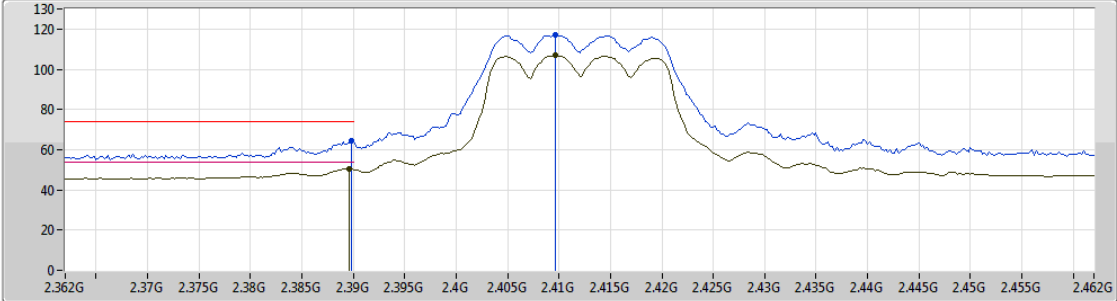

EUT_Z_2TX
Setting 20.5
04-E-2
FSP(100304)

Type	Freq (Hz)	Level (dBuV/m)	Limit (dBuV/m)	Margin (dB)	Factor (dB)	Dist (m)	Condition	Azimuth (°)	Height (m)	Comments
PK	2.3898G	64.27	74.00	-9.73	33.08	3	Vertical	238	2.41	-
AV	2.3896G	50.56	54.00	-3.44	33.08	3	Vertical	238	2.41	-
PK	2.4096G	116.89	Inf	-Inf	33.12	3	Vertical	238	2.41	-
AV	2.4096G	106.84	Inf	-Inf	33.12	3	Vertical	238	2.41	-



802.11g_Nss1,(6Mbps)_2TX

29/03/2019

2412MHz_TX

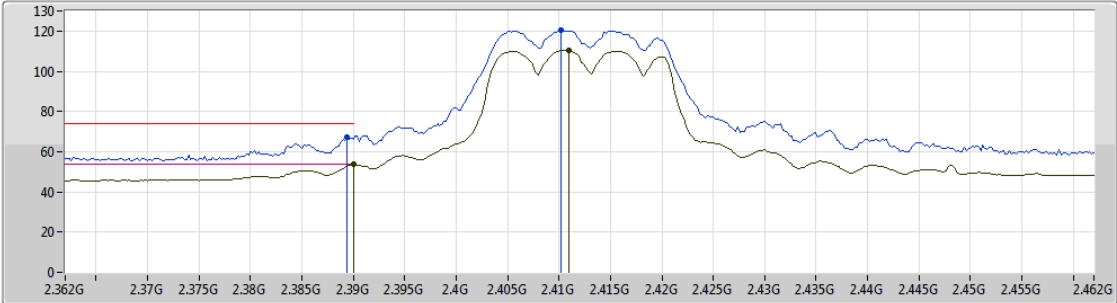

EUT_Z_2TX
Setting 20.5
04-E-2
FSP(100304)

Type	Freq (Hz)	Level (dBuV/m)	Limit (dBuV/m)	Margin (dB)	Factor (dB)	Dist (m)	Condition	Azimuth (°)	Height (m)	Comments
PK	2.3894G	67.03	74.00	-6.97	33.08	3	Horizontal	67	1.26	-
AV	2.39G	53.68	54.00	-0.32	33.08	3	Horizontal	67	1.26	-
PK	2.4102G	120.53	Inf	-Inf	33.12	3	Horizontal	67	1.26	-
AV	2.411G	110.53	Inf	-Inf	33.12	3	Horizontal	67	1.26	-



802.11g_Nss1,(6Mbps)_2TX

29/03/2019

2412MHz_TX

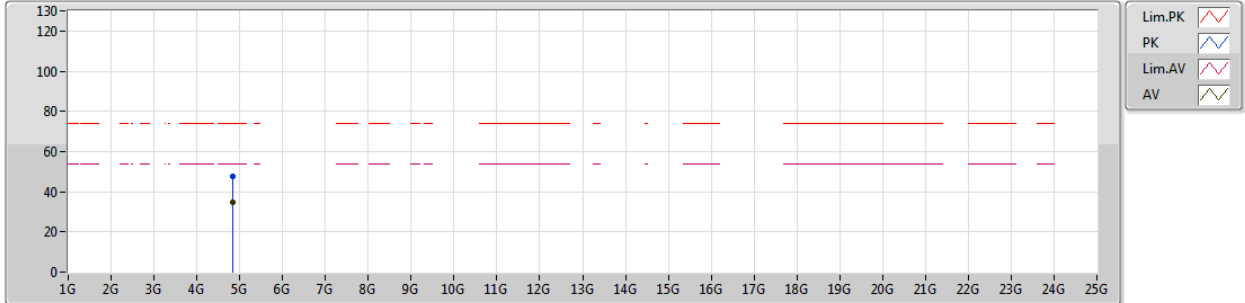

EUT_Z_2TX
Setting 20.5
04-E-2
FSP(100304)

Type	Freq (Hz)	Level (dBuV/m)	Limit (dBuV/m)	Margin (dB)	Factor (dB)	Dist (m)	Condition	Azimuth (°)	Height (m)	Comments
PK	4.83054G	47.84	74.00	-26.16	7.18	3	Vertical	256	1.50	-
AV	4.83852G	34.91	54.00	-19.09	7.22	3	Vertical	256	1.50	-



802.11g_Nss1,(6Mbps)_2TX

29/03/2019

2412MHz_TX

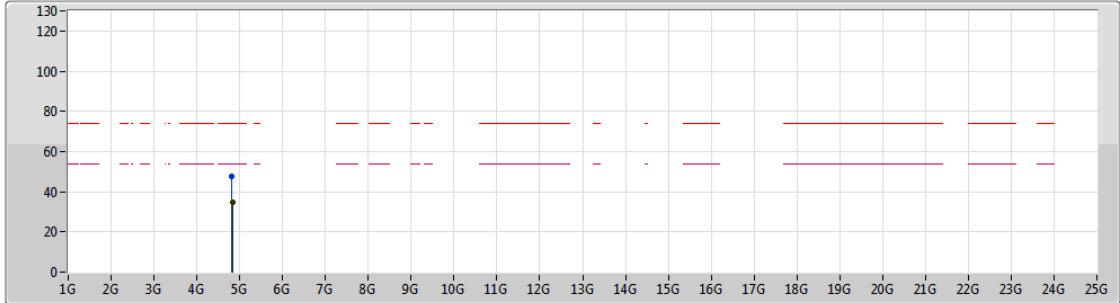

Lim.PK
 PK
 Lim.AV
 AV

EUT_Z_2TX
 Setting 20.5
 04-E-2
 FSP(100304)

Type	Freq (Hz)	Level (dBuV/m)	Limit (dBuV/m)	Margin (dB)	Factor (dB)	Dist (m)	Condition	Azimuth (°)	Height (m)	Comments
PK	4.8201G	47.61	74.00	-26.39	7.14	3	Horizontal	154	1.83	-
AV	4.82718G	34.94	54.00	-19.06	7.17	3	Horizontal	154	1.83	-



RSE TX above 1GHz Result

Appendix F.2

802.11g_Nss1,(6Mbps)_2TX

29/03/2019

2437MHz_TX

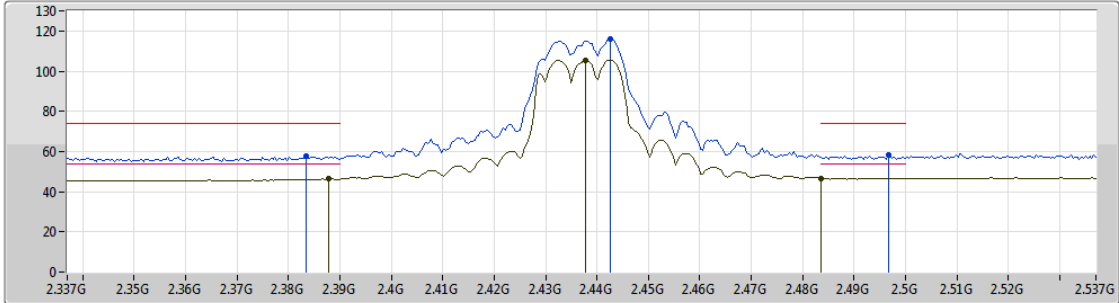

EUT_Z_2TX
Setting 22
04-E-2
FSP(100304)

Type	Freq (Hz)	Level (dBuV/m)	Limit (dBuV/m)	Margin (dB)	Factor (dB)	Dist (m)	Condition	Azimuth (°)	Height (m)	Comments
PK	2.3834G	57.76	74.00	-16.24	33.08	3	Vertical	340	1.50	-
AV	2.3878G	46.30	54.00	-7.70	33.08	3	Vertical	340	1.50	-
PK	2.4426G	116.25	Inf	-Inf	33.23	3	Vertical	340	1.50	-
AV	2.4378G	105.58	Inf	-Inf	33.22	3	Vertical	340	1.50	-
PK	2.4966G	58.00	74.00	-16.00	33.40	3	Vertical	340	1.50	-
AV	2.4835G	46.65	54.00	-7.35	33.36	3	Vertical	340	1.50	-

802.11g_Nss1,(6Mbps)_2TX

29/03/2019

2437MHz_TX

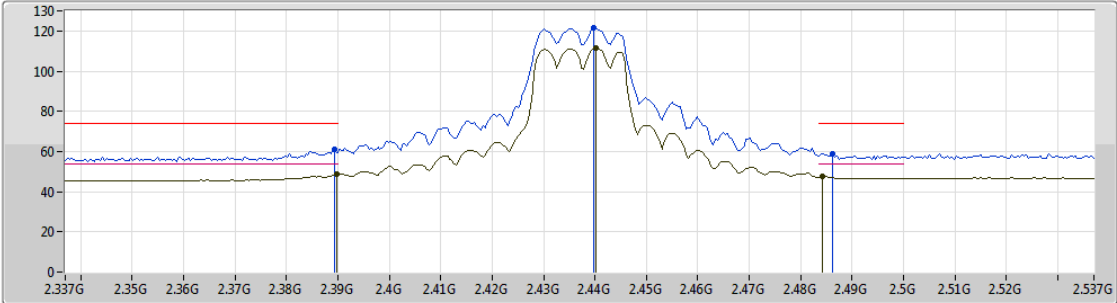

Legend for the spectrum plot:

- Lim.PK (Red line with triangle)
- PK (Blue line with triangle)
- Lim.AV (Red line with triangle)
- AV (Blue line with triangle)

EUT_Z_2TX
Setting 22
04-E-2
FSP(100304)

Type	Freq (Hz)	Level (dBuV/m)	Limit (dBuV/m)	Margin (dB)	Factor (dB)	Dist (m)	Condition	Azimuth (°)	Height (m)	Comments
PK	2.3894G	61.22	74.00	-12.78	33.08	3	Horizontal	58	1.30	-
AV	2.3898G	48.54	54.00	-5.46	33.08	3	Horizontal	58	1.30	-
PK	2.4398G	121.49	Inf	-Inf	33.22	3	Horizontal	58	1.30	-
AV	2.4402G	111.24	Inf	-Inf	33.22	3	Horizontal	58	1.30	-
PK	2.4862G	59.06	74.00	-14.94	33.36	3	Horizontal	58	1.30	-
AV	2.4842G	47.50	54.00	-6.50	33.36	3	Horizontal	58	1.30	-



802.11g_Nss1,(6Mbps)_2TX

29/03/2019

2437MHz_TX

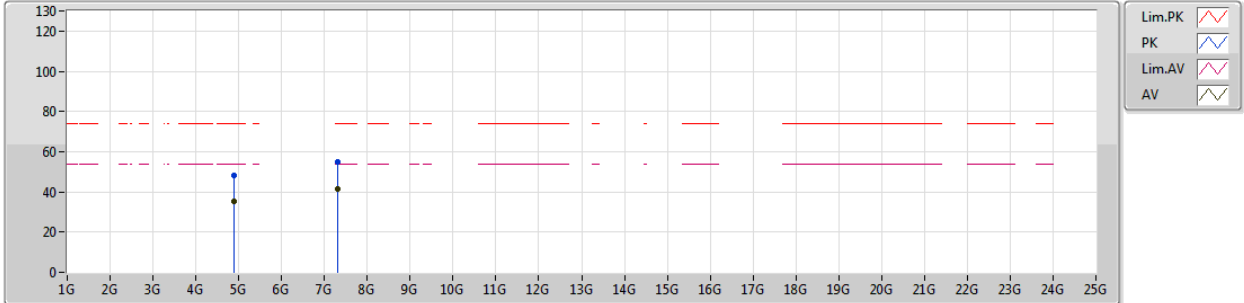

EUT_Z_2TX
Setting 22
04-E-2
FSP(100304)

Type	Freq (Hz)	Level (dBuV/m)	Limit (dBuV/m)	Margin (dB)	Factor (dB)	Dist (m)	Condition	Azimuth (°)	Height (m)	Comments
PK	4.88858G	48.20	74.00	-25.80	7.45	3	Vertical	297	2.71	-
AV	4.87958G	35.12	54.00	-18.88	7.40	3	Vertical	297	2.71	-
PK	7.31514G	54.79	74.00	-19.21	12.51	3	Vertical	87	1.50	-
AV	7.30482G	41.39	54.00	-12.61	12.51	3	Vertical	87	1.50	-



802.11g_Nss1,(6Mbps)_2TX

29/03/2019

2437MHz_TX

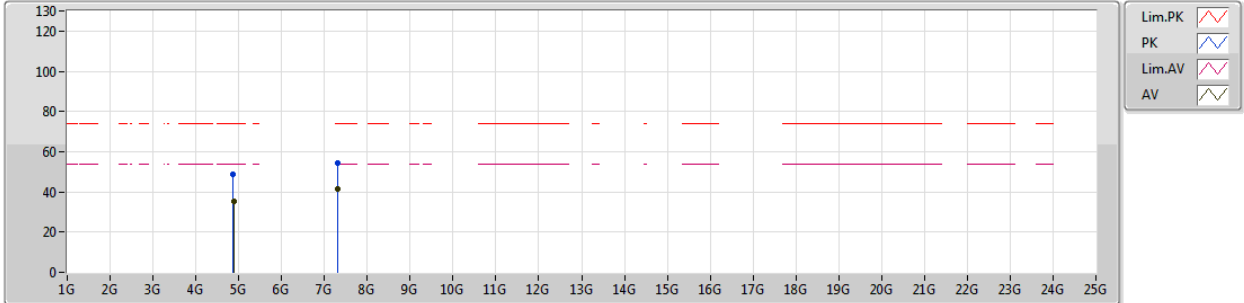

EUT_Z_2TX
Setting 22
04-E-2
FSP(100304)

Type	Freq (Hz)	Level (dBuV/m)	Limit (dBuV/m)	Margin (dB)	Factor (dB)	Dist (m)	Condition	Azimuth (°)	Height (m)	Comments
PK	4.87622G	48.70	74.00	-25.30	7.38	3	Horizontal	210	1.76	-
AV	4.88774G	35.10	54.00	-18.90	7.44	3	Horizontal	210	1.76	-
PK	7.30608G	54.15	74.00	-19.85	12.51	3	Horizontal	200	2.12	-
AV	7.29846G	41.21	54.00	-12.79	12.51	3	Horizontal	200	2.12	-



RSE TX above 1GHz Result

Appendix F.2

802.11g_Nss1,(6Mbps)_2TX

29/03/2019

2462MHz_TX

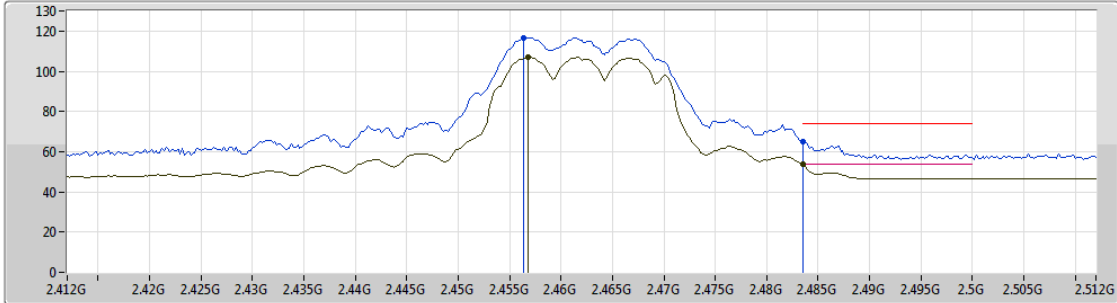

EUT_Z_2TX
Setting 21
04-E-2
FSP(100304)

Type	Freq (Hz)	Level (dBuV/m)	Limit (dBuV/m)	Margin (dB)	Factor (dB)	Dist (m)	Condition	Azimuth (°)	Height (m)	Comments
PK	2.4564G	116.60	Inf	-Inf	33.27	3	Vertical	153	2.79	-
AV	2.4568G	106.86	Inf	-Inf	33.27	3	Vertical	153	2.79	-
PK	2.4835G	65.03	74.00	-8.97	33.36	3	Vertical	153	2.79	-
AV	2.4835G	53.59	54.00	-0.41	33.36	3	Vertical	153	2.79	-



RSE TX above 1GHz Result

Appendix F.2

802.11g_Nss1,(6Mbps)_2TX

29/03/2019

2462MHz_TX

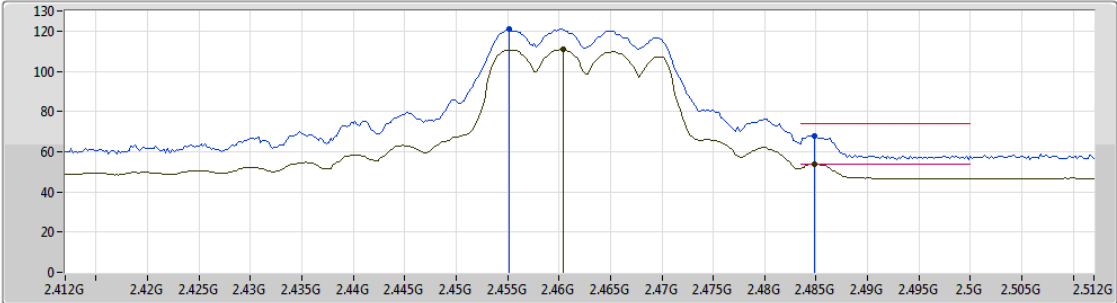

Legend for the spectrum plot:

- Lim.PK (Red line)
- PK (Blue line)
- Lim.AV (Red line)
- AV (Blue line)

EUT_Z_2TX
Setting 21
04-E-2
FSP(100304)

Type	Freq (Hz)	Level (dBuV/m)	Limit (dBuV/m)	Margin (dB)	Factor (dB)	Dist (m)	Condition	Azimuth (°)	Height (m)	Comments
PK	2.4552G	120.85	Inf	-Inf	33.27	3	Horizontal	66	1.27	-
AV	2.4604G	110.92	Inf	-Inf	33.28	3	Horizontal	66	1.27	-
PK	2.4848G	68.00	74.00	-6.00	33.36	3	Horizontal	66	1.27	-
AV	2.4848G	53.77	54.00	-0.23	33.36	3	Horizontal	66	1.27	-



802.11g_Nss1,(6Mbps)_2TX

29/03/2019

2462MHz_TX

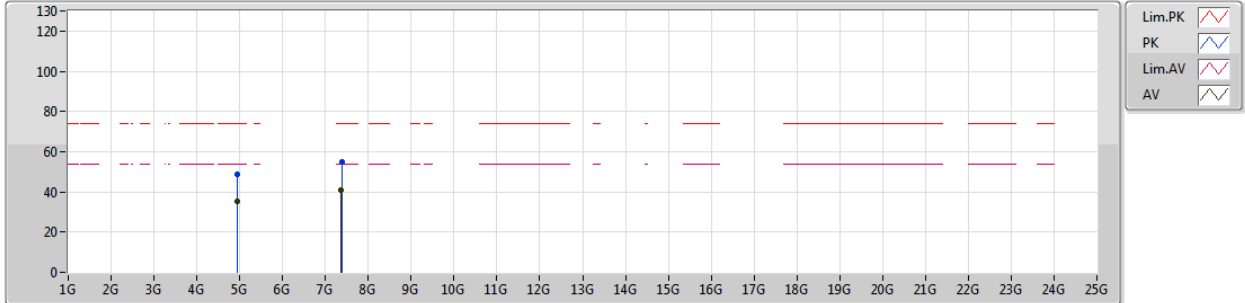

EUT_Z_2TX
Setting 21
04-E-2
FSP(100304)

Type	Freq (Hz)	Level (dBuV/m)	Limit (dBuV/m)	Margin (dB)	Factor (dB)	Dist (m)	Condition	Azimuth (°)	Height (m)	Comments
PK	4.93858G	48.82	74.00	-25.18	7.63	3	Vertical	284	1.50	-
AV	4.93774G	35.54	54.00	-18.46	7.63	3	Vertical	284	1.50	-
PK	7.38174G	54.91	74.00	-19.09	12.50	3	Vertical	122	1.50	-
AV	7.3725G	41.18	54.00	-12.82	12.51	3	Vertical	122	1.50	-



RSE TX above 1GHz Result

Appendix F.2

802.11g_Nss1,(6Mbps)_2TX

29/03/2019

2462MHz_TX

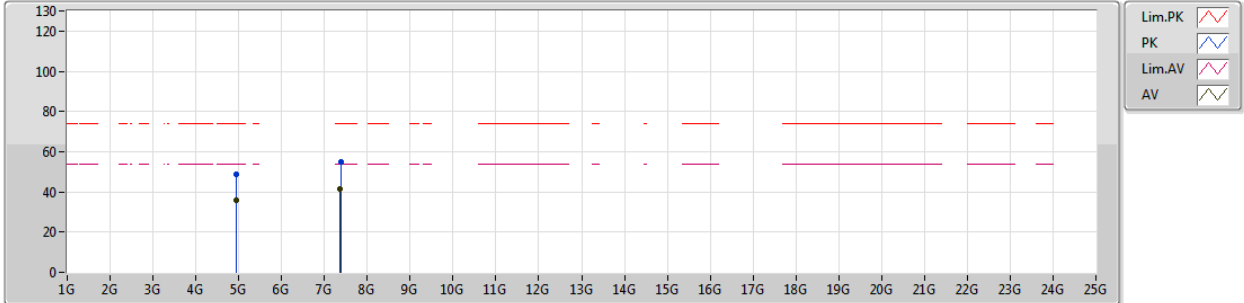

EUT_Z_2TX
Setting 21
04-E-2
FSP(100304)

Type	Freq (Hz)	Level (dBuV/m)	Limit (dBuV/m)	Margin (dB)	Factor (dB)	Dist (m)	Condition	Azimuth (°)	Height (m)	Comments
PK	4.93282G	48.54	74.00	-25.46	7.61	3	Horizontal	187	1.89	-
AV	4.93108G	35.61	54.00	-18.39	7.59	3	Horizontal	187	1.89	-
PK	7.37982G	54.87	74.00	-19.13	12.50	3	Horizontal	58	2.28	-
AV	7.37106G	41.26	54.00	-12.74	12.51	3	Horizontal	58	2.28	-



VHT20_Nss1,(MCS0)_2TX

29/03/2019

2412MHz_TX

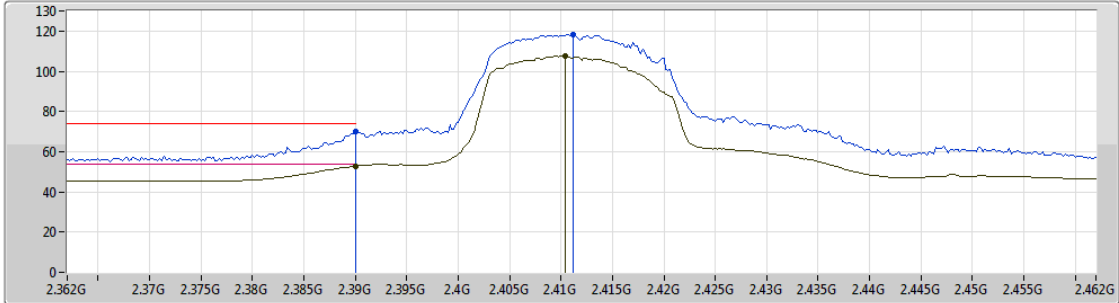

EUT_Z_2TX
Setting 21.5
04-E-2
FSP(100304)

Type	Freq (Hz)	Level (dBuV/m)	Limit (dBuV/m)	Margin (dB)	Factor (dB)	Dist (m)	Condition	Azimuth (°)	Height (m)	Comments
PK	2.39G	69.94	74.00	-4.06	33.08	3	Vertical	157	2.41	-
AV	2.39G	52.82	54.00	-1.18	33.08	3	Vertical	157	2.41	-
PK	2.4112G	118.08	Inf	-Inf	33.12	3	Vertical	157	2.41	-
AV	2.4104G	107.49	Inf	-Inf	33.12	3	Vertical	157	2.41	-



VHT20_Nss1.(MCS0)_2TX

29/03/2019

2412MHz_TX

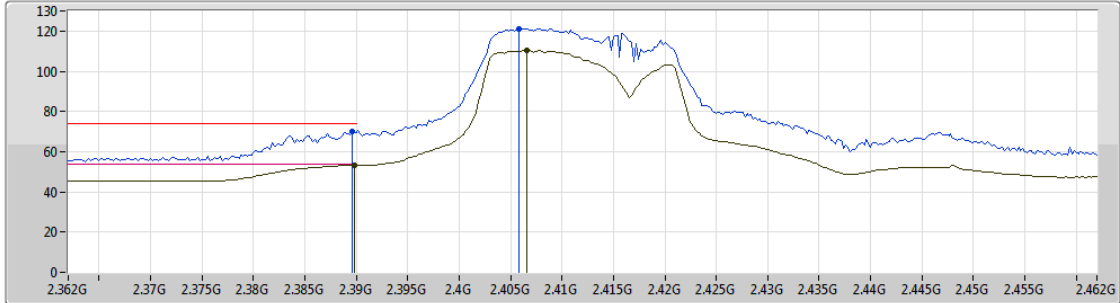

EUT_Z_2TX
Setting 21.5
04-E-2
FSP(100304)

Type	Freq (Hz)	Level (dBuV/m)	Limit (dBuV/m)	Margin (dB)	Factor (dB)	Dist (m)	Condition	Azimuth (°)	Height (m)	Comments
PK	2.3896G	69.91	74.00	-4.09	33.08	3	Horizontal	70	1.28	-
AV	2.3898G	53.50	54.00	-0.50	33.08	3	Horizontal	70	1.28	-
PK	2.4058G	121.25	Inf	-Inf	33.11	3	Horizontal	70	1.28	-
AV	2.4066G	110.28	Inf	-Inf	33.11	3	Horizontal	70	1.28	-



VHT20_Nss1,(MCS0)_2TX

29/03/2019

2412MHz_TX

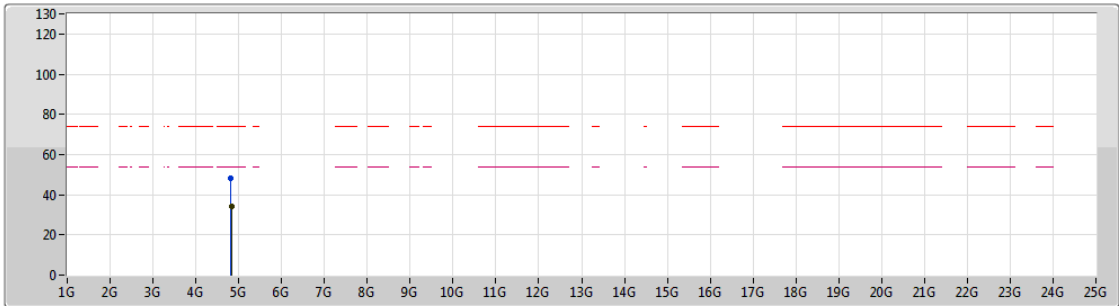

EUT_Z_2TX
Setting 21.5
04-E-2
FSP(100304)

Type	Freq (Hz)	Level (dBuV/m)	Limit (dBuV/m)	Margin (dB)	Factor (dB)	Dist (m)	Condition	Azimuth (°)	Height (m)	Comments
PK	4.81902G	48.04	74.00	-25.96	7.14	3	Vertical	290	1.41	-
AV	4.82778G	34.07	54.00	-19.93	7.17	3	Vertical	290	1.41	-



VHT20_Nss1,(MCS0)_2TX

29/03/2019

2412MHz_TX

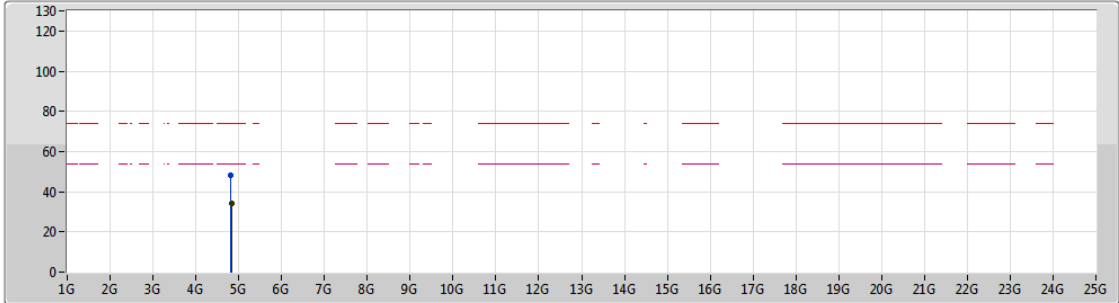

EUT_Z_2TX
Setting 21.5
04-E-2
FSP(100304)

Type	Freq (Hz)	Level (dBuV/m)	Limit (dBuV/m)	Margin (dB)	Factor (dB)	Dist (m)	Condition	Azimuth (°)	Height (m)	Comments
PK	4.80912G	47.93	74.00	-26.07	7.09	3	Horizontal	39	1.94	-
AV	4.83834G	34.11	54.00	-19.89	7.22	3	Horizontal	39	1.94	-



RSE TX above 1GHz Result

Appendix F.2

VHT20_Nss1.(MCS0)_2TX

29/03/2019

2437MHz_TX

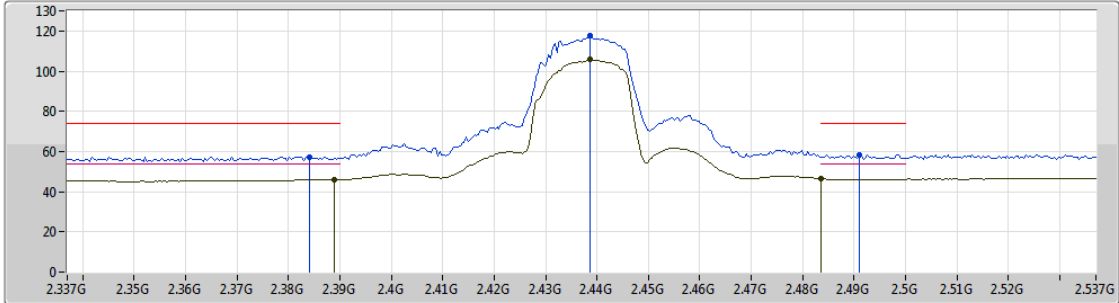

Lim.PK
 PK
 Lim.AV
 AV

EUT_Z_2TX
 Setting 22
 04-E-2
 FSP(100304)

Type	Freq (Hz)	Level (dBuV/m)	Limit (dBuV/m)	Margin (dB)	Factor (dB)	Dist (m)	Condition	Azimuth (°)	Height (m)	Comments
PK	2.3842G	57.38	74.00	-16.62	33.08	3	Vertical	340	1.50	-
AV	2.389G	45.87	54.00	-8.13	33.08	3	Vertical	340	1.50	-
PK	2.4386G	117.50	Inf	-Inf	33.22	3	Vertical	340	1.50	-
AV	2.4386G	105.70	Inf	-Inf	33.22	3	Vertical	340	1.50	-
PK	2.491G	58.37	74.00	-15.63	33.38	3	Vertical	340	1.50	-
AV	2.4835G	46.43	54.00	-7.57	33.36	3	Vertical	340	1.50	-



RSE TX above 1GHz Result

Appendix F.2

VHT20_Nss1.(MCS0)_2TX

29/03/2019

2437MHz_TX

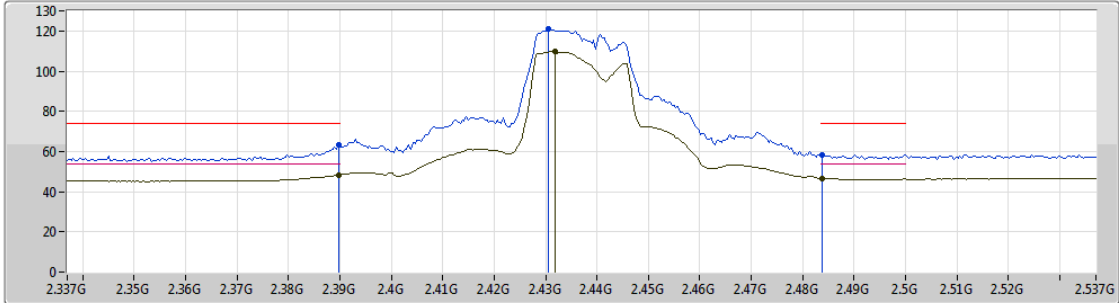

EUT_Z_2TX
Setting 22
04-E-2
FSP(100304)

Type	Freq (Hz)	Level (dBuV/m)	Limit (dBuV/m)	Margin (dB)	Factor (dB)	Dist (m)	Condition	Azimuth (°)	Height (m)	Comments
PK	2.3898G	63.07	74.00	-10.93	33.08	3	Horizontal	67	1.50	-
AV	2.3898G	48.42	54.00	-5.58	33.08	3	Horizontal	67	1.50	-
PK	2.4306G	120.79	Inf	-Inf	33.19	3	Horizontal	67	1.50	-
AV	2.4318G	109.79	Inf	-Inf	33.19	3	Horizontal	67	1.50	-
PK	2.4838G	58.16	74.00	-15.84	33.36	3	Horizontal	67	1.50	-
AV	2.4838G	46.70	54.00	-7.30	33.36	3	Horizontal	67	1.50	-



VHT20_Nss1.(MCS0)_2TX

29/03/2019

2437MHz_TX

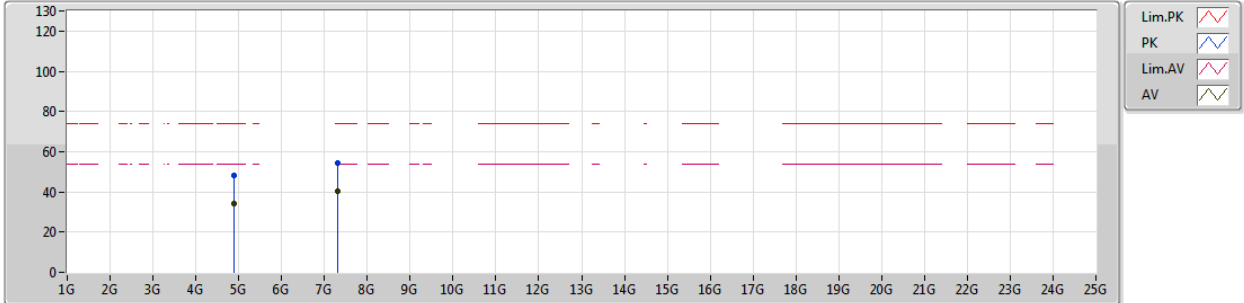

EUT_Z_2TX
Setting 22
04-E-2
FSP(100304)

Type	Freq (Hz)	Level (dBuV/m)	Limit (dBuV/m)	Margin (dB)	Factor (dB)	Dist (m)	Condition	Azimuth (°)	Height (m)	Comments
PK	4.88768G	48.38	74.00	-25.62	7.44	3	Vertical	243	2.97	-
AV	4.8815G	34.37	54.00	-19.63	7.40	3	Vertical	243	2.97	-
PK	7.30194G	54.34	74.00	-19.66	12.51	3	Vertical	360	2.14	-
AV	7.30116G	40.57	54.00	-13.43	12.51	3	Vertical	360	2.14	-



VHT20_Nss1,(MCS0)_2TX

29/03/2019

2437MHz_TX

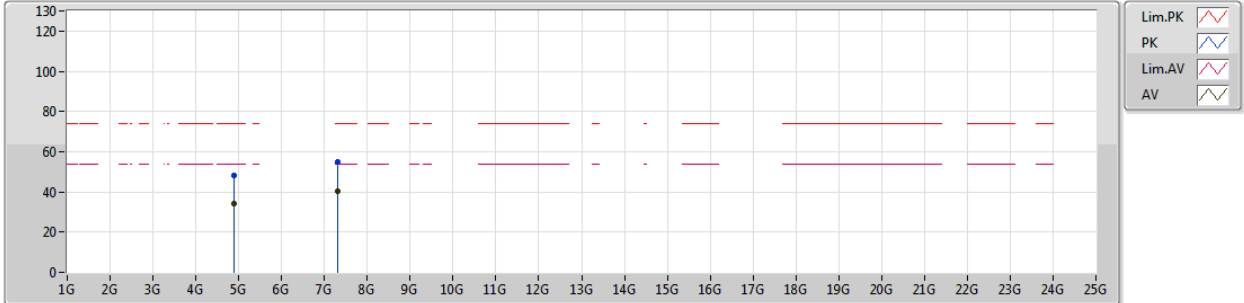

EUT_Z_2TX
Setting 22
04-E-2
FSP(100304)

Type	Freq (Hz)	Level (dBuV/m)	Limit (dBuV/m)	Margin (dB)	Factor (dB)	Dist (m)	Condition	Azimuth (°)	Height (m)	Comments
PK	4.88372G	48.25	74.00	-25.75	7.42	3	Horizontal	358	2.11	-
AV	4.87946G	34.34	54.00	-19.66	7.40	3	Horizontal	358	2.11	-
PK	7.29726G	54.78	74.00	-19.22	12.50	3	Horizontal	94	1.47	-
AV	7.29852G	40.53	54.00	-13.47	12.51	3	Horizontal	94	1.47	-

VHT20_Nss1.(MCS0)_2TX

29/03/2019

2457MHz_TX

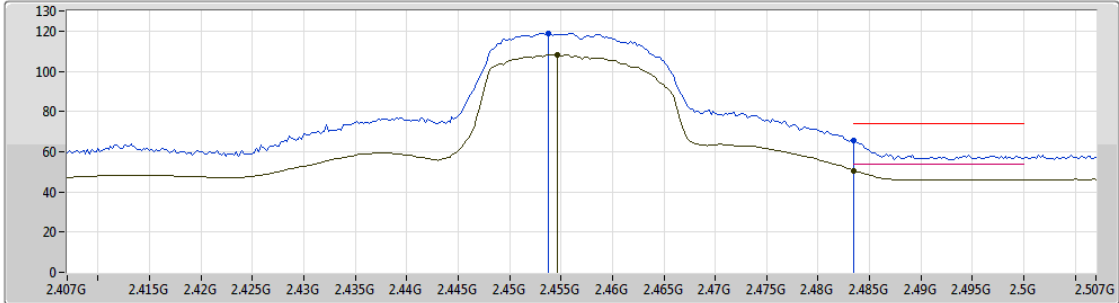

EUT_Z_2TX
Setting 22
04-E-2
FSP(100304)

Type	Freq (Hz)	Level (dBuV/m)	Limit (dBuV/m)	Margin (dB)	Factor (dB)	Dist (m)	Condition	Azimuth (°)	Height (m)	Comments
PK	2.4538G	119.07	Inf	-Inf	33.26	3	Vertical	155	2.59	-
AV	2.4546G	108.12	Inf	-Inf	33.27	3	Vertical	155	2.59	-
PK	2.4835G	65.62	74.00	-8.38	33.36	3	Vertical	155	2.59	-
AV	2.4835G	50.66	54.00	-3.34	33.36	3	Vertical	155	2.59	-



VHT20_Nss1.(MCS0)_2TX

29/03/2019

2457MHz_TX

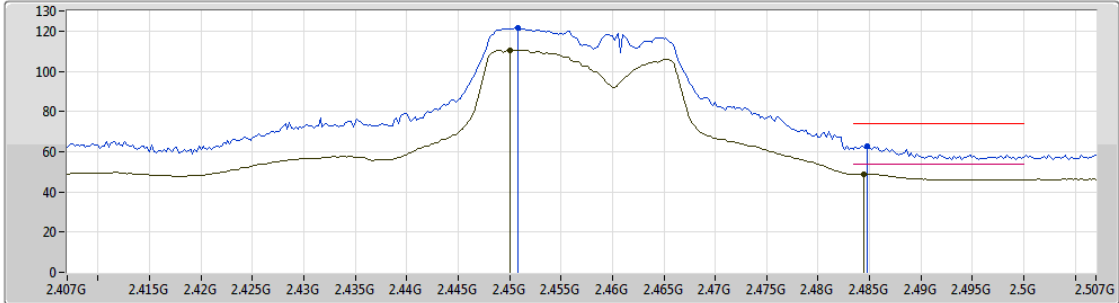

Lim.PK
 PK
 Lim.AV
 AV

EUT_Z_2TX
 Setting 22
 04-E-2
 FSP(100304)

Type	Freq (Hz)	Level (dBuV/m)	Limit (dBuV/m)	Margin (dB)	Factor (dB)	Dist (m)	Condition	Azimuth (°)	Height (m)	Comments
PK	2.4508G	121.63	Inf	-Inf	33.25	3	Horizontal	67	1.24	-
AV	2.45G	110.49	Inf	-Inf	33.25	3	Horizontal	67	1.24	-
PK	2.4848G	62.68	74.00	-11.32	33.36	3	Horizontal	67	1.24	-
AV	2.4844G	48.76	54.00	-5.24	33.36	3	Horizontal	67	1.24	-

VHT20_Nss1,(MCS0)_2TX

29/03/2019

2462MHz_TX

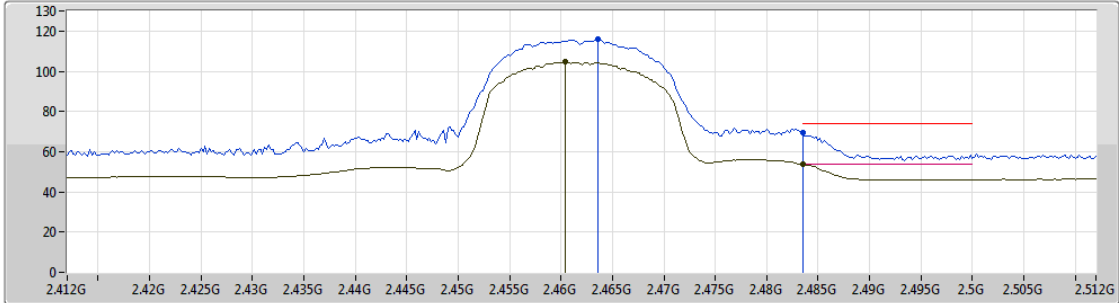

EUT_Z_2TX
Setting 18.5
04-E-2
FSP(100304)

Type	Freq (Hz)	Level (dBuV/m)	Limit (dBuV/m)	Margin (dB)	Factor (dB)	Dist (m)	Condition	Azimuth (°)	Height (m)	Comments
PK	2.4636G	115.78	Inf	-Inf	33.30	3	Vertical	151	2.77	-
AV	2.4604G	104.52	Inf	-Inf	33.28	3	Vertical	151	2.77	-
PK	2.4835G	69.54	74.00	-4.46	33.36	3	Vertical	151	2.77	-
AV	2.4835G	53.60	54.00	-0.40	33.36	3	Vertical	151	2.77	-



VHT20_Nss1.(MCS0)_2TX

29/03/2019

2462MHz_TX

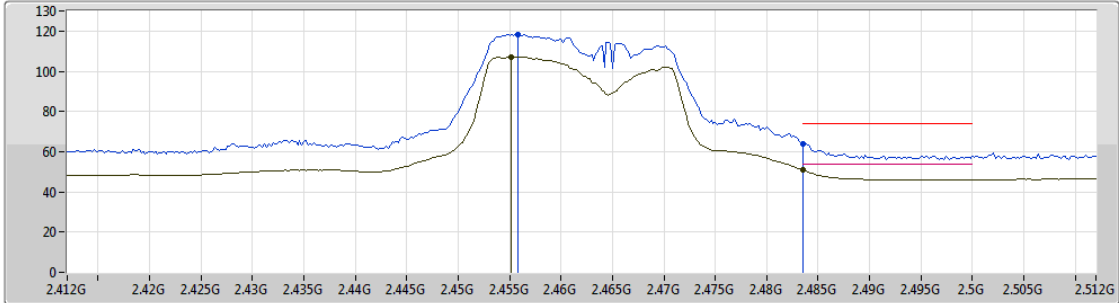

EUT_Z_2TX
Setting 18.5
04-E-2
FSP(100304)

Type	Freq (Hz)	Level (dBuV/m)	Limit (dBuV/m)	Margin (dB)	Factor (dB)	Dist (m)	Condition	Azimuth (°)	Height (m)	Comments
PK	2.4558G	118.48	Inf	-Inf	33.27	3	Horizontal	62	1.25	-
AV	2.4552G	107.29	Inf	-Inf	33.27	3	Horizontal	62	1.25	-
PK	2.4835G	64.04	74.00	-9.96	33.36	3	Horizontal	62	1.25	-
AV	2.4835G	50.73	54.00	-3.27	33.36	3	Horizontal	62	1.25	-



RSE TX above 1GHz Result

Appendix F.2

VHT20_Nss1,(MCS0)_2TX

29/03/2019

2462MHz_TX

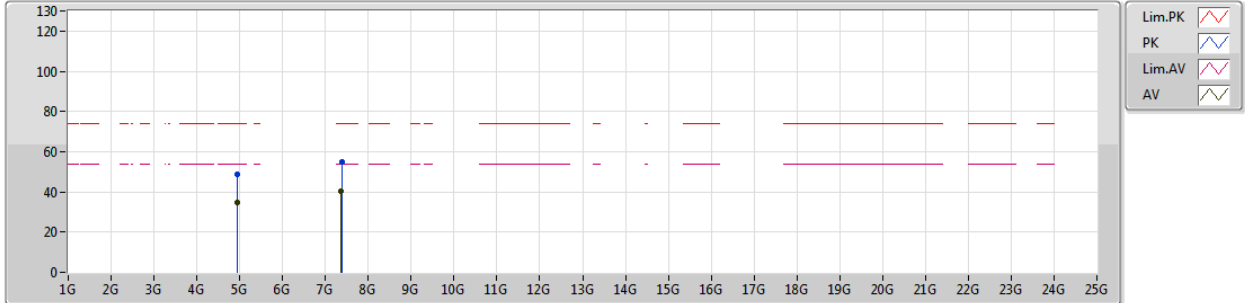

EUT_Z_2TX
Setting 18.5
04-E-2
FSP(100304)

Type	Freq (Hz)	Level (dBuV/m)	Limit (dBuV/m)	Margin (dB)	Factor (dB)	Dist (m)	Condition	Azimuth (°)	Height (m)	Comments
PK	4.93882G	48.52	74.00	-25.48	7.63	3	Vertical	360	2.03	-
AV	4.93852G	34.72	54.00	-19.28	7.63	3	Vertical	360	2.03	-
PK	7.37634G	54.77	74.00	-19.23	12.50	3	Vertical	308	1.32	-
AV	7.37358G	40.49	54.00	-13.51	12.51	3	Vertical	308	1.32	-

VHT20_Nss1,(MCS0)_2TX

29/03/2019

2462MHz_TX

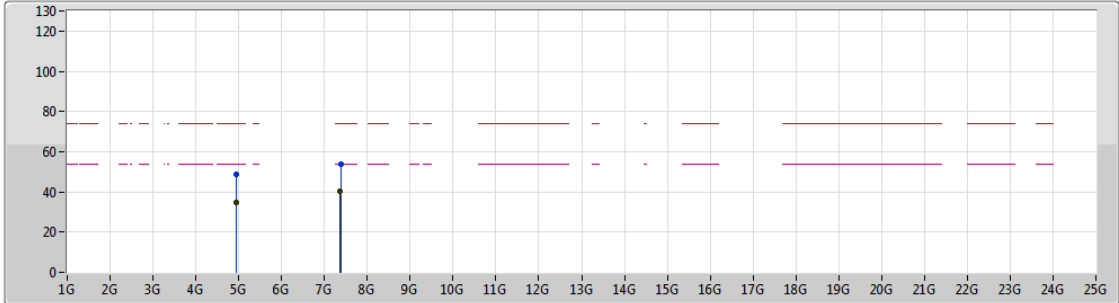

Legend for the spectrum plot:

- Lim.PK (Red dashed line)
- PK (Blue line with dot)
- Lim.AV (Pink dashed line)
- AV (Black line with dot)

EUT_Z_2TX
Setting 18.5
04-E-2
FSP(100304)

Type	Freq (Hz)	Level (dBuV/m)	Limit (dBuV/m)	Margin (dB)	Factor (dB)	Dist (m)	Condition	Azimuth (°)	Height (m)	Comments
PK	4.93144G	48.49	74.00	-25.51	7.59	3	Horizontal	294	1.75	-
AV	4.93468G	34.77	54.00	-19.23	7.61	3	Horizontal	294	1.75	-
PK	7.37862G	53.91	74.00	-20.09	12.50	3	Horizontal	103	1.82	-
AV	7.37124G	40.56	54.00	-13.44	12.51	3	Horizontal	103	1.82	-

