



FCC TEST REPORT

47 CFR FCC Part 15.249

Report Reference No.....: **WE10070006**

FCC ID.....: **YLDJRB11**

Compiled by
 (position+printed name+signature)..: File administrators Wenliang Li

Supervised by
 (position+printed name+signature)..: Test Engineer Xiankun Ding

Approved by
 (position+printed name+signature)..: Manager Jimmy Li

Date of issue.....: Jul 14, 2010

Testing Laboratory Name: **Shenzhen Huatongwei International Inspection Co., Ltd**

Address.....: Keji Nan No.12 Road, Hi-tech Park, Shenzhen, China

Applicant's name.....: **VSO TECHNOLOGY (DONG GUAN) CO.,LTD.**

Address.....: No.58 LongTou Road, Long Jian Tian, Huang Jiang, Dong Guan, China

Test specification:

Standard: **47 CFR FCC Part 15.249: Operation within the bands 920-928 MHz, 2400-2483.5 MHz, 5725-5850 MHz and 24.0 - 24.25 GHz.**

TRF Originator.....: Shenzhen Huatongwei International Inspection CO., Ltd

Master TRF.....: Dated 2006-06

Shenzhen Huatongwei International Inspection Co., Ltd. All rights reserved.

This publication may be reproduced in whole or in part for non-commercial purposes as long as the Shenzhen Huatongwei International Inspection Co., Ltd is acknowledged as copyright owner and source of the material. Shenzhen Huatongwei International Inspection Co., Ltd takes no responsibility for and will not assume liability for damages resulting from the reader's interpretation of the reproduced material due to its placement and context.

Test item description : Receiver

Trade Mark: /

Model/Type reference.....: JRB11

Listed Models: SKBM2010 SKB1

Serial Number: /

Modulation: GFSK

Result.....: **Positive**

TEST REPORT

Test Report No. :	WE10070006	Jul 14, 2010
		Date of issue

Equipment under Test : Receiver

Model /Type : JRB11

Listed Models : SKBM2010 SKB1

Applicant : VSO TECHNOLOGY (DONG GUAN) CO.,LTD.

Address : No.58 LongTou Road, Long Jian Tian, Huang Jiang, Dong Guan, China

Manufacturer : VSO TECHNOLOGY (DONG GUAN) CO.,LTD.

Address : No.58 LongTou Road, Long Jian Tian, Huang Jiang, Dong Guan, China

Test Result according to the standards on page 4:	Positive
--	-----------------

The test report merely corresponds to the test sample.
It is not permitted to copy extracts of these test result without the written permission of the test laboratory.

Contents

- 1. TEST STANDARDS 4**

- 2. SUMMARY 5**
 - 2.1. General Remarks 5
 - 2.2. Equipment Under Test 5
 - 2.3. Short description of the Equipment under Test (EUT) 5
 - 2.4. EUT operation mode 5
 - 2.5. EUT configuration 5
 - 2.6. Related Submittal(s) / Grant (s) 6
 - 2.7. Modifications 6

- 3. TEST ENVIRONMENT 7**
 - 3.1. Address of the test laboratory 7
 - 3.2. Test Facility 7
 - 3.3. Environmental conditions 8
 - 3.4. Configuration of Tested System 8
 - 3.5. Statement of the measurement uncertainty 9
 - 3.6. Equipments Used during the Test 9

- 4. TEST CONDITIONS AND RESULTS 10**
 - 4.1. Conducted Emissions Test 10
 - 4.2. Radiated Emission Test 13
 - 4.3. Band Edge Measurement 18
 - 4.4. 20dB Bandwidth Measurement 22

- 5. TEST SETUP PHOTOS OF THE EUT 25**

- 6. EXTERNAL AND INTERNAL PHOTOS OF THE EUT 26**

1. TEST STANDARDS

The tests were performed according to following standards:

[47 CFR FCC Rules Part 15.249](#): Frequency Hopping, Direct Spread Spectrum and Hybrid Systems that are in operation within the bands of 902-928 MHz, 2400-2483.5 MHz, 5725-5850 MHz and 24.0 - 24.25 GHz.

2. SUMMARY

2.1. General Remarks

Date of receipt of test sample : Jul 01, 2010

Testing commenced on : Jul 01, 2010

Testing concluded on : Jul 11, 2010

2.2. Equipment Under Test

Power supply system utilised

Power supply voltage : 120V / 60 Hz 115V / 60Hz
 12 V DC 24 V DC
 Other (specified in blank below)

DC 5V from USB

2.3. Short description of the Equipment under Test (EUT)

2.4GHz (Receiver)

For more details, refer to the user's manual of the EUT.

Serial number: Prototype

2.4. EUT operation mode

The EUT has been tested under typical operating condition.

2.5. EUT configuration

The following peripheral devices and interface cables were connected during the measurement:

- supplied by the manufacturer

- supplied by the lab

Notebook PC

Manufacturer: DELL

Model No.: PP11L

Printer

Manufacturer: HP

Model No.: Laserjet 6L C3990A

Gigabit Switch

Manufacturer: D-Link

Model No.: DGS-1005D

2.6. Related Submittal(s) / Grant (s)

This submittal(s) (test report) is intended for FCC ID: **YLDJRB11** filing to comply with Section 15.249 of the FCC Part 15, Subpart C Rules.

2.7. Modifications

No modifications were implemented to meet testing criteria.

3. TEST ENVIRONMENT

3.1. Address of the test laboratory

Shenzhen Huatongwei International Inspection Co., Ltd
Keji Nan No.12 Road, Hi-tech Park, Shenzhen, China
Phone: 86-755-26715686 Fax: 86-755-26748089

The sites are constructed in conformance with the requirements of ANSI C63.7, ANSI C63.4 (2003) and CISPR Publication 22.

3.2. Test Facility

The test facility is recognized, certified, or accredited by the following organizations:

CNAS-Lab Code: L1225

Shenzhen Huatongwei International Inspection Co., Ltd has been assessed and proved to be in compliance with CNAS-CL01 Accreditation Criteria for Testing and Calibration Laboratories (identical to ISO/IEC 17025: 2005 General Requirements) for the Competence of Testing and Calibration Laboratories, Date of Registration: Mar 30, 2009. Valid time is until Mar 29, 2012.

A2LA-Lab Cert. No. 2243.01

Shenzhen Huatongwei International Inspection Co., Ltd, EMC Laboratory has been accredited by A2LA for technical competence in the field of electrical testing, and proved to be in compliance with ISO/IEC 17025: 2005 General Requirements for the Competence of Testing and Calibration Laboratories and any additional program requirements in the identified field of testing. Valid time is until Sept 30, 2011.

FCC-Registration No.: 662850

Shenzhen Huatongwei International Inspection Co., Ltd, EMC Laboratory has been registered and fully described in a report filed with the FCC (Federal Communications Commission). The acceptance letter from the FCC is maintained in our files. Registration 662850, Renewal date Jun 01, 2009.

IC-Registration No.: 5377

The 3m Alternate Test Site of Shenzhen Huatongwei International Inspection Co., Ltd has been registered by Certification and Engineering Bureau of Industry Canada for the performance of radiated measurements with Registration No. 5377 on November Feb 13, 2009. Valid time is until Feb 13, 2011.

ACA

Shenzhen Huatongwei International Inspection Co., Ltd, EMC Laboratory can also perform testing for the Australian C-Tick mark as a result of our A2LA accreditation.

NEMKO-Aut. No.: ELA125

Shenzhen Huatongwei International Inspection Co., Ltd has been assessed the quality assurance system, the testing facilities, qualifications and testing practices of the relevant parts of the organization. The quality assurance system of the Laboratory has been validated against ISO/IEC 17025:2005 or equivalent. The laboratory also fulfils the conditions described in Nemko Document NLA-10, the Authorization is valid through July 07, 2011.

VCCI

The 3m Semi-anechoic chamber (12.2m×7.95m×6.7m) and Shielded Room (8m×4m×3m) of Shenzhen Huatongwei International Inspection Co., Ltd has been registered in accordance with the Regulations for Voluntary Control Measures with Registration No.: R-2484. Date of Registration: December 20, 2006. Valid time is until December 20, 2012.

Main Ports Conducted Interference Measurement of Shenzhen Huatongwei International Inspection Co., Ltd has been registered in accordance with the Regulations for Voluntary Control Measures with Registration No.: C-2726. Date of Registration: December 20, 2006. Valid time is until December 19, 2012.

DNV

Shenzhen Huatongwei International Inspection Co Ltd has been found to comply with the requirements of DNV towards subcontractor of EMC and safety testing services in conjunction with the EMC and Low voltage Directives and in the voluntary field. The acceptance is based on a formal quality Audit and follow-ups according to relevant parts of ISO/IEC Guide 17025(2005), in accordance with the requirements of the DNV Laboratory Quality Manual towards subcontractors. Valid time is until Jul 09, 2010.

3.3. Environmental conditions

During the measurement the environmental conditions were within the listed ranges:

Temperature: 15-35 ° C
 Humidity: 30-60 %
 Atmospheric pressure: 950-1050mbar

3.4. Configuration of Tested System

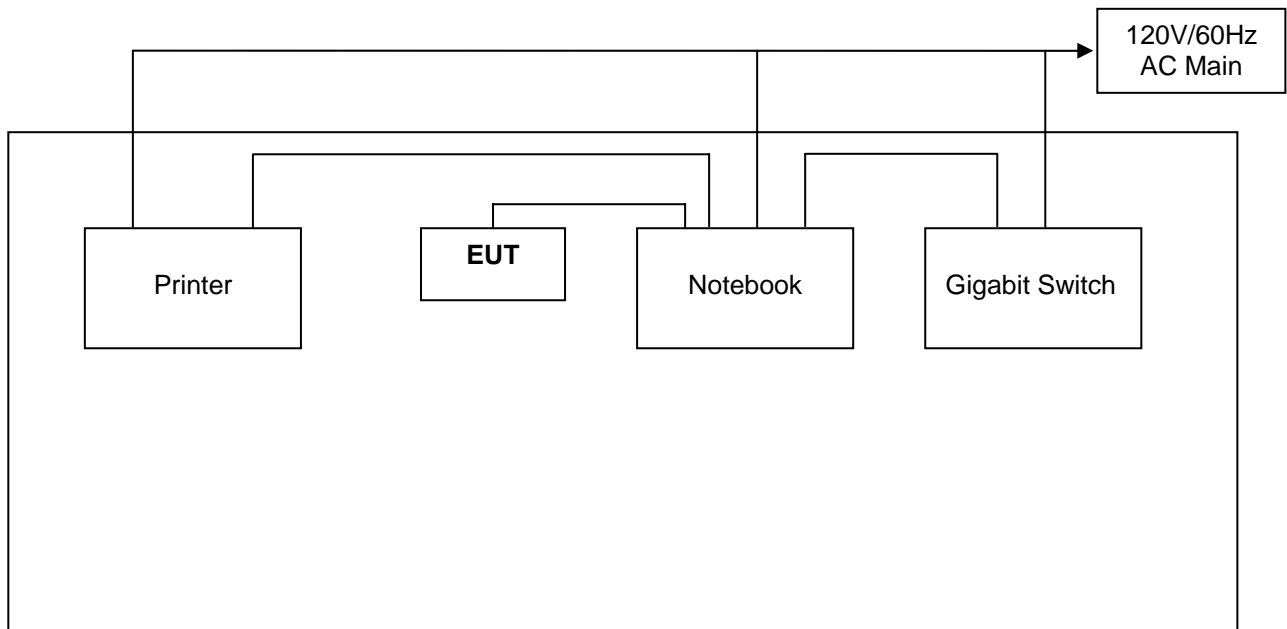

Equipment Used in Tested System

No.	Equipment	Manufacturer	Model No.	Serial No.
1	Notebook PC	DELL	PP11L	H5917A01
2	Printer	HP	Laserjet 6L C3990A	JPZP024664
3	Gigabit Switch	D-Link	DGS-1005D	DRJP576000511

3.5. Statement of the measurement uncertainty

The data and results referenced in this document are true and accurate. The reader is cautioned that there may be errors within the calibration limits of the equipment and facilities. The measurement uncertainty was calculated for all measurements listed in this test report acc. to CISPR 16 - 4 „Specification for radio disturbance and immunity measuring apparatus and methods – Part 4: Uncertainty in EMC Measurements“ and is documented in the Shenzhen Huatongwei International Inspection Co., Ltd quality system acc. to DIN EN ISO/IEC 17025. Furthermore, component and process variability of devices similar to that tested may result in additional deviation. The manufacturer has the sole responsibility of continued compliance of the device.

Hereafter the best measurement capability for Shenzhen Huatongwei laboratory is reported:

Test	Range	Measurement Uncertainty	Notes
Radiated Emission	30~1000MHz	4.22dB	(1)
Radiated Emission	1~18GHz	5.16dB	(1)
Radiated Emission	18~40GHz	5.54dB	(1)
Conducted Disturbance	0.15~30MHz	3.29dB	(1)

(1) This uncertainty represents an expanded uncertainty expressed at approximately the 95% confidence level using a coverage factor of k=2.

3.6. Equipments Used during the Test

AC Power Conducted Emission					
Item	Test Equipment	Manufacturer	Model No.	Serial No.	Last Cal.
1	EMI TEST RECEIVER	ROHDE & SCHWARZ	ESCS30	100038	2009/11
2	ARTIFICIAL MAINS	ROHDE & SCHWARZ	ESH2-Z5	100028	2009/11
3	PULSE LIMITER	ROHDE & SCHWARZ	ESHSZ2	100044	2009/11
4	EMI TEST SOFTWARE	ROHDE & SCHWARZ	ES-K1 1.71	N/A	2009/11

Radiated Emissions					
Item	Test Equipment	Manufacturer	Model No.	Serial No.	Last Cal.
1	ULTRA-BROADBAND ANTENNA	ROHDE & SCHWARZ	HL562	100015	2010/05
2	EMI TEST RECEIVER	ROHDE & SCHWARZ	ESI 26	100009	2009/11
3	RF TEST PANEL	ROHDE & SCHWARZ	TS / RSP	335015/ 0017	2009/11
4	TURNTABLE	ETS	2088	2149	2009/11
5	ANTENNA MAST	ETS	2075	2346	2009/11
6	EMI TEST SOFTWARE	ROHDE & SCHWARZ	ESK1	N/A	2009/11

Bandwidth / Band Edge Measurement					
Item	Test Equipment	Manufacturer	Model No.	Serial No.	Last Cal.
1	EMI TEST RECEIVER	ROHDE & SCHWARZ	ESCI	100106	2009/11

4. TEST CONDITIONS AND RESULTS

4.1. Conducted Emissions Test

TEST CONFIGURATION

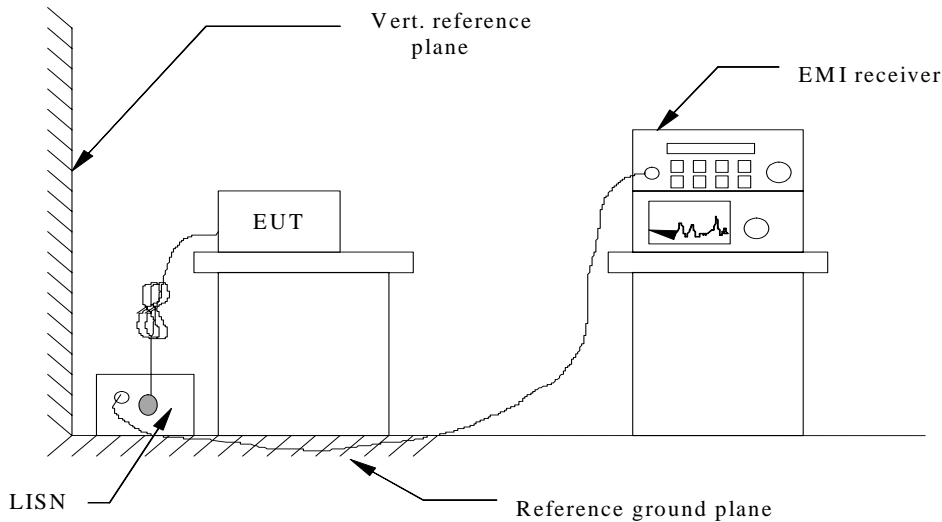

TEST PROCEDURE

1. The equipment was set up as per the test configuration to simulate typical actual usage per the user's manual. The EUT is a tabletop system, a wooden table with a height of 0.8 meters is used and is placed on the ground plane as per ANSI C63.4.
2. Support equipment, if needed, was placed as per ANSI C63.4.
3. All I/O cables were positioned to simulate typical actual usage as per ANSI C63.4.
4. The EUT received DC power from the PC, and the PC received AC120V/60Hz power through a Line Impedance Stabilization Network (LISN) which supplied power source and was grounded to the ground plane.
5. All support equipments received AC power from a second LISN, if any.
6. The EUT test program was started. Emissions were measured on each current carrying line of the EUT using a spectrum Analyzer / Receiver connected to the LISN powering the EUT. The LISN has two monitoring points: Line 1 (Hot Side) and Line 2 (Neutral Side). Two scans were taken: one with Line 1 connected to Analyzer / Receiver and Line 2 connected to a 50 ohm load; the second scan had Line 1 connected to a 50 ohm load and Line 2 connected to the Analyzer / Receiver.
7. Analyzer / Receiver scanned from 150 KHz to 30MHz for emissions in each of the test modes.
8. During the above scans, the emissions were maximized by cable manipulation.

Conducted Power Line Emission Limit

For unintentional device, according to § 15.107(a) Line Conducted Emission Limits is as following :

Frequency (MHz)	Maximum RF Line Voltage (dBµV)			
	CLASS A		CLASS B	
	Q.P.	Ave.	Q.P.	Ave.
0.15 - 0.50	79	66	66-56*	56-46*
0.50 - 5.00	73	60	56	46
5.00 - 30.0	73	60	60	50

* Decreasing linearly with the logarithm of the frequency

For intentional device, according to §15.207(a) Line Conducted Emission Limit is same as above table.

TEST RESULTS

SCAN TABLE: "Voltage (9K-30M)FIN"

Short Description: 150K-30M Voltage

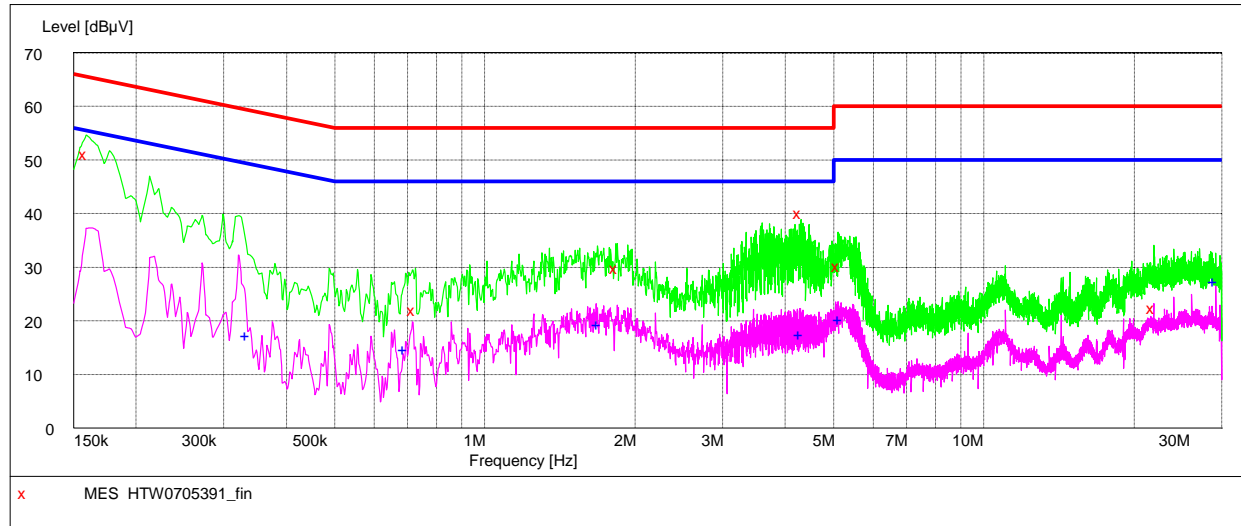

MEASUREMENT RESULT: "HTW0705391_fin"

7/5/2010 10:58PM

Frequency MHz	Level dBµV	Transd dB	Limit dBµV	Margin dB	Detector	Line	PE
0.159000	51.20	10.1	66	14.3	QP	L1	GND
0.721500	22.10	10.1	56	33.9	QP	L1	GND
1.837500	29.90	10.2	56	26.1	QP	L1	GND
4.294500	40.20	10.2	56	15.8	QP	L1	GND
5.113500	30.40	10.2	60	29.6	QP	L1	GND
21.939000	22.60	10.9	60	37.4	QP	L1	GND

MEASUREMENT RESULT: "HTW0705391_fin2"

7/5/2010 10:58PM

Frequency MHz	Level dBµV	Transd dB	Limit dBµV	Margin dB	Detector	Line	PE
0.334500	17.50	10.1	49	31.8	AV	L1	GND
0.694500	14.90	10.1	46	31.1	AV	L1	GND
1.698000	19.60	10.2	46	26.4	AV	L1	GND
4.308000	17.70	10.2	46	28.3	AV	L1	GND
5.167500	20.40	10.2	50	29.6	AV	L1	GND
29.184000	27.50	11.1	50	22.5	AV	L1	GND

SCAN TABLE: "Voltage (9K-30M)FIN"

Short Description: 150K-30M Voltage

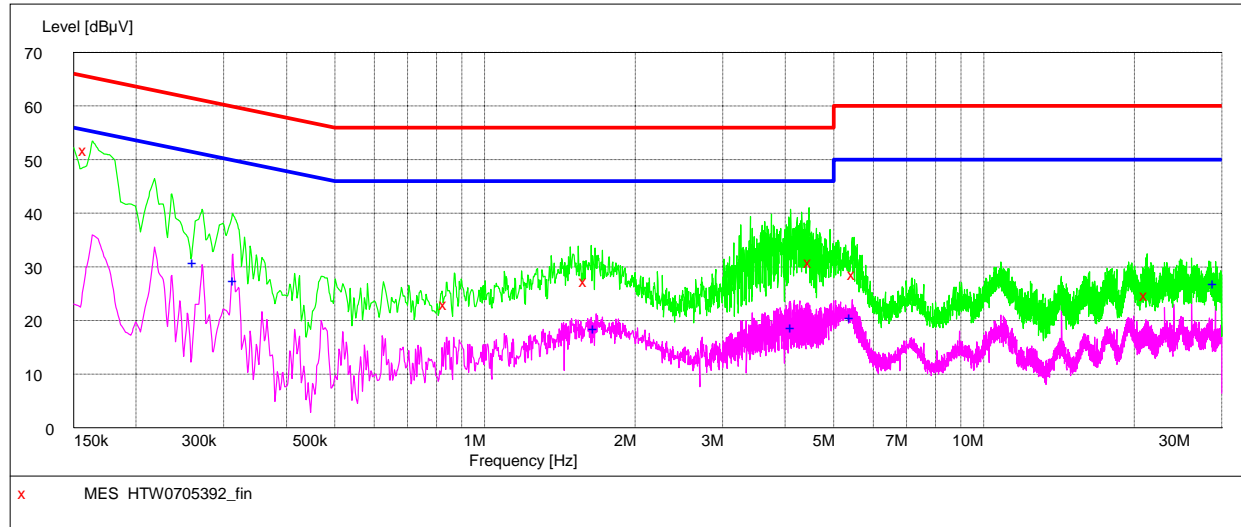

MEASUREMENT RESULT: "HTW0705392_fin"

7/5/2010 11:02PM

Frequency MHz	Level dBµV	Transd dB	Limit dBµV	Margin dB	Detector	Line	PE
0.159000	52.00	10.1	66	13.5	QP	N	GND
0.838500	23.20	10.1	56	32.8	QP	N	GND
1.599000	27.60	10.2	56	28.4	QP	N	GND
4.510500	31.00	10.2	56	25.0	QP	N	GND
5.509500	28.80	10.2	60	31.2	QP	N	GND
21.286500	25.00	10.8	60	35.0	QP	N	GND

MEASUREMENT RESULT: "HTW0705392_fin2"

7/5/2010 11:02PM

Frequency MHz	Level dBµV	Transd dB	Limit dBµV	Margin dB	Detector	Line	PE
0.262500	31.00	10.1	51	20.4	AV	N	GND
0.316500	27.70	10.1	50	22.1	AV	N	GND
1.666500	18.80	10.2	46	27.2	AV	N	GND
4.150500	18.90	10.2	46	27.1	AV	N	GND
5.451000	20.80	10.2	50	29.2	AV	N	GND
29.184000	27.20	11.1	50	22.8	AV	N	GND

4.2. Radiated Emission Test

TEST CONFIGURATION

(A) Radiated Emission Test Set-Up, Frequency below 30MHz

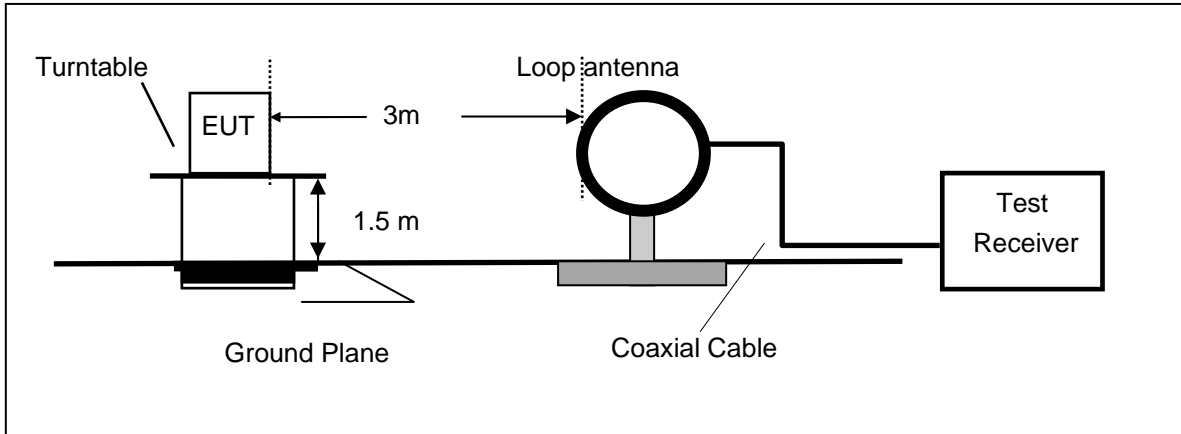

(B) Radiated Emission Test Set-Up, Frequency below 1000MHz

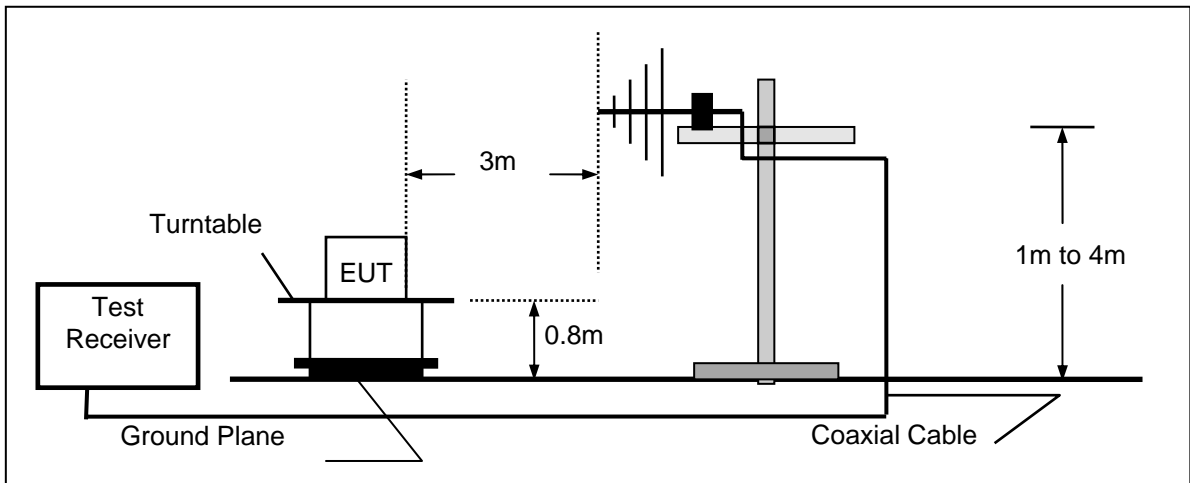

(C) Radiated Emission Test Set-Up, Frequency above 1000MHz

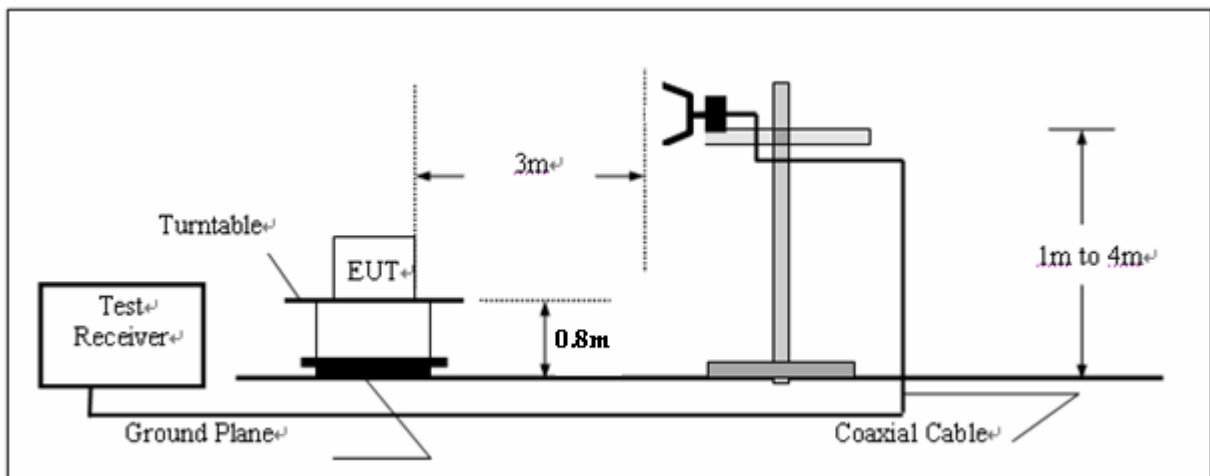

TEST PROCEDURE

1. The EUT is placed on a turntable, which is 0.8m above ground plane.
2. The turntable shall be rotated for 360 degrees to determine the position of maximum emission level.
3. EUT is set 3m away from the receiving antenna, which is varied from 1m to 4m to find out the highest emissions.
4. Maximum procedure was performed on the six highest emissions to ensure EUT compliance.
5. And also, each emission was to be maximized by changing the polarization of receiving antenna both horizontal and vertical.
6. Repeat above procedures until the measurements for all frequencies are complete.

Field Strength Calculation

The field strength is calculated by adding the Antenna Factor and Cable Factor and subtracting the Amplifier Gain and Duty Cycle Correction Factor(if any) from the measured reading. The basic equation with a sample calculation is as follows:

$$FS = RA + AF + CL - AG$$

Where FS = Field Strength	CL = Cable Attenuation Factor (Cable Loss)
RA = Reading Amplitude	AG = Amplifier Gain
AF = Antenna Factor	

RADIATION LIMIT

For unintentional device, according to § 15.109(a), except for Class A digital devices, the field strength of radiated emissions from unintentional radiators at a distance of 3 meters shall not exceed the following values:

Frequency (MHz)	Distance (Meters)	Radiated (dBµV/m)	Radiated (µV/m)
30-88	3	40.0	100
88-216	3	43.5	150
216-960	3	46.0	200
Above 960	3	54.0	500

For intentional device, according to § 15.209(a), the general requirement of field strength of radiated emissions from intentional radiators at a distance of 3 meters shall not exceed the above table.

Fundamental and Harmonics Emission Limits

Frequency MHz	Field Strength of Fundamental		Field Strength of Harmonics	
	(mV/m @3m)	(dBuV/m @3m)	(uV/m @3m)	(dBuV/m @3m)
2400-2483.5	50	94 (Average) 114 (Peak)	500	54 (Average) 74 (Peak)

TEST RESULTS

Operation Mode: TX on Top Channel Temperature: 20 °C Humidity: 70 % RH Polarity: Ver. / Hor.

Freq. (MHz)	Ant.Pol. H/V	DetectorMode (PK/AV)	Reading (dBuV)	Ant./CL/ Amp. CF(dB)	Actual FS (dBuV/m)	Limit3m (dBuV/m)	Safe Margin (dB)	Note
2479	V	Peak	74.06	-3.30	70.76	94.00	-23.24	F
2479	H	Peak	73.67	-3.30	70.37	94.00	-23.63	F
4958	V	Peak	42.20	3.90	46.10	54.00	-7.90	H
4958	H	Peak	41.00	3.90	44.90	54.00	-9.10	H
7437	V		---					H
7437	H		---					H
1374	V	Peak	49.20	-7.90	41.30	54.00	-12.70	Other
1374	H	Peak	48.10	-7.90	40.20	54.00	-13.80	Other
801.72	H	Peak	52.30	-21.10	31.20	46.00	-14.80	Other
432.38	V	Peak	53.40	-20.90	32.50	46.00	-13.50	Other
Others			---					

Remark:

- (1) Measuring frequencies from 30 MHz to the 25 GHz.
- (2) "F" denotes fundamental frequency; "H" denotes spurious frequency. "E" denotes band edge frequency.
- (3) * denotes emission frequency which appearing within the Restricted Bands specified in provision of 15.205, then the general radiated emission limits in 15.209 apply.
- (4) Data of measurement within this frequency range shown "---" in the table above means the reading of emissions are attenuated more than 20dB below the permissible limits or the field strength is too small to be measured.
- (5) The IF bandwidth of EMI Test Receiver was 120KHz for measuring from 30 MHz to 1 GHz and 1 MHz for measuring above 1 GHz
- (6) The average measurement was not performed when the peak measured data under the limit of average detection.

Operation Mode: TX on Mid Channel Temperature: 20 °C Humidity: 70 % RH Polarity: Ver. / Hor.

Freq. (MHz)	Ant.Pol. H/V	DetectorMode (PK/AV)	Reading (dBuV)	Ant./CL/ Amp. CF(dB)	Actual FS (dBuV/m)	Limit3m (dBuV/m)	Safe Margin (dB)	Note
2441	V	Peak	69.52	-3.40	66.12	94.00	-27.88	F
2441	H	Peak	68.92	-3.40	65.52	94.00	-28.48	F
4882	V	Peak	43.00	3.70	46.70	54.00	-7.30	H
4882	H	Peak	41.10	3.70	44.80	54.00	-9.20	H
7323	V		---					H
7323	H		---					H
1170	V	Peak	43.80	-8.60	35.20	54.00	-18.80	Other
1170	H	Peak	46.10	-8.60	37.50	54.00	-16.50	Other
931.96	H	Peak	28.70	-4.50	24.20	46.00	-21.80	Other
801.72	V	Peak	47.50	-12.50	35.00	46.00	-11.00	Other
Others			---					

Remark:

- (1) Measuring frequencies from 30 MHz to the 25 GHz.
- (2) "F" denotes fundamental frequency; "H" denotes spurious frequency. "E" denotes band edge frequency.
- (3) * denotes emission frequency which appearing within the Restricted Bands specified in provision of 15.205, then the general radiated emission limits in 15.209 apply.
- (4) Data of measurement within this frequency range shown "---" in the table above means the reading of emissions are attenuated more than 20dB below the permissible limits or the field strength is too small to be measured.
- (5) The IF bandwidth of EMI Test Receiver was 120KHz for measuring from 30 MHz to 1 GHz and 1 MHz for measuring above 1 GHz
- (6) The average measurement was not performed when the peak measured data under the limit of average detection.

Operation Mode: TX on Bot Channel Temperature: 20 °C Humidity: 70 % RH Polarity: Ver. / Hor.

Freq. (MHz)	Ant.Pol. H/V	DetectorMode (PK/AV)	Reading (dBuV)	Ant./CL/ Amp. CF(dB)	Actual FS (dBuV/m)	Limit3m (dBuV/m)	Safe Margin (dB)	Note
2403	V	Peak	70.80	-3.50	67.30	94.00	-26.70	F
2403	H	Peak	76.03	-3.50	72.53	49.00	23.53	F
4806	V	Peak	43.10	3.80	46.90	54.00	-7.10	H
4806	H	Peak	43.00	3.80	47.60	54.00	-6.40	H
7209	V		---					H
7209	H		---					H
1613	V	Peak	42.20	-7.20	35.00	54.00	-19.00	Other
1613	H	Peak	44.70	-7.20	37.50	54.00	-16.50	Other
30.00	H	Peak	24.70	-7.50	17.20	40.00	-22.80	Other
949.46	V	Peak	51.50	-20.00	31.50	46.00	-14.50	Other
Others			---					

Remark:

- (1) Measuring frequencies from 30 MHz to the 25 GHz. S
- (2) "F" denotes fundamental frequency; "H" denotes spurious frequency. "E" denotes band edge frequency.
- (3) * denotes emission frequency which appearing within the Restricted Bands specified in provision of 15.205, then the general radiated emission limits in 15.209 apply.
- (4) Data of measurement within this frequency range shown "---" in the table above means the reading of emissions are attenuated more than 20dB below the permissible limits or the field strength is too small to be measured.
- (5) The IF bandwidth of EMI Test Receiver was 120KHz for measuring from 30 MHz to 1 GHz and 1 MHz for measuring above 1 GHz
- (6) The average measurement was not performed when the peak measured data under the limit of average detection.

4.3. Band Edge Measurement

TEST CONFIGURATION

Same as Section 4.2

TEST PROCEDURE

The band edge compliance of RF radiated emission should be measured by following the guidance in ANSI C63.4 with respect to maximizing the emission by rotating the EUT, measuring the emission while the EUT is situated in three orthogonal planes (if appropriate), adjusting the measurement antenna height and polarization etc. Set RBW to 1MHz and VBW to 3MHz to measure the peak field strength and set RBW to 1MHz and VBW to 10Hz to measure the average radiated field strength.

The conducted RF band edge was measured by using a spectrum analyzer. Set span wide enough to capture the highest in-band emission and the emission at the band edge. Set RBW to 100 KHz and VBW to 300 KHz, to measure the conducted peak band edge.

LIMIT

FCC PART 15.249(d) Emissions radiated outside of the specified frequency bands, except for harmonics, shall be attenuated by at least 50 dB below the level of the fundamental or to the general radiated emission limits in §15.209, whichever is the lesser attenuation.

TEST RESULTS

Operation Mode: TX on Bot Channel Temperature: 20 °C Humidity: 70 % RH Polarity: Hor.

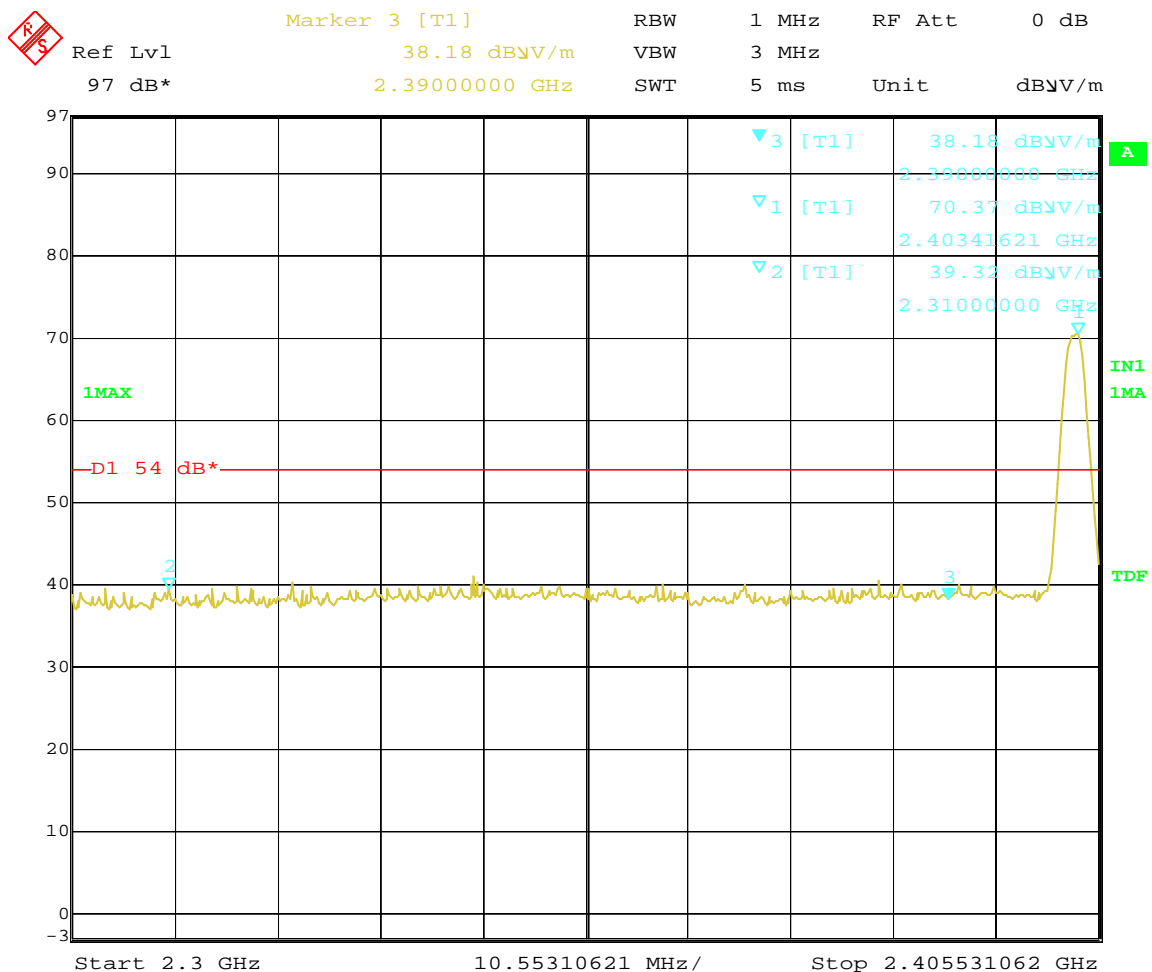

Date: 11.JUL.2010 20:49:19

Operation Mode: TX on Bot Channel Temperature: 20 °C Humidity: 70 % RH Polarity: Ver.

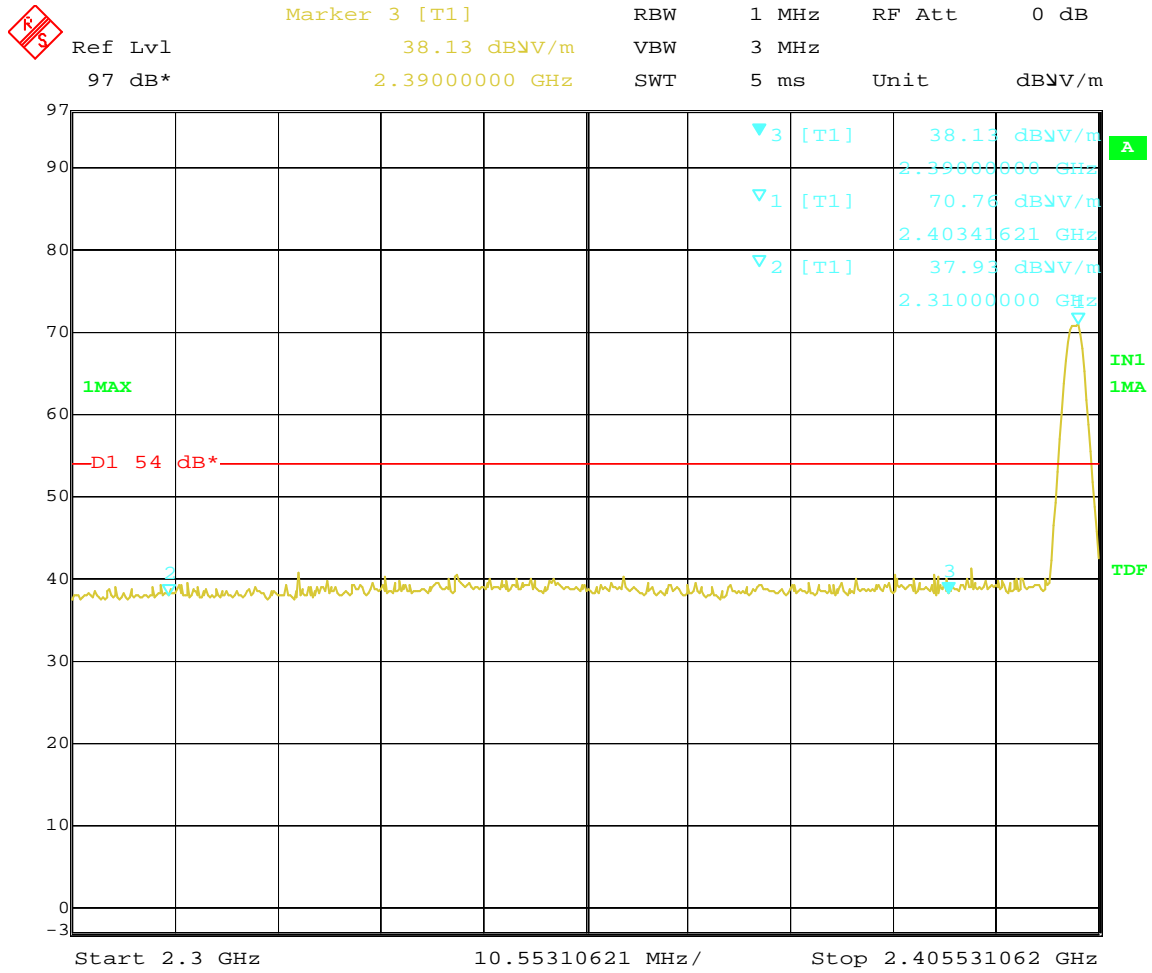

Date: 11.JUL.2010 20:50:58

Note:

1. The field strength of any emissions which appear outside of this band shall not exceed the general radiated emission limits in Section 15.209.
2. The average measurement was not performed when the peak measured data under the limit of average detection.

Operation Mode: TX on Top Channel

Temperature: 20 °C Humidity: 70 % RH

Polarity: Hor.



	Marker 1 [T1]	RBW	1 MHz	RF Att	0 dB
Ref Lvl	67.53 dBµV/m	VBW	3 MHz		
97 dB*	2.47914110 GHz	SWT	5 ms	Unit	dBµV/m

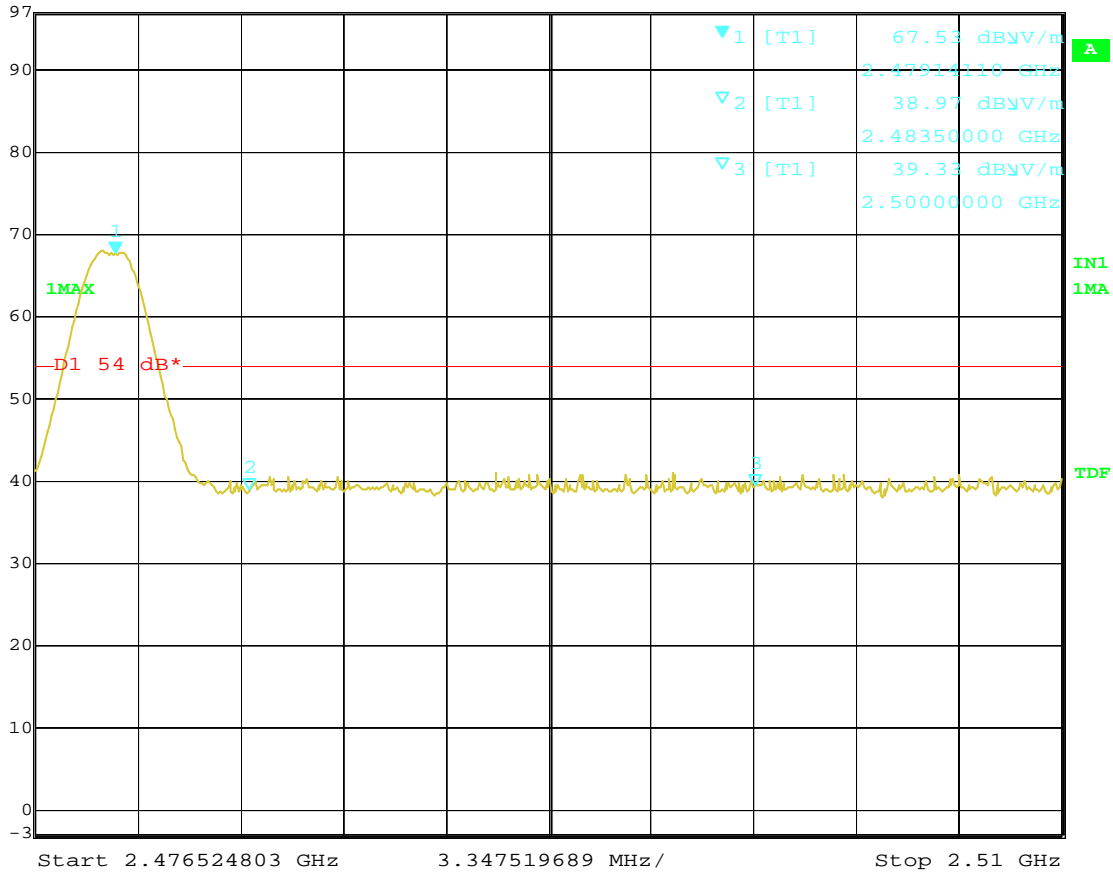

Date: 11.JUL.2010 20:58:22

Operation Mode: TX on Top Channel Temperature: 20 °C Humidity: 70 % RH Polarity: Ver.

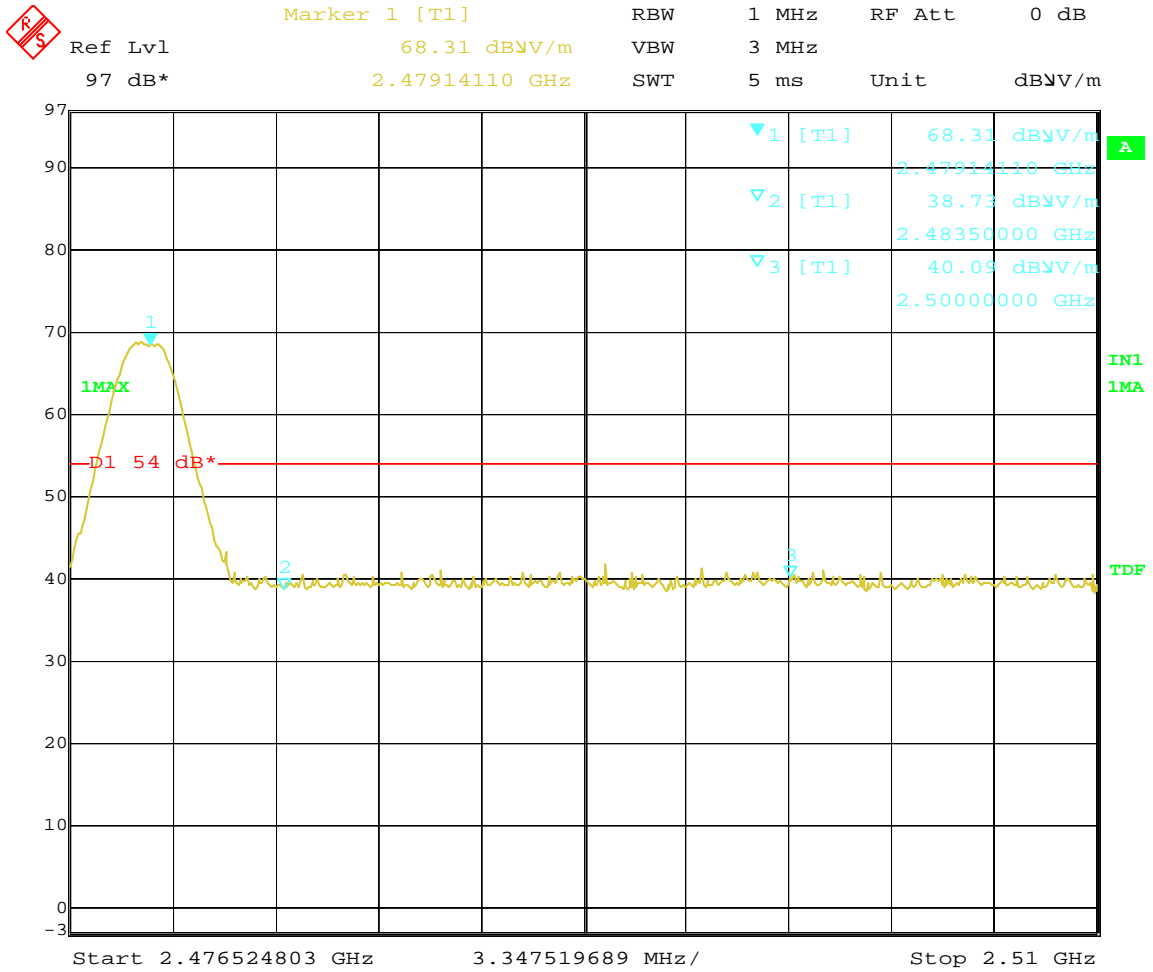

Date: 11.JUL.2010 21:00:15

Note:

1. The field strength of any emissions which appear outside of this band shall not exceed the general radiated emission limits in Section 15.209.
2. The average measurement was not performed when the peak measured data under the limit of average detection.

4.4. 20dB Bandwidth Measurement

TEST CONFIGURATION

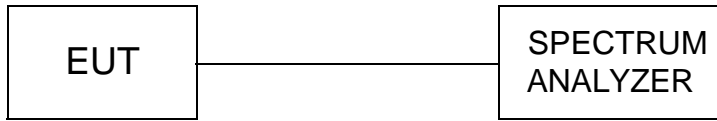

TEST PROCEDURE

The transmitter output is connected to the spectrum analyzer. The spectrum analyzer center frequency is set to the transmitter frequency. The RBW is set to 100 KHz and VBW is set 300 KHz.

LIMIT

Intentional radiators operating under the alternative provisions to the general emission limits, as contained in §§ 15.217 through 15.257 and in Subpart E of this part, must be designed to ensure that the 20 dB bandwidth of the emission, or whatever bandwidth may otherwise be specified in the specific rule section under which the equipment operates, is contained within the frequency band designated in the rule section under which the equipment is operated.

The 20dB bandwidth shall be no wider than 0.25% of the centre frequency for devices operating between 70-900 MHz. For devices operating above 900 MHz, the emission shall be no wider than 0.5% of the centre frequency.

TEST RESULTS

20dB Bandwidth Measurement Result			
Operating Frequency	Test Data(MHz)	Limits(MHz)	Result
Bottom Channel	1.2725	12.015	PASS
Middle Channel	1.2525	12.205	PASS
Top Channel	1.2926	12.395	PASS

Bottom Channel:

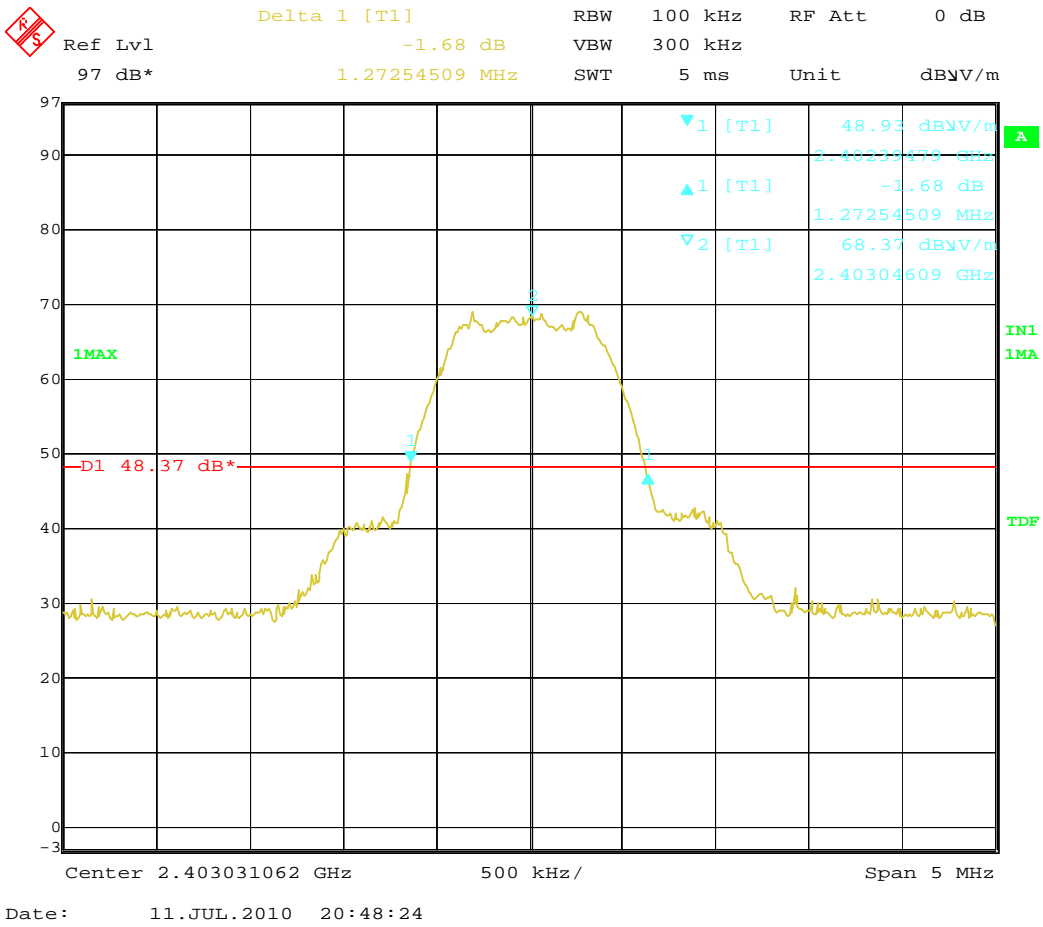

Mid Channel:

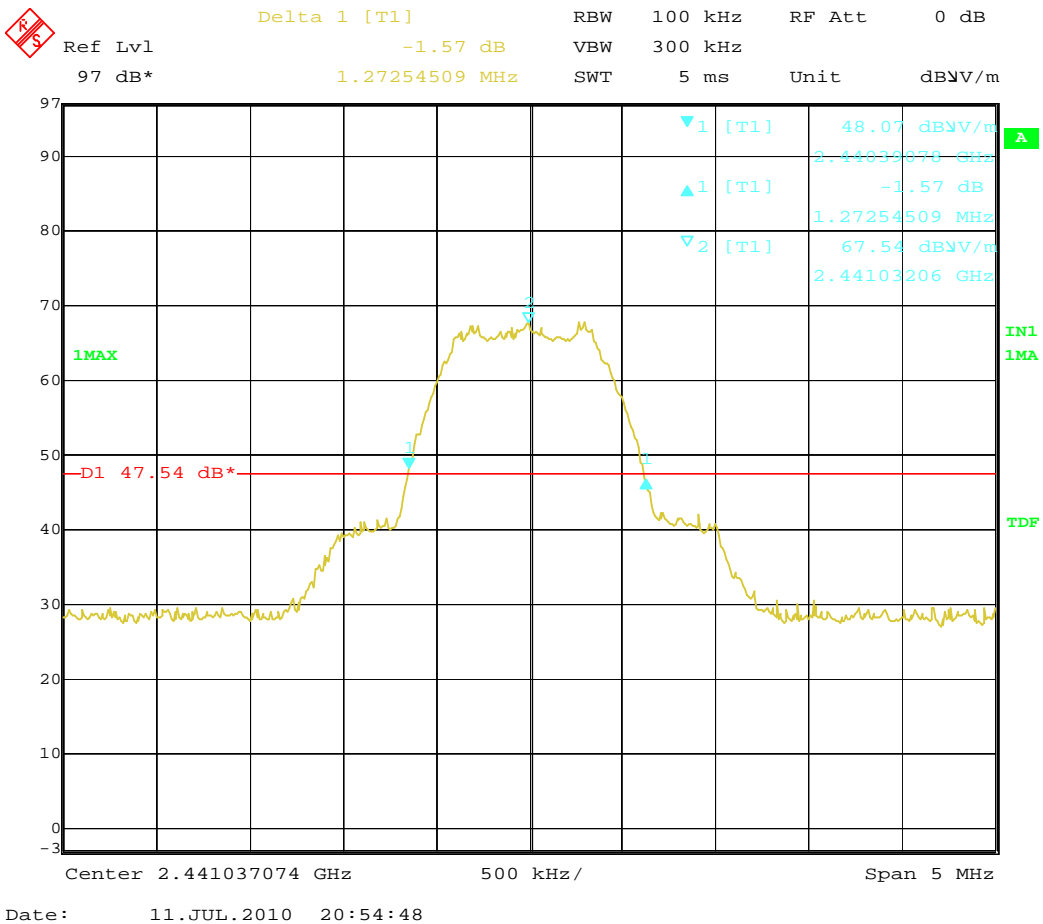

Top Channel:



Delta 1 [T1] RBW 100 kHz RF Att 0 dB
Ref Lvl 1.32 dB VBW 300 kHz
97 dB* 1.29258517 MHz SWT 5 ms Unit dB μ V/m

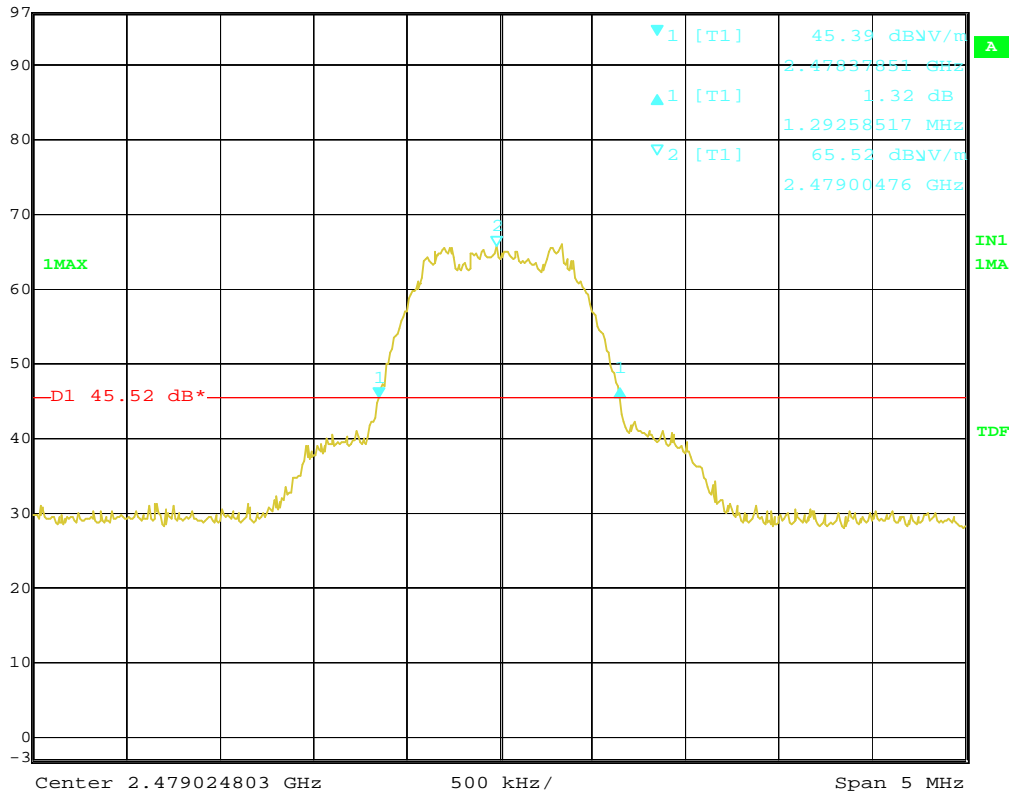

Date: 11.JUL.2010 20:56:45

5. Test Setup Photos of the EUT



EUT



EUT

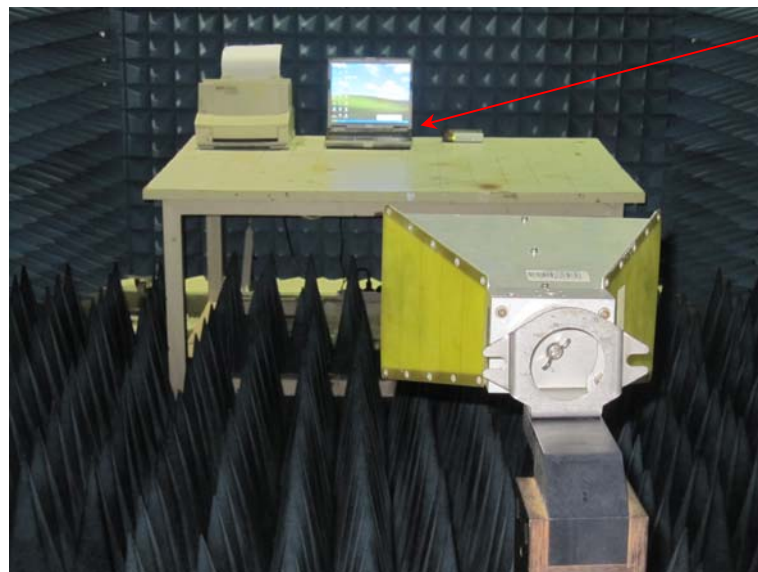

EUT

6. External and Internal Photos of the EUT

External Photos

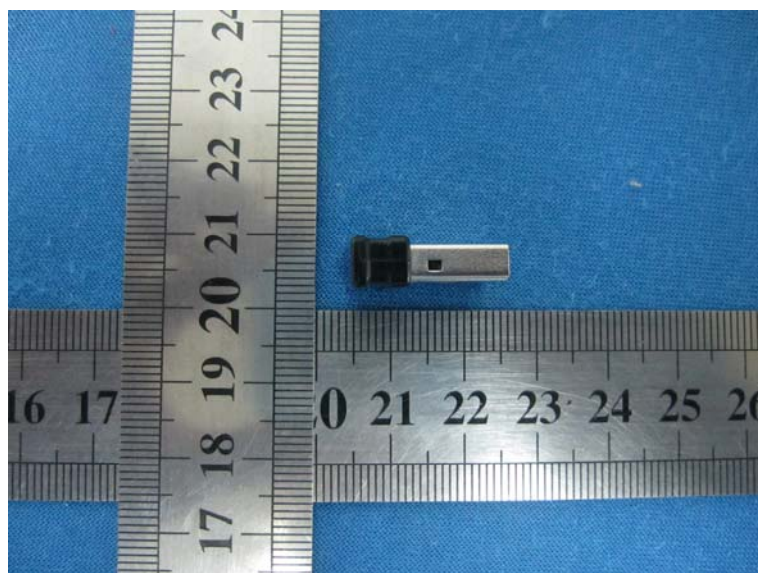
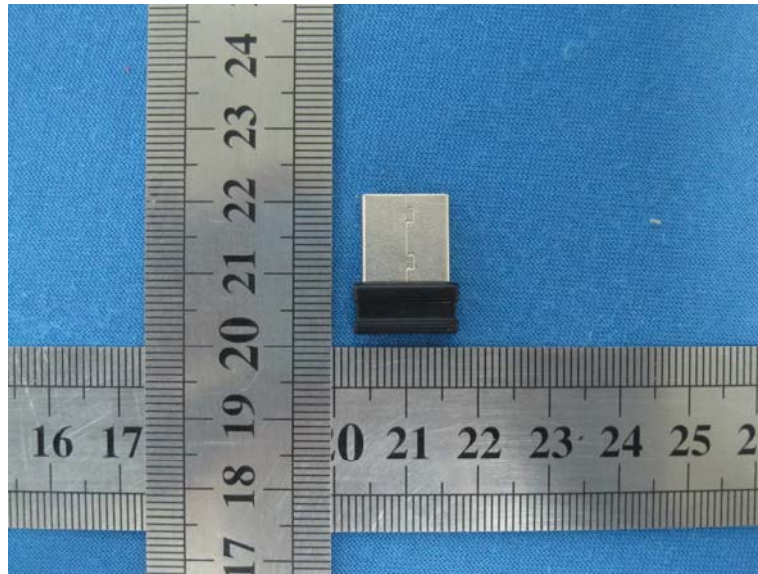

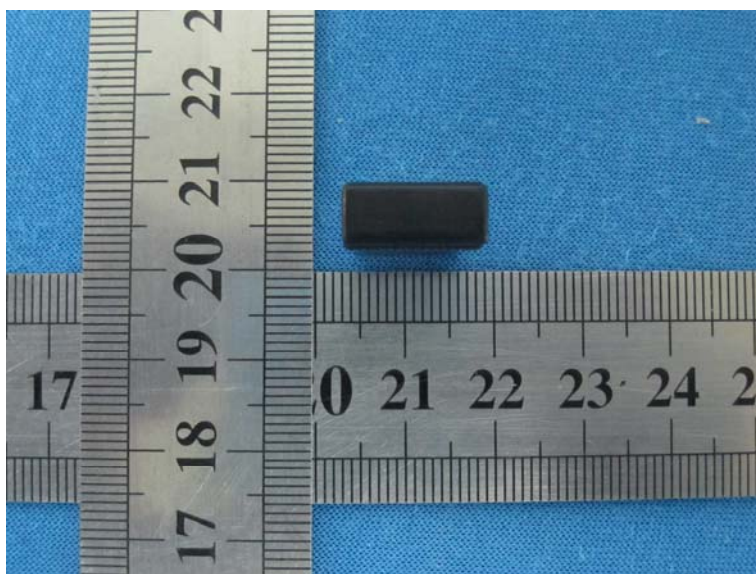
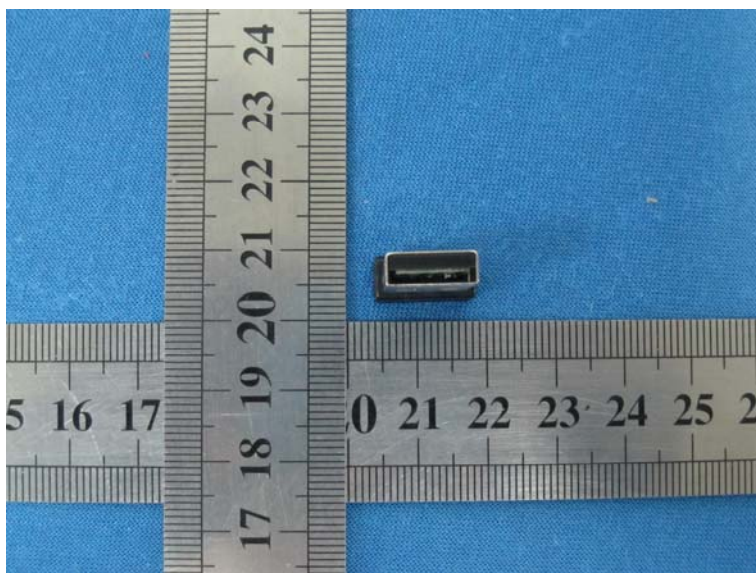

Internal Photos

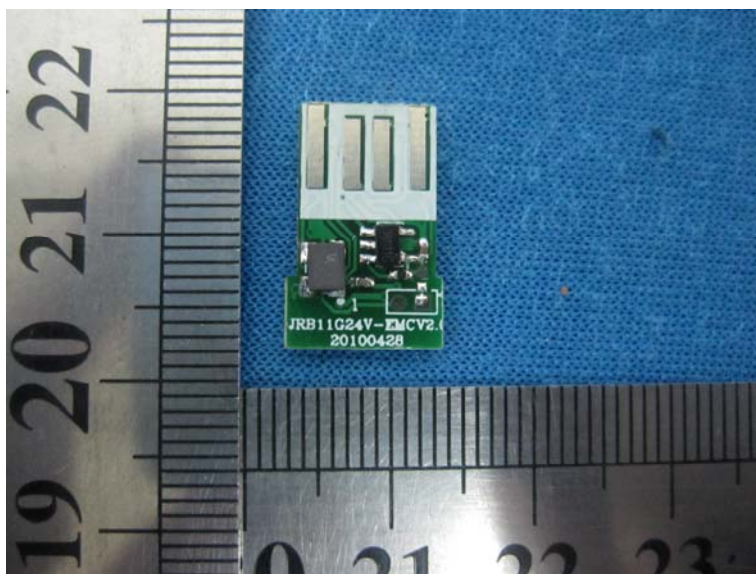
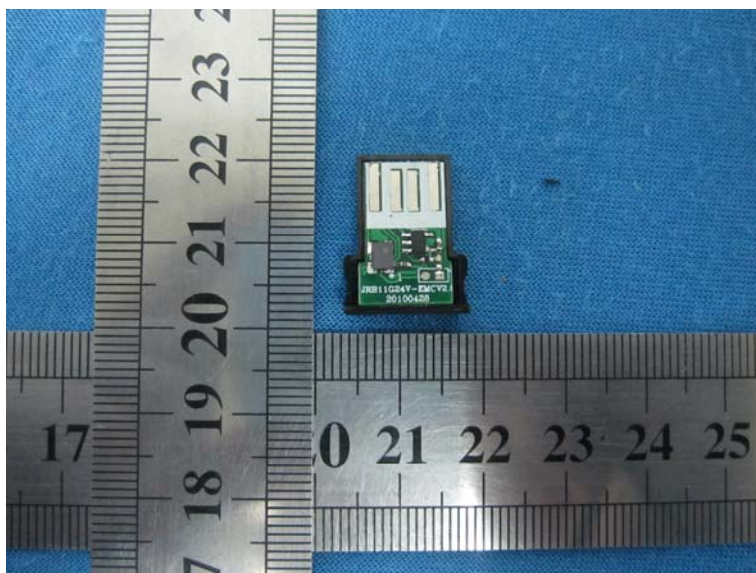
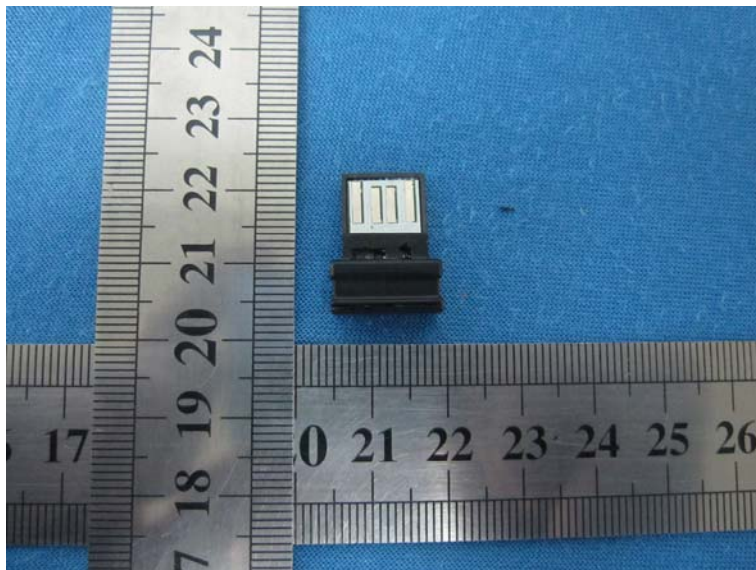

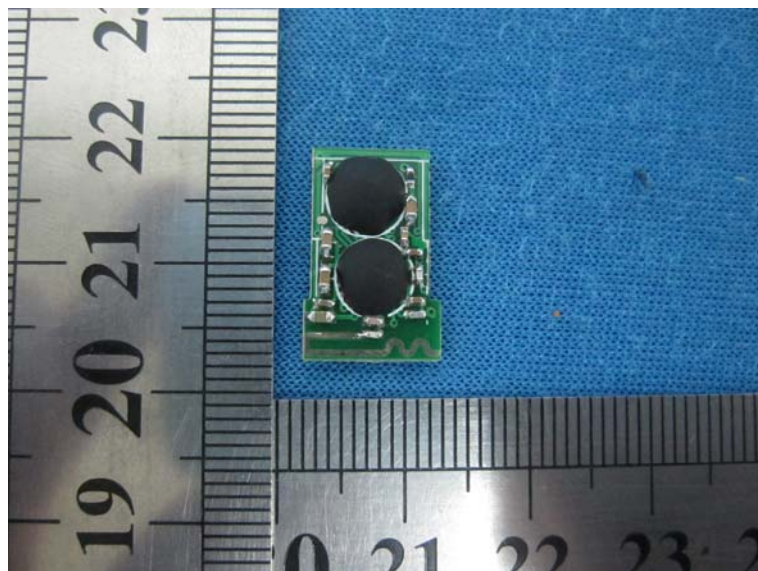

.....End of Report.....