



No. 23T04Z80629-021



SAR TEST REPORT

No. 23T04Z80629-021

For

BLU Products,Inc.

Smart phone

Model name: B160V

With

Hardware Version: V1.0

Software Version: BLU_B160V_V14.0.01.01.01.03_FSec

FCC ID: YHLBLUB160V

Issued Date: 2024-01-09

Note:

The test results in this test report relate only to the devices specified in this report. This report shall not be reproduced except in full without the written approval of CTTL.

Test Laboratory:

CTTL, Telecommunication Technology Labs, CAICT

No. 52, Huayuan North Road, Haidian District, Beijing, P. R. China 100191.

Tel:+86(0)10-62304633-2512, Fax:+86(0)10-62304633-2504

Email: ctl_terminals@caict.ac.cn, website: www.caict.ac.cn



No. 23T04Z80629-021

REPORT HISTORY

Report Number	Revision	Issue Date	Description
23T04Z80629-021	Rev.0	2024-01-09	Initial creation of test report

TABLE OF CONTENT

1 TEST LABORATORY	5
1.1. INTRODUCTION & ACCREDITATION.....	5
1.2. TESTING LOCATION	5
1.3. TESTING ENVIRONMENT	5
1.4. PROJECT DATA.....	5
1.5. SIGNATURE	5
2 STATEMENT OF COMPLIANCE	6
3 CLIENT INFORMATION	8
3.1 APPLICANT INFORMATION	8
3.2 MANUFACTURER INFORMATION	8
4 EQUIPMENT UNDER TEST (EUT) AND ANCILLARY EQUIPMENT (AE)	9
4.1 ABOUT EUT	9
4.2 INTERNAL IDENTIFICATION OF EUT USED DURING THE TEST	9
4.3 INTERNAL IDENTIFICATION OF AE USED DURING THE TEST	9
5 TEST METHODOLOGY	10
5.1 APPLICABLE LIMIT REGULATIONS	10
5.2 APPLICABLE MEASUREMENT STANDARDS.....	10
6 SPECIFIC ABSORPTION RATE (SAR)	11
6.1 INTRODUCTION.....	11
6.2 SAR DEFINITION.....	11
7 TISSUE SIMULATING LIQUIDS	12
7.1 TARGETS FOR TISSUE SIMULATING LIQUID	12
7.2 DIELECTRIC PERFORMANCE	12
8 SYSTEM VERIFICATION	14
8.1 SYSTEM SETUP.....	14
8.2 SYSTEM VERIFICATION.....	15
9 MEASUREMENT PROCEDURES	16
9.1 TESTS TO BE PERFORMED	16
9.2 GENERAL MEASUREMENT PROCEDURE.....	18
9.3 WCDMA MEASUREMENT PROCEDURES FOR SAR	19
9.4 SAR MEASUREMENT FOR LTE.....	20
9.5 BLUETOOTH & WI-FI MEASUREMENT PROCEDURES FOR SAR	21
9.6 POWER DRIFT.....	21
10 AREA SCAN BASED 1-G SAR	22



10.1 REQUIREMENT OF KDB.....	22
10.2 FAST SAR ALGORITHMS	22
11 CONDUCTED OUTPUT POWER.....	23
11.1 GSM MEASUREMENT RESULT	23
11.2 WCDMA MEASUREMENT RESULT.....	25
11.3 LTE MEASUREMENT RESULT	29
11.4 WI-FI AND BT MEASUREMENT RESULT	62
12 ANTENNA LOCATION	68
12.1 TRANSMIT ANTENNA SEPARATION DISTANCES	68
12.2 SAR MEASUREMENT POSITIONS	68
12.3 EVALUATION OF SIMULTANEOUS	69
13 SAR TEST RESULT	70
13.1 SAR RESULTS FOR CELLULAR	73
13.2 SAR RESULTS FOR WLAN	76
13.3 SAR RESULTS FOR BT	78
13.4 SAR RESULTS FOR PHABLET	78
15 SAR MEASUREMENT VARIABILITY.....	80
16 MEASUREMENT UNCERTAINTY	81
16.1 MEASUREMENT UNCERTAINTY FOR NORMAL SAR TESTS (300MHZ~3GHZ)	81
16.2 MEASUREMENT UNCERTAINTY FOR NORMAL SAR TESTS (3~6GHZ)	82
16.3 MEASUREMENT UNCERTAINTY FOR FAST SAR TESTS (300MHZ~3GHZ)	83
16.4 MEASUREMENT UNCERTAINTY FOR FAST SAR TESTS (3~6GHZ).....	84
17 MAIN TEST INSTRUMENTS.....	86
ANNEX A GRAPH RESULTS.....	87
ANNEX B SYSTEM VERIFICATION RESULTS	133
ANNEX C SAR MEASUREMENT SETUP	141
ANNEX D POSITION OF THE WIRELESS DEVICE IN RELATION TO THE PHANTOM	147
ANNEX E EQUIVALENT MEDIA RECIPES.....	150
ANNEX F SYSTEM VALIDATION	151
ANNEX G PROBE CALIBRATION CERTIFICATE.....	152
ANNEX H DIPOLE CALIBRATION CERTIFICATE	161
ANNEX I ACCREDITATION CERTIFICATE.....	203

1 Test Laboratory

1.1. Introduction & Accreditation

Telecommunication Technology Labs, CAICT is an ISO/IEC 17025:2017 accredited test laboratory under American Association for Laboratory Accreditation (A2LA) with lab code 7049.01, and is also an FCC accredited test laboratory (CN1349), and ISED accredited test laboratory (CAB identifier:CN0066). The detail accreditation scope can be found on A2LA website.

1.2. Testing Location

Location 1: CTTL(huayuan North Road)

Address: No. 52, Huayuan North Road, Haidian District, Beijing,
P. R. China 100191

1.3. Testing Environment

Normal Temperature: 15-35°C
Extreme Temperature: -10/+55°C
Relative Humidity: 20-75%

1.4. Project data

Testing Start Date: 2023-12-21
Testing End Date: 2024-01-04

1.5. Signature

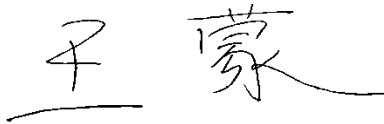

Wang Meng
(Prepared this test report)

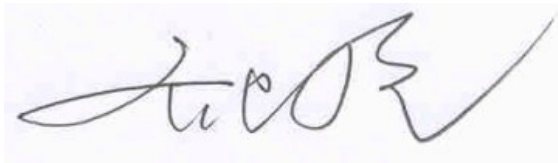

Qi Dianyuan
(Reviewed this test report)

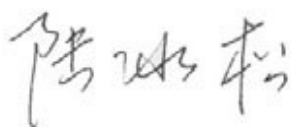

Lu Bingsong
Deputy Director of the laboratory
(Approved this test report)

2 Statement of Compliance

The maximum results of SAR found during testing for BLU Products, Inc. Smart phone B160V is as follows:

Table 2.1: Highest Reported SAR -Standalone(1g)

Mode		Highest Reported SAR (1g)		
		1g SAR Head	1g SAR Body-worn 15mm	1g SAR Hotspot 10mm
GSM	GSM 850	0.35	0.42 ^[1]	0.42
	PCS 1900	0.17	0.89 ^[1]	0.89
WCDMA	UMTS FDD 2	0.16	0.48	1.15
	UMTS FDD 4	0.24	0.59	1.25
	UMTS FDD 5	0.29	0.44 ^[1]	0.44
LTE	LTE Band 2	0.23	0.48	0.97
	LTE Band 4	0.29	0.56	1.18
	LTE Band 5	0.41	0.62 ^[1]	0.62
	LTE Band 12	0.24	0.45 ^[1]	0.45
	LTE Band 13	0.33	0.46 ^[1]	0.46
	LTE Band 66	0.25	0.59	1.08
WLAN 2.4 GHz		1.09	0.35 ^[1]	0.35
WLAN 5 GHz		1.29	0.49	1.08
BT		0.03	0.01 ^[1]	0.01

Note1: SAR result at 10mm is used for conservative evaluation.

The SAR values found for the Mobile Phone are below the maximum recommended levels of 1.6 W/kg as averaged over any 1g tissue according to the ANSI C95.1-1992.

For body operation, this device has been tested and meets FCC RF exposure guidelines when used with any accessory that contains no metal and which provides a minimum separation distance of 10 mm for hotspot and 15mm for body worn between this device and the body of the user. Use of other accessories may not ensure compliance with FCC RF exposure guidelines.

The EUT battery must be fully charged and checked periodically during the test to ascertain uniform power output.

The measurement together with the test system set-up is described in annex C. A detailed description of the equipment under test can be found in chapter 4 of this test report. The highest reported SAR value is obtained at the case of **(Table 2.1)**, and the values are:**1.29 W/kg(1g)**.

Table 2.2: The sum of SAR values for Main antenna + WiFi-5G

	Position	Main antenna	WiFi 5G	BT	Sum
Highest SAR value for Head	Left head, Tilt (LTE Band 5)	0.27	1.29	0.03	1.59

According to the above tables, The sum of reported SAR values is 1.6W/kg. So the simultaneous transmission SAR with volume scans is not required.

According to the above tables, the highest sum of reported SAR values is **1.59W/kg (1g)**. The detail for simultaneous transmission consideration is described in chapter 14.



3 Client Information

3.1 Applicant Information

Company Name:	BLU Products,Inc.
Address /Post:	8600 NW 36th Street, Suite #300 Miami, FL 33166
Contact Person:	Zeng wei
E-mail:	zwei@ctasiasz.com
Telephone:	305.715.7171
Fax:	305.436.8819

3.2 Manufacturer Information

Company Name:	BLU Products,Inc.
Address /Post:	8600 NW 36th Street, Suite #300 Miami, FL 33166
Contact Person:	Zeng wei
E-mail:	zwei@ctasiasz.com
Telephone:	305.715.7171
Fax:	305.436.8819

4 Equipment Under Test (EUT) and Ancillary Equipment (AE)

4.1 About EUT

Description:	Smart phone	
Model name:	B160V	
Tested Band:	GSM850/1900, WCDMA B2/4/5 LTE Band FDD:2/4/5/12/13/66 BT, Wi-Fi(2.4G), Wi-Fi(5G)	
Tested Tx Frequency:	824 – 849 MHz (GSM 850)	
	1850 – 1910 MHz (GSM 1900)	
	824–849 MHz (WCDMA 850 Band V)	
	1710 – 1755 MHz (WCDMA 1700 Band IV)	
	1850–1910 MHz (WCDMA1900 Band II)	
	1850 – 1910 MHz(LTE Band 2)	
	1710 – 1755 MHz (LTE Band 4)	
	824 – 849 MHz (LTE Band 5)	
	699 – 716 MHz (LTE Band 12)	
	777 –787 MHz (LTE Band 13)	
	1710 – 1780 MHz (LTE Band 66)	
	2402 – 2480 MHz (Bluetooth)	
	2412 – 2462 MHz (Wi-Fi 2.4G)	
	5180 – 5240 MHz	
5260 – 5320 MHz		
5500 – 5700 MHz		
5745 – 5825 MHz		
		(Wi-Fi 5G)
GPRS/EGPRS Multislot Class:	12	
GPRS capability Class:	B	
Antenna type:	Integrated antenna	
Hotspot mode:	Support	

4.2 Internal Identification of EUT used during the test

EUT ID*	IMEI	HW	SW Version
EUT1	356197680004193	V1.0	BLU_B160V_V14.0.01.01.01.03_FSec
EUT2	356197680004482	V1.0	BLU_B160V_V14.0.01.01.01.03_FSec
EUT3	356197680003807	V1.0	BLU_B160V_V14.0.01.01.01.03_FSec

*EUT ID: is used to identify the test sample in the lab internally.

Note: It is performed to test SAR with the EUT1&2 and conducted power with the EUT3.

4.3 Internal Identification of AE used during the test

AE ID*	Description	Model	SN	Manufacturer
AE1	Battery	C846345400P	/	Huizhou Highpower Technology Co., Ltd.

*AE ID: is used to identify the test sample in the lab internally.

5 TEST METHODOLOGY

5.1 Applicable Limit Regulations

ANSI C95.1–1992: IEEE Standard for Safety Levels with Respect to Human Exposure to Radio Frequency Electromagnetic Fields, 3 kHz to 300 GHz.

It specifies the maximum exposure limit of **1.6 W/kg** as averaged over any 1 gram of tissue for portable devices being used within 20 cm of the user in the uncontrolled environment.

5.2 Applicable Measurement Standards

IEEE 1528–2013: Recommended Practice for Determining the Peak Spatial-Average Specific Absorption Rate (SAR) in the Human Head from Wireless Communications Devices: Measurement Techniques.

KDB447498 D01: General RF Exposure Guidance v06: Mobile and Portable Devices RF Exposure Procedures and Equipment Authorization Policies.

KDB648474 D04 Handset SAR v01r03: SAR Evaluation Considerations for Wireless Handsets.

KDB941225 D01 SAR test for 3G devices v03r01: SAR Measurement Procedures for 3G Devices

KDB941225 D05 SAR for LTE Devices v02r05: SAR Evaluation Considerations for LTE Devices

KDB941225 D06 Hotspot Mode SAR v02r01: SAR Evaluation Procedures for Portable Devices with Wireless Router Capabilities

KDB248227 D01 802.11 Wi-Fi SAR v02r02: SAR GUIDANCE FOR IEEE 802.11 (Wi-Fi) TRANSMITTERS

KDB865664 D01 SAR measurement 100 MHz to 6 GHz v01r04: SAR Measurement Requirements for 100 MHz to 6 GHz.

KDB865664 D02 RF Exposure Reporting v01r02: RF Exposure Compliance Reporting and Documentation Considerations

6 Specific Absorption Rate (SAR)

6.1 Introduction

SAR is related to the rate at which energy is absorbed per unit mass in an object exposed to a radio field. The SAR distribution in a biological body is complicated and is usually carried out by experimental techniques or numerical modeling. The standard recommends limits for two tiers of groups, occupational/controlled and general population/uncontrolled, based on a person's awareness and ability to exercise control over his or her exposure. In general, occupational/controlled exposure limits are higher than the limits for general population/uncontrolled.

6.2 SAR Definition

The SAR definition is the time derivative (rate) of the incremental energy (dW) absorbed by (dissipated in) an incremental mass (dm) contained in a volume element (dv) of a given density (ρ). The equation description is as below:

$$SAR = \frac{d}{dt} \left(\frac{dW}{dm} \right) = \frac{d}{dt} \left(\frac{dW}{\rho dv} \right)$$

SAR is expressed in units of Watts per kilogram (W/kg)

SAR measurement can be either related to the temperature elevation in tissue by

$$SAR = c \left(\frac{\delta T}{\delta t} \right)$$

Where: C is the specific heat capacity, δT is the temperature rise and δt is the exposure duration, or related to the electrical field in the tissue by

$$SAR = \frac{\sigma |E|^2}{\rho}$$

Where: σ is the conductivity of the tissue, ρ is the mass density of tissue and E is the RMS electrical field strength.

However for evaluating SAR of low power transmitter, electrical field measurement is typically applied.

7 Tissue Simulating Liquids

The temperature of the tissue-equivalent medium used during measurement must also be within 18 °C to 25 °C and within ± 2 °C of the temperature when the tissue parameters are characterized. The dielectric parameters must be measured before the tissue-equivalent medium is used in a series of SAR measurements. The parameters should be re-measured after each 3 – 4 days of use; or earlier if the dielectric parameters can become out of tolerance; for example, when the parameters are marginal at the beginning of the measurement series.

The dielectric constant (ϵ_r) and conductivity (σ) of typical tissue-equivalent media recipes are expected to be within $\pm 5\%$ of the required target values; but for SAR measurement systems that have implemented the SAR error compensation algorithms documented in IEEE Std 1528-2013, to automatically compensate the measured SAR results for deviations between the measured and required tissue dielectric parameters, the tolerance for ϵ_r and σ may be relaxed to $\pm 10\%$. This is limited to frequencies ≤ 3 GHz.

7.1 Targets for tissue simulating liquid

Table 7.1: Targets for tissue simulating liquid

Frequency(MHz)	Liquid Type	Conductivity(σ)	$\pm 5\%$ Range	Permittivity(ϵ)	$\pm 5\%$ Range
750	Head	0.89	0.85~0.93	41.94	39.8~44.0
835	Head	0.90	0.86~0.95	41.5	39.4~43.6
1750	Head	1.37	1.30~1.44	40.08	38.1~42.1
1900	Head	1.40	1.33~1.47	40.0	38.0~42.0
2450	Head	1.80	1.62~1.98	39.2	35.28~43.12
5250	Head	4.71	4.47~4.95	35.93	34.13~37.73
5600	Head	5.07	4.82~5.32	35.53	33.8~37.3
5750	Head	5.22	4.96~5.48	35.36	33.59~37.13

7.2 Dielectric Performance

Table 7.2: Dielectric Performance of Tissue Simulating Liquid

Measurement Date (yyyy-mm-dd)	Type	Frequency	Permittivity ϵ	Drift (%)	Conductivity σ (S/m)	Drift (%)
2023/12/21	Head	750MHz	43.72	4.24	0.864	-2.92
2023/12/22	Head	835MHz	43.45	4.70	0.86	-4.44
2023/12/24	Head	1750MHz	41.12	2.59	1.328	-3.07
2023/12/26	Head	1900MHz	40.79	1.98	1.42	1.43
2023/12/28	Head	2450MHz	40.63	3.65	1.868	3.78
2024/1/4	Head	5250MHz	35.93	0.00	4.839	2.74
2024/1/4	Head	5600MHz	35.23	-0.84	5.251	3.57
2024/1/4	Head	5750MHz	34.93	-1.22	5.431	4.04

Note: The liquid temperature is 22.0°C

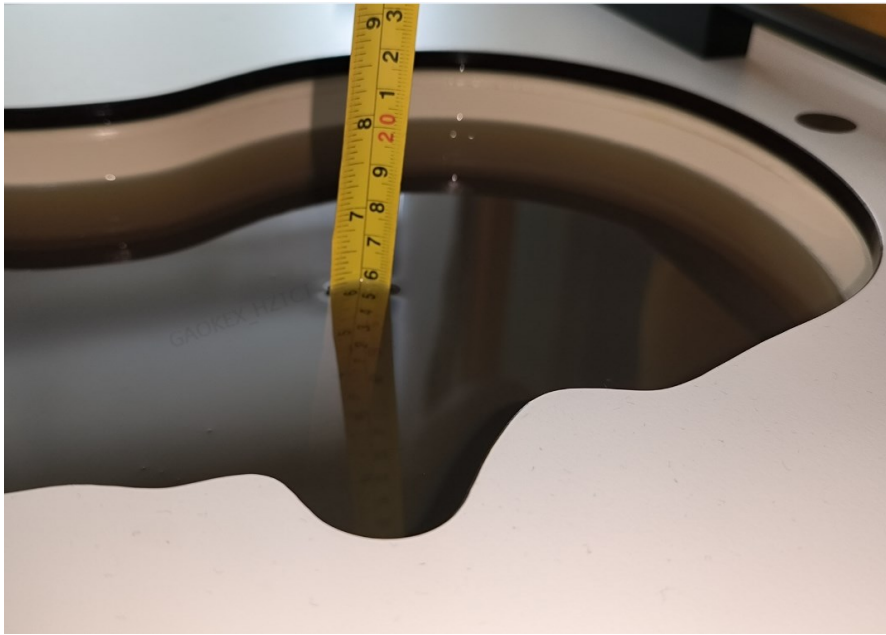

Picture 7-1 Liquid depth in the Head Phantom

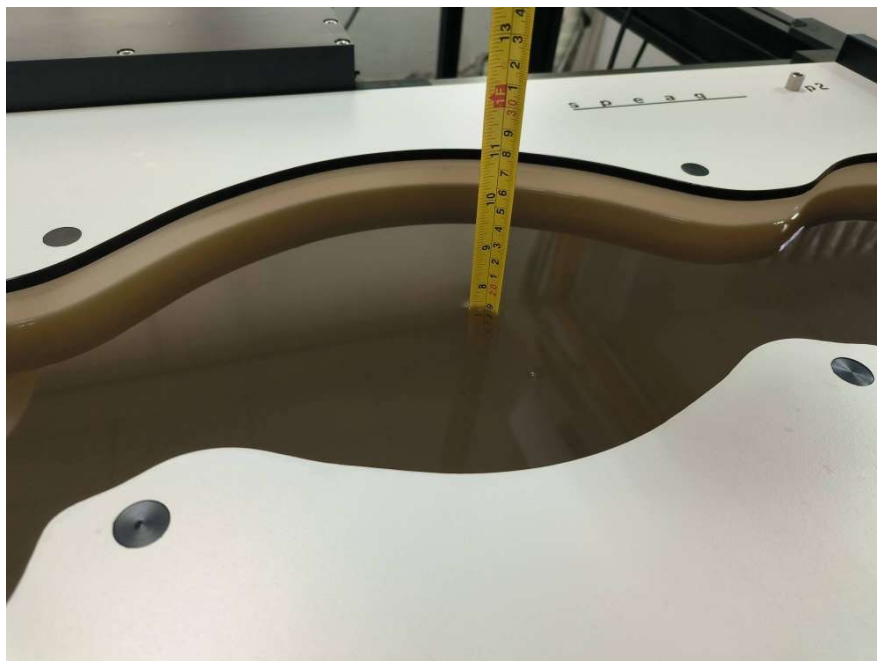

Picture 7-2 Liquid depth in the Flat Phantom

8 System verification

8.1 System Setup

In the simplified setup for system evaluation, the DUT is replaced by a calibrated dipole and the power source is replaced by a continuous wave that comes from a signal generator. The calibrated dipole must be placed beneath the flat phantom section of the SAM twin phantom with the correct distance holder. The distance holder should touch the phantom surface with a light pressure at the reference marking and be oriented parallel to the long side of the phantom. The equipment setup is shown below:

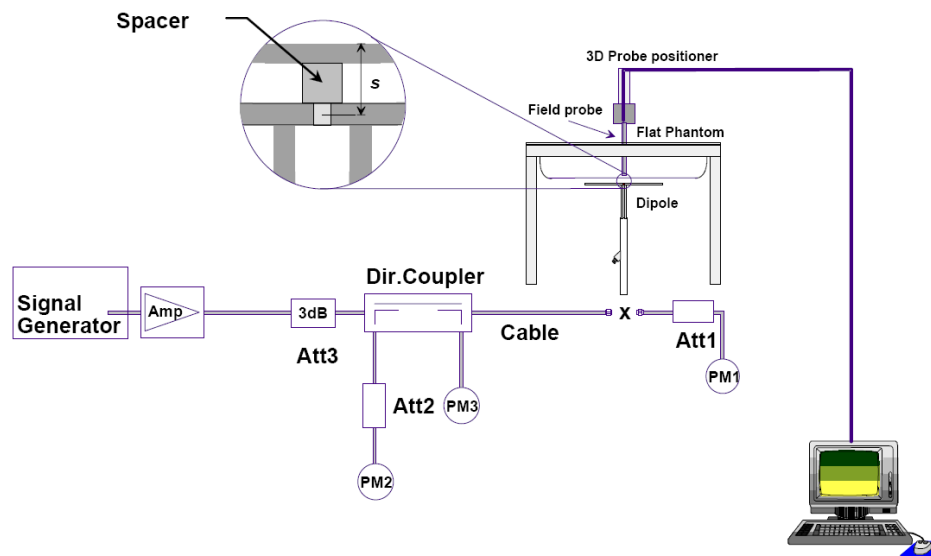

Picture 8.1 System Setup for System Evaluation

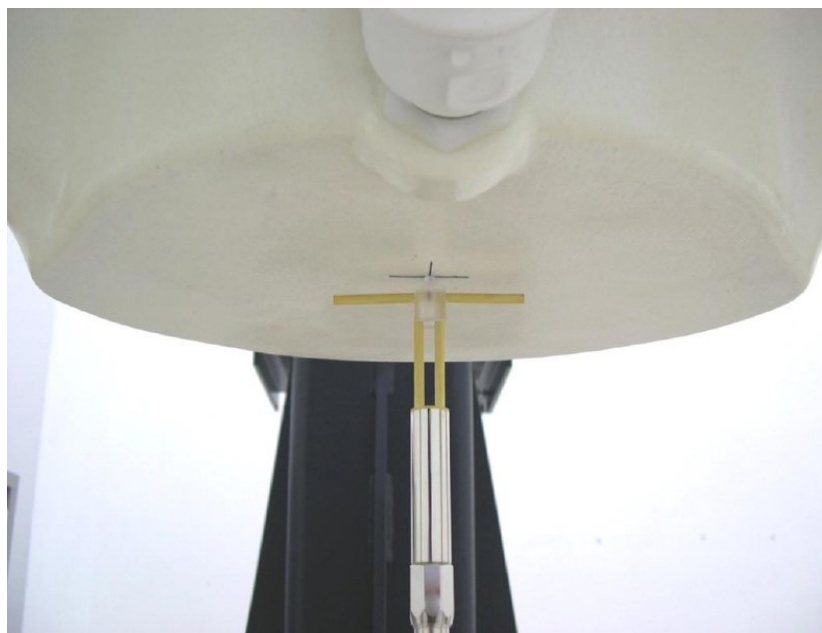

Picture 8.2 Photo of Dipole Setup

8.2 System Verification

SAR system verification is required to confirm measurement accuracy, according to the tissue dielectric media, probe calibration points and other system operating parameters required for measuring the SAR of a test device. The system verification must be performed for each frequency band and within the valid range of each probe calibration point required for testing the device.

Table 9.1: System Verification of Head

Measurement Date (yyyy-mm-dd)	Frequency	Target value (W/kg)		Measured value(W/kg)		Deviation	
		10 g Average	1 g Average	10 g Average	1 g Average	10 g Average	1 g Average
2023/12/21	750 MHz	5.49	8.42	5.64	8.48	2.73%	0.71%
2023/12/22	835 MHz	6.25	9.62	6.56	9.96	4.96%	3.53%
2023/12/24	1750 MHz	18.9	35.8	19.5	36.4	3.07%	1.79%
2023/12/26	1900 MHz	20.7	39.8	20.6	39.6	-0.29%	-0.40%
2023/12/28	2450 MHz	24.7	52.1	25.5	54.4	3.16%	4.41%
2024/1/4	5250 MHz	22.8	79.6	22.7	79.3	-0.44%	-0.38%
2024/1/4	5600 MHz	23.8	83.6	23.4	82.1	-1.68%	-1.79%
2024/1/4	5750 MHz	22.7	80.5	22.3	79.1	-1.76%	-1.74%

9 Measurement Procedures

9.1 Tests to be performed

In order to determine the highest value of the peak spatial-average SAR of a handset, all device positions, configurations and operational modes shall be tested for each frequency band according to steps 1 to 3 below. A flowchart of the test process is shown in picture 9.1.

Step 1: The tests described in 9.2 shall be performed at the channel that is closest to the centre of the transmit frequency band (f_c) for:

- a) all device positions (cheek and tilt, for both left and right sides of the SAM phantom, as described in annex D),
- b) all configurations for each device position in a), e.g., antenna extended and retracted, and
- c) all operational modes, e.g., analogue and digital, for each device position in a) and configuration in b) in each frequency band.

If more than three frequencies need to be tested according to 11.1 (i.e., $N_c > 3$), then all frequencies, configurations and modes shall be tested for all of the above test conditions.

Step 2: For the condition providing highest peak spatial-average SAR determined in Step 1, perform all tests described in 9.2 at all other test frequencies, i.e., lowest and highest frequencies. In addition, for all other conditions (device position, configuration and operational mode) where the peak spatial-average SAR value determined in Step 1 is within 3 dB of the applicable SAR limit, it is recommended that all other test frequencies shall be tested as well.

Step 3: Examine all data to determine the highest value of the peak spatial-average SAR found in Steps 1 to 2.

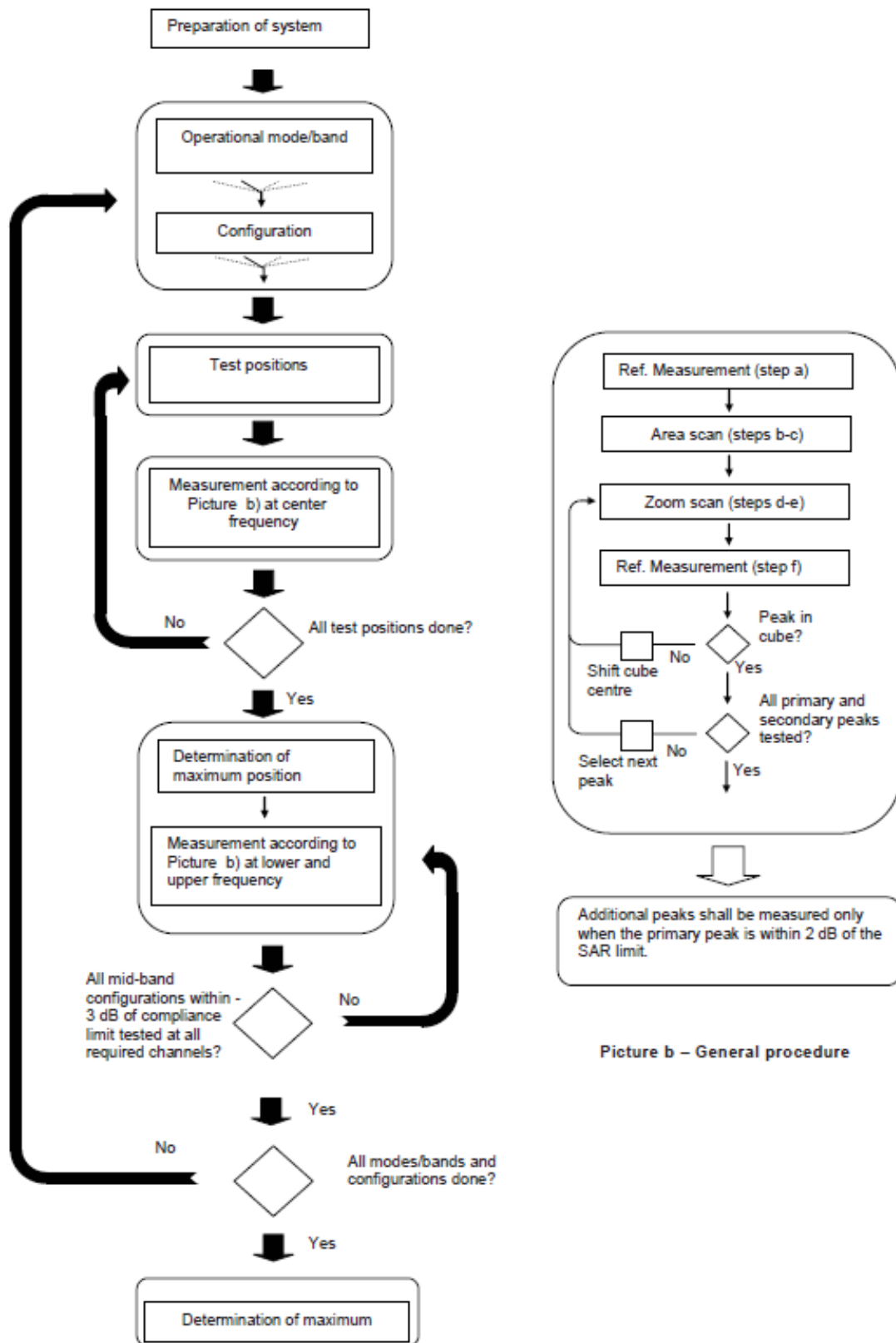

Picture a – Tests to be performed

Picture b – General procedure

Picture 10-1 Block diagram of the tests to be performed

9.2 General Measurement Procedure

The area and zoom scan resolutions specified in the table below must be applied to the SAR measurements and fully documented in SAR reports to qualify for TCB approval. Probe boundary effect error compensation is required for measurements with the probe tip closer than half a probe tip diameter to the phantom surface. Both the probe tip diameter and sensor offset distance must satisfy measurement protocols; to ensure probe boundary effect errors are minimized and the higher fields closest to the phantom surface can be correctly measured and extrapolated to the phantom surface for computing 1-g SAR. Tolerances of the post-processing algorithms must be verified by the test laboratory for the scan resolutions used in the SAR measurements, according to the reference distribution functions specified in IEEE Std 1528-2003. The results should be documented as part of the system validation records and may be requested to support test results when all the measurement parameters in the following table are not satisfied.

		≤ 3 GHz	> 3 GHz	
Maximum distance from closest measurement point (geometric center of probe sensors) to phantom surface		5 ± 1 mm	$\frac{1}{2} \cdot \delta \cdot \ln(2) \pm 0.5$ mm	
Maximum probe angle from probe axis to phantom surface normal at the measurement location		$30^\circ \pm 1^\circ$	$20^\circ \pm 1^\circ$	
Maximum area scan spatial resolution: Δx_{Area} , Δy_{Area}		≤ 2 GHz: ≤ 15 mm 2 – 3 GHz: ≤ 12 mm	3 – 4 GHz: ≤ 12 mm 4 – 6 GHz: ≤ 10 mm	
		When the x or y dimension of the test device, in the measurement plane orientation, is smaller than the above, the measurement resolution must be \leq the corresponding x or y dimension of the test device with at least one measurement point on the test device.		
Maximum zoom scan spatial resolution: Δx_{Zoom} , Δy_{Zoom}		≤ 2 GHz: ≤ 8 mm 2 – 3 GHz: ≤ 5 mm*	3 – 4 GHz: ≤ 5 mm* 4 – 6 GHz: ≤ 4 mm*	
Maximum zoom scan spatial resolution, normal to phantom surface	uniform grid: $\Delta z_{Zoom}(n)$	≤ 5 mm	3 – 4 GHz: ≤ 4 mm 4 – 5 GHz: ≤ 3 mm 5 – 6 GHz: ≤ 2 mm	
	graded grid	$\Delta z_{Zoom}(1)$: between 1 st two points closest to phantom surface	≤ 4 mm	3 – 4 GHz: ≤ 3 mm 4 – 5 GHz: ≤ 2.5 mm 5 – 6 GHz: ≤ 2 mm
		$\Delta z_{Zoom}(n>1)$: between subsequent points	$\leq 1.5 \cdot \Delta z_{Zoom}(n-1)$	
Minimum zoom scan volume	x, y, z	≥ 30 mm	3 – 4 GHz: ≥ 28 mm 4 – 5 GHz: ≥ 25 mm 5 – 6 GHz: ≥ 22 mm	
Note: δ is the penetration depth of a plane-wave at normal incidence to the tissue medium; see draft standard IEEE P1528-2011 for details. * When zoom scan is required and the <i>reported</i> SAR from the area scan based 1-g SAR estimation procedures of KDB 447498 is ≤ 1.4 W/kg, ≤ 8 mm, ≤ 7 mm and ≤ 5 mm zoom scan resolution may be applied, respectively, for 2 GHz to 3 GHz, 3 GHz to 4 GHz and 4 GHz to 6 GHz.				

9.3 WCDMA Measurement Procedures for SAR

The following procedures are applicable to WCDMA handsets operating under 3GPP Release99, Release 5 and Release 6. The default test configuration is to measure SAR with an established radio link between the DUT and a communication test set using a 12.2kbps RMC (reference measurement channel) configured in Test Loop Mode 1. SAR is selectively confirmed for other physical channel configurations (DPCCH & DPDCH_n), HSDPA and HSPA (HSUPA/HSDPA) modes according to output power, exposure conditions and device operating capabilities. Both uplink and downlink should be configured with the same RMC or AMR, when required. SAR for Release 5 HSDPA and Release 6 HSPA are measured using the applicable FRC (fixed reference channel) and E-DCH reference channel configurations. Maximum output power is verified according to applicable versions of 3GPP TS 34.121 and SAR must be measured according to these maximum output conditions. When Maximum Power Reduction (MPR) is not implemented according to Cubic Metric (CM) requirements for Release 6 HSPA, the following procedures do not apply.

For Release 5 HSDPA Data Devices:

Sub-test	β_c	β_d	β_d (SF)	β_c / β_d	β_{hs}	CM/dB
1	2/15	15/15	64	2/15	4/15	0.0
2	12/15	15/15	64	12/15	24/25	1.0
3	15/15	8/15	64	15/8	30/15	1.5
4	15/15	4/15	64	15/4	30/15	1.5

For Release 6 HSPA Data Devices

Sub-test	β_c	β_d	β_d (SF)	β_c / β_d	β_{hs}	β_{ec}	β_{ed}	β_{ed} (SF)	β_{ed} (codes)	CM (dB)	MPR (dB)	AG Index	E-TFCI
1	11/15	15/15	64	11/15	22/15	209/225	1039/225	4	1	1.5	1.5	20	75
2	6/15	15/15	64	6/15	12/15	12/15	12/15	4	1	1.5	1.5	12	67
3	15/15	9/15	64	15/9	30/15	30/15	$\beta_{ed1} : 47/15$ $\beta_{ed2} : 47/15$	4	2	1.5	1.5	15	92
4	2/15	15/15	64	2/15	4/15	4/15	56/75	4	1	1.5	1.5	17	71
5	15/15	15/15	64	15/15	24/15	30/15	134/15	4	1	1.5	1.5	21	81

Rel.8 DC-HSDPA (Cat 24)

SAR test exclusion for Rel.8 DC-HSDPA must satisfy the SAR test exclusion requirements of Rel.5 HSDPA. SAR test exclusion for DC-HSDPA devices is determined by power measurements according to the H-Set 12, Fixed Reference Channel (FRC) configuration in Table C.8.1.12 of 3GPP TS 34.121-1. A primary and a secondary serving HS-DSCH Cell are required to perform the power measurement and for the results to qualify for SAR test exclusion.

9.4 SAR Measurement for LTE

SAR tests for LTE are performed with a base station simulator, Rohde & Schwarz CMW500. Closed loop power control was used so the UE transmits with maximum output power during SAR testing. All powers were measured with the CMW 500.

It is performed for conducted power and SAR based on the KDB941225 D05.

SAR is evaluated separately according to the following procedures for the different test positions in each exposure condition – head, body, body-worn accessories and other use conditions. The procedures in the following subsections are applied separately to test each LTE frequency band.

1) QPSK with 1 RB allocation

Start with the largest channel bandwidth and measure SAR for QPSK with 1 RB allocation, using the RB offset and required test channel combination with the highest maximum output power among RB offsets at the upper edge, middle and lower edge of each required test channel. When the reported SAR is ≤ 0.8 W/kg, testing of the remaining RB offset configurations and required test channels is not required for 1 RB allocation; otherwise, SAR is required for the remaining required test channels and only for the RB offset configuration with the highest output power for that channel. When the reported SAR of a required test channel is > 1.45 W/kg, SAR is required for all three RB offset configurations for that required test channel.

2) QPSK with 50% RB allocation

The procedures required for 1 RB allocation in 1) are applied to measure the SAR for QPSK with 50% RB allocation.

3) QPSK with 100% RB allocation

For QPSK with 100% RB allocation, SAR is not required when the highest maximum output power for 100 % RB allocation is less than the highest maximum output power in 50% and 1 RB allocations and the highest reported SAR for 1 RB and 50% RB allocation in 1) and 2) are ≤ 0.8 W/kg. Otherwise, SAR is measured for the highest output power channel; and if the reported SAR is > 1.45 W/kg, the remaining required test channels must also be tested.

9.5 Bluetooth & Wi-Fi Measurement Procedures for SAR

Normal network operating configurations are not suitable for measuring the SAR of 802.11 transmitters in general. Unpredictable fluctuations in network traffic and antenna diversity conditions can introduce undesirable variations in SAR results. The SAR for these devices should be measured using chipset based test mode software to ensure that the results are consistent and reliable.

Chipset based test mode software is hardware dependent and generally varies among manufacturers. The device operating parameters established in a test mode for SAR measurements must be identical to those programmed in production units, including output power levels, amplifier gain settings and other RF performance tuning parameters. The test frequencies should correspond to actual channel frequencies defined for domestic use. SAR for devices with switched diversity should be measured with only one antenna transmitting at a time during each SAR measurement, according to a fixed modulation and data rate. The same data pattern should be used for all measurements.

9.6 Power Drift

To control the output power stability during the SAR test, DASY5 system calculates the power drift by measuring the E-field at the same location at the beginning and at the end of the measurement for each test position. These drift values can be found in section 14 labeled as: (Power Drift [dB]). This ensures that the power drift during one measurement is within 5%.

10 Area Scan Based 1-g SAR

10.1 Requirement of KDB

According to the KDB447498 D01, when the implementation is based the specific polynomial fit algorithm as presented at the 29th Bioelectromagnetics Society meeting (2007) and the estimated 1-gSAR is ≤ 1.2 W/kg, a zoom scan measurement is not required provided it is also not needed for any other purpose; for example, if the peak SAR location required for simultaneous transmission SAR test exclusion can be determined accurately by the SAR system or manually to discriminate between distinctive peaks and scattered noisy SAR distributions from area scans.

There must not be any warning or alert messages due to various measurement concerns identified by the SAR system; for example, noise in measurements, peaks too close to scan boundary, peaks are too sharp, spatial resolution and uncertainty issues etc. The SAR system verification must also demonstrate that the area scan estimated 1-g SAR is within 3% of the zoom scan 1-g SAR. When all the SAR results for each exposure condition in a frequency band and wireless mode are based on estimated 1-g SAR, the 1-g SAR for the highest SAR configuration must be determined by a zoom scan.

10.2 Fast SAR Algorithms

The approach is based on the area scan measurement applying a frequency dependent attenuation parameter. This attenuation parameter was empirically determined by analyzing a large number of phones. The MOTOROLA FAST SAR was developed and validated by the MOTOROLA Research Group in Ft. Lauderdale.

In the initial study, an approximation algorithm based on Linear fit was developed. The accuracy of the algorithm has been demonstrated across a broad frequency range (136-2450 MHz) and for both 1- and 10-g averaged SAR using a sample of 264 SAR measurements from 55 wireless handsets. For the sample size studied, the root-mean-squared errors of the algorithm are 1.2% and 5.8% for 1- and 10-g averaged SAR, respectively. The paper describing the algorithm in detail is expected to be published in August 2004 within the Special Issue of Transactions on MTT.

In the second step, the same research group optimized the fitting algorithm to an Polynomial fit whereby the frequency validity was extended to cover the range 30-6000MHz. Details of this study can be found in the BEMS 2007 Proceedings.

Both algorithms are implemented in DASYS software.

11 Conducted Output Power

This device has several different power modes for head, body-worn, hotspot SAR compliance; power selection is determined by the device's positioning and usage scenarios. The details of test scenarios categorization in the table below

Antenna	Head receiver on	Body worn receiver off	Hotspot
Main antenna	Power Level A1	Power Level B1	Power Level C1

11.1 GSM Measurement result

During the process of testing, the EUT was controlled via Anritsu Digital Radio Communication tester (MT8820C&MT8821C) to ensure the maximum power transmission and proper modulation. This result contains conducted output power for the EUT. In all cases, the measured peak output power should be greater and within 5% than EMI measurement.

GSM850(Power Level A1/B1/C1)

GSM 850 Speech (GMSK)	Measured timeslot-averaged output power (dBm)			Tune up	calculation	Source-based time-averaged output power (dBm)		
	251	190	128			251	190	128
1 Txslot	32.26	32.33	32.27	33.50	/	/	/	/
GSM 850 GPRS (GMSK)	Measured timeslot-averaged output power (dBm)			Tune up	calculation	Source-based time-averaged output power (dBm)		
	251	190	128			251	190	128
1 Txslot	32.39	32.29	32.24	33.50	-9.03	23.36	23.26	23.21
2 Txslots	30.82	30.76	30.70	31.50	-6.02	24.80	24.74	24.68
3Txslots	28.78	28.75	28.71	29.50	-4.26	24.52	24.49	24.45
4 Txslots	26.74	26.75	26.74	27.50	-3.01	23.73	23.74	23.73
GSM 850 EGPRS (GMSK)	Measured timeslot-averaged output power (dBm)			Tune up	calculation	Source-based time-averaged output power (dBm)		
	251	190	128			251	190	128
1 Txslot	32.34	32.28	32.24	33.50	-9.03	23.31	23.25	23.21
2 Txslots	30.80	30.76	30.69	31.50	-6.02	24.78	24.74	24.67
3Txslots	28.77	28.75	28.71	29.50	-4.26	24.51	24.49	24.45
4 Txslots	26.73	26.75	26.74	27.50	-3.01	23.72	23.74	23.73
GSM 850 EGPRS (8PSK)	Measured timeslot-averaged output power (dBm)			Tune up	calculation	Source-based time-averaged output power (dBm)		
	251	190	128			251	190	128
1 Txslot	26.64	26.55	26.70	27.50	-9.03	17.61	17.52	17.67
2 Txslots	24.64	24.59	24.72	25.50	-6.02	18.62	18.57	18.70
3Txslots	22.28	22.23	22.36	23.50	-4.26	18.02	17.97	18.10
4 Txslots	19.83	19.83	19.97	21.50	-3.01	16.82	16.82	16.96

GSM1900(Power Level A1/B1/C1)

GSM 1900 Speech (GMSK)	Measured timeslot-averaged output power (dBm)			Tune up	calculation	Source-based time-averaged output power (dBm)		
	810	661	512			810	661	512
1 Txslot	29.53	29.53	29.50	30.50	/	/	/	/
GSM 1900 GPRS (GMSK)	Measured timeslot-averaged output power (dBm)			Tune up	calculation	Source-based time-averaged output power (dBm)		
	810	661	512			810	661	512
1 Txslot	29.51	29.49	29.47	30.50	-9.03	20.48	20.46	20.44
2 Txslots	27.99	27.96	27.95	29.00	-6.02	21.97	21.94	21.93
3Txslots	26.00	25.96	25.95	27.00	-4.26	21.74	21.70	21.69
4 Txslots	23.99	23.97	23.95	25.00	-3.01	20.98	20.96	20.94
GSM 1900 EGPRS (GMSK)	Measured timeslot-averaged output power (dBm)			Tune up	calculation	Source-based time-averaged output power (dBm)		
	810	661	512			810	661	512
1 Txslot	29.52	29.52	29.49	30.50	-9.03	20.49	20.49	20.46
2 Txslots	28.01	27.99	27.97	29.00	-6.02	21.99	21.97	21.95
3Txslots	26.01	25.99	25.97	27.00	-4.26	21.75	21.73	21.71
4 Txslots	24.01	24.00	23.96	25.00	-3.01	21.00	20.99	20.95
GSM 1900 EGPRS (8PSK)	Measured timeslot-averaged output power (dBm)			Tune up	calculation	Source-based time-averaged output power (dBm)		
	810	661	512			810	661	512
1 Txslot	26.19	26.26	26.24	26.50	-9.03	17.16	17.23	17.21
2 Txslots	24.37	24.45	24.41	24.50	-6.02	18.35	18.43	18.39
3Txslots	22.31	22.41	22.37	22.50	-4.26	18.05	18.15	18.11
4 Txslots	20.14	21.27	20.23	20.50	-3.01	17.13	18.26	17.22

11.2 WCDMA Measurement result

WCDMA1900(Power Level A1)

Item	band	FDDII result			
	ARFCN	9538 (1907.6MHz)	9400 (1880MHz)	9262 (1852.4MHz)	Tune up
WCDMA	\	22.84	22.96	23.04	24.00
HSUPA	1	20.21	20.22	20.23	22.00
	2	20.22	20.27	20.22	22.00
	3	21.19	21.17	21.22	23.00
	4	19.8	19.75	19.76	22.50
	5	21.26	21.38	21.19	23.00
HSPA+	\	21.75	21.73	21.76	23.00
DC-HSDPA	1	21.7	21.74	21.75	23.50
	2	21.28	21.32	21.20	22.50
	3	21.65	21.70	21.61	23.50
	4	21.56	21.65	21.54	23.50

WCDMA1900(Power Level B1)

Item	band	FDDII result			
	ARFCN	9538 (1907.6MHz)	9400 (1880MHz)	9262 (1852.4MHz)	Tune up
WCDMA	\	21.73	21.61	21.48	22.50
HSUPA	1	19.13	19.14	19.15	20.50
	2	19.14	19.19	19.14	20.50
	3	20.06	20.04	20.09	21.50
	4	18.74	18.69	18.70	20.00
	5	20.12	20.24	20.06	21.50
HSPA+	\	20.59	20.57	20.60	21.50
DC-HSDPA	1	20.54	20.58	20.59	21.50
	2	20.14	20.18	20.07	21.50
	3	20.49	20.54	20.46	21.50
	4	20.41	20.49	20.39	21.50

WCDMA1900(Power Level C1)

Item	band	FDDII result			
	ARFCN	9538 (1907.6MHz)	9400 (1880MHz)	9262 (1852.4MHz)	Tune up
WCDMA	\	22.12	22.15	22.04	23.00
HSUPA	1	19.65	19.66	19.67	21.00
	2	19.66	19.71	19.66	21.00
	3	20.6	20.58	20.63	22.00
	4	19.25	19.20	19.21	20.50
	5	20.67	20.79	20.60	22.00
HSPA+	\	21.15	21.13	21.16	22.00
DC-HSDPA	1	21.1	21.14	21.15	22.50
	2	20.69	20.73	20.61	22.50
	3	21.05	21.10	21.01	22.50
	4	20.96	21.05	20.94	22.50

WCDMA1700(Power Level A1)

Item	band	FDDIV result			
	ARFCN	1513 (1752.6MHz)	1412 (1732.4MHz)	1312 (1712.4MHz)	Tune up
WCDMA	\	22.95	22.91	22.83	24.00
HSUPA	1	20.25	20.26	20.27	22.00
	2	20.26	20.31	20.26	22.00
	3	21.23	21.21	21.26	23.00
	4	19.84	19.79	19.80	22.50
	5	21.3	21.42	21.23	23.00
HSPA+	\	21.79	21.77	21.80	23.00
DC-HSDPA	1	21.74	21.78	21.79	23.50
	2	21.32	21.36	21.24	22.50
	3	21.69	21.74	21.65	23.50
	4	21.6	21.69	21.58	23.50

WCDMA1700(Power Level B1)

Item	band	FDDIV result			
	ARFCN	1513 (1752.6MHz)	1412 (1732.4MHz)	1312 (1712.4MHz)	Tune up
WCDMA	\	21.59	21.62	21.66	22.50
HSUPA	1	19.12	19.13	19.14	20.50
	2	19.13	19.18	19.13	20.50
	3	20.05	20.03	20.07	21.50
	4	18.73	18.69	18.70	20.00
	5	20.11	20.22	20.05	21.50
HSPA+	\	20.57	20.56	20.58	21.50
DC-HSDPA	1	20.53	20.56	20.57	21.50
	2	20.13	20.17	20.05	21.50
	3	20.48	20.53	20.44	21.50
	4	20.39	20.48	20.38	21.50

WCDMA1700(Power Level C1)

Item	band	FDDIV result			
	ARFCN	1513 (1752.6MHz)	1412 (1732.4MHz)	1312 (1712.4MHz)	Tune up
WCDMA	\	20.44	20.49	20.65	21.50
HSUPA	1	18.51	18.52	18.53	20.50
	2	18.22	18.26	18.22	19.50
	3	19.09	19.07	19.12	20.50
	4	18.14	18.10	18.11	20.00
	5	19.15	19.26	19.09	20.50
HSPA+	\	19.59	19.58	19.60	20.50
DC-HSDPA	1	19.55	19.59	19.59	21.00
	2	19.17	19.21	19.10	21.00
	3	19.5	19.55	19.47	21.00
	4	19.42	19.50	19.41	21.00

WCDMA850(Power Level A1/B1/C1)

Item	band	FDDV result			
	ARFCN	4233 (846.6MHz)	4183 (836.6MHz)	4132 (826.4MHz)	Tune up
WCDMA	\	23.03	23.01	23.06	24.00
HSUPA	1	20.59	20.60	20.61	22.50
	2	20.6	20.65	20.60	21.50
	3	21.59	21.57	21.62	22.50
	4	20.17	20.12	20.13	22.00
	5	21.66	21.78	21.59	22.50
HSPA+	\	22.16	22.14	22.17	23.00
DC-HSDPA	1	22.11	22.15	22.16	23.50
	2	21.68	21.72	21.60	23.50
	3	22.06	22.11	22.02	23.50
	4	21.97	22.06	21.95	23.50

11.3 LTE Measurement result

The maximum output power(Tune-up Limit)

Band	Tune up		
	Power Level A1	Power Level B1	Power Level C1
LTE Band 2	24.5	23	22.5
LTE Band 4	24.5	22.5	21.5
LTE Band 5	25	25	25
LTE Band 12	25	25	25
LTE Band 13	25	25	25
LTE Band 66	24.5	22.5	21

Maximum Power Reduction (MPR) for LTE-Normal Power

Modulation	Channel bandwidth / Transmission bandwidth configuration [RB]						MPR (dB)
	1.4 MHz	3 MHz	5 MHz	10 MHz	15 MHz	20 MHz	
QPSK	> 5	> 4	> 8	> 12	> 16	> 18	1
16 QAM	≤ 5	≤ 4	≤ 8	≤ 12	≤ 16	≤ 18	1
16 QAM	> 5	> 4	> 8	> 12	> 16	> 18	2
64 QAM	≤ 5	≤ 4	≤ 8	≤ 12	≤ 16	≤ 18	2
64 QAM	> 5	> 4	> 8	> 12	> 16	> 18	3

Maximum Power Reduction (MPR) for LTE -Low power

Modulation	Channel bandwidth / Transmission bandwidth configuration [RB]						MPR (dB)
	1.4 MHz	3 MHz	5 MHz	10 MHz	15 MHz	20 MHz	
QPSK	> 5	> 4	> 8	> 12	> 16	> 18	0
16 QAM	≤ 5	≤ 4	≤ 8	≤ 12	≤ 16	≤ 18	0
16 QAM	> 5	> 4	> 8	> 12	> 16	> 18	0
64 QAM	≤ 5	≤ 4	≤ 8	≤ 12	≤ 16	≤ 18	0
64 QAM	> 5	> 4	> 8	> 12	> 16	> 18	0

LTE Band2(Power Level A1)

BANDWIDTH	Number of RBs	Frequency	QPSK	16QAM	64QAM
1.4MHz	1RB-High (5)	1909.3 (19193)	23.61	22.84	21.69
		1880 (18900)	23.35	22.64	21.51
		1850.7 (18607)	23.25	22.52	21.38
	1RB-Middle (3)	1909.3 (19193)	23.75	22.89	21.78
		1880 (18900)	23.48	22.71	21.61
		1850.7 (18607)	23.35	22.62	21.56
	1RB-Low (0)	1909.3 (19193)	23.55	22.78	21.66
		1880 (18900)	23.34	22.56	21.48
		1850.7 (18607)	23.23	22.50	21.35
	3RB-High (3)	1909.3 (19193)	23.72	22.73	21.76
		1880 (18900)	23.45	22.41	21.44
		1850.7 (18607)	23.34	22.31	21.38
	3RB-Middle (1)	1909.3 (19193)	23.79	22.73	21.80
		1880 (18900)	23.50	22.37	21.52
		1850.7 (18607)	23.41	22.29	21.45
	3RB-Low (0)	1909.3 (19193)	23.72	22.67	21.76
		1880 (18900)	23.45	22.43	21.48
		1850.7 (18607)	23.33	22.27	21.40
	6RB (0)	1909.3 (19193)	22.75	21.79	20.71
		1880 (18900)	22.44	21.55	20.38
		1850.7 (18607)	22.35	21.43	20.33
3MHz	1RB-High (14)	1908.5 (19185)	23.69	22.92	21.75
		1880 (18900)	23.37	22.70	21.56
		1851.5 (18615)	23.30	22.50	21.48
	1RB-Middle (7)	1908.5 (19185)	23.82	23.02	21.82
		1880 (18900)	23.52	22.75	21.77
		1851.5 (18615)	23.38	22.69	21.60
	1RB-Low (0)	1908.5 (19185)	23.59	22.79	21.65
		1880 (18900)	23.40	22.68	21.56
		1851.5 (18615)	23.28	22.64	21.45
	8RB-High (7)	1908.5 (19185)	22.65	21.66	20.66
		1880 (18900)	22.42	21.45	20.46
		1851.5 (18615)	22.31	21.35	20.35
	8RB-Middle (4)	1908.5 (19185)	22.72	21.72	20.72
		1880 (18900)	22.43	21.48	20.47
		1851.5 (18615)	22.33	21.36	20.37
	8RB-Low (0)	1908.5 (19185)	22.63	21.70	20.66
		1880 (18900)	22.40	21.46	20.43
		1851.5 (18615)	22.31	21.34	20.35
	15RB (0)	1908.5 (19185)	22.66	21.63	20.60
		1880 (18900)	22.39	21.41	20.37
		1851.5 (18615)	22.28	21.29	20.30

5MHz	1RB-High (24)	1907.5 (19175)	23.63	22.83	21.80	
		1880 (18900)	23.40	22.59	21.60	
		1852.5 (18625)	23.28	22.47	21.41	
	1RB-Middle (12)	1907.5 (19175)	23.84	22.97	21.87	
		1880 (18900)	23.52	22.85	21.59	
		1852.5 (18625)	23.48	22.57	21.55	
	1RB-Low (0)	1907.5 (19175)	23.56	22.79	21.66	
		1880 (18900)	23.39	22.61	21.50	
		1852.5 (18625)	23.29	22.61	21.38	
	12RB-High (13)	1907.5 (19175)	22.69	21.68	20.70	
		1880 (18900)	22.46	21.41	20.48	
		1852.5 (18625)	22.35	21.31	20.34	
	12RB-Middle (6)	1907.5 (19175)	22.70	21.68	20.71	
		1880 (18900)	22.46	21.44	20.46	
		1852.5 (18625)	22.36	21.34	20.35	
	12RB-Low (0)	1907.5 (19175)	22.67	21.69	20.67	
		1880 (18900)	22.44	21.43	20.43	
		1852.5 (18625)	22.32	21.29	20.31	
	25RB (0)	1907.5 (19175)	22.70	21.70	20.68	
		1880 (18900)	22.48	21.47	20.45	
		1852.5 (18625)	22.33	21.32	20.32	
	10MHz	1RB-High (49)	1905 (19150)	23.73	23.00	21.81
			1880 (18900)	23.44	22.75	21.53
			1855 (18650)	23.31	22.62	21.44
1RB-Middle (24)		1905 (19150)	23.64	22.96	21.75	
		1880 (18900)	23.46	22.73	21.60	
		1855 (18650)	23.36	22.59	21.52	
1RB-Low (0)		1905 (19150)	23.60	22.89	21.71	
		1880 (18900)	23.46	22.75	21.58	
		1855 (18650)	23.37	22.57	21.47	
25RB-High (25)		1905 (19150)	22.68	21.69	20.64	
		1880 (18900)	22.50	21.49	20.49	
		1855 (18650)	22.39	21.35	20.37	
25RB-Middle (12)		1905 (19150)	22.68	21.64	20.63	
		1880 (18900)	22.46	21.44	20.48	
		1855 (18650)	22.37	21.34	20.35	
25RB-Low (0)		1905 (19150)	22.76	21.74	20.74	
		1880 (18900)	22.51	21.50	20.50	
		1855 (18650)	22.36	21.36	20.35	
50RB (0)		1905 (19150)	22.76	21.72	20.71	
		1880 (18900)	22.52	21.51	20.50	
		1855 (18650)	22.38	21.33	20.37	

15MHz	1RB-High (74)	1902.5 (19125)	23.71	22.97	21.78
		1880 (18900)	23.52	22.77	21.55
		1857.5 (18675)	23.36	22.54	21.45
	1RB-Middle (37)	1902.5 (19125)	23.58	22.85	21.64
		1880 (18900)	23.44	22.75	21.56
		1857.5 (18675)	23.33	22.60	21.43
	1RB-Low (0)	1902.5 (19125)	23.57	22.73	21.64
		1880 (18900)	23.46	22.61	21.57
		1857.5 (18675)	23.41	22.56	21.45
	36RB-High (38)	1902.5 (19125)	22.71	21.66	20.67
		1880 (18900)	22.56	21.49	20.50
		1857.5 (18675)	22.44	21.36	20.39
	36RB-Middle (19)	1902.5 (19125)	22.71	21.64	20.70
		1880 (18900)	22.56	21.51	20.47
		1857.5 (18675)	22.38	21.31	20.36
	36RB-Low (0)	1902.5 (19125)	22.71	21.65	20.66
		1880 (18900)	22.57	21.49	20.50
		1857.5 (18675)	22.38	21.34	20.34
	75RB (0)	1902.5 (19125)	22.72	21.68	20.67
		1880 (18900)	22.57	21.53	20.50
		1857.5 (18675)	22.39	21.35	20.37
20MHz	1RB-High (99)	1900 (19100)	23.81	23.07	21.81
		1880 (18900)	23.61	22.80	21.63
		1860 (18700)	23.51	22.71	21.57
	1RB-Middle (50)	1900 (19100)	23.76	23.00	21.80
		1880 (18900)	23.63	22.81	21.65
		1860 (18700)	23.50	22.81	21.57
	1RB-Low (0)	1900 (19100)	23.68	22.83	21.68
		1880 (18900)	23.57	22.81	21.60
		1860 (18700)	23.49	22.68	21.58
	50RB-High (50)	1900 (19100)	22.69	21.66	20.62
		1880 (18900)	22.72	21.66	20.61
		1860 (18700)	22.53	21.46	20.42
	50RB-Middle (25)	1900 (19100)	22.82	21.76	20.72
		1880 (18900)	22.69	21.61	20.59
		1860 (18700)	22.54	21.44	20.45
	50RB-Low (0)	1900 (19100)	22.79	21.73	20.66
		1880 (18900)	22.65	21.61	20.56
		1860 (18700)	22.44	21.39	20.36
	100RB (0)	1900 (19100)	22.77	21.70	20.67
		1880 (18900)	22.65	21.57	20.55
		1860 (18700)	22.45	21.40	20.36

LTE Band2(Power Level B1)

BANDWIDTH	Number of RBs	Frequency	QPSK	16QAM	64QAM
1.4MHz	1RB-High (5)	1909.3 (19193)	22.34	22.51	21.89
		1880 (18900)	22.22	22.47	21.90
		1850.7 (18607)	22.22	22.57	21.88
	1RB-Middle (3)	1909.3 (19193)	22.43	22.61	22.02
		1880 (18900)	22.29	22.49	21.90
		1850.7 (18607)	22.32	22.68	22.00
	1RB-Low (0)	1909.3 (19193)	22.30	22.60	21.88
		1880 (18900)	22.22	22.54	21.96
		1850.7 (18607)	22.24	22.45	22.00
	3RB-High (3)	1909.3 (19193)	22.41	22.33	21.99
		1880 (18900)	22.28	22.35	21.86
		1850.7 (18607)	22.36	22.33	21.87
	3RB-Middle (1)	1909.3 (19193)	22.47	22.48	21.97
		1880 (18900)	22.36	22.33	21.91
		1850.7 (18607)	22.38	22.40	21.95
	3RB-Low (0)	1909.3 (19193)	22.40	22.34	21.98
		1880 (18900)	22.31	22.22	21.88
		1850.7 (18607)	22.37	22.31	21.90
	6RB (0)	1909.3 (19193)	22.44	21.96	20.89
		1880 (18900)	22.33	21.86	20.76
		1850.7 (18607)	22.36	21.94	20.81
3MHz	1RB-High (14)	1908.5 (19185)	22.37	22.62	21.98
		1880 (18900)	22.26	22.52	21.91
		1851.5 (18615)	22.26	22.43	21.85
	1RB-Middle (7)	1908.5 (19185)	22.47	22.71	22.09
		1880 (18900)	22.34	22.61	22.04
		1851.5 (18615)	22.41	22.57	22.08
	1RB-Low (0)	1908.5 (19185)	22.38	22.65	21.93
		1880 (18900)	22.27	22.57	21.91
		1851.5 (18615)	22.29	22.57	21.95
	8RB-High (7)	1908.5 (19185)	22.37	21.88	20.86
		1880 (18900)	22.26	21.84	20.77
		1851.5 (18615)	22.30	21.81	20.80
	8RB-Middle (4)	1908.5 (19185)	22.40	21.95	20.91
		1880 (18900)	22.31	21.81	20.81
		1851.5 (18615)	22.29	21.82	20.81
	8RB-Low (0)	1908.5 (19185)	22.40	21.92	20.88
		1880 (18900)	22.27	21.80	20.77
		1851.5 (18615)	22.30	21.85	20.81
	15RB (0)	1908.5 (19185)	22.40	21.86	20.86
		1880 (18900)	22.28	21.75	20.75
		1851.5 (18615)	22.25	21.77	20.71

5MHz	1RB-High (24)	1907.5 (19175)	22.32	22.63	21.94	
		1880 (18900)	22.25	22.56	21.92	
		1852.5 (18625)	22.20	22.56	21.87	
	1RB-Middle (12)	1907.5 (19175)	22.48	22.82	22.01	
		1880 (18900)	22.41	22.70	22.04	
		1852.5 (18625)	22.41	22.74	22.04	
	1RB-Low (0)	1907.5 (19175)	22.34	22.61	21.98	
		1880 (18900)	22.27	22.53	21.81	
		1852.5 (18625)	22.26	22.64	21.95	
	12RB-High (13)	1907.5 (19175)	22.38	21.82	20.85	
		1880 (18900)	22.33	21.79	20.79	
		1852.5 (18625)	22.29	21.77	20.76	
	12RB-Middle (6)	1907.5 (19175)	22.44	21.91	20.91	
		1880 (18900)	22.32	21.79	20.81	
		1852.5 (18625)	22.31	21.76	20.80	
	12RB-Low (0)	1907.5 (19175)	22.43	21.84	20.88	
		1880 (18900)	22.28	21.75	20.79	
		1852.5 (18625)	22.29	21.70	20.74	
	25RB (0)	1907.5 (19175)	22.44	21.88	20.89	
		1880 (18900)	22.34	21.82	20.81	
		1852.5 (18625)	22.31	21.76	20.76	
	10MHz	1RB-High (49)	1905 (19150)	22.35	22.61	21.96
			1880 (18900)	22.27	22.65	21.93
			1855 (18650)	22.16	22.54	21.87
1RB-Middle (24)		1905 (19150)	22.43	22.66	22.05	
		1880 (18900)	22.36	22.56	22.01	
		1855 (18650)	22.32	22.57	21.95	
1RB-Low (0)		1905 (19150)	22.32	22.64	21.89	
		1880 (18900)	22.24	22.59	21.92	
		1855 (18650)	22.29	22.64	21.97	
25RB-High (25)		1905 (19150)	22.41	21.89	20.86	
		1880 (18900)	22.38	21.88	20.88	
		1855 (18650)	22.32	21.80	20.77	
25RB-Middle (12)		1905 (19150)	22.45	21.94	20.92	
		1880 (18900)	22.31	21.83	20.82	
		1855 (18650)	22.31	21.79	20.78	
25RB-Low (0)		1905 (19150)	22.54	22.01	20.98	
		1880 (18900)	22.33	21.85	20.81	
		1855 (18650)	22.28	21.78	20.78	
50RB (0)		1905 (19150)	22.49	21.97	20.95	
		1880 (18900)	22.39	21.84	20.84	
		1855 (18650)	22.31	21.80	20.77	



15MHz	1RB-High (74)	1902.5 (19125)	22.30	22.62	21.96
		1880 (18900)	22.27	22.51	21.91
		1857.5 (18675)	22.12	22.39	21.82
	1RB-Middle (37)	1902.5 (19125)	22.29	22.51	21.90
		1880 (18900)	22.25	22.57	21.85
		1857.5 (18675)	22.21	22.43	21.84
	1RB-Low (0)	1902.5 (19125)	22.31	22.53	22.01
		1880 (18900)	22.21	22.47	21.84
		1857.5 (18675)	22.29	22.62	22.00
	36RB-High (38)	1902.5 (19125)	22.36	21.80	20.87
		1880 (18900)	22.36	21.79	20.83
		1857.5 (18675)	22.24	21.70	20.70
	36RB-Middle (19)	1902.5 (19125)	22.44	21.87	20.87
		1880 (18900)	22.33	21.78	20.78
		1857.5 (18675)	22.28	21.73	20.72
	36RB-Low (0)	1902.5 (19125)	22.42	21.86	20.87
		1880 (18900)	22.30	21.77	20.78
		1857.5 (18675)	22.26	21.73	20.71
	75RB (0)	1902.5 (19125)	22.43	21.88	20.85
		1880 (18900)	22.32	21.79	20.81
		1857.5 (18675)	22.25	21.76	20.70
20MHz	1RB-High (99)	1900 (19100)	22.33	22.63	21.91
		1880 (18900)	22.27	22.46	21.92
		1860 (18700)	22.17	22.41	21.76
	1RB-Middle (50)	1900 (19100)	22.34	22.64	21.99
		1880 (18900)	22.29	22.72	21.95
		1860 (18700)	22.22	22.52	21.95
	1RB-Low (0)	1900 (19100)	22.32	22.66	22.03
		1880 (18900)	22.19	22.44	21.90
		1860 (18700)	22.28	22.54	21.95
	50RB-High (50)	1900 (19100)	22.29	21.76	20.74
		1880 (18900)	22.40	21.86	20.87
		1860 (18700)	22.20	21.68	20.66
	50RB-Middle (25)	1900 (19100)	22.39	21.88	20.85
		1880 (18900)	22.35	21.81	20.83
		1860 (18700)	22.29	21.76	20.74
	50RB-Low (0)	1900 (19100)	22.48	21.93	20.90
		1880 (18900)	22.28	21.78	20.79
		1860 (18700)	22.22	21.72	20.66
	100RB (0)	1900 (19100)	22.35	21.80	20.80
		1880 (18900)	22.33	21.80	20.80
		1860 (18700)	22.20	21.69	20.63

LTE Band2(Power Level C1)

BANDWIDTH	Number of RBs	Frequency	QPSK	16QAM	64QAM	
1.4MHz	1RB-High (5)	1909.3 (19193)	21.81	22.02	21.94	
		1880 (18900)	21.72	21.93	21.90	
		1850.7 (18607)	21.74	22.02	21.89	
	1RB-Middle (3)	1909.3 (19193)	21.90	22.08	21.98	
		1880 (18900)	21.81	22.15	21.96	
		1850.7 (18607)	21.82	22.03	21.98	
	1RB-Low (0)	1909.3 (19193)	21.80	22.07	21.95	
		1880 (18900)	21.70	22.00	21.89	
		1850.7 (18607)	21.77	21.97	21.87	
	3RB-High (3)	1909.3 (19193)	21.93	21.80	21.95	
		1880 (18900)	21.79	21.77	21.87	
		1850.7 (18607)	21.86	21.77	21.98	
	3RB-Middle (1)	1909.3 (19193)	21.95	21.88	21.96	
		1880 (18900)	21.82	21.85	21.93	
		1850.7 (18607)	21.88	21.88	21.97	
	3RB-Low (0)	1909.3 (19193)	21.89	21.82	21.93	
		1880 (18900)	21.78	21.82	21.89	
		1850.7 (18607)	21.84	21.85	21.90	
	6RB (0)	1909.3 (19193)	21.92	21.97	20.88	
		1880 (18900)	21.81	21.87	20.77	
		1850.7 (18607)	21.82	21.92	20.79	
	3MHz	1RB-High (14)	1908.5 (19185)	21.85	22.12	21.94
			1880 (18900)	21.79	22.05	21.93
			1851.5 (18615)	21.76	22.04	21.95
1RB-Middle (7)		1908.5 (19185)	22.02	22.17	22.14	
		1880 (18900)	21.90	22.08	21.99	
		1851.5 (18615)	21.86	22.21	22.09	
1RB-Low (0)		1908.5 (19185)	21.86	22.09	21.93	
		1880 (18900)	21.76	21.97	21.88	
		1851.5 (18615)	21.80	22.06	21.96	
8RB-High (7)		1908.5 (19185)	21.86	21.92	20.87	
		1880 (18900)	21.74	21.83	20.78	
		1851.5 (18615)	21.77	21.85	20.78	
8RB-Middle (4)		1908.5 (19185)	21.91	21.92	20.91	
		1880 (18900)	21.78	21.84	20.82	
		1851.5 (18615)	21.79	21.83	20.81	
8RB-Low (0)		1908.5 (19185)	21.89	21.93	20.91	
		1880 (18900)	21.76	21.81	20.80	
		1851.5 (18615)	21.80	21.85	20.82	
15RB (0)		1908.5 (19185)	21.88	21.89	20.88	
		1880 (18900)	21.77	21.77	20.77	
		1851.5 (18615)	21.76	21.76	20.74	



5MHz	1RB-High (24)	1907.5 (19175)	21.82	22.06	21.95
		1880 (18900)	21.78	21.91	21.94
		1852.5 (18625)	21.69	21.92	21.91
	1RB-Middle (12)	1907.5 (19175)	22.01	22.18	22.06
		1880 (18900)	21.93	22.09	22.03
		1852.5 (18625)	21.89	22.01	22.12
	1RB-Low (0)	1907.5 (19175)	21.85	22.07	21.90
		1880 (18900)	21.74	22.04	21.88
		1852.5 (18625)	21.79	22.07	21.97
	12RB-High (13)	1907.5 (19175)	21.89	21.86	20.83
		1880 (18900)	21.81	21.78	20.82
		1852.5 (18625)	21.79	21.75	20.77
	12RB-Middle (6)	1907.5 (19175)	21.95	21.90	20.94
		1880 (18900)	21.84	21.82	20.82
		1852.5 (18625)	21.83	21.78	20.81
	12RB-Low (0)	1907.5 (19175)	21.93	21.89	20.89
		1880 (18900)	21.79	21.77	20.78
		1852.5 (18625)	21.78	21.72	20.75
	25RB (0)	1907.5 (19175)	21.92	21.92	20.90
		1880 (18900)	21.84	21.83	20.83
		1852.5 (18625)	21.79	21.81	20.74
10MHz	1RB-High (49)	1905 (19150)	21.86	22.07	21.99
		1880 (18900)	21.80	21.99	22.01
		1855 (18650)	21.72	22.04	21.82
	1RB-Middle (24)	1905 (19150)	21.98	22.24	22.02
		1880 (18900)	21.90	22.06	21.97
		1855 (18650)	21.83	22.11	21.97
	1RB-Low (0)	1905 (19150)	21.88	22.09	21.95
		1880 (18900)	21.79	21.99	21.97
		1855 (18650)	21.83	22.13	21.97
	25RB-High (25)	1905 (19150)	21.93	21.88	20.89
		1880 (18900)	21.91	21.89	20.88
		1855 (18650)	21.82	21.81	20.81
	25RB-Middle (12)	1905 (19150)	21.99	21.95	20.93
		1880 (18900)	21.85	21.84	20.83
		1855 (18650)	21.82	21.81	20.80
	25RB-Low (0)	1905 (19150)	22.06	22.03	21.00
		1880 (18900)	21.85	21.83	20.81
		1855 (18650)	21.80	21.78	20.79
	50RB (0)	1905 (19150)	22.00	21.97	20.95
		1880 (18900)	21.86	21.87	20.84
		1855 (18650)	21.80	21.82	20.76



15MHz	1RB-High (74)	1902.5 (19125)	21.89	22.10	22.00
		1880 (18900)	21.82	22.14	21.99
		1857.5 (18675)	21.70	21.95	21.83
	1RB-Middle (37)	1902.5 (19125)	21.87	22.07	22.02
		1880 (18900)	21.78	22.03	21.95
		1857.5 (18675)	21.75	21.92	21.91
	1RB-Low (0)	1902.5 (19125)	21.90	22.15	21.97
		1880 (18900)	21.76	22.06	21.92
		1857.5 (18675)	21.84	22.18	21.97
	36RB-High (38)	1902.5 (19125)	21.93	21.87	20.88
		1880 (18900)	21.90	21.84	20.86
		1857.5 (18675)	21.80	21.77	20.74
	36RB-Middle (19)	1902.5 (19125)	22.00	21.91	20.93
		1880 (18900)	21.86	21.83	20.80
		1857.5 (18675)	21.82	21.81	20.80
	36RB-Low (0)	1902.5 (19125)	21.99	21.91	20.90
		1880 (18900)	21.84	21.82	20.81
		1857.5 (18675)	21.82	21.80	20.75
	75RB (0)	1902.5 (19125)	21.98	21.93	20.91
		1880 (18900)	21.87	21.85	20.82
		1857.5 (18675)	21.82	21.79	20.74
20MHz	1RB-High (99)	1900 (19100)	21.95	22.09	22.02
		1880 (18900)	21.89	22.14	21.97
		1860 (18700)	21.78	22.07	21.97
	1RB-Middle (50)	1900 (19100)	22.04	22.16	22.04
		1880 (18900)	21.94	22.16	22.01
		1860 (18700)	21.97	22.25	22.02
	1RB-Low (0)	1900 (19100)	21.98	22.19	22.08
		1880 (18900)	21.83	22.02	21.92
		1860 (18700)	21.90	22.20	21.97
	50RB-High (50)	1900 (19100)	21.93	21.87	20.83
		1880 (18900)	22.03	21.98	20.96
		1860 (18700)	21.81	21.79	20.74
	50RB-Middle (25)	1900 (19100)	22.05	22.00	20.97
		1880 (18900)	21.97	21.92	20.91
		1860 (18700)	21.88	21.85	20.82
	50RB-Low (0)	1900 (19100)	22.09	22.03	20.96
		1880 (18900)	21.92	21.88	20.86
		1860 (18700)	21.82	21.81	20.74
	100RB (0)	1900 (19100)	21.98	21.89	20.89
		1880 (18900)	21.95	21.90	20.89
		1860 (18700)	21.81	21.79	20.71

LTE Band4(Power Level A1)

BANDWIDTH	Number of RBs	Frequency	QPSK	16QAM	64QAM	
1.4MHz	1RB-High (5)	1754.3 (20393)	23.37	22.67	21.46	
		1732.5 (20175)	23.48	22.75	21.63	
		1710.7 (19957)	23.75	22.94	21.84	
	1RB-Middle (3)	1754.3 (20393)	23.46	22.72	21.54	
		1732.5 (20175)	23.50	22.90	21.77	
		1710.7 (19957)	23.80	22.98	21.94	
	1RB-Low (0)	1754.3 (20393)	23.35	22.55	21.54	
		1732.5 (20175)	23.45	22.72	21.62	
		1710.7 (19957)	23.73	22.92	21.83	
	3RB-High (3)	1754.3 (20393)	23.45	22.37	21.50	
		1732.5 (20175)	23.59	22.60	21.59	
		1710.7 (19957)	23.82	22.82	21.83	
	3RB-Middle (1)	1754.3 (20393)	23.51	22.42	21.55	
		1732.5 (20175)	23.63	22.64	21.67	
		1710.7 (19957)	23.83	22.79	21.94	
	3RB-Low (0)	1754.3 (20393)	23.49	22.41	21.52	
		1732.5 (20175)	23.57	22.58	21.68	
		1710.7 (19957)	23.82	22.75	21.87	
	6RB (0)	1754.3 (20393)	22.48	21.53	20.46	
		1732.5 (20175)	22.57	21.64	20.55	
		1710.7 (19957)	22.85	21.85	20.82	
	3MHz	1RB-High (14)	1753.5 (20385)	23.44	22.62	21.64
			1732.5 (20175)	23.55	22.82	21.71
			1711.5 (19965)	23.79	22.96	21.89
		1RB-Middle (7)	1753.5 (20385)	23.53	22.84	21.76
			1732.5 (20175)	23.65	22.96	21.83
			1711.5 (19965)	23.97	23.05	21.98
1RB-Low (0)		1753.5 (20385)	23.41	22.57	21.52	
		1732.5 (20175)	23.55	22.84	21.69	
		1711.5 (19965)	23.80	22.95	21.89	
8RB-High (7)		1753.5 (20385)	22.46	21.47	20.44	
		1732.5 (20175)	22.58	21.59	20.60	
		1711.5 (19965)	22.77	21.83	20.82	
8RB-Middle (4)		1753.5 (20385)	22.43	21.47	20.46	
		1732.5 (20175)	22.61	21.66	20.63	
		1711.5 (19965)	22.85	21.87	20.85	
8RB-Low (0)		1753.5 (20385)	22.46	21.45	20.48	
		1732.5 (20175)	22.56	21.62	20.65	
		1711.5 (19965)	22.82	21.88	20.81	
15RB (0)		1753.5 (20385)	22.44	21.44	20.43	
		1732.5 (20175)	22.56	21.56	20.57	
		1711.5 (19965)	22.84	21.80	20.84	

5MHz	1RB-High (24)	1752.5 (20375)	23.40	22.63	21.54	
		1732.5 (20175)	23.49	22.82	21.67	
		1712.5 (19975)	23.74	22.95	21.86	
	1RB-Middle (12)	1752.5 (20375)	23.54	22.76	21.73	
		1732.5 (20175)	23.69	22.93	21.94	
		1712.5 (19975)	23.97	23.16	21.98	
	1RB-Low (0)	1752.5 (20375)	23.39	22.53	21.43	
		1732.5 (20175)	23.53	22.83	21.70	
		1712.5 (19975)	23.79	22.96	21.88	
	12RB-High (13)	1752.5 (20375)	22.42	21.41	20.43	
		1732.5 (20175)	22.58	21.55	20.60	
		1712.5 (19975)	22.81	21.76	20.78	
	12RB-Middle (6)	1752.5 (20375)	22.48	21.49	20.50	
		1732.5 (20175)	22.65	21.57	20.65	
		1712.5 (19975)	22.88	21.81	20.87	
	12RB-Low (0)	1752.5 (20375)	22.46	21.39	20.46	
		1732.5 (20175)	22.58	21.54	20.60	
		1712.5 (19975)	22.83	21.76	20.84	
	25RB (0)	1752.5 (20375)	22.44	21.43	20.45	
		1732.5 (20175)	22.58	21.56	20.59	
		1712.5 (19975)	22.85	21.80	20.82	
	10MHz	1RB-High (49)	1750 (20350)	23.44	22.68	21.51
			1732.5 (20175)	23.48	22.74	21.61
			1715 (20000)	23.70	22.88	21.79
1RB-Middle (24)		1750 (20350)	23.52	22.81	21.66	
		1732.5 (20175)	23.62	22.90	21.81	
		1715 (20000)	23.79	23.10	22.00	
1RB-Low (0)		1750 (20350)	23.48	22.69	21.60	
		1732.5 (20175)	23.59	22.95	21.76	
		1715 (20000)	23.80	23.06	21.92	
25RB-High (25)		1750 (20350)	22.45	21.43	20.43	
		1732.5 (20175)	22.63	21.61	20.61	
		1715 (20000)	22.79	21.76	20.80	
25RB-Middle (12)		1750 (20350)	22.48	21.47	20.48	
		1732.5 (20175)	22.60	21.59	20.64	
		1715 (20000)	22.85	21.80	20.86	
25RB-Low (0)		1750 (20350)	22.56	21.53	20.54	
		1732.5 (20175)	22.59	21.57	20.59	
		1715 (20000)	22.88	21.86	20.88	
50RB (0)		1750 (20350)	22.49	21.44	20.51	
		1732.5 (20175)	22.59	21.57	20.60	
		1715 (20000)	22.85	21.82	20.85	



15MHz	1RB-High (74)	1747.5 (20325)	23.39	22.67	21.59	
		1732.5 (20175)	23.50	22.72	21.60	
		1717.5 (20025)	23.61	22.96	21.70	
	1RB-Middle (37)	1747.5 (20325)	23.44	22.61	21.50	
		1732.5 (20175)	23.52	22.90	21.66	
		1717.5 (20025)	23.70	22.93	21.79	
	1RB-Low (0)	1747.5 (20325)	23.47	22.71	21.61	
		1732.5 (20175)	23.65	22.88	21.79	
		1717.5 (20025)	23.82	23.00	21.88	
	36RB-High (38)	1747.5 (20325)	22.44	21.37	20.43	
		1732.5 (20175)	22.59	21.55	20.60	
		1717.5 (20025)	22.78	21.72	20.76	
	36RB-Middle (19)	1747.5 (20325)	22.51	21.47	20.50	
		1732.5 (20175)	22.62	21.58	20.64	
		1717.5 (20025)	22.80	21.73	20.79	
	36RB-Low (0)	1747.5 (20325)	22.53	21.48	20.51	
		1732.5 (20175)	22.62	21.60	20.63	
		1717.5 (20025)	22.85	21.80	20.85	
	75RB (0)	1747.5 (20325)	22.51	21.46	20.47	
		1732.5 (20175)	22.60	21.57	20.58	
		1717.5 (20025)	22.82	21.76	20.79	
	20MHz	1RB-High (99)	1745 (20300)	23.41	22.66	21.57
			1732.5 (20175)	23.44	22.68	21.52
			1720 (20050)	23.52	22.71	21.69
		1RB-Middle (50)	1745 (20300)	23.56	22.71	21.61
			1732.5 (20175)	23.62	22.97	21.77
			1720 (20050)	23.80	23.04	21.88
1RB-Low (0)		1745 (20300)	23.51	22.71	21.65	
		1732.5 (20175)	23.64	23.02	21.85	
		1720 (20050)	23.79	23.02	21.91	
50RB-High (50)		1745 (20300)	22.41	21.37	20.41	
		1732.5 (20175)	22.64	21.61	20.59	
		1720 (20050)	22.73	21.72	20.72	
50RB-Middle (25)		1745 (20300)	22.54	21.51	20.51	
		1732.5 (20175)	22.62	21.59	20.64	
		1720 (20050)	22.80	21.77	20.80	
50RB-Low (0)		1745 (20300)	22.54	21.48	20.49	
		1732.5 (20175)	22.60	21.61	20.64	
		1720 (20050)	22.86	21.83	20.83	
100RB (0)		1745 (20300)	22.50	21.44	20.45	
		1732.5 (20175)	22.61	21.59	20.61	
		1720 (20050)	22.76	21.75	20.78	

LTE Band4(Power Level B1)

BANDWIDTH	Number of RBs	Frequency	QPSK	16QAM	64QAM	
1.4MHz	1RB-High (5)	1754.3 (20393)	21.70	21.89	21.86	
		1732.5 (20175)	21.66	21.93	21.87	
		1710.7 (19957)	21.75	21.98	21.86	
	1RB-Middle (3)	1754.3 (20393)	21.80	22.01	21.90	
		1732.5 (20175)	21.72	22.13	21.93	
		1710.7 (19957)	21.86	22.09	21.99	
	1RB-Low (0)	1754.3 (20393)	21.71	21.99	21.80	
		1732.5 (20175)	21.65	21.93	21.78	
		1710.7 (19957)	21.78	22.01	21.94	
	3RB-High (3)	1754.3 (20393)	21.79	21.71	21.81	
		1732.5 (20175)	21.75	21.68	21.75	
		1710.7 (19957)	21.85	21.75	21.96	
	3RB-Middle (1)	1754.3 (20393)	21.84	21.74	21.81	
		1732.5 (20175)	21.80	21.72	21.87	
		1710.7 (19957)	21.84	21.84	21.93	
	3RB-Low (0)	1754.3 (20393)	21.79	21.69	21.80	
		1732.5 (20175)	21.74	21.68	21.79	
		1710.7 (19957)	21.84	21.79	21.98	
	6RB (0)	1754.3 (20393)	21.80	21.83	20.76	
		1732.5 (20175)	21.72	21.82	20.72	
		1710.7 (19957)	21.86	21.95	20.89	
	3MHz	1RB-High (14)	1753.5 (20385)	21.78	22.05	21.94
			1732.5 (20175)	21.72	22.06	21.93
			1711.5 (19965)	21.87	22.00	21.94
		1RB-Middle (7)	1753.5 (20385)	21.84	22.13	22.01
			1732.5 (20175)	21.89	22.18	22.03
			1711.5 (19965)	21.92	22.16	22.04
1RB-Low (0)		1753.5 (20385)	21.79	21.99	21.90	
		1732.5 (20175)	21.75	22.03	21.93	
		1711.5 (19965)	21.88	22.00	21.96	
8RB-High (7)		1753.5 (20385)	21.78	21.78	20.81	
		1732.5 (20175)	21.76	21.79	20.76	
		1711.5 (19965)	21.83	21.90	20.87	
8RB-Middle (4)		1753.5 (20385)	21.83	21.81	20.81	
		1732.5 (20175)	21.77	21.85	20.77	
		1711.5 (19965)	21.87	21.90	20.91	
8RB-Low (0)		1753.5 (20385)	21.79	21.82	20.77	
		1732.5 (20175)	21.75	21.81	20.73	
		1711.5 (19965)	21.85	21.91	20.93	
15RB (0)		1753.5 (20385)	21.80	21.80	20.78	
		1732.5 (20175)	21.75	21.76	20.71	
		1711.5 (19965)	21.87	21.87	20.86	



5MHz	1RB-High (24)	1752.5 (20375)	21.76	22.06	21.91	
		1732.5 (20175)	21.70	22.09	21.92	
		1712.5 (19975)	21.83	22.10	21.94	
	1RB-Middle (12)	1752.5 (20375)	21.81	22.05	21.99	
		1732.5 (20175)	21.86	22.12	22.04	
		1712.5 (19975)	21.96	22.19	22.09	
	1RB-Low (0)	1752.5 (20375)	21.76	21.96	21.91	
		1732.5 (20175)	21.73	22.08	21.97	
		1712.5 (19975)	21.85	22.05	21.96	
	12RB-High (13)	1752.5 (20375)	21.79	21.77	20.78	
		1732.5 (20175)	21.79	21.76	20.77	
		1712.5 (19975)	21.88	21.87	20.90	
	12RB-Middle (6)	1752.5 (20375)	21.82	21.80	20.83	
		1732.5 (20175)	21.81	21.75	20.78	
		1712.5 (19975)	21.90	21.84	20.93	
	12RB-Low (0)	1752.5 (20375)	21.82	21.80	20.82	
		1732.5 (20175)	21.76	21.72	20.74	
		1712.5 (19975)	21.88	21.82	20.92	
	25RB (0)	1752.5 (20375)	21.82	21.84	20.80	
		1732.5 (20175)	21.80	21.79	20.77	
		1712.5 (19975)	21.90	21.86	20.88	
	10MHz	1RB-High (49)	1750 (20350)	21.73	22.00	21.86
			1732.5 (20175)	21.67	22.02	21.84
			1715 (20000)	21.82	22.05	21.92
1RB-Middle (24)		1750 (20350)	21.87	22.07	21.91	
		1732.5 (20175)	21.79	22.18	22.00	
		1715 (20000)	21.89	22.25	22.04	
1RB-Low (0)		1750 (20350)	21.74	21.95	21.82	
		1732.5 (20175)	21.77	22.08	21.97	
		1715 (20000)	21.84	22.04	21.98	
25RB-High (25)		1750 (20350)	21.80	21.81	20.80	
		1732.5 (20175)	21.83	21.79	20.80	
		1715 (20000)	21.89	21.91	20.93	
25RB-Middle (12)		1750 (20350)	21.87	21.84	20.84	
		1732.5 (20175)	21.80	21.79	20.78	
		1715 (20000)	21.92	21.89	20.89	
25RB-Low (0)		1750 (20350)	21.87	21.85	20.83	
		1732.5 (20175)	21.80	21.80	20.76	
		1715 (20000)	21.92	21.88	20.90	
50RB (0)		1750 (20350)	21.88	21.87	20.84	
		1732.5 (20175)	21.81	21.80	20.76	
		1715 (20000)	21.92	21.90	20.92	



15MHz	1RB-High (74)	1747.5 (20325)	21.73	21.92	21.85
		1732.5 (20175)	21.65	22.00	21.85
		1717.5 (20025)	21.74	22.11	21.89
	1RB-Middle (37)	1747.5 (20325)	21.71	21.89	21.81
		1732.5 (20175)	21.71	22.09	21.88
		1717.5 (20025)	21.80	22.13	21.89
	1RB-Low (0)	1747.5 (20325)	21.74	21.92	21.84
		1732.5 (20175)	21.78	22.15	21.97
		1717.5 (20025)	21.82	21.99	21.94
	36RB-High (38)	1747.5 (20325)	21.81	21.77	20.75
		1732.5 (20175)	21.82	21.78	20.77
		1717.5 (20025)	21.87	21.83	20.88
	36RB-Middle (19)	1747.5 (20325)	21.80	21.74	20.76
		1732.5 (20175)	21.79	21.76	20.75
		1717.5 (20025)	21.85	21.84	20.88
	36RB-Low (0)	1747.5 (20325)	21.82	21.78	20.77
		1732.5 (20175)	21.75	21.74	20.75
		1717.5 (20025)	21.89	21.86	20.91
	75RB (0)	1747.5 (20325)	21.80	21.76	20.74
		1732.5 (20175)	21.78	21.76	20.73
		1717.5 (20025)	21.87	21.85	20.83
20MHz	1RB-High (99)	1745 (20300)	21.72	21.88	21.86
		1732.5 (20175)	21.68	21.97	21.84
		1720 (20050)	21.69	21.95	21.89
	1RB-Middle (50)	1745 (20300)	21.79	22.01	21.95
		1732.5 (20175)	21.81	22.09	22.02
		1720 (20050)	21.96	22.21	22.00
	1RB-Low (0)	1745 (20300)	21.72	21.85	21.80
		1732.5 (20175)	21.79	22.14	22.03
		1720 (20050)	21.79	22.11	21.97
	50RB-High (50)	1745 (20300)	21.78	21.73	20.69
		1732.5 (20175)	21.83	21.80	20.79
		1720 (20050)	21.87	21.88	20.84
	50RB-Middle (25)	1745 (20300)	21.82	21.79	20.76
		1732.5 (20175)	21.79	21.76	20.76
		1720 (20050)	21.89	21.86	20.87
	50RB-Low (0)	1745 (20300)	21.83	21.78	20.78
		1732.5 (20175)	21.84	21.73	20.72
		1720 (20050)	21.89	21.87	20.93
	100RB (0)	1745 (20300)	21.75	21.71	20.70
		1732.5 (20175)	21.78	21.74	20.74
		1720 (20050)	21.85	21.84	20.86

LTE Band4(Power Level C1)

BANDWIDTH	Number of RBs	Frequency	QPSK	16QAM	64QAM	
1.4MHz	1RB-High (5)	1754.3 (20393)	20.69	20.90	20.85	
		1732.5 (20175)	20.67	21.03	20.82	
		1710.7 (19957)	20.78	20.99	20.94	
	1RB-Middle (3)	1754.3 (20393)	20.78	21.10	20.86	
		1732.5 (20175)	20.73	21.06	20.95	
		1710.7 (19957)	20.93	21.18	21.00	
	1RB-Low (0)	1754.3 (20393)	20.69	20.98	20.81	
		1732.5 (20175)	20.65	21.06	20.83	
		1710.7 (19957)	20.81	20.99	20.96	
	3RB-High (3)	1754.3 (20393)	20.79	20.77	20.88	
		1732.5 (20175)	20.73	20.75	20.78	
		1710.7 (19957)	20.90	20.78	20.93	
	3RB-Middle (1)	1754.3 (20393)	20.81	20.73	20.84	
		1732.5 (20175)	20.76	20.76	20.83	
		1710.7 (19957)	20.92	20.85	20.96	
	3RB-Low (0)	1754.3 (20393)	20.78	20.71	20.81	
		1732.5 (20175)	20.73	20.69	20.79	
		1710.7 (19957)	20.88	20.87	20.99	
	6RB (0)	1754.3 (20393)	20.79	20.81	20.75	
		1732.5 (20175)	20.72	20.73	20.72	
		1710.7 (19957)	20.89	20.94	20.85	
	3MHz	1RB-High (14)	1753.5 (20385)	20.79	20.92	20.99
			1732.5 (20175)	20.74	20.95	20.91
			1711.5 (19965)	20.90	21.18	21.09
		1RB-Middle (7)	1753.5 (20385)	20.87	21.08	21.04
			1732.5 (20175)	20.86	21.19	21.05
			1711.5 (19965)	21.06	21.19	21.25
1RB-Low (0)		1753.5 (20385)	20.77	20.96	20.86	
		1732.5 (20175)	20.76	20.98	20.93	
		1711.5 (19965)	20.89	21.09	20.99	
8RB-High (7)		1753.5 (20385)	20.78	20.80	20.77	
		1732.5 (20175)	20.69	20.76	20.74	
		1711.5 (19965)	20.89	20.91	20.86	
8RB-Middle (4)		1753.5 (20385)	20.79	20.82	20.79	
		1732.5 (20175)	20.75	20.78	20.75	
		1711.5 (19965)	20.91	20.95	20.89	
8RB-Low (0)		1753.5 (20385)	20.79	20.84	20.80	
		1732.5 (20175)	20.71	20.76	20.73	
		1711.5 (19965)	20.89	20.91	20.91	
15RB (0)		1753.5 (20385)	20.78	20.78	20.75	
		1732.5 (20175)	20.73	20.70	20.73	
		1711.5 (19965)	20.90	20.87	20.85	



5MHz	1RB-High (24)	1752.5 (20375)	20.76	20.93	20.86	
		1732.5 (20175)	20.70	20.96	20.89	
		1712.5 (19975)	20.85	21.17	20.95	
	1RB-Middle (12)	1752.5 (20375)	20.92	21.18	21.02	
		1732.5 (20175)	20.84	21.27	21.11	
		1712.5 (19975)	21.03	21.17	21.19	
	1RB-Low (0)	1752.5 (20375)	20.74	21.02	20.85	
		1732.5 (20175)	20.73	21.13	20.97	
		1712.5 (19975)	20.88	21.19	20.96	
	12RB-High (13)	1752.5 (20375)	20.79	20.75	20.78	
		1732.5 (20175)	20.78	20.73	20.74	
		1712.5 (19975)	20.90	20.86	20.88	
	12RB-Middle (6)	1752.5 (20375)	20.85	20.85	20.82	
		1732.5 (20175)	20.77	20.73	20.76	
		1712.5 (19975)	20.91	20.89	20.88	
	12RB-Low (0)	1752.5 (20375)	20.82	20.81	20.80	
		1732.5 (20175)	20.75	20.70	20.73	
		1712.5 (19975)	20.90	20.84	20.88	
	25RB (0)	1752.5 (20375)	20.81	20.81	20.79	
		1732.5 (20175)	20.77	20.73	20.76	
		1712.5 (19975)	20.91	20.88	20.88	
	10MHz	1RB-High (49)	1750 (20350)	20.76	21.01	20.81
			1732.5 (20175)	20.69	20.95	20.81
			1715 (20000)	20.78	21.10	21.04
1RB-Middle (24)		1750 (20350)	20.82	21.13	20.96	
		1732.5 (20175)	20.84	21.16	21.05	
		1715 (20000)	20.97	21.20	21.04	
1RB-Low (0)		1750 (20350)	20.74	21.01	20.89	
		1732.5 (20175)	20.72	20.99	20.97	
		1715 (20000)	20.87	21.08	21.07	
25RB-High (25)		1750 (20350)	20.79	20.81	20.75	
		1732.5 (20175)	20.80	20.80	20.79	
		1715 (20000)	20.90	20.91	20.91	
25RB-Middle (12)		1750 (20350)	20.84	20.82	20.81	
		1732.5 (20175)	20.80	20.78	20.77	
		1715 (20000)	20.93	20.89	20.88	
25RB-Low (0)		1750 (20350)	20.88	20.87	20.84	
		1732.5 (20175)	20.74	20.77	20.76	
		1715 (20000)	20.94	20.93	20.93	
50RB (0)		1750 (20350)	20.85	20.83	20.80	
		1732.5 (20175)	20.80	20.80	20.77	
		1715 (20000)	20.94	20.92	20.89	

15MHz	1RB-High (74)	1747.5 (20325)	20.72	21.07	20.89
		1732.5 (20175)	20.67	20.94	20.90
		1717.5 (20025)	20.73	21.04	20.95
	1RB-Middle (37)	1747.5 (20325)	20.71	20.96	20.94
		1732.5 (20175)	20.72	21.09	20.90
		1717.5 (20025)	20.84	21.06	20.95
	1RB-Low (0)	1747.5 (20325)	20.74	20.92	20.83
		1732.5 (20175)	20.75	21.11	21.08
		1717.5 (20025)	20.86	21.13	21.01
	36RB-High (38)	1747.5 (20325)	20.77	20.73	20.76
		1732.5 (20175)	20.81	20.76	20.77
		1717.5 (20025)	20.87	20.83	20.83
	36RB-Middle (19)	1747.5 (20325)	20.80	20.75	20.76
		1732.5 (20175)	20.79	20.74	20.74
		1717.5 (20025)	20.89	20.86	20.84
	36RB-Low (0)	1747.5 (20325)	20.81	20.77	20.78
		1732.5 (20175)	20.77	20.73	20.77
		1717.5 (20025)	20.93	20.87	20.89
	75RB (0)	1747.5 (20325)	20.77	20.75	20.74
		1732.5 (20175)	20.78	20.73	20.71
		1717.5 (20025)	20.90	20.86	20.85
20MHz	1RB-High (99)	1745 (20300)	20.74	21.02	20.84
		1732.5 (20175)	20.72	21.01	20.93
		1720 (20050)	20.69	20.97	20.89
	1RB-Middle (50)	1745 (20300)	20.84	21.14	20.93
		1732.5 (20175)	20.83	21.04	20.97
		1720 (20050)	20.84	21.16	21.03
	1RB-Low (0)	1745 (20300)	20.70	21.02	20.81
		1732.5 (20175)	20.79	20.99	20.95
		1720 (20050)	20.86	21.17	21.01
	50RB-High (50)	1745 (20300)	20.71	20.68	20.70
		1732.5 (20175)	20.81	20.79	20.79
		1720 (20050)	20.86	20.83	20.82
	50RB-Middle (25)	1745 (20300)	20.79	20.80	20.78
		1732.5 (20175)	20.80	20.78	20.75
		1720 (20050)	20.87	20.86	20.82
	50RB-Low (0)	1745 (20300)	20.78	20.78	20.78
		1732.5 (20175)	20.71	20.72	20.71
		1720 (20050)	20.92	20.90	20.89
	100RB (0)	1745 (20300)	20.75	20.72	20.70
		1732.5 (20175)	20.76	20.72	20.73
		1720 (20050)	20.87	20.84	20.83

LTE Band5(Power Level A1/B1/C1)

BANDWIDTH	Number of RBs	Frequency	QPSK	16QAM	64QAM
1.4MHz	1RB-High (5)	848.3 (20643)	23.94	23.11	22.00
		836.5 (20525)	23.87	23.07	21.94
		824.7 (20407)	23.77	22.96	21.92
	1RB-Middle (3)	848.3 (20643)	24.07	23.19	22.11
		836.5 (20525)	23.94	23.18	22.05
		824.7 (20407)	23.86	23.08	21.94
	1RB-Low (0)	848.3 (20643)	23.93	23.08	22.06
		836.5 (20525)	23.84	23.12	22.00
		824.7 (20407)	23.74	23.02	21.90
	3RB-High (3)	848.3 (20643)	24.02	22.95	22.07
		836.5 (20525)	23.95	22.93	22.07
		824.7 (20407)	23.85	22.84	21.87
	3RB-Middle (1)	848.3 (20643)	24.10	22.99	22.13
		836.5 (20525)	23.99	22.98	22.08
		824.7 (20407)	23.89	22.84	21.93
	3RB-Low (0)	848.3 (20643)	24.07	23.03	22.13
		836.5 (20525)	23.94	22.90	22.07
		824.7 (20407)	23.84	22.84	21.92
	6RB (0)	848.3 (20643)	23.08	22.16	20.97
		836.5 (20525)	22.97	22.05	20.94
		824.7 (20407)	22.83	21.89	20.86
3MHz	1RB-High (14)	847.5 (20635)	24.00	23.14	22.15
		836.5 (20525)	23.93	23.15	22.07
		825.5 (20415)	23.82	23.04	21.96
	1RB-Middle (7)	847.5 (20635)	24.11	23.35	22.20
		836.5 (20525)	24.03	23.21	22.23
		825.5 (20415)	23.91	23.20	22.08
	1RB-Low (0)	847.5 (20635)	24.00	23.22	22.20
		836.5 (20525)	23.92	23.15	22.09
		825.5 (20415)	23.78	22.99	21.97
	8RB-High (7)	847.5 (20635)	23.01	22.02	20.96
		836.5 (20525)	22.93	21.98	20.92
		825.5 (20415)	22.80	21.88	20.86
	8RB-Middle (4)	847.5 (20635)	23.07	22.09	21.02
		836.5 (20525)	22.95	22.02	20.94
		825.5 (20415)	22.82	21.90	20.90
	8RB-Low (0)	847.5 (20635)	23.03	22.07	21.00
		836.5 (20525)	22.93	21.97	20.91
		825.5 (20415)	22.77	21.84	20.85
	15RB (0)	847.5 (20635)	23.04	22.03	20.97
		836.5 (20525)	22.95	21.93	20.90
		825.5 (20415)	22.76	21.79	20.80

5MHz	1RB-High (24)	846.5 (20625)	23.96	23.16	22.02	
		836.5 (20525)	23.91	23.18	22.02	
		826.5 (20425)	23.79	23.12	21.96	
	1RB-Middle (12)	846.5 (20625)	24.09	23.36	22.25	
		836.5 (20525)	24.01	23.26	22.21	
		826.5 (20425)	23.95	23.12	22.09	
	1RB-Low (0)	846.5 (20625)	23.96	23.23	22.16	
		836.5 (20525)	23.88	23.07	22.06	
		826.5 (20425)	23.76	22.92	21.91	
	12RB-High (13)	846.5 (20625)	23.03	21.97	20.96	
		836.5 (20525)	22.95	21.97	20.93	
		826.5 (20425)	22.89	21.82	20.84	
	12RB-Middle (6)	846.5 (20625)	23.07	22.04	21.02	
		836.5 (20525)	23.00	21.98	20.96	
		826.5 (20425)	22.86	21.86	20.87	
	12RB-Low (0)	846.5 (20625)	23.03	22.03	20.97	
		836.5 (20525)	22.95	21.96	20.93	
		826.5 (20425)	22.78	21.72	20.84	
	25RB (0)	846.5 (20625)	23.06	22.03	20.98	
		836.5 (20525)	22.98	21.97	20.94	
		826.5 (20425)	22.82	21.83	20.85	
	10MHz	1RB-High (49)	844 (20600)	23.99	23.17	22.07
			836.5 (20525)	23.95	23.17	22.07
			829 (20450)	23.82	23.12	22.00
1RB-Middle (24)		844 (20600)	24.01	23.17	22.16	
		836.5 (20525)	23.97	23.23	22.06	
		829 (20450)	23.87	23.16	21.98	
1RB-Low (0)		844 (20600)	23.93	23.10	22.14	
		836.5 (20525)	23.87	23.12	22.02	
		829 (20450)	23.77	23.11	21.93	
25RB-High (25)		844 (20600)	23.01	22.01	20.99	
		836.5 (20525)	22.95	21.98	20.96	
		829 (20450)	22.85	21.84	20.81	
25RB-Middle (12)		844 (20600)	23.07	22.05	21.01	
		836.5 (20525)	22.97	21.97	20.95	
		829 (20450)	22.85	21.83	20.84	
25RB-Low (0)		844 (20600)	23.00	22.01	21.01	
		836.5 (20525)	22.96	21.94	20.93	
		829 (20450)	22.82	21.83	20.84	
50RB (0)		844 (20600)	23.02	22.02	21.01	
		836.5 (20525)	22.98	21.94	20.95	
		829 (20450)	22.83	21.83	20.82	

LTE Band12(Power Level A1/B1/C1)

BANDWIDTH	Number of RBs	Frequency	QPSK	16QAM	64QAM	
1.4MHz	1RB-High (5)	715.3 (23173)	23.88	23.00	22.09	
		707.5 (23095)	23.77	22.95	22.02	
		699.7 (23017)	23.72	23.06	21.87	
	1RB-Middle (3)	715.3 (23173)	24.00	23.11	22.11	
		707.5 (23095)	23.85	23.09	22.15	
		699.7 (23017)	23.81	23.07	21.97	
	1RB-Low (0)	715.3 (23173)	23.90	23.03	22.09	
		707.5 (23095)	23.80	23.00	22.03	
		699.7 (23017)	23.69	22.95	21.92	
	3RB-High (3)	715.3 (23173)	24.01	22.98	22.10	
		707.5 (23095)	23.87	22.88	22.00	
		699.7 (23017)	23.86	22.82	21.97	
	3RB-Middle (1)	715.3 (23173)	24.06	23.01	22.11	
		707.5 (23095)	23.93	22.92	22.10	
		699.7 (23017)	23.84	22.83	21.99	
	3RB-Low (0)	715.3 (23173)	24.01	22.91	22.10	
		707.5 (23095)	23.89	22.92	22.02	
		699.7 (23017)	23.78	22.82	21.89	
	6RB (0)	715.3 (23173)	23.02	22.12	21.04	
		707.5 (23095)	22.93	22.05	20.95	
		699.7 (23017)	22.83	21.94	20.79	
	3MHz	1RB-High (14)	714.5 (23165)	23.87	23.11	22.14
			707.5 (23095)	23.83	23.09	22.02
			700.5 (23025)	23.78	22.99	22.00
1RB-Middle (7)		714.5 (23165)	24.02	23.32	22.15	
		707.5 (23095)	23.93	23.22	22.22	
		700.5 (23025)	23.88	23.12	22.12	
1RB-Low (0)		714.5 (23165)	23.88	23.15	22.09	
		707.5 (23095)	23.83	23.12	22.05	
		700.5 (23025)	23.73	22.96	21.97	
8RB-High (7)		714.5 (23165)	22.95	22.03	21.00	
		707.5 (23095)	22.83	21.96	20.93	
		700.5 (23025)	22.80	21.91	20.82	
8RB-Middle (4)		714.5 (23165)	22.96	22.06	21.05	
		707.5 (23095)	22.85	21.99	20.97	
		700.5 (23025)	22.82	21.93	20.87	
8RB-Low (0)		714.5 (23165)	22.93	22.03	21.02	
		707.5 (23095)	22.84	21.98	20.93	
		700.5 (23025)	22.74	21.86	20.78	
15RB (0)		714.5 (23165)	22.92	21.96	20.97	
		707.5 (23095)	22.83	21.90	20.90	
		700.5 (23025)	22.77	21.81	20.77	



5MHz	1RB-High (24)	713.5 (23155)	23.84	23.05	22.03	
		707.5 (23095)	23.78	23.07	22.05	
		701.5 (23035)	23.79	23.02	21.98	
	1RB-Middle (12)	713.5 (23155)	24.00	23.21	22.27	
		707.5 (23095)	23.91	23.18	22.14	
		701.5 (23035)	23.97	23.19	22.11	
	1RB-Low (0)	713.5 (23155)	23.82	22.97	22.05	
		707.5 (23095)	23.82	23.13	22.05	
		701.5 (23035)	23.74	22.92	21.99	
	12RB-High (13)	713.5 (23155)	22.93	21.97	20.98	
		707.5 (23095)	22.86	21.89	20.91	
		701.5 (23035)	22.83	21.88	20.91	
	12RB-Middle (6)	713.5 (23155)	22.97	22.00	20.99	
		707.5 (23095)	22.88	21.96	20.98	
		701.5 (23035)	22.89	21.93	20.93	
	12RB-Low (0)	713.5 (23155)	22.97	21.96	20.98	
		707.5 (23095)	22.87	21.92	20.94	
		701.5 (23035)	22.81	21.83	20.85	
	25RB (0)	713.5 (23155)	22.97	22.04	21.01	
		707.5 (23095)	22.83	21.91	20.92	
		701.5 (23035)	22.84	21.87	20.88	
	10MHz	1RB-High (49)	711 (23130)	23.88	23.07	22.02
			707.5 (23095)	23.84	23.11	22.06
			704 (23060)	23.80	22.97	22.03
1RB-Middle (24)		711 (23130)	23.93	23.21	22.09	
		707.5 (23095)	23.97	23.11	22.13	
		704 (23060)	23.90	23.13	22.10	
1RB-Low (0)		711 (23130)	23.85	23.13	22.10	
		707.5 (23095)	23.82	23.07	22.09	
		704 (23060)	23.76	22.99	21.97	
25RB-High (25)		711 (23130)	22.94	22.00	20.97	
		707.5 (23095)	22.85	21.95	20.91	
		704 (23060)	22.94	22.02	21.01	
25RB-Middle (12)		711 (23130)	22.94	21.98	20.99	
		707.5 (23095)	22.91	21.99	20.97	
		704 (23060)	22.93	21.96	20.96	
25RB-Low (0)		711 (23130)	22.98	22.00	21.00	
		707.5 (23095)	22.88	21.95	20.95	
		704 (23060)	22.89	21.95	20.94	
50RB (0)		711 (23130)	22.97	21.97	20.99	
		707.5 (23095)	22.90	21.94	20.94	
		704 (23060)	22.98	22.00	20.99	

LTE Band13(Power Level A1/B1/C1)

BANDWIDTH	Number of RBs	Frequency	QPSK	16QAM	64QAM
5MHz	1RB-High (24)	784.5 (23255)	23.94	23.16	22.08
		782 (23230)	23.90	23.19	21.96
		779.5 (23205)	23.89	23.08	21.95
	1RB-Middle (12)	784.5 (23255)	24.09	23.35	22.09
		782 (23230)	24.05	23.24	22.12
		779.5 (23205)	24.11	23.19	22.19
	1RB-Low (0)	784.5 (23255)	23.95	23.09	22.02
		782 (23230)	23.91	23.06	21.99
		779.5 (23205)	23.86	22.87	21.78
	12RB-High (13)	784.5 (23255)	23.05	22.03	21.07
		782 (23230)	22.96	21.91	21.01
		779.5 (23205)	23.03	21.96	21.01
	12RB-Middle (6)	784.5 (23255)	23.06	22.06	21.08
		782 (23230)	23.04	21.99	21.05
		779.5 (23205)	23.01	21.92	21.00
	12RB-Low (0)	784.5 (23255)	23.05	22.00	21.03
		782 (23230)	22.93	21.88	20.96
		779.5 (23205)	22.86	21.78	20.81
	25RB (0)	784.5 (23255)	23.09	22.05	21.11
		782 (23230)	22.98	21.96	20.99
		779.5 (23205)	22.99	21.94	20.98
10MHz	1RB-High (49)	782 (23230)	23.97	23.24	22.15
	1RB-Middle (24)	782 (23230)	24.01	23.19	22.04
	1RB-Low (0)	782 (23230)	23.96	22.96	22.05
	25RB-High (25)	782 (23230)	23.04	22.02	21.03
	25RB-Middle (12)	782 (23230)	23.02	22.02	21.06
	25RB-Low (0)	782 (23230)	22.88	21.85	21.01
	50RB (0)	782 (23230)	22.97	21.95	21.01

LTE Band66(Power Level A1)

BANDWIDTH	Number of RBs	Frequency	QPSK	16QAM	64QAM
1.4MHz	1RB-High (5)	1779.3 (132665)	23.22	22.40	21.33
		1745 (132322)	23.38	22.51	21.46
		1710.7 (131979)	23.72	22.98	21.83
	1RB-Middle (3)	1779.3 (132665)	23.31	22.65	21.56
		1745 (132322)	23.47	22.64	21.49
		1710.7 (131979)	23.80	23.02	21.96
	1RB-Low (0)	1779.3 (132665)	23.23	22.56	21.40
		1745 (132322)	23.37	22.64	21.47
		1710.7 (131979)	23.73	22.95	21.81
	3RB-High (3)	1779.3 (132665)	23.33	22.26	21.37
		1745 (132322)	23.46	22.43	21.47
		1710.7 (131979)	23.81	22.70	21.81
	3RB-Middle (1)	1779.3 (132665)	23.36	22.37	21.42
		1745 (132322)	23.49	22.47	21.52
		1710.7 (131979)	23.87	22.82	21.91
	3RB-Low (0)	1779.3 (132665)	23.35	22.26	21.41
		1745 (132322)	23.44	22.35	21.47
		1710.7 (131979)	23.82	22.79	21.85
	6RB (0)	1779.3 (132665)	22.34	21.40	20.31
		1745 (132322)	22.46	21.53	20.45
		1710.7 (131979)	22.83	21.85	20.76
3MHz	1RB-High (14)	1778.5 (132657)	23.33	22.63	21.53
		1745 (132322)	23.43	22.74	21.52
		1711.5 (131987)	23.82	22.98	21.85
	1RB-Middle (7)	1778.5 (132657)	23.45	22.77	21.69
		1745 (132322)	23.60	22.77	21.68
		1711.5 (131987)	23.86	23.05	21.90
	1RB-Low (0)	1778.5 (132657)	23.35	22.58	21.48
		1745 (132322)	23.44	22.63	21.55
		1711.5 (131987)	23.80	22.99	21.89
	8RB-High (7)	1778.5 (132657)	22.32	21.39	20.36
		1745 (132322)	22.42	21.49	20.47
		1711.5 (131987)	22.79	21.85	20.79
	8RB-Middle (4)	1778.5 (132657)	22.34	21.40	20.39
		1745 (132322)	22.47	21.51	20.52
		1711.5 (131987)	22.82	21.85	20.86
	8RB-Low (0)	1778.5 (132657)	22.33	21.40	20.39
		1745 (132322)	22.47	21.50	20.49
		1711.5 (131987)	22.82	21.84	20.82
	15RB (0)	1778.5 (132657)	22.32	21.32	20.31
		1745 (132322)	22.44	21.46	20.48
		1711.5 (131987)	22.81	21.80	20.82

5MHz	1RB-High (24)	1777.5 (132647)	23.30	22.62	21.40
		1745 (132322)	23.39	22.66	21.53
		1712.5 (131997)	23.73	23.03	21.83
	1RB-Middle (12)	1777.5 (132647)	23.51	22.69	21.56
		1745 (132322)	23.60	22.88	21.62
		1712.5 (131997)	23.95	23.08	22.00
	1RB-Low (0)	1777.5 (132647)	23.34	22.67	21.51
		1745 (132322)	23.43	22.55	21.57
		1712.5 (131997)	23.78	22.94	21.90
	12RB-High (13)	1777.5 (132647)	22.34	21.32	20.37
		1745 (132322)	22.48	21.43	20.47
		1712.5 (131997)	22.82	21.76	20.81
	12RB-Middle (6)	1777.5 (132647)	22.42	21.39	20.44
		1745 (132322)	22.50	21.46	20.53
		1712.5 (131997)	22.86	21.81	20.86
	12RB-Low (0)	1777.5 (132647)	22.36	21.33	20.38
		1745 (132322)	22.48	21.45	20.51
		1712.5 (131997)	22.84	21.81	20.82
	25RB (0)	1777.5 (132647)	22.37	21.37	20.38
		1745 (132322)	22.47	21.49	20.48
		1712.5 (131997)	22.84	21.78	20.82
10MHz	1RB-High (49)	1775 (132622)	23.27	22.61	21.43
		1745 (132322)	23.44	22.61	21.40
		1715 (132022)	23.70	23.02	21.83
	1RB-Middle (24)	1775 (132622)	23.44	22.70	21.62
		1745 (132322)	23.52	22.74	21.54
		1715 (132022)	23.81	23.00	21.90
	1RB-Low (0)	1775 (132622)	23.37	22.71	21.53
		1745 (132322)	23.47	22.76	21.60
		1715 (132022)	23.81	22.97	21.86
	25RB-High (25)	1775 (132622)	22.39	21.40	20.39
		1745 (132322)	22.49	21.45	20.47
		1715 (132022)	22.82	21.77	20.81
	25RB-Middle (12)	1775 (132622)	22.43	21.42	20.40
		1745 (132322)	22.50	21.48	20.52
		1715 (132022)	22.83	21.79	20.82
	25RB-Low (0)	1775 (132622)	22.40	21.42	20.39
		1745 (132322)	22.56	21.53	20.56
		1715 (132022)	22.86	21.81	20.85
	50RB (0)	1775 (132622)	22.40	21.38	20.39
		1745 (132322)	22.56	21.52	20.54
		1715 (132022)	22.85	21.79	20.85

15MHz	1RB-High (74)	1772.5 (132597)	23.31	22.54	21.50
		1745 (132322)	23.45	22.60	21.53
		1717.5 (132047)	23.60	22.99	21.79
	1RB-Middle (37)	1772.5 (132597)	23.38	22.72	21.49
		1745 (132322)	23.45	22.60	21.55
		1717.5 (132047)	23.74	22.95	21.90
	1RB-Low (0)	1772.5 (132597)	23.41	22.71	21.63
		1745 (132322)	23.52	22.75	21.60
		1717.5 (132047)	23.84	22.98	21.96
	36RB-High (38)	1772.5 (132597)	22.42	21.38	20.40
		1745 (132322)	22.50	21.44	20.52
		1717.5 (132047)	22.78	21.71	20.77
	36RB-Middle (19)	1772.5 (132597)	22.44	21.41	20.43
		1745 (132322)	22.57	21.52	20.54
		1717.5 (132047)	22.84	21.78	20.81
	36RB-Low (0)	1772.5 (132597)	22.44	21.42	20.43
		1745 (132322)	22.58	21.50	20.58
		1717.5 (132047)	22.85	21.77	20.85
	75RB (0)	1772.5 (132597)	22.45	21.44	20.42
		1745 (132322)	22.51	21.49	20.53
		1717.5 (132047)	22.83	21.79	20.80
20MHz	1RB-High (99)	1770 (132572)	23.30	22.60	21.45
		1745 (132322)	23.44	22.59	21.55
		1720 (132072)	23.62	22.91	21.74
	1RB-Middle (50)	1770 (132572)	23.48	22.69	21.58
		1745 (132322)	23.49	22.67	21.64
		1720 (132072)	23.81	22.97	22.01
	1RB-Low (0)	1770 (132572)	23.43	22.78	21.60
		1745 (132322)	23.54	22.82	21.69
		1720 (132072)	23.81	23.07	21.91
	50RB-High (50)	1770 (132572)	22.43	21.45	20.43
		1745 (132322)	22.48	21.47	20.45
		1720 (132072)	22.76	21.75	20.79
	50RB-Middle (25)	1770 (132572)	22.47	21.46	20.46
		1745 (132322)	22.60	21.55	20.59
		1720 (132072)	22.84	21.78	20.83
	50RB-Low (0)	1770 (132572)	22.46	21.45	20.48
		1745 (132322)	22.59	21.54	20.57
		1720 (132072)	22.84	21.80	20.84
	100RB (0)	1770 (132572)	22.44	21.40	20.45
		1745 (132322)	22.52	21.49	20.50
		1720 (132072)	22.78	21.73	20.77

LTE Band66(Power Level B1)

BANDWIDTH	Number of RBs	Frequency	QPSK	16QAM	64QAM
1.4MHz	1RB-High (5)	1779.3 (132665)	21.95	22.31	22.13
		1745 (132322)	21.80	22.06	21.95
		1710.7 (131979)	21.90	22.17	22.01
	1RB-Middle (3)	1779.3 (132665)	22.09	22.27	22.21
		1745 (132322)	21.92	22.14	21.97
		1710.7 (131979)	21.95	22.18	22.13
	1RB-Low (0)	1779.3 (132665)	21.95	22.25	22.09
		1745 (132322)	21.82	22.00	21.91
		1710.7 (131979)	21.89	22.11	22.03
	3RB-High (3)	1779.3 (132665)	22.05	21.98	22.07
		1745 (132322)	21.90	21.86	21.91
		1710.7 (131979)	22.02	21.94	21.99
	3RB-Middle (1)	1779.3 (132665)	22.11	22.05	22.12
		1745 (132322)	21.96	21.92	21.96
		1710.7 (131979)	22.03	22.00	22.10
	3RB-Low (0)	1779.3 (132665)	22.06	22.02	22.10
		1745 (132322)	21.89	21.88	21.93
		1710.7 (131979)	22.02	21.90	22.03
	6RB (0)	1779.3 (132665)	22.05	22.13	21.02
		1745 (132322)	21.92	21.99	20.85
		1710.7 (131979)	22.01	22.07	21.00
3MHz	1RB-High (14)	1778.5 (132657)	22.05	22.33	22.17
		1745 (132322)	21.85	22.04	22.00
		1711.5 (131987)	22.00	22.20	22.18
	1RB-Middle (7)	1778.5 (132657)	22.12	22.38	22.30
		1745 (132322)	22.02	22.19	22.05
		1711.5 (131987)	22.10	22.36	22.20
	1RB-Low (0)	1778.5 (132657)	21.99	22.28	22.17
		1745 (132322)	21.89	22.16	22.00
		1711.5 (131987)	21.99	22.10	22.09
	8RB-High (7)	1778.5 (132657)	22.02	22.06	21.05
		1745 (132322)	21.88	21.90	20.90
		1711.5 (131987)	22.00	22.01	21.03
	8RB-Middle (4)	1778.5 (132657)	22.04	22.08	21.03
		1745 (132322)	21.89	21.95	20.89
		1711.5 (131987)	21.97	22.00	20.99
	8RB-Low (0)	1778.5 (132657)	22.03	22.02	21.03
		1745 (132322)	21.90	21.94	20.90
		1711.5 (131987)	21.98	22.03	20.99
	15RB (0)	1778.5 (132657)	22.02	22.01	20.96
		1745 (132322)	21.91	21.87	20.83
		1711.5 (131987)	22.00	21.98	20.96

5MHz	1RB-High (24)	1777.5 (132647)	22.00	22.30	22.15
		1745 (132322)	21.83	21.97	21.94
		1712.5 (131997)	21.96	22.19	22.12
	1RB-Middle (12)	1777.5 (132647)	22.08	22.37	22.28
		1745 (132322)	22.04	22.20	22.09
		1712.5 (131997)	22.13	22.36	22.23
	1RB-Low (0)	1777.5 (132647)	21.93	22.21	22.12
		1745 (132322)	21.85	22.07	22.01
		1712.5 (131997)	21.96	22.22	22.14
	12RB-High (13)	1777.5 (132647)	22.04	22.02	21.03
		1745 (132322)	21.90	21.84	20.89
		1712.5 (131997)	22.01	21.99	21.00
	12RB-Middle (6)	1777.5 (132647)	22.07	22.00	21.03
		1745 (132322)	21.96	21.89	20.92
		1712.5 (131997)	22.06	22.00	21.03
	12RB-Low (0)	1777.5 (132647)	22.04	21.99	21.02
		1745 (132322)	21.93	21.86	20.93
		1712.5 (131997)	22.01	21.95	20.99
	25RB (0)	1777.5 (132647)	22.03	22.02	20.99
		1745 (132322)	21.91	21.92	20.87
		1712.5 (131997)	22.04	22.03	21.01
10MHz	1RB-High (49)	1775 (132622)	22.01	22.34	22.16
		1745 (132322)	21.85	22.04	22.02
		1715 (132022)	21.98	22.24	22.11
	1RB-Middle (24)	1775 (132622)	22.04	22.34	22.18
		1745 (132322)	21.93	22.12	22.02
		1715 (132022)	22.05	22.24	22.16
	1RB-Low (0)	1775 (132622)	21.94	22.29	22.09
		1745 (132322)	21.90	22.21	22.06
		1715 (132022)	21.98	22.14	22.04
	25RB-High (25)	1775 (132622)	22.03	22.02	21.03
		1745 (132322)	21.93	21.91	20.88
		1715 (132022)	22.07	22.04	21.06
	25RB-Middle (12)	1775 (132622)	22.00	21.98	20.99
		1745 (132322)	21.96	21.91	20.92
		1715 (132022)	22.02	22.00	21.02
	25RB-Low (0)	1775 (132622)	22.00	21.98	21.00
		1745 (132322)	21.97	21.97	20.94
		1715 (132022)	22.07	22.05	21.04
	50RB (0)	1775 (132622)	22.02	21.99	21.01
		1745 (132322)	21.94	21.92	20.94
		1715 (132022)	22.11	22.06	21.07

15MHz	1RB-High (74)	1772.5 (132597)	21.98	22.20	22.07
		1745 (132322)	21.82	22.05	21.92
		1717.5 (132047)	21.96	22.32	22.16
	1RB-Middle (37)	1772.5 (132597)	21.96	22.25	22.12
		1745 (132322)	21.87	22.06	21.99
		1717.5 (132047)	21.97	22.27	22.12
	1RB-Low (0)	1772.5 (132597)	21.91	22.19	22.02
		1745 (132322)	21.89	22.10	22.06
		1717.5 (132047)	21.97	22.23	22.06
	36RB-High (38)	1772.5 (132597)	22.06	22.00	21.01
		1745 (132322)	21.92	21.84	20.89
		1717.5 (132047)	22.06	22.02	21.05
	36RB-Middle (19)	1772.5 (132597)	22.01	21.99	21.02
		1745 (132322)	21.96	21.89	20.92
		1717.5 (132047)	22.04	21.99	21.03
	36RB-Low (0)	1772.5 (132597)	22.01	21.96	20.97
		1745 (132322)	21.97	21.92	20.93
		1717.5 (132047)	22.06	21.99	21.01
	75RB (0)	1772.5 (132597)	22.00	21.98	20.97
		1745 (132322)	21.92	21.89	20.91
		1717.5 (132047)	22.06	22.02	21.02
20MHz	1RB-High (99)	1770 (132572)	21.96	22.24	22.09
		1745 (132322)	21.81	22.12	21.92
		1720 (132072)	21.87	22.12	22.06
	1RB-Middle (50)	1770 (132572)	22.03	22.22	22.22
		1745 (132322)	21.97	22.09	22.00
		1720 (132072)	22.06	22.26	22.14
	1RB-Low (0)	1770 (132572)	21.87	22.07	22.02
		1745 (132322)	21.87	22.17	22.08
		1720 (132072)	21.94	22.14	22.06
	50RB-High (50)	1770 (132572)	21.98	21.99	20.98
		1745 (132322)	21.82	21.86	20.81
		1720 (132072)	22.05	22.04	21.03
	50RB-Middle (25)	1770 (132572)	22.04	22.00	21.01
		1745 (132322)	21.96	21.96	20.93
		1720 (132072)	22.03	22.03	21.03
	50RB-Low (0)	1770 (132572)	22.03	22.02	21.00
		1745 (132322)	21.95	21.92	20.91
		1720 (132072)	22.05	22.05	21.04
	100RB (0)	1770 (132572)	22.00	22.00	20.96
		1745 (132322)	21.88	21.86	20.86
		1720 (132072)	22.03	22.01	20.99

LTE Band66(Power Level C1)

BANDWIDTH	Number of RBs	Frequency	QPSK	16QAM	64QAM
1.4MHz	1RB-High (5)	1779.3 (132665)	20.47	20.76	20.63
		1745 (132322)	20.32	20.65	20.46
		1710.7 (131979)	20.44	20.61	20.52
	1RB-Middle (3)	1779.3 (132665)	20.54	20.94	20.68
		1745 (132322)	20.40	20.65	20.51
		1710.7 (131979)	20.54	20.75	20.67
	1RB-Low (0)	1779.3 (132665)	20.48	20.83	20.65
		1745 (132322)	20.29	20.64	20.49
		1710.7 (131979)	20.44	20.62	20.56
	3RB-High (3)	1779.3 (132665)	20.57	20.51	20.61
		1745 (132322)	20.44	20.41	20.51
		1710.7 (131979)	20.46	20.48	20.55
	3RB-Middle (1)	1779.3 (132665)	20.61	20.63	20.64
		1745 (132322)	20.47	20.39	20.50
		1710.7 (131979)	20.56	20.54	20.65
	3RB-Low (0)	1779.3 (132665)	20.56	20.52	20.63
		1745 (132322)	20.42	20.35	20.49
		1710.7 (131979)	20.54	20.47	20.56
	6RB (0)	1779.3 (132665)	20.55	20.65	20.55
		1745 (132322)	20.42	20.49	20.39
		1710.7 (131979)	20.52	20.59	20.48
3MHz	1RB-High (14)	1778.5 (132657)	20.55	20.78	20.72
		1745 (132322)	20.40	20.65	20.63
		1711.5 (131987)	20.49	20.78	20.65
	1RB-Middle (7)	1778.5 (132657)	20.63	20.94	20.82
		1745 (132322)	20.54	20.75	20.67
		1711.5 (131987)	20.68	20.90	20.80
	1RB-Low (0)	1778.5 (132657)	20.51	20.86	20.68
		1745 (132322)	20.38	20.65	20.62
		1711.5 (131987)	20.55	20.77	20.61
	8RB-High (7)	1778.5 (132657)	20.54	20.59	20.60
		1745 (132322)	20.39	20.44	20.42
		1711.5 (131987)	20.51	20.57	20.54
	8RB-Middle (4)	1778.5 (132657)	20.56	20.60	20.56
		1745 (132322)	20.42	20.48	20.41
		1711.5 (131987)	20.50	20.52	20.53
	8RB-Low (0)	1778.5 (132657)	20.54	20.62	20.57
		1745 (132322)	20.42	20.46	20.43
		1711.5 (131987)	20.51	20.56	20.49
	15RB (0)	1778.5 (132657)	20.54	20.56	20.54
		1745 (132322)	20.40	20.38	20.37
		1711.5 (131987)	20.47	20.49	20.46

5MHz	1RB-High (24)	1777.5 (132647)	20.51	20.75	20.61	
		1745 (132322)	20.35	20.68	20.47	
		1712.5 (131997)	20.50	20.73	20.70	
	1RB-Middle (12)	1777.5 (132647)	20.67	20.90	20.73	
		1745 (132322)	20.47	20.67	20.67	
		1712.5 (131997)	20.66	20.90	20.80	
	1RB-Low (0)	1777.5 (132647)	20.48	20.80	20.59	
		1745 (132322)	20.37	20.59	20.52	
		1712.5 (131997)	20.50	20.63	20.65	
	12RB-High (13)	1777.5 (132647)	20.57	20.53	20.53	
		1745 (132322)	20.42	20.39	20.39	
		1712.5 (131997)	20.51	20.51	20.51	
	12RB-Middle (6)	1777.5 (132647)	20.58	20.54	20.55	
		1745 (132322)	20.47	20.43	20.44	
		1712.5 (131997)	20.59	20.55	20.57	
	12RB-Low (0)	1777.5 (132647)	20.53	20.51	20.50	
		1745 (132322)	20.43	20.40	20.43	
		1712.5 (131997)	20.51	20.45	20.50	
	25RB (0)	1777.5 (132647)	20.54	20.53	20.51	
		1745 (132322)	20.43	20.41	20.41	
		1712.5 (131997)	20.54	20.52	20.52	
	10MHz	1RB-High (49)	1775 (132622)	20.54	20.76	20.67
			1745 (132322)	20.40	20.62	20.57
			1715 (132022)	20.49	20.79	20.66
1RB-Middle (24)		1775 (132622)	20.55	20.82	20.70	
		1745 (132322)	20.46	20.64	20.62	
		1715 (132022)	20.59	20.87	20.71	
1RB-Low (0)		1775 (132622)	20.50	20.82	20.67	
		1745 (132322)	20.42	20.67	20.59	
		1715 (132022)	20.52	20.73	20.66	
25RB-High (25)		1775 (132622)	20.54	20.54	20.54	
		1745 (132322)	20.43	20.42	20.41	
		1715 (132022)	20.55	20.55	20.54	
25RB-Middle (12)		1775 (132622)	20.50	20.52	20.49	
		1745 (132322)	20.45	20.43	20.44	
		1715 (132022)	20.54	20.55	20.53	
25RB-Low (0)		1775 (132622)	20.51	20.53	20.48	
		1745 (132322)	20.47	20.47	20.45	
		1715 (132022)	20.57	20.54	20.53	
50RB (0)		1775 (132622)	20.52	20.50	20.51	
		1745 (132322)	20.47	20.44	20.44	
		1715 (132022)	20.60	20.59	20.58	

15MHz	1RB-High (74)	1772.5 (132597)	20.52	20.84	20.61
		1745 (132322)	20.36	20.67	20.48
		1717.5 (132047)	20.44	20.81	20.71
	1RB-Middle (37)	1772.5 (132597)	20.48	20.73	20.74
		1745 (132322)	20.40	20.75	20.51
		1717.5 (132047)	20.49	20.78	20.65
	1RB-Low (0)	1772.5 (132597)	20.43	20.75	20.56
		1745 (132322)	20.42	20.77	20.55
		1717.5 (132047)	20.47	20.73	20.66
	36RB-High (38)	1772.5 (132597)	20.58	20.52	20.53
		1745 (132322)	20.44	20.41	20.40
		1717.5 (132047)	20.57	20.54	20.57
	36RB-Middle (19)	1772.5 (132597)	20.53	20.51	20.50
		1745 (132322)	20.48	20.42	20.43
		1717.5 (132047)	20.56	20.52	20.54
	36RB-Low (0)	1772.5 (132597)	20.54	20.50	20.48
		1745 (132322)	20.47	20.40	20.46
		1717.5 (132047)	20.57	20.50	20.51
	75RB (0)	1772.5 (132597)	20.51	20.51	20.47
		1745 (132322)	20.45	20.42	20.40
		1717.5 (132047)	20.56	20.54	20.52
20MHz	1RB-High (99)	1770 (132572)	20.50	20.84	20.71
		1745 (132322)	20.36	20.70	20.50
		1720 (132072)	20.43	20.71	20.62
	1RB-Middle (50)	1770 (132572)	20.50	20.78	20.65
		1745 (132322)	20.44	20.73	20.56
		1720 (132072)	20.60	20.87	20.75
	1RB-Low (0)	1770 (132572)	20.41	20.64	20.57
		1745 (132322)	20.42	20.66	20.62
		1720 (132072)	20.50	20.80	20.64
	50RB-High (50)	1770 (132572)	20.49	20.49	20.51
		1745 (132322)	20.35	20.34	20.35
		1720 (132072)	20.56	20.54	20.53
	50RB-Middle (25)	1770 (132572)	20.54	20.52	20.51
		1745 (132322)	20.49	20.47	20.46
		1720 (132072)	20.55	20.52	20.52
	50RB-Low (0)	1770 (132572)	20.54	20.51	20.52
		1745 (132322)	20.45	20.46	20.43
		1720 (132072)	20.57	20.57	20.56
	100RB (0)	1770 (132572)	20.53	20.50	20.50
		1745 (132322)	20.40	20.38	20.37
		1720 (132072)	20.54	20.50	20.51



11.4 Wi-Fi and BT Measurement result

The maximum output power for BT

Maximum Transmit Power(<20dBm)	GFSK			Tune up	EDR2M-4_DQPSK			Tune up	EDR3M-8DPSK			Tune up
	Channel 0	Channel 39	Channel 78		Channel 0	Channel 39	Channel 78		Channel 0	Channel 39	Channel 78	
	10.91	10.74	11.82	12.00	10.23	9.99	11.18	11.50	10.23	10.00	11.18	11.50

WIFI2.4G Tune up(Power Level B1/C1)

WiFi 802.11b (2.4GHz)			
Channel	Channel 1	Channel 6	Channel 11
Target (dBm)	18.5	18.5	18.5
Tune-up(dB)	±1	±1	±1
WiFi 802.11g (2.4GHz)			
Channel	Channel 1	Channel 6	Channel 11
Target (dBm)	18	18	18
Tune-up(dB)	±1	±1	±1
WiFi 802.11n-20 (2.4GHz)			
Channel	Channel 1	Channel 6	Channel 11
Target (dBm)	18	18	18
Tune-up(dB)	±1	±1	±1

WIFI2.4G Tune up(Power Level A1)

WiFi 802.11b (2.4GHz)			
Channel	Channel 1	Channel 6	Channel 11
Target (dBm)	17.5	17.5	17.5
Tune-up(dB)	±1	±1	±1
WiFi 802.11g (2.4GHz)			
Channel	Channel 1	Channel 6	Channel 11
Target (dBm)	17	17	17
Tune-up(dB)	±1	±1	±1
WiFi 802.11n-20 (2.4GHz)			
Channel	Channel 1	Channel 6	Channel 11
Target (dBm)	17	17	17
Tune-up(dB)	±1	±1	±1

WiFi5G Tune up(Power Level A1)

WiFi 802.11a (5GHz) 6Mbps				
Channel	36~48	52~64	100~140	149~165
Target (dBm)	15	15	15.5	15.5
Tune-up(dB)	±1	±1	±1	±1
WiFi 802.11n-20 (5GHz) MCS0				
Channel	36~48	52~64	100~140	149~165
Target (dBm)	14.5	14.5	15	15
Tune-up(dB)	±1	±1	±1	±1
WiFi 802.11n-40 (5GHz) MCS0				
Channel	38~54	62~102	110~142	151~159
Target (dBm)	14.5	14.5	15	15
Tune-up(dB)	±1	±1	±1	±1
WiFi 802.11ac-20 (5GHz) MCS0				
Channel	36~48	52~64	100~140	149~165
Target (dBm)	14.5	14.5	15	15
Tune-up(dB)	±1	±1	±1	±1
WiFi 802.11ac-40 (5GHz) MCS0				
Channel	38~46	54~62	102~142	151~159
Target (dBm)	14.5	14.5	15	15
Tune-up(dB)	±1	±1	±1	±1
WiFi 802.11ac-80 (5GHz) MCS0				
Channel	42~106	122~138	155	
Target (dBm)	14.5	15	15.5	
Tune-up(dB)	±1	±1	±1	

WiFi5G Tune up(Power Level B1)

WiFi 802.11a (5GHz)				
Channel	36~48	52~64	100~140	149~165
Target (dBm)	17	17	17.5	17.5
Tune-up(dB)	±1	±1	±1	±1
WiFi 802.11n-20 (5GHz)				
Channel	36~48	52~64	100~140	149~165
Target (dBm)	17	16.5	17.5	17.5
Tune-up(dB)	±1	±1	±1	±1
WiFi 802.11n-40 (5GHz)				
Channel	38~54	62~102	110~142	151~159
Target (dBm)	16.5	15	17	17.5
Tune-up(dB)	±1	±1	±1	±1
WiFi 802.11ac-20 (5GHz)				
Channel	36~48	52~64	100~140	149~165
Target (dBm)	16.5	16.5	17.5	17.5
Tune-up(dB)	±1	±1	±1	±1
WiFi 802.11ac-40 (5GHz)				
Channel	38~46	54~62	102~142	151~159
Target (dBm)	16.5	16	16.5	17.5
Tune-up(dB)	±1	±1	±1	±1
WiFi 802.11ac-80 (5GHz)				
Channel	42~106	122~138	155	
Target (dBm)	14.5	17	17.5	
Tune-up(dB)	±1	±1	±1	

WiFi5G Tune up(Power Level C1)

WiFi 802.11a (5GHz) 6Mbps				
Channel	36~48	52~64	100~140	149~165
Target (dBm)	16	16	16.5	16.5
Tune-up(dB)	±1	±1	±1	±1
WiFi 802.11n-20 (5GHz) MCS0				
Channel	36~48	52~64	100~140	149~165
Target (dBm)	15.5	15.5	16	16
Tune-up(dB)	±1	±1	±1	±1
WiFi 802.11n-40 (5GHz) MCS0				
Channel	38~54	62~102	110~142	151~159
Target (dBm)	15.5	15	16	16
Tune-up(dB)	±1	±1	±1	±1
WiFi 802.11ac-20 (5GHz) MCS0				
Channel	36~48	52~64	100~140	149~165
Target (dBm)	15.5	15.5	16	16
Tune-up(dB)	±1	±1	±1	±1
WiFi 802.11ac-40 (5GHz) MCS0				
Channel	38~46	54~62	102~142	151~159
Target (dBm)	15.5	15.5	16	16
Tune-up(dB)	±1	±1	±1	±1
WiFi 802.11ac-80 (5GHz) MCS0				
Channel	42~106	122~138	155	
Target (dBm)	14.5	16	16.5	
Tune-up(dB)	±1	±1	±1	

The maximum output power for WiFi 2.4G(Power Level A1)

802.11b(dBm)	
Channel\data rate	1Mbps
11(2462MHz)	18.10
6(2437MHz)	18.26
1(2412MHz)	17.95
802.11g(dBm)	
Channel\data rate	6Mbps
11(2462MHz)	17.72
6(2437MHz)	17.91
1(2412MHz)	17.47
802.11n(dBm)-20MHz	
Channel\data rate	MCS0
11(2462MHz)	17.56
6(2437MHz)	17.82
1(2412MHz)	17.52

The maximum output power for WiFi 2.4G(Power Level B1/C1)

802.11b(dBm)	
Channel\data rate	1Mbps
11(2462MHz)	18.98
6(2437MHz)	19.11
1(2412MHz)	18.84
802.11g(dBm)	
Channel\data rate	6Mbps
11(2462MHz)	18.11
6(2437MHz)	18.29
1(2412MHz)	18.00
802.11n(dBm)-20MHz	
Channel\data rate	MCS0
11(2462MHz)	17.81
6(2437MHz)	18.22
1(2412MHz)	17.88

The maximum output power for WiFi 5G(Power Level A1)

802.11a(dBm)	
Channel\data rate	6Mbps
36(5180 MHz)	15.34
40(5200 MHz)	15.33
44(5220 MHz)	15.36
48(5240 MHz)	15.31
52(5260 MHz)	15.04
56(5280 MHz)	15.27
60(5300 MHz)	15.13
64(5320 MHz)	15.28
100(5500 MHz)	15.82
104(5520 MHz)	15.87
108(5540 MHz)	16.01
112(5560 MHz)	15.99
116(5580 MHz)	16.02
120(5600 MHz)	16.07
124(5620 MHz)	16.06
128(5640 MHz)	16.15
132(5660 MHz)	16.14
136(5680 MHz)	16.23
140(5700 MHz)	16.40
144(5720 MHz)	16.44
802.11ac(dBm)-80MHz	
Channel\data rate	MCS0
155(5775 MHz)	16.13

The maximum output power for WiFi 5G(Power Level B1)

802.11a(dBm)	
Channel\data rate	6Mbps
36(5180 MHz)	17.33
40(5200 MHz)	17.21
44(5220 MHz)	17.39
48(5240 MHz)	17.24
52(5260 MHz)	17.02
56(5280 MHz)	16.99
60(5300 MHz)	17.21
64(5320 MHz)	17.29
100(5500 MHz)	17.75
104(5520 MHz)	17.74
108(5540 MHz)	17.69
112(5560 MHz)	17.87
116(5580 MHz)	17.92
120(5600 MHz)	18.05
124(5620 MHz)	18.09
128(5640 MHz)	18.14
132(5660 MHz)	18.03
136(5680 MHz)	18.12
140(5700 MHz)	18.19
144(5720 MHz)	18.29
802.11ac(dBm)-80MHz	
Channel\data rate	MCS0
155(5775 MHz)	17.85

The maximum output power for WiFi 5G(Power Level C1)

802.11a(dBm)	
Channel\data rate	6Mbps
36(5180 MHz)	16.23
40(5200 MHz)	16.23
44(5220 MHz)	16.28
48(5240 MHz)	16.22
52(5260 MHz)	16.04
56(5280 MHz)	16.01
60(5300 MHz)	16.06
64(5320 MHz)	16.11
100(5500 MHz)	16.56
104(5520 MHz)	16.65
108(5540 MHz)	16.76
112(5560 MHz)	16.79
116(5580 MHz)	17.08
120(5600 MHz)	16.77
124(5620 MHz)	17.07
128(5640 MHz)	17.20
132(5660 MHz)	16.87
136(5680 MHz)	17.18
140(5700 MHz)	17.08
144(5720 MHz)	17.28
802.11ac(dBm)-80MHz	
Channel\data rate	MCS0
155(5775 MHz)	17.27

12 Antenna Location

12.1 Transmit Antenna Separation Distances

The detail for transmit antenna separation distances is described in the additional document:

Appendix to test report No.23T04Z80629-021

The photos of SAR test

12.2 SAR Measurement Positions

According to the KDB941225 D06 Hot Spot SAR v01, the edges with less than 2.5 cm distance to the antennas need to be tested for SAR.

SAR measurement positions						
Mode	Front	Rear	Left edge	Right edge	Top edge	Bottom edge
Main ANT	Yes	Yes	Yes	Yes	No	Yes
WIFI/BT ANT	Yes	Yes	No	Yes	Yes	No

12.3 Evaluation of Simultaneous

Test Position		SAR 1g/10g(W/kg)	WWAN										MAX. SAR 10g	
			GSM850	GSM1900	WCDMA1900	WCDMA1700	WCDMA850	LTE B2	LTE B4	LTE B5	LTE B12	LTE B13		LTE B66
Head	Left Cheek	0.26	0.17	0.16	0.13	0.22	0.23	0.17	0.41	0.17	0.29	0.14	0.41	
	Left Tilt	0.19	0.13	0.12	0.15	0.18	0.19	0.15	0.27	0.15	0.24	0.12	0.27	
	Right Cheek	0.35	0.13	0.09	0.24	0.29	0.18	0.29	0.41	0.24	0.33	0.25	0.41	
	Right Tilt	0.17	0.10	0.08	0.11	0.17	0.14	0.12	0.25	0.15	0.19	0.11	0.25	
Body	Front 10mm	0.26	0.45	0.54	0.44	0.28	0.52	0.45	0.41	0.40	0.33	0.39	0.54	
	Rear 10mm	0.42	0.64	0.67	0.92	0.44	0.71	1.03	0.62	0.45	0.46	0.78	1.03	
	Left 10mm	0.22	0.16	0.17	0.08	0.26	0.21	0.10	0.43	0.31	0.22	0.08	0.43	
	Right 10mm	0.24	0.10	0.13	0.15	0.27	0.13	0.17	0.44	0.34	0.16	0.16	0.44	
	Bottom 10mm	0.05	0.89	1.15	1.25	0.06	0.97	1.18	0.10	0.09	0.18	1.08	1.25	
	Top 10mm												0.00	
	Front 15mm	0.26	0.45	0.34	0.28	0.28	0.41	0.26	0.41	0.40	0.33	0.28	0.45	
	Rear 15mm	0.42	0.64	0.48	0.59	0.44	0.48	0.56	0.62	0.45	0.46	0.59	0.64	
	Rear 0mm							2.40						2.40

Test Position		SAR 1g/10g(W/kg)	WWAN				simultaneous transmission			
			1	2	3	4	1+2	1+3	1+4	1+3+4
Head	Left Cheek	0.410	0.900	0.740	0.020	1.310	1.150	0.430	1.170	
	Left Tilt	0.270	1.090	1.290	0.030	1.360	1.560	0.300	1.590	
	Right Cheek	0.410	0.240	0.370	0.000	0.650	0.780	0.410	0.780	
	Right Tilt	0.250	0.380	0.510	0.000	0.630	0.760	0.250	0.760	
Body	Front 10mm	0.540	0.250	0.250	0.000	0.790	0.790	0.540	0.790	
	Rear 10mm	1.030	0.350	0.760	0.010	1.380	1.790	1.040	1.800	
	Left 10mm	0.430			0.000	0.430	0.430	0.430	0.430	
	Right 10mm	0.440	0.300	0.280	0.000	0.740	0.720	0.440	0.720	
	Bottom 10mm	1.250			0.000	1.250	1.250	1.250	1.250	
	Top 10mm	0.000	0.210	1.080	0.000	0.210	1.080	0.000	1.080	
	Front 15mm	0.450	0.250	0.150	0.000	0.700	0.600	0.450	0.600	
	Rear 15mm	0.640	0.350	0.490	0.010	0.990	1.130	0.650	1.140	
	Rear 0mm	2.400	1.190	0.900	0.020	3.590	3.300	2.420	3.320	

Band	Position	SAR(W/kg)	distance	Pair SAR sum(W/kg)	SPLSR	Simultaneous SAR
WCDMA1700	Rear 0mm	0.92	159.25	1.68	0.014	Not required
WIFI 5G		0.76				
LTE B4	Rear 0mm	1.03	171.38	1.79	0.014	Not required
WIFI 5G		0.76				

Band	Position	SAR(W/kg)	distance	Pair SAR sum(W/kg)	SPLSR	Simultaneous SAR
WCDMA1700	Rear 0mm	0.92	167.22	0.93	0.005	Not required
BT		0.01				
LTE B4	Rear 0mm	1.03	179.05	1.04	0.006	Not required
BT		0.01				

13 SAR Test Result

Note:

KDB 447498 D01 General RF Exposure Guidance:

For WWAN: Reported SAR(W/kg)= Measured SAR(W/kg)*Tune-up Scaling Factor

For BT/WLAN: Reported SAR(W/kg)= Measured SAR(W/kg)* Duty Cycle scaling factor * Tune-up scaling factor

Testing of other required channels within the operating mode of a frequency band is not required when the reported 1-g or 10-g SAR for the mid-band or highest output power channel is:

≤ 0.8 W/kg or 2.0 W/kg, for 1-g or 10-g respectively, when the transmission band is ≤ 100 MHz

≤ 0.6 W/kg or 1.5 W/kg, for 1-g or 10-g respectively, when the transmission band is between 100 MHz and 200 MHz

≤ 0.4 W/kg or 1.0 W/kg, for 1-g or 10-g respectively, when the transmission band is ≥ 200 MHz

KDB 648474 D04 Handset SAR:

With headset attached, when the reported SAR for body-worn accessory, measured without a headset connected to the handset, is > 1.2 W/kg, the highest reported SAR configuration for that wireless mode and frequency band should be repeated for that body-worn accessory with a headset attached to the handset.

KDB 941225 D01 SAR test for 3G devices:

When the maximum output power and tune-up tolerance specified for production units in a secondary mode is $\leq \frac{1}{4}$ dB higher than the primary mode or when the highest reported SAR of the primary mode is scaled by the ratio of specified maximum output power and tune-up tolerance of secondary to primary mode and the adjusted SAR is ≤ 1.2 W/kg, SAR measurement is not required for the secondary mode.

KDB 941225 D05 SAR for LTE Devices:

SAR test reduction is applied using the following criteria:

Start with the largest channel bandwidth and measure SAR for QPSK with 1 RB, and 50% RB allocation, using the RB offset and required test channel combination with the highest maximum output power among RB offsets at the upper edge, middle and lower edge of each required test channel.

When the reported SAR is > 0.8 W/kg, testing for other Channels is performed at the highest output power level for 1RB, and 50% RB configuration for that channel.

Testing for 100% RB configuration is performed at the highest output power level for 100% RB configuration across the Low, Mid and High Channel when the highest reported SAR for 1 RB and 50% RB are > 0.8 W/kg. Testing for the remaining required channels is not needed because the reported SAR for 100% RB Allocation < 1.45 W/kg.

Testing for 16-QAM modulation is not required because the reported SAR for QPSK is < 1.45 W/Kg and its output power is not more than 0.5 dB higher than that of QPSK.

Testing for the other channel bandwidths is not required because the reported SAR for the highest channel bandwidth is < 1.45 W/Kg and its output power is not more than 0.5 dB higher than that of the highest channel bandwidth.

For LTE bands that do not support at least three non-overlapping channels in certain channel bandwidths, test the available non-overlapping channels instead. When a device supports overlapping channel assignment in a channel bandwidth configuration, the middle channel of the

group of overlapping channels should be selected for testing; therefore, the requirement for H, M and L channels may not fully apply.

KDB 248227 D01 SAR meas for 802.11:

SAR test reduction for 802.11 Wi-Fi transmission mode configurations are considered separately for DSSS and OFDM. An initial test position is determined to reduce the number of tests required for certain exposure configurations with multiple test positions. An initial test configuration is determined for each frequency band and aggregated band according to maximum output power, channel bandwidth, wireless mode configurations and other operating parameters to streamline the measurement requirements. For 2.4 GHz DSSS, either the initial test position or DSSS procedure is applied to reduce the number of SAR tests; these are mutually exclusive. For OFDM, an initial test position is only applicable to next to the ear, UMPC mini-tablet and hotspot mode configurations, which is tested using the initial test configuration to facilitate test reduction. For other exposure conditions with a fixed test position, SAR test reduction is determined using only the initial test configuration.

To determine the initial test position, Area Scans were performed to determine the position with the Maximum Value of SAR (measured). The position that produced the highest Maximum Value of SAR is considered the worst case position; thus used as the initial test position.

The multiple test positions require SAR measurements in head, hotspot mode or UMPC mini-tablet configurations may be reduced according to the highest reported SAR determined using the initial test position(s) by applying the DSSS or OFDM SAR measurement procedures in the required wireless mode test configuration(s). The initial test position(s) is measured using the highest measured maximum output power channel in the required wireless mode test configuration(s).

When the reported SAR for the initial test position is:

≤ 0.4 W/kg, further SAR measurement is not required for the other test positions in that exposure configuration and wireless mode combination within the frequency band or aggregated band. DSSS and OFDM configurations are considered separately according to the required SAR procedures.

> 0.4 W/kg, SAR is repeated using the same wireless mode test configuration tested in the initial test position to measure the subsequent next closet/smallest test separation distance and maximum coupling test position, on the highest maximum output power channel, until the reported SAR is ≤ 0.8 W/kg or all required test positions are tested.

- For subsequent test positions with equivalent test separation distance or when exposure is dominated by coupling conditions, the position for maximum coupling condition should be tested.
- When it is unclear, all equivalent conditions must be tested.

For all positions/configurations tested using the initial test position and subsequent test positions, when the reported SAR is > 0.8 W/kg, measure the SAR for these positions/configurations on the subsequent next highest measured output power channel(s) until the reported SAR is ≤ 1.2 W/kg or all required test channels are considered.

- The additional power measurements required for this step should be limited to those necessary for identifying subsequent highest output power channels to apply the test reduction.

When the specified maximum output power is the same for both UNII 1 and UNII 2A, begin SAR measurements in UNII 2A with the channel with the highest measured output power. If the reported SAR for UNII 2A is ≤ 1.2 W/kg, SAR is not required for UNII 1; otherwise treat the remaining bands separately and test them independently for SAR.



When the specified maximum output power is different between UNII 1 and UNII 2A, begin SAR with the band that has the higher specified maximum output. If the highest reported SAR for the band with the highest specified power is ≤ 1.2 W/kg, testing for the band with the lower specified output power is not required; otherwise test the remaining bands independently for SAR.

Duty Cycle

Mode	Duty Cycle
Speech for GSM	1:8.3
GPRS&EGPRS 1 Slot	1:8.3
GPRS&EGPRS 2 Slot	1:4
GPRS&EGPRS 3 Slot	1:2.67
GPRS&EGPRS 4 Slot	1:2
WCDMA<E FDD	1:1

13.1 SAR results for Cellular

Test Position	Phantom position L/R/F	Frequency Band	Channel Number	Frequency (MHz)	Mode/RB	Test setup	Distance		EUT Measured Power (dBm)	Tune up (dBm)	Measured SAR 1g (W/kg)	Calculated SAR 1g (W/kg)	Measured SAR 10g (W/kg)	Calculated SAR 10g (W/kg)	Power Drift
Cheek	L	GSM850	190	836.6	GPRS(2TX)	Cheek Left	0mm	/	30.76	31.50	0.220	0.26	0.179	0.21	-0.14
Tilt	L	GSM850	190	836.6	GPRS(2TX)	Tilt Left	0mm	/	30.76	31.50	0.164	0.19	0.136	0.16	0.12
Cheek	R	GSM850	251	848.8	GPRS(2TX)	Cheek Right	0mm	FIG A.1	30.82	31.50	0.303	0.35	0.240	0.28	0.02
Cheek	R	GSM850	190	836.6	GPRS(2TX)	Cheek Right	0mm	/	30.76	31.50	0.270	0.32	0.217	0.26	0.11
Cheek	R	GSM850	128	824.2	GPRS(2TX)	Cheek Right	0mm	/	30.70	31.50	0.257	0.31	0.205	0.25	-0.06
Tilt	R	GSM850	190	836.6	GPRS(2TX)	Tilt Right	0mm	/	30.76	31.50	0.147	0.17	0.120	0.14	-0.01
Body	F	GSM850	190	836.6	GPRS(2TX)	Front	10mm	/	30.76	31.50	0.220	0.26	0.174	0.21	-0.04
Body	F	GSM850	251	848.8	GPRS(2TX)	Rear	10mm	/	30.82	31.50	0.335	0.39	0.265	0.31	0.05
Body	F	GSM850	190	836.6	GPRS(2TX)	Rear	10mm	FIG A.2	30.76	31.50	0.353	0.42	0.280	0.33	-0.16
Body	F	GSM850	128	824.2	GPRS(2TX)	Rear	10mm	/	30.70	31.50	0.314	0.38	0.246	0.30	-0.02
Body	F	GSM850	190	836.6	GPRS(2TX)	Left	10mm	/	30.76	31.50	0.186	0.22	0.136	0.16	0.19
Body	F	GSM850	190	836.6	GPRS(2TX)	Right	10mm	/	30.76	31.50	0.199	0.24	0.148	0.18	-0.06
Body	F	GSM850	190	836.6	GPRS(2TX)	Bottom	10mm	/	30.76	31.50	0.039	0.05	0.022	0.03	-0.17
Body	F	GSM850	190	836.6	EGPRS(2TX)	Rear	10mm	/	30.76	31.50	0.340	0.40	0.272	0.32	0.10
Cheek	L	GSM1900	810	1909.8	GPRS(2TX)	Cheek Left	0mm	/	27.99	29.00	0.097	0.12	0.065	0.08	0.15
Cheek	L	GSM1900	661	1880	GPRS(2TX)	Cheek Left	0mm	FIG A.3	27.96	29.00	0.133	0.17	0.087	0.11	0.12
Cheek	L	GSM1900	512	1850.2	GPRS(2TX)	Cheek Left	0mm	/	27.95	29.00	0.109	0.14	0.073	0.09	-0.11
Tilt	L	GSM1900	661	1880	GPRS(2TX)	Tilt Left	0mm	/	27.96	29.00	0.101	0.13	0.071	0.09	-0.11
Cheek	R	GSM1900	661	1880	GPRS(2TX)	Cheek Right	0mm	/	27.96	29.00	0.103	0.13	0.065	0.08	-0.01
Tilt	R	GSM1900	661	1880	GPRS(2TX)	Tilt Right	0mm	/	27.96	29.00	0.077	0.10	0.050	0.06	-0.07
Body	F	GSM1900	661	1880	GPRS(2TX)	Front	10mm	/	27.96	29.00	0.351	0.45	0.203	0.26	-0.16
Body	F	GSM1900	661	1880	GPRS(2TX)	Rear	10mm	/	27.96	29.00	0.507	0.64	0.260	0.33	-0.06
Body	F	GSM1900	661	1880	GPRS(2TX)	Left	10mm	/	27.96	29.00	0.128	0.16	0.076	0.10	-0.01
Body	F	GSM1900	661	1880	GPRS(2TX)	Right	10mm	/	27.96	29.00	0.082	0.10	0.046	0.06	-0.04
Body	F	GSM1900	810	1909.8	GPRS(2TX)	Bottom	10mm	FIG A.4	27.99	29.00	0.706	0.89	0.388	0.49	0.03
Body	F	GSM1900	661	1880	GPRS(2TX)	Bottom	10mm	/	27.96	29.00	0.681	0.87	0.374	0.48	-0.17
Body	F	GSM1900	512	1850.2	GPRS(2TX)	Bottom	10mm	/	27.95	29.00	0.662	0.84	0.354	0.45	-0.03
Body	F	GSM1900	810	1909.8	EGPRS(2TX)	Bottom	10mm	/	28.01	29.00	0.671	0.84	0.358	0.45	-0.07
Cheek	L	WCDMA 850	4183	836.6	RMC	Cheek Left	0mm	/	23.01	24.00	0.176	0.22	0.143	0.18	0.04
Tilt	L	WCDMA 850	4183	836.6	RMC	Tilt Left	0mm	/	23.01	24.00	0.146	0.18	0.121	0.15	0.14
Cheek	R	WCDMA 850	4233	846.6	RMC	Cheek Right	0mm	/	23.03	24.00	0.198	0.25	0.159	0.20	-0.04
Cheek	R	WCDMA 850	4183	836.6	RMC	Cheek Right	0mm	FIG A.5	23.01	24.00	0.227	0.29	0.181	0.23	0.05
Cheek	R	WCDMA 850	4132	826.4	RMC	Cheek Right	0mm	/	23.06	24.00	0.195	0.24	0.156	0.19	-0.11
Tilt	R	WCDMA 850	4183	836.6	RMC	Tilt Right	0mm	/	23.01	24.00	0.133	0.17	0.109	0.14	-0.06
Body	F	WCDMA 850	4183	836.6	RMC	Front	10mm	/	23.01	24.00	0.219	0.28	0.174	0.22	-0.16
Body	F	WCDMA 850	4233	846.6	RMC	Rear	10mm	FIG A.6	23.03	24.00	0.351	0.44	0.274	0.34	-0.08
Body	F	WCDMA 850	4183	836.6	RMC	Rear	10mm	/	23.01	24.00	0.325	0.41	0.258	0.32	-0.16
Body	F	WCDMA 850	4132	826.4	RMC	Rear	10mm	/	23.06	24.00	0.299	0.37	0.216	0.27	0.02
Body	F	WCDMA 850	4183	836.6	RMC	Left	10mm	/	23.01	24.00	0.206	0.26	0.148	0.19	-0.05
Body	F	WCDMA 850	4183	836.6	RMC	Right	10mm	/	23.01	24.00	0.215	0.27	0.155	0.19	0.15
Body	F	WCDMA 850	4183	836.6	RMC	Bottom	10mm	/	23.01	24.00	0.045	0.06	0.029	0.04	-0.15
Cheek	L	WCDMA1700	1412	1732.4	RMC	Cheek Left	0mm	/	22.91	24.00	0.101	0.13	0.071	0.09	-0.10
Tilt	L	WCDMA1700	1412	1732.4	RMC	Tilt Left	0mm	/	22.91	24.00	0.118	0.15	0.078	0.10	-0.09
Cheek	R	WCDMA1700	1513	1752.6	RMC	Cheek Right	0mm	/	22.95	24.00	0.172	0.22	0.112	0.14	0.09
Cheek	R	WCDMA1700	1412	1732.4	RMC	Cheek Right	0mm	FIG A.7	22.91	24.00	0.184	0.24	0.119	0.15	0.07
Cheek	R	WCDMA1700	1312	1712.4	RMC	Cheek Right	0mm	/	22.83	24.00	0.177	0.23	0.116	0.15	0.13
Tilt	R	WCDMA1700	1412	1732.4	RMC	Tilt Right	0mm	/	22.91	24.00	0.086	0.11	0.058	0.07	0.09
Body	F	WCDMA1700	1412	1732.5	RMC	Front	10mm	/	20.49	21.50	0.349	0.44	0.150	0.19	-0.13
Body	F	WCDMA1700	1513	1752.6	RMC	Rear	10mm	/	20.44	21.50	0.640	0.82	0.346	0.44	-0.02
Body	F	WCDMA1700	1412	1732.5	RMC	Rear	10mm	/	20.49	21.50	0.727	0.92	0.392	0.49	0.03
Body	F	WCDMA1700	1312	1712.4	RMC	Rear	10mm	/	20.65	21.50	0.645	0.78	0.348	0.42	0.16
Body	F	WCDMA1700	1412	1732.5	RMC	Left	10mm	/	20.49	21.50	0.066	0.08	0.040	0.05	0.10
Body	F	WCDMA1700	1412	1732.5	RMC	Right	10mm	/	20.49	21.50	0.117	0.15	0.068	0.09	-0.02
Body	F	WCDMA1700	1513	1752.6	RMC	Bottom	10mm	/	20.44	21.50	0.873	1.11	0.474	0.61	-0.10
Body	F	WCDMA1700	1412	1732.5	RMC	Bottom	10mm	FIG A.8	20.49	21.50	0.990	1.25	0.537	0.68	0.12
Body	F	WCDMA1700	1312	1712.4	RMC	Bottom	10mm	/	20.65	21.50	0.878	1.07	0.476	0.58	0.06
Body	F	WCDMA1700	1412	1732.5	RMC	Bottom	10mm	Headset	20.49	21.50	0.682	0.86	0.351	0.44	0.02
Body	F	WCDMA1700	1412	1732.5	RMC	Front	15mm	/	21.62	22.50	0.230	0.28	0.138	0.17	-0.05
Body	F	WCDMA1700	1513	1752.6	RMC	Rear	15mm	/	21.59	22.50	0.470	0.58	0.263	0.32	0.14
Body	F	WCDMA1700	1412	1732.5	RMC	Rear	15mm	FIG A.9	21.62	22.50	0.481	0.59	0.280	0.34	0.07
Body	F	WCDMA1700	1312	1712.4	RMC	Rear	15mm	/	21.66	22.50	0.473	0.57	0.265	0.32	-0.11
Cheek	L	WCDMA1900	9538	1907.6	RMC	Cheek Left	0mm	/	22.84	24.00	0.112	0.15	0.079	0.10	-0.15
Cheek	L	WCDMA1900	9400	1880	RMC	Cheek Left	0mm	FIG A.10	22.86	24.00	0.126	0.16	0.086	0.11	0.05
Cheek	L	WCDMA1900	9262	1852.4	RMC	Cheek Left	0mm	/	23.04	24.00	0.112	0.14	0.078	0.10	0.17
Tilt	L	WCDMA1900	9400	1880	RMC	Tilt Left	0mm	/	22.86	24.00	0.090	0.12	0.061	0.08	-0.15
Cheek	R	WCDMA1900	9400	1880	RMC	Cheek Right	0mm	/	22.86	24.00	0.071	0.09	0.050	0.07	-0.11
Tilt	R	WCDMA1900	9400	1880	RMC	Tilt Right	0mm	/	22.86	24.00	0.062	0.08	0.043	0.06	-0.02
Body	F	WCDMA1900	9400	1880	RMC	Front	10mm	/	22.15	23.00	0.443	0.54	0.256	0.31	0.03
Body	F	WCDMA1900	9400	1880	RMC	Rear	10mm	/	22.15	23.00	0.551	0.67	0.311	0.38	0.01
Body	F	WCDMA1900	9400	1880	RMC	Left	10mm	/	22.15	23.00	0.136	0.17	0.081	0.10	-0.13
Body	F	WCDMA1900	9400	1880	RMC	Right	10mm	/	22.15	23.00	0.105	0.13	0.061	0.07	0.07
Body	F	WCDMA1900	9538	1907.6	RMC	Bottom	10mm	/	22.12	23.00	0.855	1.05	0.467	0.57	-0.10
Body	F	WCDMA1900	9400	1880	RMC	Bottom	10mm	/	22.15	23.00	0.631	1.01	0.459	0.56	0.17
Body	F	WCDMA1900	9262	1852.4	RMC	Bottom	10mm	FIG A.11	22.04	23.00	0.922	1.15	0.502	0.63	0.13
Body	F	WCDMA1900	9400	1880	RMC	Front	15mm	/	21.61	22.50	0.281	0.34	0.170	0.21	-0.02
Body	F	WCDMA1900	9538	1907.6	RMC	Rear	15mm	/	21.73	22.50	0.346	0.41	0.213	0.25	0.05
Body	F	WCDMA1900	9400	1880	RMC	Rear	15mm	FIG A.12	21.61	22.50	0.389	0.48	0.232	0.28	0.08
Body	F	WCDMA1900	9262	1852.4	RMC	Rear	15mm	/	21.48	22.50	0.346	0.44	0.210	0.27	-0.16

Test Position	Phantom position L/R/F	Frequency Band	Channel Number	Frequency (MHz)	Mode/RB	Test setup	Distance		EUT Measured Power (dBm)	Tune up (dBm)	Measured SAR 1g (W/kg)	Calculated SAR 1g (W/kg)	Measured SAR 10g (W/kg)	Calculated SAR 10g (W/kg)	Power Drift
Cheek	L	LTE Band2	19100	1900	1RB-High	Cheek Left	0mm	FIG A. 13	23.81	24.50	0.195	0.23	0.128	0.15	0.12
Tilt	L	LTE Band2	19100	1900	1RB-High	Tilt Left	0mm	/	23.81	24.50	0.121	0.14	0.075	0.09	-0.19
Cheek	R	LTE Band2	19100	1900	1RB-High	Cheek Right	0mm	/	23.81	24.50	0.151	0.18	0.095	0.11	0.01
Tilt	R	LTE Band2	19100	1900	1RB-High	Tilt Right	0mm	/	23.81	24.50	0.119	0.14	0.076	0.09	0.13
Cheek	L	LTE Band2	19100	1900	50RB-Middle	Cheek Left	0mm	/	22.82	23.50	0.157	0.18	0.103	0.12	-0.12
Tilt	L	LTE Band2	19100	1900	50RB-Middle	Tilt Left	0mm	/	22.82	23.50	0.159	0.19	0.095	0.11	-0.02
Cheek	R	LTE Band2	19100	1900	50RB-Middle	Cheek Right	0mm	/	22.82	23.50	0.120	0.14	0.075	0.09	-0.02
Tilt	R	LTE Band2	19100	1900	50RB-Middle	Tilt Right	0mm	/	22.82	23.50	0.094	0.11	0.060	0.07	-0.11
Body	F	LTE Band2	19100	1900	1RB-Middle	Front	10mm	/	22.04	22.50	0.471	0.52	0.272	0.30	0.18
Body	F	LTE Band2	19100	1900	1RB-Middle	Rear	10mm	/	22.04	22.50	0.642	0.71	0.347	0.39	0.15
Body	F	LTE Band2	19100	1900	1RB-Middle	Left	10mm	/	22.04	22.50	0.186	0.21	0.106	0.12	-0.18
Body	F	LTE Band2	19100	1900	1RB-Middle	Right	10mm	/	22.04	22.50	0.120	0.13	0.070	0.08	0.12
Body	F	LTE Band2	19100	1900	1RB-Middle	Bottom	10mm	/	22.04	22.50	0.819	0.91	0.442	0.49	0.19
Body	F	LTE Band2	18900	1880	1RB-Middle	Bottom	10mm	/	21.94	22.50	0.827	0.94	0.447	0.51	-0.12
Body	F	LTE Band2	18700	1860	1RB-Middle	Bottom	10mm	FIG A. 14	21.97	22.50	0.862	0.97	0.464	0.52	0.19
Body	F	LTE Band2	19100	1900	50RB-Low	Front	10mm	/	22.09	22.50	0.461	0.51	0.266	0.29	-0.18
Body	F	LTE Band2	19100	1900	50RB-Low	Rear	10mm	/	22.09	22.50	0.554	0.61	0.307	0.34	-0.05
Body	F	LTE Band2	19100	1900	50RB-Low	Left	10mm	/	22.09	22.50	0.178	0.20	0.102	0.11	-0.03
Body	F	LTE Band2	19100	1900	50RB-Low	Right	10mm	/	22.09	22.50	0.119	0.13	0.069	0.08	0.09
Body	F	LTE Band2	19100	1900	50RB-Low	Bottom	10mm	/	22.09	22.50	0.798	0.88	0.430	0.47	-0.05
Body	F	LTE Band2	18900	1880	50RB-High	Bottom	10mm	/	22.03	22.50	0.800	0.89	0.435	0.48	0.02
Body	F	LTE Band2	18700	1860	50RB-Middle	Bottom	10mm	/	21.88	22.50	0.834	0.96	0.452	0.52	0.16
Body	F	LTE Band2	19100	1900	100RB	Bottom	10mm	/	21.98	22.50	0.793	0.89	0.419	0.47	0.02
Body	F	LTE Band2	19100	1900	1RB-Middle	Front	15mm	/	22.34	23.00	0.348	0.41	0.211	0.25	0.18
Body	F	LTE Band2	19100	1900	1RB-Middle	Rear	15mm	FIG A. 15	22.34	23.00	0.410	0.48	0.245	0.29	0.04
Body	F	LTE Band2	19100	1900	50RB-Low	Front	15mm	/	22.48	23.00	0.268	0.30	0.163	0.18	0.14
Body	F	LTE Band2	19100	1900	50RB-Low	Rear	15mm	/	22.48	23.00	0.318	0.36	0.189	0.21	0.18
Cheek	L	LTE Band4	20050	1720	1RB-Middle	Cheek Left	0mm	/	23.80	24.50	0.141	0.17	0.098	0.12	-0.13
Tilt	L	LTE Band4	20050	1720	1RB-Middle	Tilt Left	0mm	/	23.80	24.50	0.125	0.15	0.082	0.10	0.14
Cheek	R	LTE Band4	20050	1720	1RB-Middle	Cheek Right	0mm	FIG A. 16	23.80	24.50	0.243	0.29	0.157	0.18	-0.05
Tilt	R	LTE Band4	20050	1720	1RB-Middle	Tilt Right	0mm	/	23.80	24.50	0.102	0.12	0.069	0.08	-0.04
Cheek	L	LTE Band4	20050	1720	50RB-Low	Cheek Left	0mm	/	22.86	23.50	0.094	0.11	0.067	0.08	0.12
Tilt	L	LTE Band4	20050	1720	50RB-Low	Tilt Left	0mm	/	22.86	23.50	0.089	0.10	0.058	0.07	0.19
Cheek	R	LTE Band4	20050	1720	50RB-Low	Cheek Right	0mm	/	22.86	23.50	0.173	0.20	0.110	0.13	0.01
Tilt	R	LTE Band4	20050	1720	50RB-Low	Tilt Right	0mm	/	22.86	23.50	0.081	0.09	0.053	0.06	0.13
Body	F	LTE Band4	20050	1720	1RB-Low	Front	10mm	/	20.86	21.50	0.386	0.45	0.225	0.26	0.01
Body	F	LTE Band4	20300	1745	1RB-Middle	Rear	10mm	/	20.84	21.50	0.762	0.89	0.457	0.53	0.08
Body	F	LTE Band4	20175	1732.5	1RB-Middle	Rear	10mm	/	20.83	21.50	0.869	1.01	0.467	0.54	-0.12
Body	F	LTE Band4	20050	1720	1RB-Low	Rear	10mm	/	20.86	21.50	0.889	1.03	0.475	0.55	-0.05
Body	F	LTE Band4	20050	1720	1RB-Low	Left	10mm	/	20.86	21.50	0.083	0.10	0.050	0.06	0.06
Body	F	LTE Band4	20050	1720	1RB-Low	Right	10mm	/	20.86	21.50	0.149	0.17	0.090	0.10	0.15
Body	F	LTE Band4	20300	1745	1RB-Middle	Bottom	10mm	/	20.84	21.50	0.874	1.02	0.531	0.62	-0.15
Body	F	LTE Band4	20175	1732.5	1RB-Middle	Bottom	10mm	/	20.83	21.50	0.997	1.16	0.543	0.63	0.08
Body	F	LTE Band4	20050	1720	1RB-Low	Bottom	10mm	FIG A. 17	20.86	21.50	1.020	1.18	0.552	0.64	0.19
Body	F	LTE Band4	20050	1720	50RB-Low	Front	10mm	/	20.92	21.50	0.374	0.43	0.220	0.25	-0.07
Body	F	LTE Band4	20300	1745	50RB-Middle	Rear	10mm	/	20.79	21.50	0.740	0.87	0.444	0.52	-0.11
Body	F	LTE Band4	20175	1732.5	50RB-High	Rear	10mm	/	20.81	21.50	0.845	0.99	0.454	0.53	-0.05
Body	F	LTE Band4	20050	1720	50RB-Low	Rear	10mm	/	20.92	21.50	0.864	0.99	0.462	0.53	-0.01
Body	F	LTE Band4	20050	1720	50RB-Low	Left	10mm	/	20.92	21.50	0.083	0.09	0.050	0.06	-0.11
Body	F	LTE Band4	20050	1720	50RB-Low	Right	10mm	/	20.92	21.50	0.144	0.16	0.088	0.10	-0.08
Body	F	LTE Band4	20300	1745	50RB-Middle	Bottom	10mm	/	20.79	21.50	0.849	1.00	0.518	0.61	0.14
Body	F	LTE Band4	20175	1732.5	50RB-High	Bottom	10mm	/	20.81	21.50	0.969	1.14	0.529	0.62	-0.10
Body	F	LTE Band4	20050	1720	50RB-Low	Bottom	10mm	/	20.92	21.50	0.991	1.13	0.538	0.61	0.10
Body	F	LTE Band4	20050	1720	100RB	Rear	10mm	/	20.87	21.50	0.839	0.97	0.449	0.52	0.15
Body	F	LTE Band4	20050	1720	100RB	Bottom	10mm	/	20.87	21.50	0.976	1.13	0.539	0.62	-0.09
Body	F	LTE Band4	20050	1720	1RB-Middle	Front	15mm	/	21.96	22.50	0.227	0.26	0.143	0.16	-0.02
Body	F	LTE Band4	20050	1720	1RB-Middle	Rear	15mm	FIG A. 18	21.96	22.50	0.496	0.56	0.291	0.33	-0.16
Body	F	LTE Band4	20050	1720	50RB-Low	Front	15mm	/	21.89	22.50	0.170	0.20	0.107	0.12	-0.17
Body	F	LTE Band4	20050	1720	50RB-Low	Rear	15mm	/	21.89	22.50	0.367	0.42	0.216	0.25	0.06
Cheek	L	LTE Band5	20600	844	1RB-Middle	Cheek Left	0mm	FIG A. 19	24.01	25.00	0.326	0.41	0.261	0.33	0.01
Tilt	L	LTE Band5	20600	844	1RB-Middle	Tilt Left	0mm	/	24.01	25.00	0.214	0.27	0.171	0.21	-0.02
Cheek	R	LTE Band5	20600	844	1RB-Middle	Cheek Right	0mm	/	24.01	25.00	0.323	0.41	0.250	0.31	0.05
Tilt	R	LTE Band5	20600	844	1RB-Middle	Tilt Right	0mm	/	24.01	25.00	0.201	0.25	0.159	0.20	0.17
Cheek	L	LTE Band5	20600	844	25RB-Middle	Cheek Left	0mm	/	23.07	24.00	0.284	0.33	0.210	0.26	0.19
Tilt	L	LTE Band5	20600	844	25RB-Middle	Tilt Left	0mm	/	23.07	24.00	0.179	0.22	0.144	0.18	0.06
Cheek	R	LTE Band5	20600	844	25RB-Middle	Cheek Right	0mm	/	23.07	24.00	0.242	0.30	0.188	0.23	-0.04
Tilt	R	LTE Band5	20600	844	25RB-Middle	Tilt Right	0mm	/	23.07	24.00	0.151	0.19	0.121	0.15	0.18
Body	F	LTE Band5	20600	844	1RB-Middle	Front	10mm	/	24.01	25.00	0.325	0.41	0.255	0.32	0.04
Body	F	LTE Band5	20600	844	1RB-Middle	Rear	10mm	FIG A. 20	24.01	25.00	0.490	0.62	0.383	0.48	-0.08
Body	F	LTE Band5	20600	844	1RB-Middle	Left	10mm	/	24.01	25.00	0.342	0.43	0.241	0.30	0.18
Body	F	LTE Band5	20600	844	1RB-Middle	Right	10mm	/	24.01	25.00	0.350	0.44	0.249	0.31	0.18
Body	F	LTE Band5	20600	844	1RB-Middle	Bottom	10mm	/	24.01	25.00	0.078	0.10	0.046	0.06	-0.04
Body	F	LTE Band5	20600	844	25RB-Middle	Front	10mm	/	23.07	24.00	0.253	0.31	0.200	0.25	0.05
Body	F	LTE Band5	20600	844	25RB-Middle	Rear	10mm	/	23.07	24.00	0.386	0.48	0.302	0.37	-0.04
Body	F	LTE Band5	20600	844	25RB-Middle	Left	10mm	/	23.07	24.00	0.270	0.33	0.190	0.24	-0.03
Body	F	LTE Band5	20600	844	25RB-Middle	Right	10mm	/	23.07	24.00	0.279	0.35	0.201	0.25	0.14
Body	F	LTE Band5	20600	844	25RB-Middle	Bottom	10mm	/	23.07	24.00	0.066	0.08	0.038	0.05	0.14



No. 23T04Z80629-021

Test Position	Phantom position L/R/F	Frequency Band	Channel Number	Frequency (MHz)	Mode/RB	Test setup	Distance	EUT Measured Power (dBm)	Tune up (dBm)	Measured SAR 1g (W/kg)	Calculated SAR 1g (W/kg)	Measured SAR 10g (W/kg)	Calculated SAR 10g (W/kg)	Power Drift	
Cheek	L	LTE Band12	23095	707.5	1RB-Middle	Cheek Left	0mm	/	23.97	25.00	0.133	0.17	0.140	0.18	0.06
Tilt	L	LTE Band12	23095	707.5	1RB-Middle	Tilt Left	0mm	/	23.97	25.00	0.115	0.15	0.122	0.15	0.19
Cheek	R	LTE Band12	23095	707.5	1RB-Middle	Cheek Right	0mm	FIG A.21	23.97	25.00	0.190	0.24	0.156	0.20	0.02
Tilt	R	LTE Band12	23095	707.5	1RB-Middle	Tilt Right	0mm	/	23.97	25.00	0.121	0.15	0.129	0.16	-0.18
Cheek	L	LTE Band12	23130	711	25RB-Low	Cheek Left	0mm	/	22.98	24.00	0.118	0.15	0.123	0.16	-0.09
Tilt	L	LTE Band12	23130	711	25RB-Low	Tilt Left	0mm	/	22.98	24.00	0.092	0.12	0.102	0.13	0.14
Cheek	R	LTE Band12	23130	711	25RB-Low	Cheek Right	0mm	/	22.98	24.00	0.150	0.19	0.143	0.18	0.11
Tilt	R	LTE Band12	23130	711	25RB-Low	Tilt Right	0mm	/	22.98	24.00	0.094	0.12	0.100	0.13	0.03
Body	F	LTE Band12	23095	707.5	1RB-Middle	Front	10mm	/	23.97	25.00	0.315	0.40	0.245	0.31	0.14
Body	F	LTE Band12	23095	707.5	1RB-Middle	Rear	10mm	FIG A.22	23.97	25.00	0.356	0.45	0.286	0.36	-0.03
Body	F	LTE Band12	23095	707.5	1RB-Middle	Left	10mm	/	23.97	25.00	0.245	0.31	0.185	0.23	-0.18
Body	F	LTE Band12	23095	707.5	1RB-Middle	Right	10mm	/	23.97	25.00	0.272	0.34	0.204	0.26	-0.05
Body	F	LTE Band12	23095	707.5	1RB-Middle	Bottom	10mm	/	23.97	25.00	0.070	0.09	0.047	0.06	-0.16
Body	F	LTE Band12	23130	711	25RB-Low	Front	10mm	/	22.98	24.00	0.245	0.31	0.191	0.24	0.08
Body	F	LTE Band12	23130	711	25RB-Low	Rear	10mm	/	22.98	24.00	0.279	0.35	0.225	0.28	0.10
Body	F	LTE Band12	23130	711	25RB-Low	Left	10mm	/	22.98	24.00	0.192	0.24	0.146	0.18	-0.18
Body	F	LTE Band12	23130	711	25RB-Low	Right	10mm	/	22.98	24.00	0.211	0.27	0.159	0.20	-0.07
Body	F	LTE Band12	23130	711	25RB-Low	Bottom	10mm	/	22.98	24.00	0.059	0.07	0.041	0.05	-0.10
Cheek	L	LTE Band13	23230	782	1RB-Middle	Cheek Left	0mm	/	24.01	25.00	0.230	0.29	0.184	0.23	-0.07
Tilt	L	LTE Band13	23230	782	1RB-Middle	Tilt Left	0mm	/	24.01	25.00	0.191	0.24	0.161	0.20	0.10
Cheek	R	LTE Band13	23230	782	1RB-Middle	Cheek Right	0mm	FIG A.23	24.01	25.00	0.261	0.33	0.209	0.26	0.06
Tilt	R	LTE Band13	23230	782	1RB-Middle	Tilt Right	0mm	/	24.01	25.00	0.152	0.19	0.126	0.16	0.12
Cheek	L	LTE Band13	23230	782	25RB-High	Cheek Left	0mm	/	23.04	24.00	0.166	0.21	0.136	0.17	0.10
Tilt	L	LTE Band13	23230	782	25RB-High	Tilt Left	0mm	/	23.04	24.00	0.136	0.17	0.113	0.14	-0.02
Cheek	R	LTE Band13	23230	782	25RB-High	Cheek Right	0mm	/	23.04	24.00	0.206	0.26	0.165	0.21	0.17
Tilt	R	LTE Band13	23230	782	25RB-High	Tilt Right	0mm	/	23.04	24.00	0.123	0.15	0.103	0.13	0.01
Body	F	LTE Band13	23230	782	1RB-Middle	Front	10mm	/	24.01	25.00	0.263	0.33	0.198	0.25	-0.16
Body	F	LTE Band13	23230	782	1RB-Middle	Rear	10mm	FIG A.24	24.01	25.00	0.369	0.46	0.243	0.31	-0.08
Body	F	LTE Band13	23230	782	1RB-Middle	Left	10mm	/	24.01	25.00	0.174	0.22	0.118	0.15	-0.12
Body	F	LTE Band13	23230	782	1RB-Middle	Right	10mm	/	24.01	25.00	0.129	0.16	0.088	0.11	-0.08
Body	F	LTE Band13	23230	782	1RB-Middle	Bottom	10mm	/	24.01	25.00	0.147	0.18	0.087	0.11	-0.16
Body	F	LTE Band13	23230	782	25RB-High	Front	10mm	/	23.04	24.00	0.203	0.25	0.151	0.19	-0.08
Body	F	LTE Band13	23230	782	25RB-High	Rear	10mm	/	23.04	24.00	0.280	0.35	0.185	0.23	-0.03
Body	F	LTE Band13	23230	782	25RB-High	Left	10mm	/	23.04	24.00	0.076	0.09	0.052	0.06	-0.01
Body	F	LTE Band13	23230	782	25RB-High	Right	10mm	/	23.04	24.00	0.102	0.13	0.069	0.09	0.06
Body	F	LTE Band13	23230	782	25RB-High	Bottom	10mm	/	23.04	24.00	0.103	0.13	0.062	0.08	0.06
Cheek	L	LTE Band66	132072	1720	1RB-Middle	Cheek Left	0mm	/	23.81	24.50	0.116	0.14	0.080	0.09	0.07
Tilt	L	LTE Band66	132072	1720	1RB-Middle	Tilt Left	0mm	/	23.81	24.50	0.104	0.12	0.070	0.08	-0.07
Cheek	R	LTE Band66	132072	1720	1RB-Middle	Cheek Right	0mm	FIG A.25	23.81	24.50	0.215	0.25	0.141	0.17	0.05
Tilt	R	LTE Band66	132072	1720	1RB-Middle	Tilt Right	0mm	/	23.81	24.50	0.090	0.11	0.062	0.07	-0.08
Cheek	L	LTE Band66	132072	1720	50RB-Low	Cheek Left	0mm	/	22.84	23.50	0.082	0.10	0.058	0.07	0.16
Tilt	L	LTE Band66	132072	1720	50RB-Low	Tilt Left	0mm	/	22.84	23.50	0.079	0.09	0.049	0.06	0.11
Cheek	R	LTE Band66	132072	1720	50RB-Low	Cheek Right	0mm	/	22.84	23.50	0.156	0.18	0.104	0.12	-0.15
Tilt	R	LTE Band66	132072	1720	50RB-Low	Tilt Right	0mm	/	22.84	23.50	0.072	0.08	0.049	0.06	0.02
Body	F	LTE Band66	132072	1720	1RB-Middle	Front	10mm	/	20.60	21.00	0.355	0.39	0.208	0.23	0.11
Body	F	LTE Band66	132072	1720	1RB-Middle	Rear	10mm	/	20.60	21.00	0.709	0.78	0.384	0.42	0.04
Body	F	LTE Band66	132072	1720	1RB-Middle	Left	10mm	/	20.60	21.00	0.074	0.08	0.045	0.05	0.02
Body	F	LTE Band66	132072	1720	1RB-Middle	Right	10mm	/	20.60	21.00	0.144	0.16	0.084	0.09	-0.07
Body	F	LTE Band66	132572	1770	1RB-Middle	Bottom	10mm	/	20.50	21.00	0.859	0.96	0.463	0.52	0.06
Body	F	LTE Band66	132322	1745	1RB-Middle	Bottom	10mm	/	20.44	21.00	0.928	1.06	0.495	0.56	-0.09
Body	F	LTE Band66	132072	1720	1RB-Middle	Bottom	10mm	FIG A.26	20.60	21.00	0.989	1.08	0.531	0.58	0.11
Body	F	LTE Band66	132072	1720	50RB-Low	Front	10mm	/	20.57	21.00	0.340	0.38	0.197	0.22	0.11
Body	F	LTE Band66	132072	1720	50RB-Low	Rear	10mm	/	20.57	21.00	0.641	0.71	0.356	0.39	0.13
Body	F	LTE Band66	132072	1720	50RB-Low	Left	10mm	/	20.57	21.00	0.071	0.08	0.042	0.05	-0.06
Body	F	LTE Band66	132072	1720	50RB-Low	Right	10mm	/	20.57	21.00	0.136	0.15	0.078	0.09	-0.14
Body	F	LTE Band66	132572	1770	50RB-Middle	Bottom	10mm	/	20.54	21.00	0.821	0.91	0.443	0.49	-0.17
Body	F	LTE Band66	132322	1745	50RB-Middle	Bottom	10mm	/	20.49	21.00	0.884	0.99	0.474	0.53	-0.05
Body	F	LTE Band66	132072	1720	50RB-Low	Bottom	10mm	/	20.57	21.00	0.945	1.04	0.508	0.56	-0.13
Body	F	LTE Band66	132072	1720	100RB	Bottom	10mm	/	20.54	21.00	0.919	1.02	0.488	0.54	0.15
Body	F	LTE Band66	132072	1720	1RB-Middle	Front	15mm	/	22.06	22.50	0.250	0.28	0.162	0.18	-0.12
Body	F	LTE Band66	132072	1720	1RB-Middle	Rear	15mm	FIG A.27	22.06	22.50	0.531	0.59	0.314	0.35	0.11
Body	F	LTE Band66	132072	1720	50RB-Low	Front	15mm	/	22.05	22.50	0.184	0.20	0.116	0.13	-0.02
Body	F	LTE Band66	132072	1720	50RB-Low	Rear	15mm	/	22.05	22.50	0.390	0.43	0.231	0.26	0.04

13.2 SAR results for WLAN

The maximum output power specified for production units are determined for all applicable 802.11 transmission modes in each standalone and aggregated frequency band. Maximum output power is measured for the highest maximum output power configuration(s) in each frequency band according to the default power measurement procedures.

When the same transmission mode configurations have the same maximum output power on the same channel for the 802.11 a/g/n/ac/ax modes, the channel in the lower order/sequence 802.11 mode (i.e. a, g, n ac then ax) is selected.

SAR Test reduction was applied from KDB 248227 guidance, when the same maximum power is specified for multiple transmission modes in a frequency band, the largest channel bandwidth, lowest order modulation, lowest data rate and lowest order 802.11a/g/n/ac mode is used for SAR measurement, on the highest measured output power channel in the initial test configuration, for each frequency band. Additional output power measurements were not deemed necessary.

Duty factor plot

CH6

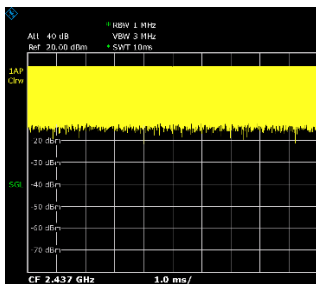

CH56

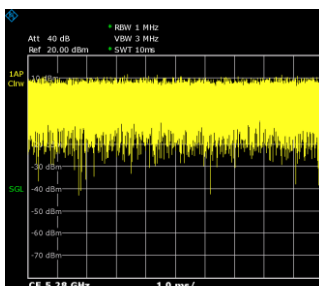

CH64

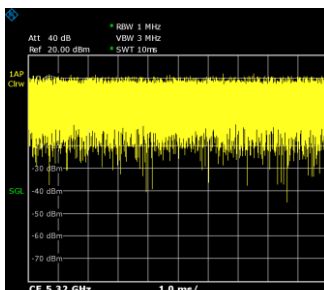

WLAN 2.4G

Test Position	Phantom position L/R/F	Frequency Band	Channel Number	Frequency (MHz)	Mode/RB	Test setup	Distance		EUT Measured Power (dBm)	Tune up (dBm)	Measured SAR 1g (W/kg)	Calculated SAR 1g (W/kg)	Measured SAR 10g (W/kg)	Calculated SAR 10g (W/kg)	Power Drift	Duty Cycle
Cheek	L	WLAN2.4G	11	2462	11b 1M	Cheek Left	0mm	/	18.10	18.50	0.795	0.87	0.349	0.38	-0.01	100.00%
Cheek	L	WLAN2.4G	6	2437	11b 1M	Cheek Left	0mm	/	18.26	18.50	0.853	0.90	0.373	0.39	0.03	100.00%
Cheek	L	WLAN2.4G	1	2412	11b 1M	Cheek Left	0mm	/	17.95	18.50	0.752	0.85	0.336	0.38	-0.08	100.00%
Tilt	L	WLAN2.4G	11	2462	11b 1M	Tilt Left	0mm	/	18.10	18.50	0.986	1.08	0.356	0.39	0.15	100.00%
Tilt	L	WLAN2.4G	6	2437	11b 1M	Tilt Left	0mm	FIG A.28	18.26	18.50	1.030	1.09	0.412	0.44	0.13	100.00%
Tilt	L	WLAN2.4G	1	2412	11b 1M	Tilt Left	0mm	/	17.95	18.50	0.917	1.04	0.351	0.40	0.10	100.00%
Cheek	R	WLAN2.4G	6	2437	11b 1M	Cheek Right	0mm	/	18.26	18.50	0.231	0.24	0.111	0.12	-0.07	100.00%
Tilt	R	WLAN2.4G	6	2437	11b 1M	Tilt Right	0mm	/	18.26	18.50	0.364	0.38	0.150	0.16	-0.11	100.00%
Body	F	WLAN2.4G	6	2437	11b 1M	Front	10mm	/	19.11	19.50	0.228	0.25	0.130	0.14	-0.15	100.00%
Body	F	WLAN2.4G	6	2437	11b 1M	Rear	10mm	FIG A.29	19.11	19.50	0.321	0.35	0.167	0.18	-0.03	100.00%
Body	F	WLAN2.4G	6	2437	11b 1M	Right	10mm	/	19.11	19.50	0.277	0.30	0.147	0.16	-0.12	100.00%
Body	F	WLAN2.4G	6	2437	11b 1M	Top	10mm	/	19.11	19.50	0.190	0.21	0.077	0.08	0.11	100.00%
Body	F	WLAN2.4G	6	2437	11b 1M	Rear	0mm	/	19.11	19.50	2.410	2.64	1.090	1.19	-0.07	100.00%

WLAN 5G

Test Position	Phantom position L/R/F	Frequency Band	Channel Number	Frequency (MHz)	Mode/RB	Test setup	Distance		EUT Measured Power (dBm)	Tune up (dBm)	Measured SAR 1g (W/kg)	Calculated SAR 1g (W/kg)	Measured SAR 10g (W/kg)	Calculated SAR 10g (W/kg)	Power Drift	Duty Cycle
Cheek	L	WLAN5G	44	5220	11a 6M	Cheek Left	0mm	/	15.36	16.00	0.512	0.59	0.148	0.17	0.04	100.00%
Tilt	L	WLAN5G	36	5180	11a 6M	Tilt Left	0mm	/	15.34	16.00	0.961	1.12	0.248	0.29	-0.09	100.00%
Tilt	L	WLAN5G	44	5220	11a 6M	Tilt Left	0mm	/	15.36	16.00	0.800	0.93	0.201	0.23	-0.04	100.00%
Cheek	R	WLAN5G	44	5220	11a 6M	Cheek Right	0mm	/	15.36	16.00	0.255	0.30	0.073	0.08	0.03	100.00%
Tilt	R	WLAN5G	44	5220	11a 6M	Tilt Right	0mm	/	15.36	16.00	0.363	0.42	0.099	0.11	0.17	100.00%
Cheek	L	WLAN5G	64	5320	11a 6M	Cheek Left	0mm	/	15.28	16.00	0.624	0.74	0.163	0.19	0.04	100.00%
Tilt	L	WLAN5G	56	5280	11a 6M	Tilt Left	0mm	FIG A.30	15.27	16.00	1.090	1.29	0.273	0.32	0.18	100.00%
Tilt	L	WLAN5G	60	5300	11a 6M	Tilt Left	0mm	/	15.13	16.00	0.861	1.05	0.223	0.27	0.19	100.00%
Tilt	L	WLAN5G	64	5320	11a 6M	Tilt Left	0mm	/	15.28	16.00	0.825	0.97	0.202	0.24	0.06	100.00%
Cheek	R	WLAN5G	64	5320	11a 6M	Cheek Right	0mm	/	15.28	16.00	0.232	0.27	0.069	0.08	-0.12	100.00%
Tilt	R	WLAN5G	64	5320	11a 6M	Tilt Right	0mm	/	15.28	16.00	0.321	0.38	0.092	0.11	0.16	100.00%
Cheek	L	WLAN5G	144	5720	11a 6M	Cheek Left	0mm	/	16.44	16.50	0.587	0.60	0.158	0.16	0.04	100.00%
Tilt	L	WLAN5G	140	5700	11a 6M	Tilt Left	0mm	/	16.40	16.50	1.030	1.05	0.255	0.26	0.07	100.00%
Tilt	L	WLAN5G	144	5720	11a 6M	Tilt Left	0mm	/	16.44	16.50	0.939	0.95	0.244	0.25	0.17	100.00%
Cheek	R	WLAN5G	144	5720	11a 6M	Cheek Right	0mm	/	16.44	16.50	0.368	0.37	0.119	0.12	0.10	100.00%
Tilt	R	WLAN5G	144	5720	11a 6M	Tilt Right	0mm	/	16.44	16.50	0.507	0.51	0.157	0.16	-0.10	100.00%
Cheek	L	WLAN5G	155	5775	11ac-80M	Cheek Left	0mm	/	16.13	16.50	0.477	0.52	0.134	0.15	0.18	100.00%
Tilt	L	WLAN5G	155	5775	11ac-80M	Tilt Left	0mm	/	16.13	16.50	0.694	0.76	0.189	0.21	-0.04	100.00%
Cheek	R	WLAN5G	155	5775	11ac-80M	Cheek Right	0mm	/	16.13	16.50	0.286	0.31	0.088	0.10	-0.06	100.00%
Tilt	R	WLAN5G	155	5775	11ac-80M	Tilt Right	0mm	/	16.13	16.50	0.384	0.42	0.116	0.13	0.11	100.00%
Body	F	WLAN5G	44	5220	11a 6M	Front	10mm	/	16.28	17.00	0.202	0.24	0.072	0.08	0.07	100.00%
Body	F	WLAN5G	44	5220	11a 6M	Rear	10mm	/	16.28	17.00	0.509	0.60	0.185	0.22	-0.16	100.00%
Body	F	WLAN5G	44	5220	11a 6M	Right	10mm	/	16.28	17.00	0.238	0.28	0.096	0.11	0.14	100.00%
Body	F	WLAN5G	40	5200	11a 6M	Top	10mm	/	16.23	17.00	0.695	0.83	0.232	0.28	0.16	100.00%
Body	F	WLAN5G	44	5220	11a 6M	Top	10mm	/	16.28	17.00	0.736	0.87	0.242	0.29	0.07	100.00%
Body	F	WLAN5G	64	5320	11a 6M	Front	10mm	/	16.11	17.00	0.202	0.25	0.071	0.09	0.05	100.00%
Body	F	WLAN5G	64	5320	11a 6M	Rear	10mm	/	16.11	17.00	0.623	0.76	0.228	0.28	-0.07	100.00%
Body	F	WLAN5G	64	5320	11a 6M	Right	10mm	/	16.11	17.00	0.215	0.25	0.090	0.11	0.11	100.00%
Body	F	WLAN5G	60	5300	11a 6M	Top	10mm	/	16.06	17.00	0.758	0.94	0.244	0.30	0.13	100.00%
Body	F	WLAN5G	64	5320	11a 6M	Top	10mm	FIG A.31	16.11	17.00	0.876	1.08	0.290	0.36	0.03	100.00%
Body	F	WLAN5G	144	5720	11a 6M	Front	10mm	/	17.28	17.50	0.178	0.19	0.062	0.07	0.13	100.00%
Body	F	WLAN5G	144	5720	11a 6M	Rear	10mm	/	17.28	17.50	0.503	0.53	0.188	0.20	-0.09	100.00%
Body	F	WLAN5G	144	5720	11a 6M	Right	10mm	/	17.28	17.50	0.194	0.20	0.089	0.09	0.03	100.00%
Body	F	WLAN5G	144	5720	11a 6M	Top	10mm	/	17.28	17.50	0.631	0.66	0.214	0.23	-0.14	100.00%
Body	F	WLAN5G	155	5775	11ac-80M	Front	10mm	/	17.27	17.50	0.182	0.19	0.056	0.06	-0.15	100.00%
Body	F	WLAN5G	155	5775	11ac-80M	Rear	10mm	/	17.27	17.50	0.458	0.48	0.170	0.18	0.05	100.00%
Body	F	WLAN5G	155	5775	11ac-80M	Right	10mm	/	17.27	17.50	0.219	0.23	0.083	0.09	0.11	100.00%
Body	F	WLAN5G	155	5775	11ac-80M	Top	10mm	/	17.27	17.50	0.534	0.56	0.181	0.19	0.09	100.00%
Body	F	WLAN5G	44	5220	11a 6M	Front	15mm	/	17.39	18.00	0.105	0.12	0.041	0.05	-0.04	100.00%
Body	F	WLAN5G	44	5220	11a 6M	Rear	15mm	/	17.39	18.00	0.367	0.42	0.152	0.17	-0.08	100.00%
Body	F	WLAN5G	64	5320	11a 6M	Front	15mm	/	17.29	18.00	0.129	0.15	0.046	0.05	-0.13	100.00%
Body	F	WLAN5G	64	5320	11a 6M	Rear	15mm	FIG A.32	17.29	18.00	0.418	0.49	0.169	0.20	-0.04	100.00%
Body	F	WLAN5G	144	5720	11a 6M	Front	15mm	/	18.29	18.50	0.098	0.10	0.038	0.04	-0.18	100.00%
Body	F	WLAN5G	144	5720	11a 6M	Rear	15mm	/	18.29	18.50	0.317	0.33	0.136	0.14	-0.05	100.00%
Body	F	WLAN5G	155	5775	11ac-80M	Front	15mm	/	17.85	18.50	0.102	0.12	0.040	0.05	0.09	100.00%
Body	F	WLAN5G	155	5775	11ac-80M	Rear	15mm	/	17.85	18.50	0.307	0.36	0.130	0.15	0.15	100.00%
Body	F	WLAN5G	64	5320	11a 6M	Rear	0mm	/	17.85	18.50	2.790	3.24	0.778	0.90	0.10	100.00%

13.3 SAR results for BT

Test Position	Phantom position L/R/F	Frequency Band	Channel Number	Frequency (MHz)	Mode/RB	Test setup	Distance		EUT Measured Power (dBm)	Tune up (dBm)	Measured SAR 1g (W/kg)	Calculated SAR 1g (W/kg)	Measured SAR 10g (W/kg)	Calculated SAR 10g (W/kg)	Power Drift
Cheek	L	BT	78	2480	GFSK	Cheek Left	0mm	/	11.82	12.00	0.022	0.02	0.010	0.01	-0.01
Tilt	L	BT	78	2480	GFSK	Tilt Left	0mm	FIG A.33	11.82	12.00	0.032	0.03	0.012	0.01	0.11
Cheek	R	BT	78	2480	GFSK	Cheek Right	0mm	/	11.82	12.00	<0.01	<0.01	<0.01	<0.01	
Tilt	R	BT	78	2480	GFSK	Tilt Right	0mm	/	11.82	12.00	<0.01	<0.01	<0.01	<0.01	
Body	F	BT	78	2480	GFSK	Front	10mm	/	11.82	12.00	<0.01	<0.01	<0.01	<0.01	
Body	F	BT	78	2480	GFSK	Rear	10mm	FIG A.34	11.82	12.00	0.011	0.01	0.005	0.01	0.09
Body	F	BT	78	2480	GFSK	Right	10mm	/	11.82	12.00	<0.01	<0.01	<0.01	<0.01	
Body	F	BT	78	2480	GFSK	Top	10mm	/	11.82	12.00	<0.01	<0.01	<0.01	<0.01	
Body	F	BT	78	2480	GFSK	Rear	0mm	/	11.82	12.00	0.054	0.06	0.023	0.02	0.07

13.4 SAR results for Phablet

According to the KDB648474 D04, for smart phones, with a display diagonal dimension > 15.0 cm or an overall diagonal dimension > 16.0 cm, that can provide similar mobile web access and multimedia support found in mini-tablets or UMPC mini-tablets and support voice calls next to the ear, unless it is confirmed otherwise through KDB inquiries, the following phablet procedures should be applied to evaluate SAR compliance for each applicable wireless modes and frequency band. Devices marketed as phablets, regardless of form factors and operating characteristics must be tested as a phablet to determine SAR compliance.

1. The normally required head and body-worn accessory SAR test procedures for handsets, including hotspot mode, must be applied.
2. The UMPC mini-tablet procedures must also be applied to test the SAR of all surfaces and edges with an antenna located at ≤ 25 mm from that surface or edge, in direct contact with a flat phantom, for 10-g extremity SAR according to the body-equivalent tissue dielectric parameters in KDB Publication 865664 D01 to address interactive hand use exposure conditions. When hotspot mode applies, 10-g extremity SAR is required only for the surfaces and edges with hotspot mode 1-g reported SAR > 1.2 W/kg; however, when power reduction applies to hotspot mode the measured SAR must be scaled to the maximum output power, including tolerance, allowed for phablet modes to compare with the 1.2 W/kg SAR test reduction threshold. The normal tablet procedures in KDB Publication 616217 are required when the overall diagonal dimension of the device is > 20.0 cm. Hotspot mode SAR is not required when normal tablet procedures are applied. Extremity 10-g SAR is also not required for the front (top) surface of larger form factor full size tablets. The more conservative normal tablet SAR results can be used to support phablet mode 10-g extremity SAR.
3. The simultaneous transmission operating configurations applicable to voice and data transmissions for both phone and mini-tablet modes must be taken into consideration separately for 1-g and 10-g SAR to determine the simultaneous transmission SAR test exclusion and measurement requirements for the relevant wireless modes and exposure conditions

Test Position	Phantom position L/R/F	Frequency Band	Channel Number	Frequency (MHz)	Mode/RB	Test setup	Distance	EUT Measured Power (dBm)	Tune up (dBm)	Measured SAR 1g (W/kg)	Calculated SAR 1g (W/kg)	Measured SAR 10g (W/kg)	Calculated SAR 10g (W/kg)	Power Drift
Body	F	WCDMA1700	1513	1752.6	RMC	Bottom	0mm	21.59	22.50	4.650	5.73	2.180	2.69	0.09
Body	F	WCDMA1700	1412	1732.5	RMC	Bottom	0mm	21.62	22.50	6.000	7.35	2.590	3.17	0.09
Body	F	WCDMA1700	1312	1712.4	RMC	Bottom	0mm	21.66	22.50	4.770	5.79	2.230	2.71	0.14
Body	F	LTE Band4	20300	1745	1RB-Middle	Rear	0mm	21.79	22.50	4.740	5.58	1.960	2.31	0.12
Body	F	LTE Band4	20175	1732.5	1RB-Middle	Rear	0mm	21.81	22.50	4.830	5.66	2.010	2.36	-0.18
Body	F	LTE Band4	20050	1720	1RB-Middle	Rear	0mm	21.96	22.50	5.220	5.91	2.120	2.40	-0.11
Body	F	LTE Band4	20300	1745	1RB-Middle	Bottom	0mm	21.79	22.50	5.540	6.52	2.430	2.86	0.17
Body	F	LTE Band4	20175	1732.5	1RB-Middle	Bottom	0mm	21.81	22.50	5.660	6.63	2.480	2.91	0.09
Body	F	LTE Band4	20050	1720	1RB-Middle	Bottom	0mm	21.96	22.50	5.700	6.45	2.620	2.97	0.12
Body	F	LTE Band4	20050	1745	50RB-Low	Rear	0mm	21.83	22.50	4.650	5.43	1.930	2.25	-0.13
Body	F	LTE Band4	20050	1732.5	50RB-Low	Rear	0mm	21.84	22.50	4.750	5.53	1.980	2.30	0.05
Body	F	LTE Band4	20050	1720	50RB-Low	Rear	0mm	21.89	22.50	4.880	5.62	2.040	2.35	-0.17
Body	F	LTE Band4	20050	1745	50RB-Low	Bottom	0mm	21.83	22.50	5.580	6.51	2.420	2.82	0.19
Body	F	LTE Band4	20050	1732.5	50RB-Low	Bottom	0mm	21.84	22.50	5.490	6.39	2.390	2.78	0.06
Body	F	LTE Band4	20050	1720	50RB-Low	Bottom	0mm	21.89	22.50	5.400	6.21	2.360	2.72	-0.03
Body	F	LTE Band4	20050	1720	100RB	Rear	0mm	21.83	22.50	4.900	5.72	2.050	2.39	-0.02
Body	F	LTE Band4	20050	1720	100RB	Bottom	0mm	21.83	22.50	5.450	6.37	2.240	2.62	0.14
Body	F	LTE Band66	132572	1770	1RB-Middle	Bottom	0mm	22.03	22.50	5.750	6.41	2.520	2.81	-0.09
Body	F	LTE Band66	132322	1745	1RB-Middle	Bottom	0mm	21.97	22.50	5.950	6.72	2.580	2.91	0.14
Body	F	LTE Band66	132072	1720	1RB-Middle	Bottom	0mm	22.06	22.50	6.000	6.64	2.630	2.91	0.06
Body	F	LTE Band66	132572	1770	50RB-Middle	Bottom	0mm	22.04	22.50	5.830	6.48	2.520	2.80	-0.07
Body	F	LTE Band66	132322	1745	50RB-Middle	Bottom	0mm	21.96	22.50	5.960	6.75	2.570	2.91	-0.17
Body	F	LTE Band66	132072	1720	50RB-Low	Bottom	0mm	22.05	22.50	5.660	6.28	2.470	2.74	0.02
Body	F	LTE Band66	132072	1720	100RB	Bottom	0mm	22.03	22.50	5.770	6.43	2.510	2.80	-0.03

Test Position	Phantom position L/R/F	Frequency Band	Channel Number	Frequency (MHz)	Mode/RB	Test setup	Distance	EUT Measured Power (dBm)	Tune up (dBm)	Measured SAR 1g (W/kg)	Calculated SAR 1g (W/kg)	Measured SAR 10g (W/kg)	Calculated SAR 10g (W/kg)	Power Drift	Duty Cycle
Body	F	WLAN2.4G	6	2437	11b 1M	Rear	0mm	19.11	19.50	2.410	2.64	1.090	1.19	-0.07	100.00%
Body	F	WLAN5G	64	5320	11a 6M	Rear	0mm	17.85	18.50	2.790	3.24	0.778	0.90	0.10	100.00%
Body	F	BT	78	2480	GFSK	Rear	0mm	11.82	12.00	0.054	0.06	0.023	0.02	0.07	

15 SAR Measurement Variability

SAR measurement variability must be assessed for each frequency band, which is determined by the SAR probe calibration point and tissue-equivalent medium used for the device measurements. When both head and body tissue-equivalent media are required for SAR measurements in a frequency band, the variability measurement procedures should be applied to the tissue medium with the highest measured SAR, using the highest measured SAR configuration for that tissue-equivalent medium.

The following procedures are applied to determine if repeated measurements are required.

- 1) Repeated measurement is not required when the original highest measured SAR is < 0.80 W/kg; steps 2) through 4) do not apply.
- 2) When the original highest measured SAR is ≥ 0.80 W/kg, repeat that measurement once.
- 3) Perform a second repeated measurement only if the ratio of largest to smallest SAR for the original and first repeated measurements is > 1.20 or when the original or repeated measurement is ≥ 1.45 W/kg (~ 10% from the 1-g SAR limit).
- 4) Perform a third repeated measurement only if the original, first or second repeated measurement is ≥ 1.5 W/kg and the ratio of largest to smallest SAR for the original, first and second repeated measurements is > 1.20.

Test Position	Phantom position L/R/F	Frequency Band	Channel Number	Frequency (MHz)	Mode/IRB	Test setup	Distance	Original SAR 1g (W/kg)	First Repeated SAR 10g (W/kg)	The Ratio	Second Repeated SAR 10g (W/kg)
Body	F	WCDMA1700	1513	1752.6	RMC	Bottom	10mm	0.873	0.833	1.05	/
Body	F	WCDMA1700	1412	1732.5	RMC	Bottom	10mm	0.990	0.970	1.02	/
Body	F	WCDMA1700	1312	1712.4	RMC	Bottom	10mm	0.878	0.848	1.04	/
Body	F	WCDMA1900	9538	1907.6	RMC	Bottom	10mm	0.855	0.805	1.06	/
Body	F	WCDMA1900	9400	1880	RMC	Bottom	10mm	0.831	0.811	1.02	/
Body	F	WCDMA1900	9262	1852.4	RMC	Bottom	10mm	0.922	0.872	1.06	/
Body	F	LTE Band2	19100	1900	1RB-Middle	Bottom	10mm	0.819	0.799	1.03	/
Body	F	LTE Band2	18900	1880	1RB-Middle	Bottom	10mm	0.827	0.817	1.01	/
Body	F	LTE Band2	18700	1860	1RB-Middle	Bottom	10mm	0.862	0.812	1.06	/
Body	F	LTE Band2	18900	1880	50RB-High	Bottom	10mm	0.800	0.770	1.04	/
Body	F	LTE Band2	18700	1860	50RB-Middle	Bottom	10mm	0.834	0.814	1.02	/
Body	F	LTE Band4	20175	1732.5	1RB-Middle	Rear	10mm	0.869	0.839	1.04	/
Body	F	LTE Band4	20050	1720	1RB-Low	Rear	10mm	0.889	0.879	1.01	/
Body	F	LTE Band4	20300	1745	1RB-Middle	Bottom	10mm	0.874	0.834	1.05	/
Body	F	LTE Band4	20175	1732.5	1RB-Middle	Bottom	10mm	0.997	0.947	1.05	/
Body	F	LTE Band4	20050	1720	1RB-Low	Bottom	10mm	1.020	1.010	1.01	/
Body	F	LTE Band4	20175	1732.5	50RB-High	Rear	10mm	0.845	0.835	1.01	/
Body	F	LTE Band4	20050	1720	50RB-Low	Rear	10mm	0.864	0.844	1.02	/
Body	F	LTE Band4	20300	1745	50RB-Middle	Bottom	10mm	0.849	0.819	1.04	/
Body	F	LTE Band4	20175	1732.5	50RB-High	Bottom	10mm	0.969	0.929	1.04	/
Body	F	LTE Band4	20050	1720	50RB-Low	Bottom	10mm	0.991	0.941	1.05	/
Body	F	LTE Band4	20050	1720	100RB	Rear	10mm	0.839	0.789	1.06	/
Body	F	LTE Band4	20050	1720	100RB	Bottom	10mm	0.976	0.926	1.05	/
Body	F	LTE Band66	132572	1770	1RB-Middle	Bottom	10mm	0.859	0.809	1.06	/
Body	F	LTE Band66	132322	1745	1RB-Middle	Bottom	10mm	0.928	0.918	1.01	/
Body	F	LTE Band66	132072	1720	1RB-Middle	Bottom	10mm	0.989	0.969	1.02	/
Body	F	LTE Band66	132572	1770	50RB-Middle	Bottom	10mm	0.821	0.801	1.02	/
Body	F	LTE Band66	132322	1745	50RB-Middle	Bottom	10mm	0.884	0.834	1.06	/
Body	F	LTE Band66	132072	1720	50RB-Low	Bottom	10mm	0.945	0.915	1.03	/
Body	F	LTE Band66	132072	1720	100RB	Bottom	10mm	0.919	0.899	1.02	/
Cheek	L	WLAN2.4G	6	2437	11b 1M	Cheek Left	0mm	0.853	0.833	1.02	/
Tilt	L	WLAN2.4G	11	2462	11b 1M	Tilt Left	0mm	0.986	0.946	1.04	/
Tilt	L	WLAN2.4G	6	2437	11b 1M	Tilt Left	0mm	1.030	0.990	1.04	/
Tilt	L	WLAN2.4G	1	2412	11b 1M	Tilt Left	0mm	0.917	0.907	1.01	/
Tilt	L	WLAN5G	36	5180	11a 6M	Tilt Left	0mm	0.961	0.931	1.03	/
Tilt	L	WLAN5G	44	5220	11a 6M	Tilt Left	0mm	0.800	0.750	1.07	/
Tilt	L	WLAN5G	56	5280	11a 6M	Tilt Left	0mm	1.090	1.060	1.03	/
Tilt	L	WLAN5G	60	5300	11a 6M	Tilt Left	0mm	0.861	0.821	1.05	/
Tilt	L	WLAN5G	64	5320	11a 6M	Tilt Left	0mm	0.825	0.795	1.04	/
Tilt	L	WLAN5G	140	5700	11a 6M	Tilt Left	0mm	1.030	0.980	1.05	/
Tilt	L	WLAN5G	144	5720	11a 6M	Tilt Left	0mm	0.939	0.889	1.06	/
Body	F	WLAN5G	64	5320	11a 6M	Top	10mm	0.876	0.846	1.04	/

16 Measurement Uncertainty

16.1 Measurement Uncertainty for Normal SAR Tests (300MHz~3GHz)

No.	Error Description	Type	Uncertainty value	Probably Distribution	Div.	(Ci) 1g	(Ci) 10g	Std. Unc. (1g)	Std. Unc. (10g)	Degree of freedom
Measurement system										
1	Probe calibration	B	6.0	N	1	1	1	6.0	6.0	∞
2	Isotropy	B	4.7	R	$\sqrt{3}$	0.7	0.7	1.9	1.9	∞
3	Boundary effect	B	1.0	R	$\sqrt{3}$	1	1	0.6	0.6	∞
4	Linearity	B	4.7	R	$\sqrt{3}$	1	1	2.7	2.7	∞
5	Detection limit	B	1.0	N	1	1	1	0.6	0.6	∞
6	Readout electronics	B	0.3	R	$\sqrt{3}$	1	1	0.3	0.3	∞
7	Response time	B	0.8	R	$\sqrt{3}$	1	1	0.5	0.5	∞
8	Integration time	B	2.6	R	$\sqrt{3}$	1	1	1.5	1.5	∞
9	RF ambient conditions-noise	B	0	R	$\sqrt{3}$	1	1	0	0	∞
10	RFambient conditions-reflection	B	0	R	$\sqrt{3}$	1	1	0	0	∞
11	Probe positioned mech. restrictions	B	0.4	R	$\sqrt{3}$	1	1	0.2	0.2	∞
12	Probe positioning with respect to phantom shell	B	2.9	R	$\sqrt{3}$	1	1	1.7	1.7	∞
13	Post-processing	B	1.0	R	$\sqrt{3}$	1	1	0.6	0.6	∞
Test sample related										
14	Test sample positioning	A	3.3	N	1	1	1	3.3	3.3	71
15	Device holder uncertainty	A	3.4	N	1	1	1	3.4	3.4	5
16	Drift of output power	B	5.0	R	$\sqrt{3}$	1	1	2.9	2.9	∞
Phantom and set-up										
17	Phantom uncertainty	B	4.0	R	$\sqrt{3}$	1	1	2.3	2.3	∞
18	Liquid conductivity (target)	B	5.0	R	$\sqrt{3}$	0.64	0.43	1.8	1.2	∞
19	Liquid conductivity (meas.)	A	2.06	N	1	0.64	0.43	1.32	0.89	43
20	Liquid permittivity (target)	B	5.0	R	$\sqrt{3}$	0.6	0.49	1.7	1.4	∞
21	Liquid permittivity (meas.)	A	1.6	N	1	0.6	0.49	1.0	0.8	521

Combined standard uncertainty	$u_c = \sqrt{\sum_{i=1}^{21} c_i^2 u_i^2}$							9.55	9.43	257
Expanded uncertainty (confidence interval of 95 %)	$u_e = 2u_c$							19.1	18.9	

16.2 Measurement Uncertainty for Normal SAR Tests (3~6GHz)

No.	Error Description	Type	Uncertainty value	Probably Distribution	Div.	(Ci) 1g	(Ci) 10g	Std. Unc. (1g)	Std. Unc. (10g)	Degree of freedom
Measurement system										
1	Probe calibration	B	6.55	N	1	1	1	6.55	6.55	∞
2	Isotropy	B	4.7	R	$\sqrt{3}$	0.7	0.7	1.9	1.9	∞
3	Boundary effect	B	2.0	R	$\sqrt{3}$	1	1	1.2	1.2	∞
4	Linearity	B	4.7	R	$\sqrt{3}$	1	1	2.7	2.7	∞
5	Detection limit	B	1.0	R	$\sqrt{3}$	1	1	0.6	0.6	∞
6	Readout electronics	B	0.3	R	$\sqrt{3}$	1	1	0.3	0.3	∞
7	Response time	B	0.8	R	$\sqrt{3}$	1	1	0.5	0.5	∞
8	Integration time	B	2.6	R	$\sqrt{3}$	1	1	1.5	1.5	∞
9	RF ambient conditions-noise	B	0	R	$\sqrt{3}$	1	1	0	0	∞
10	RF ambient conditions-reflection	B	0	R	$\sqrt{3}$	1	1	0	0	∞
11	Probe positioned mech. restrictions	B	0.8	R	$\sqrt{3}$	1	1	0.5	0.5	∞
12	Probe positioning with respect to phantom shell	B	6.7	R	$\sqrt{3}$	1	1	3.9	3.9	∞
13	Post-processing	B	4.0	R	$\sqrt{3}$	1	1	2.3	2.3	∞
Test sample related										
14	Test sample positioning	A	3.3	N	1	1	1	3.3	3.3	71
15	Device holder uncertainty	A	3.4	N	1	1	1	3.4	3.4	5
16	Drift of output power	B	5.0	R	$\sqrt{3}$	1	1	2.9	2.9	∞
Phantom and set-up										
17	Phantom uncertainty	B	4.0	R	$\sqrt{3}$	1	1	2.3	2.3	∞
18	Liquid conductivity (target)	B	5.0	R	$\sqrt{3}$	0.64	0.43	1.8	1.2	∞
19	Liquid conductivity (meas.)	A	2.06	N	1	0.64	0.43	1.32	0.89	43
20	Liquid permittivity (target)	B	5.0	R	$\sqrt{3}$	0.6	0.49	1.7	1.4	∞

21	Liquid permittivity (meas.)	A	1.6	N	1	0.6	0.49	1.0	0.8	521
Combined standard uncertainty		$u_c = \sqrt{\sum_{i=1}^{21} c_i^2 u_i^2}$						10.7	10.6	257
Expanded uncertainty (confidence interval of 95 %)		$u_e = 2u_c$						21.4	21.1	

16.3 Measurement Uncertainty for Fast SAR Tests (300MHz~3GHz)

No.	Error Description	Type	Uncertainty value	Probably Distribution	Div.	(Ci) 1g	(Ci) 10g	Std. Unc. (1g)	Std. Unc. (10g)	Degree of freedom
Measurement system										
1	Probe calibration	B	6.0	N	1	1	1	6.0	6.0	∞
2	Isotropy	B	4.7	R	$\sqrt{3}$	0.7	0.7	1.9	1.9	∞
3	Boundary effect	B	1.0	R	$\sqrt{3}$	1	1	0.6	0.6	∞
4	Linearity	B	4.7	R	$\sqrt{3}$	1	1	2.7	2.7	∞
5	Detection limit	B	1.0	R	$\sqrt{3}$	1	1	0.6	0.6	∞
6	Readout electronics	B	0.3	R	$\sqrt{3}$	1	1	0.3	0.3	∞
7	Response time	B	0.8	R	$\sqrt{3}$	1	1	0.5	0.5	∞
8	Integration time	B	2.6	R	$\sqrt{3}$	1	1	1.5	1.5	∞
9	RF ambient conditions-noise	B	0	R	$\sqrt{3}$	1	1	0	0	∞
10	RFambient conditions-reflection	B	0	R	$\sqrt{3}$	1	1	0	0	∞
11	Probe positioned mech. Restrictions	B	0.4	R	$\sqrt{3}$	1	1	0.2	0.2	∞
12	Probe positioning with respect to phantom shell	B	2.9	R	$\sqrt{3}$	1	1	1.7	1.7	∞
13	Post-processing	B	1.0	R	$\sqrt{3}$	1	1	0.6	0.6	∞
14	Fast SAR z-Approximation	B	7.0	R	$\sqrt{3}$	1	1	4.0	4.0	∞
Test sample related										
15	Test sample positioning	A	3.3	N	1	1	1	3.3	3.3	71
16	Device holder uncertainty	A	3.4	N	1	1	1	3.4	3.4	5
17	Drift of output power	B	5.0	R	$\sqrt{3}$	1	1	2.9	2.9	∞
Phantom and set-up										
18	Phantom uncertainty	B	4.0	R	$\sqrt{3}$	1	1	2.3	2.3	∞
19	Liquid conductivity (target)	B	5.0	R	$\sqrt{3}$	0.64	0.43	1.8	1.2	∞

20	Liquid conductivity (meas.)	A	2.06	N	1	0.64	0.43	1.32	0.89	43
21	Liquid permittivity (target)	B	5.0	R	$\sqrt{3}$	0.6	0.49	1.7	1.4	∞
22	Liquid permittivity (meas.)	A	1.6	N	1	0.6	0.49	1.0	0.8	521
Combined standard uncertainty		$u_c = \sqrt{\sum_{i=1}^{22} c_i^2 u_i^2}$						10.4	10.3	257
Expanded uncertainty (confidence interval of 95 %)		$u_e = 2u_c$						20.8	20.6	

16.4 Measurement Uncertainty for Fast SAR Tests (3~6GHz)

No.	Error Description	Type	Uncertainty value	Probably Distribution	Div.	(Ci) 1g	(Ci) 10g	Std. Unc. (1g)	Std. Unc. (10g)	Degree of freedom
Measurement system										
1	Probe calibration	B	6.55	N	1	1	1	6.55	6.55	∞
2	Isotropy	B	4.7	R	$\sqrt{3}$	0.7	0.7	1.9	1.9	∞
3	Boundary effect	B	2.0	R	$\sqrt{3}$	1	1	1.2	1.2	∞
4	Linearity	B	4.7	R	$\sqrt{3}$	1	1	2.7	2.7	∞
5	Detection limit	B	1.0	R	$\sqrt{3}$	1	1	0.6	0.6	∞
6	Readout electronics	B	0.3	R	$\sqrt{3}$	1	1	0.3	0.3	∞
7	Response time	B	0.8	R	$\sqrt{3}$	1	1	0.5	0.5	∞
8	Integration time	B	2.6	R	$\sqrt{3}$	1	1	1.5	1.5	∞
9	RF ambient conditions-noise	B	0	R	$\sqrt{3}$	1	1	0	0	∞
10	RFambient conditions-reflection	B	0	R	$\sqrt{3}$	1	1	0	0	∞
11	Probe positioned mech. Restrictions	B	0.8	R	$\sqrt{3}$	1	1	0.5	0.5	∞
12	Probe positioning with respect to phantom shell	B	6.7	R	$\sqrt{3}$	1	1	3.9	3.9	∞
13	Post-processing	B	1.0	R	$\sqrt{3}$	1	1	0.6	0.6	∞
14	Fast SAR z-Approximation	B	14.0	R	$\sqrt{3}$	1	1	8.1	8.1	∞
Test sample related										
15	Test sample positioning	A	3.3	N	1	1	1	3.3	3.3	71
16	Device holder uncertainty	A	3.4	N	1	1	1	3.4	3.4	5

17	Drift of output power	B	5.0	R	$\sqrt{3}$	1	1	2.9	2.9	∞
Phantom and set-up										
18	Phantom uncertainty	B	4.0	R	$\sqrt{3}$	1	1	2.3	2.3	∞
19	Liquid conductivity (target)	B	5.0	R	$\sqrt{3}$	0.64	0.43	1.8	1.2	∞
20	Liquid conductivity (meas.)	A	2.06	N	1	0.64	0.43	1.32	0.89	43
21	Liquid permittivity (target)	B	5.0	R	$\sqrt{3}$	0.6	0.49	1.7	1.4	∞
22	Liquid permittivity (meas.)	A	1.6	N	1	0.6	0.49	1.0	0.8	521
Combined standard uncertainty		$u_c = \sqrt{\sum_{i=1}^{22} c_i^2 u_i^2}$						13.5	13.4	257
Expanded uncertainty (confidence interval of 95 %)		$u_e = 2u_c$						27.0	26.8	

17 MAIN TEST INSTRUMENTS

No.	Name	Type	Serial Number	Calibration Date	Valid Period
01	Network analyzer	N5239A	MY55491241	June 5, 2023	One year
02	Power sensor	NRP50S	101488	June 14, 2023	One year
03	Power sensor	NRP50S	101489	June 14, 2023	One year
04	Signal Generator	E4438C	MY49071430	January 19, 2023	One year
05	Amplifier	60S1G4	0331848	No Calibration Requested	
06	BTS	CMW500	170672	April 18, 2023	One year
07	E-field Probe	SPEAG EX3DV4	7464	January 19, 2023	One year
08	DAE	SPEAG DAE4	1556	January 11, 2023	One year
09	Dipole Validation Kit	SPEAG D750V3	1017	July 14,2023	One year
10	Dipole Validation Kit	SPEAG D835V2	4d069	July 14,2023	One year
11	Dipole Validation Kit	SPEAG D1750V2	1003	July 12,2023	One year
12	Dipole Validation Kit	SPEAG D1900V2	5d101	July 17,2023	One year
13	Dipole Validation Kit	SPEAG D2450V2	853	July 11,2023	One year
14	Dipole Validation Kit	SPEAG D5GHzV2	1060	June 19,2023	One year

END OF REPORT BODY

ANNEX A Graph Results

GSM850 Head

Date: 2023/12/22

Electronics: DAE4 Sn1556

Medium: H700-6000M

Medium parameters used (interpolated): $f = 848.8$ MHz; $\sigma = 0.866$ S/m; $\epsilon_r = 43.4$; $\rho = 1000$ kg/m³

Ambient Temperature: 23.3°C Liquid Temperature: 22.5°C

Communication System: GSM 850 GPRS-2 (0) Frequency: 848.8 MHz Duty Cycle: 1:4.00037

Probe: EX3DV4 - SN7464 ConvF(10.26, 10.26, 10.26)

Area Scan (71x131x1): Interpolated grid: $dx=1.500$ mm, $dy=1.500$ mm

Maximum value of SAR (interpolated) = 0.355 W/kg

Zoom Scan (6x6x7)/Cube 0: Measurement grid: $dx=8$ mm, $dy=8$ mm, $dz=5$ mm

Reference Value = 3.520 V/m; Power Drift = 0.02 dB

Peak SAR (extrapolated) = 0.374 W/kg

SAR(1 g) = 0.303 W/kg; SAR(10 g) = 0.240 W/kg

Maximum value of SAR (measured) = 0.345 W/kg

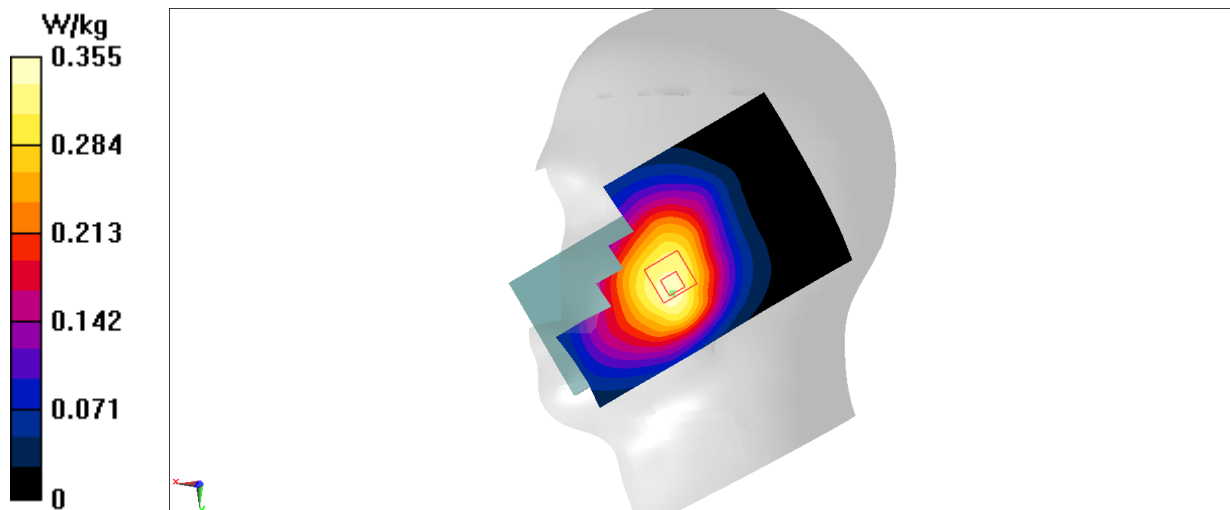

GSM850 Body 10mm

Date: 2023/12/22

Electronics: DAE4 Sn1556

Medium: H700-6000M

Medium parameters used (interpolated): $f = 836.6$ MHz; $\sigma = 0.86$ S/m; $\epsilon_r = 43.447$; $\rho = 1000$ kg/m³

Ambient Temperature: 23.3°C Liquid Temperature: 22.5°C

Communication System: UID 0, 1GSM 850 GPRS-2 (0) Frequency: 836.6 MHz Duty Cycle: 1:4.00037

Probe: EX3DV4 - SN7464 ConvF(10.26, 10.26, 10.26)

Area Scan (161x81x1): Interpolated grid: dx=1.500 mm, dy=1.500 mm

Maximum value of SAR (interpolated) = 0.437 W/kg

Zoom Scan (5x5x7)/Cube 0: Measurement grid: dx=8mm, dy=8mm, dz=5mm

Reference Value = 19.80 V/m; Power Drift = -0.16 dB

Peak SAR (extrapolated) = 0.430 W/kg

SAR(1 g) = 0.353 W/kg; SAR(10 g) = 0.280 W/kg

Maximum value of SAR (measured) = 0.368 W/kg

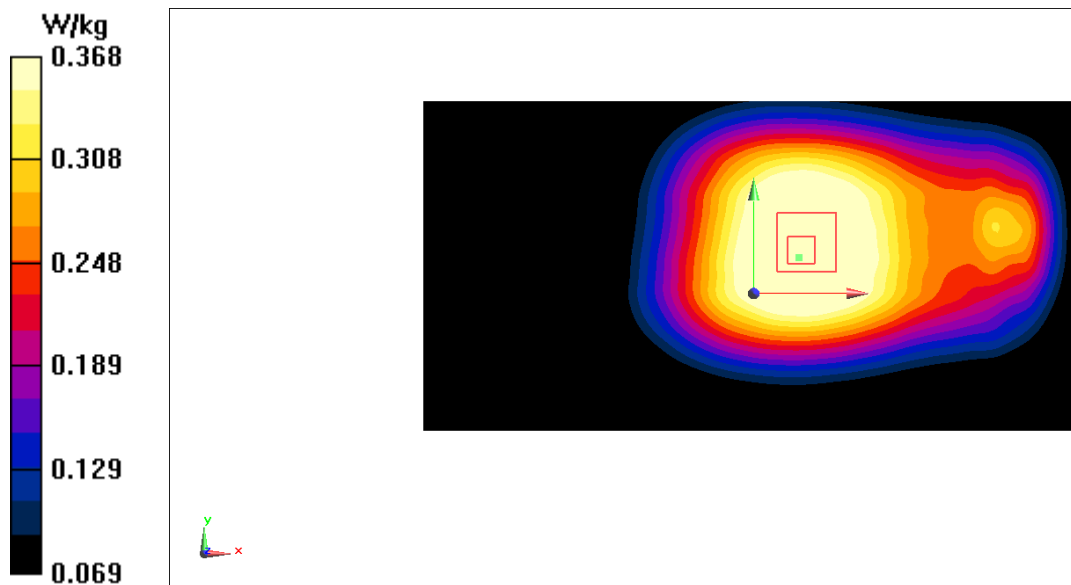

GSM1900 Head

Date: 2023/12/26

Electronics: DAE4 Sn1556

Medium: H700-6000M

Medium parameters used: $f = 1880$ MHz; $\sigma = 1.409$ S/m; $\epsilon_r = 40.836$; $\rho = 1000$ kg/m³

Ambient Temperature: 23.3°C Liquid Temperature: 22.5°C

Communication System: GSM 1900MHz GPRS-2 (0) Frequency: 1880 MHz Duty Cycle: 1:4.00037

Probe: EX3DV4 - SN7464 ConvF(8.13, 8.13, 8.13)

Area Scan (71x131x1): Interpolated grid: $dx=1.500$ mm, $dy=1.500$ mm

Maximum value of SAR (interpolated) = 0.178 W/kg

Zoom Scan (6x6x7)/Cube 0: Measurement grid: $dx=8$ mm, $dy=8$ mm, $dz=5$ mm

Reference Value = 2.823 V/m; Power Drift = 0.12 dB

Peak SAR (extrapolated) = 0.200 W/kg

SAR(1 g) = 0.133 W/kg; SAR(10 g) = 0.087 W/kg

Maximum value of SAR (measured) = 0.174 W/kg

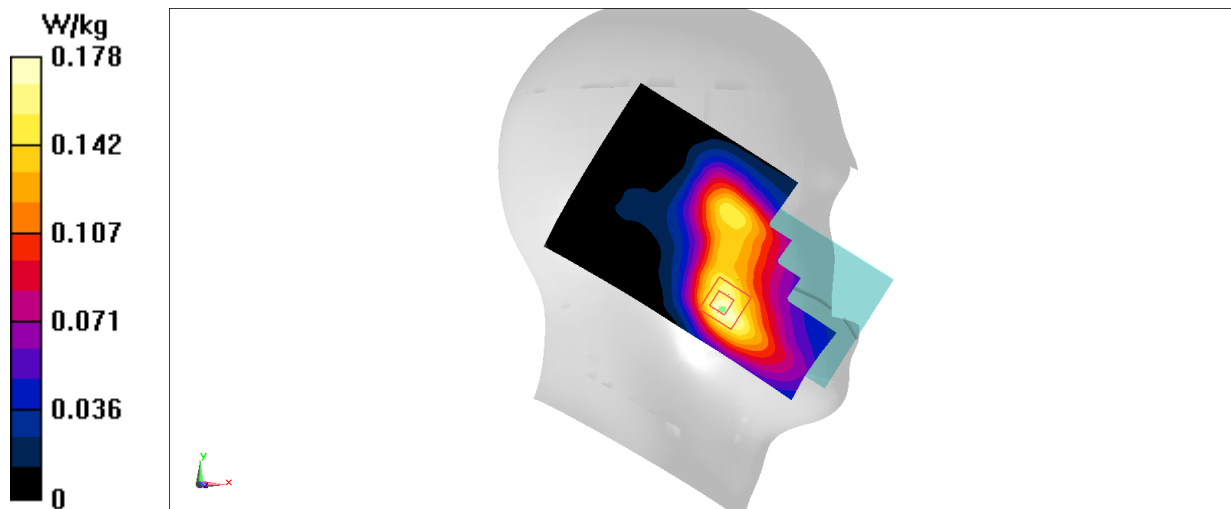

GSM1900 Body 10mm

Date: 2023/12/26

Electronics: DAE4 Sn1556

Medium: H700-6000M

Medium parameters used: $f = 1910$ MHz; $\sigma = 1.426$ S/m; $\epsilon_r = 40.76$; $\rho = 1000$ kg/m³

Ambient Temperature: 23.3°C Liquid Temperature: 22.5°C

Communication System: UID 0, 1GSM 1900 GPRS-2 (0) Frequency: 1909.8 MHz Duty Cycle: 1:4.00037

Probe: EX3DV4 - SN7464 ConvF(8.13, 8.13, 8.13)

Area Scan (161x81x1): Interpolated grid: dx=1.500 mm, dy=1.500 mm

Maximum value of SAR (interpolated) = 1.06 W/kg

Zoom Scan (5x5x7)/Cube 0: Measurement grid: dx=8mm, dy=8mm, dz=5mm

Reference Value = 15.54 V/m; Power Drift = 0.03 dB

Peak SAR (extrapolated) = 1.21 W/kg

SAR(1 g) = 0.706 W/kg; SAR(10 g) = 0.388 W/kg

Maximum value of SAR (measured) = 0.785 W/kg

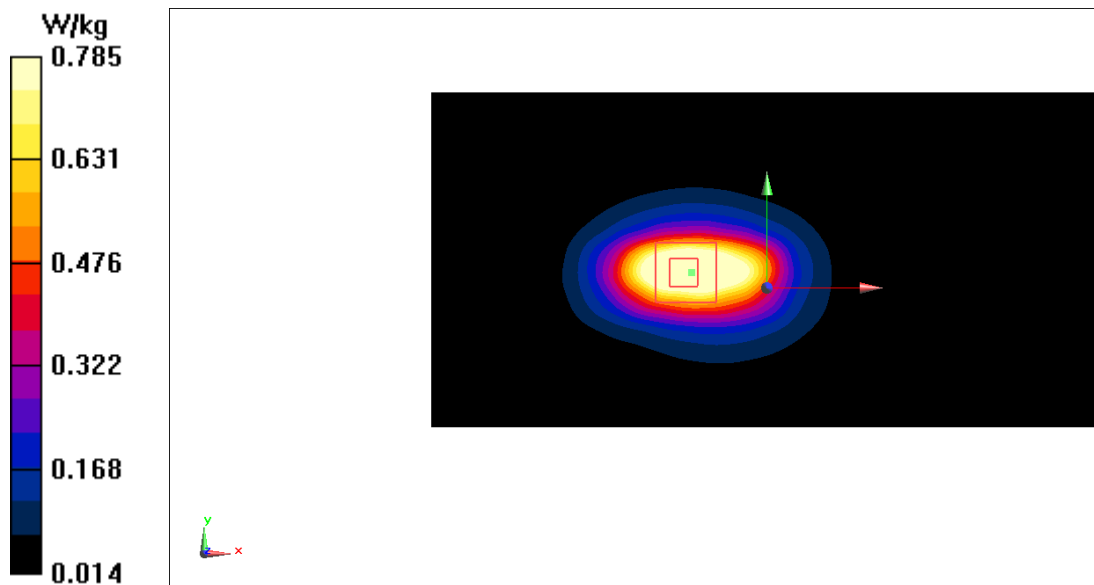

WCDMA850 Head

Date: 2023/12/22

Electronics: DAE4 Sn1556

Medium: H700-6000M

Medium parameters used (interpolated): $f = 836.6$ MHz; $\sigma = 0.86$ S/m; $\epsilon_r = 43.447$; $\rho = 1000$ kg/m³

Ambient Temperature: 23.3°C Liquid Temperature: 22.5°C

Communication System: WCDMA 850 (0) Frequency: 836.6 MHz Duty Cycle: 1:1

Probe: EX3DV4 - SN7464 ConvF(10.26, 10.26, 10.26)

Area Scan (71x131x1): Interpolated grid: $dx=1.500$ mm, $dy=1.500$ mm

Maximum value of SAR (interpolated) = 0.268 W/kg

Zoom Scan (6x6x7)/Cube 0: Measurement grid: $dx=8$ mm, $dy=8$ mm, $dz=5$ mm

Reference Value = 2.797 V/m; Power Drift = 0.05 dB

Peak SAR (extrapolated) = 0.279 W/kg

SAR(1 g) = 0.227 W/kg; SAR(10 g) = 0.181 W/kg

Maximum value of SAR (measured) = 0.261 W/kg

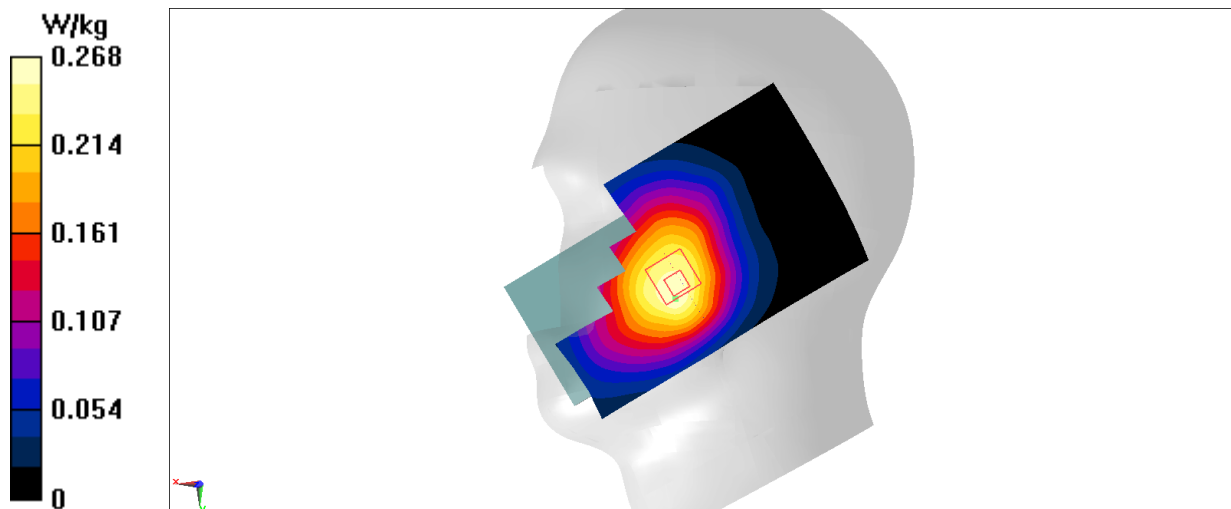

WCDMA850 Body 10mm

Date: 2023/12/22

Electronics: DAE4 Sn1556

Medium: H700-6000M

Medium parameters used (interpolated): $f = 846.6$ MHz; $\sigma = 0.864$ S/m; $\epsilon_r = 43.41$; $\rho = 1000$ kg/m³

Ambient Temperature: 23.3°C Liquid Temperature: 22.5°C

Communication System: WCDMA850(B5) (0) Frequency: 846.6 MHz Duty Cycle: 1:1

Probe: EX3DV4 - SN7464 ConvF(10.26, 10.26, 10.26)

Area Scan (81x131x1): Interpolated grid: dx=1.500 mm, dy=1.500 mm

Maximum value of SAR (interpolated) = 0.408 W/kg

Zoom Scan (5x5x7)/Cube 0: Measurement grid: dx=8mm, dy=8mm, dz=5mm

Reference Value = 21.40 V/m; Power Drift = -0.08 dB

Peak SAR (extrapolated) = 0.426 W/kg

SAR(1 g) = 0.351 W/kg; SAR(10 g) = 0.274 W/kg

Maximum value of SAR (measured) = 0.403 W/kg

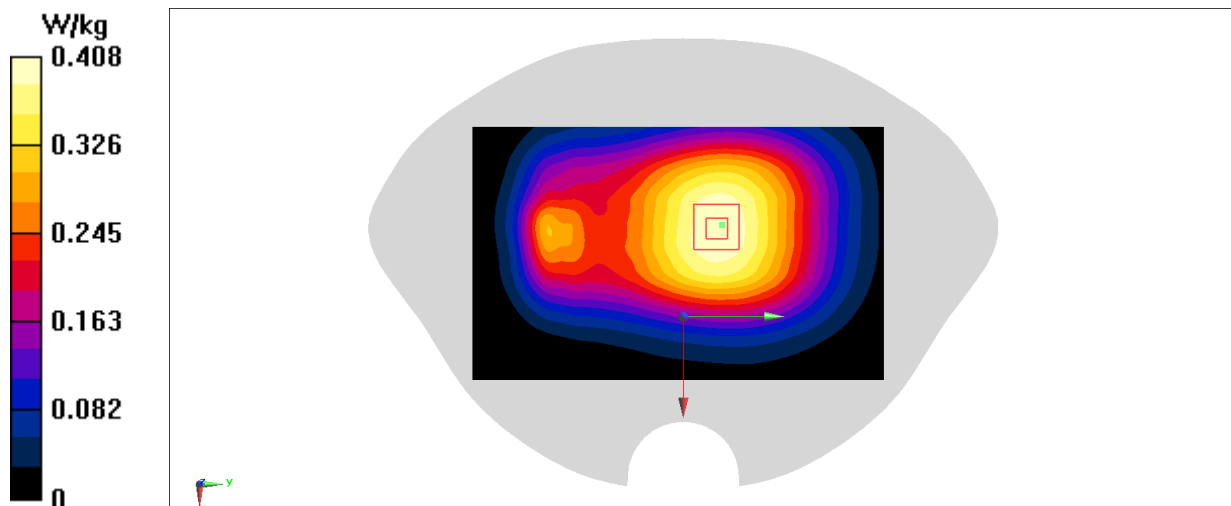

WCDMA1700 Head

Date: 2023/12/24

Electronics: DAE4 Sn1556

Medium: H700-6000M

Medium parameters used (interpolated): $f = 1732.4$ MHz; $\sigma = 1.317$ S/m; $\epsilon_r = 41.141$; $\rho = 1000$ kg/m³

Ambient Temperature: 23.3°C Liquid Temperature: 22.5°C

Communication System: WCDMA 1700 Band4 (0) Frequency: 1732.4 MHz Duty Cycle: 1:1

Probe: EX3DV4 - SN7464 ConvF(8.54, 8.54, 8.54)

Area Scan (71x131x1): Interpolated grid: $dx=1.500$ mm, $dy=1.500$ mm

Maximum value of SAR (interpolated) = 0.245 W/kg

Zoom Scan (5x5x7)/Cube 0: Measurement grid: $dx=8$ mm, $dy=8$ mm, $dz=5$ mm

Reference Value = 3.327 V/m; Power Drift = 0.07 dB

Peak SAR (extrapolated) = 0.268 W/kg

SAR(1 g) = 0.184 W/kg; SAR(10 g) = 0.119 W/kg

Maximum value of SAR (measured) = 0.237 W/kg

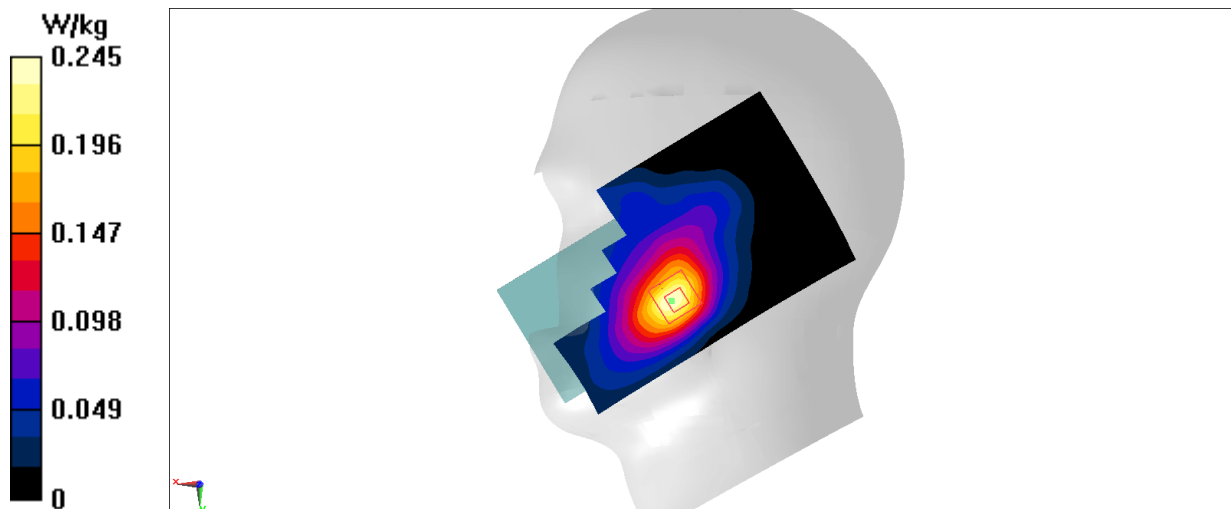

WCDMA1700 Body 10mm

Date: 2023/12/24

Electronics: DAE4 Sn1556

Medium: H700-6000M

Medium parameters used (interpolated): $f = 1732.4$ MHz; $\sigma = 1.317$ S/m; $\epsilon_r = 41.141$; $\rho = 1000$ kg/m³

Ambient Temperature: 23.3°C Liquid Temperature: 22.5°C

Communication System: WCDMA 1700 Band4 (0) Frequency: 1732.4 MHz Duty Cycle: 1:1

Probe: EX3DV4 - SN7464 ConvF(8.54, 8.54, 8.54)

Area Scan (81x141x1): Interpolated grid: $dx=1.500$ mm, $dy=1.500$ mm

Maximum value of SAR (interpolated) = 1.46 W/kg

Zoom Scan (5x6x7)/Cube 0: Measurement grid: $dx=8$ mm, $dy=8$ mm, $dz=5$ mm

Reference Value = 19.30 V/m; Power Drift = 0.12 dB

Peak SAR (extrapolated) = 1.75 W/kg

SAR(1 g) = 0.990 W/kg; SAR(10 g) = 0.537 W/kg

Maximum value of SAR (measured) = 1.46 W/kg

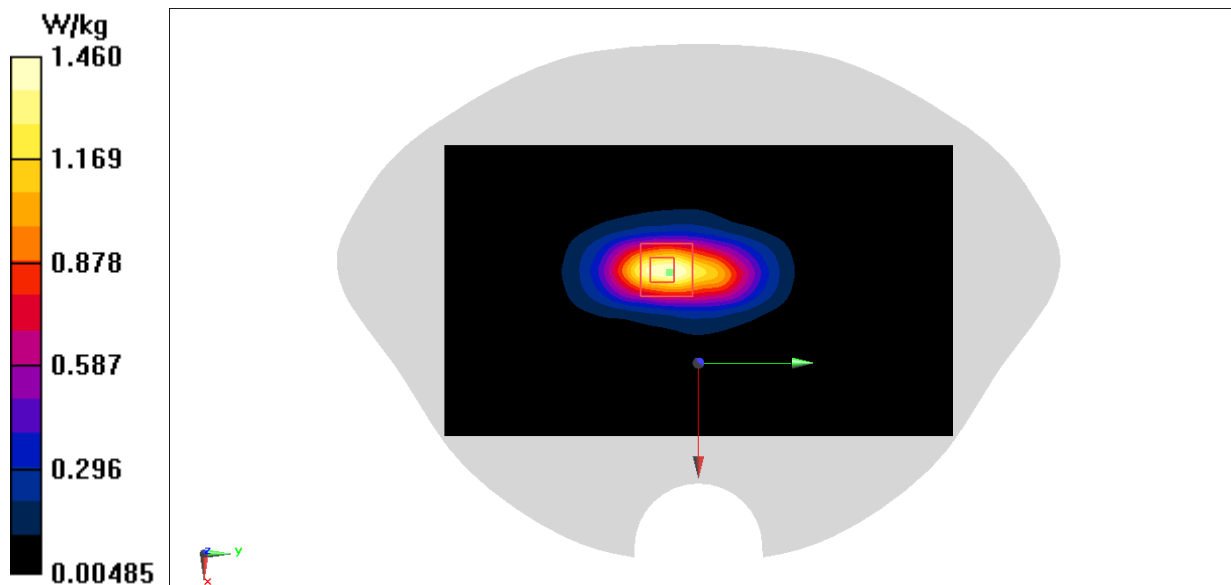

WCDMA1700 Body 15mm

Date: 2023/12/24

Electronics: DAE4 Sn1556

Medium: H700-6000M

Medium parameters used (interpolated): $f = 1732.4$ MHz; $\sigma = 1.317$ S/m; $\epsilon_r = 41.141$; $\rho = 1000$ kg/m³

Ambient Temperature: 23.3°C Liquid Temperature: 22.5°C

Communication System: WCDMA 1700 Band4 (0) Frequency: 1732.4 MHz Duty Cycle: 1:1

Probe: EX3DV4 - SN7464 ConvF(8.54, 8.54, 8.54)

Area Scan (81x141x1): Interpolated grid: dx=1.500 mm, dy=1.500 mm

Maximum value of SAR (interpolated) = 0.654 W/kg

Zoom Scan (5x6x7)/Cube 0: Measurement grid: dx=8mm, dy=8mm, dz=5mm

Reference Value = 7.123 V/m; Power Drift = 0.07 dB

Peak SAR (extrapolated) = 0.796 W/kg

SAR(1 g) = 0.481 W/kg; SAR(10 g) = 0.280 W/kg

Maximum value of SAR (measured) = 0.686 W/kg

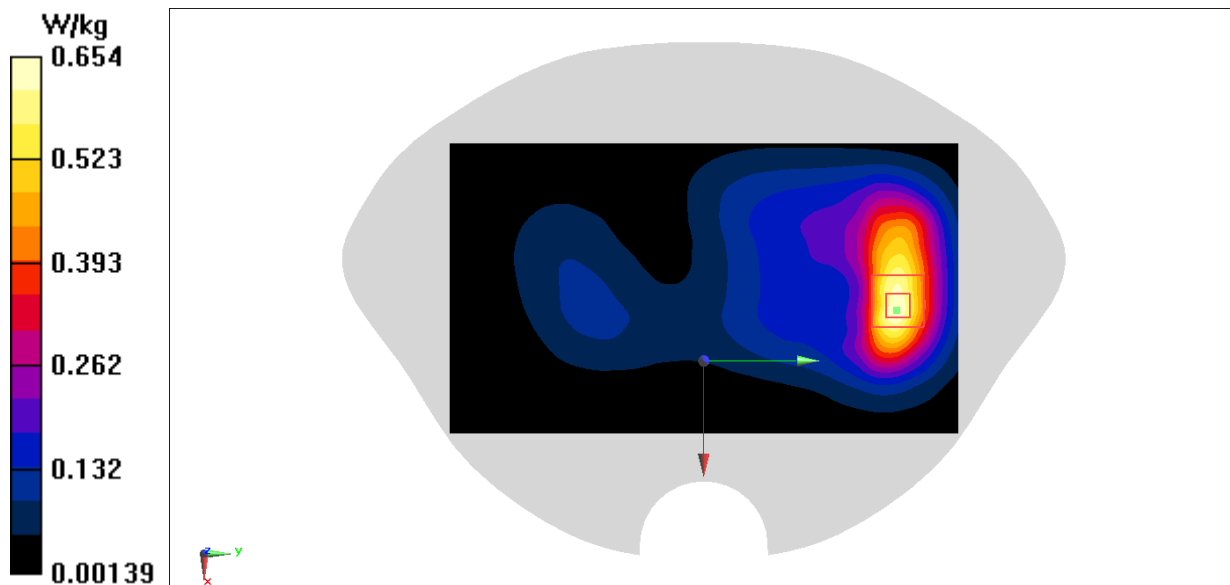

WCDMA1900 Head

Date: 2023/12/26

Electronics: DAE4 Sn1556

Medium: H700-6000M

Medium parameters used: $f = 1880$ MHz; $\sigma = 1.409$ S/m; $\epsilon_r = 40.836$; $\rho = 1000$ kg/m³

Ambient Temperature: 23.3°C Liquid Temperature: 22.5°C

Communication System: WCDMA 1900 (0) Frequency: 1880 MHz Duty Cycle: 1:1

Probe: EX3DV4 - SN7464 ConvF(8.13, 8.13, 8.13)

Area Scan (71x131x1): Interpolated grid: $dx=1.500$ mm, $dy=1.500$ mm

Maximum value of SAR (interpolated) = 0.168 W/kg

Zoom Scan (5x5x7)/Cube 0: Measurement grid: $dx=8$ mm, $dy=8$ mm, $dz=5$ mm

Reference Value = 2.155 V/m; Power Drift = 0.05 dB

Peak SAR (extrapolated) = 0.180 W/kg

SAR(1 g) = 0.126 W/kg; SAR(10 g) = 0.086 W/kg

Maximum value of SAR (measured) = 0.161 W/kg

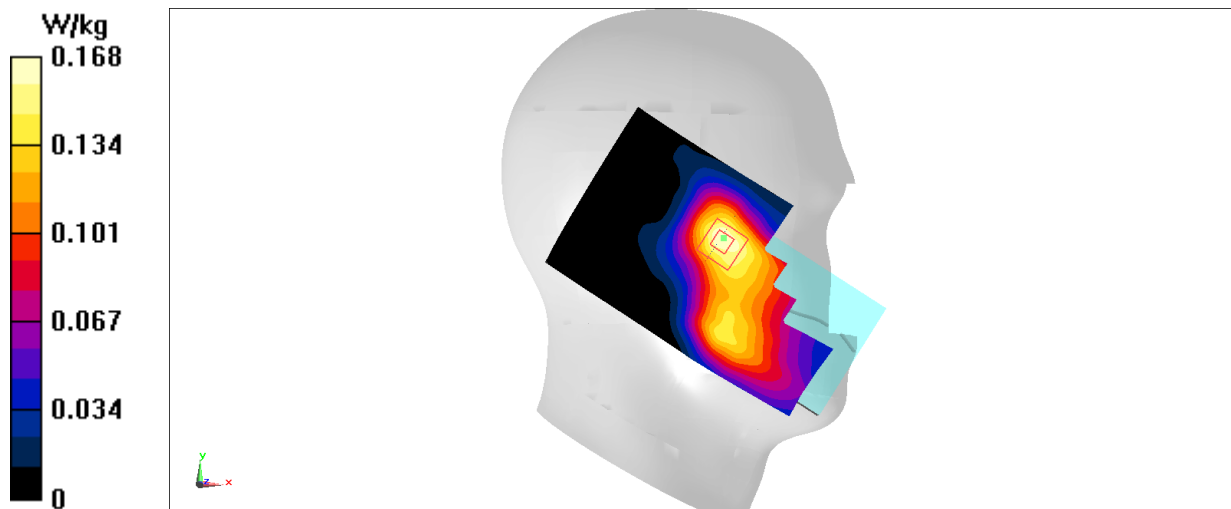

WCDMA1900 Body 10mm

Date: 2023/12/26

Electronics: DAE4 Sn1556

Medium: H700-6000M

Medium parameters used (interpolated): $f = 1852.4$ MHz; $\sigma = 1.394$ S/m; $\epsilon_r = 40.896$; $\rho = 1000$ kg/m³

Ambient Temperature: 23.3°C Liquid Temperature: 22.5°C

Communication System: WCDMA 1900 (0) Frequency: 1852.4 MHz Duty Cycle: 1:1

Probe: EX3DV4 - SN7464 ConvF(8.13, 8.13, 8.13)

Area Scan (81x141x1): Interpolated grid: dx=1.500 mm, dy=1.500 mm

Maximum value of SAR (interpolated) = 1.36 W/kg

Zoom Scan (5x6x7)/Cube 0: Measurement grid: dx=8mm, dy=8mm, dz=5mm

Reference Value = 20.39 V/m; Power Drift = 0.13 dB

Peak SAR (extrapolated) = 1.62 W/kg

SAR(1 g) = 0.922 W/kg; SAR(10 g) = 0.502 W/kg

Maximum value of SAR (measured) = 1.36 W/kg

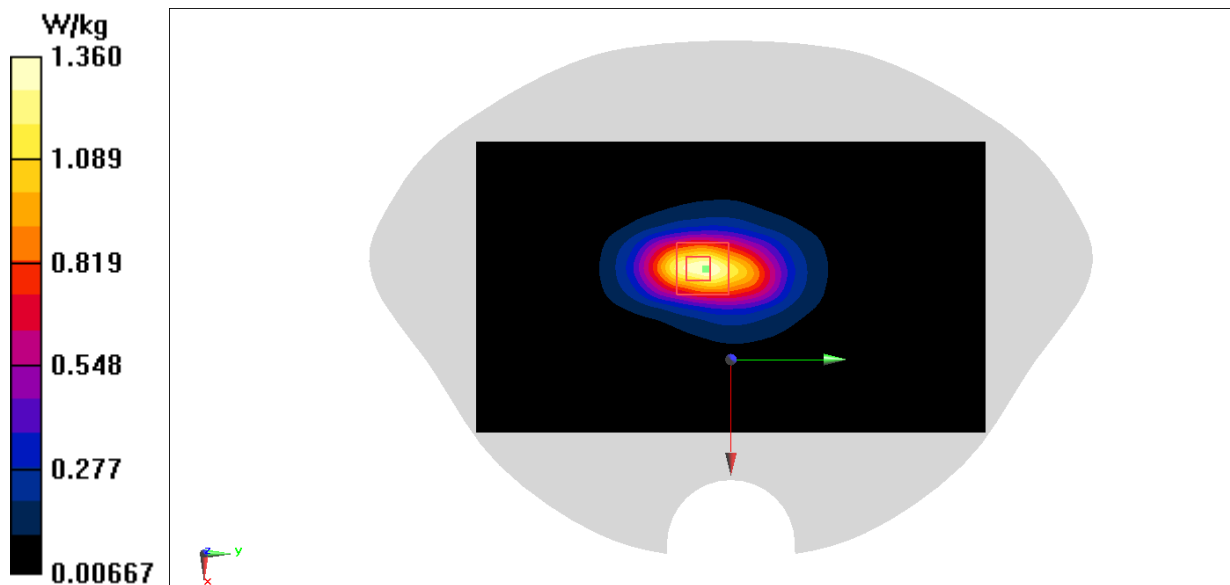

WCDMA1900 Body 15mm

Date: 2023/12/26

Electronics: DAE4 Sn1556

Medium: H700-6000M

Medium parameters used: $f = 1880$ MHz; $\sigma = 1.409$ S/m; $\epsilon_r = 40.836$; $\rho = 1000$ kg/m³

Ambient Temperature: 23.3°C Liquid Temperature: 22.5°C

Communication System: WCDMA 1900 (0) Frequency: 1880 MHz Duty Cycle: 1:1

Probe: EX3DV4 - SN7464 ConvF(8.13, 8.13, 8.13)

Area Scan (81x131x1): Interpolated grid: dx=1.500 mm, dy=1.500 mm

Maximum value of SAR (interpolated) = 0.567 W/kg

Zoom Scan (5x5x7)/Cube 0: Measurement grid: dx=8mm, dy=8mm, dz=5mm

Reference Value = 10.79 V/m; Power Drift = 0.08 dB

Peak SAR (extrapolated) = 0.642 W/kg

SAR(1 g) = 0.389 W/kg; SAR(10 g) = 0.232 W/kg

Maximum value of SAR (measured) = 0.548 W/kg

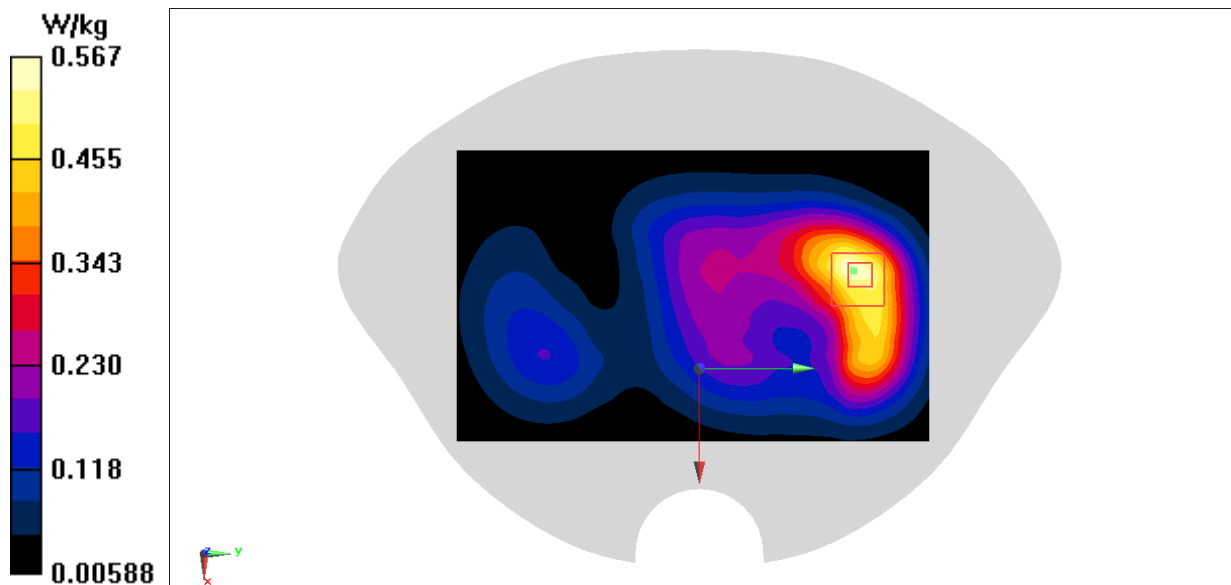

LTE Band2 Head

Date: 2023/12/26

Electronics: DAE4 Sn1556

Medium: H700-6000M

Medium parameters used: $f = 1900$ MHz; $\sigma = 1.42$ S/m; $\epsilon_r = 40.788$; $\rho = 1000$ kg/m³

Ambient Temperature: 23.3°C Liquid Temperature: 22.5°C

Communication System: LTE Band2(20MB) (0) Frequency: 1900 MHz Duty Cycle: 1:1

Probe: EX3DV4 - SN7464 ConvF(8.13, 8.13, 8.13)

Area Scan (71x131x1): Interpolated grid: $dx=1.500$ mm, $dy=1.500$ mm

Maximum value of SAR (interpolated) = 0.262 W/kg

Zoom Scan (6x5x7)/Cube 0: Measurement grid: $dx=8$ mm, $dy=8$ mm, $dz=5$ mm

Reference Value = 3.885 V/m; Power Drift = 0.12 dB

Peak SAR (extrapolated) = 0.296 W/kg

SAR(1 g) = 0.195 W/kg; SAR(10 g) = 0.128 W/kg

Maximum value of SAR (measured) = 0.258 W/kg

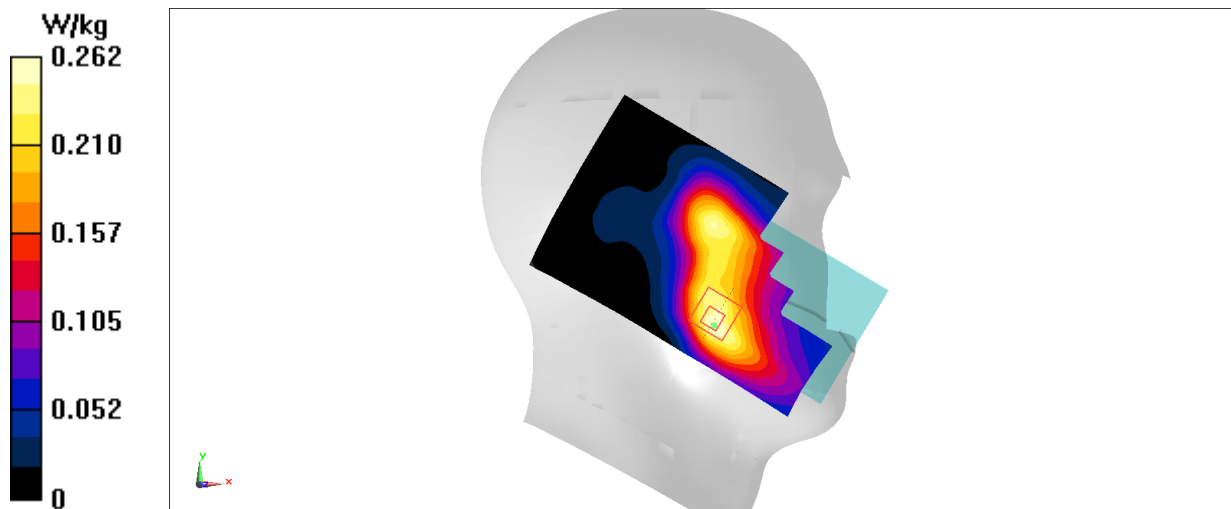

LTE Band2 Body 10mm

Date: 2023/12/26

Electronics: DAE4 Sn1556

Medium: H700-6000M

Medium parameters used: $f = 1860$ MHz; $\sigma = 1.398$ S/m; $\epsilon_r = 40.88$; $\rho = 1000$ kg/m³

Ambient Temperature: 23.3°C Liquid Temperature: 22.5°C

Communication System: LTE Band2 (0) Frequency: 1860 MHz Duty Cycle: 1:1

Probe: EX3DV4 - SN7464 ConvF(8.13, 8.13, 8.13)

Area Scan (81x141x1): Interpolated grid: dx=1.500 mm, dy=1.500 mm

Maximum value of SAR (interpolated) = 1.29 W/kg

Zoom Scan (5x5x7)/Cube 0: Measurement grid: dx=8mm, dy=8mm, dz=5mm

Reference Value = 23.59 V/m; Power Drift = 0.19 dB

Peak SAR (extrapolated) = 1.54 W/kg

SAR(1 g) = 0.862 W/kg; SAR(10 g) = 0.464 W/kg

Maximum value of SAR (measured) = 1.27 W/kg

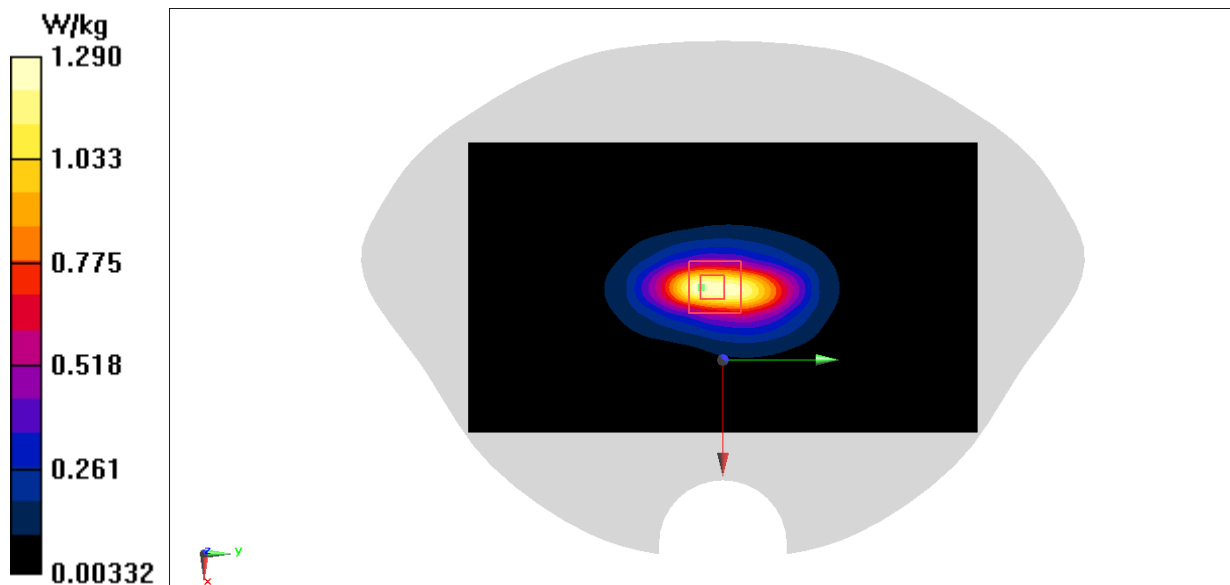

LTE Band2 Body 15mm

Date: 2023/12/26

Electronics: DAE4 Sn1556

Medium: H700-6000M

Medium parameters used: $f = 1900$ MHz; $\sigma = 1.42$ S/m; $\epsilon_r = 40.788$; $\rho = 1000$ kg/m³

Ambient Temperature: 23.3°C Liquid Temperature: 22.5°C

Communication System: LTE Band2(20MB) (0) Frequency: 1900 MHz Duty Cycle: 1:1

Probe: EX3DV4 - SN7464 ConvF(8.13, 8.13, 8.13)

Area Scan (81x131x1): Interpolated grid: dx=1.500 mm, dy=1.500 mm

Maximum value of SAR (interpolated) = 0.588 W/kg

Zoom Scan (5x5x7)/Cube 0: Measurement grid: dx=8mm, dy=8mm, dz=5mm

Reference Value = 10.03 V/m; Power Drift = 0.04 dB

Peak SAR (extrapolated) = 0.672 W/kg

SAR(1 g) = 0.410 W/kg; SAR(10 g) = 0.245 W/kg

Maximum value of SAR (measured) = 0.575 W/kg

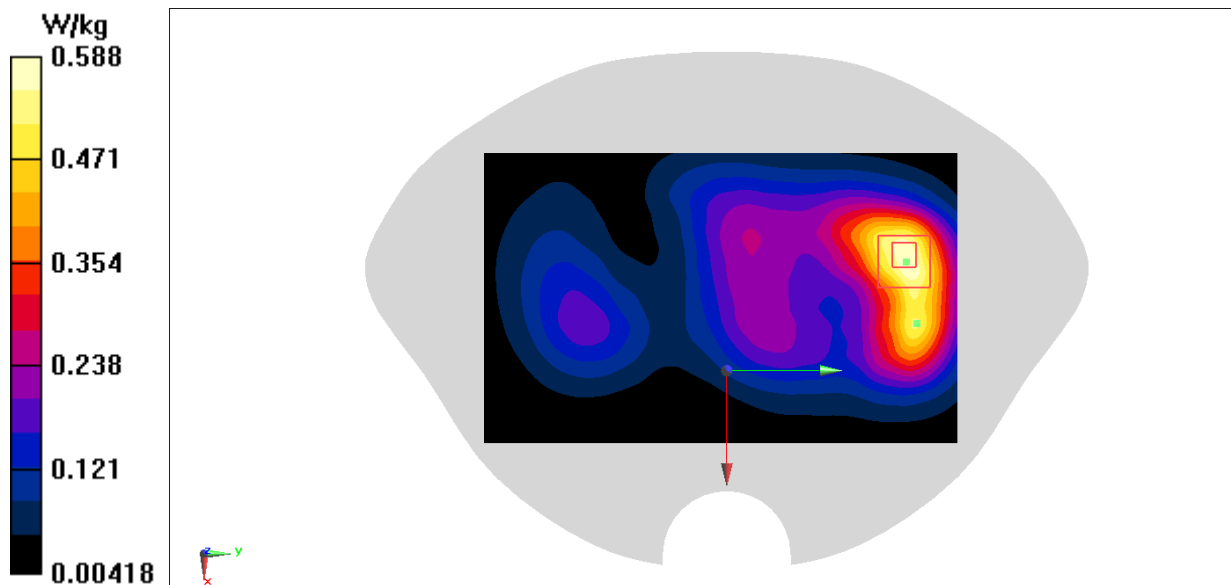

LTE Band4 Head

Date: 2023/12/24

Electronics: DAE4 Sn1556

Medium: H700-6000M

Medium parameters used: $f = 1720$ MHz; $\sigma = 1.31$ S/m; $\epsilon_r = 41.154$; $\rho = 1000$ kg/m³

Ambient Temperature: 23.3°C Liquid Temperature: 22.5°C

Communication System: LTE Band4 (0) Frequency: 1720 MHz Duty Cycle: 1:1

Probe: EX3DV4 - SN7464 ConvF(8.54, 8.54, 8.54)

Area Scan (71x131x1): Interpolated grid: dx=1.500 mm, dy=1.500 mm

Maximum value of SAR (interpolated) = 0.250 W/kg

Zoom Scan (6x6x7)/Cube 0: Measurement grid: dx=8mm, dy=8mm, dz=5mm

Reference Value = 4.606 V/m; Power Drift = -0.05 dB

Peak SAR (extrapolated) = 0.356 W/kg

SAR(1 g) = 0.243 W/kg; SAR(10 g) = 0.157 W/kg

Maximum value of SAR (measured) = 0.307 W/kg

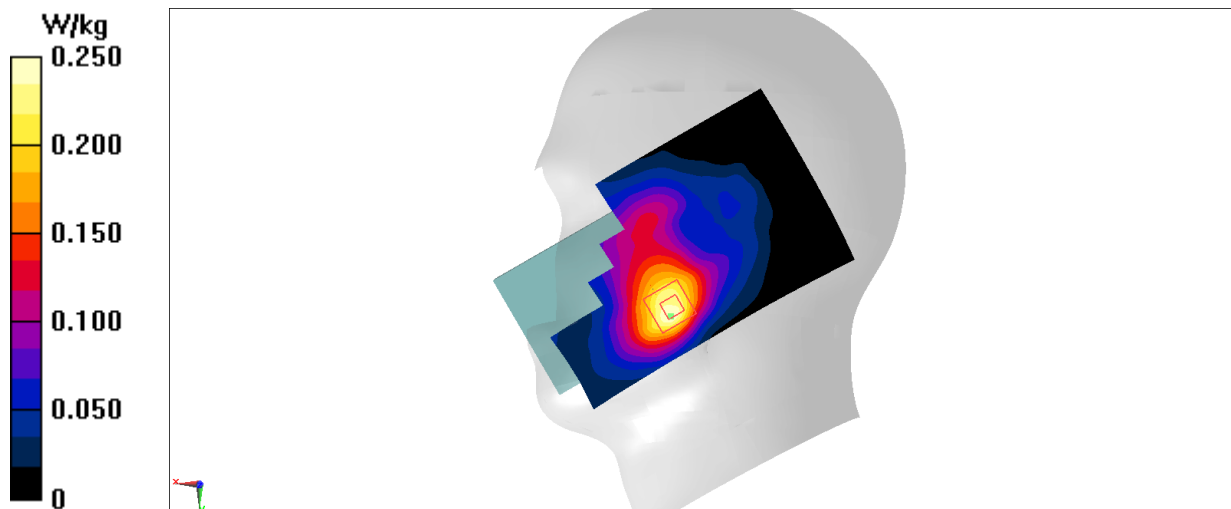

LTE Band4 Body 10mm

Date: 2023/12/24

Electronics: DAE4 Sn1556

Medium: H700-6000M

Medium parameters used: $f = 1720$ MHz; $\sigma = 1.31$ S/m; $\epsilon_r = 41.154$; $\rho = 1000$ kg/m³

Ambient Temperature: 23.3°C Liquid Temperature: 22.5°C

Communication System: LTE Band4 (0) Frequency: 1720 MHz Duty Cycle: 1:1

Probe: EX3DV4 - SN7464 ConvF(8.54, 8.54, 8.54)

Area Scan (81x141x1): Interpolated grid: $dx=1.500$ mm, $dy=1.500$ mm

Maximum value of SAR (interpolated) = 1.56 W/kg

Zoom Scan (5x5x7)/Cube 0: Measurement grid: $dx=8$ mm, $dy=8$ mm, $dz=5$ mm

Reference Value = 24.98 V/m; Power Drift = 0.19 dB

Peak SAR (extrapolated) = 1.83 W/kg

SAR(1 g) = 1.02 W/kg; SAR(10 g) = 0.552 W/kg

Maximum value of SAR (measured) = 1.49 W/kg

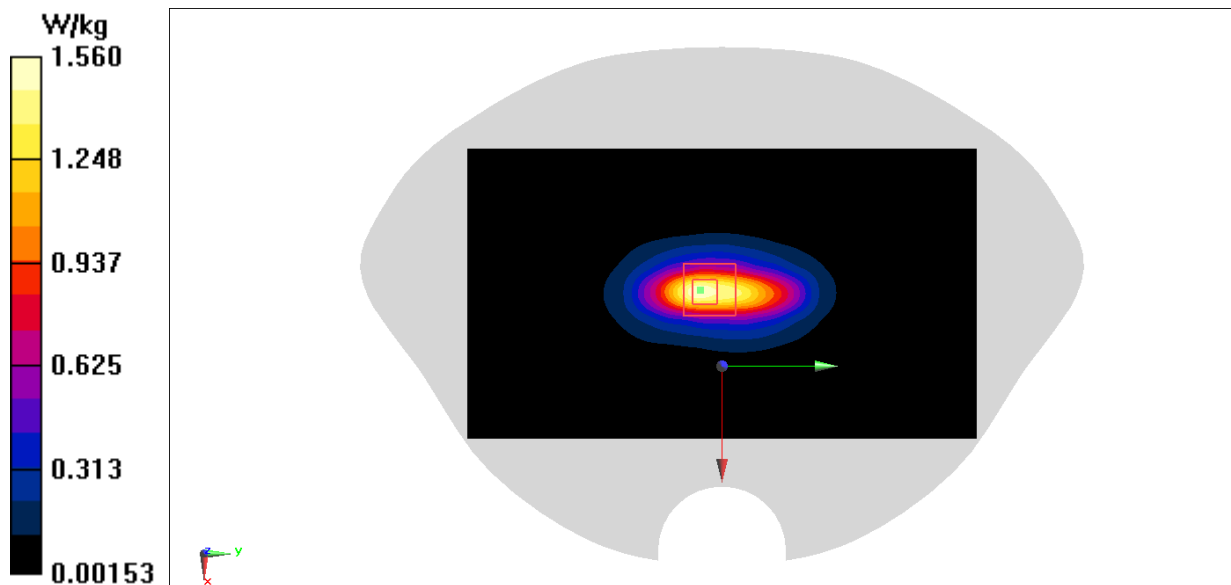

LTE Band4 Body 15mm

Date: 2023/12/24

Electronics: DAE4 Sn1556

Medium: H700-6000M

Medium parameters used: $f = 1720$ MHz; $\sigma = 1.31$ S/m; $\epsilon_r = 41.154$; $\rho = 1000$ kg/m³

Ambient Temperature: 23.3°C Liquid Temperature: 22.5°C

Communication System: LTE Band4 (0) Frequency: 1720 MHz Duty Cycle: 1:1

Probe: EX3DV4 - SN7464 ConvF(8.54, 8.54, 8.54)

Area Scan (81x141x1): Interpolated grid: dx=1.500 mm, dy=1.500 mm

Maximum value of SAR (interpolated) = 0.666 W/kg

Zoom Scan (5x6x7)/Cube 0: Measurement grid: dx=8mm, dy=8mm, dz=5mm

Reference Value = 6.969 V/m; Power Drift = -0.16 dB

Peak SAR (extrapolated) = 0.816 W/kg

SAR(1 g) = 0.496 W/kg; SAR(10 g) = 0.291 W/kg

Maximum value of SAR (measured) = 0.701 W/kg

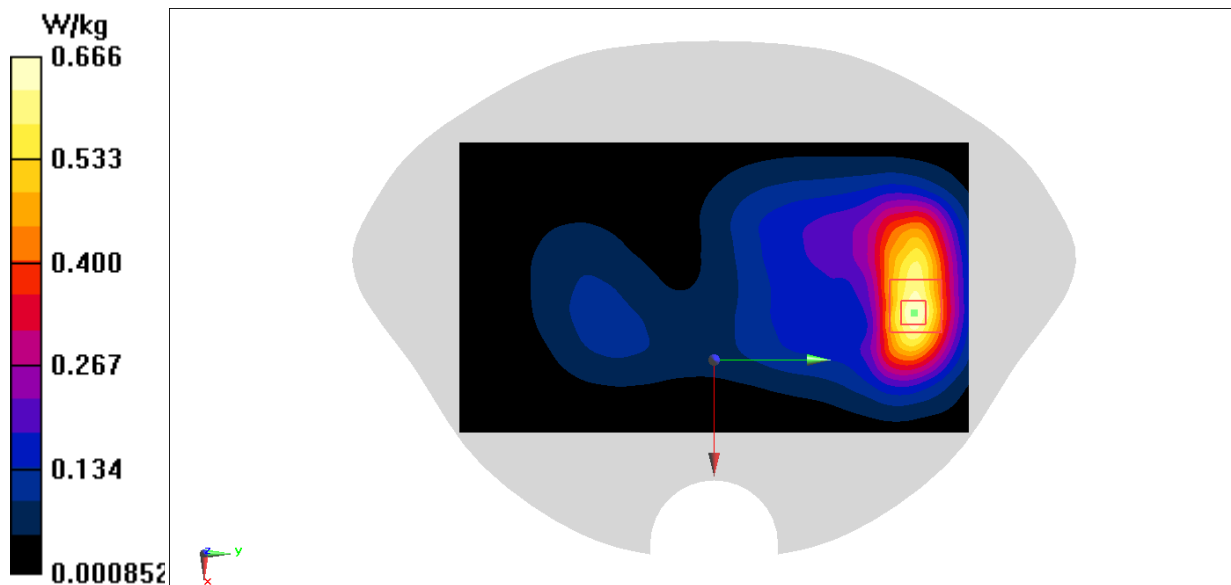

LTE Band5 Head

Date: 2023/12/22

Electronics: DAE4 Sn1556

Medium: H700-6000M

Medium parameters used (interpolated): $f = 844$ MHz; $\sigma = 0.864$ S/m; $\epsilon_r = 43.418$; $\rho = 1000$ kg/m³

Ambient Temperature: 23.3°C Liquid Temperature: 22.5°C

Communication System: LTE Band5 (0) Frequency: 844 MHz Duty Cycle: 1:1

Probe: EX3DV4 - SN7464 ConvF(10.26, 10.26, 10.26)

Area Scan (71x131x1): Interpolated grid: $dx=1.500$ mm, $dy=1.500$ mm

Maximum value of SAR (interpolated) = 0.374 W/kg

Zoom Scan (6x6x7)/Cube 0: Measurement grid: $dx=8$ mm, $dy=8$ mm, $dz=5$ mm

Reference Value = 4.122 V/m; Power Drift = 0.01 dB

Peak SAR (extrapolated) = 0.393 W/kg

SAR(1 g) = 0.326 W/kg; SAR(10 g) = 0.261 W/kg

Maximum value of SAR (measured) = 0.370 W/kg

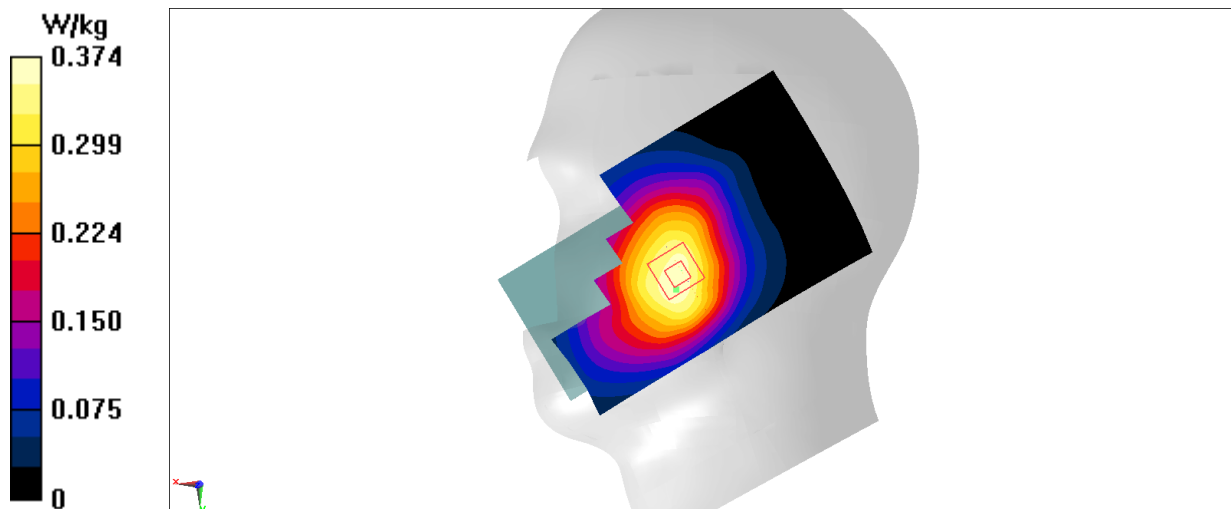

LTE Band5 Body 10mm

Date: 2023/12/22

Electronics: DAE4 Sn1556

Medium: H700-6000M

Medium parameters used (interpolated): $f = 844$ MHz; $\sigma = 0.864$ S/m; $\epsilon_r = 43.418$; $\rho = 1000$ kg/m³

Ambient Temperature: 23.3°C Liquid Temperature: 22.5°C

Communication System: LTE Band5 (0) Frequency: 844 MHz Duty Cycle: 1:1

Probe: EX3DV4 - SN7464 ConvF(10.26, 10.26, 10.26)

Area Scan (81x131x1): Interpolated grid: dx=1.500 mm, dy=1.500 mm

Maximum value of SAR (interpolated) = 0.569 W/kg

Zoom Scan (6x5x7)/Cube 0: Measurement grid: dx=8mm, dy=8mm, dz=5mm

Reference Value = 24.13 V/m; Power Drift = -0.08 dB

Peak SAR (extrapolated) = 0.595 W/kg

SAR(1 g) = 0.490 W/kg; SAR(10 g) = 0.383 W/kg

Maximum value of SAR (measured) = 0.565 W/kg

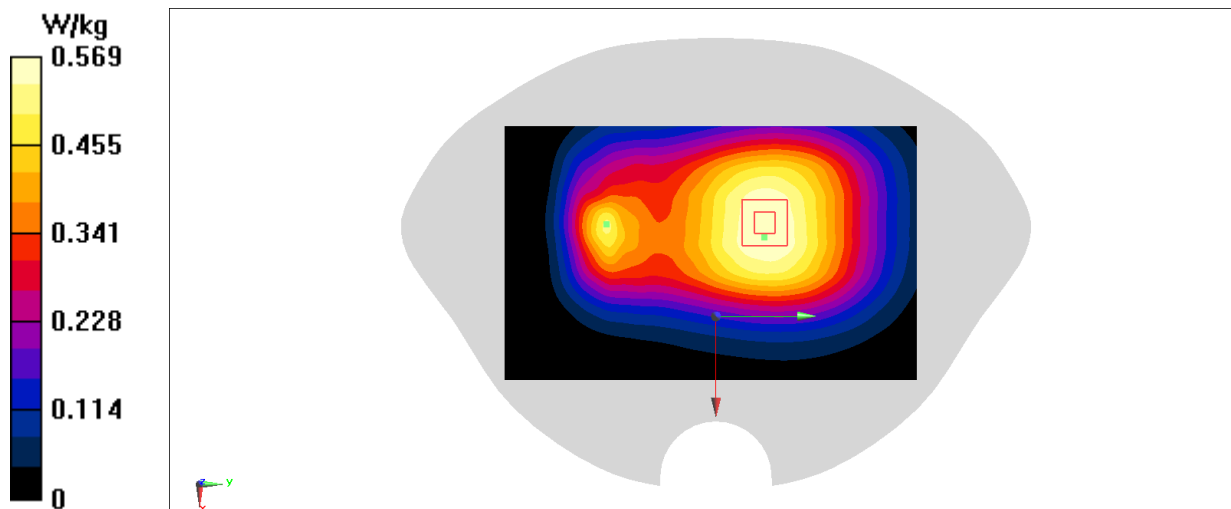

LTE Band12 Head

Date: 2023/12/21

Electronics: DAE4 Sn1556

Medium: H700-6000M

Medium parameters used (interpolated): $f = 707.5$ MHz; $\sigma = 0.846$ S/m; $\epsilon_r = 43.875$; $\rho = 1000$ kg/m³

Ambient Temperature: 23.3°C Liquid Temperature: 22.5°C

Communication System: LTE Band12 (0) Frequency: 707.5 MHz Duty Cycle: 1:1

Probe: EX3DV4 - SN7464 ConvF(10.26, 10.26, 10.26)

Area Scan (71x131x1): Interpolated grid: $dx=1.500$ mm, $dy=1.500$ mm

Maximum value of SAR (interpolated) = 0.217 W/kg

Zoom Scan (6x6x7)/Cube 0: Measurement grid: $dx=8$ mm, $dy=8$ mm, $dz=5$ mm

Reference Value = 4.502 V/m; Power Drift = 0.02 dB

Peak SAR (extrapolated) = 0.224 W/kg

SAR(1 g) = 0.190 W/kg; SAR(10 g) = 0.156 W/kg

Maximum value of SAR (measured) = 0.214 W/kg

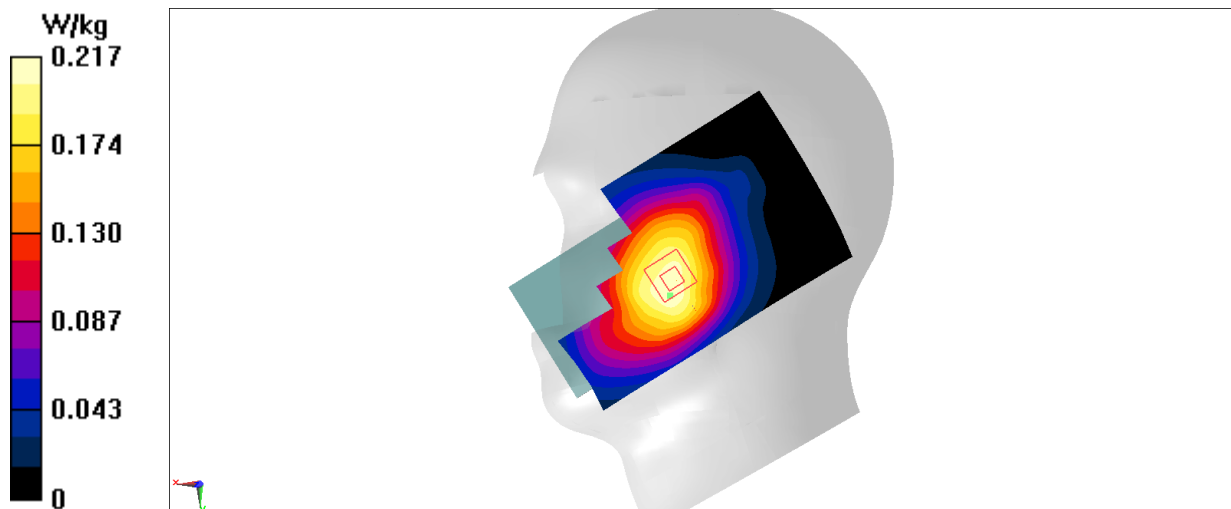

LTE Band12 Body 10mm

Date: 2023/12/21

Electronics: DAE4 Sn1556

Medium: H700-6000M

Medium parameters used (interpolated): $f = 707.5$ MHz; $\sigma = 0.846$ S/m; $\epsilon_r = 43.875$; $\rho = 1000$ kg/m³

Ambient Temperature: 23.3°C Liquid Temperature: 22.5°C

Communication System: LTE Band12 (0) Frequency: 707.5 MHz Duty Cycle: 1:1

Probe: EX3DV4 - SN7464 ConvF(10.26, 10.26, 10.26)

Area Scan (81x131x1): Interpolated grid: $dx=1.500$ mm, $dy=1.500$ mm

Maximum value of SAR (interpolated) = 0.403 W/kg

Zoom Scan (6x5x7)/Cube 0: Measurement grid: $dx=8$ mm, $dy=8$ mm, $dz=5$ mm

Reference Value = 22.85 V/m; Power Drift = -0.03 dB

Peak SAR (extrapolated) = 0.420 W/kg

SAR(1 g) = 0.356 W/kg; SAR(10 g) = 0.286 W/kg

Maximum value of SAR (measured) = 0.402 W/kg

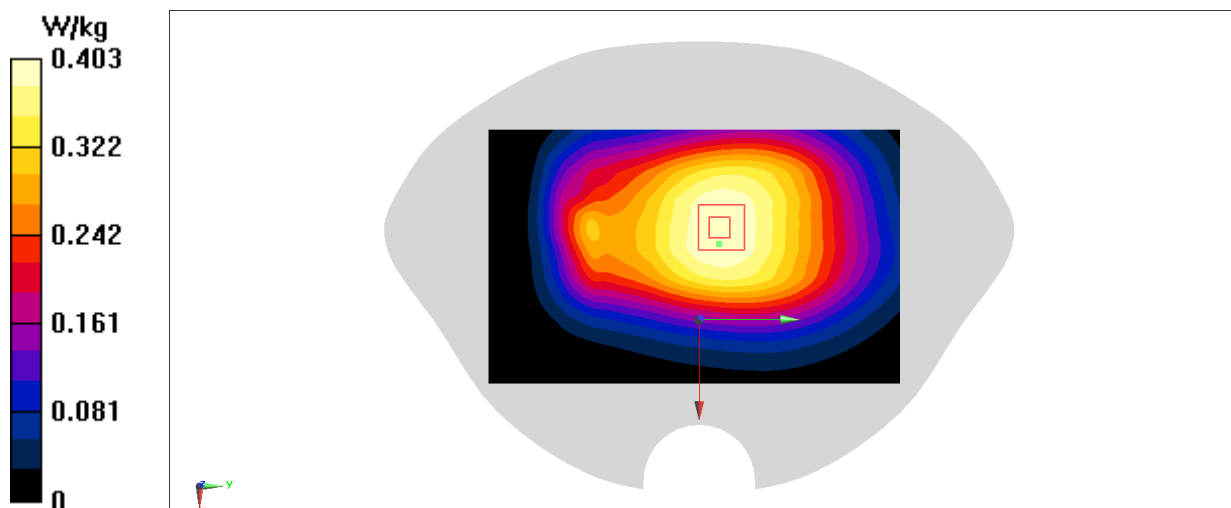

LTE Band13 Head

Date: 2023/12/21

Electronics: DAE4 Sn1556

Medium: H700-6000M

Medium parameters used (interpolated): $f = 782$ MHz; $\sigma = 0.878$ S/m; $\epsilon_r = 43.613$; $\rho = 1000$ kg/m³

Ambient Temperature: 23.3°C Liquid Temperature: 22.5°C

Communication System: LTE Band13 (0) Frequency: 782 MHz Duty Cycle: 1:1

Probe: EX3DV4 - SN7464 ConvF(10.26, 10.26, 10.26)

Area Scan (71x131x1): Interpolated grid: $dx=1.500$ mm, $dy=1.500$ mm

Maximum value of SAR (interpolated) = 0.300 W/kg

Zoom Scan (6x6x7)/Cube 0: Measurement grid: $dx=8$ mm, $dy=8$ mm, $dz=5$ mm

Reference Value = 6.376 V/m; Power Drift = 0.06 dB

Peak SAR (extrapolated) = 0.313 W/kg

SAR(1 g) = 0.261 W/kg; SAR(10 g) = 0.209 W/kg

Maximum value of SAR (measured) = 0.297 W/kg

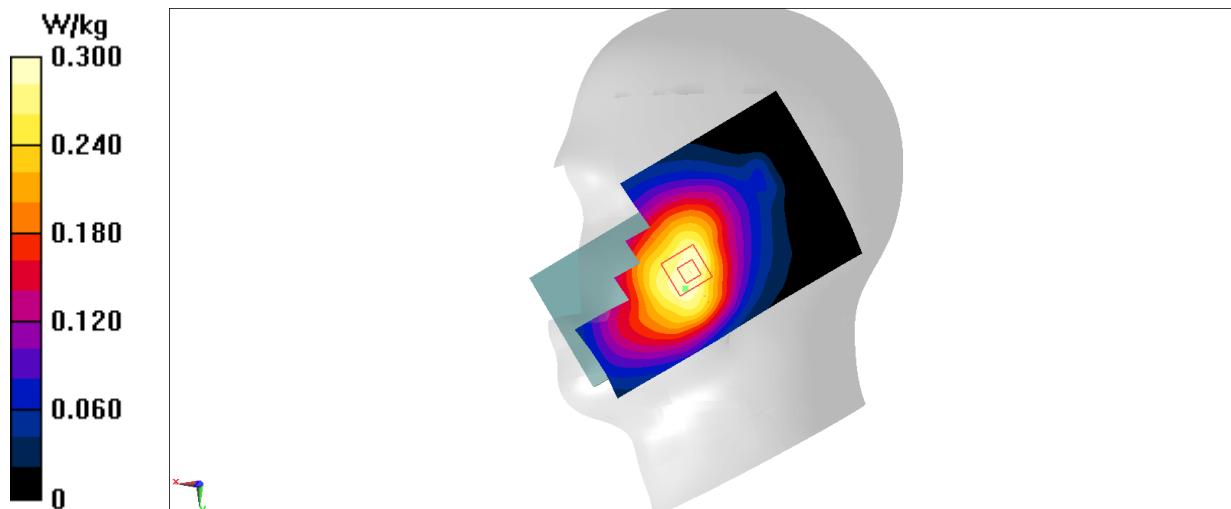

LTE Band13 Body 10mm

Date: 2023/12/21

Electronics: DAE4 Sn1556

Medium: H700-6000M

Medium parameters used (interpolated): $f = 782$ MHz; $\sigma = 0.878$ S/m; $\epsilon_r = 43.613$; $\rho = 1000$ kg/m³

Ambient Temperature: 23.3°C Liquid Temperature: 22.5°C

Communication System: LTE Band13 (0) Frequency: 782 MHz Duty Cycle: 1:1

Probe: EX3DV4 - SN7464 ConvF(10.26, 10.26, 10.26)

Area Scan (81x131x1): Interpolated grid: dx=1.500 mm, dy=1.500 mm

Maximum value of SAR (interpolated) = 0.510 W/kg

Zoom Scan (5x5x7)/Cube 0: Measurement grid: dx=8mm, dy=8mm, dz=5mm

Reference Value = 20.43 V/m; Power Drift = -0.08 dB

Peak SAR (extrapolated) = 0.550 W/kg

SAR(1 g) = 0.369 W/kg; SAR(10 g) = 0.243 W/kg

Maximum value of SAR (measured) = 0.478 W/kg

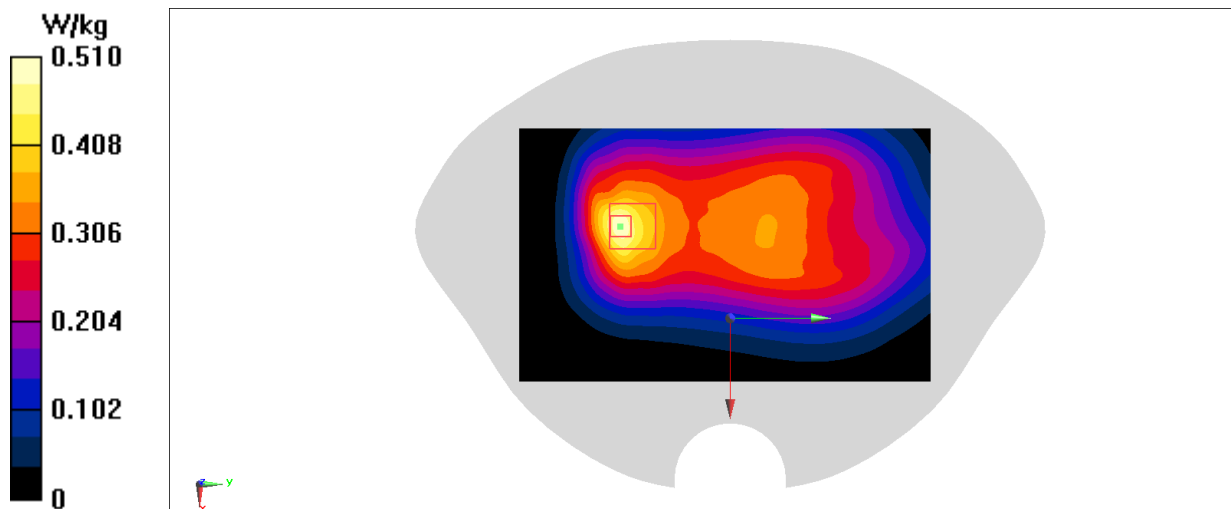

LTE Band66 Head

Date: 2023/12/24

Electronics: DAE4 Sn1556

Medium: H700-6000M

Medium parameters used: $f = 1720$ MHz; $\sigma = 1.31$ S/m; $\epsilon_r = 41.154$; $\rho = 1000$ kg/m³

Ambient Temperature: 23.3°C Liquid Temperature: 22.5°C

Communication System: LTE Band66 (0) Frequency: 1720 MHz Duty Cycle: 1:1

Probe: EX3DV4 - SN7464 ConvF(8.54, 8.54, 8.54)

Area Scan (71x131x1): Interpolated grid: $dx=1.500$ mm, $dy=1.500$ mm

Maximum value of SAR (interpolated) = 0.280 W/kg

Zoom Scan (6x6x7)/Cube 0: Measurement grid: $dx=8$ mm, $dy=8$ mm, $dz=5$ mm

Reference Value = 3.490 V/m; Power Drift = 0.05 dB

Peak SAR (extrapolated) = 0.306 W/kg

SAR(1 g) = 0.215 W/kg; SAR(10 g) = 0.141 W/kg

Maximum value of SAR (measured) = 0.267 W/kg

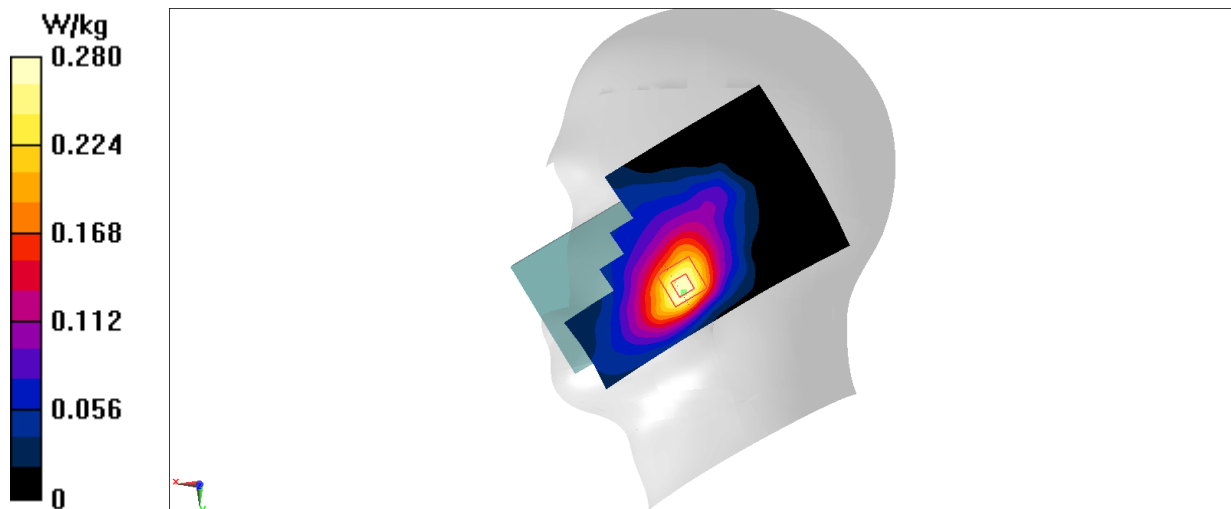

LTE Band66 Body 10mm

Date: 2023/12/24

Electronics: DAE4 Sn1556

Medium: H700-6000M

Medium parameters used: $f = 1720$ MHz; $\sigma = 1.31$ S/m; $\epsilon_r = 41.154$; $\rho = 1000$ kg/m³

Ambient Temperature: 23.3°C Liquid Temperature: 22.5°C

Communication System: LTE Band66 (0) Frequency: 1720 MHz Duty Cycle: 1:1

Probe: EX3DV4 - SN7464 ConvF(8.54, 8.54, 8.54)

Area Scan (81x141x1): Interpolated grid: dx=1.500 mm, dy=1.500 mm

Maximum value of SAR (interpolated) = 1.51 W/kg

Zoom Scan (5x5x7)/Cube 0: Measurement grid: dx=8mm, dy=8mm, dz=5mm

Reference Value = 25.69 V/m; Power Drift = 0.11 dB

Peak SAR (extrapolated) = 1.82 W/kg

SAR(1 g) = 0.989 W/kg; SAR(10 g) = 0.531 W/kg

Maximum value of SAR (measured) = 1.49 W/kg

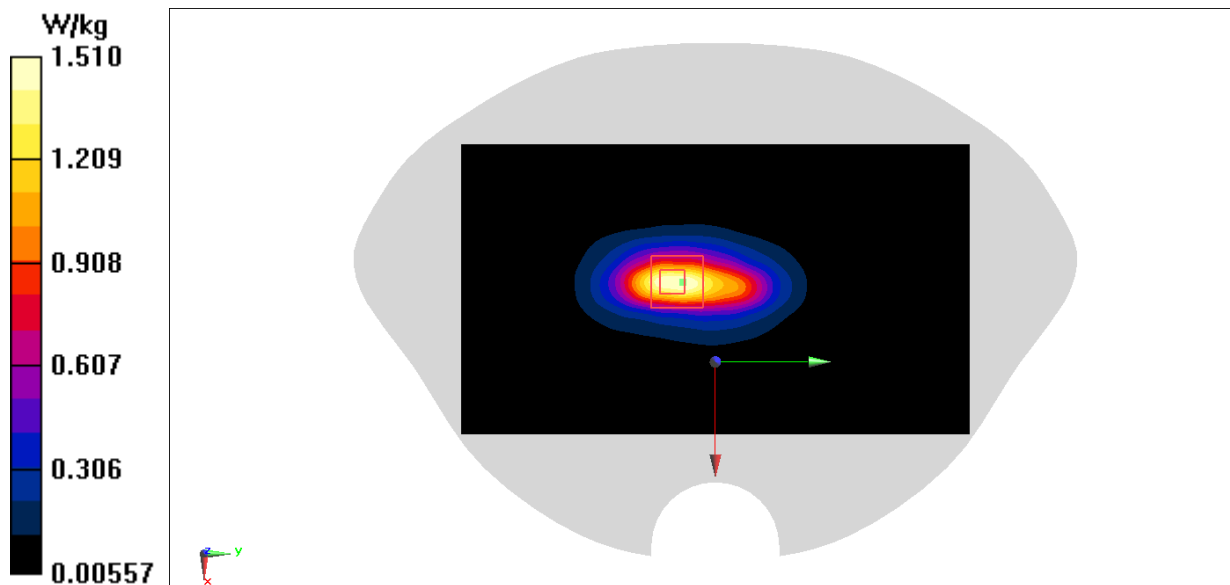

LTE Band66 Body 15mm

Date: 2023/12/24

Electronics: DAE4 Sn1556

Medium: H700-6000M

Medium parameters used: $f = 1720$ MHz; $\sigma = 1.31$ S/m; $\epsilon_r = 41.154$; $\rho = 1000$ kg/m³

Ambient Temperature: 23.3°C Liquid Temperature: 22.5°C

Communication System: LTE Band66 (0) Frequency: 1720 MHz Duty Cycle: 1:1

Probe: EX3DV4 - SN7464 ConvF(8.54, 8.54, 8.54)

Area Scan (101x171x1): Interpolated grid: $dx=1.200$ mm, $dy=1.200$ mm

Maximum value of SAR (interpolated) = 0.750 W/kg

Zoom Scan (7x7x7)/Cube 0: Measurement grid: $dx=5$ mm, $dy=5$ mm, $dz=5$ mm

Reference Value = 6.486 V/m; Power Drift = 0.11 dB

Peak SAR (extrapolated) = 0.860 W/kg

SAR(1 g) = 0.531 W/kg; SAR(10 g) = 0.314 W/kg

Maximum value of SAR (measured) = 0.740 W/kg

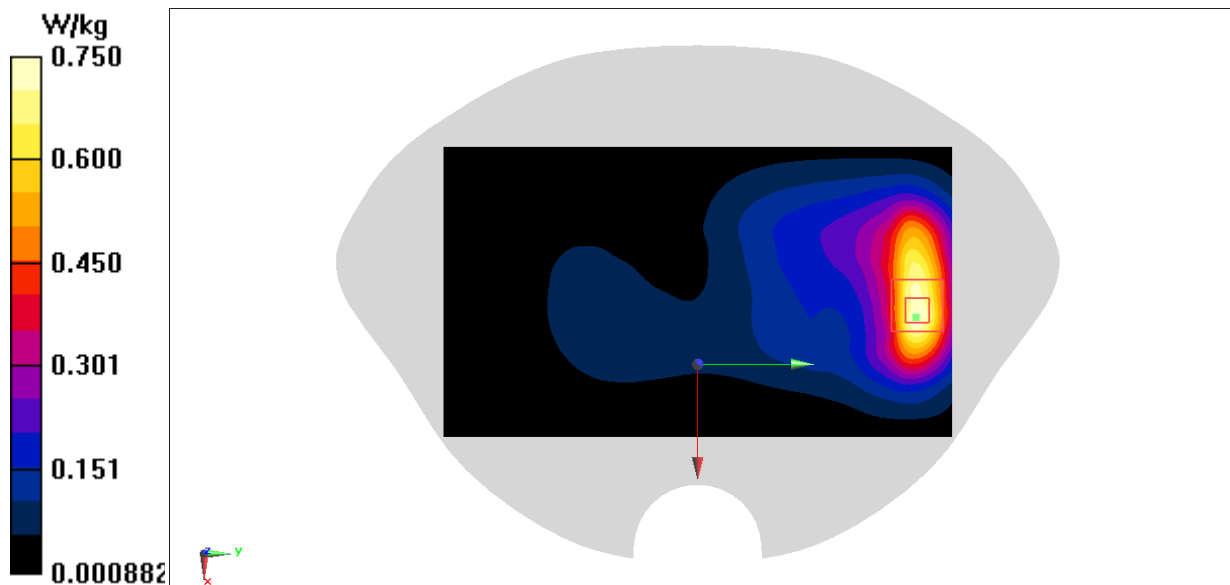

WiFi2.4G Head

Date: 2023/12/28

Electronics: DAE4 Sn1556

Medium: H700-6000M

Medium parameters used (interpolated): $f = 2437$ MHz; $\sigma = 1.856$ S/m; $\epsilon_r = 40.66$; $\rho = 1000$ kg/m³

Ambient Temperature: 23.3°C Liquid Temperature: 22.5°C

Communication System: WLAN 2450 (0) Frequency: 2437 MHz Duty Cycle: 1:1

Probe: EX3DV4 - SN7464 ConvF(7.67, 7.67, 7.67)

Area Scan (101x171x1): Interpolated grid: $dx=1.200$ mm, $dy=1.200$ mm

Maximum value of SAR (interpolated) = 1.54 W/kg

Zoom Scan (7x7x7)/Cube 0: Measurement grid: $dx=5$ mm, $dy=5$ mm, $dz=5$ mm

Reference Value = 9.189 V/m; Power Drift = 0.13 dB

Peak SAR (extrapolated) = 2.59 W/kg

SAR(1 g) = 1.03 W/kg; SAR(10 g) = 0.412 W/kg

Maximum value of SAR (measured) = 1.84 W/kg

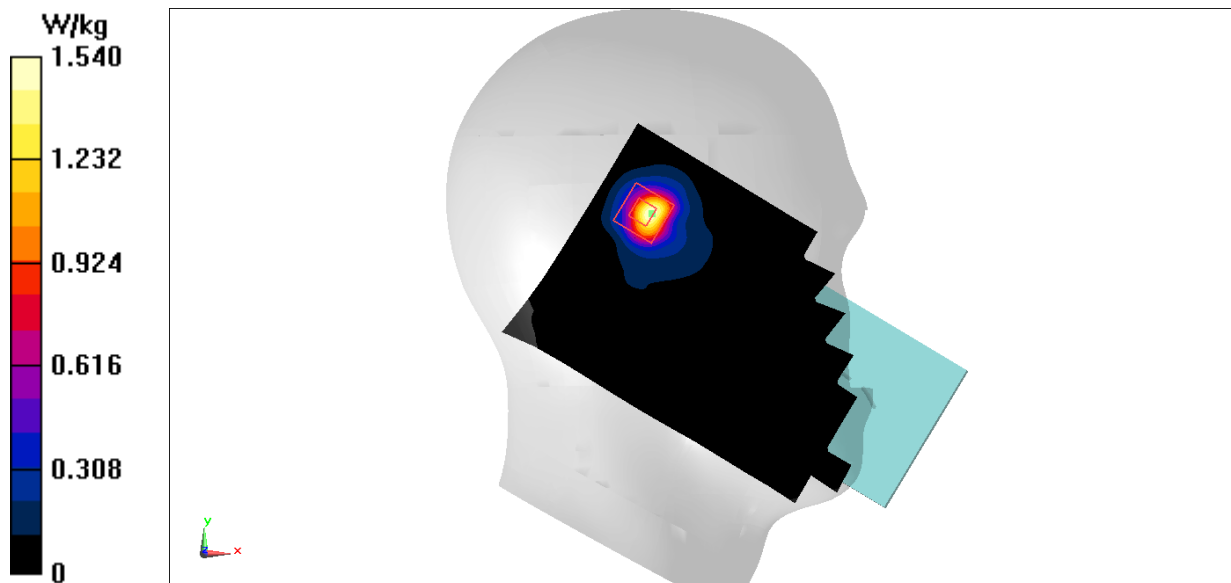

WiFi2.4G Body 10mm

Date: 2023/12/28

Electronics: DAE4 Sn1556

Medium: H700-6000M

Medium parameters used (interpolated): $f = 2437$ MHz; $\sigma = 1.856$ S/m; $\epsilon_r = 40.66$; $\rho = 1000$ kg/m³

Ambient Temperature: 23.3°C Liquid Temperature: 22.5°C

Communication System: WLAN 2450 (0) Frequency: 2437 MHz Duty Cycle: 1:1

Probe: EX3DV4 - SN7464 ConvF(7.67, 7.67, 7.67)

Area Scan (101x171x1): Interpolated grid: $dx=1.200$ mm, $dy=1.200$ mm

Maximum value of SAR (interpolated) = 0.521 W/kg

Zoom Scan (7x7x7)/Cube 0: Measurement grid: $dx=5$ mm, $dy=5$ mm, $dz=5$ mm

Reference Value = 6.861 V/m; Power Drift = -0.03 dB

Peak SAR (extrapolated) = 0.667 W/kg

SAR(1 g) = 0.321 W/kg; SAR(10 g) = 0.167 W/kg

Maximum value of SAR (measured) = 0.346 W/kg

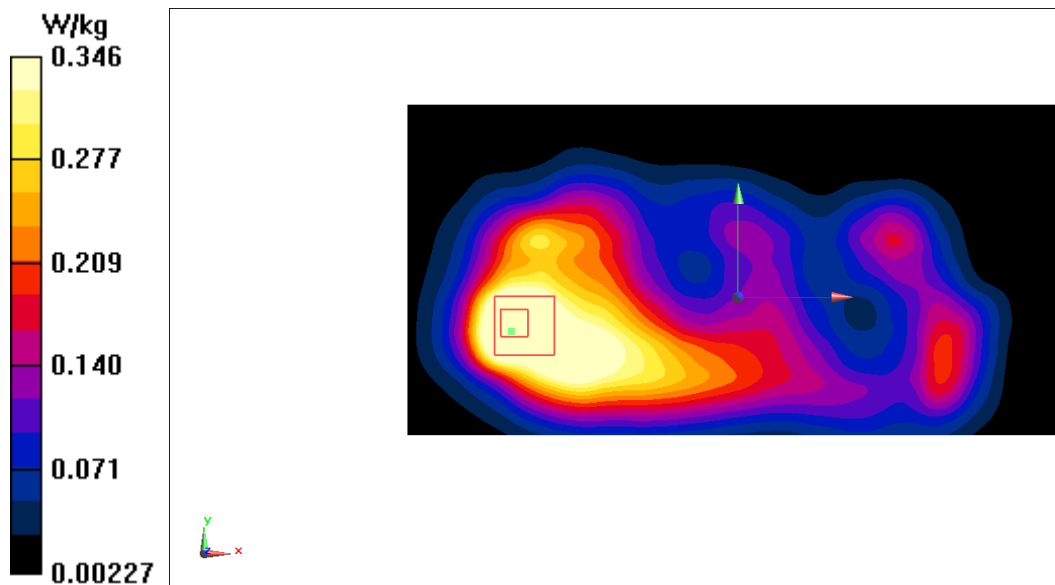

WiFi5G Head

Date: 2024/1/4

Electronics: DAE4 Sn1556

Medium: H700-6000M

Medium parameters used: $f = 5280$ MHz; $\sigma = 4.875$ S/m; $\epsilon_r = 35.865$; $\rho = 1000$ kg/m³

Ambient Temperature: 23.3°C Liquid Temperature: 22.5°C

Communication System: WiFi 5G (0) Frequency: 5280 MHz Duty Cycle: 1:1

Probe: EX3DV4 - SN7464 ConvF(5.42, 5.42, 5.42)

Area Scan (121x211x1): Interpolated grid: $dx=1.000$ mm, $dy=1.000$ mm

Maximum value of SAR (interpolated) = 1.41 W/kg

Zoom Scan (9x9x7)/Cube 0: Measurement grid: $dx=4$ mm, $dy=4$ mm, $dz=1.4$ mm

Reference Value = 2.739 V/m; Power Drift = 0.18 dB

Peak SAR (extrapolated) = 5.48 W/kg

SAR(1 g) = 1.09 W/kg; SAR(10 g) = 0.273 W/kg

Maximum value of SAR (measured) = 2.28 W/kg

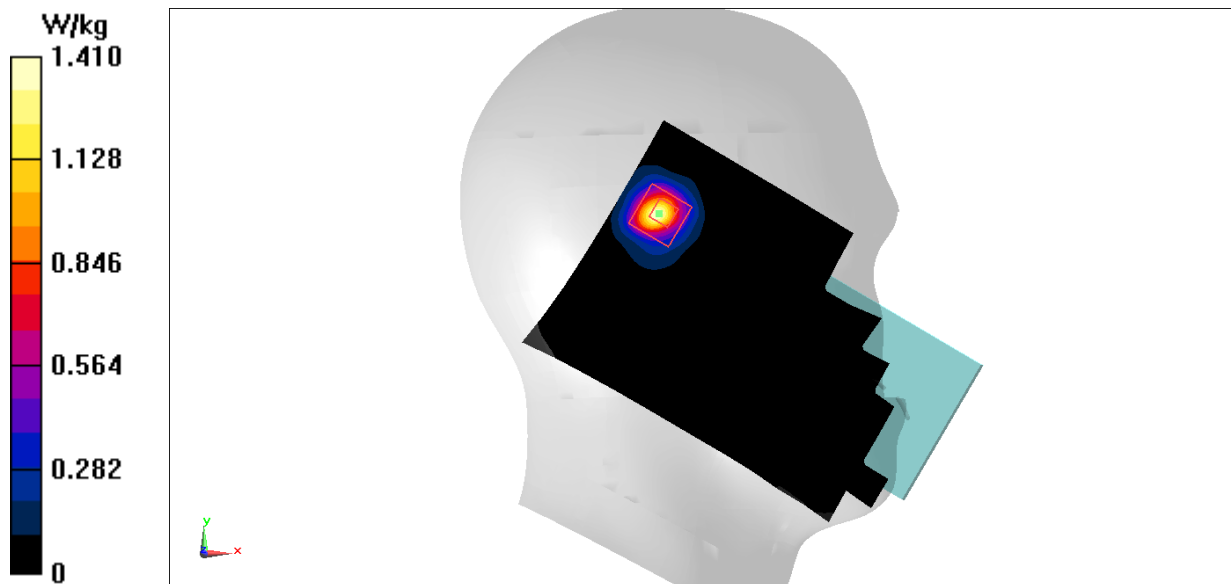

WiFi5G Body 10mm

Date: 2024/1/4

Electronics: DAE4 Sn1556

Medium: H700-6000M

Medium parameters used: $f = 5320$ MHz; $\sigma = 4.922$ S/m; $\epsilon_r = 35.786$; $\rho = 1000$ kg/m³

Ambient Temperature: 23.3°C Liquid Temperature: 22.5°C

Communication System: WiFi 5G (0) Frequency: 5320 MHz Duty Cycle: 1:1

Probe: EX3DV4 - SN7464 ConvF(5.42, 5.42, 5.42)

Area Scan (121x211x1): Interpolated grid: $dx=1.000$ mm, $dy=1.000$ mm

Maximum value of SAR (interpolated) = 1.89 W/kg

Zoom Scan (9x9x7)/Cube 0: Measurement grid: $dx=4$ mm, $dy=4$ mm, $dz=1.4$ mm

Reference Value = 1.679 V/m; Power Drift = 0.03 dB

Peak SAR (extrapolated) = 3.33 W/kg

SAR(1 g) = 0.876 W/kg; SAR(10 g) = 0.290 W/kg

Maximum value of SAR (measured) = 2.03 W/kg

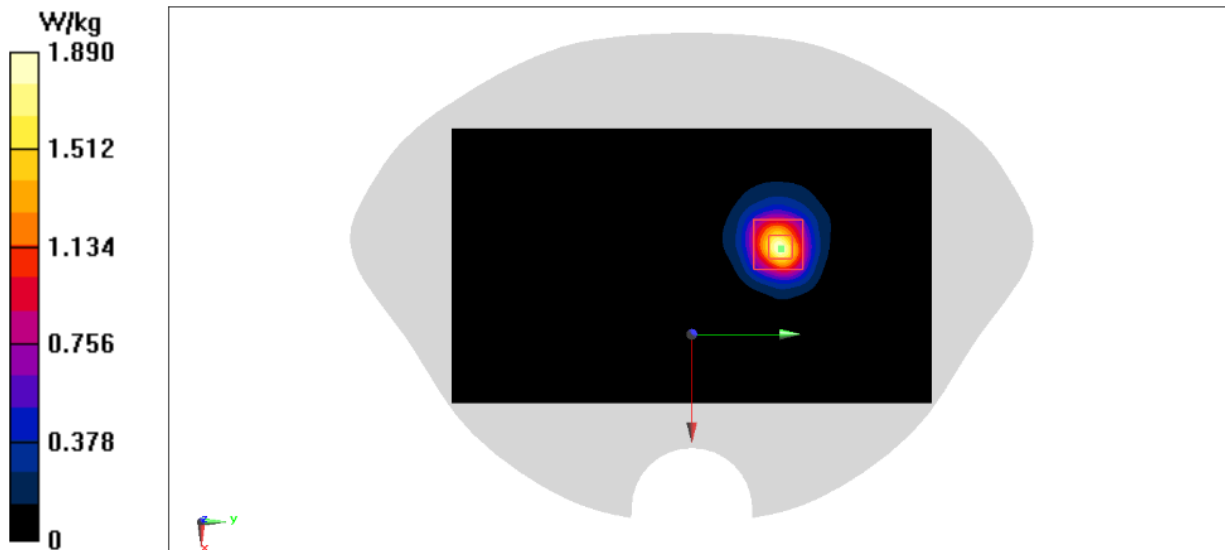

WiFi5G Body 15mm

Date: 2024/1/4

Electronics: DAE4 Sn1556

Medium: H700-6000M

Medium parameters used: $f = 5320$ MHz; $\sigma = 4.922$ S/m; $\epsilon_r = 35.786$; $\rho = 1000$ kg/m³

Ambient Temperature: 23.3°C Liquid Temperature: 22.5°C

Communication System: WiFi 5G (0) Frequency: 5320 MHz Duty Cycle: 1:1

Probe: EX3DV4 - SN7464 ConvF(5.42, 5.42, 5.42)

Area Scan (121x211x1): Interpolated grid: $dx=1.000$ mm, $dy=1.000$ mm

Maximum value of SAR (interpolated) = 0.855 W/kg

Zoom Scan (9x9x7)/Cube 0: Measurement grid: $dx=4$ mm, $dy=4$ mm, $dz=1.4$ mm

Reference Value = 0.6400 V/m; Power Drift = -0.04 dB

Peak SAR (extrapolated) = 1.42 W/kg

SAR(1 g) = 0.418 W/kg; SAR(10 g) = 0.169 W/kg

Maximum value of SAR (measured) = 0.903 W/kg

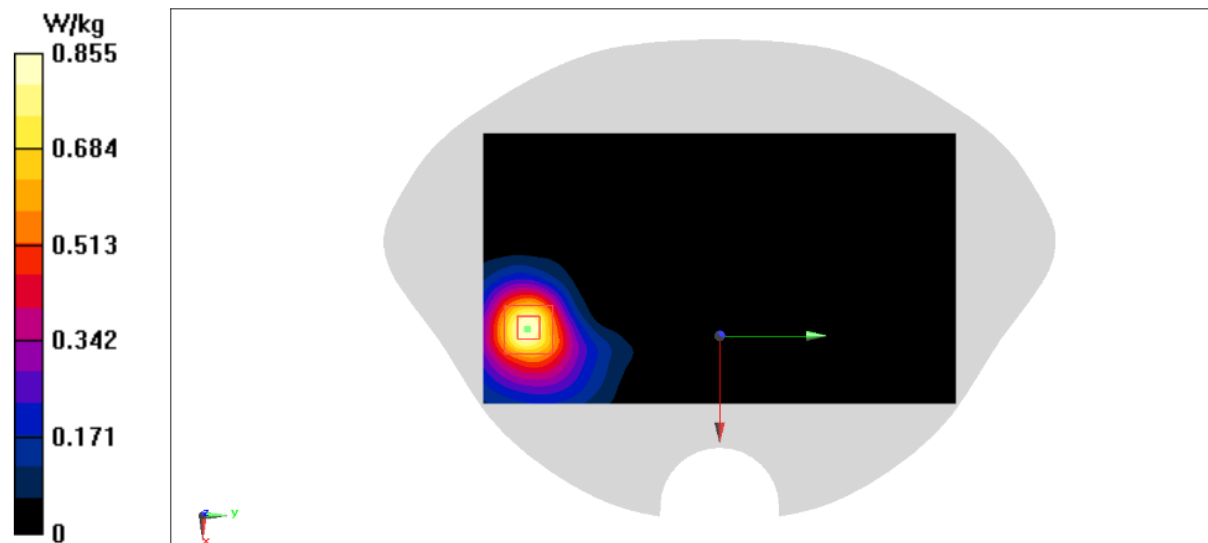

BT Head

Date: 2023/12/28

Electronics: DAE4 Sn1556

Medium: H700-6000M

Medium parameters used: $f = 2480$ MHz; $\sigma = 1.893$ S/m; $\epsilon_r = 40.582$; $\rho = 1000$ kg/m³

Ambient Temperature: 23.3°C Liquid Temperature: 22.5°C

Communication System: Bluetooth2 (0) Frequency: 2480 MHz Duty Cycle: 1:1

Probe: EX3DV4 - SN7464 ConvF(7.67, 7.67, 7.67)

Area Scan (101x171x1): Interpolated grid: $dx=1.200$ mm, $dy=1.200$ mm

Maximum value of SAR (interpolated) = 0.0659 W/kg

Zoom Scan (7x7x7)/Cube 0: Measurement grid: $dx=5$ mm, $dy=5$ mm, $dz=5$ mm

Reference Value = 0.4720 V/m; Power Drift = 0.11 dB

Peak SAR (extrapolated) = 0.0860 W/kg

SAR(1 g) = 0.032 W/kg; SAR(10 g) = 0.012 W/kg

Maximum value of SAR (measured) = 0.0628 W/kg

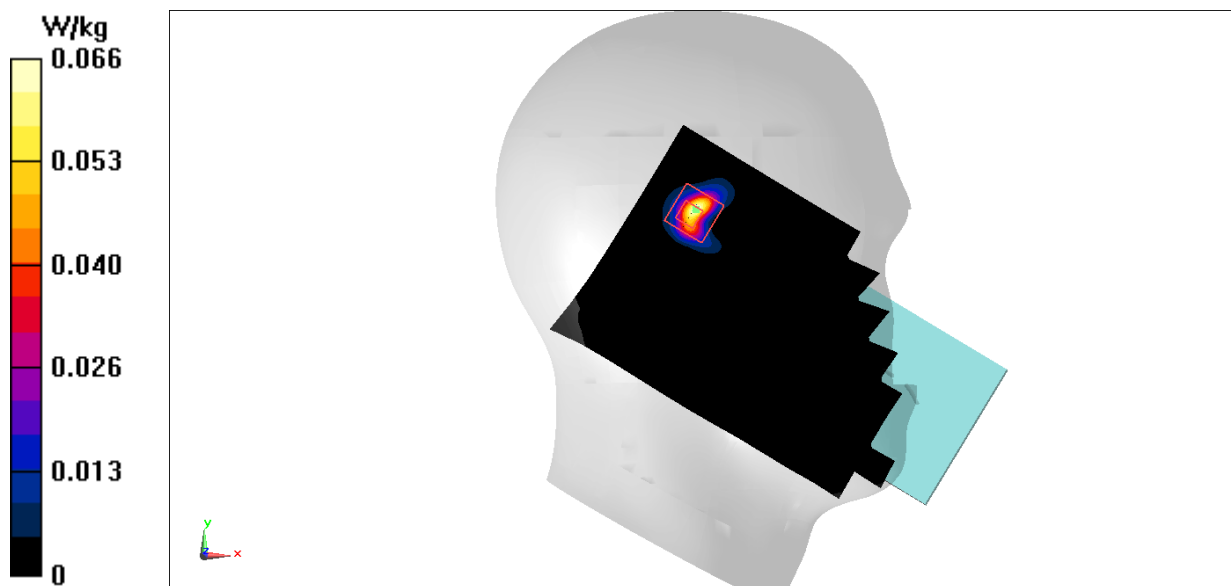

BT Body 10mm

Date: 2023/12/28

Electronics: DAE4 Sn1556

Medium: H700-6000M

Medium parameters used: $f = 2480$ MHz; $\sigma = 1.893$ S/m; $\epsilon_r = 40.582$; $\rho = 1000$ kg/m³

Ambient Temperature: 23.3°C Liquid Temperature: 22.5°C

Communication System: Bluetooth2 (0) Frequency: 2480 MHz Duty Cycle: 1:1

Probe: EX3DV4 - SN7464 ConvF(7.67, 7.67, 7.67)

Area Scan (101x171x1): Interpolated grid: $dx=1.200$ mm, $dy=1.200$ mm

Maximum value of SAR (interpolated) = 0.0385 W/kg

Zoom Scan (7x7x7)/Cube 0: Measurement grid: $dx=5$ mm, $dy=5$ mm, $dz=5$ mm

Reference Value = 0.7760 V/m; Power Drift = 0.09 dB

Peak SAR (extrapolated) = 0.0270 W/kg

SAR(1 g) = 0.011 W/kg; SAR(10 g) = 0.00493 W/kg

Maximum value of SAR (measured) = 0.0193 W/kg

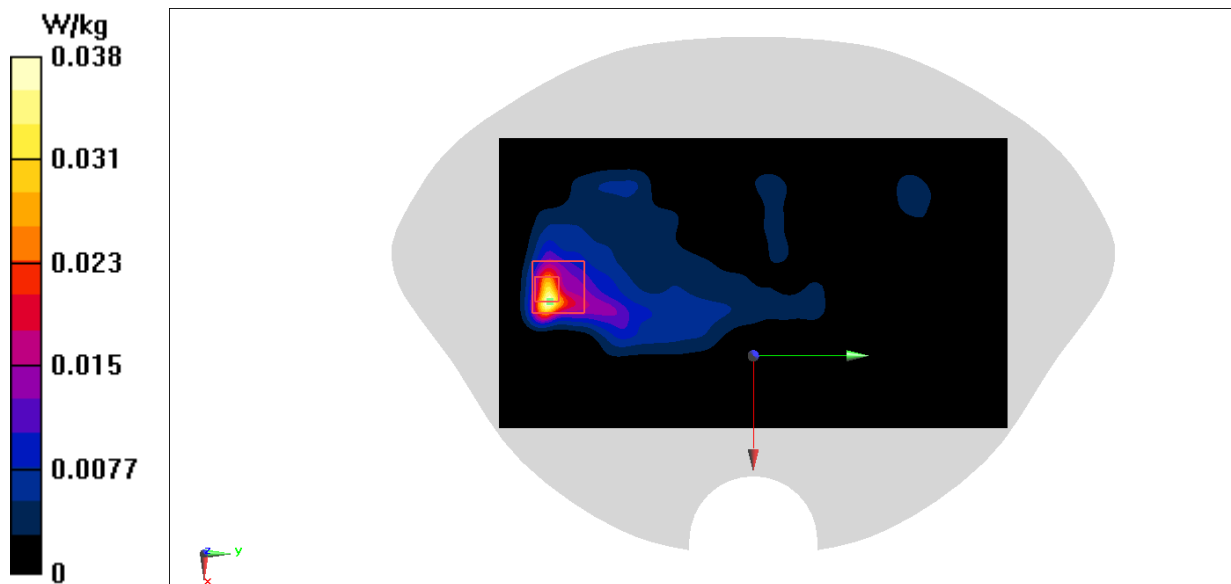

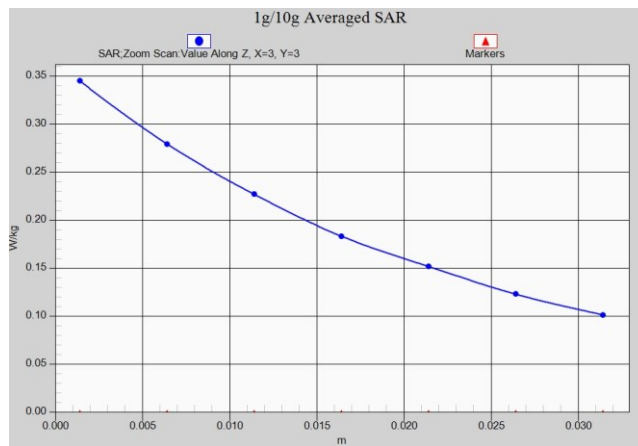

GSM850 Head

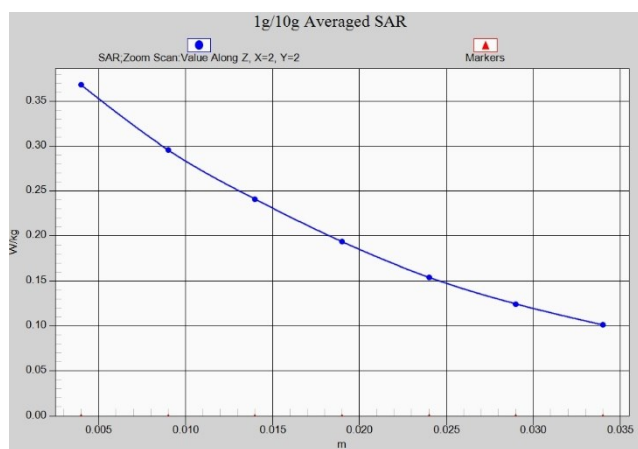

GSM850 Body 10mm



GSM1900 Head

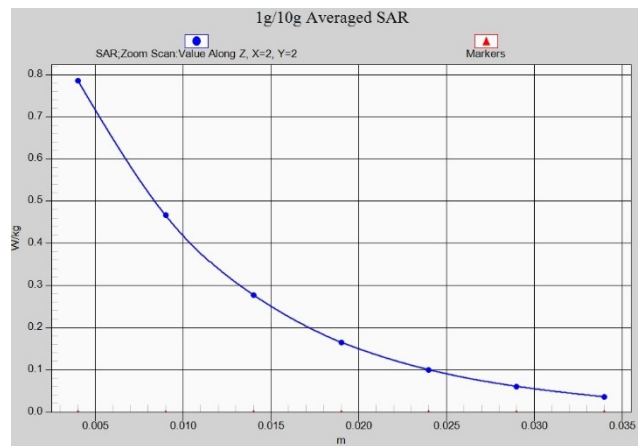

GSM1900 Body 10mm



WCDMA850 Head

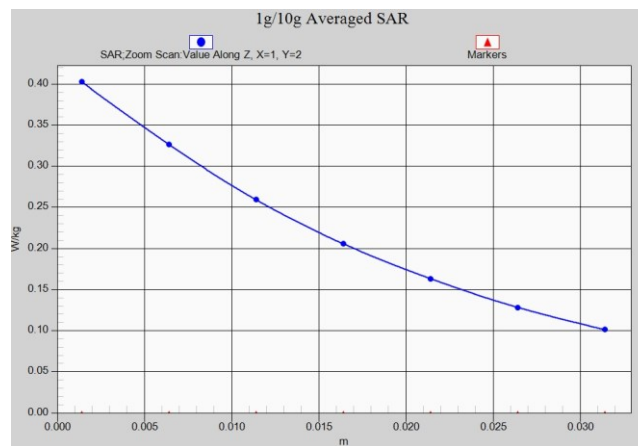

WCDMA850 Body 10mm

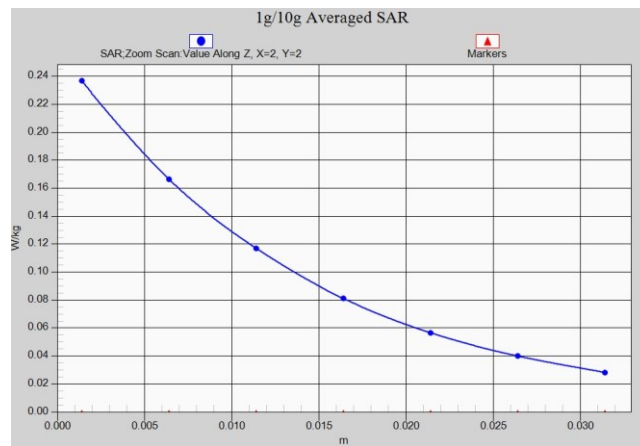

WCDMA1700 Head

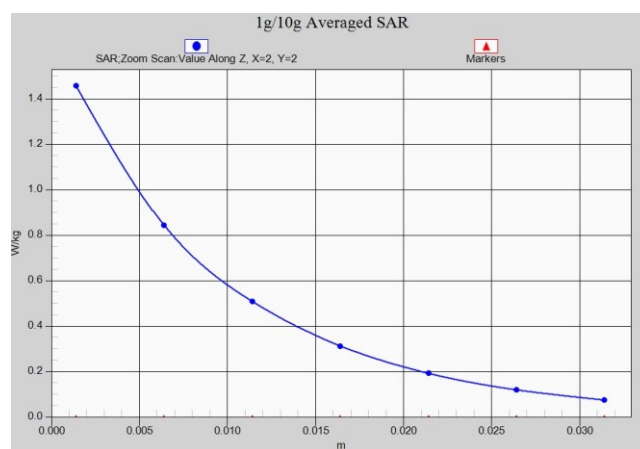

WCDMA1700 Body 10mm

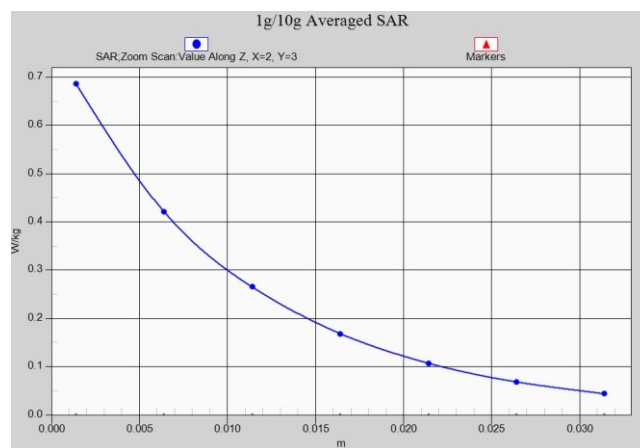

WCDMA1700 Body 15mm

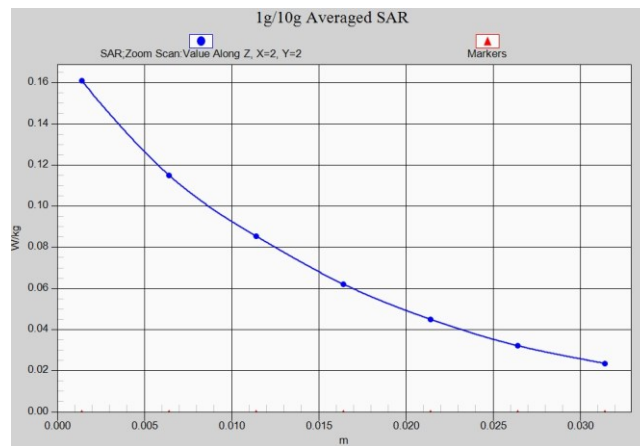

WCDMA1900 Head

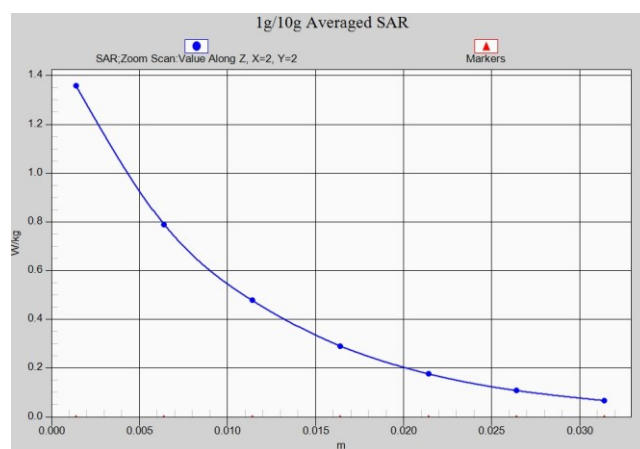

WCDMA1900 Body 10mm

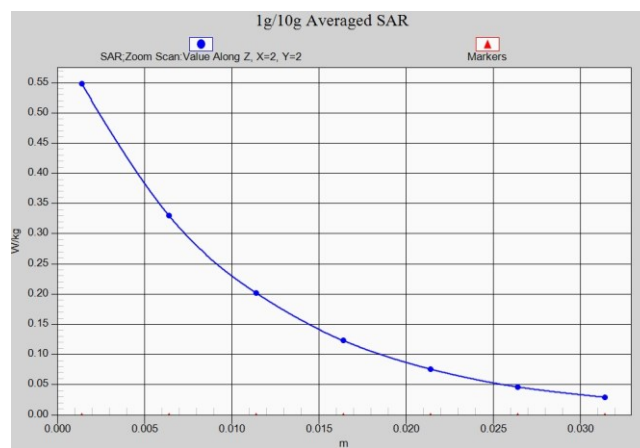

WCDMA1900 Body 15mm

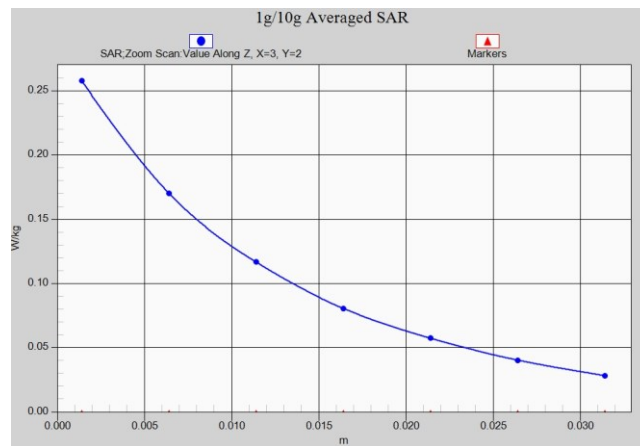

LTE BAND2 Head

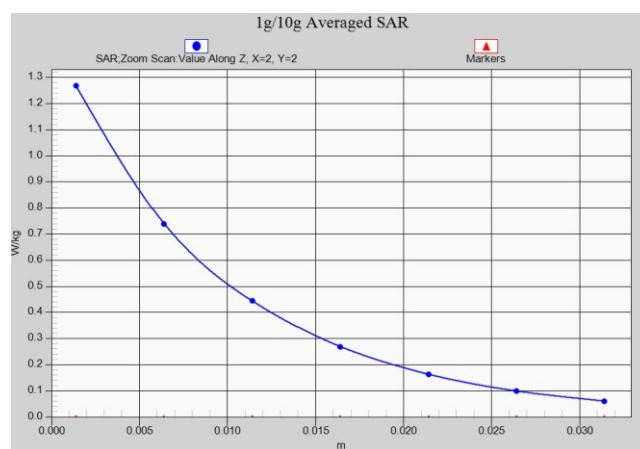

LTE BAND2 Body 10mm

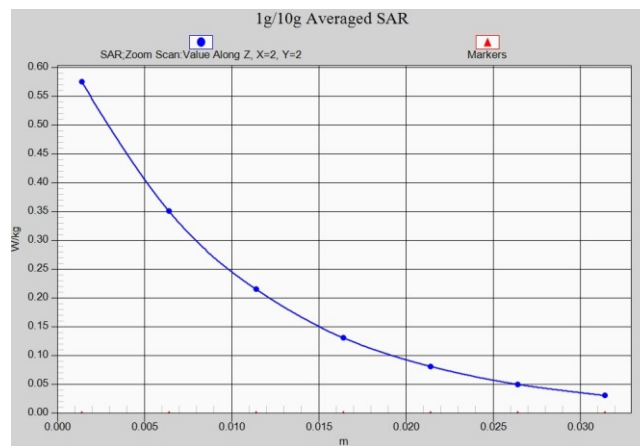

LTE BAND2 Body 15mm

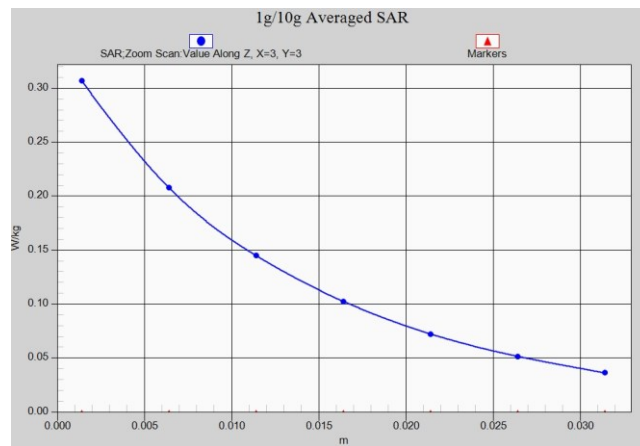

LTE BAND4 Head

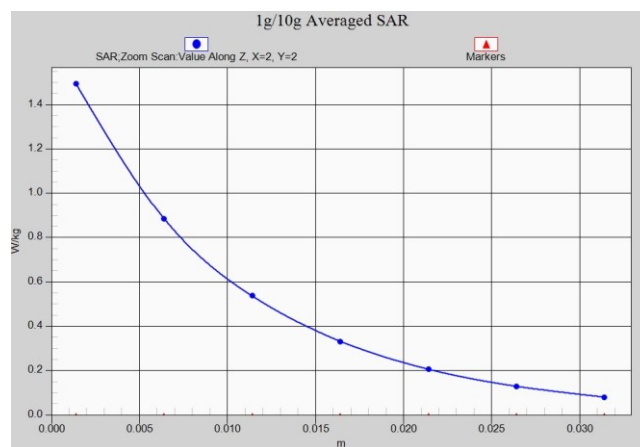

LTE BAND4 Body 10mm

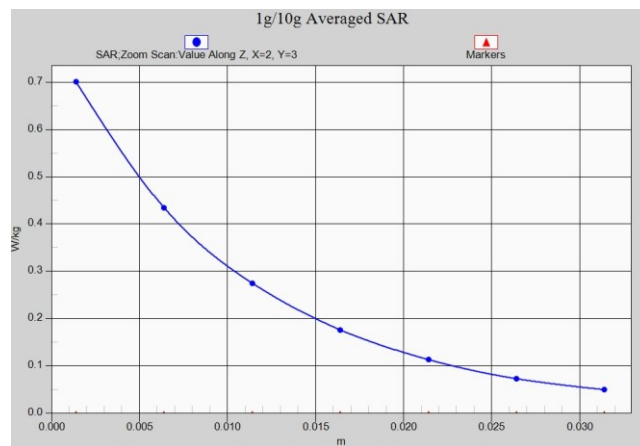

LTE BAND4 Body 15mm

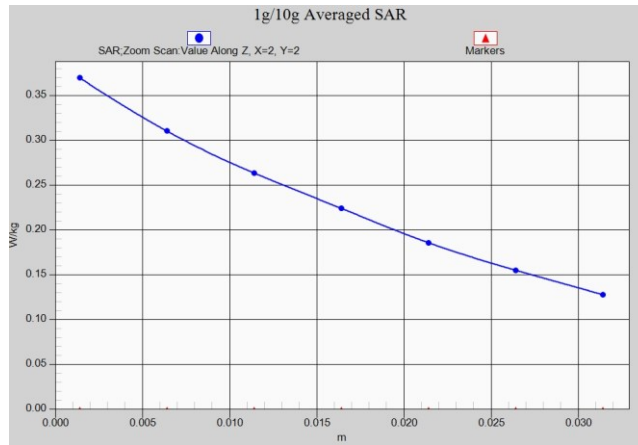

LTE BAND5 Head

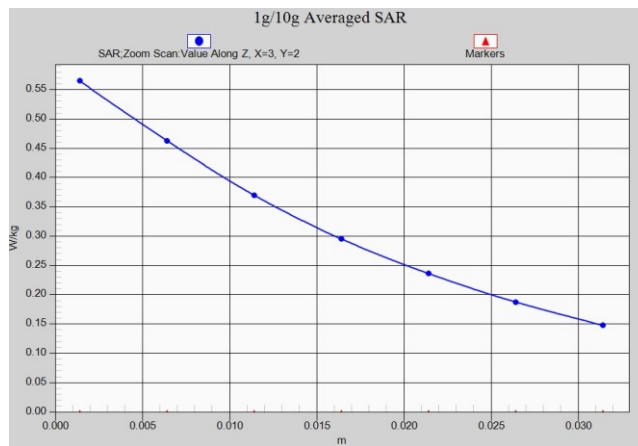

LTE BAND5 Body 10mm

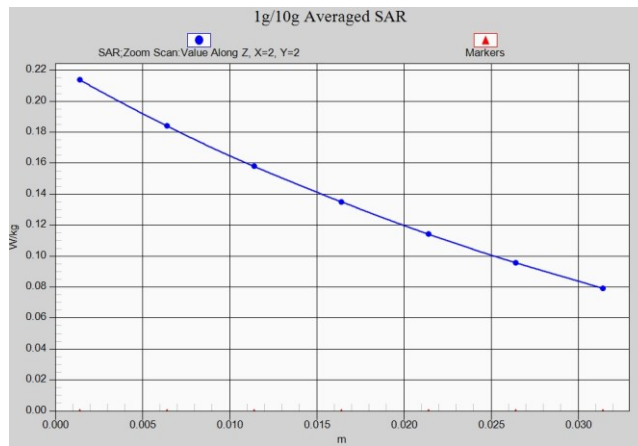

LTE BAND12 Head

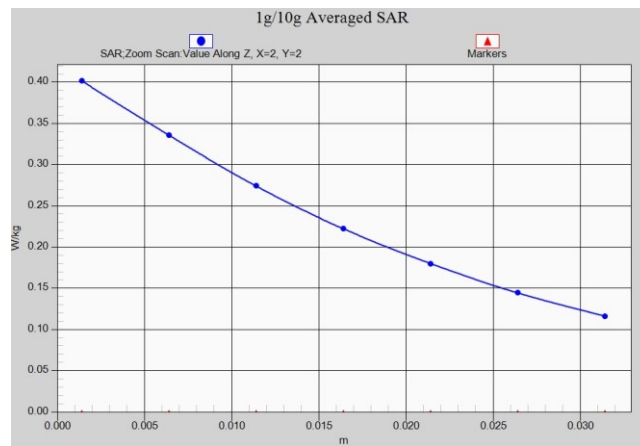

LTE BAND12 Body 10mm

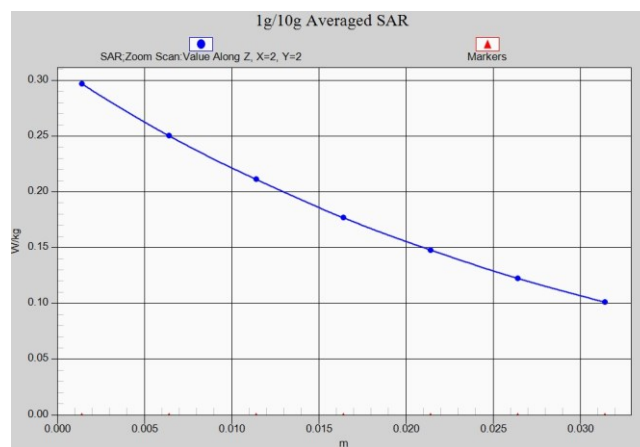

LTE BAND13 Head

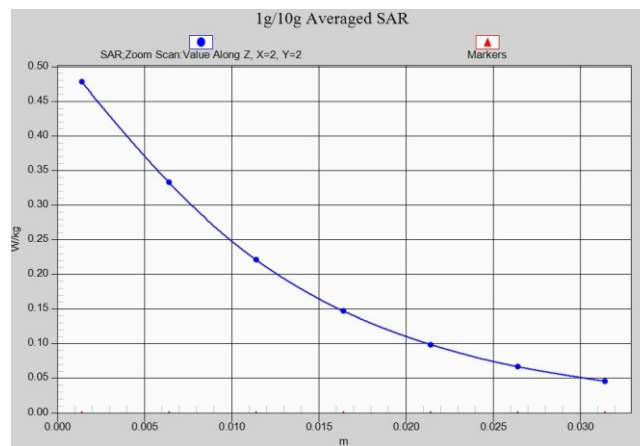

LTE BAND13 Body 10mm

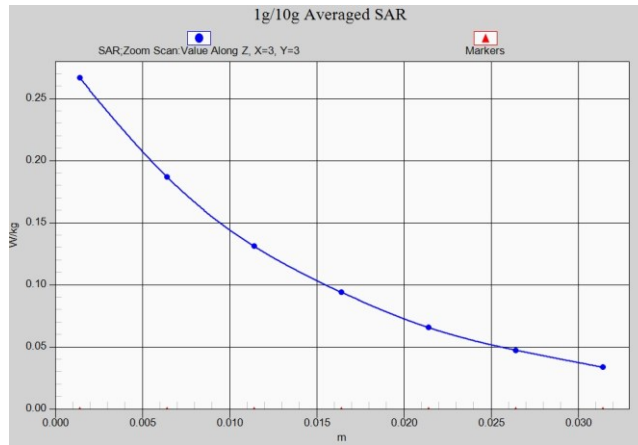

LTE BAND66 Head

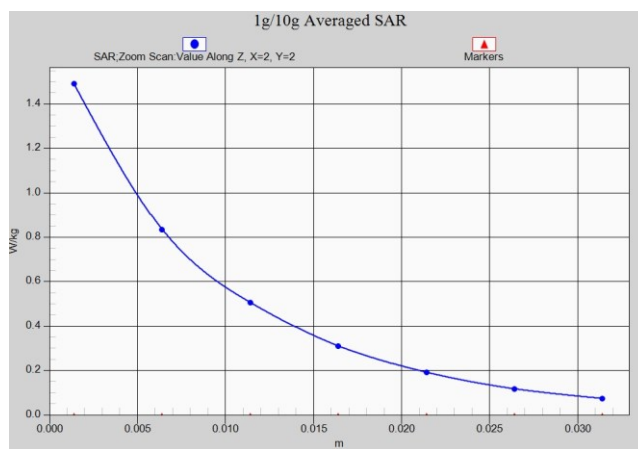

LTE BAND66 Body 10mm

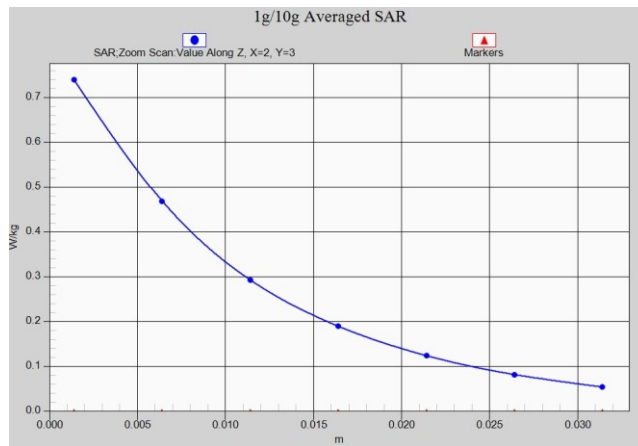

LTE BAND66 Body 15mm

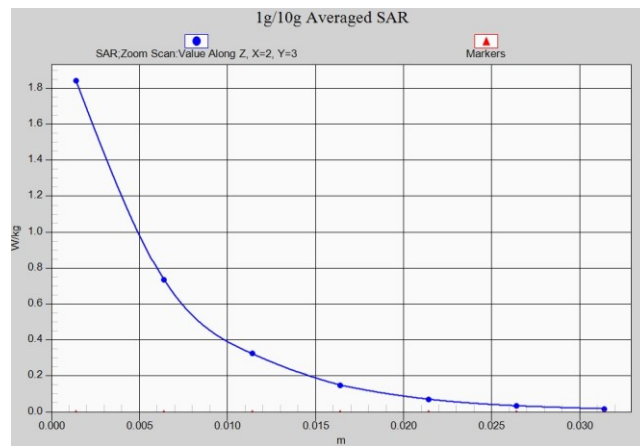

WiFi2.4G Head

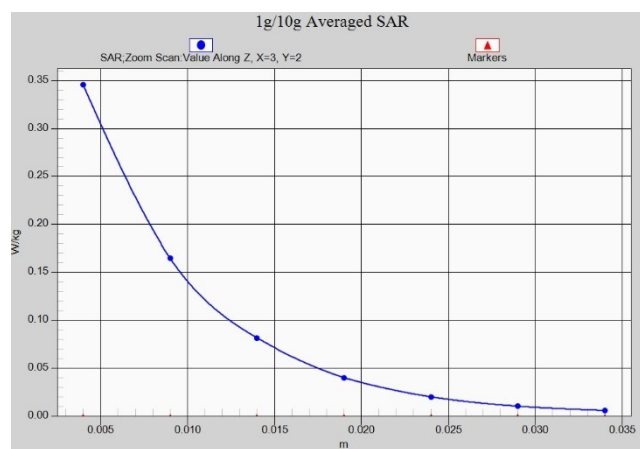

WiFi2.4G Body 10mm

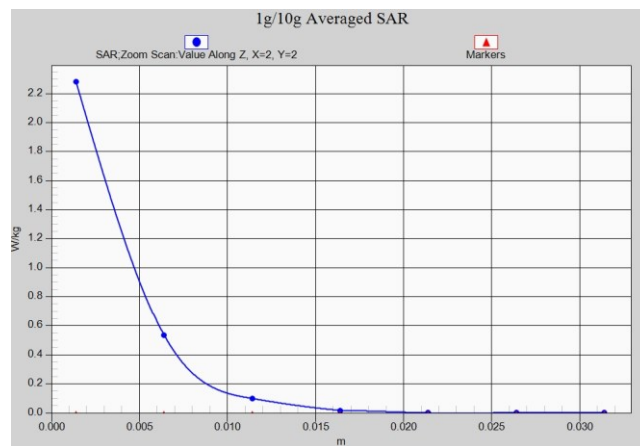

WiFi5G Head

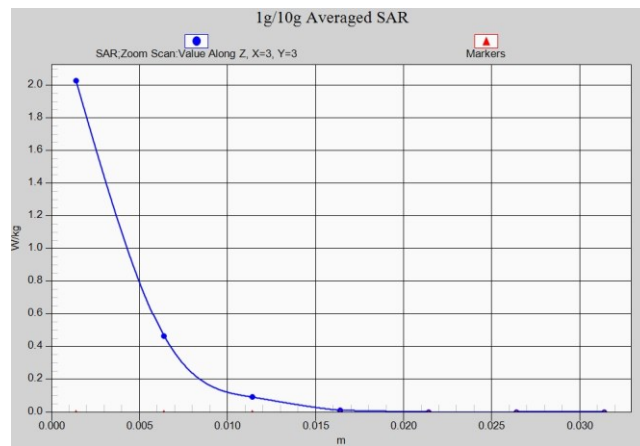

WiFi5G Body 10mm

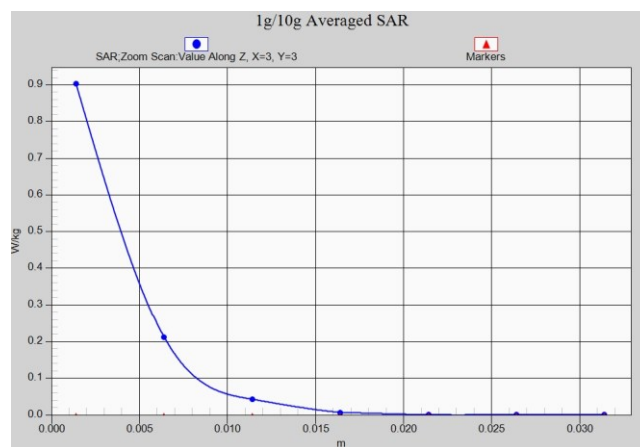

WiFi5G Body 15mm

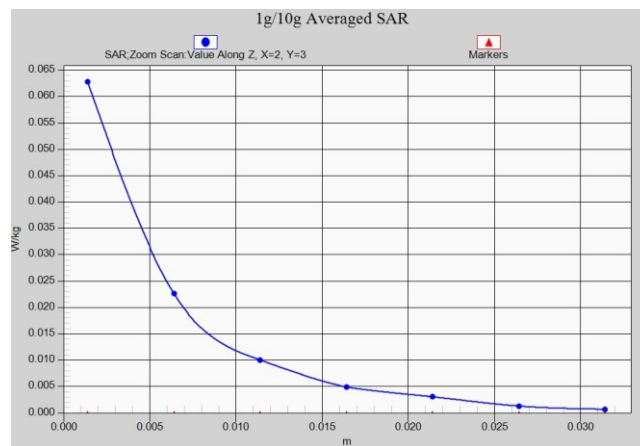

BT Head

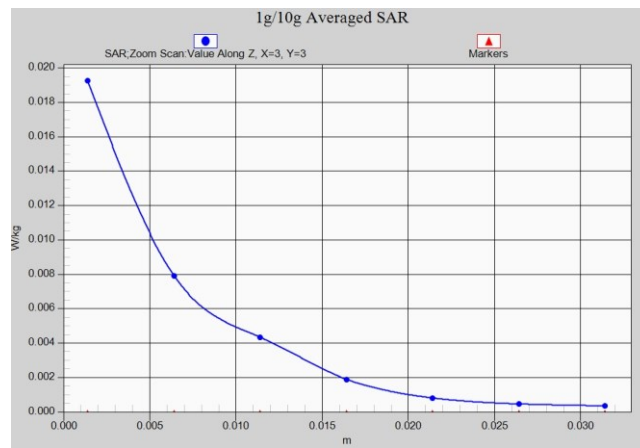

BT Body 10mm

ANNEX B System Verification Results

750MHz

Date: 2023/12/21

Electronics: DAE4 Sn1556

Medium: H700-6000M

Medium parameters used: $f = 750 \text{ MHz}$; $\sigma = 0.864 \text{ S/m}$; $\epsilon_r = 43.72$; $\rho = 1000 \text{ kg/m}^3$

Ambient Temperature: 23.3°C Liquid Temperature: 22.5°C

Communication System: UID 0, CW (0) Frequency: 750 MHz Duty Cycle: 1:1

Probe: EX3DV4 - SN7464 ConvF(10.26, 10.26, 10.26)

Area Scan (131x61x1): Interpolated grid: $dx=1.500 \text{ mm}$, $dy=1.500 \text{ mm}$

Maximum value of SAR (interpolated) = 2.74 W/kg

Zoom Scan (7x7x7) (7x7x7)/Cube 0: Measurement grid: $dx=5\text{mm}$, $dy=5\text{mm}$, $dz=5\text{mm}$

Reference Value = 54.09 V/m ; Power Drift = -0.11 dB

Peak SAR (extrapolated) = 3.12 W/kg

SAR(1 g) = 2.12 W/kg ; SAR(10 g) = 1.41 W/kg

Maximum value of SAR (measured) = 2.81 W/kg

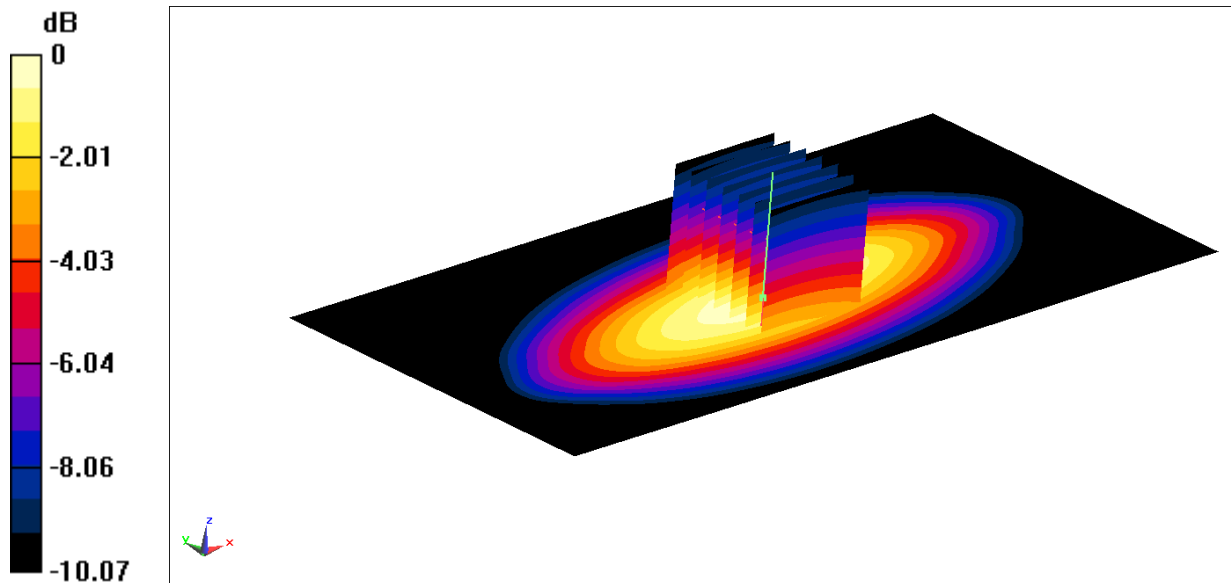

0 dB = 2.81 W/kg = 4.49 dBW/kg

835MHz

Date: 2023/12/22

Electronics: DAE4 Sn1556

Medium: H700-6000M

Medium parameters used: $f = 835$ MHz; $\sigma = 0.86$ S/m; $\epsilon_r = 43.45$; $\rho = 1000$ kg/m³

Ambient Temperature: 23.3°C Liquid Temperature: 22.5°C

Communication System: UID 0, CW (0) Frequency: 835 MHz Duty Cycle: 1:1

Probe: EX3DV4 - SN7464 ConvF(10.26, 10.26, 10.26)

Area Scan (131x61x1): Interpolated grid: dx=1.500 mm, dy=1.500 mm

Maximum value of SAR (interpolated) = 3.29 W/kg

Zoom Scan (7x7x7) (7x7x7)/Cube 0: Measurement grid: dx=5mm, dy=5mm, dz=5mm

Reference Value = 57.12 V/m; Power Drift = -0.11 dB

Peak SAR (extrapolated) = 3.73 W/kg

SAR(1 g) = 2.49 W/kg; SAR(10 g) = 1.64 W/kg

Maximum value of SAR (measured) = 3.31 W/kg

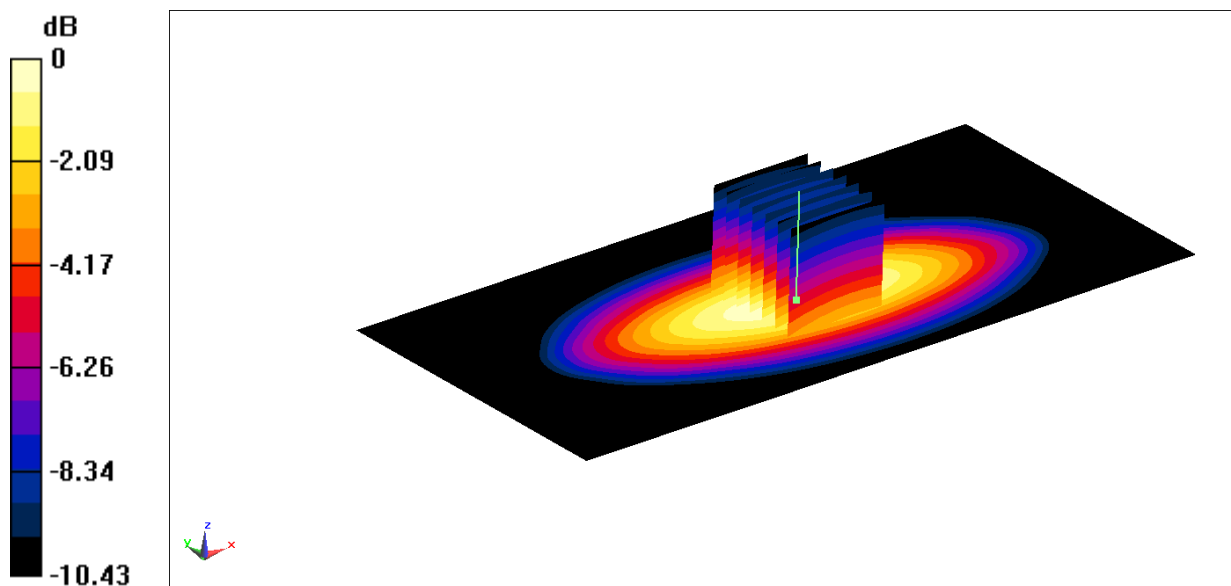

0 dB = 3.31 W/kg = 5.20 dBW/kg

1750MHz

Date: 2023/12/24

Electronics: DAE4 Sn1556

Medium: H700-6000M

Medium parameters used: $f = 1750$ MHz; $\sigma = 1.328$ S/m; $\epsilon_r = 41.12$; $\rho = 1000$ kg/m³

Ambient Temperature: 23.3oC Liquid Temperature: 22.5oC

Communication System: UID 0, CW (0) Frequency: 1750 MHz Duty Cycle: 1:1

Probe: EX3DV4 - SN7464 ConvF(8.54, 8.54, 8.54)

Area Scan (61x61x1): Interpolated grid: dx=1.500 mm, dy=1.500 mm

Maximum value of SAR (interpolated) = 13.6 W/kg

Zoom Scan (7x7x7) (7x7x7)/Cube 0: Measurement grid: dx=5mm, dy=5mm, dz=5mm

Reference Value = 94.45 V/m; Power Drift = -0.09 dB

Peak SAR (extrapolated) = 16.1 W/kg

SAR(1 g) = 9.11 W/kg; SAR(10 g) = 4.87 W/kg

Maximum value of SAR (measured) = 13.9 W/kg

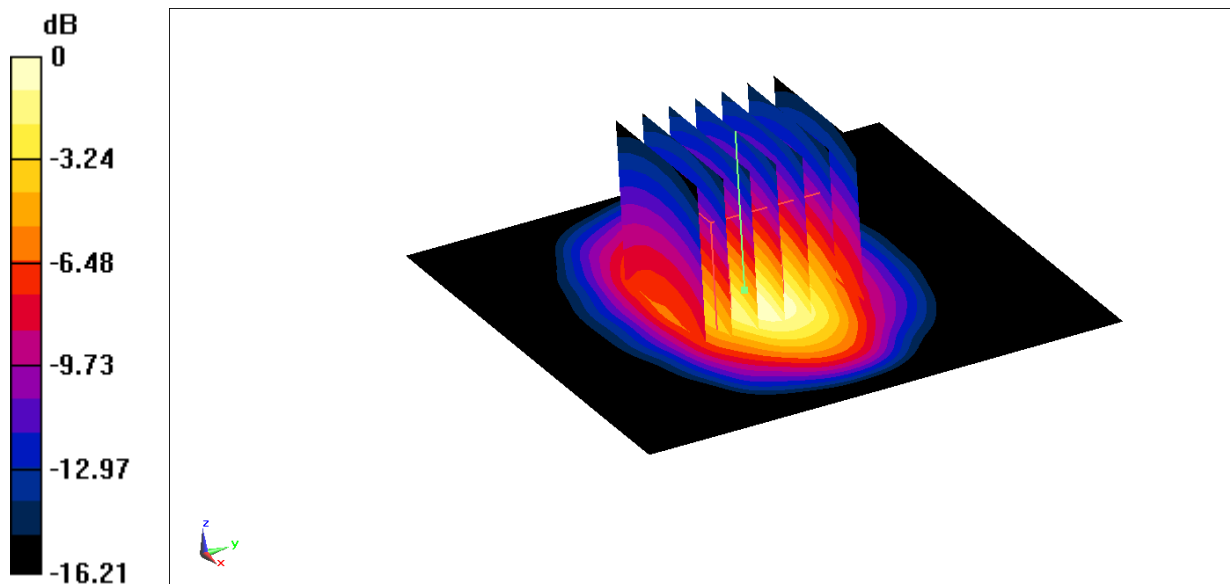

0 dB = 13.9 W/kg = 11.43 dBW/kg

1900MHz

Date: 2023/12/26

Electronics: DAE4 Sn1556

Medium: H700-6000M

Medium parameters used: $f = 1900$ MHz; $\sigma = 1.42$ S/m; $\epsilon_r = 40.79$; $\rho = 1000$ kg/m³

Ambient Temperature: 23.3oC Liquid Temperature: 22.5oC

Communication System: UID 0, CW (0) Frequency: 1900 MHz Duty Cycle: 1:1

Probe: EX3DV4 - SN7464 ConvF(8.13, 8.13, 8.13)

Area Scan (61x61x1): Interpolated grid: dx=1.500 mm, dy=1.500 mm

Maximum value of SAR (interpolated) = 15.2 W/kg

Zoom Scan (7x7x7) (7x7x7)/Cube 0: Measurement grid: dx=5mm, dy=5mm, dz=5mm

Reference Value = 96.48 V/m; Power Drift = -0.03 dB

Peak SAR (extrapolated) = 18.6 W/kg

SAR(1 g) = 9.91 W/kg; SAR(10 g) = 5.16 W/kg

Maximum value of SAR (measured) = 15.5 W/kg

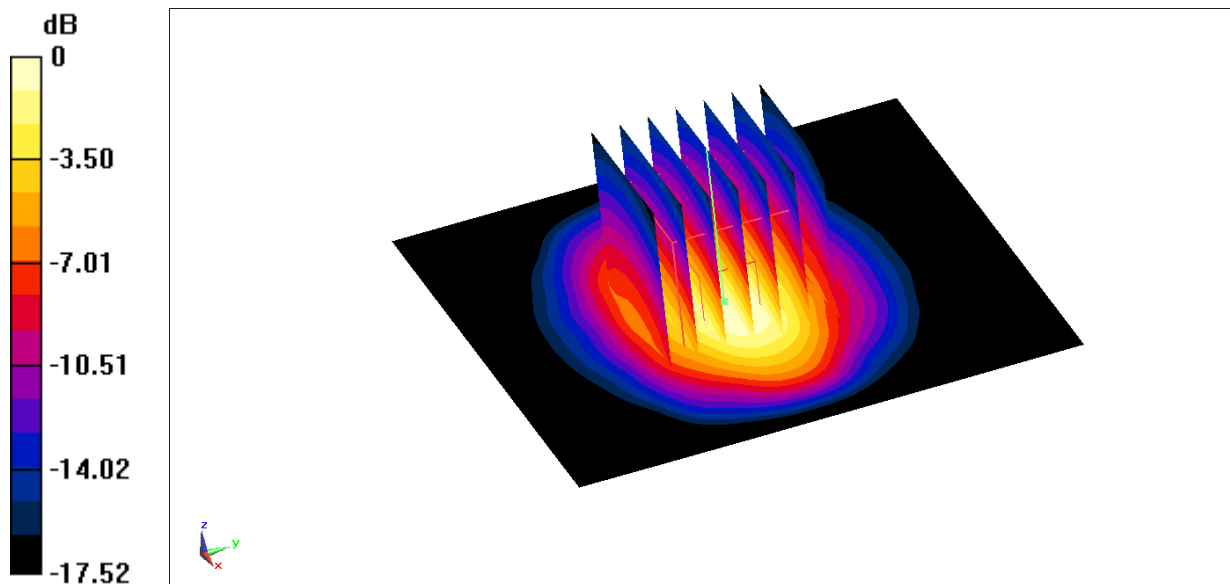

0 dB = 15.5 W/kg = 11.90 dBW/kg

2450MHz

Date: 2023/12/28

Electronics: DAE4 Sn1556

Medium: H700-6000M

Medium parameters used: $f = 2450$ MHz; $\sigma = 1.868$ S/m; $\epsilon_r = 40.63$ $\rho = 1000$ kg/m³

Ambient Temperature: 23.3oC Liquid Temperature: 22.5oC

Communication System: UID 0, CW (0) Frequency: 2450 MHz Duty Cycle: 1:1

Probe: EX3DV4 - SN7464 ConvF(7.67, 7.67, 7.67)

Area Scan (61x61x1): Interpolated grid: dx=1.200 mm, dy=1.200 mm

Maximum value of SAR (interpolated) = 22.1 W/kg

Zoom Scan (7x7x7) (7x7x7)/Cube 0: Measurement grid: dx=5mm, dy=5mm, dz=5mm

Reference Value = 105.9 V/m; Power Drift = -0.12 dB

Peak SAR (extrapolated) = 27.9 W/kg

SAR(1 g) = 13.6 W/kg; SAR(10 g) = 6.37 W/kg

Maximum value of SAR (measured) = 22.6 W/kg

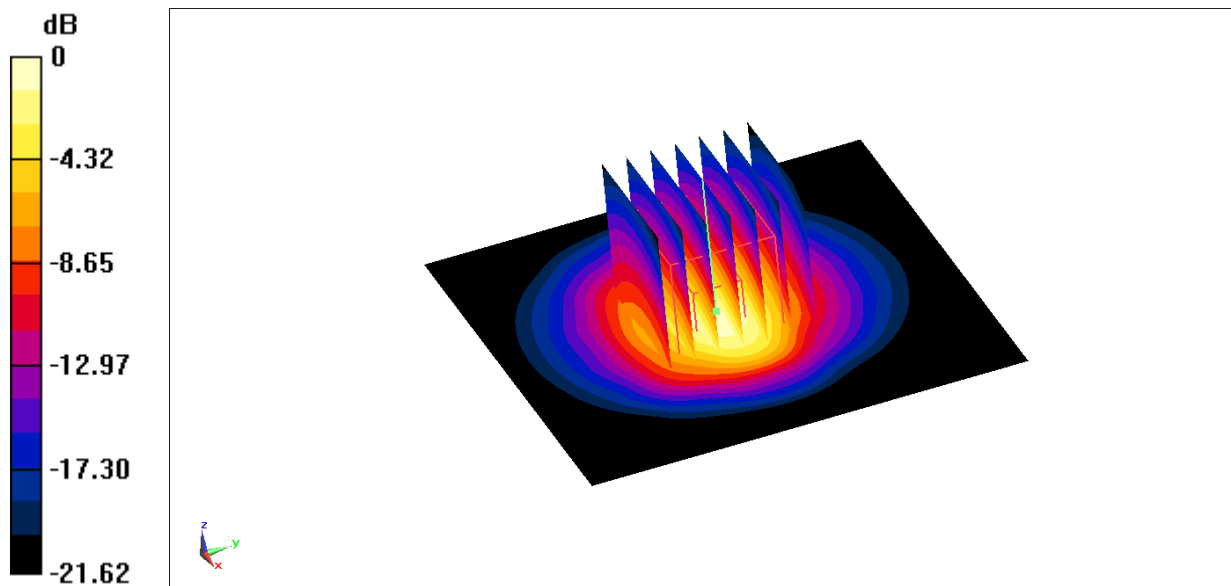

0 dB = 22.6 W/kg = 13.54 dBW/kg

5250MHz

Date: 2024/1/4

Electronics: DAE4 Sn1556

Medium: H700-6000M

Medium parameters used: $f = 5250$ MHz; $\sigma = 4.839$ S/m; $\epsilon_r = 35.93$; $\rho = 1000$ kg/m³

Ambient Temperature: 23.30C Liquid Temperature: 22.50C

Communication System: UID 0, CW (0) Frequency: 5250 MHz Duty Cycle: 1:1

Probe: EX3DV4 - SN7464 ConvF(5.42, 5.42, 5.42)

Area Scan (91x91x1): Interpolated grid: dx=1.000 mm, dy=1.000 mm

Maximum value of SAR (interpolated) = 18.8 W/kg

Zoom Scan (4x4x1.4mm, graded), dist=1.4mm (8x8x8)/Cube 0: Measurement grid: dx=4mm, dy=4mm, dz=1.4mm

Reference Value = 66.97 V/m; Power Drift = -0.15 dB

Peak SAR (extrapolated) = 31.9 W/kg

SAR(1 g) = 7.93 W/kg; SAR(10 g) = 2.27 W/kg

Maximum value of SAR (measured) = 18.5 W/kg

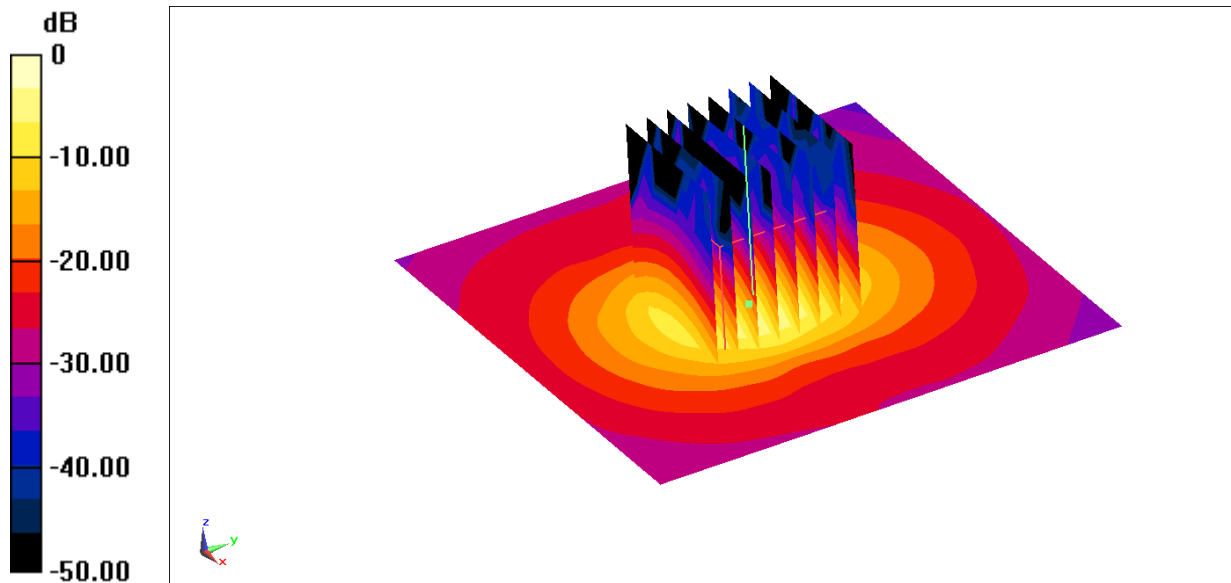

0 dB = 18.5 W/kg = 12.67 dBW/kg

5600MHz

Date: 2024/1/4

Electronics: DAE4 Sn1556

Medium: H700-6000M

Medium parameters used: $f = 5600$ MHz; $\sigma = 5.251$ S/m; $\epsilon_r = 35.23$; $\rho = 1000$ kg/m³

Ambient Temperature: 23.30C Liquid Temperature: 22.50C

Communication System: UID 0, CW (0) Frequency: 5600 MHz Duty Cycle: 1:1

Probe: EX3DV4 - SN7464 ConvF(4.85, 4.85, 4.85)

Area Scan (91x91x1): Interpolated grid: dx=1.000 mm, dy=1.000 mm

Maximum value of SAR (interpolated) = 19.9 W/kg

Zoom Scan (4x4x1.4mm, graded), dist=1.4mm (8x8x8)/Cube 0: Measurement grid: dx=4mm, dy=4mm, dz=1.4mm

Reference Value = 67.06 V/m; Power Drift = -0.11 dB

Peak SAR (extrapolated) = 36.2 W/kg

SAR(1 g) = 8.21 W/kg; SAR(10 g) = 2.34 W/kg

Maximum value of SAR (measured) = 19.8 W/kg

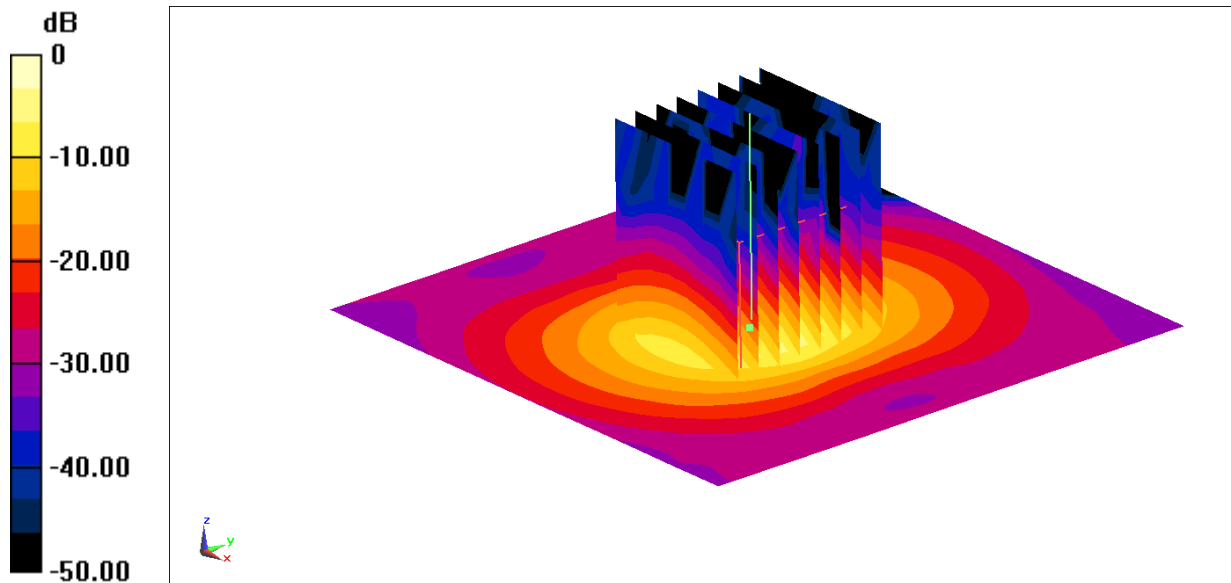

0 dB = 19.8 W/kg = 12.97 dBW/kg

5750MHz

Date: 2024/1/4

Electronics: DAE4 Sn1556

Medium: H700-6000M

Medium parameters used: $f = 5750$ MHz; $\sigma = 5.431$ S/m; $\epsilon_r = 34.93$; $\rho = 1000$ kg/m³

Ambient Temperature: 23.30C Liquid Temperature: 22.50C

Communication System: UID 0, CW (0) Frequency: 5750 MHz Duty Cycle: 1:1

Probe: EX3DV4 - SN7464 ConvF(4.92, 4.92, 4.92)

Area Scan (91x91x1): Interpolated grid: dx=1.000 mm, dy=1.000 mm

Maximum value of SAR (interpolated) = 19.5 W/kg

Zoom Scan (4x4x1.4mm, graded), dist=1.4mm (8x8x8)/Cube 0: Measurement grid: dx=4mm, dy=4mm, dz=1.4mm

Reference Value = 66.11 V/m; Power Drift = -0.18 dB

Peak SAR (extrapolated) = 37.1 W/kg

SAR(1 g) = 7.91 W/kg; SAR(10 g) = 2.23 W/kg

Maximum value of SAR (measured) = 19.6 W/kg

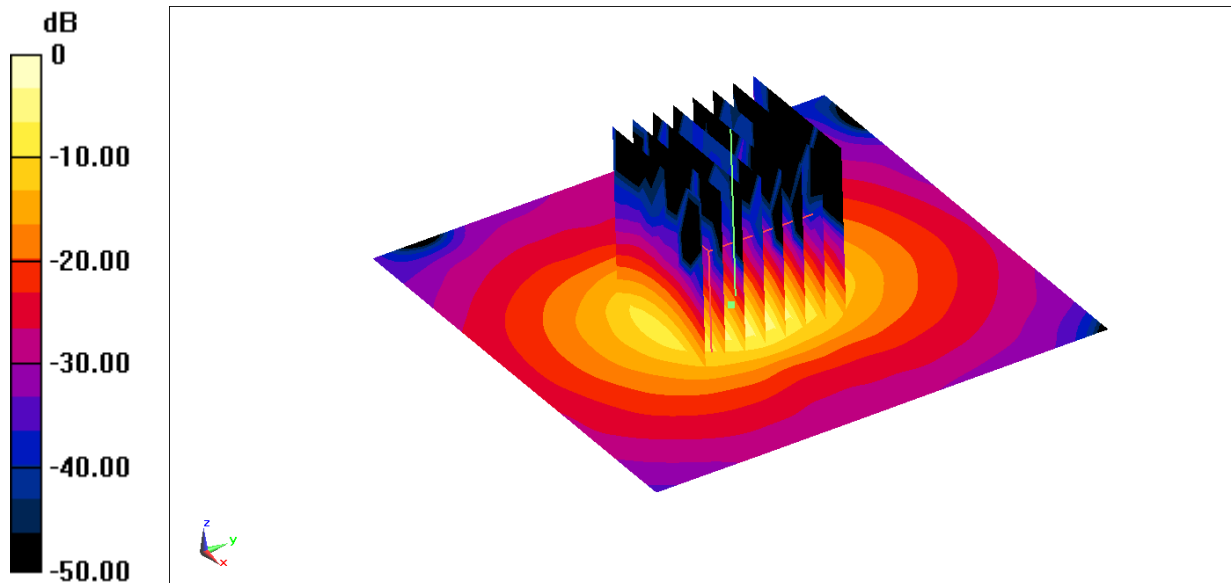

0 dB = 19.6 W/kg = 12.92 dBW/kg

ANNEX C SAR Measurement Setup

C.1 Measurement Set-up

The Dasy5 or DASY6 system for performing compliance tests is illustrated above graphically. This system consists of the following items:

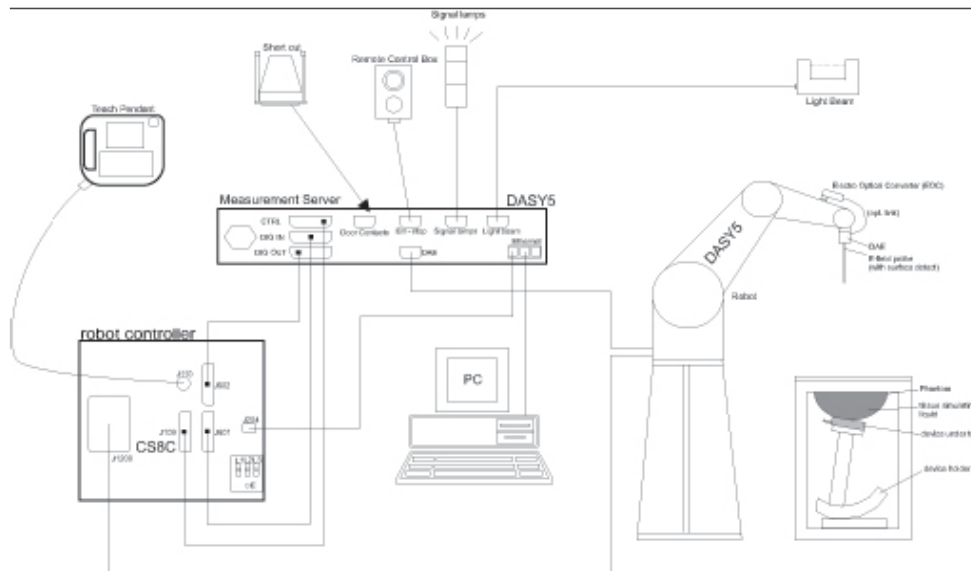

Picture C.1 SAR Lab Test Measurement Set-up

- A standard high precision 6-axis robot (StäubliTX=RX family) with controller, teach pendant and software. An arm extension for accommodating the data acquisition electronics (DAE).
- An isotropic field probe optimized and calibrated for the targeted measurement.
- A data acquisition electronics (DAE) which performs the signal amplification, signal multiplexing, AD-conversion, offset measurements, mechanical surface detection, collision detection, etc. The unit is battery powered with standard or rechargeable batteries. The signal is optically transmitted to the EOC.
- The Electro-optical converter (EOC) performs the conversion from optical to electrical signals for the digital communication to the DAE. To use optical surface detection, a special version of the EOC is required. The EOC signal is transmitted to the measurement server.
- The function of the measurement server is to perform the time critical tasks such as signal filtering, control of the robot operation and fast movement interrupts.
- The Light Beam used is for probe alignment. This improves the (absolute) accuracy of the probe positioning.
- A computer running WinXP and the DASY5 or DASY6 software.
- Remote control and teach pendant as well as additional circuitry for robot safety such as warning lamps, etc.
- The phantom, the device holder and other accessories according to the targeted measurement.

C.2 Dasy5 E-field Probe System

The SAR measurements were conducted with the dosimetric probe designed in the classical triangular configuration and optimized for dosimetric evaluation. The probe is constructed using the thick film technique; with printed resistive lines on ceramic substrates. The probe is equipped with an optical multifiber line ending at the front of the probe tip. It is connected to the EOC box on the robot arm and provides an automatic detection of the phantom surface. Half of the fibers are connected to a pulsed infrared transmitter, the other half to a synchronized receiver. As the probe approaches the surface, the reflection from the surface produces a coupling from the transmitting to the receiving fibers. This reflection increases first during the approach, reaches maximum and then decreases. If the probe is flatly touching the surface, the coupling is zero. The distance of the coupling maximum to the surface is independent of the surface reflectivity and largely independent of the surface to probe angle. The DASY5 or DASY6 software reads the reflection during a software approach and looks for the maximum using 2nd ord curve fitting. The approach is stopped at reaching the maximum.

Probe Specifications:

Model:	ES3DV3, EX3DV4
Frequency	10MHz — 6.0GHz(EX3DV4)
Range:	10MHz — 4GHz(ES3DV3)
Calibration:	In head and body simulating tissue at Frequencies from 835 up to 5800MHz
Linearity:	± 0.2 dB(30 MHz to 6 GHz) for EX3DV4 ± 0.2 dB(30 MHz to 4 GHz) for ES3DV3
DynamicRange:	10 mW/kg — 100W/kg
Probe Length:	330 mm
Probe Tip	
Length:	20 mm
Body Diameter:	12 mm
Tip Diameter:	2.5 mm (3.9 mm for ES3DV3)
Tip-Center:	1 mm (2.0mm for ES3DV3)
Application:	SAR Dosimetry Testing Compliance tests of mobile phones Dosimetry in strong gradient fields



Picture C.2 Near-field Probe



Picture C.3 E-field Probe

C.3 E-field Probe Calibration

Each E-Probe/Probe Amplifier combination has unique calibration parameters. A TEM cell calibration procedure is conducted to determine the proper amplifier settings to enter in the probe parameters. The amplifier settings are determined for a given frequency by subjecting the probe to a known E-field density (1 mW/cm^2) using an RF Signal generator, TEM cell, and RF Power Meter.

The free space E-field from amplified probe outputs is determined in a test chamber. This calibration can be performed in a TEM cell if the frequency is below 1 GHz and in a waveguide or

other methodologies above 1 GHz for free space. For the free space calibration, the probe is placed in the volumetric center of the cavity and at the proper orientation with the field. The probe is then rotated 360 degrees until the three channels show the maximum reading. The power density readings equates to 1 mW/cm².

E-field temperature correlation calibration is performed in a flat phantom filled with the appropriate simulated brain tissue. The E-field in the medium correlates with the temperature rise in the dielectric medium. For temperature correlation calibration a RF transparent thermistor-based temperature probe is used in conjunction with the E-field probe.

$$SAR = C \frac{\Delta T}{\Delta t}$$

Where:

Δt = Exposure time (30 seconds),

C = Heat capacity of tissue (brain or muscle),

ΔT = Temperature increase due to RF exposure.

$$SAR = \frac{|E|^2 \cdot \sigma}{\rho}$$

Where:

σ = Simulated tissue conductivity,

ρ = Tissue density (kg/m³).

C.4 Other Test Equipment

C.4.1 Data Acquisition Electronics(DAE)

The data acquisition electronics consist of a highly sensitive electrometer-grade preamplifier with auto-zeroing, a channel and gain-switching multiplexer, a fast 16 bit AD-converter and a command decoder with a control logic unit. Transmission to the measurement server is accomplished through an optical downlink for data and status information, as well as an optical uplink for commands and the clock.

The mechanical probe mounting device includes two different sensor systems for frontal and sideways probe contacts. They are used for mechanical surface detection and probe collision detection.

The input impedance of the DAE is 200 MOhm; the inputs are symmetrical and floating. Common mode rejection is above 80 dB.

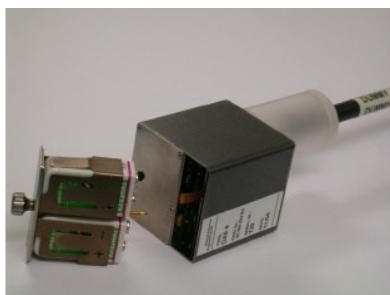

PictureC.4: DAE

C.4.2 Robot

The SPEAG DASY system uses the high precision robots (DASY5: RX160L) type from Stäubli SA (France). For the 6-axis controller system, the robot controller version from Stäubli is used. The Stäubli robot series have many features that are important for our application:

- High precision (repeatability 0.02mm)
- High reliability (industrial design)
- Low maintenance costs (virtually maintenance free due to direct drive gears; no belt drives)
- Jerk-free straight movements (brushless synchron motors; no stepper motors)
- Low ELF interference (motor control fields shielded via the closed metallic construction shields)



Picture C.5 DASY 5

C.4.3 Measurement Server

The Measurement server is based on a PC/104 CPU board with CPU (DASY5: 400 MHz, Intel Celeron), chipdisk (DASY5: 128MB), RAM (DASY5: 128MB). The necessary circuits for communication with the DAE electronic box, as well as the 16 bit AD converter system for optical detection and digital I/O interface are contained on the DASY I/O board, which is directly connected to the PC/104 bus of the CPU board.

The measurement server performs all real-time data evaluation of field measurements and surface detection, controls robot movements and handles safety operation. The PC operating system cannot interfere with these time critical processes. All connections are supervised by a watchdog, and disconnection of any of the cables to the measurement server will automatically disarm the robot and disable all program-controlled robot movements. Furthermore, the measurement server is equipped with an expansion port which is reserved for future applications. Please note that this expansion port does not have a standardized pinout, and therefore only devices provided by SPEAG can be connected. Devices from any other supplier could seriously damage the measurement server.



Picture C.6 Server for DASY 5

C.4.4 Device Holder for Phantom

The SAR in the phantom is approximately inversely proportional to the square of the distance between the source and the liquid surface. For a source at 5mm distance, a positioning uncertainty of $\pm 0.5\text{mm}$ would produce a SAR uncertainty of $\pm 20\%$. Accurate device positioning is therefore crucial for accurate and repeatable measurements. The positions in which the devices must be measured are defined by the standards.

The DASY device holder is designed to cope with the different positions given in the standard. It has two scales for device rotation (with respect to the body axis) and device inclination (with respect to the line between the ear reference points). The rotation centers for both scales are the ear reference point (ERP). Thus the device needs no repositioning when changing the angles. The DASY device holder is constructed of low-loss POM material having the following dielectric parameters: relative permittivity $\epsilon = 3$ and loss tangent $\delta = 0.02$. The amount of dielectric material has been reduced in the closest vicinity of the device, since measurements have suggested that the influence of the clamp on the test results could thus be lowered.

<Laptop Extension Kit>

The extension is lightweight and made of POM, acrylic glass and foam. It fits easily on the upper part of the Mounting Device in place of the phone positioner. The extension is fully compatible with the Twin-SAM and ELI phantoms.



Picture C7-1: Device Holder

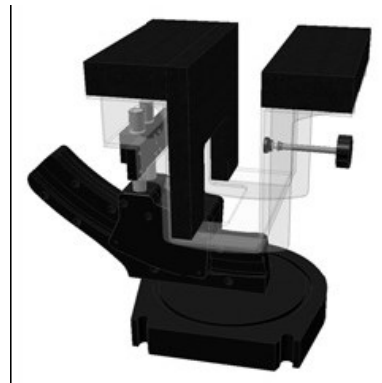

Picture C.7-2: Laptop Extension Kit

C.4.5 Phantom

The SAM Twin Phantom V4.0 is constructed of a fiberglass shell integrated in a table. The shape of the shell is based on data from an anatomical study designed to represent the 90th percentile of the population. The phantom enables the dissymmetric evaluation of SAR for both left and right handed handset usage, as well as body-worn usage using the flat phantom region. Reference markings on the Phantom allow the complete setup of all predefined phantom positions and measurement grids by manually teaching three points in the robot. The shell phantom has a 2mm shell thickness (except the ear region where shell thickness increases to 6 mm).

Shell Thickness: 2 ± 0.2 mm

Filling Volume: Approx. 25 liters

Dimensions: 810 x 1000 x 500 mm (H x L x W)

Available: Special



Picture C.8: SAM Twin Phantom

ANNEX D Position of the wireless device in relation to the phantom

D.1 General considerations

This standard specifies two handset test positions against the head phantom – the “cheek” position and the “tilt” position.

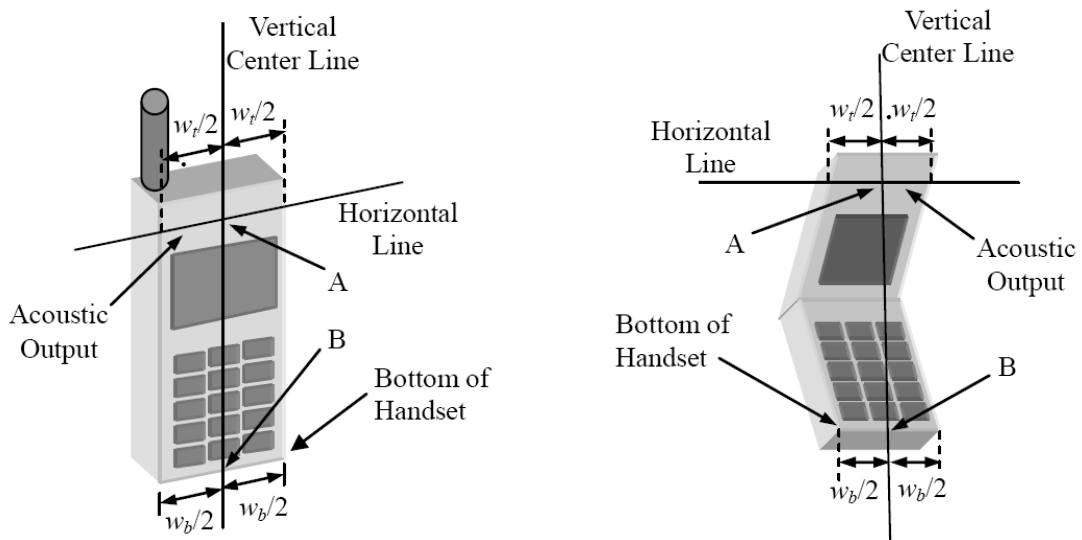

- w_t Width of the handset at the level of the acoustic
- w_b Width of the bottom of the handset
- A Midpoint of the width w_t of the handset at the level of the acoustic output
- B Midpoint of the width w_b of the bottom of the handset

Picture D.1-a Typical “fixed” case handset Picture D.1-b Typical “clam-shell” case handset

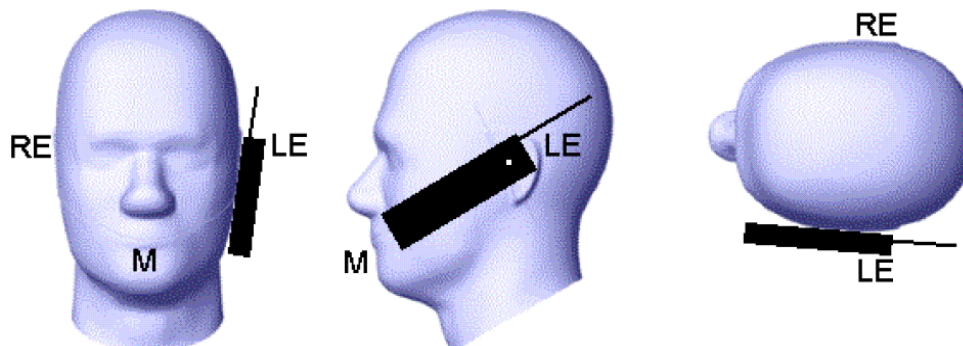

Picture D.2 Cheek position of the wireless device on the left side of SAM

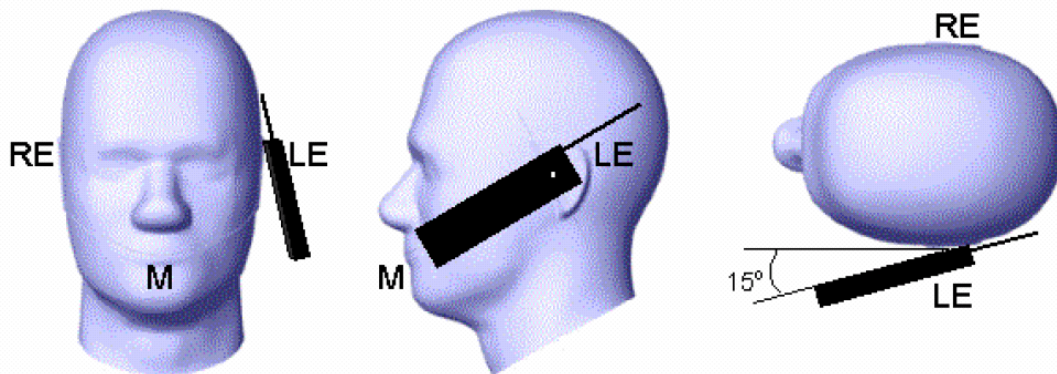

Picture D.3 Tilt position of the wireless device on the left side of SAM

D.2 Body-worn device

A typical example of a body-worn device is a mobile phone, wireless enabled PDA or other battery operated wireless device with the ability to transmit while mounted on a person's body using a carry accessory approved by the wireless device manufacturer.

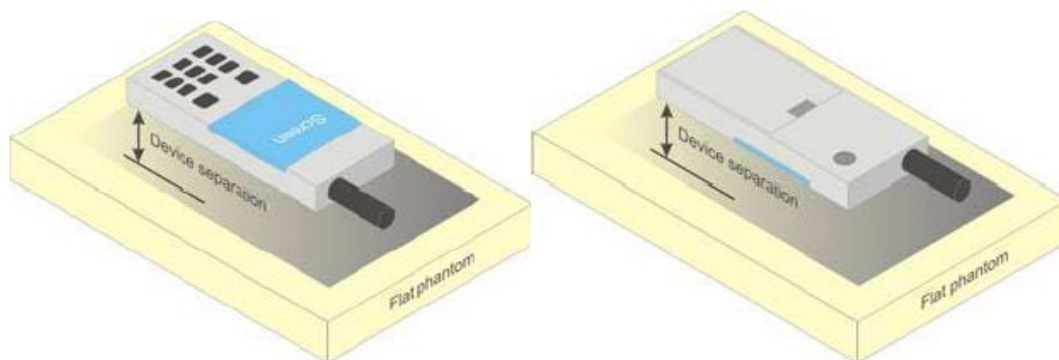

Picture D.4 Test positions for body-worn devices

D.3 Desktop device

A typical example of a desktop device is a wireless enabled desktop computer placed on a table or desk when used.

The DUT shall be positioned at the distance and in the orientation to the phantom that corresponds to the intended use as specified by the manufacturer in the user instructions. For devices that employ an external antenna with variable positions, tests shall be performed for all antenna positions specified. Picture 8.5 show positions for desktop device SAR tests. If the intended use is not specified, the device shall be tested directly against the flat phantom.

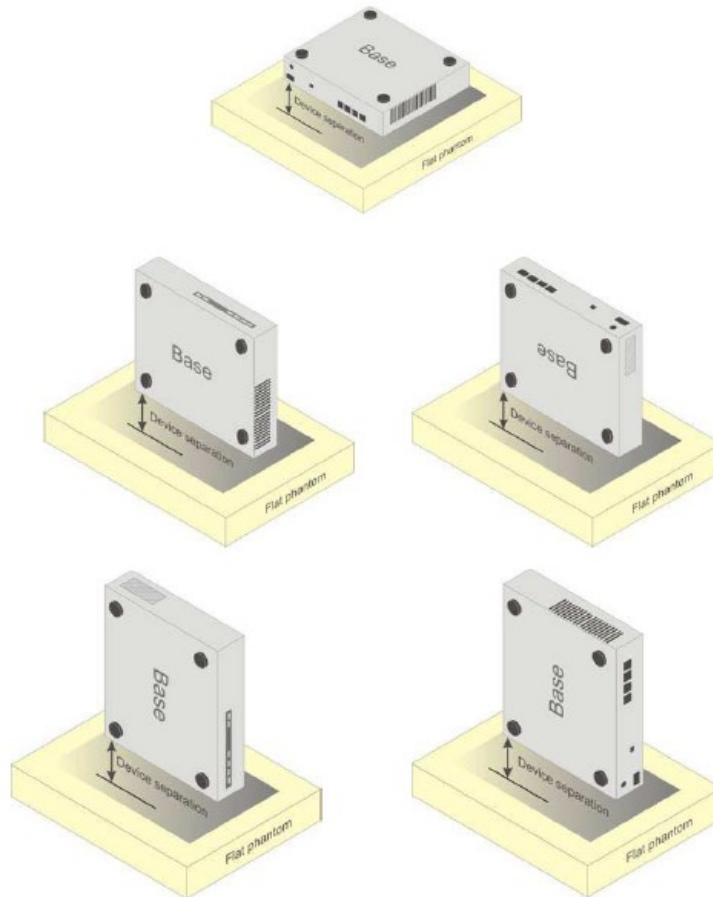

Picture D.5 Test positions for desktop devices

D.4 DUT Setup Photos

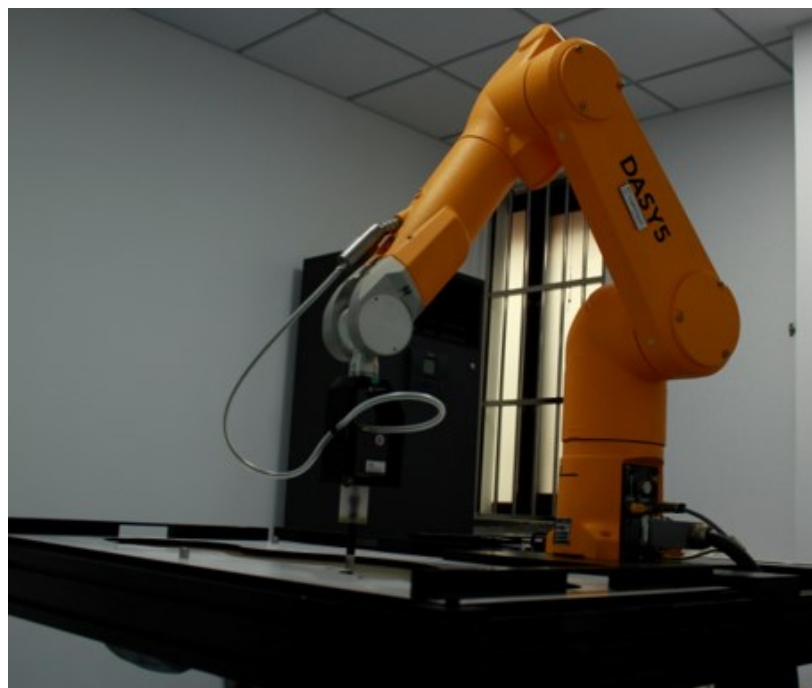

Picture D.6

ANNEX E Equivalent Media Recipes

The liquid used for the frequency range of 800-3000 MHz consisted of water, sugar, salt, preventol, glycol monobutyl and Cellulose. The liquid has been previously proven to be suited for worst-case. The Table E.1 shows the detail solution. It's satisfying the latest tissue dielectric parameters requirements proposed by the IEEE 1528 and IEC 62209.

TableE.1: Composition of the Tissue Equivalent Matter

Frequency (MHz)	835Head	835Body	1900 Head	1900 Body	2450 Head	2450 Body	5800 Head	5800 Body
Ingredients (% by weight)								
Water	41.45	52.5	55.242	69.91	58.79	72.60	65.53	65.53
Sugar	56.0	45.0	\	\	\	\	\	\
Salt	1.45	1.4	0.306	0.13	0.06	0.18	\	\
Preventol	0.1	0.1	\	\	\	\	\	\
Cellulose	1.0	1.0	\	\	\	\	\	\
Glycol Monobutyl	\	\	44.452	29.96	41.15	27.22	\	\
Diethylenglycol monohexylether	\	\	\	\	\	\	17.24	17.24
Triton X-100	\	\	\	\	\	\	17.24	17.24
Dielectric Parameters Target Value	$\epsilon=41.5$ $\sigma=0.90$	$\epsilon=55.2$ $\sigma=0.97$	$\epsilon=40.0$ $\sigma=1.40$	$\epsilon=53.3$ $\sigma=1.52$	$\epsilon=39.2$ $\sigma=1.80$	$\epsilon=52.7$ $\sigma=1.95$	$\epsilon=35.3$ $\sigma=5.27$	$\epsilon=48.2$ $\sigma=6.00$

Note: There are a little adjustment respectively for 750, 1750, 2600, 5200, 5300 and 5600 based on the recipe of closest frequency in table E.1.