

Schematic diagram

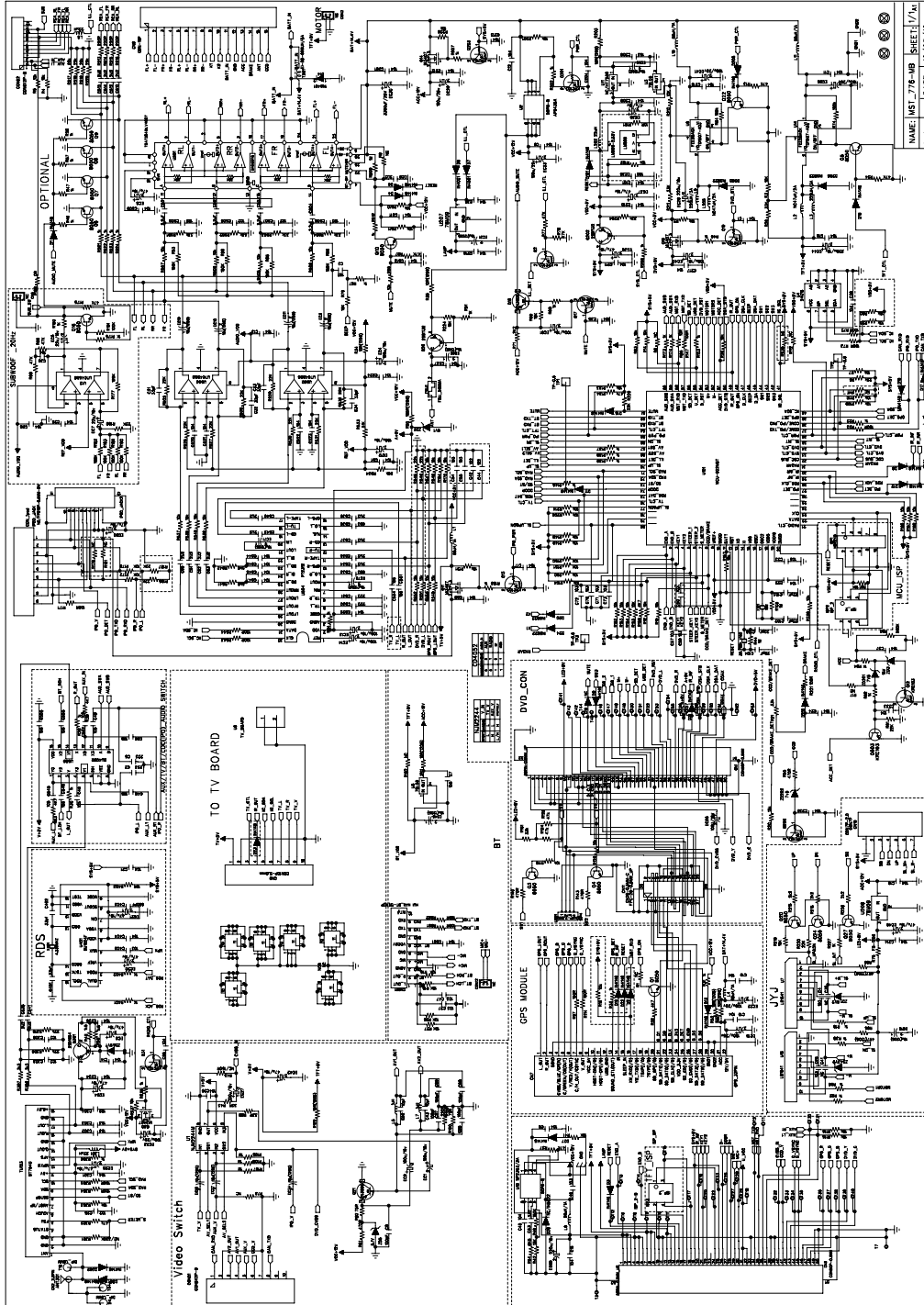

2DIN + SL_6.2" & 7.0"

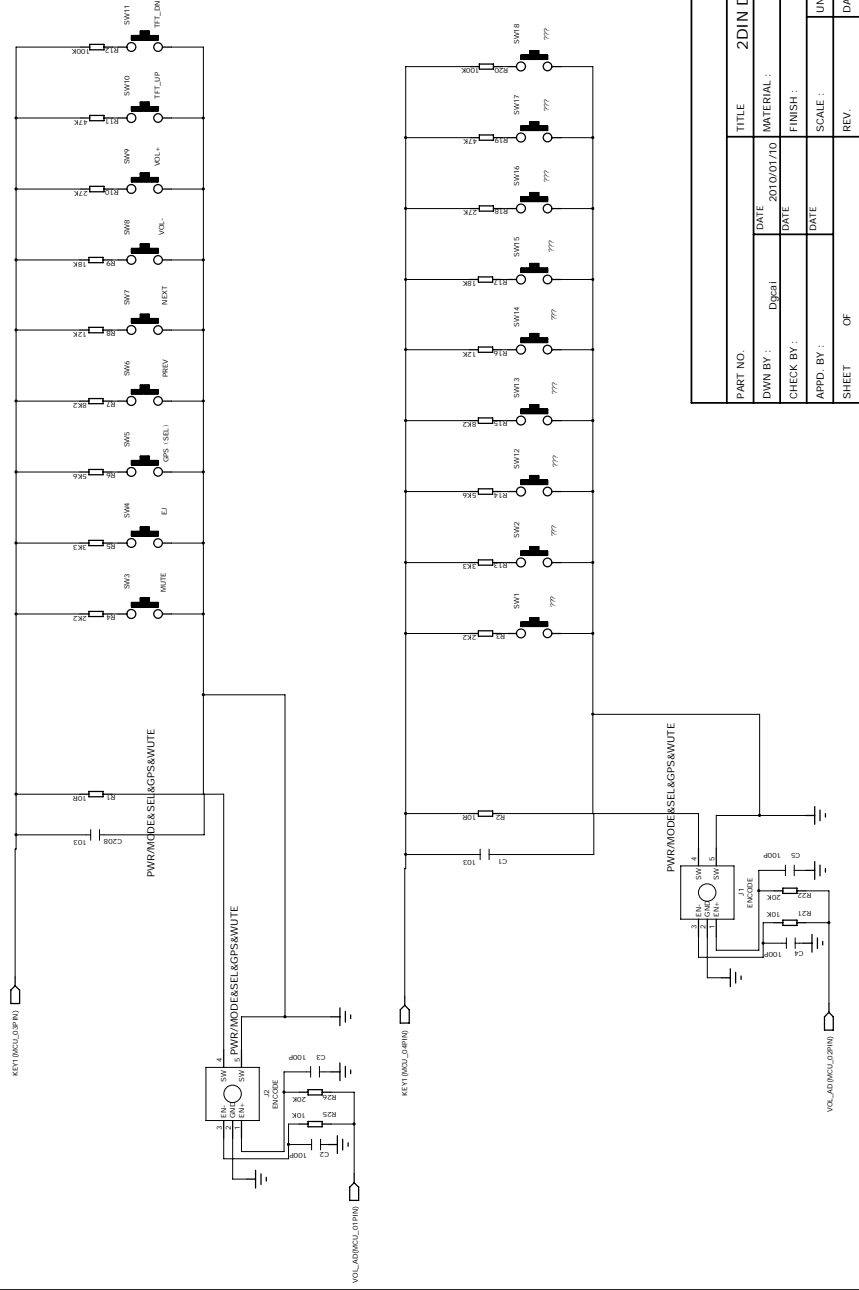

PART NO.	TITLE			
DWV BY : Digei	DATE	2DIN DVD MAIN_SCH		MATERIAL :
CHECK BY :	DATE	2010/01/10	FINISH :	
APPD. BY :	DATE		SCALE :	
SHEET	OF	UNIT :	DATE :	2010/01/10
		REV :		

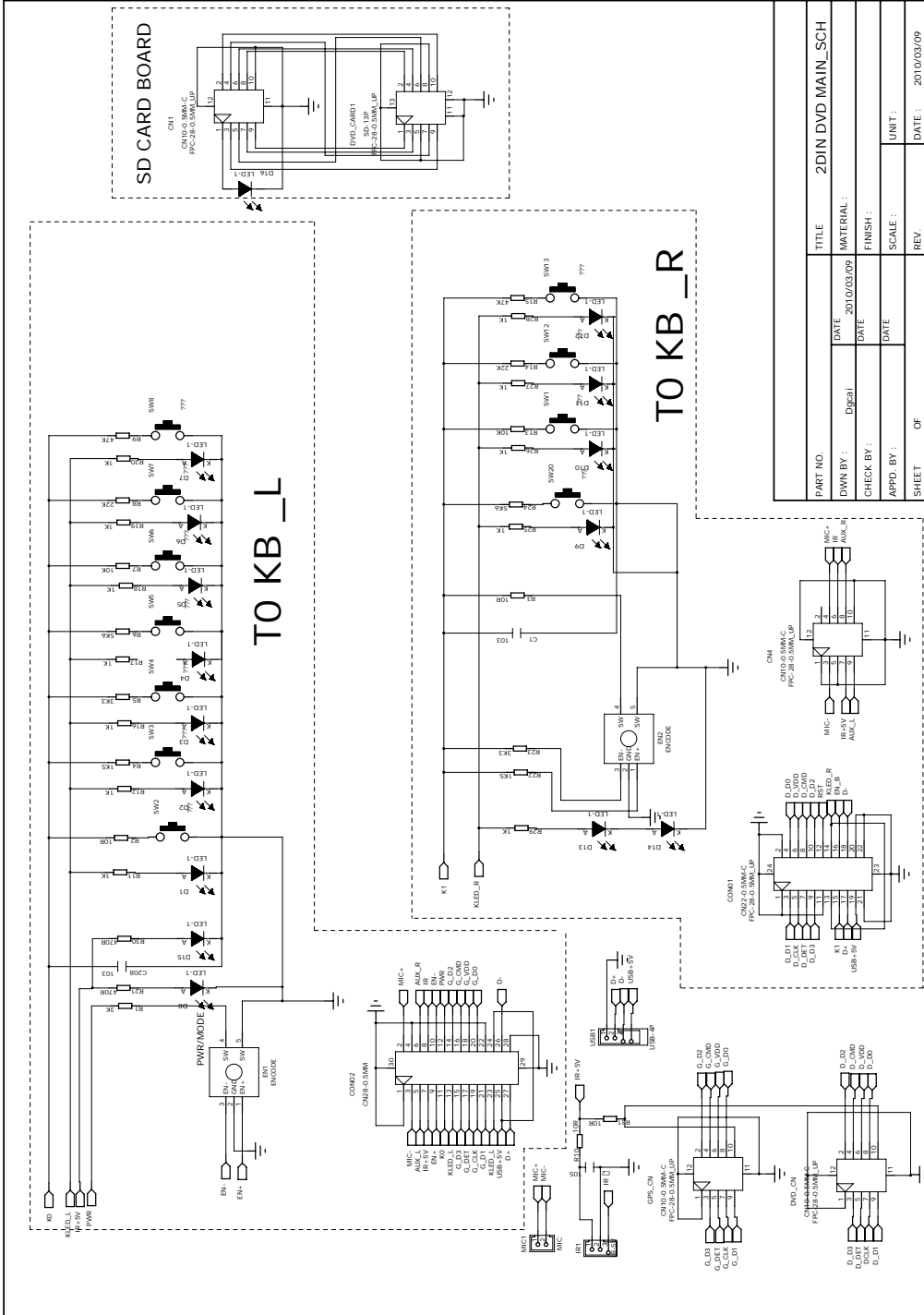

PART NO.	TITLE	2DIN DVD MAIN_SCH
DWN BY:	DATE	2010/03/09
CHECK BY:	DATE	
APPD. BY:	DATE	
SHEET	OF	
UNIT:	REV.	2010/03/09

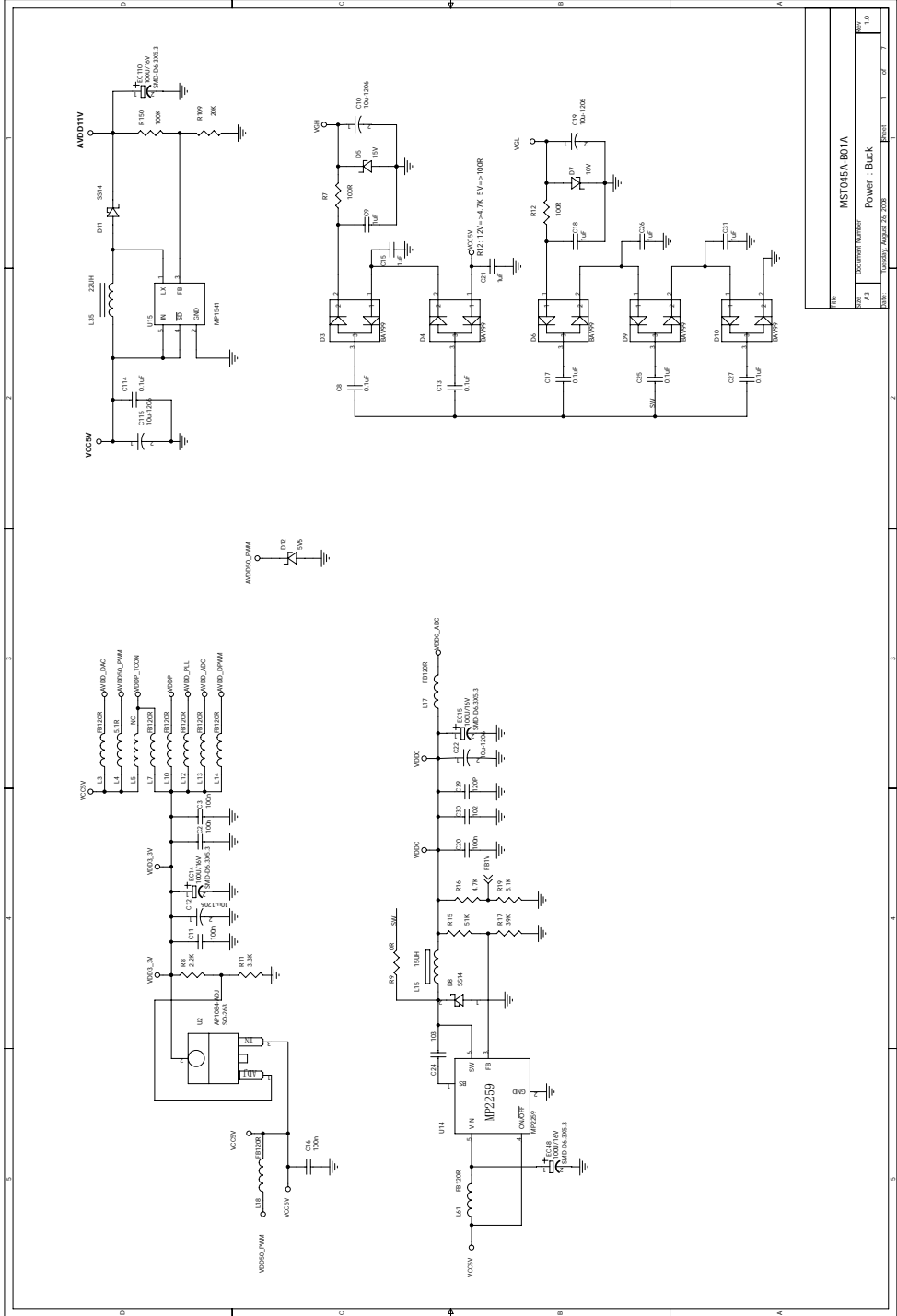

REV	MST045A-B01A	
REV	DESCRIPTION	DATE
A1	Power : Buck	02/2008
B3	1000000_000000_000000	02/2008
REV	1.0	02/2008

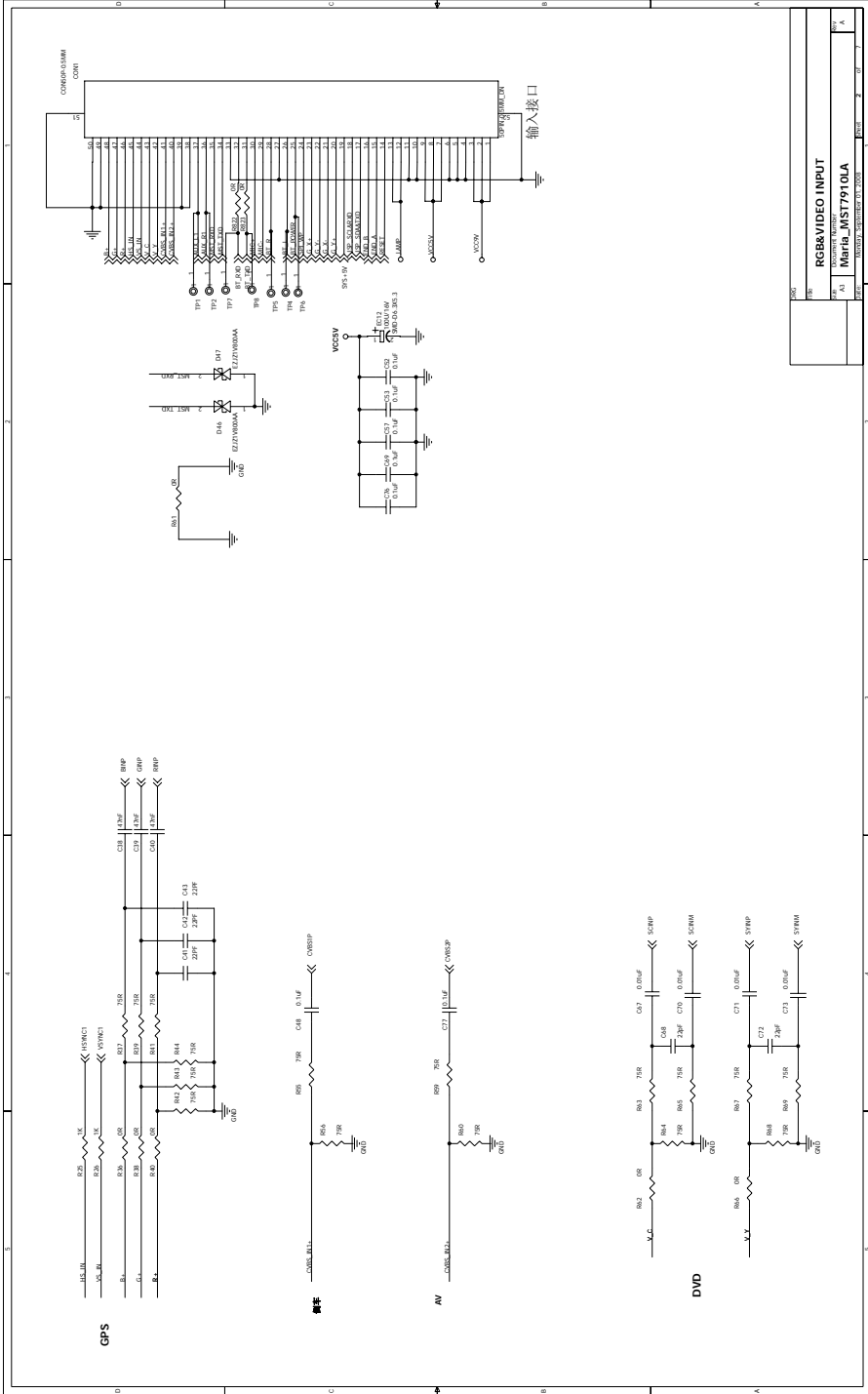

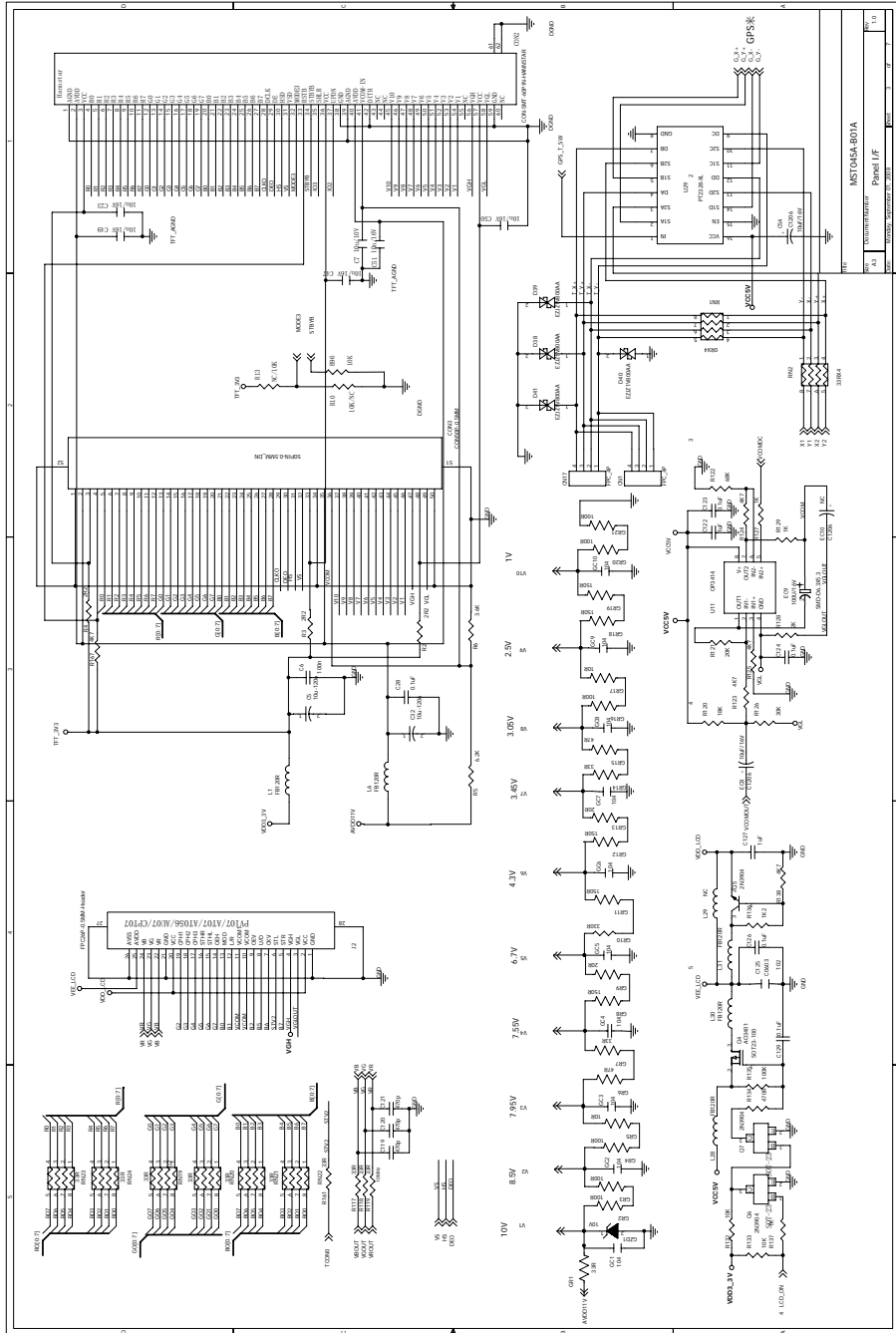

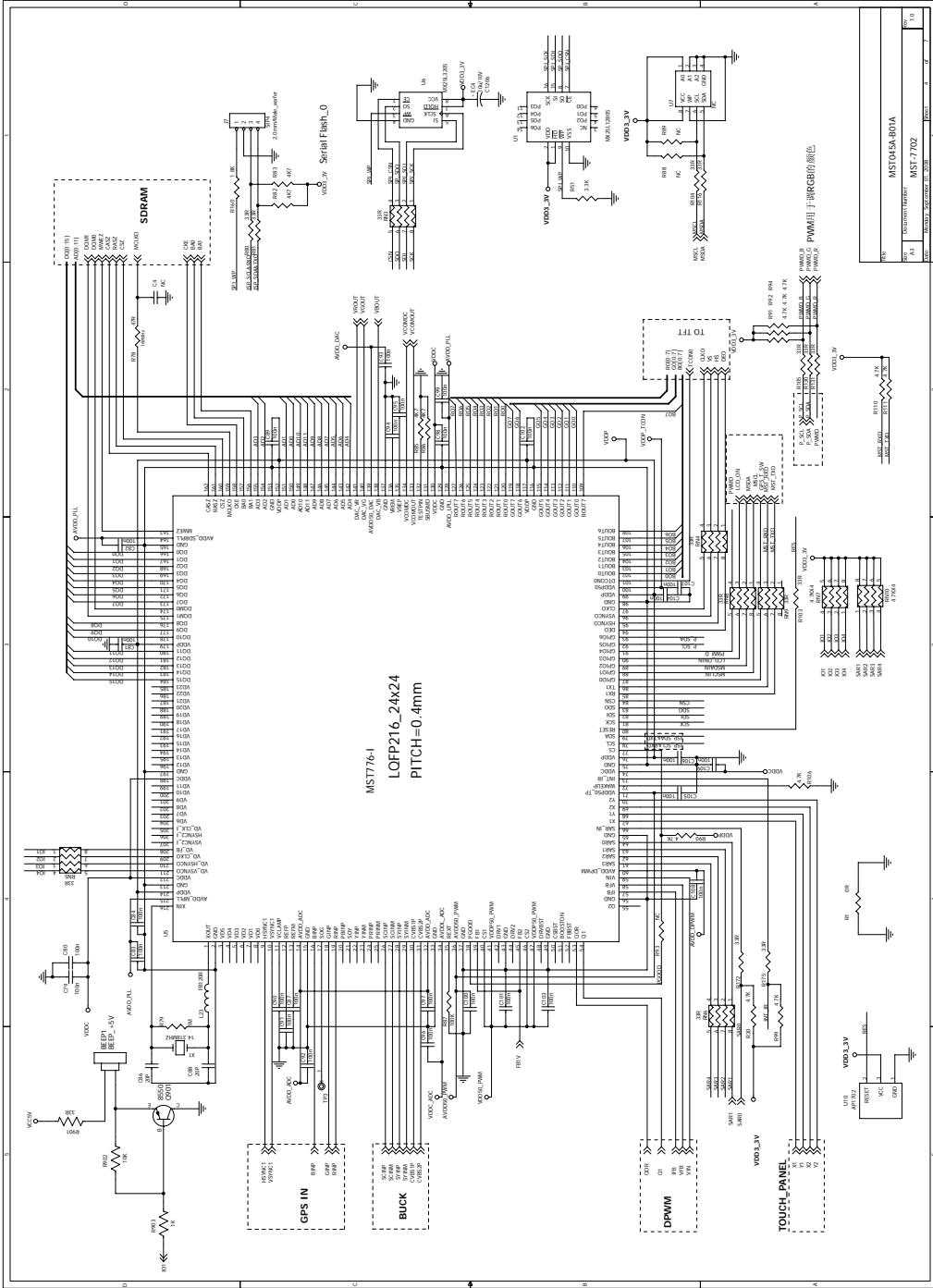

SDRAM

SerialFlash_0

GPS IN

BUCK

DPWM

TOUCH_PANEL

VIBO_LV

VIBO_LV

VIBO_LV

VIBO_LV

VIBO_LV

VIBO_LV

VIBO_LV

VIBO_LV

VIBO_LV

VIBO_LV

VIBO_LV

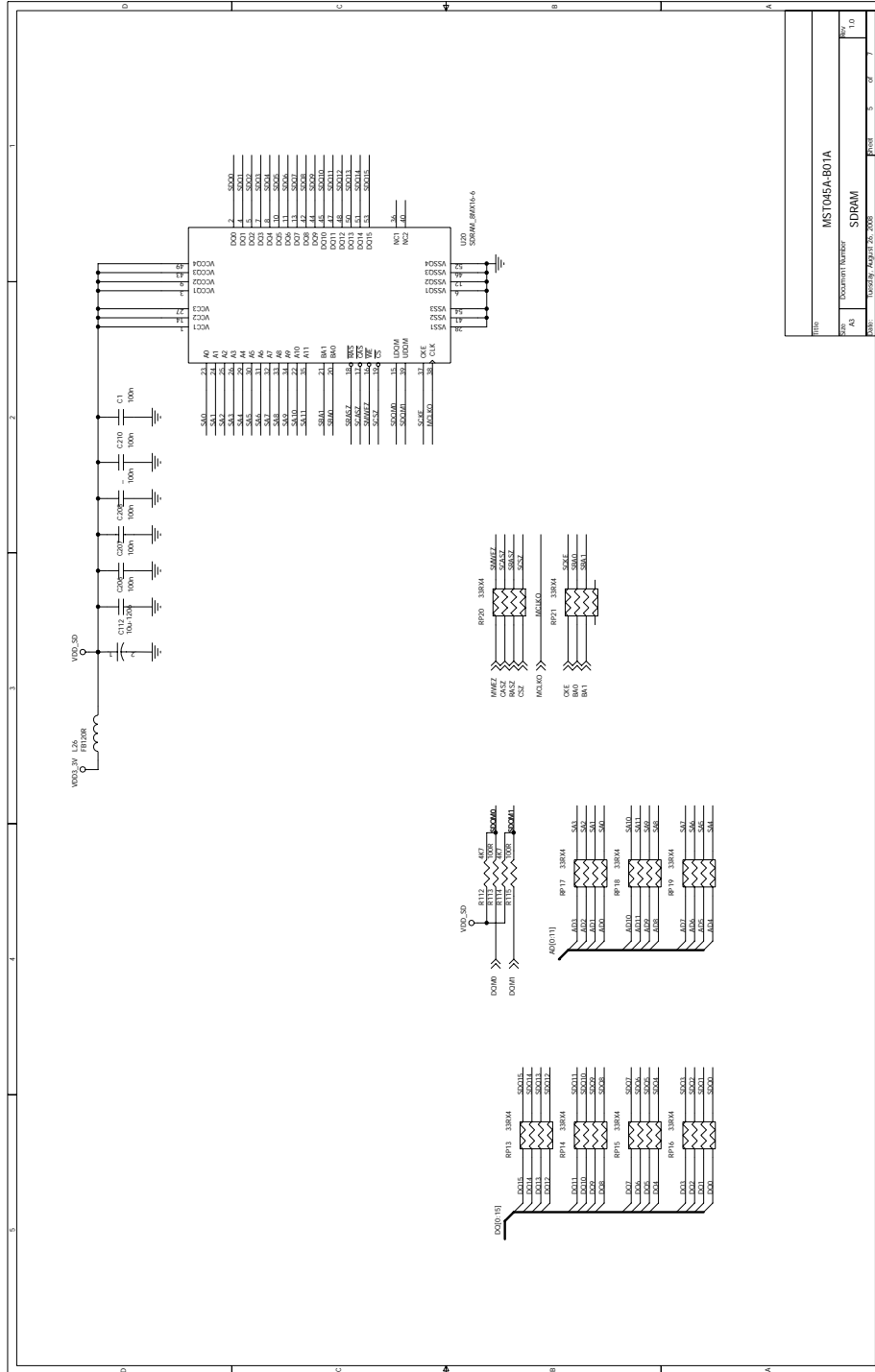

Title: MSTO6EA-B01A
 Docu: Docu: MSTO6EA-B01A
 Rev: 1.0
 Date: 2005.08.18
 File: MSTO6EA-B01A.dwg

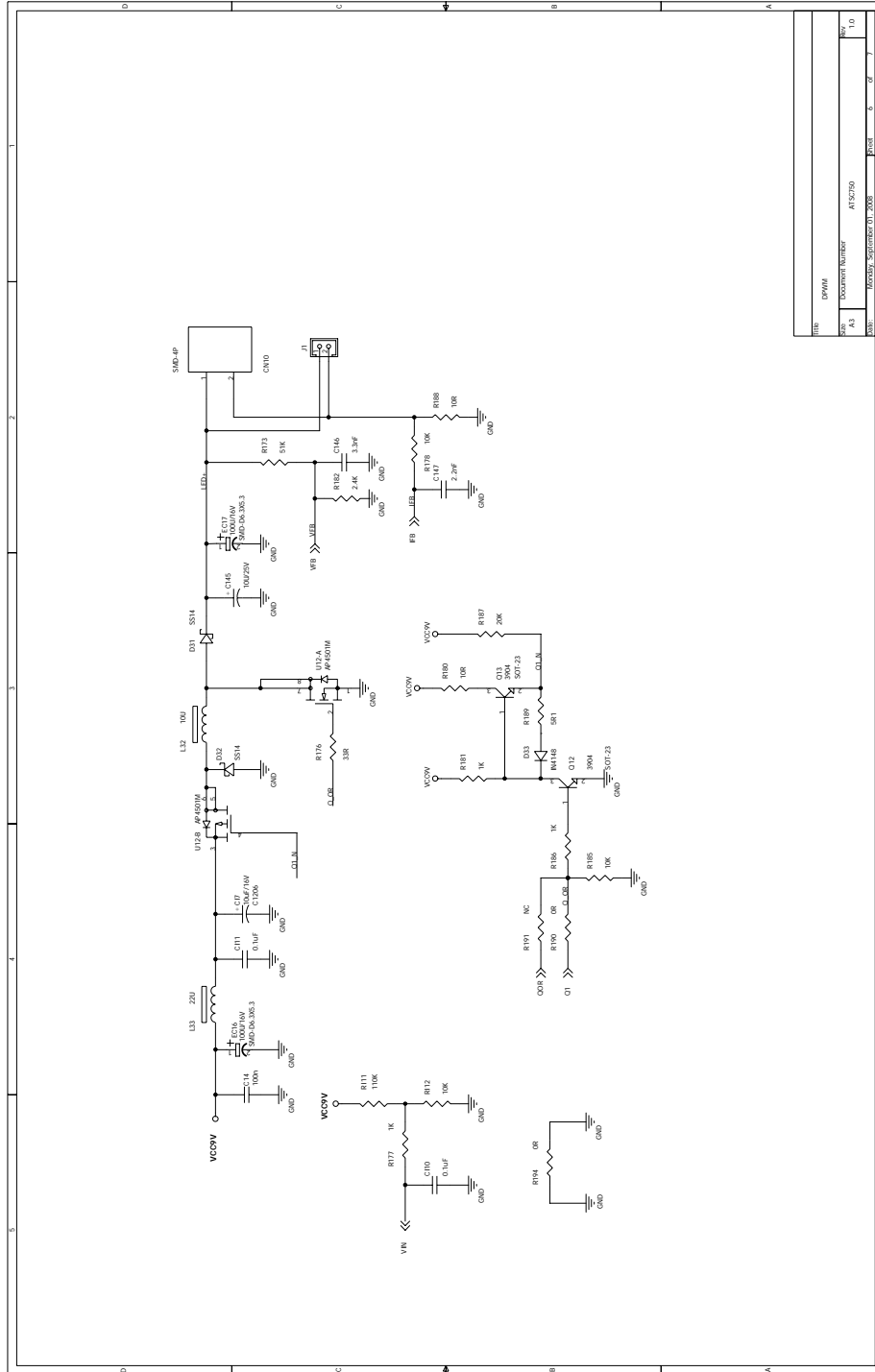

REV	DPW/M						
DATE	10/20/2018	PROJECT NUMBER	AT52750				
DESIGNER	A3	DATE	10/20/2018				
APP'D		WORKING SCHEMATIC (Y/N)	YES				
		REV	1.0				
		REV	1				
		REV	2				
		REV	3				
		REV	4				
		REV	5				
		REV	6				
		REV	7				

2DIN_ 固定面板按键 (右边)

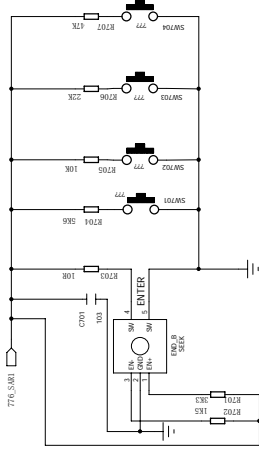

2DIN_ 固定面板按键 (左边)

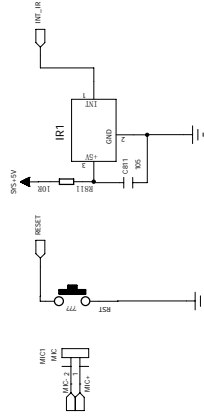
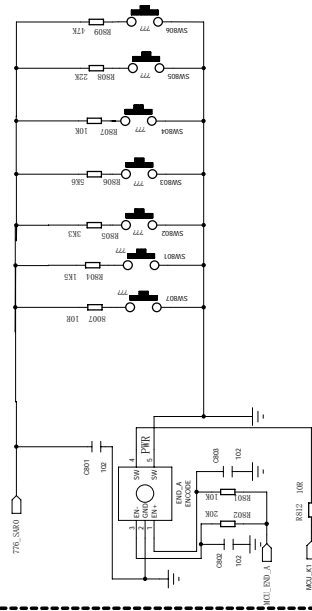

PART NO.		TITLE	
DWN BY : Drccl		2DIN DVD TFT_SCH	
CHECK BY :	DATE	MATERIAL :	
APPD. BY :	DATE	FINISH :	
SHEET	OF	SCALE :	UNIT :
01		REV. 01	DATE : 2009/04/10

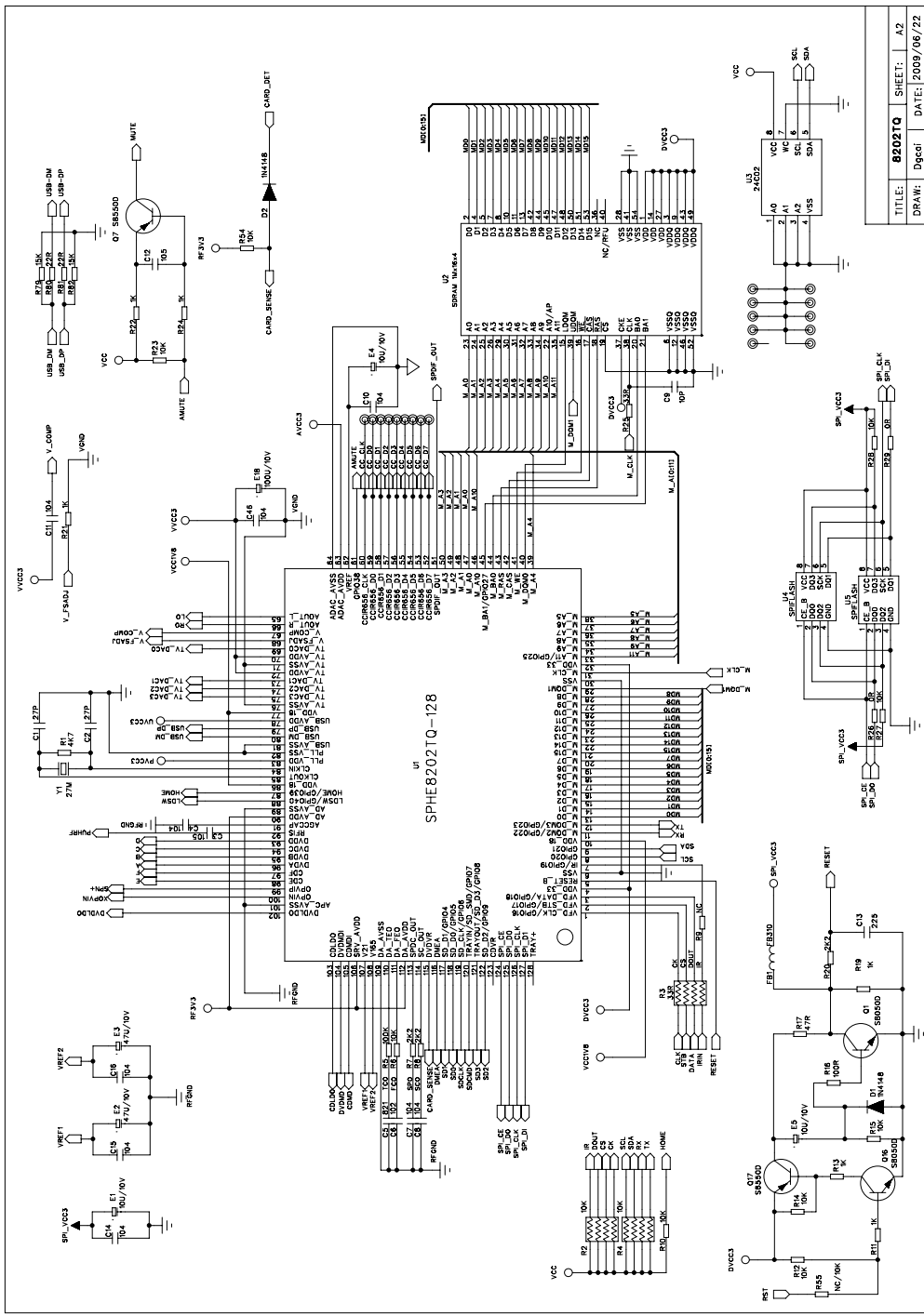

TITLE:	8202TQ	SHEET:	A2
DRAW:	Dgcal	DATE:	2009/06/22

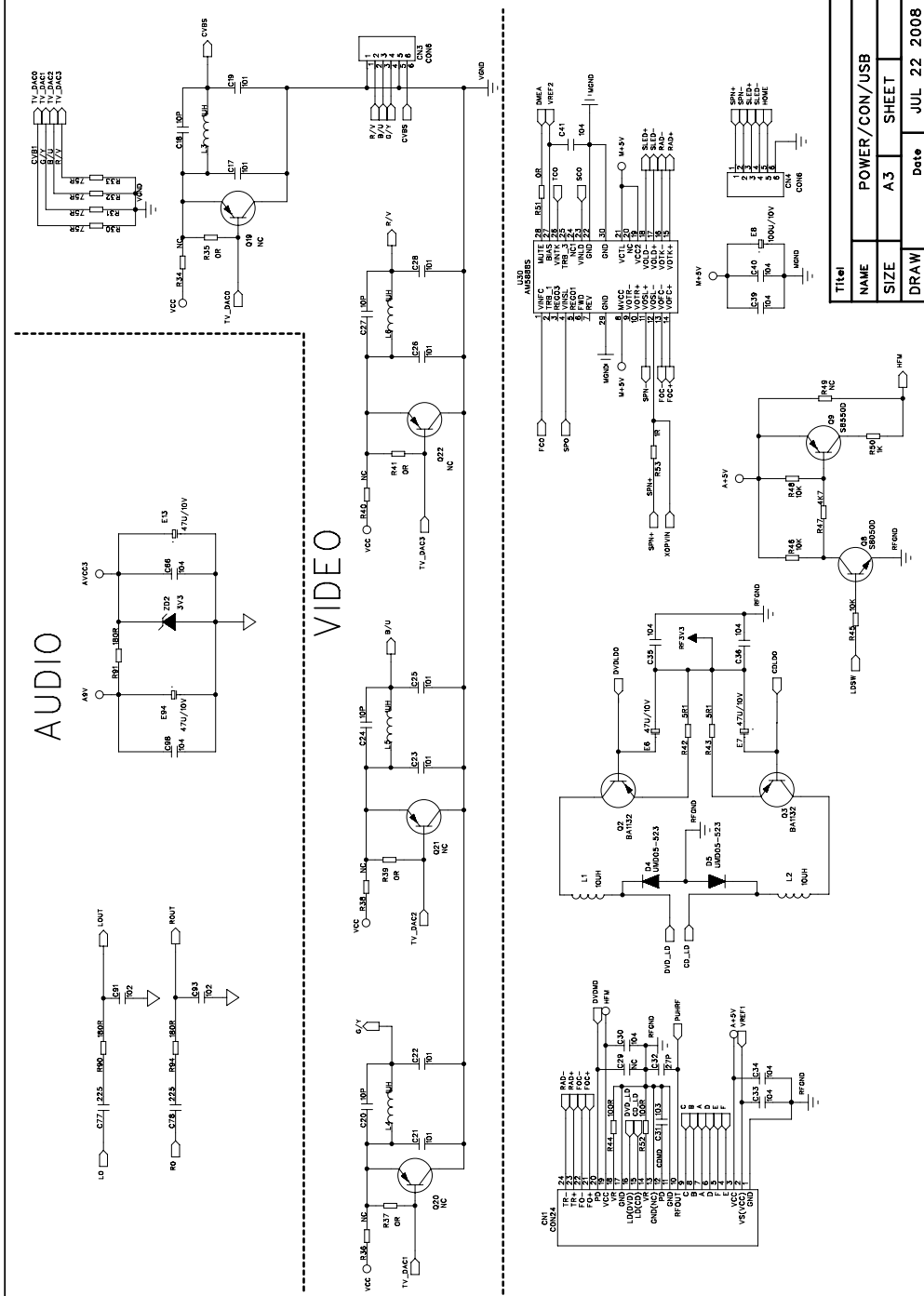

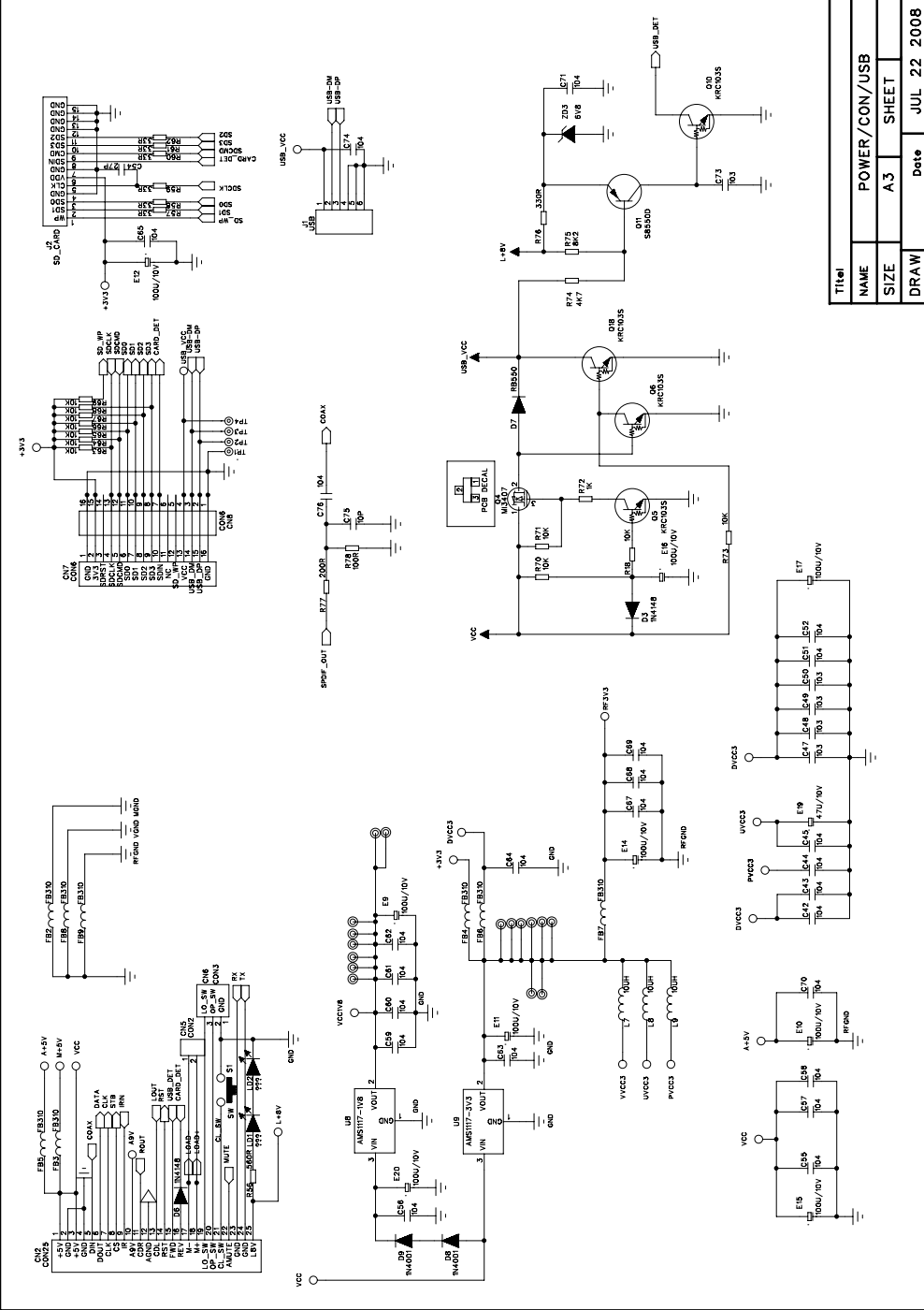

Title	
NAME	POWER/CON/USB
SIZE	A3
DRAW	SHEET
Date	JUL 22 2008

TV TUNER

