

FCC TEST REPORT (BLUETOOTH)

Report No.: RF150915W002-1

FCC ID: YCNA2010L36

Test Model: Lenovo A2010I36

Received Date: Sep. 15, 2015

Test Date: Sep. 16, 2015 ~ Oct. 12, 2015

Issued Date: Oct. 13, 2015

Applicant: Lenovo Mobile Communication Technology Ltd.

Address: No.999, Qishan North 2nd Road, Information & Optoelectronics Park, Torch Hi-tech Industry Development Zone, Xiamen, P.R. China

Issued By: Bureau Veritas Consumer Products Services (H.K.) Ltd., Taoyuan Branch

Lab Address: No. 47-2, 14th Ling, Chia Cau Vil., Lin Kou Dist., New Taipei City, Taiwan (R.O.C.)

Test Location: No. 19, Hwa Ya 2nd Rd., Wen Hwa Tsuen, Kwei Shan Hsiang, Taoyuan Hsien 333, Taiwan, R.O.C.

This report should not be used by the client to claim product certification, approval, or endorsement by TAF or any government agencies.



This report is for your exclusive use. Any copying or replication of this report to or for any other person or entity, or use of our name or trademark, is permitted only with our prior written permission. This report sets forth our findings solely with respect to the test samples identified herein. The results set forth in this report are not indicative or representative of the quality or characteristics of the lot from which a test sample was taken or any similar or identical product specifically and expressly noted. Our report includes all of the tests requested by you and the results thereof based upon the information that you provided to us. You have 60 days from date of issuance of this report to notify us of any material error or omission caused by our negligence, provided, however, that such notice shall be in writing and shall specifically address the issue you wish to raise. A failure to raise such issue within the prescribed time shall constitute your unqualified acceptance of the completeness of this report, the tests conducted and the correctness of the report contents. Unless specific mention, the uncertainty of measurement has been explicitly taken into account to declare the compliance or non-compliance to the specification. The report must not be used by the client to claim product certification, approval, or endorsement by TAF or any government agencies.

TABLE OF CONTENTS

RELEASE CONTROL RECORD	5
1 Certificate of Conformity.....	6
2 Summary of Test Results	7
2.1 Measurement Uncertainty	8
3 General Information.....	9
3.1 General Description of EUT	9
3.2 Description of Test Modes.....	10
3.2.1 Test Mode Applicability and Tested Channel Detail.....	11
3.3 Description of Support Units	14
3.3.1 Configuration of System under Test	14
3.4 General Description of Applied Standards	14
4 Test Types and Results(For BT EDR)	15
4.1 Radiated Emission and Bandedge Measurement.....	15
4.1.1 Limits of Radiated Emission and Bandedge Measurement	15
4.1.2 Test Instruments	16
4.1.3 Test Procedures.....	17
4.1.4 Deviation from Test Standard	17
4.1.5 Test Set Up	18
4.1.6 EUT Operating Conditions.....	19
4.1.7 Test Results	19
4.2 Conducted Emission Measurement	27
4.2.1 Limits of Conducted Emission Measurement.....	27
4.2.2 Test Instruments	27
4.2.3 Test Procedures.....	28
4.2.4 Deviation From Test Standard	28
4.2.5 Test Setup.....	28
4.2.6 EUT Operating Condition	28
4.2.7 Test Results	29
4.3 Number of Hopping Frequency Used.....	31
4.3.1 Limits of Hopping Frequency Used Measurement	31
4.3.2 Test Setup.....	31
4.3.3 Test Instruments	31
4.3.4 Test Procedure	31
4.3.5 Deviation from Test Standard	31
4.3.6 Test Results	32
4.4 Dwell Time on Each Channel	33
4.4.1 Limits of Dwell Time on Each Channel Measurement.....	33
4.4.2 Test Setup.....	33
4.4.3 Test Instruments	33
4.4.4 Test Procedures.....	33
4.4.5 Deviation from Test Standard	33
4.4.6 Test Results	34
4.5 Channel Bandwidth	36
4.5.1 Limits of Channel Bandwidth Measurement.....	36
4.5.2 Test Setup.....	36
4.5.3 Test Instruments	36
4.5.4 Test Procedure	36
4.5.5 Deviation from Test Standard	36
4.5.6 EUT Operating Condition	36
4.5.7 Test Results	37
4.6 Hopping Channel Separation	38
4.6.1 Limits of Hopping Channel Separation Measurement.....	38
4.6.2 Test Setup.....	38

4.6.3	Test Instruments	38
4.6.4	Test Procedure	38
4.6.5	Deviation From Test Standard	38
4.6.6	Test Results	39
4.7	Maximum Output Power	41
4.7.1	Limits of Maximum Output Power Measurement	41
4.7.2	Test Setup	41
4.7.3	Test Instruments	41
4.7.4	Test Procedure	41
4.7.5	Deviation fromTest Standard	41
4.7.6	EUT Operating Condition	41
4.7.7	Test Results	42
4.8	Conducted Out of Band Emission Measurement	43
4.8.1	Limits Of Conducted Out Of Band Emission Measurement	43
4.8.2	Test Instruments	43
4.8.3	Test Procedure	43
4.8.4	Deviation From Test Standard	43
4.8.5	Eut Operating Condition	43
4.8.6	Test Results	43
5	Test Types and Results(For BT LE 4.0)	46
5.1	Radiated Emission and Bandedge Measurement	46
5.1.1	Limits of Radiated Emission and Bandedge Measurement	46
5.1.2	Test Instruments	46
5.1.3	Test Procedures	47
5.1.4	Deviation from Test Standard	47
5.1.5	Test Set Up	48
5.1.6	EUT Operating Conditions	48
5.1.7	Test Results	49
5.2	Conducted Emission Measurement	54
5.2.1	Limits of Conducted Emission Measurement	54
5.2.2	Test Instruments	54
5.2.3	Test Procedures	54
5.2.4	Deviation from Test Standard	54
5.2.5	TEST SETUP	54
5.2.6	EUT Operating Conditions	54
5.2.7	Test Results	54
5.3	6dB Bandwidth Measurement	55
5.3.1	Limits of 6dB Bandwidth Measurement	55
5.3.2	Test Setup	55
5.3.3	Test Instruments	55
5.3.4	Test Procedure	55
5.3.5	Deviation fromTest Standard	55
5.3.6	EUT Operating Conditions	55
5.3.7	Test Result	56
5.4	Conducted Output Power Measurement	57
5.4.1	Limits OF Conducted Output Power Measurement	57
5.4.2	Test Setup	57
5.4.3	Test Instruments	57
5.4.4	Test Procedures	57
5.4.5	Deviation from Test Standard	57
5.4.6	EUT Operating Conditions	57
5.4.7	Test Results	57
5.5	Power Spectral Density Measurement	58
5.5.1	Limits of Power Spectral Density Measurement	58
5.5.2	Test Setup	58
5.5.3	Test Instruments	58
5.5.4	Test Procedure	58



5.5.5	Deviation from Test Standard	58
5.5.6	EUT Operating Condition	58
5.5.7	Test Results	59
5.6	Conducted Out of Band Emission Measurement	60
5.6.1	Limits of Conducted Out of Band Emission Measurement.....	60
5.6.2	Test Setup.....	60
5.6.3	Test Instruments	60
5.6.4	Test Procedure	60
5.6.5	Deviation from Test Standard	60
5.6.6	EUT Operating Condition	60
5.6.7	TEST RESULTS	61
6	Pictures of Test Arrangements.....	62
	Appendix – Information on the Testing Laboratories	63



RELEASE CONTROL RECORD

ISSUE NO.	REASON FOR CHANGE	DATE ISSUED
RF150915W002-1	Original release	Oct. 13, 2015

1 Certificate of Conformity

Product: Lenovo Mobile Phone
Brand: Lenovo
Test Model: Lenovo A2010I36
Sample Status: Production unit
Applicant: Lenovo Mobile Communication Technology Ltd.
Test Date: Sep. 16, 2015 ~ Oct. 12, 2015
Standards: FCC Part 15, Subpart C (Section 15.247)
ANSI C63.10: 2013

The above equipment has been tested by **Bureau Veritas Consumer Products Services (H.K.) Ltd., Taoyuan Branch**, and found compliance with the requirement of the above standards. The test record, data evaluation & Equipment Under Test (EUT) configurations represented herein are true and accurate accounts of the measurements of the sample's EMC characteristics under the conditions specified in this report.

Prepared by : , **Date:** Oct. 13, 2015
Amyee Qian / Engineer

Approved by : , **Date:** Oct. 13, 2015
William Chung / Manager

2 Summary of Test Results

FCC Part 15, Subpart C (SECTION 15.247) (BT EDR)			
FCC Clause	Test Item	Result	Remarks
15.207	AC Power Conducted Emission	PASS	Meet the requirement of limit. Minimum passing margin is -12.40dB at 0.396000MHz.
15.247(a)(1)(iii)	Number of Hopping Frequency Used	PASS	Meet the requirement of limit.
15.247(a)(1)(iii)	Dwell Time on Each Channel	PASS	Meet the requirement of limit.
15.247(a)(1)	1. Hopping Channel Separation 2. Spectrum Bandwidth of a Frequency Hopping Sequence Spread Spectrum System	PASS	Meet the requirement of limit.
15.247(b)	Maximum Peak Output Power	PASS	Meet the requirement of limit.
15.205 & 209	Radiated Emissions	PASS	Meet the requirement of limit. Minimum passing margin is -1.9dB at 4804.00MHz.
15.247(d)	Band Edge Measurement	PASS	Meet the requirement of limit.
15.203	Antenna Requirement	PASS	No antenna connector is used.

NOTE: If The Frequency Hopping System operating in 2400-2483.5MHz band and the output power less than 125mW. The hopping channel carrier frequencies separated by a minimum of 25kHz or two-thirds of the 20dB bandwidth of hopping channel whichever is greater.

FCC Part 15, Subpart C (SECTION 15.247) (BT LE 4.0)			
FCC Clause	Test Item	Result	Remarks
15.207	AC Power Conducted Emission	PASS	Meet the requirement of limit. Minimum passing margin is -12.40dB at 0.396000MHz.
15.205 & 209	Radiated Emissions	PASS	Meet the requirement of limit. Minimum passing margin is -7.2dB at 30.00MHz.
15.247(d)	Band Edge Measurement	PASS	Meet the requirement of limit.
15.247(d)	Antenna Port Emission	PASS	Meet the requirement of limit.
15.247(a)(2)	6dB bandwidth	PASS	Meet the requirement of limit.
15.247(b)	Conducted power	PASS	Meet the requirement of limit.
15.247(e)	Power Spectral Density	PASS	Meet the requirement of limit.
15.203	Antenna Requirement	PASS	No antenna connector is used.

2.1 Measurement Uncertainty

Where relevant, the following measurement uncertainty levels have been estimated for tests performed on the EUT as specified in CISPR 16-4-2:

Measurement	Frequency	Expanded Uncertainty (k=2) (±)
Conducted Emissions at mains ports	9kHz ~ 30MHz	2.44 dB
Radiated Emissions up to 1 GHz	30MHz ~ 200MHz	2.93 dB
	200MHz ~ 1000MHz	2.95 dB
Radiated Emissions above 1 GHz	1GHz ~ 18GHz	2.26 dB
	18GHz ~ 40GHz	1.94 dB

This uncertainty represents an expanded uncertainty expressed at approximately the 95% confidence level using a coverage factor of k=2.

3 General Information

3.1 General Description of EUT

Product	Lenovo Mobile Phone	
Brand	Lenovo	
Test Model	Lenovo A2010I36	
Power Supply Rating	5.0Vdc (adapter or host equipment) 3.8Vdc (battery)	
Modulation Technology	BT EDR	FHSS
	BT LE 4.0	DTS
Modulation Type	BT EDR	GFSK, 8DPSK, $\pi/4$ DQPSK
	BT LE 4.0	GFSK
Transfer Rate	BT EDR	1/2/3 Mbps
	BT LE 4.0	1Mbps
Operating Frequency	2402MHz ~ 2480MHz	
Number of Channel	BT EDR	79
	BT LE 4.0	40
Output Power	BT EDR	2.427mW
	BT LE 4.0	0.511mW
Antenna Type	PIFA Antenna with -2.8dBi gain	
Accessory Device	Refer to note as below	
Data Cable Supplied	USB cable: Unshielded, detachable, 0.7m Earphone cable: Unshielded, detachable, 1.3m	

Note:

- The above EUT information is declared by manufacturer and for more detailed features description, please refer to the manufacturer's specifications or User's Manual.
- The EUT was powered by the following adapter:

ADAPTER	
BRAND:	Lenovo
MODEL:	C-P56
INPUT:	AC 100-240V, 0.13A
OUTPUT:	DC 5V, 1.0A
MANUFACTURER:	chenyang

- The EUT matched the following USB Cable and Earphone.

USB CABLE	
BRAND:	lenovo
MODEL:	L16W-05100070L
SIGNAL LINE:	0.7 METER

EARPHONE	
BRAND:	Lenovo
MODEL:	TS990B-28AMS05-M
SIGNAL LINE:	1.3 METER

- For the test results, the EUT had been tested with all conditions. But only the worst case was shown in test report.

3.2 Description of Test Modes

79 channels are provided for BT-EDR mode:

Channel	Freq. (MHz)	Channel	Freq. (MHz)	Channel	Freq. (MHz)	Channel	Freq. (MHz)
0	2402	20	2422	40	2442	60	2462
1	2403	21	2423	41	2443	61	2463
2	2404	22	2424	42	2444	62	2464
3	2405	23	2425	43	2445	63	2465
4	2406	24	2426	44	2446	64	2466
5	2407	25	2427	45	2447	65	2467
6	2408	26	2428	46	2448	66	2468
7	2409	27	2429	47	2449	67	2469
8	2410	28	2430	48	2450	68	2470
9	2411	29	2431	49	2451	69	2471
10	2412	30	2432	50	2452	70	2472
11	2413	31	2433	51	2453	71	2473
12	2414	32	2434	52	2454	72	2474
13	2415	33	2435	53	2455	73	2475
14	2416	34	2436	54	2456	74	2476
15	2417	35	2437	55	2457	75	2477
16	2418	36	2438	56	2458	76	2478
17	2419	37	2439	57	2459	77	2479
18	2420	38	2440	58	2460	78	2480
19	2421	39	2441	59	2461		

40 channels are provided for BT LE 4.0 mode:

CHANNEL	FREQ. (MHz)	CHANNEL	FREQ. (MHz)	CHANNEL	FREQ. (MHz)	CHANNEL	FREQ. (MHz)
0	2402	10	2422	20	2442	30	2462
1	2404	11	2424	21	2444	31	2464
2	2406	12	2426	22	2446	32	2466
3	2408	13	2428	23	2448	33	2468
4	2410	14	2430	24	2450	34	2470
5	2412	15	2432	25	2452	35	2472
6	2414	16	2434	26	2454	36	2474
7	2416	17	2436	27	2456	37	2476
8	2418	18	2438	28	2458	38	2478
9	2420	19	2440	29	2460	39	2480

3.2.1 Test Mode Applicability and Tested Channel Detail

BT EDR

EUT CONFIGURE MODE	APPLICABLE TO				DESCRIPTION
	RE≥1G	RE<1G	PLC	APCM	
-	√	√	√	√	-

Where **RE≥1G**: Radiated Emission above 1GHz **RE<1G**: Radiated Emission below 1GHz
PLC: Power Line Conducted Emission **APCM**: Antenna Port Conducted Measurement

NOTE:

1. The EUT had been pre-tested on the positioned of each 3 axis. The worst case was found when positioned on **X-plane**.
2. "-" means no effect.

Radiated Emission Test (Above 1GHz):

- Pre-Scan has been conducted to determine the worst-case mode from all possible combinations between available modulations, data rates and antenna ports (if EUT with antenna diversity architecture).
- Following channel(s) was (were) selected for the final test as listed below.

EUT CONFIGURE MODE	AVAILABLE CHANNEL	TESTED CHANNEL	MODULATION TECHNOLOGY	MODULATION TYPE	PACKET TYPE
-	0 to 78	0, 39, 78	FHSS	GFSK	DH5

Radiated Emission Test (Below 1GHz):

- Pre-Scan has been conducted to determine the worst-case mode from all possible combinations between available modulations, data rates and antenna ports (if EUT with antenna diversity architecture).
- Following channel(s) was (were) selected for the final test as listed below.

EUT CONFIGURE MODE	AVAILABLE CHANNEL	TESTED CHANNEL	MODULATION TECHNOLOGY	MODULATION TYPE	PACKET TYPE
-	0 to 78	78	FHSS	GFSK	DH5

Power Line Conducted Emission Test:

- Pre-Scan has been conducted to determine the worst-case mode from all possible combinations between available modulations, data rates and antenna ports (if EUT with antenna diversity architecture).
- Following channel(s) was (were) selected for the final test as listed below.

EUT CONFIGURE MODE	AVAILABLE CHANNEL	TESTED CHANNEL	MODULATION TECHNOLOGY	MODULATION TYPE	PACKET TYPE
-	0 to 78	78	FHSS	8DPSK	DH5

Antenna Port Conducted Measurement:

- This item includes all test value of each mode, but only includes spectrum plot of worst value of each mode.
- Pre-Scan has been conducted to determine the worst-case mode from all possible combinations between available modulations, data rates and antenna ports (if EUT with antenna diversity architecture).
- Following channel(s) was (were) selected for the final test as listed below.

EUT CONFIGURE MODE	AVAILABLE CHANNEL	TESTED CHANNEL	MODULATION TECHNOLOGY	MODULATION TYPE	PACKET TYPE
-	0 to 78	0, 39, 78	FHSS	GFSK	DH5
-	0 to 78	0, 39, 78	FHSS	8DPSK	DH5

Test Condition:

APPLICABLE TO	ENVIRONMENTAL CONDITIONS	INPUT POWER	TESTED BY
RE≥1G	25deg. C, 65%RH	120Vac, 60Hz	Chris Lin
RE<1G	25deg. C, 65%RH	120Vac, 60Hz	Chris Lin
PLC	25deg. C, 68%RH	120Vac, 60Hz	Sun Lin
APCM	21deg. C, 60%RH	120Vac, 60Hz	Nick Chen

BT LE 4.0

EUT CONFIGURE MODE	APPLICABLE TO				DESCRIPTION
	RE≥1G	RE<1G	PLC	APCM	
-	√	√	√	√	-

Where **RE≥1G:** Radiated Emission above 1GHz **RE<1G:** Radiated Emission below 1GHz
PLC: Power Line Conducted Emission **APCM:** Antenna Port Conducted Measurement

NOTE: The EUT had been pre-tested on the positioned of each 3 axis. The worst case was found when positioned on **Y-plane**.

NOTE: "-" means no effect.

Radiated Emission Test (Above 1GHz):

- Pre-Scan has been conducted to determine the worst-case mode from all possible combinations between available modulations, data rates and antenna ports (if EUT with antenna diversity architecture).
- Following channel(s) was (were) selected for the final test as listed below.

EUT CONFIGURE MODE	AVAILABLE CHANNEL	TESTED CHANNEL	MODULATION TYPE	DATA RATE (Mbps)
-	0 to 39	0, 19, 39	GFSK	1

Radiated Emission Test (Below 1GHz):

- Pre-Scan has been conducted to determine the worst-case mode from all possible combinations between available modulations, data rates and antenna ports (if EUT with antenna diversity architecture).
- Following channel(s) was (were) selected for the final test as listed below.

EUT CONFIGUURE MODE	AVAILABLE CHANNEL	TESTED CHANNEL	MODULATION TYPE	DATA RATE (Mbps)
-	0 to 39	0	GFSK	1

Power Line Conducted Emission Test:

- Pre-Scan has been conducted to determine the worst-case mode from all possible combinations between available modulations, data rates and antenna ports (if EUT with antenna diversity architecture).
- Following channel(s) was (were) selected for the final test as listed below.

EUT CONFIGUURE MODE	AVAILABLE CHANNEL	TESTED CHANNEL	MODULATION TYPE	DATA RATE (Mbps)
-	0 to 39	0	GFSK	1

Antenna Port Conducted Measurement:

- This item includes all test value of each mode, but only includes spectrum plot of worst value of each mode.
- Pre-Scan has been conducted to determine the worst-case mode from all possible combinations between available modulations, data rates and antenna ports (if EUT with antenna diversity architecture).
- Following channel(s) was (were) selected for the final test as listed below.

EUT CONFIGUURE MODE	AVAILABLE CHANNEL	TESTED CHANNEL	MODULATION TYPE	DATA RATE (Mbps)
-	0 to 39	0, 19, 39	GFSK	1

Test Condition:

APPLICABLE TO	ENVIRONMENTAL CONDITIONS	INPUT POWER	TESTED BY
RE≥1G	25deg. C, 65%RH	120Vac, 60Hz	Chris Lin
RE<1G	25deg. C, 65%RH	120Vac, 60Hz	Chris Lin
PLC	25deg. C, 68%RH	120Vac, 60Hz	Sun Lin
APCM	21deg. C, 60%RH	120Vac, 60Hz	Nick Chen

3.3 Description of Support Units

The EUT has been tested as an independent unit together with other necessary accessories or support units. The following support units or accessories were used to form a representative test configuration during the tests.

NO.	PRODUCT	BRAND	MODEL NO.	SERIAL NO.	FCC ID
1	DC source	LONG WEI	PS-6403D	010934269	N/A
2	PC	HP	A6608CN	3CR83825X3	N/A

NO.	SIGNAL CABLE DESCRIPTION OF THE ABOVE SUPPORT UNITS
1	DC Line: Unshielded, Detachable 1.0m
2	AC Line: Unshielded, Detachable 1.5m

3.3.1 Configuration of System under Test

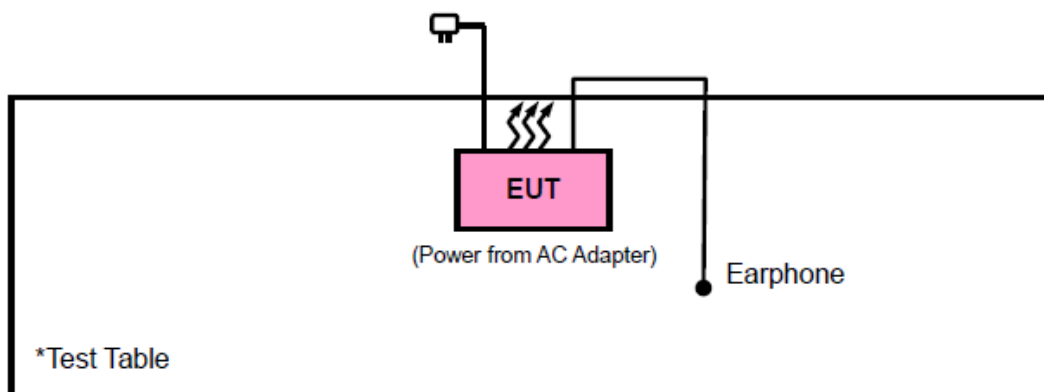

3.4 General Description of Applied Standards

The EUT is a RF Product. According to the specifications of the manufacturer, it must comply with the requirements of the following standards:

- FCC Part 15, Subpart C (15.247)**
- FCC Public Notice DA 00-705**
- 558074 D01 DTS Meas Guidance v03r03**
- ANSI C63.10-2013

All test items have been performed and recorded as per the above standards.

NOTE: The EUT is also considered as a kind of computer peripheral, because the connection to computer is necessary for typical use. It has been verified to comply with the requirements of FCC Part 15, Subpart B, Class B (DoC). The test report has been issued separately.

4 Test Types and Results(For BT EDR)

4.1 Radiated Emission and Bandedge Measurement

4.1.1 Limits of Radiated Emission and Bandedge Measurement

Radiated emissions which fall in the restricted bands must comply with the radiated emission limits specified as below table. Other emissions shall be at least 20dB below the highest level of the desired power:

Frequencies (MHz)	Field Strength (microvolts/meter)	Measurement Distance (meters)
0.009 ~ 0.490	2400/F(kHz)	300
0.490 ~ 1.705	24000/F(kHz)	30
1.705 ~ 30.0	30	30
30 ~ 88	100	3
88 ~ 216	150	3
216 ~ 960	200	3
Above 960	500	3

NOTE:

1. The lower limit shall apply at the transition frequencies.
2. Emission level (dBuV/m) = 20 log Emission level (uV/m).
3. For frequencies above 1000MHz, the field strength limits are based on average detector, however, the peak field strength of any emission shall not exceed the maximum permitted average limits, specified above by more than 20dB under any condition of modulation.

4.1.2 Test Instruments

Description & Manufacturer	Model No.	Serial No.	Date Of Calibration	Due Date Of Calibration
Spectrum Analyzer Agilent Technologies	N9038A	MY52260177	May 19, 2015	May 18, 2016
Spectrum Analyzer ROHDE & SCHWARZ	FSU43	101261	Dec. 10, 2014	Dec. 09, 2015
BILOG Antenna ETS-Lindgren	3142E	117536	Feb. 23, 2015	Feb. 22, 2016
HORN Antenna ETS-Lindgren	3117	00143293	Aug. 27, 2015	Aug. 26, 2016
Bluetooth Tester	CBT	100980	Apr. 27, 2015	Apr. 26, 2016
Agilent Communications Tester-Wireless	8960 Series 10	MY53201073	Jul. 06, 2015	Jul. 05, 2017
Preamplifier Agilent	310N	187226	Jun. 29, 2015	Jun. 28, 2016
Preamplifier Agilent	83017A	980116	Jan. 09, 2015	Jan. 08, 2016
Power Meter Anritsu	ML2495A	1232002	Sep. 16, 2015	Sep. 15, 2016
Power Sensor Anritsu	MA2411B	1207325	Sep. 16, 2015	Sep. 15, 2016
RF signal cable ETS-LINDGREN	5D-FB	Cable-CH1-01(RFC-SM S-100-SMS-120+RFC-S MS-100-SMS-400)	Jun. 27, 2015	Jun. 26, 2016
RF signal cable ETS-LINDGREN	8D-FB	Cable-CH1-02(RFC-SM S-100-SMS-24)	Jun. 27, 2015	Jun. 26, 2016
Software BV ADT	E38.130425b	NA	NA	NA
Antenna Tower MF	NA	NA	NA	NA
Turn Table MF	NA	NA	NA	NA
Antenna Tower & Turn Table Controller MF	MF-7802	NA	NA	NA

NOTE: 1. The calibration interval of the above test instruments is 12 months and the calibrations are traceable to NML/ROC and NIST/USA.

2. The calibration interval of the loop antenna is 24 months and the calibrations are traceable to NML/ROC and NIST/USA.

3. The test was performed in HwaYa Chamber 4.

4. The horn antenna and HP preamplifier (model: 8449B) are used only for the measurement of emission frequency above 1GHz if tested.

5. The FCC Site Registration No. is 460141.

6. The IC Site Registration No. is IC7450F-4.

4.1.3 Test Procedures

- a. The EUT was placed on the top of a rotating table 0.8 meters (for below 1GHz) / 1.5 meters (for above 1GHz) above the ground at 3 meter chamber room for test. The table was rotated 360 degrees to determine the position of the highest radiation.
- b. The EUT was set 3 meters away from the interference-receiving antenna, which was mounted on the top of a variable-height antenna tower.
- c. The height of antenna is varied from one meter to four meters above the ground to determine the maximum value of the field strength. Both horizontal and vertical polarizations of the antenna are set to make the measurement.
- d. For each suspected emission, the EUT was arranged to its worst case and then the antenna was tuned to heights from 1 meter to 4 meters and the rotatable table was turned from 0 degrees to 360 degrees to find the maximum reading.
- e. The test-receiver system was set to quasi-peak detect function and specified bandwidth with maximum hold mode when the test frequency is below 1 GHz.
- f. The test-receiver system was set to peak detect function and specified bandwidth with maximum hold mode when the test frequency is above 1 GHz.

Note:

1. The resolution bandwidth and video bandwidth of test receiver/spectrum analyzer is 120kHz for Quasi-peak detection (QP) at frequency below 1GHz.
2. The resolution bandwidth of test receiver/spectrum analyzer is 1 MHz and the video bandwidth is 3 MHz for Peak detection (PK) at frequency above 1GHz.
3. For Average measurement, due to the DH5 packet was the worse case duty cycle for a transmit dwell time on a channel, based upon bluetooth theory the transmitter is on $0.625 * 5$ per 296.25 ms per channel. Therefore, the duty cycle correlation factor be equal to: $20\log(3.125 / 100) = -30.1$ dB, therefore Average value = peak reading + $20\log(\text{duty cycle})$.
4. All modes of operation were investigated and the worst-case emissions are reported.

4.1.4 Deviation from Test Standard

No deviation.

4.1.5 Test Set Up

<Frequency Range below 1GHz>

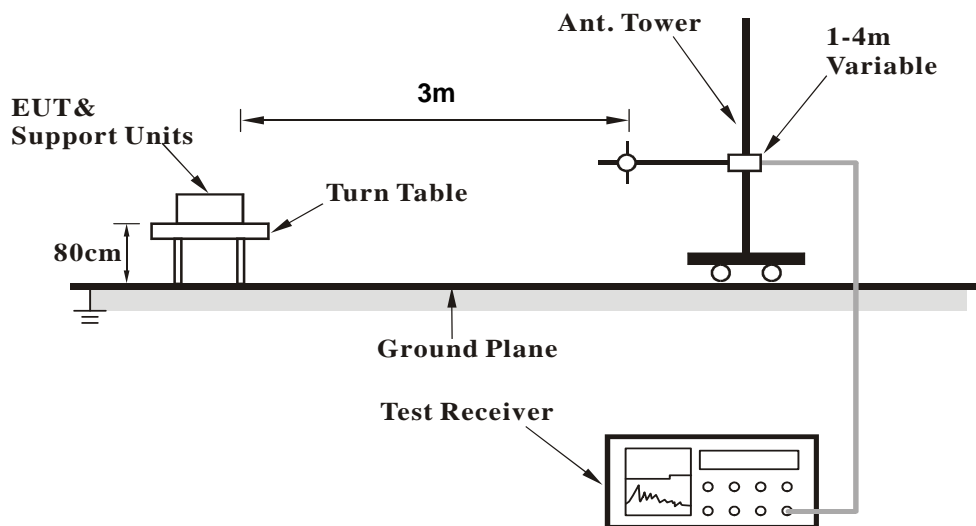

<Frequency Range above 1GHz>

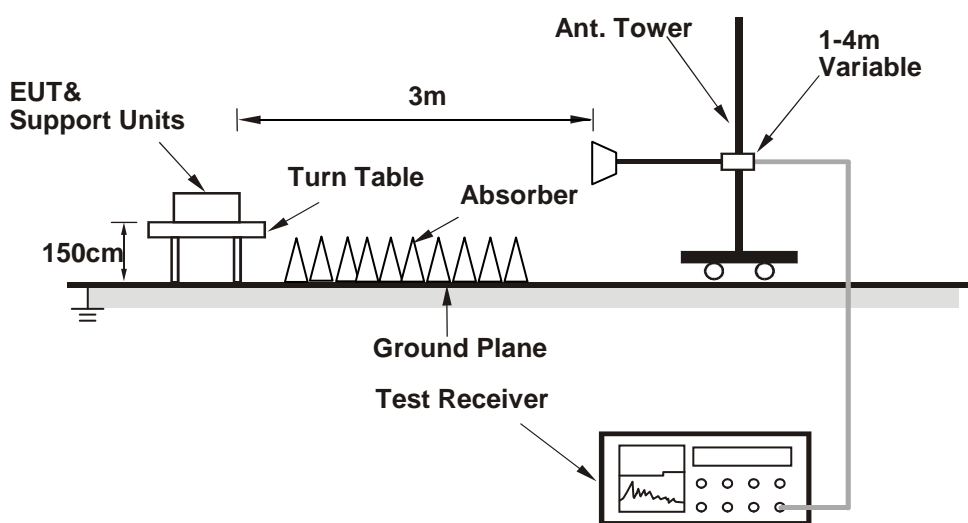

For the actual test configuration, please refer to the attached file (Test Setup Photo).

4.1.6 EUT Operating Conditions

Set the EUT under transmission condition continuously at specific channel frequency.

4.1.7 Test Results

BELOW 1GHz WORST-CASE DATA:

GFSK DH5

CHANNEL	Channel 78	DETECTOR FUNCTION	Quasi-Peak (QP)
FREQUENCY RANGE	30MHz ~ 1GHz		

ANTENNA POLARITY & TEST DISTANCE: HORIZONTAL AT 3 M								
NO.	FREQ. (MHz)	EMISSION LEVEL (dBuV/m)	LIMIT (dBuV/m)	MARGIN (dB)	ANTENNA HEIGHT (m)	TABLE ANGLE (Degree)	RAW VALUE (dBuV)	CORRECTION FACTOR (dB/m)
1	30.00	22.0 QP	40.0	-18.0	1.00 H	0	40.22	-18.21
2	58.13	20.1 QP	40.0	-19.9	1.00 H	0	48.55	-28.47
3	107.60	9.5 QP	43.5	-34.0	1.00 H	0	36.24	-26.74
4	170.65	9.5 QP	43.5	-34.0	1.00 H	0	33.44	-23.95
5	206.54	14.7 QP	43.5	-28.8	1.00 H	0	38.17	-23.46
6	243.40	17.2 QP	46.0	-28.8	1.00 H	0	38.77	-21.59

REMARKS:

1. Emission Level(dBuV/m) = Raw Value(dBuV) + Correction Factor(dB/m)
2. Correction Factor(dB/m) = Antenna Factor(dB/m) + Cable Factor(dB) – Pre-Amplifier Factor(dB)
3. The other emission levels were very low against the limit.
4. Margin value = Emission Level – Limit value

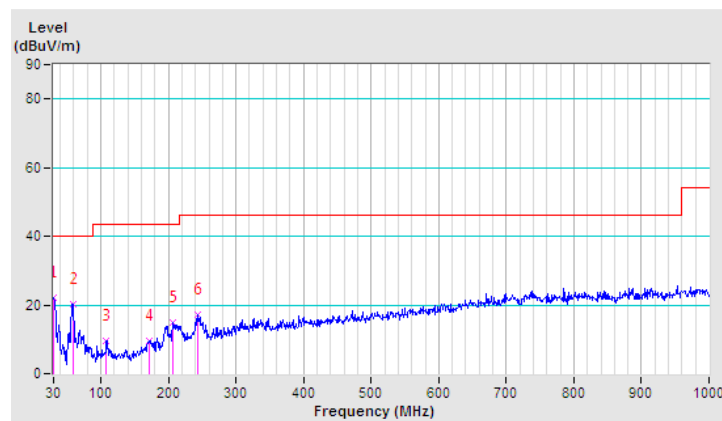

CHANNEL	Channel 78	DETECTOR FUNCTION	Quasi-Peak (QP)
FREQUENCY RANGE	30MHz ~ 1GHz		

ANTENNA POLARITY & TEST DISTANCE: VERTICAL AT 3 M								
NO.	FREQ. (MHz)	EMISSION LEVEL (dBuV/m)	LIMIT (dBuV/m)	MARGIN (dB)	ANTENNA HEIGHT (m)	TABLE ANGLE (Degree)	RAW VALUE (dBuV)	CORRECTION FACTOR (dB/m)
1	30.00	32.4 QP	40.0	-7.6	1.00 V	0	50.60	-18.21
2	57.16	24.0 QP	40.0	-16.0	1.00 V	0	52.51	-28.49
3	84.32	17.3 QP	40.0	-22.7	1.00 V	0	45.24	-27.95
4	104.69	16.6 QP	43.5	-26.9	1.00 V	0	43.25	-26.66
5	161.92	10.3 QP	43.5	-33.2	1.00 V	0	34.19	-23.86
6	196.84	14.4 QP	43.5	-29.1	1.00 V	0	38.19	-23.83

REMARKS:

1. Emission Level(dBuV/m) = Raw Value(dBuV) + Correction Factor(dB/m)
2. Correction Factor(dB/m) = Antenna Factor(dB/m) + Cable Factor(dB) – Pre-Amplifier Factor(dB)
3. The other emission levels were very low against the limit.
4. Margin value = Emission Level – Limit value

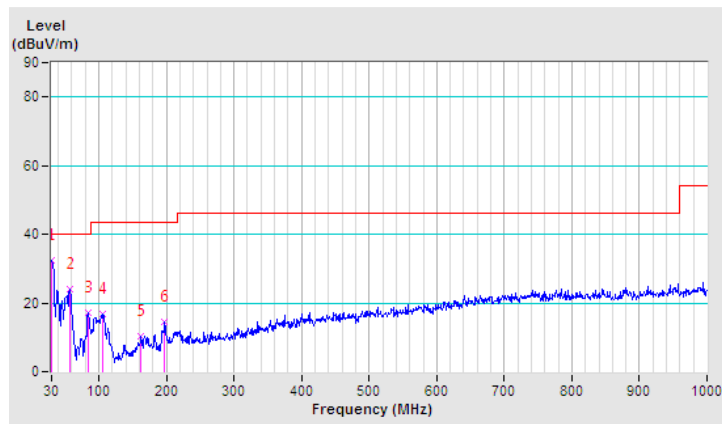

**ABOVE 1GHz WORST-CASE DATA:
GFSK DH5**

CHANNEL	TX Channel 0	DETECTOR FUNCTION	Peak (PK)
FREQUENCY RANGE	1GHz ~ 25GHz		Average (AV)

ANTENNA POLARITY & TEST DISTANCE: HORIZONTAL AT 3 M								
NO.	FREQ. (MHz)	EMISSION LEVEL (dBuV/m)	LIMIT (dBuV/m)	MARGIN (dB)	ANTENNA HEIGHT (m)	TABLE ANGLE (Degree)	RAW VALUE (dBuV)	CORRECTION FACTOR (dB/m)
1	#2390.00	60.7 PK	74.0	-13.3	1.73 H	276	64.56	-3.86
2	#2390.00	40.1 AV	54.0	-13.9	1.73 H	276	43.96	-3.86
3	*2402.00	104.2 PK			1.73 H	276	108.04	-3.84
4	*2402.00	71.5 AV			1.73 H	276	75.34	-3.84
5	#4804.00	54.9 PK	74.0	-19.1	1.00 H	0	55.49	-0.59
6	#4804.00	41.3 AV	54.0	-12.7	1.00 H	0	41.89	-0.59
ANTENNA POLARITY & TEST DISTANCE: VERTICAL AT 3 M								
NO.	FREQ. (MHz)	EMISSION LEVEL (dBuV/m)	LIMIT (dBuV/m)	MARGIN (dB)	ANTENNA HEIGHT (m)	TABLE ANGLE (Degree)	RAW VALUE (dBuV)	CORRECTION FACTOR (dB/m)
1	#2390.00	59.8 PK	74.0	-14.2	1.00 V	113	63.66	-3.86
2	#2390.00	42.1 AV	54.0	-11.9	1.00 V	113	45.96	-3.86
3	*2402.00	103.1 PK			1.00 V	113	106.94	-3.84
4	*2402.00	71.1 AV			1.00 V	113	74.94	-3.84
5	#4804.00	54.3 PK	74.0	-19.7	1.00 V	0	54.89	-0.59
6	#4804.00	41.6 AV	54.0	-12.4	1.00 V	0	42.19	-0.59

REMARKS:

1. Emission Level(dBuV/m) = Raw Value(dBuV) + Correction Factor(dB/m)
2. Correction Factor(dB/m) = Antenna Factor(dB/m) + Cable Factor(dB) – Pre-Amplifier Factor(dB)
3. The other emission levels were very low against the limit.
4. Margin value = Emission Level – Limit value
5. " * " : Fundamental frequency.
6. " # " : The radiated frequency is out of the restricted band.

CHANNEL	TX Channel 39	DETECTOR FUNCTION	Peak (PK)
FREQUENCY RANGE	1GHz ~ 25GHz		Average (AV)

ANTENNA POLARITY & TEST DISTANCE: HORIZONTAL AT 3 M								
NO.	FREQ. (MHz)	EMISSION LEVEL (dBuV/m)	LIMIT (dBuV/m)	MARGIN (dB)	ANTENNA HEIGHT (m)	TABLE ANGLE (Degree)	RAW VALUE (dBuV)	CORRECTION FACTOR (dB/m)
1	*2441.00	106.1 PK			1.00 H	183	109.89	-3.79
2	*2441.00	73.4 AV			1.00 H	183	77.19	-3.79
3	#4882.00	55.1 PK	74.0	-18.9	1.00 H	0	55.71	-0.61
4	#4882.00	44.1 AV	54.0	-9.9	1.00 H	0	44.71	-0.61
5	#7323.00	58.4 PK	74.0	-15.6	1.00 H	0	55.10	3.30
6	#7323.00	46.2 AV	54.0	-7.8	1.00 H	0	42.90	3.30
ANTENNA POLARITY & TEST DISTANCE: VERTICAL AT 3 M								
NO.	FREQ. (MHz)	EMISSION LEVEL (dBuV/m)	LIMIT (dBuV/m)	MARGIN (dB)	ANTENNA HEIGHT (m)	TABLE ANGLE (Degree)	RAW VALUE (dBuV)	CORRECTION FACTOR (dB/m)
1	*2441.00	104.4 PK			1.00 V	114	108.19	-3.79
2	*2441.00	72.4 AV			1.00 V	114	76.19	-3.79
3	#4882.00	54.6 PK	74.0	-19.4	1.00 V	0	55.21	-0.61
4	#4882.00	42.3 AV	54.0	-11.7	1.00 V	0	42.91	-0.61
5	#7323.00	58.6 PK	74.0	-15.4	1.00 V	0	55.30	3.30
6	#7323.00	45.3 AV	54.0	-8.7	1.00 V	0	42.00	3.30

REMARKS:

1. Emission Level(dBuV/m) = Raw Value(dBuV) + Correction Factor(dB/m)
2. Correction Factor(dB/m) = Antenna Factor(dB/m) + Cable Factor(dB) – Pre-Amplifier Factor(dB)
3. The other emission levels were very low against the limit.
4. Margin value = Emission Level – Limit value
5. " * " : Fundamental frequency.
6. " # " : The radiated frequency is out of the restricted band.

CHANNEL	TX Channel 78	DETECTOR FUNCTION	Peak (PK)
FREQUENCY RANGE	1GHz ~ 25GHz		Average (AV)

ANTENNA POLARITY & TEST DISTANCE: HORIZONTAL AT 3 M								
NO.	FREQ. (MHz)	EMISSION LEVEL (dBuV/m)	LIMIT (dBuV/m)	MARGIN (dB)	ANTENNA HEIGHT (m)	TABLE ANGLE (Degree)	RAW VALUE (dBuV)	CORRECTION FACTOR (dB/m)
1	*2480.00	1024.0 PK			1.00 H	10	1027.74	-3.74
2	*2480.00	713.0 AV			1.00 H	10	716.74	-3.74
3	#2483.50	52.7 PK	74.0	-21.3	1.00 H	10	56.43	-3.73
4	#2483.50	38.3 AV	54.0	-15.7	1.00 H	10	42.03	-3.73
5	#4960.00	56.7 PK	74.0	-17.3	1.00 H	0	57.34	-0.64
6	#4960.00	44.5 AV	54.0	-9.5	1.00 H	0	45.14	-0.64
7	#7440.00	58.9 PK	74.0	-15.1	1.00 H	0	55.32	3.58
8	#7440.00	45.7 AV	54.0	-8.3	1.00 H	0	42.12	3.58
ANTENNA POLARITY & TEST DISTANCE: VERTICAL AT 3 M								
NO.	FREQ. (MHz)	EMISSION LEVEL (dBuV/m)	LIMIT (dBuV/m)	MARGIN (dB)	ANTENNA HEIGHT (m)	TABLE ANGLE (Degree)	RAW VALUE (dBuV)	CORRECTION FACTOR (dB/m)
1	*2480.00	103.6 PK			1.00 V	160	107.34	-3.74
2	*2480.00	71.4 AV			1.00 V	160	75.14	-3.74
3	#2483.50	52.9 PK	74.0	-21.1	1.00 V	160	56.63	-3.73
4	#2483.50	39.1 AV	54.0	-14.9	1.00 V	160	42.83	-3.73
5	#4960.00	55.6 PK	74.0	-18.4	1.00 V	0	56.24	-0.64
6	#4960.00	41.9 AV	54.0	-12.1	1.00 V	0	42.54	-0.64
7	#7440.00	58.5 PK	74.0	-15.5	1.00 V	0	54.92	3.58
8	#7440.00	45.6 AV	54.0	-8.4	1.00 V	0	42.02	3.58

REMARKS:

1. Emission Level(dBuV/m) = Raw Value(dBuV) + Correction Factor(dB/m)
2. Correction Factor(dB/m) = Antenna Factor(dB/m) + Cable Factor(dB) – Pre-Amplifier Factor(dB)
3. The other emission levels were very low against the limit.
4. Margin value = Emission Level – Limit value
5. " * ": Fundamental frequency.
6. " # ": The radiated frequency is out of the restricted band.

BT_8DPSK

CHANNEL	TX Channel 0	DETECTOR FUNCTION	Peak (PK)
FREQUENCY RANGE	1GHz ~ 25GHz		Average (AV)

ANTENNA POLARITY & TEST DISTANCE: HORIZONTAL AT 3 M								
NO.	FREQ. (MHz)	EMISSION LEVEL (dBuV/m)	LIMIT (dBuV/m)	MARGIN (dB)	ANTENNA HEIGHT (m)	TABLE ANGLE (Degree)	RAW VALUE (dBuV)	CORRECTION FACTOR (dB/m)
1	#2390.00	54.6 PK	74.0	-19.4	1.00 H	263	58.46	-3.86
2	#2390.00	39.6 AV	54.0	-14.4	1.00 H	263	43.46	-3.86
3	*2402.00	101.6 PK			1.00 H	263	105.44	-3.84
4	*2402.00	68.7 AV			1.00 H	263	72.54	-3.84
5	#4804.00	54.4 PK	74.0	-19.6	1.00 H	0	54.99	-0.59
6	#4804.00	41.5 AV	54.0	-12.5	1.00 H	0	42.09	-0.59
ANTENNA POLARITY & TEST DISTANCE: VERTICAL AT 3 M								
NO.	FREQ. (MHz)	EMISSION LEVEL (dBuV/m)	LIMIT (dBuV/m)	MARGIN (dB)	ANTENNA HEIGHT (m)	TABLE ANGLE (Degree)	RAW VALUE (dBuV)	CORRECTION FACTOR (dB/m)
1	#2390.00	57.5 PK	74.0	-16.5	1.00 V	111	61.36	-3.86
2	#2390.00	40.3 AV	54.0	-13.7	1.00 V	111	44.16	-3.86
3	*2402.00	102.1 PK			1.00 V	111	105.94	-3.84
4	*2402.00	69.2 AV			1.00 V	111	73.04	-3.84
5	#4804.00	54.6 PK	74.0	-19.4	1.00 V	0	55.19	-0.59
6	#4804.00	52.1 AV	54.0	-1.9	1.00 V	0	52.69	-0.59

REMARKS:

1. Emission Level(dBuV/m) = Raw Value(dBuV) + Correction Factor(dB/m)
2. Correction Factor(dB/m) = Antenna Factor(dB/m) + Cable Factor(dB) – Pre-Amplifier Factor(dB)
3. The other emission levels were very low against the limit.
4. Margin value = Emission Level – Limit value
5. " * ": Fundamental frequency.
6. " # ": The radiated frequency is out of the restricted band.

CHANNEL	TX Channel 39	DETECTOR FUNCTION	Peak (PK)
FREQUENCY RANGE	1GHz ~ 25GHz		Average (AV)

ANTENNA POLARITY & TEST DISTANCE: HORIZONTAL AT 3 M								
NO.	FREQ. (MHz)	EMISSION LEVEL (dBuV/m)	LIMIT (dBuV/m)	MARGIN (dB)	ANTENNA HEIGHT (m)	TABLE ANGLE (Degree)	RAW VALUE (dBuV)	CORRECTION FACTOR (dB/m)
1	*2441.00	100.9 PK			1.00 H	233	104.69	-3.79
2	*2441.00	68.8 AV			1.00 H	233	72.59	-3.79
3	#4882.00	55.6 PK	74.0	-18.4	1.00 H	0	56.21	-0.61
4	#4882.00	44.3 AV	54.0	-9.7	1.00 H	0	44.91	-0.61
5	#7323.00	58.6 PK	74.0	-15.4	1.00 H	0	55.30	3.30
6	#7323.00	46.6 AV	54.0	-7.4	1.00 H	0	43.30	3.30
ANTENNA POLARITY & TEST DISTANCE: VERTICAL AT 3 M								
NO.	FREQ. (MHz)	EMISSION LEVEL (dBuV/m)	LIMIT (dBuV/m)	MARGIN (dB)	ANTENNA HEIGHT (m)	TABLE ANGLE (Degree)	RAW VALUE (dBuV)	CORRECTION FACTOR (dB/m)
1	*2441.00	102.1 PK			1.00 V	56	105.89	-3.79
2	*2441.00	69.2 AV			1.00 V	56	72.99	-3.79
3	#4882.00	54.3 PK	74.0	-19.7	1.00 V	0	54.91	-0.61
4	#4882.00	42.1 AV	54.0	-11.9	1.00 V	0	42.71	-0.61
5	#7323.00	58.1 PK	74.0	-15.9	1.00 V	0	54.80	3.30
6	#7323.00	45.8 AV	54.0	-8.2	1.00 V	0	42.50	3.30

REMARKS:

1. Emission Level(dBuV/m) = Raw Value(dBuV) + Correction Factor(dB/m)
2. Correction Factor(dB/m) = Antenna Factor(dB/m) + Cable Factor(dB) – Pre-Amplifier Factor(dB)
3. The other emission levels were very low against the limit.
4. Margin value = Emission Level – Limit value
5. " * " : Fundamental frequency.
6. " # " : The radiated frequency is out of the restricted band.

CHANNEL	TX Channel 78	DETECTOR FUNCTION	Peak (PK)
FREQUENCY RANGE	1GHz ~ 25GHz		Average (AV)

ANTENNA POLARITY & TEST DISTANCE: HORIZONTAL AT 3 M								
NO.	FREQ. (MHz)	EMISSION LEVEL (dBuV/m)	LIMIT (dBuV/m)	MARGIN (dB)	ANTENNA HEIGHT (m)	TABLE ANGLE (Degree)	RAW VALUE (dBuV)	CORRECTION FACTOR (dB/m)
1	*2480.00	101.1 PK			1.00 H	194	104.84	-3.74
2	*2480.00	68.6 AV			1.00 H	194	72.34	-3.74
3	#2483.50	53.1 PK	74.0	-20.9	1.00 H	194	56.83	-3.73
4	#2483.50	38.1 AV	54.0	-15.9	1.00 H	194	41.83	-3.73
5	#4960.00	56.2 PK	74.0	-17.8	1.00 H	0	56.84	-0.64
6	#4960.00	44.3 AV	54.0	-9.7	1.00 H	0	44.94	-0.64
7	#7440.00	58.4 PK	74.0	-15.6	1.00 H	0	54.82	3.58
8	#7440.00	44.9 AV	54.0	-9.1	1.00 H	0	41.32	3.58
ANTENNA POLARITY & TEST DISTANCE: VERTICAL AT 3 M								
NO.	FREQ. (MHz)	EMISSION LEVEL (dBuV/m)	LIMIT (dBuV/m)	MARGIN (dB)	ANTENNA HEIGHT (m)	TABLE ANGLE (Degree)	RAW VALUE (dBuV)	CORRECTION FACTOR (dB/m)
1	*2480.00	100.6 PK			1.00 V	173	104.34	-3.74
2	*2480.00	68.5 AV			1.00 V	173	72.24	-3.74
3	#2483.50	53.4 PK	74.0	-20.6	1.00 V	173	57.13	-3.73
4	#2483.50	38.6 AV	54.0	-15.4	1.00 V	173	42.33	-3.73
5	#4960.00	55.8 PK	74.0	-18.2	1.00 V	0	56.44	-0.64
6	#4960.00	41.6 AV	54.0	-12.4	1.00 V	0	42.24	-0.64
7	#7440.00	58.4 PK	74.0	-15.6	1.00 V	0	54.82	3.58
8	#7440.00	45.0 AV	54.0	-9.0	1.00 V	0	41.42	3.58

REMARKS:

1. Emission Level(dBuV/m) = Raw Value(dBuV) + Correction Factor(dB/m)
2. Correction Factor(dB/m) = Antenna Factor(dB/m) + Cable Factor(dB) – Pre-Amplifier Factor(dB)
3. The other emission levels were very low against the limit.
4. Margin value = Emission Level – Limit value
5. " * ": Fundamental frequency.
6. " # ": The radiated frequency is out of the restricted band.

4.2 Conducted Emission Measurement

4.2.1 Limits of Conducted Emission Measurement

Frequency (MHz)	Conducted Limit (dBuV)	
	Quasi-peak	Average
0.15 - 0.5	66 - 56	56 - 46
0.50 - 5.0	56	46
5.0 - 30.0	60	50

NOTE: 1. The lower limit shall apply at the transition frequencies.

2. The limit decreases in line with the logarithm of the frequency in the range of 0.15 to 0.50MHz.

3. All emanations from a class A/B digital device or system, including any network of conductors and apparatus connected thereto, shall not exceed the level of field strengths specified above.

4.2.2 Test Instruments

Description & Manufacturer	Model No.	Serial No.	Date Of Calibration	Due Date Of Calibration
Test Receiver ROHDE & SCHWARZ	ESCI	100613	Nov. 11, 2014	Nov. 10, 2015
RF signal cable Woken	5D-FB	Cable-HYC01-01	Dec. 26, 2014	Dec. 25, 2015
LISN ROHDE & SCHWARZ (EUT)	ESH3-Z5	835239/001	Feb. 26, 2015	Feb. 25, 2016
LISN ROHDE & SCHWARZ (Peripheral)	ESH3-Z5	100311	Jul. 24, 2015	Jul. 23, 2016
Software ADT	BV ADT_Cond_ V7.3.7.3	NA	NA	NA

NOTE: 1. The calibration interval of the above test instruments is 12 months and the calibrations are traceable to NML/ROC and NIST/USA.

2. The test was performed in HwaYa Shielded Room 1.

3. The VCCI Site Registration No. is C-2040.

4.2.3 Test Procedures

- The EUT was placed 0.4 meters from the conducting wall of the shielded room with EUT being connected to the power mains through a line impedance stabilization network (LISN). Other support units were connected to the power mains through another LISN. The two LISNs provide 50 ohm/ 50uH of coupling impedance for the measuring instrument.
- Both lines of the power mains connected to the EUT were checked for maximum conducted interference.
- The frequency range from 150kHz to 30MHz was searched. Emission levels under (Limit - 20dB) was not recorded.

NOTE: All modes of operation were investigated and the worst-case emissions are reported.

4.2.4 Deviation From Test Standard

No deviation.

4.2.5 Test Setup

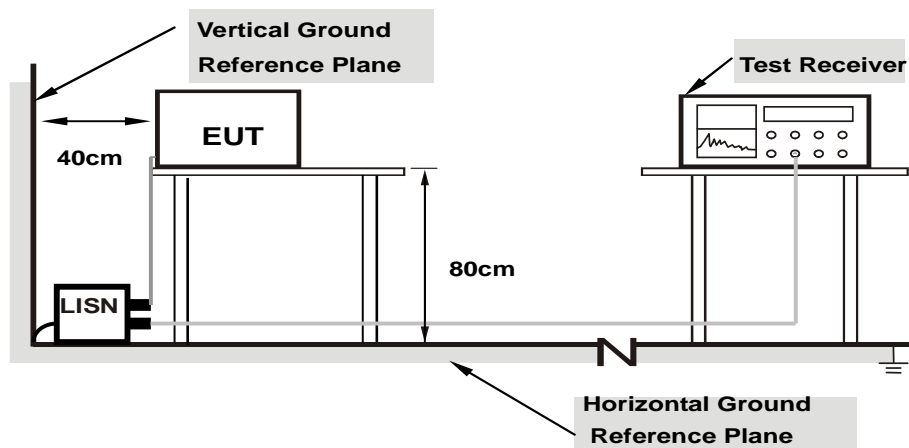

- Note: 1.Support units were connected to second LISN.**
2.Both of LISNs (AMN) are 80 cm from EUT and at least 80 from other units and other metal planes

For the actual test configuration, please refer to the attached file (Test Setup Photo).

4.2.6 EUT Operating Condition

Same as 4.1.6.

4.2.7 Test Results

Phase	Line (L)	Detector Function	Quasi-Peak (QP) / Average (AV)				
Frequency (MHz)	QuasiPeak (dBuV)	CAverage (dBuV)	Limit (dBuV)	Margin (dB)	Line	Filter	Corr. (dB)
0.196000	---	30.01	53.78	-23.77	L	ON	9.7
0.196000	43.19	---	63.78	-20.59	L1	ON	9.7
0.396000	---	35.54	47.94	-12.40	L	ON	9.7
0.396000	41.65	---	57.94	-16.29	L	ON	9.7
0.496000	---	26.05	46.07	-20.02	L	ON	9.7
0.496000	35.83	---	56.07	-20.24	L	ON	9.7
1.036000	---	23.00	46.00	-23.00	L	ON	9.7
1.036000	36.83	---	56.00	-19.17	L	ON	9.7
1.332000	---	28.09	46.00	-17.91	L	ON	9.7
1.332000	36.60	---	56.00	-19.40	L	ON	9.7
2.472000	---	27.74	46.00	-18.26	L	ON	9.7
2.472000	34.04	---	56.00	-21.96	L	ON	9.7

- REMARKS:**
1. Q.P. and AV. are abbreviations of quasi-peak and average individually.
 2. "-": The Quasi-peak reading value also meets average limit and measurement with the average detector is unnecessary.
 3. The emission levels of other frequencies were very low against the limit.
 4. Margin value = Emission level - Limit value
 5. Correction factor = Insertion loss + Cable loss
 6. Emission Level = Correction Factor + Reading Value.

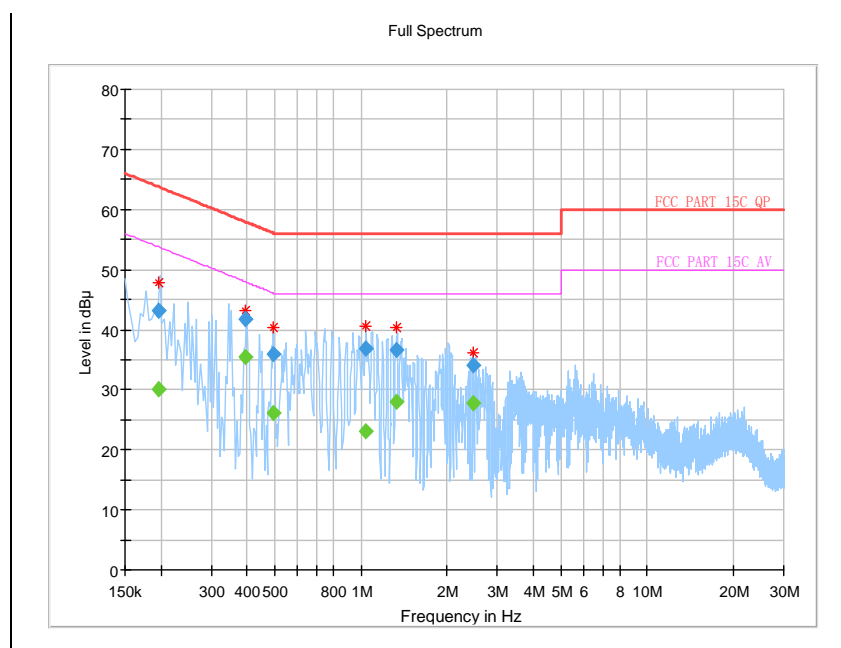

Phase	Neutral (N)	Detector Function	Quasi-Peak (QP) / Average (AV)
--------------	-------------	--------------------------	--------------------------------

Frequency (MHz)	QuasiPeak (dBuV)	CAverage (dBuV)	Limit (dBuV)	Margin (dB)	Line	Filter	Corr. (dB)
0.150000	---	35.81	56.00	-20.19	N	ON	9.8
0.150000	52.56	---	66.00	-13.44	N	ON	9.8
0.296000	---	31.49	50.35	-18.86	N	ON	10.0
0.296000	46.80	---	60.35	-13.55	N	ON	10.0
0.476000	---	24.43	46.41	-21.98	N	ON	10.1
0.476000	43.56	---	56.41	-12.85	N	ON	10.1
0.792000	---	29.85	46.00	-16.15	N	ON	10.0
0.792000	40.68	---	56.00	-15.32	N	ON	10.0
1.936000	---	28.40	46.00	-17.60	N	ON	9.8
1.936000	36.62	---	56.00	-19.38	N	ON	9.8
2.076000	---	26.19	46.00	-19.81	N	ON	9.8
2.076000	36.41	---	56.00	-19.59	N	ON	9.8

- REMARKS:**
1. Q.P. and AV. are abbreviations of quasi-peak and average individually.
 2. "-": The Quasi-peak reading value also meets average limit and measurement with the average detector is unnecessary.
 3. The emission levels of other frequencies were very low against the limit.
 4. Margin value = Emission level - Limit value
 5. Correction factor = Insertion loss + Cable loss
 6. Emission Level = Correction Factor + Reading Value.

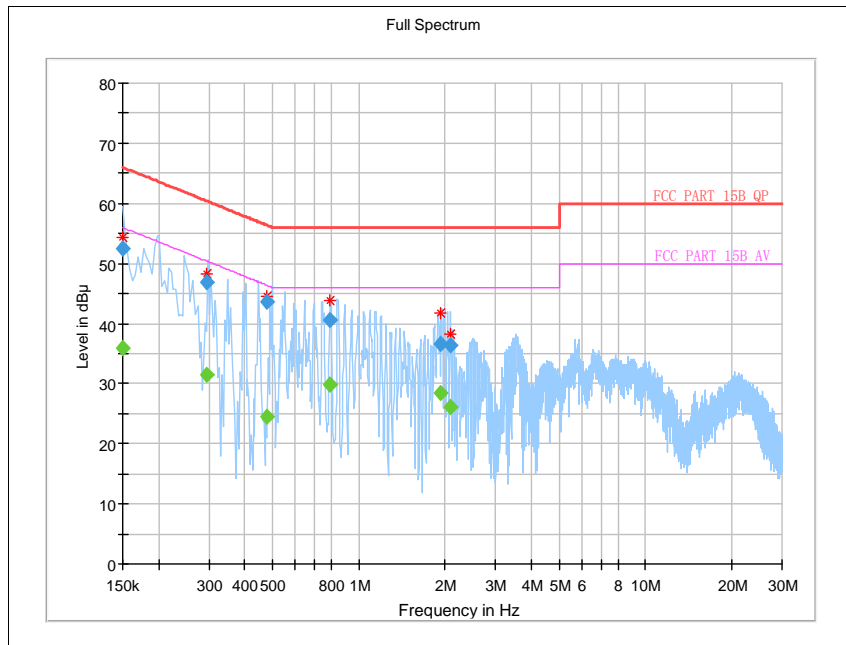

4.3 Number of Hopping Frequency Used

4.3.1 Limits of Hopping Frequency Used Measurement

At least 15 channels frequencies, and should be equally spaced.

4.3.2 Test Setup

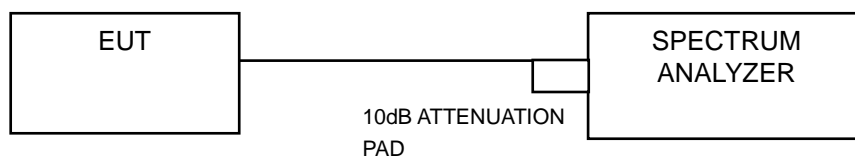

4.3.3 Test Instruments

Refer to section 4.1.2 to get information of above instrument.

4.3.4 Test Procedure

- a. Check the calibration of the measuring instrument (SA) using either an internal calibrator or a known signal from an external generator.
- b. Turn on the EUT and connect its antenna terminal to measurement via a low loss cable. Then set it to any one measured frequency within its operating range and make sure the instrument is operated in its linear range.
- c. Set the SA on MaxHold Mode, and then keep the EUT in hopping mode. Record all the signals from each channel until each one has been recorded.
- d. Set the SA on View mode and then plot the result on SA screen.
- e. Repeat above procedures until all frequencies measured were complete.

4.3.5 Deviation from Test Standard

No deviation.

4.3.6 Test Results

There are 79 hopping frequencies in the hopping mode. Please refer to next page for the test result. On the plots, it shows that the hopping frequencies are equally spaced.

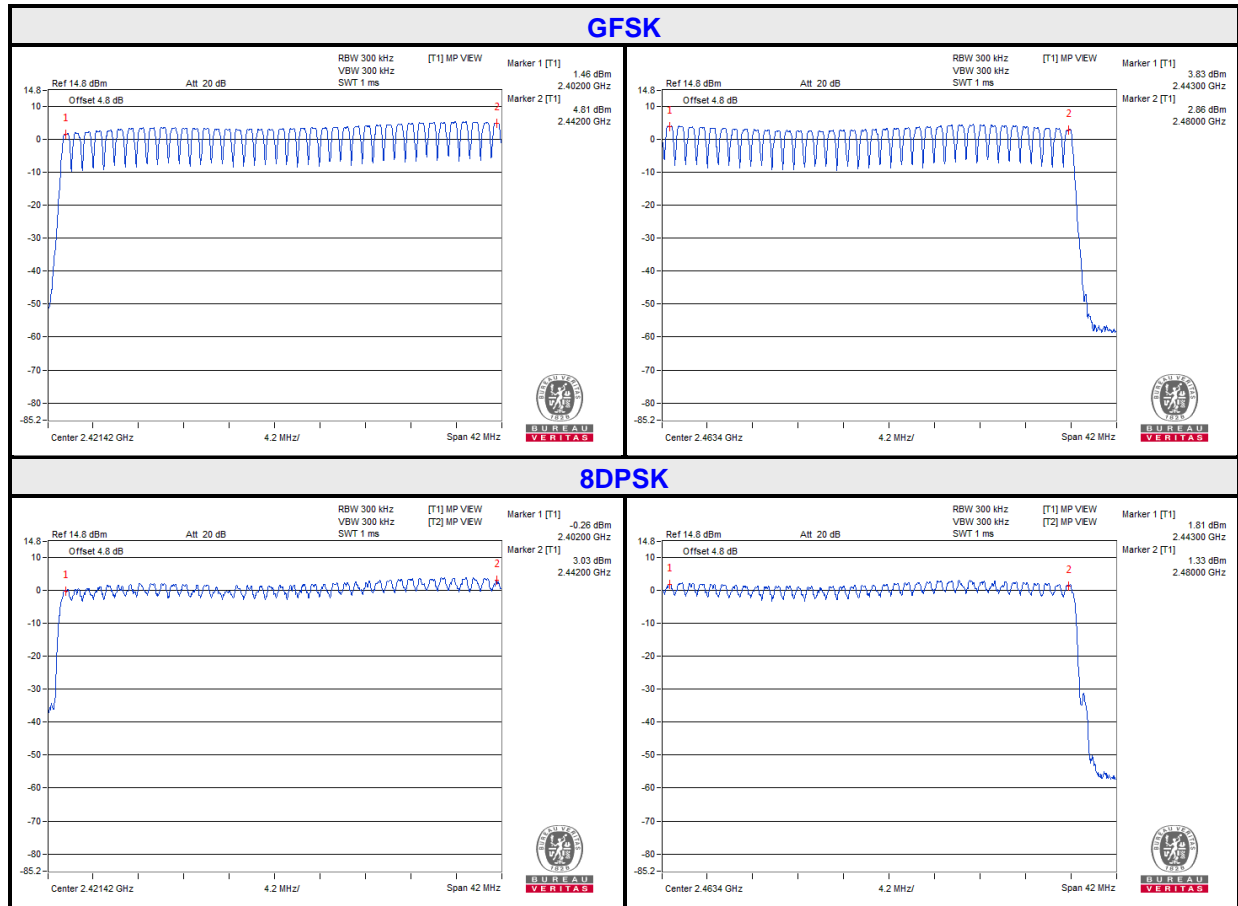

4.4 Dwell Time on Each Channel

4.4.1 Limits of Dwell Time on Each Channel Measurement

The average time of occupancy on any channel shall not be greater than 0.4 seconds within a period of 0.4 seconds multiplied by the number of hopping channels employed.

4.4.2 Test Setup

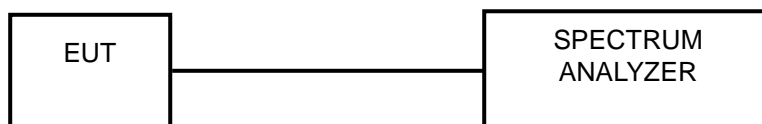

4.4.3 Test Instruments

Refer to section 4.1.2 to get information of above instrument.

4.4.4 Test Procedures

- a. Check the calibration of the measuring instrument (SA) using either an internal calibrator or a known signal from an external generator.
- b. Turn on the EUT and connect its antenna terminal to measurement via a low loss cable. Then set it to any one measured frequency within its operating range and make sure the instrument is operated in its linear range.
- c. Adjust the center frequency of SA on any frequency to be measured and set SA to zero span mode. And then, set RBW and VBW of spectrum analyzer to proper value.
- d. Measure the time duration of one transmission on the measured frequency. And then plot the result with time difference of this time duration.
- e. Repeat above procedures until all different time-slot modes have been completed.

4.4.5 Deviation from Test Standard

No deviation.

4.4.6 Test Results

GFSK

Mode	Number of Hopping Channel	Number of transmission in a period(channel number*0.4 sec)				Length of transmission time (msec)	Result (msec)	Limit (msec)	PASS / FAIL
		period (sec)	sweep time (sec)	times in a sweep	times in a period				
DH1	79	31.6	5	50	316	0.396	125.14	400	PASS
DH3	79	31.6	5	25	158	1.68	265.44	400	PASS
DH5	79	31.6	5	18	113.76	2.9	329.9	400	PASS

NOTE: Test plots of the transmitting time slot are shown on next 3 pages.



8DPSK

Mode	Number of Hopping Channel	Number of transmission in a period(channel number*0.4 sec)				Length of transmission time (msec)	Result (msec)	Limit (msec)	PASS / FAIL
		period (sec)	sweep time (sec)	times in a sweep	times in a period				
DH1	79	31.6	5	46	290.72	0.405	117.74	400	PASS
DH3	79	31.6	5	25	158	1.66	262.28	400	PASS
DH5	79	31.6	5	18	113.76	2.925	332.75	400	PASS

NOTE: Test plots of the transmitting time slot are shown on next 3 pages.



4.5 Channel Bandwidth

4.5.1 Limits of Channel Bandwidth Measurement

For frequency hopping system operating in the 2400-2483.5MHz, If the 20dB bandwidth of hopping channel is greater than 25kHz, two-thirds 20dB bandwidth of hopping channel shall be a minimum limit for the hopping channel separation.

4.5.2 Test Setup

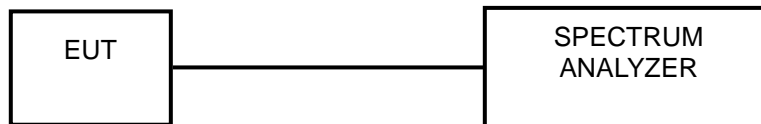

4.5.3 Test Instruments

Refer to section 4.1.2 to get information of above instrument.

4.5.4 Test Procedure

- Check the calibration of the measuring instrument using either an internal calibrator or a known signal from an external generator.
- Turn on the EUT and connect it to measurement instrument. Then set it to any one convenient frequency within its operating range. Set a reference level on the measuring instrument equal to the highest peak value.
- Measure the frequency difference of two frequencies that were attenuated 20dB from the reference level. Record the frequency difference as the emission bandwidth.
- Repeat above procedures until all frequencies measured were complete.

4.5.5 Deviation from Test Standard

No deviation.

4.5.6 EUT Operating Condition

The software provided by client enabled the EUT to transmit and receive data at lowest, middle and highest channel frequencies individually.

4.5.7 Test Results

Channel	Frequency (MHz)	20dB Bandwidth (MHz)	
		GFSK	8DPSK
0	2402	0.96	1.29
39	2441	1.02	1.27
78	2480	1.02	1.29

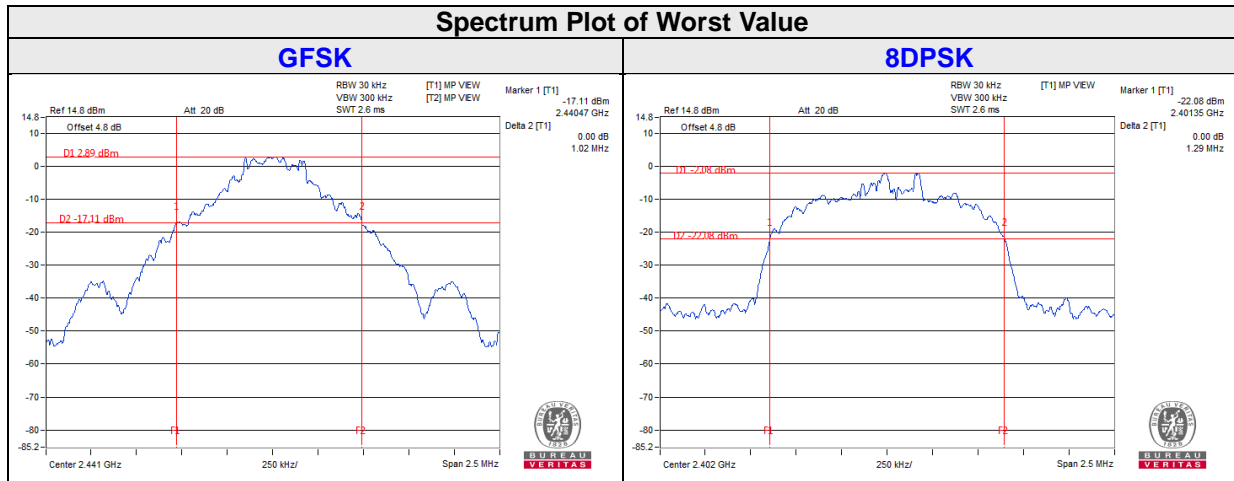

4.6 Hopping Channel Separation

4.6.1 Limits of Hopping Channel Separation Measurement

At least 25kHz or two-third of 20dB hopping channel bandwidth (whichever is greater).

4.6.2 Test Setup

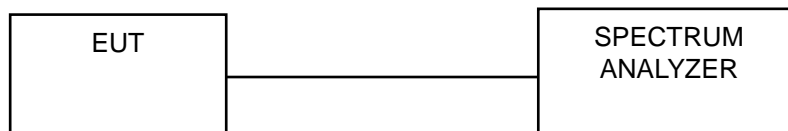

4.6.3 Test Instruments

Refer to section 4.1.2 to get information of above instrument.

4.6.4 Test Procedure

Measurement Procedure REF

- a. Check the calibration of the measuring instrument using either an internal calibrator or a known signal from an external generator.
- b. Turn on the EUT and connect it to measurement instrument. Then set it to any one convenient frequency within its operating range.
- c. By using the MaxHold function record the separation of two adjacent channels.
- d. Measure the frequency difference of these two adjacent channels by SA MARK function. And then plot the result on SA screen.
- e. Repeat above procedures until all frequencies measured were complete.

4.6.5 Deviation From Test Standard

No deviation.

4.6.6 Test Results

Channel	Frequency (MHz)	Adjacent Channel Separation (MHz)		20dB Bandwidth (MHz)		Minimum Limit (MHz)		Pass / Fail
		GFSK	8DPSK	GFSK	8DPSK	GFSK	8DPSK	
0	2402	1.00	1.00	0.96	1.29	0.64	0.86	Pass
39	2441	1.00	1.00	1.02	1.27	0.68	0.85	Pass
78	2480	1.00	1.01	1.02	1.29	0.68	0.86	Pass

NOTE: The minimum limit is two-third 20dB bandwidth.

GFSK

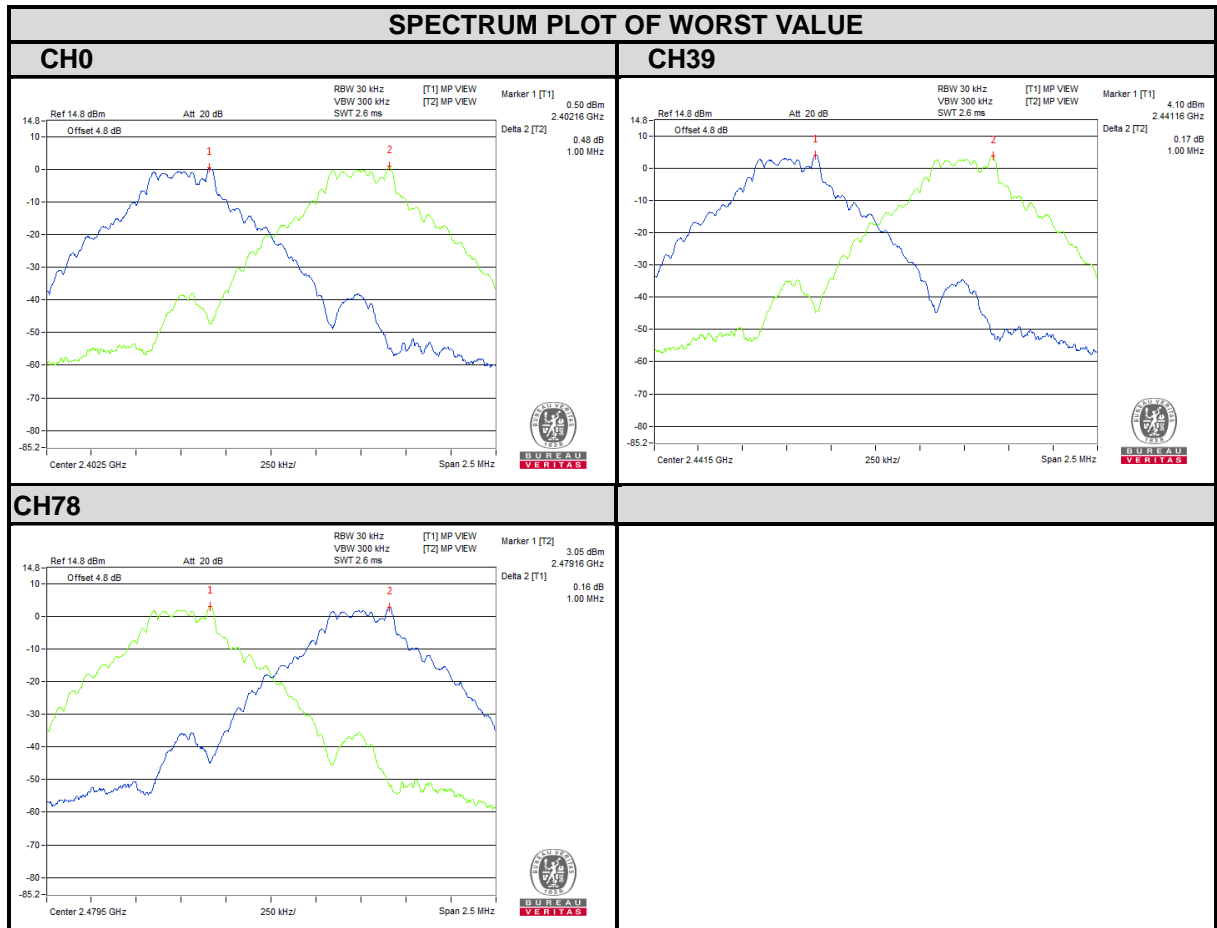

8DPSK

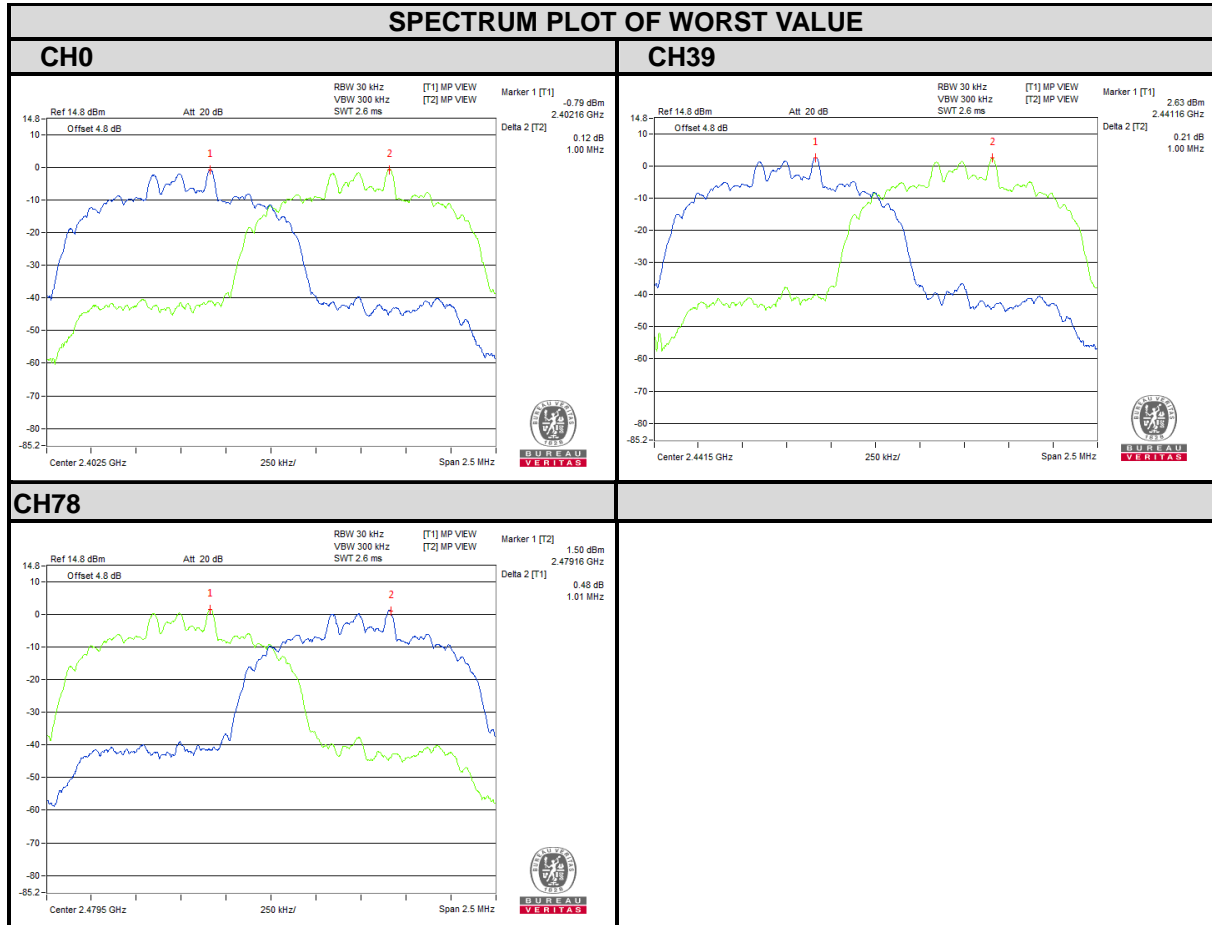

4.7 Maximum Output Power

4.7.1 Limits of Maximum Output Power Measurement

The Maximum Output Power Measurement is 125mW.

4.7.2 Test Setup

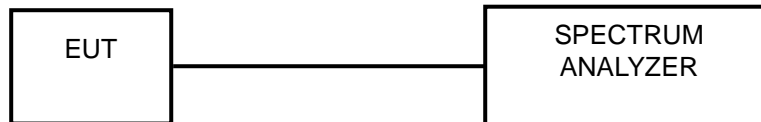

4.7.3 Test Instruments

Refer to section 4.1.2 to get information of above instrument.

4.7.4 Test Procedure

- a. Check the calibration of the measuring instrument using either an internal calibrator or a known signal from an external generator.
- b. Turn on the EUT and connect it to measurement instrument. Then set it to any one convenient frequency within its operating range. Set a reference level on the measuring instrument equal to the highest peak value.
- c. The center frequency of the spectrum analyzer is set to the fundamental frequency and using 3MHz RBW and 10 MHz VBW.
- d. Measure the captured power within the band and recording the plot.
- e. Repeat above procedures until all frequencies required were complete.

4.7.5 Deviation from Test Standard

No deviation.

4.7.6 EUT Operating Condition

The software provided by client enabled the EUT to transmit and receive data at lowest, middle and highest channel frequencies individually.

4.7.7 Test Results

Channel	Frequency (MHZ)	Output Power (mW)		Output Power (dBm)		Power Limit (mW)	Pass / Fail
		GFSK	8DPSK	GFSK	8DPSK		
0	2402	0.975	0.705	-0.11	-1.52	125	Pass
39	2441	2.427	1.750	3.85	2.43	125	Pass
78	2480	1.538	1.117	1.87	0.48	125	Pass

4.8 Conducted Out of Band Emission Measurement

4.8.1 Limits Of Conducted Out Of Band Emission Measurement

Below -20dB of the highest emission level of operating band (in 100kHz RBW).

4.8.2 Test Instruments

Refer to section 4.1.2 to get information of above instrument.

4.8.3 Test Procedure

The transmitter output was connected to the spectrum analyzer via a low loss cable. of Spectrum Analyzer was set RBW to 100 kHz and VBW to 100 kHz with suitable frequency span including 100 MHz bandwidth from band edge. Detector = PEAK and Trace mode = Max Hold. The band edges was measured and recorded.

4.8.4 Deviation From Test Standard

No deviation.

4.8.5 Eut Operating Condition

The software provided by client enabled the EUT to transmit and receive data at lowest, middle and highest channel frequencies individually.

4.8.6 Test Results

The spectrum plots are attached on the following images. D1 line indicates the highest level, D2 line indicates the 20dB offset below D1. It shows compliance with the requirement.

GFSK

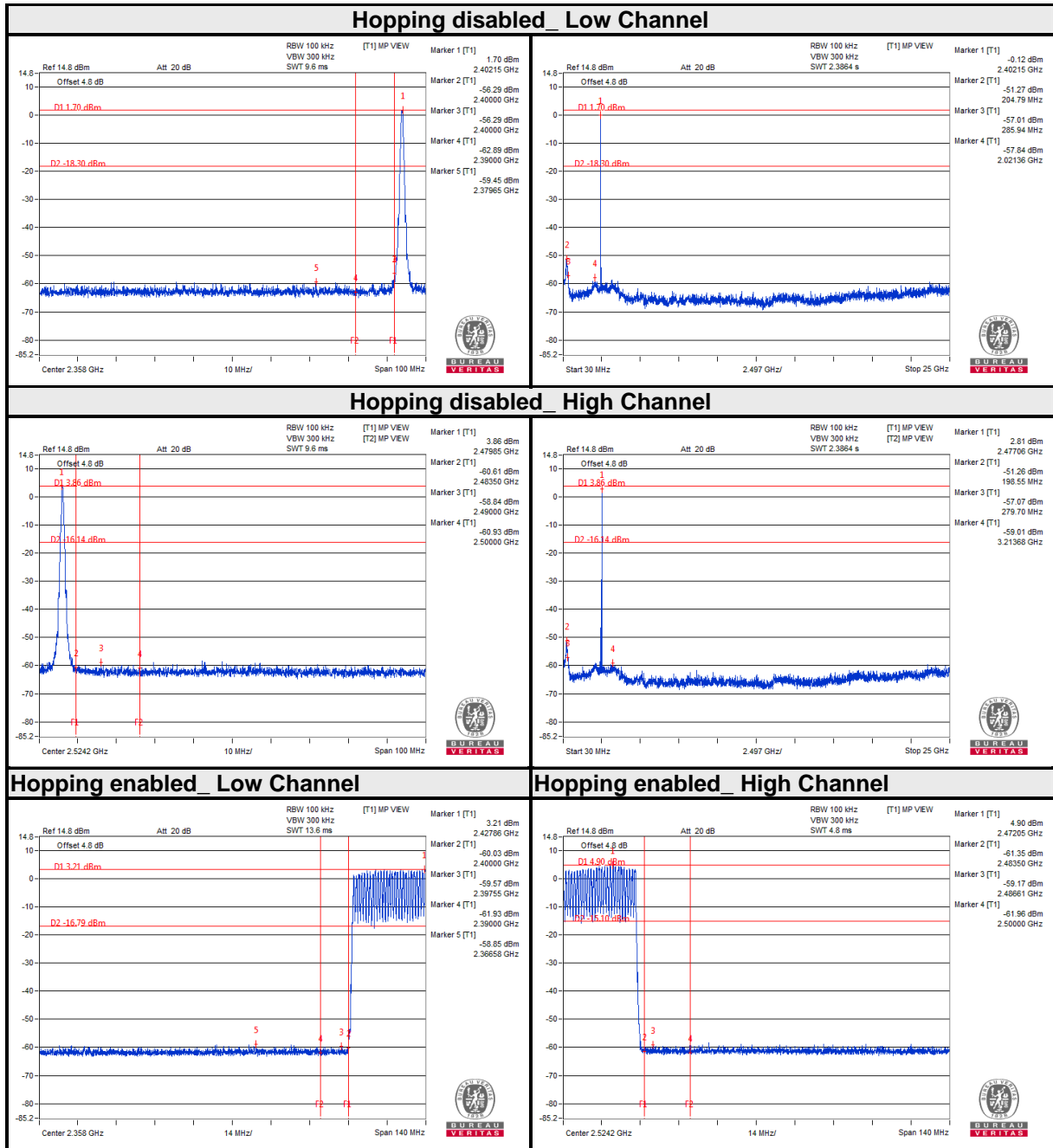

8DPSK

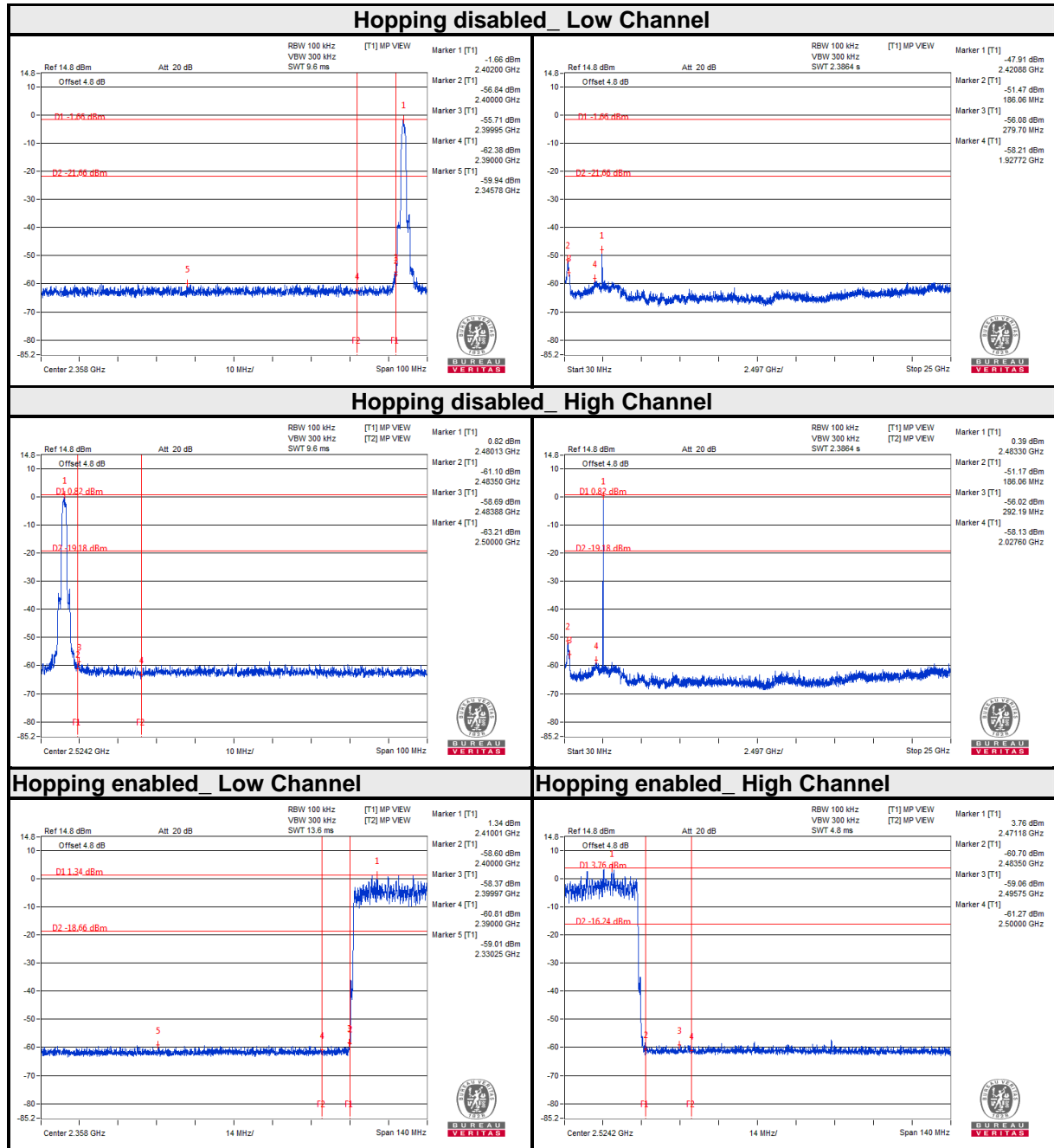

5 Test Types and Results(For BT LE 4.0)

5.1 Radiated Emission and Bandedge Measurement

5.1.1 Limits of Radiated Emission and Bandedge Measurement

Radiated emissions which fall in the restricted bands must comply with the radiated emission limits specified as below table. Other emissions shall be at least 20dB below the highest level of the desired power:

Frequencies (MHz)	Field Strength (microvolts/meter)	Measurement Distance (meters)
0.009 ~ 0.490	2400/F(kHz)	300
0.490 ~ 1.705	24000/F(kHz)	30
1.705 ~ 30.0	30	30
30 ~ 88	100	3
88 ~ 216	150	3
216 ~ 960	200	3
Above 960	500	3

NOTE:

1. The lower limit shall apply at the transition frequencies.
2. Emission level (dBuV/m) = 20 log Emission level (uV/m).
3. For frequencies above 1000MHz, the field strength limits are based on average detector, however, the peak field strength of any emission shall not exceed the maximum permitted average limits, specified above by more than 20dB under any condition of modulation.

5.1.2 Test Instruments

Same as section 4.1.2.

5.1.3 Test Procedures

- a. The EUT was placed on the top of a rotating table 0.8 meters (for below 1GHz) / 1.5 meters (for above 1GHz) above the ground at 3 meter chamber room for test. The table was rotated 360 degrees to determine the position of the highest radiation.
- b. The EUT was set 3 meters away from the interference-receiving antenna, which was mounted on the top of a variable-height antenna tower.
- c. The height of antenna is varied from one meter to four meters above the ground to determine the maximum value of the field strength. Both horizontal and vertical polarizations of the antenna are set to make the measurement.
- d. For each suspected emission, the EUT was arranged to its worst case and then the antenna was tuned to heights from 1 meter to 4 meters and the rotatable table was turned from 0 degrees to 360 degrees to find the maximum reading.
- e. The test-receiver system was set to quasi-peak detect function and specified bandwidth with maximum hold mode when the test frequency is below 1 GHz.
- f. The test-receiver system was set to peak and average detect function and specified bandwidth with maximum hold mode when the test frequency is above 1 GHz. If the peak reading value also meets average limit, measurement with the average detector is unnecessary.

Note:

1. The resolution bandwidth and video bandwidth of test receiver/spectrum analyzer is 120kHz for Quasi-peak detection (QP) at frequency below 1GHz.
2. The resolution bandwidth of test receiver/spectrum analyzer is 1 MHz and the video bandwidth is 3 MHz for Peak detection (PK) at frequency above 1GHz.
3. The resolution bandwidth of test receiver/spectrum analyzer is 1MHz and the video bandwidth is 3MHz for RMS Average (Duty cycle < 98%) for Average detection (AV) at frequency above 1GHz, then the measurement results was added to a correction factor ($10 \log(1/\text{duty cycle})$).
4. The resolution bandwidth of test receiver/spectrum analyzer is 1MHz and the video bandwidth is 10Hz (Duty cycle $\geq 98\%$) for Average detection (AV) at frequency above 1GHz.
5. All modes of operation were investigated and the worst-case emissions are reported.

5.1.4 Deviation from Test Standard

No deviation.

5.1.5 Test Set Up

<Frequency Range below 1GHz>

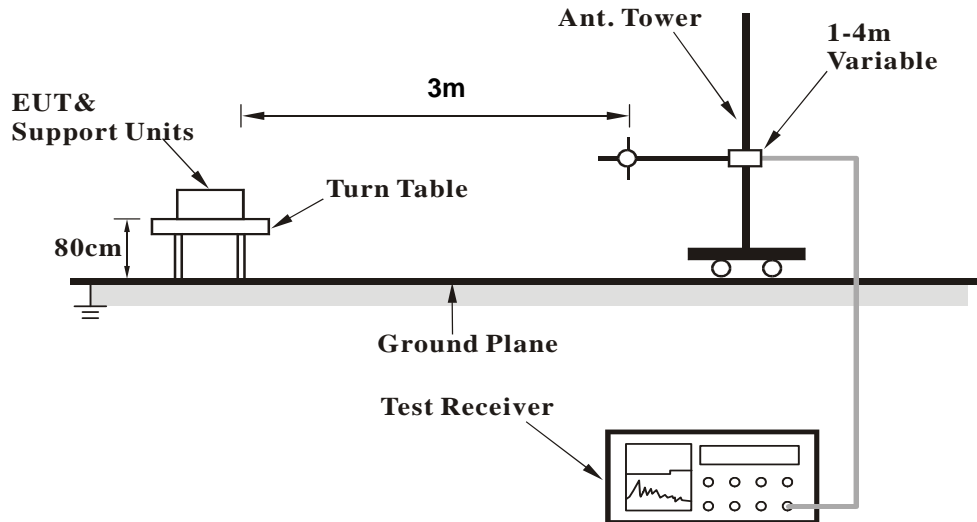

<Frequency Range above 1GHz>

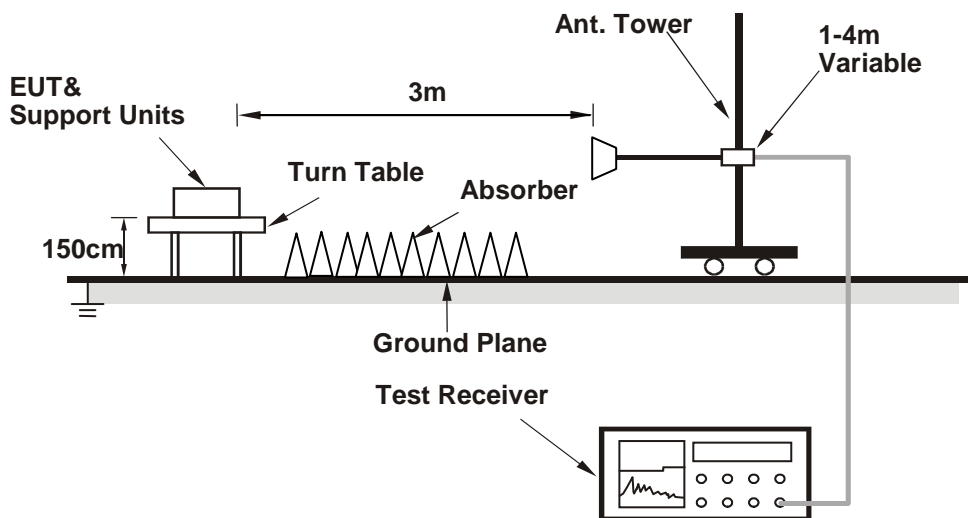

For the actual test configuration, please refer to the attached file (Test Setup Photo).

5.1.6 EUT Operating Conditions

- a. Placed the EUT on the testing table.
- b. Set the EUT under transmission condition continuously at specific channel frequency.

5.1.7 Test Results

BELOW 1GHz WORST-CASE DATA:

BT-LE (GFSK)

CHANNEL	TX Channel 0	DETECTOR FUNCTION	Quasi-Peak (QP)
FREQUENCY RANGE	30MHz ~ 1GHz		

ANTENNA POLARITY & TEST DISTANCE: HORIZONTAL AT 3 M								
NO.	FREQ. (MHz)	EMISSION LEVEL (dBuV/m)	LIMIT (dBuV/m)	MARGIN (dB)	ANTENNA HEIGHT (m)	TABLE ANGLE (Degree)	RAW VALUE (dBuV)	CORRECTION FACTOR (dB/m)
1	30.00	22.9 QP	40.0	-17.1	1.00 H	0	41.13	-18.21
2	57.16	20.0 QP	40.0	-20.0	1.00 H	0	48.49	-28.49
3	171.62	11.4 QP	43.5	-32.1	1.00 H	0	35.36	-23.95
4	239.52	14.9 QP	46.0	-31.1	1.00 H	0	36.72	-21.79
5	304.51	16.6 QP	46.0	-29.4	1.00 H	0	36.84	-20.28
6	390.84	16.9 QP	46.0	-29.1	1.00 H	0	33.39	-16.45

REMARKS:

1. Emission Level(dBuV/m) = Raw Value(dBuV) + Correction Factor(dB/m)
2. Correction Factor(dB/m) = Antenna Factor(dB/m) + Cable Factor(dB) – Pre-Amplifier Factor(dB)
3. The other emission levels were very low against the limit.
4. Margin value = Emission Level – Limit value

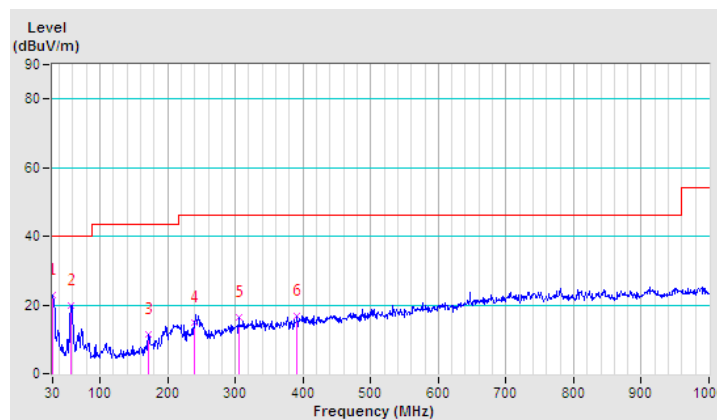

CHANNEL	TX Channel 0	DETECTOR FUNCTION	Quasi-Peak (QP)
FREQUENCY RANGE	30MHz ~ 1GHz		

ANTENNA POLARITY & TEST DISTANCE: VERTICAL AT 3 M								
NO.	FREQ. (MHz)	EMISSION LEVEL (dBuV/m)	LIMIT (dBuV/m)	MARGIN (dB)	ANTENNA HEIGHT (m)	TABLE ANGLE (Degree)	RAW VALUE (dBuV)	CORRECTION FACTOR (dB/m)
1	30.00	32.8 QP	40.0	-7.2	1.00 V	0	50.99	-18.21
2	38.73	25.0 QP	40.0	-15.0	1.00 V	0	49.15	-24.12
3	56.19	24.4 QP	40.0	-15.6	1.00 V	0	52.90	-28.50
4	83.35	17.7 QP	40.0	-22.3	1.00 V	0	45.69	-27.98
5	103.72	17.6 QP	43.5	-25.9	1.00 V	0	44.27	-26.63
6	196.84	14.5 QP	43.5	-29.0	1.00 V	0	38.35	-23.83

REMARKS:

1. Emission Level(dBuV/m) = Raw Value(dBuV) + Correction Factor(dB/m)
2. Correction Factor(dB/m) = Antenna Factor(dB/m) + Cable Factor(dB) – Pre-Amplifier Factor(dB)
3. The other emission levels were very low against the limit.
4. Margin value = Emission Level – Limit value

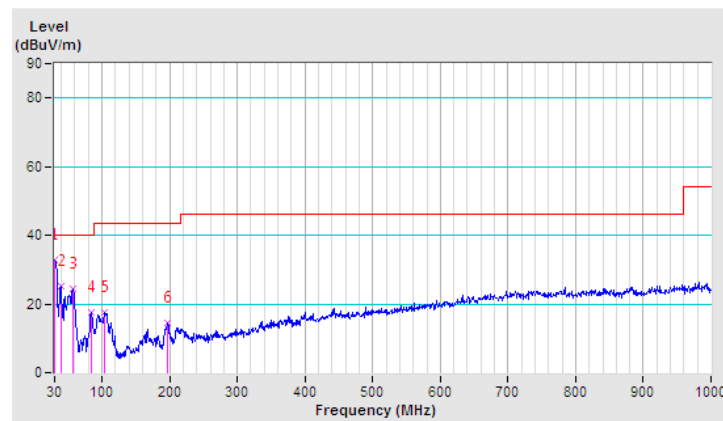

ABOVE 1GHz TEST DATA:

BT-LE (GFSK)

CHANNEL	TX Channel 0	DETECTOR FUNCTION	Peak (PK)
FREQUENCY RANGE	1GHz ~ 25GHz		Average (AV)

ANTENNA POLARITY & TEST DISTANCE: HORIZONTAL AT 3 M

NO.	FREQ. (MHz)	EMISSION LEVEL (dBuV/m)	LIMIT (dBuV/m)	MARGIN (dB)	ANTENNA HEIGHT (m)	TABLE ANGLE (Degree)	RAW VALUE (dBuV)	CORRECTION FACTOR (dB/m)
1	#2390.00	55.3 PK	74.0	-18.7	1.00 H	167	59.16	-3.86
2	#2390.00	39.8 AV	54.0	-14.2	1.00 H	167	43.66	-3.86
3	#2400.00	60.7 PK	74.0	-13.3	1.00 H	167	64.54	-3.84
4	#2400.00	45.6 AV	54.0	-8.4	1.00 H	167	49.44	-3.84
5	*2402.00	97.3 PK			1.00 H	167	101.14	-3.84
6	*2402.00	74.2 AV			1.00 H	167	78.04	-3.84
7	#4804.00	55.4 PK	74.0	-18.6	1.00 H	0	55.99	-0.59
8	#4804.00	41.9 AV	54.0	-12.1	1.00 H	0	42.49	-0.59

ANTENNA POLARITY & TEST DISTANCE: VERTICAL AT 3 M

NO.	FREQ. (MHz)	EMISSION LEVEL (dBuV/m)	LIMIT (dBuV/m)	MARGIN (dB)	ANTENNA HEIGHT (m)	TABLE ANGLE (Degree)	RAW VALUE (dBuV)	CORRECTION FACTOR (dB/m)
1	#2390.00	55.6 PK	74.0	-18.4	1.00 V	248	59.46	-3.86
2	#2390.00	39.8 AV	54.0	-14.2	1.00 V	248	43.66	-3.86
3	#2400.00	60.5 PK	74.0	-13.5	1.00 V	248	64.34	-3.84
4	#2400.00	45.3 AV	54.0	-8.7	1.00 V	248	49.14	-3.84
5	*2402.00	97.2 PK			1.00 V	248	101.04	-3.84
6	*2402.00	73.7 AV			1.00 V	248	77.54	-3.84
7	#4804.00	54.1 PK	74.0	-19.9	1.00 V	0	54.69	-0.59
8	#4804.00	41.8 AV	54.0	-12.2	1.00 V	0	42.39	-0.59

REMARKS:

1. Emission Level(dBuV/m) = Raw Value(dBuV) + Correction Factor(dB/m)
2. Correction Factor(dB/m) = Antenna Factor(dB/m) + Cable Factor(dB) – Pre-Amplifier Factor(dB)
3. The other emission levels were very low against the limit.
4. Margin value = Emission Level – Limit value
5. " * ": Fundamental frequency.
6. " # ": The radiated frequency is out of the restricted band.

CHANNEL	TX Channel 19	DETECTOR FUNCTION	Peak (PK)
FREQUENCY RANGE	1GHz ~ 25GHz		Average (AV)

ANTENNA POLARITY & TEST DISTANCE: HORIZONTAL AT 3 M

NO.	FREQ. (MHz)	EMISSION LEVEL (dBuV/m)	LIMIT (dBuV/m)	MARGIN (dB)	ANTENNA HEIGHT (m)	TABLE ANGLE (Degree)	RAW VALUE (dBuV)	CORRECTION FACTOR (dB/m)
1	*2440.00	100.7 PK			1.00 H	179	104.49	-3.79
2	*2440.00	76.1 AV			1.00 H	179	79.89	-3.79
3	#4880.00	55.2 PK	74.0	-18.8	1.00 H	0	55.81	-0.61
4	#4880.00	43.1 AV	54.0	-10.9	1.00 H	0	43.71	-0.61
5	#7320.00	58.6 PK	74.0	-15.4	1.00 H	0	55.30	3.30
6	#7320.00	46.3 AV	54.0	-7.7	1.00 H	0	43.00	3.30

ANTENNA POLARITY & TEST DISTANCE: VERTICAL AT 3 M

NO.	FREQ. (MHz)	EMISSION LEVEL (dBuV/m)	LIMIT (dBuV/m)	MARGIN (dB)	ANTENNA HEIGHT (m)	TABLE ANGLE (Degree)	RAW VALUE (dBuV)	CORRECTION FACTOR (dB/m)
1	*2440.00	98.6 PK			1.00 V	213	102.39	-3.79
2	*2440.00	75.0 AV			1.00 V	213	78.79	-3.79
3	#4880.00	54.8 PK	74.0	-19.2	1.00 V	0	55.41	-0.61
4	#4880.00	42.9 AV	54.0	-11.1	1.00 V	0	43.51	-0.61
5	#7320.00	58.1 PK	74.0	-15.9	1.00 V	0	54.80	3.30
6	#7320.00	45.9 AV	54.0	-8.1	1.00 V	0	42.60	3.30

REMARKS:

1. Emission Level(dBuV/m) = Raw Value(dBuV) + Correction Factor(dB/m)
2. Correction Factor(dB/m) = Antenna Factor(dB/m) + Cable Factor(dB) – Pre-Amplifier Factor(dB)
3. The other emission levels were very low against the limit.
4. Margin value = Emission Level – Limit value
5. " * " : Fundamental frequency.
6. " # " : The radiated frequency is out of the restricted band.

CHANNEL	TX Channel 39	DETECTOR FUNCTION	Peak (PK)
FREQUENCY RANGE	1GHz ~ 25GHz		Average (AV)

ANTENNA POLARITY & TEST DISTANCE: HORIZONTAL AT 3 M								
NO.	FREQ. (MHz)	EMISSION LEVEL (dBuV/m)	LIMIT (dBuV/m)	MARGIN (dB)	ANTENNA HEIGHT (m)	TABLE ANGLE (Degree)	RAW VALUE (dBuV)	CORRECTION FACTOR (dB/m)
1	*2480.00	98.8 PK			1.73 H	162	102.54	-3.74
2	*2480.00	75.3 AV			1.73 H	162	79.04	-3.74
3	#2483.50	53.0 PK	74.0	-21.0	1.73 H	162	56.73	-3.73
4	#2483.50	38.2 AV	54.0	-15.8	1.73 H	162	41.93	-3.73
5	#4960.00	56.3 PK	74.0	-17.7	1.00 H	0	56.94	-0.64
6	#4960.00	43.1 AV	54.0	-10.9	1.00 H	0	43.74	-0.64
7	#7440.00	58.6 PK	74.0	-15.4	1.00 H	0	55.02	3.58
8	#7440.00	46.4 AV	54.0	-7.6	1.00 H	0	42.82	3.58
ANTENNA POLARITY & TEST DISTANCE: VERTICAL AT 3 M								
NO.	FREQ. (MHz)	EMISSION LEVEL (dBuV/m)	LIMIT (dBuV/m)	MARGIN (dB)	ANTENNA HEIGHT (m)	TABLE ANGLE (Degree)	RAW VALUE (dBuV)	CORRECTION FACTOR (dB/m)
1	*2480.00	96.2 PK			1.00 V	188	99.94	-3.74
2	*2480.00	73.2 AV			1.00 V	188	76.94	-3.74
3	#2483.50	56.0 PK	74.0	-18.0	1.00 V	188	59.73	-3.73
4	#2483.50	38.6 AV	54.0	-15.4	1.00 V	188	42.33	-3.73
5	#4960.00	55.5 PK	74.0	-18.5	1.00 V	0	56.14	-0.64
6	#4960.00	42.5 AV	54.0	-11.5	1.00 V	0	43.14	-0.64
7	#7440.00	58.3 PK	74.0	-15.7	1.00 V	0	54.72	3.58
8	#7440.00	45.7 AV	54.0	-8.3	1.00 V	0	42.12	3.58

REMARKS:

1. Emission Level(dBuV/m) = Raw Value(dBuV) + Correction Factor(dB/m)
2. Correction Factor(dB/m) = Antenna Factor(dB/m) + Cable Factor(dB) – Pre-Amplifier Factor(dB)
3. The other emission levels were very low against the limit.
4. Margin value = Emission Level – Limit value
5. " * ": Fundamental frequency.
6. " # ": The radiated frequency is out of the restricted band.

5.2 Conducted Emission Measurement

5.2.1 Limits of Conducted Emission Measurement

Same as section 4.2.1.

5.2.2 Test Instruments

Same as section 4.2.2.

5.2.3 Test Procedures

Same as section 4.2.3.

5.2.4 Deviation from Test Standard

No deviation.

5.2.5 TEST SETUP

Same as section 4.2.5.

5.2.6 EUT Operating Conditions

Same as section 4.2.6.

5.2.7 Test Results

Same as section 4.2.7.

5.3 6dB Bandwidth Measurement

5.3.1 Limits of 6dB Bandwidth Measurement

The minimum of 6dB Bandwidth Measurement is 0.5 MHz.

5.3.2 Test Setup

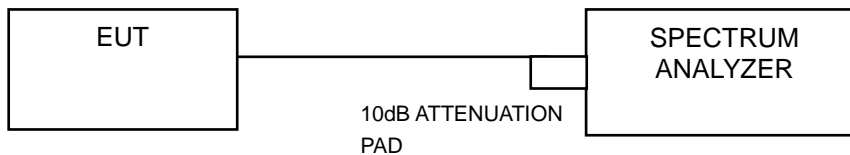

5.3.3 Test Instruments

Refer to section 4.1.2 to get information of above instrument.

5.3.4 Test Procedure

- a. Set resolution bandwidth (RBW) = 100kHz
- b. Set the video bandwidth (VBW) $\geq 3 \times$ RBW, Detector = Peak.
- c. Trace mode = max hold.
- d. Sweep = auto couple.
- e. Measure the maximum width of the emission that is constrained by the frequencies associated with the two amplitude points (upper and lower) that are attenuated by 6 dB relative to the maximum level measured in the fundamental emission

5.3.5 Deviation from Test Standard

No deviation.

5.3.6 EUT Operating Conditions

The software provided by client to enable the EUT under transmission condition continuously at lowest, middle and highest channel frequencies individually.

5.3.7 Test Result

CHANNEL	FREQUENCY (MHz)	6dB BANDWIDTH (MHz)	MINIMUM LIMIT (MHz)	PASS / FAIL
0	2402	0.71	0.5	PASS
19	2440	0.72	0.5	PASS
39	2480	0.72	0.5	PASS

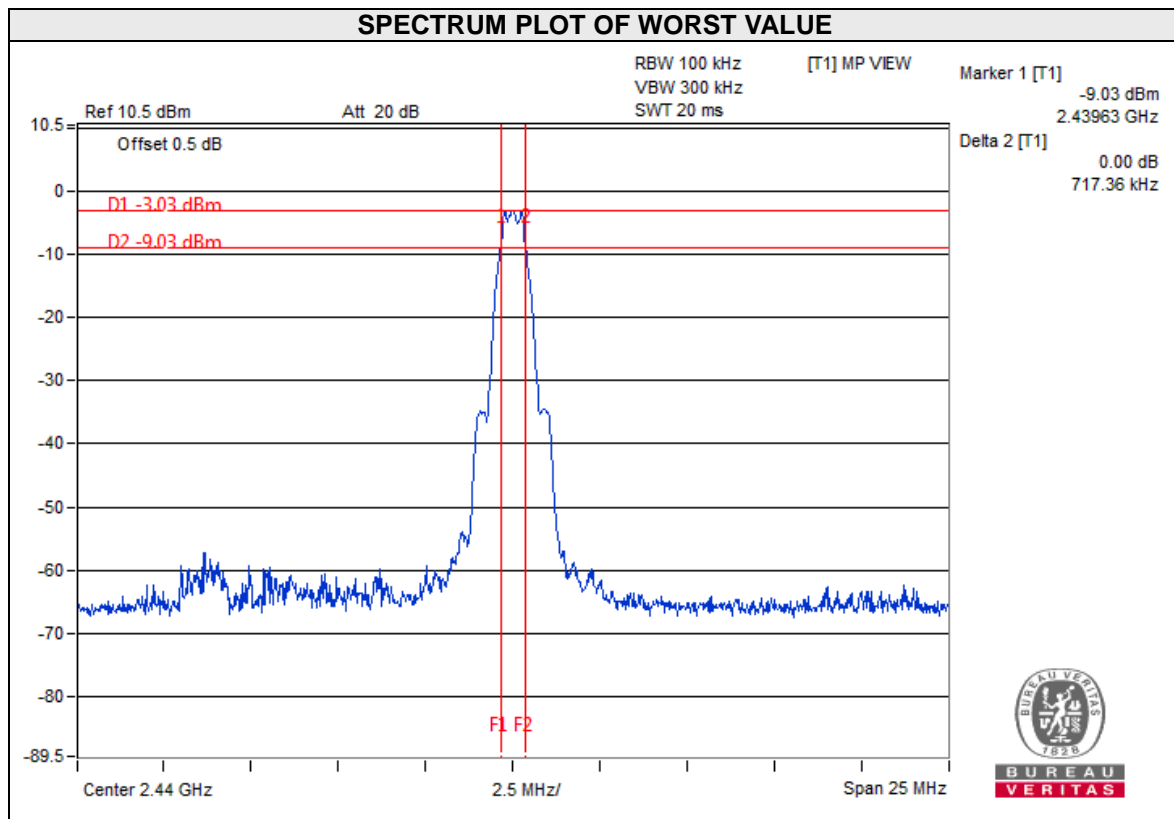

5.4 Conducted Output Power Measurement

5.4.1 Limits OF Conducted Output Power Measurement

For systems using digital modulation in the 2400–2483.5 MHz bands: 1 Watt (30dBm)

5.4.2 Test Setup

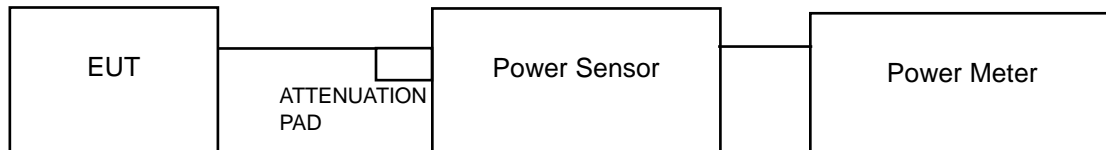

5.4.3 Test Instruments

Refer to section 4.1.2 to get information of above instrument.

5.4.4 Test Procedures

A peak / average power sensor was used on the output port of the EUT. A power meter was used to read the response of the peak / average power sensor. Record the power level.

5.4.5 Deviation from Test Standard

No deviation.

5.4.6 EUT Operating Conditions

Same as Item 4.3.6.

5.4.7 Test Results

CHANNEL	FREQUENCY (MHz)	PEAK POWER (mW)	PEAK POWER (dBm)	LIMIT (dBm)	PASS/FAIL
0	2402	0.217	-6.64	30	PASS
19	2440	0.511	-2.92	30	PASS
39	2480	0.348	-4.58	30	PASS

5.5 Power Spectral Density Measurement

5.5.1 Limits of Power Spectral Density Measurement

The Maximum of Power Spectral Density Measurement is 8dBm.

5.5.2 Test Setup

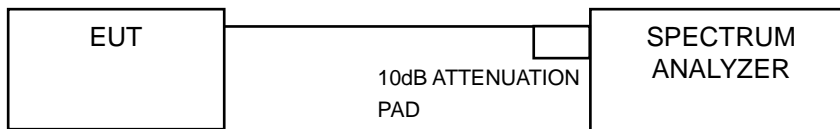

5.5.3 Test Instruments

Refer to section 4.1.2 to get information of above instrument.

5.5.4 Test Procedure

- a. Set analyzer center frequency to DTS channel center frequency.
- b. Set the span to 1.5 times the DTS bandwidth.
- c. Set the RBW to: $3 \text{ kHz} \leq \text{RBW} \leq 100 \text{ kHz}$.
- d. Set the VBW $\geq 3 \times \text{RBW}$.
- e. Detector = peak.
- f. Sweep time = auto couple.
- g. Trace mode = max hold.
- h. Allow trace to fully stabilize.
- i. Use the peak marker function to determine the maximum amplitude level within the RBW.

5.5.5 Deviation from Test Standard

No deviation.

5.5.6 EUT Operating Condition

Same as Item 4.3.6

5.5.7 Test Results

Channel	Freq. (MHz)	PSD (dBm/3kHz)	Limit (dBm/3kHz)	PASS /FAIL
0	2402	-19.63	8	PASS
19	2440	-16.23	8	PASS
39	2480	-17.39	8	PASS

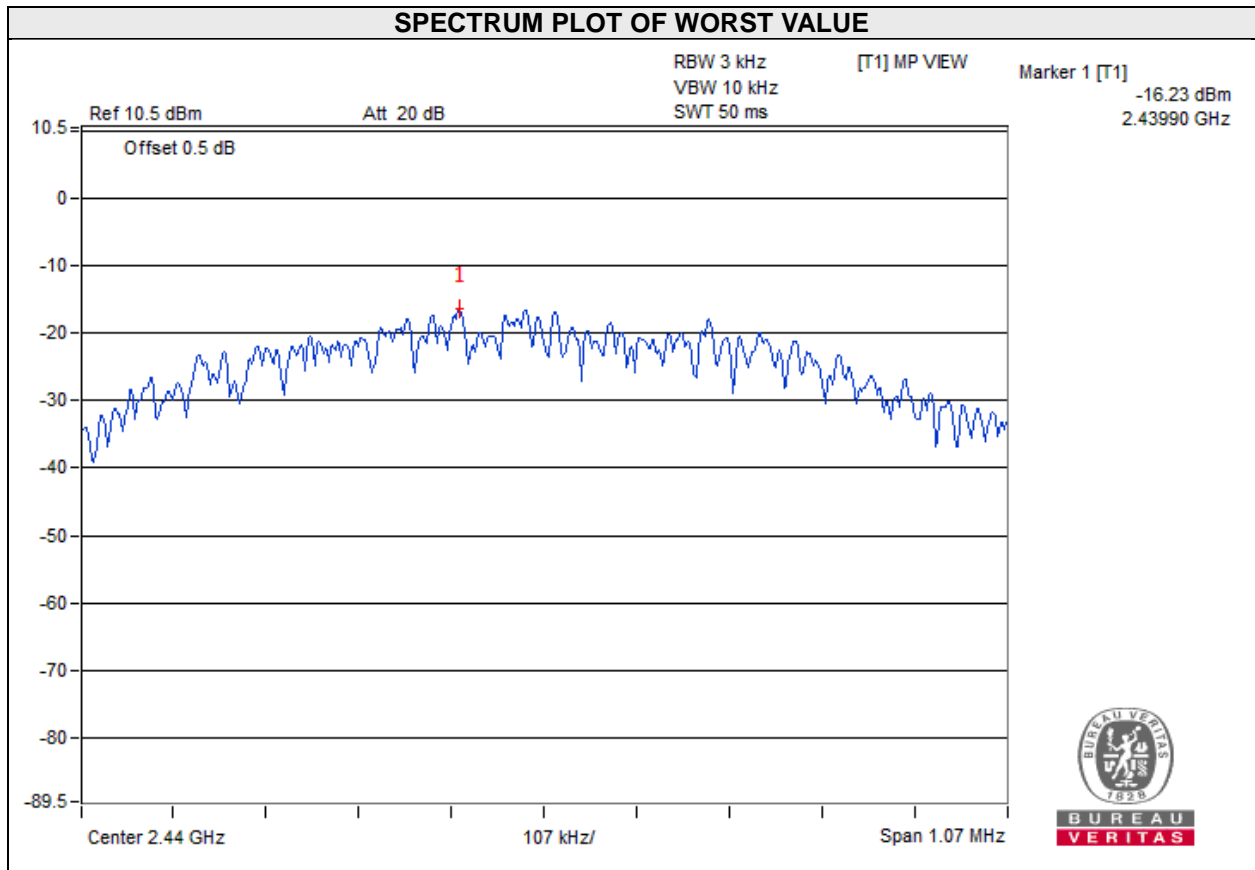

5.6 Conducted Out of Band Emission Measurement

5.6.1 Limits of Conducted Out of Band Emission Measurement

Below -20dB of the highest emission level of operating band (in 100kHz Resolution Bandwidth).

5.6.2 Test Setup

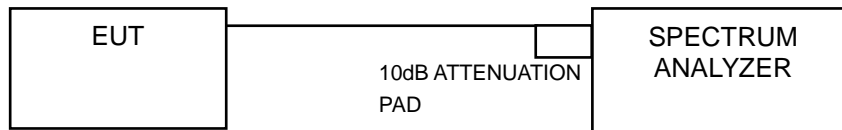

5.6.3 Test Instruments

Refer to section 4.1.2 to get information of above instrument.

5.6.4 Test Procedure

MEASUREMENT PROCEDURE REF

1. Set the RBW = 100 kHz.
2. Set the VBW \geq 300 kHz.
3. Detector = peak.
4. Sweep time = auto couple.
5. Trace mode = max hold.
6. Allow trace to fully stabilize.
7. Use the peak marker function to determine the maximum power level in any 100 kHz band segment within the fundamental EBW.

MEASUREMENT PROCEDURE OOB

1. Set RBW = 100 kHz.
2. Set VBW \geq 300 kHz.
3. Detector = peak.
4. Sweep = auto couple.
5. Trace Mode = max hold.
6. Allow trace to fully stabilize.
7. Use the peak marker function to determine the maximum amplitude level.

5.6.5 Deviation from Test Standard

No deviation.

5.6.6 EUT Operating Condition

Same as Item 4.3.6

5.6.7 TEST RESULTS

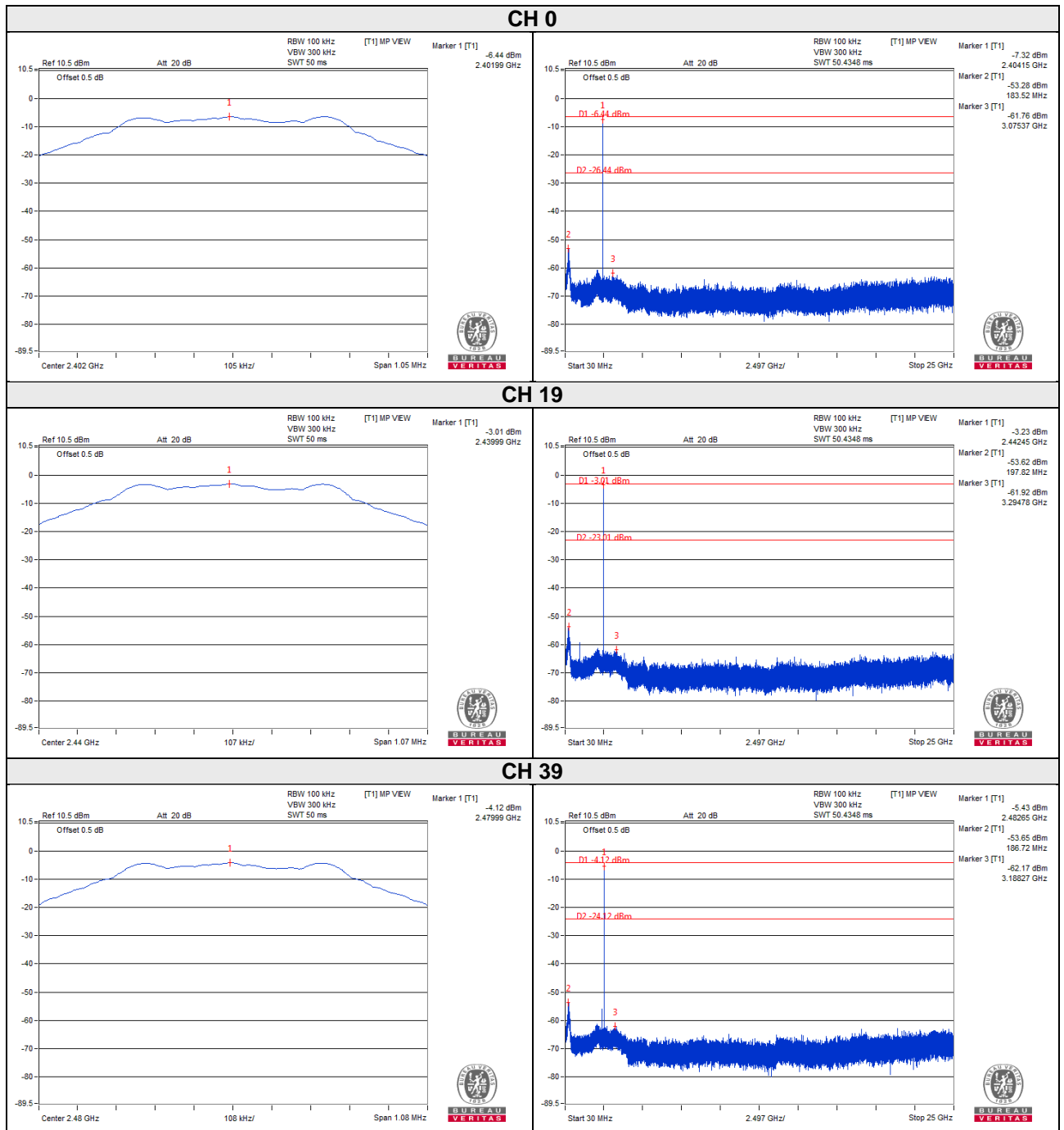

6 Pictures of Test Arrangements

Please refer to the attached file (Test Setup Photo).

Appendix – Information on the Testing Laboratories

We, Bureau Veritas Consumer Products Services (H.K.) Ltd., Taoyuan Branch, were founded in 1988 to provide our best service in EMC, Radio, Telecom and Safety consultation. Our laboratories are accredited and approved according to ISO/IEC 17025.

If you have any comments, please feel free to contact us at the following:

Linko EMC/RF Lab

Tel: 886-2-26052180

Fax: 886-2-26051924

Hsin Chu EMC/RF Lab/Telecom Lab

Tel: 886-3-5935343

Fax: 886-3-5935342

Hwa Ya EMC/RF/Safety

Tel: 886-3-3183232

Fax: 886-3-3270892

Email: service.adt@tw.bureauveritas.com

Web Site: www.bureauveritas-adt.com

The address and road map of all our labs can be found in our web site also.

--- END ---