

Test Report

Report Number: F110734E2, 2nd version

Applicant:

Robert Bosch Car Multimedia GmbH

Manufacturer:

Robert Bosch Car Multimedia GmbH

Equipment under Test (EUT):

CCD PROFESSIONAL (BT)

Article number: 7 620 200 026

Laboratory (CAB) accredited by
Deutsche Gesellschaft für Akkreditierung mbH
in compliance with DIN EN ISO/IEC 17025
under the Reg. No. DGA-PL-105/99-22,
FCC Test site registration number 90877 and
Industry Canada Test site registration IC3469A-1



REFERENCES

- [1] **ANSI C63.4-2009** American National Standard for Methods of Measuring of Radio-Noise Emissions from Low-Voltage Electrical and Electronic Equipment in the Range of 9 kHz to 40 GHz.
- [2] **FCC CFR 47 Part 15 (October 2009)** Radio Frequency Devices
- [3] **FCC Public Notice DA 00-705 (March 2000)**
- [4] **RSS-210 Issue 8 (December 2010)** Licence-exempt Radio Apparatus (All Frequency Bands): Category I Equipment
- [5] **RSS-Gen Issue 3 (December 2010)** General Requirements and Information for the Certification of Radio Apparatus
- [6] **Publication Number 913591 (March 2007)** Measurement of radiated emissions at the edge of the band for a Part 15 RF Device

TEST RESULT

The requirements of the tests performed as shown in the overview (clause 4) were fulfilled by the equipment under test.

The complete test results are presented in the following.

Test engineer:	Thomas KÜHN		13 April 2012
	_____	_____	_____
	Name	Signature	Date
Authorized reviewer:	Bernd STEINER		13 April 2012
	_____	_____	_____
	Name	Signature	Date

RESERVATION

This test report is only valid in its original form.

Any reproduction of its contents in extracts without written permission of the accredited test laboratory PHOENIX TESTLAB GmbH is prohibited.

The test results herein refer only to the tested sample. PHOENIX TESTLAB GmbH is not responsible for any generalisations or conclusions drawn from these test results concerning further samples. Any modification of the tested samples is prohibited and leads to the invalidity of this test report. Each page necessarily contains the PHOENIX TESTLAB Logo and the TEST REPORT NUMBER.

Contents:		Page
1	IDENTIFICATION.....	4
1.1	Applicant	4
1.2	Manufacturer	4
1.3	Test laboratory	4
1.4	EUT (Equipment Under Test)	5
1.5	Technical data of equipment	5
1.6	Dates	5
2	OPERATIONAL STATES.....	6
3	ADDITIONAL INFORMATION	7
4	OVERVIEW	7
5	TEST RESULTS.....	8
5.1	20 dB bandwidth	8
5.1.1	Method of measurement (20 dB bandwidth)	8
5.1.2	Test results (20 dB bandwidth).....	9
5.2	Carrier frequency separation	11
5.2.1	Method of measurement (carrier frequency separation)	11
5.2.2	Test results (carrier frequency separation)	12
5.3	Number of hopping frequencies.....	14
5.3.1	Method of measurement (number of hopping frequencies)	14
5.3.2	Test results (number of hopping frequencies)	15
5.4	Dwell time.....	16
5.4.1	Method of measurement (dwell time)	16
5.4.2	Test results (dwell time).....	17
5.5	Maximum peak output power.....	20
5.5.1	Method of measurement (maximum peak output power)	20
5.5.2	Test results (maximum peak output power)	21
5.6	Band-edge compliance	23
5.6.1	Method of measurement (band-edge compliance (radiated))	23
5.6.2	Test results (band-edge compliance (radiated)).....	24
5.7	Radiated emissions.....	28
5.7.1	Method of measurement (radiated emissions)	28
5.7.2	Test results (radiated emissions)	33
5.7.2.1	Preliminary radiated emission measurement (9 kHz to 1 GHz)	33
5.7.2.2	Final radiated emission test (30 MHz to 1 GHz).....	36
5.7.2.3	Preliminary radiated emission measurement (1 GHz to 25 GHz)	38
5.7.2.4	Final radiated emission measurement (1 GHz to 25 GHz).....	45
6	TEST EQUIPMENT AND ANCILLARIES USED FOR TESTS	48
7	REPORT HISTORY	49
8	LIST OF ANNEXES.....	49

1 IDENTIFICATION

1.1 Applicant

Name:	Robert Bosch Car Multimedia GmbH
Address:	Robert-Bosch-Straße 200
	31129 Hildesheim
Country:	Germany
Name for contact purposes:	Mr. Manfred AUFZUG
Phone:	+49 (0) 5121 49 26 08
Fax:	+49 (0) 5121 49 17 26 08
Mail address:	Manfred.Aufzug@de.bosch.com

1.2 Manufacturer

Name:	Robert Bosch Car Multimedia GmbH
Address:	Robert-Bosch-Straße 200
	31129 Hildesheim
Country:	Germany
Name for contact purposes:	Mr. Manfred AUFZUG
Phone:	+49 (0) 5121 49 26 08
Fax:	+49 (0) 5121 49 17 26 08
Mail address:	Manfred.Aufzug@de.bosch.com

1.3 Test laboratory

The tests were carried out at: **PHOENIX TESTLAB GmbH**
Königswinkel 10
32825 Blomberg
Germany

accredited by DGA Deutsche Gesellschaft für Akkreditierung mbH in compliance with DIN EN ISO/IEC 17025 under Reg. No. DGA-PL-105/99-22, FCC Test site registration number 90877 and Industry Canada Test site registration IC3469A-1.

1.4 EUT (Equipment Under Test)

Equipment under test: *	Coach radio with Bluetooth functionality
Model name: *	CCD PROFESSIONAL (BT)
Article number: *	7 620 200 026
FCC ID:	YBN-CCD-PROLINE3
IC:	9595A-CCDPROLINE3
Serial number:	815 CM0026 B 1406526
Hardware version:	C2
Software version:	V100430_EMG

1.5 Technical data of equipment

Fulfills Bluetooth specification: *	2.1 (without EDR)					
Antenna type: *	ISM2400 Vertical Embedded Antenna					
Antenna gain: *	3 dBi					
Rated output power: *	0.0 dBm (50 Ω)					
Antenna connector: *	None (SMB connector temporary installed for conducted tests)					
Power supply: *	$U_{nom} =$	12.0 V DC	$U_{min} =$	-	$U_{max} =$	-
Type of modulation: *	FHSS (GFSK)					
Operating frequency range:*	2402 MHz to 2480 MHz					
Number of channels: *	79					
Temperature range: *	-20 °C to +55 °C					

*: declared by the applicant

The following external I/O cables were used:

Identification	Connector		Length *
	EUT	Ancillary	
Power supply	Customer defined	-	2 m
-	-	-	-
-	-	-	-
-	-	-	-

*: Length during the test if no other specified.

1.6 Dates

Date of receipt of test sample:	08 March 2011
Start of test:	15 March 2011
End of test:	17 March 2011

2 OPERATIONAL STATES

The EUT is a coach radio providing Bluetooth functionality to take a telephone call using the Hands Free Profile (HFP). For the tests two modified samples were used. One with the internal antenna and one with a temporary antenna connector installed instead of the internal antenna. At both samples the UART interface of the Bluetooth chip was wired to an external connector.

If not otherwise stated, for modulating the transmitter, a pseudo random bit sequence with a length of 339 byte and with a pattern type DH5 was used. During all tests a power setting of 50 was used.

The Coach Control Display (CCD) ProLine 3 consists at least of three parts: The Coach control Display (CCD PROFESSIONAL (BT)), the Coach Cabin Selector (CCS) and the Coach Power Amplifier (CPA). Object of this test report is the Coach Control Display, which contains the Bluetooth part. Because the CCD is supplied by the CCS by regulated 12 V DC and the supply voltage of the Bluetooth part will be additionally regulated down to 5 V DC no tests under extreme supply voltages were carried out.

The spurious emission measurement was carried as radiated spurious emissions with the integrated antenna. The receiver spurious radiation measurement was carried out in the same manner. During the tests the test sample was powered with 12 V DC.

The operation mode was adjusted with the help of a configuration-software installed on a laptop computer. It was connected to the EUT via ALPS evaluation board to the UART interface of the Bluetooth part. After adjusting the operation mode the ALPS evaluation board and the PC were disconnected from the EUT.

The following operation modes were used during the tests:

Operation mode	Description of the operation mode	Modulation	Hopping mode
1, 1a, 1b	Continuous transmitting on 2402 MHz	GFSK	DH1, DH3, DH5
2, 2a, 2b	Continuous transmitting on 2441 MHz	GFSK	DH1, DH3, DH5
3, 3a, 3b	Continuous transmitting on 2480 MHz	GFSK	DH1, DH3, DH5
4, 4a, 4b	Transmitter hopping on all channels	GFSK	DH1, DH3, DH5
5	Continuous receiving on 2402 MHz		DH1, DH3, DH5
6	Continuous receiving on 2480 MHz		DH1

Physical boundary of the EUT

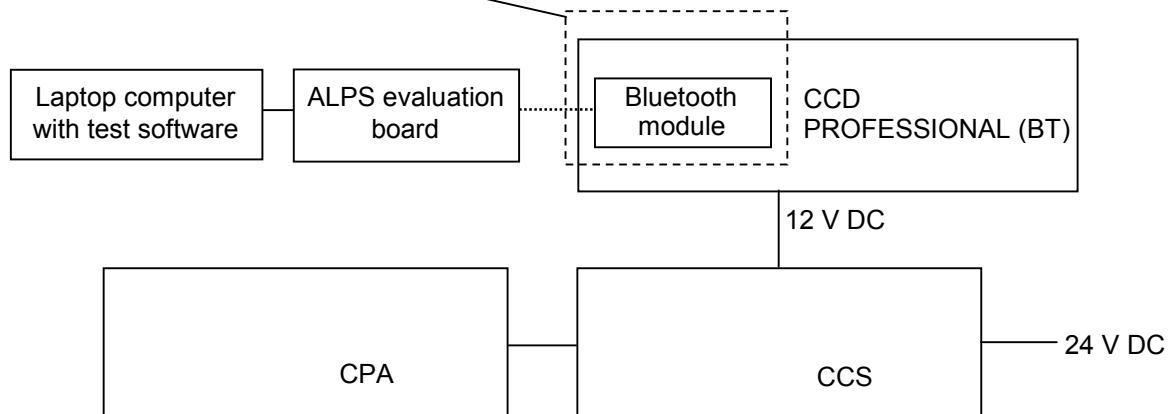

The following test modes were adjusted during the tests:

Preliminary tests were performed in different data rates and different orthogonal directions (if applicable), to find worst-case configuration and position. The data rate shown in the table below shows the found worst-case rate with respect to specific test item. The following table shows a list of the test modes used for the results, documented in this report. The radiated emission measurement was carried out in the orthogonal direction that emits the highest spurious emission levels.

Test items	Operation mode
Band edge compliance (radiated)	1b, 3b, 4b (1 Mbps)
Radiated emissions (transmitter)	1b, 2b, 3b (1 Mbps)
Radiated emissions (receiver)	5

3 ADDITIONAL INFORMATION

During the tests the EUT was not labelled with a label which fulfils the FCC / IC requirements.

4 OVERVIEW

Application	Frequency range [MHz]	FCC 47 CFR Part 15 section [2]	RSS 210, Issue 8 [4] or RSS-Gen, Issue 3 [5]	Status	Refer page
20 dB bandwidth	General	15.247 (a) (1)	A8.1 (a) [4]	Passed	8 et seq.
Carrier frequency separation	General	15.247 (a) (1)	A8.1 (b) [4]	Passed	11 et seq.
Number of hopping channels	2400.0 - 2483.5	15.247 (a) (1) (iii)	A8.1 (c) [4]	Passed	14 et seq.
Dwell time	2400.0 - 2483.5	15.247 (a) (1) (iii)	A8.1 (d) [4]	Passed	16 et seq.
Maximum peak output power	2400.0 - 2483.5	15.247 (b) (1)	A8.4 (2) [4]	Passed	20 et seq.
Band edge compliance	2400.0 - 2483.5	15.247 (d)	A8.5 [4]	Passed	23 et seq.
Radiated emissions (transmitter)	0.009 - 25,000	15.205 (a) 15.209 (a)	A8.5 [4] 2.5 [4]	Passed	28 et seq.
Conducted emissions on supply line	0.15 - 30	15.207 (a)	7.2.2 [5]	Not applicable *	
Radiated emissions (receiver)	0.009 - 25,000	15.109 (a)	6 [5]	Passed	Annex D

*: Not applicable because of vehicular environment.

5 TEST RESULTS

5.1 20 dB bandwidth

5.1.1 Method of measurement (20 dB bandwidth)

The calibration of the spectrum analyser has to be checked with the help of a known signal from a signal generator. The EUT has to be connected to the spectrum analyser via a low loss cable. If the EUT is not equipped with an antenna connector, a temporary antenna connector has to be installed. The EUT has to be switched on and the hopping function has to be disabled, the transmitter shall work with its maximum data rate.

The following spectrum analyser settings shall be used:

- Span: App. 2 to 3 times the 20 dB bandwidth, centred on the actual hopping channel.
- Resolution bandwidth: $\geq 1\%$ of the 20 dB bandwidth.
- Video bandwidth: \geq the resolution bandwidth.
- Sweep: Auto.
- Detector function: peak.
- Trace mode: Max hold.

After trace stabilisation the marker shall be set on the signal peak. The first display line has to be set on this value. The second display line has to be set 20 dB below the first line (or the peak marker). The frequency lines shall be set on the intersection points between the second display line and the measured curve.

The measurement will be performed at the upper, the lower end and the middle of the assigned frequency band.

Test set-up:

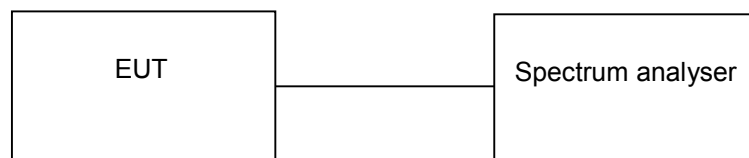

5.1.2 Test results (20 dB bandwidth)

Ambient temperature	21 °C	Relative humidity	37 %
---------------------	-------	-------------------	------

110734_56.wmf: 20 dB bandwidth at the lower end of the assigned frequency band:

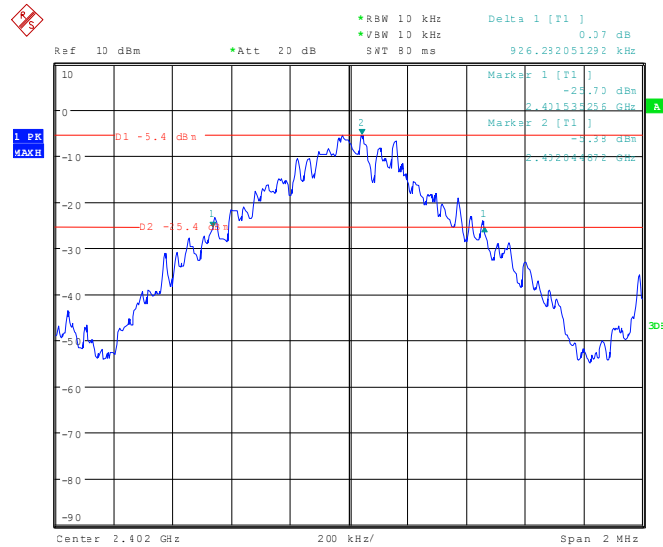

110734_57.wmf: 20 dB bandwidth at the middle of the assigned frequency band:

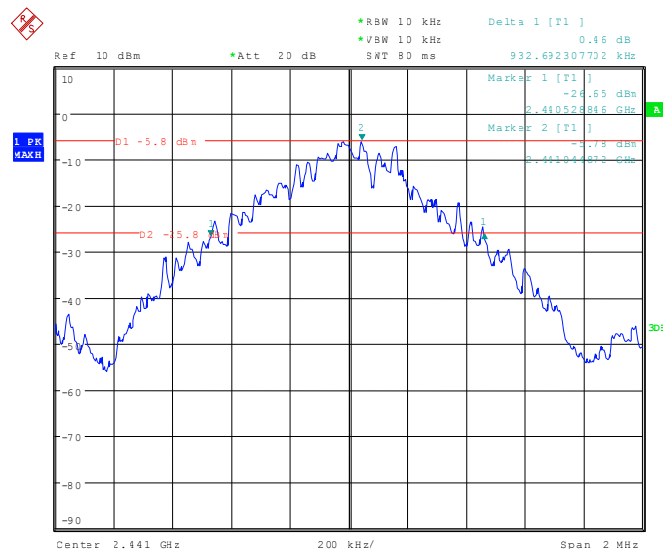

110734_58.wmf: 20 dB bandwidth at the upper end of the assigned frequency band:

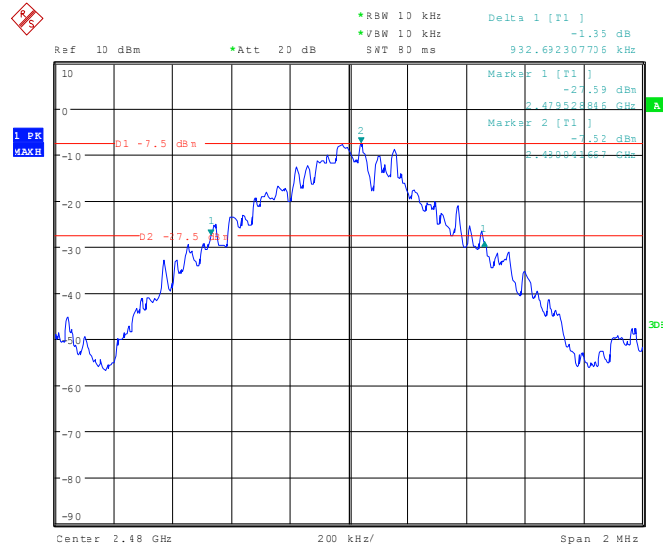

Channel number	Channel frequency [MHz]	20 dB bandwidth [kHz]
Operation mode 1b, 2b, 3b		
0	2402	926.282
39	2441	932.692
78	2480	932.692
Measurement uncertainty		+0.66 dB / -0.72 dB

TEST EQUIPMENT USED FOR THE TEST:

165

5.2 Carrier frequency separation

5.2.1 Method of measurement (carrier frequency separation)

The calibration of the spectrum analyser has to be checked with the help of a known signal from a signal generator. The EUT has to be connected to the spectrum analyser via a low loss cable. If the EUT is not equipped with an antenna connector, a temporary antenna connector has to be installed. The EUT has to be switched on and the hopping function has to be enabled.

The following spectrum analyser settings shall be used:

- Span: Wide enough to capture the peaks of two adjacent channels.
- Resolution bandwidth: ≥ 1 % of the span.
- Video bandwidth: \geq the resolution bandwidth.
- Sweep: Auto.
- Detector function: peak.
- Trace mode: Max hold.

After trace stabilisation the marker and the delta marker function will be used to determine the separation between the peaks of two adjacent channel signals.

The measurement will be performed at the upper, the lower end and the middle of the assigned frequency band.

Test set-up:

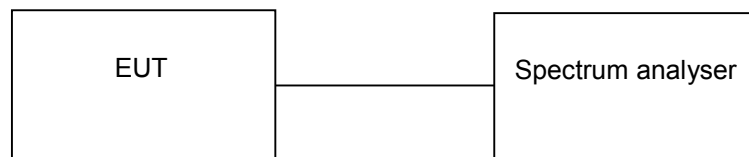

5.2.2 Test results (carrier frequency separation)

Ambient temperature	21 °C	Relative humidity	37 %
---------------------	-------	-------------------	------

110734_59.wmf: Channel separation at the lower end of the assigned frequency band:

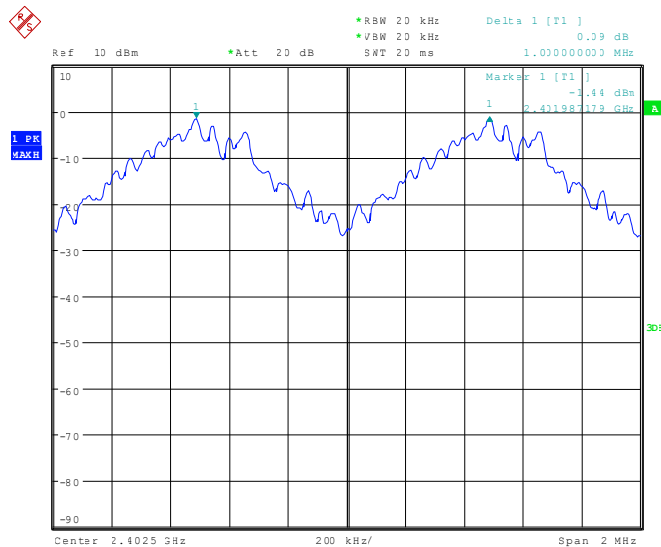

110734_60.wmf: Channel separation at the middle of the assigned frequency band:

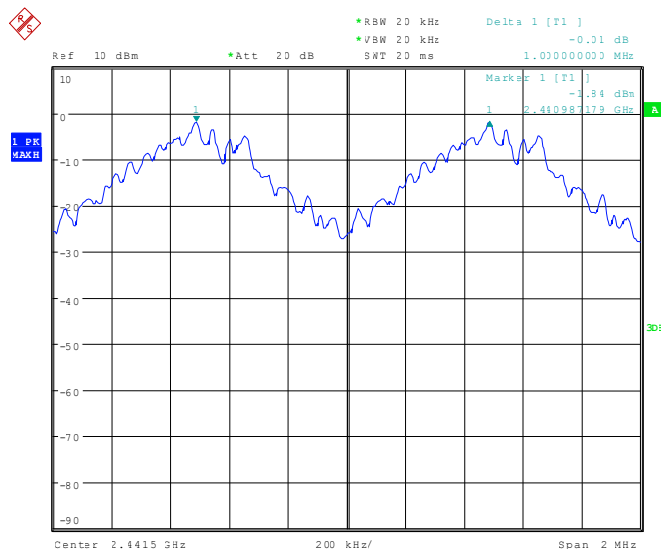

110734_61.wmf: Channel separation at the upper end of the assigned frequency band:

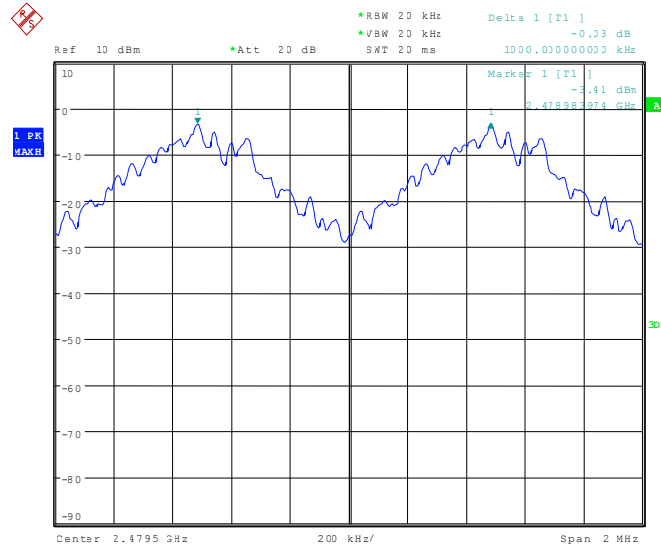

Channel number	Channel frequency [MHz]	Channel separation [kHz]	Minimum limit [kHz]
Operation mode 4			
0	2402	1000.000	617.521 ($\frac{2}{3}$ of the 20 dB bandwidth)
39	2441	1000.000	621.795 ($\frac{2}{3}$ of the 20 dB bandwidth)
78	2480	1000.000	621.795 ($\frac{2}{3}$ of the 20 dB bandwidth)
Measurement uncertainty			$<10^{-7}$

Test result: Passed

TEST EQUIPMENT USED FOR THE TEST:

165

5.3 Number of hopping frequencies

5.3.1 Method of measurement (number of hopping frequencies)

The calibration of the spectrum analyser has to be checked with the help of a known signal from a signal generator. The EUT has to be connected to the spectrum analyser via a low loss cable. If the EUT is not equipped with an antenna connector, a temporary antenna connector has to be installed. The EUT has to be switched on and the hopping function has to be enabled.

The following spectrum analyser settings shall be used:

- Span: Equal to the assigned frequency band.
- Resolution bandwidth: $\geq 1\%$ of the span.
- Video bandwidth: \geq the resolution bandwidth.
- Sweep: Auto.
- Detector function: Peak.
- Trace mode: Max hold.

After trace stabilisation the number of hopping channels could be counted. It might be possible to divide the span into some sub ranges in order to clearly show all hopping frequencies.

Test set-up:

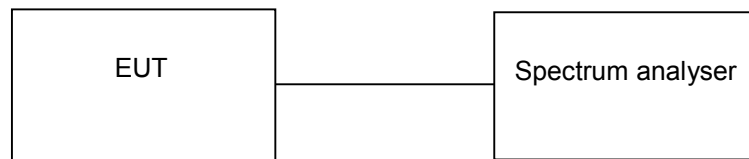

5.3.2 Test results (number of hopping frequencies)

Ambient temperature	21 °C
---------------------	-------

Relative humidity	37 %
-------------------	------

110734_62.wmf: Number of hopping channels:

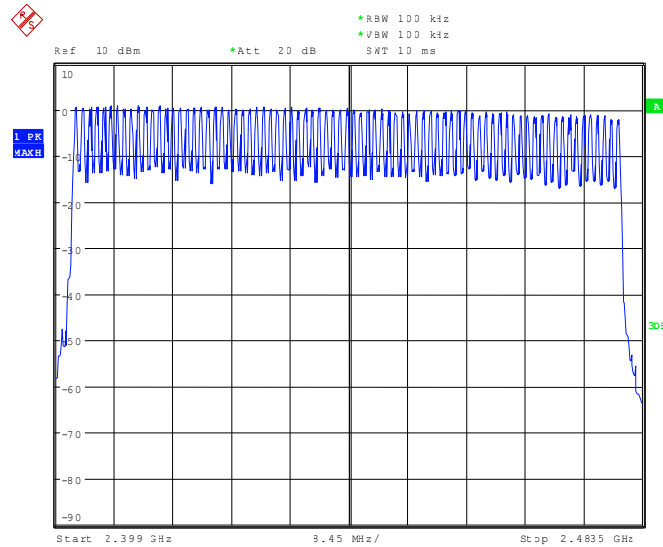

Number of hopping channels	Limit
79	At least 15

TEST EQUIPMENT USED FOR THE TEST:

165

5.4 Dwell time

5.4.1 Method of measurement (dwell time)

The calibration of the spectrum analyser has to be checked with the help of a known signal from a signal generator. The EUT has to be connected to the spectrum analyser via a low loss cable. If the EUT is not equipped with an antenna connector, a temporary antenna connector has to be installed. The EUT has to be switched on and the hopping function has to be enabled.

The following spectrum analyser settings shall be used:

- Span: Zero, centred on a hopping channel.
- Resolution bandwidth: 1 MHz.
- Video bandwidth: \geq the resolution bandwidth.
- Sweep: As necessary to capture the entire dwell time per hopping channel.
- Detector function: peak.
- Trace mode: Max hold.

The marker and delta marker function of the spectrum analyser will be used to determine the dwell time.

The measurement will be performed at the upper and lower end and the middle of the assigned frequency band.

If the EUT is possible to operate with different mode of operation (data rates, modulation formats etc.) the test will be repeated with every different operation mode of the EUT.

Test set-up:

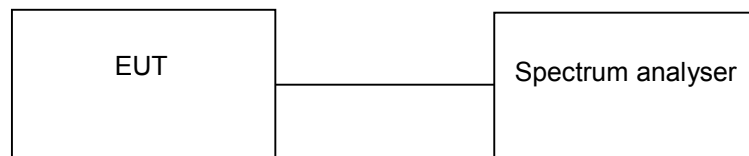

5.4.2 Test results (dwell time)

Ambient temperature	21 °C	Relative humidity	37 %
---------------------	-------	-------------------	------

110734_53.wmf: Dwell time at the middle of the assigned frequency band (operation mode 2):

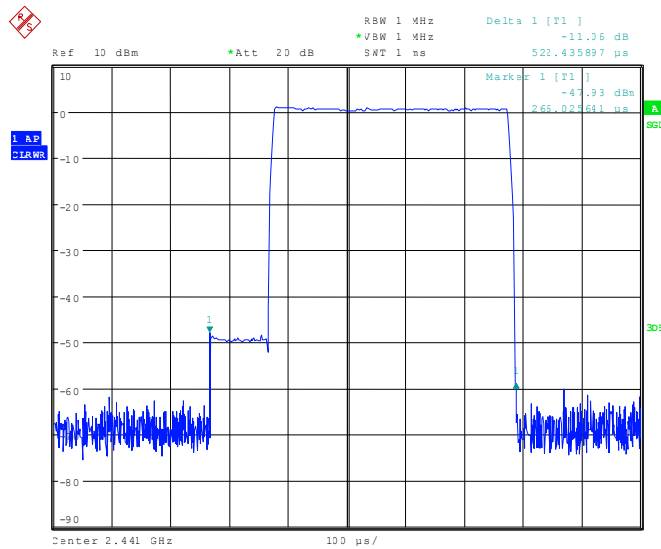

110734_54.wmf: Dwell time at the middle of the assigned frequency band (operation mode 2a):

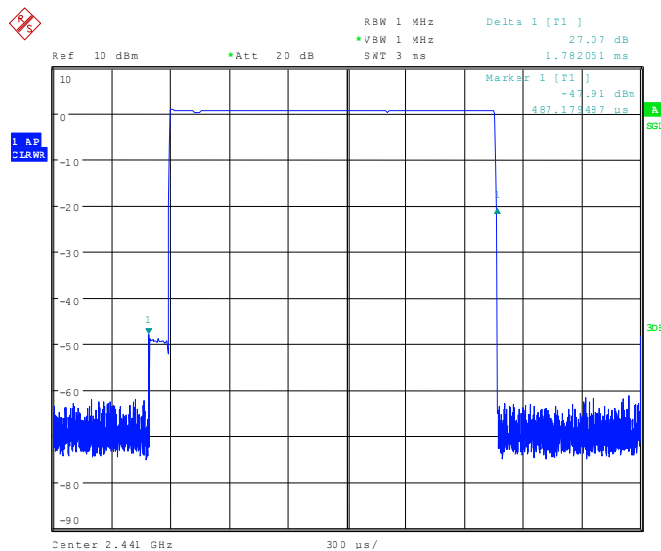

110734_55.wmf: Dwell time at the middle of the assigned frequency band (operation mode 2b):

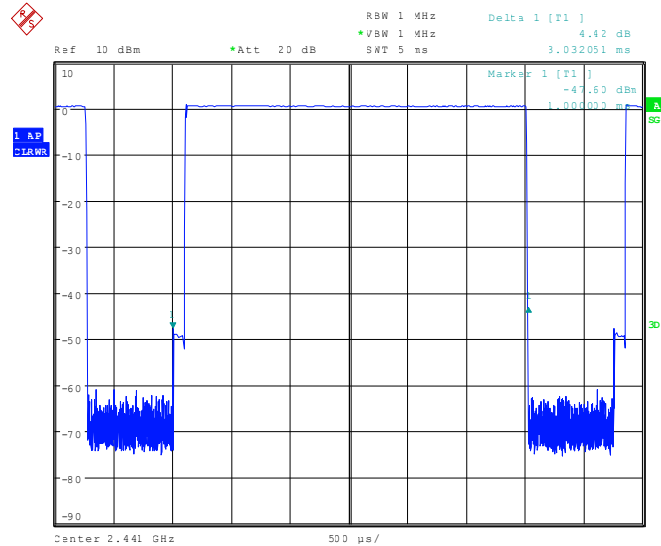

The dwell time is calculated with the following formula:

Dwell time = $t_{\text{pulse}} \times n_{\text{hops}} / \text{number of hopping channels} \times 31.6$ (equal to 0.4 s x number of hopping channels)

Where:

t_{pulse} is the measured pulse time (pls. refer the plots of the spectrum analyser above) [s],
 n_{hops} is the number of hops per second in the actual operating mode of the transmitter [1/s].

The hopping rate of the system is 1600 hops per second and the system uses 79 channels. For this reason one time slot has a length of 625 μs .

With the used hopping mode (DH1) a packet need 1 timeslot for transmitting and the next timeslot for receiving. So the system makes in worst case 800 hops per second in transmit mode ($n_{\text{hops}} = 800 \text{ 1/s}$).

With the used hopping mode (DH3) a packet need 3 timeslots for transmitting and the next timeslot for receiving. So the system makes in worst case 400 hops per second in transmit mode ($n_{\text{hops}} = 400 \text{ 1/s}$).

With the used hopping mode (DH5) a packet need 5 timeslots for transmitting and the next timeslot for receiving. So the system makes in worst case 267 hops per second in transmit mode ($n_{\text{hops}} = 267 \text{ 1/s}$).

Operation mode 2				
Channel number	Channel frequency [MHz]	t_{pulse} [μs]	Dwell time [ms]	Limit [ms]
39	2441	522.436	167.180	400
Operation mode 2a				
Channel number	Channel frequency [MHz]	t_{pulse} [μs]	Dwell time [ms]	Limit [ms]
39	2441	1.782	285.120	400
Operation mode 2b				
Channel number	Channel frequency [MHz]	t_{pulse} [μs]	Dwell time [ms]	Limit [ms]
39	2441	3.032	323.414	400
Measurement uncertainty			$<10^{-7}$	

Test result:

Passed

TEST EQUIPMENT USED FOR THE TEST:

165

5.5 Maximum peak output power

5.5.1 Method of measurement (maximum peak output power)

The calibration of the spectrum analyser has to be checked with the help of a known signal from a signal generator. The EUT has to be connected to the spectrum analyser via a low loss cable. If the EUT is not equipped with an antenna connector, a temporary antenna connector has to be installed. The EUT has to be switched on and the hopping function has to be disabled.

The following spectrum analyser settings shall be used:

- Span: Approx. 5 times the 20 dB bandwidth, centred on a hopping channel.
- Resolution bandwidth: > the 20 dB bandwidth of the emission being measured.
- Video bandwidth: \geq the resolution bandwidth.
- Sweep: Auto.
- Detector function: peak.
- Trace mode: Max hold.

After trace stabilisation the marker shall be set on the signal peak. The indicated level is the peak output power, which has to be corrected with the value of the cable loss and an external attenuation (if necessary).

The measurement will be performed at the upper and lower end and the middle of the assigned frequency band.

Test set-up:

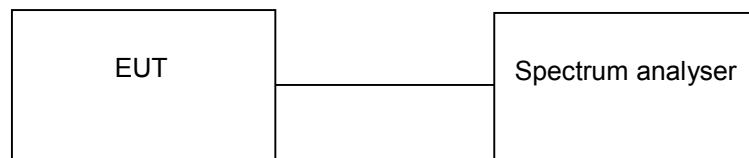

5.5.2 Test results (maximum peak output power)

Ambient temperature	21 °C	Relative humidity	37 %
---------------------	-------	-------------------	------

110734_63.wmf: Maximum peak output power at the lower end of the assigned frequency band (operation mode 1):

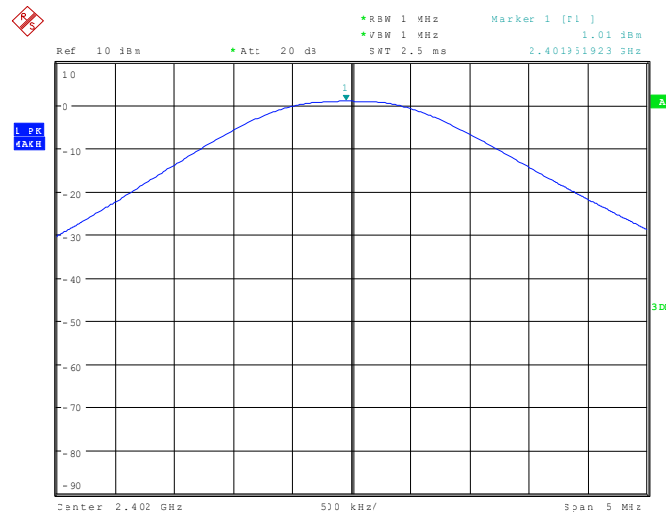

110734_64.wmf: Maximum peak output power at the middle of the assigned frequency band (operation mode 2):

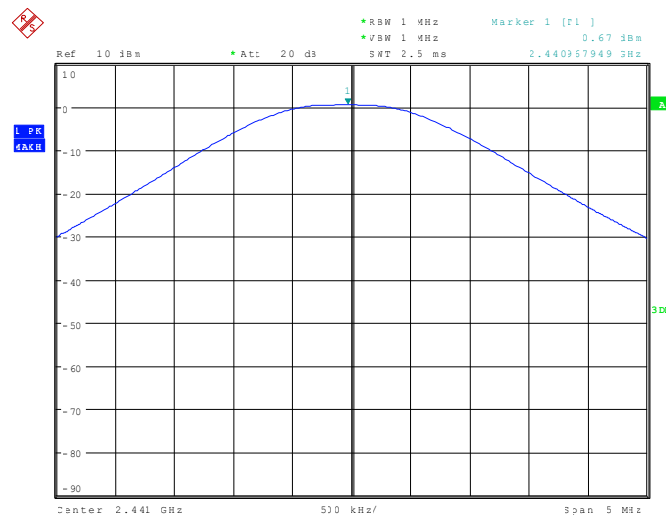

110734_65.wmf: Maximum peak output power at the upper end of the assigned frequency band (operation mode 3):

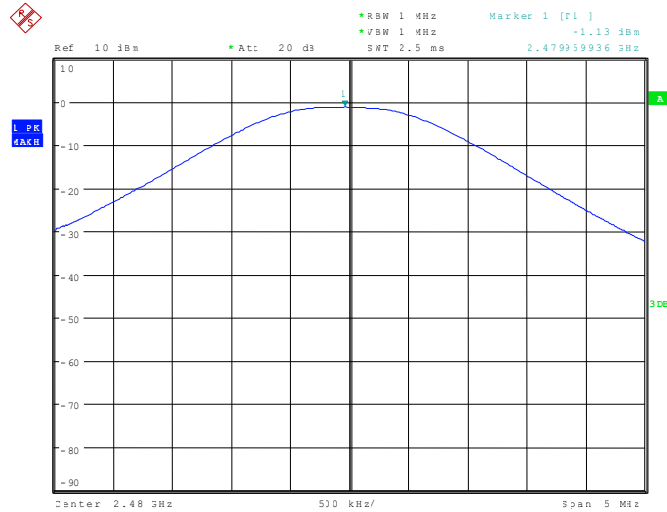

Operation mode	Channel number	Channel frequency [MHz]	Maximum peak output power [dBm]	Antenna gain [dBi]	Peak power limit [dBm]
1	0	2402	1.0	3.0	30.0
2	39	2441	0.7	3.0	30.0
3	78	2480	-1.1	3.0	30.0
Measurement uncertainty				+0.66 dB / -0.72 dB	

Test result: Passed

TEST EQUIPMENT USED FOR THE TEST:

165

5.6 Band-edge compliance

5.6.1 Method of measurement (band-edge compliance (radiated))

The same test set-up as used for the final radiated emission measurement shall be used (refer also subclause 5.2.1 of this test report). The measurements shall be carried out with using a resolution bandwidth of 100 kHz.

The following spectrum analyser settings shall be used:

- Span: Wide enough to capture the peak level of the emission on the channel closest to the band-edge, as well as any modulation products, which fall outside the assigned frequency band.
- Resolution bandwidth: 100 kHz.
- Video bandwidth: \geq the resolution bandwidth.
- Sweep: Auto.
- Detector function: Peak.
- Trace mode: Max hold.

After trace stabilisation the marker shall be set on the signal peak. The first display line has to be set on this value. The second display line has to be set 20 dB below the first line (or the peak marker). The frequency line shall be set on the edge of the assigned frequency band. Set the second marker on the emission at the band-edge, or on the highest modulation product outside of the band, if this level is higher than that at the band-edge. This frequency shall be measured with the EMI receiver as described in subclause 5.2.1 of this test report, but 100 kHz resolution bandwidth shall be used.

The measurement will be performed at the upper end of the assigned frequency band and with hopping on and off.

5.6.2 Test results (band-edge compliance (radiated))

Ambient temperature	21 °C	Relative humidity	38 %
---------------------	-------	-------------------	------

110734_25.wmf: Radiated band-edge compliance, lower band edge, hopping off:

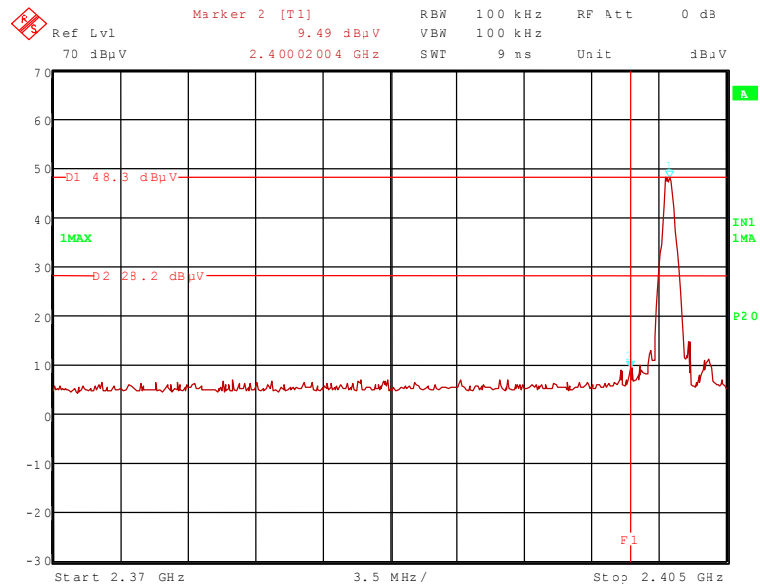

110734_30.wmf: Radiated band-edge compliance, lower band edge, hopping on:

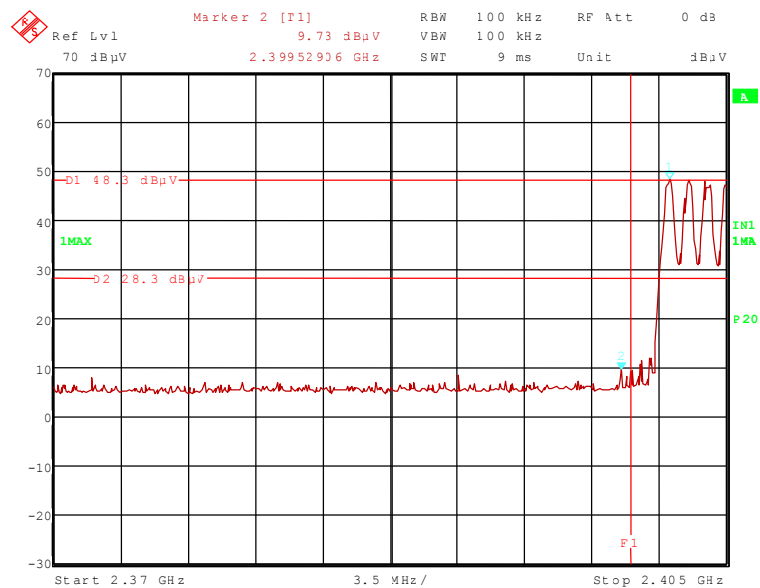

110734_28.wmf: Radiated band-edge compliance, upper band edge, hopping off:

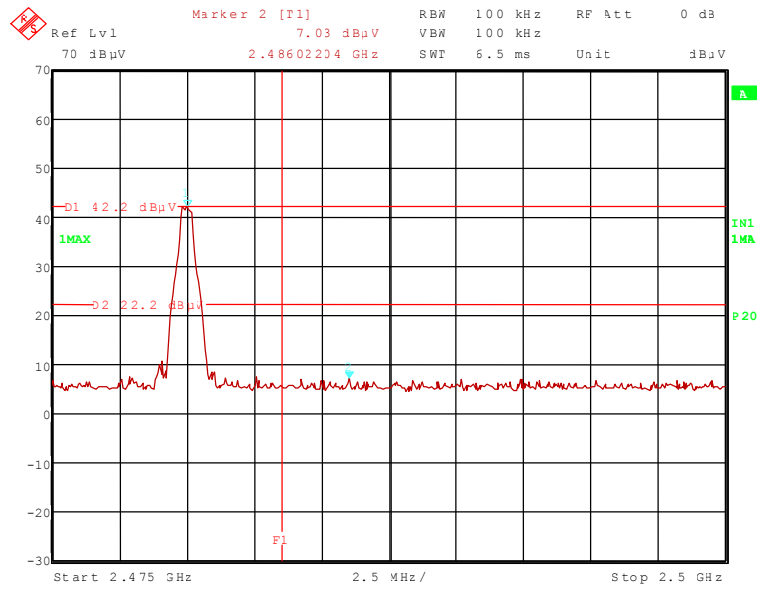

110734_29.wmf: Radiated band-edge compliance, upper band edge, hopping on:

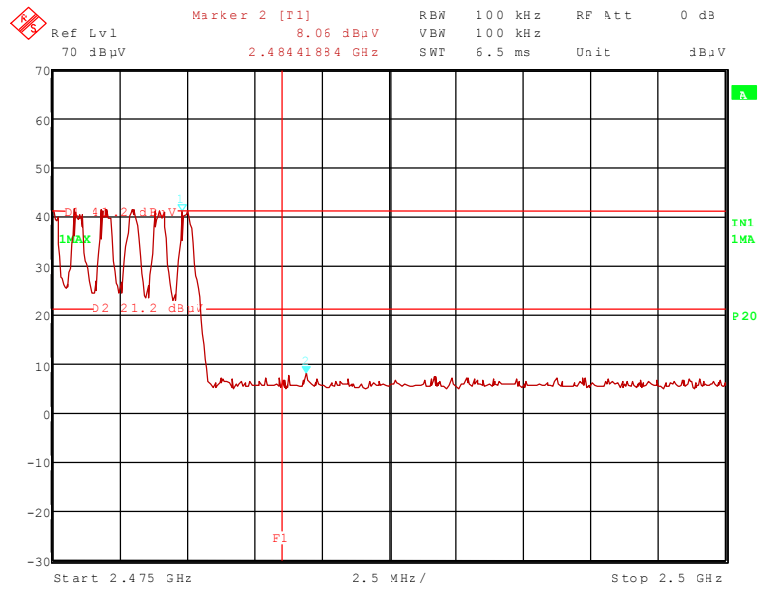

The plots on the page before are showing the radiated band-edge compliance for the upper band-edge, with and without hopping. The display line 1 (D1) in these plots represents the highest level within the assigned frequency band. The display line 2 (D2) represents the 20 dB offset to this highest level and shows the compliance with FCC 47 CFR Part 15.247 (d). The frequency line 1 (F1) shows the edge of the assigned frequency.

Band-edge compliance (lower band edge. hopping disabled)										
Result measured with the peak detector:										
Frequency GHz	Corr. value dBµV/m	Limit dBµV/m	Margin dB	Readings dBµV	Antenna factor 1/m	Preamplifier dB	Cable loss dB	Height cm	Pol.	Restr. Band
2.402	80.5	-	-	48.5	28.3	0.0	3.7	150	Vert.	-
2.400	43.4	74.0	30.6	11.4	28.3	0.0	3.7	150	Vert.	No
Result measured with the average detector:										
Frequency GHz	Corr. value dBµV/m	Limit dBµV/m	Margin dB	Readings dBµV	Antenna factor 1/m	Preamplifier dB	Cable loss dB	Height cm	Pol.	Restr. Band
2.402	69.9	-	-	37.9	28.3	0.0	3.7	150	Vert.	-
2.400	27.2	54.0	26.8	-4.8	28.3	0.0	3.7	150	Vert.	No
Measurement uncertainty							+2.2 dB / -3.6 dB			

Band-edge compliance (lower band edge. hopping enabled)										
Result measured with the peak detector:										
Frequency GHz	Corr. value dBµV/m	Limit dBµV/m	Margin dB	Readings dBµV	Antenna factor 1/m	Preamplifier dB	Cable loss dB	Height cm	Pol.	Restr. Band
2.402	80.5	-	-	48.5	28.3	0.0	3.7	150	Vert.	-
2.3996	39.4	74.0	34.6	7.4	28.3	0.0	3.7	150	Vert.	No
Result measured with the average detector:										
Frequency GHz	Corr. value dBµV/m	Limit dBµV/m	Margin dB	Readings dBµV	Antenna factor 1/m	Preamplifier dB	Cable loss dB	Height cm	Pol.	Restr. Band
2.402	69.9	-	-	37.9	28.3	0.0	3.7	150	Vert.	-
2.3996	26.2	54.0	27.8	-5.8	28.3	0.0	3.7	150	Vert.	No
Measurement uncertainty							+2.2 dB / -3.6 dB			

Band-edge compliance (upper band edge. hopping disabled)										
Result measured with the peak detector:										
Frequency GHz	Corr. value dB μ V/m	Limit dB μ V/m	Margin dB	Readings dB μ V	Antenna factor 1/m	Preamp dB	Cable loss dB	Height cm	Pol.	Restr. Band
2.480	74.6	-	-	42.3	28.5	0.0	3.8	150	Vert.	-
2.486	38.8	74.0	35.2	6.5	28.5	0.0	3.8	150	Vert.	Yes
Result measured with the average detector:										
Frequency GHz	Corr. value dB μ V/m	Limit dB μ V/m	Margin dB	Readings dB μ V	Antenna factor 1/m	Preamp dB	Cable loss dB	Height cm	Pol.	Restr. Band
2.480	64.1	-	-	31.8	28.5	0.0	3.8	150	Vert.	-
2.486	26.6	54.0	27.4	-5.7	28.5	0.0	3.8	150	Vert.	Yes
Measurement uncertainty							+2.2 dB / -3.6 dB			

Band-edge compliance (upper band edge. hopping enabled)										
Result measured with the peak detector:										
Frequency GHz	Corr. value dB μ V/m	Limit dB μ V/m	Margin dB	Readings dB μ V	Antenna factor 1/m	Preamp dB	Cable loss dB	Height cm	Pol.	Restr. Band
2.480	74.6	-	-	42.3	28.5	0.0	3.8	150	Vert.	-
2.4845	39.7	74.0	34.3	7.4	28.5	0.0	3.8	150	Vert.	Yes
Result measured with the average detector:										
Frequency GHz	Corr. value dB μ V/m	Limit dB μ V/m	Margin dB	Readings dB μ V	Antenna factor 1/m	Preamp dB	Cable loss dB	Height cm	Pol.	Restr. Band
2.480	64.1	-	-	31.8	28.5	0.0	3.8	150	Vert.	-
2.4845	26.6	54.0	27.4	-5.7	28.5	0.0	3.8	150	Vert.	Yes
Measurement uncertainty							+2.2 dB / -3.6 dB			

Test result: Passed

TEST EQUIPMENT USED FOR THE TEST:
29, 31 – 34, 36, 44

5.7 Radiated emissions

5.7.1 Method of measurement (radiated emissions)

The radiated emission measurement is subdivided into four stages.

- A preliminary measurement carried out in a fully anechoic chamber with a fixed antenna height in the frequency range 30 MHz to 1 GHz.
- A final measurement carried out on an open area test site with reflecting ground plane and various antenna height in the frequency range 30 MHz to 1 GHz.
- A preliminary measurement carried out in a fully anechoic chamber with a variable antenna distance and height in the frequency range 1 GHz to 110 GHz.
- A final measurement carried out in a fully anechoic chamber with a fixed antenna height in the frequency range 1 GHz to 110 GHz.

All measurements will be carried out with the EUT working on the middle of the assigned frequency band.

Preliminary measurement (30 MHz to 1 GHz)

In the first stage a preliminary measurement will be performed in a fully anechoic chamber with a measuring distance of 3 meter. Tabletop devices will set up on a non-conducting support with a size of 1 m by 1.5 m and a height of 80 cm. Floor-standing devices will be placed directly on the turntable/ground plane. The set up of the Equipment under test will be in accordance to ANSI C63.4-2009 [1].

The frequency range 30 MHz to 1 GHz will be measured with an EMI Receiver set to MAX Hold mode and a resolution bandwidth of 100 kHz. The measurement will be performed in horizontal and vertical polarisation of the measuring antenna and while rotating the EUT in its vertical axis in the range of 0 ° to 360 °.

The resolution bandwidth of the EMI Receiver will be set to the following values:

Frequency range	Resolution bandwidth
30 MHz to 230 MHz	100 kHz
230 MHz to 1 GHz	100 kHz

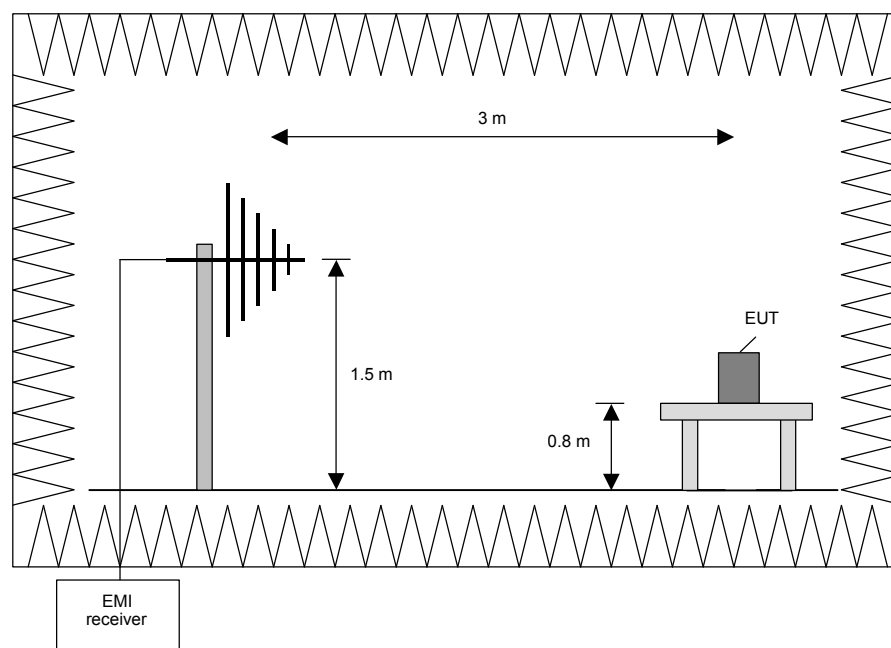

Procedure preliminary measurement:

Prescans were performed in the frequency range 30 MHz to 230 MHz and 230 MHz to 1 GHz.

The following procedure will be used:

1. Monitor the frequency range at horizontal polarisation and a EUT azimuth of 0 °.
2. Manipulate the system cables within the range to produce the maximum level of emission.
3. Rotate the EUT by 360 ° to maximize the detected signals.
4. Make a hardcopy of the spectrum.
5. Measure the frequency of the detected emissions with a lower span and resolution bandwidth to increase the accuracy and note the frequency value.
6. Repeat 1) to 4) with the other orthogonal axes of the EUT (because of EUT is a module and might be used in a handheld equipment application).
7. Repeat 1) to 5) with the vertical polarisation of the measuring antenna.

Final measurement (30 MHz to 1 GHz)

A final measurement on an open area test site will be performed on selected frequencies found in the preliminary measurement. During this test the EUT will be rotated in the range of 0 ° to 360 °, the measuring antenna will be set to horizontal and vertical polarisation and raised and lowered in the range from 1 m to 4 m to find the maximum level of emissions.

The resolution bandwidth of the EMI Receiver will be set to the following values:

Frequency range	Resolution bandwidth
30 MHz to 1 GHz	120 kHz

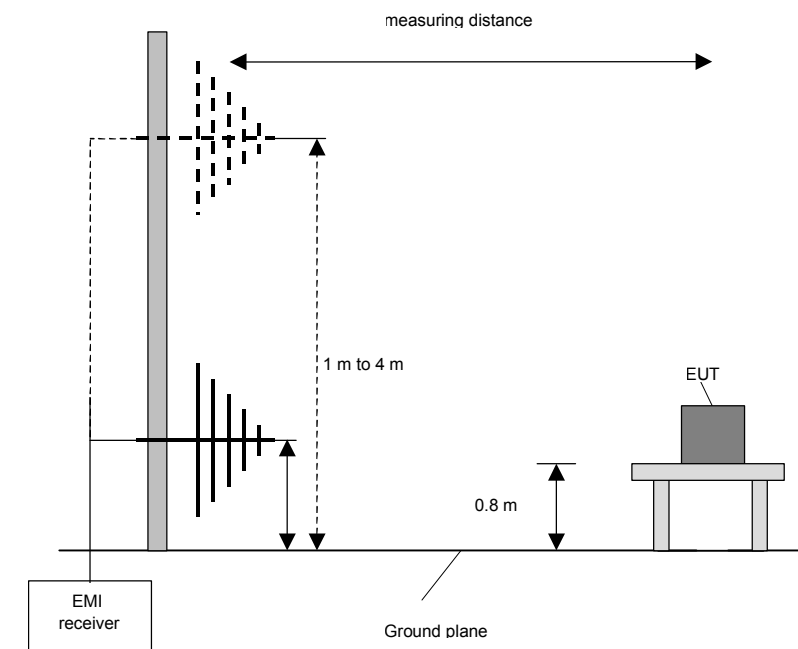

Procedure final measurement:

The following procedure will be used:

- 1) Measure on the selected frequencies at an antenna height of 1 m and a EUT azimuth of 23 °.
- 2) Move the antenna from 1 m to 4 m and note the maximum value at each frequency.
- 3) Rotate the EUT by 45 ° and repeat 2) until an azimuth of 337 ° is reached.
- 4) Repeat 1) to 3) for the other orthogonal antenna polarization.
- 5) Move the antenna and the turntable to the position where the maximum value is detected.
- 6) Measure while moving the antenna slowly +/- 1 m.
- 7) Set the antenna to the position where the maximum value is found.
- 8) Measure while moving the turntable +/- 45 °.
- 9) Set the turntable to the azimuth where the maximum value is found.
- 10) Measure with Final detector (QP and AV) and note the value.
- 11) Repeat 5) to 10) for each frequency.
- 12) Repeat 1) to 11) for each orthogonal axes of the EUT (because of EUT is a module and might be used in a handheld equipment application).

Preliminary and final measurement (1 GHz to 110 GHz)

This measurement will be performed in a fully anechoic chamber. Tabletop devices will set up on a non-conducting support with a size of 1 m by 1.5 m and a height of 80 cm. Floor-standing devices will be placed directly on the turntable/ground plane. The set up of the Equipment under test will be in accordance to ANSI C63.4-2009 [1].

Preliminary measurement (1 GHz to 110 GHz)

The frequency range will be divided into different sub ranges depending of the frequency range of the used horn antenna. The spectrum analyser set to MAX Hold mode and a resolution bandwidth of 100 kHz. The measurement will be performed in horizontal and vertical polarisation of the measuring antenna, the antenna close to the EUT and while moving the antenna over all sides of the EUT. With the spectrum analyser in CLEAR / WRITE mode the cone of the emission should be found and than the measuring distance will be set to 3 m with the receiving antenna moving in this cone of emission. At this position the final measurement will be carried out.

The resolution bandwidth of the EMI Receiver will be set to the following values:

Frequency range	Resolution bandwidth
1 GHz to 4 GHz	100 kHz
4 GHz to 12 GHz	100 kHz
12 GHz to 18 GHz	100 kHz
18 GHz to 26.5 GHz	100 kHz
26.5 GHz to 40 GHz	100 kHz
40 GHz to 60 GHz	100 kHz
50 GHz to 75 GHz	100 kHz
75 GHz to 110 GHz	100 kHz

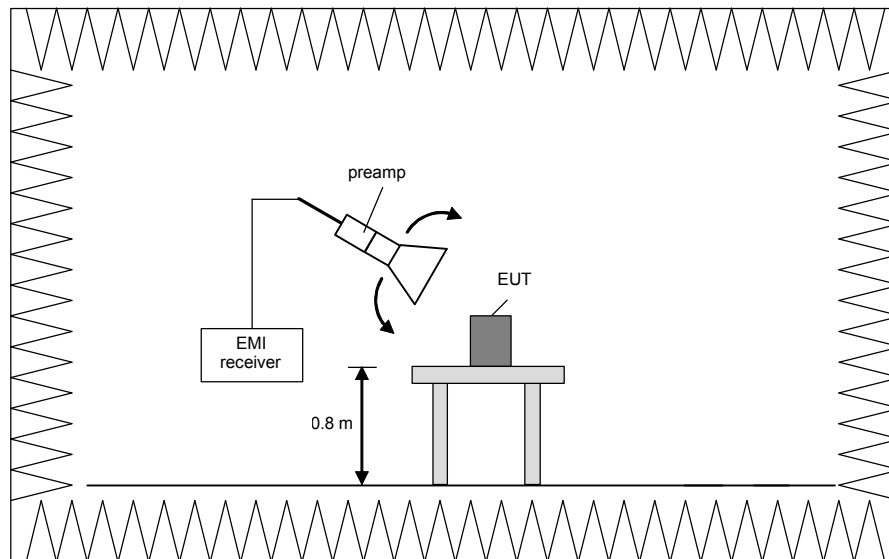

Final measurement (1 GHz to 110 GHz)

The frequency range will be divided into different sub ranges depending of the frequency range of the used horn antenna. The EMI Receiver set to peak and average mode and a resolution bandwidth of 1 MHz. The measurement will be performed in horizontal and vertical polarisation of the measuring antenna and while rotating the EUT in its vertical axis in the range of 0 ° to 360 ° in order to have the antenna inside the cone of radiation.

The resolution bandwidth of the EMI Receiver will be set to the following values:

Frequency range	Resolution bandwidth
1 GHz to 4 GHz	1 MHz
4 GHz to 12 GHz	1 MHz
12 GHz to 18 GHz	1 MHz
18 GHz to 26.5 GHz	1 MHz
26.5 GHz to 40 GHz	1 MHz
40 GHz to 60 GHz	1 MHz
50 GHz to 75 GHz	1 MHz
75 GHz to 110 GHz	1 MHz

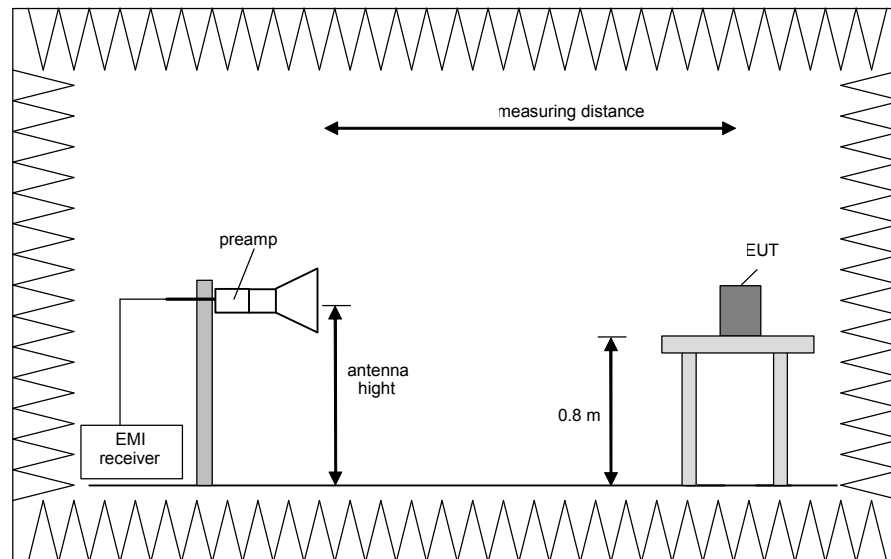

Procedure of measurement:

The measurements were performed in the frequency range 1 GHz to 4 GHz, 4 GHz to 12 GHz, 12 GHz to 18 GHz, 18 GHz to 26.5 GHz, 26.5 GHz to 40 GHz, 40 GHz to 60 GHz, 60 GHz to 75 GHz and 75 GHz to 110 GHz.

The following procedure will be used:

- 1) Monitor the frequency range at horizontal polarisation and move the antenna over all sides of the EUT (if necessary move the EUT to another orthogonal axis).
- 2) Change the antenna polarisation and repeat 1) with vertical polarisation.
- 3) Make a hardcopy of the spectrum.
- 4) Measure the frequency of the detected emissions with a lower span and resolution bandwidth to increase the accuracy and note the frequency value.
- 5) Change the analyser mode to Clear / Write and found the cone of emission.
- 6) Rotate and move the EUT, so that the measuring distance can be enlarged to 3 m and the antenna will be still inside the cone of emission.
- 7) Measure the level of the detected frequency with the correct resolution bandwidth, with the antenna polarisation and azimuth and the peak and average detector, which causes the maximum emission.
- 8) Repeat steps 1) to 7) for the next antenna spot if the EUT is larger than the antenna beamwidth.

Step 1) to 6) are defined as preliminary measurement.

5.7.2 Test results (radiated emissions)

5.7.2.1 Preliminary radiated emission measurement (9 kHz to 1 GHz)

Ambient temperature	20 °C	Relative humidity	43 %
---------------------	-------	-------------------	------

Position of EUT: The EUT was set-up on a non-conducting table of a height of 0.8 m. The distance between EUT and antenna was 3 m.

Cable guide: The cable of the EUT is running vertically to the false floor. For detail information of test set-up and the cable guide refer to the pictures in annex A of this test report.

Test record: All results are shown in the following.

Supply voltage: During all measurements the EUT was supplied with 12.0 V DC.

110734_19.wmf: Spurious emissions from 9 kHz to 150 kHz (operation mode 2):

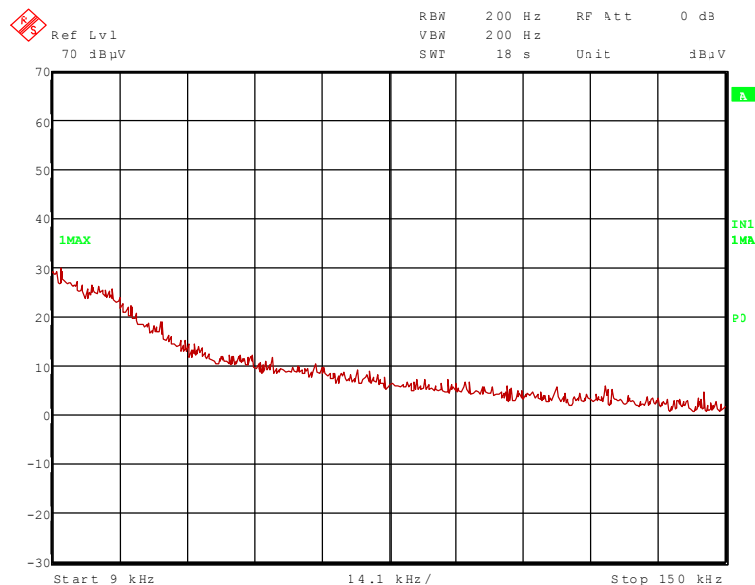

TEST EQUIPMENT USED FOR THE TEST:

29, 31 – 35, 43, 55

110734_20.wmf: Spurious emissions from 150 kHz to 1 MHz (operation mode 2):

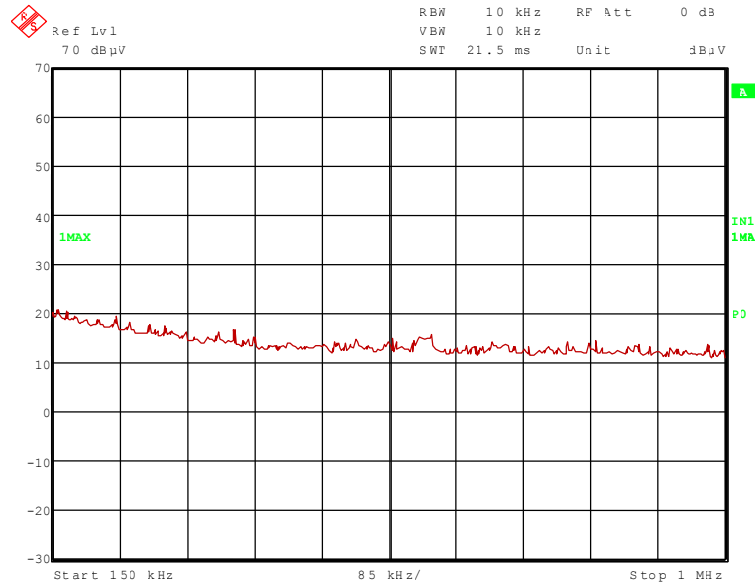

110734_21.wmf: Spurious emissions from 1 MHz to 30 MHz (operation mode 2):

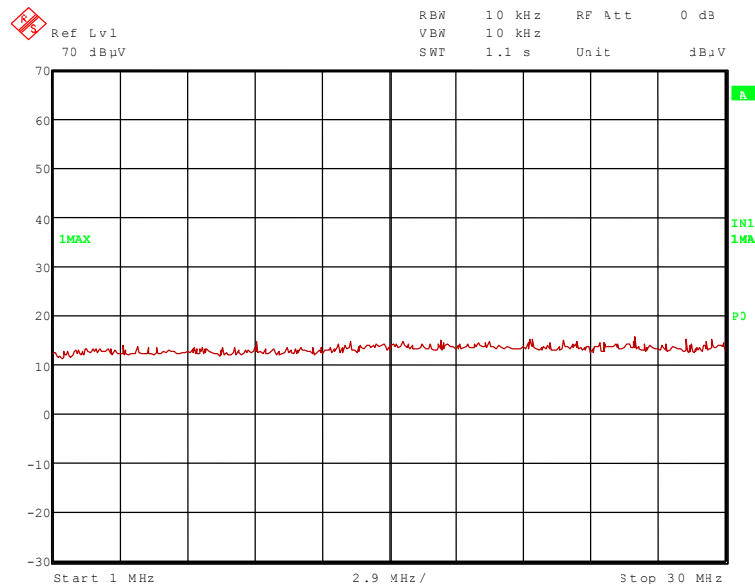

No significant frequencies above the noise floor of the system were found during the preliminary radiated emission test inside this frequency range, so no measurements were carried out on the outdoor test site.

110734_22.wmf: Spurious emissions from 30 MHz to 230 MHz (operation mode 2):

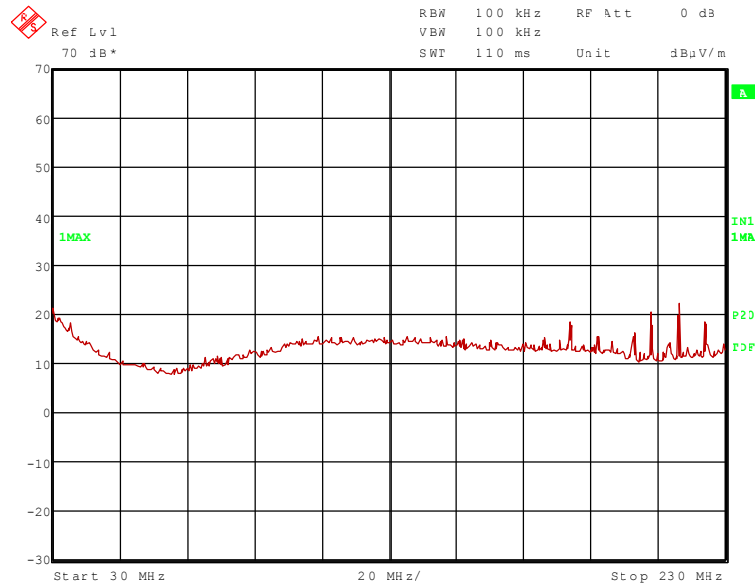

110734_23.wmf: Spurious emissions from 230 MHz to 1 GHz (operation mode 2):

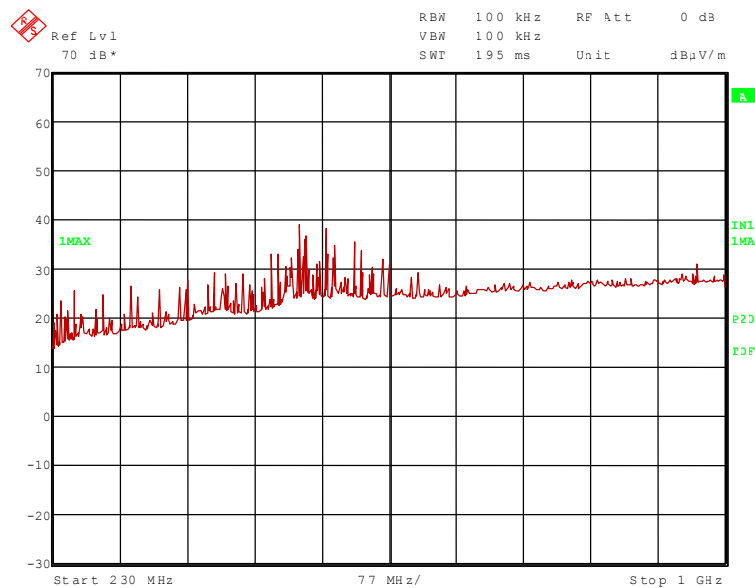

The following frequencies were found during the preliminary radiated emission test:

184.060 MHz, 192.080 MHz, 202.826 MHz, 208.116 MHz, 215.972 MHz, 223.988 MHz,
320.000 MHz, 415.974 MHz, 480.000 MHz, 512.045 MHz, 520.025 MHz, 544.015 MHz and
552.005 MHz.

The following frequencies were found inside the restricted bands during the radiated emission test:

256.000 MHz.

These frequencies have to be measured on the open area test site. The result is presented in the following.

5.7.2.2 Final radiated emission test (30 MHz to 1 GHz)

Ambient temperature	°C	Relative humidity	%
---------------------	----	-------------------	---

Position of EUT: The EUT was set-up on a non-conducting table of a height of 0.8 m. The distance between EUT and antenna was 3 m.

Cable guide: The cable of the EUT is running vertically to the false floor. For detail information of test set-up and the cable guide refer to the pictures in annex A of this test report.

Test record: All results are shown in the following.

Supply voltage: During all measurements the EUT was supplied with 12.0 V DC.

Test results: The test results were calculated with the following formula:

$$\text{Result [dB}\mu\text{V/m]} = \text{reading [dB}\mu\text{V]} + \text{cable loss [dB]} + \text{antenna factor [dB/m]}$$

The measured points and the limit line in the following diagram refer to the standard measurement of the emitted interference in compliance with the above-mentioned standard. The measured points marked with an x are the measured results of the standard final measurement on the open area test site.

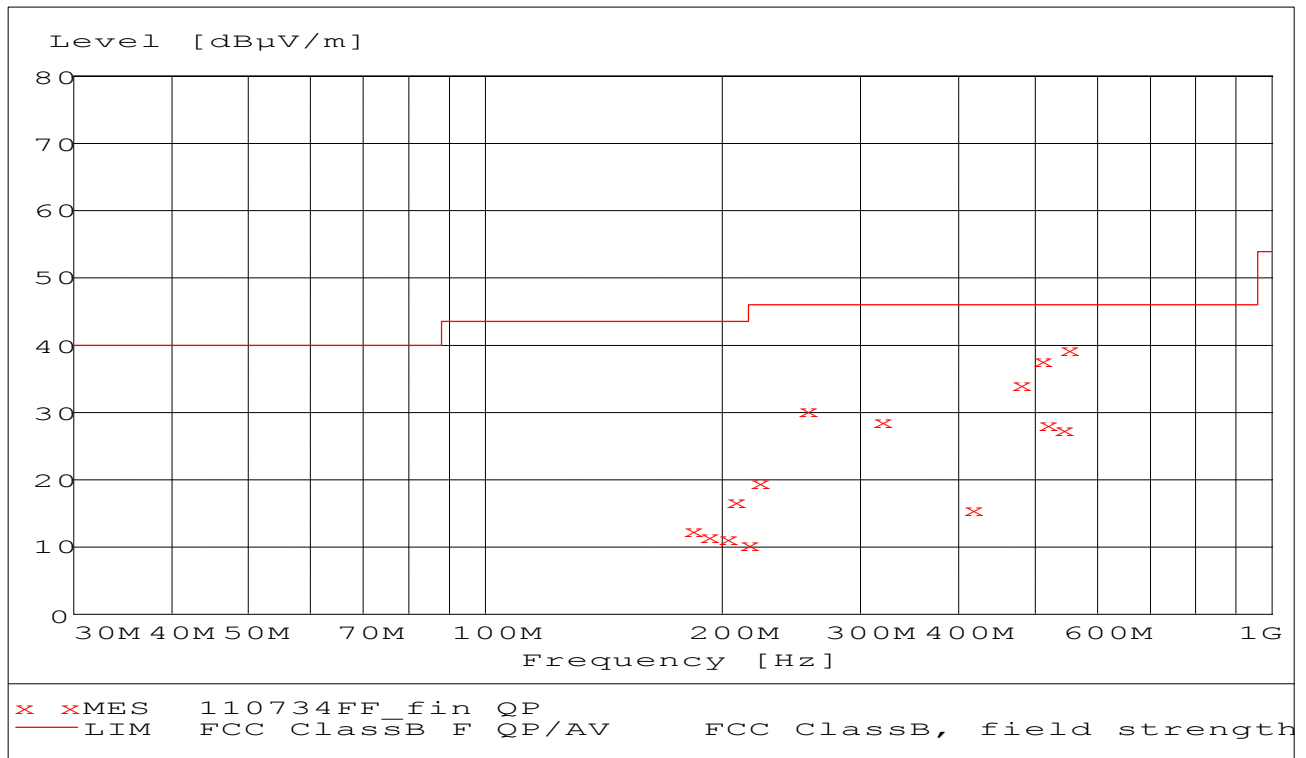

Data record name: 110734TX

The results of the standard subsequent measurement on the open area test site are indicated in the table below. The limits as well as the measured results (levels) refer to the above mentioned standard while taking account of the specified requirements for a 3 m measuring distance.

The measurement time with the quasi-peak measuring detector is 1 second.

Result measured with the quasipeak detector:

(This value is marked in the diagram by an x)

Spurious emissions outside restricted bands									
Frequency MHz	Result dB μ V/m	Limit dB μ V/m	Margin dB	Readings dB μ V	Antenna factor dB/m	Cable loss dB	Height cm	Azimuth deg	Pol.
184.060	12.4	43.5	31.1	1.7	9.2	1.5	325.0	25.0	Vert.
192.080	11.9	43.5	31.6	1.4	9.0	1.5	382.0	45.0	Vert.
202.826	11.1	43.5	32.4	0.5	9.1	1.5	100.0	247.0	Vert.
208.116	17	43.5	26.5	6.2	9.3	1.5	111.0	38.0	Vert.
215.972	10.6	43.5	32.9	-0.5	9.5	1.6	342.0	45.0	Vert.
223.988	19.7	46.0	26.3	8.1	10.0	1.6	400.0	3.0	Vert.
320.000	28.8	46.0	17.2	13.5	13.4	1.9	100.0	304.0	Hor.
415.974	15.7	46.0	30.3	-2.6	16.0	2.3	177.0	132.0	Vert.
480.000	34.3	46.0	11.7	14.9	17.0	2.4	177.0	151.0	Hor.
512.045	12.4	46.0	33.6	-7.7	17.6	2.5	175.0	46.0	Vert.
520.025	11.9	46.0	34.1	-8.4	17.7	2.6	400.0	314.0	Hor.
544.015	11.1	46.0	34.9	-10.5	18.9	2.7	250.0	328.0	Hor.
552.005	17	46.0	29.0	-5.4	19.7	2.7	100.0	315.0	Vert.
Spurious emissions in restricted bands									
Frequency MHz	Result dB μ V/m	Limit dB μ V/m	Margin dB	Readings dB μ V	Antenna factor dB/m	Cable loss dB	Height cm	Azimuth deg	Pol.
256.000	30.2	46.0	15.8	15.8	12.6	1.8	102.0	158.0	Hor.
Measurement uncertainty				+2.2 dB / -3.6 dB					

The test results were calculated with the following formula:

$$\text{Result [dB}\mu\text{V/m]} = \text{reading [dB}\mu\text{V]} + \text{cable loss [dB]} + \text{antenna factor [dB/m]}$$

Test result: Passed

TEST EQUIPMENT USED FOR THE TEST:

14 – 20

5.7.2.3 Preliminary radiated emission measurement (1 GHz to 25 GHz)

Ambient temperature	21 °C	Relative humidity	38 %
---------------------	-------	-------------------	------

- Position of EUT: The EUT was set-up on a non-conducting table of a height of 0.8 m. The distance between EUT and antenna was 3 m.
- Cable guide: The cable of the EUT is running vertically to the false floor. For detail information of test set-up and the cable guide refer to the pictures in annex A of this test report.
- Test record: All results are shown in the following.
- Supply voltage: During all measurements the EUT was supplied with 12.0 V DC.

Transmitter operates at the lower end of the assigned frequency band (operation mode 1b)

110734_24.wmf: Spurious emissions from 1 GHz to 4 GHz:

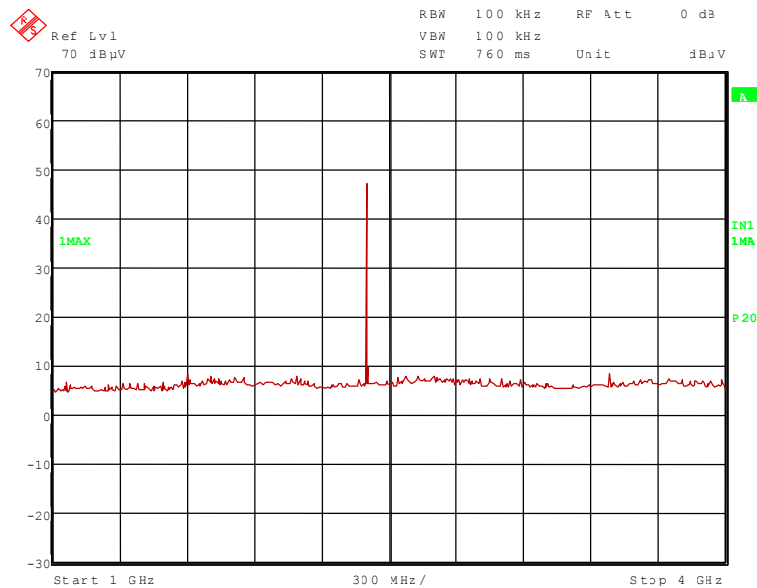

110734_33.wmf: Spurious emissions from 4 GHz to 12 GHz:

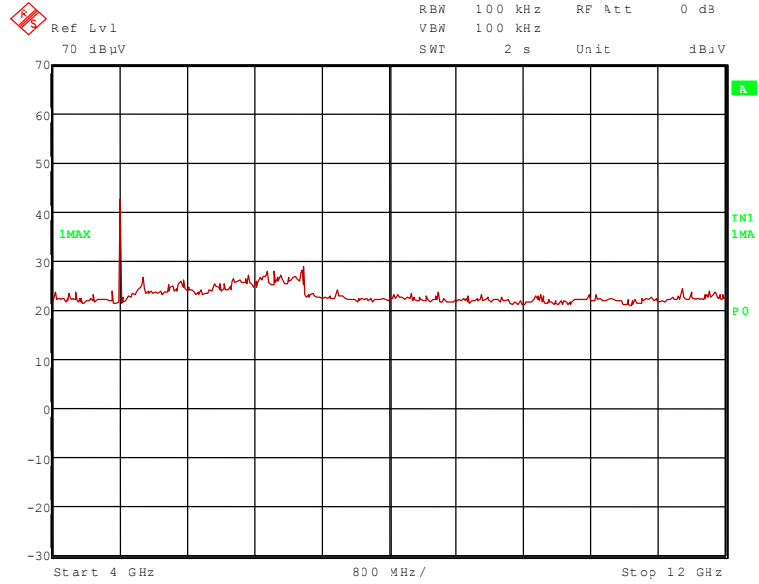

110734_41.wmf: Spurious emissions from 12 GHz to 18 GHz:

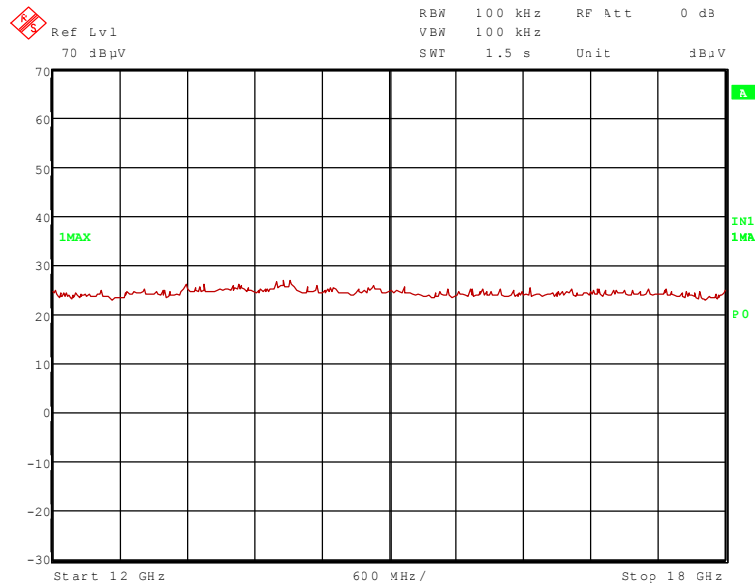

110734_42.wmf: Spurious emissions from 18 GHz to 25 GHz:

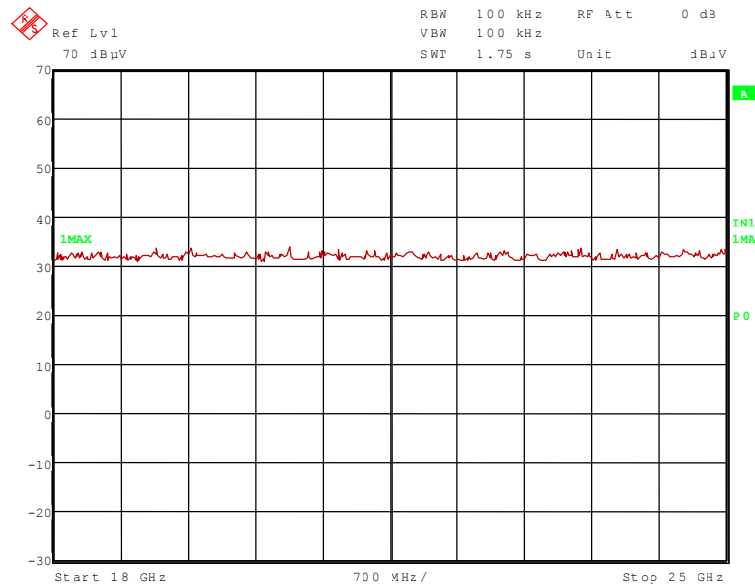

The following frequencies were found inside the restricted bands during the preliminary radiated emission test:

- 1.602 GHz and 4.804 GHz.

The following frequencies were found outside the restricted bands during the preliminary radiated emission test:

- 2.402 GHz and 3.482 GHz.

These frequencies have to be measured in a final measurement. The results were presented in the following.

TEST EQUIPMENT USED FOR THE TEST:
29, 31 –34, 36, 37, 39, 44, 46, 49 - 51, 72

Transmitter operates on the middle of the assigned frequency band (operation mode 2b)

110734_26.wmf: Spurious emissions from 1 GHz to 4 GHz:

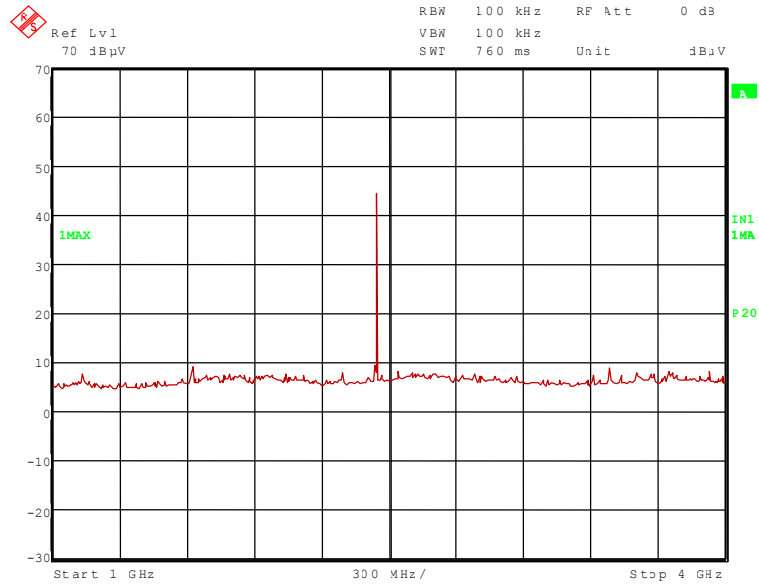

110734_32.wmf: Spurious emissions from 4 GHz to 12 GHz:

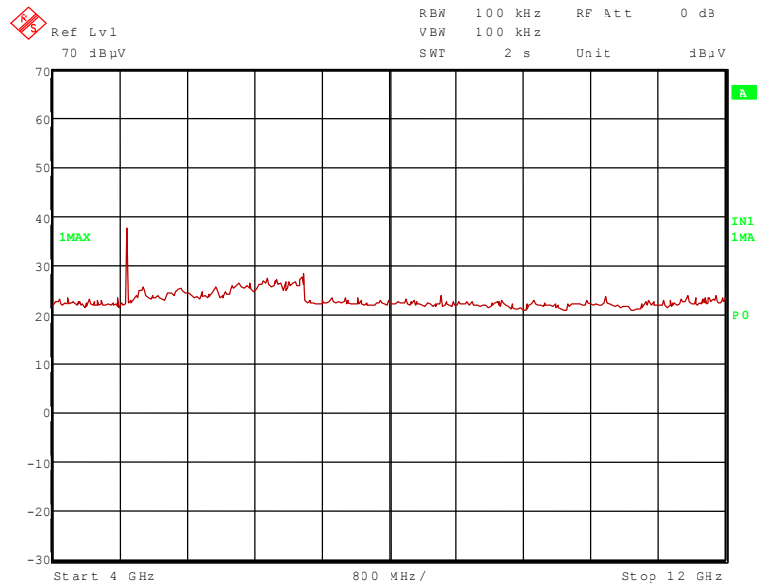

110734_44.wmf: Spurious emissions from 12 GHz to 18 GHz:

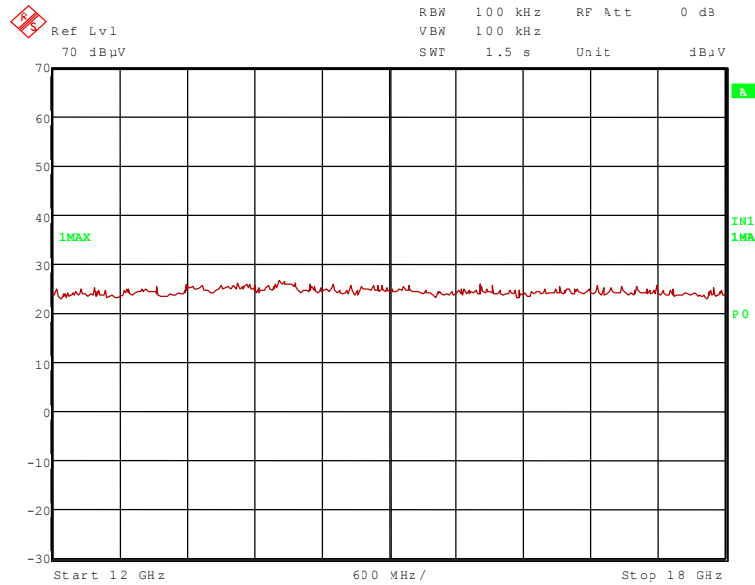

110734_43.wmf: Spurious emissions from 18 GHz to 25 GHz:

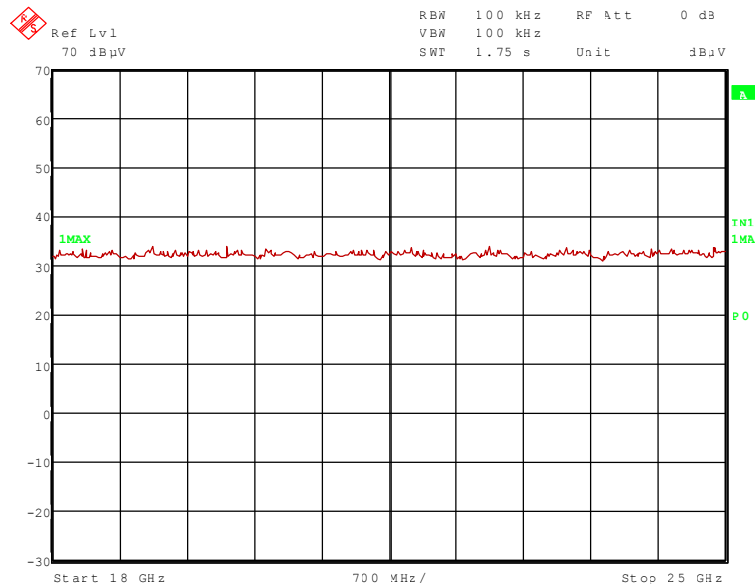

The following frequency was found inside the restricted bands during the preliminary radiated emission test:

- 4.882 GHz.

The following frequency was found outside the restricted bands during the preliminary radiated emission test:

- 1.627 GHz, 2.441 GHz and 3.482 GHz.

These frequencies have to be measured in a final measurement. The results were presented in the following.

Transmitter operates on the upper end of the assigned frequency (operation mode 3b)

110734_27.wmf: Spurious emissions from 1 GHz to 4 GHz:

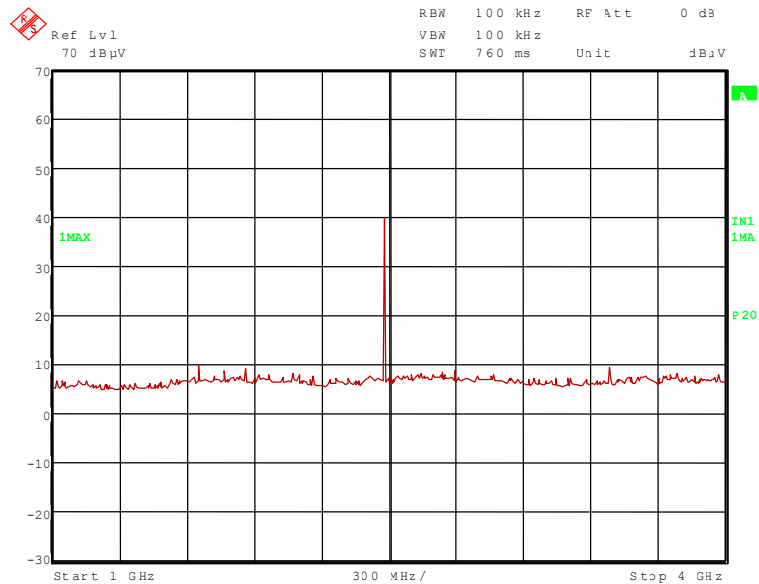

110734_31.wmf: Spurious emissions from 4 GHz to 12 GHz:

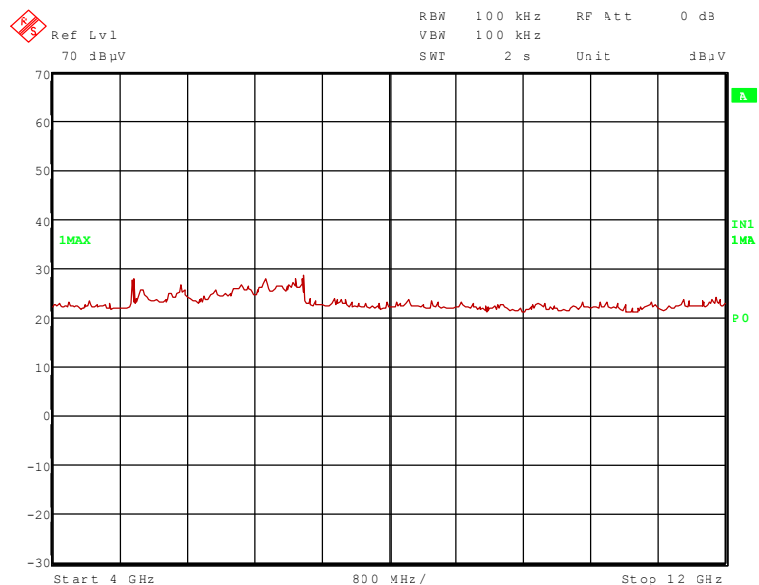

110734_45.wmf: Spurious emissions from 12 GHz to 18 GHz:

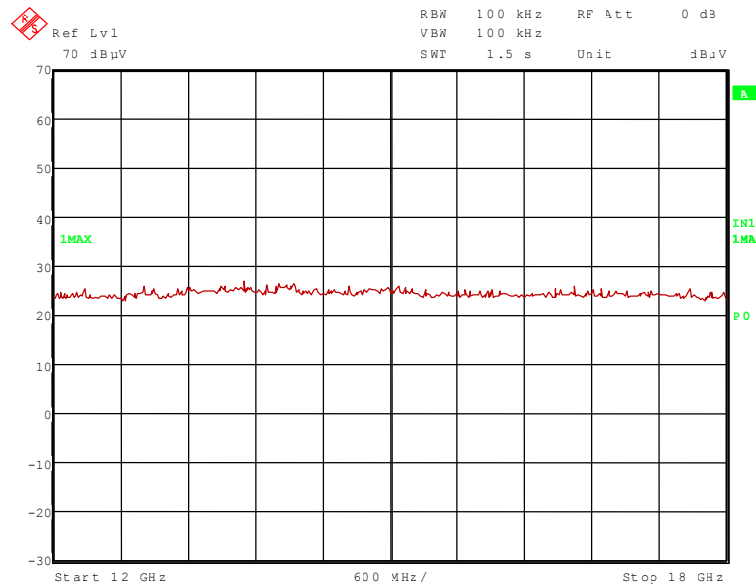

110734_46.wmf: Spurious emissions from 18 GHz to 25 GHz:

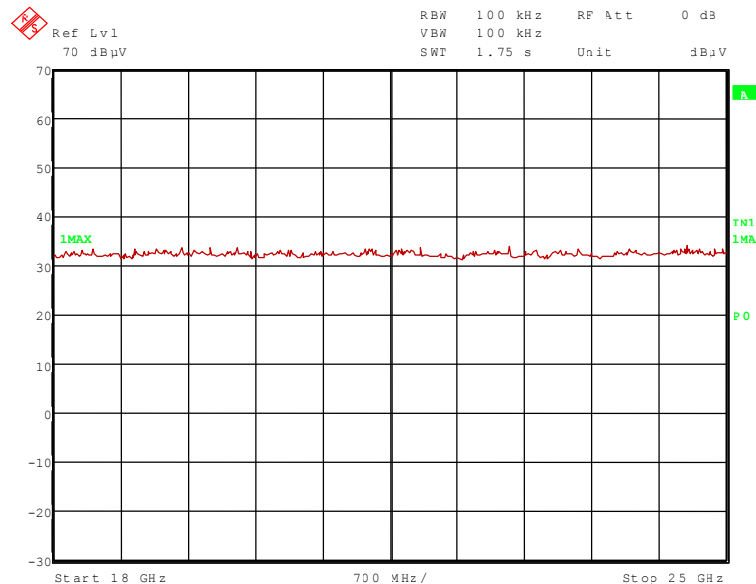

The following frequency was found inside the restricted bands during the preliminary radiated emission test:

- 4.960 GHz.

The following frequencies were found outside the restricted bands during the preliminary radiated emission test:

- 1.653 GHz, 2.480 GHz and 3.482 GHz.

These frequencies have to be measured in a final measurement. The results were presented in the following.

5.7.2.4 Final radiated emission measurement (1 GHz to 25 GHz)

Ambient temperature	21 °C	Relative humidity	38 %
---------------------	-------	-------------------	------

Position of EUT: The EUT was set-up on a non-conducting table of a height of 0.8 m. The distance between EUT and antenna was 3 m.

Cable guide: The cable of the EUT is running vertically to the false floor. For detail information of test set-up and the cable guide refer to the pictures in annex A of this test report.

Test record: All results are shown in the following.

Supply voltage: During all measurements the EUT was supplied with 12.0 V DC.

Resolution bandwidth: For all measurements a resolution bandwidth of 1 MHz was used.

Transmitter operates at the lower end of the assigned frequency band (operation mode 1)

Result measured with the peak detector:

Frequency GHz	Corr. value dB μ V/m	Limit dB μ V/m	Margin dB	Readings dB μ V	Antenna factor 1/m	Preamp dB	Cable loss dB	Height cm	Pol.	Restr. Band
1.602	46.1	74.0	27.9	17.8	25.3	0.0	3.0	150	Vert.	Yes
2.402	80.5	-	-	48.5	28.3	0.0	3.7	150	Vert.	-
3.482	52.1	74.0	21.9	16.5	31.1	0.0	4.5	150	Vert.	No
4.804	55.8	74.0	18.2	43.6	32.6	25.7	5.3	150	Vert.	Yes
Measurement uncertainty						+2.2 dB / -3.6 dB				

Result measured with the average detector:

Frequency GHz	Corr. value dB μ V/m	Limit dB μ V/m	Margin dB	Readings dB μ V	Antenna factor 1/m	Preamp dB	Cable loss dB	Height cm	Pol.	Restr. Band
1.602	34.2	54.0	19.8	5.9	25.3	0.0	3.0	150	Vert.	Yes
2.402	69.9	-	-	37.9	28.3	0.0	3.7	150	Vert.	-
3.482	40.2	54.0	13.8	4.6	31.1	0.0	4.5	150	Vert.	No
4.804	43.3	54.0	10.7	31.1	32.6	25.7	5.3	150	Vert.	Yes
Measurement uncertainty						+2.2 dB / -3.6 dB				

Transmitter operates at the middle of the assigned frequency band (operation mode 2)

Result measured with the peak detector:

Frequency GHz	Corr. value dB μ V/m	Limit dB μ V/m	Margin dB	Readings dB μ V	Antenna factor 1/m	Preamp dB	Cable loss dB	Height Cm	Pol.	Restr. Band
1.627	45.6	74.0	28.4	17.1	25.4	0.0	3.1	150	Vert.	No
2.441	80.0	-	-	47.9	28.4	0.0	3.7	150	Vert.	-
3.482	52.1	74.0	21.9	16.5	31.1	0.0	4.5	150	Vert.	No
4.882	53.1	74.0	20.9	40.7	32.8	25.7	5.3	150	Vert.	Yes
Measurement uncertainty						+2.2 dB / -3.6 dB				

Result measured with the average detector:

Frequency GHz	Corr. value dB μ V/m	Limit dB μ V/m	Margin dB	Readings dB μ V	Antenna factor 1/m	Preamp dB	Cable loss dB	Height cm	Pol.	Restr. Band
1.627	33.3	54.0	20.7	4.8	25.4	0.0	3.1	150	Vert.	No
2.441	69.5	-	-	37.4	28.4	0.0	3.7	150	Vert.	-
3.482	40.2	54.0	13.8	4.6	31.1	0.0	4.5	150	Vert.	No
4.882	40.3	54.0	13.7	27.9	32.8	25.7	5.3	150	Vert.	Yes
Measurement uncertainty						+2.2 dB / -3.6 dB				

Transmitter operates at the upper end of the assigned frequency band (operation mode 3)

Result measured with the peak detector:

Frequency GHz	Corr. value dB μ V/m	Limit dB μ V/m	Margin dB	Readings dB μ V	Antenna factor 1/m	Preamp dB	Cable loss dB	Height cm	Pol.	Restr. Band
1.653	46.0	74.0	28.0	17.4	25.5	0.0	3.1	150	Vert.	No
2.480	74.6	-	-	42.3	28.5	0.0	3.8	150	Vert.	-
3.482	52.1	74.0	21.9	16.5	31.1	0.0	4.5	150	Vert.	No
4.960	49.1	74.0	24.9	36.5	32.9	25.6	5.3	150	Vert.	Yes
Measurement uncertainty						+2.2 dB / -3.6 dB				

Result measured with the average detector:

Frequency GHz	Corr. value dB μ V/m	Limit dB μ V/m	Margin dB	Readings dB μ V	Antenna factor 1/m	Preamp dB	Cable loss dB	Height cm	Pol.	Restr. Band
1.653	33.5	54.0	20.5	4.9	25.5	0.0	3.1	150	Vert.	No
2.480	64.1	-	-	31.8	28.5	0.0	3.8	150	Vert.	-
3.482	40.2	54.0	13.8	4.6	31.1	0.0	4.5	150	Vert.	No
4.960	33.3	54.0	20.7	20.7	32.9	25.6	5.3	150	Vert.	Yes
Measurement uncertainty						+2.2 dB / -3.6 dB				

Test result: Passed

TEST EQUIPMENT USED FOR THE TEST:
29, 31 –34, 36, 37, 39, 44, 46, 49 - 51, 72

6 TEST EQUIPMENT AND ANCILLARIES USED FOR TESTS

No.	Test equipment	Type	Manufacturer	Serial No.	PM. No.	Cal. Date	Cal. due
14	Open area test site	-	Phoenix Test-Lab	-	480085	Weekly verification (system cal.)	
15	Measuring receiver	ESIB7	Rohde & Schwarz	100304	480521	03/15/2010	03/2012
16	Controller	HD100	Deisel	100/670	480139	-	-
17	Turntable	DS420HE	Deisel	420/620/80	480087	-	-
18	Antenna support	AS615P	Deisel	615/310	480086	-	-
19	Antenna	CBL6111 A	Chase	1643	480147	08/01/2007	08/2012
20	EMI Software	ES-K1	Rohde & Schwarz	-	480111	-	-
29	Fully anechoic chamber M20	-	Albatross Projects	B83107-E2439-T232	480303	Weekly verification (system cal.)	
30	Spectrum analyser	FSU	Rohde & Schwarz	200125	480956	04/15/2010	04/2012
31	Measuring receiver	ESI 40	Rohde & Schwarz	100064	480355	03/17/2010	03/2012
32	Controller	MCU	Maturo	MCU/043/971107	480832	-	-
33	Turntable	DS420HE	Deisel	420/620/80	480315	-	-
34	Antenna support	AS615P	Deisel	615/310	480187	-	-
35	Antenna	CBL6112 B	Chase	2917	480447	09/28/2010	09/2015
36	Antenna	3115 A	EMCO	9609-4918	480183	04/11/2008	11/2013
37	Standard Gain Horn 11.9 GHz – 18 GHz	18240-20	Flann Microwave	483	480294	Six month verification (system cal.)	
39	Standard Gain Horn 17.9 GHz – 26.7 GHz	20240-20	Flann Microwave	411	480297	Six month verification (system cal.)	
43	RF-cable No. 30	RTK 081	Rosenberger	-	410141	Weekly verification (system cal.)	
44	RF-cable No. 31	RTK 081	Rosenberger	-	410142	Weekly verification (system cal.)	
46	RF-cable 1 m	KPS-1533-400-KPS	Insulated Wire	-	480301	Six month verification (system cal.)	
49	Preamplifier	JS3-00101200-23-5A	Miteq	681851	480337	Six month verification (system cal.)	
50	Preamplifier	JS3-12001800-16-5A	Miteq	571667	480343	Six month verification (system cal.)	
51	Preamplifier	JS3-18002600-20-5A	Miteq	658697	480342	Six month verification (system cal.)	
55	Antenna	HFH2-Z2	Rohde & Schwarz	832609/014	480059	03/10/2010	03/2012
72	4 GHz High Pass Filter	WHKX4.0/18 G-8SS	Wainwright Instruments	1	480587	Weekly verification (system cal.)	

7 REPORT HISTORY

Report Number	Date	Comment
F110734E2	07 April 2011	Document created
F110734E2, 2 nd version	13 April 2012	Model name and FCC ID changed

8 LIST OF ANNEXES

ANNEX A	TEST SETUP PHOTOGRAPHS	5 pages
	<ul style="list-style-type: none"> 110734_8.jpg Test set-up fully anechoic chamber 110734_6.jpg Test set-up fully anechoic chamber 110734_9.jpg Test set-up fully anechoic chamber 110734_10.jpg Test set-up fully anechoic chamber 110734_17.jpg Test set-up open area test site 	
ANNEX B	EXTERNAL PHOTOGRAPHS	4 pages
	<ul style="list-style-type: none"> 110734_f.jpg CCD, 3D view 1 110734_g.jpg CCD, 3D view 2 110734_i.jpg CCD, type plate 1 110734_h.jpg CCD, type plate 2 	
ANNEX C	INTERNAL PHOTOGRAPHS	7 pages
	<ul style="list-style-type: none"> 110734_d.jpg Switch PCB, rear view 110734_e.jpg Switch PCB, front view 110734_l.jpg Switch PCB, rear view, detail view to Bluetooth unit 110734_o.jpg Switch PCB, rear view, detail view to Bluetooth unit, housing removed 110734_k.jpg Switch PCB, rear view, detail view to Bluetooth unit (sample with temporary antenna connector) 110734_n.jpg ALPS evaluation board, top view 110734_m.jpg ALPS evaluation board, bottom view 	
ANNEX D	RESULTS OF THE RECEIVER MEASUREMENT	8 Pages