

Test Plot 1#: PTT_DMO_Face Up_350.0125 MHz**DUT: TETRA PORTABLE TERMINAL; Type: PT350 F8; Serial: 18092600120**Communication System: $\pi/4$ -DQPSK; Frequency: 350.012 MHz; Duty Cycle: 1:1Medium parameters used: $f = 350.012$ MHz; $\sigma = 0.839$ S/m; $\epsilon_r = 46.102$; $\rho = 1000$ kg/m³

Phantom section: Flat Section

DASY5 Configuration:

- Probe: ES3DV2 - SN3019; ConvF(7.18, 7.18, 7.18); Calibrated: 2018/8/20;
- Sensor-Surface: 4mm (Mechanical Surface Detection)
- Electronics: DAE3 Sn494; Calibrated: 2017/11/15
- Phantom: ELI v8.0; Type: QDOVA004AA; Serial: 2051
- Measurement SW: DASY52, Version 52.8 (8);

Area Scan (61x121x1): Interpolated grid: dx=1.500 mm, dy=1.500 mm

Maximum value of SAR (interpolated) = 2.22 W/kg

Zoom Scan (5x5x7)/Cube 0: Measurement grid: dx=8mm, dy=8mm, dz=5mm

Reference Value = 43.98 V/m; Power Drift = -0.13 dB

Peak SAR (extrapolated) = 2.25 W/kg

SAR(1 g) = 1.5 W/kg; SAR(10 g) = 1.16 W/kg

Maximum value of SAR (measured) = 1.93 W/kg

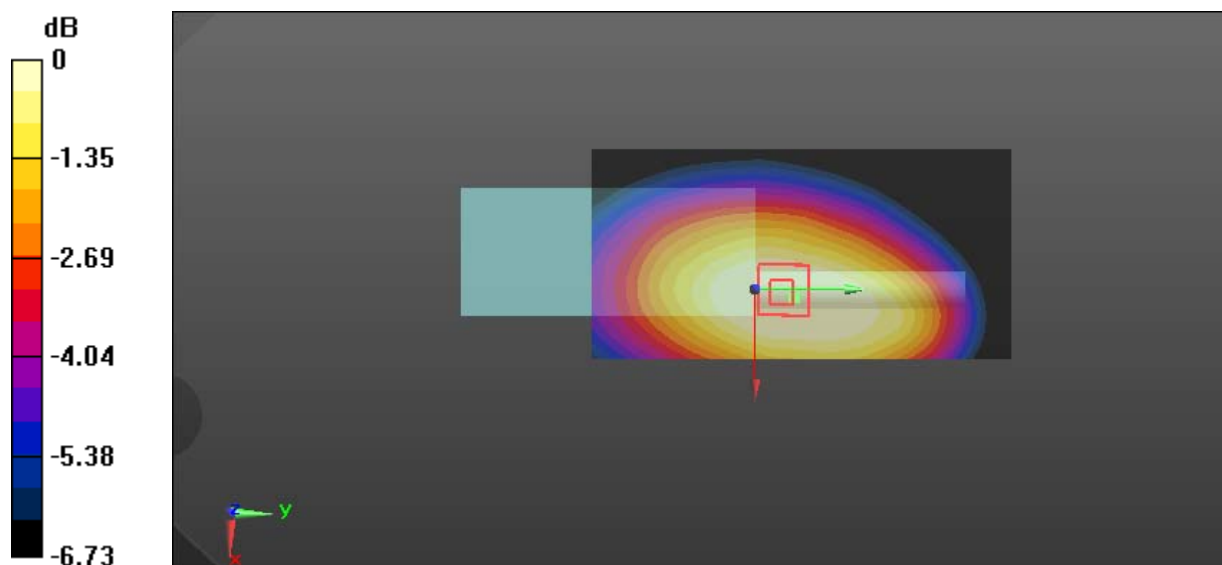

0 dB = 1.93 W/kg = 2.86 dBW/kg

Test Plot 2#: PTT_DMO_Face Up_360.0125 MHz**DUT: TETRA PORTABLE TERMINAL; Type: PT350 F8; Serial: 18092600120**Communication System: $\pi/4$ -DQPSK; Frequency: 360.012 MHz; Duty Cycle: 1:1Medium parameters used: $f = 360.012$ MHz; $\sigma = 0.842$ S/m; $\epsilon_r = 45.905$; $\rho = 1000$ kg/m³

Phantom section: Flat Section

DASY5 Configuration:

- Probe: ES3DV2 - SN3019; ConvF(7.18, 7.18, 7.18); Calibrated: 2018/8/20;
- Sensor-Surface: 4mm (Mechanical Surface Detection)
- Electronics: DAE3 Sn494; Calibrated: 2017/11/15
- Phantom: ELI v8.0; Type: QDOVA004AA; Serial: 2051
- Measurement SW: DASY52, Version 52.8 (8);

Area Scan (61x121x1): Interpolated grid: dx=1.500 mm, dy=1.500 mm

Maximum value of SAR (interpolated) = 1.33 W/kg

Zoom Scan (5x5x7)/Cube 0: Measurement grid: dx=8mm, dy=8mm, dz=5mm

Reference Value = 36.36 V/m; Power Drift = -0.10 dB

Peak SAR (extrapolated) = 1.56 W/kg

SAR(1 g) = 1.07 W/kg; SAR(10 g) = 0.837 W/kg

Maximum value of SAR (measured) = 1.35 W/kg

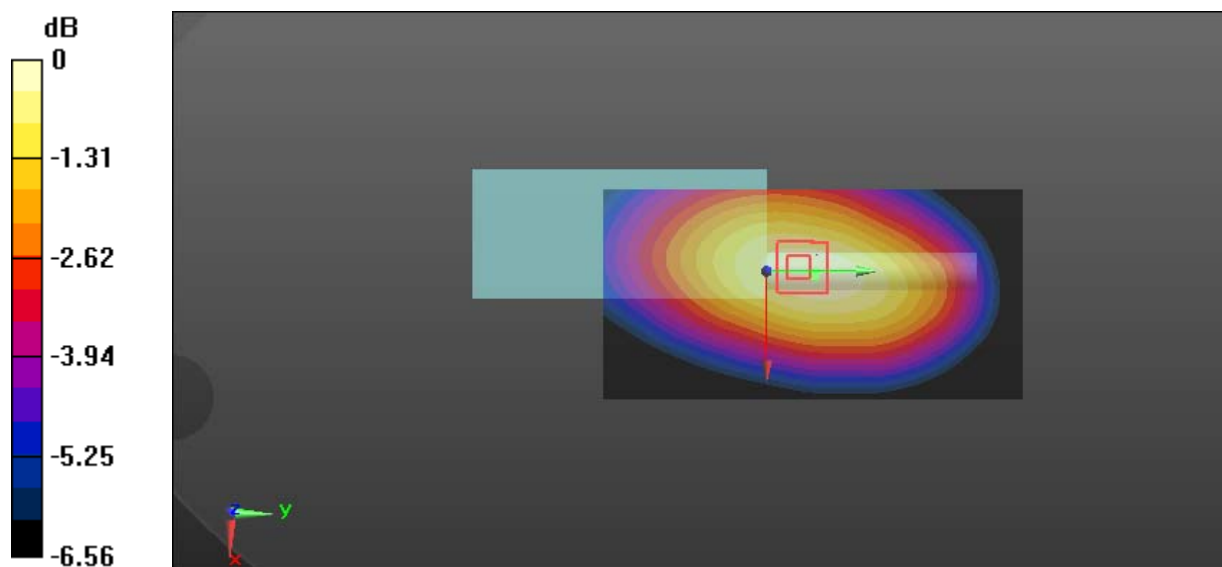

0 dB = 1.35 W/kg = 1.30 dBW/kg

Test Plot 3#: PTT_DMO_Face Up_370.0125 MHz**DUT: TETRA PORTABLE TERMINAL; Type: PT350 F8; Serial: 18092600120**Communication System: $\pi/4$ -DQPSK; Frequency: 370.012 MHz; Duty Cycle: 1:1Medium parameters used: $f = 370.012$ MHz; $\sigma = 0.849$ S/m; $\epsilon_r = 45.537$; $\rho = 1000$ kg/m³

Phantom section: Flat Section

DASY5 Configuration:

- Probe: ES3DV2 - SN3019; ConvF(7.18, 7.18, 7.18); Calibrated: 2018/8/20;
- Sensor-Surface: 4mm (Mechanical Surface Detection)
- Electronics: DAE3 Sn494; Calibrated: 2017/11/15
- Phantom: ELI v8.0; Type: QDOVA004AA; Serial: 2051
- Measurement SW: DASY52, Version 52.8 (8);

Area Scan (61x121x1): Interpolated grid: dx=1.500 mm, dy=1.500 mm

Maximum value of SAR (interpolated) = 0.946 W/kg

Zoom Scan (5x5x7)/Cube 0: Measurement grid: dx=8mm, dy=8mm, dz=5mm

Reference Value = 30.06 V/m; Power Drift = -0.19 dB

Peak SAR (extrapolated) = 1.13 W/kg

SAR(1 g) = 0.774 W/kg; SAR(10 g) = 0.601 W/kg

Maximum value of SAR (measured) = 0.966 W/kg

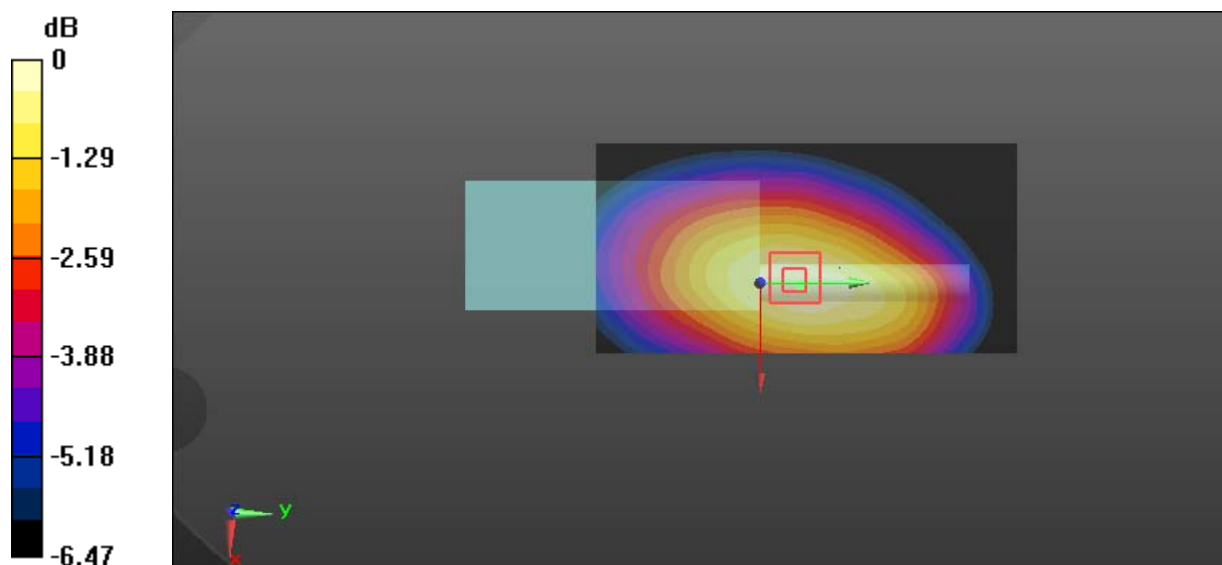

0 dB = 0.966 W/kg = -0.15 dBW/kg

Test Plot 4#: PTT_DMO_Face Up_379.9875 MHz**DUT: TETRA PORTABLE TERMINAL; Type: PT350 F8; Serial: 18092600120**Communication System: $\pi/4$ -DQPSK; Frequency: 379.988 MHz; Duty Cycle: 1:1Medium parameters used: $f = 379.988$ MHz; $\sigma = 0.853$ S/m; $\epsilon_r = 45.421$; $\rho = 1000$ kg/m³

Phantom section: Flat Section

DASY5 Configuration:

- Probe: ES3DV2 - SN3019; ConvF(7.18, 7.18, 7.18); Calibrated: 2018/8/20;
- Sensor-Surface: 4mm (Mechanical Surface Detection)
- Electronics: DAE3 Sn494; Calibrated: 2017/11/15
- Phantom: ELI v8.0; Type: QDOVA004AA; Serial: 2051
- Measurement SW: DASY52, Version 52.8 (8);

Area Scan (61x121x1): Interpolated grid: dx=1.500 mm, dy=1.500 mm

Maximum value of SAR (interpolated) = 0.669 W/kg

Zoom Scan (6x6x7)/Cube 0: Measurement grid: dx=8mm, dy=8mm, dz=5mm

Reference Value = 24.45 V/m; Power Drift = -0.08 dB

Peak SAR (extrapolated) = 0.741 W/kg

SAR(1 g) = 0.498 W/kg; SAR(10 g) = 0.385 W/kg

Maximum value of SAR (measured) = 0.636 W/kg

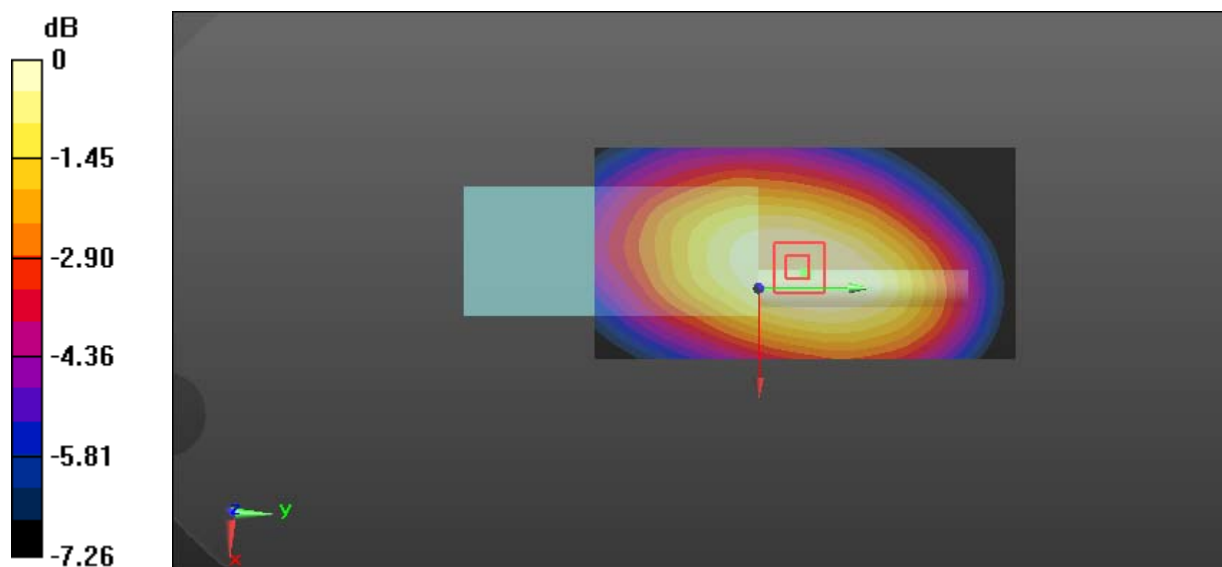

0 dB = 0.636 W/kg = -1.97 dBW/kg

Test Plot 5#: PTT_TMO_Face Up_350.0125 MHz**DUT: TETRA PORTABLE TERMINAL; Type: PT350 F8; Serial: 18092600120**Communication System: $\pi/4$ -DQPSK; Frequency: 350.012 MHz; Duty Cycle: 1:1Medium parameters used: $f = 350.012$ MHz; $\sigma = 0.839$ S/m; $\epsilon_r = 46.102$; $\rho = 1000$ kg/m³

Phantom section: Flat Section

DASY5 Configuration:

- Probe: ES3DV2 - SN3019; ConvF(7.18, 7.18, 7.18); Calibrated: 2018/8/20;
- Sensor-Surface: 4mm (Mechanical Surface Detection)
- Electronics: DAE3 Sn494; Calibrated: 2017/11/15
- Phantom: ELI v8.0; Type: QDOVA004AA; Serial: 2051
- Measurement SW: DASY52, Version 52.8 (8);

Area Scan (61x121x1): Interpolated grid: dx=1.500 mm, dy=1.500 mm

Maximum value of SAR (interpolated) = 1.60 W/kg

Zoom Scan (6x6x7)/Cube 0: Measurement grid: dx=8mm, dy=8mm, dz=5mm

Reference Value = 37.65 V/m; Power Drift = -0.14 dB

Peak SAR (extrapolated) = 1.87 W/kg

SAR(1 g) = 1.25 W/kg; SAR(10 g) = 0.953 W/kg

Maximum value of SAR (measured) = 1.60 W/kg

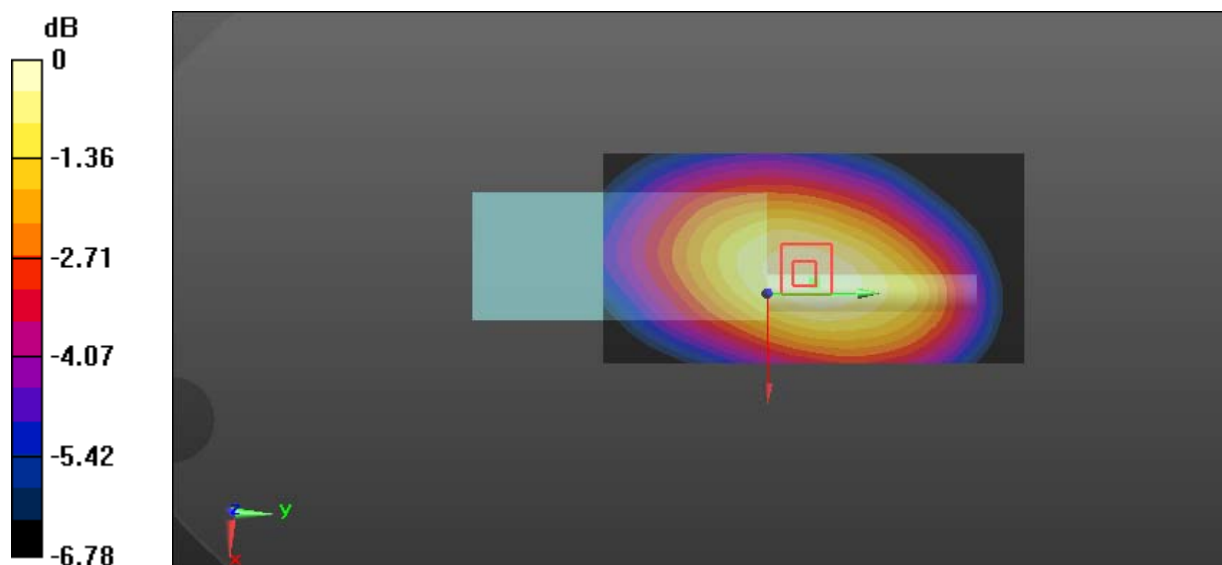

0 dB = 1.60 W/kg = 2.04 dBW/kg

Test Plot 6#: PTT_DMO_Face Up_350.0125 MHz**DUT: TETRA PORTABLE TERMINAL; Type: PT310 F8; Serial: 18092600121**Communication System: $\pi/4$ -DQPSK; Frequency: 350.012 MHz; Duty Cycle: 1:1Medium parameters used: $f = 350.012$ MHz; $\sigma = 0.839$ S/m; $\epsilon_r = 46.102$; $\rho = 1000$ kg/m³

Phantom section: Flat Section

DASY5 Configuration:

- Probe: ES3DV2 - SN3019; ConvF(7.18, 7.18, 7.18); Calibrated: 2018/8/20;
- Sensor-Surface: 4mm (Mechanical Surface Detection)
- Electronics: DAE3 Sn494; Calibrated: 2017/11/15
- Phantom: ELI v8.0; Type: QDOVA004AA; Serial: 2051
- Measurement SW: DASY52, Version 52.8 (8);

Area Scan (61x121x1): Interpolated grid: dx=1.500 mm, dy=1.500 mm

Maximum value of SAR (interpolated) = 1.37 W/kg

Zoom Scan (6x6x7)/Cube 0: Measurement grid: dx=8mm, dy=8mm, dz=5mm

Reference Value = 39.81 V/m; Power Drift = -0.15 dB

Peak SAR (extrapolated) = 1.57 W/kg

SAR(1 g) = 1.19 W/kg; SAR(10 g) = 0.909 W/kg

Maximum value of SAR (measured) = 1.25 W/kg

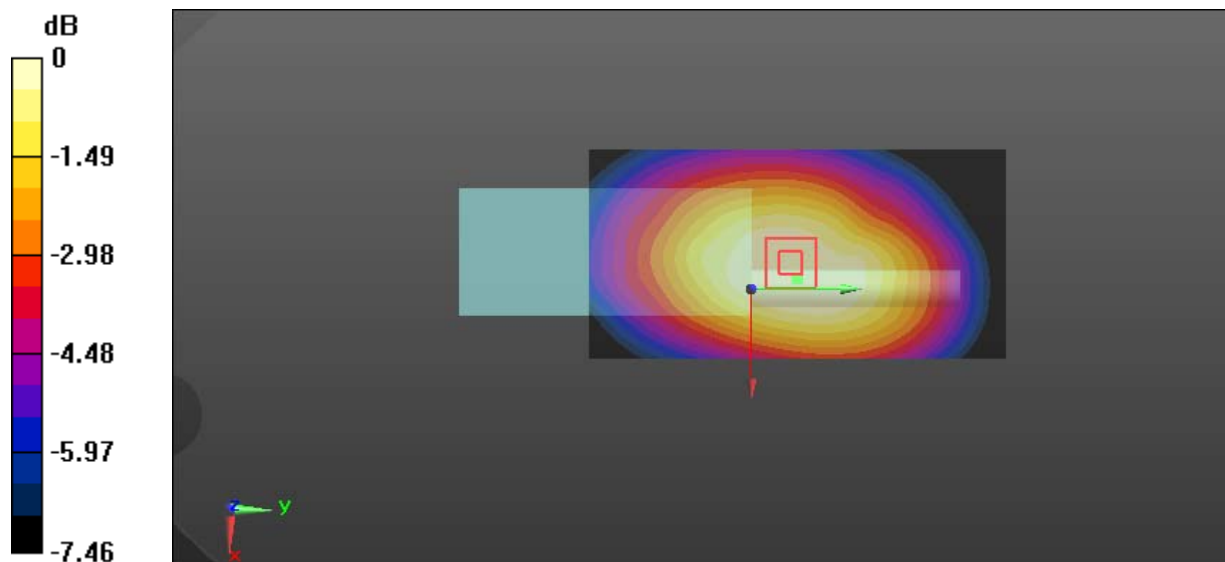

0 dB = 1.25 W/kg = 0.97 dBW/kg

Test Plot 7#: PTT_DMO_Body Back_350.0125 MHz**DUT: TETRA PORTABLE TERMINAL; Type: PT350 F8; Serial: 18092600120**Communication System: $\pi/4$ -DQPSK; Frequency: 350.012 MHz; Duty Cycle: 1:1Medium parameters used: $f = 350.012$ MHz; $\sigma = 0.914$ S/m; $\epsilon_r = 58.504$; $\rho = 1000$ kg/m³

Phantom section: Flat Section

DASY5 Configuration:

- Probe: ES3DV2 - SN3019; ConvF(7.1, 7.1, 7.1); Calibrated: 2018/8/20;
- Sensor-Surface: 4mm (Mechanical Surface Detection)
- Electronics: DAE3 Sn494; Calibrated: 2017/11/15
- Phantom: ELI v8.0; Type: QDOVA004AA; Serial: 2051
- Measurement SW: DASY52, Version 52.8 (8);

Area Scan (61x121x1): Interpolated grid: dx=1.500 mm, dy=1.500 mm

Maximum value of SAR (interpolated) = 1.38 W/kg

Zoom Scan (6x7x7)/Cube 0: Measurement grid: dx=8mm, dy=8mm, dz=5mm

Reference Value = 26.74 V/m; Power Drift = -0.03 dB

Peak SAR (extrapolated) = 1.63 W/kg

SAR(1 g) = 1.06 W/kg; SAR(10 g) = 0.774 W/kg

Maximum value of SAR (measured) = 1.38 W/kg

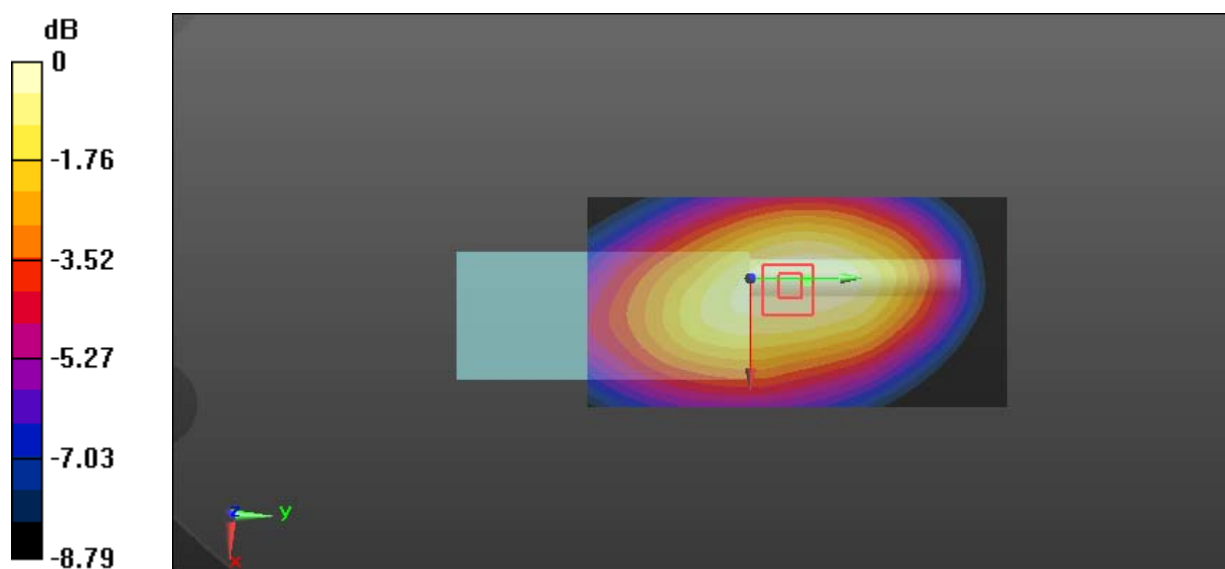

0 dB = 1.38 W/kg = 1.40 dBW/kg

Test Plot 8#: PTT_DMO_Body Back_360.0125 MHz**DUT: TETRA PORTABLE TERMINAL; Type: PT350 F8; Serial: 18092600120**Communication System: $\pi/4$ -DQPSK; Frequency: 360.012 MHz; Duty Cycle: 1:1Medium parameters used: $f = 360.012$ MHz; $\sigma = 0.918$ S/m; $\epsilon_r = 58.327$; $\rho = 1000$ kg/m³

Phantom section: Flat Section

DASY5 Configuration:

- Probe: ES3DV2 - SN3019; ConvF(7.1, 7.1, 7.1); Calibrated: 2018/8/20;
- Sensor-Surface: 4mm (Mechanical Surface Detection)
- Electronics: DAE3 Sn494; Calibrated: 2017/11/15
- Phantom: ELI v8.0; Type: QDOVA004AA; Serial: 2051
- Measurement SW: DASY52, Version 52.8 (8);

Area Scan (61x121x1): Interpolated grid: dx=1.500 mm, dy=1.500 mm

Maximum value of SAR (interpolated) = 0.844 W/kg

Zoom Scan (6x6x7)/Cube 0: Measurement grid: dx=8mm, dy=8mm, dz=5mm

Reference Value = 26.16 V/m; Power Drift = -0.15 dB

Peak SAR (extrapolated) = 0.973 W/kg

SAR(1 g) = 0.659 W/kg; SAR(10 g) = 0.489 W/kg

Maximum value of SAR (measured) = 0.848 W/kg

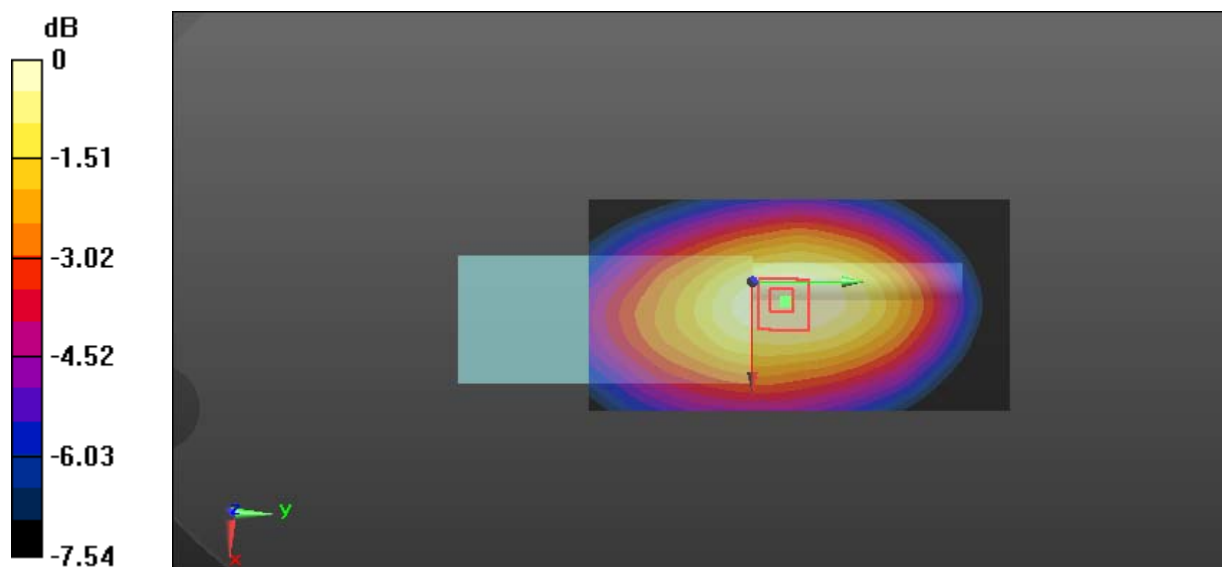

0 dB = 0.848 W/kg = -0.72 dBW/kg

Test Plot 9#: PTT_DMO_Body Back_370.0125 MHz**DUT: TETRA PORTABLE TERMINAL; Type: PT350 F8; Serial: 18092600120**Communication System: $\pi/4$ -DQPSK; Frequency: 370.012 MHz; Duty Cycle: 1:1Medium parameters used: $f = 370.012$ MHz; $\sigma = 0.921$ S/m; $\epsilon_r = 58.184$; $\rho = 1000$ kg/m³

Phantom section: Flat Section

DASY5 Configuration:

- Probe: ES3DV2 - SN3019; ConvF(7.1, 7.1, 7.1); Calibrated: 2018/8/20;
- Sensor-Surface: 4mm (Mechanical Surface Detection)
- Electronics: DAE3 Sn494; Calibrated: 2017/11/15
- Phantom: ELI v8.0; Type: QDOVA004AA; Serial: 2051
- Measurement SW: DASY52, Version 52.8 (8);

Area Scan (61x121x1): Interpolated grid: dx=1.500 mm, dy=1.500 mm

Maximum value of SAR (interpolated) = 0.799 W/kg

Zoom Scan (6x6x7)/Cube 0: Measurement grid: dx=8mm, dy=8mm, dz=5mm

Reference Value = 20.65 V/m; Power Drift = 0.03 dB

Peak SAR (extrapolated) = 0.918 W/kg

SAR(1 g) = 0.619 W/kg; SAR(10 g) = 0.459 W/kg

Maximum value of SAR (measured) = 0.799 W/kg

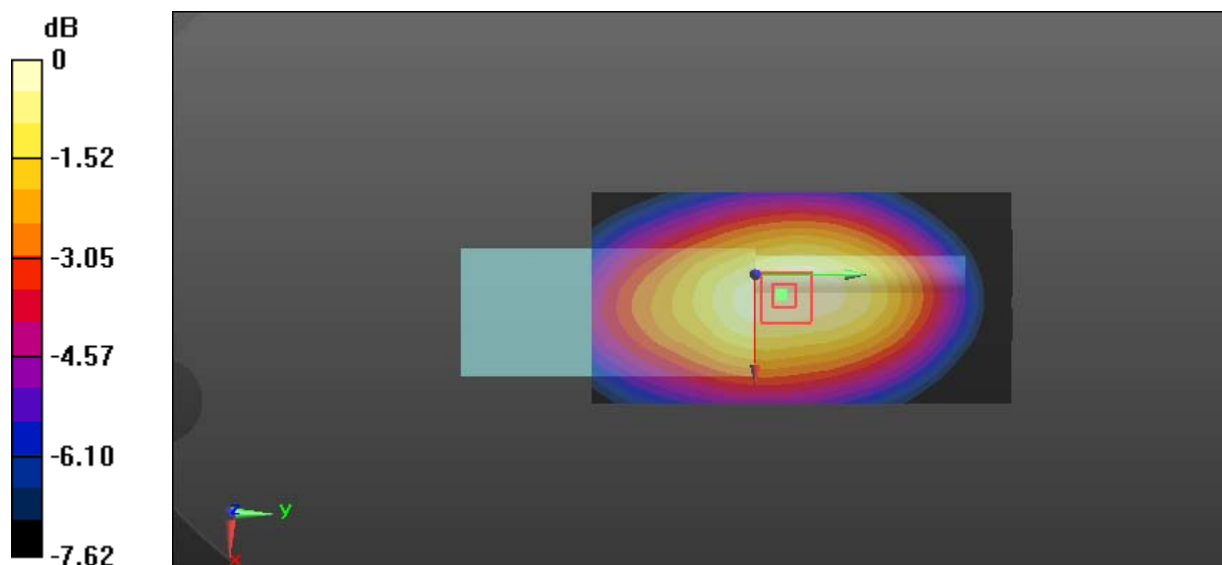

0 dB = 0.799 W/kg = -0.97 dBW/kg

Test Plot 10#: PTT_DMO_Body Back_379.9875 MHz**DUT: TETRA PORTABLE TERMINAL; Type: PT350 F8; Serial: 18092600120**Communication System: $\pi/4$ -DQPSK; Frequency: 379.988 MHz; Duty Cycle: 1:1Medium parameters used: $f = 379.988$ MHz; $\sigma = 0.926$ S/m; $\epsilon_r = 57.615$; $\rho = 1000$ kg/m³

Phantom section: Flat Section

DASY5 Configuration:

- Probe: ES3DV2 - SN3019; ConvF(7.1, 7.1, 7.1); Calibrated: 2018/8/20;
- Sensor-Surface: 4mm (Mechanical Surface Detection)
- Electronics: DAE3 Sn494; Calibrated: 2017/11/15
- Phantom: ELI v8.0; Type: QDOVA004AA; Serial: 2051
- Measurement SW: DASY52, Version 52.8 (8);

Area Scan (61x121x1): Interpolated grid: dx=1.500 mm, dy=1.500 mm

Maximum value of SAR (interpolated) = 0.522 W/kg

Zoom Scan (6x6x7)/Cube 0: Measurement grid: dx=8mm, dy=8mm, dz=5mm

Reference Value = 19.11 V/m; Power Drift = 0.08 dB

Peak SAR (extrapolated) = 0.583 W/kg

SAR(1 g) = 0.399 W/kg; SAR(10 g) = 0.296 W/kg

Maximum value of SAR (measured) = 0.508 W/kg

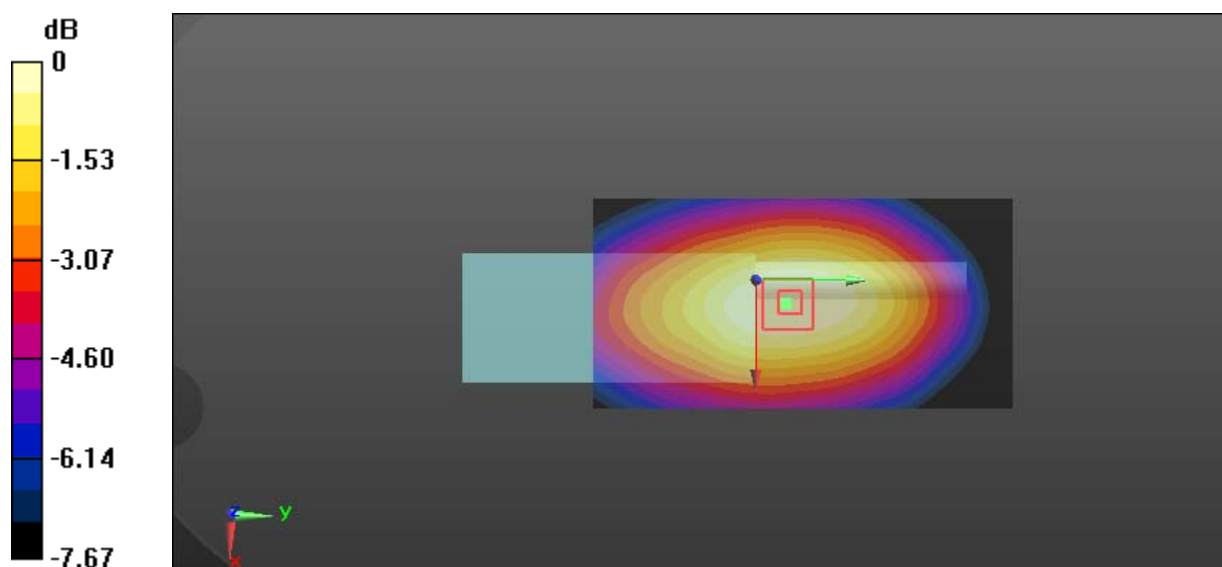

0 dB = 0.508 W/kg = -2.94 dBW/kg

Test Plot 11#: PTT_TMO_Body Back_350.0125 MHz**DUT: TETRA PORTABLE TERMINAL; Type: PT350 F8; Serial: 18092600120**Communication System: $\pi/4$ -DQPSK; Frequency: 350.012 MHz; Duty Cycle: 1:1Medium parameters used: $f = 350.012$ MHz; $\sigma = 0.914$ S/m; $\epsilon_r = 58.504$; $\rho = 1000$ kg/m³

Phantom section: Flat Section

DASY5 Configuration:

- Probe: ES3DV2 - SN3019; ConvF(7.1, 7.1, 7.1); Calibrated: 2018/8/20;
- Sensor-Surface: 4mm (Mechanical Surface Detection)
- Electronics: DAE3 Sn494; Calibrated: 2017/11/15
- Phantom: ELI v8.0; Type: QDOVA004AA; Serial: 2051
- Measurement SW: DASY52, Version 52.8 (8);

Area Scan (61x121x1): Interpolated grid: dx=1.500 mm, dy=1.500 mm

Maximum value of SAR (interpolated) = 1.43 W/kg

Zoom Scan (5x5x7)/Cube 0: Measurement grid: dx=8mm, dy=8mm, dz=5mm

Reference Value = 33.34 V/m; Power Drift = -0.00 dB

Peak SAR (extrapolated) = 1.65 W/kg

SAR(1 g) = 1 W/kg; SAR(10 g) = 0.807 W/kg

Maximum value of SAR (measured) = 1.42 W/kg

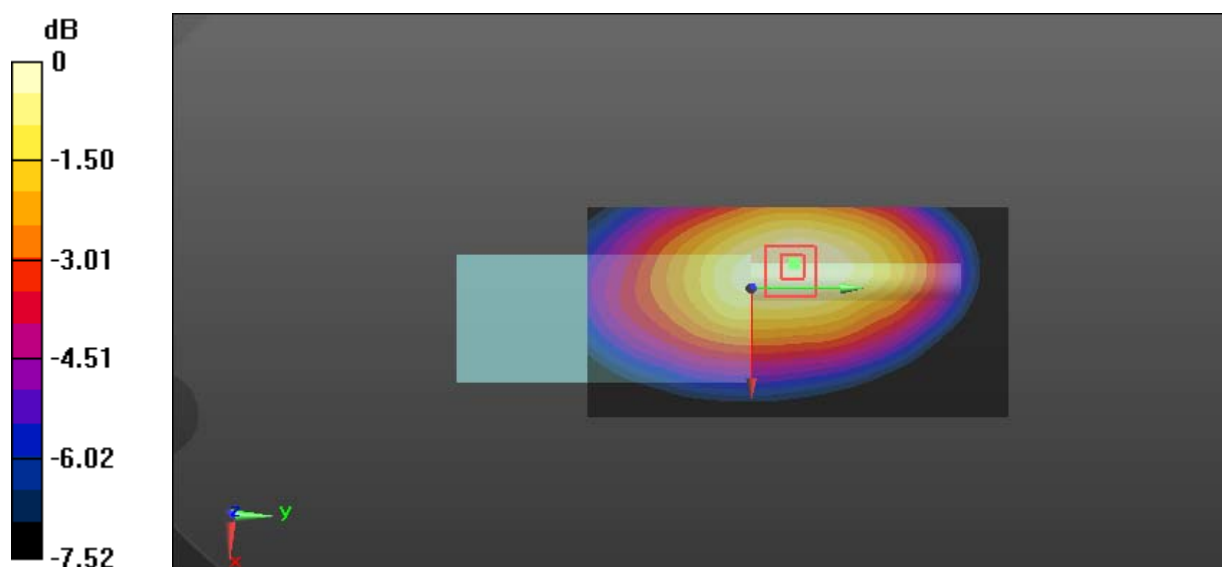

Test Plot 12#: PTT_DMO_Body Back_350.0125 MHz**DUT: TETRA PORTABLE TERMINAL; Type: PT310 F8; Serial: 18092600121**Communication System: $\pi/4$ -DQPSK; Frequency: 350.012 MHz; Duty Cycle: 1:1Medium parameters used: $f = 350.012$ MHz; $\sigma = 0.914$ S/m; $\epsilon_r = 58.504$; $\rho = 1000$ kg/m³

Phantom section: Flat Section

DASY5 Configuration:

- Probe: ES3DV2 - SN3019; ConvF(7.1, 7.1, 7.1); Calibrated: 2018/8/20;
- Sensor-Surface: 4mm (Mechanical Surface Detection)
- Electronics: DAE3 Sn494; Calibrated: 2017/11/15
- Phantom: ELI v8.0; Type: QDOVA004AA; Serial: 2051
- Measurement SW: DASY52, Version 52.8 (8);

Area Scan (61x121x1): Interpolated grid: dx=1.500 mm, dy=1.500 mm

Maximum value of SAR (interpolated) = 0.936 W/kg

Zoom Scan (5x5x7)/Cube 0: Measurement grid: dx=8mm, dy=8mm, dz=5mm

Reference Value = 32.14 V/m; Power Drift = -0.19 dB

Peak SAR (extrapolated) = 1.12 W/kg

SAR(1 g) = 0.832 W/kg; SAR(10 g) = 0.616 W/kg

Maximum value of SAR (measured) = 0.875 W/kg

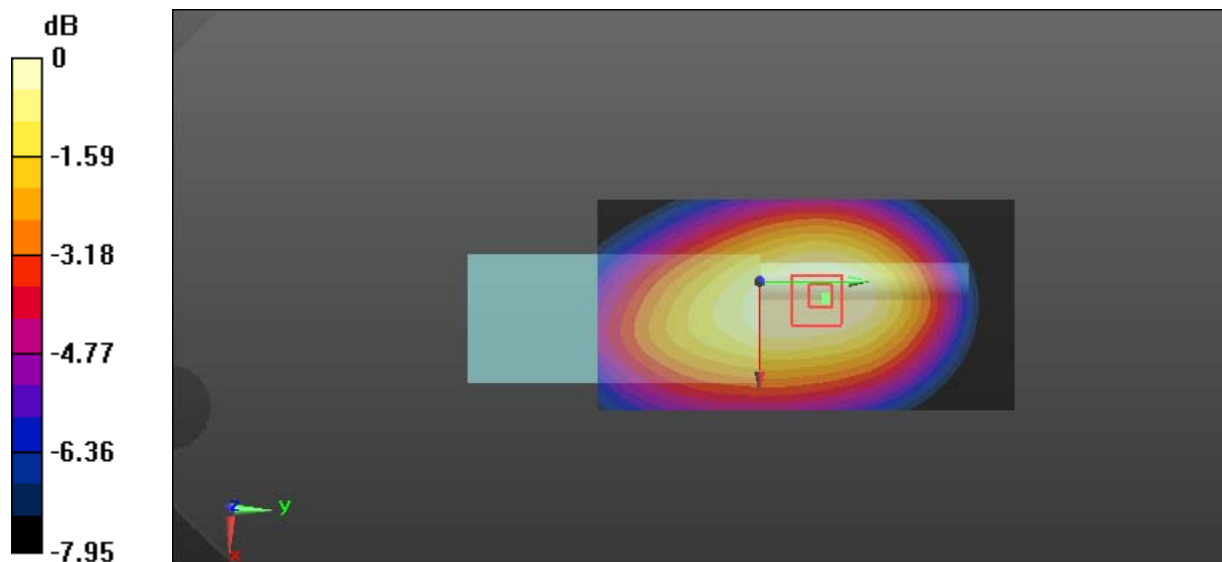

0 dB = 0.875 W/kg = -0.58 dBW/kg

Test Plot 13#: PTT_DMO_Face_380.0125 MHz**DUT: TETRA PORTABLE TERMINAL; Type: PT350 F8; Serial: 18092600120**Communication System: $\pi/4$ -DQPSK; Frequency: 380.012 MHz; Duty Cycle: 1:1Medium parameters used: $f = 380.012$ MHz; $\sigma = 0.855$ S/m; $\epsilon_r = 45.319$; $\rho = 1000$ kg/m³

Phantom section: Flat Section

DASY5 Configuration:

- Probe: ES3DV2 - SN3019; ConvF(7.18, 7.18, 7.18); Calibrated: 2018/8/20;
- Sensor-Surface: 4mm (Mechanical Surface Detection)
- Electronics: DAE3 Sn494; Calibrated: 2017/11/15
- Phantom: ELI v8.0; Type: QDOVA004AA; Serial: 2051
- Measurement SW: DASY52, Version 52.8 (8);

Area Scan (61x101x1): Interpolated grid: dx=1.500 mm, dy=1.500 mm

Maximum value of SAR (interpolated) = 1.66 W/kg

Zoom Scan (7x8x7)/Cube 0: Measurement grid: dx=8mm, dy=8mm, dz=5mm

Reference Value = 38.68 V/m; Power Drift = -0.12 dB

Peak SAR (extrapolated) = 1.98 W/kg

SAR(1 g) = 1.34 W/kg; SAR(10 g) = 1.01 W/kg

Maximum value of SAR (measured) = 1.67 W/kg

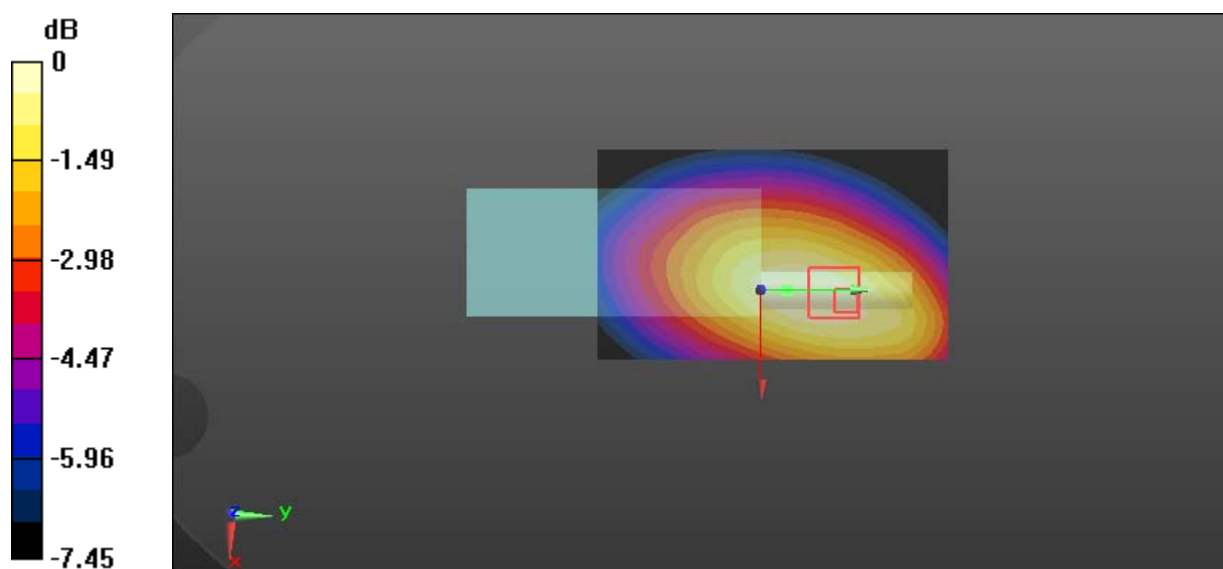

0 dB = 1.67 W/kg = 2.23 dBW/kg

Test Plot 14#: PTT_DMO_Face_390.0125 MHz**DUT: TETRA PORTABLE TERMINAL; Type: PT350 F8; Serial: 18092600120**Communication System: $\pi/4$ -DQPSK; Frequency: 390.012 MHz; Duty Cycle: 1:1Medium parameters used: $f = 390.012$ MHz; $\sigma = 0.864$ S/m; $\epsilon_r = 45.248$; $\rho = 1000$ kg/m³

Phantom section: Flat Section

DASY5 Configuration:

- Probe: ES3DV2 - SN3019; ConvF(7.18, 7.18, 7.18); Calibrated: 2018/8/20;
- Sensor-Surface: 4mm (Mechanical Surface Detection)
- Electronics: DAE3 Sn494; Calibrated: 2017/11/15
- Phantom: ELI v8.0; Type: QDOVA004AA; Serial: 2051
- Measurement SW: DASY52, Version 52.8 (8);

Area Scan (61x101x1): Interpolated grid: dx=1.500 mm, dy=1.500 mm

Maximum value of SAR (interpolated) = 0.708 W/kg

Zoom Scan (5x5x7)/Cube 0: Measurement grid: dx=8mm, dy=8mm, dz=5mm

Reference Value = 26.28 V/m; Power Drift = -0.13 dB

Peak SAR (extrapolated) = 0.813 W/kg

SAR(1 g) = 0.561 W/kg; SAR(10 g) = 0.432 W/kg

Maximum value of SAR (measured) = 0.709 W/kg

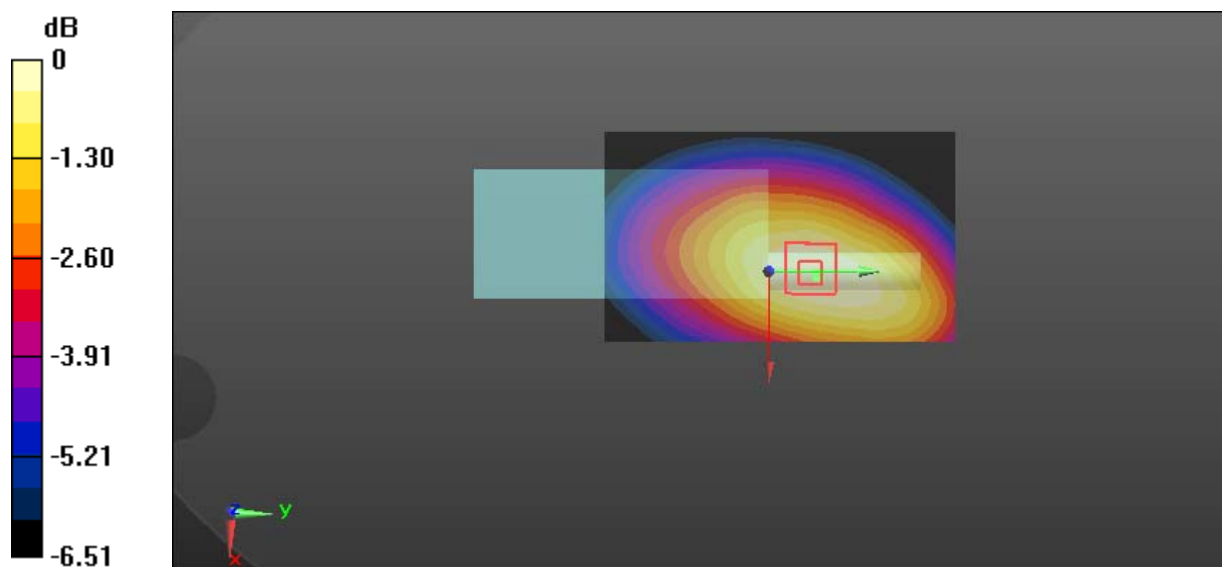

0 dB = 0.709 W/kg = -1.49 dBW/kg

Test Plot 15#: PTT_DMO_Face_399.9875 MHz**DUT: TETRA PORTABLE TERMINAL; Type: PT350 F8; Serial: 18092600120**Communication System: $\pi/4$ -DQPSK; Frequency: 399.988 MHz; Duty Cycle: 1:1Medium parameters used: $f = 399.988$ MHz; $\sigma = 0.865$ S/m; $\epsilon_r = 45.211$; $\rho = 1000$ kg/m³

Phantom section: Flat Section

DASY5 Configuration:

- Probe: ES3DV2 - SN3019; ConvF(7.18, 7.18, 7.18); Calibrated: 2018/8/20;
- Sensor-Surface: 4mm (Mechanical Surface Detection)
- Electronics: DAE3 Sn494; Calibrated: 2017/11/15
- Phantom: ELI v8.0; Type: QDOVA004AA; Serial: 2051
- Measurement SW: DASY52, Version 52.8 (8);

Area Scan (61x101x1): Interpolated grid: dx=1.500 mm, dy=1.500 mm

Maximum value of SAR (interpolated) = 0.479 W/kg

Zoom Scan (7x7x7)/Cube 0: Measurement grid: dx=8mm, dy=8mm, dz=5mm

Reference Value = 21.95 V/m; Power Drift = -0.12 dB

Peak SAR (extrapolated) = 0.514 W/kg

SAR(1 g) = 0.347 W/kg; SAR(10 g) = 0.272 W/kg

Maximum value of SAR (measured) = 0.443 W/kg

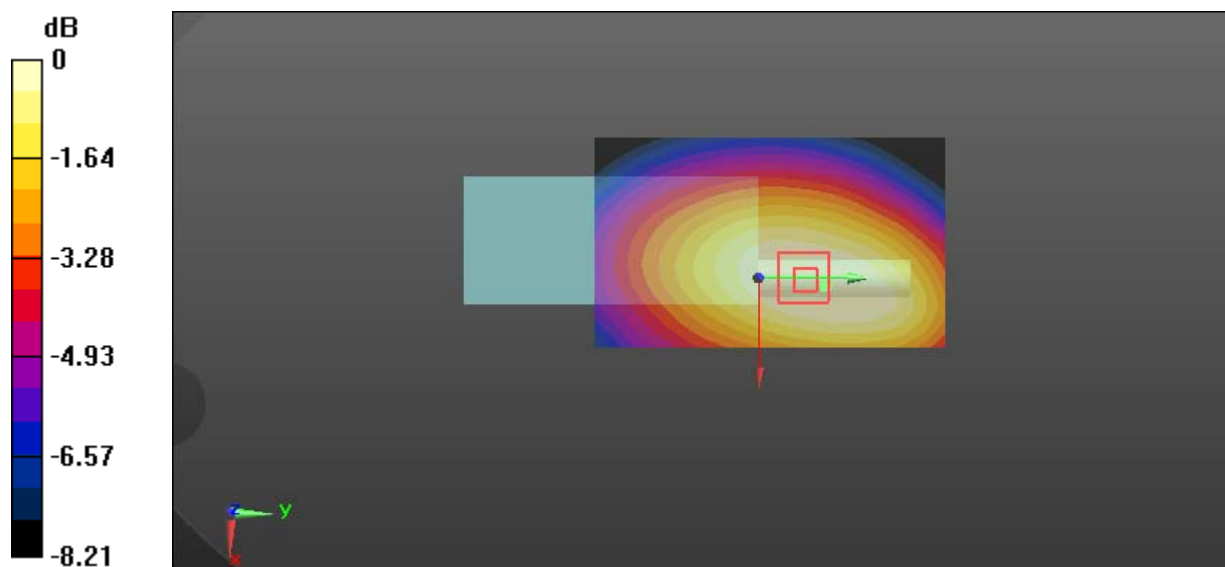

0 dB = 0.443 W/kg = -3.54 dBW/kg

Test Plot 16#: PTT_TMO_Face_380.0125 MHz**DUT: TETRA PORTABLE TERMINAL; Type: PT350 F8; Serial: 18092600120**Communication System: $\pi/4$ -DQPSK; Frequency: 380.012 MHz; Duty Cycle: 1:1Medium parameters used: $f = 380.012$ MHz; $\sigma = 0.855$ S/m; $\epsilon_r = 45.319$; $\rho = 1000$ kg/m³

Phantom section: Flat Section

DASY5 Configuration:

- Probe: ES3DV2 - SN3019; ConvF(7.18, 7.18, 7.18); Calibrated: 2018/8/20;
- Sensor-Surface: 4mm (Mechanical Surface Detection)
- Electronics: DAE3 Sn494; Calibrated: 2017/11/15
- Phantom: ELI v8.0; Type: QDOVA004AA; Serial: 2051
- Measurement SW: DASY52, Version 52.8 (8);

Area Scan (61x101x1): Interpolated grid: dx=1.500 mm, dy=1.500 mm

Maximum value of SAR (interpolated) = 1.58 W/kg

Zoom Scan (5x5x7)/Cube 0: Measurement grid: dx=8mm, dy=8mm, dz=5mm

Reference Value = 39.30 V/m; Power Drift = -0.10 dB

Peak SAR (extrapolated) = 1.86 W/kg

SAR(1 g) = 1.29 W/kg; SAR(10 g) = 1 W/kg

Maximum value of SAR (measured) = 1.64 W/kg

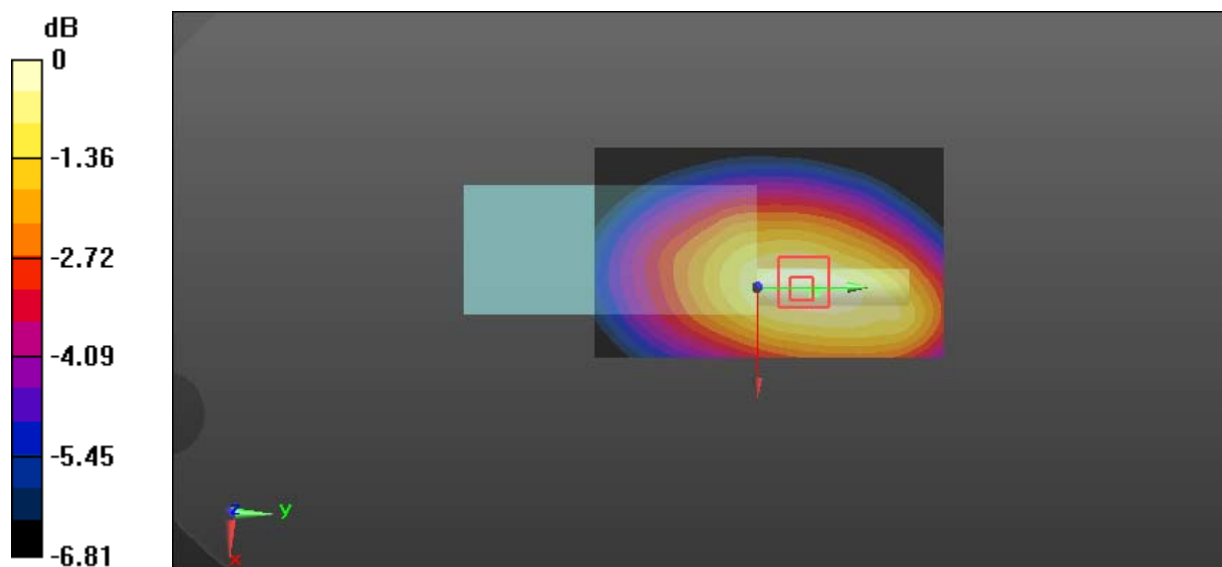

0 dB = 1.64 W/kg = 2.15 dBW/kg

Test Plot 17#: PTT_DMO_Face_380.0125 MHz**DUT: TETRA PORTABLE TERMINAL; Type: PT310 F8; Serial: 18092600121**Communication System: $\pi/4$ -DQPSK; Frequency: 380.012 MHz; Duty Cycle: 1:1Medium parameters used: $f = 380.012$ MHz; $\sigma = 0.855$ S/m; $\epsilon_r = 45.319$; $\rho = 1000$ kg/m³

Phantom section: Flat Section

DASY5 Configuration:

- Probe: ES3DV2 - SN3019; ConvF(7.18, 7.18, 7.18); Calibrated: 2018/8/20;
- Sensor-Surface: 4mm (Mechanical Surface Detection)
- Electronics: DAE3 Sn494; Calibrated: 2017/11/15
- Phantom: ELI v8.0; Type: QDOVA004AA; Serial: 2051
- Measurement SW: DASY52, Version 52.8 (8);

Area Scan (61x101x1): Interpolated grid: dx=1.500 mm, dy=1.500 mm

Maximum value of SAR (interpolated) = 1.21 W/kg

Zoom Scan (5x5x7)/Cube 0: Measurement grid: dx=8mm, dy=8mm, dz=5mm

Reference Value = 37.08 V/m; Power Drift = -0.10 dB

Peak SAR (extrapolated) = 1.45 W/kg

SAR(1 g) = 1.09 W/kg; SAR(10 g) = 0.821 W/kg

Maximum value of SAR (measured) = 1.15 W/kg

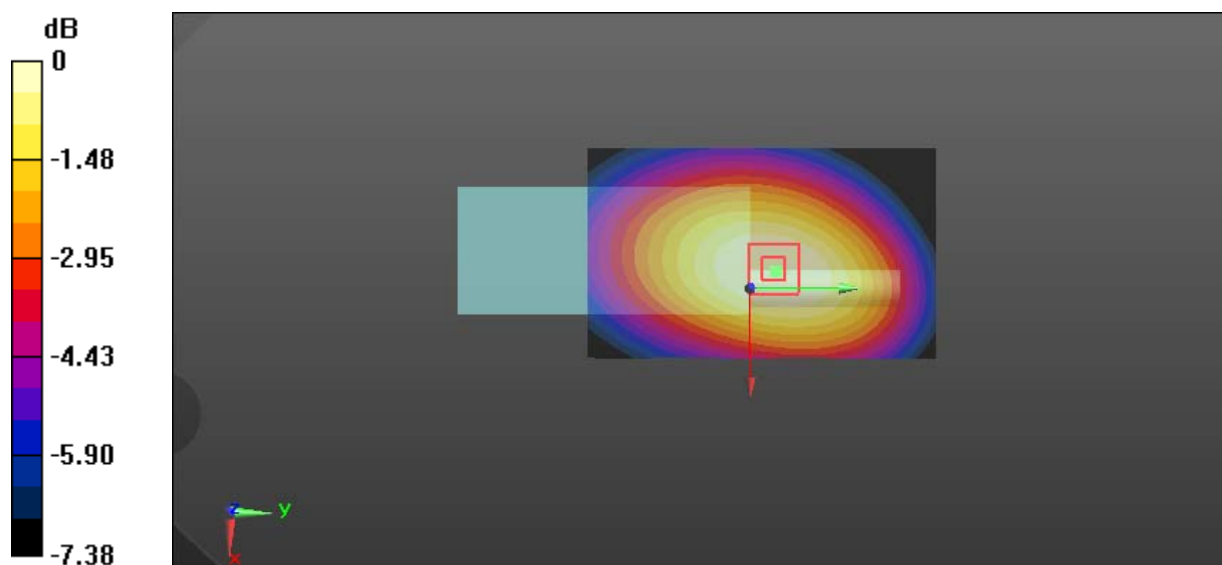

0 dB = 1.15 W/kg = 0.61 dBW/kg

Test Plot 18#: PTT_DMO_Body Back_380.0125 MHz**DUT: TETRA PORTABLE TERMINAL; Type: PT350 F8; Serial: 18092600120**Communication System: $\pi/4$ -DQPSK; Frequency: 380.012 MHz; Duty Cycle: 1:1Medium parameters used: $f = 380.012$ MHz; $\sigma = 0.927$ S/m; $\epsilon_r = 57.308$; $\rho = 1000$ kg/m³

Phantom section: Flat Section

DASY5 Configuration:

- Probe: ES3DV2 - SN3019; ConvF(7.1, 7.1, 7.1); Calibrated: 2018/8/20;
- Sensor-Surface: 4mm (Mechanical Surface Detection)
- Electronics: DAE3 Sn494; Calibrated: 2017/11/15
- Phantom: ELI v8.0; Type: QDOVA004AA; Serial: 2051
- Measurement SW: DASY52, Version 52.8 (8);

Area Scan (61x121x1): Interpolated grid: dx=1.500 mm, dy=1.500 mm

Maximum value of SAR (interpolated) = 1.69 W/kg

Zoom Scan (6x7x7)/Cube 0: Measurement grid: dx=8mm, dy=8mm, dz=5mm

Reference Value = 37.23 V/m; Power Drift = -0.13 dB

Peak SAR (extrapolated) = 2.01 W/kg

SAR(1 g) = 1.29 W/kg; SAR(10 g) = 0.937 W/kg

Maximum value of SAR (measured) = 1.70 W/kg

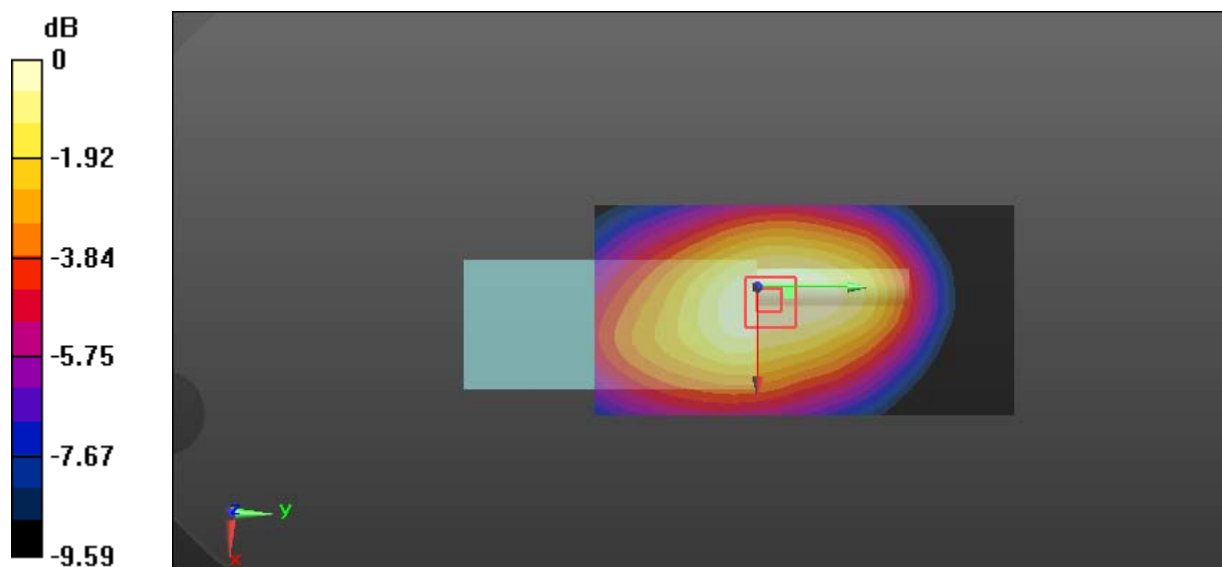

0 dB = 1.70 W/kg = 2.30 dBW/kg

Test Plot 19#: PTT_DMO_Body Back_390.0125 MHz**DUT: TETRA PORTABLE TERMINAL; Type: PT350 F8; Serial: 18092600120**Communication System: $\pi/4$ -DQPSK; Frequency: 390.012 MHz; Duty Cycle: 1:1Medium parameters used: $f = 390.012$ MHz; $\sigma = 0.929$ S/m; $\epsilon_r = 57.049$; $\rho = 1000$ kg/m³

Phantom section: Flat Section

DASY5 Configuration:

- Probe: ES3DV2 - SN3019; ConvF(7.1, 7.1, 7.1); Calibrated: 2018/8/20;
- Sensor-Surface: 4mm (Mechanical Surface Detection)
- Electronics: DAE3 Sn494; Calibrated: 2017/11/15
- Phantom: ELI v8.0; Type: QDOVA004AA; Serial: 2051
- Measurement SW: DASY52, Version 52.8 (8);

Area Scan (61x121x1): Interpolated grid: dx=1.500 mm, dy=1.500 mm

Maximum value of SAR (interpolated) = 0.545 W/kg

Zoom Scan (6x7x7)/Cube 0: Measurement grid: dx=8mm, dy=8mm, dz=5mm

Reference Value = 20.52 V/m; Power Drift = -0.06 dB

Peak SAR (extrapolated) = 0.632 W/kg

SAR(1 g) = 0.430 W/kg; SAR(10 g) = 0.317 W/kg

Maximum value of SAR (measured) = 0.551 W/kg

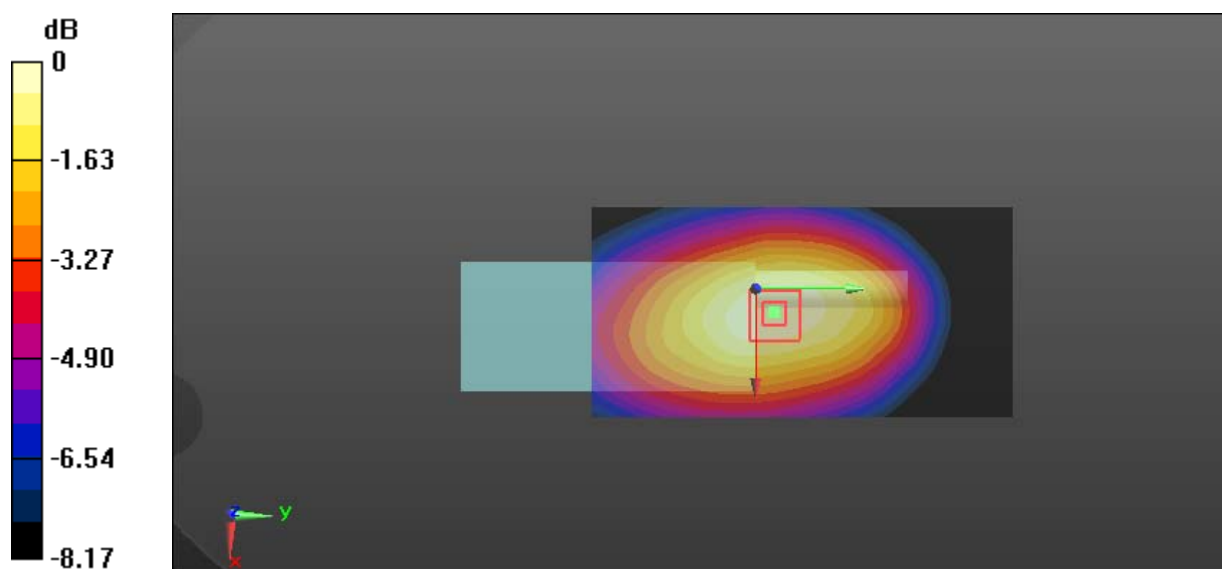

0 dB = 0.551 W/kg = -2.59 dBW/kg

Test Plot 20#: PTT_DMO_Body Back_399.9875 MHz**DUT: TETRA PORTABLE TERMINAL; Type: PT350 F8; Serial: 18092600120**Communication System: $\pi/4$ -DQPSK; Frequency: 399.988 MHz; Duty Cycle: 1:1Medium parameters used: $f = 399.988$ MHz; $\sigma = 0.934$ S/m; $\epsilon_r = 56.786$; $\rho = 1000$ kg/m³

Phantom section: Flat Section

DASY5 Configuration:

- Probe: ES3DV2 - SN3019; ConvF(7.1, 7.1, 7.1); Calibrated: 2018/8/20;
- Sensor-Surface: 4mm (Mechanical Surface Detection)
- Electronics: DAE3 Sn494; Calibrated: 2017/11/15
- Phantom: ELI v8.0; Type: QDOVA004AA; Serial: 2051
- Measurement SW: DASY52, Version 52.8 (8);

Area Scan (61x121x1): Interpolated grid: dx=1.500 mm, dy=1.500 mm

Maximum value of SAR (interpolated) = 0.342 W/kg

Zoom Scan (6x7x7)/Cube 0: Measurement grid: dx=8mm, dy=8mm, dz=5mm

Reference Value = 16.61 V/m; Power Drift = -0.19 dB

Peak SAR (extrapolated) = 0.389 W/kg

SAR(1 g) = 0.267 W/kg; SAR(10 g) = 0.198 W/kg

Maximum value of SAR (measured) = 0.340 W/kg

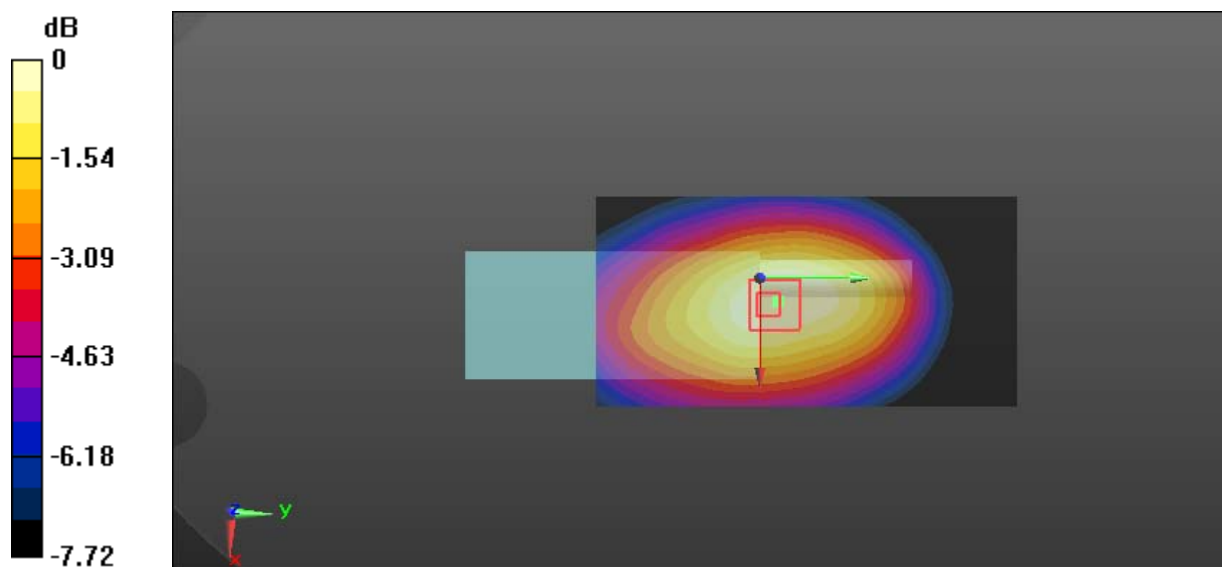

0 dB = 0.340 W/kg = -4.69 dBW/kg

Test Plot 21#: PTT_TMO_Body Back_380.0125 MHz**DUT: TETRA PORTABLE TERMINAL; Type: PT350 F8; Serial: 18092600120**Communication System: $\pi/4$ -DQPSK; Frequency: 380.012 MHz; Duty Cycle: 1:1Medium parameters used: $f = 380.012$ MHz; $\sigma = 0.927$ S/m; $\epsilon_r = 57.308$; $\rho = 1000$ kg/m³

Phantom section: Flat Section

DASY5 Configuration:

- Probe: ES3DV2 - SN3019; ConvF(7.1, 7.1, 7.1); Calibrated: 2018/8/20;
- Sensor-Surface: 4mm (Mechanical Surface Detection)
- Electronics: DAE3 Sn494; Calibrated: 2017/11/15
- Phantom: ELI v8.0; Type: QDOVA004AA; Serial: 2051
- Measurement SW: DASY52, Version 52.8 (8);

Area Scan (61x121x1): Interpolated grid: dx=1.500 mm, dy=1.500 mm

Maximum value of SAR (interpolated) = 1.68 W/kg

Zoom Scan (6x7x7)/Cube 0: Measurement grid: dx=8mm, dy=8mm, dz=5mm

Reference Value = 34.89 V/m; Power Drift = -0.11 dB

Peak SAR (extrapolated) = 1.92 W/kg

SAR(1 g) = 1.29 W/kg; SAR(10 g) = 0.946 W/kg

Maximum value of SAR (measured) = 1.66 W/kg

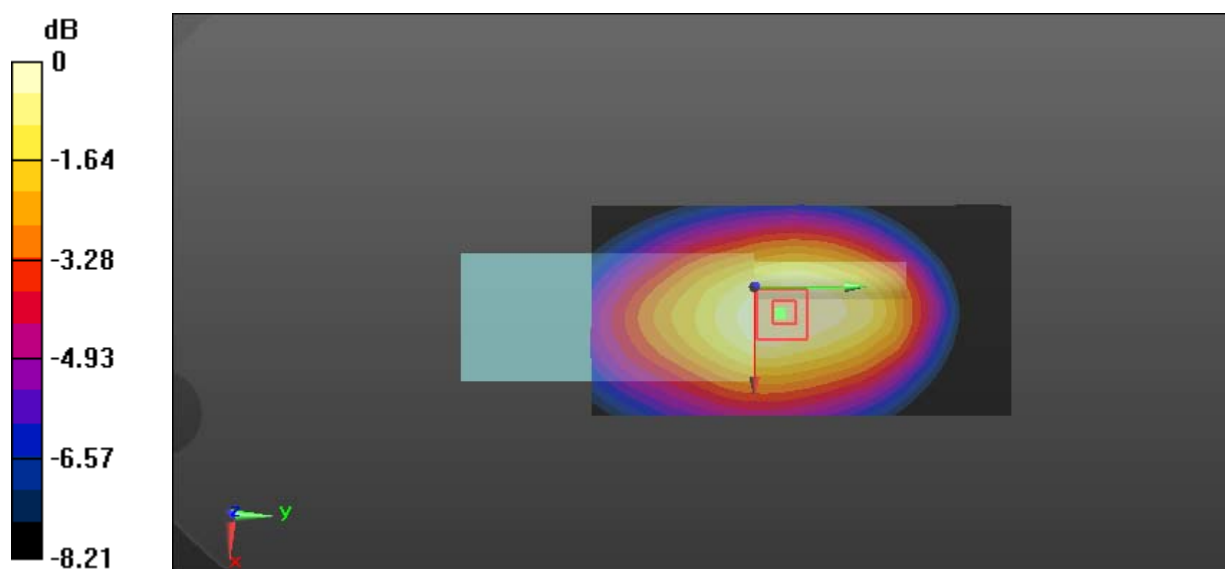

0 dB = 1.66 W/kg = 2.20 dBW/kg

Test Plot 22#: PTT_DMO_Body Back_380.0125 MHz**DUT: TETRA PORTABLE TERMINAL; Type: PT310 F8; Serial: 18092600121**Communication System: $\pi/4$ -DQPSK; Frequency: 380.012 MHz; Duty Cycle: 1:1Medium parameters used: $f = 380.012$ MHz; $\sigma = 0.927$ S/m; $\epsilon_r = 57.308$; $\rho = 1000$ kg/m³

Phantom section: Flat Section

DASY5 Configuration:

- Probe: ES3DV2 - SN3019; ConvF(7.1, 7.1, 7.1); Calibrated: 2018/8/20;
- Sensor-Surface: 4mm (Mechanical Surface Detection)
- Electronics: DAE3 Sn494; Calibrated: 2017/11/15
- Phantom: ELI v8.0; Type: QDOVA004AA; Serial: 2051
- Measurement SW: DASY52, Version 52.8 (8);

Area Scan (61x101x1): Interpolated grid: dx=1.500 mm, dy=1.500 mm

Maximum value of SAR (interpolated) = 1.10 W/kg

Zoom Scan (5x5x7)/Cube 0: Measurement grid: dx=8mm, dy=8mm, dz=5mm

Reference Value = 32.37 V/m; Power Drift = -0.13 dB

Peak SAR (extrapolated) = 1.38 W/kg

SAR(1 g) = 1.02 W/kg; SAR(10 g) = 0.749 W/kg

Maximum value of SAR (measured) = 1.07 W/kg

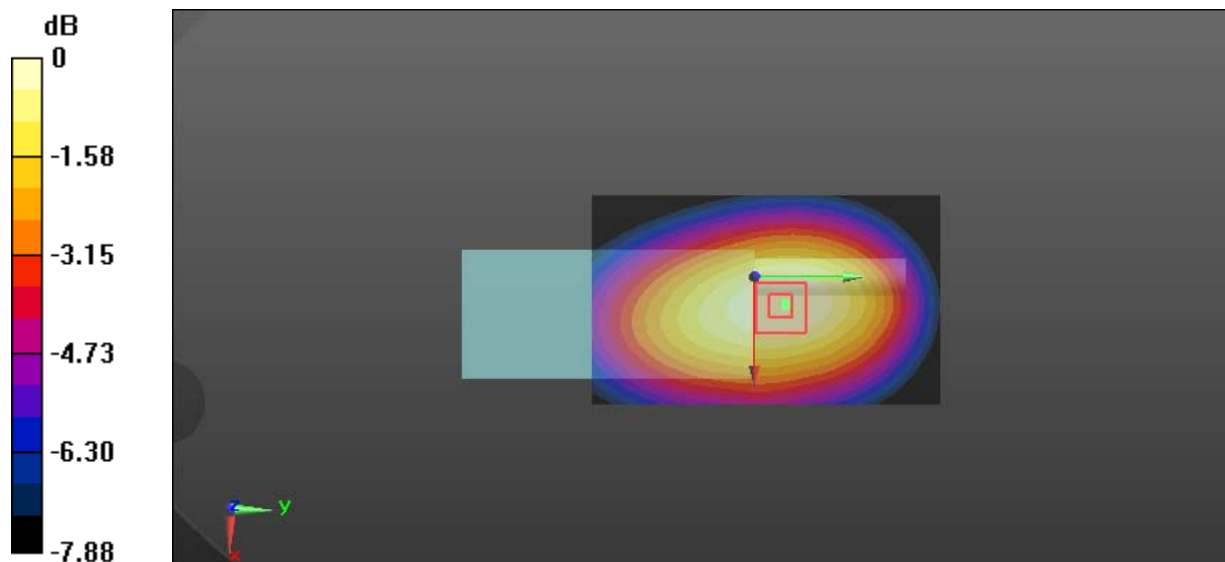

0 dB = 1.07 W/kg = 0.29 dBW/kg

Test Plot 23#: PTT_DMO_Face Up_400.0125 MHz**DUT: TETRA PORTABLE TERMINAL; Type: PT350 F8; Serial: 18092600120**Communication System: $\pi/4$ -DQPSK; Frequency: 400.012 MHz; Duty Cycle: 1:1Medium parameters used: $f = 400.012$ MHz; $\sigma = 0.867$ S/m; $\epsilon_r = 45.207$; $\rho = 1000$ kg/m³

Phantom section: Flat Section

DASY5 Configuration:

- Probe: ES3DV2 - SN3019; ConvF(7.18, 7.18, 7.18); Calibrated: 2018/8/20;
- Sensor-Surface: 4mm (Mechanical Surface Detection)
- Electronics: DAE3 Sn494; Calibrated: 2017/11/15
- Phantom: ELI v8.0; Type: QDOVA004AA; Serial: 2051
- Measurement SW: DASY52, Version 52.8 (8);

Area Scan (61x101x1): Interpolated grid: dx=1.500 mm, dy=1.500 mm

Maximum value of SAR (interpolated) = 1.47 W/kg

Zoom Scan (5x5x7)/Cube 0: Measurement grid: dx=8mm, dy=8mm, dz=5mm

Reference Value = 37.12 V/m; Power Drift = -0.19 dB

Peak SAR (extrapolated) = 1.60 W/kg

SAR(1 g) = 1.09 W/kg; SAR(10 g) = 0.824 W/kg

Maximum value of SAR (measured) = 1.38 W/kg

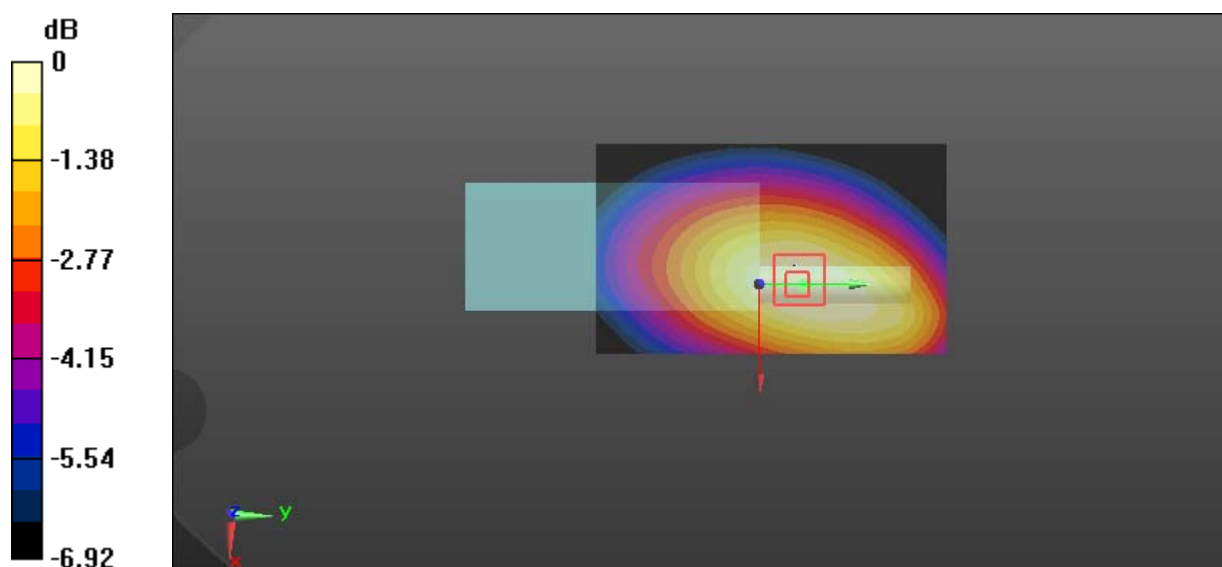

0 dB = 1.38 W/kg = 1.40 dBW/kg

Test Plot 24#: PTT_DMO_Face Up_410.0125 MHz**DUT: TETRA PORTABLE TERMINAL; Type: PT350 F8; Serial: 18092600120**Communication System: $\pi/4$ -DQPSK; Frequency: 410.012 MHz; Duty Cycle: 1:1Medium parameters used: $f = 410.012$ MHz; $\sigma = 0.869$ S/m; $\epsilon_r = 45.186$; $\rho = 1000$ kg/m³

Phantom section: Flat Section

DASY5 Configuration:

- Probe: ES3DV2 - SN3019; ConvF(7.18, 7.18, 7.18); Calibrated: 2018/8/20;
- Sensor-Surface: 4mm (Mechanical Surface Detection)
- Electronics: DAE3 Sn494; Calibrated: 2017/11/15
- Phantom: ELI v8.0; Type: QDOVA004AA; Serial: 2051
- Measurement SW: DASY52, Version 52.8 (8);

Area Scan (61x101x1): Interpolated grid: dx=1.500 mm, dy=1.500 mm

Maximum value of SAR (interpolated) = 0.704 W/kg

Zoom Scan (5x5x7)/Cube 0: Measurement grid: dx=8mm, dy=8mm, dz=5mm

Reference Value = 26.26 V/m; Power Drift = -0.10 dB

Peak SAR (extrapolated) = 0.807 W/kg

SAR(1 g) = 0.559 W/kg; SAR(10 g) = 0.425 W/kg

Maximum value of SAR (measured) = 0.710 W/kg

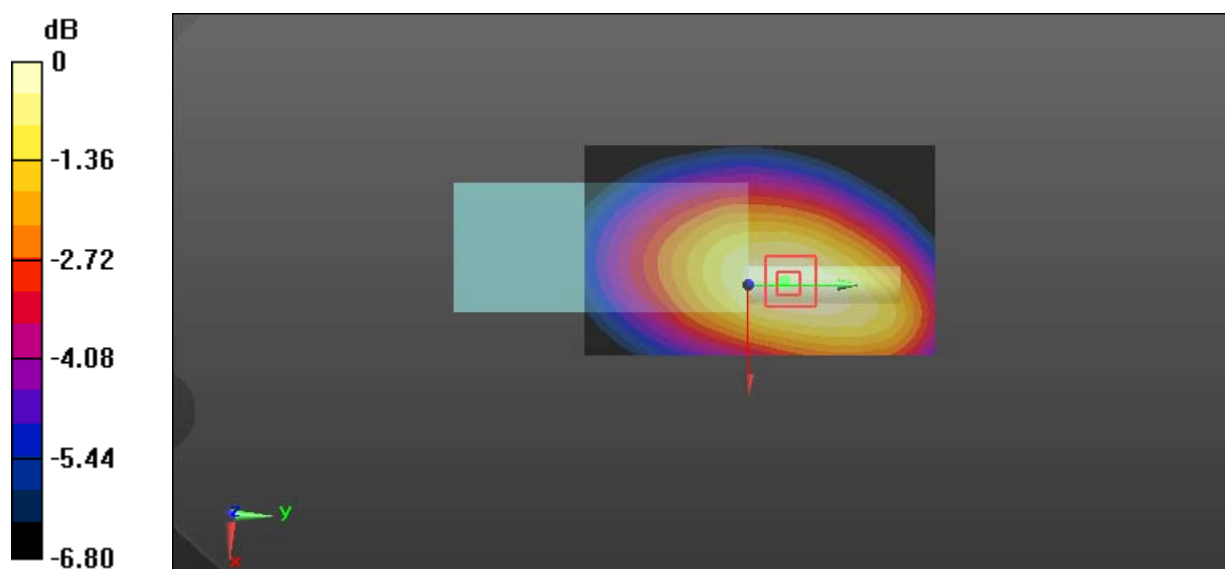

0 dB = 0.710 W/kg = -1.49 dBW/kg

Test Plot 25#: PTT_DMO_Face Up_420.0125 MHz**DUT: TETRA PORTABLE TERMINAL; Type: PT350 F8; Serial: 18092600120**Communication System: $\pi/4$ -DQPSK; Frequency: 420.012 MHz; Duty Cycle: 1:1Medium parameters used: $f = 420.012$ MHz; $\sigma = 0.874$ S/m; $\epsilon_r = 45.119$; $\rho = 1000$ kg/m³

Phantom section: Flat Section

DASY5 Configuration:

- Probe: ES3DV2 - SN3019; ConvF(7.18, 7.18, 7.18); Calibrated: 2018/8/20;
- Sensor-Surface: 4mm (Mechanical Surface Detection)
- Electronics: DAE3 Sn494; Calibrated: 2017/11/15
- Phantom: ELI v8.0; Type: QDOVA004AA; Serial: 2051
- Measurement SW: DASY52, Version 52.8 (8);

Area Scan (61x101x1): Interpolated grid: dx=1.500 mm, dy=1.500 mm

Maximum value of SAR (interpolated) = 0.730 W/kg

Zoom Scan (5x5x7)/Cube 0: Measurement grid: dx=8mm, dy=8mm, dz=5mm

Reference Value = 26.52 V/m; Power Drift = -0.10 dB

Peak SAR (extrapolated) = 0.849 W/kg

SAR(1 g) = 0.571 W/kg; SAR(10 g) = 0.437 W/kg

Maximum value of SAR (measured) = 0.728 W/kg

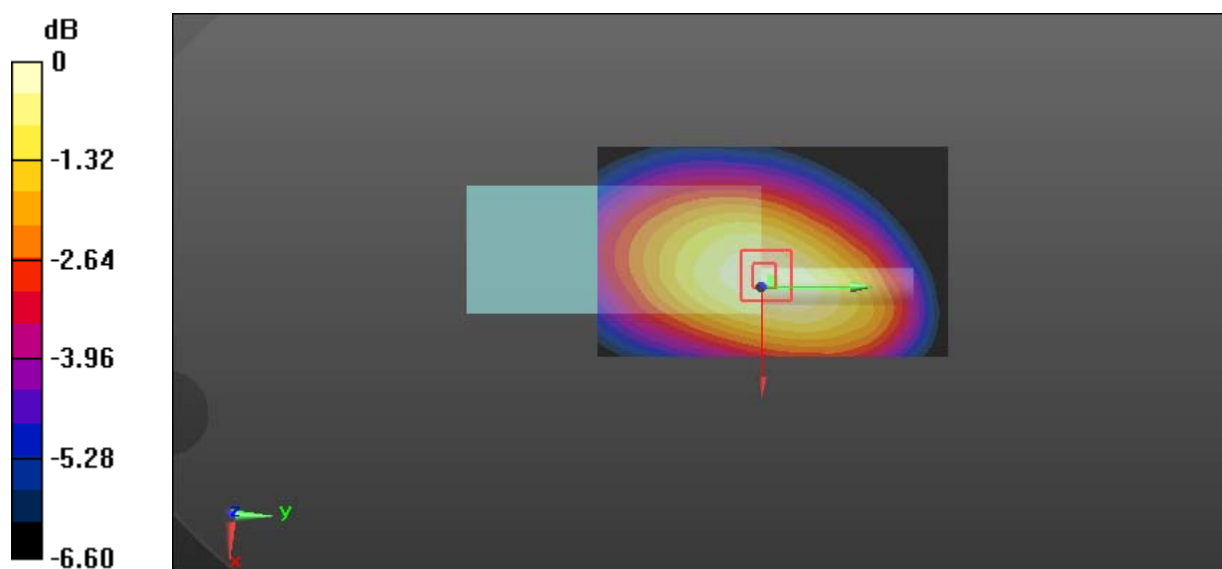

0 dB = 0.728 W/kg = -1.38 dBW/kg

Test Plot 26#: PTT_DMO_Face Up_429.9875 MHz**DUT: TETRA PORTABLE TERMINAL; Type: PT350 F8; Serial: 18092600120**Communication System: $\pi/4$ -DQPSK; Frequency: 429.988 MHz; Duty Cycle: 1:1Medium parameters used: $f = 429.988$ MHz; $\sigma = 0.879$ S/m; $\epsilon_r = 45.102$; $\rho = 1000$ kg/m³

Phantom section: Flat Section

DASY5 Configuration:

- Probe: ES3DV2 - SN3019; ConvF(7.18, 7.18, 7.18); Calibrated: 2018/8/20;
- Sensor-Surface: 4mm (Mechanical Surface Detection)
- Electronics: DAE3 Sn494; Calibrated: 2017/11/15
- Phantom: ELI v8.0; Type: QDOVA004AA; Serial: 2051
- Measurement SW: DASY52, Version 52.8 (8);

Area Scan (61x101x1): Interpolated grid: dx=1.500 mm, dy=1.500 mm

Maximum value of SAR (interpolated) = 1.12 W/kg

Zoom Scan (5x5x7)/Cube 0: Measurement grid: dx=8mm, dy=8mm, dz=5mm

Reference Value = 32.77 V/m; Power Drift = -0.11 dB

Peak SAR (extrapolated) = 1.32 W/kg

SAR(1 g) = 0.887 W/kg; SAR(10 g) = 0.676 W/kg

Maximum value of SAR (measured) = 1.13 W/kg

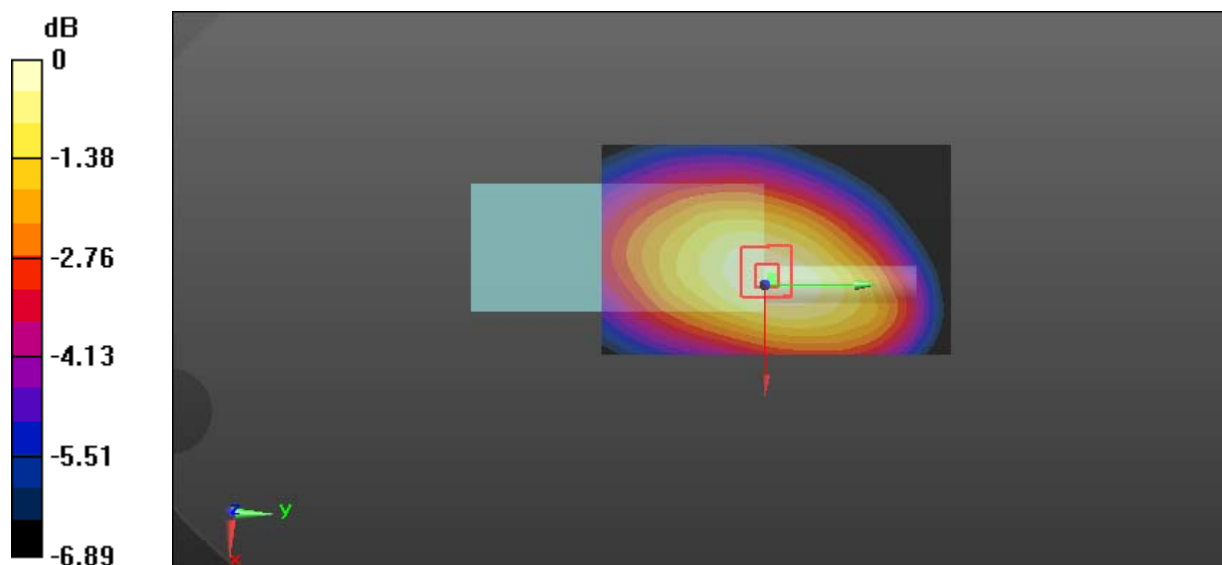

0 dB = 1.13 W/kg = 0.53 dBW/kg

Test Plot 27#: PTT_TMO_Face Up_400.0125 MHz**DUT: TETRA PORTABLE TERMINAL; Type: PT350 F8; Serial: 18092600120**Communication System: $\pi/4$ -DQPSK; Frequency: 400.012 MHz; Duty Cycle: 1:1Medium parameters used: $f = 400.012$ MHz; $\sigma = 0.867$ S/m; $\epsilon_r = 45.207$; $\rho = 1000$ kg/m³

Phantom section: Flat Section

DASY5 Configuration:

- Probe: ES3DV2 - SN3019; ConvF(7.18, 7.18, 7.18); Calibrated: 2018/8/20;
- Sensor-Surface: 4mm (Mechanical Surface Detection)
- Electronics: DAE3 Sn494; Calibrated: 2017/11/15
- Phantom: ELI v8.0; Type: QDOVA004AA; Serial: 2051
- Measurement SW: DASY52, Version 52.8 (8);

Area Scan (61x101x1): Interpolated grid: dx=1.500 mm, dy=1.500 mm

Maximum value of SAR (interpolated) = 1.31 W/kg

Zoom Scan (5x5x7)/Cube 0: Measurement grid: dx=8mm, dy=8mm, dz=5mm

Reference Value = 35.07 V/m; Power Drift = -0.17 dB

Peak SAR (extrapolated) = 1.52 W/kg

SAR(1 g) = 1.05 W/kg; SAR(10 g) = 0.803 W/kg

Maximum value of SAR (measured) = 1.33 W/kg

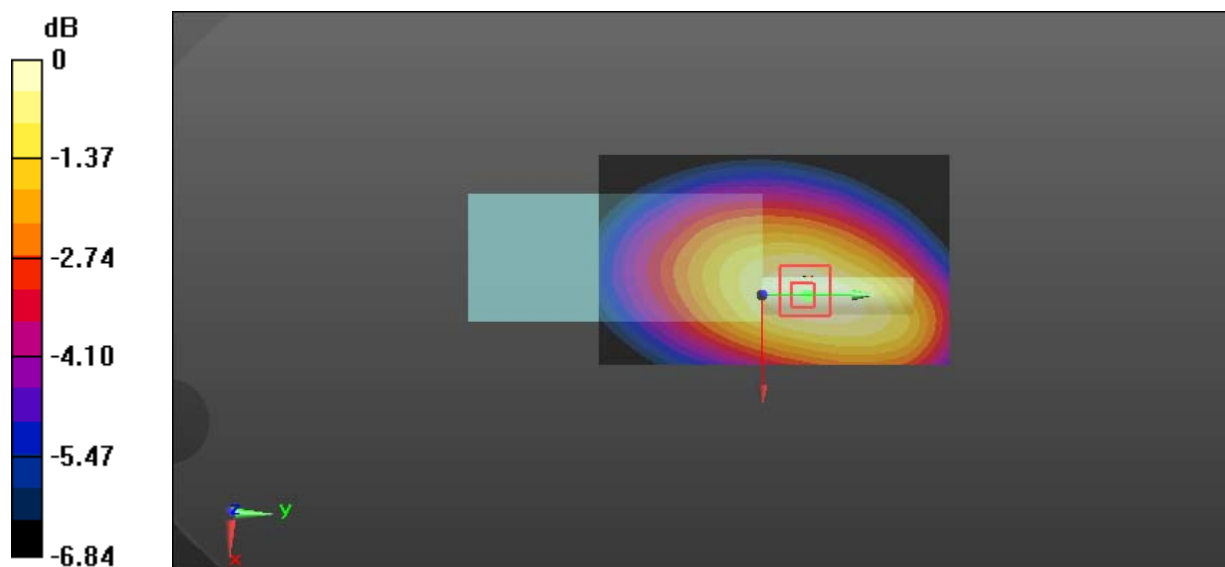

0 dB = 1.33 W/kg = 1.24 dBW/kg

Test Plot 28#: PTT_DMO_Face Up_400.0125 MHz**DUT: TETRA PORTABLE TERMINAL; Type: PT310 F8; Serial: 18092600121**Communication System: $\pi/4$ -DQPSK; Frequency: 400.012 MHz; Duty Cycle: 1:1Medium parameters used: $f = 400.012$ MHz; $\sigma = 0.867$ S/m; $\epsilon_r = 45.207$; $\rho = 1000$ kg/m³

Phantom section: Flat Section

DASY5 Configuration:

- Probe: ES3DV2 - SN3019; ConvF(7.18, 7.18, 7.18); Calibrated: 2018/8/20;
- Sensor-Surface: 4mm (Mechanical Surface Detection)
- Electronics: DAE3 Sn494; Calibrated: 2017/11/15
- Phantom: ELI v8.0; Type: QDOVA004AA; Serial: 2051
- Measurement SW: DASY52, Version 52.8 (8);

Area Scan (61x101x1): Interpolated grid: dx=1.500 mm, dy=1.500 mm

Maximum value of SAR (interpolated) = 0.906 W/kg

Zoom Scan (6x6x7)/Cube 0: Measurement grid: dx=8mm, dy=8mm, dz=5mm

Reference Value = 33.44 V/m; Power Drift = -0.12 dB

Peak SAR (extrapolated) = 1.11 W/kg

SAR(1 g) = 0.825 W/kg; SAR(10 g) = 0.607 W/kg

Maximum value of SAR (measured) = 0.875 W/kg

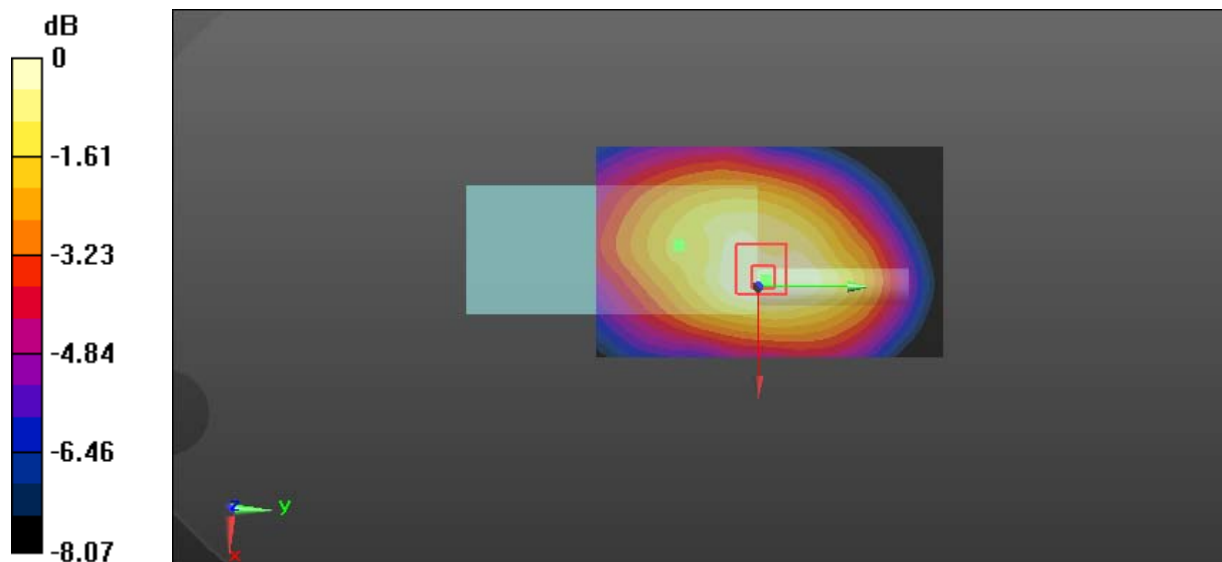

0 dB = 0.875 W/kg = -0.58 dBW/kg

Test Plot 29#: PTT_DMO_Body Back_400.0125 MHz**DUT: TETRA PORTABLE TERMINAL; Type: PT350 F8; Serial: 18092600120**Communication System: $\pi/4$ -DQPSK; Frequency: 400.012 MHz; Duty Cycle: 1:1Medium parameters used: $f = 400.012$ MHz; $\sigma = 0.935$ S/m; $\epsilon_r = 56.772$; $\rho = 1000$ kg/m³

Phantom section: Flat Section

DASY5 Configuration:

- Probe: ES3DV2 - SN3019; ConvF(7.1, 7.1, 7.1); Calibrated: 2018/8/20;
- Sensor-Surface: 4mm (Mechanical Surface Detection)
- Electronics: DAE3 Sn494; Calibrated: 2017/11/15
- Phantom: ELI v8.0; Type: QDOVA004AA; Serial: 2051
- Measurement SW: DASY52, Version 52.8 (8);

Area Scan (61x121x1): Interpolated grid: dx=1.500 mm, dy=1.500 mm

Maximum value of SAR (interpolated) = 1.39 W/kg

Zoom Scan (5x5x7)/Cube 0: Measurement grid: dx=8mm, dy=8mm, dz=5mm

Reference Value = 31.89 V/m; Power Drift = 0.00 dB

Peak SAR (extrapolated) = 1.68 W/kg

SAR(1 g) = 1.13 W/kg; SAR(10 g) = 0.873 W/kg

Maximum value of SAR (measured) = 1.43 W/kg

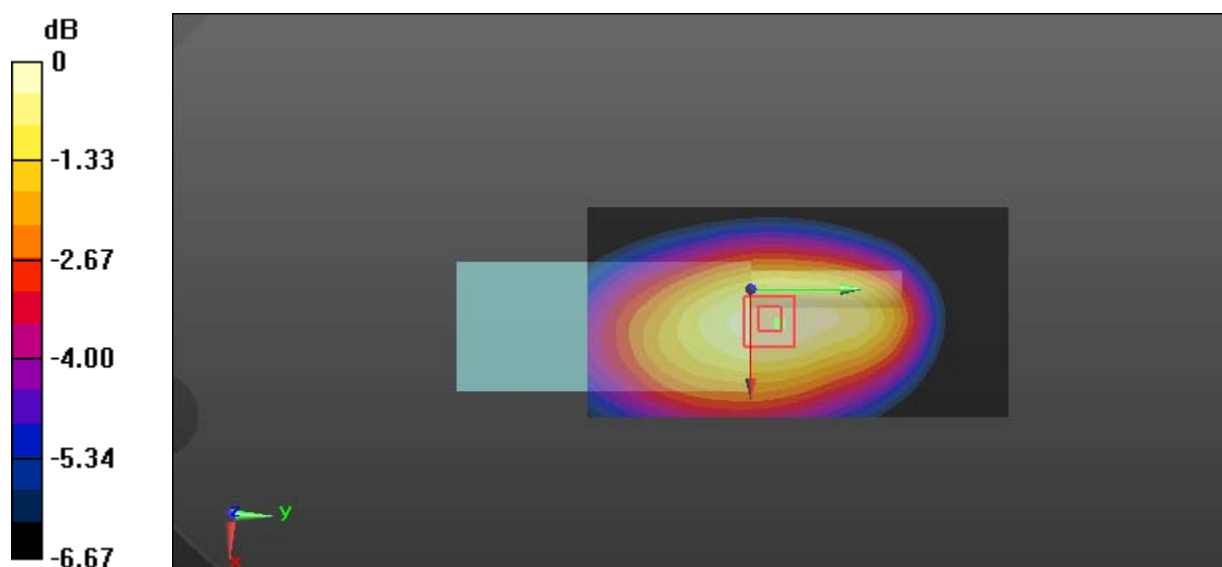

0 dB = 1.43 W/kg = 1.55 dBW/kg

Test Plot 30#: PTT_DMO_Body Back_410.0125 MHz**DUT: TETRA PORTABLE TERMINAL; Type: PT350 F8; Serial: 18092600120**Communication System: $\pi/4$ -DQPSK; Frequency: 410.012 MHz; Duty Cycle: 1:1Medium parameters used: $f = 410.012$ MHz; $\sigma = 0.941$ S/m; $\epsilon_r = 56.443$; $\rho = 1000$ kg/m³

Phantom section: Flat Section

DASY5 Configuration:

- Probe: ES3DV2 - SN3019; ConvF(7.1, 7.1, 7.1); Calibrated: 2018/8/20;
- Sensor-Surface: 4mm (Mechanical Surface Detection)
- Electronics: DAE3 Sn494; Calibrated: 2017/11/15
- Phantom: ELI v8.0; Type: QDOVA004AA; Serial: 2051
- Measurement SW: DASY52, Version 52.8 (8);

Area Scan (61x121x1): Interpolated grid: dx=1.500 mm, dy=1.500 mm

Maximum value of SAR (interpolated) = 0.810 W/kg

Zoom Scan (6x7x7)/Cube 0: Measurement grid: dx=8mm, dy=8mm, dz=5mm

Reference Value = 26.81 V/m; Power Drift = -0.19 dB

Peak SAR (extrapolated) = 0.870 W/kg

SAR(1 g) = 0.595 W/kg; SAR(10 g) = 0.437 W/kg

Maximum value of SAR (measured) = 0.760 W/kg

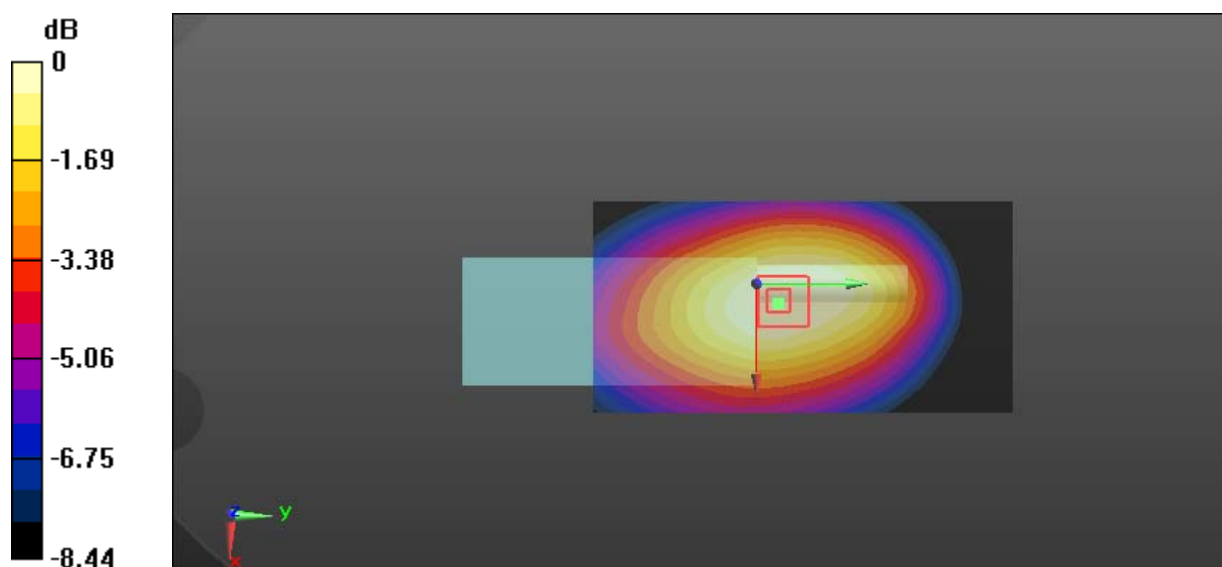

0 dB = 0.760 W/kg = -1.19 dBW/kg

Test Plot 31#: PTT_DMO_Body Back_420.0125 MHz**DUT: TETRA PORTABLE TERMINAL; Type: PT350 F8; Serial: 18092600120**Communication System: $\pi/4$ -DQPSK; Frequency: 420.012 MHz; Duty Cycle: 1:1Medium parameters used: $f = 420.012$ MHz; $\sigma = 0.952$ S/m; $\epsilon_r = 56.125$; $\rho = 1000$ kg/m³

Phantom section: Flat Section

DASY5 Configuration:

- Probe: ES3DV2 - SN3019; ConvF(7.1, 7.1, 7.1); Calibrated: 2018/8/20;
- Sensor-Surface: 4mm (Mechanical Surface Detection)
- Electronics: DAE3 Sn494; Calibrated: 2017/11/15
- Phantom: ELI v8.0; Type: QDOVA004AA; Serial: 2051
- Measurement SW: DASY52, Version 52.8 (8);

Area Scan (61x121x1): Interpolated grid: dx=1.500 mm, dy=1.500 mm

Maximum value of SAR (interpolated) = 0.737 W/kg

Zoom Scan (6x7x7)/Cube 0: Measurement grid: dx=8mm, dy=8mm, dz=5mm

Reference Value = 24.60 V/m; Power Drift = -0.15 dB

Peak SAR (extrapolated) = 0.783 W/kg

SAR(1 g) = 0.534 W/kg; SAR(10 g) = 0.391 W/kg

Maximum value of SAR (measured) = 0.680 W/kg

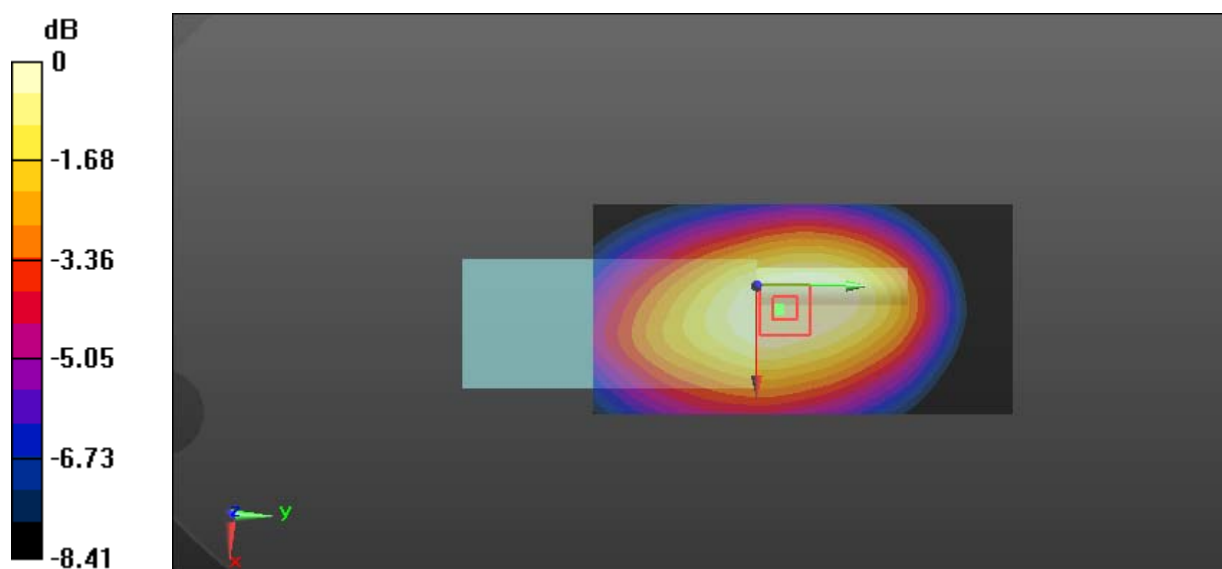

0 dB = 0.680 W/kg = -1.67 dBW/kg

Test Plot 32#: PTT_DMO_Body Back_429.9875 MHz**DUT: TETRA PORTABLE TERMINAL; Type: PT350 F8; Serial: 18092600120**Communication System: $\pi/4$ -DQPSK; Frequency: 429.988 MHz; Duty Cycle: 1:1Medium parameters used: $f = 429.988$ MHz; $\sigma = 0.958$ S/m; $\epsilon_r = 55.862$; $\rho = 1000$ kg/m³

Phantom section: Flat Section

DASY5 Configuration:

- Probe: ES3DV2 - SN3019; ConvF(7.1, 7.1, 7.1); Calibrated: 2018/8/20;
- Sensor-Surface: 4mm (Mechanical Surface Detection)
- Electronics: DAE3 Sn494; Calibrated: 2017/11/15
- Phantom: ELI v8.0; Type: QDOVA004AA; Serial: 2051
- Measurement SW: DASY52, Version 52.8 (8);

Area Scan (61x121x1): Interpolated grid: dx=1.500 mm, dy=1.500 mm

Maximum value of SAR (interpolated) = 1.02 W/kg

Zoom Scan (6x7x7)/Cube 0: Measurement grid: dx=8mm, dy=8mm, dz=5mm

Reference Value = 28.32 V/m; Power Drift = 0.16 dB

Peak SAR (extrapolated) = 1.14 W/kg

SAR(1 g) = 0.783 W/kg; SAR(10 g) = 0.573 W/kg

Maximum value of SAR (measured) = 0.996 W/kg

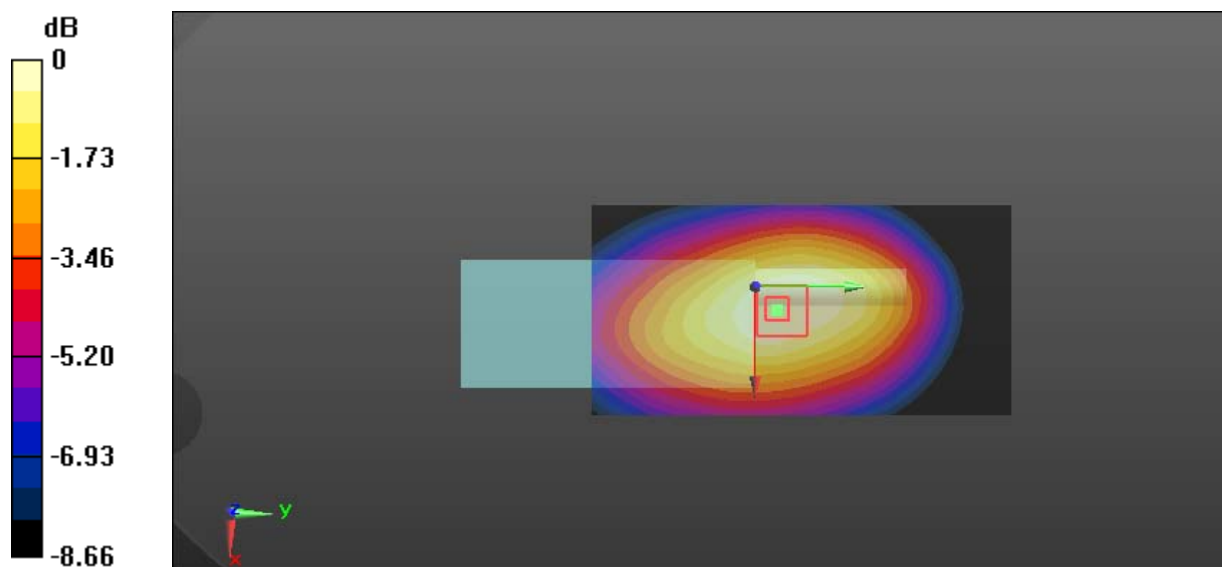

0 dB = 0.996 W/kg = -0.02 dBW/kg

Test Plot 33#: PTT_TMO_Body Back_400.0125 MHz**DUT: TETRA PORTABLE TERMINAL; Type: PT350 F8; Serial: 18092600120**Communication System: $\pi/4$ -DQPSK; Frequency: 400.012 MHz; Duty Cycle: 1:1Medium parameters used: $f = 400.012$ MHz; $\sigma = 0.935$ S/m; $\epsilon_r = 56.772$; $\rho = 1000$ kg/m³

Phantom section: Flat Section

DASY5 Configuration:

- Probe: ES3DV2 - SN3019; ConvF(7.1, 7.1, 7.1); Calibrated: 2018/8/20;
- Sensor-Surface: 4mm (Mechanical Surface Detection)
- Electronics: DAE3 Sn494; Calibrated: 2017/11/15
- Phantom: ELI v8.0; Type: QDOVA004AA; Serial: 2051
- Measurement SW: DASY52, Version 52.8 (8);

Area Scan (61x121x1): Interpolated grid: dx=1.500 mm, dy=1.500 mm

Maximum value of SAR (interpolated) = 1.47 W/kg

Zoom Scan (5x5x7)/Cube 0: Measurement grid: dx=8mm, dy=8mm, dz=5mm

Reference Value = 35.54 V/m; Power Drift = -0.15 dB

Peak SAR (extrapolated) = 1.64 W/kg

SAR(1 g) = 1.09 W/kg; SAR(10 g) = 0.791 W/kg

Maximum value of SAR (measured) = 1.41 W/kg

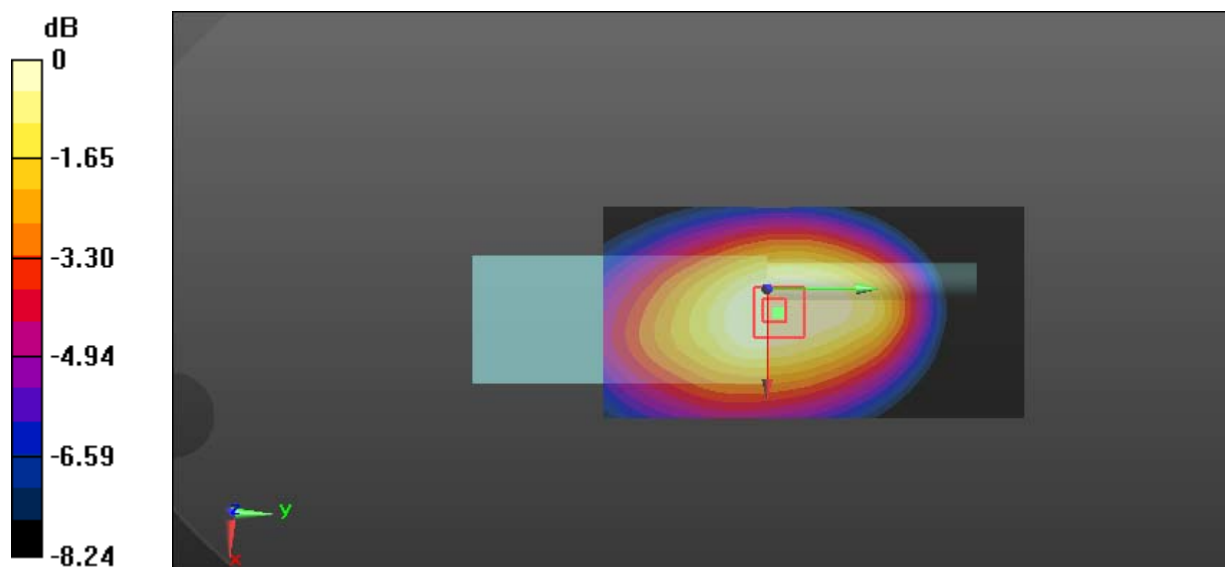

0 dB = 1.41 W/kg = 1.49 dBW/kg

Test Plot 34#: PTT_DMO_Body Back_400.0125 MHz**DUT: TETRA PORTABLE TERMINAL; Type: PT310 F8; Serial: 18092600121**Communication System: $\pi/4$ -DQPSK; Frequency: 400.012 MHz; Duty Cycle: 1:1Medium parameters used: $f = 400.012$ MHz; $\sigma = 0.935$ S/m; $\epsilon_r = 56.772$; $\rho = 1000$ kg/m³

Phantom section: Flat Section

DASY5 Configuration:

- Probe: ES3DV2 - SN3019; ConvF(7.1, 7.1, 7.1); Calibrated: 2018/8/20;
- Sensor-Surface: 4mm (Mechanical Surface Detection)
- Electronics: DAE3 Sn494; Calibrated: 2017/11/15
- Phantom: ELI v8.0; Type: QDOVA004AA; Serial: 2051
- Measurement SW: DASY52, Version 52.8 (8);

Area Scan (61x101x1): Interpolated grid: dx=1.500 mm, dy=1.500 mm

Maximum value of SAR (interpolated) = 1.14 W/kg

Zoom Scan (5x5x7)/Cube 0: Measurement grid: dx=8mm, dy=8mm, dz=5mm

Reference Value = 34.76 V/m; Power Drift = -0.10 dB

Peak SAR (extrapolated) = 1.39 W/kg

SAR(1 g) = 1.02 W/kg; SAR(10 g) = 0.745 W/kg

Maximum value of SAR (measured) = 1.08 W/kg

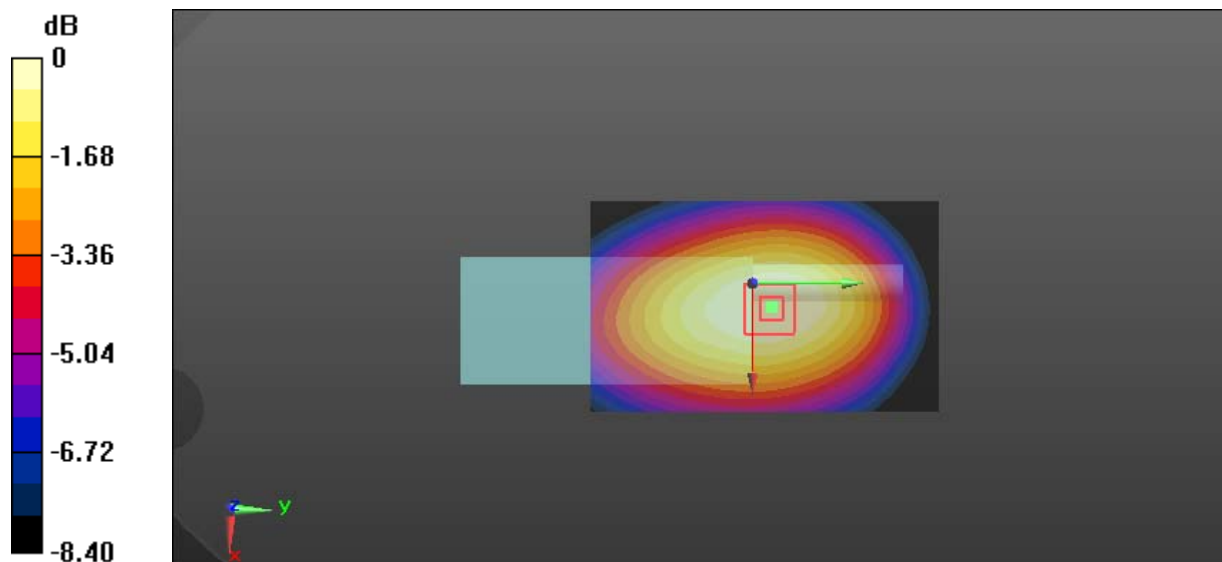

0 dB = 1.08 W/kg = 0.33 dBW/kg

Test Plot 35#: PTT_DMO_Face Up_400.0125 MHz**DUT: TETRA PORTABLE TERMINAL; Type: PT350 F8; Serial: 18092600120**Communication System: $\pi/4$ -DQPSK; Frequency: 400.012 MHz; Duty Cycle: 1:1Medium parameters used: $f = 400.012$ MHz; $\sigma = 0.867$ S/m; $\epsilon_r = 45.207$; $\rho = 1000$ kg/m³

Phantom section: Flat Section

DASY5 Configuration:

- Probe: ES3DV2 - SN3019; ConvF(7.18, 7.18, 7.18); Calibrated: 2018/8/20;
- Sensor-Surface: 4mm (Mechanical Surface Detection)
- Electronics: DAE3 Sn494; Calibrated: 2017/11/15
- Phantom: ELI v8.0; Type: QDOVA004AA; Serial: 2051
- Measurement SW: DASY52, Version 52.8 (8);

Area Scan (61x121x1): Interpolated grid: dx=1.500 mm, dy=1.500 mm

Maximum value of SAR (interpolated) = 3.06 W/kg

Zoom Scan (9x8x7)/Cube 0: Measurement grid: dx=8mm, dy=8mm, dz=5mm

Reference Value = 54.52 V/m; Power Drift = -0.11 dB

Peak SAR (extrapolated) = 3.61 W/kg

SAR(1 g) = 2.44 W/kg; SAR(10 g) = 1.84 W/kg

Maximum value of SAR (measured) = 3.12 W/kg

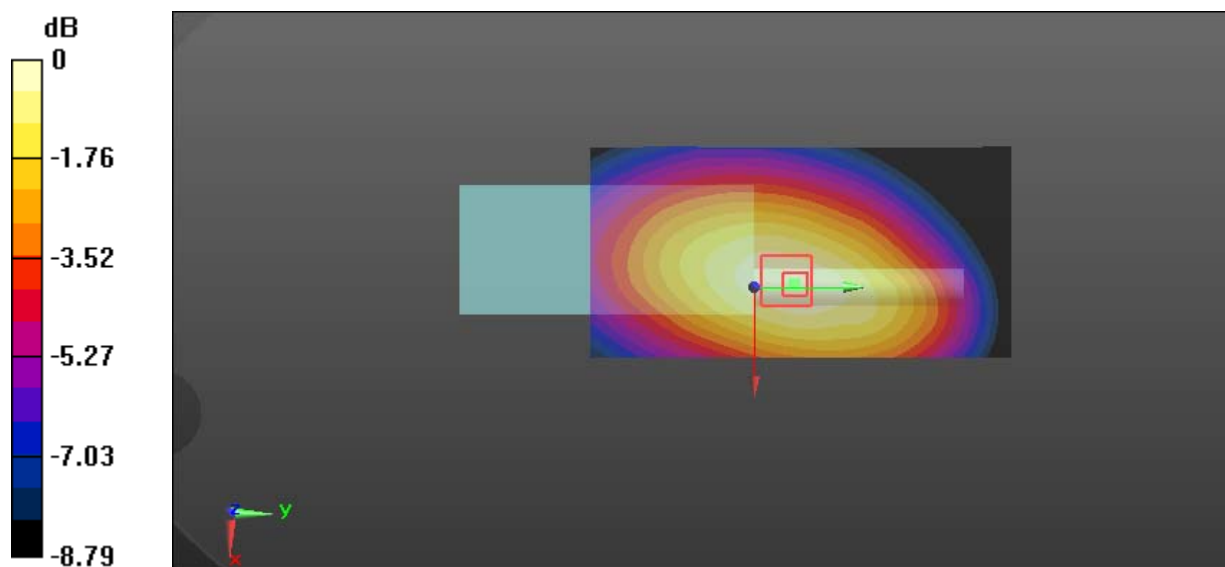

0 dB = 3.12 W/kg = 4.94 dBW/kg

Test Plot 36#: PTT_DMO_Face Up_417 MHz**DUT: TETRA PORTABLE TERMINAL; Type: PT350 F8; Serial: 18092600120**Communication System: $\pi/4$ -DQPSK; Frequency: 417 MHz; Duty Cycle: 1:1Medium parameters used: $f = 417$ MHz; $\sigma = 0.872$ S/m; $\epsilon_r = 45.123$; $\rho = 1000$ kg/m³

Phantom section: Flat Section

DASY5 Configuration:

- Probe: ES3DV2 - SN3019; ConvF(7.18, 7.18, 7.18); Calibrated: 2018/8/20;
- Sensor-Surface: 4mm (Mechanical Surface Detection)
- Electronics: DAE3 Sn494; Calibrated: 2017/11/15
- Phantom: ELI v8.0; Type: QDOVA004AA; Serial: 2051
- Measurement SW: DASY52, Version 52.8 (8);

Area Scan (61x121x1): Interpolated grid: dx=1.500 mm, dy=1.500 mm

Maximum value of SAR (interpolated) = 1.64 W/kg

Zoom Scan (5x5x7)/Cube 0: Measurement grid: dx=8mm, dy=8mm, dz=5mm

Reference Value = 39.14 V/m; Power Drift = -0.14 dB

Peak SAR (extrapolated) = 1.83 W/kg

SAR(1 g) = 1.24 W/kg; SAR(10 g) = 0.934 W/kg

Maximum value of SAR (measured) = 1.58 W/kg

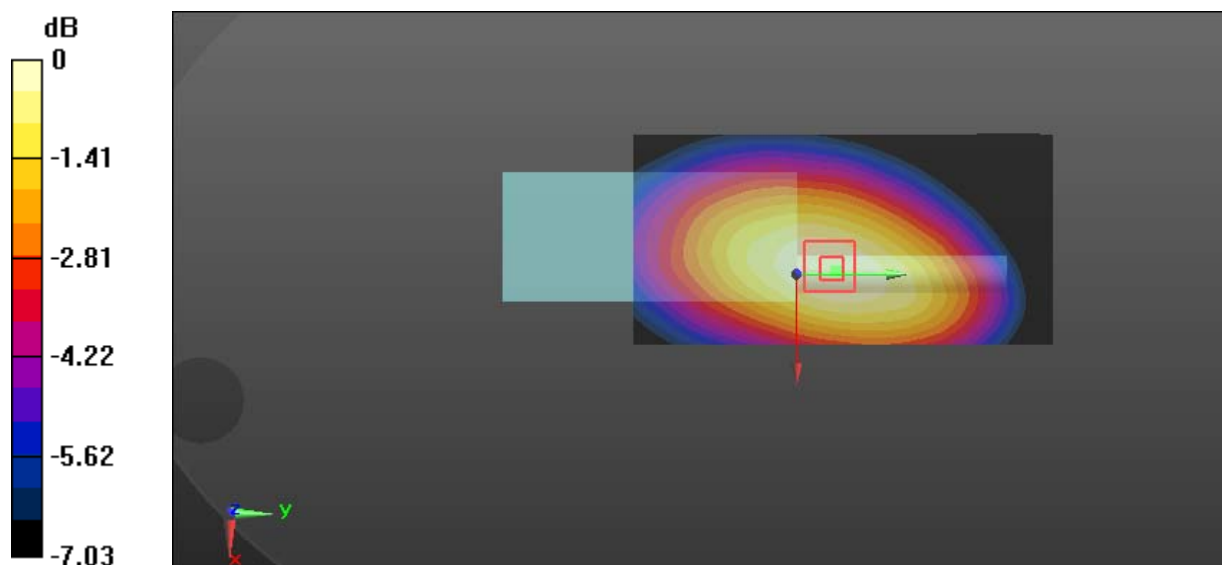

0 dB = 1.58 W/kg = 1.99 dBW/kg

Test Plot 37#: PTT_DMO_Face Up_435 MHz**DUT: TETRA PORTABLE TERMINAL; Type: PT350 F8; Serial: 18092600120**Communication System: $\pi/4$ -DQPSK; Frequency: 435 MHz; Duty Cycle: 1:1Medium parameters used: $f = 435$ MHz; $\sigma = 0.881$ S/m; $\epsilon_r = 45.047$; $\rho = 1000$ kg/m³

Phantom section: Flat Section

DASY5 Configuration:

- Probe: ES3DV2 - SN3019; ConvF(7.18, 7.18, 7.18); Calibrated: 2018/8/20;
- Sensor-Surface: 4mm (Mechanical Surface Detection)
- Electronics: DAE3 Sn494; Calibrated: 2017/11/15
- Phantom: ELI v8.0; Type: QDOVA004AA; Serial: 2051
- Measurement SW: DASY52, Version 52.8 (8);

Area Scan (61x121x1): Interpolated grid: dx=1.500 mm, dy=1.500 mm

Maximum value of SAR (interpolated) = 1.96 W/kg

Zoom Scan (5x5x7)/Cube 0: Measurement grid: dx=8mm, dy=8mm, dz=5mm

Reference Value = 42.45 V/m; Power Drift = -0.19 dB

Peak SAR (extrapolated) = 2.27 W/kg

SAR(1 g) = 1.52 W/kg; SAR(10 g) = 1.13 W/kg

Maximum value of SAR (measured) = 1.96 W/kg

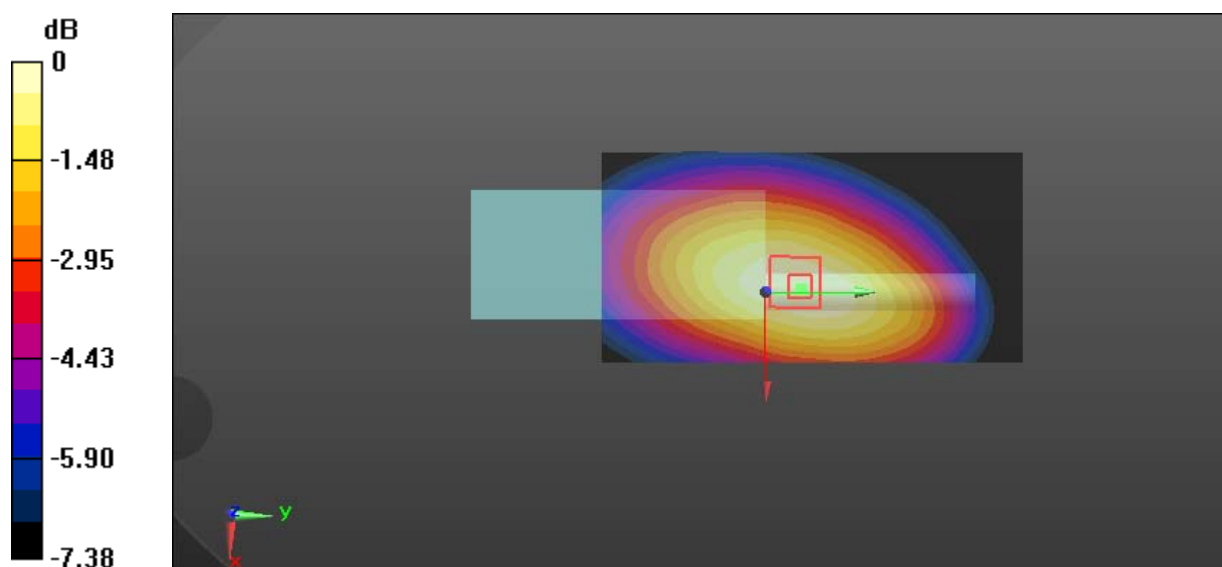

0 dB = 1.96 W/kg = 2.92 dBW/kg

Test Plot 38#: PTT_DMO_Face Up_452 MHz**DUT: TETRA PORTABLE TERMINAL; Type: PT350 F8; Serial: 18092600120**Communication System: $\pi/4$ -DQPSK; Frequency: 452 MHz; Duty Cycle: 1:1Medium parameters used: $f = 452$ MHz; $\sigma = 0.892$ S/m; $\epsilon_r = 44.804$; $\rho = 1000$ kg/m³

Phantom section: Flat Section

DASY5 Configuration:

- Probe: ES3DV2 - SN3019; ConvF(7.18, 7.18, 7.18); Calibrated: 2018/8/20;
- Sensor-Surface: 4mm (Mechanical Surface Detection)
- Electronics: DAE3 Sn494; Calibrated: 2017/11/15
- Phantom: ELI v8.0; Type: QDOVA004AA; Serial: 2051
- Measurement SW: DASY52, Version 52.8 (8);

Area Scan (61x121x1): Interpolated grid: dx=1.500 mm, dy=1.500 mm

Maximum value of SAR (interpolated) = 1.67 W/kg

Zoom Scan (6x7x7)/Cube 0: Measurement grid: dx=8mm, dy=8mm, dz=5mm

Reference Value = 37.87 V/m; Power Drift = -0.20 dB

Peak SAR (extrapolated) = 1.94 W/kg

SAR(1 g) = 1.28 W/kg; SAR(10 g) = 0.960 W/kg

Maximum value of SAR (measured) = 1.65 W/kg

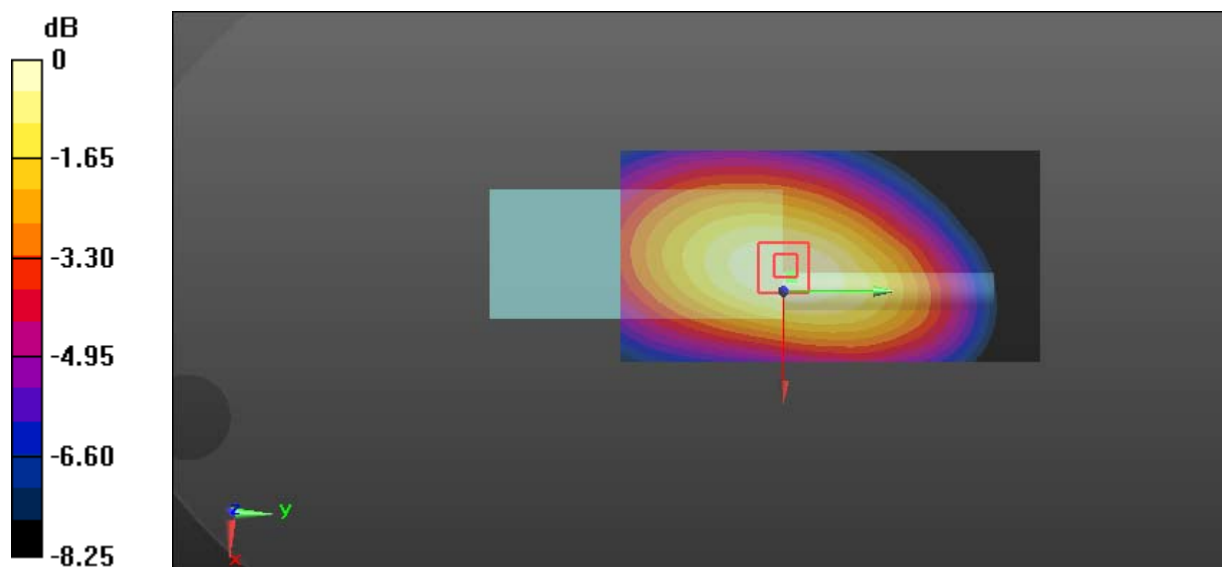

0 dB = 1.65 W/kg = 2.17 dBW/kg

Test Plot 39#: PTT_DMO_Face Up_469.9875 MHz**DUT: TETRA PORTABLE TERMINAL; Type: PT350 F8; Serial: 18092600120**Communication System: $\pi/4$ -DQPSK; Frequency: 469.988 MHz; Duty Cycle: 1:1Medium parameters used: $f = 469.988$ MHz; $\sigma = 0.902$ S/m; $\epsilon_r = 44.731$; $\rho = 1000$ kg/m³

Phantom section: Flat Section

DASY5 Configuration:

- Probe: ES3DV2 - SN3019; ConvF(7.18, 7.18, 7.18); Calibrated: 2018/8/20;
- Sensor-Surface: 4mm (Mechanical Surface Detection)
- Electronics: DAE3 Sn494; Calibrated: 2017/11/15
- Phantom: ELI v8.0; Type: QDOVA004AA; Serial: 2051
- Measurement SW: DASY52, Version 52.8 (8);

Area Scan (61x121x1): Interpolated grid: dx=1.500 mm, dy=1.500 mm

Maximum value of SAR (interpolated) = 0.714 W/kg

Zoom Scan (6x6x7)/Cube 0: Measurement grid: dx=8mm, dy=8mm, dz=5mm

Reference Value = 26.49 V/m; Power Drift = -0.14 dB

Peak SAR (extrapolated) = 0.795 W/kg

SAR(1 g) = 0.540 W/kg; SAR(10 g) = 0.407 W/kg

Maximum value of SAR (measured) = 0.683 W/kg

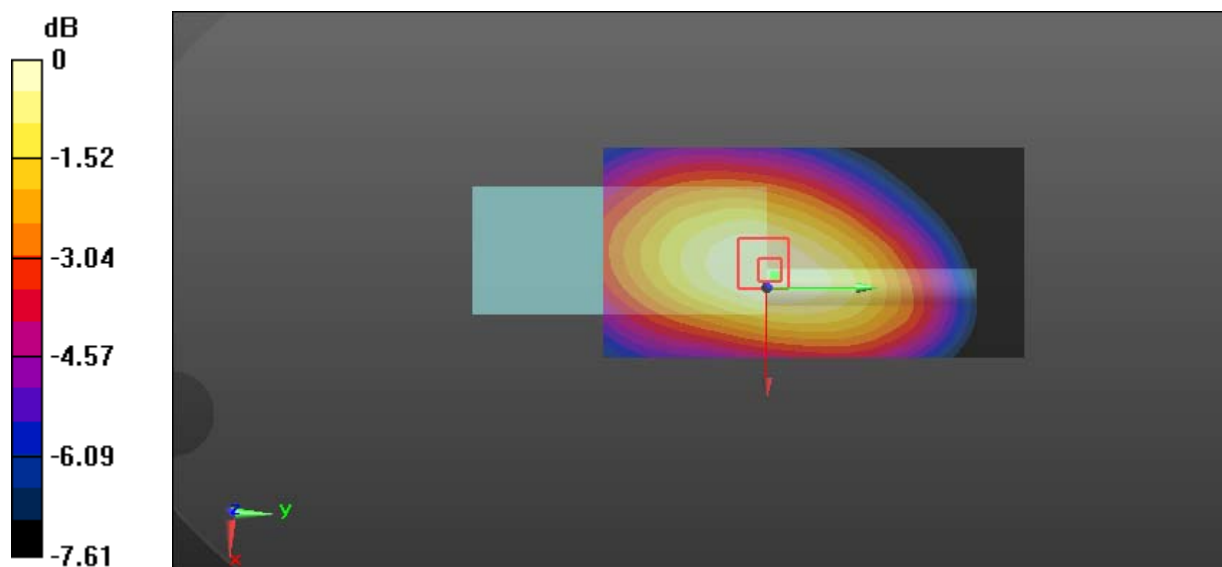

0 dB = 0.683 W/kg = -1.66 dBW/kg

Test Plot 40#: PTT_DMO_Face Up_474.9875 MHz**DUT: TETRA PORTABLE TERMINAL; Type: PT350 F8; Serial: 18092600120**Communication System: $\pi/4$ -DQPSK; Frequency: 474.988 MHz; Duty Cycle: 1:1Medium parameters used: $f = 474.988$ MHz; $\sigma = 0.905$ S/m; $\epsilon_r = 44.263$; $\rho = 1000$ kg/m³

Phantom section: Flat Section

DASY5 Configuration:

- Probe: ES3DV2 - SN3019; ConvF(7.18, 7.18, 7.18); Calibrated: 2018/8/20;
- Sensor-Surface: 4mm (Mechanical Surface Detection)
- Electronics: DAE3 Sn494; Calibrated: 2017/11/15
- Phantom: ELI v8.0; Type: QDOVA004AA; Serial: 2051
- Measurement SW: DASY52, Version 52.8 (8);

Area Scan (61x121x1): Interpolated grid: dx=1.500 mm, dy=1.500 mm

Maximum value of SAR (interpolated) = 0.427 W/kg

Zoom Scan (5x5x7)/Cube 0: Measurement grid: dx=8mm, dy=8mm, dz=5mm

Reference Value = 21.03 V/m; Power Drift = 0.03 dB

Peak SAR (extrapolated) = 0.552 W/kg

SAR(1 g) = 0.421 W/kg; SAR(10 g) = 0.314 W/kg

Maximum value of SAR (measured) = 0.443 W/kg

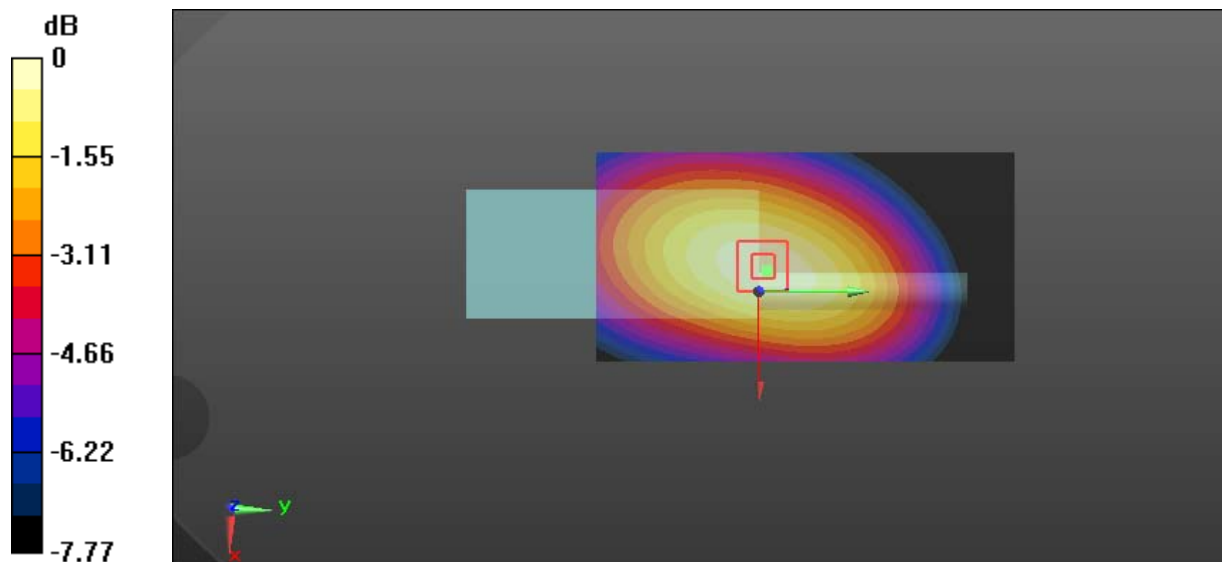

0 dB = 0.443 W/kg = -3.54 dBW/kg

Test Plot 41#: PTT_TMO_Face Up_400.0125 MHz**DUT: TETRA PORTABLE TERMINAL; Type: PT350 F8; Serial: 18092600120**Communication System: $\pi/4$ -DQPSK; Frequency: 400.012 MHz; Duty Cycle: 1:1Medium parameters used: $f = 400.012$ MHz; $\sigma = 0.867$ S/m; $\epsilon_r = 45.207$; $\rho = 1000$ kg/m³

Phantom section: Flat Section

DASY5 Configuration:

- Probe: ES3DV2 - SN3019; ConvF(7.18, 7.18, 7.18); Calibrated: 2018/8/20;
- Sensor-Surface: 4mm (Mechanical Surface Detection)
- Electronics: DAE3 Sn494; Calibrated: 2017/11/15
- Phantom: ELI v8.0; Type: QDOVA004AA; Serial: 2051
- Measurement SW: DASY52, Version 52.8 (8);

Area Scan (61x121x1): Interpolated grid: dx=1.500 mm, dy=1.500 mm

Maximum value of SAR (interpolated) = 2.78 W/kg

Zoom Scan (5x5x7)/Cube 0: Measurement grid: dx=8mm, dy=8mm, dz=5mm

Reference Value = 50.72 V/m; Power Drift = -0.17 dB

Peak SAR (extrapolated) = 3.11 W/kg

SAR(1 g) = 2.12 W/kg; SAR(10 g) = 1.63 W/kg

Maximum value of SAR (measured) = 2.67 W/kg

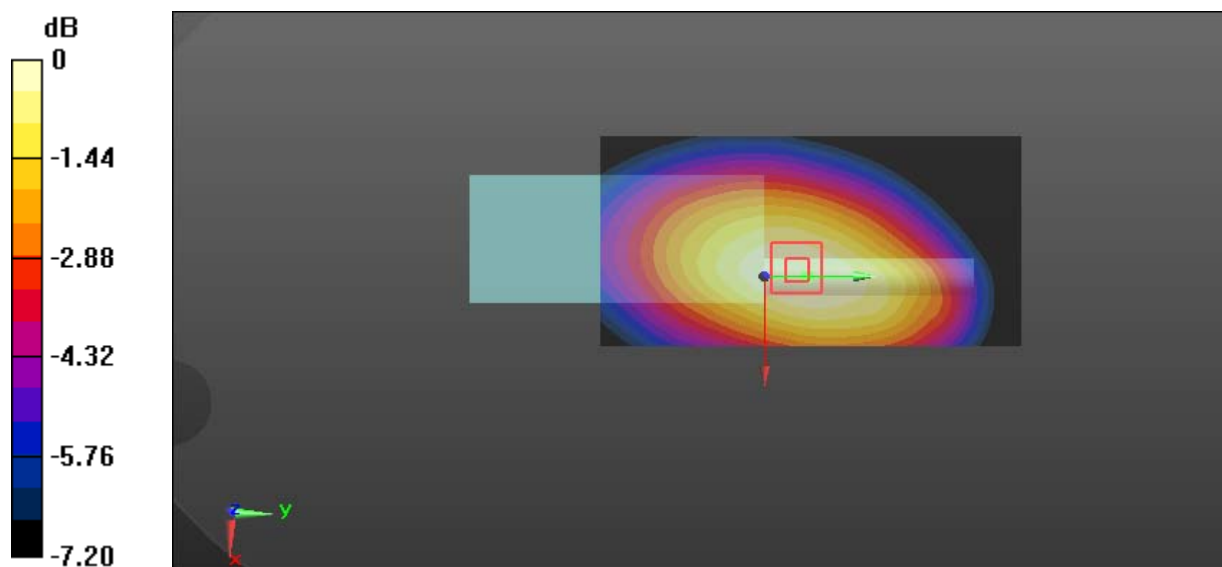

0 dB = 2.67 W/kg = 4.27 dBW/kg

Test Plot 42#: PTT_DMO_Face Up_400.0125 MHz**DUT: TETRA PORTABLE TERMINAL; Type: PT310 F8; Serial: 18092600121**Communication System: $\pi/4$ -DQPSK; Frequency: 400.012 MHz; Duty Cycle: 1:1Medium parameters used: $f = 400.012$ MHz; $\sigma = 0.867$ S/m; $\epsilon_r = 45.207$; $\rho = 1000$ kg/m³

Phantom section: Flat Section

DASY5 Configuration:

- Probe: ES3DV2 - SN3019; ConvF(7.18, 7.18, 7.18); Calibrated: 2018/8/20;
- Sensor-Surface: 4mm (Mechanical Surface Detection)
- Electronics: DAE3 Sn494; Calibrated: 2017/11/15
- Phantom: ELI v8.0; Type: QDOVA004AA; Serial: 2051
- Measurement SW: DASY52, Version 52.8 (8);

Area Scan (61x121x1): Interpolated grid: dx=1.500 mm, dy=1.500 mm

Maximum value of SAR (interpolated) = 1.95 W/kg

Zoom Scan (6x7x7)/Cube 0: Measurement grid: dx=8mm, dy=8mm, dz=5mm

Reference Value = 48.23 V/m; Power Drift = 0.02 dB

Peak SAR (extrapolated) = 2.41 W/kg

SAR(1 g) = 1.81 W/kg; SAR(10 g) = 1.34 W/kg

Maximum value of SAR (measured) = 1.91 W/kg

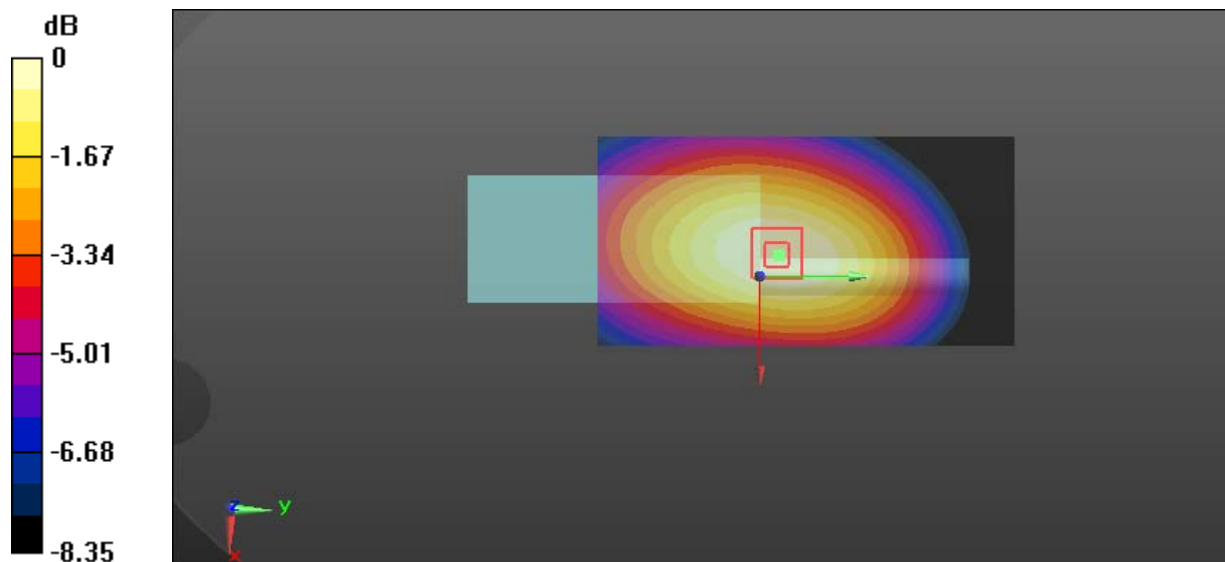

0 dB = 1.91 W/kg = 2.81 dBW/kg

Test Plot 43#: PTT_DMO_Body Back_400.0125 MHz**DUT: TETRA PORTABLE TERMINAL; Type: PT350 F8; Serial: 18092600120**Communication System: $\pi/4$ -DQPSK; Frequency: 400.012 MHz; Duty Cycle: 1:1Medium parameters used: $f = 400.012$ MHz; $\sigma = 0.935$ S/m; $\epsilon_r = 56.772$; $\rho = 1000$ kg/m³

Phantom section: Flat Section

DASY5 Configuration:

- Probe: ES3DV2 - SN3019; ConvF(7.1, 7.1, 7.1); Calibrated: 2018/8/20;
- Sensor-Surface: 4mm (Mechanical Surface Detection)
- Electronics: DAE3 Sn494; Calibrated: 2017/11/15
- Phantom: ELI v8.0; Type: QDOVA004AA; Serial: 2051
- Measurement SW: DASY52, Version 52.8 (8);

Area Scan (61x121x1): Interpolated grid: dx=1.500 mm, dy=1.500 mm

Maximum value of SAR (interpolated) = 2.97 W/kg

Zoom Scan (6x7x7)/Cube 0: Measurement grid: dx=8mm, dy=8mm, dz=5mm

Reference Value = 47.58 V/m; Power Drift = -0.20 dB

Peak SAR (extrapolated) = 3.61 W/kg

SAR(1 g) = 2.33 W/kg; SAR(10 g) = 1.68 W/kg

Maximum value of SAR (measured) = 3.08 W/kg

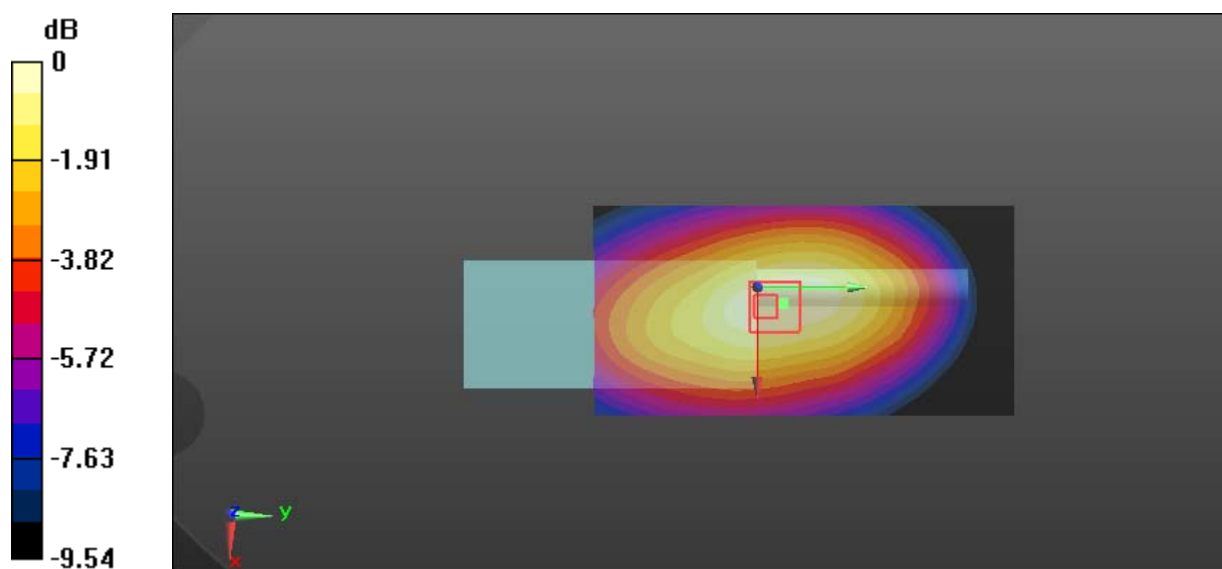

0 dB = 3.08 W/kg = 4.89 dBW/kg

Test Plot 44#: PTT_DMO_Body Back_417 MHz**DUT: TETRA PORTABLE TERMINAL; Type: PT350 F8; Serial: 18092600120**Communication System: $\pi/4$ -DQPSK; Frequency: 417 MHz; Duty Cycle: 1:1Medium parameters used: $f = 417$ MHz; $\sigma = 0.948$ S/m; $\epsilon_r = 56.209$; $\rho = 1000$ kg/m³

Phantom section: Flat Section

DASY5 Configuration:

- Probe: ES3DV2 - SN3019; ConvF(7.1, 7.1, 7.1); Calibrated: 2018/8/20;
- Sensor-Surface: 4mm (Mechanical Surface Detection)
- Electronics: DAE3 Sn494; Calibrated: 2017/11/15
- Phantom: ELI v8.0; Type: QDOVA004AA; Serial: 2051
- Measurement SW: DASY52, Version 52.8 (8);

Area Scan (61x121x1): Interpolated grid: dx=1.500 mm, dy=1.500 mm

Maximum value of SAR (interpolated) = 1.46 W/kg

Zoom Scan (5x5x7)/Cube 0: Measurement grid: dx=8mm, dy=8mm, dz=5mm

Reference Value = 35.04 V/m; Power Drift = -0.13 dB

Peak SAR (extrapolated) = 1.70 W/kg

SAR(1 g) = 1.11 W/kg; SAR(10 g) = 0.805 W/kg

Maximum value of SAR (measured) = 1.45 W/kg

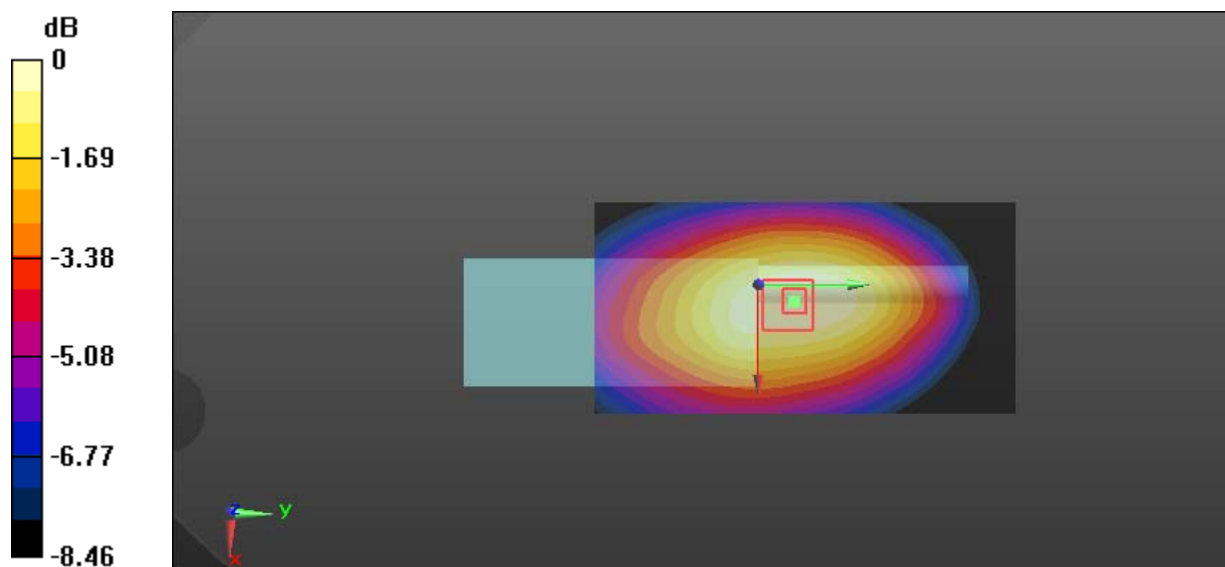

0 dB = 1.45 W/kg = 1.61 dBW/kg

Test Plot 45#: PTT_DMO_Body Back_435 MHz**DUT: TETRA PORTABLE TERMINAL; Type: PT350 F8; Serial: 18092600120**Communication System: $\pi/4$ -DQPSK; Frequency: 435 MHz; Duty Cycle: 1:1Medium parameters used: $f = 435$ MHz; $\sigma = 0.962$ S/m; $\epsilon_r = 55.644$; $\rho = 1000$ kg/m³

Phantom section: Flat Section

DASY5 Configuration:

- Probe: ES3DV2 - SN3019; ConvF(7.1, 7.1, 7.1); Calibrated: 2018/8/20;
- Sensor-Surface: 4mm (Mechanical Surface Detection)
- Electronics: DAE3 Sn494; Calibrated: 2017/11/15
- Phantom: ELI v8.0; Type: QDOVA004AA; Serial: 2051
- Measurement SW: DASY52, Version 52.8 (8);

Area Scan (61x121x1): Interpolated grid: dx=1.500 mm, dy=1.500 mm

Maximum value of SAR (interpolated) = 1.69 W/kg

Zoom Scan (5x5x7)/Cube 0: Measurement grid: dx=8mm, dy=8mm, dz=5mm

Reference Value = 36.24 V/m; Power Drift = -0.04 dB

Peak SAR (extrapolated) = 1.94 W/kg

SAR(1 g) = 1.27 W/kg; SAR(10 g) = 0.929 W/kg

Maximum value of SAR (measured) = 1.67 W/kg

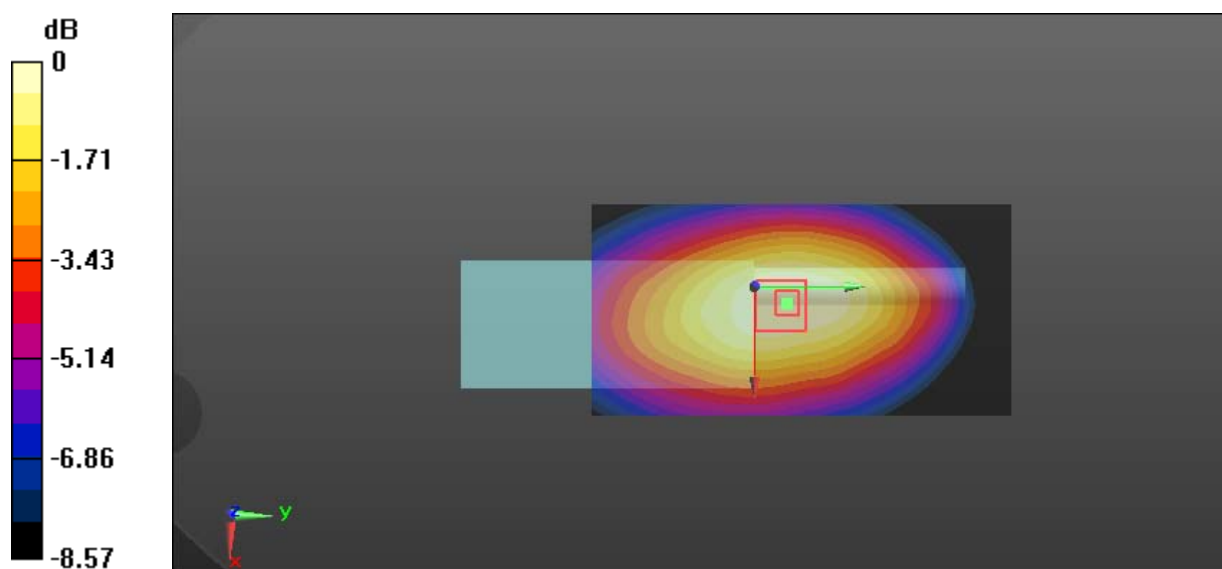

0 dB = 1.67 W/kg = 2.23 dBW/kg

Test Plot 46#: PTT_DMO_Body Back_452 MHz

DUT: TETRA PORTABLE TERMINAL; Type: PT350 F8; Serial: 18092600120

Communication System: $\pi/4$ -DQPSK; Frequency: 452 MHz; Duty Cycle: 1:1

Medium parameters used: $f = 452$ MHz; $\sigma = 0.971$ S/m; $\epsilon_r = 55.482$; $\rho = 1000$ kg/m³

Phantom section: Flat Section

DASY5 Configuration:

- Probe: ES3DV2 - SN3019; ConvF(7.1, 7.1, 7.1); Calibrated: 2018/8/20;
- Sensor-Surface: 4mm (Mechanical Surface Detection)
- Electronics: DAE3 Sn494; Calibrated: 2017/11/15
- Phantom: ELI v8.0; Type: QDOVA004AA; Serial: 2051
- Measurement SW: DASY52, Version 52.8 (8);

Area Scan (61x121x1): Interpolated grid: dx=1.500 mm, dy=1.500 mm

Maximum value of SAR (interpolated) = 2.46 W/kg

Zoom Scan (9x8x7)/Cube 0: Measurement grid: dx=8mm, dy=8mm, dz=5mm

Reference Value = 42.36 V/m; Power Drift = -0.18 dB

Peak SAR (extrapolated) = 2.78 W/kg

SAR(1 g) = 1.8 W/kg; SAR(10 g) = 1.27 W/kg

Maximum value of SAR (measured) = 2.39 W/kg

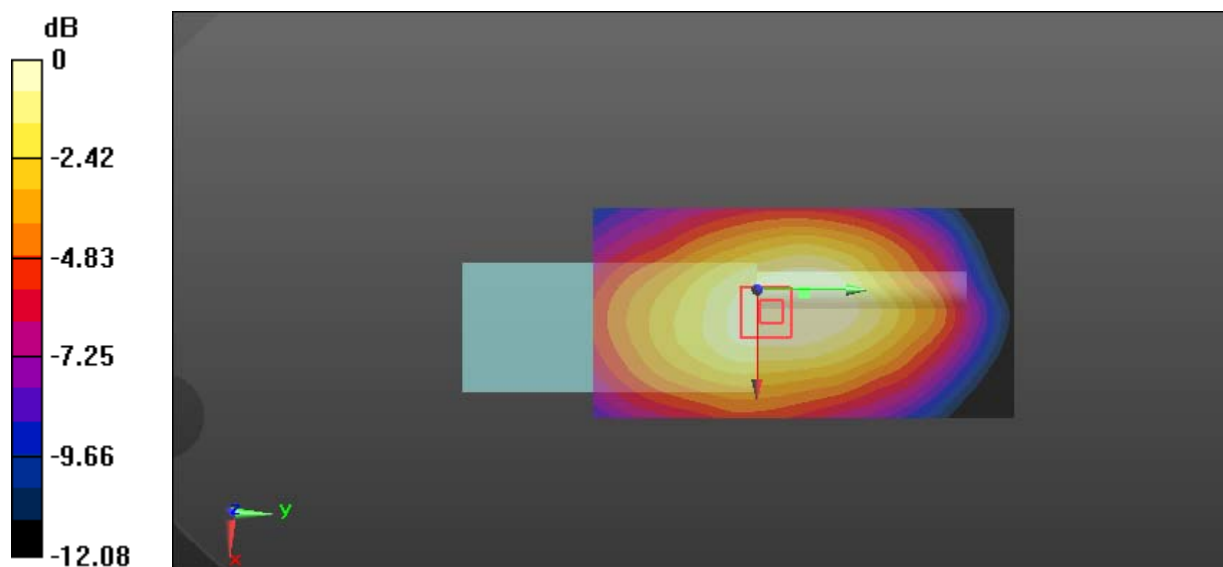

0 dB = 2.39 W/kg = 3.78 dBW/kg

Test Plot 47#: PTT_DMO_Body Back_469.9875 MHz**DUT: TETRA PORTABLE TERMINAL; Type: PT350 F8; Serial: 18092600120**Communication System: $\pi/4$ -DQPSK; Frequency: 469.988 MHz; Duty Cycle: 1:1Medium parameters used: $f = 469.988$ MHz; $\sigma = 0.983$ S/m; $\epsilon_r = 55.375$; $\rho = 1000$ kg/m³

Phantom section: Flat Section

DASY5 Configuration:

- Probe: ES3DV2 - SN3019; ConvF(7.1, 7.1, 7.1); Calibrated: 2018/8/20;
- Sensor-Surface: 4mm (Mechanical Surface Detection)
- Electronics: DAE3 Sn494; Calibrated: 2017/11/15
- Phantom: ELI v8.0; Type: QDOVA004AA; Serial: 2051
- Measurement SW: DASY52, Version 52.8 (8);

Area Scan (61x121x1): Interpolated grid: dx=1.500 mm, dy=1.500 mm

Maximum value of SAR (interpolated) = 0.840 W/kg

Zoom Scan (6x6x7)/Cube 0: Measurement grid: dx=8mm, dy=8mm, dz=5mm

Reference Value = 27.17 V/m; Power Drift = -0.18 dB

Peak SAR (extrapolated) = 0.947 W/kg

SAR(1 g) = 0.646 W/kg; SAR(10 g) = 0.475 W/kg

Maximum value of SAR (measured) = 0.821 W/kg

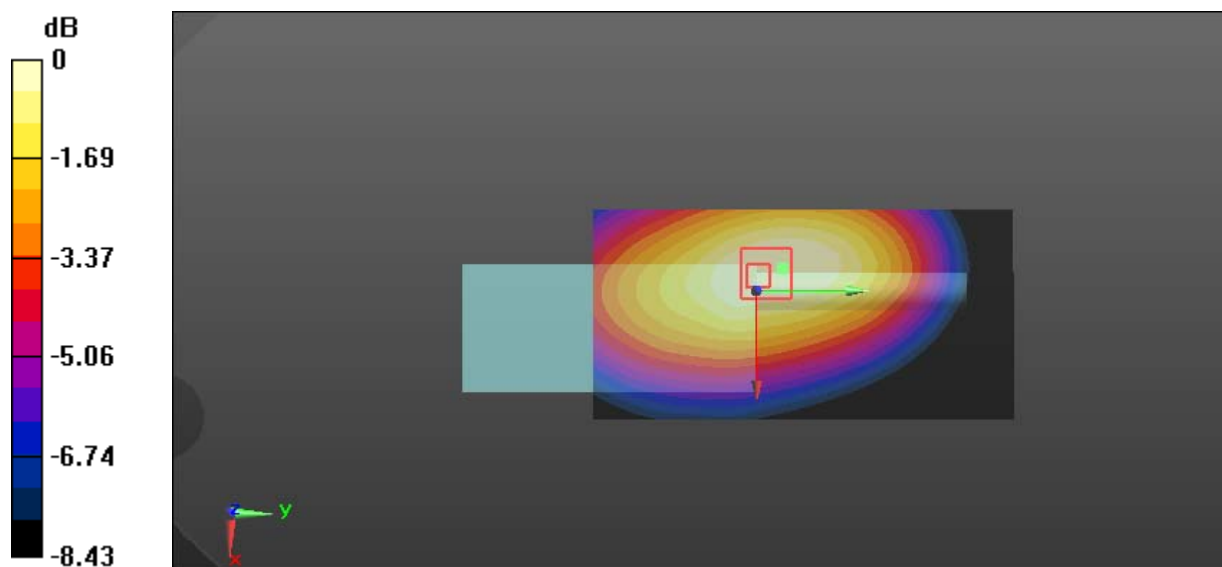

0 dB = 0.821 W/kg = -0.86 dBW/kg

Test Plot 48#: PTT_DMO_Body Back_474.9875 MHz**DUT: TETRA PORTABLE TERMINAL; Type: PT350 F8; Serial: 18092600120**Communication System: $\pi/4$ -DQPSK; Frequency: 474.988 MHz; Duty Cycle: 1:1Medium parameters used: $f = 474.988$ MHz; $\sigma = 0.975$ S/m; $\epsilon_r = 55.342$; $\rho = 1000$ kg/m³

Phantom section: Flat Section

DASY5 Configuration:

- Probe: ES3DV2 - SN3019; ConvF(7.1, 7.1, 7.1); Calibrated: 2018/8/20;
- Sensor-Surface: 4mm (Mechanical Surface Detection)
- Electronics: DAE3 Sn494; Calibrated: 2017/11/15
- Phantom: ELI v8.0; Type: QDOVA004AA; Serial: 2051
- Measurement SW: DASY52, Version 52.8 (8);

Area Scan (61x121x1): Interpolated grid: dx=1.500 mm, dy=1.500 mm

Maximum value of SAR (interpolated) = 0.536 W/kg

Zoom Scan (6x6x7)/Cube 0: Measurement grid: dx=8mm, dy=8mm, dz=5mm

Reference Value = 21.92 V/m; Power Drift = -0.12 dB

Peak SAR (extrapolated) = 0.0.642 W/kg

SAR(1 g) = 0.494 W/kg; SAR(10 g) = 0.371 W/kg

Maximum value of SAR (measured) = 0.518 W/kg

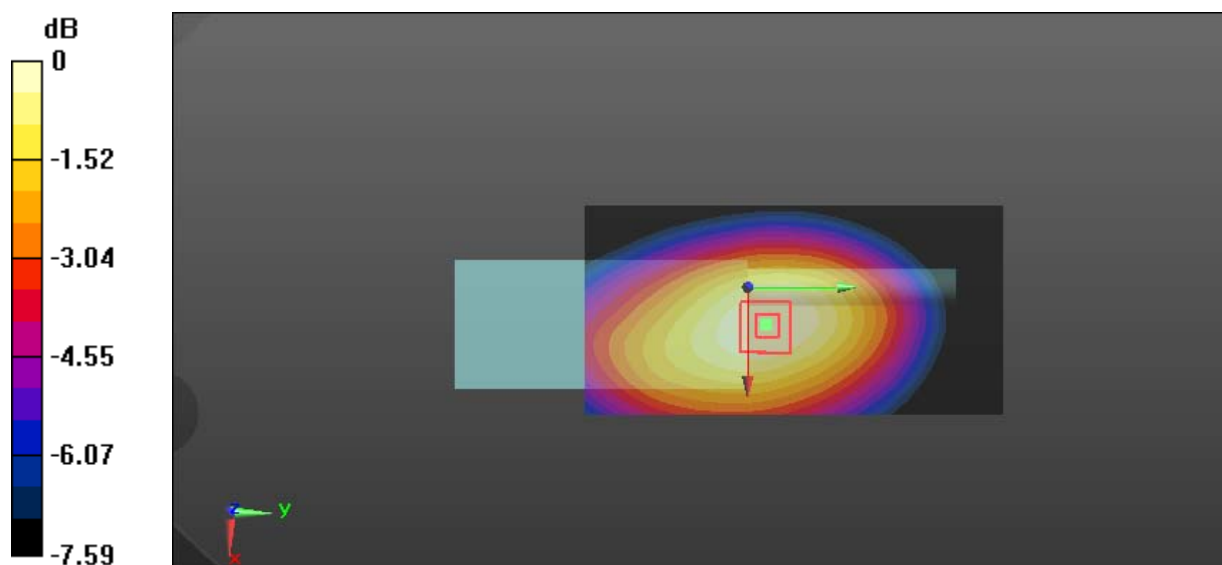

0 dB = 0.518 W/kg = -2.86 dBW/kg

Test Plot 49#: PTT_TMO_Body Back_400.0125 MHz**DUT: TETRA PORTABLE TERMINAL; Type: PT350 F8; Serial: 18092600120**Communication System: $\pi/4$ -DQPSK; Frequency: 400.012 MHz; Duty Cycle: 1:1Medium parameters used: $f = 400.012$ MHz; $\sigma = 0.935$ S/m; $\epsilon_r = 56.772$; $\rho = 1000$ kg/m³

Phantom section: Flat Section

DASY5 Configuration:

- Probe: ES3DV2 - SN3019; ConvF(7.1, 7.1, 7.1); Calibrated: 2018/8/20;
- Sensor-Surface: 4mm (Mechanical Surface Detection)
- Electronics: DAE3 Sn494; Calibrated: 2017/11/15
- Phantom: ELI v8.0; Type: QDOVA004AA; Serial: 2051
- Measurement SW: DASY52, Version 52.8 (8);

Area Scan (61x121x1): Interpolated grid: dx=1.500 mm, dy=1.500 mm

Maximum value of SAR (interpolated) = 2.19 W/kg

Zoom Scan (6x6x7)/Cube 0: Measurement grid: dx=8mm, dy=8mm, dz=5mm

Reference Value = 42.38 V/m; Power Drift = -0.01 dB

Peak SAR (extrapolated) = 2.59 W/kg

SAR(1 g) = 1.73 W/kg; SAR(10 g) = 1.26 W/kg

Maximum value of SAR (measured) = 2.25 W/kg

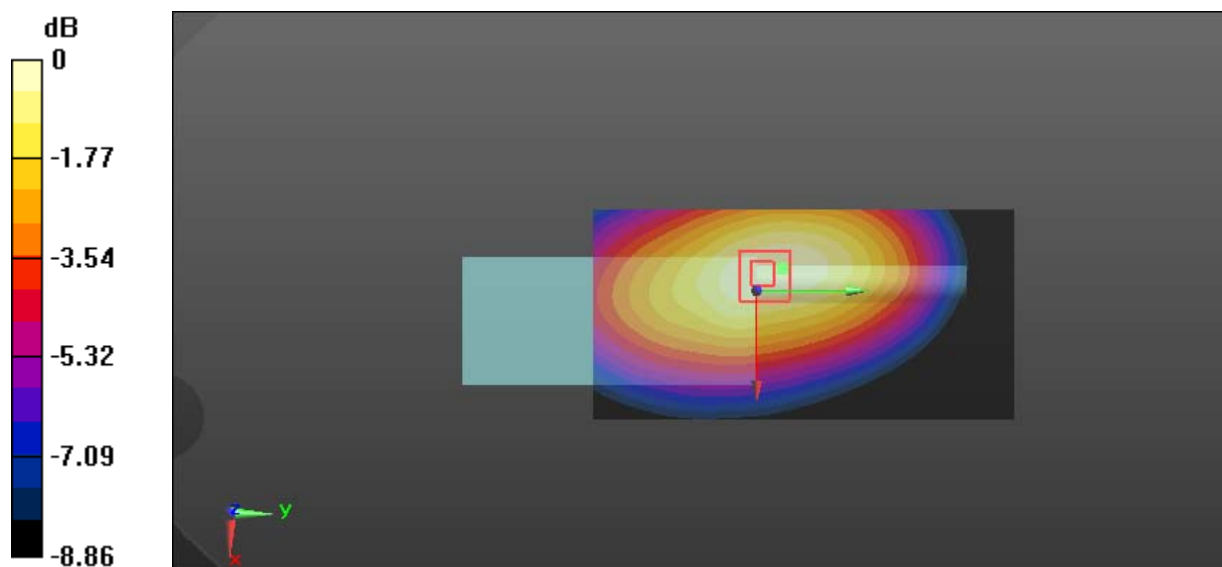

0 dB = 2.25 W/kg = 3.52 dBW/kg

Test Plot 50#: PTT_DMO_Body Back_400.0125 MHz**DUT: TETRA PORTABLE TERMINAL; Type: PT310 F8; Serial: 18092600121**Communication System: $\pi/4$ -DQPSK; Frequency: 400.012 MHz; Duty Cycle: 1:1Medium parameters used: $f = 400.012$ MHz; $\sigma = 0.935$ S/m; $\epsilon_r = 56.772$; $\rho = 1000$ kg/m³

Phantom section: Flat Section

DASY5 Configuration:

- Probe: ES3DV2 - SN3019; ConvF(7.1, 7.1, 7.1); Calibrated: 2018/8/20;
- Sensor-Surface: 4mm (Mechanical Surface Detection)
- Electronics: DAE3 Sn494; Calibrated: 2017/11/15
- Phantom: ELI v8.0; Type: QDOVA004AA; Serial: 2051
- Measurement SW: DASY52, Version 52.8 (8);

Area Scan (61x121x1): Interpolated grid: dx=1.500 mm, dy=1.500 mm

Maximum value of SAR (interpolated) = 1.92 W/kg

Zoom Scan (5x5x7)/Cube 0: Measurement grid: dx=8mm, dy=8mm, dz=5mm

Reference Value = 46.91 V/m; Power Drift = -0.08 dB

Peak SAR (extrapolated) = 2.35 W/kg

SAR(1 g) = 1.69 W/kg; SAR(10 g) = 0.661 W/kg

Maximum value of SAR (measured) = 0.956 W/kg

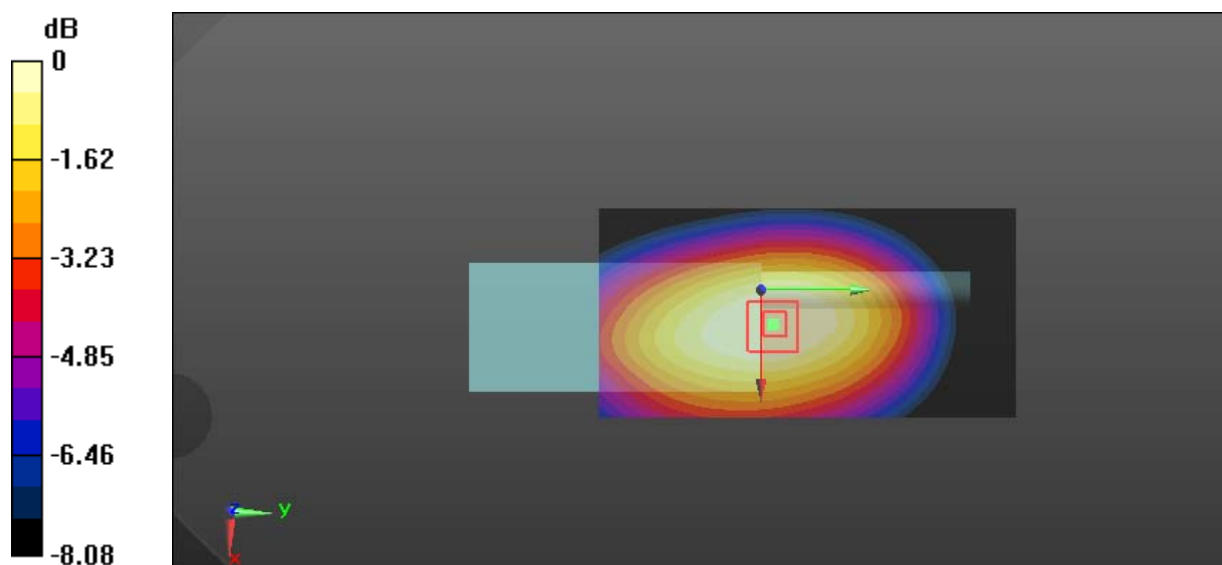

0 dB = 0.956 W/kg = -0.20 dBW/kg