



QUICK REFERENCE GUIDE

PT350 PORTABLE TERMINAL



is the trademark or registered trademark of Hytera Communications Corporation Limited.

© 2018 Hytera Communications Corporation Limited. All Rights Reserved.

Address: Hytera Tower, Hi-Tech Industrial Park North, 9108# Beihuan Road, Nanshan District, Shenzhen, People's Republic of China

Postcode: 518057

[http:// www.hytera.com](http://www.hytera.com)

Copyright Information

Hytera is the trademark or registered trademark of Hytera Communications Corporation Limited (the Company) in the People's Republic of China (PRC) and/or other countries or areas. The Company retains the ownership of its trademarks and product names. All other trademarks and/or product names that may be used in this manual are properties of their respective owners.

The product described in this manual may include the Company's computer programs stored in memory or other media. Laws in PRC and/or other countries or areas protect the exclusive rights of the Company with respect to its computer programs. The purchase of this product shall not be deemed to grant, either directly or by implication, any rights to the purchaser regarding the Company's computer programs. The Company's computer programs may not be copied, modified, distributed, decompiled, or reverse-engineered in any manner without the prior written consent of the Company.

Disclaimer

The Company endeavors to achieve the accuracy and completeness of this manual, but no warranty of accuracy or reliability is given. All the specifications and designs are subject to change without notice due to continuous technological development. No part of this manual may be

copied, modified, translated, or distributed in any manner without the prior written consent of the Company.

We do not guarantee, for any particular purpose, the accuracy, validity, timeliness, legitimacy or completeness of the third-party products and contents involved in this manual.

If you have any suggestions or would like to receive more information, please visit our website at:

<http://www.hytera.com>.

FCC Statement

This equipment has been tested and found to comply with the limits for a Class B digital device, pursuant to part 15 of FCC Rules. These limits are designed to provide reasonable protection against harmful interference in a residential installation. This equipment generates and can radiate radio frequency energy. If not installed and used in accordance with the instructions, it may cause harmful interference to radio communications. However, there is no guarantee that interference will not occur in a particular installation.

Verification of harmful interference by this equipment to radio or television reception can be determined by turning it off and then on. The user is encouraged to try to correct the interference by one or more of the following measures:

- Reorient or relocate the receiving antenna. Increase the separation between the equipment and receiver.

- Connect the equipment into an outlet on a different circuit to that of the receiver's outlet.
- Consult the dealer or an experienced radio/TV technician for help.

Operation is subject to the following two conditions:

- This device may not cause harmful interference.
- This device must accept any interference received, including interference that may cause undesired operation.

Note: Changes or modifications to this unit not expressly approved by the party responsible for compliance could void the user's authority to operate the equipment.

RF Energy Exposure Awareness and Control Information and Operational Instructions for Occupational Use

NOTICE: This radio is intended for use in

occupational/controlled conditions where users have full knowledge of their exposure and can exercise control over their exposure to meet the occupational limits in FCC and International standards. This radio device is NOT authorized for general population consumer use.

This radio uses electromagnetic energy in the radio frequency (RF) spectrum to provide communications between two or more users over a distance. It uses radio frequency (RF) energy or radio waves to send and receive calls. RF energy is one form of electromagnetic energy. Other forms include, but are not limited to, sunlight and x-rays. RF energy, however, should not be confused with these other forms of electromagnetic energy, which when used improperly, can cause biological damage. Very high levels of x-rays, for example, can damage tissues and genetic material.

Experts in science, engineering, medicine, health, and industry work with organizations to develop standards for safe exposure to RF energy. These standards provide recommended levels of RF exposure for both workers and the general public. These recommended RF exposure levels include substantial margins of protection.

All Hytera radios are designed, manufactured, and tested to ensure they meet government-established RF exposure levels.

In addition, manufacturers also recommend specific operating instructions to users of radios. These instructions are important because they inform users about RF energy exposure and provide simple procedures on how to control it.

Please refer to the following websites for more information on what RF energy exposure is and how to control your exposure to assure compliance with established RF exposure

limits:

<http://www.fcc.gov/oet/rfsafety/rf-faqs.html>

Compliance with RF Exposure Standards

Hytera's radio complies with the following RF energy exposure standards and guidelines:

- United States Federal Communications Commission, Code of Federal Regulations; 47 CFR § 1.1307, 1.1310 and 2.1093
- American National Standards Institute (ANSI) / Institute of Electrical and Electronic Engineers (IEEE) C95. 1:2005; Canada RSS102 Issue 5 March 2015
- Institute of Electrical and Electronic Engineers (IEEE) C95.1:2005 Edition

RF Exposure Compliance and Control Guidelines and Operating Instructions

To control your exposure and ensure compliance with the occupational/controlled environmental exposure limits, always adhere to the following procedures.

Guidelines:

- Do not remove the RF Exposure Label from the device.
- User awareness instructions should accompany device when transferred to other users.
- Do not use this device if the operational requirements described herein are not met.

Operating Instructions:

- Transmit no more than the rated duty factor of 50% of the time. To transmit (talk), push the Push-To-Talk (PTT) key. To receive calls, release the PTT key. Transmitting 50% of the time, or less, is important because the radio generates measurable RF energy only when transmitting (in terms of measuring for standards compliance).
- Keep the radio unit at least 2.5 cm away from the face. Keeping the radio at the proper distance is important as RF exposure decreases with distance from the antenna. The antenna should be kept away from the face and eyes.
- When worn on the body, always place the radio in a Hytera-approved holder, holster, case, or body harness or by use of the correct clip for this product. Use of non-approved accessories may result in exposure levels which exceed the FCC's occupational/controlled environmental RF exposure limits.
- Use of non-approved antennas, batteries, and accessories causes the radio to exceed the FCC RF exposure guidelines.
- Contact your local dealer for the optional accessories of the product.

ISED Statement

The device has been tested and complies with SAR limits, users can obtain Canadian information on RF exposure and compliance

Après examen de ce matériel aux conformités aux limites DAS et/ou aux limites d'intensité de champ RF, les utilisateurs peuvent sur l'exposition aux radiofréquences et la conformité and compliance d'acquérir les informations correspondantes

This device complies with Innovation, Science and Economic Development Canada Compliance license-exempt RSS standard(s). Operation is subject to the following two conditions:

- This device may not cause harmful interference.
- This device must accept any interference received, including interference that may cause undesired operation.

Le présent appareil est conforme aux CNR d'Industrie Canada applicables aux appareils radio exempts de licence.

L'exploitation est autorisée aux deux conditions suivantes: (1) l'appareil ne doit pas produire de brouillage, et (2) l'utilisateur de l'appareil doit accepter tout brouillage radioélectrique subi, même si le brouillage est susceptible d'en compromettre le fonctionnement

EU Regulatory Conformance

As certified by the qualified laboratory, the product is in compliance with the essential requirements and other relevant provisions of the following directives: 2014/53/EU, 2006/66/EC, 2011/65/EU, and 2012/19/EU.

Please note that the above information is applicable to EU countries only.

Product Overview

Product Layout

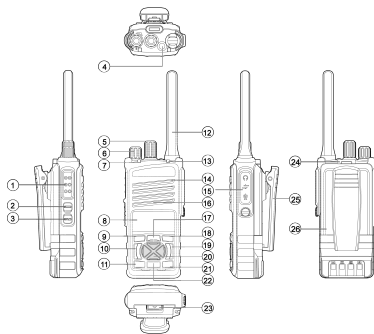

No.	Part Name	No.	Part Name
1	Push-to-Talk (PTT) Key	14	Built-in Microphone
2	Side Key 1 (SK1)	15	Accessory Connector Cover
3	Side Key 2 (SK2)	16	Speaker

No.	Part Name	No.	Part Name
4	Emergency Key	17	Menu Key
5	Group Selector Knob	18	Cancel/Back Key
6	Volume Control Knob	19	Power On-Off/End Key
7	Operation Status Indicator	20	Navigation Keys
8	OLED Display	21	P3 Key
9	OK Key	22	P2 Key
10	Answer/Call Key	23	Battery Latch
11	P1 Key	24	Strap Hole
12	Antenna	25	Belt Clip
13	Battery Status Indicator	26	Battery

Programmable Keys

For enhanced convenience, you can set the following keys as shortcuts to assignable terminal features: **Up** key, **Down** key, **Answer/Call** key, **SK1**, **SK2**, **P1** key, **P2** key, and **P3** key. To set or cancel a shortcut, go to **Menu > Settings > Radio > Keypad > Shortcuts**.

Basic Operations

Charging the Battery

CAUTION

- Read the *Safety Information Booklet* before charging.
- Use the approved charger to charge the battery.
- The remaining lithium-ion battery power is limited to 30% pursuant to the new lithium battery shipment regulation approved by International Air Transport Association (IATA).

Before initial use, make sure to charge the battery. You can charge either the standalone battery or the terminal with battery attached. It is recommended that the terminal remain powered off during charging.

The LED indicator on the charger shows the charging status. For details, see the following table.

LED Indicator	Charging Status
Glows orange	The battery is being charged.

LED Indicator	Charging Status
Flashes orange rapidly (every 0.2 second)	The battery cannot be charged due to overheating.
Glowes green	The battery is fully charged.
Glowes red	The battery fails to be charged.
Flashes red rapidly	The battery encounters communication error.
Flashes green slowly (every 2 seconds)	No battery is placed on the charger.

Turning the Terminal On or Off

To turn the terminal on, long press .

The battery status indicator glows green and the OLED display shows the charge left in the battery.

To turn the terminal off, do as follows:

1. Long press .
2. Press the **OK** key when the OLED display shows "Power off?".

Adjusting the Volume

To increase the volume, rotate the **Volume Control** knob clockwise.

To decrease the volume, rotate the **Volume Control** knob counter-clockwise.



Selecting a Group



Locking or Unlocking the Keypad

When the keypad is not in use, it is recommended that you lock it to avoid unintended operations.

To lock or unlock the keypad, press the **OK** key and then the **P1** key on the home screen.

To allow the keypad to be locked automatically, do as follows:

1. Go to **Menu > Settings > Radio > Keypad > Auto Lock**.

2. Select **On**, and then press the **OK** key.

With this feature enabled, the keypad will be locked automatically if no operation is made or no call/message is received within the preset time period.

Switching the Operation Mode











The terminal can operate in direct mode (DMO) or trunking mode (TMO).









To switch the operation mode, do one of the following:

- Go to **Menu > Mode**, select the required mode, and then press the **OK** key.
- On the home screen, press the **OK** key, select **Mode**, select the required mode, and then press the **OK** key.
- Press the preprogrammed **TMO&DMO Switch** key.

Status Indications

Icons

Icon	Terminal Status
	The battery is being charged.
	The battery power is low.
	The fuller the battery bar is, the stronger the battery power remains.
	The battery is damaged or counterfeit.
	The terminal is not registered with the system in TMO.
	The terminal is registered with the system in TMO, and the number of bars indicates the signal strength.
	The Gateway work type is enabled in DMO, and a gateway is connected.
	The Gateway work type is enabled in DMO, but no gateway is connected.
	The Repeater work type is enabled in DMO, and a repeater is connected.
	The Repeater work type is enabled in DMO, but no repeater is connected.

Icon	Terminal Status
	The keypad is locked.
	There is/are unread short message(s).
	An emergency call is in progress.
	A broadcast call is in progress.
	A group call is in progress.
	An individual call is in progress.
	An all call is in progress.
	An audio accessory is connected.

For details on other icons, refer to the *User Manual*.

LED Indication

Operation Status Indicator

Indicator	Terminal Status
Glows green	The terminal is receiving during a call.
Flashes green slowly	<ul style="list-style-type: none"> ● The terminal is standby in TMO.

Indicator	Terminal Status
	<ul style="list-style-type: none"> The terminal is switching from DMO to TMO.
Glows red	The terminal is transmitting during a call.
Flashes red rapidly	The terminal is out of service.
Glows orange	<ul style="list-style-type: none"> The channel is busy in DMO. The terminal is prohibited from transmitting. The terminal is switching from TMO to DMO.
Flashes orange rapidly	<ul style="list-style-type: none"> The terminal cannot request talk rights. The talkgroup is an empty group.
Flashes orange slowly	The terminal is working in Fallback mode.
Glows blue	The BT feature is being enabled.

Indicator	Terminal Status
Flashes blue slowly	<ul style="list-style-type: none"> The terminal is standby in DMO. The BT feature is enabled, but no BT device is connected.
Double flashes blue slowly	The BT feature is enabled, and a BT device is connected.
Glows purple	Call reserved time: No voice is being transmitted or received on the channel during a call. Within such a period, you can press and hold the PTT key and speak.

Battery Status Indicator

Indicator	Terminal Status
Glows green	The terminal is being turned on.
Flashes red slowly	The battery power is low. Charge or replace the battery.
Glows orange	<ul style="list-style-type: none"> The terminal is being upgraded. The battery is counterfeit.

Indicator	Terminal Status
Flashes orange slowly	The battery power is below 60%.

Call Services

Group Call

A group call is a call from an individual user in a group to all the other members in the group.

Initiating a Group Call

On the home screen, press and hold the **PTT** key to initiate a group call to the default group.

For details on setting the default group, refer to the *User Manual*.

Receiving a Group Call

You can listen to an incoming group call without any operation.

If the terminal is assigned with the pre-emptive priority, you can press and hold the **PTT** key to interrupt the talking party and speak at any time.

Ending a Group Call

A group call ends when the calling party presses .

The called party can exit the group call by pressing



NOTE

In TMO, with the Virtual Channel Reservation feature enabled by your dealer, you can press the **PTT** key to call back within the preset time period after the other party hangs up.

Individual Call

An individual call is a call from an individual user to another individual user.

In TMO, an individual call is a half-duplex call or full duplex call.

In DMO, an individual call is a half-duplex call.

NOTE

You need to connect an external microphone before receiving an full-duplex individual call.

Initiating an Individual Call

To initiate a half-duplex individual call, do as follows:

1. Go to **Menu > PhoneBook** or **Menu > Call Log > Dialed/Received/Missed**, and then select the required individual contact.
2. Press and hold the **PTT** key.

To initiate a full-duplex individual call, do as follows:

1. Go to **Menu > PhoneBook** or **Menu > Call Log > Dialed/Received/Missed**, and then select the required individual contact.
2. Press  or the **OK** key.

Receiving an Individual Call

TMO

When receiving a half-duplex or full-duplex individual call with direct signaling, you can answer the call without any operation. The call is established automatically.

When receiving a half-duplex or full-duplex individual call with hook signaling, press , the **PTT** key, or the **OK** key to answer the call.

DMO

You can listen to an incoming individual call without any operation.

The terminal assigned with higher priority or the preemptive priority can interrupt the call from the terminal without those priority.

Ending an Individual Call

An individual call ends when the calling or called party presses .

NOTE

During a half-duplex call in TMO, with the Virtual Channel Reservation feature enabled by your dealer, you can press the **PTT** key to call back within the preset time period after the other party hangs up.

PABX/PSTN Call

In TMO, a PABX/PSTN call is a full-duplex individual call with hook signaling established between an individual user and a PABX or PSTN user outside the TETRA network.

Initiating a PABX/PSTN Call

To initiate a PABX/PSTN call, do as follows:

1. Go to **Menu > Phone Book**, and then select the required PABX or PSTN number.

2. Press  or the **PTT** key.

Receiving a PABX/PSTN Call

When receiving a PABX/PSTN call, press  or the **PTT** key to answer the call.

Both the calling and the called party can speak without any operations during the call.

Ending a PABX/PSTN Call

A PABX/PSTN call ends when the calling or called party presses .

Second PTT Call (TMO Only)

If the **SK1** or **SK2** is preprogrammed as the **Second PTT** key, you can use it to initiate a group call to the preset group.

The operations of receiving and ending the second PTT call are similar to those of the group call. For details, see "Group Call".

Emergency Call

An emergency call is a call initiated by an individual user to the predefined contact for summoning help in

emergency situations. With the highest priority, the emergency call can interrupt any calls with lower priority.

The terminal can initiate an emergency call in one of the following modes:

- **Regular:** The terminal gives visual and audio indications. After the emergency call ends, it enters the standby state.
- **Silent (TMO only):** The terminal gives no visual or audio indications. After the emergency call ends, it enters the standby state.

Initiating an Emergency Call

TMO

You can press the **Emergency** key to initiate an emergency call to an individual contact, a group contact, a PABX/PSTN user, or the default group. The emergency call type is configured by your dealer.

DMO

Press the **Emergency** key to initiate an emergency call to the default group.

Receiving an Emergency Call

TMO

When receiving an emergency call initiated by an individual ID, see the operations in "Receiving an Individual Call".

When receiving an emergency call initiated by a group ID, you can answer the call without any operation. The call is established automatically.

When receiving an emergency call initiated by a PABX or PSTN number, press  or the **PTT** key to answer the call.

DMO

You can answer an incoming emergency call without any operation.

Ending an Emergency Call

To end an emergency call in Regular mode, do one of the following:

- The calling party presses . The called party can exit the emergency call by doing so.

- The calling party long presses the **Cancel/Back** key. The called party can exit the emergency call by doing so.

To end an emergency call in Silent mode, press the **OK** key and then the **P3** key.

Emergency Cycle

During an emergency call, the called party cannot request talk permit until the calling party presses the **PTT** key. To avoid this situation, request your dealer to configure the Emergency Cycle feature. With this feature enabled, the calling party and the called party request talk right and speak in turn until the emergency cycle call time runs out.

NOTE

In an emergency cycle, the calling party can press and hold the **PTT** key to pre-empt talk right. After the talk right is pre-empted, the emergency cycle ends.

Message Services

Short Messages

Short messages include status messages and text messages.

NOTE

You can go to **Menu > Message > Settings** to enable **DeliveryReport**, **Save SentMsg**, and **Msg Preview**, or select **Adr Type** and **Msg Box Type**.

Sending a Status Message

To send a status message, do as follows:

1. Go to **Menu > Message > Status Msg**.
2. Select the required status message, and then press the **OK** key.
3. Press the **Menu** key, and then select **Send**.
4. Select the required contact, and then press the **OK** key.

Viewing a Message

To view a newly received message from the home screen, press the **OK** key.

To view all received messages from the Inbox or Outbox, go to **Menu > Message > Inbox/Outbox**, and then select the required message.

Resending a Message

To resend a message, do as follows:

1. Go to **Menu > Message > Outbox**.
2. Select the required message, and then press the **OK** key.
3. Press the **Menu** key, and then select **Resend**.

Forwarding a Message

To forward a message, do as follows:

1. Go to **Menu > Message > Inbox/Outbox**.
2. Select the required message, and then press the **OK** key.
3. Press the **Menu** key, and then select **Forward**.
4. Select the required contact, and then press the **OK** key.

Deleting a Message

To delete a message, do as follows:

1. Go to **Menu > Message > Inbox/Outbox/Templates**.

2. Select the required message or template, and then press the **OK** key.
3. Press the **Menu** key, and then select **Delete**.
4. Press the **OK** key to confirm.

Deleting All Messages

To delete all messages, do as follows:

1. Go to **Menu > Message > Delete**.
2. Select **Delete All/All Read/Inbox/Outbox/Templates**, and then press the **OK** key.
3. Press the **OK** key to confirm.

Templates

A short data template is a predefined text message that can be sent to the required contact.

Sending a Template

To send a template, do as follows:

1. Go to **Menu > Message > Templates**.
2. Select the required template, and then press the **OK** key.
3. Press the **Menu** key, and then select **Send**.
4. Select the number type and the required contact, and then press the **OK** key.

Saving as a Template

To save a message as a template, do as follows:

1. Go to **Menu > Message > Inbox/Outbox**.
2. Select the required message, and then press the **OK** key.
3. Press the **Menu** key, and then select **Save as Template**.



NOTE

Only the message shorter than 140 bytes can be saved as a template.

Flash Messages (TMO Only)

A flash message is a special text message shorter than 140 bytes. The receiving party can preview the message content on the current screen. After the preview time expires, the terminal returns to the original screen with  on the status bar.

Sending a Flash Message

To send a flash message, do as follows:

1. Go to **Menu > Message > Templates**.
2. Select the required message, and then press the **OK** key.

3. Press the **Menu** key, and then select **Send Flash**.
4. Select **Private No.**, and then select the required contact.
5. Press the **OK** key to confirm.

Forwarding a Flash Message

The operations of forwarding a flash message are similar to those of forwarding a short message. Select **Forward Flash** instead of **Forward**.

For details on more features and operations, please visit our website at: <http://www.hytera.com>, or scan the QR code to download the *User Manual*.

