



NFC TEST REPORT

No.I22Z60641-IOT05

for

Hytera Communications Corporation Limited

Poc Mobile Radio

Model Name: MNC360

FCC ID: YAMMNC360

IC number:8913A-MNC360

with

Hardware Version: V1.0.01.000.01

Software Version: V1.0.06.000.01

Issued Date: 2022-05-16

Note:

The test results in this test report relate only to the devices specified in this report. This report shall not be reproduced except in full without the written approval of CTTL.

The report must not be used by the client to claim product certification, approval, or endorsement by NVLAP, NIST, or any agency of the U.S.Government.

Test Laboratory:

CTTL-Telecommunication Technology Labs, CAICT

No. 52, Huayuan North Road, Haidian District, Beijing, P. R. China 100191.

Tel:+86(0)10-62304633-2512, Fax:+86(0)10-62304633-2504

Email: ctl_terminals@caict.ac.cn, website: www.caict.ac.cn



REPORT HISTORY

Report Number	Revision	Description	Issue Date
I22Z60641-IOT05	Rev.0	1 st edition	2022-05-16

Note: the latest revision of the test report supersedes all previous version.

CONTENTS

1. TEST LABORATORY	4
1.1. INTRODUCTION & ACCREDITATION.....	4
1.2. TESTING LOCATION	4
1.3. TESTING ENVIRONMENT	5
1.4. PROJECT DATA	5
1.5. SIGNATURE.....	5
2. CLIENT INFORMATION.....	6
2.1. APPLICANT INFORMATION.....	6
2.2. MANUFACTURER INFORMATION.....	6
3. EQUIPMENT UNDER TEST (EUT) AND ANCILLARY EQUIPMENT (AE)	7
3.1. ABOUT EUT	7
3.2. INTERNAL IDENTIFICATION OF EUT	7
3.3. INTERNAL IDENTIFICATION OF AE	7
3.4. EUT SET-UPS.....	8
4. REFERENCE DOCUMENTS	9
4.1. DOCUMENTS SUPPLIED BY APPLICANT	9
4.2. REFERENCE DOCUMENTS FOR TESTING.....	9
5. TEST RESULTS	10
5.1. SUMMARY OF TEST RESULTS	10
5.2. STATEMENTS.....	10
6. TEST FACILITIES UTILIZED	12
7. MEASUREMENT UNCERTAINTY	13
ANNEX A: EUT PARAMETERS.....	14
ANNEX B: DETAILED TEST RESULTS.....	15
ANNEX C: PERSONS INVOLVED IN THIS TESTING	26
ANNEX D: ACCREDITATION CERTIFICATE	27



1. Test Laboratory

1.1. Introduction & Accreditation

Telecommunication Technology Labs, CAICT is an ISO/IEC 17025:2017 accredited test laboratory under NATIONAL VOLUNTARY LABORATORY ACCREDITATION PROGRAM (NVLAP) with lab code 600118-0, and is also an FCC accredited test laboratory (CN5017), and ISED accredited test laboratory (ISED#: 24849). The detail accreditation scope can be found on NVLAP website.

1.2. Testing Location

Location 1: CTTL(huayuan North Road)

Address: No. 52, Huayuan North Road, Haidian District, Beijing,
P. R. China 100191

Location 4: CTTL(BDA)

Address: No.18A, Kangding Street, Beijing Economic-Technology
Development Area, Beijing, P. R. China 100176

1.3. Testing Environment

Normal Temperature: 15-35°C
Extreme Temperature: -20/+60°C
Normal Relative Humidity: 20-75%
Normal Air Pressure 86Kpa-106Kpa

1.4. Project data

Testing Start Date: 2022-04-25
Testing End Date: 2022-05-11

1.5. Signature



Zhou Bin

(Prepared this test report)



Zhang Qiang

(Reviewed this test report)



Zhu Liang

(Approved this test report)



2. Client Information

2.1. Applicant Information

Company Name: Hytera Communications Corporation Limited
Address: Hytera Tower, Hi-Tech Industrial Park North, 9108# Beihuan Road,
Nanshan District, Shenzhen, P.R.C., P 518057
Contact: Ruifen.Huang
Telephone: 18925250460
Email: Ruifen.Huang@hytera.com

2.2. Manufacturer Information

Company Name: Hytera Communications Corporation Limited
Address: Hytera Tower, Hi-Tech Industrial Park North, 9108# Beihuan Road,
Nanshan District, Shenzhen, P.R.C., P 518057
Contact: Ruifen.Huang
Telephone: 18925250460
Email: Ruifen.Huang@hytera.com

3. Equipment Under Test (EUT) and Ancillary Equipment (AE)

3.1. About EUT

Description	PoC Mobile Radio
Model Name	MNC360
FCC ID	YAMMNC360
IC number	8913A-MNC360
GSM Frequency bands	850/900/1800/1900
UMTS Frequency bands	FDD I/ II/ III/ IV/ V/ VIII
E-UTRA Frequency bands	FDD 1/2/3/4/5/7/8/12/13/17/20/26/28A/28B TDD 38/39/40/41
Operating temperature	-20/+60°C
Extreme low voltage	9 V
Normal voltage	13.6 V
Extreme high voltage	25 V

3.2. Internal Identification of EUT

EUT ID*	SN or IMEI	HW Version	SW Version	Receive Date
UT19aa	866346040178469	V1.0.01.000.01	V1.0.06.000.01	2022-04-25
UT22aa	866346040178493	V1.0.01.000.01	V1.0.06.000.01	2022-05-09

*EUT ID: is used to identify the test sample in the lab internally.

3.3. Internal Identification of AE

AE ID*	Description	SN	Remarks
AE1	Power Supply	/	/
AE2	DC Power Supply	/	/
AE3	GPS Antenna	/	/
AE4	2G/3G/4G Antenna	/	/
AE5	Palm microphone	/	/
AE6	NFC Card	/	/

AE1

Model	NGSM
Manufacturer	Rohde & Schwarz

AE2

Model	ZUP60-14
Manufacturer	/

AE3

Model	DAMA1575AT41
-------	--------------



Manufacturer	ZHANGJIAGANG FREE TRADE ZONE CAIQIN TECHNOLOGY CO.,LTD.
AE4	
Model	AN1700W01
Manufacturer	/
AE5	
Model	SM16A1
Manufacturer	Hytera Communications Corporation Limited

*AE ID: is used to identify the ancillary equipment in the lab internally.

3.4. EUT Set-ups

EUT set-up No.	Combination of EUT and AE	Remarks
Set.NFC01	EUT22aa+AE2+AE6	/
Set.NFC02	EUT19aa+AE1	/

The Transmit State of NFC: the NFC function is on. The EUT will transmit the NFC data and command continuously during the test.

The Transmit state without modulation: The EUT will transmit the CW signal at the operating frequency.

4. Reference Documents

4.1. Documents supplied by applicant

EUT parameters, referring to Annex A for detailed information, are supplied by the client or manufacturer, which are the bases of testing.

4.2. Reference Documents for testing

The following documents listed in this section are referred for testing.

Reference	Title	Version
CFR 47 Part 2	Part 2 — Frequency Allocations and Radio Treaty Matters; General Rules and Regulations.	2019
CFR 47 Part 15	Part 15 — Radio Frequency Devices. Subpart C — Intentional Radiators. § 15.35 Measurement detector functions and bandwidths. § 15.207 Conducted limits. § 15.209 Radiated emission limits, general requirements. § 15.215 Additional provisions to the general radiated emission limitations. § 15.225 Operation within the band 13.110–14.010 MHz.	2019
ANSI C63.10	American National Standard of Procedures for Compliance Testing of Unlicensed Wireless Devices	2013
RSS -210	License-exempt Radio Apparatus (All Frequency Bands): Category I Equipment Spectrum Management and	Issue10
RSS - Gen	Telecommunications - Radio Standards Specification General Requirements and Information for the Certification of Radio communication Equipment	Issue5

5. Test Results

5.1. Summary of Test Results

No	Test Cases	Clause in Regulation	Section in This Report	Verdict
1	Electric Field Strength of Fundamental Emissions	CFR 47 § 15.225(a) RSS-210 Issue 10 § Annex B.6	B.1	P(Set. NFC01)
2	Electric Field Strength of Outside the Allocated Bands	CFR 47 § 15.225(b) CFR 47 § 15.225(c) RSS-210 Issue9 B.6		P(Set. NFC01)
3	Electric Field Radiated Emissions	CFR 47 § 15.209	B.2	P(Set. NFC01)
		CFR 47 § 15.225(d) RSS-Gen Issue 5 § 6.7	B.3	P(Set. NFC01)
4	Frequency Tolerance	CFR 47 § 15.225(e) RSS-210 Issue 10 § Annex B.6(b)	B.4	P(Set. NFC02)
5	20dB Bandwidth	CFR 47 § 15.215(c) RSS-Gen Issue 5 § 6.7	B.5	P(Set. NFC02)
6	99% Occupied Bandwidth	RSS-Gen Issue 5 § 6.7	B.6	P(Set. NFC02)
The measurement is carried out according to ANSI C63.10. See ANNEX B for details.				

Test Conditions:

For this report, all the test cases listed above were tested under normal Temperature, Voltage, humidity and Air Pressure except the Frequency Tolerance test case. The specific conditions of Frequency Tolerance test case are listed in section B.4.3

See **Table 3** for terms for result verdict:

Table 1 Terms for result verdict

P	Pass, The EUT complies with the essential requirements in the standard.
NP	Not Perform, The test was not performed by CTTL
NA	Not Applicable, The test was not applicable
F	Fail, The EUT does not comply with the essential requirements in the standard

5.2. Statements

The test cases listed in Section 5.1 of this report for the EUT specified in Section 3 were performed



by CTTL according to the reference documents in Section 4.

The EUT meets all applicable requirements of the regulations and standards in Section 4.2.

Disclaimer:

A. After confirmation with the customer, the sample information provided by the customer may affect the validity of the measurement results in this report, and the impact and consequences arising therefrom shall be borne by the customer.

B. The samples in this report are provided by the customer, and the test results are only applicable to the samples received.

6. Test Facilities Utilized

NO.	NAME	TYPE	SERIES NUMBER	PRODUCER	CAL. DUE DATE	CAL. INTERVAL
1.	Vector Signal Analyzer	FSV40	100903	Rohde & Schwarz	2022-12-29	1 year
2.	DC Power Supply	NGSM	5425	Rohde & Schwarz	2022-09-15	1 year
3.	Climate chamber	SU-242	93008165	ESPEC	2023-03-13	1 year
4.	Receiver	ESU26	100376	R&S	2022-09-15	1 year
5.	Antenna	VULB9163	01176	Schwarzbeck	2022-11-15	1 year
6.	Horn Antenna	3117	00066577	ETS-Lindgren	2025-03-15	3 years
7.	Antenna	3117	00139065	ETS-Lindgren	2022-09-13	1 year
8.	Chamber	FACT3-2.0	1285	ETS-Lindgren	2023-05-29	2 years

7. Measurement Uncertainty

Item	Uncertainty
Electric Field Strength of Fundamental and Outside the Allocated bands	$U = 1.79 \text{ dB}, k=2$
Radiated Emissions(<30MHz)	$U = 4.49 \text{ dB}, k=2$
Radiated Emissions (30MHz-1GHz)	$U = 5.73 \text{ dB}, k=2$
Frequency Tolerance	$U = 77 \text{ Hz}, k=2$
20dB Bandwidth	$U = 77 \text{ Hz}, k=2$
99% Emission Bandwidth	$U = 77 \text{ Hz}, k=2$



ANNEX A: EUT parameters

/

ANNEX B: Detailed Test Results

B.1. Electric Field Strength of Fundamental and Outside the Allocated bands

B.1.1. Reference

See Clause 4, Clause 5 of ANSI C63.10-2013 generally.

B.1.2. Measurement Methods

The transmitter carrier output levels (E-Field) from the EUT are measured in a semi-anechoic chamber. The EUT is placed on a non-conductive stand of 80cm high, and at a measurement distance of 3m from the receiving antenna. The center of the receiving loop antenna is 1.0 meter above the ground. The E-field is measured with a shielded loop antenna connected to a measurement receiver. Detected E-field was maximized by rotating the EUT through 360° and adjusting the receiving antenna polarizations. The maximization processes were repeated with the EUT positioned respectively in its three orthogonal axes. The measurements were performed with the peak detector and if required, the quasi-peak detector.

The measurement bandwidth is:

Table B-1: Measurement bandwidth

Frequency of Emission (MHz)	RBW/VBW
12.56-14.56	10/30 kHz

The E-field measured at 3m is calculated as:

$$\text{E-field (dB}\mu\text{V/m)} = \text{Rx (dB}\mu\text{V)} + \text{Cable Loss (dB)} + \text{AF@3m (dB/m)}$$

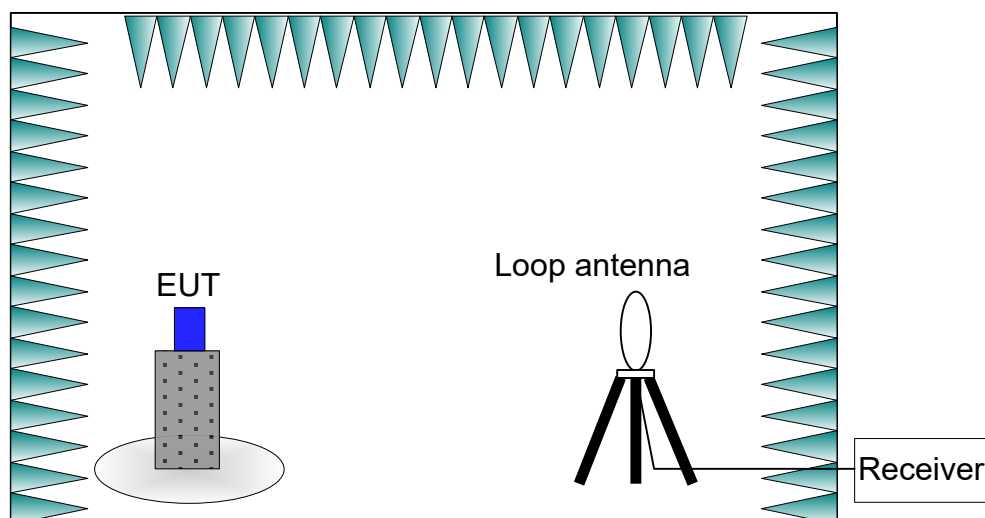

Figure B-1: Measurement Setup

B.1.3. EUT Operating Mode and Test Conditions

The measurement of EUT is carried out under the transmit state of NFC(See 3.4).

The EUT is powered by a travel adapter.

During the measurements, the ambient temperature of the electromagnetic anechoic chamber is in the range of 15 ~ 25 °C.

B.1.4. Limits

Table B-2: Limits

Frequency Range (MHz)	E-field Strength Limit @ 30 m (μV/m)	E-field Strength Limit @ 3 m (dBμV/m)
13.560 ± 0.007	+15,848	124
13.410 to 13.553 13.567 to 13.710	+334	90
13.110 to 13.410 13.710 to 14.010	+106	81

Note: Where the limits have been defined at one distance, and a signal level measured at another, the limits have been extrapolated using the following formula:

$$\text{Extrapolation(dB)} = 40\log_{10}(\text{Measurement Distance}/\text{Specification Distance})$$

B.1.5. Measurement Results

Measurement results of normal conditions see Figure B-2 for different set-ups of EUT. The results displayed take into account applicable antenna factors and cable losses.

Conclusions: Set.NFC01, **PASS**.

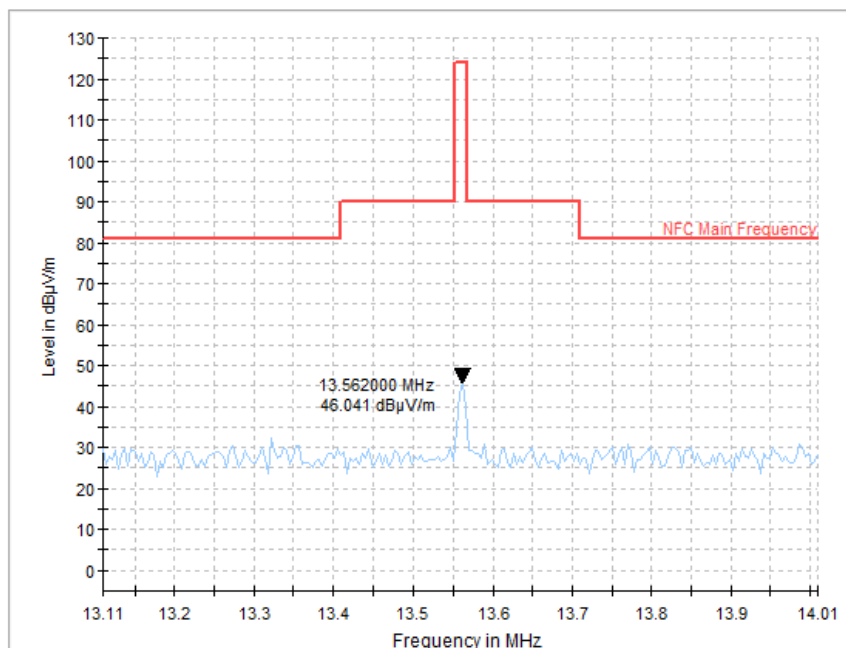

Figure B-2: Measurement results for Electric Field Strength of Fundamental and Outside the Allocated bands

B.1.6. Measurement Uncertainty

Measurement uncertainty: U = 1.79 dB, k=2.

B.2. Electric Field Radiated Emissions (< 30MHz)

B.2.1. Reference

See Clause 6.4 of ANSI C63.10-2013 specifically.

See Clause 4 and Clause 5 of ANSI C63.10-2013 generally.

B.2.2. Measurement Methods

The transmitter carrier output levels (E-Field) from the EUT are measured in a semi-anechoic chamber. The EUT is placed on a non-conductive stand of 80cm high, and at a measurement distance of 3m from the receiving antenna. The center of the receiving loop antenna is 1.0 meter above the ground. The E-field is measured with a shielded loop antenna connected to a measurement receiver. Detected E-field was maximized by rotating the EUT through 360° and adjusting the receiving antenna polarizations. The maximization processes were repeated with the EUT positioned respectively in its three orthogonal axes. The measurements were performed with the peak detector and if required, the quasi-peak detector.

The measurement bandwidth is:

Frequency of Emission (MHz)	RBW/VBW
0.009-0.15	100/300 Hz
0.15-30	10/30 kHz

The E-field measured at 3m is calculated as:

$$\text{E-field (dB}\mu\text{V/m)} = \text{Rx (dB}\mu\text{V)} + \text{Cable Loss (dB)} + \text{AF@3m (dB/m)}$$

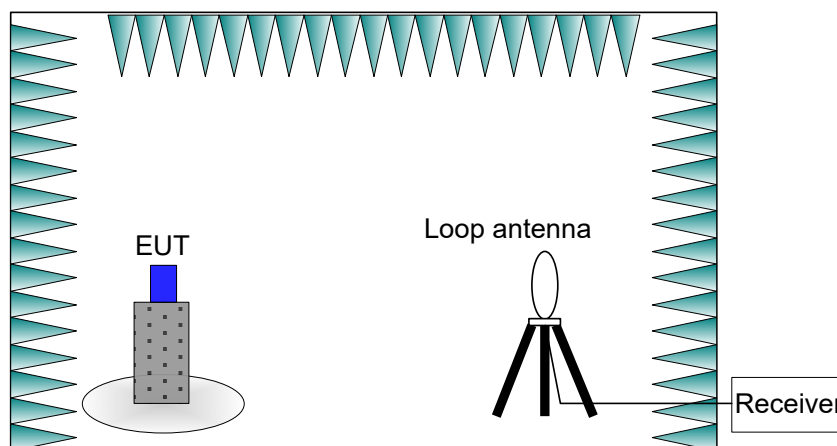

Figure B-3: Measurement Setup

B.2.3. EUT Operating Mode and Test Conditions

The measurement of EUT is carried out under the transmit state of NFC(See 3.4).

The EUT is powered by a travel adapter.

During the measurements, the ambient temperature of the electromagnetic anechoic chamber is

in the range of 15 ~ 25 °C.

B.2.4. Limits

Frequency Range (MHz)	E-field Strength Limit @ 30m (mV/m)	E-field Strength Limit @ 3m (dB μ V/m)
0.009-0.490	2400/F(kHz)	129-94
0.490-1.705	24000/F(kHz)	74-63
1.705-30	30	70

Note: Where the limits have been defined at one distance, and a signal level measured at another, the limits have been extrapolated using the following formula:
 Extrapolation(dB) = $40\log_{10}(\text{Measurement Distance}/\text{Specification Distance})$

B.2.5. Measurement Results

Measurement results of normal conditions see Figure B-4 for different set-ups of EUT. The results displayed take into account applicable antenna factors and cable losses.

Conclusions: Set.NFC01, **PASS**.

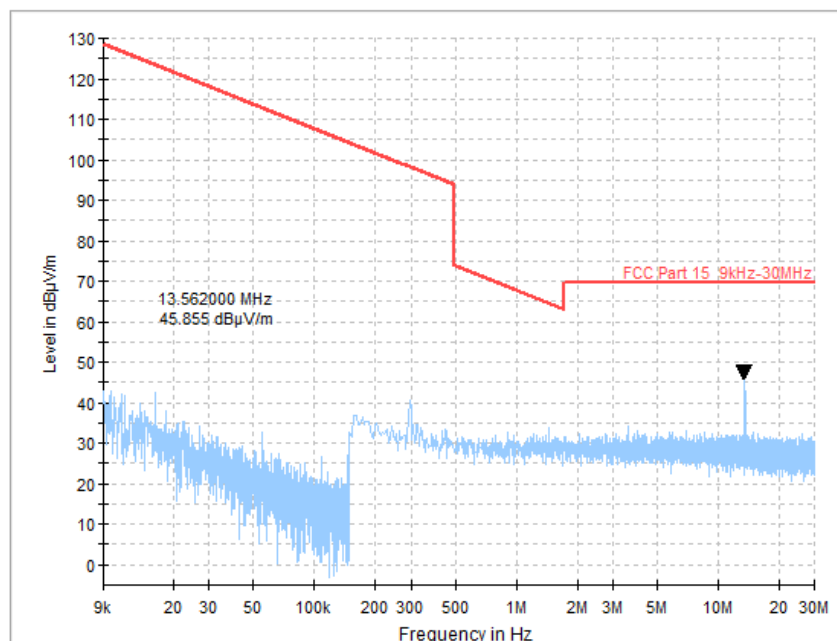

Figure B-4: Measurement results for Electric Field Radiated Emissions (< 30MHz)

B.2.6. Measurement Uncertainty

Measurement uncertainty: U = 1.79 dB, k=2.

B.3. Electric Field Radiated Emissions ($\geq 30\text{MHz}$)

B.3.1. Reference

See Clause 6.5 of ANSI C63.10-2013 specifically.

See Clause 4 and Clause 5 of ANSI C63.10-2013 generally.

B.3.2. Measurement Methods

The electric field radiated emissions from the EUT are measured in a semi-anechoic chamber. The EUT is placed on a non-conductive stand of 80cm high, and at a measurement distance of 10m from the receiving antenna. The receiving antennas connected to a measurement receiver. In order to search for maximum field strength emitted from the EUT, the receiving antenna can be moved between the height of 1.0 m to 4.0 m. Detected E-field was maximized at each frequency by rotating the EUT through 360° and adjusting the receiving antenna positions for both vertical and horizontal antenna polarizations. The maximization processes were repeated with the EUT positioned respectively in its three orthogonal axes. The measurements were performed with the peak detector and if required, the quasi-peak detector.

The measurement bandwidth is:

Frequency of Emission (MHz)	RBW/VBW
30-1000	120kHz

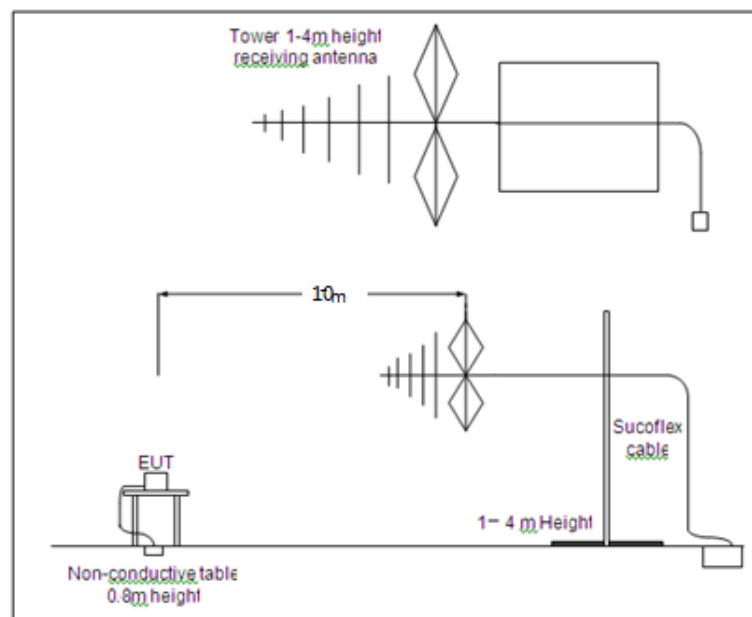

Figure B-5: Measurement Setup

B.3.3. EUT Operating Mode and Test Conditions

The measurement of EUT is carried out under the transmit state of NFC(See 3.4).

The EUT had been connected to a travel adapter.

During the measurements, the ambient temperature of the electromagnetic anechoic chamber is in the range of 15 ~ 25 °C.

B.3.4. Limits

Frequency Range (MHz)	E-field Strength Limit @ 3m (mV/m)	E-field Strength Limit @ 3m (dBµV/m)	E-field Strength Limit @ 10m (dBµV/m)
30-88	100	40	30
88-216	150	43.5	33.5
216-960	200	46	36
960-1000	500	54	44

B.3.5. Measurement Results

Measurement results of normal conditions see Figure B-6 for different set-ups of EUT. The results displayed take into account applicable antenna factors and cable losses.

Conclusions: Set.NFC01, **PASS**.

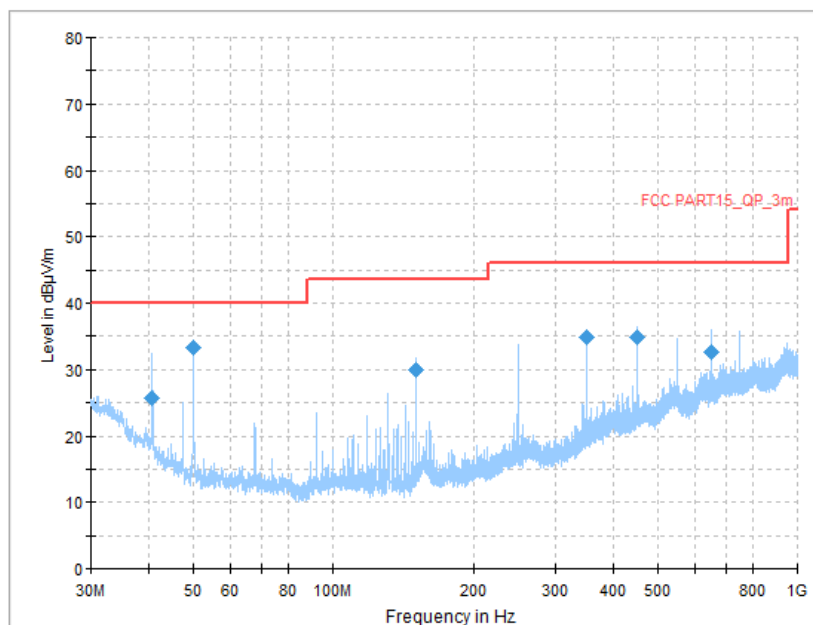

Figure B-6: Measurement results for Electric Field Radiated Emissions (≥30MHz)

B.3.6. Measurement Uncertainty

Measurement uncertainty: $U = 1.79 \text{ dB}$, $k=2$.

B.4. Frequency Tolerance

B.4.1. Reference

See Clause 6.8 of ANSI C63.10-2013 specifically.

See Clause 4 and Clause 5 of ANSI C63.10-2013 generally.

B.4.2. Measurement Methods

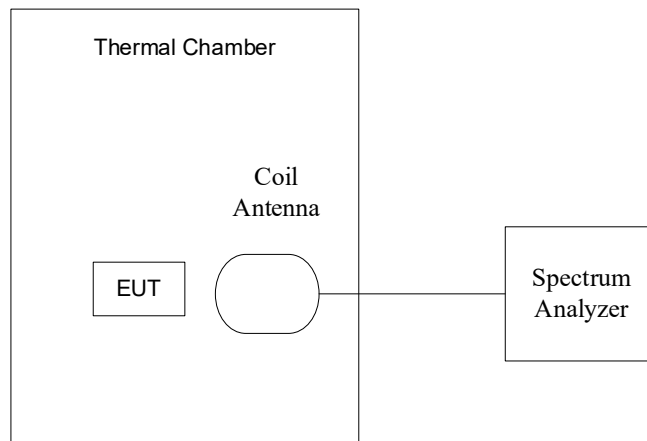

Figure B-7: Measurement Setup

The transmitter output signal was picked up by coil antenna connected to the spectrum analyzer. The center frequency was measured with 30Hz RBW and 1kHz span. During the test, the EUT was placed in a thermal chamber until thermal balance and lasting appropriate time.

B.4.3. EUT Operating Mode and Test Conditions

The measurement of EUT was carried out under the transmit state of without modulation(See 3.4). EUT had not been connected to a travel adapter. The frequency stability was measured with the different voltage and temperature combinations:

- a) The nominal voltage 13.60V(See 3.1)was used and the temperature was varied from -20°C to +50°C in 10°C increments using an environmental chamber.
- b) The 20°C was used and the voltages were 11.56V, 13.60V and 15.64V (85% of the normal voltage ,the normal voltage and 115% of the normal voltage .The normal voltage defined in section 3.1).

The details were as following:

Table B-3: Combinations of Voltage andTemperature

Test items	Voltage	Temperature
Frequency stability with respect to ambient temperature	13.60V	-20°C
		-10°C
		0°C
		10°C
		20°C
		30°C
		40°C
		50°C
Frequency stability when varying supply voltage	11.56V	20°C
	13.60V	
	15.64V	

B.4.4. Test Layouts

See B.4.2.

B.4.5. Limits

The frequency tolerance of the carrier signal shall be maintained within +/- 0.01% of the operating frequency.

B.4.6. Measurement Results

Measurement results see Table B-4 for different test conditions.

Conclusions: Set.NFC02, **PASS**.

Table B-4: Measurement results for Frequency Tolerance

Temperature	Voltage	Frequency (MHz)			
		Startup	2 Min Later	5 Min Later	10 Min Later
-20°C	13.60V	13.560810	13.560809	13.560805	13.560807
-10°C	13.60V	13.560798	13.560791	13.560789	13.560795
0°C	13.60V	13.560801	13.560812	13.560820	13.560819
10°C	13.60V	13.560879	13.560879	13.560880	13.560879
20°C	13.60V	13.560865	13.560860	13.560867	13.560871
30°C	13.60V	13.560872	13.560869	13.560868	13.560866
40°C	13.60V	13.560875	13.560879	13.560876	13.560875
50°C	13.60V	13.560870	13.560871	13.560876	13.560875
20°C	11.56V	13.560865	13.560863	13.560863	13.560864
20°C	15.64V	13.560810	13.560809	13.560805	13.560807

Temperature	Voltage	Frequency Error (%)			
		Startup	2 Min Later	5 Min Later	10 Min Later
-20°C	13.60V	0.006	0.006	0.006	0.006
-10°C	13.60V	0.006	0.006	0.006	0.006
0°C	13.60V	0.006	0.006	0.006	0.006
10°C	13.60V	0.006	0.006	0.006	0.006
20°C	13.60V	0.006	0.006	0.006	0.006
30°C	13.60V	0.006	0.006	0.006	0.006
40°C	13.60V	0.006	0.006	0.006	0.006
50°C	13.60V	0.006	0.006	0.006	0.006
20°C	11.56V	0.006	0.006	0.006	0.006
20°C	15.64V	0.006	0.006	0.006	0.006

B.4.7. Measurement Uncertainty

Measurement uncertainty: $U = 77 \text{ Hz}$, $k=2$

B.5. 20dB Bandwidth

B.5.1. Reference

See Clause 6.9 of ANSI C63.10-2013 specifically.

See Clause 4 and Clause 5 of ANSI C63.10-2013 generally.

B.5.2. Measurement Methods

The transmitter output signal was picked up by coil antenna connected to the spectrum analyzer. The bandwidth of the center frequency was measured with 100Hz RBW, 300Hz VBW and 10kHz span.

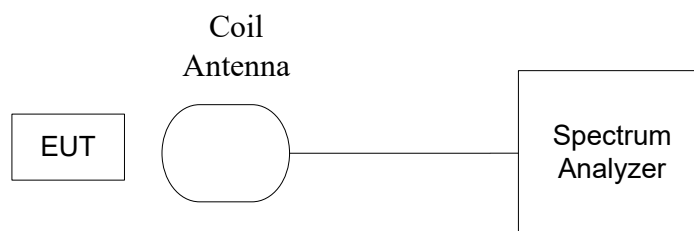

Figure B-8: Measurement Setup

B.5.3. EUT Operating Mode and Test Conditions

The measurement of EUT was carried out under the transmit state of NFC (See 3.4). EUT had not been connected to a travel adapter.

During the measurements, the ambient temperature was in the range of 15 ~ 25 °C.

B.5.4. Test Layouts

See B.5.2.

B.5.5. Limits

The transmitter output signal was picked up by coil antenna to the spectrum analyzer.

The 20dB bandwidth shall be less than 80% of the permitted frequency band. For 13.56 MHz NFC, the permitted frequency band is 14kHz, so the limit is 11.2 kHz.

B.5.6. Measurement Results

Measurement results see Figure B-9.

Conclusions: Set.NFC02, **PASS**.

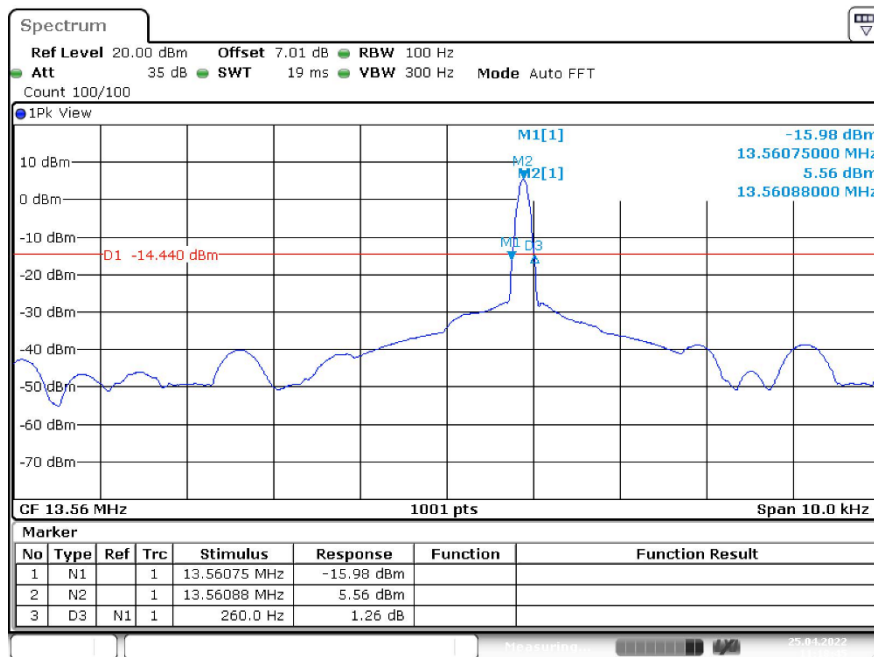

Figure B-9: Measurement results for 20dB Bandwidth

B.5.7. Measurement Uncertainty

Measurement uncertainty: $U = 77$ Hz, $k=2$.

B.6. 99% Emission Bandwidth

B.6.1. Reference

See RSS-Gen section 6.7

B.6.2. Measurement Methods

The transmitter output signal was picked up by coil antenna to the spectrum analyzer. The transmitter output signal was picked up by coil antenna connected to the spectrum analyzer. The bandwidth of the center frequency was measured with 100Hz RBW, 300Hz VBW and 10kHz span.

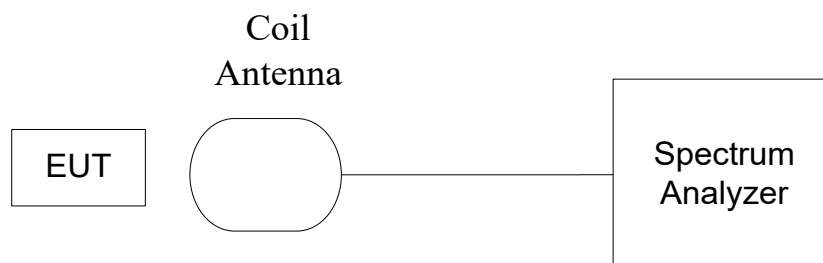

Figure B-10: Measurement Setup

B.6.3. EUT Operating Mode and Test Conditions

The measurement of EUT is carried out under the transmit state of NFC and with modulation (See 3.4).

EUT had been not connected to a travel adapter.

During the measurements, the ambient temperature was in the range of 15 ~ 25 °C.

B.6.4. Limits

When the occupied bandwidth limit is not stated in the applicable RSS or reference measurement method, the transmitted signal bandwidth shall be reported as the 99% emission bandwidth, as calculated or measured.

B.6.5. Measurement Results

Table B-5: Measurements Results

Test Conditions		99% Emission Bandwidth
Nominal Voltage	Normal Temperature	624.375624376 kHz

Measurement results see Figure B-11.

Conclusions: Set.NFC02, PASS.

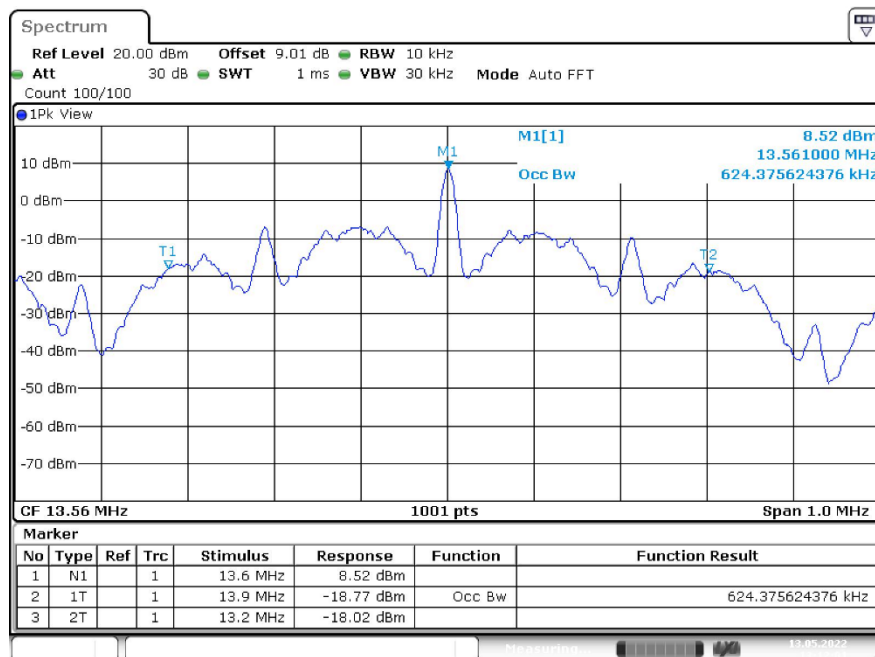

Figure B-11: Measurement results for 99% Emission Bandwidth

B.5.7. Measurement Uncertainty

Measurement uncertainty: $U = 77$ Hz, $k=2$

**ANNEX C: Persons involved in this testing**

Test Item	Tester
Electric Field Strength of Fundamental and Outside the Allocated bands	Zhao Wenhui
Electric Field Radiated Emissions (< 30MHz)	Zhao Wenhui
Electric Field Radiated Emissions (≥ 30 MHz)	Zhao Wenhui
Frequency Tolerance	Zhou Bin
20dB Bandwidth	Zhou Bin
99% Emission Bandwidth	Zhou Bin

ANNEX D: Accreditation Certificate

United States Department of Commerce
National Institute of Standards and Technology

NVLAP® 

Certificate of Accreditation to ISO/IEC 17025:2017

NVLAP LAB CODE: 600118-0

Telecommunication Technology Labs, CAICT
Beijing
China

*is accredited by the National Voluntary Laboratory Accreditation Program for specific services,
listed on the Scope of Accreditation, for:*

Electromagnetic Compatibility & Telecommunications

*This laboratory is accredited in accordance with the recognized International Standard ISO/IEC 17025:2017.
This accreditation demonstrates technical competence for a defined scope and the operation of a laboratory quality
management system (refer to joint ISO-ILAC-IAF Communique dated January 2009).*

2021-09-29 through 2022-09-30
Effective Dates

 
For the National Voluntary Laboratory Accreditation Program

*****END OF REPORT*****