



中认信通
CHINA CERTIFICATION ICT CO.,LTD (DONGGUAN)



SAR TEST REPORT

Applicant: SHENZHEN COVALUE COMMUNICATIONS CO.,LTD.

Address: No.616,Block A,Building 7,No. 1008 Songbai Road,Xili street,Nanshan District, Shenzhen,Guangdong,China

FCC ID: Y4GDR5810S-1

Product Name: Two Way Radio

Test Models: DR5810S-1,DR5610S-1,DR5510S-1

Multiple Models: DR5800S-1,DR5600S-1,DR5500S-1

Standard(s): 47 CFR Part 2(2.1093)

The above equipment has been tested and found compliant with the requirement of the relative standards by China Certification ICT Co., Ltd (Dongguan)

Report Number: CR22040011-20A

Date Of Issue: 2022-06-08

Reviewed By: Sun Zhong

Sun Zhong

Title: Manager

Test Laboratory: China Certification ICT Co., Ltd (Dongguan)
No. 113, Pingkang Road, Dalang Town, Dongguan,
Guangdong, China
Tel: +86-769-82016888

SAR TEST RESULTS SUMMARY

Operation Frequency Bands	Model	Highest Reported 1g SAR (W/kg)		Limits (W/kg)
		Head Face Up (Gap 25mm)	Body-Worn (Gap 0mm)	
PTT (136~174MHz)	DR5810S-1	0.96	5.35	8.0
	DR5610S-1	0.77	4.94	
	DR5510S-1	1.06	5.28	
Maximum Simultaneous Transmission SAR				
Items		Head Face Up (Gap 25mm)	Body-Worn (Gap 0mm)	Limits
Sum SAR(W/kg)	N/A	N/A	N/A	8.0
SPLSR		N/A	N/A	0.04
EUT Received Date:		2022/04/07		
Test Date:		2022/05/14~2022/05/15		
Test Result:		Pass		

Test Facility

The Test site used by China Certification ICT Co., Ltd (Dongguan) to collect test data is located on the No. 113, Pingkang Road, Dalang Town, Dongguan, Guangdong, China.

The lab has been recognized as the FCC accredited lab under the KDB 974614 D01 and is listed in the FCC Public Access Link (PAL) database, FCC Registration No. : 442868, the FCC Designation No. : CN1314.

The lab has been recognized by Innovation, Science and Economic Development Canada to test to Canadian radio equipment requirements, the CAB identifier: CN0123.

Declarations

China Certification ICT Co., Ltd (Dongguan) is not responsible for the authenticity of any test data provided by the applicant. Data included from the applicant that may affect test results are marked with a triangle symbol “▲”. Customer model name, addresses, names, trademarks etc. are not considered data.

Unless otherwise stated the results shown in this test report refer only to the sample(s) tested.

This report cannot be reproduced except in full, without prior written approval of the Company.

This report is valid only with a valid digital signature. The digital signature may be available only under the Adobe software above version 7.0.

This report may contain data that are not covered by the accreditation scope and shall be marked with an asterisk “★”.

CONTENTS

SAR TEST RESULTS SUMMARY	2
TEST FACILITY	3
DECLARATIONS	3
1. GENERAL INFORMATION	6
1.1 PRODUCT DESCRIPTION FOR EQUIPMENT UNDER TEST (EUT)	6
1.2 ANTENNAS INFORMATION:	6
1.3 TEST SPECIFICATION, METHODS AND PROCEDURES	7
1.4 SAR LIMITS	8
2. SAR MEASUREMENT SYSTEM	9
3. EQUIPMENT LIST AND CALIBRATION	16
3.1 EQUIPMENTS LIST & CALIBRATION INFORMATION	16
4. SAR MEASUREMENT SYSTEM VERIFICATION	17
4.1 LIQUID VERIFICATION	17
4.2 SYSTEM ACCURACY VERIFICATION	19
4.3 SAR SYSTEM VALIDATION DATA	20
5. EUT TEST STRATEGY AND METHODOLOGY	22
5.1 TEST POSITIONS FOR DEVICE OPERATING NEXT TO A PERSON'S EAR	22
5.2 CHEEK/TOUCH POSITION	23
5.3 EAR/TILT POSITION	23
5.4 TEST POSITIONS FOR BODY-WORN AND OTHER CONFIGURATIONS	24
5.5 TEST DISTANCE FOR SAR EVALUATION	25
5.6 SAR EVALUATION PROCEDURE	26
6. CONDUCTED OUTPUT POWER MEASUREMENT	27
6.1 TEST PROCEDURE	27
6.2 MAXIMUM TARGET OUTPUT POWER	27
6.3 TEST RESULTS:	28
7. SAR MEASUREMENT RESULTS	32
7.1 SAR TEST DATA	32
8. SAR Measurement Variability	39
9. SAR Plots	40
APPENDIX A MEASUREMENT UNCERTAINTY	41

APPENDIX B EUT TEST POSITION PHOTOS 43
APPENDIX C CALIBRATION CERTIFICATES 44

1. GENERAL INFORMATION

1.1 Product Description for Equipment under Test (EUT)

Device Type:	Portable	
Exposure Category:	Occupational/Controlled Exposure	
Antenna Type(s):	External Antenna for PTT	
Body-Worn Accessories:	Belt Clip	
Face-Head Accessories:	None	
Operation Mode:	PTT_FM, PTT_4FSK	
Frequency Band:	PTT_FM/PTT_4FSK: 136-174 MHz	
Conducted RF Power:	DR5810S-1	PTT_FM/PTT_4FSK: 36.95dBm
	DR5610S-1	PTT_FM/PTT_4FSK: 36.94dBm
	DR5510S-1	PTT_FM/PTT_4FSK: 36.93dBm
Power Source:	7.4VDC Rechargeable Battery	
Serial Number:	DR5810S-1: CR22040011-SA-S1 DR5610S-1: CR22040011-SA-S2 DR5510S-1: CR22040011-SA-S3	
Normal Operation:	Face Up and Body-worn	

1.2 Antennas information:

	PTT Antenna 1	PTT Antenna 2
Model:	RAOK14149152-B0072	RAOK14149132-B0072
Manufacturer:	Bondale Electronics Ltd.	Bondale Electronics Ltd.
Frequency Range:	136-150MHZ	150-174MHZ
Maximum Gain:	0dBi	0dBi
Antenna Type:	Exteral/Helical antenna	Exteral/Helical antenna
Dimensions:	φ15mm*150MM(L)	φ15mm*150MM(L)

1.3 Test Specification, Methods and Procedures

The tests documented in this report were performed in accordance with FCC 47 CFR § 2.1093, IEEE 1528-2013, the following FCC Published RF exposure KDB procedures:

447498 D04 Interim General RF Exposure Guidance v01
KDB 865664 D01 SAR Measurement 100 MHz to 6 GHz v01r04
KDB 865664 D02 RF Exposure Reporting v01r02
KDB 643646 D01 SAR Test for PTT Radios v01r03

TCB Workshop April 2019: RF Exposure Procedures

1.4 SAR Limits**FCC Limit**

EXPOSURE LIMITS	SAR (W/kg)	
	(General Population / Uncontrolled Exposure Environment)	(Occupational / Controlled Exposure Environment)
Spatial Average (averaged over the whole body)	0.08	0.4
Spatial Peak (averaged over any 1 g of tissue)	1.60	8.0
Spatial Peak (hands/wrists/feet/ankles averaged over 10 g)	4.0	20.0

Population/Uncontrolled Environments are defined as locations where there is the exposure of individual who have no knowledge or control of their exposure.

Occupational/Controlled Environments are defined as locations where there is exposure that may be incurred by people who are aware of the potential for exposure (i.e. as a result of employment or occupation).

2. SAR MEASUREMENT SYSTEM

These measurements were performed with the automated near-field scanning system DASY5 from Schmid & Partner Engineering AG (SPEAG) which is the Fifth generation of the system shown in the figure hereinafter:



DASY5 System Description

The DASY5 system for performing compliance tests consists of the following items:

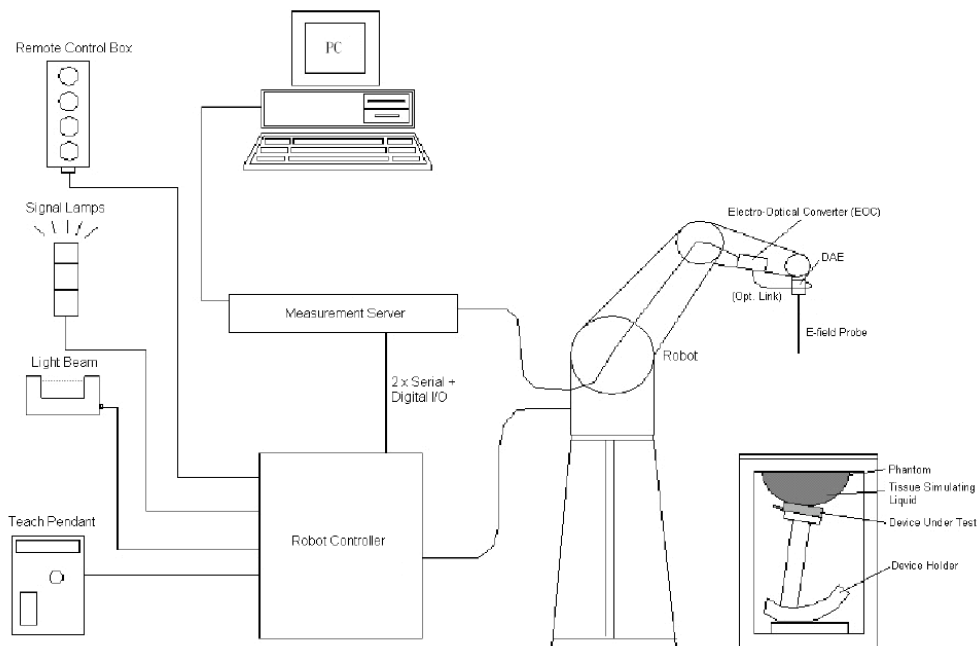

- A standard high precision 6-axis robot with controller, teach pendant and software. An arm extension for accommodating the data acquisition electronics (DAE).
- An isotropic field probe optimized and calibrated for the targeted measurement.
- A data acquisition electronics (DAE) which performs the signal application, signal multiplexing, AD-conversion, offset measurements, mechanical surface detection, collision detection, etc. The unit is battery powered with standard or rechargeable batteries. The signal is optically transmitted to the EOC.
- The Electro-optical converter (EOC) performs the conversion from optical to electrical signals for the digital communication to the DAE. To use optical surface detection, a special version of the EOC is required. The EOC signal is transmitted to the measurement server.
- The function of the measurement server is to perform the time critical tasks such as signal filtering, control of the robot operation and fast movement interrupts.
- The Light Beam used is for probe alignment. This improves the (absolute) accuracy of the probe positioning.
- A computer running Win7 professional operating system and the DASY52 software.
- Remote control and teach pendant as well as additional circuitry for robot safety such as warning lamps, etc.
- The phantom, the device holder and other accessories according to the targeted measurement.

DASY5 Measurement Server

The DASY5 measurement server is based on a PC/104 CPU board with a 400MHz Intel ULV Celeron, 128MB chip-disk and 128MB RAM. The necessary circuits for communication with the DAE4 (or DAE3) electronics box, as well as the 16 bit AD-converter system for optical detection and digital I/O interface are contained on the DASY5 I/O board, which is directly connected to the PC/104 bus of the CPU board.



The measurement server performs all real-time data evaluation of field measurements and surface detection, controls robot movements and handles safety operation. The PC operating system cannot interfere with these time critical processes. All connections are supervised by a watchdog, and disconnection of any of the cables to the measurement server will automatically disarm the robot and disable all program-controlled robot movements. Furthermore, the measurement server is equipped with an expansion port which is reserved for future applications. Please note that this expansion port does not have a standardized point out, and therefore only devices provided by SPEAG can be connected. Devices from any other supplier could seriously damage the measurement server.

Data Acquisition Electronics

The data acquisition electronics (DAE4) consist of a highly sensitive electrometer-grade preamplifier with auto-zeroing, a channel and gain-switching multiplexer, a fast 16 bit AD-converter and a command decoder with a control logic unit. Transmission to the measurement server is accomplished through an optical downlink for data and status information, as well as an optical uplink for commands and the clock.

The mechanical probe mounting device includes two different sensor systems for frontal and sideways probe contacts. They are used for mechanical surface detection and probe collision detection.

The input impedance of both the DAE4 as well as of the DAE3 box is 200M Ω ; the inputs are symmetrical and floating. Common mode rejection is above 80 dB.

ES3DV2 E-Field Probes

Frequency	10 MHz to > 4 GHz Linearity: ± 0.2 dB (30 MHz to 4 GHz)
Directivity	± 0.2 dB in TSL (rotation around probe axis) ± 0.3 dB in TSL (rotation normal to probe axis)
Dynamic Range	5 μ W/g to > 100 mW/g Linearity: ± 0.2 dB (noise: typically < 1 μ W/g)
Dimensions	Overall length: 337 mm (Tip: 10 mm) Tip diameter: 4 mm (Body: 10 mm) Typical distance from probe tip to dipole centers: 4.0 mm
Application	General dosimetry up to 4 GHz Dosimetry in strong gradient fields Compliance tests of mobile phones
Compatibility	DASY3, DASY4, DASY52 SAR and higher, EASY4/MRI

Calibration Frequency Points for ES3DV2 E-Field Probes SN: 3019 Calibrated: 2021/12/13

Calibration Frequency Point(MHz)	Frequency Range(MHz)		Conversion Factor		
	From	To	X	Y	Z
150 Head	100	200	7.69	7.69	7.69
150 Body	100	200	7.51	7.51	7.51
450 Head	350	550	7.02	7.02	7.02
450 Body	350	550	6.95	6.95	6.95

SAM Twin Phantom

The SAM twin phantom is a fiberglass shell phantom with 2mm shell thickness (except the ear region, where shell thickness increases to 6 mm). The phantom has three measurement areas:

- _ Left Head
- _ Right Head
- _ Flat phantom

The phantom table for the DASY systems based on the robots have the size of 100 x 50 x 85 cm (L x W x H). For easy dislocation these tables have fork lift cut outs at the bottom.

The bottom plate contains three pairs of bolts for locking the device holder. The device holder positions are adjusted to the standard measurement positions in the three sections. Only one device holder is necessary if two phantoms are used (e.g., for different liquids)



A white cover is provided to cover the phantom during off-periods to prevent water evaporation and changes in the liquid parameters. Free space scans of devices on top of this phantom cover are possible. Three reference marks are provided on the phantom counter. These reference marks are used to teach the absolute phantom position relative to the robot.

Robots

The DASY5 system uses the high precision industrial robot. The robot offers the same features important for our application:

- High precision (repeatability 0.02mm)
- High reliability (industrial design)
- Low maintenance costs (virtually maintenance free due to direct drive gears; no belt drives)
- Jerk-free straight movements (brushless synchrony motors; no stepper motors)
- Low ELF interference (motor control fields shielded via the closed metallic construction shields)

The above mentioned robots are controlled by the Staubli CS8c robot controllers. All information regarding the use and maintenance of the robot arm and the robot controller is contained on the CDs delivered along with the robot. Paper manuals are available upon request direct from Staubli.

SAR Scan Procedures

Step 1: Power Reference Measurement

The Power Reference Measurement and Power Drift Measurements are for monitoring the power drift of the device under test in the batch process. The minimum distance of probe sensors to surface determines the closest measurement point to phantom surface. The minimum distance of probe sensors to surface is 1.4 mm. This distance cannot be smaller than the distance of sensor calibration points to probe tip as defined in the probe properties.

Step 2: Area Scans

Area scans are defined prior to the measurement process being executed with a user defined variable spacing between each measurement point (integral) allowing low uncertainty measurements to be conducted. Scans defined for FCC applications utilize a 15mm 2 step integral, with 1.5mm interpolation used to locate the peak SAR area used for zoom scan assessments.

Where the system identifies multiple SAR peaks (which are within 25% of peak value) the system will provide the user with the option of assessing each peak location individually for zoom scan averaging.

Area Scan Parameters extracted from KDB 865664 D01 SAR Measurement 100 MHz to 6 GHz

	≤ 3 GHz	> 3 GHz
Maximum distance from closest measurement point (geometric center of probe sensors) to phantom surface	5 mm ± 1 mm	$\frac{1}{2} \cdot \delta \cdot \ln(2)$ mm ± 0.5 mm
Maximum probe angle from probe axis to phantom surface normal at the measurement location	30° ± 1°	20° ± 1°
Maximum area scan spatial resolution: Δx_{Area} , Δy_{Area}	≤ 2 GHz: ≤ 15 mm 2 – 3 GHz: ≤ 12 mm	3 – 4 GHz: ≤ 12 mm 4 – 6 GHz: ≤ 10 mm
	When the x or y dimension of the test device, in the measurement plane orientation, is smaller than the above, the measurement resolution must be ≤ the corresponding x or y dimension of the test device with at least one measurement point on the test device.	

Step 3: Zoom Scan (Cube Scan Averaging)

The averaging zoom scan volume utilized in the DASY5 software is in the shape of a cube and the side dimension of a 1 g or 10 g mass is dependent on the density of the liquid representing the simulated tissue. A density of 1000 kg/m³ is used to represent the head and body tissue density and not the phantom liquid density, in order to be consistent with the definition of the liquid dielectric properties, i.e. the side length of the 1g cube is 10mm, with the side length of the 10g cube is 21.5mm.

Zoom Scan Parameters extracted from KDB 865664 D01 SAR Measurement 100 MHz to 6 GHz

			≤ 3 GHz	> 3 GHz
Maximum zoom scan spatial resolution: Δx_{Zoom} , Δy_{Zoom}			≤ 2 GHz: ≤ 8 mm 2 – 3 GHz: ≤ 5 mm*	3 – 4 GHz: ≤ 5 mm* 4 – 6 GHz: ≤ 4 mm*
Maximum zoom scan spatial resolution, normal to phantom surface	uniform grid: $\Delta z_{Zoom}(n)$		≤ 5 mm	3 – 4 GHz: ≤ 4 mm 4 – 5 GHz: ≤ 3 mm 5 – 6 GHz: ≤ 2 mm
	graded grid	$\Delta z_{Zoom}(1)$: between 1 st two points closest to phantom surface	≤ 4 mm	3 – 4 GHz: ≤ 3 mm 4 – 5 GHz: ≤ 2.5 mm 5 – 6 GHz: ≤ 2 mm
		$\Delta z_{Zoom}(n>1)$: between subsequent points	≤ 1.5 · $\Delta z_{Zoom}(n-1)$ mm	
Minimum zoom scan volume	x, y, z	≥ 30 mm	3 – 4 GHz: ≥ 28 mm 4 – 5 GHz: ≥ 25 mm 5 – 6 GHz: ≥ 22 mm	
Note: δ is the penetration depth of a plane-wave at normal incidence to the tissue medium; see IEEE Std 1528-2013 for details. * When zoom scan is required and the <i>reported</i> SAR from the <i>area scan based 1-g SAR estimation</i> procedures of KDB Publication 447498 is ≤ 1.4 W/kg, ≤ 8 mm, ≤ 7 mm and ≤ 5 mm zoom scan resolution may be applied, respectively, for 2 GHz to 3 GHz, 3 GHz to 4 GHz and 4 GHz to 6 GHz.				

Step 4: Power Drift Measurement

The Power Drift Measurement measures the field at the same location as the most recent power reference measurement within the same procedure, and with the same settings. The Power Drift Measurement gives the field difference in dB from the reading conducted within the last Power Reference Measurement. This allows a user to monitor the power drift of the device under test within a batch process. The measurement procedure is the same as Step 1.

When the cube intersects with the surface of the phantom, it is oriented so that 3 vertices touch the surface of the shell or the center of a face is tangent to the surface. The face of the cube closest to the surface is modified in order to conform to the tangent surface.

The zoom scan integer steps can be user defined so as to reduce uncertainty, but normal practice for typical test applications (including FCC) utilize a physical step of 7 x7 x 7 (5mmx5mmx5mm) providing a volume of 30 mm in the X & Y & Z axis.

Tissue Dielectric Parameters for Head and Body Phantoms

The head tissue dielectric parameters recommended by the IEEE SCC-34/SC-2 in P1528 have been incorporated in the following table. These head parameters are derived from planar layer models simulating the highest expected SAR for the dielectric properties and tissue thickness variations in a human head. Other head and body tissue parameters that have not been specified in P1528 are derived from the tissue dielectric parameters computed from the 4-Cole-Cole equations described in Reference [12] and extrapolated according to the head parameters specified in P1528.

Recommended Tissue Dielectric Parameters for Head and Body

Frequency (MHz)	Head Tissue		Body Tissue	
	ϵ_r	σ (S/m)	ϵ_r	σ (S/m)
150	52.3	0.76	61.9	0.80
300	45.3	0.87	58.2	0.92
450	43.5	0.87	56.7	0.94
835	41.5	0.90	55.2	0.97
900	41.5	0.97	55.0	1.05
915	41.5	0.98	55.0	1.06
1450	40.5	1.20	54.0	1.30
1610	40.3	1.29	53.8	1.40
1800-2000	40.0	1.40	53.3	1.52
2450	39.2	1.80	52.7	1.95
3000	38.5	2.40	52.0	2.73
5800	35.3	5.27	48.2	6.00

3. EQUIPMENT LIST AND CALIBRATION

3.1 Equipments List & Calibration Information

Equipment	Model	S/N	Calibration Date	Calibration Due Date
DASY5 Test Software	DASY52.10	N/A	NCR	NCR
DASY5 Measurement Server	DASY5 4.5.12	1567	NCR	NCR
Data Acquisition Electronics	DAE4	1354	2021/9/1	2022/8/31
E-Field Probe	ES3DV2	3019	2021/12/13	2022/12/12
Mounting Device	MD4HHTV5	BJPCTC0152	NCR	NCR
Oval Flat Phantom	ELI V8.0	2051	NCR	NCR
Loop, 150 MHz	CLA150	4020	2019/11/25	2022/11/24
			2020/2/17	2023/2/16
Simulated Tissue 150 MHz Head	TS-150-H	2109015001	Each Time	/
Simulated Tissue 150 MHz Body	TS-150-B	2109015002	Each Time	/
Network Analyzer	8753B	2828A00170	2021/10/26	2022/10/25
Dielectric assessment kit	1253	SM DAK 040 CA	NCR	NCR
synthesized signal generator	8665B	3438a00584	2021/7/22	2022/7/21
EPM Series Power Meter	E4419B	MY45103907	2021/7/22	2022/7/21
Power Amplifier	ZVA-183-S+	5969001149	NCR	NCR
Directional Coupler	441493	520Z	NCR	NCR
Attenuator	20dB, 100W	LN749	NCR	NCR
Attenuator	6dB, 150W	2754	NCR	NCR
Signal Analyzer	FSIQ26	831929/006	2021/7/22	2022/7/21

4. SAR MEASUREMENT SYSTEM VERIFICATION

4.1 Liquid Verification

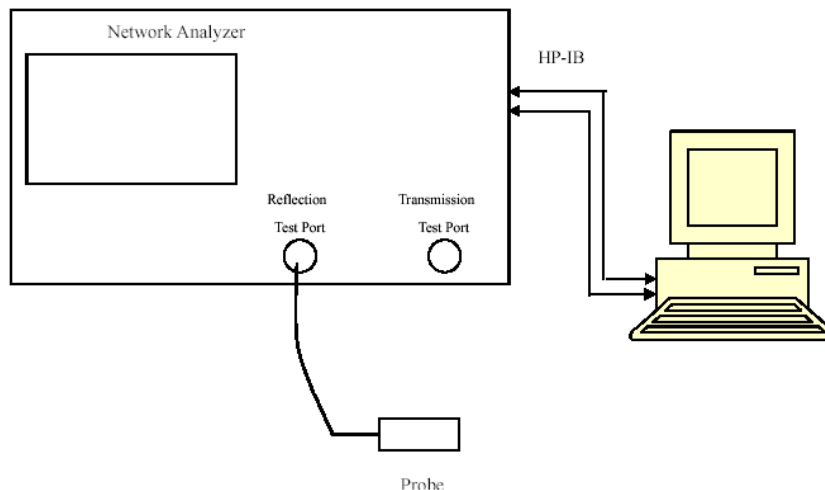

Liquid Verification Setup Block Diagram

Liquid Verification Results

Frequency (MHz)	Liquid Type	Liquid Parameter		Target Value		Delta (%)		Tolerance (%)
		ϵ_r	σ (S/m)	ϵ_r	σ (S/m)	$\Delta\epsilon_r$	$\Delta\sigma$ (S/m)	
136.0125	Simulated Tissue 150 MHz Head	52.807	0.743	52.95	0.75	-0.27	-0.93	± 5
143	Simulated Tissue 150 MHz Head	52.689	0.748	52.63	0.75	0.11	-0.27	± 5
149.9875	Simulated Tissue 150 MHz Head	52.435	0.761	52.3	0.76	0.26	0.13	± 5
150	Simulated Tissue 150 MHz Head	52.424	0.765	52.3	0.76	0.24	0.66	± 5
150.0125	Simulated Tissue 150 MHz Head	52.419	0.769	52.3	0.76	0.23	1.18	± 5
158.0125	Simulated Tissue 150 MHz Head	51.818	0.778	51.93	0.77	-0.22	1.04	± 5
165.9875	Simulated Tissue 150 MHz Head	51.571	0.789	51.55	0.77	0.04	2.47	± 5
173.9875	Simulated Tissue 150 MHz Head	51.117	0.797	51.18	0.78	-0.12	2.18	± 5

*Liquid Verification above was performed on 2022/05/14.

Frequency (MHz)	Liquid Type	Liquid Parameter		Target Value		Delta (%)		Tolerance (%)
		ϵ_r	σ (S/m)	ϵ_r	σ (S/m)	$\Delta\epsilon_r$	$\Delta\sigma$ (S/m)	
136.0125	Simulated Tissue 150 MHz Body	62.393	0.769	62.25	0.79	0.23	-2.66	± 5
143	Simulated Tissue 150 MHz Body	62.208	0.776	62.07	0.79	0.22	-1.77	± 5
149.9875	Simulated Tissue 150 MHz Body	62.043	0.782	61.9	0.8	0.23	-2.25	± 5
150	Simulated Tissue 150 MHz Body	61.998	0.785	61.9	0.8	0.16	-1.88	± 5
150.0125	Simulated Tissue 150 MHz Body	61.971	0.788	61.9	0.8	0.11	-1.5	± 5
158.0125	Simulated Tissue 150 MHz Body	61.646	0.798	61.7	0.81	-0.09	-1.48	± 5
165.9875	Simulated Tissue 150 MHz Body	61.402	0.805	61.51	0.81	-0.18	-0.62	± 5
173.9875	Simulated Tissue 150 MHz Body	61.135	0.816	61.31	0.82	-0.29	-0.49	± 5

*Liquid Verification above was performed on 2022/05/15.

4.2 System Accuracy Verification

Prior to the assessment, the system validation kit was used to test whether the system was operating within its specifications of $\pm 10\%$. The validation results are tabulated below. And also the corresponding SAR plot is attached as well in the SAR plots files.

The spacing distances in the **System Verification Setup Block Diagram** is given by the following:

- a) $s = 15 \text{ mm} \pm 0,2 \text{ mm}$ for $300 \text{ MHz} \leq f \leq 1\,000 \text{ MHz}$;
- b) $s = 10 \text{ mm} \pm 0,2 \text{ mm}$ for $1\,000 \text{ MHz} < f \leq 3\,000 \text{ MHz}$;
- c) $s = 10 \text{ mm} \pm 0,2 \text{ mm}$ for $3\,000 \text{ MHz} < f \leq 6\,000 \text{ MHz}$.

System Verification Setup Block Diagram

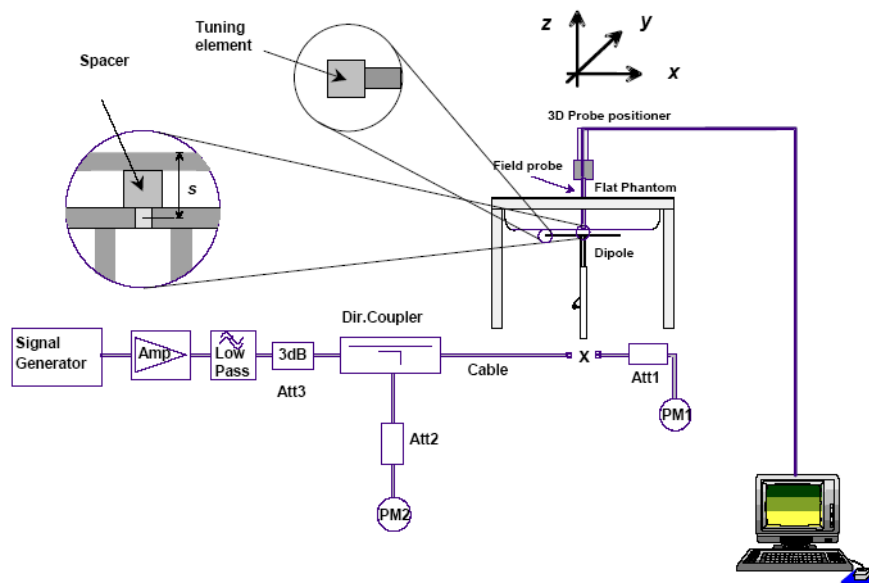

System Accuracy Check Results

Date	Frequency Band	Liquid Type	Input Power (mW)	Measured SAR (W/kg)		Normalized to 1W (W/kg)	Target Value (W/kg)	Delta (%)	Tolerance (%)
2022/05/14	150 MHz	Simulated Tissue 150 MHz Head	100	1g	0.353	3.53	3.64	-3.02	± 10
2022/05/15	150 MHz	Simulated Tissue 150 MHz Body	100	1g	0.385	3.85	3.72	3.49	± 10

*The SAR values above are normalized to 1 Watt forward power.

4.3 SAR SYSTEM VALIDATION DATA

System Performance 150 MHz Head

DUT: Loop, 150 MHz; Type: CLA150; Serial: 4020

Communication System: CW; Frequency: 150 MHz; Duty Cycle: 1:1

Medium parameters used: $f = 150$ MHz; $\sigma = 0.765$ S/m; $\epsilon_r = 52.424$; $\rho = 1000$ kg/m³

Phantom section: Flat Section

DASY5 Configuration:

- Probe: ES3DV2 - SN3019; ConvF(7.69, 7.69, 7.69) @ 150 MHz; Calibrated: 2021/12/13
- Sensor-Surface: 4mm (Mechanical Surface Detection)
- Electronics: DAE4 Sn1354; Calibrated: 2021/9/1
- Phantom: ELI v8.0; Type: QDOVA002AA; Serial: TP:2051
- Measurement SW: DASY52, Version 52.10 (2); SEMCAD X Version 14.6.12 (7470)

Area Scan (181x181x1): Interpolated grid: dx=1.500 mm, dy=1.500 mm

Maximum value of SAR (interpolated) = 0.416 W/kg

Zoom Scan (5x5x7)/Cube 0: Measurement grid: dx=8mm, dy=8mm, dz=5mm

Reference Value = 22.92 V/m; Power Drift = 0.11 dB

Peak SAR (extrapolated) = 0.563 W/kg

SAR(1 g) = 0.353 W/kg; SAR(10 g) = 0.249 W/kg

Maximum value of SAR (measured) = 0.405 W/kg

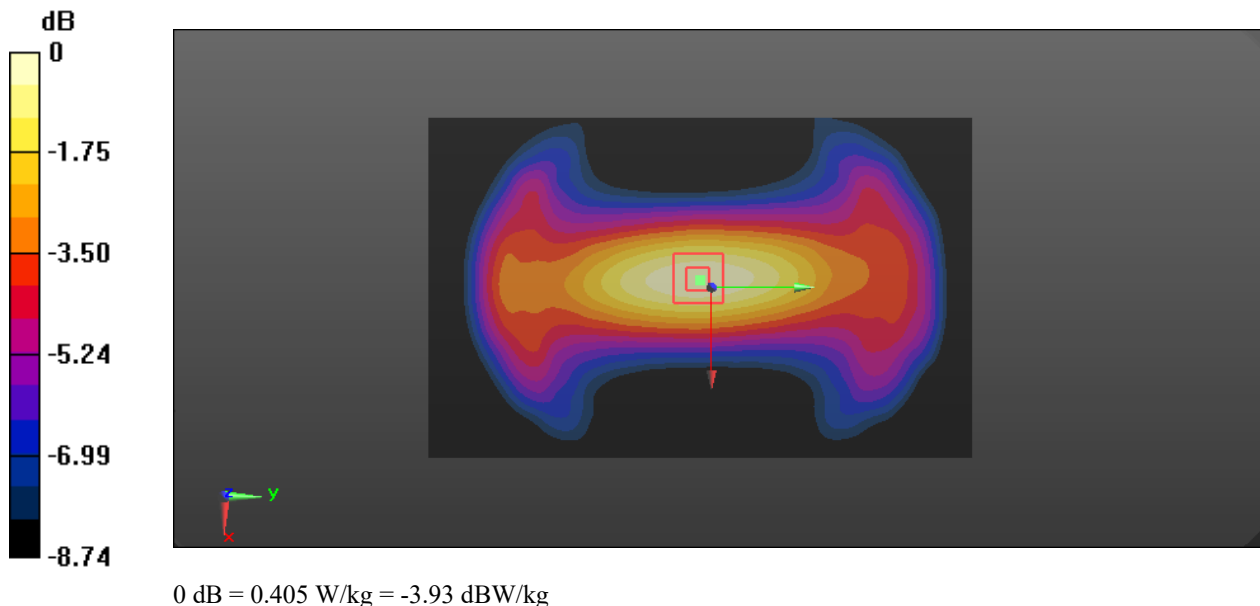

System Performance 150 MHz Body**DUT: Loop, 150 MHz; Type: CLA150; Serial: 4020**

Communication System: CW; Frequency: 150 MHz; Duty Cycle: 1:1

Medium parameters used: $f = 150$ MHz; $\sigma = 0.785$ S/m; $\epsilon_r = 61.998$; $\rho = 1000$ kg/m³

Phantom section: Flat Section

DASY5 Configuration:

- Probe: ES3DV2 - SN3019; ConvF(7.51, 7.51, 7.51) @ 150 MHz; Calibrated: 2021/12/13
- Sensor-Surface: 4mm (Mechanical Surface Detection)
- Electronics: DAE4 Sn1354; Calibrated: 2021/9/1
- Phantom: ELI v8.0; Type: QDOVA002AA; Serial: TP:2051
- Measurement SW: DASY52, Version 52.10 (2); SEMCAD X Version 14.6.12 (7470)

Area Scan (91x151x1): Interpolated grid: dx=1.500 mm, dy=1.500 mm

Maximum value of SAR (interpolated) = 0.435 W/kg

Zoom Scan (5x5x7)/Cube 0: Measurement grid: dx=8mm, dy=8mm, dz=5mm

Reference Value = 42.96 V/m; Power Drift = 0.06 dB

Peak SAR (extrapolated) = 0.567 W/kg

SAR(1 g) = 0.385 W/kg; SAR(10 g) = 0.257 W/kg

Maximum value of SAR (measured) = 0.428 W/kg

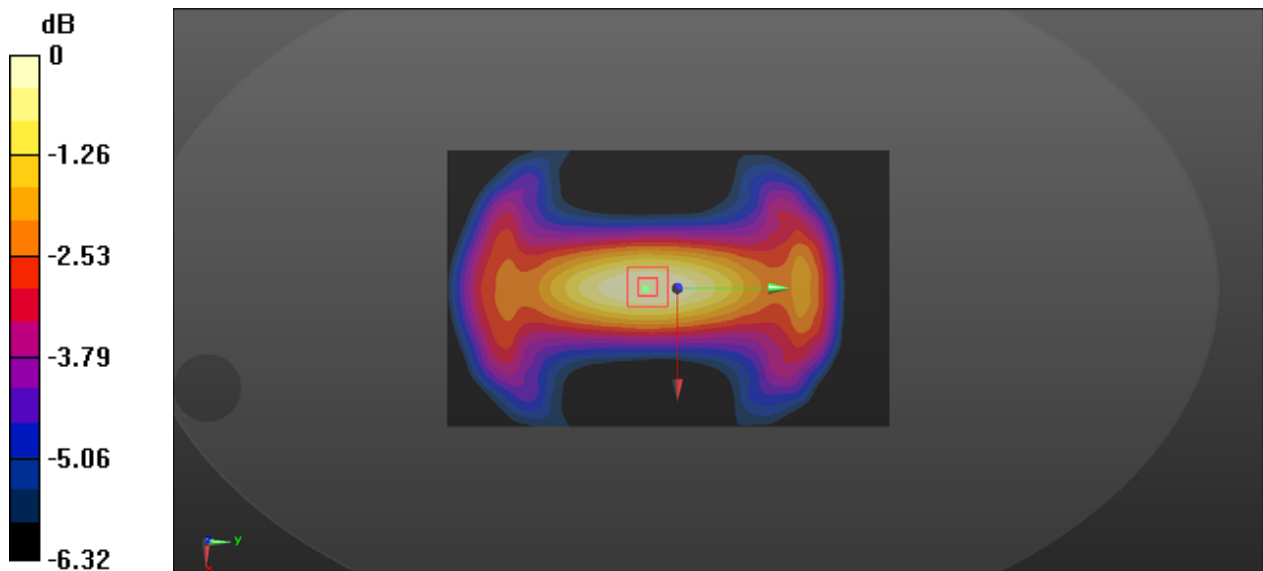

5. EUT TEST STRATEGY AND METHODOLOGY

5.1 Test Positions for Device Operating Next to a Person's Ear

This category includes most wireless handsets with fixed, retractable or internal antennas located toward the top half of the device, with or without a foldout, sliding or similar keypad cover. The handset should have its earpiece located within the upper ¼ of the device, either along the centerline or off-centered, as perceived by its users. This type of handset should be positioned in a normal operating position with the “test device reference point” located along the “vertical centerline” on the front of the device aligned to the “ear reference point”. The “test device reference point” should be located at the same level as the center of the earpiece region. The “vertical centerline” should bisect the front surface of the handset at its top and bottom edges. A “ear reference point” is located on the outer surface of the head phantom on each ear spacer. It is located 1.5 cm above the center of the ear canal entrance in the “phantom reference plane” defined by the three lines joining the center of each “ear reference point” (left and right) and the tip of the mouth.

A handset should be initially positioned with the earpiece region pressed against the ear spacer of a head phantom. For the SCC-34/SC-2 head phantom, the device should be positioned parallel to the “N-F” line defined along the base of the ear spacer that contains the “ear reference point”. For interim head phantoms, the device should be positioned parallel to the cheek for maximum RF energy coupling. The “test device reference point” is aligned to the “ear reference point” on the head phantom and the “vertical centerline” is aligned to the “phantom reference plane”. This is called the “initial ear position”. While maintaining these three alignments, the body of the handset is gradually adjusted to each of the following positions for evaluating SAR:

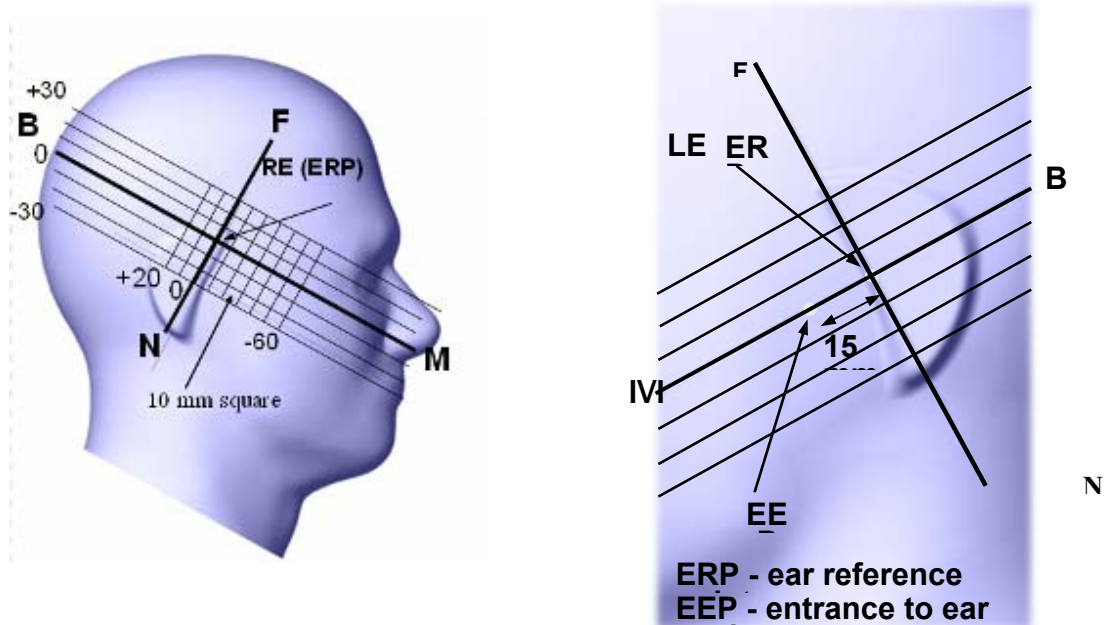

5.2 Cheek/Touch Position

The device is brought toward the mouth of the head phantom by pivoting against the “ear reference point” or along the “N-F” line for the SCC-34/SC-2 head phantom.

This test position is established:

When any point on the display, keypad or mouthpiece portions of the handset is in contact with the phantom.

(or) When any portion of a foldout, sliding or similar keypad cover opened to its intended self-adjusting normal use position is in contact with the cheek or mouth of the phantom.

For existing head phantoms – when the handset loses contact with the phantom at the pivoting point, rotation should continue until the device touches the cheek of the phantom or breaks its last contact from the ear spacer.

Cheek /Touch Position

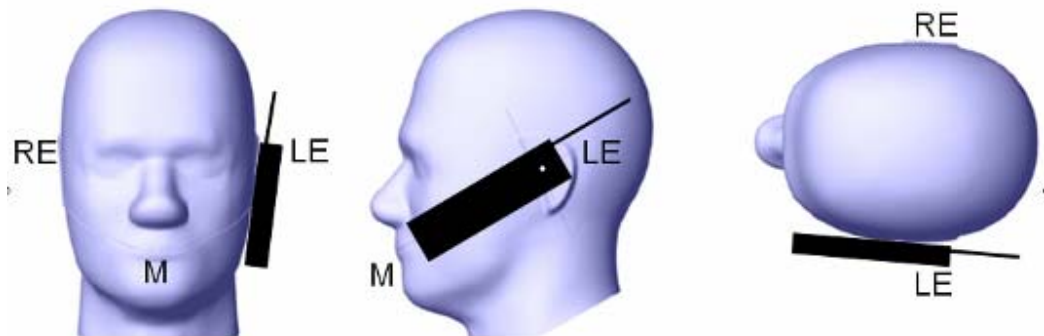

5.3 Ear/Tilt Position

With the handset aligned in the “Cheek/Touch Position”:

1) If the earpiece of the handset is not in full contact with the phantom’s ear spacer (in the “Cheek/Touch position”) and the peak SAR location for the “Cheek/Touch” position is located at the ear spacer region or corresponds to the earpiece region of the handset, the device should be returned to the “initial ear position” by rotating it away from the mouth until the earpiece is in full contact with the ear spacer.

2) (otherwise) The handset should be moved (translated) away from the cheek perpendicular to the line passes through both “ear reference points” (note: one of these ear reference points may not physically exist on a split head model) for approximate 2-3 cm. While it is in this position, the device handset is tilted away from the mouth with respect to the “test device reference point” until the inside angle between the vertical centerline on the front surface of the phone and the horizontal line passing through the ear reference point is by 15° to 80° . After the tilt, it is then moved (translated) back toward the head perpendicular to the line passes through both “ear reference points” until the device touches the phantom or the ear spacer. If the antenna touches the head first, the positioning process should be repeated with a tilt angle less than 15° so that the device and its antenna would touch the phantom simultaneously. This test position may require a device holder or positioner to achieve the translation and tilting with acceptable positioning repeatability.

If a device is also designed to transmit with its keypad cover closed for operating in the head position, such positions should also be considered in the SAR evaluation. The device should be tested on the left and

right side of the head phantom in the “Cheek/Touch” and “Ear/Tilt” positions. When applicable, each configuration should be tested with the antenna in its fully extended and fully retracted positions. These test configurations should be tested at the high, middle and low frequency channels of each operating mode; for example, AMPS, CDMA, and TDMA. If the SAR measured at the middle channel for each test configuration (left, right, Cheek/Touch, Tilt/Ear, extended and retracted) is at least 2.0 dB lower than the SAR limit, testing at the high and low channels is optional for such test configuration(s). If the transmission band of the test device is less than 10 MHz, testing at the high and low frequency channels is optional.

Ear /Tilt 15° Position

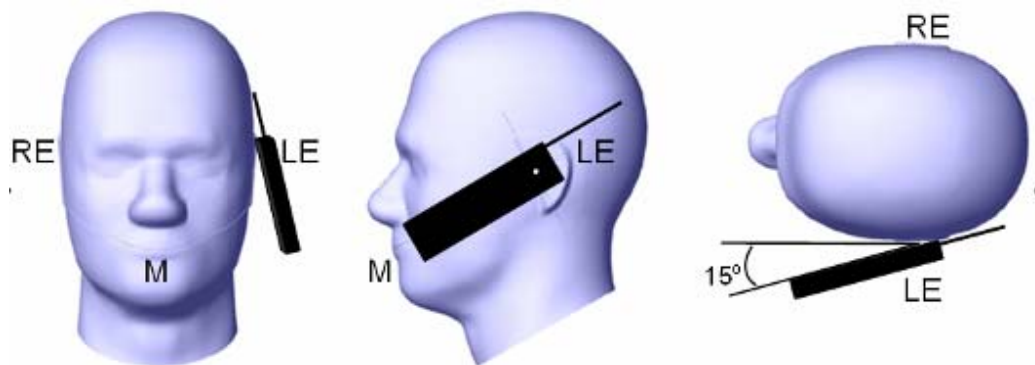

5.4 Test positions for body-worn and other configurations

Body-worn operating configurations should be tested with the belt-clips and holsters attached to the device and positioned against a flat phantom in normal use configurations. Devices with a headset output should be tested with a headset connected to the device. When multiple accessories that do not contain metallic components are supplied with the device, the device may be tested with only the accessory that dictates the closest spacing to the body. When multiple accessories that contain metallic components are supplied with the device, the device must be tested with each accessory that contains a unique metallic component. If multiple accessories share an identical metallic component (e.g., the same metallic belt-clip used with different holsters with no other metallic components), only the accessory that dictates the closest spacing to the body must be tested.

Body-worn accessories may not always be supplied or available as options for some devices that are intended to be authorized for body-worn use. A separation distance of 1.5 cm between the back of the device and a flat phantom is recommended for testing body-worn SAR compliance under such circumstances. Other separation distances may be used, but they should not exceed 2.5 cm. In these cases, the device may use body-worn accessories that provide a separation distance greater than that tested for the device provided however that the accessory contains no metallic components.

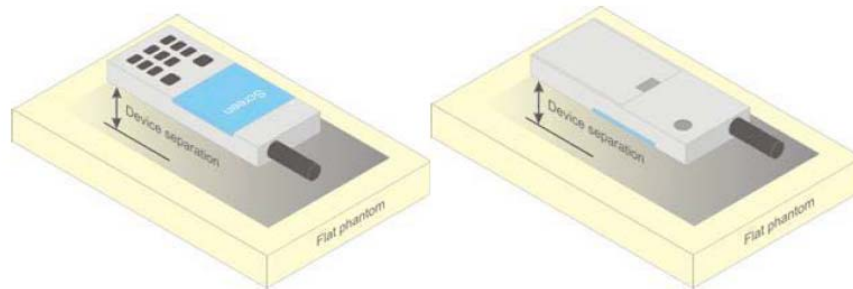

Figure 5 – Test positions for body-worn devices

5.5 Test Distance for SAR Evaluation

In this case the DUT(Device Under Test) is set directly against the phantom, the test distance is 0mm for Body Back mode; for Face Up mode the distance is 25mm.

5.6 SAR Evaluation Procedure

The evaluation was performed with the following procedure:

Step 1: Measurement of the SAR value at a fixed location above the ear point or central position was used as a reference value for assessing the power drop. The SAR at this point is measured at the start of the test and then again at the end of the testing.

Step 2: The SAR distribution at the exposed side of the head was measured at a distance of 4 mm from the inner surface of the shell. The area covered the entire dimension of the head or radiating structures of the EUT, the horizontal grid spacing was 15 mm x 15 mm, and the SAR distribution was determined by integrated grid of 1.5mm x 1.5mm. Based on these data, the area of the maximum absorption was determined by spline interpolation. The first Area Scan covers the entire dimension of the EUT to ensure that the hotspot was correctly identified.

Step 3: Around this point, a volume of 30 mm x 30 mm x 30 mm was assessed by measuring 7x 7 x 7 points. On the basis of this data set, the spatial peak SAR value was evaluated under the following procedure:

1) The data at the surface were extrapolated, since the center of the dipoles is 1.2 mm away from the tip of the probe and the distance between the surface and the lowest measuring point is 1.3 mm. The extrapolation was based on a least square algorithm. A polynomial of the fourth order was calculated through the points in z-axes. This polynomial was then used to evaluate the points between the surface and the probe tip.

2) The maximum interpolated value was searched with a straightforward algorithm. Around this maximum the SAR values averaged over the spatial volumes (1 g or 10 g) were computed by the 3D-Spline interpolation algorithm. The 3D-Spline is composed of three one dimensional splines with the "Not a knot"-condition (in x, y and z-directions). The volume was integrated with the trapezoidal-algorithm. One thousand points (10 x 10 x 10) were interpolated to calculate the averages.

All neighboring volumes were evaluated until no neighboring volume with a higher average value was found.

Step 4: Re-measurement of the SAR value at the same location as in Step 1. If the value changed by more than 5%, the evaluation was repeated.

6. CONDUCTED OUTPUT POWER MEASUREMENT

6.1 Test Procedure

The RF output of the transmitter was connected to the input of the Signal Analyzer through sufficient attenuation.

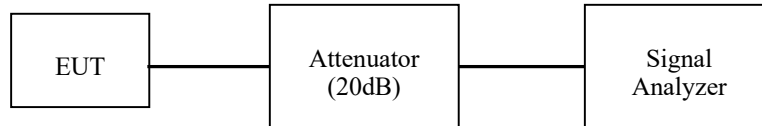

The Signal Analyzer setting:

RBW	VBW
100 kHz	300 kHz

6.2 Maximum Target Output Power

Mode		Max. tune-up tolerance power limit for Production(dBm)
PTT (136-174MHz)	FM_12.5kHz	37
	FM_25kHz	37
	4FSK_12.5kHz	37

6.3 Test Results:
DR5810S-1:

Test Mode		Frequency (MHz)	Output Power(dBm)	Power level
PTT (136-174MHz)	FM 12.5 kHz	136.0125	36.86	High
		143	36.92	High
		149.9875	36.89	High
		150.0125	36.93	High
		158.0125	36.91	High
		165.9875	36.87	High
		173.9875	36.82	High
	FM 25 kHz	136.0125	36.85	High
		143	36.88	High
		149.9875	36.87	High
		150.0125	36.9	High
		158.0125	36.93	High
		165.9875	36.87	High
		173.9875	36.91	High
	4FSK 12.5 kHz	136.0125	36.81	High
		143	36.92	High
		149.9875	36.87	High
		150.0125	36.91	High
		158.0125	36.95	High
		165.9875	36.94	High
		173.9875	36.88	High

DR5610S-1:

Test Mode		Frequency (MHz)	Output Power(dBm)	Power level
PTT (136-174MHz)	FM 12.5 kHz	136.0125	36.92	High
		143	36.94	High
		149.9875	36.81	High
		150.0125	36.93	High
		158.0125	36.89	High
		165.9875	36.83	High
		173.9875	36.88	High
	FM 25 kHz	136.0125	36.82	High
		143	36.89	High
		149.9875	36.83	High
		150.0125	36.91	High
		158.0125	36.93	High
		165.9875	36.87	High
		173.9875	36.93	High
	4FSK 12.5 kHz	136.0125	36.85	High
		143	36.87	High
		149.9875	36.84	High
		150.0125	36.92	High
		158.0125	36.91	High
		165.9875	36.89	High
		173.9875	36.86	High

DR5510S-1:

Test Mode		Frequency (MHz)	Output Power(dBm)	Power level
PTT (136-174MHz)	FM 12.5 kHz	136.0125	36.82	High
		143	36.89	High
		149.9875	36.91	High
		150.0125	36.92	High
		158.0125	36.9	High
		165.9875	36.82	High
		173.9875	36.92	High
	FM 25 kHz	136.0125	36.82	High
		143	36.91	High
		149.9875	36.86	High
		150.0125	36.9	High
		158.0125	36.88	High
		165.9875	36.92	High
		173.9875	36.89	High
	4FSK 12.5 kHz	136.0125	36.88	High
		143	36.93	High
		149.9875	36.87	High
		150.0125	36.89	High
		158.0125	36.93	High
		165.9875	36.86	High
		173.9875	36.88	High

Antennas Location:

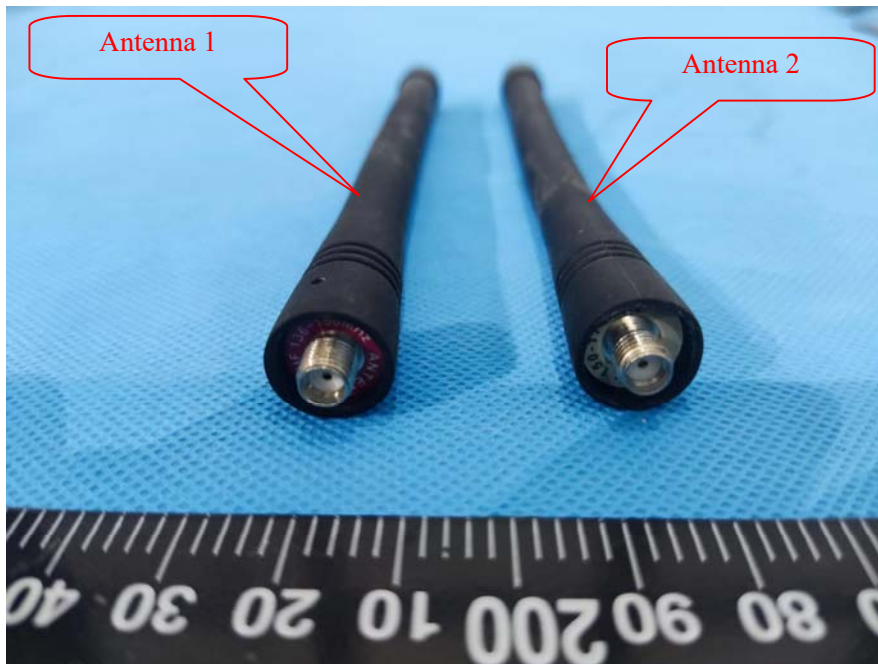

7. SAR MEASUREMENT RESULTS

This page summarizes the results of the performed dosimetric evaluation.

7.1 SAR Test Data

Environmental Conditions

Temperature:	22.3-23.8 °C	21.3-22.7 °C
Relative Humidity:	52 %	40 %
ATM Pressure:	100.3 kPa	100.4 kPa
Test Date:	2022/05/14	2022/05/15

Testing was performed by Karl Gong, Ken Zong, Way Li.

PTT(136~174MHz):**DR5810S-1:**

For antenna 1, pre-scan all 3 Channels, the peak SAR located on 143MHz for Face Up mode and Body Back mode, and for antenna 2, pre-scan all 4 Channels, the peak SAR located on 150.0125MHz for Face Up mode and Body Back mode

Test Mode	Antenna	Frequency (MHz)	Max. Meas. Power (dBm)	Maximum output Power(dBm)	1 g SAR Value(W/kg)					
					Scaled Factor	Meas. SAR	50%	Scaled SAR	Plot	
Face Up (25 mm)	FM 12.5 kHz	Antenna 1 (136-150MHz)	136.0125	/	/	/	/	/	/	/
			143	36.92	37	1.019	1.88	0.94	0.96	1#
			149.9875	/	/	/	/	/	/	/
		Antenna 2 (150-174MHz)	150.0125	36.93	37	1.016	1.05	0.525	0.53	2#
			158.0125	/	/	/	/	/	/	/
			173.9875	/	/	/	/	/	/	/
	FM 25 kHz	Antenna 1 (136-150MHz)	136.0125	/	/	/	/	/	/	/
			143	36.88	37	1.028	1.79	0.895	0.92	3#
			149.9875	/	/	/	/	/	/	/
		Antenna 2 (150-174MHz)	150.0125	36.9	37	1.023	1.2	0.6	0.61	4#
			158.0125	/	/	/	/	/	/	/
			173.9875	/	/	/	/	/	/	/
	4FSK 12.5 kHz	Antenna 1 (136-150MHz)	136.0125	/	/	/	/	/	/	/
			143	36.92	37	1.019	0.812	0.406	0.41	5#
			149.9875	/	/	/	/	/	/	/
		Antenna 2 (150-174MHz)	150.0125	36.91	37	1.021	0.475	0.2375	0.24	6#
			158.0125	/	/	/	/	/	/	/
			173.9875	/	/	/	/	/	/	/
Body Back (0 mm)	FM 12.5 kHz	Antenna 1 (136-150MHz)	136.0125	36.86	37	1.033	7.71	3.855	3.98	7#
			143	36.92	37	1.019	10.5	5.25	5.35	8#
			149.9875	36.89	37	1.026	4.08	2.04	2.07	9#
		Antenna 2 (150-174MHz)	150.0125	36.93	37	1.016	9.84	4.92	5	10#
			158.0125	36.91	37	1.021	4.7	2.35	2.4	11#
			173.9875	36.82	37	1.042	2.43	1.215	1.27	13#
	FM 25 kHz	Antenna 1 (136-150MHz)	136.0125	36.85	37	1.035	7.47	3.735	3.87	14#
			143	36.88	37	1.028	9.03	4.515	4.64	15#
			149.9875	36.87	37	1.03	3.83	1.915	1.97	16#
		Antenna 2 (150-174MHz)	150.0125	36.9	37	1.023	9.65	4.825	4.94	17#
			158.0125	36.93	37	1.016	4.19	2.095	2.13	18#
			165.9875	36.87	37	1.03	2.82	1.41	1.45	19#
			173.9875	36.91	37	1.021	2.44	1.22	1.25	20#

Test Mode		Antenna	Frequency (MHz)	Max. Meas. Power (dBm)	Maximum output Power(dBm)	1 g SAR Value(W/kg)				
						Scaled Factor	Meas. SAR	50%	Scaled SAR	Plot
Body Back (0 mm)	4FSK 12.5 kHz	Antenna 1 (136-150MHz)	136.0125	/	/	/	/	/	/	/
			143	36.92	37	1.019	5.14	2.57	2.62	21#
			149.9875	/	/	/	/	/	/	/
		Antenna 2 (150-174MHz)	150.0125	36.91	37	1.021	4.5	2.25	2.3	22#
			158.0125	/	/	/	/	/	/	/
			165.9875	/	/	/	/	/	/	/
		173.9875	/	/	/	/	/	/		

DR5610S-1:

For antenna 1, pre-scan all 3 Channels, the peak SAR located on 143MHz for Face Up mode and Body Back mode, and for antenna 2, pre-scan all 4 Channels, the peak SAR located on 150.0125MHz for Face Up mode and Body Back mode

Test Mode	Antenna	Frequency (MHz)	Max. Meas. Power (dBm)	Maximum output Power(dBm)	1 g SAR Value(W/kg)						
					Scaled Factor	Meas. SAR	50%	Scaled SAR	Plot		
Face Up (25 mm)	FM 12.5 kHz	Antenna 1 (136-150MHz)	136.0125	/	/	/	/	/	/	/	
			143	36.94	37	1.014	1.46	0.73	0.74	23#	
			149.9875	/	/	/	/	/	/	/	
		Antenna 2 (150-174MHz)	150.0125	36.93	37	1.016	1.27	0.635	0.65	24#	
			158.0125	/	/	/	/	/	/	/	
			165.9875	/	/	/	/	/	/	/	
	173.9875		/	/	/	/	/	/	/		
	Antenna 1 (136-150MHz)		136.0125	/	/	/	/	/	/	/	
			143	36.89	37	1.026	1.5	0.75	0.77	25#	
		149.9875	/	/	/	/	/	/	/		
		Antenna 2 (150-174MHz)	150.0125	36.91	37	1.021	1.17	0.585	0.6	26#	
			158.0125	/	/	/	/	/	/	/	
			165.9875	/	/	/	/	/	/	/	
	4FSK 12.5 kHz	Antenna 1 (136-150MHz)	136.0125	/	/	/	/	/	/	/	
			143	36.87	37	1.03	0.659	0.3295	0.34	27#	
			149.9875	/	/	/	/	/	/	/	
		Antenna 2 (150-174MHz)	150.0125	36.92	37	1.019	0.576	0.288	0.29	28#	
			158.0125	/	/	/	/	/	/	/	
			165.9875	/	/	/	/	/	/	/	
	Body Back (0 mm)	FM 12.5 kHz	Antenna 1 (136-150MHz)	136.0125	36.92	37	1.019	4.85	2.425	2.47	29#
				143	36.94	37	1.014	9.58	4.79	4.86	30#
149.9875				36.81	37	1.045	4.14	2.07	2.16	31#	
Antenna 2 (150-174MHz)			150.0125	36.93	37	1.016	9.72	4.86	4.94	32#	
			158.0125	36.89	37	1.026	3.98	1.99	2.04	33#	
			165.9875	36.83	37	1.04	2.78	1.39	1.45	34#	
FM 25 kHz		Antenna 1 (136-150MHz)	173.9875	36.88	37	1.028	2.5	1.25	1.29	35#	
			136.0125	/	/	/	/	/	/	/	
			143	36.89	37	1.026	9.42	4.71	4.83	36#	
		Antenna 2 (150-174MHz)	149.9875	/	/	/	/	/	/	/	
			150.0125	36.91	37	1.021	8.92	4.46	4.55	37#	
			158.0125	/	/	/	/	/	/	/	
			165.9875	/	/	/	/	/	/	/	
			173.9875	/	/	/	/	/	/	/	
			173.9875	/	/	/	/	/	/	/	

Test Mode		Antenna	Frequency (MHz)	Max. Meas. Power (dBm)	Maximum output Power(dBm)	1 g SAR Value(W/kg)				
						Scaled Factor	Meas. SAR	50%	Scaled SAR	Plot
Body Back (0 mm)	4FSK 12.5 kHz	Antenna 1 (136-150MHz)	136.0125	/	/	/	/	/	/	/
			143	36.87	37	1.03	3.4	1.7	1.75	38#
			149.9875	/	/	/	/	/	/	/
		Antenna 2 (150-174MHz)	150.0125	36.92	37	1.019	4.78	2.39	2.44	39#
			158.0125	/	/	/	/	/	/	/
			165.9875	/	/	/	/	/	/	/
			173.9875	/	/	/	/	/	/	/

DR5510S-1:

For antenna 1, pre-scan all 3 Channels, the peak SAR located on 143MHz for Face Up mode and Body Back mode, and for antenna 2, pre-scan all 4 Channels, the peak SAR located on 150.0125MHz for Face Up mode and Body Back mode

Test Mode	Antenna	Frequency (MHz)	Max. Meas. Power (dBm)	Maximum output Power(dBm)	1 g SAR Value(W/kg)						
					Scaled Factor	Meas. SAR	50%	Scaled SAR	Plot		
Face Up (25 mm)	FM 12.5 kHz	Antenna 1 (136-150MHz)	136.0125	/	/	/	/	/	/	/	
			143	36.89	37	1.026	1.5	0.75	0.77	40#	
			149.9875	/	/	/	/	/	/	/	
		Antenna 2 (150-174MHz)	150.0125	36.92	37	1.019	0.97	0.485	0.49	41#	
			158.0125	/	/	/	/	/	/	/	
			165.9875	/	/	/	/	/	/	/	
	FM 25 kHz	Antenna 1 (136-150MHz)	136.0125	/	/	/	/	/	/	/	
			143	36.91	37	1.021	2.08	1.04	1.06	42#	
			149.9875	/	/	/	/	/	/	/	
		Antenna 2 (150-174MHz)	150.0125	36.9	37	1.023	0.997	0.4985	0.51	43#	
			158.0125	/	/	/	/	/	/	/	
			165.9875	/	/	/	/	/	/	/	
	4FSK 12.5 kHz	Antenna 1 (136-150MHz)	136.0125	/	/	/	/	/	/	/	
			143	36.93	37	1.016	0.646	0.323	0.33	44#	
			149.9875	/	/	/	/	/	/	/	
		Antenna 2 (150-174MHz)	150.0125	36.89	37	1.026	0.346	0.173	0.18	45#	
			158.0125	/	/	/	/	/	/	/	
			165.9875	/	/	/	/	/	/	/	
	Body Back (0 mm)	FM 12.5 kHz	Antenna 1 (136-150MHz)	136.0125	36.82	37	1.042	4.97	2.485	2.59	46#
				143	36.89	37	1.026	10.3	5.15	5.28	47#
				149.9875	36.91	37	1.021	3.45	1.725	1.76	48#
			Antenna 2 (150-174MHz)	150.0125	36.92	37	1.019	9.52	4.76	4.85	49#
				158.0125	36.9	37	1.023	4.76	2.38	2.43	50#
				165.9875	36.82	37	1.042	3.91	1.955	2.04	51#
FM 25 kHz		Antenna 1 (136-150MHz)	173.9875	36.92	37	1.019	2.73	1.365	1.39	52#	
			136.0125	/	/	/	/	/	/	/	
			143	36.91	37	1.021	10.1	5.05	5.16	53#	
		Antenna 2 (150-174MHz)	149.9875	/	/	/	/	/	/	/	
			150.0125	36.9	37	1.023	9.45	4.725	4.834	54#	
			158.0125	/	/	/	/	/	/	/	
Antenna 2 (150-174MHz)		165.9875	/	/	/	/	/	/	/		
		173.9875	/	/	/	/	/	/	/		

Test Mode		Antenna	Frequency (MHz)	Max. Meas. Power (dBm)	Maximum output Power(dBm)	1 g SAR Value(W/kg)				
						Scaled Factor	Meas. SAR	50%	Scaled SAR	Plot
Body Back (0 mm)	4FSK 12.5 kHz	Antenna 1 (136-150MHz)	136.0125	/	/	/	/	/	/	/
			143	36.93	37	1.016	5.02	2.51	2.55	55#
			149.9875	/	/	/	/	/	/	/
		Antenna 2 (150-174MHz)	150.0125	36.89	37	1.026	3.34	1.67	1.71	56#
			158.0125	/	/	/	/	/	/	/
			165.9875	/	/	/	/	/	/	/
			173.9875	/	/	/	/	/	/	/

Note:

1. When the 1-g SAR is ≤ 3.5 W/kg, testing for other channels are optional.
2. KDB 447498 D04 - A duty factor of 50% should be applied to determine compliance for radios with maximum operating duty factors $\leq 50\%$. The 50% duty factor only applies to exposure conditions where the radio operates with a mechanical PTT button.
3. The whole antenna and radiating structures that may contribute to the measured SAR or influence the SAR distribution has been included in the area scan.
4. The differents between model DR5810S-1,DR5610S-1,DR5510S-1 are the hardware with display and key board , DR5810S-1 was selected for fully testing, DR5610S-1,DR5510S-1 was tested the worst case.

8. SAR Measurement Variability

In accordance with published RF Exposure KDB procedure 865664 D01 SAR measurement 100 MHz to 6 GHz v01. These additional measurements are repeated after the completion of all measurements requiring the same head or body tissue-equivalent medium in a frequency band. The test device should be returned to ambient conditions (normal room temperature) with the battery fully charged before it is re-mounted on the device holder for the repeated measurement(s) to minimize any unexpected variations in the repeated results

- 1) Repeated measurement is not required when the original highest measured SAR is < 0.80 W/kg; steps 2) through 4) do not apply.
- 2) When the original highest measured SAR is ≥ 0.80 W/kg, repeat that measurement once.
- 3) Perform a second repeated measurement only if the ratio of largest to smallest SAR for the original and first repeated measurements is > 1.20 or when the original or repeated measurement is ≥ 1.45 W/kg (~ 10% from the 1-g SAR limit).
- 4) Perform a third repeated measurement only if the original, first or second repeated measurement is ≥ 1.5 W/kg and the ratio of largest to smallest SAR for the original, first and second repeated measurements is > 1.20 .

Note: The same procedures should be adapted for measurements according to extremity and occupational exposure limits by applying a factor of 2.5 for extremity exposure and a factor of 5 for occupational exposure to the corresponding SAR thresholds.

The Highest Measured SAR Configuration in Each Frequency Band

Head(Face Up)

SAR probe calibration point	Frequency Band	Freq.(MHz)	EUT Position	Meas. SAR (W/kg)		Largest to Smallest SAR Ratio
				Original	Repeated	
/	/	/	/	/	/	/

Body(Body Back)

SAR probe calibration point	Frequency Band	Freq.(MHz)	EUT Position	Meas. SAR (W/kg)		Largest to Smallest SAR Ratio	
				Original	Repeated		
150MHz (100-200MHz)	DR5810S-1	FM 12.5 kHz	136.0125	Body Back	10.5	10.1	1.04
	DR5610S-1	FM 12.5 kHz	136.0125	Body Back	9.72	9.63	1.01
	DR5510S-1	FM 12.5 kHz	136.0125	Body Back	10.3	9.87	1.04

Note:

1. Second Repeated Measurement is not required since the ratio of the largest to smallest SAR for the original and first repeated measurement is not > 1.20 .
2. The measured SAR results **do not** have to be scaled to the maximum tune-up tolerance to determine if repeated measurements are required.
3. SAR measurement variability must be assessed for each frequency band, which is determined by the **SAR probe calibration point and tissue-equivalent medium** used for the device measurements.

9. SAR Plots

Please Refer to the Attachment.

APPENDIX A MEASUREMENT UNCERTAINTY

The uncertainty budget has been determined for the measurement system and is given in the following Table.

Measurement uncertainty evaluation for IEEE1528-2013 SAR test

Source of uncertainty	Tolerance/ uncertainty ± %	Probability distribution	Divisor	ci (1 g)	ci (10 g)	Standard uncertainty ± %, (1 g)	Standard uncertainty ± %, (10 g)
Measurement system							
Probe calibration	6.55	N	1	1	1	6.3	6.3
Axial Isotropy	4.7	R	$\sqrt{3}$	1	1	2.7	2.7
Hemispherical Isotropy	9.6	R	$\sqrt{3}$	0	0	0.0	0.0
Boundary effect	1.0	R	$\sqrt{3}$	1	1	0.6	0.6
Linearity	4.7	R	$\sqrt{3}$	1	1	2.7	2.7
Detection limits	1.0	R	$\sqrt{3}$	1	1	0.6	0.6
Readout electronics	0.3	N	1	1	1	0.3	0.3
Response time	0.0	R	$\sqrt{3}$	1	1	0.0	0.0
Integration time	0.0	R	$\sqrt{3}$	1	1	0.0	0.0
RF ambient conditions – noise	1.0	R	$\sqrt{3}$	1	1	0.6	0.6
RF ambient conditions– reflections	1.0	R	$\sqrt{3}$	1	1	0.6	0.6
Probe positioner mech. Restrictions	0.8	R	$\sqrt{3}$	1	1	0.5	0.5
Probe positioning with respect to phantom shell	6.7	R	$\sqrt{3}$	1	1	3.9	3.9
Post-processing	2.0	R	$\sqrt{3}$	1	1	1.2	1.2
Test sample related							
Test sample positioning	2.8	N	1	1	1	2.8	2.8
Device holder uncertainty	6.3	N	1	1	1	6.3	6.3
Drift of output power	5.0	R	$\sqrt{3}$	1	1	2.9	2.9
Phantom and set-up							
Phantom uncertainty (shape and thickness tolerances)	4.0	R	$\sqrt{3}$	1	1	2.3	2.3
Liquid conductivity target)	5.0	R	$\sqrt{3}$	0.64	0.43	1.8	1.2
Liquid conductivity meas.)	2.5	N	1	0.64	0.43	1.6	1.1
Liquid permittivity target)	5.0	R	$\sqrt{3}$	0.6	0.49	1.7	1.4
Liquid permittivity meas.)	2.5	N	1	0.6	0.49	1.5	1.2
Combined standard uncertainty		RSS				12.2	12.0
Expanded uncertainty 95 % confidence interval)						24.1	23.7

Measurement uncertainty evaluation for IEC62209-1 SAR test

Source of uncertainty	Tolerance/uncertainty ± %	Probability distribution	Divisor	ci (1 g)	ci (10 g)	Standard uncertainty ± %, (1 g)	Standard uncertainty ± %, (10 g)
Measurement system							
Probe calibration	6.55	N	1	1	1	6.3	6.3
Axial Isotropy	4.7	R	√3	1	1	2.7	2.7
Hemispherical Isotropy	9.6	R	√3	0	0	0.0	0.0
Boundary effect	1.0	R	√3	1	1	0.6	0.6
Linearity	4.7	R	√3	1	1	2.7	2.7
Detection limits	1.0	R	√3	1	1	0.6	0.6
Readout electronics	0.3	N	1	1	1	0.3	0.3
Response time	0.0	R	√3	1	1	0.0	0.0
Integration time	0.0	R	√3	1	1	0.0	0.0
RF ambient conditions – noise	1.0	R	√3	1	1	0.6	0.6
Probe positioning with respect to phantom shell	6.7	R	√3	1	1	3.9	3.9
Probe positioner mech. Restrictions	0.8	R	√3	1	1	0.5	0.5
RF ambient conditions– reflections	1.0	R	√3	1	1	0.6	0.6
Post-processing	2.0	R	√3	1	1	1.2	1.2
Test sample related							
Test sample positioning	2.8	N	1	1	1	2.8	2.8
Device holder uncertainty	6.3	N	1	1	1	6.3	6.3
Drift of output power	5.0	R	√3	1	1	2.9	2.9
Phantom and set-up							
Phantom uncertainty (shape and thickness tolerances)	4.0	R	√3	1	1	2.3	2.3
Liquid conductivity target)	5.0	R	√3	0.64	0.43	1.8	1.2
Liquid conductivity meas.)	2.5	N	1	0.64	0.43	1.6	1.1
Liquid permittivity target)	5.0	R	√3	0.6	0.49	1.7	1.4
Liquid permittivity meas.)	2.5	N	1	0.6	0.49	1.5	1.2
Combined standard uncertainty		RSS				12.2	12.0
Expanded uncertainty 95 % confidence interval)						24.0	23.6

APPENDIX B EUT TEST POSITION PHOTOS

Please Refer to the Attachment.

APPENDIX C CALIBRATION CERTIFICATES

Please Refer to the Attachment.

******* END OF REPORT *******

Plot 1#: FM 12.5kHz_143MHz_Face Up_Antenna 1**DUT: Two Way Radio; Type: DR5810S-1; Serial: CR22040011-SA-S1**

Communication System: FM; Frequency: 143 MHz; Duty Cycle: 1:1

Medium parameters used: $f = 143$ MHz; $\sigma = 0.748$ S/m; $\epsilon_r = 52.689$; $\rho = 1000$ kg/m³

Phantom section: Flat Section

DASY5 Configuration:

- Probe: ES3DV2 - SN3019; ConvF(7.69, 7.69, 7.69) @ 143 MHz; Calibrated: 2021/12/13
- Sensor-Surface: 4mm (Mechanical Surface Detection)
- Electronics: DAE4 Sn1354; Calibrated: 2021/9/1
- Phantom: ELI v8.0; Type: QDOVA002AA; Serial: TP:2051
- Measurement SW: DASY52, Version 52.10 (2); SEMCAD X Version 14.6.12 (7470)

Area Scan (71x161x1): Interpolated grid: dx=1.500 mm, dy=1.500 mm

Maximum value of SAR (interpolated) = 1.95 W/kg

Zoom Scan (5x5x7)/Cube 0: Measurement grid: dx=8mm, dy=8mm, dz=5mm

Reference Value = 48.88 V/m; Power Drift = 0.01 dB

Peak SAR (extrapolated) = 2.31 W/kg

SAR(1 g) = 1.88 W/kg; SAR(10 g) = 1.55 W/kg

Maximum value of SAR (measured) = 1.95 W/kg

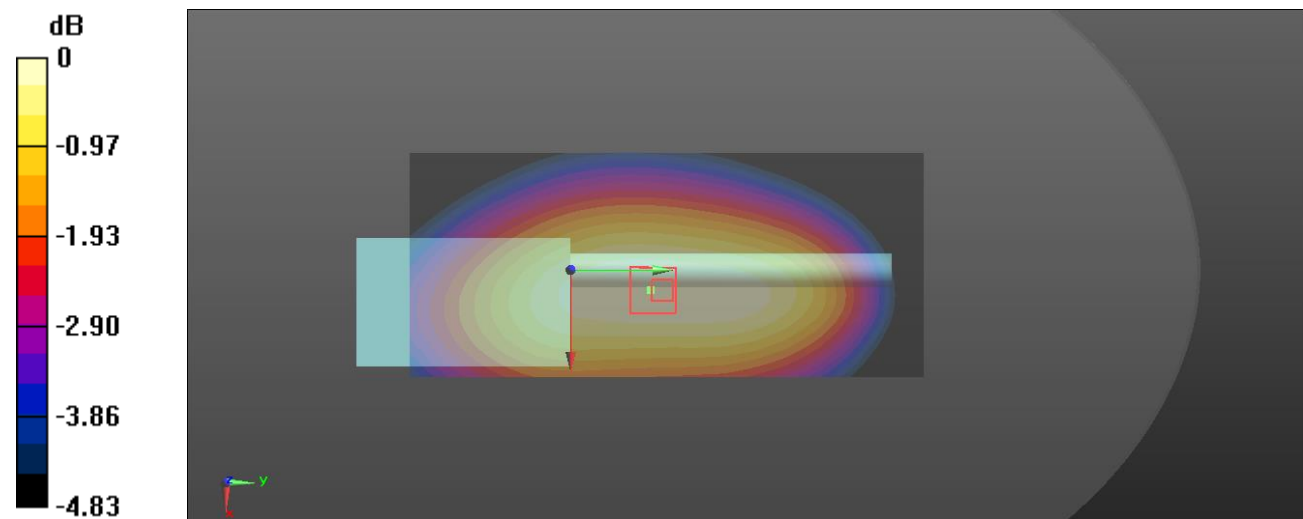

0 dB = 1.95 W/kg = 2.90 dBW/kg

Plot 2#: FM 12.5kHz_150.0125MHz_Face Up_Antenna 2**DUT: Two Way Radio; Type: DR5810S-1; Serial: CR22040011-SA-S1**

Communication System: FM; Frequency: 150.012 MHz; Duty Cycle: 1:1

Medium parameters used: $f = 150.012$ MHz; $\sigma = 0.769$ S/m; $\epsilon_r = 52.419$; $\rho = 1000$ kg/m³

Phantom section: Flat Section

DASY5 Configuration:

- Probe: ES3DV2 - SN3019; ConvF(7.69, 7.69, 7.69) @ 150.012 MHz; Calibrated: 2021/12/13
- Sensor-Surface: 4mm (Mechanical Surface Detection)
- Electronics: DAE4 Sn1354; Calibrated: 2021/9/1
- Phantom: ELI v8.0; Type: QDOVA002AA; Serial: TP:2051
- Measurement SW: DASY52, Version 52.10 (2); SEMCAD X Version 14.6.12 (7470)

Area Scan (81x191x1): Interpolated grid: dx=1.500 mm, dy=1.500 mm

Maximum value of SAR (interpolated) = 1.10 W/kg

Zoom Scan (5x5x7)/Cube 0: Measurement grid: dx=8mm, dy=8mm, dz=5mm

Reference Value = 37.96 V/m; Power Drift = -0.09 dB

Peak SAR (extrapolated) = 1.28 W/kg

SAR(1 g) = 1.05 W/kg; SAR(10 g) = 0.858 W/kg

Maximum value of SAR (measured) = 1.08 W/kg

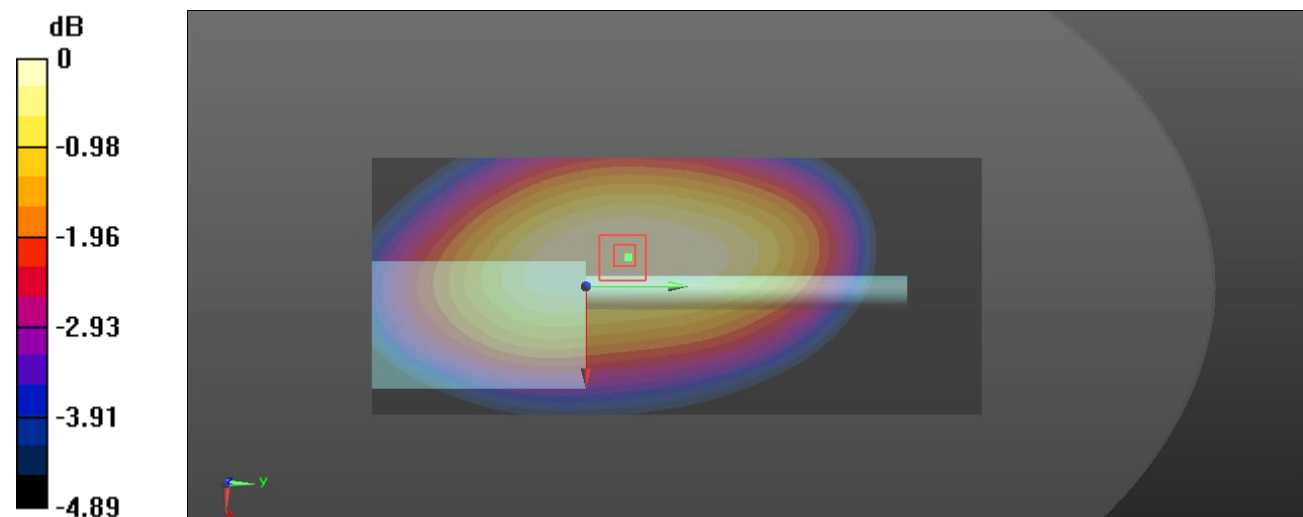

0 dB = 1.08 W/kg = 0.33 dBW/kg

Plot 3#: FM 25kHz_143MHz_Face Up_Antenna 1**DUT: Two Way Radio; Type: DR5810S-1; Serial: CR22040011-SA-S1**

Communication System: FM; Frequency: 143 MHz; Duty Cycle: 1:1

Medium parameters used: $f = 143$ MHz; $\sigma = 0.748$ S/m; $\epsilon_r = 52.689$; $\rho = 1000$ kg/m³

Phantom section: Flat Section

DASY5 Configuration:

- Probe: ES3DV2 - SN3019; ConvF(7.69, 7.69, 7.69) @ 143 MHz; Calibrated: 2021/12/13
- Sensor-Surface: 4mm (Mechanical Surface Detection)
- Electronics: DAE4 Sn1354; Calibrated: 2021/9/1
- Phantom: ELI v8.0; Type: QDOVA002AA; Serial: TP:2051
- Measurement SW: DASY52, Version 52.10 (2); SEMCAD X Version 14.6.12 (7470)

Area Scan (71x161x1): Interpolated grid: dx=1.500 mm, dy=1.500 mm

Maximum value of SAR (interpolated) = 1.80 W/kg

Zoom Scan (5x5x7)/Cube 0: Measurement grid: dx=8mm, dy=8mm, dz=5mm

Reference Value = 46.59 V/m; Power Drift = 0.19 dB

Peak SAR (extrapolated) = 2.19 W/kg

SAR(1 g) = 1.79 W/kg; SAR(10 g) = 1.47 W/kg

Maximum value of SAR (measured) = 1.85 W/kg

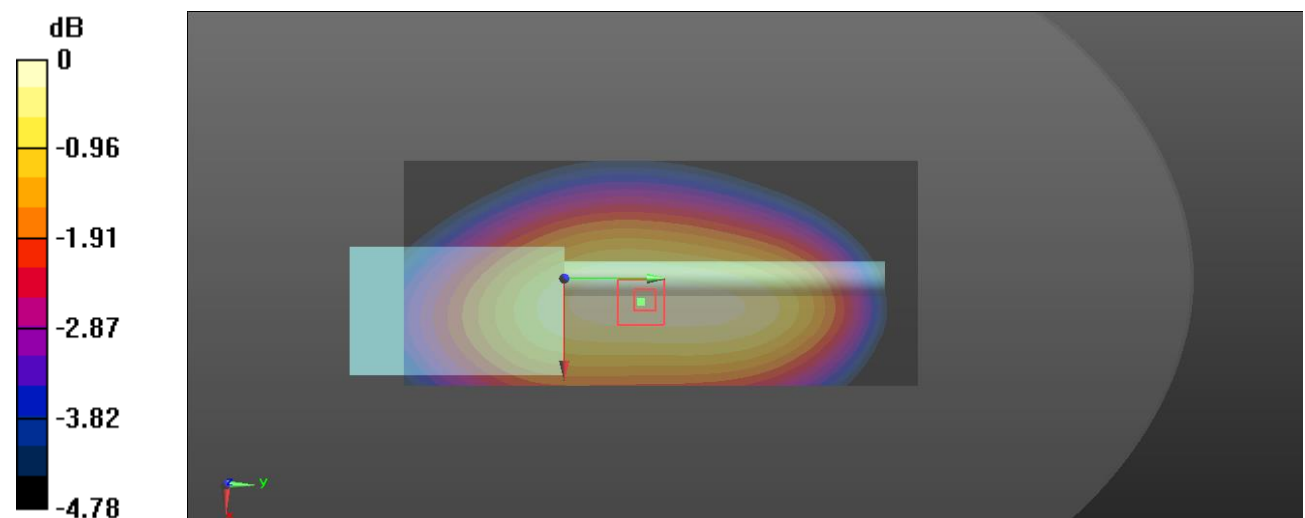

0 dB = 1.85 W/kg = 2.67 dBW/kg

Plot 4#: FM 25kHz_150.0125MHz_Face Up_Antenna 2**DUT: Two Way Radio; Type: DR5810S-1; Serial: CR22040011-SA-S1**

Communication System: FM; Frequency: 150.012 MHz; Duty Cycle: 1:1

Medium parameters used: $f = 150.012$ MHz; $\sigma = 0.769$ S/m; $\epsilon_r = 52.419$; $\rho = 1000$ kg/m³

Phantom section: Flat Section

DASY5 Configuration:

- Probe: ES3DV2 - SN3019; ConvF(7.69, 7.69, 7.69) @ 150.012 MHz; Calibrated: 2021/12/13
- Sensor-Surface: 4mm (Mechanical Surface Detection)
- Electronics: DAE4 Sn1354; Calibrated: 2021/9/1
- Phantom: ELI v8.0; Type: QDOVA002AA; Serial: TP:2051
- Measurement SW: DASY52, Version 52.10 (2); SEMCAD X Version 14.6.12 (7470)

Area Scan (81x191x1): Interpolated grid: dx=1.500 mm, dy=1.500 mm

Maximum value of SAR (interpolated) = 1.28 W/kg

Zoom Scan (6x6x7)/Cube 0: Measurement grid: dx=8mm, dy=8mm, dz=5mm

Reference Value = 41.56 V/m; Power Drift = -0.16 dB

Peak SAR (extrapolated) = 1.48 W/kg

SAR(1 g) = 1.2 W/kg; SAR(10 g) = 0.980 W/kg

Maximum value of SAR (measured) = 1.24 W/kg

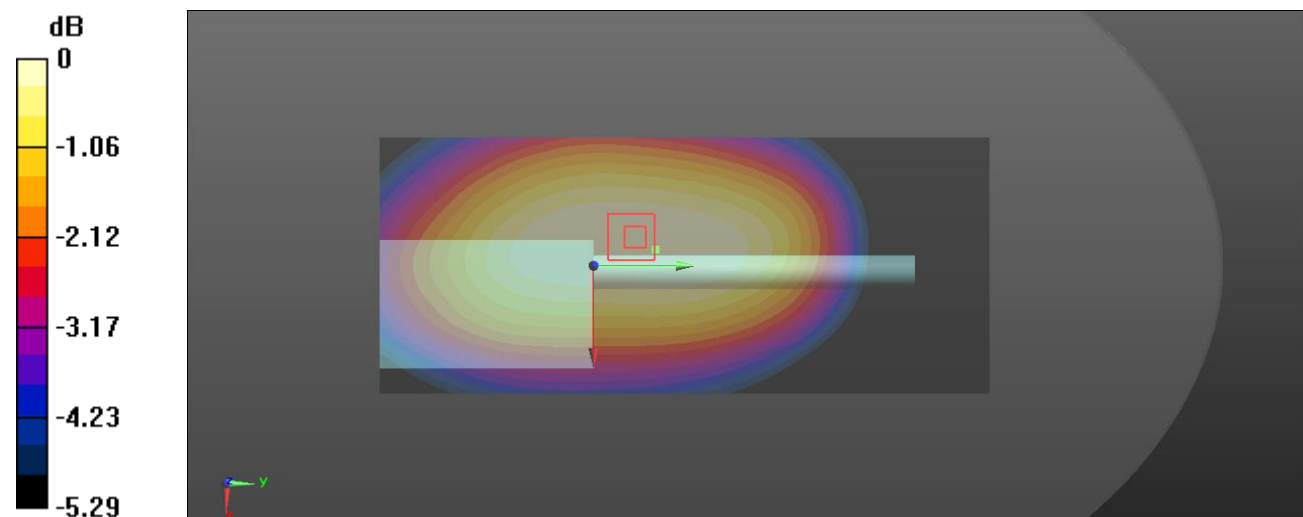

0 dB = 1.24 W/kg = 0.93 dBW/kg

Plot 5#: 4FSK 12.5kHz_143MHz_Face Up_Antenna 1**DUT: Two Way Radio; Type: DR5810S-1; Serial: CR22040011-SA-S1**

Communication System: 4FSK; Frequency: 143 MHz; Duty Cycle: 1:2

Medium parameters used: $f = 143$ MHz; $\sigma = 0.748$ S/m; $\epsilon_r = 52.689$; $\rho = 1000$ kg/m³

Phantom section: Flat Section

DASY5 Configuration:

- Probe: ES3DV2 - SN3019; ConvF(7.69, 7.69, 7.69) @ 143 MHz; Calibrated: 2021/12/13
- Sensor-Surface: 4mm (Mechanical Surface Detection)
- Electronics: DAE4 Sn1354; Calibrated: 2021/9/1
- Phantom: ELI v8.0; Type: QDOVA002AA; Serial: TP:2051
- Measurement SW: DASY52, Version 52.10 (2); SEMCAD X Version 14.6.12 (7470)

Area Scan (71x161x1): Interpolated grid: dx=1.500 mm, dy=1.500 mm

Maximum value of SAR (interpolated) = 0.852 W/kg

Zoom Scan (6x8x7)/Cube 0: Measurement grid: dx=8mm, dy=8mm, dz=5mm

Reference Value = 32.03 V/m; Power Drift = 0.18 dB

Peak SAR (extrapolated) = 1.02 W/kg

SAR(1 g) = 0.812 W/kg; SAR(10 g) = 0.666 W/kg

Maximum value of SAR (measured) = 0.864 W/kg

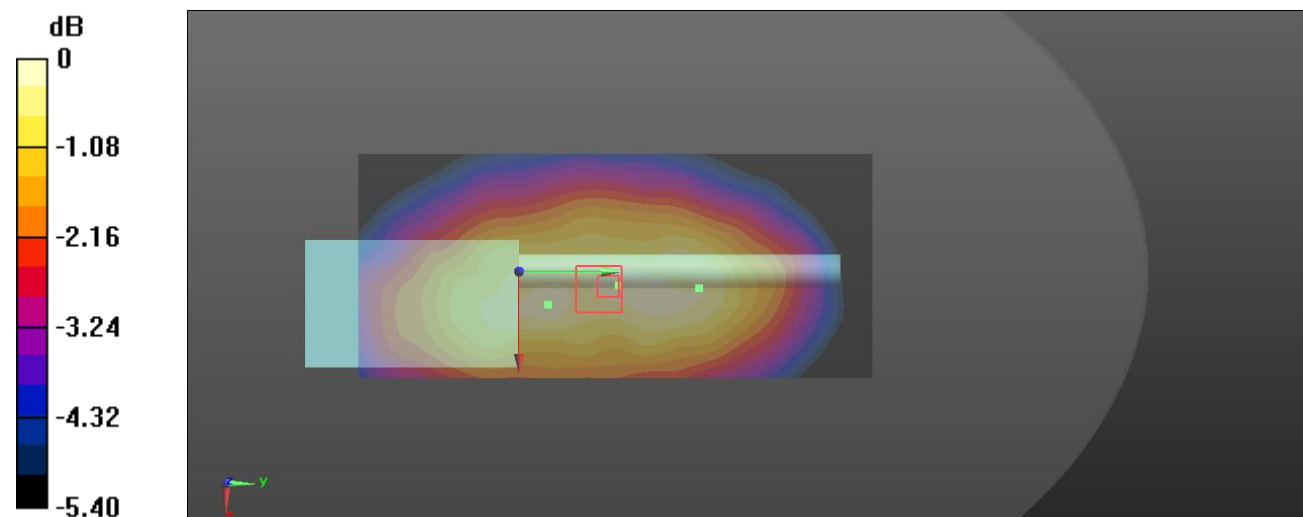

0 dB = 0.864 W/kg = -0.63 dBW/kg

Plot 6#: 4FSK 12.5kHz_150.0125MHz_Face Up_Antenna 2**DUT: Two Way Radio; Type: DR5810S-1; Serial: CR22040011-SA-S1**

Communication System: 4FSK; Frequency: 150.012 MHz; Duty Cycle: 1:2

Medium parameters used: $f = 150.012$ MHz; $\sigma = 0.769$ S/m; $\epsilon_r = 52.419$; $\rho = 1000$ kg/m³

Phantom section: Flat Section

DASY5 Configuration:

- Probe: ES3DV2 - SN3019; ConvF(7.69, 7.69, 7.69) @ 150.012 MHz; Calibrated: 2021/12/13
- Sensor-Surface: 4mm (Mechanical Surface Detection)
- Electronics: DAE4 Sn1354; Calibrated: 2021/9/1
- Phantom: ELI v8.0; Type: QDOVA002AA; Serial: TP:2051
- Measurement SW: DASY52, Version 52.10 (2); SEMCAD X Version 14.6.12 (7470)

Area Scan (81x191x1): Interpolated grid: dx=1.500 mm, dy=1.500 mm

Maximum value of SAR (interpolated) = 0.516 W/kg

Zoom Scan (6x6x7)/Cube 0: Measurement grid: dx=8mm, dy=8mm, dz=5mm

Reference Value = 25.93 V/m; Power Drift = -0.09 dB

Peak SAR (extrapolated) = 0.628 W/kg

SAR(1 g) = 0.475 W/kg; SAR(10 g) = 0.386 W/kg

Maximum value of SAR (measured) = 0.500 W/kg

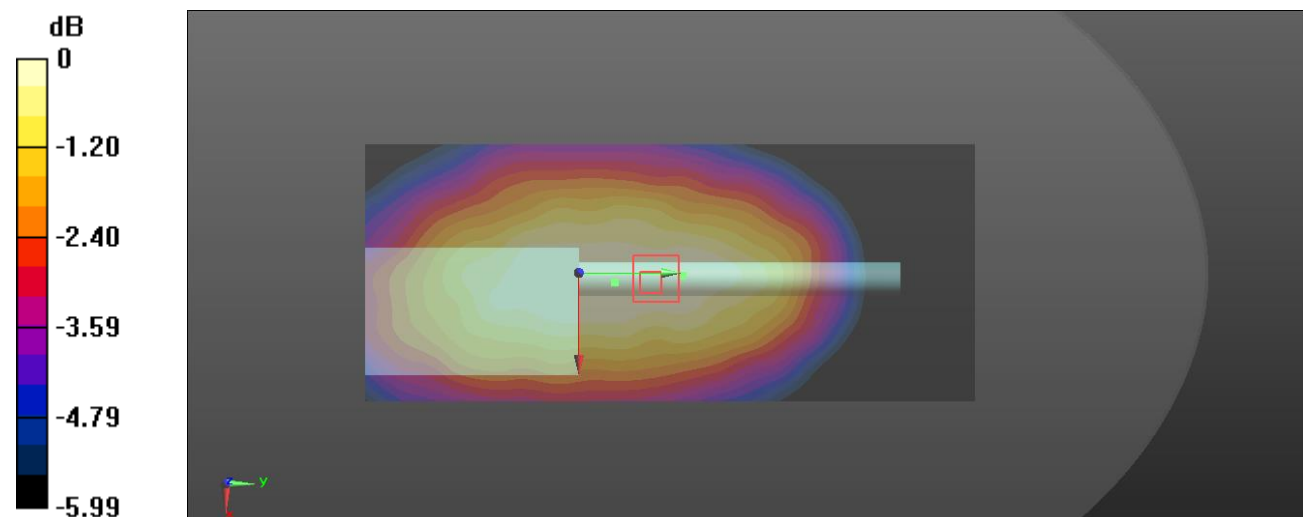

0 dB = 0.500 W/kg = -3.01 dBW/kg

Plot 7#: FM 12.5kHz_136.0125MHz_Body Back_Antenna 1**DUT: Two Way Radio; Type: DR5810S-1; Serial: CR22040011-SA-S1**

Communication System: FM; Frequency: 136.012 MHz; Duty Cycle: 1:1

Medium parameters used: $f = 136.012$ MHz; $\sigma = 0.769$ S/m; $\epsilon_r = 62.393$; $\rho = 1000$ kg/m³

Phantom section: Flat Section

DASY5 Configuration:

- Probe: ES3DV2 - SN3019; ConvF(7.51, 7.51, 7.51) @ 136.012 MHz; Calibrated: 2021/12/13
- Sensor-Surface: 4mm (Mechanical Surface Detection)
- Electronics: DAE4 Sn1354; Calibrated: 2021/9/1
- Phantom: ELI v8.0; Type: QDOVA002AA; Serial: TP:2051
- Measurement SW: DASY52, Version 52.10 (2); SEMCAD X Version 14.6.12 (7470)

Area Scan (71x161x1): Interpolated grid: dx=1.500 mm, dy=1.500 mm

Maximum value of SAR (interpolated) = 8.38 W/kg

Zoom Scan (5x5x7)/Cube 0: Measurement grid: dx=8mm, dy=8mm, dz=5mm

Reference Value = 67.97 V/m; Power Drift = -0.07 dB

Peak SAR (extrapolated) = 19.1 W/kg

SAR(1 g) = 7.71 W/kg; SAR(10 g) = 4.19 W/kg

Maximum value of SAR (measured) = 8.08 W/kg

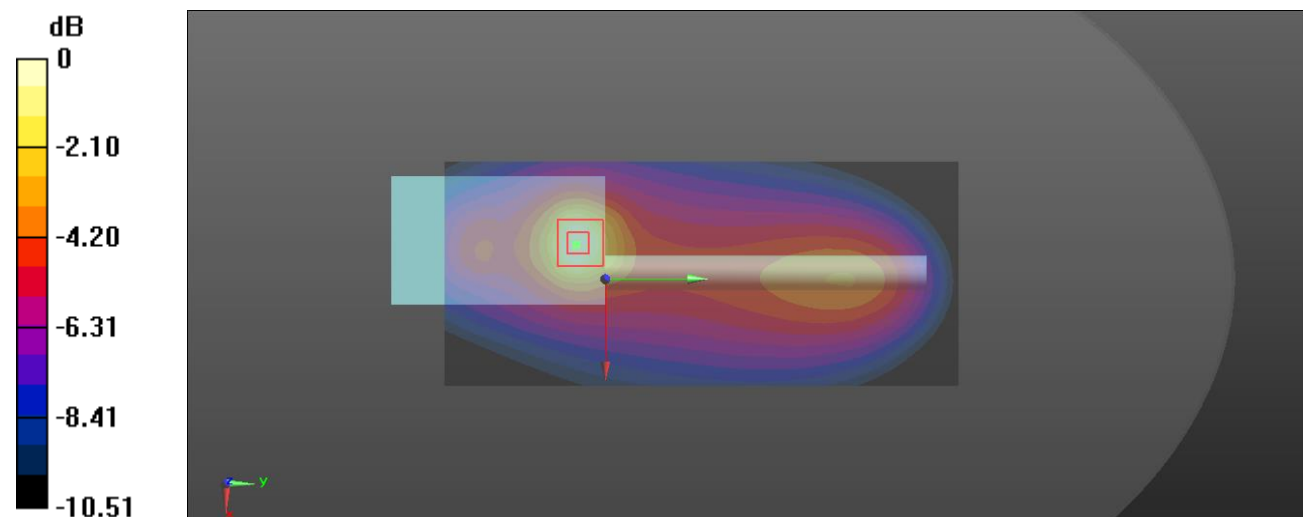

0 dB = 8.08 W/kg = 9.07 dBW/kg

Plot 8#: FM 12.5kHz_143MHz_Body Back_Antenna 1**DUT: Two Way Radio; Type: DR5810S-1; Serial: CR22040011-SA-S1**

Communication System: FM; Frequency: 143 MHz; Duty Cycle: 1:1

Medium parameters used: $f = 143$ MHz; $\sigma = 0.776$ S/m; $\epsilon_r = 62.208$; $\rho = 1000$ kg/m³

Phantom section: Flat Section

DASY5 Configuration:

- Probe: ES3DV2 - SN3019; ConvF(7.51, 7.51, 7.51) @ 143 MHz; Calibrated: 2021/12/13
- Sensor-Surface: 4mm (Mechanical Surface Detection)
- Electronics: DAE4 Sn1354; Calibrated: 2021/9/1
- Phantom: ELI v8.0; Type: QDOVA002AA; Serial: TP:2051
- Measurement SW: DASY52, Version 52.10 (2); SEMCAD X Version 14.6.12 (7470)

Area Scan (71x161x1): Interpolated grid: dx=1.500 mm, dy=1.500 mm

Maximum value of SAR (interpolated) = 8.89 W/kg

Zoom Scan (5x5x7)/Cube 0: Measurement grid: dx=8mm, dy=8mm, dz=5mm

Reference Value = 75.47 V/m; Power Drift = -0.09 dB

Peak SAR (extrapolated) = 19.9 W/kg

SAR(1 g) = 10.5 W/kg; SAR(10 g) = 5.6 W/kg

Maximum value of SAR (measured) = 8.84 W/kg

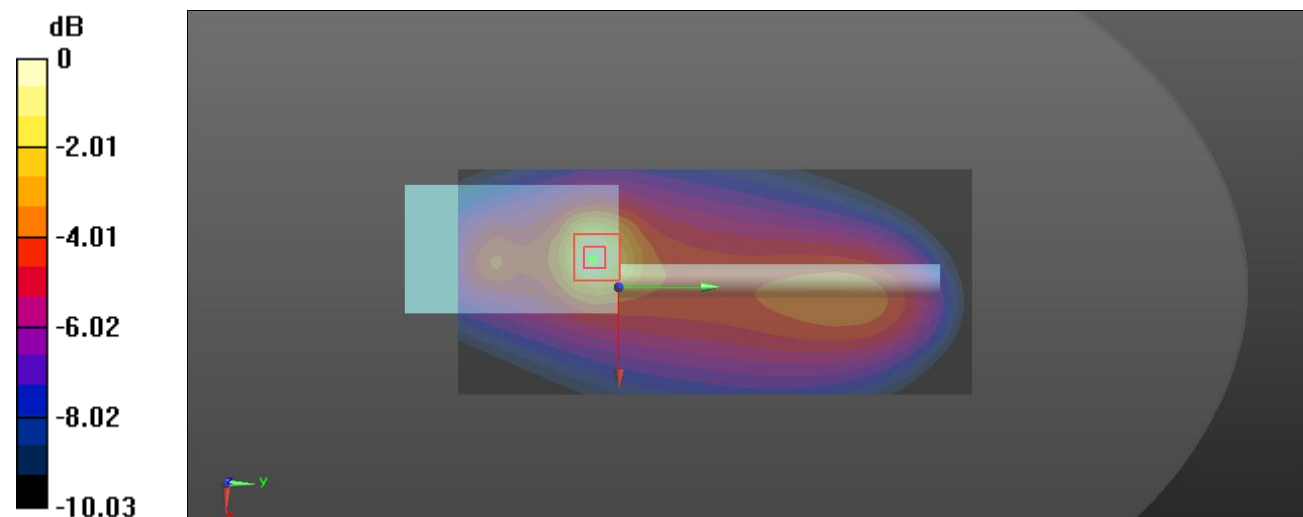

0 dB = 8.84 W/kg = 9.46 dBW/kg

Plot 9#: FM 12.5kHz_149.9875MHz_Body Back_Antenna 1**DUT: Two Way Radio; Type: DR5810S-1; Serial: CR22040011-SA-S1**

Communication System: FM; Frequency: 149.988 MHz; Duty Cycle: 1:1

Medium parameters used: $f = 149.988$ MHz; $\sigma = 0.782$ S/m; $\epsilon_r = 62.043$; $\rho = 1000$ kg/m³

Phantom section: Flat Section

DASY5 Configuration:

- Probe: ES3DV2 - SN3019; ConvF(7.51, 7.51, 7.51) @ 149.988 MHz; Calibrated: 2021/12/13
- Sensor-Surface: 4mm (Mechanical Surface Detection)
- Electronics: DAE4 Sn1354; Calibrated: 2021/9/1
- Phantom: ELI v8.0; Type: QDOVA002AA; Serial: TP:2051
- Measurement SW: DASY52, Version 52.10 (2); SEMCAD X Version 14.6.12 (7470)

Area Scan (71x161x1): Interpolated grid: dx=1.500 mm, dy=1.500 mm

Maximum value of SAR (interpolated) = 5.20 W/kg

Zoom Scan (5x5x7)/Cube 0: Measurement grid: dx=8mm, dy=8mm, dz=5mm

Reference Value = 45.53 V/m; Power Drift = 0.11 dB

Peak SAR (extrapolated) = 8.97 W/kg

SAR(1 g) = 4.08 W/kg; SAR(10 g) = 2.18 W/kg

Maximum value of SAR (measured) = 5.17 W/kg

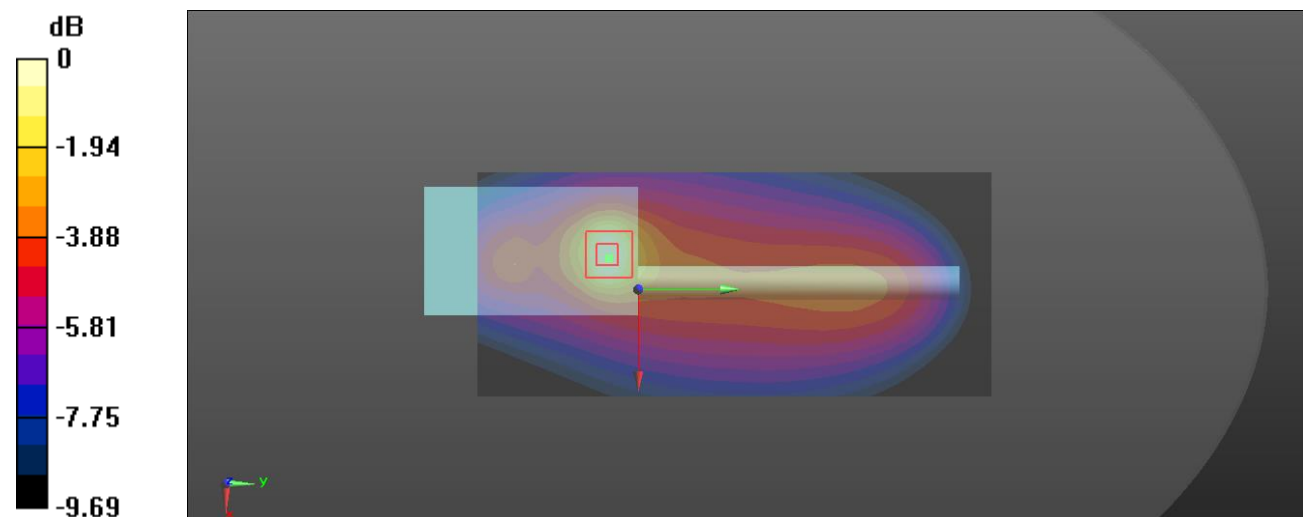

0 dB = 5.17 W/kg = 7.13 dBW/kg

Plot 10#: FM 12.5kHz_150.0125MHz_Body Back_Antenna 2**DUT: Two Way Radio; Type: DR5810S-1; Serial: CR22040011-SA-S1**

Communication System: FM; Frequency: 150.012 MHz; Duty Cycle: 1:1

Medium parameters used: $f = 150.012$ MHz; $\sigma = 0.788$ S/m; $\epsilon_r = 61.971$; $\rho = 1000$ kg/m³

Phantom section: Flat Section

DASY5 Configuration:

- Probe: ES3DV2 - SN3019; ConvF(7.51, 7.51, 7.51) @ 150.012 MHz; Calibrated: 2021/12/13
- Sensor-Surface: 4mm (Mechanical Surface Detection)
- Electronics: DAE4 Sn1354; Calibrated: 2021/9/1
- Phantom: ELI v8.0; Type: QDOVA002AA; Serial: TP:2051
- Measurement SW: DASY52, Version 52.10 (2); SEMCAD X Version 14.6.12 (7470)

Area Scan (81x191x1): Interpolated grid: dx=1.500 mm, dy=1.500 mm

Maximum value of SAR (interpolated) = 10.7 W/kg

Zoom Scan (5x5x7)/Cube 0: Measurement grid: dx=8mm, dy=8mm, dz=5mm

Reference Value = 92.67 V/m; Power Drift = -0.04 dB

Peak SAR (extrapolated) = 20.0 W/kg

SAR(1 g) = 9.84 W/kg; SAR(10 g) = 5.79 W/kg

Maximum value of SAR (measured) = 10.1 W/kg

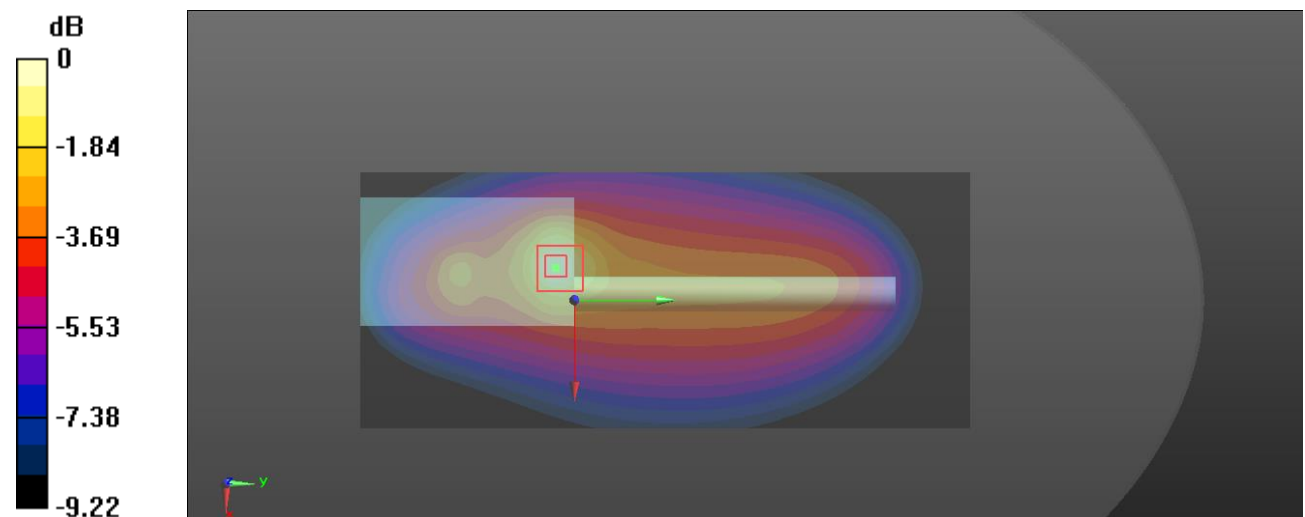

0 dB = 10.1 W/kg = 10.04 dBW/kg

Plot 11#: FM 12.5kHz_158.0125MHz_Body Back_Antenna 2**DUT: Two Way Radio; Type: DR5810S-1; Serial: CR22040011-SA-S1**

Communication System: FM; Frequency: 158.012 MHz; Duty Cycle: 1:1

Medium parameters used: $f = 158.012$ MHz; $\sigma = 0.798$ S/m; $\epsilon_r = 61.646$; $\rho = 1000$ kg/m³

Phantom section: Flat Section

DASY5 Configuration:

- Probe: ES3DV2 - SN3019; ConvF(7.51, 7.51, 7.51) @ 158.012 MHz; Calibrated: 2021/12/13
- Sensor-Surface: 4mm (Mechanical Surface Detection)
- Electronics: DAE4 Sn1354; Calibrated: 2021/9/1
- Phantom: ELI v8.0; Type: QDOVA002AA; Serial: TP:2051
- Measurement SW: DASY52, Version 52.10 (2); SEMCAD X Version 14.6.12 (7470)

Area Scan (81x191x1): Interpolated grid: dx=1.500 mm, dy=1.500 mm

Maximum value of SAR (interpolated) = 4.37 W/kg

Zoom Scan (5x5x7)/Cube 0: Measurement grid: dx=8mm, dy=8mm, dz=5mm

Reference Value = 53.34 V/m; Power Drift = 0.06 dB

Peak SAR (extrapolated) = 12.0 W/kg

SAR(1 g) = 4.7 W/kg; SAR(10 g) = 2.61 W/kg

Maximum value of SAR (measured) = 4.69 W/kg

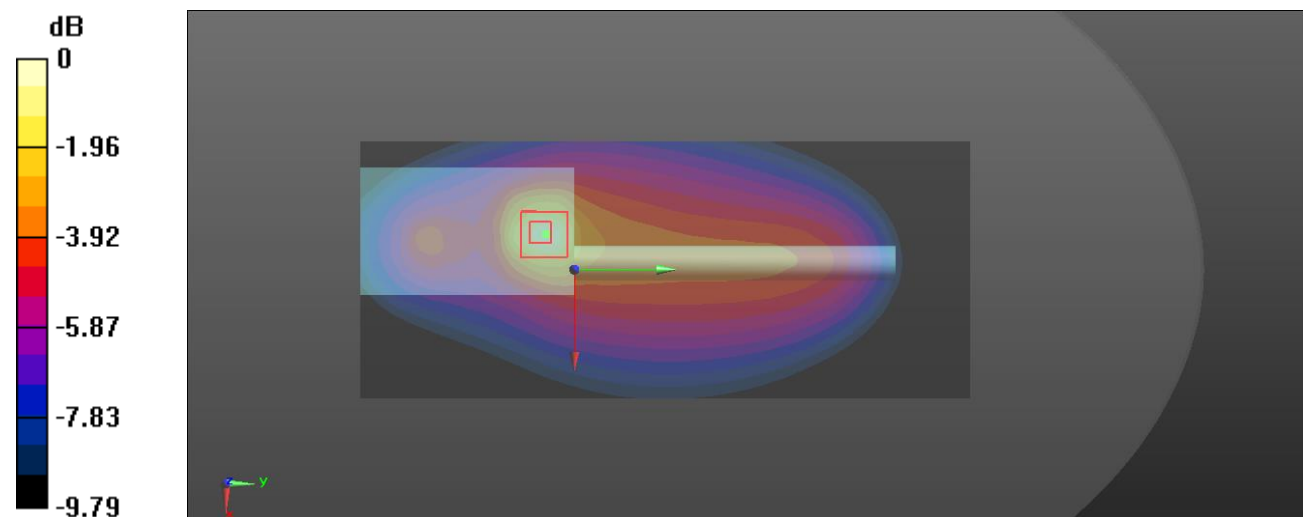

0 dB = 4.69 W/kg = 6.71 dBW/kg

Plot 12#: FM 12.5kHz_165.9875MHz_Body Back_Antenna 2**DUT: Two Way Radio; Type: DR5810S-1; Serial: CR22040011-SA-S1**

Communication System: FM; Frequency: 165.988 MHz; Duty Cycle: 1:1

Medium parameters used: $f = 165.988$ MHz; $\sigma = 0.805$ S/m; $\epsilon_r = 61.402$; $\rho = 1000$ kg/m³

Phantom section: Flat Section

DASY5 Configuration:

- Probe: ES3DV2 - SN3019; ConvF(7.51, 7.51, 7.51) @ 165.988 MHz; Calibrated: 2021/12/13
- Sensor-Surface: 4mm (Mechanical Surface Detection)
- Electronics: DAE4 Sn1354; Calibrated: 2021/9/1
- Phantom: ELI v8.0; Type: QDOVA002AA; Serial: TP:2051
- Measurement SW: DASY52, Version 52.10 (2); SEMCAD X Version 14.6.12 (7470)

Area Scan (81x191x1): Interpolated grid: dx=1.500 mm, dy=1.500 mm

Maximum value of SAR (interpolated) = 2.99 W/kg

Zoom Scan (5x5x7)/Cube 0: Measurement grid: dx=8mm, dy=8mm, dz=5mm

Reference Value = 41.43 V/m; Power Drift = -0.06 dB

Peak SAR (extrapolated) = 9.33 W/kg

SAR(1 g) = 3.26 W/kg; SAR(10 g) = 1.7 W/kg

Maximum value of SAR (measured) = 3.33 W/kg

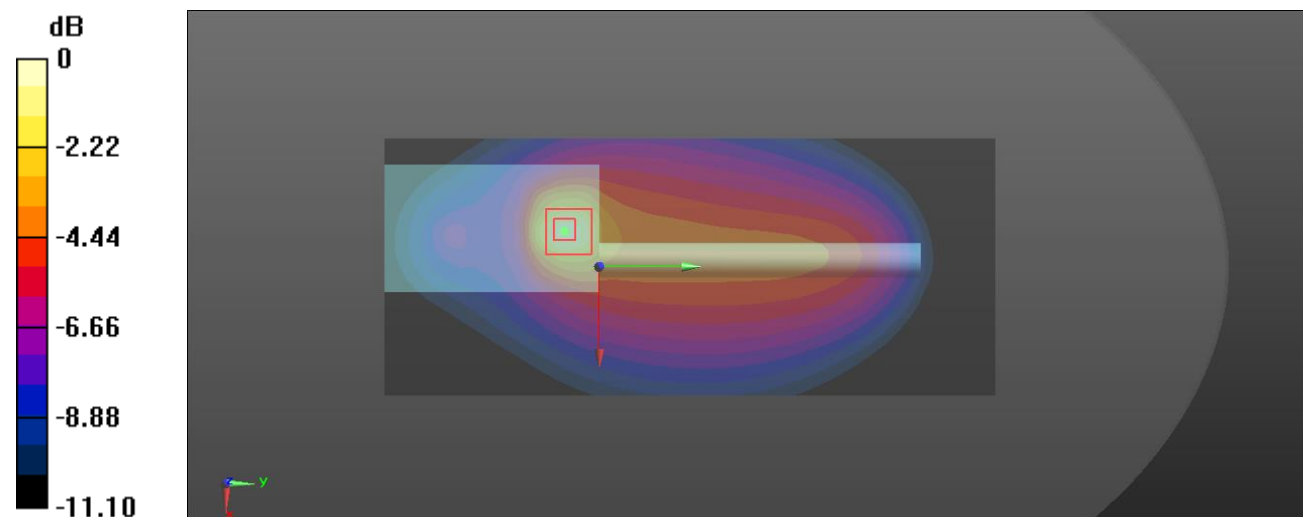

0 dB = 3.33 W/kg = 5.22 dBW/kg

Plot 13#: FM 12.5kHz_173.9875MHz_Body Back_Antenna 2**DUT: Two Way Radio; Type: DR5810S-1; Serial: CR22040011-SA-S1**

Communication System: FM; Frequency: 173.988 MHz; Duty Cycle: 1:1

Medium parameters used: $f = 173.988 \text{ MHz}$; $\sigma = 0.816 \text{ S/m}$; $\epsilon_r = 61.135$; $\rho = 1000 \text{ kg/m}^3$

Phantom section: Flat Section

DASY5 Configuration:

- Probe: ES3DV2 - SN3019; ConvF(7.51, 7.51, 7.51) @ 173.988 MHz; Calibrated: 2021/12/13
- Sensor-Surface: 4mm (Mechanical Surface Detection)
- Electronics: DAE4 Sn1354; Calibrated: 2021/9/1
- Phantom: ELI v8.0; Type: QDOVA002AA; Serial: TP:2051
- Measurement SW: DASY52, Version 52.10 (2); SEMCAD X Version 14.6.12 (7470)

Area Scan (81x191x1): Interpolated grid: $dx=1.500 \text{ mm}$, $dy=1.500 \text{ mm}$

Maximum value of SAR (interpolated) = 2.58 W/kg

Zoom Scan (5x5x7)/Cube 0: Measurement grid: $dx=8\text{mm}$, $dy=8\text{mm}$, $dz=5\text{mm}$

Reference Value = 41.54 V/m; Power Drift = -0.10 dB

Peak SAR (extrapolated) = 5.55 W/kg

SAR(1 g) = 2.43 W/kg; SAR(10 g) = 1.42 W/kg

Maximum value of SAR (measured) = 2.48 W/kg

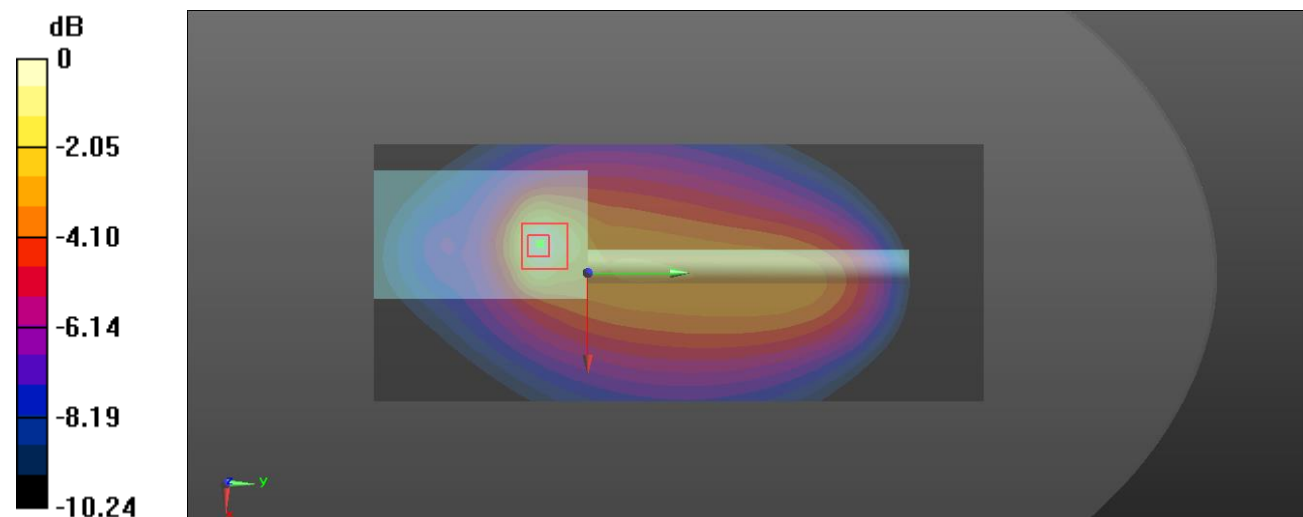

0 dB = 2.48 W/kg = 3.94 dBW/kg

Plot 14#: FM 25kHz_136.0125MHz_Body Back_Antenna 1**DUT: Two Way Radio; Type: DR5810S-1; Serial: CR22040011-SA-S1**

Communication System: FM; Frequency: 136.012 MHz; Duty Cycle: 1:1

Medium parameters used: $f = 136.012$ MHz; $\sigma = 0.769$ S/m; $\epsilon_r = 62.393$; $\rho = 1000$ kg/m³

Phantom section: Flat Section

DASY5 Configuration:

- Probe: ES3DV2 - SN3019; ConvF(7.51, 7.51, 7.51) @ 136.012 MHz; Calibrated: 2021/12/13
- Sensor-Surface: 4mm (Mechanical Surface Detection)
- Electronics: DAE4 Sn1354; Calibrated: 2021/9/1
- Phantom: ELI v8.0; Type: QDOVA002AA; Serial: TP:2051
- Measurement SW: DASY52, Version 52.10 (2); SEMCAD X Version 14.6.12 (7470)

Area Scan (71x161x1): Interpolated grid: dx=1.500 mm, dy=1.500 mm

Maximum value of SAR (interpolated) = 7.82 W/kg

Zoom Scan (5x5x7)/Cube 0: Measurement grid: dx=8mm, dy=8mm, dz=5mm

Reference Value = 62.36 V/m; Power Drift = -0.07 dB

Peak SAR (extrapolated) = 19.2 W/kg

SAR(1 g) = 7.47 W/kg; SAR(10 g) = 3.98 W/kg

Maximum value of SAR (measured) = 7.79 W/kg

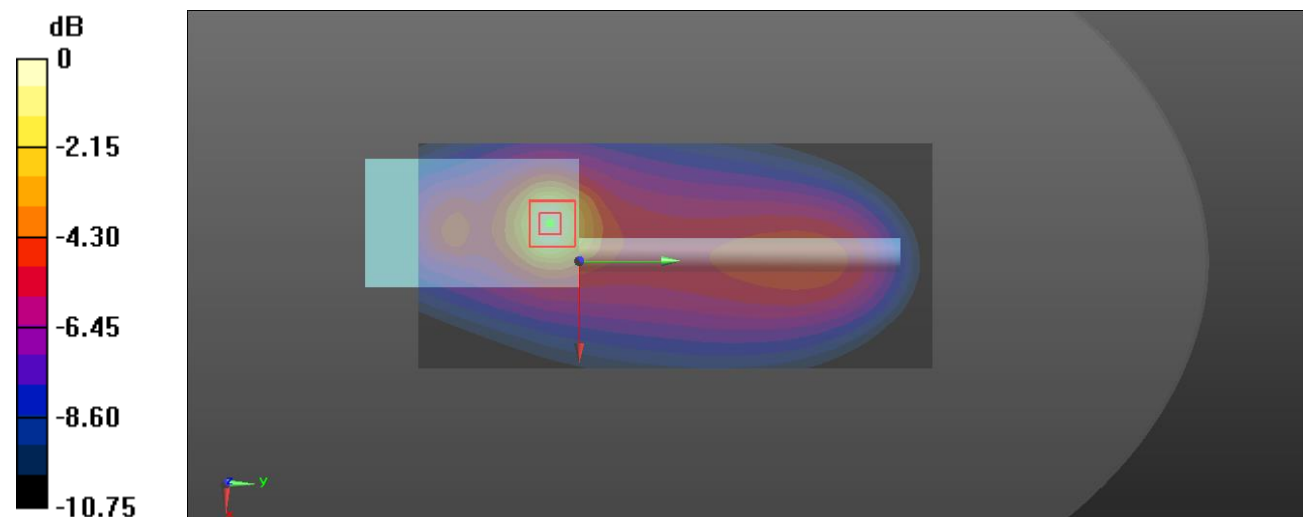

0 dB = 7.79 W/kg = 8.92 dBW/kg

Plot 15#: FM 25kHz_143MHz_Body Back_Antenna 1**DUT: Two Way Radio; Type: DR5810S-1; Serial: CR22040011-SA-S1**

Communication System: FM; Frequency: 143 MHz; Duty Cycle: 1:1

Medium parameters used: $f = 143 \text{ MHz}$; $\sigma = 0.776 \text{ S/m}$; $\epsilon_r = 62.208$; $\rho = 1000 \text{ kg/m}^3$

Phantom section: Flat Section

DASY5 Configuration:

- Probe: ES3DV2 - SN3019; ConvF(7.51, 7.51, 7.51) @ 143 MHz; Calibrated: 2021/12/13
- Sensor-Surface: 4mm (Mechanical Surface Detection)
- Electronics: DAE4 Sn1354; Calibrated: 2021/9/1
- Phantom: ELI v8.0; Type: QDOVA002AA; Serial: TP:2051
- Measurement SW: DASY52, Version 52.10 (2); SEMCAD X Version 14.6.12 (7470)

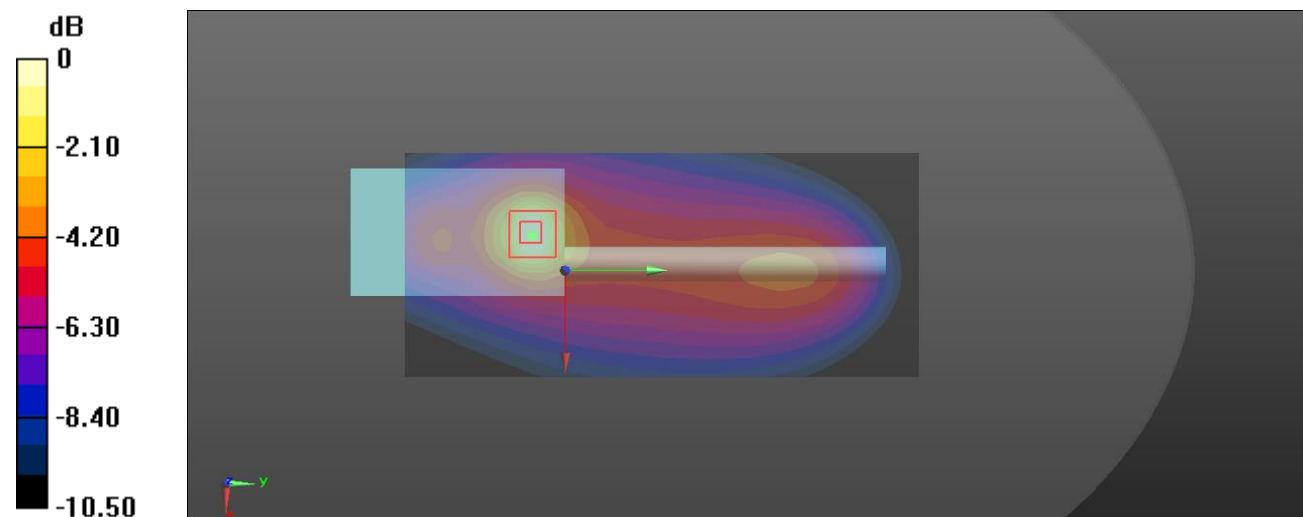
Area Scan (71x161x1): Interpolated grid: $dx=1.500 \text{ mm}$, $dy=1.500 \text{ mm}$ Maximum value of SAR (interpolated) = 9.40 W/kg **Zoom Scan (5x5x7)/Cube 0:** Measurement grid: $dx=8\text{mm}$, $dy=8\text{mm}$, $dz=5\text{mm}$ Reference Value = 69.15 V/m ; Power Drift = -0.11 dB Peak SAR (extrapolated) = 23.4 W/kg **SAR(1 g) = 9.03 W/kg ; SAR(10 g) = 4.82 W/kg** Maximum value of SAR (measured) = 9.25 W/kg 0 dB = 9.25 W/kg = 9.66 dBW/kg

Plot 16#: FM 25kHz_149.9875MHz_Body Back_Antenna 1**DUT: Two Way Radio; Type: DR5810S-1; Serial: CR22040011-SA-S1**

Communication System: FM; Frequency: 149.988 MHz; Duty Cycle: 1:1

Medium parameters used: $f = 149.988 \text{ MHz}$; $\sigma = 0.782 \text{ S/m}$; $\epsilon_r = 62.043$; $\rho = 1000 \text{ kg/m}^3$

Phantom section: Flat Section

DASY5 Configuration:

- Probe: ES3DV2 - SN3019; ConvF(7.51, 7.51, 7.51) @ 149.988 MHz; Calibrated: 2021/12/13
- Sensor-Surface: 4mm (Mechanical Surface Detection)
- Electronics: DAE4 Sn1354; Calibrated: 2021/9/1
- Phantom: ELI v8.0; Type: QDOVA002AA; Serial: TP:2051
- Measurement SW: DASY52, Version 52.10 (2); SEMCAD X Version 14.6.12 (7470)

Area Scan (71x161x1): Interpolated grid: $dx=1.500 \text{ mm}$, $dy=1.500 \text{ mm}$

Maximum value of SAR (interpolated) = 4.78 W/kg

Zoom Scan (5x5x7)/Cube 0: Measurement grid: $dx=8\text{mm}$, $dy=8\text{mm}$, $dz=5\text{mm}$

Reference Value = 4237.43 V/m; Power Drift = 0.06 dB

Peak SAR (extrapolated) = 7.00 W/kg

SAR(1 g) = 3.83 W/kg; SAR(10 g) = 2.09 W/kg

Maximum value of SAR (measured) = 4.94 W/kg

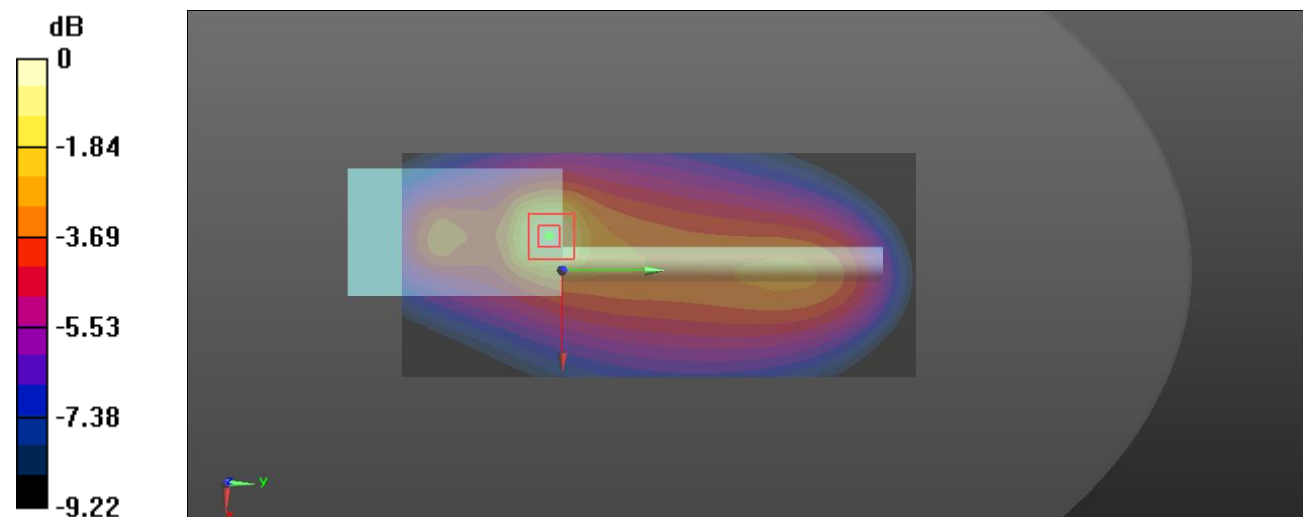

0 dB = 4.94 W/kg = 6.94 dBW/kg

Plot 17#: FM 25kHz_150.0125MHz_Body Back_Antenna 2**DUT: Two Way Radio; Type: DR5810S-1; Serial: CR22040011-SA-S1**

Communication System: FM; Frequency: 150.012 MHz; Duty Cycle: 1:1

Medium parameters used: $f = 150.012$ MHz; $\sigma = 0.788$ S/m; $\epsilon_r = 61.971$; $\rho = 1000$ kg/m³

Phantom section: Flat Section

DASY5 Configuration:

- Probe: ES3DV2 - SN3019; ConvF(7.51, 7.51, 7.51) @ 150.012 MHz; Calibrated: 2021/12/13
- Sensor-Surface: 4mm (Mechanical Surface Detection)
- Electronics: DAE4 Sn1354; Calibrated: 2021/9/1
- Phantom: ELI v8.0; Type: QDOVA002AA; Serial: TP:2051
- Measurement SW: DASY52, Version 52.10 (2); SEMCAD X Version 14.6.12 (7470)

Area Scan (81x191x1): Interpolated grid: dx=1.500 mm, dy=1.500 mm

Maximum value of SAR (interpolated) = 8.64 W/kg

Zoom Scan (5x5x7)/Cube 0: Measurement grid: dx=8mm, dy=8mm, dz=5mm

Reference Value = 77.68 V/m; Power Drift = -0.03 dB

Peak SAR (extrapolated) = 16.1 W/kg

SAR(1 g) = 9.65 W/kg; SAR(10 g) = 5.64 W/kg

Maximum value of SAR (measured) = 8.23 W/kg

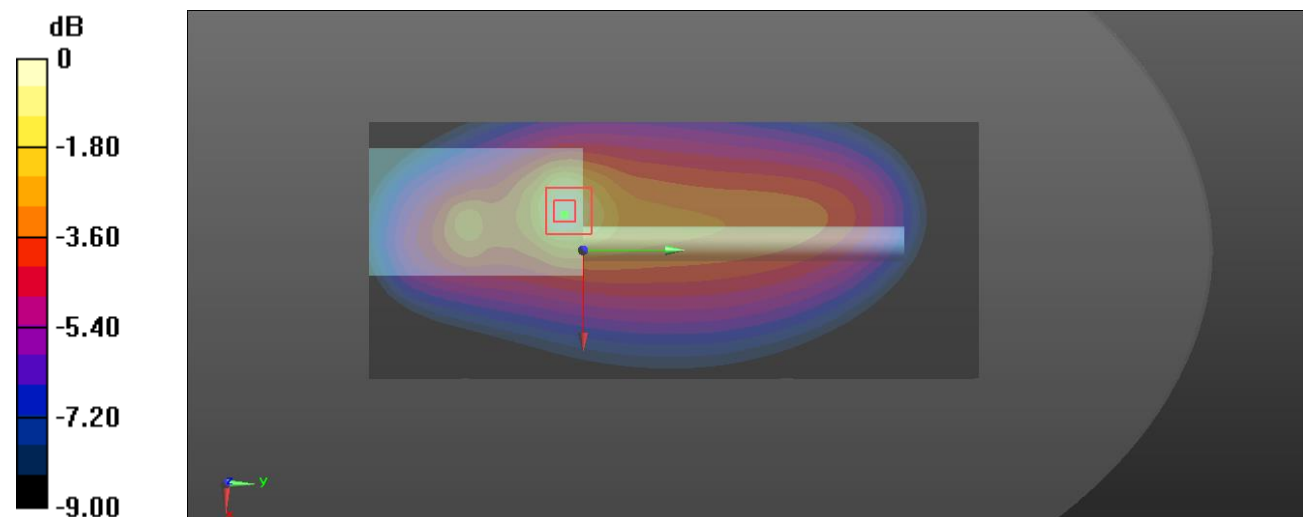

0 dB = 8.23 W/kg = 9.15 dBW/kg

Plot 18#: FM 25kHz_158.012MHz_Body Back_Antenna 2**DUT: Two Way Radio; Type: DR5810S-1; Serial: CR22040011-SA-S1**

Communication System: FM; Frequency: 158.012 MHz; Duty Cycle: 1:1

Medium parameters used: $f = 158.012$ MHz; $\sigma = 0.798$ S/m; $\epsilon_r = 61.646$; $\rho = 1000$ kg/m³

Phantom section: Flat Section

DASY5 Configuration:

- Probe: ES3DV2 - SN3019; ConvF(7.51, 7.51, 7.51) @ 158.012 MHz; Calibrated: 2021/12/13
- Sensor-Surface: 4mm (Mechanical Surface Detection)
- Electronics: DAE4 Sn1354; Calibrated: 2021/9/1
- Phantom: ELI v8.0; Type: QDOVA002AA; Serial: TP:2051
- Measurement SW: DASY52, Version 52.10 (2); SEMCAD X Version 14.6.12 (7470)

Area Scan (81x191x1): Interpolated grid: dx=1.500 mm, dy=1.500 mm

Maximum value of SAR (interpolated) = 4.32 W/kg

Zoom Scan (5x5x7)/Cube 0: Measurement grid: dx=8mm, dy=8mm, dz=5mm

Reference Value = 53.83 V/m; Power Drift = -0.00 dB

Peak SAR (extrapolated) = 9.36 W/kg

SAR(1 g) = 4.19 W/kg; SAR(10 g) = 2.46 W/kg

Maximum value of SAR (measured) = 4.36 W/kg

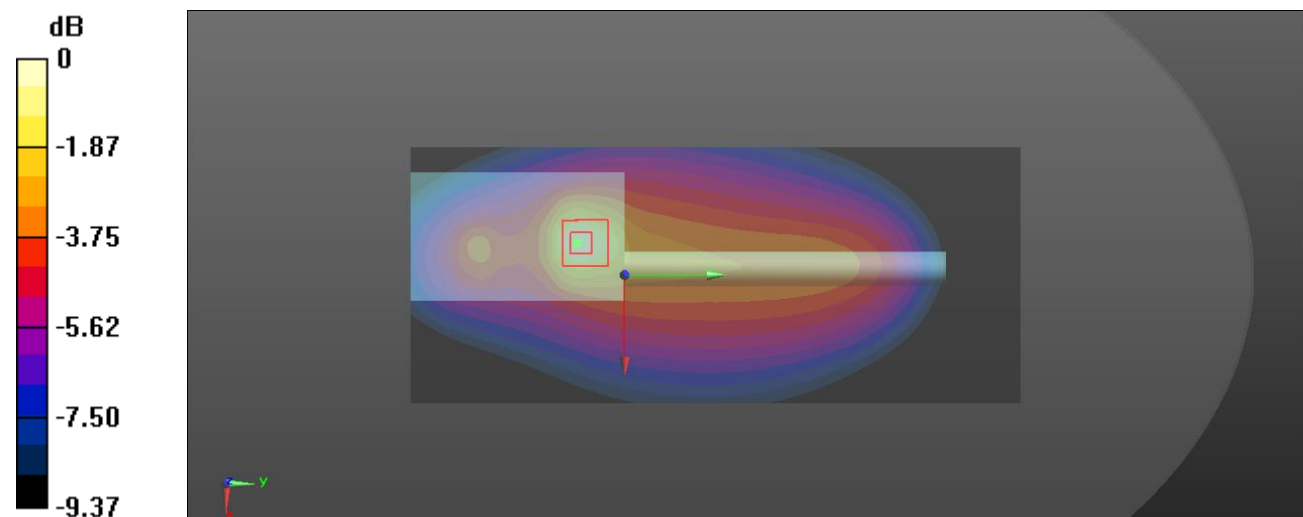

0 dB = 4.36 W/kg = 6.39 dBW/kg

Plot 19#: FM 25kHz_165.9875MHz_Body Back_Antenna 2**DUT: Two Way Radio; Type: DR5810S-1; Serial: CR22040011-SA-S1**

Communication System: FM; Frequency: 165.988 MHz; Duty Cycle: 1:1

Medium parameters used: $f = 165.988 \text{ MHz}$; $\sigma = 0.805 \text{ S/m}$; $\epsilon_r = 61.402$; $\rho = 1000 \text{ kg/m}^3$

Phantom section: Flat Section

DASY5 Configuration:

- Probe: ES3DV2 - SN3019; ConvF(7.51, 7.51, 7.51) @ 165.988 MHz; Calibrated: 2021/12/13
- Sensor-Surface: 4mm (Mechanical Surface Detection)
- Electronics: DAE4 Sn1354; Calibrated: 2021/9/1
- Phantom: ELI v8.0; Type: QDOVA002AA; Serial: TP:2051
- Measurement SW: DASY52, Version 52.10 (2); SEMCAD X Version 14.6.12 (7470)

Area Scan (81x191x1): Interpolated grid: $dx=1.500 \text{ mm}$, $dy=1.500 \text{ mm}$

Maximum value of SAR (interpolated) = 2.67 W/kg

Zoom Scan (5x5x7)/Cube 0: Measurement grid: $dx=8\text{mm}$, $dy=8\text{mm}$, $dz=5\text{mm}$

Reference Value = 43.22 V/m; Power Drift = -0.15 dB

Peak SAR (extrapolated) = 7.44 W/kg

SAR(1 g) = 2.82 W/kg; SAR(10 g) = 1.58 W/kg

Maximum value of SAR (measured) = 2.84 W/kg

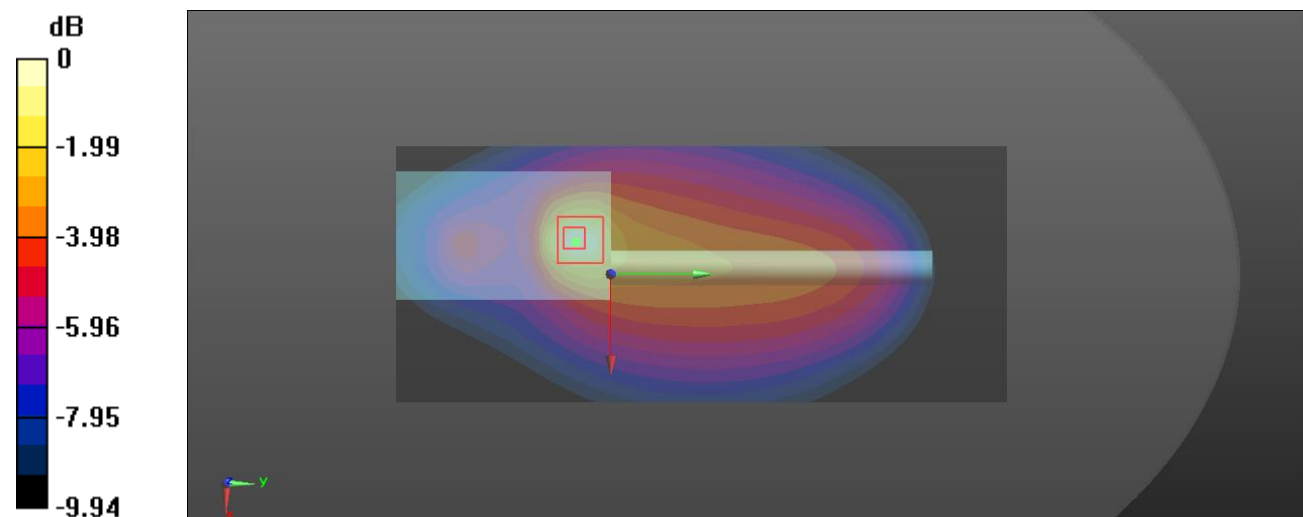

0 dB = 2.84 W/kg = 4.53 dBW/kg

Plot 20#: FM 25kHz_173.9875MHz_Body Back_Antenna 2**DUT: Two Way Radio; Type: DR5810S-1; Serial: CR22040011-SA-S1**

Communication System: FM; Frequency: 173.988 MHz; Duty Cycle: 1:1

Medium parameters used: $f = 173.988$ MHz; $\sigma = 0.816$ S/m; $\epsilon_r = 61.135$; $\rho = 1000$ kg/m³

Phantom section: Flat Section

DASY5 Configuration:

- Probe: ES3DV2 - SN3019; ConvF(7.51, 7.51, 7.51) @ 173.988 MHz; Calibrated: 2021/12/13
- Sensor-Surface: 4mm (Mechanical Surface Detection)
- Electronics: DAE4 Sn1354; Calibrated: 2021/9/1
- Phantom: ELI v8.0; Type: QDOVA002AA; Serial: TP:2051
- Measurement SW: DASY52, Version 52.10 (2); SEMCAD X Version 14.6.12 (7470)

Area Scan (81x191x1): Interpolated grid: dx=1.500 mm, dy=1.500 mm

Maximum value of SAR (interpolated) = 2.61 W/kg

Zoom Scan (5x5x7)/Cube 0: Measurement grid: dx=8mm, dy=8mm, dz=5mm

Reference Value = 42.40 V/m; Power Drift = -0.05 dB

Peak SAR (extrapolated) = 5.43 W/kg

SAR(1 g) = 2.44 W/kg; SAR(10 g) = 1.39 W/kg

Maximum value of SAR (measured) = 2.53 W/kg

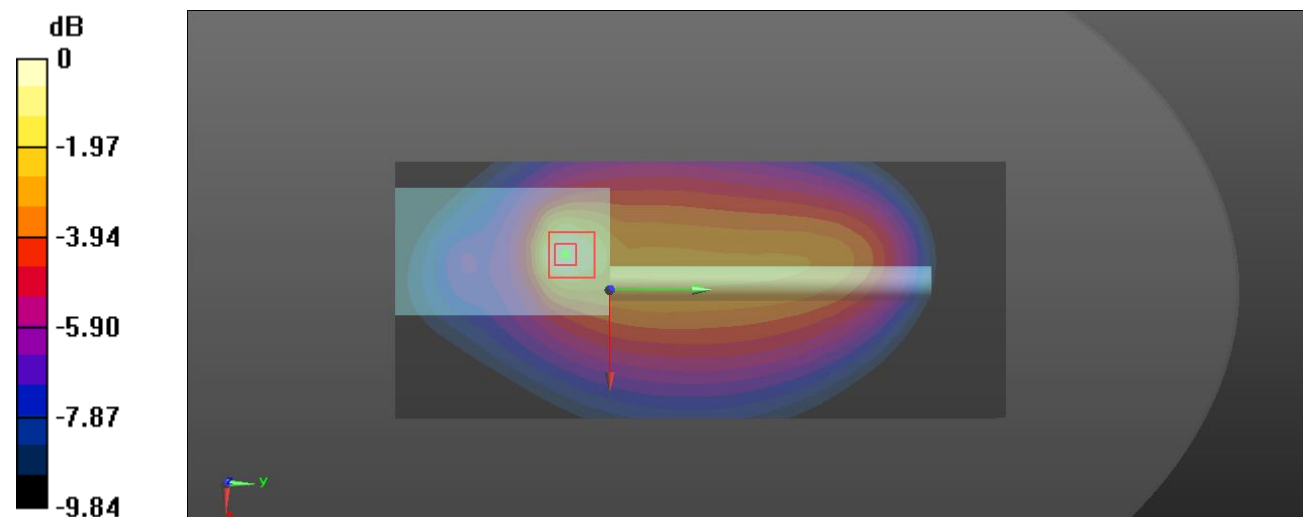

0 dB = 2.53 W/kg = 4.03 dBW/kg

Plot 21#:4FSK 12.5kHz_143MHz_Body Back_Antenna 1**DUT: Two Way Radio; Type: DR5810S-1; Serial: CR22040011-SA-S1**

Communication System: 4FSK; Frequency: 143 MHz;Duty Cycle: 1:2

Medium parameters used: $f = 143 \text{ MHz}$; $\sigma = 0.776 \text{ S/m}$; $\epsilon_r = 62.208$; $\rho = 1000 \text{ kg/m}^3$

Phantom section: Flat Section

DASY5 Configuration:

- Probe: ES3DV2 - SN3019; ConvF(7.51, 7.51, 7.51) @ 143 MHz; Calibrated: 2021/12/13
- Sensor-Surface: 4mm (Mechanical Surface Detection)
- Electronics: DAE4 Sn1354; Calibrated: 2021/9/1
- Phantom: ELI v8.0; Type: QDOVA002AA; Serial: TP:2051
- Measurement SW: DASY52, Version 52.10 (2); SEMCAD X Version 14.6.12 (7470)

Area Scan (71x161x1): Interpolated grid: $dx=1.500 \text{ mm}$, $dy=1.500 \text{ mm}$

Maximum value of SAR (interpolated) = 5.24 W/kg

Zoom Scan (5x5x7)/Cube 0: Measurement grid: $dx=8\text{mm}$, $dy=8\text{mm}$, $dz=5\text{mm}$

Reference Value = 57.44 V/m; Power Drift = -0.03 dB

Peak SAR (extrapolated) = 13.6 W/kg

SAR(1 g) = 5.14 W/kg; SAR(10 g) = 2.7 W/kg

Maximum value of SAR (measured) = 5.34 W/kg

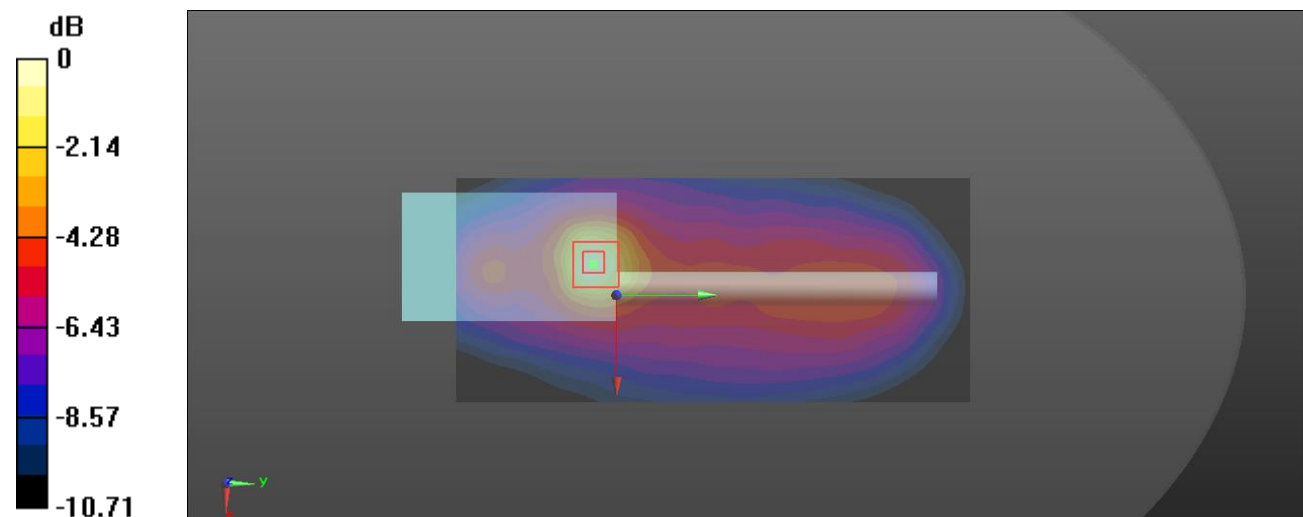

0 dB = 5.34 W/kg = 7.28 dBW/kg

Plot 22#:4FSK 12.5kHz_150.0125MHz_Body Back_Antenna 2**DUT: Two Way Radio; Type: DR5810S-1; Serial: CR22040011-SA-S1**

Communication System: 4FSK; Frequency: 150.012 MHz; Duty Cycle: 1:2

Medium parameters used: $f = 150.012$ MHz; $\sigma = 0.788$ S/m; $\epsilon_r = 61.971$; $\rho = 1000$ kg/m³

Phantom section: Flat Section

DASY5 Configuration:

- Probe: ES3DV2 - SN3019; ConvF(7.51, 7.51, 7.51) @ 150.012 MHz; Calibrated: 2021/12/13
- Sensor-Surface: 4mm (Mechanical Surface Detection)
- Electronics: DAE4 Sn1354; Calibrated: 2021/9/1
- Phantom: ELI v8.0; Type: QDOVA002AA; Serial: TP:2051
- Measurement SW: DASY52, Version 52.10 (2); SEMCAD X Version 14.6.12 (7470)

Area Scan (81x191x1): Interpolated grid: dx=1.500 mm, dy=1.500 mm

Maximum value of SAR (interpolated) = 4.89 W/kg

Zoom Scan (5x5x7)/Cube 0: Measurement grid: dx=8mm, dy=8mm, dz=5mm

Reference Value = 51.19 V/m; Power Drift = -0.12 dB

Peak SAR (extrapolated) = 10.3 W/kg

SAR(1 g) = 4.5 W/kg; SAR(10 g) = 2.64 W/kg

Maximum value of SAR (measured) = 4.68 W/kg

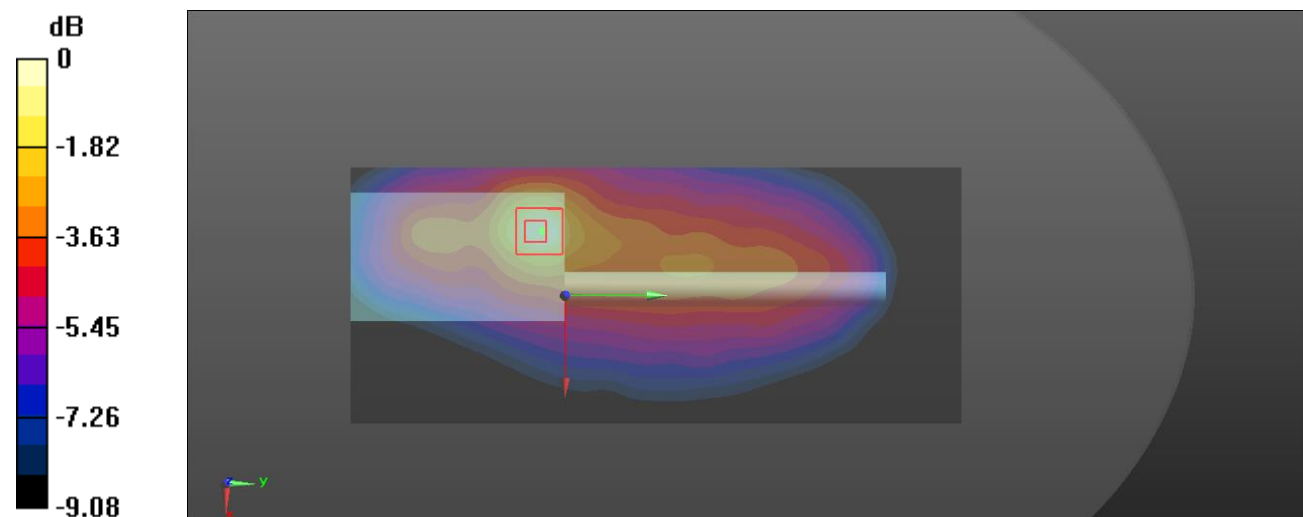

0 dB = 4.68 W/kg = 6.70 dBW/kg

Plot 23#: FM 12.5kHz_143MHz_Face Up_Antenna 1**DUT: Two Way Radio; Type: DR5610S-1; Serial: CR22040011-SA-S2**

Communication System: FM; Frequency: 143 MHz; Duty Cycle: 1:1

Medium parameters used: $f = 143 \text{ MHz}$; $\sigma = 0.748 \text{ S/m}$; $\epsilon_r = 52.689$; $\rho = 1000 \text{ kg/m}^3$

Phantom section: Flat Section

DASY5 Configuration:

- Probe: ES3DV2 - SN3019; ConvF(7.69, 7.69, 7.69) @ 143 MHz; Calibrated: 2021/12/13
- Sensor-Surface: 4mm (Mechanical Surface Detection)
- Electronics: DAE4 Sn1354; Calibrated: 2021/9/1
- Phantom: ELI v8.0; Type: QDOVA002AA; Serial: TP:2051
- Measurement SW: DASY52, Version 52.10 (2); SEMCAD X Version 14.6.12 (7470)

Area Scan (71x161x1): Interpolated grid: $dx=1.500 \text{ mm}$, $dy=1.500 \text{ mm}$

Maximum value of SAR (interpolated) = 1.48 W/kg

Zoom Scan (5x6x7)/Cube 0: Measurement grid: $dx=8\text{mm}$, $dy=8\text{mm}$, $dz=5\text{mm}$

Reference Value = 43.45 V/m; Power Drift = 0.17 dB

Peak SAR (extrapolated) = 1.78 W/kg

SAR(1 g) = 1.46 W/kg; SAR(10 g) = 1.2 W/kg

Maximum value of SAR (measured) = 1.51 W/kg

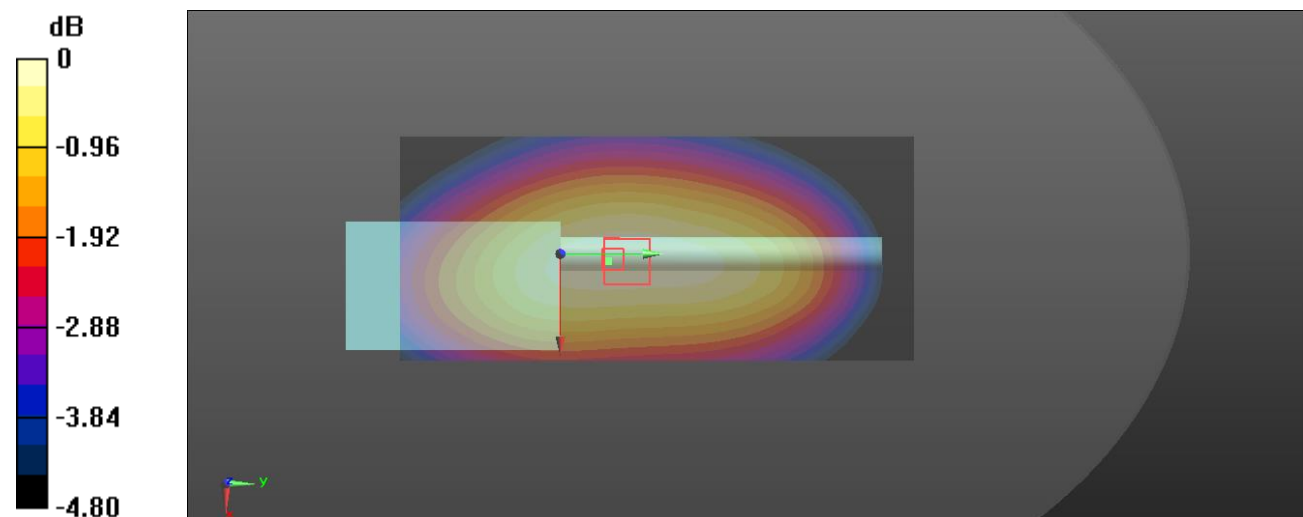

0 dB = 1.51 W/kg = 1.79 dBW/kg

Plot 24#: FM 12.5kHz_150.0125MHz_Face Up_Antenna 2**DUT: Two Way Radio; Type: DR5610S-1; Serial: CR22040011-SA-S2**

Communication System: FM; Frequency: 150.012 MHz; Duty Cycle: 1:1

Medium parameters used: $f = 150.012$ MHz; $\sigma = 0.769$ S/m; $\epsilon_r = 52.419$; $\rho = 1000$ kg/m³

Phantom section: Flat Section

DASY5 Configuration:

- Probe: ES3DV2 - SN3019; ConvF(7.69, 7.69, 7.69) @ 150.012 MHz; Calibrated: 2021/12/13
- Sensor-Surface: 4mm (Mechanical Surface Detection)
- Electronics: DAE4 Sn1354; Calibrated: 2021/9/1
- Phantom: ELI v8.0; Type: QDOVA002AA; Serial: TP:2051
- Measurement SW: DASY52, Version 52.10 (2); SEMCAD X Version 14.6.12 (7470)

Area Scan (81x161x1): Interpolated grid: dx=1.500 mm, dy=1.500 mm

Maximum value of SAR (interpolated) = 1.35 W/kg

Zoom Scan (5x5x7)/Cube 0: Measurement grid: dx=8mm, dy=8mm, dz=5mm

Reference Value = 41.14 V/m; Power Drift = -0.10 dB

Peak SAR (extrapolated) = 1.55 W/kg

SAR(1 g) = 1.27 W/kg; SAR(10 g) = 1.04 W/kg

Maximum value of SAR (measured) = 1.31 W/kg

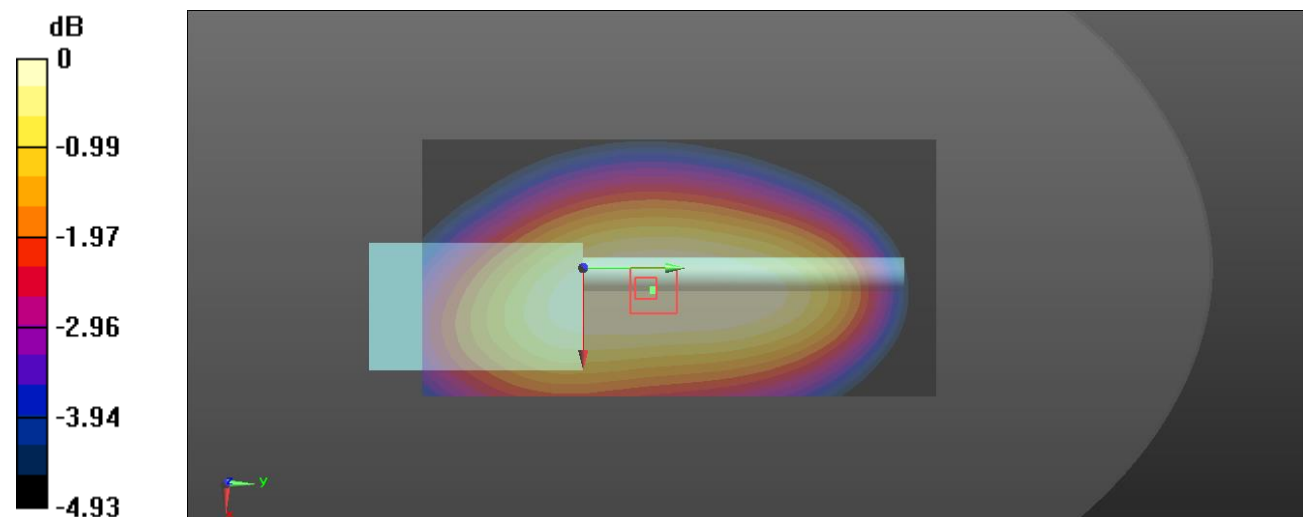

0 dB = 1.31 W/kg = 1.17 dBW/kg

Plot 25#: FM 25kHz_143MHz_Face Up_Antenna 1**DUT: Two Way Radio; Type: DR5610S-1; Serial: CR22040011-SA-S2**

Communication System: FM; Frequency: 143 MHz;Duty Cycle: 1:1

Medium parameters used: $f = 143$ MHz; $\sigma = 0.748$ S/m; $\epsilon_r = 52.689$; $\rho = 1000$ kg/m³

Phantom section: Flat Section

DASY5 Configuration:

- Probe: ES3DV2 - SN3019; ConvF(7.69, 7.69, 7.69) @ 143 MHz; Calibrated: 2021/12/13
- Sensor-Surface: 4mm (Mechanical Surface Detection)
- Electronics: DAE4 Sn1354; Calibrated: 2021/9/1
- Phantom: ELI v8.0; Type: QDOVA002AA; Serial: TP:2051
- Measurement SW: DASY52, Version 52.10 (2); SEMCAD X Version 14.6.12 (7470)

Area Scan (71x161x1): Interpolated grid: dx=1.500 mm, dy=1.500 mm

Maximum value of SAR (interpolated) = 1.51 W/kg

Zoom Scan (5x5x7)/Cube 0: Measurement grid: dx=8mm, dy=8mm, dz=5mm

Reference Value = 44.26 V/m; Power Drift = 0.16 dB

Peak SAR (extrapolated) = 1.83 W/kg

SAR(1 g) = 1.5 W/kg; SAR(10 g) = 1.24 W/kg

Maximum value of SAR (measured) = 1.55 W/kg

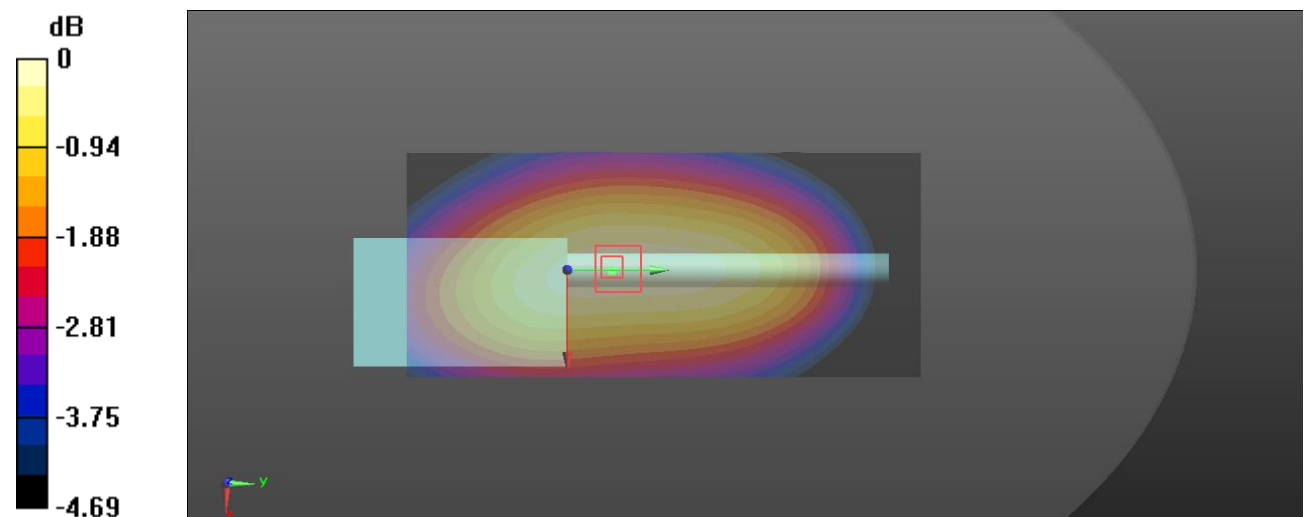

0 dB = 1.55 W/kg = 1.90 dBW/kg

Plot 26#: FM 25kHz_150.0125MHz_Face Up_Antenna 2**DUT: Two Way Radio; Type: DR5610S-1; Serial: CR22040011-SA-S2**

Communication System: FM; Frequency: 150.012 MHz; Duty Cycle: 1:1

Medium parameters used: $f = 150.012$ MHz; $\sigma = 0.769$ S/m; $\epsilon_r = 52.419$; $\rho = 1000$ kg/m³

Phantom section: Flat Section

DASY5 Configuration:

- Probe: ES3DV2 - SN3019; ConvF(7.69, 7.69, 7.69) @ 150.012 MHz; Calibrated: 2021/12/13
- Sensor-Surface: 4mm (Mechanical Surface Detection)
- Electronics: DAE4 Sn1354; Calibrated: 2021/9/1
- Phantom: ELI v8.0; Type: QDOVA002AA; Serial: TP:2051
- Measurement SW: DASY52, Version 52.10 (2); SEMCAD X Version 14.6.12 (7470)

Area Scan (81x161x1): Interpolated grid: dx=1.500 mm, dy=1.500 mm

Maximum value of SAR (interpolated) = 1.24 W/kg

Zoom Scan (5x5x7)/Cube 0: Measurement grid: dx=8mm, dy=8mm, dz=5mm

Reference Value = 39.37 V/m; Power Drift = -0.05 dB

Peak SAR (extrapolated) = 1.43 W/kg

SAR(1 g) = 1.17 W/kg; SAR(10 g) = 0.961 W/kg

Maximum value of SAR (measured) = 1.21 W/kg

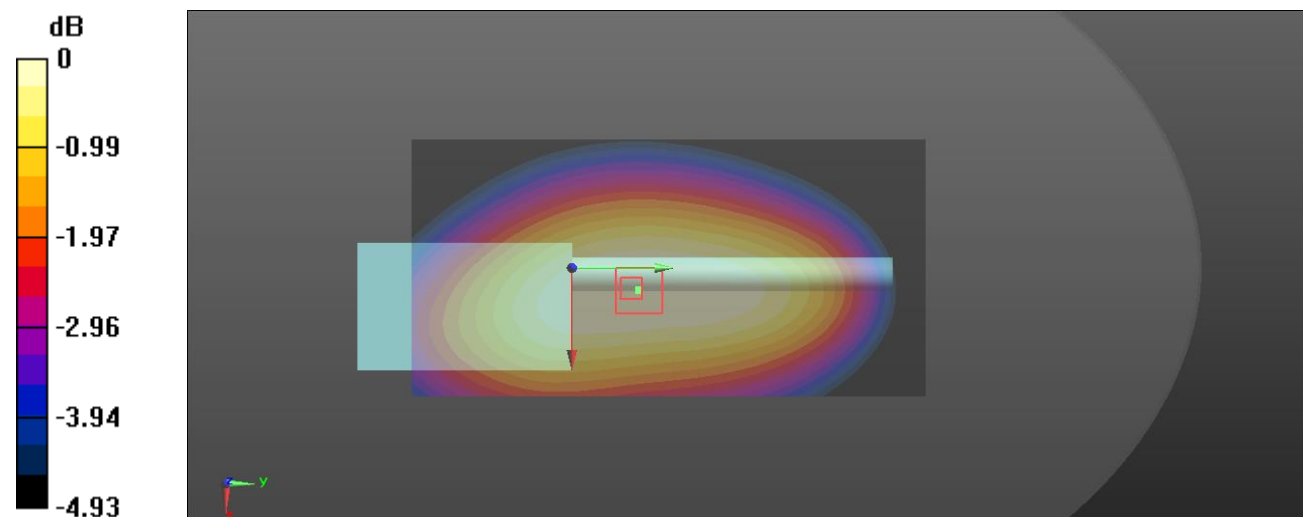

0 dB = 1.21 W/kg = 0.83 dBW/kg

Plot 27#: 4FSK 12.5kHz_143MHz_Face Up_Antenna 1**DUT: Two Way Radio; Type: DR5610S-1; Serial: CR22040011-SA-S2**

Communication System: 4FSK; Frequency: 143 MHz; Duty Cycle: 1:2

Medium parameters used: $f = 143$ MHz; $\sigma = 0.748$ S/m; $\epsilon_r = 52.689$; $\rho = 1000$ kg/m³

Phantom section: Flat Section

DASY5 Configuration:

- Probe: ES3DV2 - SN3019; ConvF(7.69, 7.69, 7.69) @ 143 MHz; Calibrated: 2021/12/13
- Sensor-Surface: 4mm (Mechanical Surface Detection)
- Electronics: DAE4 Sn1354; Calibrated: 2021/9/1
- Phantom: ELI v8.0; Type: QDOVA002AA; Serial: TP:2051
- Measurement SW: DASY52, Version 52.10 (2); SEMCAD X Version 14.6.12 (7470)

Area Scan (71x161x1): Interpolated grid: dx=1.500 mm, dy=1.500 mm

Maximum value of SAR (interpolated) = 0.697 W/kg

Zoom Scan (6x8x7)/Cube 0: Measurement grid: dx=8mm, dy=8mm, dz=5mm

Reference Value = 29.89 V/m; Power Drift = 0.17 dB

Peak SAR (extrapolated) = 0.812 W/kg

SAR(1 g) = 0.659 W/kg; SAR(10 g) = 0.540 W/kg

Maximum value of SAR (measured) = 0.700 W/kg

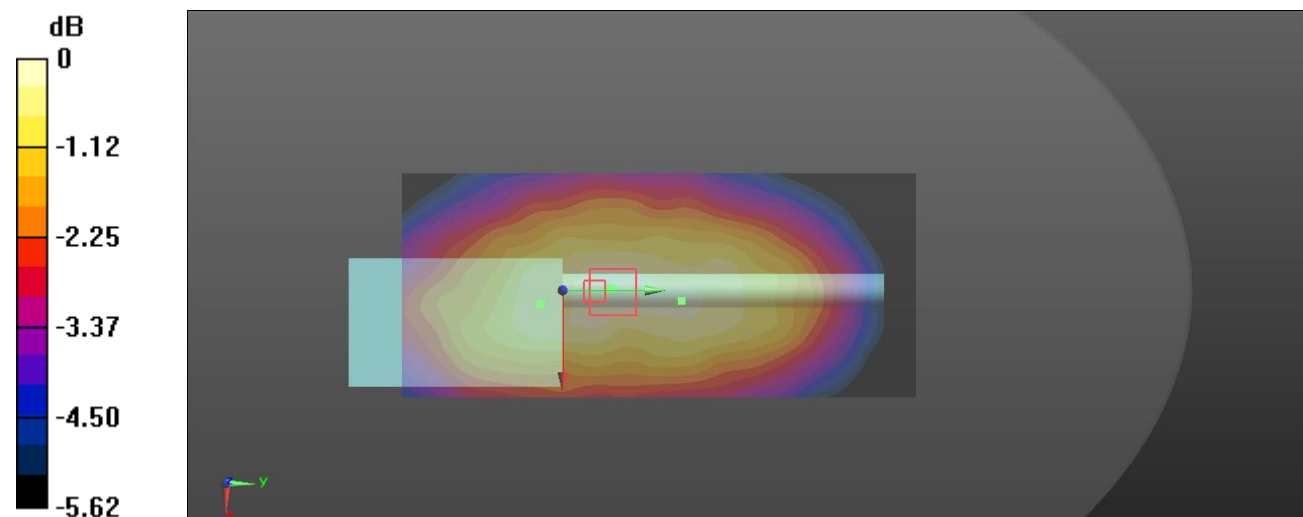

0 dB = 0.700 W/kg = -1.55 dBW/kg

Plot 28#: 4FSK 12.5kHz_150.0125MHz_Face Up_Antenna 2**DUT: Two Way Radio; Type: DR5610S-1; Serial: CR22040011-SA-S2**

Communication System: 4FSK; Frequency: 150.012 MHz; Duty Cycle: 1:2

Medium parameters used: $f = 150.012$ MHz; $\sigma = 0.769$ S/m; $\epsilon_r = 52.419$; $\rho = 1000$ kg/m³

Phantom section: Flat Section

DASY5 Configuration:

- Probe: ES3DV2 - SN3019; ConvF(7.69, 7.69, 7.69) @ 150.012 MHz; Calibrated: 2021/12/13
- Sensor-Surface: 4mm (Mechanical Surface Detection)
- Electronics: DAE4 Sn1354; Calibrated: 2021/9/1
- Phantom: ELI v8.0; Type: QDOVA002AA; Serial: TP:2051
- Measurement SW: DASY52, Version 52.10 (2); SEMCAD X Version 14.6.12 (7470)

Area Scan (81x161x1): Interpolated grid: dx=1.500 mm, dy=1.500 mm

Maximum value of SAR (interpolated) = 0.614 W/kg

Zoom Scan (6x6x7)/Cube 0: Measurement grid: dx=8mm, dy=8mm, dz=5mm

Reference Value = 27.41 V/m; Power Drift = -0.12 dB

Peak SAR (extrapolated) = 0.758 W/kg

SAR(1 g) = 0.576 W/kg; SAR(10 g) = 0.467 W/kg

Maximum value of SAR (measured) = 0.609 W/kg

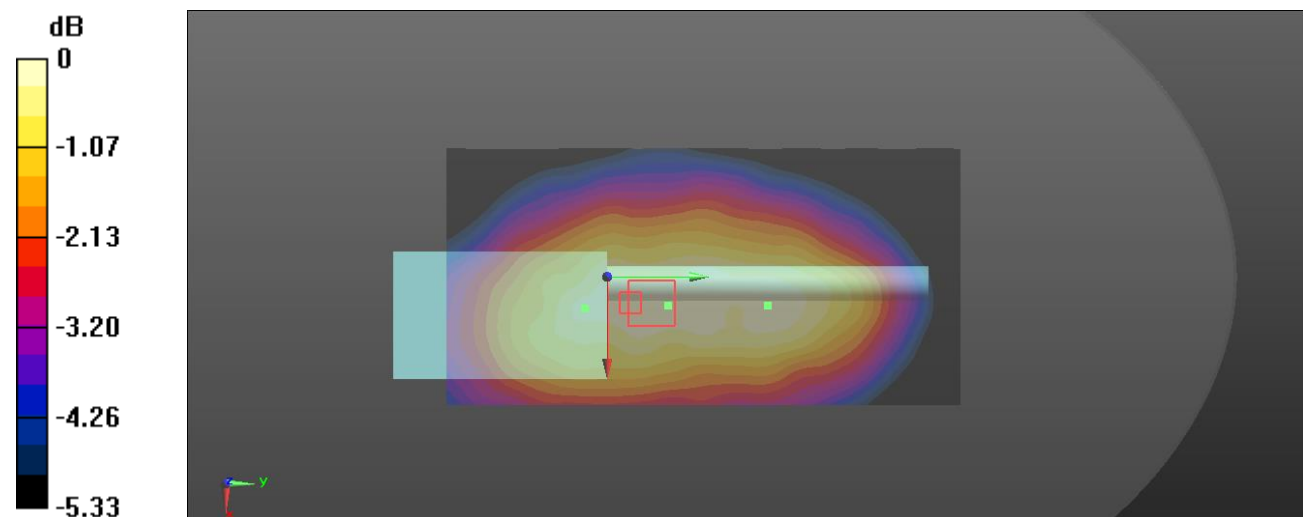

0 dB = 0.609 W/kg = -2.15 dBW/kg

Plot 29#: FM 12.5kHz_136.0125MHz_Body Back_Antenna 1**DUT: Two Way Radio; Type: DR5610S-1; Serial: CR22040011-SA-S2**

Communication System: FM; Frequency: 136.012 MHz; Duty Cycle: 1:1

Medium parameters used: $f = 136.012$ MHz; $\sigma = 0.769$ S/m; $\epsilon_r = 62.393$; $\rho = 1000$ kg/m³

Phantom section: Flat Section

DASY5 Configuration:

- Probe: ES3DV2 - SN3019; ConvF(7.51, 7.51, 7.51) @ 136.012 MHz; Calibrated: 2021/12/13
- Sensor-Surface: 4mm (Mechanical Surface Detection)
- Electronics: DAE4 Sn1354; Calibrated: 2021/9/1
- Phantom: ELI v8.0; Type: QDOVA002AA; Serial: TP:2051
- Measurement SW: DASY52, Version 52.10 (2); SEMCAD X Version 14.6.12 (7470)

Area Scan (71x161x1): Interpolated grid: dx=1.500 mm, dy=1.500 mm

Maximum value of SAR (interpolated) = 4.70 W/kg

Zoom Scan (5x5x7)/Cube 0: Measurement grid: dx=8mm, dy=8mm, dz=5mm

Reference Value = 43.98 V/m; Power Drift = -0.15 dB

Peak SAR (extrapolated) = 13.0 W/kg

SAR(1 g) = 4.85 W/kg; SAR(10 g) = 2.56 W/kg

Maximum value of SAR (measured) = 4.89 W/kg

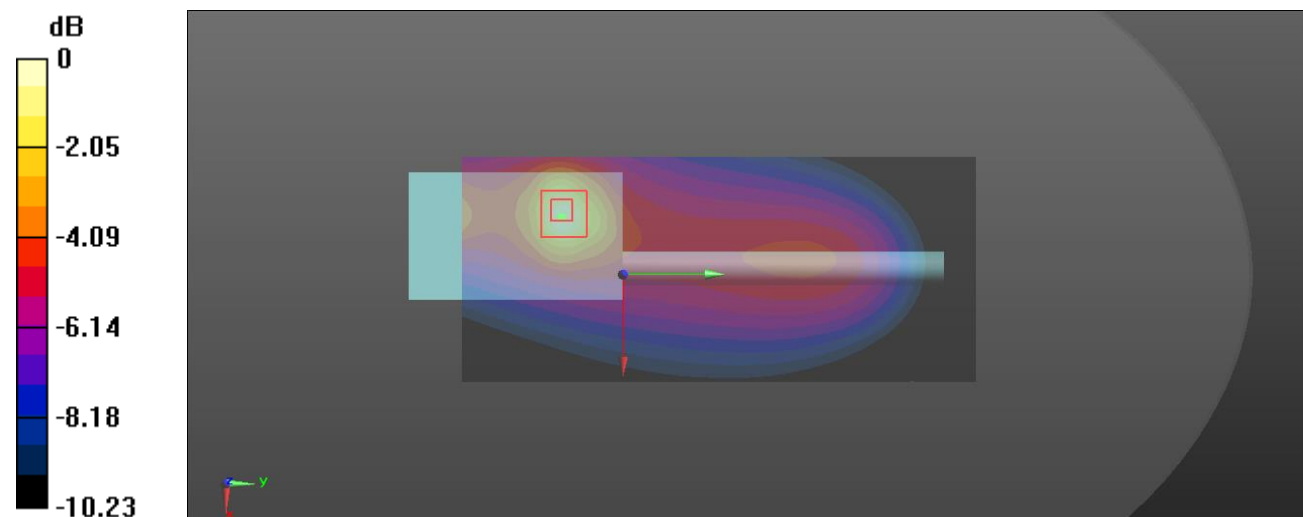

0 dB = 4.89 W/kg = 6.89 dBW/kg

Plot 30#: FM 12.5kHz_143MHz_Body Back_Antenna 1**DUT: Two Way Radio; Type: DR5610S-1; Serial: CR22040011-SA-S2**

Communication System: FM; Frequency: 143 MHz; Duty Cycle: 1:1

Medium parameters used: $f = 143 \text{ MHz}$; $\sigma = 0.776 \text{ S/m}$; $\epsilon_r = 62.208$; $\rho = 1000 \text{ kg/m}^3$

Phantom section: Flat Section

DASY5 Configuration:

- Probe: ES3DV2 - SN3019; ConvF(7.51, 7.51, 7.51) @ 143 MHz; Calibrated: 2021/12/13
- Sensor-Surface: 4mm (Mechanical Surface Detection)
- Electronics: DAE4 Sn1354; Calibrated: 2021/9/1
- Phantom: ELI v8.0; Type: QDOVA002AA; Serial: TP:2051
- Measurement SW: DASY52, Version 52.10 (2); SEMCAD X Version 14.6.12 (7470)

Area Scan (71x161x1): Interpolated grid: $dx=1.500 \text{ mm}$, $dy=1.500 \text{ mm}$

Maximum value of SAR (interpolated) = 10.1 W/kg

Zoom Scan (5x5x7)/Cube 0: Measurement grid: $dx=8\text{mm}$, $dy=8\text{mm}$, $dz=5\text{mm}$

Reference Value = 74.65 V/m; Power Drift = 0.01 dB

Peak SAR (extrapolated) = 25.2 W/kg

SAR(1 g) = 9.58 W/kg; SAR(10 g) = 5.08 W/kg

Maximum value of SAR (measured) = 9.91 W/kg

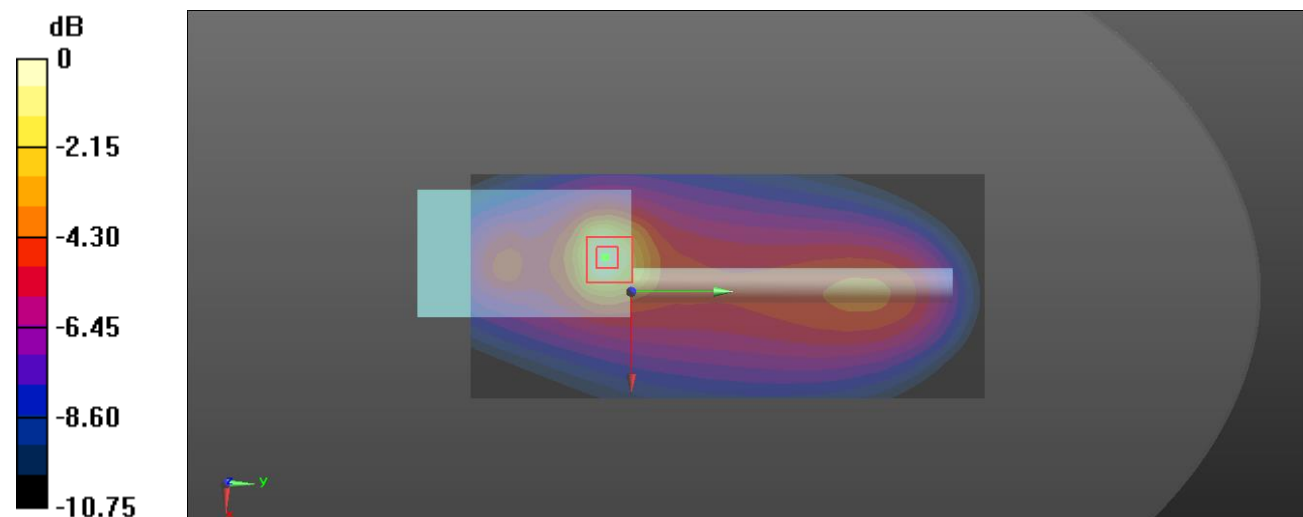

0 dB = 9.91 W/kg = 9.96 dBW/kg

Plot 31#: FM 12.5kHz_149.9875MHz_Body Back_Antenna 1**DUT: Two Way Radio; Type: DR5610S-1; Serial: CR22040011-SA-S2**

Communication System: FM; Frequency: 149.988 MHz; Duty Cycle: 1:1

Medium parameters used: $f = 149.988$ MHz; $\sigma = 0.782$ S/m; $\epsilon_r = 62.043$; $\rho = 1000$ kg/m³

Phantom section: Flat Section

DASY5 Configuration:

- Probe: ES3DV2 - SN3019; ConvF(7.51, 7.51, 7.51) @ 149.988 MHz; Calibrated: 2021/12/13
- Sensor-Surface: 4mm (Mechanical Surface Detection)
- Electronics: DAE4 Sn1354; Calibrated: 2021/9/1
- Phantom: ELI v8.0; Type: QDOVA002AA; Serial: TP:2051
- Measurement SW: DASY52, Version 52.10 (2); SEMCAD X Version 14.6.12 (7470)

Area Scan (71x161x1): Interpolated grid: dx=1.500 mm, dy=1.500 mm

Maximum value of SAR (interpolated) = 5.20 W/kg

Zoom Scan (5x5x7)/Cube 0: Measurement grid: dx=8mm, dy=8mm, dz=5mm

Reference Value = 54.98 V/m; Power Drift = 0.03 dB

Peak SAR (extrapolated) = 8.60 W/kg

SAR(1 g) = 4.14 W/kg; SAR(10 g) = 2.14 W/kg

Maximum value of SAR (measured) = 5.19 W/kg

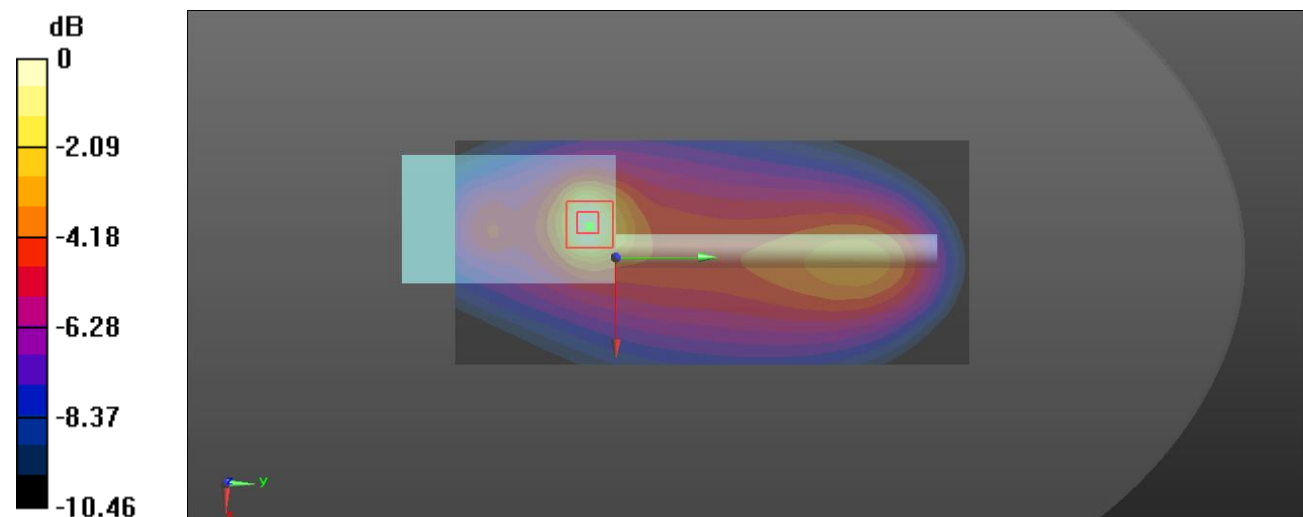

0 dB = 5.19 W/kg = 7.15 dBW/kg

Plot 32#: FM 12.5kHz_150.0125MHz_Body Back_Antenna 2**DUT: Two Way Radio; Type: DR5610S-1; Serial: CR22040011-SA-S2**

Communication System: FM; Frequency: 150.012 MHz; Duty Cycle: 1:1

Medium parameters used: $f = 150.012$ MHz; $\sigma = 0.788$ S/m; $\epsilon_r = 61.971$; $\rho = 1000$ kg/m³

Phantom section: Flat Section

DASY5 Configuration:

- Probe: ES3DV2 - SN3019; ConvF(7.51, 7.51, 7.51) @ 150.012 MHz; Calibrated: 2021/12/13
- Sensor-Surface: 4mm (Mechanical Surface Detection)
- Electronics: DAE4 Sn1354; Calibrated: 2021/9/1
- Phantom: ELI v8.0; Type: QDOVA002AA; Serial: TP:2051
- Measurement SW: DASY52, Version 52.10 (2); SEMCAD X Version 14.6.12 (7470)

Area Scan (81x191x1): Interpolated grid: dx=1.500 mm, dy=1.500 mm

Maximum value of SAR (interpolated) = 10.8 W/kg

Zoom Scan (5x5x7)/Cube 0: Measurement grid: dx=8mm, dy=8mm, dz=5mm

Reference Value = 96.50 V/m; Power Drift = -0.16 dB

Peak SAR (extrapolated) = 23.1 W/kg

SAR(1 g) = 9.72 W/kg; SAR(10 g) = 5.76 W/kg

Maximum value of SAR (measured) = 10.7 W/kg

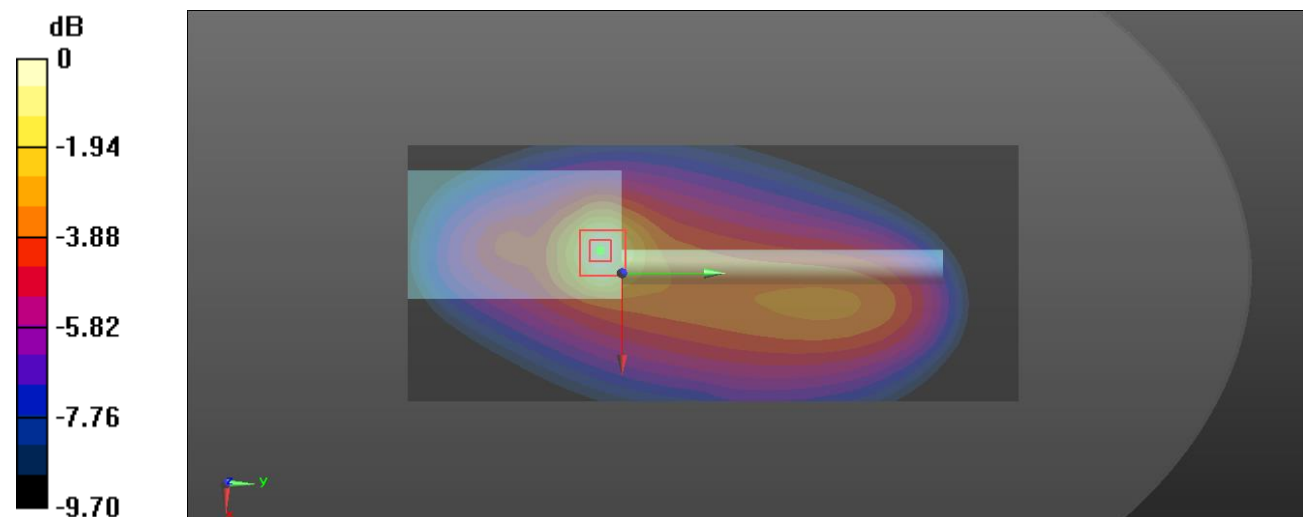

0 dB = 10.7 W/kg = 10.29 dBW/kg

Plot 33#: FM 25kHz_158.0125MHz_Body Back_Antenna 2**DUT: Two Way Radio; Type: DR5610S-1; Serial: CR22040011-SA-S2**

Communication System: FM; Frequency: 158.012 MHz; Duty Cycle: 1:1

Medium parameters used: $f = 158.012$ MHz; $\sigma = 0.798$ S/m; $\epsilon_r = 61.646$; $\rho = 1000$ kg/m³

Phantom section: Flat Section

DASY5 Configuration:

- Probe: ES3DV2 - SN3019; ConvF(7.51, 7.51, 7.51) @ 158.012 MHz; Calibrated: 2021/12/13
- Sensor-Surface: 4mm (Mechanical Surface Detection)
- Electronics: DAE4 Sn1354; Calibrated: 2021/9/1
- Phantom: ELI v8.0; Type: QDOVA002AA; Serial: TP:2051
- Measurement SW: DASY52, Version 52.10 (2); SEMCAD X Version 14.6.12 (7470)

Area Scan (81x161x1): Interpolated grid: dx=1.500 mm, dy=1.500 mm

Maximum value of SAR (interpolated) = 3.83 W/kg

Zoom Scan (5x5x7)/Cube 0: Measurement grid: dx=8mm, dy=8mm, dz=5mm

Reference Value = 61.05 V/m; Power Drift = 0.11 dB

Peak SAR (extrapolated) = 8.90 W/kg

SAR(1 g) = 3.98 W/kg; SAR(10 g) = 2.38 W/kg

Maximum value of SAR (measured) = 4.17 W/kg

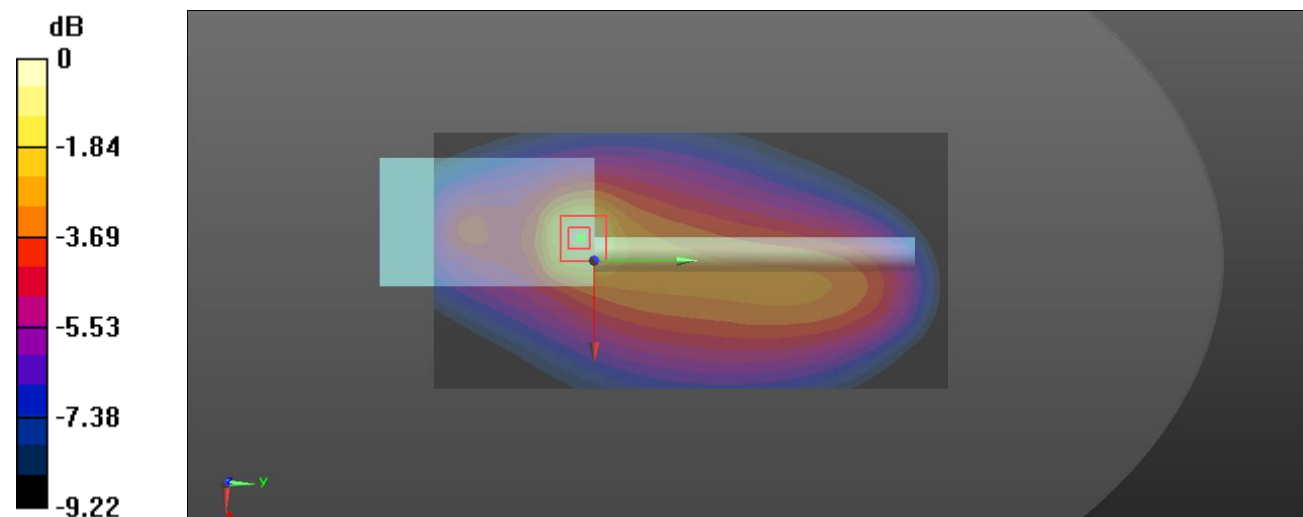

0 dB = 4.17 W/kg = 6.20 dBW/kg

Plot 34#: FM 25kHz_165.9875MHz_Body Back_Antenna 2**DUT: Two Way Radio; Type: DR5610S-1; Serial: CR22040011-SA-S2**

Communication System: FM; Frequency: 165.988 MHz; Duty Cycle: 1:1

Medium parameters used: $f = 165.988$ MHz; $\sigma = 0.805$ S/m; $\epsilon_r = 61.402$; $\rho = 1000$ kg/m³

Phantom section: Flat Section

DASY5 Configuration:

- Probe: ES3DV2 - SN3019; ConvF(7.51, 7.51, 7.51) @ 165.988 MHz; Calibrated: 2021/12/13
- Sensor-Surface: 4mm (Mechanical Surface Detection)
- Electronics: DAE4 Sn1354; Calibrated: 2021/9/1
- Phantom: ELI v8.0; Type: QDOVA002AA; Serial: TP:2051
- Measurement SW: DASY52, Version 52.10 (2); SEMCAD X Version 14.6.12 (7470)

Area Scan (81x161x1): Interpolated grid: dx=1.500 mm, dy=1.500 mm

Maximum value of SAR (interpolated) = 2.90 W/kg

Zoom Scan (5x5x7)/Cube 0: Measurement grid: dx=8mm, dy=8mm, dz=5mm

Reference Value = 46.04 V/m; Power Drift = -0.10 dB

Peak SAR (extrapolated) = 7.46 W/kg

SAR(1 g) = 2.78 W/kg; SAR(10 g) = 1.52 W/kg

Maximum value of SAR (measured) = 2.84 W/kg

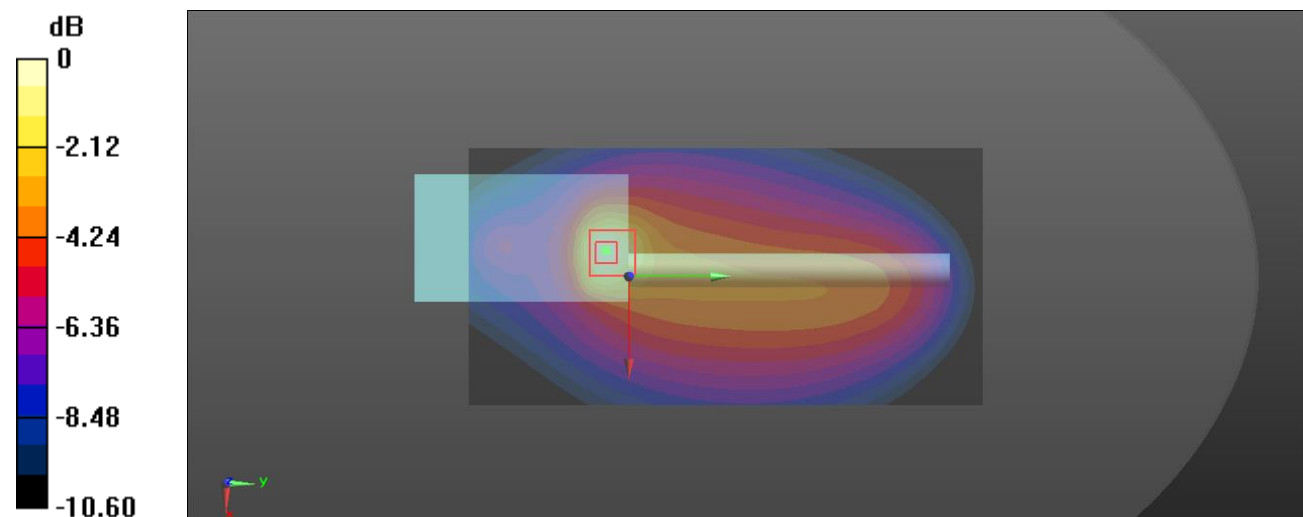

0 dB = 2.84 W/kg = 4.53 dBW/kg

Plot 35#: FM 25kHz_173.9875MHz_Body Back_Antenna 2**DUT: Two Way Radio; Type: DR5610S-1; Serial: CR22040011-SA-S2**

Communication System: FM; Frequency: 173.988 MHz; Duty Cycle: 1:1

Medium parameters used: $f = 173.988$ MHz; $\sigma = 0.816$ S/m; $\epsilon_r = 61.135$; $\rho = 1000$ kg/m³

Phantom section: Flat Section

DASY5 Configuration:

- Probe: ES3DV2 - SN3019; ConvF(7.51, 7.51, 7.51) @ 173.988 MHz; Calibrated: 2021/12/13
- Sensor-Surface: 4mm (Mechanical Surface Detection)
- Electronics: DAE4 Sn1354; Calibrated: 2021/9/1
- Phantom: ELI v8.0; Type: QDOVA002AA; Serial: TP:2051
- Measurement SW: DASY52, Version 52.10 (2); SEMCAD X Version 14.6.12 (7470)

Area Scan (81x161x1): Interpolated grid: dx=1.500 mm, dy=1.500 mm

Maximum value of SAR (interpolated) = 2.61 W/kg

Zoom Scan (5x5x7)/Cube 0: Measurement grid: dx=8mm, dy=8mm, dz=5mm

Reference Value = 38.41 V/m; Power Drift = -0.07 dB

Peak SAR (extrapolated) = 4.62 W/kg

SAR(1 g) = 2.5 W/kg; SAR(10 g) = 0.852 W/kg

Maximum value of SAR (measured) = 2.83 W/kg

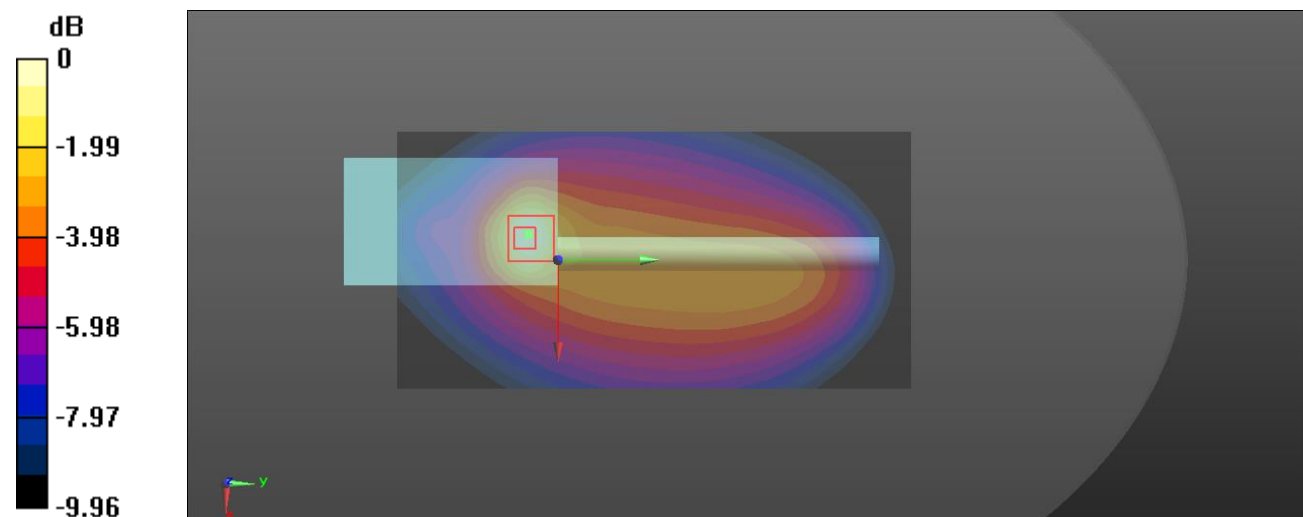

0 dB = 2.83 W/kg = 4.52 dBW/kg

Plot 36#: FM 25kHz_143MHz_Body Back_Antenna 1**DUT: Two Way Radio; Type: DR5610S-1; Serial: CR22040011-SA-S2**

Communication System: FM; Frequency: 143 MHz; Duty Cycle: 1:1

Medium parameters used: $f = 143 \text{ MHz}$; $\sigma = 0.776 \text{ S/m}$; $\epsilon_r = 62.208$; $\rho = 1000 \text{ kg/m}^3$

Phantom section: Flat Section

DASY5 Configuration:

- Probe: ES3DV2 - SN3019; ConvF(7.51, 7.51, 7.51) @ 143 MHz; Calibrated: 2021/12/13
- Sensor-Surface: 4mm (Mechanical Surface Detection)
- Electronics: DAE4 Sn1354; Calibrated: 2021/9/1
- Phantom: ELI v8.0; Type: QDOVA002AA; Serial: TP:2051
- Measurement SW: DASY52, Version 52.10 (2); SEMCAD X Version 14.6.12 (7470)

Area Scan (71x161x1): Interpolated grid: $dx=1.500 \text{ mm}$, $dy=1.500 \text{ mm}$

Maximum value of SAR (interpolated) = 8.83 W/kg

Zoom Scan (5x5x7)/Cube 0: Measurement grid: $dx=8\text{mm}$, $dy=8\text{mm}$, $dz=5\text{mm}$

Reference Value = 62.80 V/m; Power Drift = -0.09 dB

Peak SAR (extrapolated) = 24.6 W/kg

SAR(1 g) = 9.42 W/kg; SAR(10 g) = 5.04 W/kg

Maximum value of SAR (measured) = 9.45 W/kg

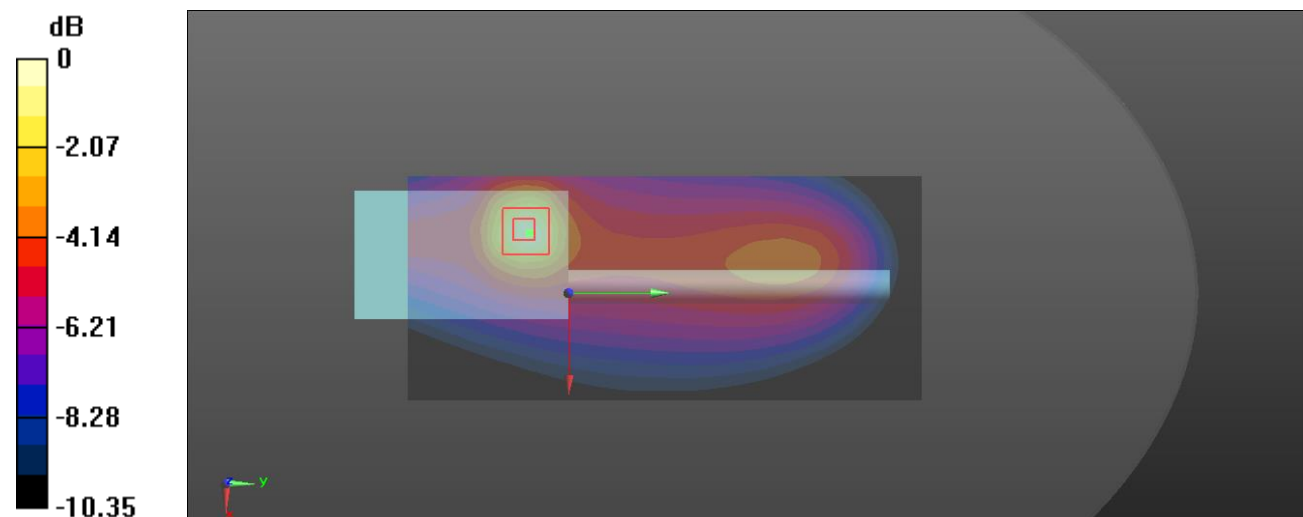

0 dB = 9.45 W/kg = 9.75 dBW/kg

Plot 37#: FM 25kHz_150.0125MHz_Body Back_Antenna 2**DUT: Two Way Radio; Type: DR5610S-1; Serial: CR22040011-SA-S2**

Communication System: FM; Frequency: 150.012 MHz; Duty Cycle: 1:1

Medium parameters used: $f = 150.012$ MHz; $\sigma = 0.788$ S/m; $\epsilon_r = 61.971$; $\rho = 1000$ kg/m³

Phantom section: Flat Section

DASY5 Configuration:

- Probe: ES3DV2 - SN3019; ConvF(7.51, 7.51, 7.51) @ 150.012 MHz; Calibrated: 2021/12/13
- Sensor-Surface: 4mm (Mechanical Surface Detection)
- Electronics: DAE4 Sn1354; Calibrated: 2021/9/1
- Phantom: ELI v8.0; Type: QDOVA002AA; Serial: TP:2051
- Measurement SW: DASY52, Version 52.10 (2); SEMCAD X Version 14.6.12 (7470)

Area Scan (81x161x1): Interpolated grid: dx=1.500 mm, dy=1.500 mm

Maximum value of SAR (interpolated) = 11.6 W/kg

Zoom Scan (5x5x7)/Cube 0: Measurement grid: dx=8mm, dy=8mm, dz=5mm

Reference Value = 95.97 V/m; Power Drift = -0.14 dB

Peak SAR (extrapolated) = 27.7 W/kg

SAR(1 g) = 8.92 W/kg; SAR(10 g) = 5.22 W/kg

Maximum value of SAR (measured) = 11.7 W/kg

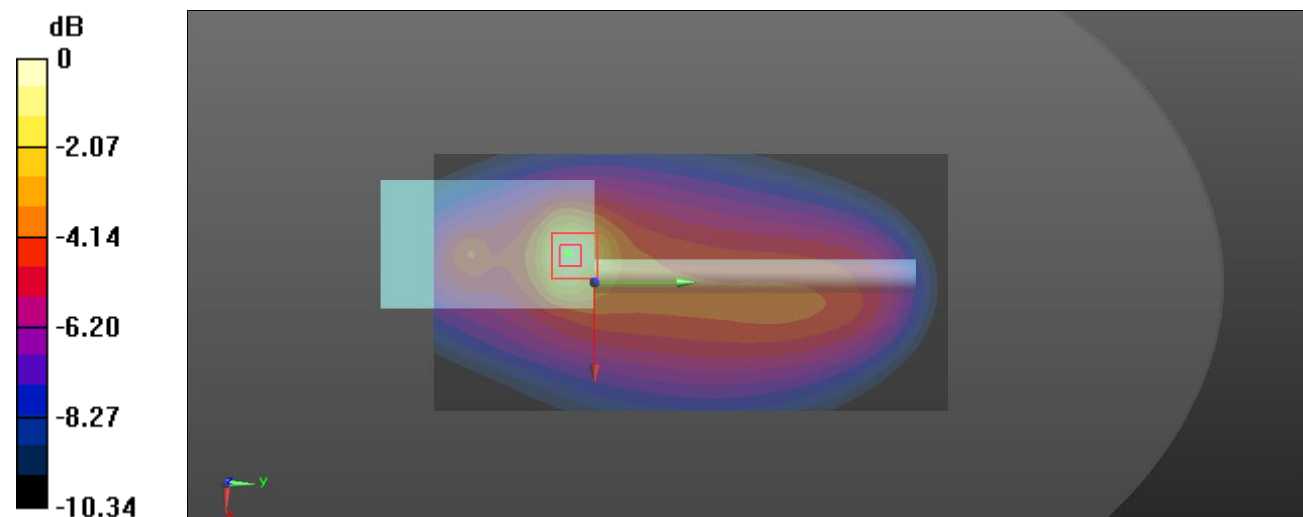

0 dB = 11.7 W/kg = 10.68 dBW/kg

Plot 38#: 4FSK 12.5kHz_143MHz_Body Back_Antenna 1**DUT: Two Way Radio; Type: DR5610S-1; Serial: CR22040011-SA-S2**

Communication System: 4FSK; Frequency: 143 MHz; Duty Cycle: 1:2

Medium parameters used: $f = 143$ MHz; $\sigma = 0.776$ S/m; $\epsilon_r = 62.208$; $\rho = 1000$ kg/m³

Phantom section: Flat Section

DASY5 Configuration:

- Probe: ES3DV2 - SN3019; ConvF(7.51, 7.51, 7.51) @ 143 MHz; Calibrated: 2021/12/13
- Sensor-Surface: 4mm (Mechanical Surface Detection)
- Electronics: DAE4 Sn1354; Calibrated: 2021/9/1
- Phantom: ELI v8.0; Type: QDOVA002AA; Serial: TP:2051
- Measurement SW: DASY52, Version 52.10 (2); SEMCAD X Version 14.6.12 (7470)

Area Scan (71x161x1): Interpolated grid: dx=1.500 mm, dy=1.500 mm

Maximum value of SAR (interpolated) = 3.76 W/kg

Zoom Scan (5x5x7)/Cube 0: Measurement grid: dx=8mm, dy=8mm, dz=5mm

Reference Value = 46.22 V/m; Power Drift = 0.06 dB

Peak SAR (extrapolated) = 9.05 W/kg

SAR(1 g) = 3.4 W/kg; SAR(10 g) = 1.8 W/kg

Maximum value of SAR (measured) = 3.36 W/kg

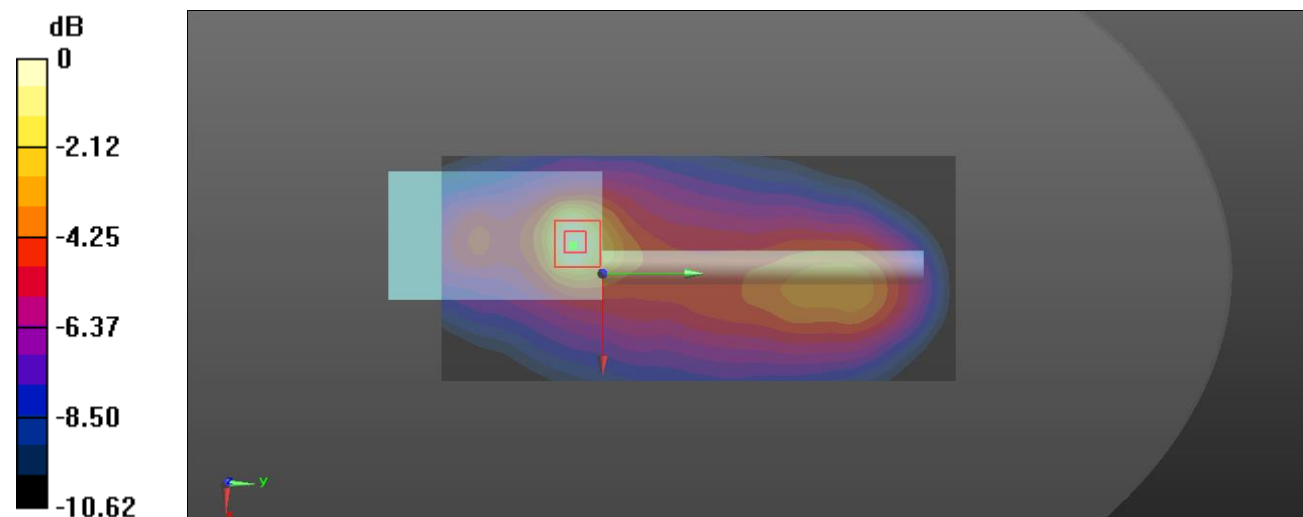

0 dB = 3.36 W/kg = 5.26 dBW/kg

Plot 39#: 4FSK 12.5kHz_150.0125MHz_Body Back_Antenna 2**DUT: Two Way Radio; Type: DR5610S-1; Serial: CR22040011-SA-S2**

Communication System: 4FSK; Frequency: 150.012 MHz; Duty Cycle: 1:2

Medium parameters used: $f = 150.012$ MHz; $\sigma = 0.788$ S/m; $\epsilon_r = 61.971$; $\rho = 1000$ kg/m³

Phantom section: Flat Section

DASY5 Configuration:

- Probe: ES3DV2 - SN3019; ConvF(7.51, 7.51, 7.51) @ 150.012 MHz; Calibrated: 2021/12/13
- Sensor-Surface: 4mm (Mechanical Surface Detection)
- Electronics: DAE4 Sn1354; Calibrated: 2021/9/1
- Phantom: ELI v8.0; Type: QDOVA002AA; Serial: TP:2051
- Measurement SW: DASY52, Version 52.10 (2); SEMCAD X Version 14.6.12 (7470)

Area Scan (81x161x1): Interpolated grid: dx=1.500 mm, dy=1.500 mm

Maximum value of SAR (interpolated) = 6.23 W/kg

Zoom Scan (5x5x7)/Cube 0: Measurement grid: dx=8mm, dy=8mm, dz=5mm

Reference Value = 60.90 V/m; Power Drift = 0.01 dB

Peak SAR (extrapolated) = 17.1 W/kg

SAR(1 g) = 4.78 W/kg; SAR(10 g) = 2.61 W/kg

Maximum value of SAR (measured) = 5.57 W/kg

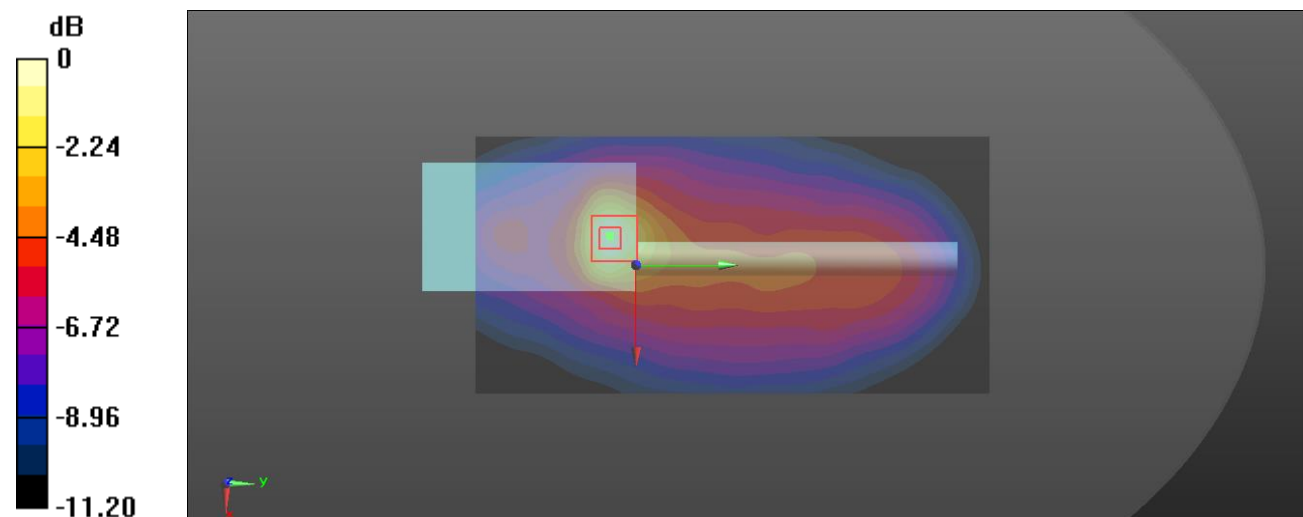

0 dB = 5.57 W/kg = 7.46 dBW/kg

Plot 40#: FM 12.5kHz_143MHz_Face Up_Antenna 1**DUT: Two Way Radio; Type: DR5510S-1; Serial: CR22040011-SA-S3**

Communication System: FM; Frequency: 143 MHz; Duty Cycle: 1:1

Medium parameters used: $f = 143 \text{ MHz}$; $\sigma = 0.748 \text{ S/m}$; $\epsilon_r = 52.689$; $\rho = 1000 \text{ kg/m}^3$

Phantom section: Flat Section

DASY5 Configuration:

- Probe: ES3DV2 - SN3019; ConvF(7.69, 7.69, 7.69) @ 143 MHz; Calibrated: 2021/12/13
- Sensor-Surface: 4mm (Mechanical Surface Detection)
- Electronics: DAE4 Sn1354; Calibrated: 2021/9/1
- Phantom: ELI v8.0; Type: QDOVA002AA; Serial: TP:2051
- Measurement SW: DASY52, Version 52.10 (2); SEMCAD X Version 14.6.12 (7470)

Area Scan (71x161x1): Interpolated grid: $dx=1.500 \text{ mm}$, $dy=1.500 \text{ mm}$

Maximum value of SAR (interpolated) = 1.52 W/kg

Zoom Scan (6x10x7)/Cube 0: Measurement grid: $dx=8\text{mm}$, $dy=8\text{mm}$, $dz=5\text{mm}$

Reference Value = 42.87 V/m; Power Drift = 0.03 dB

Peak SAR (extrapolated) = 1.86 W/kg

SAR(1 g) = 1.5 W/kg; SAR(10 g) = 1.24 W/kg

Maximum value of SAR (measured) = 1.55 W/kg

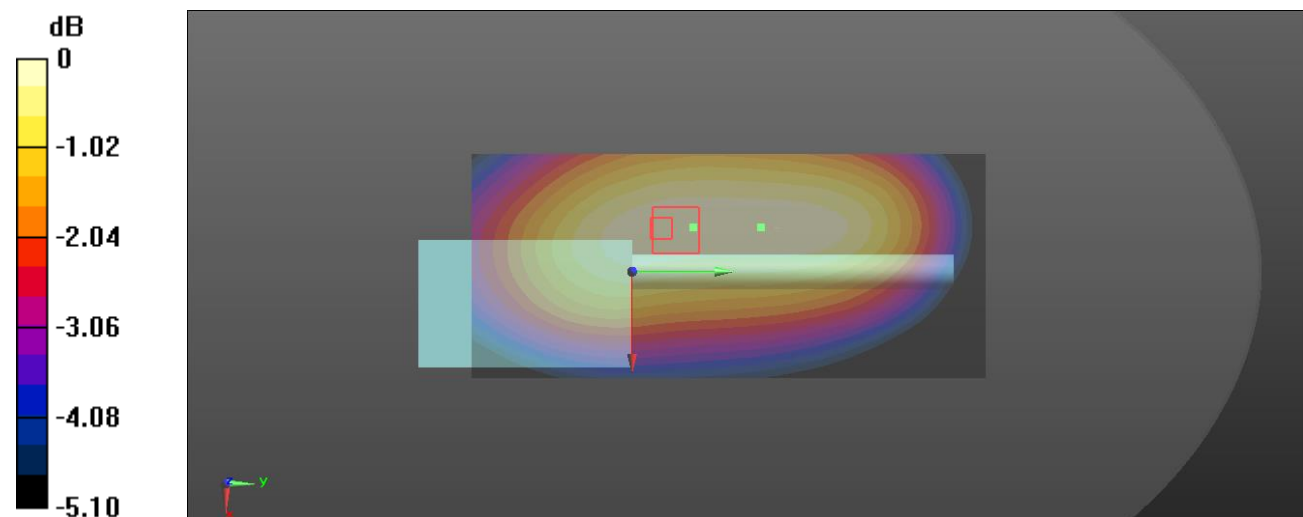

0 dB = 1.55 W/kg = 1.90 dBW/kg

Plot 41#: FM 12.5kHz_150.0125MHz_Face Up_Antenna 2**DUT: Two Way Radio; Type: DR5510S-1; Serial: CR22040011-SA-S3**

Communication System: FM; Frequency: 150.012 MHz; Duty Cycle: 1:1

Medium parameters used: $f = 150.012$ MHz; $\sigma = 0.769$ S/m; $\epsilon_r = 52.419$; $\rho = 1000$ kg/m³

Phantom section: Flat Section

DASY5 Configuration:

- Probe: ES3DV2 - SN3019; ConvF(7.69, 7.69, 7.69) @ 150.012 MHz; Calibrated: 2021/12/13
- Sensor-Surface: 4mm (Mechanical Surface Detection)
- Electronics: DAE4 Sn1354; Calibrated: 2021/9/1
- Phantom: ELI v8.0; Type: QDOVA002AA; Serial: TP:2051
- Measurement SW: DASY52, Version 52.10 (2); SEMCAD X Version 14.6.12 (7470)

Area Scan (81x161x1): Interpolated grid: dx=1.500 mm, dy=1.500 mm

Maximum value of SAR (interpolated) = 1.02 W/kg

Zoom Scan (5x5x7)/Cube 0: Measurement grid: dx=8mm, dy=8mm, dz=5mm

Reference Value = 34.99 V/m; Power Drift = -0.18 dB

Peak SAR (extrapolated) = 1.18 W/kg

SAR(1 g) = 0.970 W/kg; SAR(10 g) = 0.799 W/kg

Maximum value of SAR (measured) = 1.00 W/kg

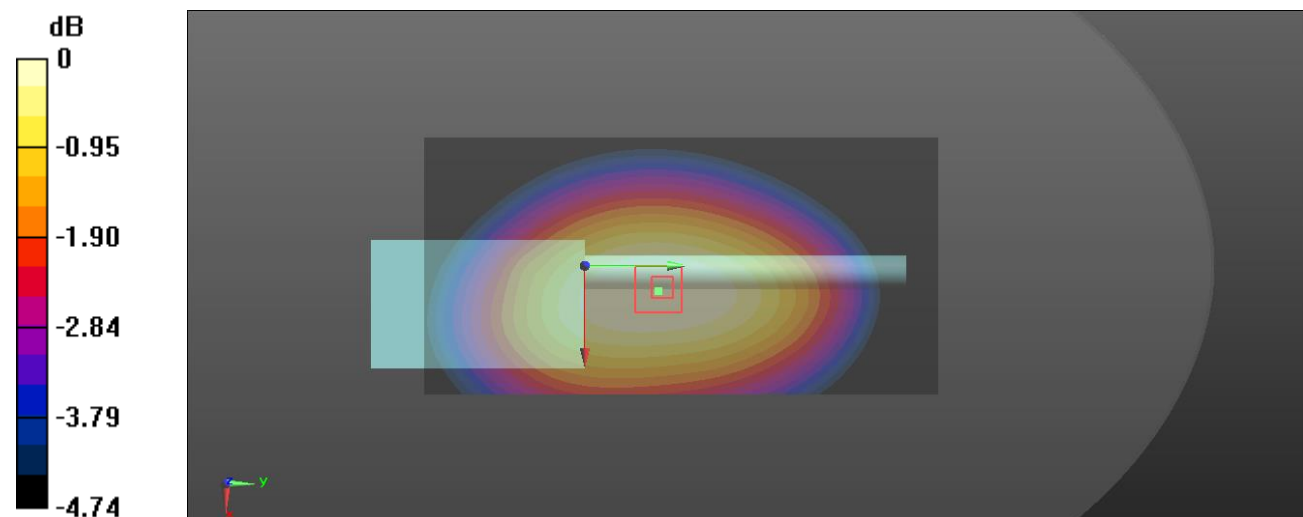

0 dB = 1.00 W/kg = 0.00 dBW/kg

Plot 42#: FM 25kHz_143MHz_Face Up_Antenna 1**DUT: Two Way Radio; Type: DR5510S-1; Serial: CR22040011-SA-S3**

Communication System: FM; Frequency: 143 MHz; Duty Cycle: 1:1

Medium parameters used: $f = 143$ MHz; $\sigma = 0.748$ S/m; $\epsilon_r = 52.689$; $\rho = 1000$ kg/m³

Phantom section: Flat Section

DASY5 Configuration:

- Probe: ES3DV2 - SN3019; ConvF(7.69, 7.69, 7.69) @ 143 MHz; Calibrated: 2021/12/13
- Sensor-Surface: 4mm (Mechanical Surface Detection)
- Electronics: DAE4 Sn1354; Calibrated: 2021/9/1
- Phantom: ELI v8.0; Type: QDOVA002AA; Serial: TP:2051
- Measurement SW: DASY52, Version 52.10 (2); SEMCAD X Version 14.6.12 (7470)

Area Scan (71x161x1): Interpolated grid: dx=1.500 mm, dy=1.500 mm

Maximum value of SAR (interpolated) = 2.33 W/kg

Zoom Scan (5x6x7)/Cube 0: Measurement grid: dx=8mm, dy=8mm, dz=5mm

Reference Value = 50.47 V/m; Power Drift = 0.12 dB

Peak SAR (extrapolated) = 3.39 W/kg

SAR(1 g) = 2.08 W/kg; SAR(10 g) = 1.75 W/kg

Maximum value of SAR (measured) = 2.36 W/kg

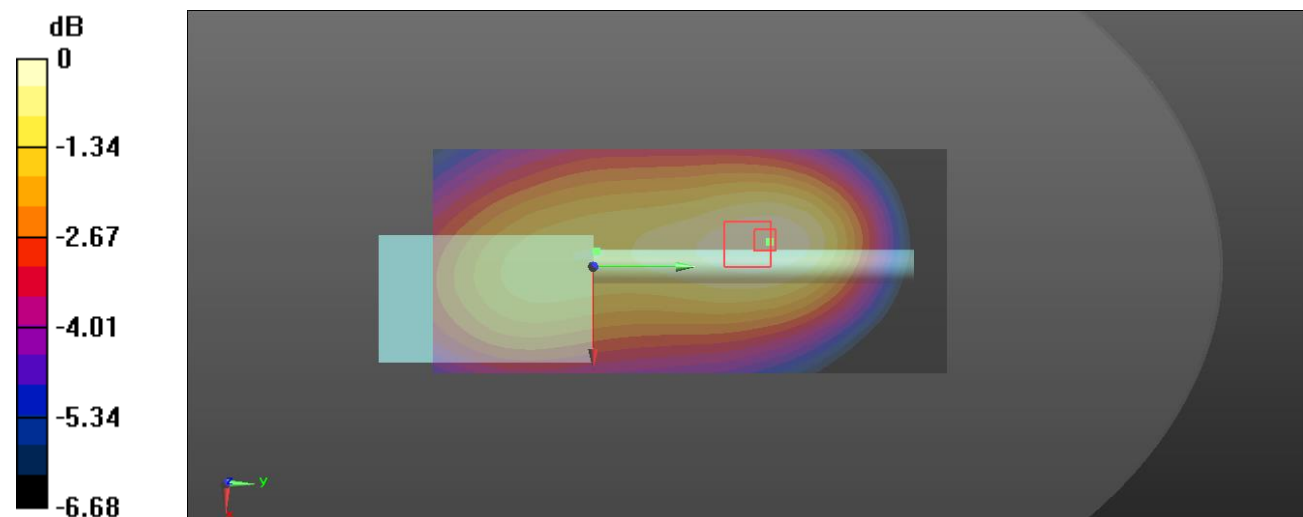

0 dB = 2.36 W/kg = 3.73 dBW/kg

Plot 43#: FM 25kHz_150.0125MHz_Face Up_Antenna 2**DUT: Two Way Radio; Type: DR5510S-1; Serial: CR22040011-SA-S3**

Communication System: FM; Frequency: 150.012 MHz; Duty Cycle: 1:1

Medium parameters used: $f = 150.012$ MHz; $\sigma = 0.769$ S/m; $\epsilon_r = 52.419$; $\rho = 1000$ kg/m³

Phantom section: Flat Section

DASY5 Configuration:

- Probe: ES3DV2 - SN3019; ConvF(7.69, 7.69, 7.69) @ 150.012 MHz; Calibrated: 2021/12/13
- Sensor-Surface: 4mm (Mechanical Surface Detection)
- Electronics: DAE4 Sn1354; Calibrated: 2021/9/1
- Phantom: ELI v8.0; Type: QDOVA002AA; Serial: TP:2051
- Measurement SW: DASY52, Version 52.10 (2); SEMCAD X Version 14.6.12 (7470)

Area Scan (81x161x1): Interpolated grid: dx=1.500 mm, dy=1.500 mm

Maximum value of SAR (interpolated) = 1.04 W/kg

Zoom Scan (5x5x7)/Cube 0: Measurement grid: dx=8mm, dy=8mm, dz=5mm

Reference Value = 38.06 V/m; Power Drift = -0.06 dB

Peak SAR (extrapolated) = 1.21 W/kg

SAR(1 g) = 0.997 W/kg; SAR(10 g) = 0.820 W/kg

Maximum value of SAR (measured) = 1.03 W/kg

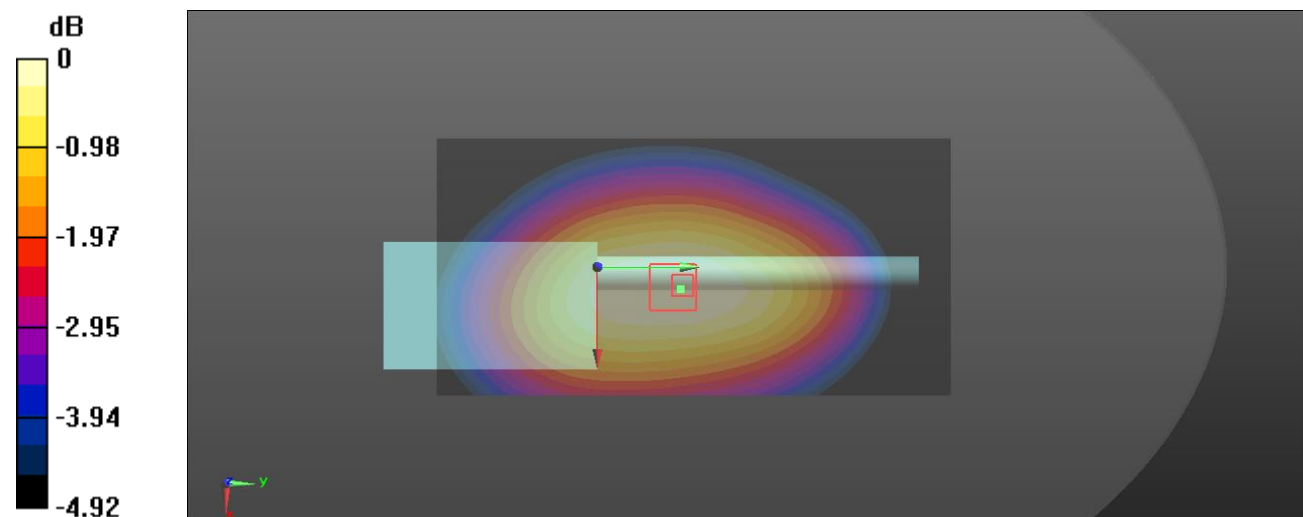

0 dB = 1.03 W/kg = 0.13 dBW/kg

Plot 44#: 4FSK 12.5kHz_143MHz_Face Up_Antenna 1**DUT: Two Way Radio; Type: DR5510S-1; Serial: CR22040011-SA-S3**

Communication System: 4FSK; Frequency: 143 MHz; Duty Cycle: 1:2

Medium parameters used: $f = 143$ MHz; $\sigma = 0.748$ S/m; $\epsilon_r = 52.689$; $\rho = 1000$ kg/m³

Phantom section: Flat Section

DASY5 Configuration:

- Probe: ES3DV2 - SN3019; ConvF(7.69, 7.69, 7.69) @ 143 MHz; Calibrated: 2021/12/13
- Sensor-Surface: 4mm (Mechanical Surface Detection)
- Electronics: DAE4 Sn1354; Calibrated: 2021/9/1
- Phantom: ELI v8.0; Type: QDOVA002AA; Serial: TP:2051
- Measurement SW: DASY52, Version 52.10 (2); SEMCAD X Version 14.6.12 (7470)

Area Scan (71x161x1): Interpolated grid: dx=1.500 mm, dy=1.500 mm

Maximum value of SAR (interpolated) = 0.637 W/kg

Zoom Scan (7x14x7)/Cube 0: Measurement grid: dx=8mm, dy=8mm, dz=5mm

Reference Value = 29.05 V/m; Power Drift = 0.10 dB

Peak SAR (extrapolated) = 0.904 W/kg

SAR(1 g) = 0.646 W/kg; SAR(10 g) = 0.531 W/kg

Maximum value of SAR (measured) = 0.685 W/kg

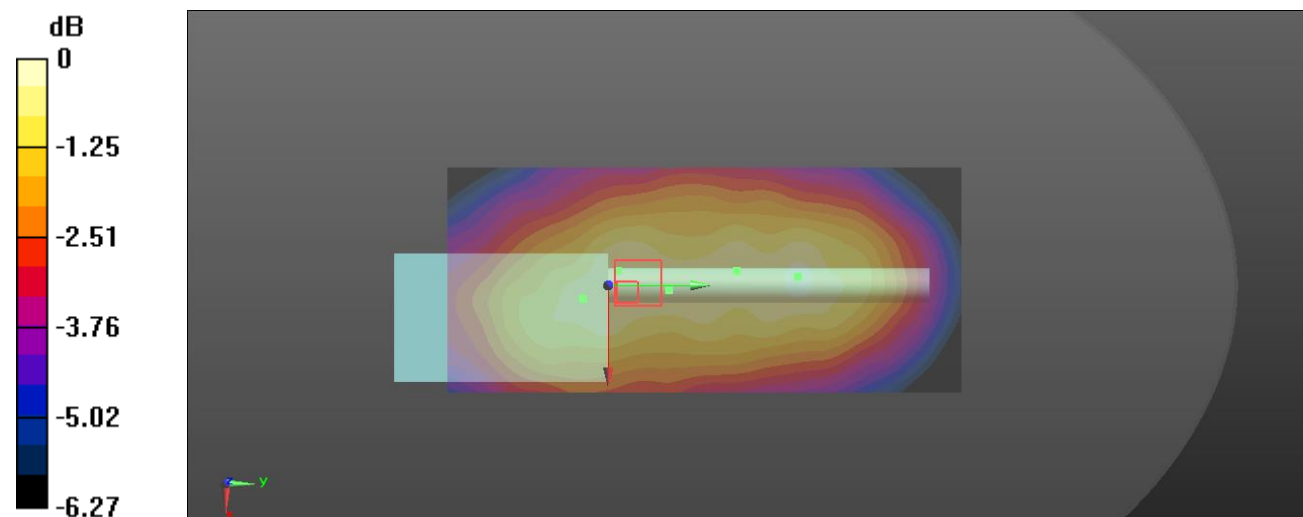

0 dB = 0.685 W/kg = -1.64 dBW/kg

Plot 45#: 4FSK 12.5kHz_150.0125MHz_Face Up_Antenna 2**DUT: Two Way Radio; Type: DR5510S-1; Serial: CR22040011-SA-S3**

Communication System: 4FSK; Frequency: 150.012 MHz; Duty Cycle: 1:2

Medium parameters used: $f = 150.012$ MHz; $\sigma = 0.769$ S/m; $\epsilon_r = 52.419$; $\rho = 1000$ kg/m³

Phantom section: Flat Section

DASY5 Configuration:

- Probe: ES3DV2 - SN3019; ConvF(7.69, 7.69, 7.69) @ 150.012 MHz; Calibrated: 2021/12/13
- Sensor-Surface: 4mm (Mechanical Surface Detection)
- Electronics: DAE4 Sn1354; Calibrated: 2021/9/1
- Phantom: ELI v8.0; Type: QDOVA002AA; Serial: TP:2051
- Measurement SW: DASY52, Version 52.10 (2); SEMCAD X Version 14.6.12 (7470)

Area Scan (81x161x1): Interpolated grid: dx=1.500 mm, dy=1.500 mm

Maximum value of SAR (interpolated) = 0.357 W/kg

Zoom Scan (7x7x7)/Cube 0: Measurement grid: dx=8mm, dy=8mm, dz=5mm

Reference Value = 21.64 V/m; Power Drift = -0.07 dB

Peak SAR (extrapolated) = 0.461 W/kg

SAR(1 g) = 0.346 W/kg; SAR(10 g) = 0.280 W/kg

Maximum value of SAR (measured) = 0.365 W/kg

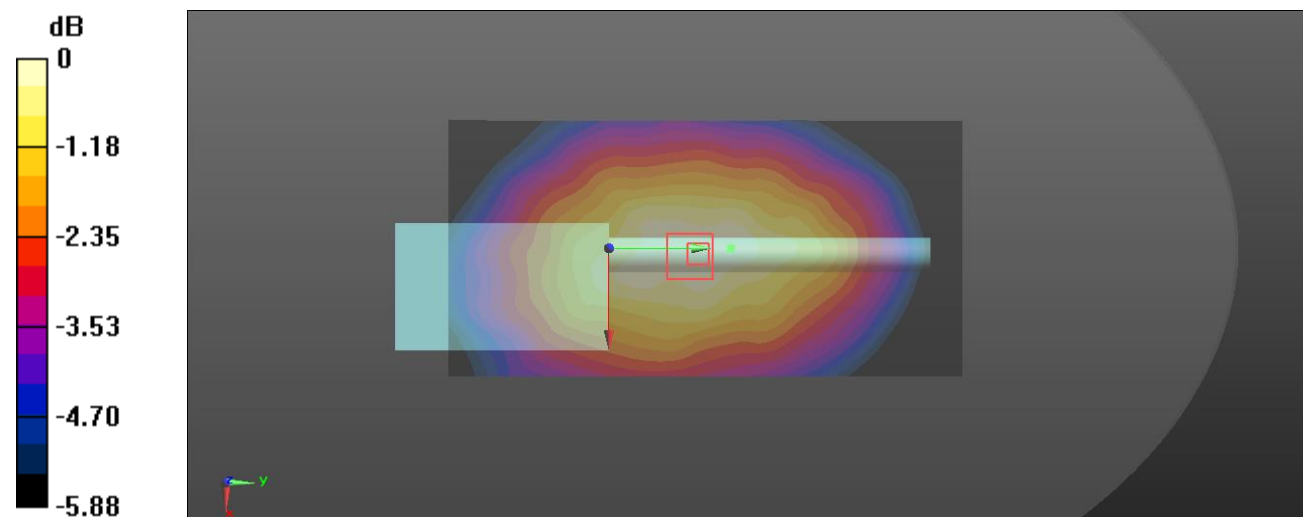

0 dB = 0.365 W/kg = -4.38 dBW/kg

Plot 46#: FM 12.5kHz_136.0125MHz_Body Back_Antenna 1**DUT: Two Way Radio; Type: DR5510S-1; Serial: CR22040011-SA-S3**

Communication System: FM; Frequency: 136.012 MHz; Duty Cycle: 1:1

Medium parameters used: $f = 136.012$ MHz; $\sigma = 0.769$ S/m; $\epsilon_r = 62.393$; $\rho = 1000$ kg/m³

Phantom section: Flat Section

DASY5 Configuration:

- Probe: ES3DV2 - SN3019; ConvF(7.51, 7.51, 7.51) @ 136.012 MHz; Calibrated: 2021/12/13
- Sensor-Surface: 4mm (Mechanical Surface Detection)
- Electronics: DAE4 Sn1354; Calibrated: 2021/9/1
- Phantom: ELI v8.0; Type: QDOVA002AA; Serial: TP:2051
- Measurement SW: DASY52, Version 52.10 (2); SEMCAD X Version 14.6.12 (7470)

Area Scan (71x161x1): Interpolated grid: dx=1.500 mm, dy=1.500 mm

Maximum value of SAR (interpolated) = 5.63 W/kg

Zoom Scan (5x5x7)/Cube 0: Measurement grid: dx=8mm, dy=8mm, dz=5mm

Reference Value = 48.91 V/m; Power Drift = -0.04 dB

Peak SAR (extrapolated) = 12.5 W/kg

SAR(1 g) = 4.97 W/kg; SAR(10 g) = 2.65 W/kg

Maximum value of SAR (measured) = 5.18 W/kg

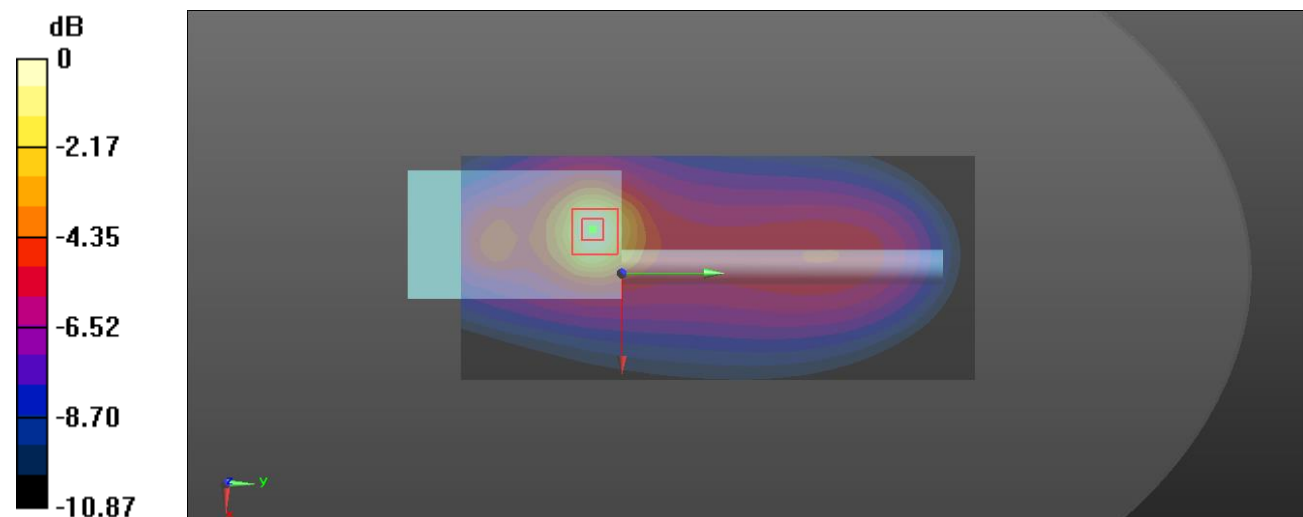

0 dB = 5.18 W/kg = 7.14 dBW/kg

Plot 47#: FM 12.5kHz_143MHz_Body Back_Antenna 1**DUT: Two Way Radio; Type: DR5510S-1; Serial: CR22040011-SA-S3**

Communication System: FM; Frequency: 143 MHz; Duty Cycle: 1:1

Medium parameters used: $f = 143 \text{ MHz}$; $\sigma = 0.776 \text{ S/m}$; $\epsilon_r = 62.208$; $\rho = 1000 \text{ kg/m}^3$

Phantom section: Flat Section

DASY5 Configuration:

- Probe: ES3DV2 - SN3019; ConvF(7.51, 7.51, 7.51) @ 143 MHz; Calibrated: 2021/12/13
- Sensor-Surface: 4mm (Mechanical Surface Detection)
- Electronics: DAE4 Sn1354; Calibrated: 2021/9/1
- Phantom: ELI v8.0; Type: QDOVA002AA; Serial: TP:2051
- Measurement SW: DASY52, Version 52.10 (2); SEMCAD X Version 14.6.12 (7470)

Area Scan (71x161x1): Interpolated grid: $dx=1.500 \text{ mm}$, $dy=1.500 \text{ mm}$

Maximum value of SAR (interpolated) = 12.6 W/kg

Zoom Scan (5x5x7)/Cube 0: Measurement grid: $dx=8\text{mm}$, $dy=8\text{mm}$, $dz=5\text{mm}$

Reference Value = 80.88 V/m; Power Drift = -0.10 dB

Peak SAR (extrapolated) = 28.1 W/kg

SAR(1 g) = 10.3 W/kg; SAR(10 g) = 5.64 W/kg

Maximum value of SAR (measured) = 11.4 W/kg

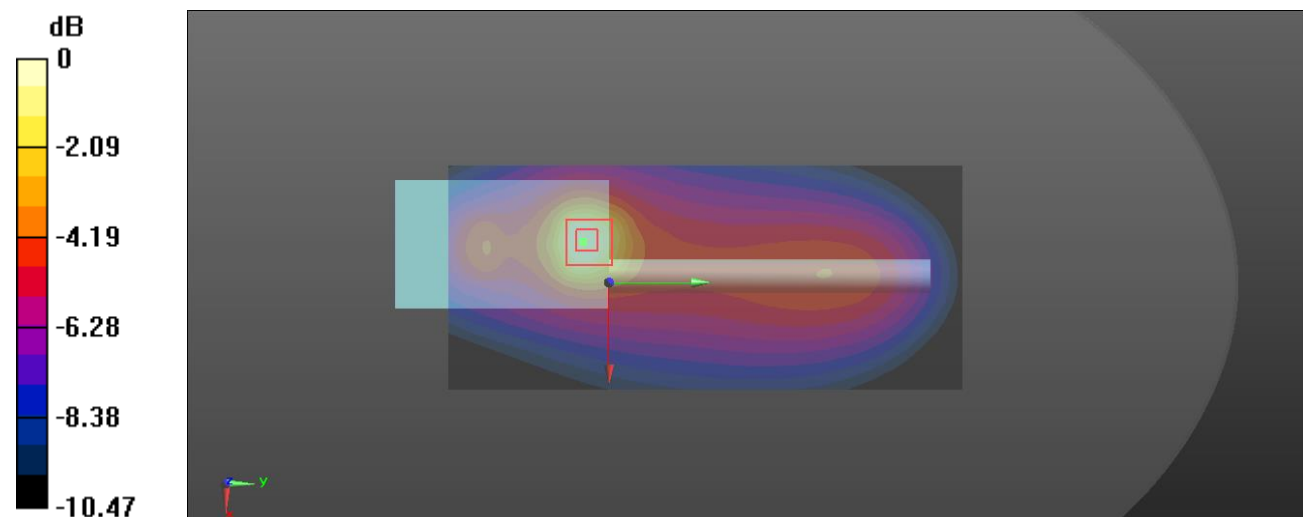

0 dB = 11.4 W/kg = 10.57 dBW/kg

Plot 48#: FM 12.5kHz_149.9875MHz_Body Back_Antenna 1**DUT: Two Way Radio; Type: DR5510S-1; Serial: CR22040011-SA-S3**

Communication System: FM; Frequency: 149.988 MHz; Duty Cycle: 1:1

Medium parameters used: $f = 149.988$ MHz; $\sigma = 0.782$ S/m; $\epsilon_r = 62.043$; $\rho = 1000$ kg/m³

Phantom section: Flat Section

DASY5 Configuration:

- Probe: ES3DV2 - SN3019; ConvF(7.51, 7.51, 7.51) @ 149.988 MHz; Calibrated: 2021/12/13
- Sensor-Surface: 4mm (Mechanical Surface Detection)
- Electronics: DAE4 Sn1354; Calibrated: 2021/9/1
- Phantom: ELI v8.0; Type: QDOVA002AA; Serial: TP:2051
- Measurement SW: DASY52, Version 52.10 (2); SEMCAD X Version 14.6.12 (7470)

Area Scan (71x161x1): Interpolated grid: dx=1.500 mm, dy=1.500 mm

Maximum value of SAR (interpolated) = 4.38 W/kg

Zoom Scan (5x5x7)/Cube 0: Measurement grid: dx=8mm, dy=8mm, dz=5mm

Reference Value = 38.74 V/m; Power Drift = 0.11 dB

Peak SAR (extrapolated) = 6.82 W/kg

SAR(1 g) = 3.45 W/kg; SAR(10 g) = 1.98 W/kg

Maximum value of SAR (measured) = 2.58 W/kg

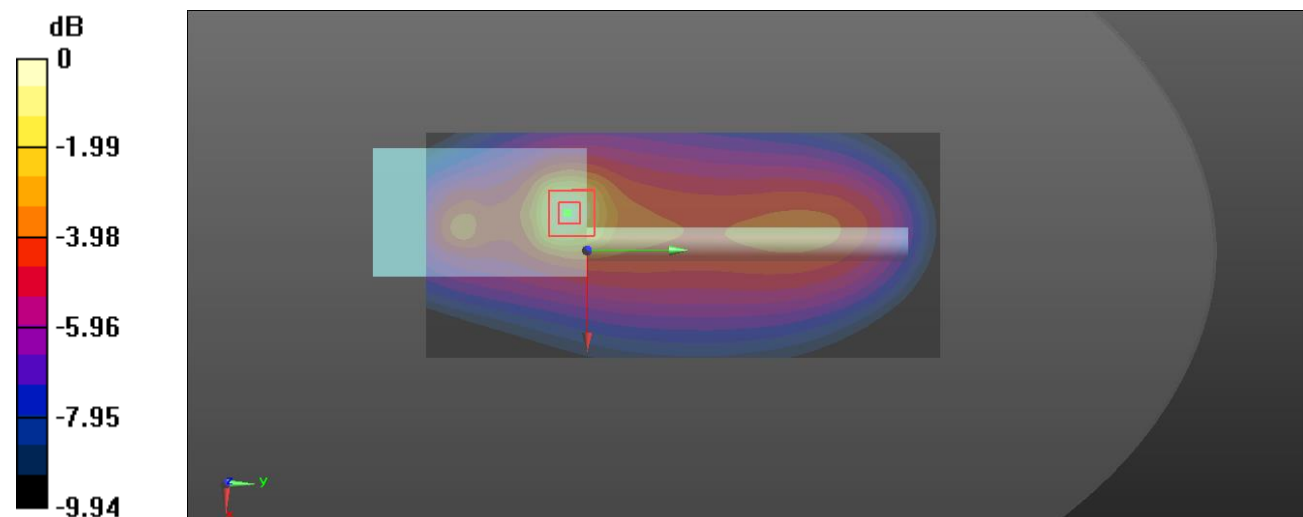

0 dB = 4.58 W/kg = 6.61 dBW/kg

Plot 49#: FM 12.5kHz_150.0125MHz_Body Back_Antenna 2**DUT: Two Way Radio; Type: DR5510S-1; Serial: CR22040011-SA-S3**

Communication System: FM; Frequency: 150.012 MHz; Duty Cycle: 1:1

Medium parameters used: $f = 150.012$ MHz; $\sigma = 0.788$ S/m; $\epsilon_r = 61.971$; $\rho = 1000$ kg/m³

Phantom section: Flat Section

DASY5 Configuration:

- Probe: ES3DV2 - SN3019; ConvF(7.51, 7.51, 7.51) @ 150.012 MHz; Calibrated: 2021/12/13
- Sensor-Surface: 4mm (Mechanical Surface Detection)
- Electronics: DAE4 Sn1354; Calibrated: 2021/9/1
- Phantom: ELI v8.0; Type: QDOVA002AA; Serial: TP:2051
- Measurement SW: DASY52, Version 52.10 (2); SEMCAD X Version 14.6.12 (7470)

Area Scan (81x191x1): Interpolated grid: dx=1.500 mm, dy=1.500 mm

Maximum value of SAR (interpolated) = 10.6 W/kg

Zoom Scan (5x5x7)/Cube 0: Measurement grid: dx=8mm, dy=8mm, dz=5mm

Reference Value = 71.83 V/m; Power Drift = -0.09 dB

Peak SAR (extrapolated) = 22.8 W/kg

SAR(1 g) = 9.52 W/kg; SAR(10 g) = 5.24 W/kg

Maximum value of SAR (measured) = 10.7 W/kg

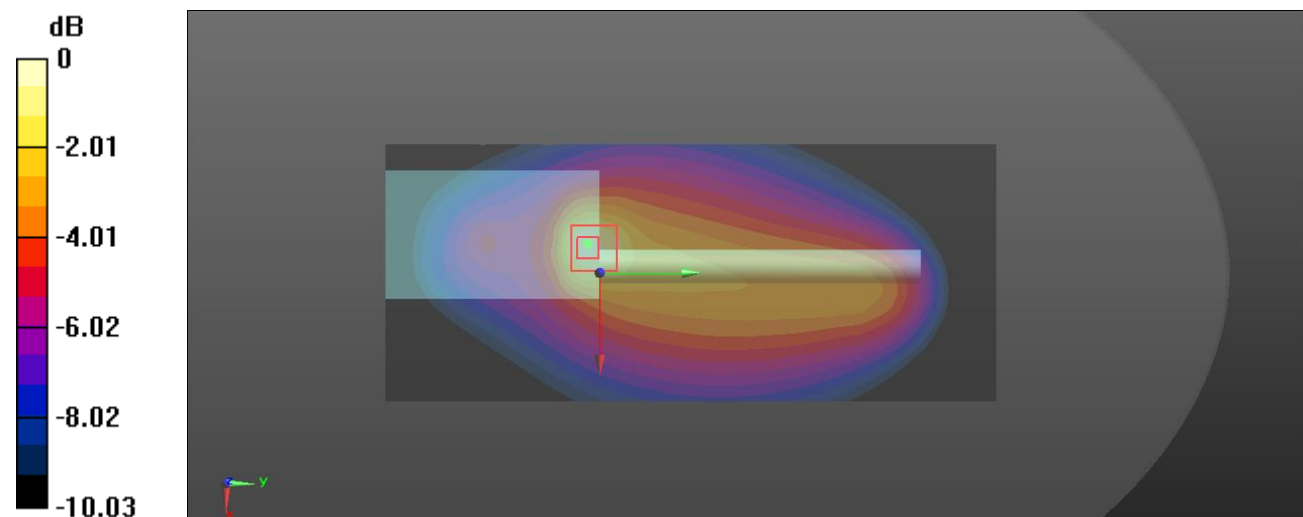

0 dB = 10.7 W/kg = 10.29 dBW/kg

Plot 50#: FM 12.5kHz_158.0125MHz_Body Back_Antenna 2**DUT: Two Way Radio; Type: DR5510S-1; Serial: CR22040011-SA-S3**

Communication System: FM; Frequency: 158.012 MHz; Duty Cycle: 1:1

Medium parameters used: $f = 158.012$ MHz; $\sigma = 0.798$ S/m; $\epsilon_r = 61.646$; $\rho = 1000$ kg/m³

Phantom section: Flat Section

DASY5 Configuration:

- Probe: ES3DV2 - SN3019; ConvF(7.51, 7.51, 7.51) @ 158.012 MHz; Calibrated: 2021/12/13
- Sensor-Surface: 4mm (Mechanical Surface Detection)
- Electronics: DAE4 Sn1354; Calibrated: 2021/9/1
- Phantom: ELI v8.0; Type: QDOVA002AA; Serial: TP:2051
- Measurement SW: DASY52, Version 52.10 (2); SEMCAD X Version 14.6.12 (7470)

Area Scan (81x191x1): Interpolated grid: dx=1.500 mm, dy=1.500 mm

Maximum value of SAR (interpolated) = 7.71 W/kg

Zoom Scan (5x5x7)/Cube 0: Measurement grid: dx=8mm, dy=8mm, dz=5mm

Reference Value = 52.78 V/m; Power Drift = 0.14 dB

Peak SAR (extrapolated) = 9.10 W/kg

SAR(1 g) = 4.76 W/kg; SAR(10 g) = 2.49 W/kg

Maximum value of SAR (measured) = 7.51 W/kg

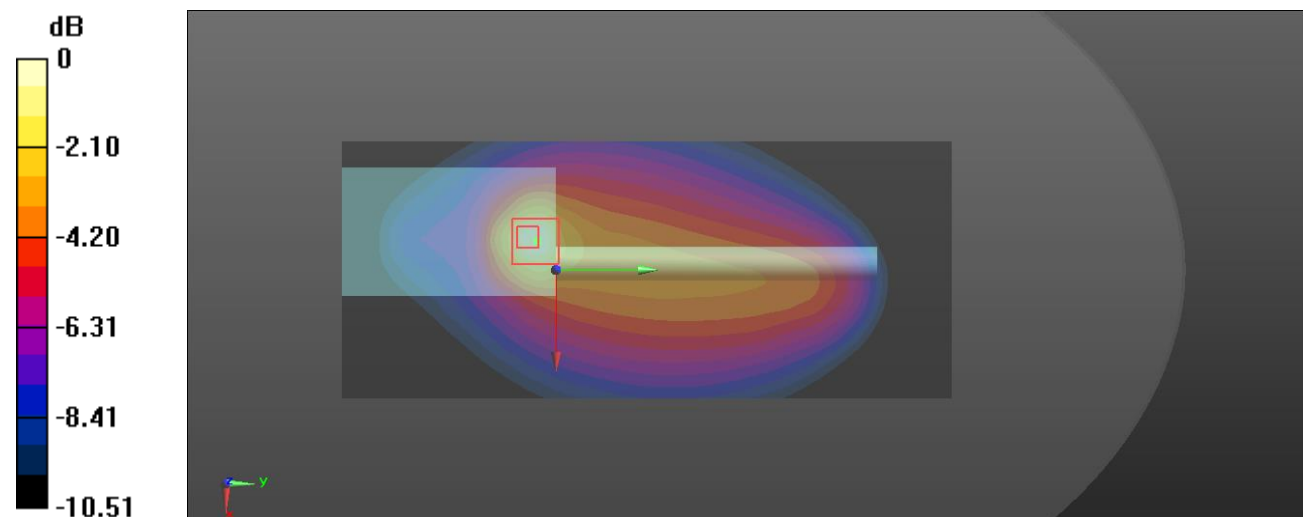

0 dB = 7.51 W/kg = 8.76 dBW/kg

Plot 51#: FM 12.5kHz_165.9875MHz_Body Back_Antenna 2**DUT: Two Way Radio; Type: DR5510S-1; Serial: CR22040011-SA-S3**

Communication System: FM; Frequency: 165.988 MHz; Duty Cycle: 1:1

Medium parameters used: $f = 165.988$ MHz; $\sigma = 0.805$ S/m; $\epsilon_r = 61.402$; $\rho = 1000$ kg/m³

Phantom section: Flat Section

DASY5 Configuration:

- Probe: ES3DV2 - SN3019; ConvF(7.51, 7.51, 7.51) @ 165.988 MHz; Calibrated: 2021/12/13
- Sensor-Surface: 4mm (Mechanical Surface Detection)
- Electronics: DAE4 Sn1354; Calibrated: 2021/9/1
- Phantom: ELI v8.0; Type: QDOVA002AA; Serial: TP:2051
- Measurement SW: DASY52, Version 52.10 (2); SEMCAD X Version 14.6.12 (7470)

Area Scan (81x191x1): Interpolated grid: dx=1.500 mm, dy=1.500 mm

Maximum value of SAR (interpolated) = 5.03 W/kg

Zoom Scan (5x5x7)/Cube 0: Measurement grid: dx=8mm, dy=8mm, dz=5mm

Reference Value = 40.18 V/m; Power Drift = -0.17 dB

Peak SAR (extrapolated) = 7.85 W/kg

SAR(1 g) = 3.91 W/kg; SAR(10 g) = 2.09 W/kg

Maximum value of SAR (measured) = 4.89 W/kg

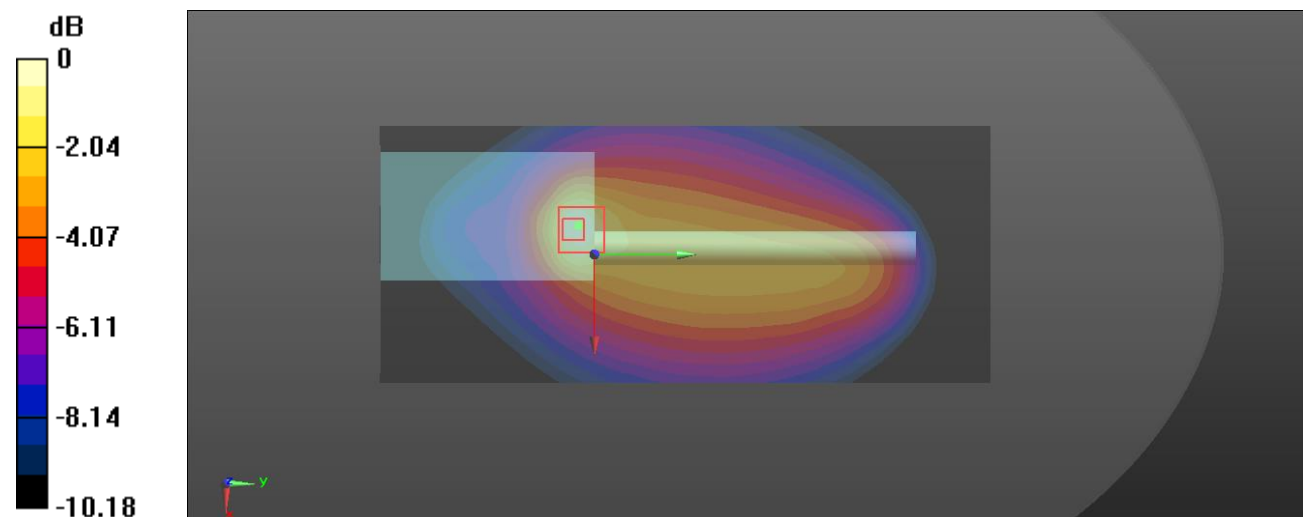

0 dB = 4.89 W/kg = 6.89 dBW/kg

Plot 52#: FM 12.5kHz_173.9875MHz_Body Back_Antenna 2**DUT: Two Way Radio; Type: DR5510S-1; Serial: CR22040011-SA-S3**

Communication System: FM; Frequency: 173.988 MHz; Duty Cycle: 1:1

Medium parameters used: $f = 173.988$ MHz; $\sigma = 0.816$ S/m; $\epsilon_r = 61.135$; $\rho = 1000$ kg/m³

Phantom section: Flat Section

DASY5 Configuration:

- Probe: ES3DV2 - SN3019; ConvF(7.51, 7.51, 7.51) @ 173.988 MHz; Calibrated: 2021/12/13
- Sensor-Surface: 4mm (Mechanical Surface Detection)
- Electronics: DAE4 Sn1354; Calibrated: 2021/9/1
- Phantom: ELI v8.0; Type: QDOVA002AA; Serial: TP:2051
- Measurement SW: DASY52, Version 52.10 (2); SEMCAD X Version 14.6.12 (7470)

Area Scan (81x191x1): Interpolated grid: dx=1.500 mm, dy=1.500 mm

Maximum value of SAR (interpolated) = 2.96 W/kg

Zoom Scan (5x5x7)/Cube 0: Measurement grid: dx=8mm, dy=8mm, dz=5mm

Reference Value = 37.98 V/m; Power Drift = -0.03 dB

Peak SAR (extrapolated) = 7.26 W/kg

SAR(1 g) = 3.73 W/kg; SAR(10 g) = 1.44 W/kg

Maximum value of SAR (measured) = 2.91 W/kg

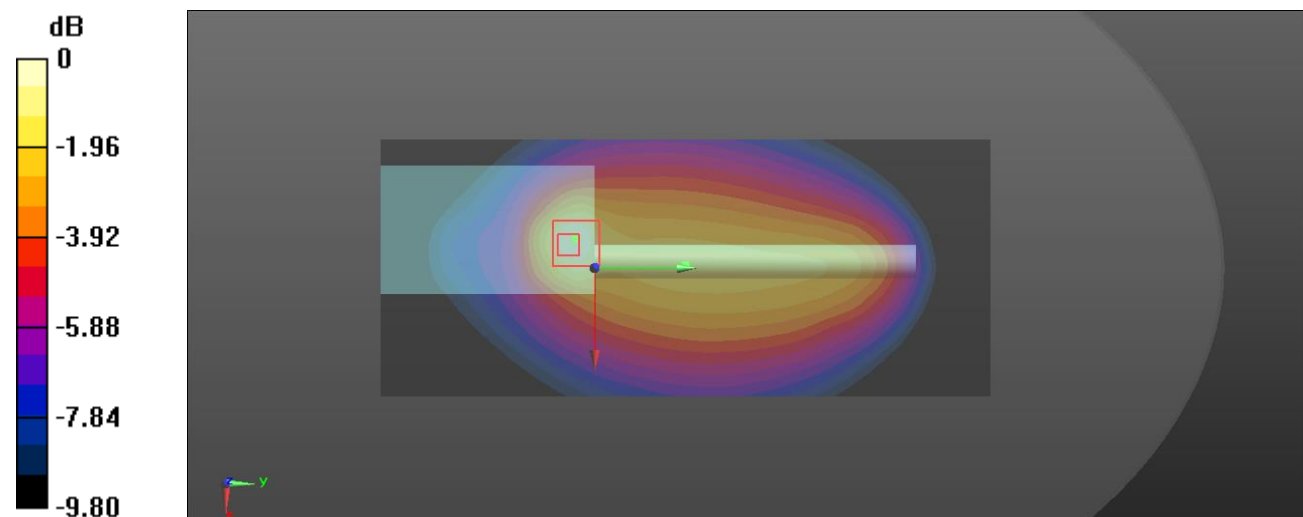

0 dB = 2.91 W/kg = 4.647 dBW/kg

Plot 53#: FM 25kHz_143MHz_Body Back_Antenna 1**DUT: Two Way Radio; Type: DR5510S-1; Serial: CR22040011-SA-S3**

Communication System: FM; Frequency: 143 MHz; Duty Cycle: 1:1

Medium parameters used: $f = 143 \text{ MHz}$; $\sigma = 0.776 \text{ S/m}$; $\epsilon_r = 62.208$; $\rho = 1000 \text{ kg/m}^3$

Phantom section: Flat Section

DASY5 Configuration:

- Probe: ES3DV2 - SN3019; ConvF(7.51, 7.51, 7.51) @ 143 MHz; Calibrated: 2021/12/13
- Sensor-Surface: 4mm (Mechanical Surface Detection)
- Electronics: DAE4 Sn1354; Calibrated: 2021/9/1
- Phantom: ELI v8.0; Type: QDOVA002AA; Serial: TP:2051
- Measurement SW: DASY52, Version 52.10 (2); SEMCAD X Version 14.6.12 (7470)

Area Scan (71x161x1): Interpolated grid: $dx=1.500 \text{ mm}$, $dy=1.500 \text{ mm}$

Maximum value of SAR (interpolated) = 10.4 W/kg

Zoom Scan (5x5x7)/Cube 0: Measurement grid: $dx=8\text{mm}$, $dy=8\text{mm}$, $dz=5\text{mm}$

Reference Value = 76.04 V/m; Power Drift = -0.04 dB

Peak SAR (extrapolated) = 24.9 W/kg

SAR(1 g) = 10.1 W/kg; SAR(10 g) = 5.5 W/kg

Maximum value of SAR (measured) = 10.3 W/kg

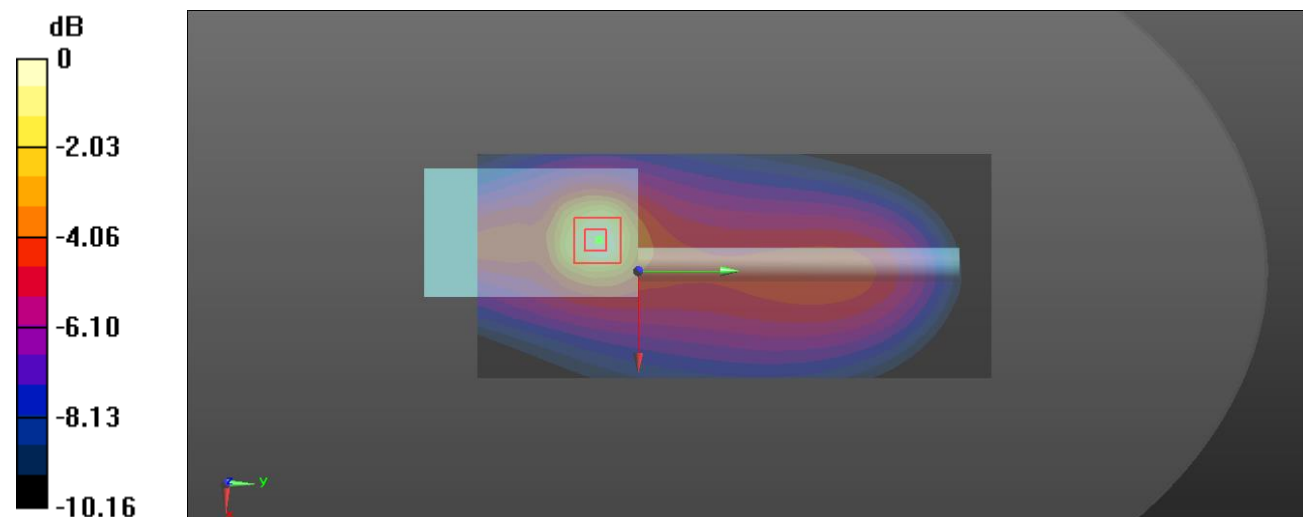

0 dB = 10.3 W/kg = 10.13 dBW/kg

Plot 54#: FM 25kHz_150.0125MHz_Body Back_Antenna 2**DUT: Two Way Radio; Type: DR5510S-1; Serial: CR22040011-SA-S3**

Communication System: FM; Frequency: 150.012 MHz; Duty Cycle: 1:1

Medium parameters used: $f = 150.012$ MHz; $\sigma = 0.788$ S/m; $\epsilon_r = 61.971$; $\rho = 1000$ kg/m³

Phantom section: Flat Section

DASY5 Configuration:

- Probe: ES3DV2 - SN3019; ConvF(7.51, 7.51, 7.51) @ 150.012 MHz; Calibrated: 2021/12/13
- Sensor-Surface: 4mm (Mechanical Surface Detection)
- Electronics: DAE4 Sn1354; Calibrated: 2021/9/1
- Phantom: ELI v8.0; Type: QDOVA002AA; Serial: TP:2051
- Measurement SW: DASY52, Version 52.10 (2); SEMCAD X Version 14.6.12 (7470)

Area Scan (81x161x1): Interpolated grid: dx=1.500 mm, dy=1.500 mm

Maximum value of SAR (interpolated) = 11.6 W/kg

Zoom Scan (5x5x7)/Cube 0: Measurement grid: dx=8mm, dy=8mm, dz=5mm

Reference Value = 68.41 V/m; Power Drift = -0.00 dB

Peak SAR (extrapolated) = 22.7 W/kg

SAR(1 g) = 9.45 W/kg; SAR(10 g) = 5.18 W/kg

Maximum value of SAR (measured) = 11.5 W/kg

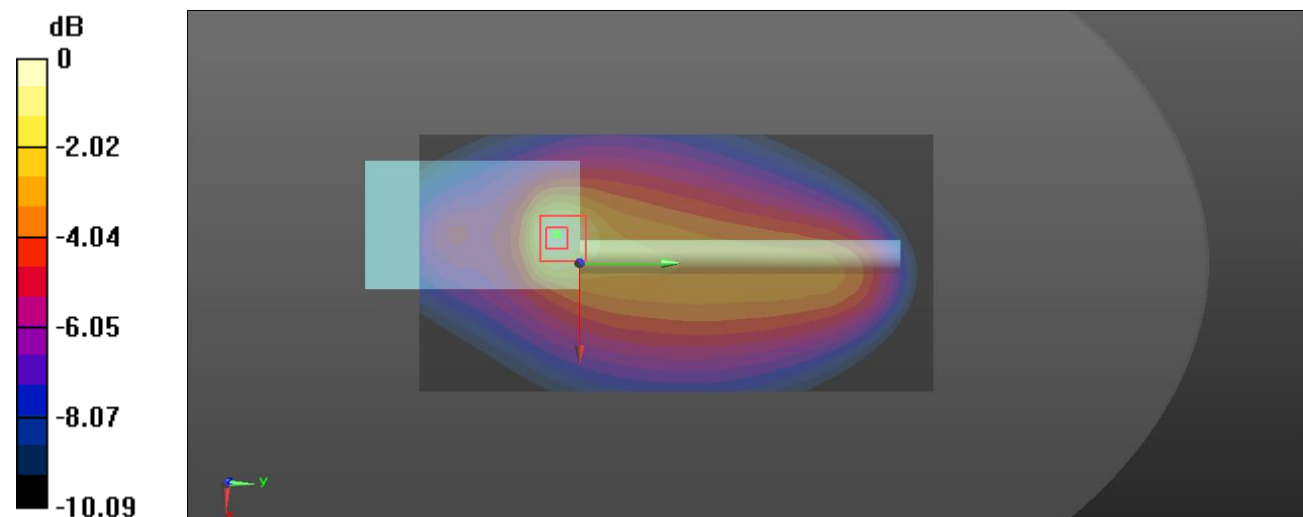

0 dB = 11.5 W/kg = 10.61 dBW/kg

Plot 55#: 4FSK 12.5kHz_143MHz_Body Back_Antenna 1**DUT: Two Way Radio; Type: DR5510S-1; Serial: CR22040011-SA-S3**

Communication System: 4FSK; Frequency: 143 MHz; Duty Cycle: 1:2

Medium parameters used: $f = 143$ MHz; $\sigma = 0.776$ S/m; $\epsilon_r = 62.208$; $\rho = 1000$ kg/m³

Phantom section: Flat Section

DASY5 Configuration:

- Probe: ES3DV2 - SN3019; ConvF(7.51, 7.51, 7.51) @ 143 MHz; Calibrated: 2021/12/13
- Sensor-Surface: 4mm (Mechanical Surface Detection)
- Electronics: DAE4 Sn1354; Calibrated: 2021/9/1
- Phantom: ELI v8.0; Type: QDOVA002AA; Serial: TP:2051
- Measurement SW: DASY52, Version 52.10 (2); SEMCAD X Version 14.6.12 (7470)

Area Scan (71x161x1): Interpolated grid: dx=1.500 mm, dy=1.500 mm

Maximum value of SAR (interpolated) = 7.87 W/kg

Zoom Scan (5x5x7)/Cube 0: Measurement grid: dx=8mm, dy=8mm, dz=5mm

Reference Value = 51.07 V/m; Power Drift = -0.01 dB

Peak SAR (extrapolated) = 16.8 W/kg

SAR(1 g) = 5.02 W/kg; SAR(10 g) = 3.02 W/kg

Maximum value of SAR (measured) = 8.47 W/kg

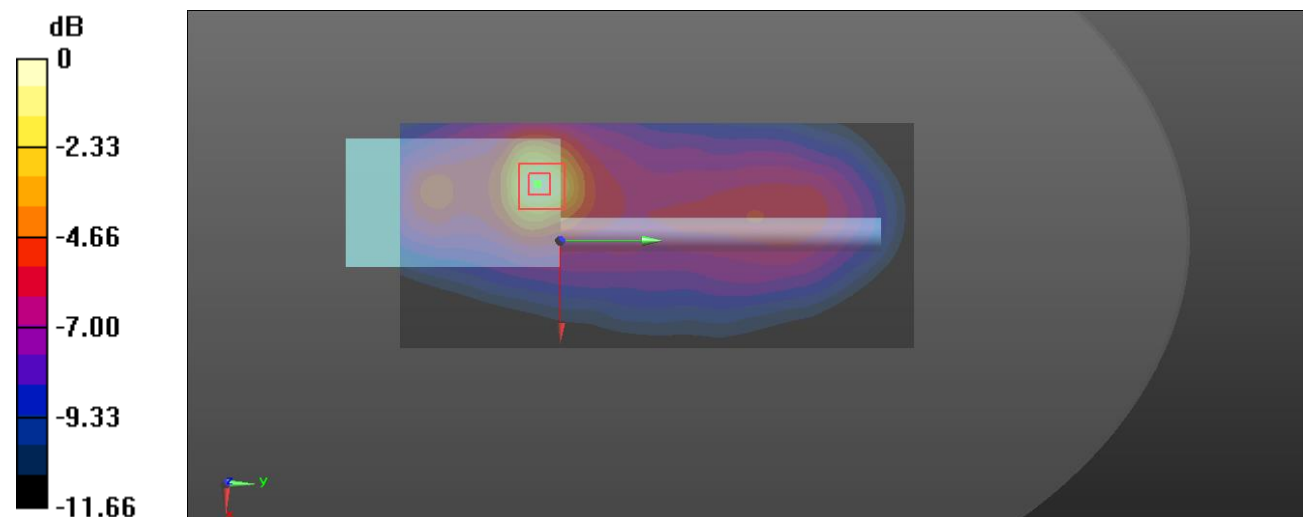

0 dB = 8.47 W/kg = 9.28 dBW/kg

Plot 56#: 4FSK 12.5kHz_150.0125MHz_Body Back_Antenna 2**DUT: Two Way Radio; Type: DR5510S-1; Serial: CR22040011-SA-S3**

Communication System: 4FSK; Frequency: 150.012 MHz; Duty Cycle: 1:2

Medium parameters used: $f = 150.012$ MHz; $\sigma = 0.788$ S/m; $\epsilon_r = 61.971$; $\rho = 1000$ kg/m³

Phantom section: Flat Section

DASY5 Configuration:

- Probe: ES3DV2 - SN3019; ConvF(7.51, 7.51, 7.51) @ 150.012 MHz; Calibrated: 2021/12/13
- Sensor-Surface: 4mm (Mechanical Surface Detection)
- Electronics: DAE4 Sn1354; Calibrated: 2021/9/1
- Phantom: ELI v8.0; Type: QDOVA002AA; Serial: TP:2051
- Measurement SW: DASY52, Version 52.10 (2); SEMCAD X Version 14.6.12 (7470)

Area Scan (81x161x1): Interpolated grid: dx=1.500 mm, dy=1.500 mm

Maximum value of SAR (interpolated) = 3.49 W/kg

Zoom Scan (5x5x7)/Cube 0: Measurement grid: dx=8mm, dy=8mm, dz=5mm

Reference Value = 57.26 V/m; Power Drift = -0.18 dB

Peak SAR (extrapolated) = 7.02 W/kg

SAR(1 g) = 3.34 W/kg; SAR(10 g) = 2.04 W/kg

Maximum value of SAR (measured) = 3.58 W/kg

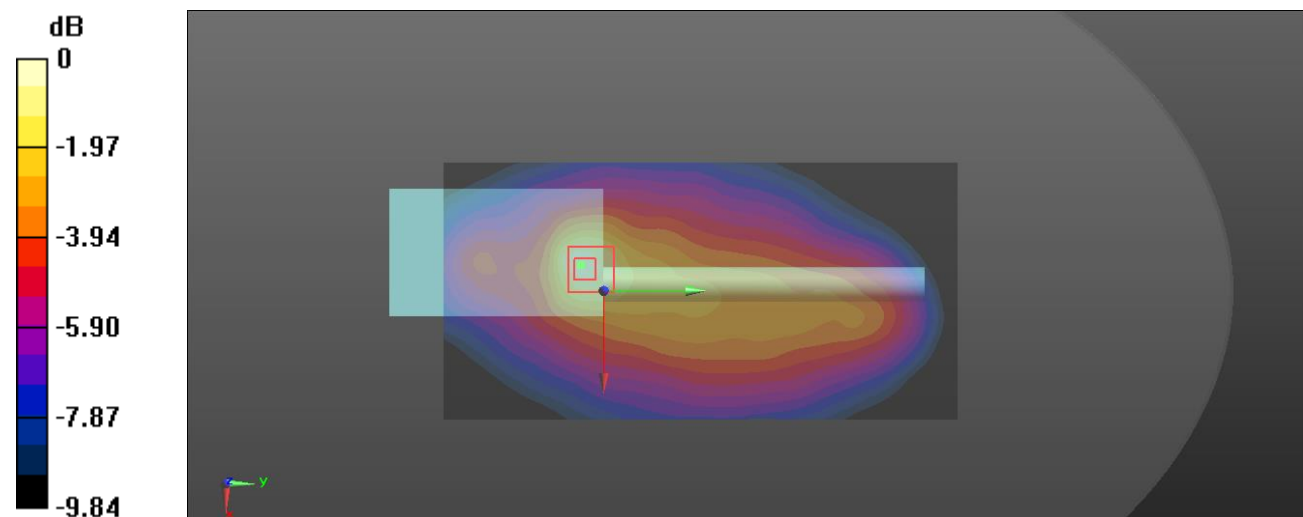

0 dB = 3.58 W/kg = 5.54 dBW/kg

APPENDIX B EUT TEST POSITION PHOTOS

Liquid depth $\geq 15\text{cm}$

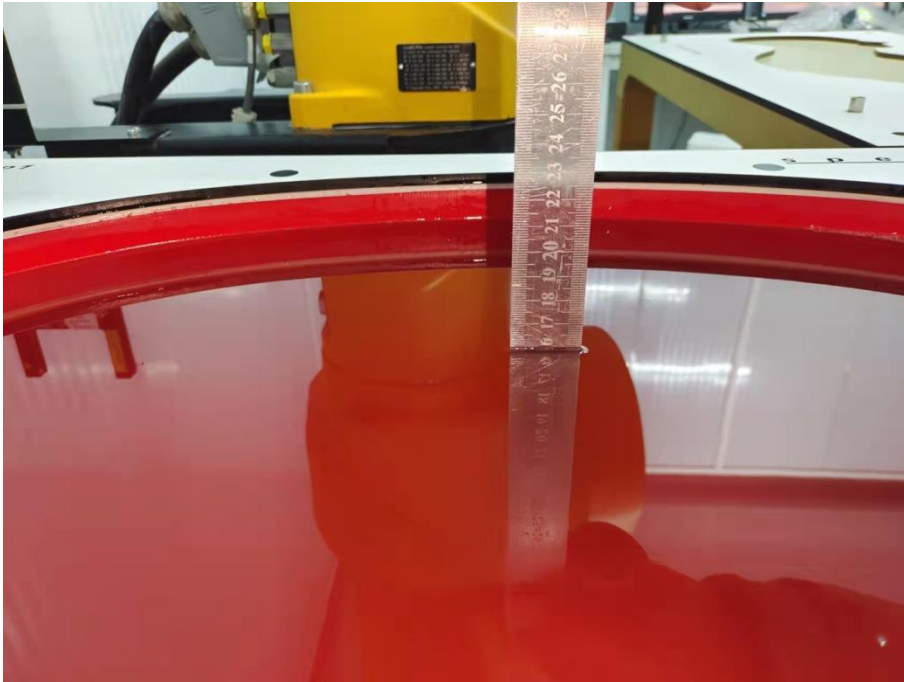

Face Up Setup Photo (25mm)



Body Back Setup Photo (0mm)



APPENDIX C PROBE CALIBRATION CERTIFICATES

Calibration Laboratory of
Schmid & Partner
Engineering AG
Zeughausstrasse 43, 8004 Zurich, Switzerland



S Schweizerischer Kalibrierdienst
C Service suisse d'étalonnage
S Servizio svizzero di taratura
Swiss Calibration Service

Accredited by the Swiss Accreditation Service (SAS)
The Swiss Accreditation Service is one of the signatories to the EA
Multilateral Agreement for the recognition of calibration certificates

Accreditation No.: SCS 0108

Client **BACL USA**

Certificate No: **ES3-3019_Dec21**

CALIBRATION CERTIFICATE

Object **ES3DV2 - SN:3019**

Calibration procedure(s) **QA CAL-01.v9, QA CAL-12.v9, QA CAL-23.v5, QA CAL-25.v7
Calibration procedure for dosimetric E-field probes**

Calibration date: **December 13, 2021**

This calibration certificate documents the traceability to national standards, which realize the physical units of measurements (SI).
The measurements and the uncertainties with confidence probability are given on the following pages and are part of the certificate.

All calibrations have been conducted in the closed laboratory facility: environment temperature (22 ± 3)°C and humidity < 70%.

Calibration Equipment used (M&TE critical for calibration)

Primary Standards	ID	Cal Date (Certificate No.)	Scheduled Calibration
Power meter NRP	SN: 104778	09-Apr-21 (No. 217-03291/03292)	Apr-22
Power sensor NRP-Z91	SN: 103244	09-Apr-21 (No. 217-03291)	Apr-22
Power sensor NRP-Z91	SN: 103245	09-Apr-21 (No. 217-03292)	Apr-22
Reference 20 dB Attenuator	SN: CC2552 (20x)	09-Apr-21 (No. 217-03343)	Apr-22
DAE4	SN: 660	23-Dec-20 (No. DAE4-660_Dec20)	Dec-21
Reference Probe ES3DV2	SN: 3013	30-Dec-20 (No. ES3-3013_Dec20)	Dec-21
Secondary Standards	ID	Check Date (in house)	Scheduled Check
Power meter E4419B	SN: GB41293874	06-Apr-16 (in house check Jun-20)	In house check: Jun-22
Power sensor E4412A	SN: MY41498087	06-Apr-16 (in house check Jun-20)	In house check: Jun-22
Power sensor E4412A	SN: 000110210	06-Apr-16 (in house check Jun-20)	In house check: Jun-22
RF generator HP 8648C	SN: US3642U01700	04-Aug-99 (in house check Jun-20)	In house check: Jun-22
Network Analyzer E8358A	SN: US41080477	31-Mar-14 (in house check Oct-20)	In house check: Oct-22

	Name	Function	Signature
Calibrated by:	Michael Weber	Laboratory Technician	
Approved by:	Niels Kuster	Quality Manager	

Issued: December 14, 2021

This calibration certificate shall not be reproduced except in full without written approval of the laboratory.

Calibration Laboratory of
Schmid & Partner
Engineering AG
Zeughausstrasse 43, 8004 Zurich, Switzerland



S Schweizerischer Kalibrierdienst
C Service suisse d'étalonnage
S Servizio svizzero di taratura
S Swiss Calibration Service

Accredited by the Swiss Accreditation Service (SAS)
The Swiss Accreditation Service is one of the signatories to the EA
Multilateral Agreement for the recognition of calibration certificates

Accreditation No.: SCS 0108

Glossary:

TSL	tissue simulating liquid
NORM _{x,y,z}	sensitivity in free space
ConvF	sensitivity in TSL / NORM _{x,y,z}
DCP	diode compression point
CF	crest factor (1/duty_cycle) of the RF signal
A, B, C, D	modulation dependent linearization parameters
Polarization φ	φ rotation around probe axis
Polarization ϑ	ϑ rotation around an axis that is in the plane normal to probe axis (at measurement center), i.e., $\vartheta = 0$ is normal to probe axis
Connector Angle	information used in DASY system to align probe sensor X to the robot coordinate system

Calibration is Performed According to the Following Standards:

- a) IEC/IEEE 62209-1528, "Measurement Procedure For The Assessment Of Specific Absorption Rate Of Human Exposure To Radio Frequency Fields From Hand-Held And Body-Worn Wireless Communication Devices - Part 1528: Human Models, Instrumentation And Procedures (Frequency Range of 4 MHz to 10 GHz)", October 2020.
- b) KDB 865664, "SAR Measurement Requirements for 100 MHz to 6 GHz"

Methods Applied and Interpretation of Parameters:

- **NORM_{x,y,z}**: Assessed for E-field polarization $\vartheta = 0$ ($f \leq 900$ MHz in TEM-cell; $f > 1800$ MHz: R22 waveguide). NORM_{x,y,z} are only intermediate values, i.e., the uncertainties of NORM_{x,y,z} does not affect the E²-field uncertainty inside TSL (see below ConvF).
- **NORM(ϑ)_{x,y,z} = NORM_{x,y,z} * frequency_response** (see Frequency Response Chart). This linearization is implemented in DASY4 software versions later than 4.2. The uncertainty of the frequency response is included in the stated uncertainty of ConvF.
- **DCP_{x,y,z}**: DCP are numerical linearization parameters assessed based on the data of power sweep with CW signal (no uncertainty required). DCP does not depend on frequency nor media.
- **PAR**: PAR is the Peak to Average Ratio that is not calibrated but determined based on the signal characteristics
- **A_{x,y,z}; B_{x,y,z}; C_{x,y,z}; D_{x,y,z}; VR_{x,y,z}**: A, B, C, D are numerical linearization parameters assessed based on the data of power sweep for specific modulation signal. The parameters do not depend on frequency nor media. VR is the maximum calibration range expressed in RMS voltage across the diode.
- **ConvF and Boundary Effect Parameters**: Assessed in flat phantom using E-field (or Temperature Transfer Standard for $f \leq 800$ MHz) and inside waveguide using analytical field distributions based on power measurements for $f > 800$ MHz. The same setups are used for assessment of the parameters applied for boundary compensation (alpha, depth) of which typical uncertainty values are given. These parameters are used in DASY4 software to improve probe accuracy close to the boundary. The sensitivity in TSL corresponds to NORM_{x,y,z} * ConvF whereby the uncertainty corresponds to that given for ConvF. A frequency dependent ConvF is used in DASY version 4.4 and higher which allows extending the validity from ± 50 MHz to ± 100 MHz.
- **Spherical isotropy (3D deviation from isotropy)**: in a field of low gradients realized using a flat phantom exposed by a patch antenna.
- **Sensor Offset**: The sensor offset corresponds to the offset of virtual measurement center from the probe tip (on probe axis). No tolerance required.
- **Connector Angle**: The angle is assessed using the information gained by determining the NORM_x (no uncertainty required).

DASY/EASY - Parameters of Probe: ES3DV2 - SN:3019**Basic Calibration Parameters**

	Sensor X	Sensor Y	Sensor Z	Unc (k=2)
Norm ($\mu\text{V}/(\text{V/m})^2$) ^A	1.01	1.13	0.93	± 10.1 %
DCP (mV) ^B	106.7	102.3	107.9	

Calibration Results for Modulation Response

UID	Communication System Name		A dB	B dB $\sqrt{\mu\text{V}}$	C	D dB	VR mV	Max dev.	Unc ^E (k=2)
0	CW	X	0.0	0.0	1.0	0.00	188.9	±3.0 %	± 4.7 %
		Y	0.0	0.0	1.0		191.5		
		Z	0.0	0.0	1.0		184.9		

The reported uncertainty of measurement is stated as the standard uncertainty of measurement multiplied by the coverage factor k=2, which for a normal distribution corresponds to a coverage probability of approximately 95%.

^A The uncertainties of Norm X,Y,Z do not affect the E²-field uncertainty inside TSL (see Pages 5 and 6).

^B Numerical linearization parameter: uncertainty not required.

^E Uncertainty is determined using the max. deviation from linear response applying rectangular distribution and is expressed for the square of the field value.

DASY/EASY - Parameters of Probe: ES3DV2 - SN:3019**Other Probe Parameters**

Sensor Arrangement	Triangular
Connector Angle (°)	-45.8
Mechanical Surface Detection Mode	enabled
Optical Surface Detection Mode	disabled
Probe Overall Length	337 mm
Probe Body Diameter	10 mm
Tip Length	10 mm
Tip Diameter	4 mm
Probe Tip to Sensor X Calibration Point	2 mm
Probe Tip to Sensor Y Calibration Point	2 mm
Probe Tip to Sensor Z Calibration Point	2 mm
Recommended Measurement Distance from Surface	3 mm

Note: Measurement distance from surface can be increased to 3-4 mm for an *Area Scan* job.

DASY/EASY - Parameters of Probe: ES3DV2 - SN:3019

Calibration Parameter Determined in Head Tissue Simulating Media

f (MHz) ^C	Relative Permittivity ^F	Conductivity (S/m) ^F	ConvF X	ConvF Y	ConvF Z	Alpha ^G	Depth ^G (mm)	Unc (k=2)
150	52.3	0.76	7.69	7.69	7.69	0.00	1.00	± 13.3 %
450	43.5	0.87	7.02	7.02	7.02	0.16	1.30	± 13.3 %

^C Frequency validity above 300 MHz of ± 100 MHz only applies for DASY v4.4 and higher (see Page 2), else it is restricted to ± 50 MHz. The uncertainty is the RSS of the ConvF uncertainty at calibration frequency and the uncertainty for the indicated frequency band. Frequency validity below 300 MHz is ± 10, 25, 40, 50 and 70 MHz for ConvF assessments at 30, 64, 128, 150 and 220 MHz respectively. Validity of ConvF assessed at 6 MHz is 4-9 MHz, and ConvF assessed at 13 MHz is 9-19 MHz. Above 5 GHz frequency validity can be extended to ± 110 MHz.

^F At frequencies below 3 GHz, the validity of tissue parameters (ϵ and σ) can be relaxed to ± 10% if liquid compensation formula is applied to measured SAR values. At frequencies above 3 GHz, the validity of tissue parameters (ϵ and σ) is restricted to ± 5%. The uncertainty is the RSS of the ConvF uncertainty for indicated target tissue parameters.

^G Alpha/Depth are determined during calibration. SPEAG warrants that the remaining deviation due to the boundary effect after compensation is always less than ± 1% for frequencies below 3 GHz and below ± 2% for frequencies between 3-6 GHz at any distance larger than half the probe tip diameter from the boundary.

DASY/EASY - Parameters of Probe: ES3DV2 - SN:3019

Calibration Parameter Determined in Body Tissue Simulating Media

f (MHz) ^C	Relative Permittivity ^F	Conductivity (S/m) ^F	ConvF X	ConvF Y	ConvF Z	Alpha ^G	Depth ^G (mm)	Unc (k=2)
150	61.9	0.80	7.51	7.51	7.51	0.00	1.00	± 13.3 %
450	56.7	0.94	6.95	6.95	6.95	0.11	1.20	± 13.3 %

^C Frequency validity above 300 MHz of ± 100 MHz only applies for DASY v4.4 and higher (see Page 2), else it is restricted to ± 50 MHz. The uncertainty is the RSS of the ConvF uncertainty at calibration frequency and the uncertainty for the indicated frequency band. Frequency validity below 300 MHz is ± 10, 25, 40, 50 and 70 MHz for ConvF assessments at 30, 64, 128, 150 and 220 MHz respectively. Validity of ConvF assessed at 6 MHz is 4-9 MHz, and ConvF assessed at 13 MHz is 9-19 MHz. Above 5 GHz frequency validity can be extended to ± 110 MHz.

^F At frequencies below 3 GHz, the validity of tissue parameters (ϵ and σ) can be relaxed to ± 10% if liquid compensation formula is applied to measured SAR values. At frequencies above 3 GHz, the validity of tissue parameters (ϵ and σ) is restricted to ± 5%. The uncertainty is the RSS of the ConvF uncertainty for indicated target tissue parameters.

^G Alpha/Depth are determined during calibration. SPEAG warrants that the remaining deviation due to the boundary effect after compensation is always less than ± 1% for frequencies below 3 GHz and below ± 2% for frequencies between 3-6 GHz at any distance larger than half the probe tip diameter from the boundary.

Frequency Response of E-Field (TEM-Cell: ifi110 EXX, Waveguide: R22)

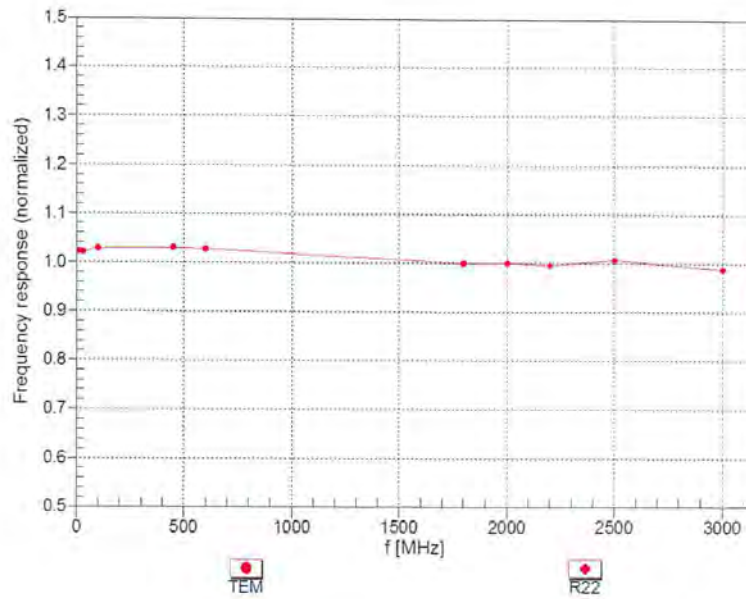

Uncertainty of Frequency Response of E-field: $\pm 6.3\%$ (k=2)

Receiving Pattern (ϕ), $\vartheta = 0^\circ$

f=600 MHz,TEM

f=1800 MHz,R22

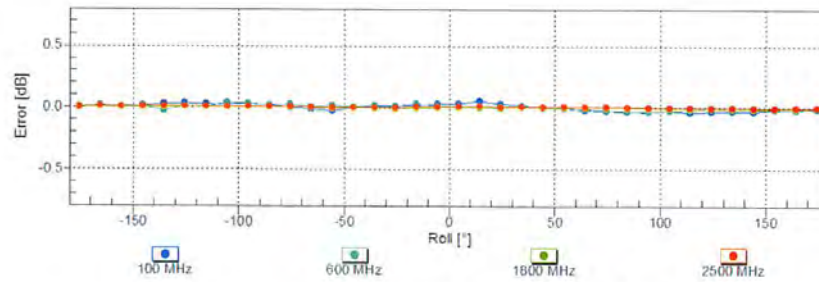
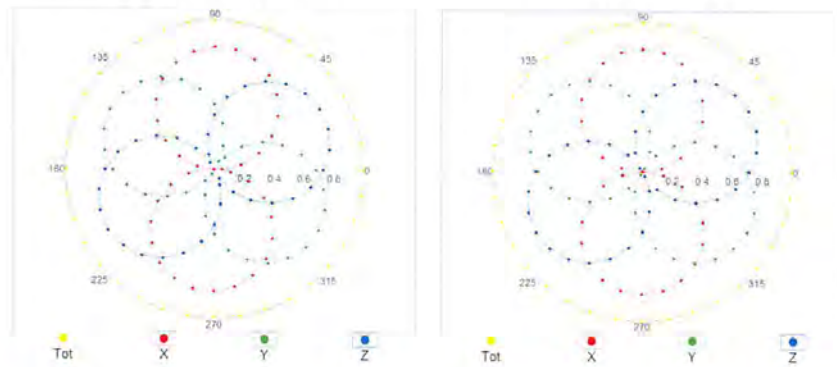

Uncertainty of Axial Isotropy Assessment: $\pm 0.5\%$ (k=2)

Dynamic Range $f(SAR_{head})$ (TEM cell, $f_{eval} = 1900$ MHz)

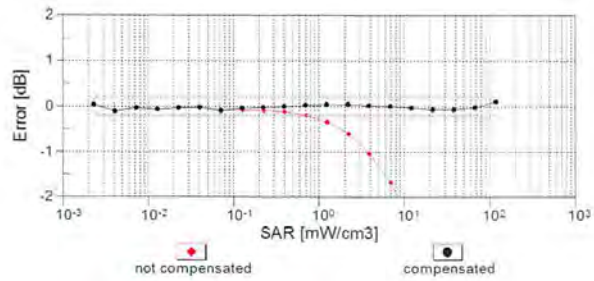
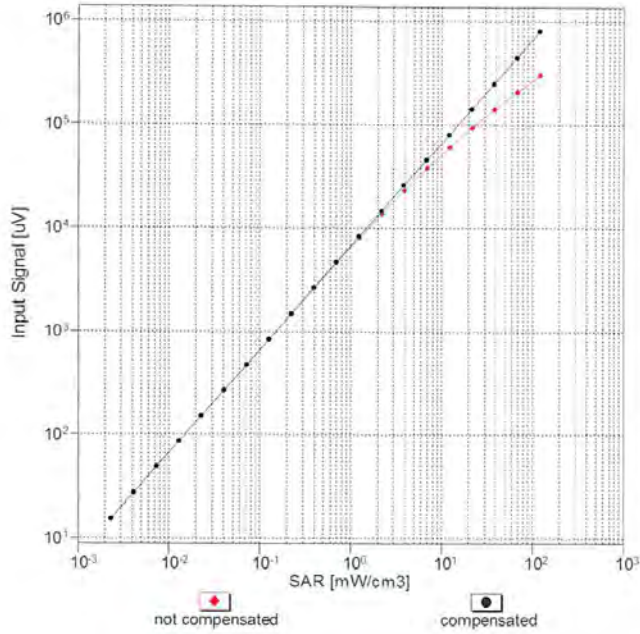

Uncertainty of Linearity Assessment: $\pm 0.6\%$ ($k=2$)

Conversion Factor Assessment

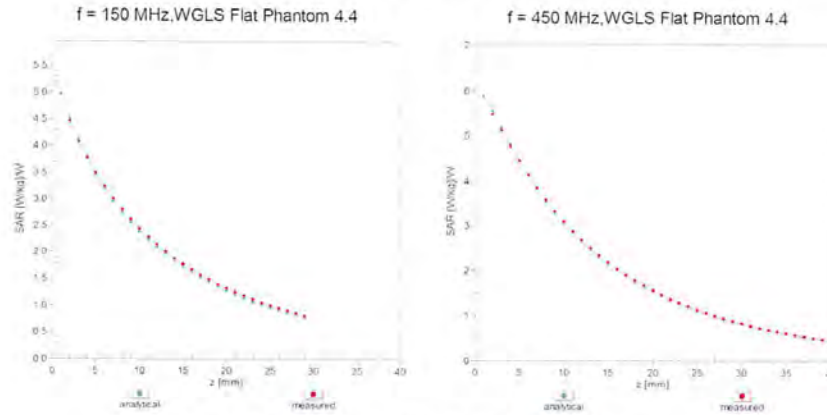

Deviation from Isotropy in Liquid Error (ϕ, θ), $f = 900$ MHz

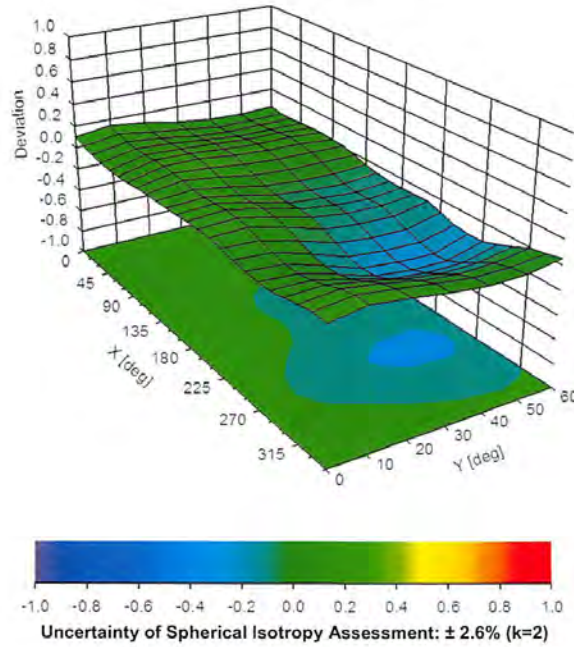

DIPOLE CALIBRATION CERTIFICATES

**Calibration Laboratory of
Schmid & Partner
Engineering AG**
Zeughausstrasse 43, 8004 Zurich, Switzerland



S Schweizerischer Kalibrierdienst
C Service suisse d'étalonnage
S Servizio svizzero di taratura
S Swiss Calibration Service

Accredited by the Swiss Accreditation Service (SAS)
The Swiss Accreditation Service is one of the signatories to the EA
Multilateral Agreement for the recognition of calibration certificates

Accreditation No.: **SCS 0108**

Client **BACL-SZ (Auden)**

Certificate No: **CLA150-4020_Nov19**

CALIBRATION CERTIFICATE

Object **CLA150 - SN: 4020**

Calibration procedure(s) **QA CAL-15.v9
Calibration Procedure for SAR Validation Sources below 700 MHz**

Calibration date: **November 25, 2019**

This calibration certificate documents the traceability to national standards, which realize the physical units of measurements (SI).
The measurements and the uncertainties with confidence probability are given on the following pages and are part of the certificate.

All calibrations have been conducted in the closed laboratory facility: environment temperature ($22 \pm 3^\circ\text{C}$) and humidity $< 70\%$.

Calibration Equipment used (M&TE critical for calibration)

Primary Standards	ID #	Cal Date (Certificate No.)	Scheduled Calibration
Power meter NRP	SN: 104778	03-Apr-19 (No. 217-02892/02893)	Apr-20
Power sensor NRP-Z91	SN: 103244	03-Apr-19 (No. 217-02892)	Apr-20
Power sensor NRP-Z91	SN: 103245	03-Apr-19 (No. 217-02893)	Apr-20
Reference 20 dB Attenuator	SN: 5277 (20x)	04-Apr-19 (No. 217-02894)	Apr-20
Type-N mismatch combination	SN: 5047.2 / 06327	04-Apr-19 (No. 217-02895)	Apr-20
Reference Probe EX3DV4	SN: 3877	31-Dec-18 (No. EX3-3877_Dec18)	Dec-19
DAE4	SN: 654	27-Jun-19 (No. DAE4-654_Jun19)	Jun-20
Secondary Standards	ID #	Check Date (in house)	Scheduled Check
Power meter E4419B	SN: GB41293874	06-Apr-16 (in house check Jun-18)	In house check: Jun-20
Power sensor E4412A	SN: MY41498087	06-Apr-16 (in house check Jun-18)	In house check: Jun-20
Power sensor E4412A	SN: 000110210	06-Apr-16 (in house check Jun-18)	In house check: Jun-20
RF generator HP 8648C	SN: US3642U01700	04-Aug-99 (in house check Jun-18)	In house check: Jun-20
Network Analyzer Agilent E8358A	SN: US41080477	31-Mar-14 (in house check Oct-19)	In house check: Oct-20

Calibrated by:	Name Claudio Leubler	Function Laboratory Technician	Signature
Approved by:	Name Katja Pokovic	Function Technical Manager	Signature

Issued: November 26, 2019

This calibration certificate shall not be reproduced except in full without written approval of the laboratory.

**Calibration Laboratory of
Schmid & Partner
Engineering AG**
Zeughausstrasse 43, 8004 Zurich, Switzerland



S Schweizerischer Kalibrierdienst
C Service suisse d'étalonnage
S Servizio svizzero di taratura
S Swiss Calibration Service

Accredited by the Swiss Accreditation Service (SAS)
The Swiss Accreditation Service is one of the signatories to the EA
Multilateral Agreement for the recognition of calibration certificates

Accreditation No.: **SCS 0108**

Glossary:

TSL	tissue simulating liquid
ConvF	sensitivity in TSL / NORM x,y,z
N/A	not applicable or not measured

Calibration is Performed According to the Following Standards:

- IEEE Std 1528-2013, "IEEE Recommended Practice for Determining the Peak Spatial-Averaged Specific Absorption Rate (SAR) in the Human Head from Wireless Communications Devices: Measurement Techniques", June 2013
- IEC 62209-1, "Measurement procedure for the assessment of Specific Absorption Rate (SAR) from hand-held and body-mounted devices used next to the ear (frequency range of 300 MHz to 6 GHz)", July 2016
- IEC 62209-2, "Procedure to determine the Specific Absorption Rate (SAR) for wireless communication devices used in close proximity to the human body (frequency range of 30 MHz to 6 GHz)", March 2010
- KDB 865664, "SAR Measurement Requirements for 100 MHz to 6 GHz"

Additional Documentation:

- DASY4/5 System Handbook

Methods Applied and Interpretation of Parameters:

- Measurement Conditions:* Further details are available from the Validation Report at the end of the certificate. All figures stated in the certificate are valid at the frequency indicated.
- Antenna Parameters with TSL:* The source is mounted in a touch configuration below the center marking of the flat phantom.
- Return Loss:* This parameter is measured with the source positioned under the liquid filled phantom (as described in the measurement condition clause). The Return Loss ensures low reflected power. No uncertainty required.
- SAR measured:* SAR measured at the stated antenna input power.
- SAR normalized:* SAR as measured, normalized to an input power of 1 W at the antenna connector.
- SAR for nominal TSL parameters:* The measured TSL parameters are used to calculate the nominal SAR result.

The reported uncertainty of measurement is stated as the standard uncertainty of measurement multiplied by the coverage factor $k=2$, which for a normal distribution corresponds to a coverage probability of approximately 95%.

Measurement Conditions

DASY system configuration, as far as not given on page 1.

DASY Version	DASY5	V52.10.3
Extrapolation	Advanced Extrapolation	
Phantom	ELI4 Flat Phantom	Shell thickness: 2 ± 0.2 mm
EUT Positioning	Touch Position	
Zoom Scan Resolution	$dx, dy = 4.0$ mm, $dz = 1.4$ mm	Graded Ratio = 1.4 (Z direction)
Frequency	150 MHz ± 1 MHz	

Head TSL parameters

The following parameters and calculations were applied.

	Temperature	Permittivity	Conductivity
Nominal Head TSL parameters	22.0 °C	52.3	0.76 mho/m
Measured Head TSL parameters	(22.0 ± 0.2) °C	51.1 ± 6 %	0.76 mho/m ± 6 %
Head TSL temperature change during test	< 0.5 °C	----	----

SAR result with Head TSL

SAR averaged over 1 cm ³ (1 g) of Head TSL	Condition	
SAR measured	1 W input power	3.66 W/kg
SAR for nominal Head TSL parameters	normalized to 1W	3.64 W/kg ± 18.4 % (k=2)

SAR averaged over 10 cm ³ (10 g) of Head TSL	condition	
SAR measured	1 W input power	2.47 W/kg
SAR for nominal Head TSL parameters	normalized to 1W	2.46 W/kg ± 18.0 % (k=2)

Appendix (Additional assessments outside the scope of SCS 0108)

Antenna Parameters with Head TSL

Impedance, transformed to feed point	45.1 Ω - 2.2 j Ω
Return Loss	- 25.0 dB

Additional EUT Data

Manufactured by	SPEAG
-----------------	-------

DASY5 Validation Report for Head TSL

Date: 25.11.2019

Test Laboratory: SPEAG, Zurich, Switzerland

DUT: CLA150; Type: CLA150; Serial: CLA150 - SN: 4020

Communication System: UID 0 - CW; Frequency: 150 MHz
Medium parameters used: $f = 150$ MHz; $\sigma = 0.76$ S/m; $\epsilon_r = 51.1$; $\rho = 1000$ kg/m³
Phantom section: Flat Section
Measurement Standard: DASY5 (IEEE/IEC/ANSI C63.19-2011)

DASY52 Configuration:

- Probe: EX3DV4 - SN3877; ConvF(12.4, 12.4, 12.4) @ 150 MHz; Calibrated: 31.12.2018
- Sensor-Surface: 1.4mm (Mechanical Surface Detection)
- Electronics: DAE4 Sn654; Calibrated: 27.06.2019
- Phantom: ELI v4.0; Type: QDOVA001BB; Serial: TP:1003
- DASY52 52.10.3(1513); SEMCAD X 14.6.13(7474)

CLA Calibration for HSL-LF Tissue/CLA150, touch configuration, Pin=1W/Area Scan

(81x81x1): Interpolated grid: $dx=1.500$ mm, $dy=1.500$ mm
Maximum value of SAR (interpolated) = 5.09 W/kg

CLA Calibration for HSL-LF Tissue/CLA150, touch configuration, Pin=1W/Zoom Scan,

dist=1.4mm (8x10x7)/Cube 0: Measurement grid: $dx=4$ mm, $dy=4$ mm, $dz=1.4$ mm
Reference Value = 80.89 V/m; Power Drift = 0.03 dB
Peak SAR (extrapolated) = 6.73 W/kg
SAR(1 g) = 3.66 W/kg; SAR(10 g) = 2.47 W/kg
Ratio of SAR at M2 to SAR at M1 = 81.4%
Maximum value of SAR (measured) = 5.06 W/kg

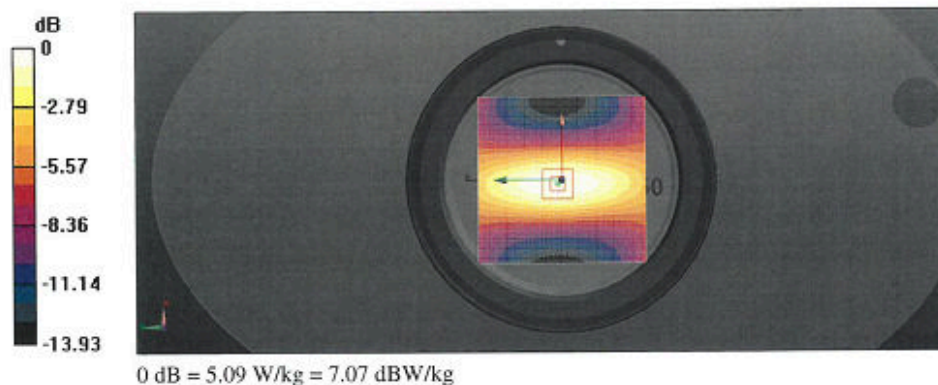

Impedance Measurement Plot for Head TSL

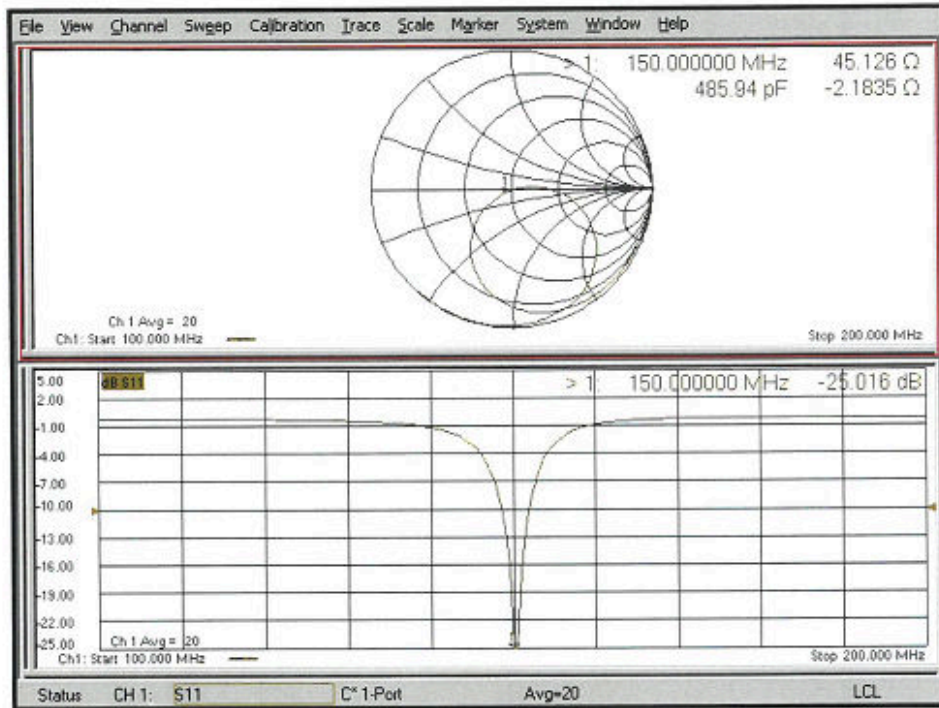

DIPOLE CALIBRATION CERTIFICATES

**Calibration Laboratory of
Schmid & Partner
Engineering AG**
Zeughausstrasse 43, 8004 Zurich, Switzerland



S Schweizerischer Kalibrierdienst
C Service suisse d'étalonnage
S Servizio svizzero di taratura
S Swiss Calibration Service

Accredited by the Swiss Accreditation Service (SAS)
The Swiss Accreditation Service is one of the signatories to the EA
Multilateral Agreement for the recognition of calibration certificates

Accreditation No.: **SCS 0108**

Client **BACL**

Certificate No: **CLA150-4020_Feb20**

CALIBRATION CERTIFICATE

Object: **CLA150 - SN: 4020**

Calibration procedure(s): **QA CAL-15.v9
Calibration Procedure for SAR Validation Sources below 700 MHz**

Calibration date: **February 17, 2020**

This calibration certificate documents the traceability to national standards, which realize the physical units of measurements (SI).
The measurements and the uncertainties with confidence probability are given on the following pages and are part of the certificate.

All calibrations have been conducted in the closed laboratory facility: environment temperature (22 ± 3)°C and humidity < 70%.

Calibration Equipment used (M&TE critical for calibration)

Primary Standards	ID #	Cal Date (Certificate No.)	Scheduled Calibration
Power meter NRP	SN: 104778	03-Apr-19 (No. 217-02892/02893)	Apr-20
Power sensor NRP-Z91	SN: 103244	03-Apr-19 (No. 217-02892)	Apr-20
Power sensor NRP-Z91	SN: 103245	03-Apr-19 (No. 217-02893)	Apr-20
Reference 20 dB Attenuator	SN: 5277 (20x)	04-Apr-19 (No. 217-02894)	Apr-20
Type-N mismatch combination	SN: 5047.2 / 06327	04-Apr-19 (No. 217-02895)	Apr-20
Reference Probe EX3DV4	SN: 3877	31-Dec-19 (No. EX3-3877_Dec19)	Dec-20
DAE4	SN: 654	27-Jun-19 (No. DAE4-654_Jun19)	Jun-20
Secondary Standards	ID #	Check Date (in house)	Scheduled Check
Power meter E4419B	SN: GB41293874	06-Apr-16 (in house check Jun-18)	In house check: Jun-20
Power sensor E4412A	SN: MY41498087	06-Apr-16 (in house check Jun-18)	In house check: Jun-20
Power sensor E4412A	SN: 000110210	06-Apr-16 (in house check Jun-18)	In house check: Jun-20
RF generator HP 8648C	SN: US3642U01700	04-Aug-99 (in house check Jun-18)	In house check: Jun-20
Network Analyzer Agilent E8358A	SN: US41080477	31-Mar-14 (in house check Oct-19)	In house check: Oct-20

	Name	Function	Signature
Calibrated by:	Jeton Kastrali	Laboratory Technician	
Approved by:	Katja Pokovic	Technical Manager	

Issued: February 18, 2020

This calibration certificate shall not be reproduced except in full without written approval of the laboratory.

**Calibration Laboratory of
Schmid & Partner
Engineering AG**
Zeughausstrasse 43, 8004 Zurich, Switzerland



S Schweizerischer Kalibrierdienst
C Service suisse d'étalonnage
S Servizio svizzero di taratura
S Swiss Calibration Service

Accredited by the Swiss Accreditation Service (SAS)

The Swiss Accreditation Service is one of the signatories to the EA
Multilateral Agreement for the recognition of calibration certificates

Accreditation No.: **SCS 0108**

Glossary:

TSL	tissue simulating liquid
ConvF	sensitivity in TSL / NORM x,y,z
N/A	not applicable or not measured

Calibration is Performed According to the Following Standards:

- IEEE Std 1528-2013, "IEEE Recommended Practice for Determining the Peak Spatial-Averaged Specific Absorption Rate (SAR) in the Human Head from Wireless Communications Devices: Measurement Techniques", June 2013
- IEC 62209-1, "Measurement procedure for the assessment of Specific Absorption Rate (SAR) from hand-held and body-mounted devices used next to the ear (frequency range of 300 MHz to 6 GHz)", July 2016
- IEC 62209-2, "Procedure to determine the Specific Absorption Rate (SAR) for wireless communication devices used in close proximity to the human body (frequency range of 30 MHz to 6 GHz)", March 2010
- KDB 865664, "SAR Measurement Requirements for 100 MHz to 6 GHz"

Additional Documentation:

- DASY4/5 System Handbook

Methods Applied and Interpretation of Parameters:

- Measurement Conditions:* Further details are available from the Validation Report at the end of the certificate. All figures stated in the certificate are valid at the frequency indicated.
- Antenna Parameters with TSL:* The source is mounted in a touch configuration below the center marking of the flat phantom.
- Return Loss:* This parameter is measured with the source positioned under the liquid filled phantom (as described in the measurement condition clause). The Return Loss ensures low reflected power. No uncertainty required.
- SAR measured:* SAR measured at the stated antenna input power.
- SAR normalized:* SAR as measured, normalized to an input power of 1 W at the antenna connector.
- SAR for nominal TSL parameters:* The measured TSL parameters are used to calculate the nominal SAR result.

The reported uncertainty of measurement is stated as the standard uncertainty of measurement multiplied by the coverage factor $k=2$, which for a normal distribution corresponds to a coverage probability of approximately 95%.

Measurement Conditions

DASY system configuration, as far as not given on page 1.

DASY Version	DASY5	V52.10.4
Extrapolation	Advanced Extrapolation	
Phantom	ELI4 Flat Phantom	Shell thickness: 2 ± 0.2 mm
EUT Positioning	Touch Position	
Zoom Scan Resolution	$dx, dy =$ mm, $dz =$ mm	Graded Ratio = 1.4 (Z direction)
Frequency	150 MHz \pm 1 MHz	

Body TSL parameters

The following parameters and calculations were applied.

	Temperature	Permittivity	Conductivity
Nominal Body TSL parameters	22.0 °C	61.9	0.80 mho/m
Measured Body TSL parameters	(22.0 ± 0.2) °C	63.6 ± 6 %	0.81 mho/m \pm 6 %
Body TSL temperature change during test	< 0.5 °C	----	----

SAR result with Body TSL

SAR averaged over 1 cm ³ (1 g) of Body TSL	Condition	
SAR measured	1 W input power	3.74 W/kg
SAR for nominal Body TSL parameters	normalized to 1W	3.72 W/kg \pm 18.4 % (k=2)

SAR averaged over 10 cm ³ (10 g) of Body TSL	condition	
SAR measured	1 W input power	2.54 W/kg
SAR for nominal Body TSL parameters	normalized to 1W	2.53 W/kg \pm 18.0 % (k=2)

Appendix (Additional assessments outside the scope of SCS 0108)

Antenna Parameters with Body TSL

Impedance, transformed to feed point	45.5 Ω + 1.8 j Ω
Return Loss	- 25.9 dB

Additional EUT Data

Manufactured by	SPEAG
-----------------	-------

DASY5 Validation Report for Body TSL

Date: 17.02.2020

Test Laboratory: SPEAG, Zurich, Switzerland

DUT: CLA150; Type: CLA150; Serial: CLA150 - SN: 4020

Communication System: UID 0 - CW; Frequency: 150 MHz

Medium parameters used: $f = 150$ MHz; $\sigma = 0.81$ S/m; $\epsilon_r = 63.6$; $\rho = 1000$ kg/m³

Phantom section: Flat Section

Measurement Standard: DASY5 (IEEE/IEC/ANSI C63.19-2011)

DASY52 Configuration:

- Probe: EX3DV4 - SN3877; ConvF(11.51, 11.51, 11.51) @ 150 MHz; Calibrated: 31.12.2019
- Sensor-Surface: 1.4mm (Mechanical Surface Detection)
- Electronics: DAE4 Sn654; Calibrated: 27.06.2019
- Phantom: ELI v4.0; Type: QDOVA001BB; Serial: TP:1003
- DASY52 52.10.4(1527); SEMCAD X 14.6.14(7483)

CLA Calibration for MSL-LF Tissue/CLA150, touch configuration, Pin=1W/Zoom Scan,

dist=1.4mm (8x10x7)/Cube 0: Measurement grid: dx=4mm, dy=4mm, dz=1.4mm

Reference Value = 78.40 V/m; Power Drift = 0.01 dB

Peak SAR (extrapolated) = 6.77 W/kg

SAR(1 g) = 3.74 W/kg; SAR(10 g) = 2.54 W/kg

Smallest distance from peaks to all points 3 dB below: Larger than measurement grid (>30 mm)

Ratio of SAR at M2 to SAR at M1 = 82.3%

Maximum value of SAR (measured) = 5.11 W/kg

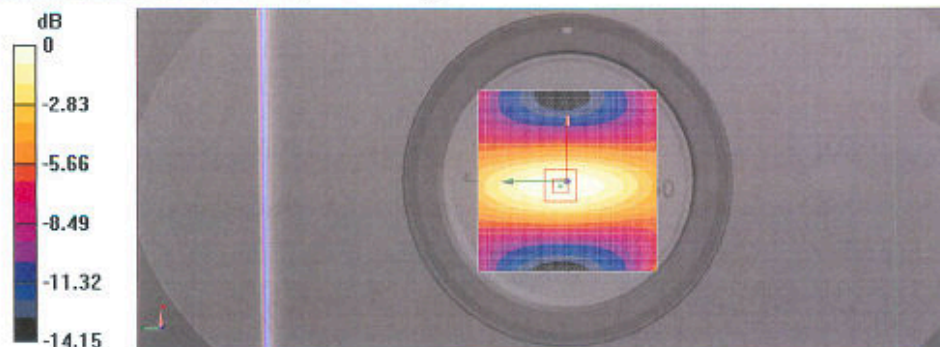

Impedance Measurement Plot for Body TSL

