



PROFESSIONAL FM TRANSCEIVER

Digital Two-Way Radio

DM-580



USER'S MANUAL



Preface

Thanks for your favor in **iradio** product. This manual provides guidance for you to quickly know how to use this product.

To avoid bodily injury or property loss caused by misoperations, please carefully read this manual before using our product.

This manual is applicable to the following product: DM-580.

Welcome to use iradio digital two-way radio.

iradio

Main Function

UHF:400-470MHz

1000 Channels

250 Zones

Message Function

CTCSS/DCS

VOX Function

DTMF Function

High/Low power Selection

Scan Function

Low Power Alert

Emergency Alarm Function

Digital Encryption

Side Key P1/P2 Can be Customized

Single Call、Group Call、All Call



CONTENTS

Section 1.....	01-02
Attention.....	01
Unpacking and device checking.....	02
Section 2.....	03-10
Familiar with the radio.....	04-05
Preparation before using.....	06-10
Charging the battery.....	06
Attaching the battery.....	07
Attaching the antenna.....	08
Attaching the belt clip.....	09
Attaching the audio accessory/programming cable.....	10
Section 3.....	11-15
Basic operations.....	12
Turning the radio on/off.....	12
Adjusting the volume.....	12
Selecting a zone.....	12
Channels、 users ID、 talk group ID selection.....	12
Call.....	12-15
Private Call.....	13
Group Call.....	14
All Call.....	15

Section 4.....	16-48
Emergency Alarm Function and operations.....	17-20
Emergency type.....	17
Emergency Mode.....	18
Operation of sending emergency alarm.....	19
Operation of receiving emergency alarm.....	19
Operation of replying emergency alarm.....	20
Menu Functions and Operations.....	21-30
Character input.....	21
English character mode.....	21
Radio Detection.....	22
Send a Radio Detection.....	22
Setting contacts person.....	23
Call recording function.....	23
Missed call screen.....	23
Store/Delete Missed, Answered, Outgoing list name/ID.....	23
Call prompt operation.....	24
Receiving & Confirm call prompt.....	24
Message function.....	24
Encryption.....	25
Basci encryption.....	25
DTMF.....	26
Make a DTMF call.....	26
Anti-Theft.....	26

Kill Function.....	26
Revival Function.....	27
Scanning list	27-30
Check the Members of Scanning List.....	28
Scanning indicator and method.....	28
There are two scanning methods.....	29
Start/stop Scanning.....	29
Reply	30
Utilities.....	31-41
Radio Settings.....	31
Talk around.....	32
Tones/Alerts.....	33
All Tones.....	33
Keypad Tones.....	34
Power Level Setting.....	34-35
Back light.....	35
Squelch.....	36
Intro Screen.....	37
Keypad Lock.....	37
Language.....	38
LED indicator light.....	38
VOX.....	39
Password Lock.....	40
Clock.....	41-42

Time.....	41
Date.....	41
Radio Info.....	42-43
My number.....	42
Versions.....	43
Program Radio.....	43-48
RX Frequency.....	44
TX Frequency	44-45
Channel Name.....	45
TOT.....	46
CTC/DCS.....	46
Encode.....	46-47
Decode.....	47
Color code.....	47-48
Repeater Slot.....	48
Technical Parameter.....	49-51
General.....	49
Receiving.....	50
Transmitting.....	51
Guarantee.....	52

User's Manual

Attention

Unpacking and device checking

Preparation before using

iradio

ATTENTION

Please read the following brief instructions, if you non-compliance with these rules may cause danger or violate the law.

1. Obey the government regulation before using this radio, improper operation may violate the law and will be punished.
2. Turn off the radio before entering flammable or explosive areas.
3. Do not charge or change the battery in flammable or explosive areas.
4. Do not use radio which antenna is damaged, touching of the damaged antenna will cause heat injury.
5. Do not attempt to open the radio: the maintenance work must be done by technical expert only.
6. To avoid troubles caused by electromagnetic interference or electromagnetic compatibility, please turn off the radio in places where have the banner "Do not use wireless equipment," Such as hospital and other health-care areas.
7. In a car with a safety airbag, do not put the radio within the scope of the airbag deployed.
8. Do not put the radio under the direct sunshine or hot areas.
9. When you transmit the signaling, please keep away from radio's antenna for 3.1CM at least.
10. If you smell radio appears fumes or burning, please shut off it's power immediately and contact with your local dealer.

Unpacking and device checking

iradio

Before using:

1. Please check whether the packing box is damaged or not.
2. Please unpack packing box carefully, and confirm the following list of items are in the box. If any items are missing or have been damaged during shipment, please contact dealers immediately.

Supplied accessories

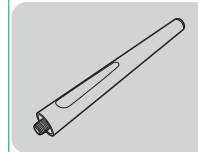

Antenna (1)

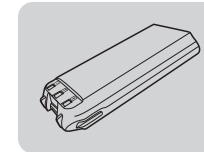

Li-ion battery (1)

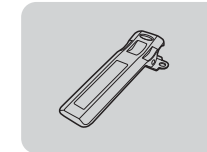

Belt Clip (1)

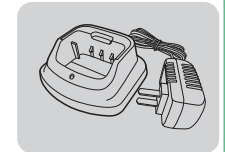

Charger (1)



Verification (1)



User's Manual (1)

Note :

The antenna may vary with different frequency bands. And the frequency band is marked on the label of antenna. If no, please refer to the label on the radio unit for frequency band information.

Familiar with the radio

Preparation before using

Basic operations



Familiar with the radio

Antenna
with threaded head. for
transmitting and receiving

LED indicator light
The indicator light turns red when
transmit, turns green when receive.
It blinks red when the battery
capacity is low, and blinks green
when scanning.

Speaker
sound output

Power/volume knob
To power on/off and adjust the volume.
Rotate it clockwise, a "click" sound is
heard and a "Du" tone prompts the
radio power on, continue to rotate it to
adjust the volume. Rotate it counter-
clockwise until a "click" sound is heard,
it powers off.

Microphone
sound input

P1

P2

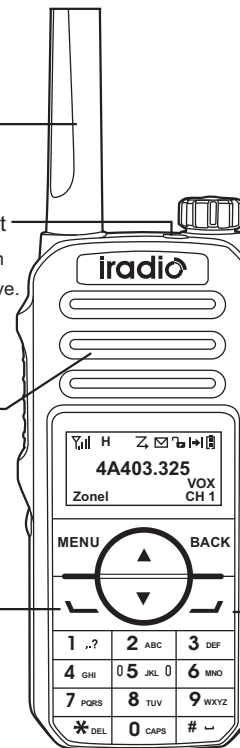

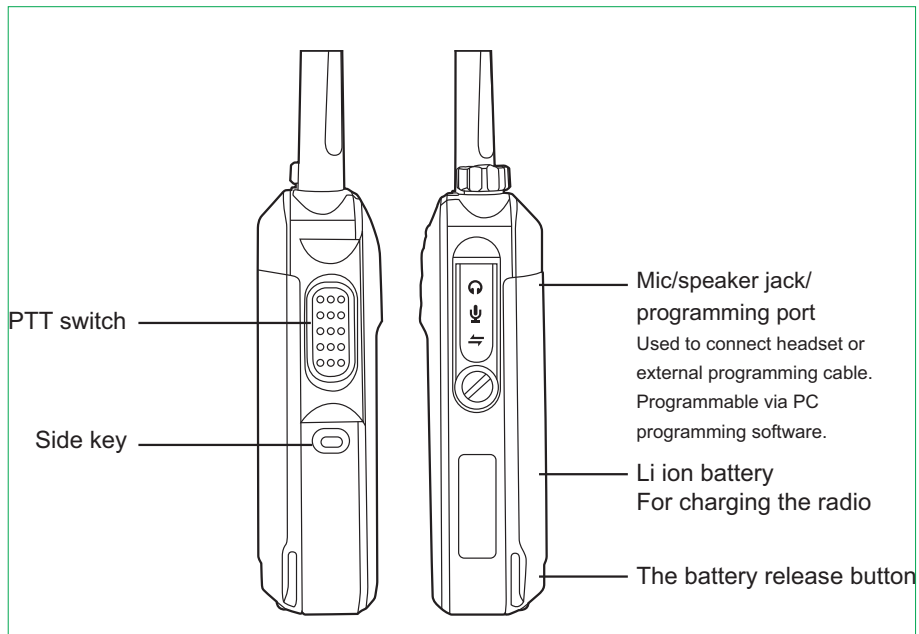

Notice: Either Long-press or Short-press of Side-key /P1-key /P2-key can be set by program software.

Preparation before using

Charging the battery

Use only the charger and battery specified by **iradio** charger, LED can indicate the charging process. Charge diagram

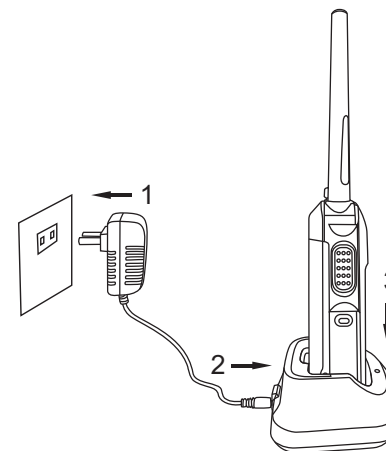

Procedures

1. Connect the power adapter to AC socket. See arrow 1.
2. Plug the power adapter into the rear jack of the charger. See arrow 2.
3. Place the radio with the battery attached, into the charger. See arrow 3.

LED Indicator	Status
Red	Charging
Green	Fully charged

Attaching the battery

- 1) Slide the battery into the radio's slot. (Arrow 1)
- 2) Buckle the battery until the battery and radio were tightly fixed. (Arrow 2)

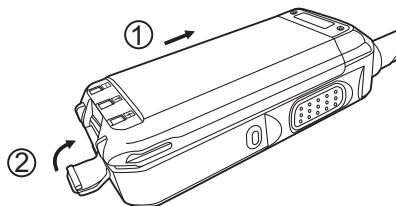

- 3) To remove the battery, turn off the radio first. Then release the lock catch to unlock the battery. (Arrow 2)

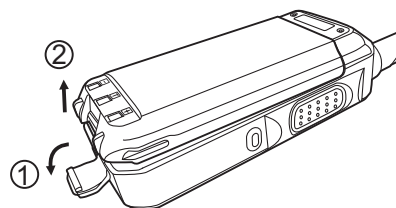

Attaching the antenna

- 1) Turn the antenna clockwise to fasten it.
- 2) To remove the antenna, rotate it counter-clockwise.

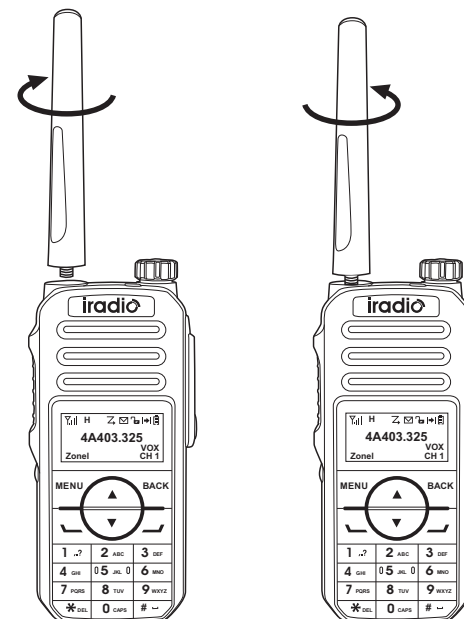

Attaching the belt clip

- 1) Using two screws align the screw holes on the belt clip with those on the radio's body, and then tighten this two screws. (Arrow 1)
- 2) Loosen the screw set to remove the belt clip. (Arrow 2)

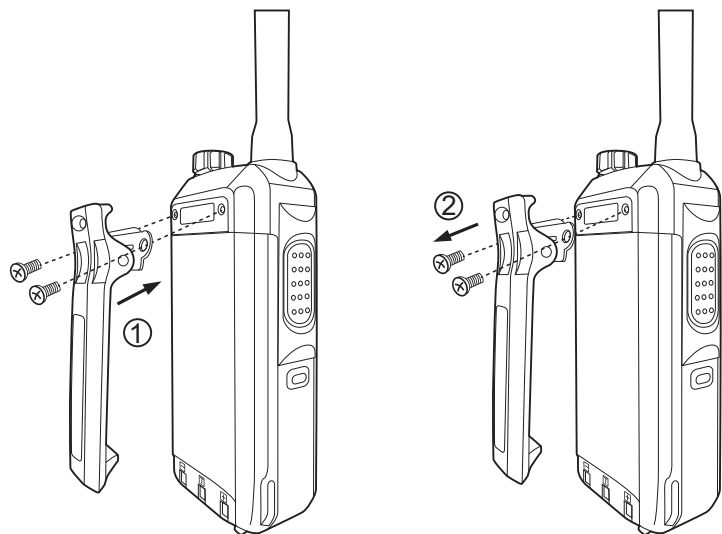

Attaching the audio accessory/programming cable

- 1) Using screw-driver to release the screw.
- 2) Align the plug with the accessory jack.
- 3) Tighten the screw on the plug.

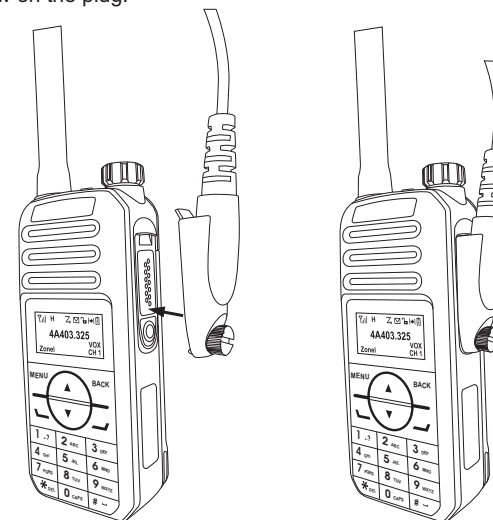

To remove accessories, loosen the screw.

 Caution: When you are using as external accessory, waterproof performance of the radio may get affected.

Basic operations

Private Call、 Group Call、 All Call

iradio

Basic operations

Turning the radio on/off

Rotate the radio on-off/volume control knob, clockwise/counter-clockwise until a click is heard to turn the radio on/off.

Adjusting the volume

After turning the radio on, rotate the radio on-off/volume control knob clockwise to increase the call volume, or counter-clockwise to decrease it.

Selecting a zone

A zone is a group of channels exhibiting the same property, and is programmed by your dealer. The radio supports up to 64 zones, each with a maximum of 16 channels. You may select a zone through any of the following methods:

1. Press **MENU** key to enter menu, go to the menu "Zone", and use the [**▲** or **▼**] key to select your desired zone.
2. You may quickly toggle to your desired zone by pressing the **MENU** key to confirm.

Channels、 users ID、 talk group ID selection

Select Channels、 users ID、 talk group ID by pressing [**▲** or **▼**] key.

Call

To ensure an optimal volume of the receiving radio, hold the radio approximately 2.5 to 5 centimeters away from your mouth.

Private call

Transmitting a private call

Transmitting a private call through any of the following methods:

- Transmitting a call to the preset contact

In the home screen, hold down the [PTT] key to transmit a private call to the private call contact preset for the current channel.



Note: Your dealer may preset a contact for each digital channel. The preset contact could be a private call contact, a group call contact or an all call contact.

- 1) Transmitting a call through contact list or call logs
- 2) Press [MENU], then go to "Contacts→Contacts List", or go to "Call Log" and access the Missed/Answered/Outgoing list.
- 3) Use the [▲] or [▼] key to select the private call contact you want to call.

Receiving and responding to a private call

- 1) When a private call is received, the LED indicator light for green light.
- 2) In the home screen, top line will display RSSI etc status icon, in the display area below, the first line shows private call + User's name/ID, next line shows a private call icon.
- 3) You may hold down the [PTT] key within the preset time period to call back. If you do not respond to a received private call, your radio's Missed Call Log will display the missed calling number.

Group Call

Transmitting a group call

You may transmit a group call through any of the following methods.

1. Transmitting a call to the preset contact

In the home screen, hold down the [PTT] key to transmit a group call to the group call contact preset for the current channel.

2. Transmitting a call through contact list or call logs

- 1) Press [MENU], then go to "Contacts→Contacts List", or go to "Call Log" and access the Missed/Answered/Outgoing list.
- 2) Use the [▲] or [▼] key to select the group call contact you want to call.
- 3) Hold down the [PTT] key to transmit the group call.

Receiving and responding to a group call

- 1) When a group call is received, the LED indicator light for green light.
- 2) In the home screen, top line will display RSSI etc status icon, in the display area below, the first line shows group call + User's name/ID, next line shows a group call icon.
- 4) You may hold down the [PTT] key within the preset time period to call back. If you do not respond to a received group call, your radio's Missed Call Log will display the missed calling number.

All Call

Transmitting an all call

Method are the same as those in transmitting a group call.



Note: You can transmit an all call only when it is enabled by your dealer. And you cannot respond to an all call.

Calls on analog channels

To transmit on an analog channel, hold down the [PTT] key and speak into the microphone.

To receive, release the [PTT] key.

Emergency Alarm Function and Operations Menu Functions and Operations

iradio

Emergency Alarm Function

In case of an emergency, you can use the feature to ask for help from your companion or control center. The emergency process has the highest priority. You can make emergency operation even when your radio is transmitting or receiving.

To enable the feature on a channel, an emergency system must be assigned to the channel via the programming software. In addition, the system name, emergency type and emergency mode are settable via the programming software.

Emergency type

For each emergency mode, there are four emergency types available. You can select one of them via the programming software.

Emergency Type	Description
Disabled	Turn off the function of emergency alarm
Regular	In emergency mode, the radio will give audible and visible indication.
Silent	In emergency mode, the radio won't give any audible or visible indication.
Silent with Voice	In emergency mode, the radio won't give any audible or visible indication, but will receive voice from the companion or control center automatically.

Emergency Mode

Emergency Mode	Description
Emergency Alarm	In this mode, you can send alarm information to your companion or control center by pressing the programmed emergency key, but you cannot talk with them.
Emergency Alarm with Call	In this mode, you can send alarm information by pressing the programmed emergency key, then press [PTT] and speak into the microphone, allowing your voice and background noise to be transmitted, release the [PTT] key to receiving.
Emergency Alarm with Voice to Follow	In this mode, press the programmed emergency key to go to the revert channel, then you can speak into the microphone, allowing your voice and background noise to be transmitted automatically (You do not need to hold down the [PTT] key).

Operation of sending emergency alarm

1. Press preset key to turn on the emergency alarm function.
 2. Home screen will display
 3. While receiving confirmation of emergency alarm, it will prompt Emergency call tone and the LED indicator light will flashing green color.
 - Emergency Alarm
- 1) The screen display emergency alarm success. or if the radio didn't received any confirmation of emergency alarm and used all the number of replication, will send a prompt tone, then display emergency alarm failure on screen.
 - 2) The radio exit emergency alarm mode, and back to the home screen.
 - Emergency Alarm with CallRefer to the description of Emergency Alarm with Call.
 - Emergency Alarm with Voice to Follow
- Refer to the description of Emergency Alarm with Voice to Follow.

Operation of receiving emergency alarm

1. While you receiving emergency alarm, the alarm and number of receiving will interchanging display with sender's name and ID.
2. Sending one prompt tone and LED indicator light flashing red color.
3. If activated, radio will confirm the emergency alarm automatically. While you receiving the emergency alarm, the screen will display the prompt of emergency alarm, meanwhile you can not receive other prompt or other calling, until you exit the emergency alarm mode.

Caution: Short press [**MENU**] key, then press preset key to turn off the alarm.

Operation of replying emergency alarm

1. Press any key to stop all sounds of receiving an emergency alarm.
2. Hold the radio approximately 2.5 to 5 centimeters away from your mouth. If you turn on the function of Channel free indication tone, when you release [PTT] key, you will heard a short prompt tone, indicates that this channel can use now.
3. Press [PTT] to start a call, LED indicator light flashing red color. The radio are on the emergency alarm mode.
4. Release the [PTT] to receiving the call, when the sender part reply, LED indicator light flashing green color. You will see the group call icon, Talk Group ID and sender part ID.
5. After finish the call, short press [**MENU**] key, then press preset key to turn off the alarm.
6. Radio back to home screen.

Menu Functions and Operations

Character input

You can use 3×4 alphanumeric keyboard to access the radio's function. While using keyboard to input user's name or message, have three mode to select:

1. English character mode.
2. Chinese input method mode.
3. Digital input mode

While input ID by keyboard, only can using digital input mode.

English character mode

Some characters need to press a key several times, The following table shows the number of times you need to press a key to get the desired character.

Button	1	2	3	4	5	6	7	8	9	10	11	12	13
1	1	.	,	?	!	@	&	'	%	-	:	*	#
2	a	b	c	2	A	B	C						
3	d	e	f	3	D	E	F						
4	g	h	i	4	G	H	I						
5	j	k	l	5	J	K	L						
6	m	n	o	6	M	N	O						
7	p	q	r	s	7	P	Q	R	S				
8	t	u	v	8	T	U	V						
9	w	x	y	z	9	W	X	Y	Z				
0	Long press "0" to switch the case of character.												
*	Backspace, can delete one character or one number.												
#	Space key, long press "#" can switch input method.												

Radio Detection

Activation function allows you to determine whether there are other walkie talkies in the system is active, and won't disturb the walkie talkie users. This feature only suitable for user's name or ID.

Send a Radio Detection

1. Press [MENU] to enter menu mode.
2. Go to Call Log, press [MENU] to confirm.
3. Go to the user's name or ID that you required., then press [MENU] to confirm. Or go to Manual dial, press [MENU] to confirm, edit ID number then press [MENU] key.
4. Go to radio detection., then press [MENU] to confirm.
5. The screen display radio detection: <user's name or ID>, Indicates that the intercom is being detected. LED indicator light flashing red color.
6. Waiting confirmation.
7. If the target radio is active in the system, you will hear a prompt voice, the screen display target radio have responded.
Or if the target radio is not active in the system, you will hear a prompt voice, the screen display target radio didn't responded.
8. Radio will back to user's name or ID screen. If you press [MENU] while waiting confirmation, you will hear a prompt voice and the radio will terminate all retry and exit the walkie talkie detection mode.

Setting contacts person

Call log provides "Address Book" for radio. Each entry corresponds to a user's name or ID for initiating the call. In addition, Each entry is different according to the settings, consist of group call, private call and all call. This radio support digital call log.

Entries in the "Contacts" show the following information:

- Contacts List
- New Contact
- Manual Dial

Call recording function

This radio can record recent Missed, Answered, Outgoing information. You can press [Call Log] to check and manage the recent call. While check the list, press [PTT] to initiate a call.

Missed call screen

Whenever you missed the call, it will display a missed calling message in home screen, you can check or check later.

 Note: If press [PTT] key while check missed call, it will initiate a call with current number.

Store/Delete Missed, Answered, Outgoing list name/ID

1. Press [MENU] to enter menu mode.
2. Press [▲ or ▼] key to Call Log, press [MENU] to confirm.
3. Go to the list that you want, press [MENU] to choose current name/ID
4. You can select store or delete.
5. If you store the ID, press [MENU] , input it's name that you want, then press [MENU] to confirm.

Call prompt operation

This function allow you to send a prompt in order to remind receiver call back while free.

 Note: This function only suitable for user alias/ID, it can sending by Call Log or manual dialing.

Receiving & Confirm call prompt

The screen will display calling party's alias/ID when you received a call prompt.

1. You will heard a reduplicated sound, LED indicator light flashing red color.
2. Press and release [PTT] key to confirm call prompt, or press [MENU] key then select "Ignore" to exit call prompt mode.

Message function

To access this item, press the [MENU] key and then select [Message].

- New message

You can create new text message (144 characters at most) and send it to an individual user or to a talk group.

- Quick text

Under this option there are some text message (50 entries at most). You can choose to edit and send any entry.

- InBox

The InBox can save up to 50 received messages. When the InBox is full, the earliest message will be overwritten by the latest one automatically.

For each message, you can choose to perform any of these operations: Reply, Forward, View Details and Delete. To delete all messages in the InBox, select "Message → InBox → Delete All".

- OutBox

The OutBox can save up to 50 sent messages. When the OutBox is full, the earliest message will be overwritten by the latest one automatically.

For each of message, you can choose to perform any of these operations: Resend, Forward, View Details and Delete. To delete all messages in the OutBox, select "Message→OutBox→Delete All".

- Drafts

The Drafts can save up to 50 sent messages. When the Drafts is full, the earliest message will be overwritten by the latest one automatically.

For each of message, you can choose to perform any of these operations: Send, Save and Delete. To delete all messages in the Drafts, select "Message→Drafts→Delete All".

Encryption

If this function is enabled, which is beneficial to preventing other users on the channel by using a number of encryption and decryption technologies for unauthorized eavesdropping. The launch of signaling and user identification is unencrypted. The encryption must be enabled so that the radio can transmit the signal encrypted, even if you don't have to encrypt it when receive it.

Basic encryption

Two way radio can only be assigned to one of the above encryption types. In order to decrypt the encrypted call or data transmission, the receiver must have the same encryption key with the transmitter. (Apply to Basic encryption)

If your radio received the call of different encryption keys or key values and keyID, then you will receive some confused noisy. (Basic encryption)

Press the pre-programmed encryption key to turn on or turn off this function.

DTMF

Dual Tone Multi-Frequency (DTMF) function allows you to operate the radio when there is interference in the radio system

Make a DTMF call

1. Press and hold [PTT] key.
2. Input the number you need.

You can disable DTMF tone by turning off all radio prompt sound.

Anti-Theft

You can revival or kill any radio in the system. For example, you might want to disable a stolen radio, to prevent thief using it, and enable it when you get it back.

Note: Only the radio with kill or revival function can be enable and disable.

Kill Function

Choose Menu,

1. Press [MENU] key to enter the menu
2. Press [▲ or ▼] key and choose Contact list, then press [MENU] key to confirm, the contacts are grouped by letter.
3. Press [▲ or ▼] key to choose the name or ID, and press [MENU] key to confirm.
Or press [▲ or ▼] key to choose Manual Dial, press [MENU] twice and input the user's name and ID, then press [MENU] to confirm.
4. Press [▲ or ▼] key to choose Radio disable, and press [MENU] key to confirm.
5. The screen displays: radio disable:<user's name or ID>, Indicator light turns red.

6. Wait for confirmation.

7. The radio will issue a prompt sound when disable the radio successfully, and the screen displays:radio disable successfully.

The radio will issue a prompt sound as well when it fail to disable the radio. And the screen displays: Radio disable failed.

During the process of disabling the radio, please do not press the [**MENU**] key, otherwise, you won't get the confirmation.

Revival Function

Use menu function:

1.Press [**MENU**] key to enter the menu.

2.Press [**▲** or **▼**] key and choose Contact list, then press [**MENU**] key to confirm, the contacts are grouped by letter.

3. Press [**▲** or **▼**] key to choose the name or ID, and press [**MENU**] key to confirm.

Or Press [**▲** or **▼**] key to choose Manual Dial, press [**MENU**] twice and input the user's name and ID, then press [**MENU**] key to confirm.

4. Press [**▲** or **▼**] key to choose Radio enable, and press [**MENU**] key to confirm.

5.The screen displays: radio enable:<user's name or ID>, Indicator light turns red.

6. Wait for confirmation.

7.The radio will issue a prompt sound when enable the radio successfully, and the screen displays:radio enable successfully.

The radio will issue a prompt sound as well when it fail to enable the radio. And the screen displays: Radio enable failed.

During the process of disabling the radio, please do not press the [**MENU**] key,otherwise, you won't get the confirmation.

Scanning list

Create the scan list and assign them to each channel or each group. There are up to 250 scanning lists available, each list is up to 16 members.

Each scanning list supports mixed analogue and digital channels. You can edit the scanning list to add/delete the channel or set up a priority channel.

Check the Members of Scanning List

1.Press the [**MENU**] key to enter the menu.

2.Press [**▲** or **▼**] key and choose Scan, then press the [**MENU**] key to confirm.

3.Press [**▲** or **▼**] key to view/edit the scanning list. then press the [**MENU**] key to confirm.

4.Use [**▲** or **▼**] key to check members in scanning list.

5.If the priority channel has been set,the priority icon will appear in the left of user name, it means the user is priority channel ① or priority channel ②. If the priority channel is none (N), then the radio won't display the special icon. In a scanning list, the radio can't have more than one priority channel 1 or priority channel 2.

Scanning indicator and method:

When scanning, The radio will scan the current channels in a circular manner throughout the pre-programmed scanning list to find out which channel has received the signal. LED turns red and flashes, the scanning icon  will appear on the screen.

When scanning in dual modes,If the radio is in a digital channel while lock in an analogue channel, will switch from digital mode to analogue mode automatically during the call duration.Vice versa.

There are two scanning methods

- Manual Scan: According to pre-programmed the scanning key to turn on/off scanning or enter the Menu and choose Scan. When you start to scan, radio will detect all channels/contact groups in the pre-programmed scan list.
- Auto Scan: When you select an already activated auto scan channels/contact groups, radio will start to scan from the activated auto scan channel.

Start/stop Scanning:

Press the scanning key which has been programmed by software or enter the menu list.

1. Press the [MENU] key to enter the menu
2. Press [▲ or ▼] key and choose Scan, then press the [MENU] key to confirm.
3. If the scanning function is disable, the scanning interface displays TURN ON, or if this function is enable, the scanning interface displays TRUN OFF.
4. Press the [MENU] key to confirm.
5. When this function is enable, indicator light turns red and flashes, the scanning icon  appears on the screen; when this function is disable, LED indicator light and scanning icon disappear.

Reply

Radio detect active channel/contact group when scanning, at this time radio will stay in this channel/contact group, which called "scanning hold time".

Procedure:

1. Hold the radio in a vertical position and keep one to two inches (2.5 to 5.0 cm) distance from the mouth. If the "channel idle tone" is enable, then you will hear a short prompt sound when release the PTT button after transmitting the signal, which indicates that the channel is idle, and waiting for your response.
2. Press PTT button during the hold time, the LED indicator light turns red.
3. Release PTT button to receive the signal.
4. If you didn't respond the signal during the hold time, the radio will carry on scanning.

Utilities

The utilities shall consist of the following options:

- Radio Settings
- Radio Info
- Program Radio

Radio Settings

- Radio Setting Includes:
- Talk around
- Tones/Alerts
- Power
- Back light
- Squelch
- Intro Screen
- Keypad Lock
- Language
- LED Indicator
- VOX
- Password Lock
- Clock

Talk around

This function allows the radio that continues to communicate where the repeater does not work, or the radio is out of the range of repeater while is within the call range of other radios. That called "talk around".

Press the 1750hz replay echo/talk around key which has been programmed via software, then you can switch these two kinds of modes.

Use the menu function

1. Press Key to enter the menu
 2. Press [or] key and choose Utilities, then press key to confirm.
 3. Press [or] key and choose Radio Setting, then press key to confirm.
 4. then press key to confirm. and choose Talk around, then press key to confirm.
 5. If radio is in 1750hz reply mode, you will see selected Turn off, when the radio is in talk around mode, you will see selected Turn on.
 6. press key to confirm.
 7. The screen displays talk around icon(), or it will disappear when this function has shut down.
 8. The interface will return to the previous options list.
- Even after shutdown, talk around will be remained.

Tones/Alerts

Including the following options:

- All Tones
- Keypad Tones

All Tones

If needed, all tones could be enable or disable.(Except emergency alerts tone).
Press All tones key which pre-programmed by software to turn on/off this function.

Use the menu function:

- 1.Press [**MENU**] key to enter the menu
- 2.Press [**▲** or **▼**] key and choose utilities,then press key to confirm.
- 3.Press [**▲** or **▼**] key and choose radio settings, then press key to confirm.
- 4.Press [**▲** or **▼**] key and choose tones/alerts,then press key to confirm.
- 5.Press [**▲** or **▼**] key and choose all tone,then press key to confirm.
- 6.Press [**MENU**] key to turn on all tones,the screen displays"all tones on"
Or 6.Press [**MENU**] key to turn off all tones, the screen displays "all tones off".

Keypad Tones

If needed, Keypad tones could be enable or disable.

Use the menu function:

- 1.Press [**MENU**] key to enter the menu
- 2.Press [**▲** or **▼**] key and choose utilities,then press key to confirm.
- 3.Press [**▲** or **▼**] key and choose radio settings, then press key to confirm.
- 4.Press [**▲** or **▼**] key and choose tones/alerts,then press key to confirm.
- 5.Press [**▲** or **▼**] key and choose keypad tones,then press key to confirm.
- 6.Press [**MENU**] key to turn on, the screen displays"keypad tones on"
Or press [**MENU**] key to turn off all tones, the screen displays "keypad tones off".

Power Level Setting

There is High/Low power available for each channel.

Setting:High power allow you to communicate with other radio with long distance. Low power allows you to communicate with other radio with short distance. Press High/Low power key which has been programmed by software, you can switch high/low power.

Use the menu function:

- 1.Press key to enter the menu
- 2.Press [or] key and choose utilities,then press key to confirm.
- 3.Press [or] key and choose radio settings, then press key to confirm.
- 4.Press [or] key and choose Power,then press key to confirm.

5. Under the instruction to switch the power.

6. Press **key** to confirm high/low power

7. The interface will return to the radio setting options.

Press <back> to return the main interface. The power level icon will be displayed on the screen.

Back light

You can turn on or off the screen back light according to your requirement.

Press the Back light key which has been programmed by software, to turn on/off this function.

Use the menu function:

1. Press [**MENU**] key to enter the menu

2. Press [**▲** or **▼**] key and choose utilities, then press **key** to confirm.

3. Press [**▲** or **▼**] key and choose radio settings, then press **key** to confirm.

4. Press [**▲** or **▼**] key and choose Back light, then press **key** to confirm.

5. Press [**MENU**] key to turn on this function when the interface displays Auto On.

Or Press [**MENU**] key to turn off this function when the interface displays Turn off.

Once you turn off this function, the back light of keypad and screen will be shut down.

Squelch

Adjust the squelch level to filter useless call with low signal or when there's too much background noise.

Setting: The normal value is default value, to filter (useless) call or background strictly. However, a call from a remote location may also be filtered out.

Press the squelch level key which has been pre-programmed by software, to switch between Normal and Tight.

Use the menu function:

1. Press [**MENU**] key to enter the menu

2. Press [**▲** or **▼**] key and choose utilities, then press **key** to confirm.

3. Press [**▲** or **▼**] key and choose radio settings, then press **key** to confirm.

4. Press [**▲** or **▼**] key and choose Back light, then press **key** to confirm.

5. Select Press [**MENU**] Normal or Tight, then press **key** to Confirm.

6. The interface will return to the option list of radio settings option list.

Intro Screen

If needed, Intro Screen could be enable or disable.

1. Press [**MENU**] key to enter the menu
2. Press [**▲** or **▼**] key and choose utilities, then press [**MENU**] key to confirm.
3. Press [**▲** or **▼**] key and choose Intro Screen, then press [**MENU**] key to confirm.
4. Press [**▲** or **▼**] key and choose Back light, then press [**MENU**] key to confirm.
5. Press [**MENU**] key to turn on, the screen displays "Intro screen on"
6. Press [**MENU**] key to turn off, the screen displays "Intro screen off".

Keypad Lock

You can lock the keypad to prevent the unexpected input.

1. Press [**MENU**] key to enter the menu
2. Press [**▲** or **▼**] key and choose utilities, then press [**MENU**] key to confirm.
3. Press [**▲** or **▼**] key and choose Intro Screen, then press [**MENU**] key to confirm.
4. Press [**▲** or **▼**] key and choose Keypad Lock, then press [**MENU**] key to confirm.
5. The interface displays "keypad locked". Press [**MENU**] , then press [***#0**] Key to unlock the keypad.
6. The screen displays Keypad unlock and return the main interface.

Language

Radio supports the following languages:

- English
- Chinese

1. Press [**MENU**] key to enter the menu
2. Press [**▲** or **▼**] key and choose utilities, then press [**MENU**] key to confirm.
3. Press [**▲** or **▼**] key and choose radio settings, then press [**MENU**] key to confirm.
4. Press [**▲** or **▼**] key and choose Language, then press [**MENU**] key to confirm.
5. Press [**▲** or **▼**] key and choose the language option, then press [**MENU**] key to confirm.
6. The interface displays the selected language and return to the main interface.

LED indicator light

If needed, LED Indicator could be enable or disable.

1. Press [**MENU**] key to enter the menu
2. Press [**▲** or **▼**] key and choose utilities, then press key to confirm.
3. Press [**▲** or **▼**] key and choose radio settings, then press [**MENU**] key to confirm.
4. Press [**▲** or **▼**] key and choose LED indicator, then press [**MENU**] key to confirm.
5. Press [**MENU**] key to turn on, the screen displays "All LED's on"
Or Press [**MENU**] key to turn off, the screen displays "All LED's off".

VOX

This function allows you to initiate voice-activated hands-free calls on pre-programmed channels. Whenever a microphone with VOX function detect voice, radio will transmit signals automatically with the pre-programmed period of time.











Press [PTT] button during the operation will disable VOX function, to re-enable the VOX function, You must do one of the following options:

- Turn off and reboot the radio.
- Perform the following operation:



















Note: Only the radio with these functions can be enable or disable VOX.

Press VOX key which has been pre-programmed by software to turn on/off this function.

Use the menu function:

1. Press [] key to enter the menu
2. Press [ or ] key and choose utilities, then press [] key to confirm.
3. Press [ or ] key and choose radio settings, then press [] key to confirm.
4. Press [ or ] key and choose VOX, then press [] key to confirm.

Password Lock

1. Press [] key to enter the menu
2. Press [ or ] key and choose utilities, then press [] key to confirm.
3. Press [ or ] key and choose radio settings, then press [] key to confirm.
4. Press [ or ] key and choose Password Lock, then press [] key to confirm.
5. Input the correct eight-digit number password which has been programmed by software, then press [] key to confirm.
6. If the password is incorrect, the interface displays “wrong password”, if the password is correct, the interface will change to the Password lock options list.
7. If the first line displays “turn on”, press [] key to confirm, then you should input the correct password to turn on the radio. If the first line displays “turn off”, press [] key to confirm, then you can turn on the radio directly while don't have to input the password.
8. Press [ or ] key and choose Change Pwd, then press [] key to confirm.
9. Enter 8 digits new password. then press [] key to confirm.
10. Confirm the new 8 digits password, then press [] key to confirm.
11. Screen displays that Password changed.

Note: The password should be 8 digits number.

Clock

Clock settings are divided into:

- Time
- Date

Time

1. Press [**MENU**] key to enter the menu
2. Press [**▲** or **▼**] key and choose utilities, then press [**MENU**] key to confirm.
3. Press [**▲** or **▼**] key and choose radio settings, then press [**MENU**] key to confirm.
4. Press [**▲** or **▼**] key and choose Clock, then press [**MENU**] key to confirm.
5. Press [**▲** or **▼**] key and choose time, then press [**MENU**] key to confirm.
6. Press [**MENU**] key to enter time setting interface
7. Press [**▲** or **▼**] key to move right and left and choose the number you want to change, the number turns to reverse video text, input the right number via keypad.
8. The screen display "time saved" after pressing key to confirm.

Date

1. Press key to enter the menu
2. Press [or] key and choose utilities, then press key to confirm.
3. Press [or] key and choose radio settings, then press key to confirm.

4. Press [or] key and choose Clock, then press key to confirm.
5. Press [or] key and choose date, then press key to confirm.
6. Press key to enter date setting interface
7. Press [or] key to move right and left and choose the number you want to change, the number turns to reverse video text, input the right number via keypad.
8. The screen display "date saved" after pressing key to confirm.

Radio Info

The Radio Info contains the following parts:

- My Number
- Radio Versions (Firmwares Ver, and Codeplus Ver.)

Note: Press Back key to return the previous interface.

My Number

1. Press [**MENU**] key to enter the menu
2. Press [**▲** or **▼**] key and choose utilities, then press [**MENU**] key to confirm.
3. Press [**▲** or **▼**] key and choose radio information, then press [**MENU**] key to confirm.
4. Press [**▲** or **▼**] key and choose My Number, then press [**MENU**] key to confirm.
5. The radio's ID and name will be displayed on the interface.

Versions

Display radio firmware version.

1. Press [**MENU**] key to enter the menu
2. Press [**▲** or **▼**] key and choose utilities, then press [**MENU**] key to confirm.
3. Press [**▲** or **▼**] key and choose radio information, then press [**MENU**] key to confirm.
4. Press [**▲** or **▼**] key and choose Firmware Ver./CP Ver., then press [**MENU**] key to confirm.
5. The radio's version will be displayed on the interface.

Program Radio

This Option allows you to edit the channel content.

The editable channel content contains the following options:

- RX Frequency
- TX Frequency
- Channel Name
- Time out Timer
- CTC/DCS
- Color Code
- Repeater Slot

RX Frequency

1. Press [**MENU**] key to enter the menu
2. Press [**▲** or **▼**] key and choose utilities, then press [**MENU**] key to confirm.
3. Press [**▲** or **▼**] key and choose Program Radio, then press [**MENU**] key to confirm.
4. Input the correct password which has been programmed already by software. then press [**MENU**] key to confirm.
5. Press [**▲** or **▼**] key and choose RX Frequency, then press [**MENU**] key to confirm.
6. The screen displays the current RX frequency, then press [**MENU**] key to confirm.
7. Press [**▲** or **▼**] key to move right and left and choose the number you want to change, the number turns to reverse video text, input the right number via keypad.
8. Press key to save the new frequency, the screen display "RX frequency saved".

Note: Editing frequency will be limited within the frequency range setted by programming software, If the frequency is less than the minimum of the frequency range, the radio will take the minimal value, conversely, when it greater than the maximum, take the maximal value of the frequency range.

TX Frequency

1. Press [**MENU**] key to enter the menu
2. Press [**▲** or **▼**] key and choose utilities, then press [**MENU**] key to confirm.
3. Press [**▲** or **▼**] key and choose Program Radio, then press [**MENU**] key to confirm.

4. Input the correct password which has been programmed already by software. then press [MENU] key to confirm.

5. Press [▲ or ▼] key and choose TX Frequency, then press [MENU] key to confirm.

6. The screen displays the current TX frequency, then press [MENU] key to confirm.

7. Press [▲ or ▼] key to move right and left and choose the number you want to change, the number turns to reverse video text, input the right number via keypad.

8. Press [MENU] key to save the new frequency, the screen display "TX frequency saved".

Note: Editing frequency will be limited within the frequency range set by programming software, If the frequency is less than the minimum of the frequency range, the radio will take the minimal value, conversely, when it greater than the maximum, take the maximal value of the frequency range.

Channel Name

1. Press [MENU] key to enter the menu

2. Press [▲ or ▼] key and choose utilities, then press [MENU] key to confirm.

3. Press [▲ or ▼] key and choose Program Radio, then press [MENU] key to confirm.

4. Input the correct password which has been programmed already by software. then press [MENU] key to confirm.

5. Press [▲ or ▼] key and choose Channel Name, then press [MENU] key to confirm.

6. The screen displays the current channel name, then press [#1] key to change the letter, number, Chinese input method, the same as text editing.

7. The screen displays "Channel name saved" after pressing [MENU] key.

TOT

1. Press [MENU] key to enter the menu

2. Press [▲ or ▼] key and choose utilities, then press [MENU] key to confirm.

3. Press [▲ or ▼] key and choose Program Radio, then press [MENU] key to confirm.

4. Input the correct password which has been programmed already by software. then press [MENU] key to confirm.

5. Press [▲ or ▼] key and choose TOT, then press [MENU] key to confirm.

6. The screen displays infinite, 15S, 30S, ..., 555S (Increasing 15S each time), Press [MENU] key to choose the option you want. then The interface displays "TOT saved" after pressing [MENU] key.

CTC/DCS

CTCSS/DCS is available only in analogue channel, it contains:

- CTCSS/DCS encoding
- CTCSS/DCS decoding

Encode

1. Press [MENU] key to enter the menu

2. Press [▲ or ▼] key and choose utilities, then press [MENU] key to confirm.

3. Press [▲ or ▼] key and choose Program Radio, then press [MENU] key to confirm.

4. Input the correct password which has been programmed already by software. then press [MENU] key to confirm.

5. Press [▲ or ▼] key and choose QT/DQT Code, then press [MENU] key to confirm.

6. There's empty option and all kinds encoding value, press [▲ or ▼] key and choose Empty, press [MENU] key confirm. Then the CTCSS/DCS has been shut down. press [▲ or ▼] key and choose the codes, press [MENU] key to confirm. The interface displays "QT/DQT encode saved".

Decode

1. Press [MENU] key to enter the menu
2. Press [▲ or ▼] key and choose utilities, then press [MENU] key to confirm.
3. Press [▲ or ▼] key and choose Program Radio, then press [MENU] key to confirm.
4. Input the correct password which has been programmed already by software. then press [MENU] key to confirm.
5. Press [▲ or ▼] key and choose QT/DQT Code, then press [MENU] key to confirm.
6. There's empty option and all kinds decoding value, press [▲ or ▼] key and choose Empty, press [MENU] key confirm. Then the CTCSS/DCS has been shut down. press [▲ or ▼] key and choose the codes, press [MENU] key to confirm. The interface displays "QT/DQT decode saved".

Color Code

Color Code is available only in digital mode.

1. Press [MENU] key to enter the menu
2. Press [▲ or ▼] key and choose utilities, then press [MENU] key to confirm.
3. Press [▲ or ▼] key and choose Program Radio, then press [MENU] key to confirm.

4. Input the correct password which has been programmed already by software. then press [MENU] key to confirm.
5. Press [▲ or ▼] key and choose Color Code, then press [MENU] key to confirm.
6. Input the number and press [MENU] key to confirm.

Repeater Slot

Repeater Slot is available only in digital channels.

1. Press [MENU] key to enter the menu
2. Press [▲ or ▼] key and choose utilities, then press key to confirm.
3. Press [▲ or ▼] key and choose Program Radio, then press [MENU] key to confirm.
4. Input the correct password which has been programmed already by software. then press [MENU] key to confirm.
5. Press [▲ or ▼] key and choose Repeater Slot, then press [MENU] key to confirm.
6. Press [▲ or ▼] key and choose repeater slot, then press [MENU] key to confirm. The interface displays "Repeater slot saved".

Technical Parameter

General

Frequency Range	UHF:400-470MHz
Channel Storage	1000 channels
Channel Spacing	12.5KHz
Working Voltage	7.4V DC
Battery Type	Polymer lithium battery
Working Temperature	-30 C ~+60 C
Store Temperature	-40 C ~+85 C
Antenna Impedance	50Ω
Dimension	130*58*35mm

Receiving

Analogue Sensibility	0.22uV/-120dBm(20dB SINDA)
Digital Sensibility	0.282uV/-118dBm(BER 5%)
Co-channel Rejection	≥-12dB
Adjacent Channel Selectivity	TIA603C:65Db ETSI:60dB
Spurious Response	TIA603C:75Db ETSI:70dB
Audio Power	1W
Audio Distortion	≤3% (Type)
Audio Response	1dB~-3dB
Weight	300g

Transmitting

Output power	High:5W Low:1W
Frequency Stability	±1ppm
Adjacent channel power	≤-60dB
Idle Time Slot Power	TDMA≤-57dBm
FM Modulation Mode	12.5KHz@11K0F3E
Modulation maximum deviation	2.5KHz@12.5KHz
Nonactive slot power	-57dBm
Digital protocol	ETSI TS 102 361-1-2-3
Vocoder type	AMBE+2TM
Modulation BER(Bit Error Rate)	≤5%
4FSK digital mode	7K60F1D, 7K60F1E

Guarantee

Model Number: _____

Serial Number: _____

Purchase Date: _____

Dealer: _____ Telephone: _____

User's Name: _____ Telephone: _____

Address: _____ Post Code: _____

Remarks:

- 1.This guarantee card to be kept by user,we will not re offer if lost.
- 2.This guarantee card should be filled by dealer,otherwise it's invalid.
- 3.Do not alter the guarantee card,please confirm that the serial number on the guarantee card is the same with radio.
- 4.One-year guarantee for radio,half a year guarantee for accessory.
- 5.Users can get maintenance service from following ways:
 - Go to the shop where you bought the radio
 - Find our local maintenance agent
 - Send back to our company

Please cut along with this line

FCC Statement

INFORMATION TO THE DIGITAL DEVICE USER REQUIRED BY THE FCC

This equipment has been tested and found to comply with the limits for a Class B digital device, pursuant to Part 15 of the FCC Rules. These limits are designed to provide reasonable protection against harmful interference in a residential installation. This equipment generates, uses and can generate radio frequency energy and, if not installed and used in accordance with the instructions, may cause harmful interference to radio communications. However, there is no guarantee that the interference will not occur in a particular installation. If this equipment does cause harmful interference to radio or television reception, which can be determined by turning the equipment off and on, the user is encouraged to try to correct the interference by one or more of the following measures:

- Reorient or relocate the receiving antenna.
- Increase the separation between the equipment and receiver.
- Connect the equipment to an outlet on a circuit different from that to which the receiver is connected.
- Consult the dealer for technic

FCC WARNING

This equipment generates or uses radio frequency energy. Changes or modifications to this equipment may cause harmful interference unless the modifications are expressly approved by the party responsible/Iradio Electronics Co., Ltd. The user could lose the authority to operate this equipment if an unauthorized change or modification is made.

This Iradio transceiver has been tested and complies with the standards listed below, in regards to Radio Frequency (RF) energy and electromagnetic energy (EME) generated by the transceiver.

- FCC 47 CFR 1.1307, 1.1310 & 1.1093 RF exposure limits for Occupational Use Only. RF Exposure limits adopted by the FCC are generally based on recommendations from the National Council on Radiation Protection and Measurements & the American National Standards Institute.
- American National Standards Institute (ANSI)/Institute of Electrical and Electronic Engineers (IEEE) C95.1: 2005

The following list provides you with the information required to ensure that you are aware of RF exposure and of how to operate this transceiver so that the FCC RF exposure limitations are not exceeded.

- While transmitting (holding the PTT switch or speaking with VOX enabled), always keep the antenna and the radio at least 2.5cm (1 inch) from your body or face, as well as from any bystanders.
- Do not transmit for more than 50% of the total transceiver use time; transmitting over 50% of the total use time may exceed the limits in accordance to the FCC RF exposure requirements. Nominal transceiver operation is 5% transmission time, 5% reception time, and 90% stand-by time.
- Use only the specified antenna for this transceiver; this may be either the antenna provided with the transceiver or another antenna authorized by Iradio. Use only Iradio authorized accessories (antennas, battery packs, belt clips, Speaker/Mics or headsets etc.): When worn on the body, always place the radio in a Iradio recommended clip or carrying case meant for this product. The use of other than recommended or approved body-worn accessories may result in RF exposure levels which exceed the FCC's occupational/controlled environment RF exposure limits.