



FCC TEST REPORT

REPORT NO.: RF980611A09-1

MODEL NO.: TPC-2A Plus

RECEIVED: June 11, 2009

TESTED: Oct. 19 ~ Nov 5, 2009

ISSUED: Nov. 6, 2009

APPLICANT: i-Mobile Technology Corporation

ADDRESS: 8F., No.8, Alley 15, Lane 120, Sec. 1, Neihu Rd.,
Neihu District, Taipei City 114, Taiwan (R.O.C.)

ISSUED BY: Bureau Veritas Consumer Products Services (H.K.)
Ltd., Taoyuan Branch

LAB LOCATION: No. 47, 14th Ling, Chia Pau Tsuen, Lin Kou Hsiang,
Taipei Hsien, 244 Taiwan

This test report consists of 69 pages in total. It may be duplicated completely for legal use with the approval of the applicant. It should not be reproduced except in full, without the written approval of our laboratory. The client should not use it to claim product endorsement by TAF or any government agencies. The test results in the report only apply to the tested sample.





A D T

TABLE OF CONTENTS

1.	CERTIFICATION	4
2.	SUMMARY OF TEST RESULTS	5
2.1	MEASUREMENT UNCERTAINTY	6
3.	GENERAL INFORMATION	7
3.1	GENERAL DESCRIPTION OF EUT	7
3.2	DESCRIPTION OF TEST MODES	9
3.2.1	CONFIGURATION OF SYSTEM UNDER TEST	10
3.2.2	TEST MODE APPLICABILITY AND TESTED CHANNEL DETAIL	11
3.2.3	GENERAL DESCRIPTION OF APPLIED STANDARDS	13
3.2.4	DESCRIPTION OF SUPPORT UNITS	13
4.	TEST TYPES AND RESULTS	14
4.1	CONDUCTED EMISSION MEASUREMENT	14
4.1.1	LIMITS OF CONDUCTED EMISSION MEASUREMENT	14
4.1.2	TEST INSTRUMENTS	15
4.1.3	TEST PROCEDURES	16
4.1.4	DEVIATION FROM TEST STANDARD	16
4.1.5	TEST SETUP	16
4.1.6	EUT OPERATING CONDITIONS	17
4.1.7	TEST RESULTS	18
4.2	RADIATED EMISSION MEASUREMENT	20
4.2.1	LIMITS OF RADIATED EMISSION MEASUREMENT	20
4.2.2	TEST INSTRUMENTS	21
4.2.3	TEST PROCEDURES	22
4.2.4	DEVIATION FROM TEST STANDARD	22
4.2.5	TEST SETUP	23
4.2.6	EUT OPERATING CONDITIONS	24
4.2.7	TEST RESULTS	25
4.3	NUMBER OF HOPPING FREQUENCY USED	35
4.3.1	LIMIT OF HOPPING FREQUENCY USED	35
4.3.2	TEST INSTRUMENTS	35
4.3.3	TEST PROCEDURES	35
4.3.4	DEVIATION FROM TEST STANDARD	36
4.3.5	TEST SETUP	36
4.3.6	TEST RESULTS	36
4.4	DWELL TIME ON EACH CHANNEL	39
4.4.1	LIMIT OF DWELL TIME USED	39
4.4.2	TEST INSTRUMENTS	39
4.4.3	TEST PROCEDURES	39
4.4.4	DEVIATION FROM TEST STANDARD	39
4.4.5	TEST SETUP	40
4.4.6	TEST RESULTS	40
4.5	CHANNEL BANDWIDTH	48
4.5.1	LIMITS OF CHANNEL BANDWIDTH	48
4.5.2	TEST INSTRUMENTS	48
4.5.3	TEST PROCEDURE	48
4.5.4	DEVIATION FROM TEST STANDARD	49



4.5.5	TEST SETUP	49
4.5.6	EUT OPERATING CONDITION	49
4.5.7	TEST RESULTS.....	50
4.6	HOPPING CHANNEL SEPARATION	52
4.6	HOPPING CHANNEL SEPARATION	52
4.6.1	LIMIT OF HOPPING CHANNEL SEPARATION	52
4.6.2	TEST INSTRUMENTS	52
4.6.3	TEST PROCEDURES.....	52
4.6.4	DEVIATION FROM TEST STANDARD	53
4.6.5	TEST SETUP	53
4.6.6	TEST RESULTS.....	54
4.7	MAXIMUM PEAK OUTPUT POWER	56
4.7.1	LIMITS OF MAXIMUM PEAK OUTPUT POWER MEASUREMENT	56
4.7.2	TEST INSTRUMENTS	56
4.7.3	TEST PROCEDURES.....	56
4.7.4	DEVIATION FROM TEST STANDARD	56
4.7.5	TEST SETUP	57
4.7.6	EUT OPERATING CONDITION	57
4.7.7	TEST RESULTS.....	58
4.8	BAND EDGES MEASUREMENT	60
4.8	BAND EDGES MEASUREMENT	60
4.8.1	LIMITS OF BAND EDGES MEASUREMENT	60
4.8.2	TEST INSTRUMENTS	60
4.8.3	TEST PROCEDURE	60
4.8.4	DEVIATION FROM TEST STANDARD	60
4.8.5	EUT OPERATING CONDITION	60
4.8.6	TEST RESULTS.....	61
5.	PHOTOGRAPHS OF THE TEST CONFIGURATION.....	67
6.	INFORMATION ON THE TESTING LABORATORIES	68
7.	APPENDIX A – MODIFICATIONS RECORDERS FOR ENGINEERING CHANGES TO THE EUT BY THE LAB.....	69



1. CERTIFICATION

PRODUCT: Mobile Tablet PC
BRAND NAME: N/A
MODEL NO.: TPC-2A Plus
APPLICANT: i-Mobile Technology Corporation
TESTED: Oct. 19 ~ Nov 5, 2009
TEST ITEM: ENGINEERING SAMPLE
STANDARDS: FCC Part 15, Subpart C (Section 15.247),
ANSI C63.4-2003

The above equipment has been tested by **Bureau Veritas Consumer Products Services (H.K.) Ltd., Taoyuan Branch**, and found compliance with the requirement of the above standards. The test record, data evaluation & Equipment Under Test (EUT) configurations represented herein are true and accurate accounts of the measurements of the sample's EMC characteristics under the conditions specified in this report.

PREPARED BY : Jessica Cheng , **DATE:** Nov. 6, 2009
(Jessica Cheng / Specialist)

TECHNICAL ACCEPTANCE : Jamison Chan , **DATE:** Nov. 6, 2009
Responsible for RF (Jamison Chan / Supervisor)

APPROVED BY : Ken Liu , **DATE:** Nov. 6, 2009
(Ken Liu / Assistant Manager)

2. SUMMARY OF TEST RESULTS

The EUT has been tested according to the following specifications:

APPLIED STANDARD: FCC Part 15, Subpart C			
STANDARD SECTION	TEST TYPE AND LIMIT	RESULT	REMARK
15.207	AC Power Conducted Emission	PASS	Meet the requirement of limit. Minimum passing margin is -16.48dB at 0.162MHz.
15.247(a)(1)(iii)	Number of Hopping Frequency Used Spec.: At least 15 channels	PASS	Meet the requirement of limit.
15.247(a)(1)(iii)	Dwell Time on Each Channel Spec. : Max. 0.4 second within 31.6 second	PASS	Meet the requirement of limit.
15.247(a)(1)	1. Hopping Channel Separation Spec. : Min. 25 kHz or 20 dB bandwidth, whichever is greater (see Note) 2. Spectrum Bandwidth of a Frequency Hopping Sequence Spread Spectrum System	PASS	Meet the requirement of limit.
15.247(b)	Maximum Peak Output Power Spec.: max. 21dBm (see Note)	PASS	Meet the requirement of limit.
15.247(d)	Transmitter Radiated Emissions Spec.: Table 15.209	PASS	Meet the requirement of limit. Minimum passing margin is -1.9dB at 47.49MHz.
15.247(d)	Band Edge Measurement	PASS	Meet the requirement of limit.
15.203	Antenna Requirement	PASS	No antenna connector is used.

NOTE: If The Frequency Hopping System operating in 2400-2483.5MHz band and the output power less than 125mW. The hopping channel carrier frequencies separated by a minimum of 25kHz or two-thirds of the 20dB bandwidth of hopping channel whichever is greater.

2.1 MEASUREMENT UNCERTAINTY

Where relevant, the following measurement uncertainty levels have been estimated for tests performed on the EUT as specified in CISPR 16-4-2:

This uncertainty represents an expanded uncertainty expressed at approximately the 95% confidence level using a coverage factor of $k=2$.

MEASUREMENT	FREQUENCY	UNCERTAINTY
Conducted emissions	150kHz ~ 30MHz	2.44 dB
Radiated emissions	30MHz ~ 1GHz	3.72 dB
	Above 1GHz	2.89 dB

3. GENERAL INFORMATION

3.1 GENERAL DESCRIPTION OF EUT

PRODUCT	Mobile Tablet PC
MODEL NO.	TPC-2A Plus
FCC ID	XZOIM01
POWER SUPPLY	15Vdc or 16Vdc (from Adapter) 11.1Vdc (from Battery)
MODULATION TYPE	GFSK, π /4-DQPSK, 8DPSK
RADIO TECHNOLOGY	FHSS
TRANSFER RATE	1/2/3Mbps
OPERATING FREQUENCY	2402 ~ 2480MHz
NUMBER OF CHANNEL	79
OUTPUT POWER	3.2mW
ANTENNA TYPE	PCB antenna with 2.4dBi gain
ANTENNA CONNECTOR	N/A
I/O PORTS	Refer to user's manual
DATA CABLE	NA
ASSOCIATED DEVICES	Refer to note 3 as below

NOTE:

- The EUT is a Mobile Tablet PC, the functions of EUT listed as below:

Function	Test Standard	Reference Report
WLAN IEEE802.11b/g Mini-PCI Card (Brand: QCOM, Model: LR802UKN2-3A)	FCC Part 15, Subpart C (Section 15.247)	RF980611A09
Bluetooth module (Brand: QCOM, Model: QBTM400-01(V7))		RF980611A09-1

- The EUT is equipped the following interfaces:

- ◆ LAN PORT
- ◆ USB x 3
- ◆ D-Sub
- ◆ Audio x 2

3. The EUT was power supplied from the following power adapters or battery::

Item	Brand/ Model No.	Specification
Adapter	Sunny, SYS1318-6016	AC I/P: 100-240V, 50-60 Hz, 1.6A DC O/P: 16V, 3.75A Non-shielded DC cable (1.8m) with two ferrite cores
	ADAPTER TECH. STD-16040	AC I/P: 100-240V, 47-63Hz, 1.4A DC O/P: 16V, 4A Non-shielded DC cable (1.8m) with one ferrite cores
	ELJINTEK INC , GPSU60C-4	AC I/P: 100-240V, 50-60Hz, 1.5A DC O/P: 15V, 4A Non-shielded DC cable (1.8m) with one ferrite cores
Battery	Li-ion	DC11.1V, 5200MAH, 57.72WH

The EUT was pre-tested with three adapters (model: refer to the list above), and the worst emission was found when EUT was tested with **Sunny Adapter** and therefore only its test data was recorded in this report.

4. The above EUT information was declared by manufacturer and for more detailed features description, please refer to the manufacturer's specifications or user's manual.

3.2 DESCRIPTION OF TEST MODES

79 channels are provided to this EUT:

CHANNEL	FREQ. (MHz)	CHANNEL	FREQ. (MHz)	CHANNEL	FREQ. (MHz)	CHANNEL	FREQ. (MHz)
0	2402	20	2422	40	2442	60	2462
1	2403	21	2423	41	2443	61	2463
2	2404	22	2424	42	2444	62	2464
3	2405	23	2425	43	2445	63	2465
4	2406	24	2426	44	2446	64	2466
5	2407	25	2427	45	2447	65	2467
6	2408	26	2428	46	2448	66	2468
7	2409	27	2429	47	2449	67	2469
8	2410	28	2430	48	2450	68	2470
9	2411	29	2431	49	2451	69	2471
10	2412	30	2432	50	2452	70	2472
11	2413	31	2433	51	2453	71	2473
12	2414	32	2434	52	2454	72	2474
13	2415	33	2435	53	2455	73	2475
14	2416	34	2436	54	2456	74	2476
15	2417	35	2437	55	2457	75	2477
16	2418	36	2438	56	2458	76	2478
17	2419	37	2439	57	2459	77	2479
18	2420	38	2440	58	2460	78	2480
19	2421	39	2441	59	2461		

3.2.1 CONFIGURATION OF SYSTEM UNDER TEST

Mode A

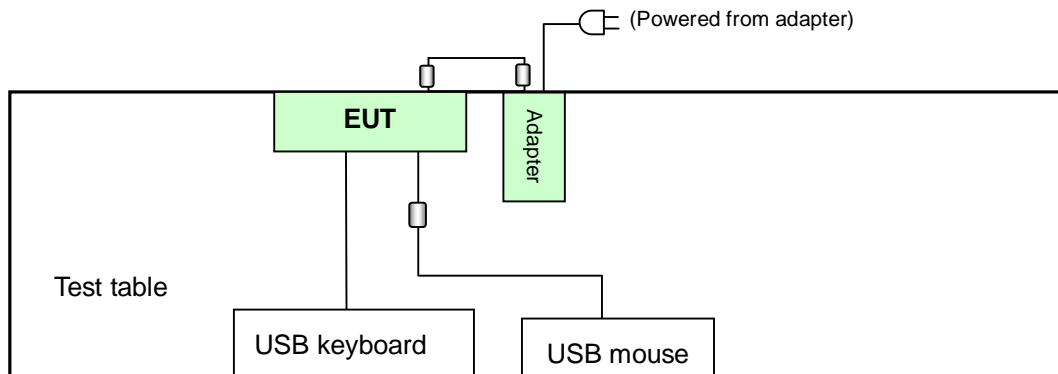

Mode B

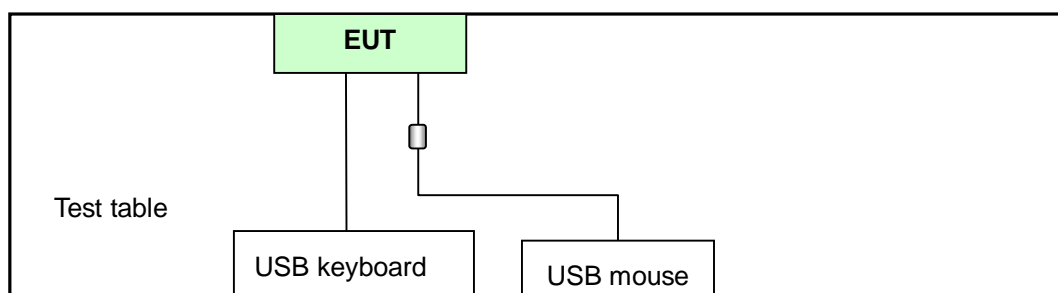

3.2.2 TEST MODE APPLICABILITY AND TESTED CHANNEL DETAIL

EUT CONFIGURE MODE	Applicable to				Description
	PLC	RE<1G	RE [≥] 1G	APCM	
A	√	√	√	√	Adapter mode
B	-	√	-	-	Battery mode

Where **PLC**: Power Line Conducted Emission

RE<1G: Radiated Emission below 1GHz

RE[≥]1G: Radiated Emission above 1GHz

APCM: Antenna Port Conducted Measurement

NOTE: "-" means no effect.

POWER LINE CONDUCTED EMISSION TEST:

- Pre-Scan has been conducted to determine the worst-case mode from all possible combinations between available modulations and packet types.
- Following channel(s) was (were) selected for the final test as listed below.

EUT CONFIGURE MODE	AVAILABLE CHANNEL	TESTED CHANNEL	MODULATION TECHNOLOGY	MODULATION TYPE	PACKET TYPE	DATE RATE
A	0 to 78	0	FHSS	GFSK	DH5	1

RADIATED EMISSION TEST (BELOW 1 GHz):

- Pre-Scan has been conducted to determine the worst-case mode from all possible combinations between available modulations, data rates, packet types data rate, XYZ axis and antenna ports (if EUT with antenna diversity architecture).
- Following channel(s) was (were) selected for the final test as listed below.

EUT CONFIGURE MODE	AVAILABLE CHANNEL	TESTED CHANNEL	MODULATION TECHNOLOGY	MODULATION TYPE	PACKET TYPE	DATE RATE	AXIS
A	0 to 78	0	FHSS	GFSK	DH5	1	Y
B	0 to 78	0	FHSS	GFSK	DH5	1	Y

RADIATED EMISSION TEST (ABOVE 1 GHz):

- Pre-Scan has been conducted to determine the worst-case mode from all possible combinations between available modulations, data rates, packet types data rate, XYZ axis and antenna ports (if EUT with antenna diversity architecture).
- Following channel(s) was (were) selected for the final test as listed below.

EUT CONFIGURE MODE	AVAILABLE CHANNEL	TESTED CHANNEL	MODULATION TECHNOLOGY	MODULATION TYPE	PACKET TYPE	DATE RATE	AXIS
A	0 to 78	0, 39, 78	FHSS	GFSK	DH5	1	Y
A	0 to 78	0, 39, 78	FHSS	8DPSK	DH5	3	Y



BANDEDGE MEASUREMENT:

- Pre-Scan has been conducted to determine the worst-case mode from all possible combinations between available modulations and packet types of the antenna and antenna ports (if EUT with antenna diversity architecture).
- Following channel(s) was (were) selected for the final test as listed below.

EUT CONFIGURE MODE	AVAILABLE CHANNEL	TESTED CHANNEL	MODULATION TECHNOLOGY	MODULATION TYPE	PACKET TYPE	DATE RATE
A	0 to 78	0, 78	FHSS	GFSK	DH5	1
A	0 to 78	0, 78	FHSS	8DPSK	DH5	3

ANTENNA PORT CONDUCTED MEASUREMENT:

- Pre-Scan has been conducted to determine the worst-case mode from all possible combinations between available modulations and packet types of the antenna and antenna ports (if EUT with antenna diversity architecture).
- Following channel(s) was (were) selected for the final test as listed below.

EUT CONFIGURE MODE	AVAILABLE CHANNEL	TESTED CHANNEL	MODULATION TECHNOLOGY	MODULATION TYPE	PACKET TYPE	DATE RATE
A	0 to 78	0, 39, 78	FHSS	GFSK	DH5	1
A	0 to 78	0, 39, 78	FHSS	8DPSK	DH5	3

TEST CONDITION:

APPLICABLE TO	ENVIRONMENTAL CONDITIONS	INPUT POWER	TESTED BY
RE ³ 1G	25deg. C, 63%RH, 1028 hPa	120Vac, 60Hz	Nick Chen
RE<1G	25deg. C, 63%RH, 1028 hPa	120Vac, 60Hz/ 12Vdc	Nick Chen
PLC	25deg. C, 73%RH, 1019 hPa	120Vac, 60Hz	Nick Chen
APCM	23deg. C, 72%RH, 1026 hPa	120Vac, 60Hz	Nick Chen

3.2.3 GENERAL DESCRIPTION OF APPLIED STANDARDS

The EUT is a RF Product. According to the specifications of the manufacturer, it must comply with the requirements of the following standards:

FCC Part 15, Subpart C. (15.247)

ANSI C63.4- 2003

All test items have been performed and recorded as per the above standards.

NOTE: The EUT is also considered as a kind of computer peripheral, because the connection to computer is necessary for typical use. It has been verified to comply with the requirements of FCC Part 15, Subpart B, Class B (DoC). The test report has been issued separately.

3.2.4 DESCRIPTION OF SUPPORT UNITS

The EUT has been tested as an independent unit together with other necessary accessories or support units. The following support units or accessories were used to form a representative test configuration during the tests.

NO.	PRODUCT	BRAND	MODEL NO.	SERIAL NO.	FCC ID
1	USB KEYBOARD	BTC	5200U	G09302046659	E5XKB5122U
2	USB MOUSE	MICROSOFT	X800898	9241804-30608	FCC DoC Approved

NO.	SIGNAL CABLE DESCRIPTION OF THE ABOVE SUPPORT UNITS
1	1.5 m braid shielded wire, terminated with USB connector via drain wire, w/o core.
2	1.8 m foil shielded wire, terminated with USB connector via drain wire, with 1 core.

NOTE: All power cords of the above support units are non shielded (1.8m).

4. TEST TYPES AND RESULTS

4.1 CONDUCTED EMISSION MEASUREMENT

4.1.1 LIMITS OF CONDUCTED EMISSION MEASUREMENT

FREQUENCY OF EMISSION (MHz)	CONDUCTED LIMIT (dB μ V)	
	Quasi-peak	Average
0.15 ~ 0.5	66 to 56	56 to 46
0.5 ~ 5	56	46
5 ~ 30	60	50

- NOTE:**
1. The lower limit shall apply at the transition frequencies.
 2. The limit decreases in line with the logarithm of the frequency in the range of 0.15 to 0.50 MHz.
 3. All emanations from a class A/B digital device or system, including any network of conductors and apparatus connected thereto, shall not exceed the level of field strengths specified above.



4.1.2 TEST INSTRUMENTS

DESCRIPTION & MANUFACTURER	MODEL NO.	SERIAL NO.	CALIBRATED DATE	CALIBRATED UNTIL
ROHDE & SCHWARZ Test Receiver	ESCS 30	838251/021	Mar. 05, 2009	Mar. 04, 2010
ROHDE & SCHWARZ Artificial Mains Network (for EUT)	ESH3-Z5	100218	Nov. 26, 2008	Nov. 25, 2009
LISN With Adapter (for EUT)	AD10	C10Ada-001	Nov. 26, 2008	Nov. 25, 2009
ROHDE & SCHWARZ Artificial Mains Network (for peripherals)	ESH3-Z5	100219	Nov. 20, 2008	Nov. 19, 2009
Software	ADT_Cond_V7.3.7	NA	NA	NA
Software	ADT_ISN_V7.3.7	NA	NA	NA
RF cable (JYEBAO)	5D-FB	Cable-C10.01	Feb. 26, 2009	Feb. 25, 2010
SUHNER Terminator (For ROHDE & SCHWARZ LISN)	65BNC-5001	E1-010773	Feb. 27, 2009	Feb. 26, 2010

- NOTE:**
1. The calibration interval of the above test instruments is 12 months and the calibrations are traceable to NML/ROC and NIST/USA.
 2. The test was performed in Shielded Room No. 10.
 3. The VCCI Site Registration No. C-1852.

4.1.3 TEST PROCEDURES

- a. The EUT was placed 0.4 meters from the conducting wall of the shielded room with EUT being connected to the power mains through a line impedance stabilization network (LISN). Other support units were connected to the power mains through another LISN. The two LISNs provide 50 ohm/ 50uH of coupling impedance for the measuring instrument.
- b. Both lines of the power mains connected to the EUT were checked for maximum conducted interference.
- c. The frequency range from 150kHz to 30MHz was searched. Emission levels under (Limit - 20dB) were not recorded.

4.1.4 DEVIATION FROM TEST STANDARD

No deviation

4.1.5 TEST SETUP

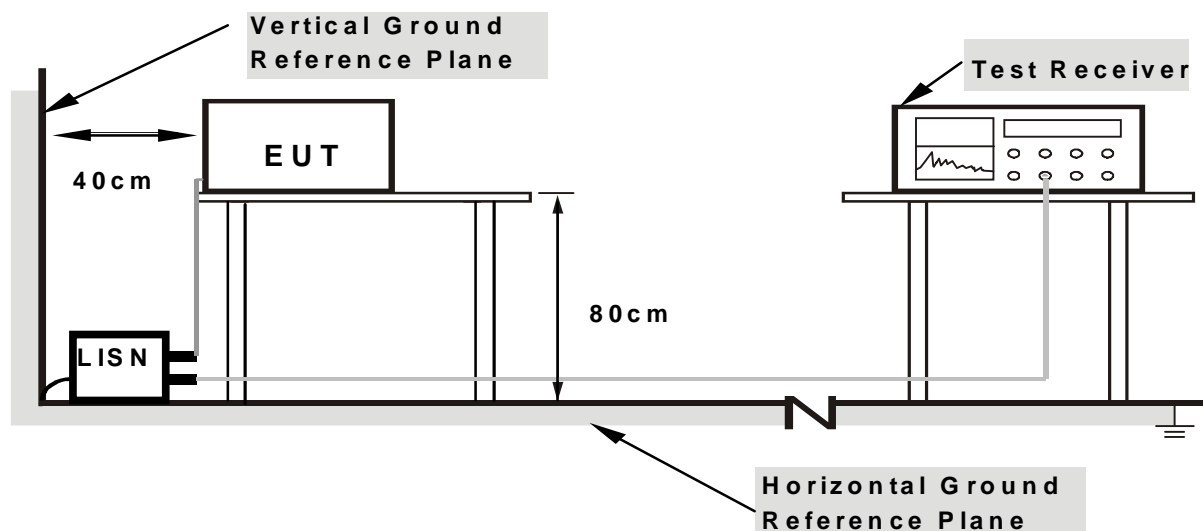

- Note:**
1. Support units were connected to second LISN.
 2. Both of LISNs (AMN) are 80 cm from EUT and at least 80 cm from other units and other metal planes support units.

For the actual test configuration, please refer to the related item – Photographs of the Test Configuration.

4.1.6 EUT OPERATING CONDITIONS

- a. Connected the EUT with adapter placed on testing table.
- b. Set the EUT under transmission/receiving condition continuously at specific channel frequency and charging condition.

4.1.7 TEST RESULTS

PHASE	Line 1	6dB BANDWIDTH	9kHz
TEST MODE	A		

No	Freq.	Corr.	Reading Value		Emission Level		Limit		Margin	
	[MHz]	[dB]	[dB (uV)]		[dB (uV)]		[dB (uV)]		(dB)	
			Q.P.	AV.	Q.P.	AV.	Q.P.	AV.	Q.P.	AV.
1	0.162	0.12	48.78	-	48.90	-	65.38	55.38	-16.48	-
2	0.236	0.14	37.73	-	37.87	-	62.24	52.24	-24.37	-
3	1.051	0.24	23.48	-	23.72	-	56.00	46.00	-32.28	-
4	3.674	0.35	28.06	-	28.41	-	56.00	46.00	-27.59	-
5	11.512	0.76	32.87	-	33.63	-	60.00	50.00	-26.37	-
6	16.809	1.17	30.81	-	31.98	-	60.00	50.00	-28.02	-

- REMARKS:**
1. Q.P. and AV. are abbreviations of quasi-peak and average individually.
 2. "-": The Quasi-peak reading value also meets average limit and measurement with the average detector is unnecessary.
 3. The emission levels of other frequencies were very low against the limit.
 4. Margin value = Emission level - Limit value
 5. Correction factor = Insertion loss + Cable loss
 6. Emission Level = Correction Factor + Reading Value.

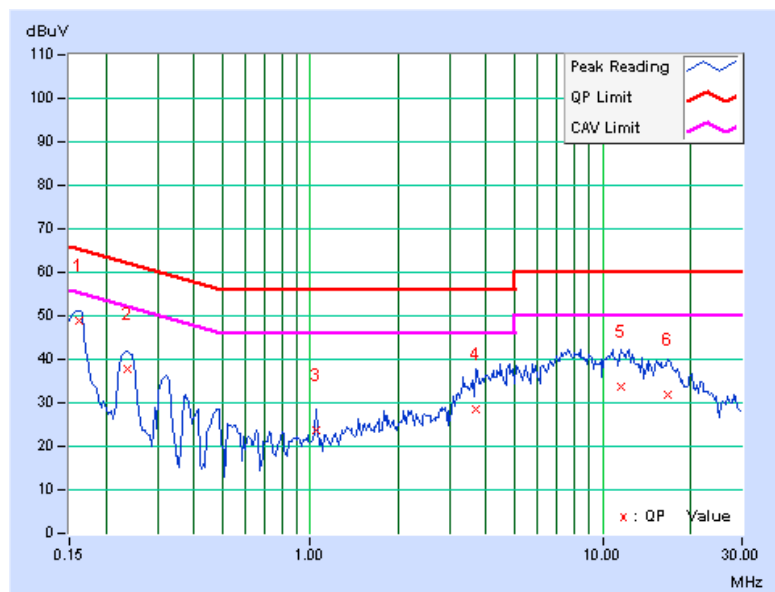

PHASE	Line 2	6dB BANDWIDTH	9kHz
TEST MODE	A		

No	Freq. [MHz]	Corr. Factor (dB)	Reading Value [dB (uV)]		Emission Level [dB (uV)]		Limit [dB (uV)]		Margin (dB)	
			Q.P.	AV.	Q.P.	AV.	Q.P.	AV.	Q.P.	AV.
1	0.163	0.09	48.68	-	48.77	-	65.33	55.33	-16.56	-
2	0.237	0.11	38.22	-	38.33	-	62.20	52.20	-23.87	-
3	1.047	0.22	24.49	-	24.71	-	56.00	46.00	-31.29	-
4	3.708	0.30	27.93	-	28.23	-	56.00	46.00	-27.77	-
5	7.910	0.45	33.40	-	33.85	-	60.00	50.00	-26.15	-
6	12.703	0.67	32.72	-	33.39	-	60.00	50.00	-26.61	-

- REMARKS:**
1. Q.P. and AV. are abbreviations of quasi-peak and average individually.
 2. "-": The Quasi-peak reading value also meets average limit and measurement with the average detector is unnecessary.
 3. The emission levels of other frequencies were very low against the limit.
 4. Margin value = Emission level - Limit value
 5. Correction factor = Insertion loss + Cable loss
 6. Emission Level = Correction Factor + Reading Value.

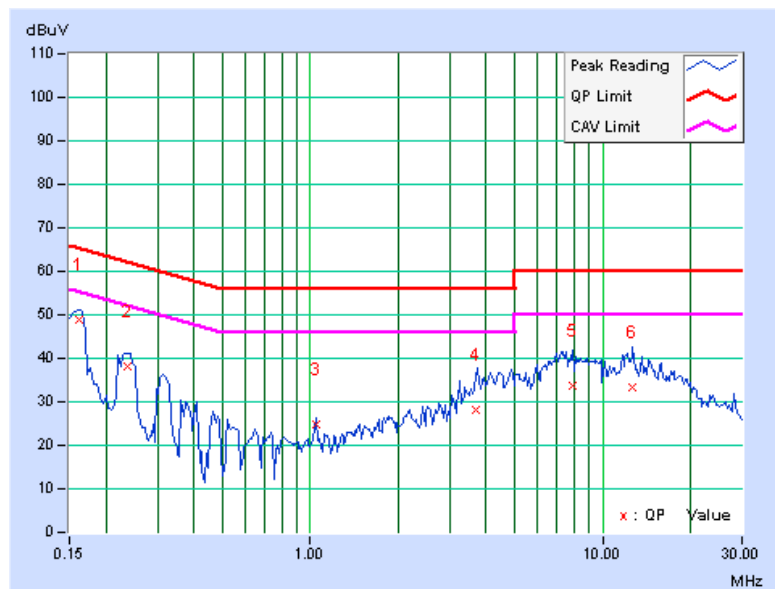

4.2 RADIATED EMISSION MEASUREMENT

4.2.1 LIMITS OF RADIATED EMISSION MEASUREMENT

Emissions radiated outside of the specified bands, shall be according to the general radiated limits in 15.209 as following:

FREQUENCIES (MHz)	FIELD STRENGTH (microvolts/meter)	MEASUREMENT DISTANCE (meters)
0.009 ~ 0.490	2400/F(kHz)	300
0.490 ~ 1.705	24000/F(kHz)	30
1.705 ~ 30.0	30	30
30 ~ 88	100	3
88 ~ 216	150	3
216 ~ 960	200	3
Above 960	500	3

NOTE:

1. The lower limit shall apply at the transition frequencies.
2. Emission level (dBuV/m) = 20 log Emission level (uV/m).
3. As shown in 15.35(b), for frequencies above 1000MHz, the field strength limits are based on average detector, however, the peak field strength of any emission shall not exceed the maximum permitted average limits, specified above by more than 20dB under any condition of modulation.



4.2.2 TEST INSTRUMENTS

DESCRIPTION & MANUFACTURER	MODEL NO.	SERIAL NO.	CALIBRATED DATE	CALIBRATED UNTIL
HP Preamplifier	8447D	2432A03504	May 04, 2009	May 03, 2010
HP Preamplifier	8449B	3008A01924	Aug. 31, 2009	Aug. 30, 2010
HP Preamplifier	8449B	3008A01292	Aug. 10, 2009	Aug. 09, 2010
ROHDE & SCHWARZ TEST RECEIVER	ESI7	836697/012	Dec. 04, 2008	Dec. 03, 2009
Schwarzbeck Antenna	VULB 9168	137	Apr. 29, 2009	Apr. 28, 2010
Schwarzbeck Antenna	VHBA 9123	480	Apr. 21, 2009	Apr. 20, 2010
EMCO Horn Antenna	3115	6714	Oct. 21, 2009	Oct. 20, 2010
EMCO Horn Antenna	3115	9312-4192	Apr. 17, 2009	Apr. 16, 2010
ADT. Turn Table	TT100	0306	NA	NA
ADT. Tower	AT100	0306	NA	NA
Software	ADT_Radiated_V 7.6.15.9.2	NA	NA	NA
SUHNER RF cable	SF104-26.5	CABLE-CH6-17m -01	Aug. 20, 2009	Aug. 19, 2010
ROHDE & SCHWARZ Spectrum Analyzer	FSP 40	100036	Apr. 03, 2009	Apr. 02, 2010

- NOTE:**
1. The calibration interval of the above test instruments is 12/24 months. And the calibrations are traceable to NML/ROC and NIST/USA.
 2. The horn antenna and HP preamplifier (model: 8449B) are used only for the measurement of emission frequency above 1GHz if tested.
 3. The test was performed in Chamber No. 6.
 4. The Industry Canada Reference No. IC 7450E-6.
 5. The FCC Site Registration No. is 447212.

4.2.3 TEST PROCEDURES

- a. The EUT was placed on the top of a rotating table 0.8 meters above the ground at a 3 meter semi-anechoic chamber. The table was rotated 360 degrees to determine the position of the highest radiation.
- b. The EUT was set 3 meters away from the interference-receiving antenna, which was mounted on the top of a variable-height antenna tower.
- c. The height of antenna is varied from one meter to four meters above the ground to determine the maximum value of the field strength. Both horizontal and vertical polarizations of the antenna are set to make the measurement.
- d. For each suspected emission, the EUT was arranged to its worst case and then the antenna was tuned to heights from 1 meter to 4 meters and the rotatable table was turned from 0 degrees to 360 degrees to find the maximum reading.
- e. The test-receiver system was set to quasi-peak detect function and specified bandwidth with maximum hold mode when the test frequency is below 1 GHz.
- f. If the emission level of the EUT in peak mode was lower than the limit specified, then testing could be stopped and the peak values of the EUT would be reported. Otherwise the emissions would be re-tested one by one using peak, quasi-peak or average method as specified and then reported in a data sheet.

NOTE:

1. The resolution bandwidth of test receiver/spectrum analyzer is 120kHz for Quasi-peak detection at frequency below 1GHz.
2. The resolution bandwidth is 1MHz and video bandwidth of test receiver/spectrum analyzer is 3MHz for Peak detection at frequency above 1GHz. The resolution bandwidth of test receiver/spectrum analyzer is 1 MHz for Average detection (AV) at frequency above 1GHz.

4.2.4 DEVIATION FROM TEST STANDARD

No deviation

4.2.5 TEST SETUP

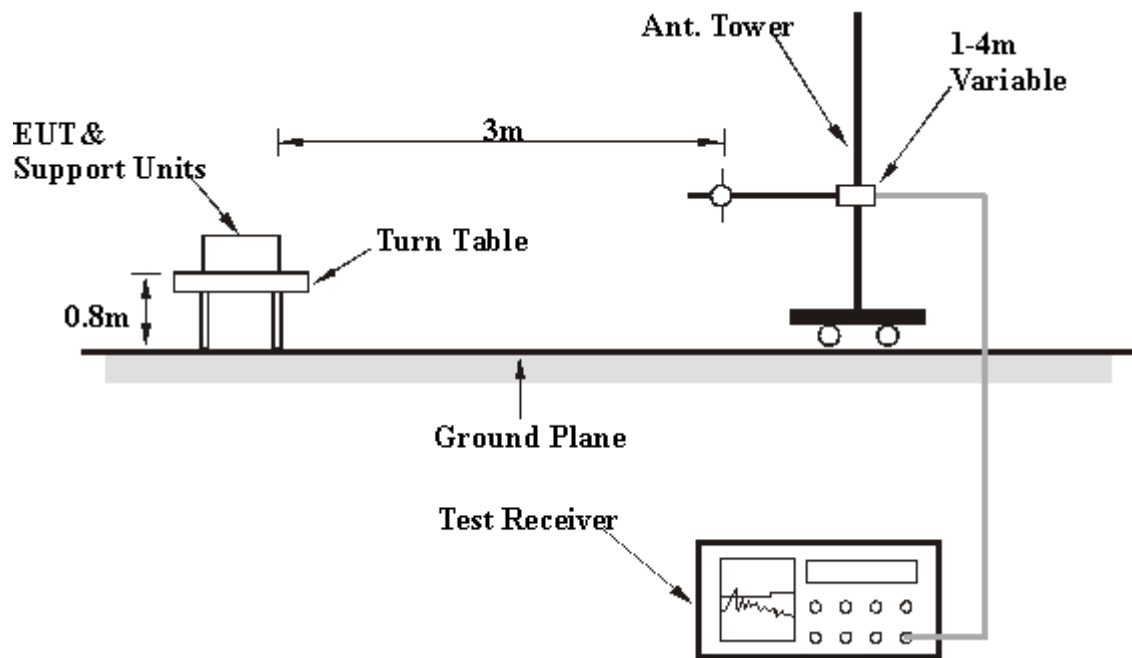

For the actual test configuration, please refer to the related item – Photographs of the Test Configuration.

4.2.6 EUT OPERATING CONDITIONS

For Mode A:

- a. Connected the EUT with AC adapter placed on testing table.
- b. Set the EUT under transmission/receiving condition continuously at specific channel frequency and charging condition.

For Mode B:

Set the EUT under transmission/receiving condition continuously at specific channel frequency.

4.2.7 TEST RESULTS

GFSK MODULATION

EUT TEST CONDITION		MEASUREMENT DETAIL	
CHANNEL	Channel 0	FREQUENCY RANGE	1 ~ 25GHz
INPUT POWER	120Vac, 60 Hz	DETECTOR FUNCTION	Peak (PK) Average (AV)
ENVIRONMENTAL CONDITIONS	25deg. C, 63%RH 1010 hPa	TESTED BY	Nick Chen
TEST MODE	A		

ANTENNA POLARITY & TEST DISTANCE: HORIZONTAL AT 3 M								
NO.	FREQ. (MHz)	EMISSION LEVEL (dBuV/m)	LIMIT (dBuV/m)	MARGIN (dB)	ANTENNA HEIGHT (m)	TABLE ANGLE (Degree)	RAW VALUE (dBuV)	CORRECTION FACTOR (dB/m)
1	1602.00	42.7 PK	74.00	-31.3	1.22 H	144	13.27	29.39
2	1602.00	33.6 AV	54.00	-20.4	1.22 H	144	4.20	29.39
3	2390.00	60.4 PK	74.00	-13.6	1.00 H	173	27.78	32.60
4	2390.00	46.9 AV	54.00	-7.1	1.00 H	173	14.26	32.60
5	#2400.00	49.5 PK	67.88	-18.4	1.00 H	173	16.84	32.63
6	#2400.00	19.4 AV	37.78	-18.4	1.00 H	173	-13.26	32.63
7	*2402.00	87.9 PK			1.00 H	173	55.25	32.63
8	*2402.00	57.8 AV			1.00 H	173	25.15	32.63
9	4804.00	56.1 PK	74.00	-17.9	1.18 H	180	16.30	39.80
10	4804.00	26.0 AV	54.00	-28.0	1.18 H	180	-13.80	39.80

- REMARKS:**
1. Emission level (dBuV/m) = Raw Value (dBuV) + Correction Factor (dB/m).
 2. Correction Factor (dB/m) = Antenna Factor (dB/m) + Cable Factor (dB).
 3. The other emission levels were very low against the limit.
 4. Margin value = Emission level – Limit value.
 5. “ * “: Fundamental frequency.
 6. The DH5 packet was the worse case duty cycle for a transmit dwell time on a channel, based upon bluetooth theory the transmitter is on 0.625 * 5 per 296.25 ms per channel. Therefore, the duty cycle correlation factor be equal to: $20\log(3.125 / 100) = -30.1$ dB.
 7. Average value = peak reading + $20\log(\text{duty cycle})$.
 8. "#":The radiated frequency is out the restricted band.

EUT TEST CONDITION		MEASUREMENT DETAIL	
CHANNEL	Channel 0	FREQUENCY RANGE	1 ~ 25GHz
INPUT POWER	120Vac, 60 Hz	DETECTOR FUNCTION	Peak (PK) Average (AV)
ENVIRONMENTAL CONDITIONS	25deg. C, 63%RH 1010 hPa	TESTED BY	Nick Chen
TEST MODE	A		

ANTENNA POLARITY & TEST DISTANCE: VERTICAL AT 3 M								
NO.	FREQ. (MHz)	EMISSION LEVEL (dBuV/m)	LIMIT (dBuV/m)	MARGIN (dB)	ANTENNA HEIGHT (m)	TABLE ANGLE (Degree)	RAW VALUE (dBuV)	CORRECTION FACTOR (dB/m)
1	1602.00	42.9 PK	74.00	-31.1	1.22 V	210	13.52	29.39
2	1602.00	32.8 AV	54.00	-21.2	1.22 V	210	3.45	29.39
3	2390.00	59.6 PK	74.00	-14.4	1.00 V	180	26.98	32.60
4	2390.00	47.0 AV	54.00	-7.0	1.00 V	180	14.42	32.60
5	#2400.00	54.4 PK	72.85	-18.4	1.00 V	180	21.81	32.63
6	#2400.00	24.3 AV	42.75	-18.4	1.00 V	180	-8.29	32.63
7	*2402.00	92.9 PK			1.00 V	180	60.22	32.63
8	*2402.00	62.8 AV			1.00 V	180	30.12	32.63
9	4804.00	54.5 PK	74.00	-19.5	1.23 V	209	14.67	39.80
10	4804.00	24.4 AV	54.00	-29.6	1.23 V	209	-15.43	39.80

- REMARKS:**
1. Emission level (dBuV/m) = Raw Value (dBuV) + Correction Factor (dB/m).
 2. Correction Factor (dB/m) = Antenna Factor (dB/m) + Cable Factor (dB).
 3. The other emission levels were very low against the limit.
 4. Margin value = Emission level – Limit value.
 5. “ * “: Fundamental frequency.
 6. The DH5 packet was the worse case duty cycle for a transmit dwell time on a channel, based upon bluetooth theory the transmitter is on 0.625 * 5 per 296.25 ms per channel. Therefore, the duty cycle correlation factor be equal to: $20\log(3.125 / 100) = -30.1$ dB.
 7. Average value = peak reading + $20\log(\text{duty cycle})$.
 8. "#":The radiated frequency is out the restricted band.

EUT TEST CONDITION		MEASUREMENT DETAIL	
CHANNEL	Channel 39	FREQUENCY RANGE	1 ~ 25GHz
INPUT POWER	120Vac, 60 Hz	DETECTOR FUNCTION	Peak (PK) Average (AV)
ENVIRONMENTAL CONDITIONS	25deg. C, 63%RH 1010 hPa	TESTED BY	Nick Chen
TEST MODE	A		

ANTENNA POLARITY & TEST DISTANCE: HORIZONTAL AT 3 M								
NO.	FREQ. (MHz)	EMISSION LEVEL (dBuV/m)	LIMIT (dBuV/m)	MARGIN (dB)	ANTENNA HEIGHT (m)	TABLE ANGLE (Degree)	RAW VALUE (dBuV)	CORRECTION FACTOR (dB/m)
1	#1628.00	45.0 PK	68.83	-23.8	1.00 H	225	15.48	29.52
2	#1628.00	32.7 AV	38.73	-6.0	1.00 H	225	3.21	29.52
3	*2441.00	88.8 PK			1.00 H	181	56.10	32.73
4	*2441.00	58.7 AV			1.00 H	181	26.00	32.73
5	4882.00	60.3 PK	74.00	-13.8	1.11 H	179	20.19	40.06
6	4882.00	30.2 AV	54.00	-23.9	1.11 H	179	-9.91	40.06
ANTENNA POLARITY & TEST DISTANCE: VERTICAL AT 3 M								
NO.	FREQ. (MHz)	EMISSION LEVEL (dBuV/m)	LIMIT (dBuV/m)	MARGIN (dB)	ANTENNA HEIGHT (m)	TABLE ANGLE (Degree)	RAW VALUE (dBuV)	CORRECTION FACTOR (dB/m)
1	#1628.00	48.4 PK	73.42	-25.0	1.27 V	159	18.87	29.52
2	#1628.00	37.2 AV	43.32	-6.1	1.27 V	159	7.66	29.52
3	*2441.00	93.4 PK			1.29 V	186	60.69	32.73
4	*2441.00	63.3 AV			1.29 V	186	30.59	32.73
5	4882.00	62.3 PK	74.00	-11.8	1.00 V	213	22.19	40.06
6	4882.00	32.2 AV	54.00	-21.9	1.00 V	213	-7.91	40.06

- REMARKS:**
1. Emission level (dBuV/m) = Raw Value (dBuV) + Correction Factor (dB/m).
 2. Correction Factor (dB/m) = Antenna Factor (dB/m) + Cable Factor (dB).
 3. The other emission levels were very low against the limit.
 4. Margin value = Emission level – Limit value.
 5. “ * “: Fundamental frequency.
 6. The DH5 packet was the worse case duty cycle for a transmit dwell time on a channel, based upon bluetooth theory the transmitter is on 0.625 * 5 per 296.25 ms per channel. Therefore, the duty cycle correlation factor be equal to: $20\log(3.125 / 100) = -30.1$ dB.
 7. Average value = peak reading + $20\log(\text{duty cycle})$.
 8. "#":The radiated frequency is out the restricted band.

EUT TEST CONDITION		MEASUREMENT DETAIL	
CHANNEL	Channel 78	FREQUENCY RANGE	1 ~ 25GHz
INPUT POWER	120Vac, 60 Hz	DETECTOR FUNCTION	Peak (PK) Average (AV)
ENVIRONMENTAL CONDITIONS	25deg. C, 63%RH 1010 hPa	TESTED BY	Nick Chen
TEST MODE	A		

ANTENNA POLARITY & TEST DISTANCE: HORIZONTAL AT 3 M								
NO.	FREQ. (MHz)	EMISSION LEVEL (dBuV/m)	LIMIT (dBuV/m)	MARGIN (dB)	ANTENNA HEIGHT (m)	TABLE ANGLE (Degree)	RAW VALUE (dBuV)	CORRECTION FACTOR (dB/m)
1	#1654.00	41.7 PK	66.02	-24.3	1.17 H	134	12.04	29.66
2	#1654.00	30.4 AV	35.92	-5.5	1.17 H	134	0.74	29.66
3	*2480.00	86.0 PK			1.00 H	175	53.20	32.82
4	*2480.00	55.9 AV			1.00 H	175	23.10	32.82
5	2483.50	35.9 PK	74.00	-38.1	1.00 H	175	3.06	32.83
6	2483.50	5.8 AV	54.00	-48.2	1.00 H	175	-27.04	32.83
7	4960.00	58.7 PK	74.00	-15.3	1.10 H	182	18.46	40.21
8	4960.00	28.6 AV	54.00	-25.4	1.10 H	182	-11.64	40.21
ANTENNA POLARITY & TEST DISTANCE: VERTICAL AT 3 M								
NO.	FREQ. (MHz)	EMISSION LEVEL (dBuV/m)	LIMIT (dBuV/m)	MARGIN (dB)	ANTENNA HEIGHT (m)	TABLE ANGLE (Degree)	RAW VALUE (dBuV)	CORRECTION FACTOR (dB/m)
1	#1654.00	42.4 PK	71.37	-29.0	1.10 V	156	12.76	29.66
2	#1654.00	33.8 AV	41.27	-7.4	1.10 V	156	4.18	29.66
3	*2480.00	91.4 PK			1.06 V	183	58.55	32.82
4	*2480.00	61.3 AV			1.06 V	183	28.45	32.82
5	2483.50	41.2 PK	74.00	-32.8	1.06 V	183	8.41	32.83
6	2483.50	11.1 AV	54.00	-42.9	1.06 V	183	-21.69	32.83
7	4960.00	60.1 PK	74.00	-13.9	1.16 V	198	19.86	40.21
8	4960.00	30.0 AV	54.00	-24.0	1.16 V	198	-10.24	40.21

- REMARKS:**
1. Emission level (dBuV/m) = Raw Value (dBuV) + Correction Factor (dB/m).
 2. Correction Factor (dB/m) = Antenna Factor (dB/m) + Cable Factor (dB).
 3. The other emission levels were very low against the limit.
 4. Margin value = Emission level – Limit value.
 5. “ * “: Fundamental frequency.
 6. The DH5 packet was the worse case duty cycle for a transmit dwell time on a channel, based upon bluetooth theory the transmitter is on 0.625 * 5 per 296.25 ms per channel. Therefore, the duty cycle correlation factor be equal to: $20\log(3.125 / 100) = -30.1$ dB.
 7. Average value = peak reading + $20\log(\text{duty cycle})$.
 8. "#":The radiated frequency is out the restricted band.

8DPSK MODULATION

EUT TEST CONDITION		MEASUREMENT DETAIL	
CHANNEL	Channel 0	FREQUENCY RANGE	1 ~ 25GHz
INPUT POWER	120Vac, 60 Hz	DETECTOR FUNCTION	Peak (PK) Average (AV)
ENVIRONMENTAL CONDITIONS	25deg. C, 63%RH 1010 hPa	TESTED BY	Nick Chen
TEST MODE	A		

ANTENNA POLARITY & TEST DISTANCE: HORIZONTAL AT 3 M								
NO.	FREQ. (MHz)	EMISSION LEVEL (dBuV/m)	LIMIT (dBuV/m)	MARGIN (dB)	ANTENNA HEIGHT (m)	TABLE ANGLE (Degree)	RAW VALUE (dBuV)	CORRECTION FACTOR (dB/m)
1	1602.00	46.5 PK	74.00	-27.5	1.00 H	201	17.09	29.39
2	1602.00	33.9 AV	54.00	-20.1	1.00 H	201	4.52	29.39
3	2390.00	59.6 PK	74.00	-14.4	1.05 H	158	26.98	32.60
4	2390.00	47.0 AV	54.00	-7.1	1.05 H	158	14.35	32.60
5	#2400.00	49.2 PK	70.05	-20.9	1.05 H	158	16.56	32.63
6	#2400.00	19.1 AV	39.95	-20.9	1.05 H	158	-13.54	32.63
7	*2402.00	90.1 PK			1.05 H	158	57.42	32.63
8	*2402.00	60.0 AV			1.05 H	158	27.32	32.63
9	4804.00	55.4 PK	74.00	-18.6	1.00 H	180	15.62	39.80
10	4804.00	25.3 AV	54.00	-28.7	1.00 H	180	-14.48	39.80

- REMARKS:**
1. Emission level (dBuV/m) = Raw Value (dBuV) + Correction Factor (dB/m).
 2. Correction Factor (dB/m) = Antenna Factor (dB/m) + Cable Factor (dB).
 3. The other emission levels were very low against the limit.
 4. Margin value = Emission level – Limit value.
 5. “ * “: Fundamental frequency.
 6. The DH5 packet was the worse case duty cycle for a transmit dwell time on a channel, based upon bluetooth theory the transmitter is on 0.625 * 5 per 296.25 ms per channel. Therefore, the duty cycle correlation factor be equal to: $20\log(3.125 / 100) = -30.1$ dB.
 7. Average value = peak reading + $20\log(\text{duty cycle})$.
 8. "#":The radiated frequency is out the restricted band.

EUT TEST CONDITION		MEASUREMENT DETAIL	
CHANNEL	Channel 0	FREQUENCY RANGE	1 ~ 25GHz
INPUT POWER	120Vac, 60 Hz	DETECTOR FUNCTION	Peak (PK) Average (AV)
ENVIRONMENTAL CONDITIONS	25deg. C, 63%RH 1010 hPa	TESTED BY	Nick Chen
TEST MODE	A		

ANTENNA POLARITY & TEST DISTANCE: VERTICAL AT 3 M								
NO.	FREQ. (MHz)	EMISSION LEVEL (dBuV/m)	LIMIT (dBuV/m)	MARGIN (dB)	ANTENNA HEIGHT (m)	TABLE ANGLE (Degree)	RAW VALUE (dBuV)	CORRECTION FACTOR (dB/m)
1	1602.00	43.6 PK	74.00	-30.4	1.22 V	213	14.17	29.39
2	1602.00	33.3 AV	54.00	-20.7	1.22 V	213	3.90	29.39
3	2390.00	59.9 PK	74.00	-14.1	1.08 V	195	27.29	32.60
4	2390.00	46.8 AV	54.00	-7.2	1.08 V	195	14.24	32.60
5	#2400.00	52.4 PK	73.28	-20.9	1.08 V	195	19.79	32.63
6	#2400.00	22.3 AV	43.18	-20.9	1.08 V	195	-10.31	32.63
7	*2402.00	93.3 PK			1.08 V	195	60.65	32.63
8	*2402.00	63.2 AV			1.08 V	195	30.55	32.63
9	4804.00	54.5 PK	74.00	-19.5	1.10 V	208	14.70	39.80
10	4804.00	24.4 AV	54.00	-29.6	1.10 V	208	-15.40	39.80

- REMARKS:**
1. Emission level (dBuV/m) = Raw Value (dBuV) + Correction Factor (dB/m).
 2. Correction Factor (dB/m) = Antenna Factor (dB/m) + Cable Factor (dB).
 3. The other emission levels were very low against the limit.
 4. Margin value = Emission level – Limit value.
 5. “ * “: Fundamental frequency.
 6. The DH5 packet was the worse case duty cycle for a transmit dwell time on a channel, based upon bluetooth theory the transmitter is on 0.625 * 5 per 296.25 ms per channel. Therefore, the duty cycle correlation factor be equal to: $20\log(3.125 / 100) = -30.1$ dB.
 7. Average value = peak reading + $20\log(\text{duty cycle})$.
 8. "#":The radiated frequency is out the restricted band.

EUT TEST CONDITION		MEASUREMENT DETAIL	
CHANNEL	Channel 39	FREQUENCY RANGE	1 ~ 25GHz
INPUT POWER	120Vac, 60 Hz	DETECTOR FUNCTION	Peak (PK) Average (AV)
ENVIRONMENTAL CONDITIONS	25deg. C, 63%RH 1010 hPa	TESTED BY	Nick Chen
TEST MODE	A		

ANTENNA POLARITY & TEST DISTANCE: HORIZONTAL AT 3 M								
NO.	FREQ. (MHz)	EMISSION LEVEL (dBuV/m)	LIMIT (dBuV/m)	MARGIN (dB)	ANTENNA HEIGHT (m)	TABLE ANGLE (Degree)	RAW VALUE (dBuV)	CORRECTION FACTOR (dB/m)
1	#1628.00	45.0 PK	68.17	-23.2	1.03 H	219	15.49	29.52
2	#1628.00	34.2 AV	38.07	-3.9	1.03 H	219	4.67	29.52
3	*2441.00	88.2 PK			1.03 H	153	55.44	32.73
4	*2441.00	58.1 AV			1.03 H	153	25.34	32.73
5	4882.00	57.7 PK	74.00	-16.3	1.09 H	182	17.67	40.06
6	4882.00	27.6 AV	54.00	-26.4	1.09 H	182	-12.43	40.06
ANTENNA POLARITY & TEST DISTANCE: VERTICAL AT 3 M								
NO.	FREQ. (MHz)	EMISSION LEVEL (dBuV/m)	LIMIT (dBuV/m)	MARGIN (dB)	ANTENNA HEIGHT (m)	TABLE ANGLE (Degree)	RAW VALUE (dBuV)	CORRECTION FACTOR (dB/m)
1	#1628.00	47.8 PK	72.52	-24.7	1.29 V	164	18.30	29.52
2	#1628.00	34.9 AV	42.42	-7.5	1.29 V	164	5.41	29.52
3	*2441.00	92.5 PK			1.28 V	185	59.79	32.73
4	*2441.00	62.4 AV			1.28 V	185	29.69	32.73
5	4882.00	57.7 PK	74.00	-16.3	1.09 V	195	17.66	40.06
6	4882.00	27.6 AV	54.00	-26.4	1.09 V	195	-12.44	40.06

- REMARKS:**
1. Emission level (dBuV/m) = Raw Value (dBuV) + Correction Factor (dB/m).
 2. Correction Factor (dB/m) = Antenna Factor (dB/m) + Cable Factor (dB).
 3. The other emission levels were very low against the limit.
 4. Margin value = Emission level – Limit value.
 5. “ * “: Fundamental frequency.
 6. The DH5 packet was the worse case duty cycle for a transmit dwell time on a channel, based upon bluetooth theory the transmitter is on 0.625 * 5 per 296.25 ms per channel. Therefore, the duty cycle correlation factor be equal to: $20\log(3.125 / 100) = -30.1$ dB.
 7. Average value = peak reading + $20\log(\text{duty cycle})$.
 8. "#":The radiated frequency is out the restricted band.

EUT TEST CONDITION		MEASUREMENT DETAIL	
CHANNEL	Channel 78	FREQUENCY RANGE	1 ~ 25GHz
INPUT POWER	120Vac, 60 Hz	DETECTOR FUNCTION	Peak (PK) Average (AV)
ENVIRONMENTAL CONDITIONS	25deg. C, 63%RH 1010 hPa	TESTED BY	Nick Chen
TEST MODE	A		

ANTENNA POLARITY & TEST DISTANCE: HORIZONTAL AT 3 M								
NO.	FREQ. (MHz)	EMISSION LEVEL (dBuV/m)	LIMIT (dBuV/m)	MARGIN (dB)	ANTENNA HEIGHT (m)	TABLE ANGLE (Degree)	RAW VALUE (dBuV)	CORRECTION FACTOR (dB/m)
1	#1654.00	42.3 PK	64.43	-22.1	1.16 H	137	12.68	29.66
2	#1654.00	30.6 AV	34.33	-3.8	1.16 H	137	0.92	29.66
3	*2480.00	84.4 PK			1.00 H	179	51.61	32.82
4	*2480.00	54.3 AV			1.00 H	179	21.51	32.82
5	2483.50	39.9 PK	74.00	-34.1	1.00 H	179	7.05	32.83
6	2483.50	9.8 AV	54.00	-44.2	1.00 H	179	-23.05	32.83
7	4960.00	55.8 PK	74.00	-18.2	1.18 H	184	15.63	40.21
8	4960.00	25.7 AV	54.00	-28.3	1.18 H	184	-14.47	40.21
ANTENNA POLARITY & TEST DISTANCE: VERTICAL AT 3 M								
NO.	FREQ. (MHz)	EMISSION LEVEL (dBuV/m)	LIMIT (dBuV/m)	MARGIN (dB)	ANTENNA HEIGHT (m)	TABLE ANGLE (Degree)	RAW VALUE (dBuV)	CORRECTION FACTOR (dB/m)
1	#1654.00	43.2 PK	68.98	-25.8	1.14 V	179	13.56	29.66
2	#1654.00	32.4 AV	38.88	-6.5	1.14 V	179	2.75	29.66
3	*2480.00	89.0 PK			1.00 V	175	56.16	32.82
4	*2480.00	58.9 AV			1.00 V	175	26.06	32.82
5	2483.50	44.4 PK	74.00	-29.6	1.00 V	175	11.60	32.83
6	2483.50	14.3 AV	54.00	-39.7	1.00 V	175	-18.50	32.83
7	4960.00	56.9 PK	74.00	-17.1	1.17 V	195	16.73	40.21
8	4960.00	26.8 AV	54.00	-27.2	1.17 V	195	-13.37	40.21

- REMARKS:**
1. Emission level (dBuV/m) = Raw Value (dBuV) + Correction Factor (dB/m).
 2. Correction Factor (dB/m) = Antenna Factor (dB/m) + Cable Factor (dB).
 3. The other emission levels were very low against the limit.
 4. Margin value = Emission level – Limit value.
 5. “ * “: Fundamental frequency.
 6. The DH5 packet was the worse case duty cycle for a transmit dwell time on a channel, based upon bluetooth theory the transmitter is on 0.625 * 5 per 296.25 ms per channel. Therefore, the duty cycle correlation factor be equal to: $20\log(3.125 / 100) = -30.1$ dB.
 7. Average value = peak reading + $20\log(\text{duty cycle})$.
 8. "#":The radiated frequency is out the restricted band.

BELOW 1GHz WORST-CASE DATA : GFSK MODULATION

EUT TEST CONDITION		MEASUREMENT DETAIL	
CHANNEL	Channel 0	FREQUENCY RANGE	Below 1000MHz
INPUT POWER	120Vac, 60 Hz	DETECTOR FUNCTION	Quasi-Peak
ENVIRONMENTAL CONDITIONS	25deg. C, 63%RH 1010 hPa	TESTED BY	Nick Chen
TEST MODE	A		

ANTENNA POLARITY & TEST DISTANCE: HORIZONTAL AT 3 M								
NO.	FREQ. (MHz)	EMISSION LEVEL (dBuV/m)	LIMIT (dBuV/m)	MARGIN (dB)	ANTENNA HEIGHT (m)	TABLE ANGLE (Degree)	RAW VALUE (dBuV)	CORRECTION FACTOR (dB/m)
1	59.16	34.3 QP	40.00	-5.7	1.02 H	85	21.49	12.81
2	286.59	35.8 QP	46.00	-10.2	1.03 H	238	21.03	14.78
3	313.81	43.3 QP	46.00	-2.7	1.18 H	238	27.53	15.79
4	342.97	36.9 QP	46.00	-9.1	1.24 H	241	20.38	16.53
5	372.12	38.2 QP	46.00	-7.8	1.00 H	202	20.85	17.33
6	500.42	35.9 QP	46.00	-10.1	1.10 H	175	14.81	21.09
7	700.64	38.8 QP	46.00	-7.2	1.12 H	169	13.98	24.82
ANTENNA POLARITY & TEST DISTANCE: VERTICAL AT 3 M								
NO.	FREQ. (MHz)	EMISSION LEVEL (dBuV/m)	LIMIT (dBuV/m)	MARGIN (dB)	ANTENNA HEIGHT (m)	TABLE ANGLE (Degree)	RAW VALUE (dBuV)	CORRECTION FACTOR (dB/m)
1	59.16	33.1 QP	40.00	-6.9	1.07 V	190	20.33	12.81
2	189.40	33.1 QP	43.50	-10.4	1.13 V	196	21.22	11.90
3	313.81	35.4 QP	46.00	-10.6	1.26 V	163	19.64	15.79
4	455.71	36.5 QP	46.00	-9.5	1.10 V	10	16.68	19.79
5	521.80	39.6 QP	46.00	-6.4	1.08 V	10	18.05	21.57
6	585.95	34.9 QP	46.00	-11.1	1.32 V	325	11.99	22.94
7	912.53	34.6 QP	46.00	-11.4	1.25 V	25	6.42	28.18

- REMARKS:**
1. Emission level (dBuV/m) = Raw Value (dBuV) + Correction Factor (dB/m).
 2. Correction Factor (dB/m) = Antenna Factor (dB/m) + Cable Factor (dB).
 3. The other emission levels were very low against the limit.
 4. Margin value = Emission level – Limit value.

EUT TEST CONDITION		MEASUREMENT DETAIL	
CHANNEL	Channel 0	FREQUENCY RANGE	Below 1000MHz
INPUT POWER	12Vdc	DETECTOR FUNCTION	Quasi-Peak
ENVIRONMENTAL CONDITIONS	25deg. C, 63%RH 1010 hPa	TESTED BY	Nick Chen
TEST MODE	B		

ANTENNA POLARITY & TEST DISTANCE: HORIZONTAL AT 3 M								
NO.	FREQ. (MHz)	EMISSION LEVEL (dBuV/m)	LIMIT (dBuV/m)	MARGIN (dB)	ANTENNA HEIGHT (m)	TABLE ANGLE (Degree)	RAW VALUE (dBuV)	CORRECTION FACTOR (dB/m)
1	59.16	35.4 QP	40.00	-4.6	1.02 H	259	22.60	12.81
2	191.34	34.8 QP	43.50	-8.8	1.17 H	166	22.98	11.77
3	286.59	36.2 QP	46.00	-9.8	1.23 H	238	21.46	14.78
4	313.81	43.7 QP	46.00	-2.3	1.11 H	238	27.93	15.79
5	342.97	36.9 QP	46.00	-9.1	1.28 H	244	20.35	16.53
6	372.12	38.5 QP	46.00	-7.5	1.05 H	196	21.14	17.33
7	500.42	37.3 QP	46.00	-8.7	1.13 H	178	16.18	21.09
8	700.64	39.5 QP	46.00	-6.5	1.00 H	160	14.65	24.82
ANTENNA POLARITY & TEST DISTANCE: VERTICAL AT 3 M								
NO.	FREQ. (MHz)	EMISSION LEVEL (dBuV/m)	LIMIT (dBuV/m)	MARGIN (dB)	ANTENNA HEIGHT (m)	TABLE ANGLE (Degree)	RAW VALUE (dBuV)	CORRECTION FACTOR (dB/m)
1	47.49	38.2 QP	40.00	-1.9	1.12 V	229	24.93	13.22
2	64.99	29.4 QP	40.00	-10.6	1.32 V	10	16.92	12.51
3	195.23	35.6 QP	43.50	-7.9	1.27 V	208	24.09	11.53
4	313.81	35.1 QP	46.00	-10.9	1.26 V	169	19.31	15.79
5	455.71	35.6 QP	46.00	-10.5	1.12 V	346	15.76	19.79
6	521.80	40.3 QP	46.00	-5.7	1.01 V	10	18.74	21.57
7	585.95	36.2 QP	46.00	-9.8	1.00 V	10	13.31	22.94
8	700.64	34.9 QP	46.00	-11.1	1.25 V	172	10.10	24.82

- REMARKS:**
1. Emission level (dBuV/m) = Raw Value (dBuV) + Correction Factor (dB/m).
 2. Correction Factor (dB/m) = Antenna Factor (dB/m) + Cable Factor (dB).
 3. The other emission levels were very low against the limit.
 4. Margin value = Emission level – Limit value.



4.3 NUMBER OF HOPPING FREQUENCY USED

4.3.1 LIMIT OF HOPPING FREQUENCY USED

At least 15 channels frequencies, and should be equally spaced.

4.3.2 TEST INSTRUMENTS

DESCRIPTION & MANUFACTURER	MODEL NO.	SERIAL NO.	CALIBRATED DATE	CALIBRATED UNTIL
SPECTRUM ANALYZER	FSP 40	100036	Apr. 03, 2009	Apr. 02, 2010

NOTE: The calibration interval of the above test instruments is 12 months and the calibrations are traceable to NML/ROC and NIST/USA.

4.3.3 TEST PROCEDURES

- a. Check the calibration of the measuring instrument (SA) using either an internal calibrator or a known signal from an external generator.
- b. Turn on the EUT and connect its antenna terminal to measurement via a low loss cable. Then set it to any one measured frequency within its operating range and make sure the instrument is operated in its linear range.
- c. Set the SA on MaxHold Mode, and then keep the EUT in hopping mode. Record all the signals from each channel until each one has been recorded.
- d. Set the SA on View mode and then plot the result on SA screen.
- e. Repeat above procedures until all frequencies measured were complete.

4.3.4 DEVIATION FROM TEST STANDARD

No deviation.

4.3.5 TEST SETUP

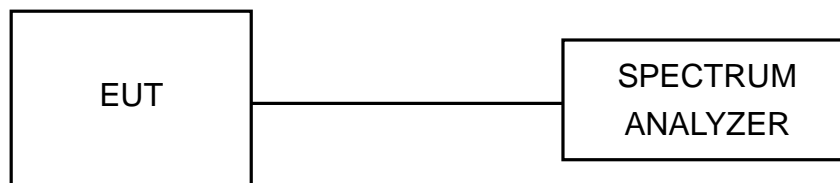

4.3.6 TEST RESULTS

There are 79 hopping frequencies in the hopping mode. Please refer to next two pages for the test result. On the plots, it shows that the hopping frequencies are equally spaced.



A D T

Mode A: FOR GFSK

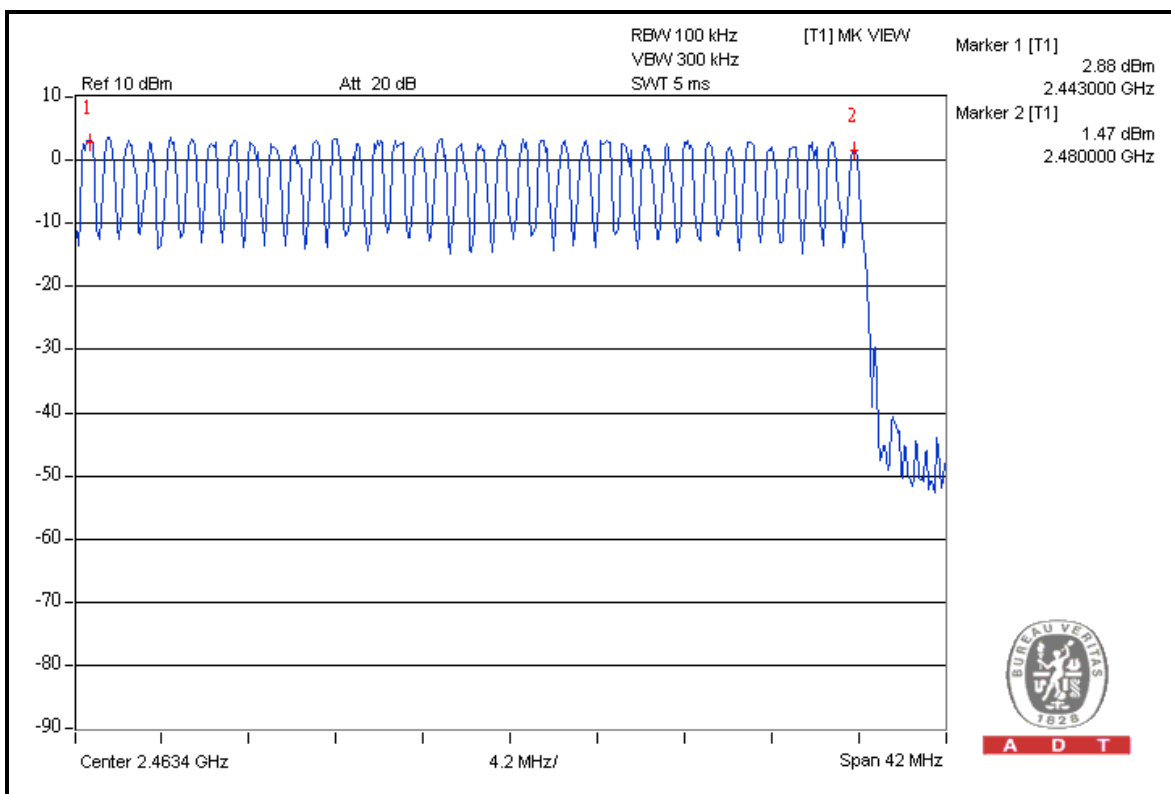
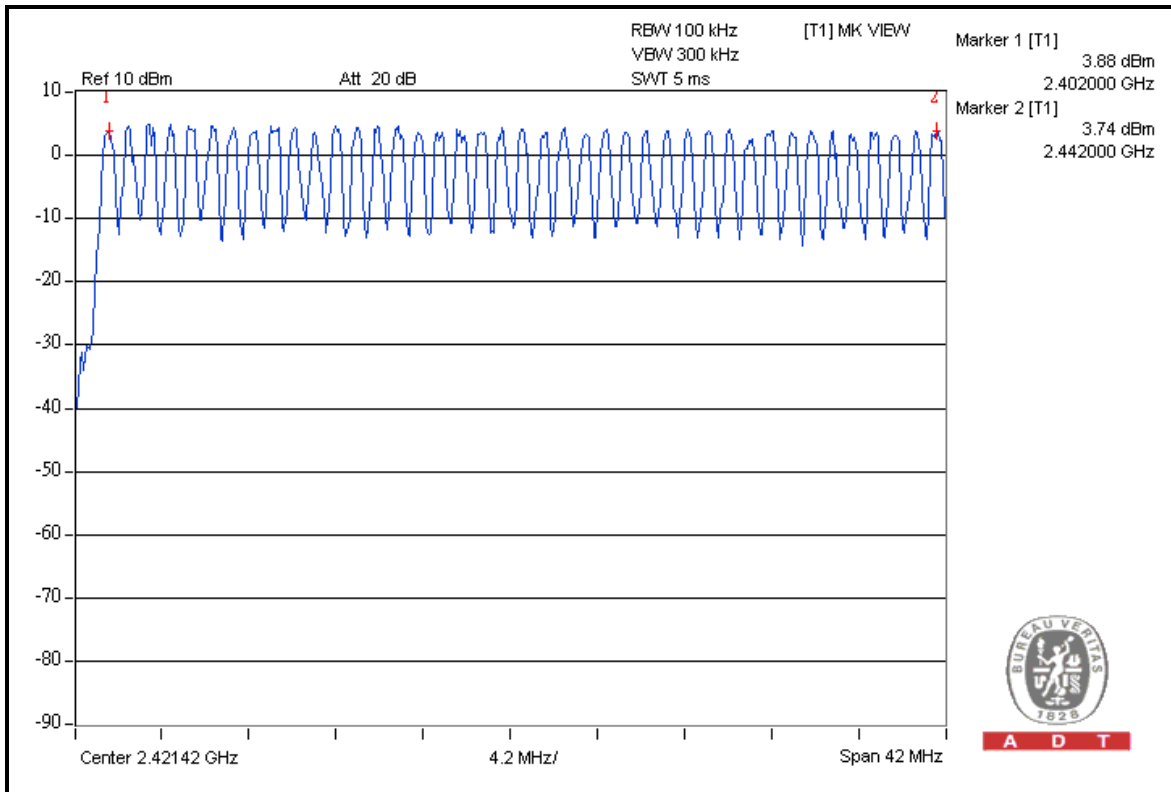



A D T

Mode A: FOR 8DPSK

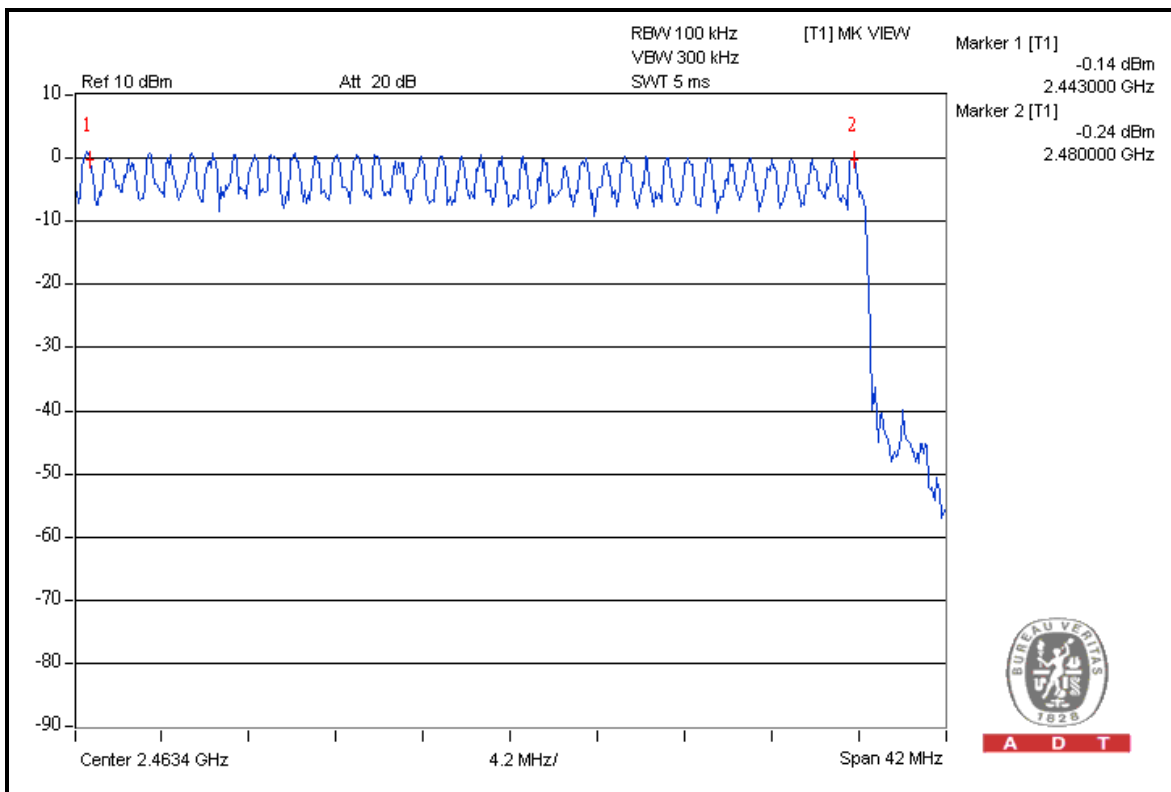
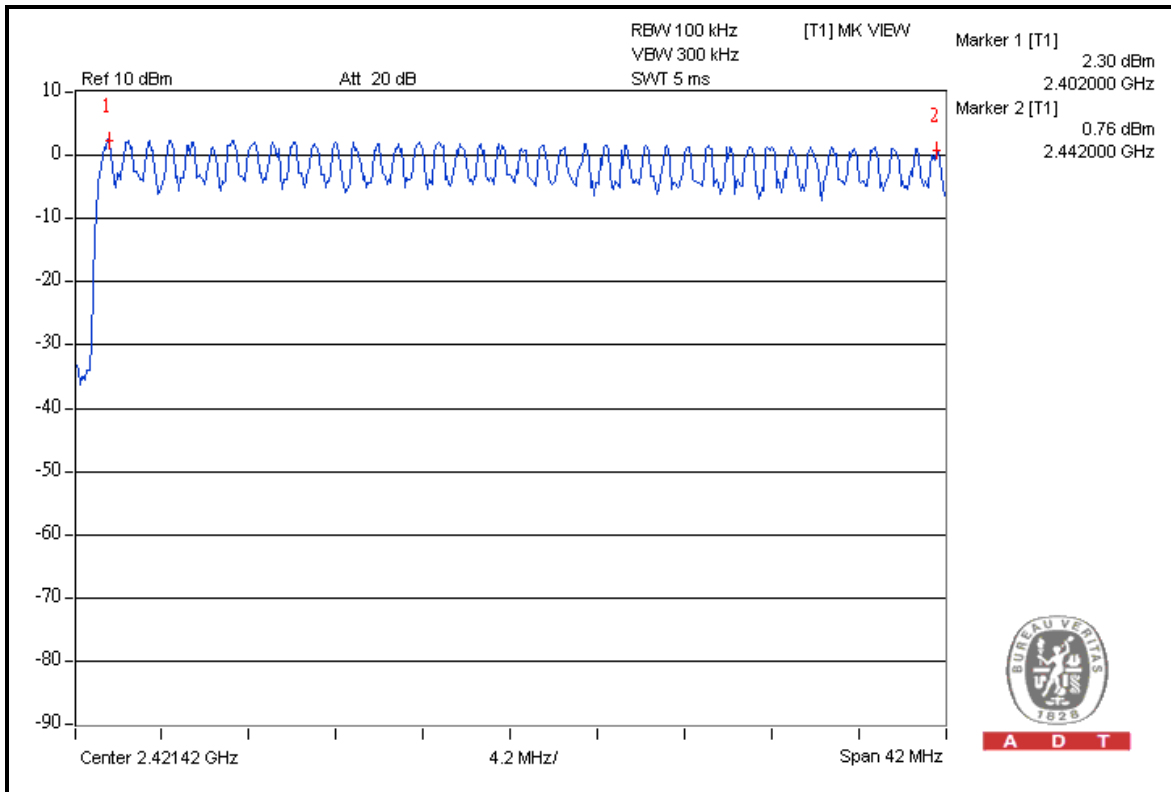

4.4 DWELL TIME ON EACH CHANNEL

4.4.1 LIMIT OF DWELL TIME USED

The average time of occupancy on any channel shall not be greater than 0.4 seconds within a period of 0.4 seconds multiplied by the number of hopping channels employed.

4.4.2 TEST INSTRUMENTS

DESCRIPTION & MANUFACTURER	MODEL NO.	SERIAL NO.	CALIBRATED DATE	CALIBRATED UNTIL
SPECTRUM ANALYZER	FSP 40	100036	Apr. 03, 2009	Apr. 02, 2010

NOTE: The calibration interval of the above test instruments is 12 months and the calibrations are traceable to NML/ROC and NIST/USA.

4.4.3 TEST PROCEDURES

- a. Check the calibration of the measuring instrument (SA) using either an internal calibrator or a known signal from an external generator.
- b. Turn on the EUT and connect its antenna terminal to measurement via a low loss cable. Then set it to any one measured frequency within its operating range and make sure the instrument is operated in its linear range.
- c. Adjust the center frequency of SA on any frequency be measured and set SA to zero span mode. And then, set RBW and VBW of spectrum analyzer to proper value.
- d. Measure the time duration of one transmission on the measured frequency. And then plot the result with time difference of this time duration.
- e. Repeat above procedures until all different time-slot modes have been completed.

4.4.4 DEVIATION FROM TEST STANDARD

No deviation.

4.4.5 TEST SETUP

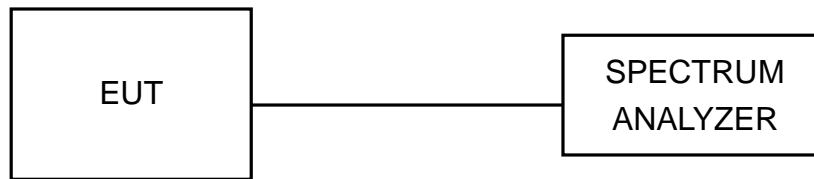

4.4.6 TEST RESULTS

MODE A: FOR GFSK MODULATION

Mode	Number of transmission in a 31.6 (79Hopping*0.4)	Length of transmission time (msec)	Result (msec)	Limit (msec)
DH1	50 (times / 5 sec) *6.32=316.00 times	0.474	149.7840	400
DH3	25 (times / 5 sec) *6.32=158.00 times	1.728	273.0240	400
DH5	17 (times / 5 sec) *6.32=107.44 times	2.970	319.0968	400

NOTE: Test plots of the transmitting time slot are shown on next 3 pages for test channel 39.



A D T

DH1

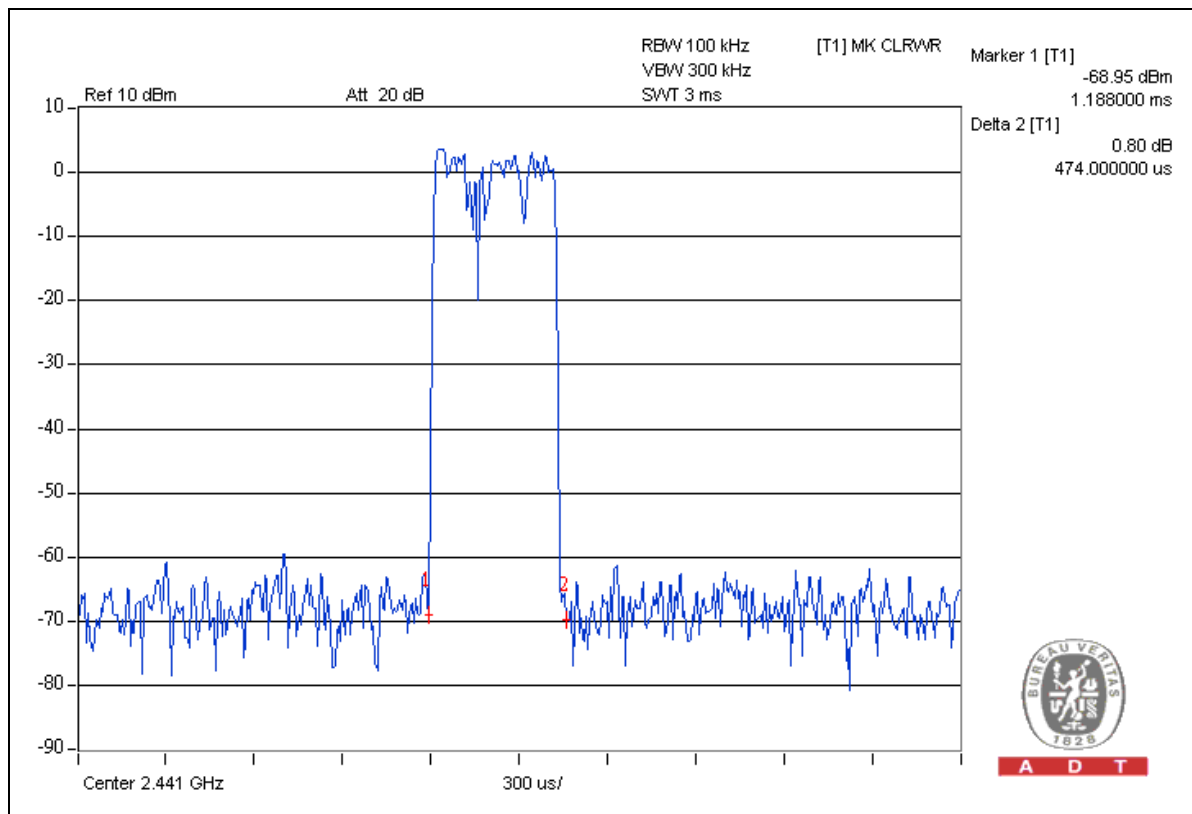
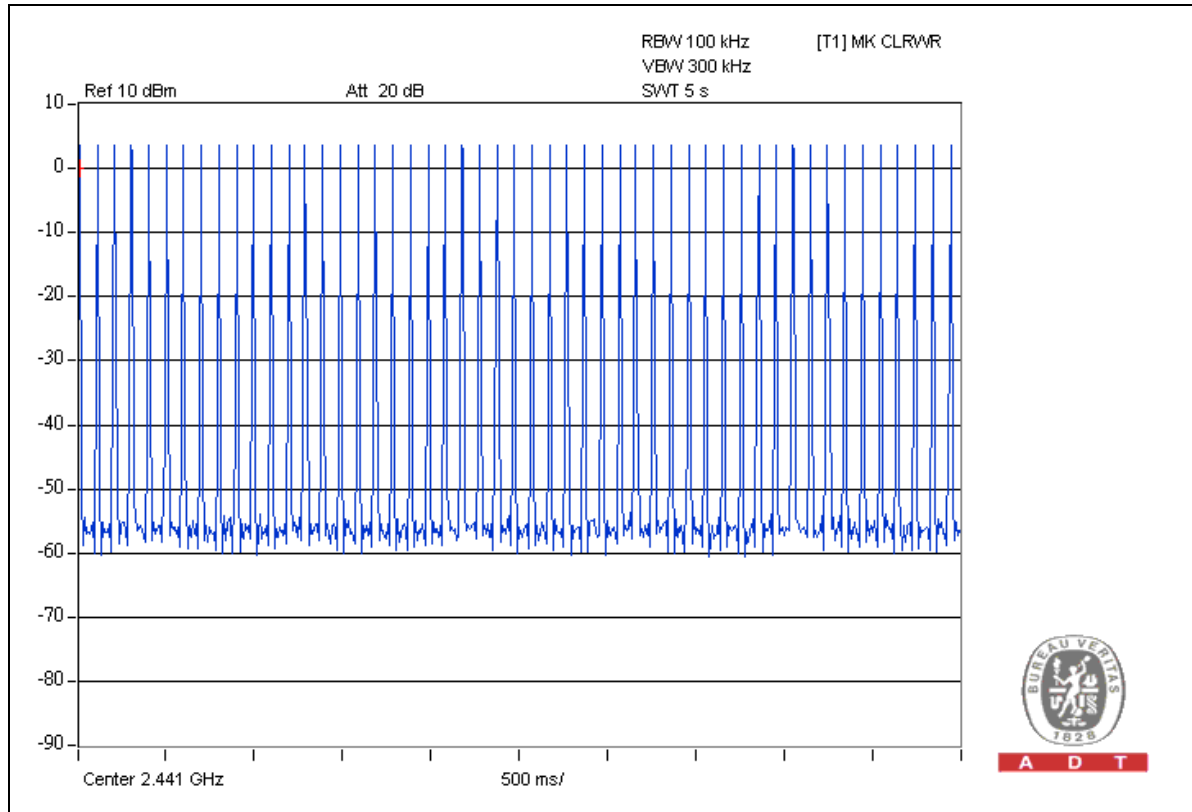



A D T

DH3

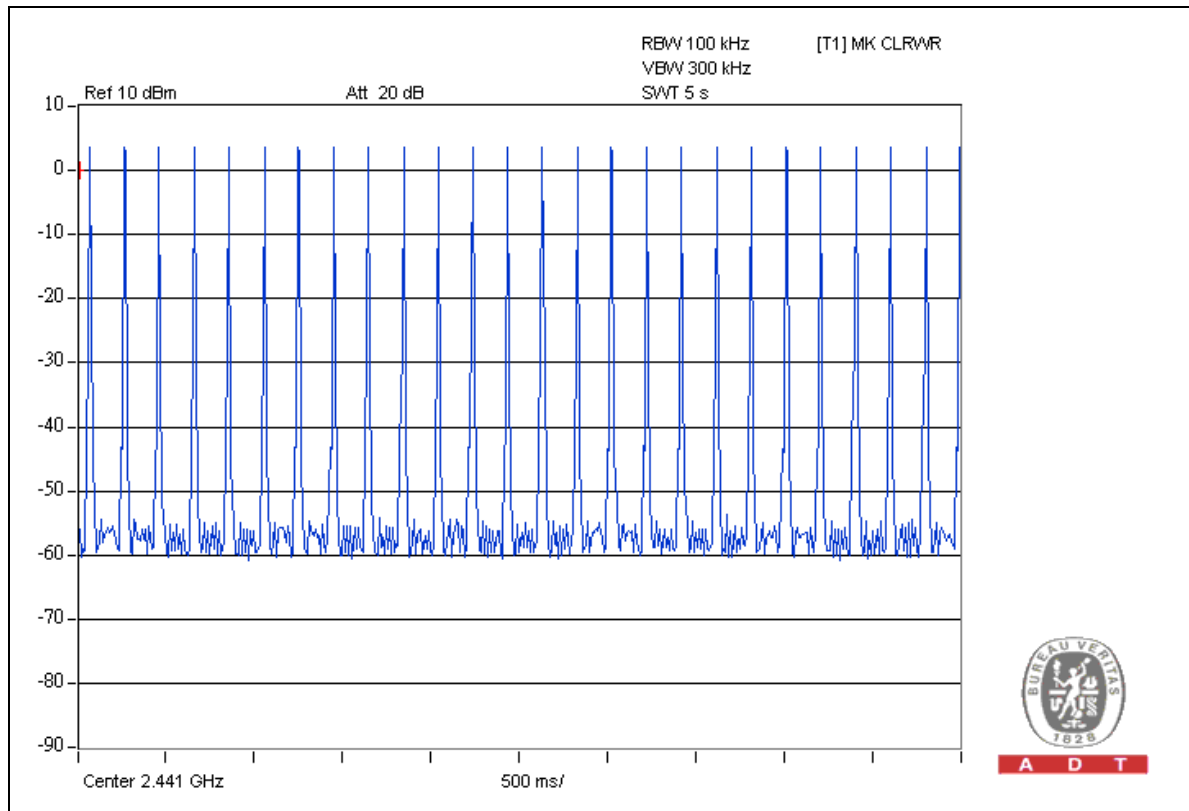

A D T

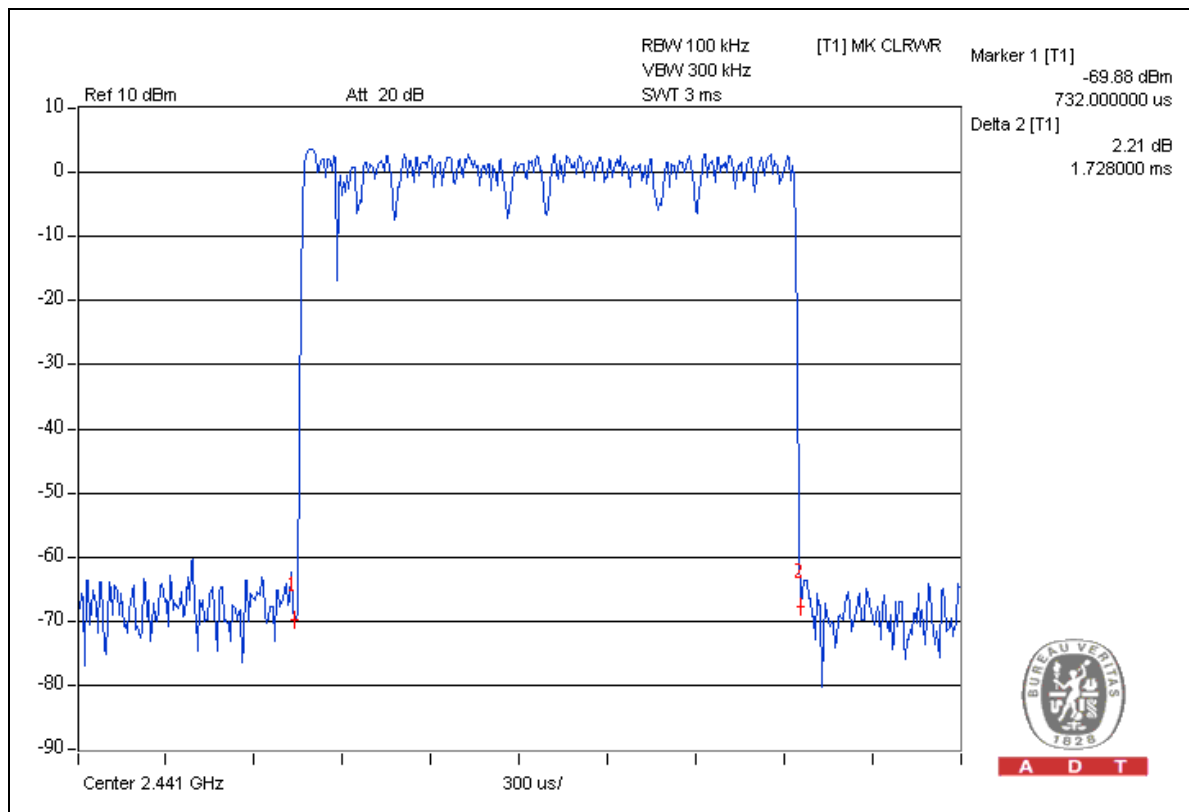

A D T



A D T

DH5

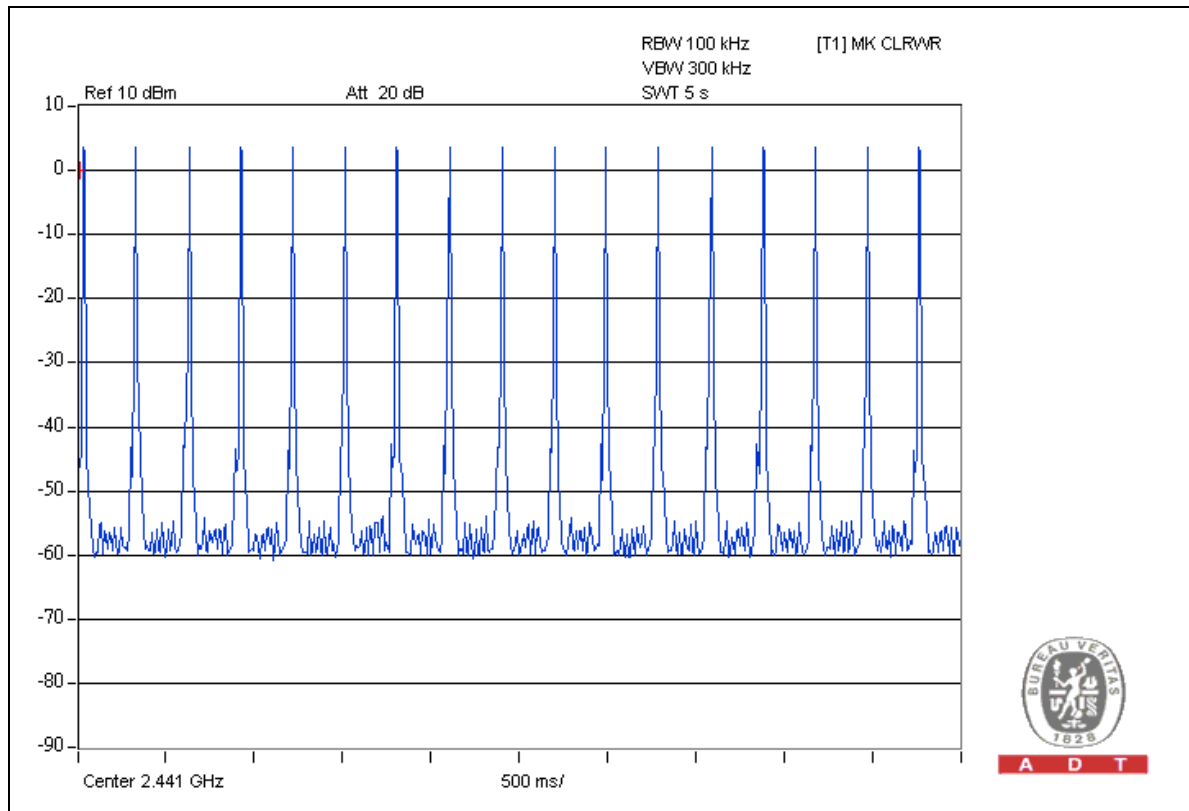

A D T

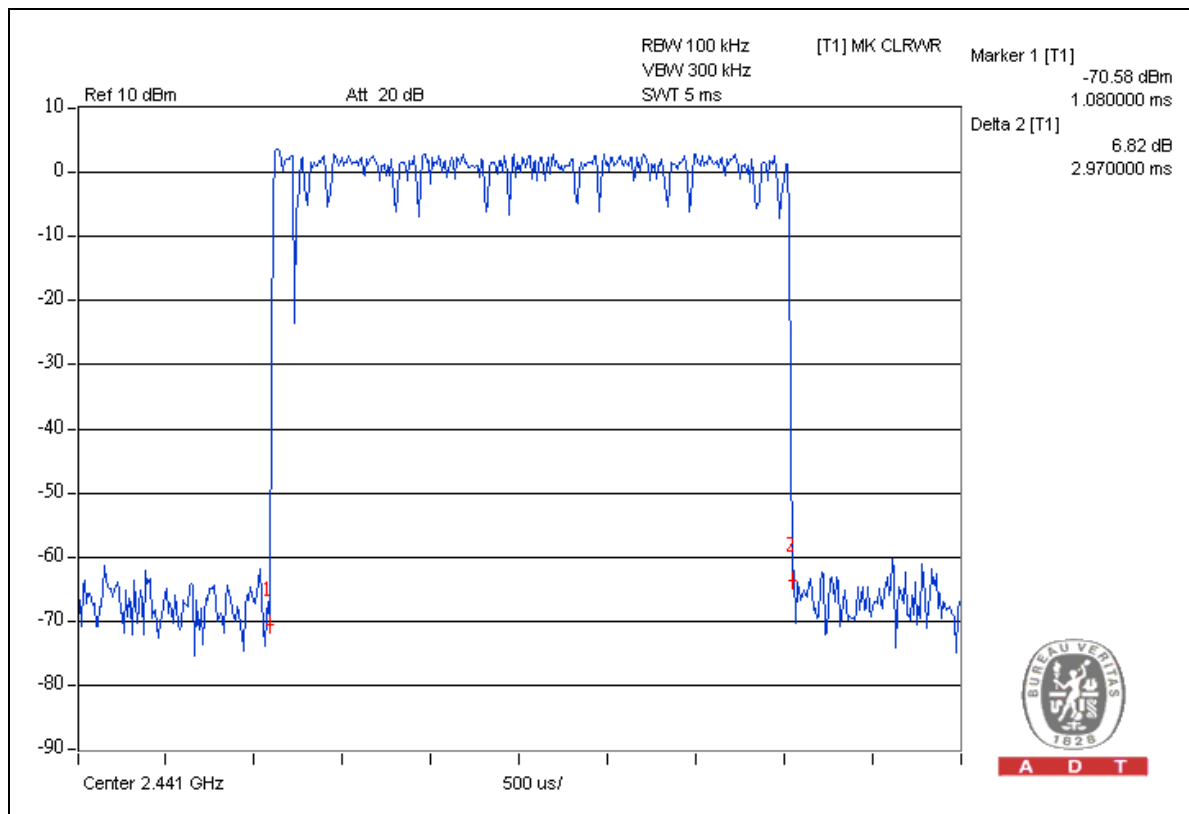

A D T

MODE A: FOR 8DPSK MODULATION

Mode	Number of transmission in a 31.6 (79Hopping*0.4)	Length of transmission time (msec)	Result (msec)	Limit (msec)
DH1	50 (times / 5 sec) *6.32=316.00 times	0.486	153.5760	400
DH3	25 (times / 5 sec) *6.32=164.32 times	1.722	272.0760	400
DH5	17 (times / 5 sec) *6.32=107.44 times	3.020	324.4688	400

NOTE: Test plots of the transmitting time slot are shown on next 3 pages for test channel 39.



A D T

DH1

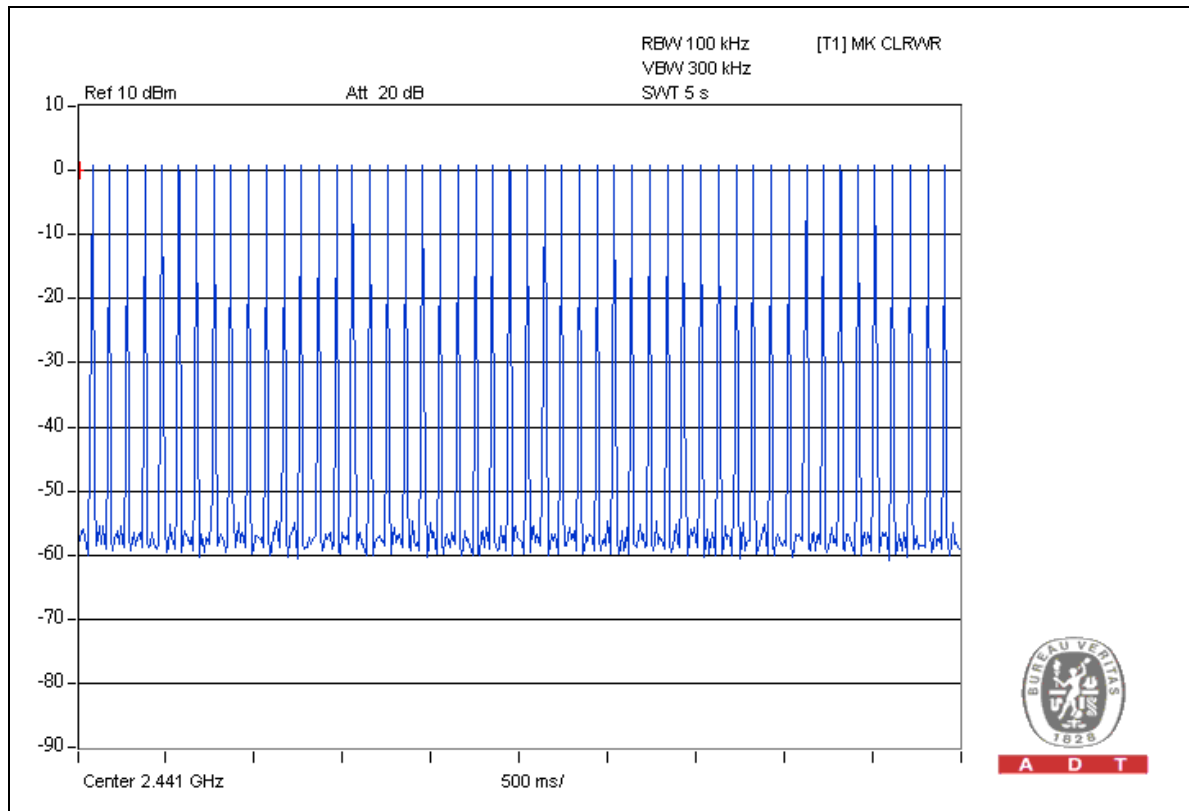

A D T

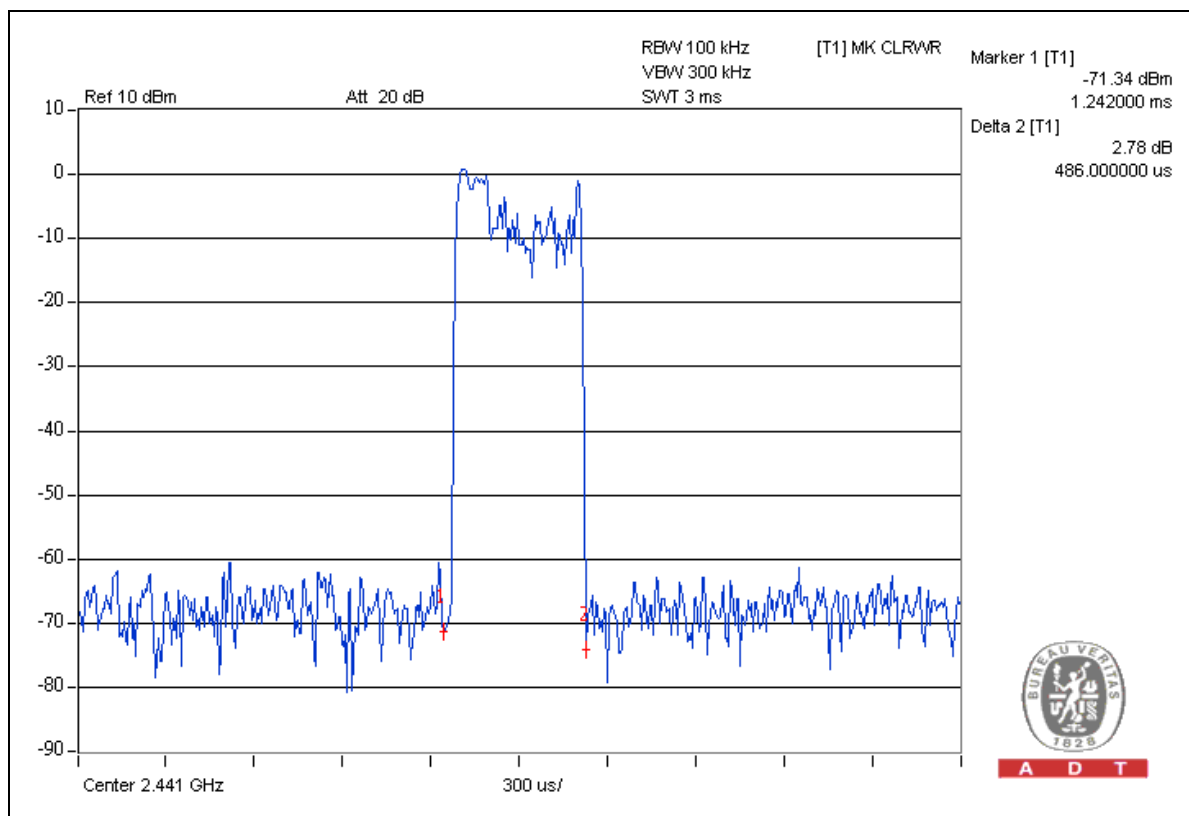

A D T



A D T

DH3

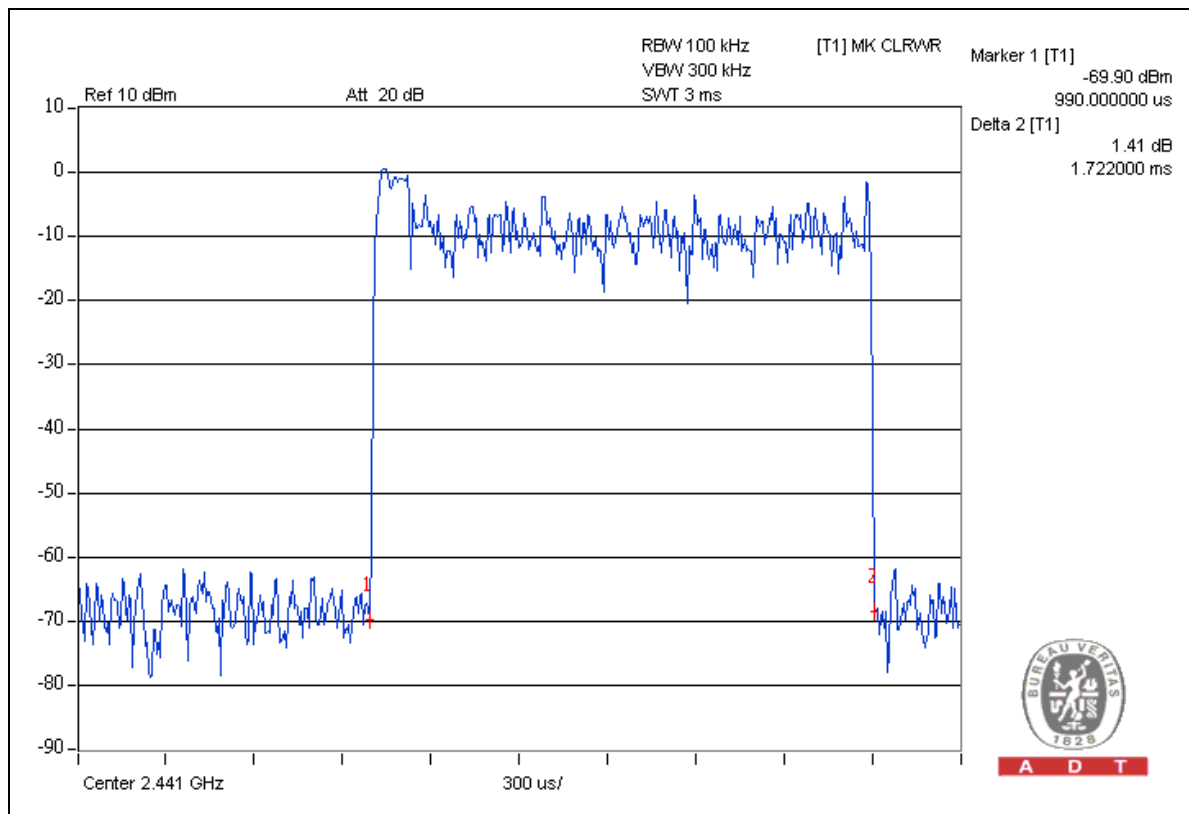
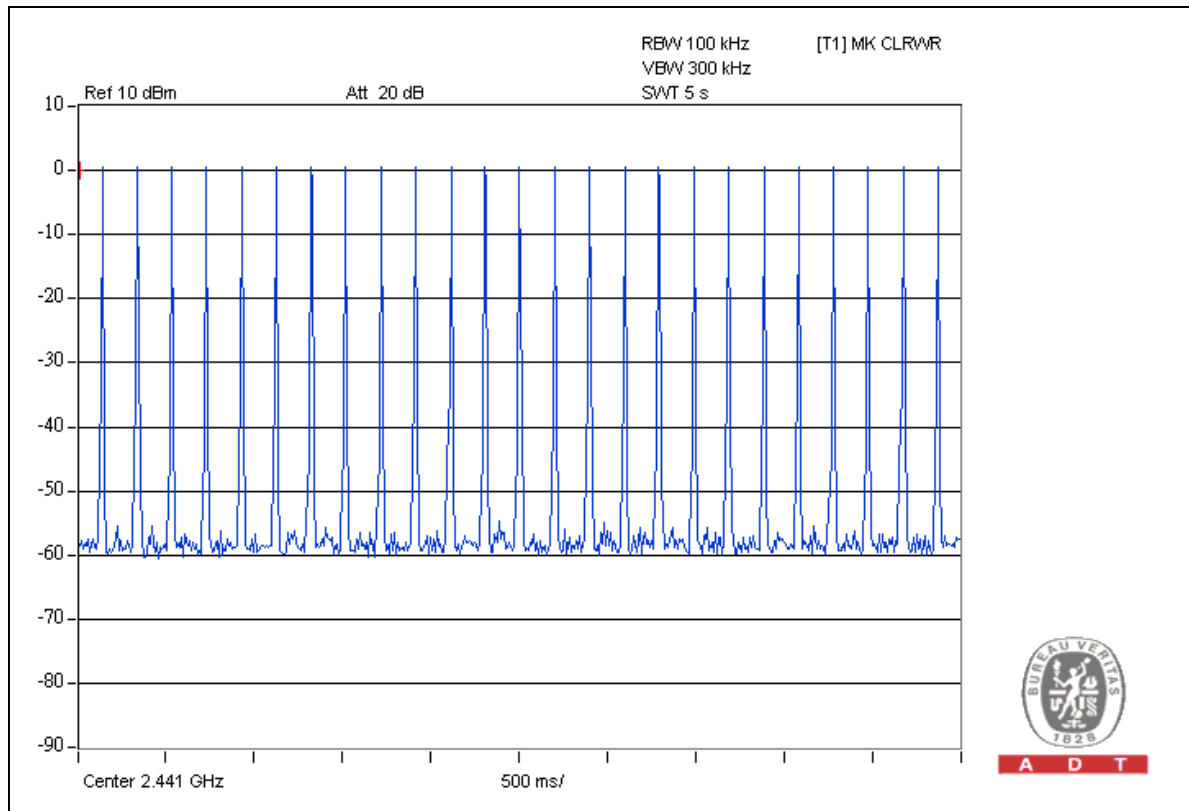



A D T

DH5

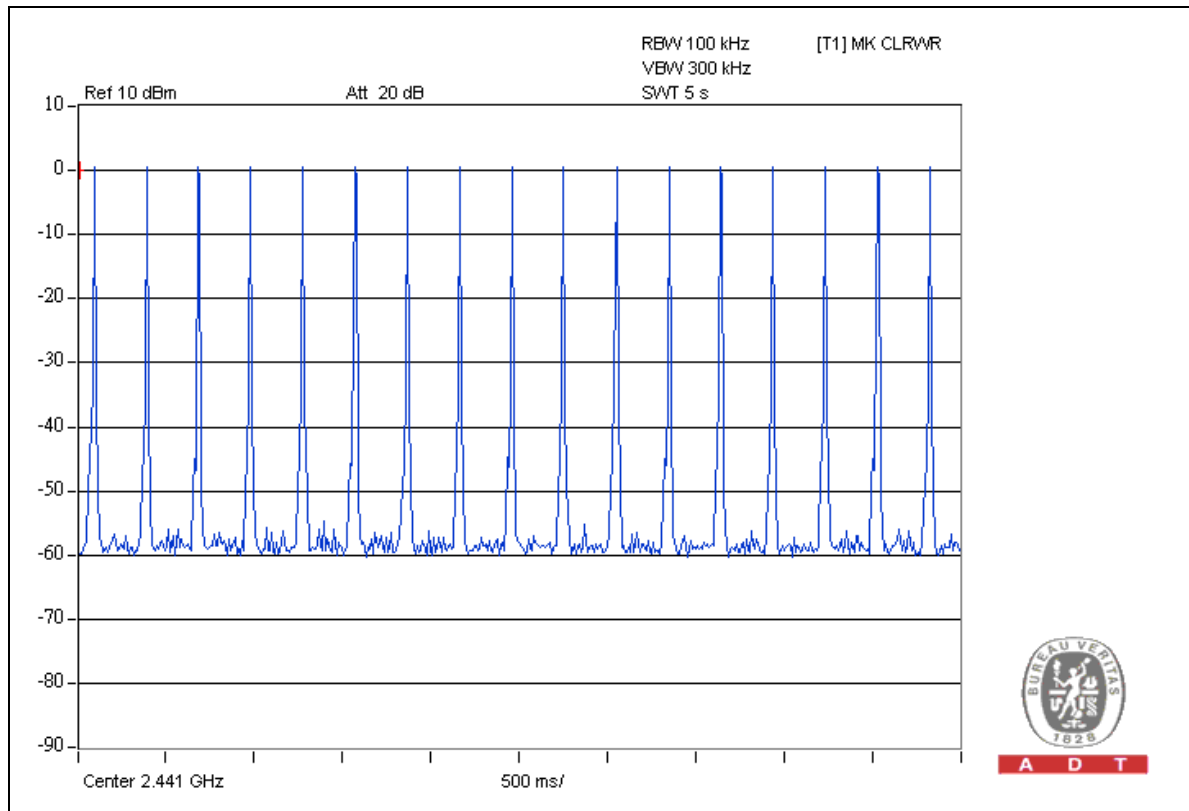

A D T

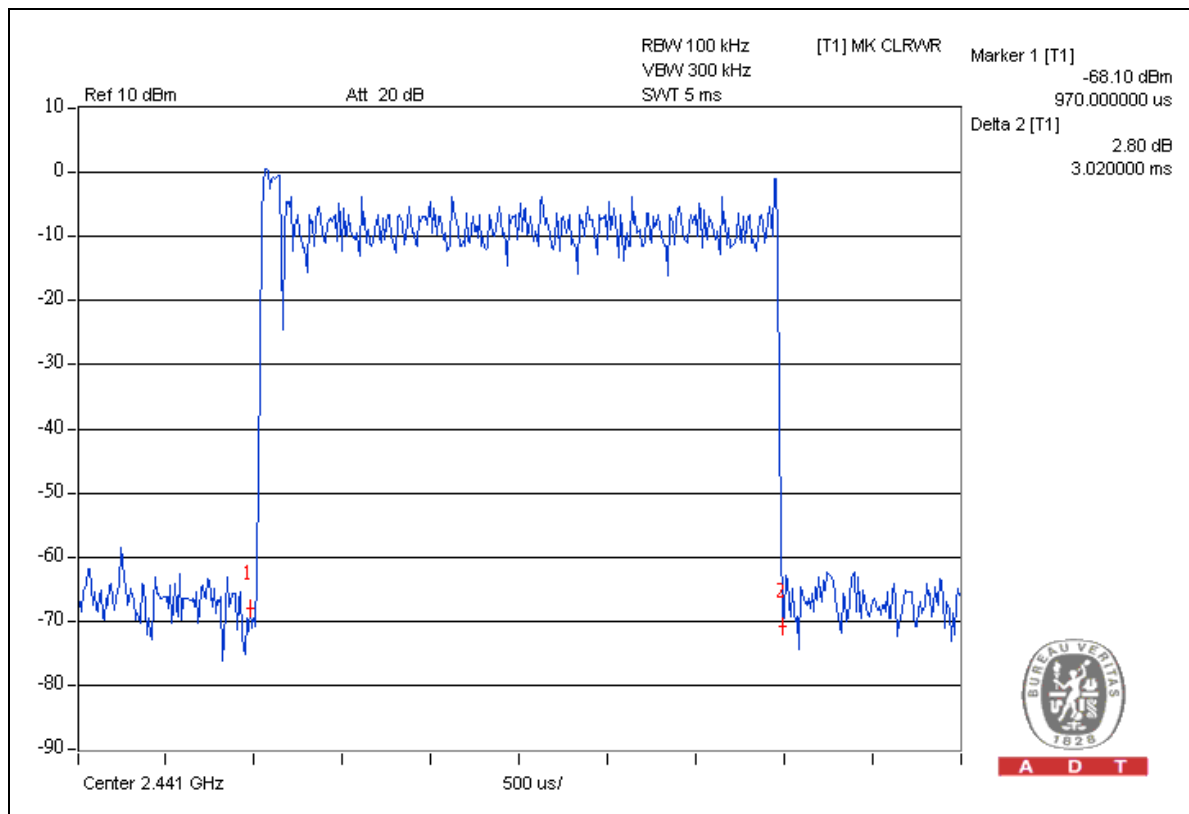

A D T

4.5 CHANNEL BANDWIDTH

4.5.1 LIMITS OF CHANNEL BANDWIDTH

For frequency hopping system operating in the 2400-2483.5MHz, If the 20dB bandwidth of hopping channel is greater than 25kHz, two-thirds 20dB bandwidth of hopping channel shall be a minimum limit for the hopping channel separation.

4.5.2 TEST INSTRUMENTS

DESCRIPTION & MANUFACTURER	MODEL NO.	SERIAL NO.	CALIBRATED DATE	CALIBRATED UNTIL
SPECTRUM ANALYZER	FSP 40	100036	Apr. 03, 2009	Apr. 02, 2010

NOTE: The calibration interval of the above test instruments is 12 months and the calibrations are traceable to NML/ROC and NIST/USA.

4.5.3 TEST PROCEDURE

- a. Check the calibration of the measuring instrument using either an internal calibrator or a known signal from an external generator.
- b. Turn on the EUT and connect it to measurement instrument. Then set it to any one convenient frequency within its operating range. Set a reference level on the measuring instrument equal to the highest peak value.
- c. Measure the frequency difference of two frequencies that were attenuated 20dB from the reference level. Record the frequency difference as the emission bandwidth.
- d. Repeat above procedures until all frequencies measured were complete.

4.5.4 DEVIATION FROM TEST STANDARD

No deviation.

4.5.5 TEST SETUP

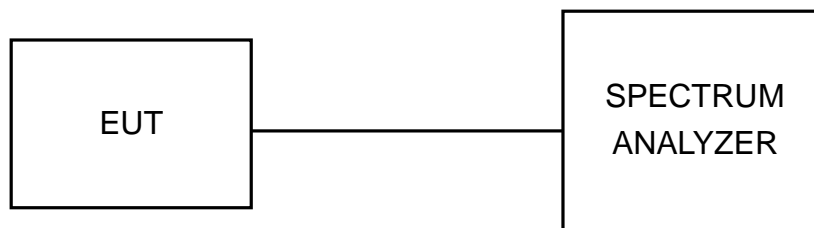

4.5.6 EUT OPERATING CONDITION

The software provided by client enabled the EUT to transmit and receive data at lowest, middle and highest channel frequencies individually.

4.5.7 TEST RESULTS

MODE A: FOR GFSK

CHANNEL	CHANNEL FREQUENCY (MHz)	20dB BANDWIDTH (MHz)
0	2402	0.869
39	2441	0.823
78	2480	0.839

CH 0

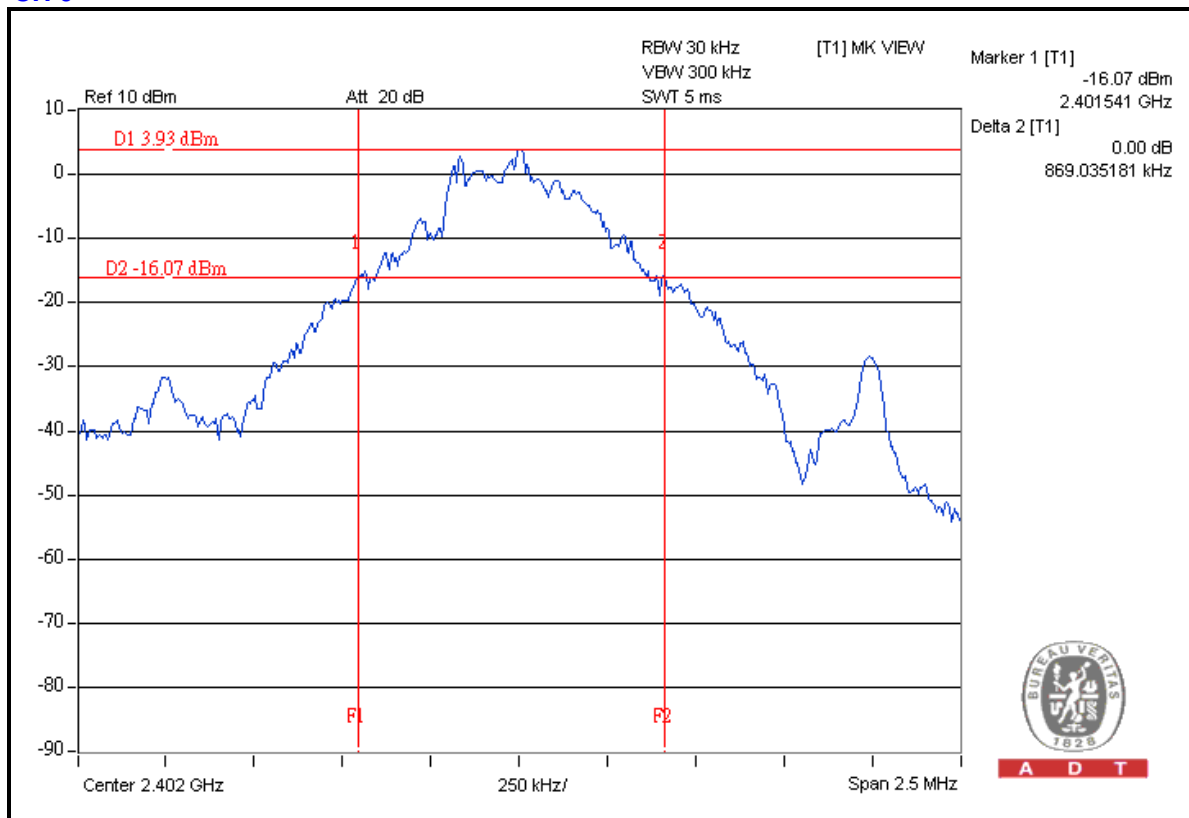



A D T

MODE A: FOR 8DPSK

CHANNEL	CHANNEL FREQUENCY (MHz)	20dB BANDWIDTH (MHz)
0	2402	1.217
39	2441	1.219
78	2480	1.214

CH 39

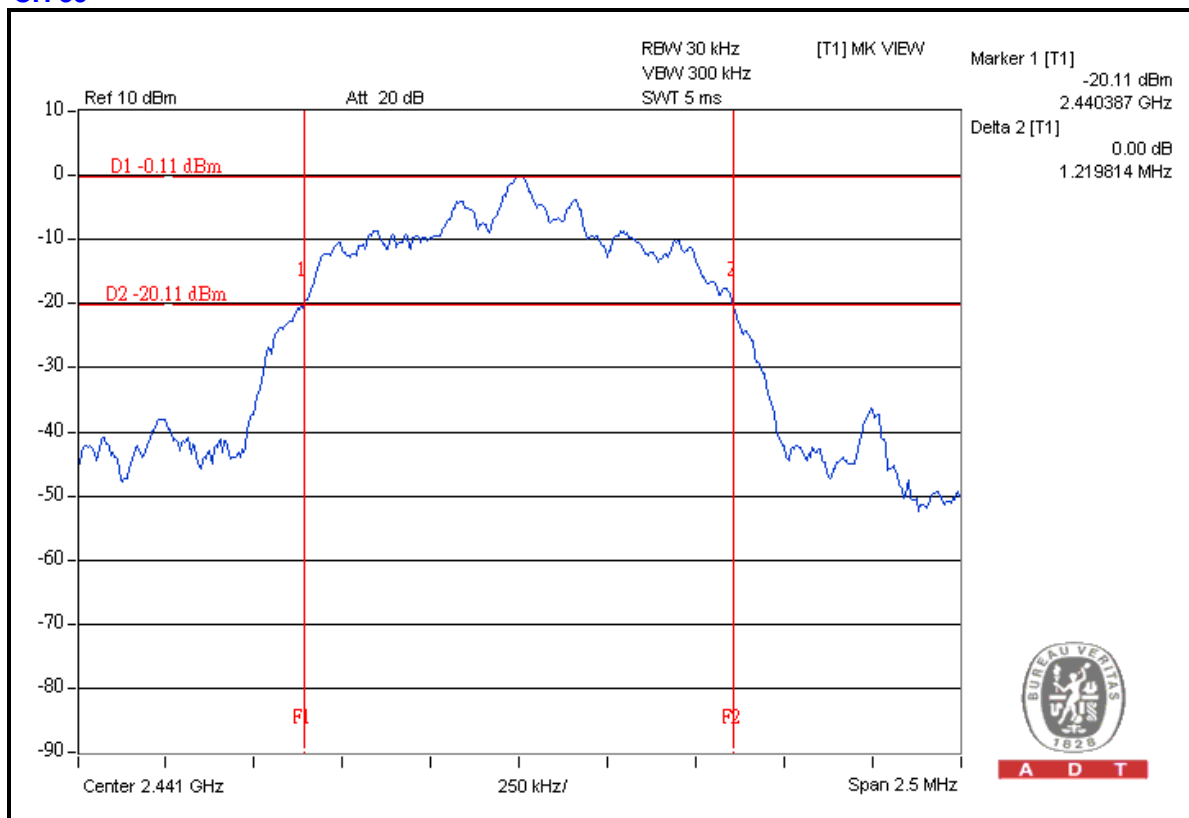



4.6 HOPPING CHANNEL SEPARATION

4.6.1 LIMIT OF HOPPING CHANNEL SEPARATION

At least 25kHz or two-third of 20dB hopping channel bandwidth (whichever is greater).

4.6.2 TEST INSTRUMENTS

DESCRIPTION & MANUFACTURER	MODEL NO.	SERIAL NO.	CALIBRATED DATE	CALIBRATED UNTIL
SPECTRUM ANALYZER	FSP 40	100036	Apr. 03, 2009	Apr. 02, 2010

NOTE: The calibration interval of the above test instruments is 12 months and the calibrations are traceable to NML/ROC and NIST/USA.

4.6.3 TEST PROCEDURES

1. Check the calibration of the measuring instrument using either an internal calibrator or a known signal from an external generator.
2. Turn on the EUT and connect it to measurement instrument. Then set it to any one convenient frequency within its operating range.
3. By using the MaxHold function record the separation of two adjacent channels.
4. Measure the frequency difference of these two adjacent channels by SA MARK function. And then plot the result on SA screen.
5. Repeat above procedures until all frequencies measured were complete.

4.6.4 DEVIATION FROM TEST STANDARD

No deviation.

4.6.5 TEST SETUP

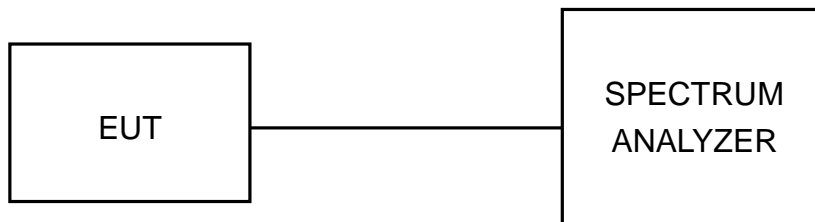

4.6.6 TEST RESULTS

MODE A: FOR GFSK

CHANNEL	FREQUENCY (MHz)	ADJACENT CHANNEL SEPARATION (MHz)	20dB BANDWIDTH (MHz)	MINIMUM LIMIT (MHz)	PASS / FAIL
0	2402	1.002	0.869	0.579	PASS
39	2441	1.005	0.823	0.549	PASS
78	2480	1.007	0.839	0.559	PASS

NOTE: The minimum limit is 20dB bandwidth. Test results please refer to the plot as below.

CH 78

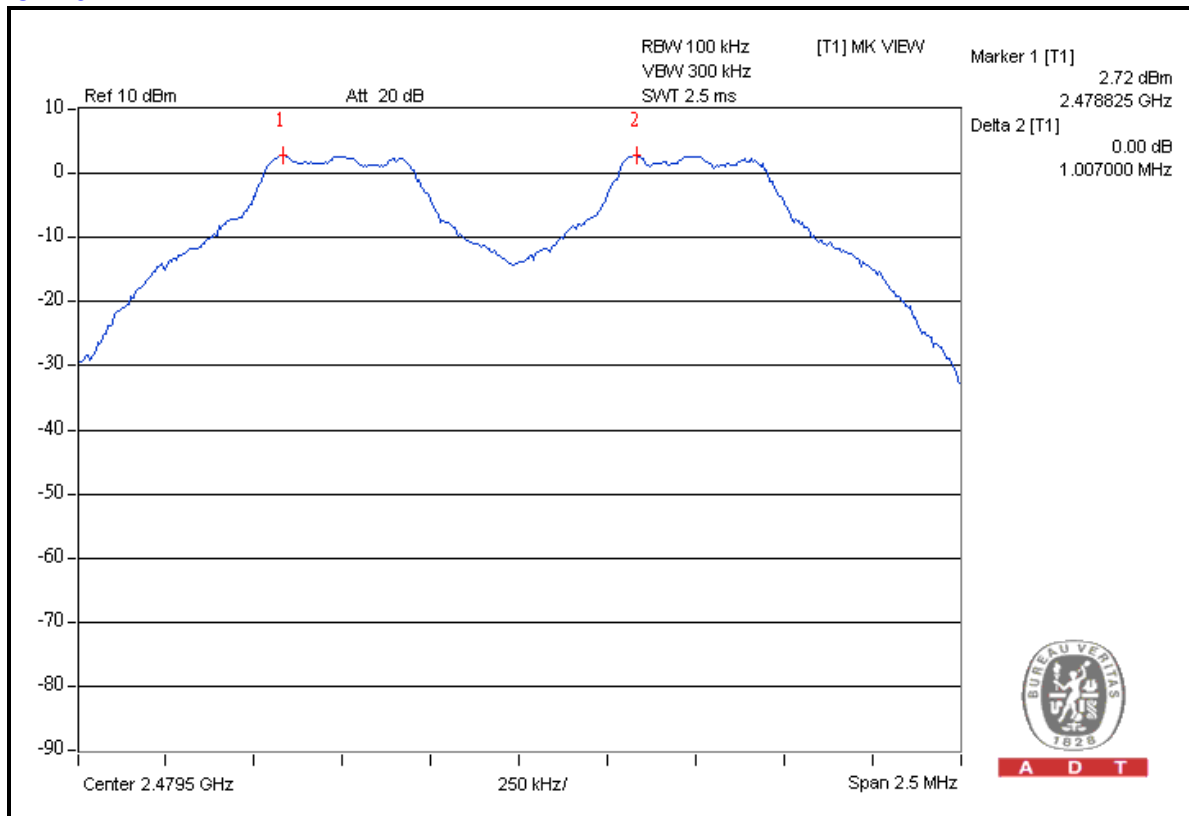



A D T

MODE A: FOR 8DPSK

CHANNEL	FREQUENCY (MHz)	ADJACENT CHANNEL SEPARATION (MHz)	20dB BANDWIDTH (MHz)	MINIMUM LIMIT (MHz)	PASS / FAIL
0	2402	1.000	1.217	0.811	PASS
39	2441	1.001	1.219	0.813	PASS
78	2480	1.004	1.214	0.809	PASS

NOTE: The minimum limit is 20dB bandwidth. Test results please refer to the plot as below.

CH 78

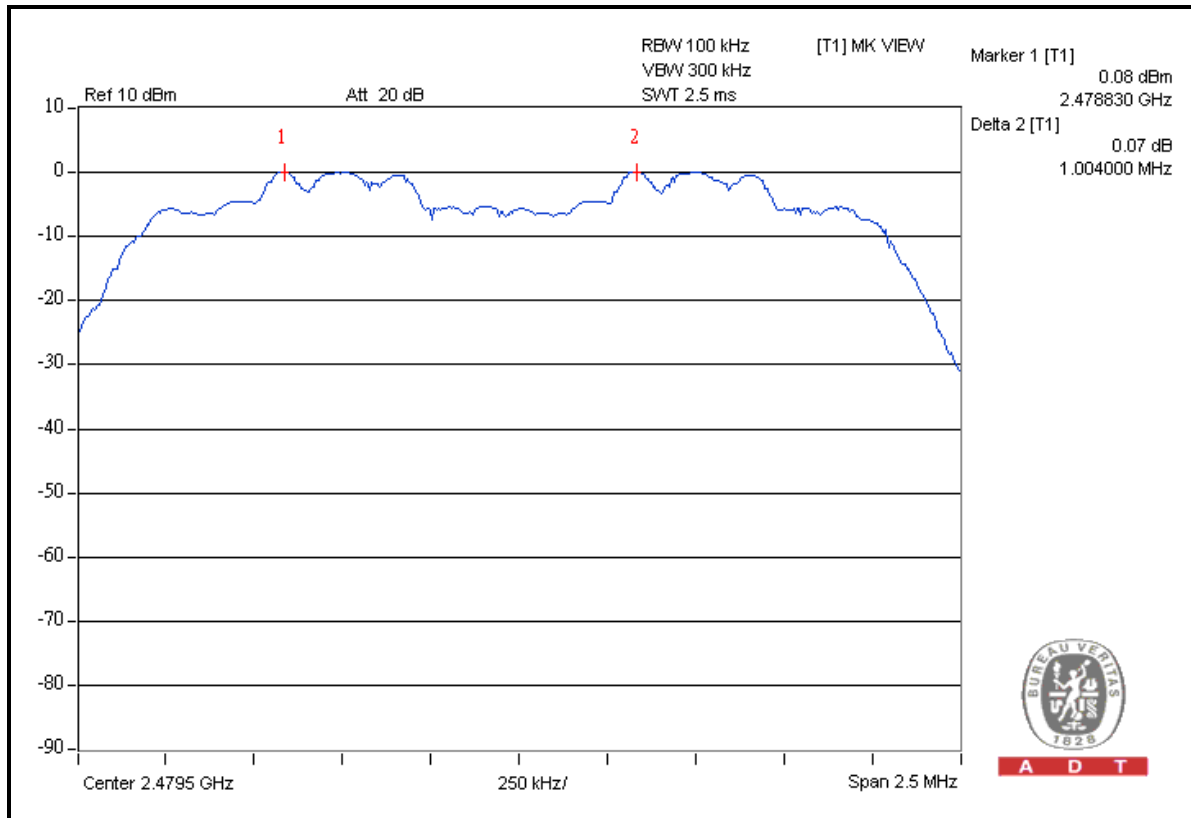



4.7 MAXIMUM PEAK OUTPUT POWER

4.7.1 LIMITS OF MAXIMUM PEAK OUTPUT POWER MEASUREMENT

The Maximum Peak Output Power Measurement is 125mW.

4.7.2 TEST INSTRUMENTS

DESCRIPTION & MANUFACTURER	MODEL NO.	SERIAL NO.	CALIBRATED DATE	CALIBRATED UNTIL
SPECTRUM ANALYZER	FSP 40	100036	Apr. 03, 2009	Apr. 02, 2010

NOTE: The calibration interval of the above test instruments is 12 months and the calibrations are traceable to NML/ROC and NIST/USA.

4.7.3 TEST PROCEDURES

- a. Check the calibration of the measuring instrument using either an internal calibrator or a known signal from an external generator.
- b. Turn on the EUT and connect it to measurement instrument. Then set it to any one convenient frequency within its operating range. Set a reference level on the measuring instrument equal to the highest peak value.
- c. The center frequency of the spectrum analyzer is set to the fundamental frequency and using 3MHz RBW and 10 MHz VBW.
- d. Measure the captured power within the band and recording the plot.
- e. Repeat above procedures until all frequencies required were complete.

4.7.4 DEVIATION FROM TEST STANDARD

No deviation

4.7.5 TEST SETUP

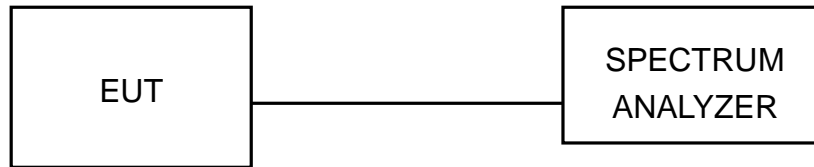

For the actual test configuration, please refer to the related Item – Photographs of the Test Configuration.

4.7.6 EUT OPERATING CONDITION

The software provided by client enabled the EUT to transmit and receive data at lowest, middle and highest channel frequencies individually.

4.7.7 TEST RESULTS

MODE A: FOR GFSK

CHANNEL	CHANNEL FREQUENCY (MHz)	PEAK POWER OUTPUT (dBm)	PEAK POWER OUTPUT (mW)	PEAK POWER LIMIT (mW)	PASS/FAIL
0	2402	5.0	3.2	125	PASS
39	2441	4.1	2.6	125	PASS
78	2480	3.0	2.0	125	PASS

CH 0

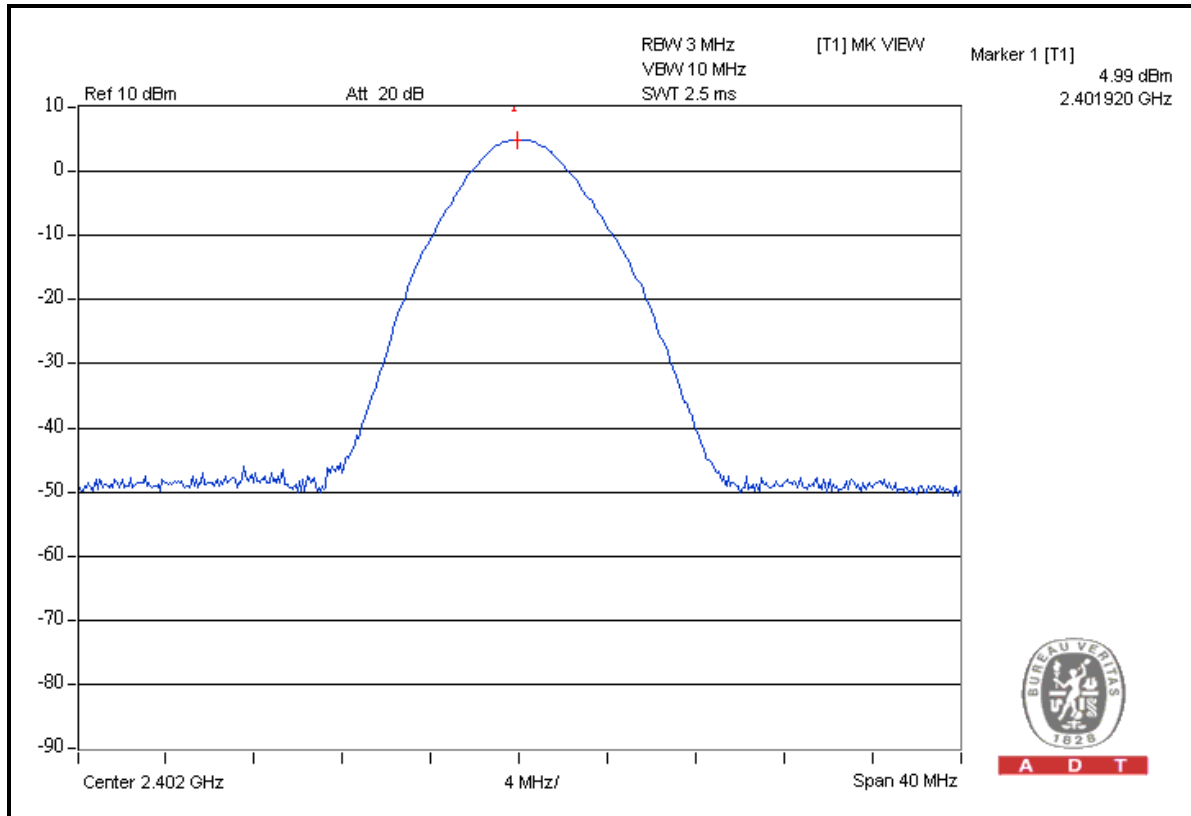



A D T

MODE A: FOR 8DPSK

CHANNEL	CHANNEL FREQUENCY (MHz)	PEAK POWER OUTPUT (dBm)	PEAK POWER OUTPUT (mW)	PEAK POWER LIMIT (mW)	PASS/FAIL
0	2402	3.4	2.2	125	PASS
39	2441	2.3	1.7	125	PASS
78	2480	1.0	1.3	125	PASS

CH 0

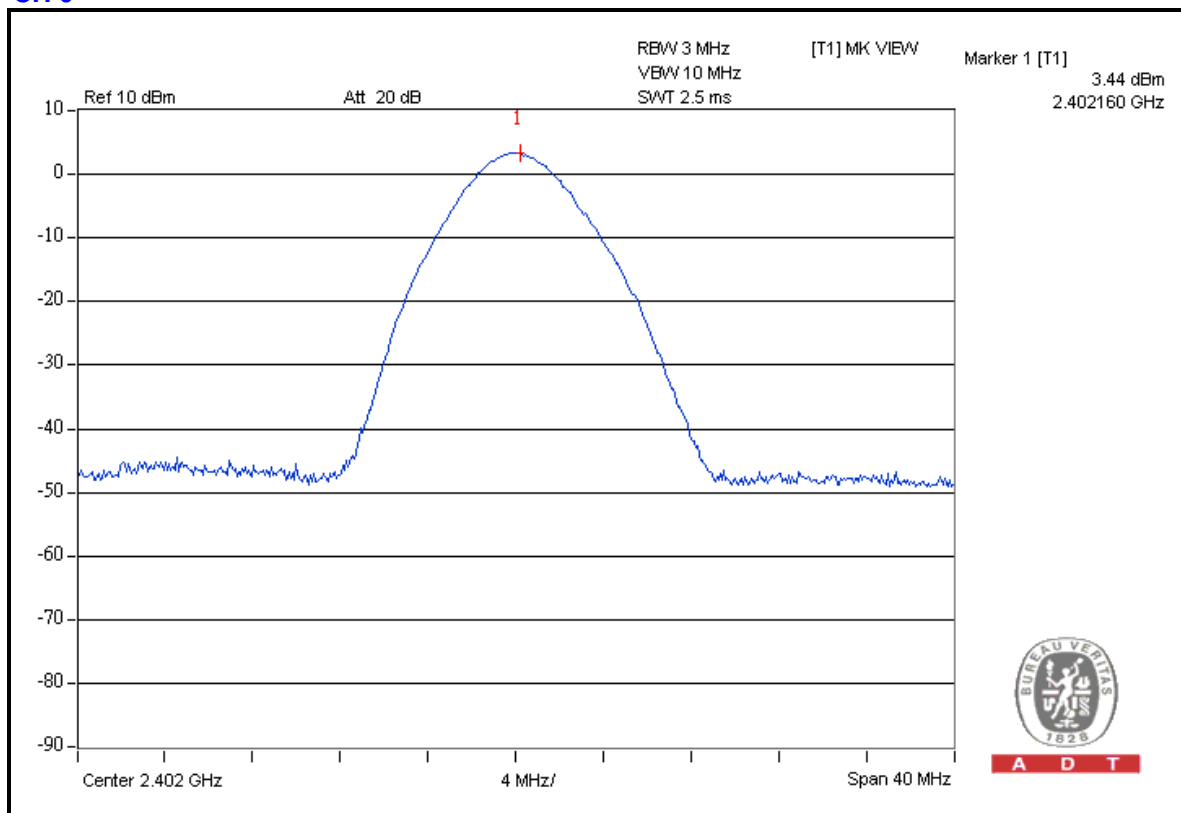

A D T



4.8 BAND EDGES MEASUREMENT

4.8.1 LIMITS OF BAND EDGES MEASUREMENT

Below -20dB of the highest emission level of operating band (in 100KHz RBW).

4.8.2 TEST INSTRUMENTS

DESCRIPTION & MANUFACTURER	MODEL NO.	SERIAL NO.	CALIBRATED DATE	CALIBRATED UNTIL
SPECTRUM ANALYZER	FSP 40	100036	Apr. 03, 2009	Apr. 02, 2010

NOTE: The calibration interval of the above test instruments is 12 months and the calibrations are traceable to NML/ROC and NIST/USA.

4.8.3 TEST PROCEDURE

The transmitter output was connected to the spectrum analyzer via a low lose cable. Set both RBW and VBW of spectrum analyzer to 100 kHz and 300 kHz with suitable frequency span including 100 MHz bandwidth from band edge. The band edges was measured and recorded.

The spectrum plots are attached on the following pages.

4.8.4 DEVIATION FROM TEST STANDARD

No deviation.

4.8.5 EUT OPERATING CONDITION

The software provided by client enabled the EUT to transmit and receive data at lowest, middle and highest channel frequencies individually.

4.8.6 TEST RESULTS

The spectrum plots are attached on the following 4 images. D1 line indicates the highest level, D2 line indicates the 20dB offset below D1. It shows compliance with the requirement in part 15.247(d).

MODE A: FOR GFSK

RESTRICT BAND (2310 ~ 2390 MHz)

FREQUENCY (MHz)	FUNDAMENTAL EMISSION (dBuV/m)	DELTA (dB)	MAXIMUM FIELD STRENGTH IN RESTRICT BAND (dBuV/m)	LIMIT (dBuV/m)
2402.00 (PK)	92.9	59.7	33.2	74.00
2402.00 (AV)	-	-	3.1	54.00

RESTRICT BAND (2483.5 ~ 2500 MHz)

FREQUENCY (MHz)	FUNDAMENTAL EMISSION (dBuV/m)	DELTA (dB)	MAXIMUM FIELD STRENGTH IN RESTRICT BAND (dBuV/m)	LIMIT (dBuV/m)
2480.00 (PK)	91.4	47.2	44.2	74.00
2480.00 (AV)	-	-	14.1	54.00

NOTE:

1. Delta = Amplitude between the peak of the fundamental and the peak of the band edge emission. Please check following 2 pages.
2. Maximum field strength in restrict band (PK value) = Fundamental emission (PK value) – Delta.
3. Average value = Peak value + 20 Log (duty cycle) = Peak value -30.1dB.
4. The DH5 packet was the worse case duty cycle for a transmit dwell time on a channel, based upon bluetooth theory the transmitter is on 0.625 * 5 per 296.25 ms per channel. Therefore, the duty cycle correlation factor be equal to: $20\log(3.125 / 100) = -30.1$ dB.



A D T

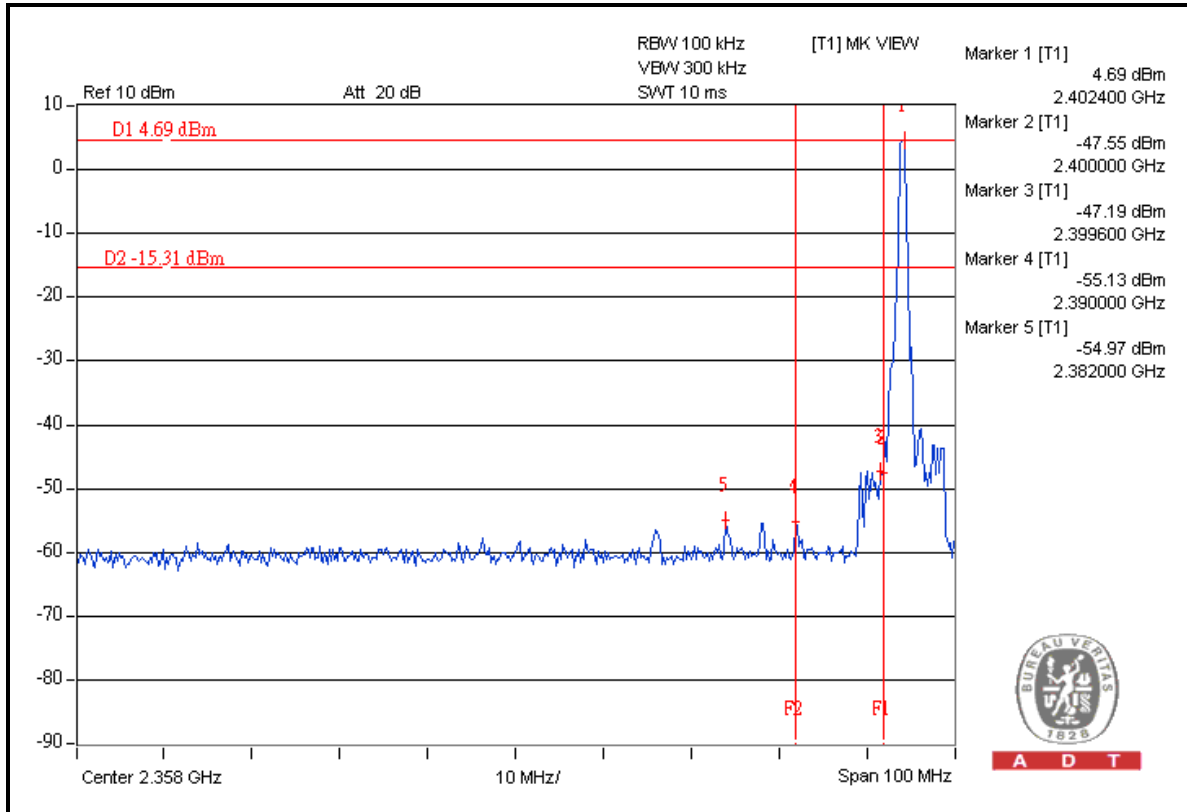

A D T

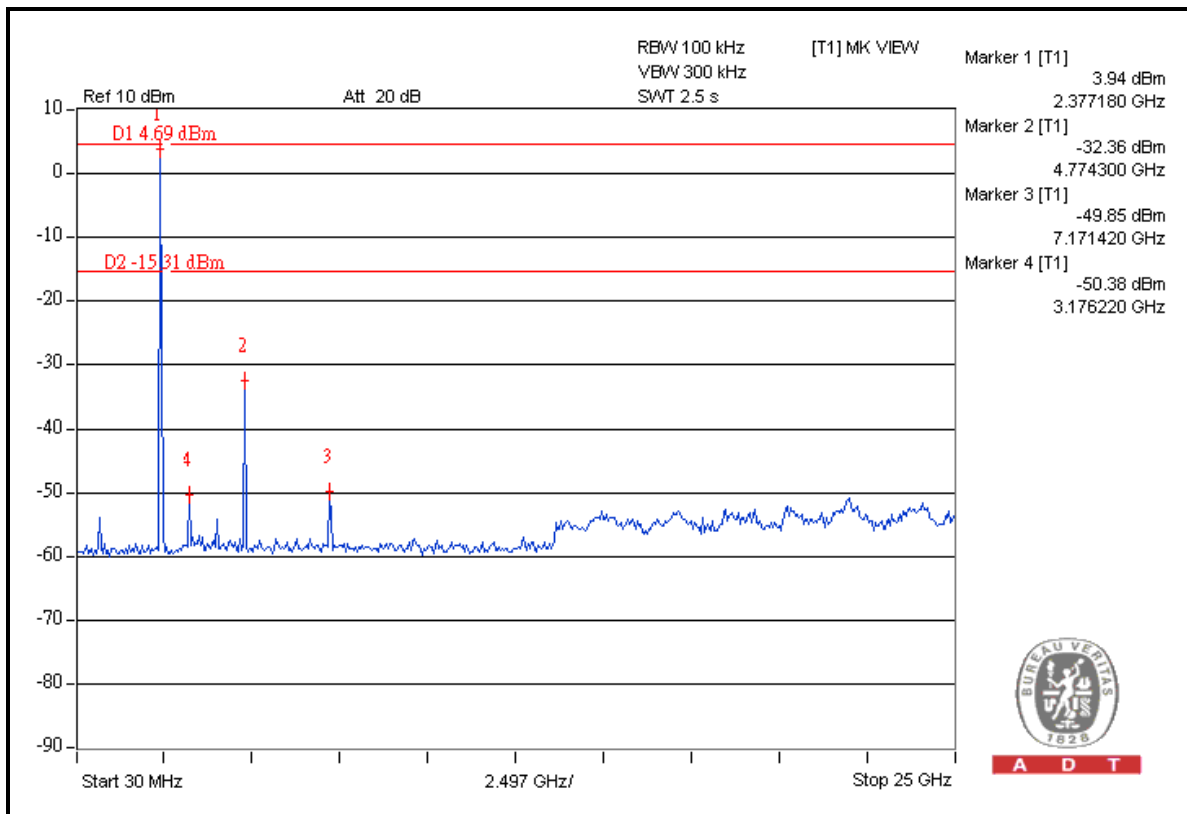

A D T



A D T

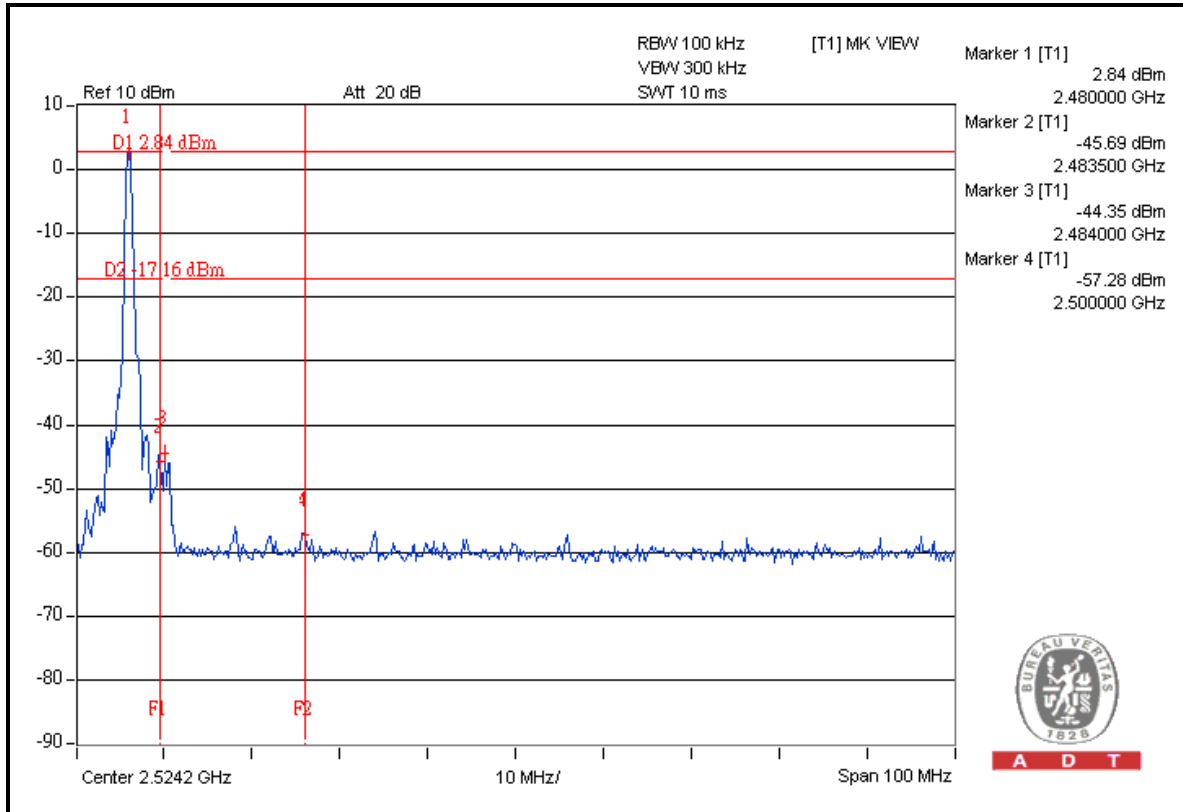

A D T

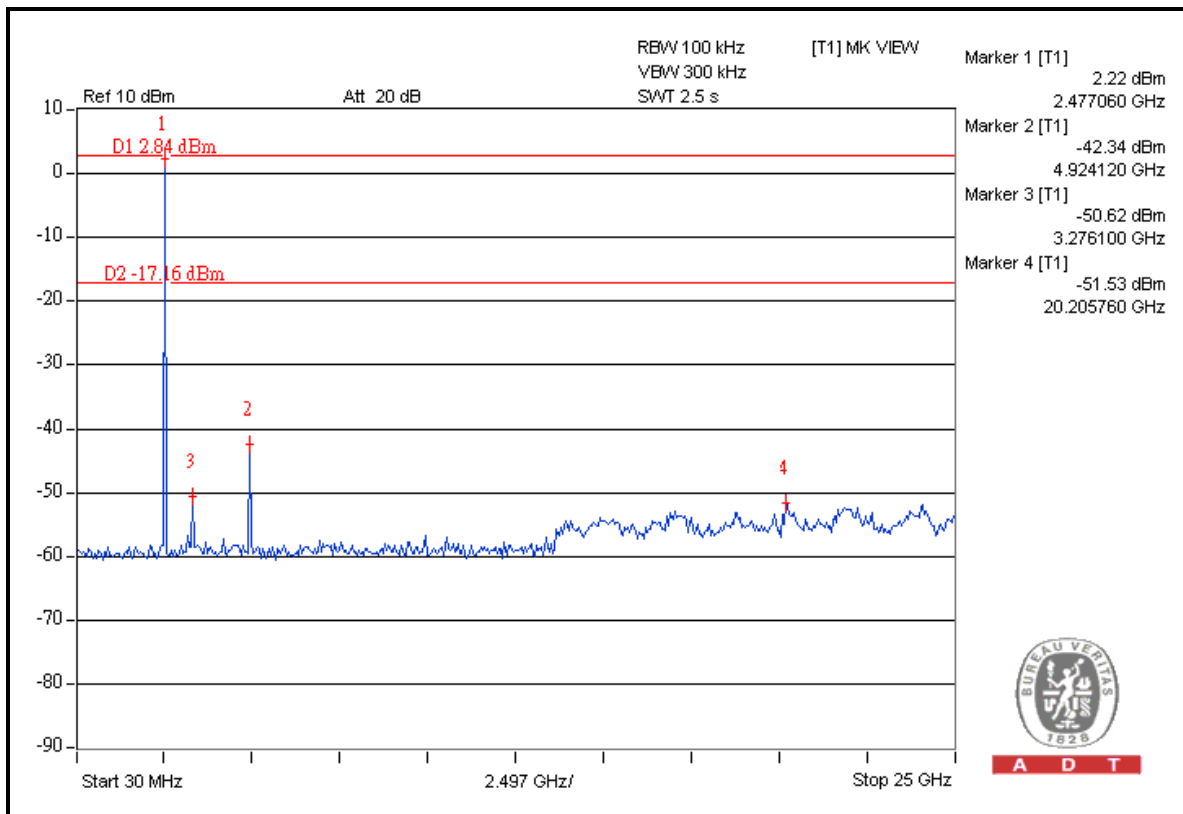

A D T

Mode A: FOR 8DPSK

RESTRICT BAND (2310 ~ 2390 MHz)

FREQUENCY (MHz)	FUNDAMENTAL EMISSION (dBuV/m)	DELTA (dB)	MAXIMUM FIELD STRENGTH IN RESTRICT BAND (dBuV/m)	LIMIT (dBuV/m)
2402.00 (PK)	93.3	56.4	36.9	74.00
2402.00 (AV)	-	-	6.8	54.00

RESTRICT BAND (2483.5 ~ 2500 MHz)

FREQUENCY (MHz)	FUNDAMENTAL EMISSION (dBuV/m)	DELTA (dB)	MAXIMUM FIELD STRENGTH IN RESTRICT BAND (dBuV/m)	LIMIT (dBuV/m)
2480.00 (PK)	89.0	47.1	41.9	74.00
2480.00 (AV)	-	-	11.8	54.00

NOTE:

1. Delta = Amplitude between the peak of the fundamental and the peak of the band edge emission. Please check following 2 pages.
2. Maximum field strength in restrict band (PK value) = Fundamental emission (PK value) – Delta.
3. Average value = Peak value + 20 Log (duty cycle) = Peak value -30.1dB.
4. The DH5 packet was the worse case duty cycle for a transmit dwell time on a channel, based upon bluetooth theory the transmitter is on $0.625 * 5$ per 296.25 ms per channel. Therefore, the duty cycle correlation factor be equal to: $20\log(3.125 / 100) = -30.1$ dB.



A D T

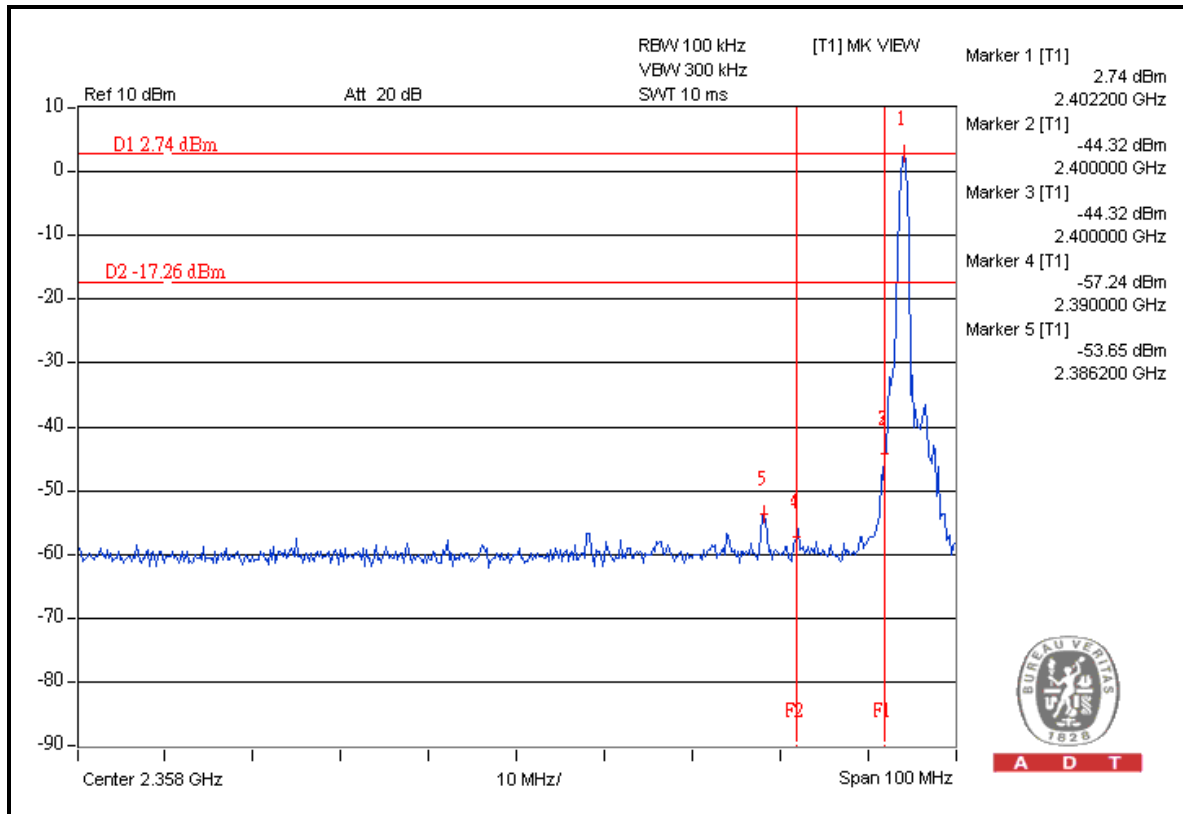

A D T

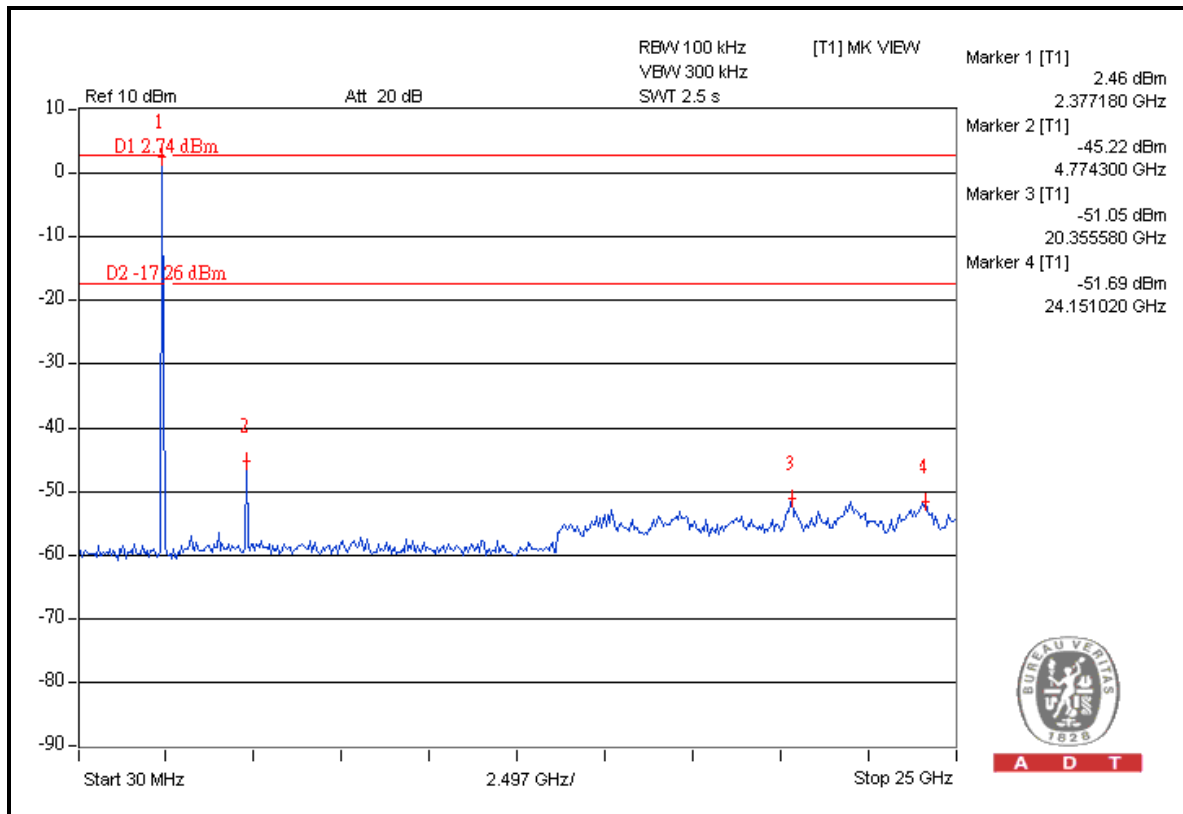

A D T



A D T

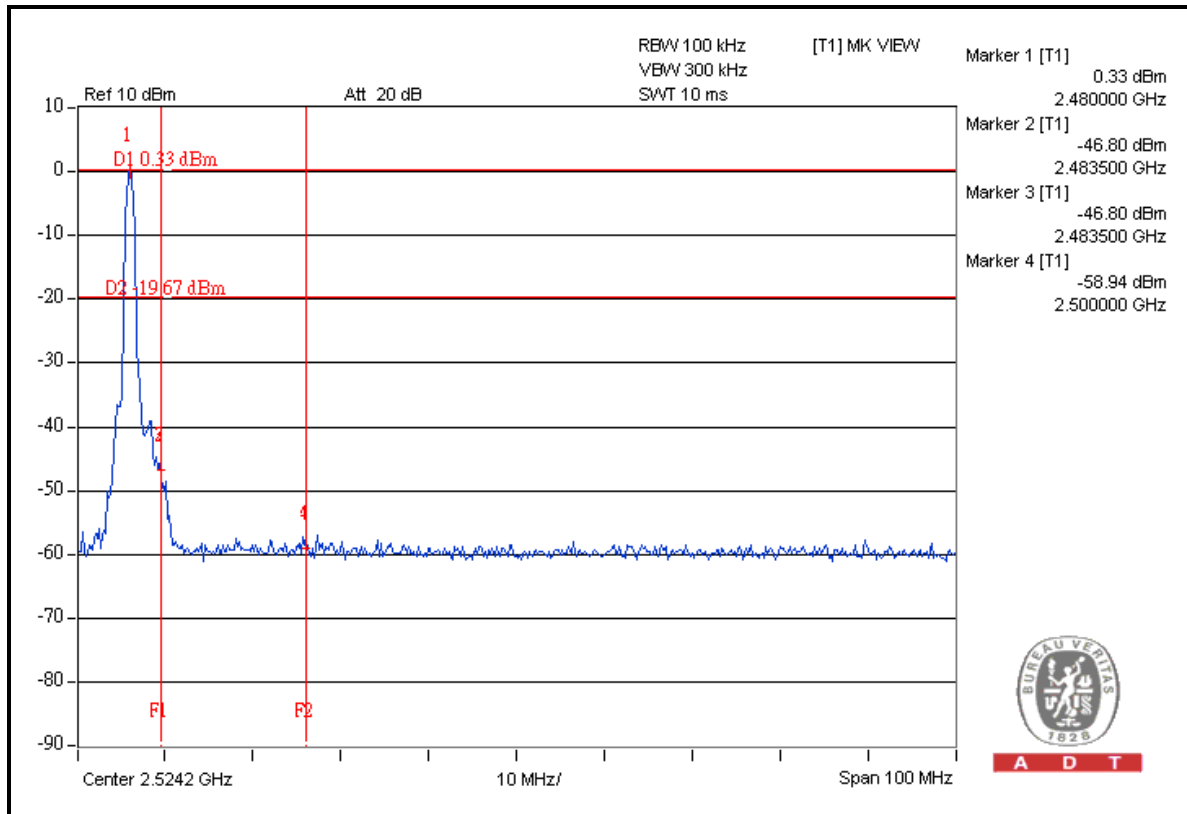

A D T

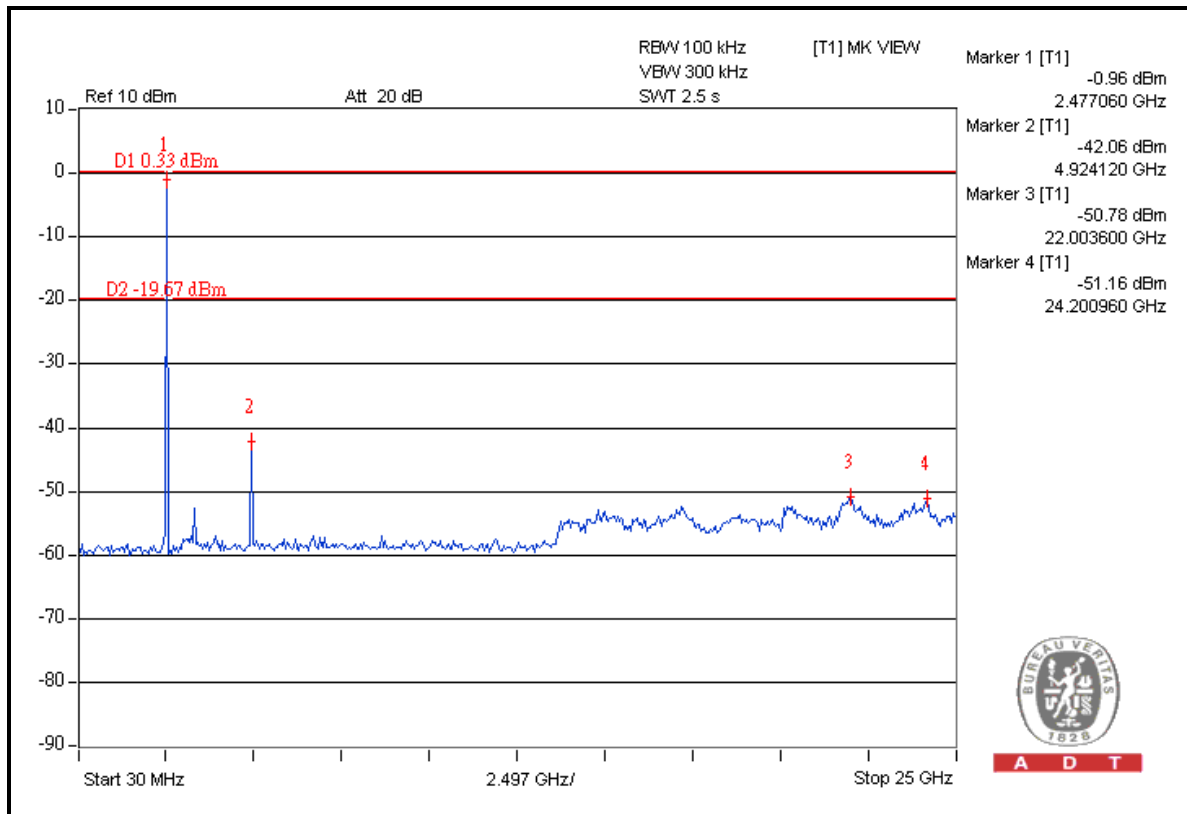

A D T

5. PHOTOGRAPHS OF THE TEST CONFIGURATION

Please refer to the attached file (Test Setup Photo).

6. INFORMATION ON THE TESTING LABORATORIES

We, Bureau Veritas Consumer Products Services (H.K.) Ltd., Taoyuan Branch, were founded in 1988 to provide our best service in EMC, Radio, Telecom and Safety consultation. Our laboratories are accredited and approved by the following approval agencies according to ISO/IEC 17025.

USA	FCC, NVLAP
Germany	TUV Rheinland
Japan	VCCI
Norway	NEMKO
Canada	INDUSTRY CANADA, CSA
R.O.C.	TAF, BSMI, NCC
Netherlands	Telefication
Singapore	GOST-ASIA (MOU)
Russia	CERTIS (MOU)

Copies of accreditation certificates of our laboratories obtained from approval agencies can be downloaded from our web site: www.adt.com.tw/index.5/phtml.
If you have any comments, please feel free to contact us at the following:

Linko EMC/RF Lab:
Tel: 886-2-26052180
Fax: 886-2-26051924

Hsin Chu EMC/RF Lab:
Tel: 886-3-5935343
Fax: 886-3-5935342

Hwa Ya EMC/RF/Safety Telecom Lab:
Tel: 886-3-3183232
Fax: 886-3-3185050

Web Site: www.adt.com.tw

The address and road map of all our labs can be found in our web site also.

7. APPENDIX A – MODIFICATIONS RECORDERS FOR ENGINEERING CHANGES TO THE EUT BY THE LAB

No any modifications are made to the EUT by the lab during the test.

---END---