



**CONFORMANCE TEST REPORT
FOR
FCC Part 15, subpart D (15.323c)**

Report No.: 11-01-MAS-196-01

Client: CCT Marketing, Ltd.
 Product: DECT 6.0 Cordless handset speakerphone answering system
 Model: 30529
 FCC ID: XYT30529

Manufacturer/supplier: Huiyang CCT Telecommunications Products Co. Ltd.

Date test item received: 2011/01/14
 Date test campaign completed: 2011/02/11
 Date of issue: 2011/02/18

The test result only corresponds to the tested sample. It is not permitted to copy this report, in part or in full, without the permission of the test laboratory.

Total number of pages of this test report: 40 pages



Test Engineer	Checked By	Approved By
 John Li	 James Cheng	 Joe Hsieh

Table of Contents Page

1 GENERAL INFORMATION	3
1.1 Testing Laboratory.....	3
1.2 Client Information.....	3
1.3 Manufacturer	3
2 TEST INFORMATION	4
2.1 Description of Tested Device(s)	4
2.2 Test Environment.....	4
3 TEST REPORT SUMMARY	5
3.1 Test Summary	5
3.2 Other Comments.....	6
4 TEST SETUP	7
4.1 Monitoring Tests.....	7
5 TEST EQUIPMENT LIST	8
6 TEST RESULT	9
6.1 Monitoring time.....	9
6.2 Monitoring threshold.....	10
6.3 Maximum transmit period	11
6.4 System Acknowledgement	13
6.5 Least Interfered Channel, LIC.....	錯誤! 尚未定義書籤。
6.6 Random waiting	錯誤! 尚未定義書籤。
6.7 Monitoring bandwidth and reaction time	錯誤! 尚未定義書籤。
6.8 Monitoring antenna.....	錯誤! 尚未定義書籤。
6.9 Monitoring threshold relaxation	錯誤! 尚未定義書籤。
6.10 Duplex system LBT	錯誤! 尚未定義書籤。
6.11 Co-located device LBT	錯誤! 尚未定義書籤。
6.12 Fair Access	錯誤! 尚未定義書籤。
APPENDIX1 MANUFACTURER DECLARATION	錯誤! 尚未定義書籤。

1 GENERAL INFORMATION

1.1 Testing Laboratory

Name: Electronic Testing Center, Taiwan
Address: No. 8, Lane 29, Wenming Rd., Leshan Tsuen, Guishan Shiang,
Taoyuan Country, 33383, Taiwan, R.O.C.
Telephone: 886-3-3280026
Fax: 886-3-3276188
NVLAP lab registration #: 200133-0
IC OATS registration #: IC 2949-1
E-Mail: hsieh@etc.org.tw

1.2 Client Information

Name: CCT Marketing, Ltd.
Address: 18/F, CCT Telecom Building, 11 Wo Shing Street, Fo Tan,
Shatin, N.T., Hong Kong

1.3 Manufacturer

Name: Huiyang CCT Telecommunications Products Co. Ltd.
Address: CCT Technology Park, San He Economic Developmental Zone,
Huiyang District, Huizhou City, Guangdong Province, PRC

2 TEST INFORMATION

2.1 Description of Tested Device(s)

The tested equipment is a DECT handset, which complies with ETSI EN 300175. The frequencies have been reprogrammed to comply with the FCC requirements to an Isochronous UPCS device after FCC Part 15D.

The EUT is an initiating device as described in ANSI C63.17 and is designed to operate together with a DECT base station, which is then the responding device.

Frequency Channel	Frequency	Test Frequency
CH4	1921.536 MHz	F _L
CH3	1923.264 MHz	-
CH2	1924.992 MHz	F _M
CH1	1926.720 MHz	-
CH0	1928.448 MHz	F _H

2.2 Test Environment

Normal test condition

Temperature:	20 - 25 °C
Relative humidity:	55 - 75%

3 TEST REPORT SUMMARY

3.1 Test Summary

Requirement	FCC Paragraph #	Required	Customer Declaration	Test Pass
Monitoring time	15.323(c)(1)	<input checked="" type="checkbox"/>	<input type="checkbox"/>	<input checked="" type="checkbox"/>
Monitoring threshold	15.323(c)(2)	<input checked="" type="checkbox"/>	<input checked="" type="checkbox"/>	<input type="checkbox"/>
Maximum transmit period	15.323(c)(3)	<input checked="" type="checkbox"/>	<input type="checkbox"/>	<input checked="" type="checkbox"/>
System acknowledgement	15.323(c)(4)	<input checked="" type="checkbox"/>	<input type="checkbox"/>	<input checked="" type="checkbox"/>
Least Interfered Channel, LIC	15.323(c)(5)	<input checked="" type="checkbox"/>	<input type="checkbox"/>	<input checked="" type="checkbox"/>
Random waiting	15.323(c)(6)	<input checked="" type="checkbox"/>	<input checked="" type="checkbox"/>	<input type="checkbox"/>
Monitoring bandwidth and reaction time	15.323(c)(7)	<input checked="" type="checkbox"/>	<input type="checkbox"/>	<input checked="" type="checkbox"/>
Monitoring antenna	15.323(c)(8)	<input checked="" type="checkbox"/>	<input checked="" type="checkbox"/>	<input type="checkbox"/>
Monitoring threshold relaxation	15.323(c)(9)	<input checked="" type="checkbox"/>	<input type="checkbox"/>	<input checked="" type="checkbox"/>
Duplex system LBT	15.323(c)(10)	<input checked="" type="checkbox"/>	<input checked="" type="checkbox"/>	<input type="checkbox"/>
Co-located device LBT	15.323(c)(11)	<input checked="" type="checkbox"/>	<input checked="" type="checkbox"/>	<input type="checkbox"/>
Fair access	15.323(c)(12)	<input checked="" type="checkbox"/>	<input checked="" type="checkbox"/>	<input type="checkbox"/>

3.2 Other Comments

All measurements are traceable to national standards.

The tests were conducted on a sample of the equipment for the purpose of demonstrating compliance with FCC CFR47 Part 15, Paragraph 15.323 for Isochronous UPCS Devices.

The conducted test methods have been in accordance with ANSI C63.17-1998 and ANSI C63.17-2006 Draft where applicable.

4 TEST SETUP

4.1 Monitoring Tests

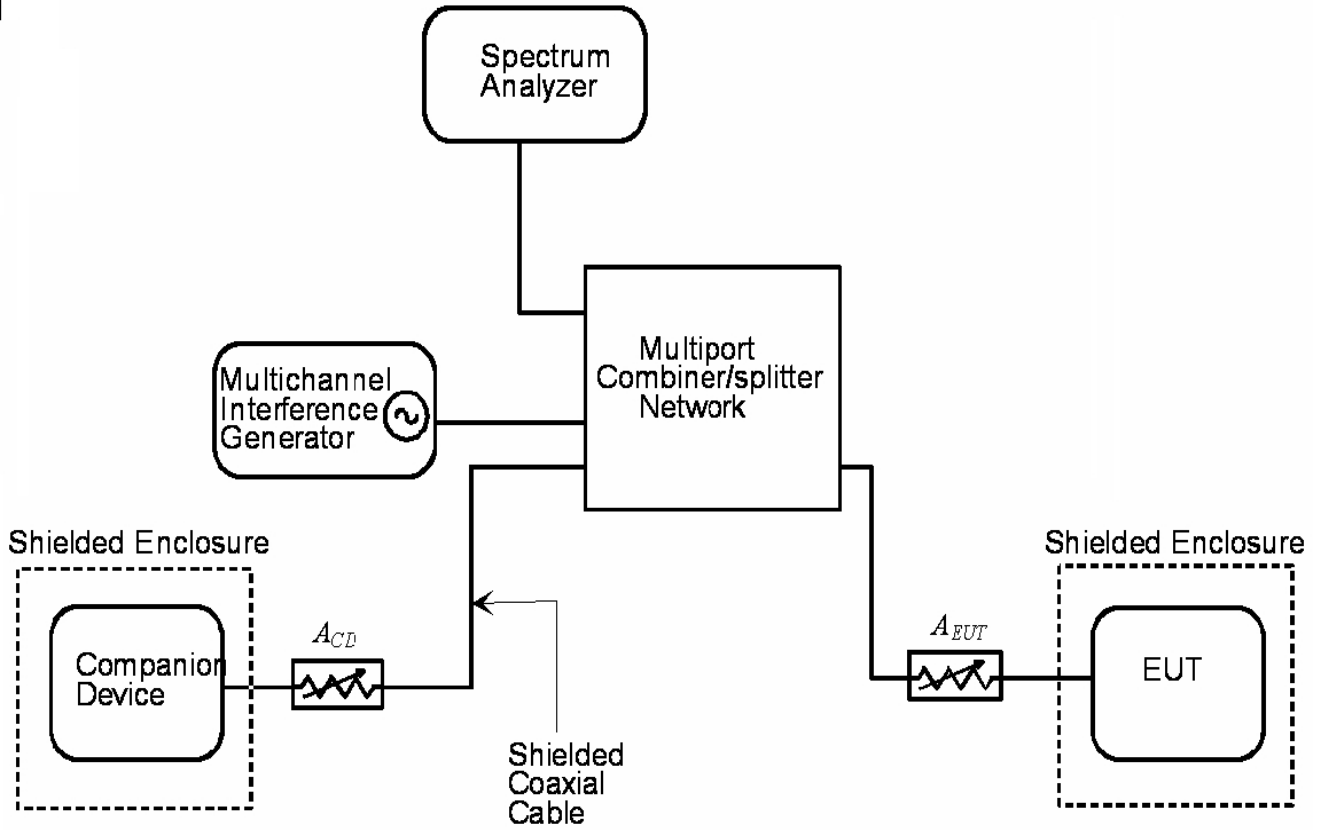

Test Set-Up 1

This test setup is used for all Monitoring and Time and Spectrum Access Procedure tests.

Companion Device	A _{CD} (dB)	EUT	A _{EUT} (dB)
Base	50	Handset	0
Handset	30	Base	0

5 TEST EQUIPMENT LIST

To facilitate inclusion on each page of the test equipment used for related tests, each item of test equipment and ancillaries are identified (numbered) by the Test Laboratory.

Equipment	Manufacturer	Model No.	Next Calibration Date (MM/DD/YY)
RF Downconverter	National Instruments	PXI-5600 (S/N: E35372)	02/23/2012
RF Downconverter	National Instruments	PXI-5600 (S/N: E224BD)	02/23/2012
64 MS/s Digitizer	National Instruments	PXI-5620 (S/N: E34BOB)	02/23/2012
64 MS/s Digitizer	National Instruments	PXI-5620 (S/N: E22946)	02/23/2012
100 MS/s AWG OSP	National Instruments	PXI-5441 (S/N: E32987)	02/23/2012
8-Bit 250 MS/s Digitizer	National Instruments	PXI-5114 (S/N: E41FBC)	02/23/2012
8-Bit 250 MS/s Digitizer	National Instruments	PXI-5114 (S/N: E41FBE)	02/23/2012
RF Upconverter	National Instruments	PXI-5610 (S/N: E4370F)	02/23/2012

6 TEST RESULT

6.1 Monitoring time

6.1.1 Standard Applicable: FCC 15.323(c)(1), RSS-213_4.3.4(b)(1)

Immediately prior to initiating transmission, devices must monitor the combined time and spectrum window in which they intend to transmit. For a period of at least 10 milliseconds for systems designed to use a 10 millisecond or shorter frame period or at least 20 milliseconds for systems designed to use a 20 millisecond frame period.

6.1.2 Measurement procedure

Measurement method according to ANSI C63.17 2006 paragraph 7.3.4

6.1.3 Results: Complies

EUT monitors the combined time and spectrum window prior to initiation of transmission.

Measurement Data:

This requirement is covered by results of Least Interfered Channel (LIC) test according to FCC 15.323(c) (5)	<input checked="" type="checkbox"/>
--	-------------------------------------

6.2 Monitoring threshold

6.2.1 Standard Applicable: FCC 15.323(c)(2), RSS-213_4.3.4(b)(2)

The monitoring threshold must not be more than 30 dB above the thermal noise power for a bandwidth equivalent to the emission bandwidth of the device.

6.2.2 Measurement procedure

Measurement method according to ANSI C63.17 2006 paragraph 7.3.1

6.2.3 Result: Not applicable

6.3 Maximum transmit period

6.3.1 Standard Applicable: FCC 15.323(C)(3), RSS-213_4.3.4(b)(3)

Occupation of the same combined time and spectrum windows by a device or group of cooperating devices continuously over a period of time longer than 8 hours is not permitted without repeating the access criteria.

6.3.2 Measurement procedure

Measurement method according to ANSI C63.17 2006 paragraph 8.2.2

6.3.3 Test Results: Complies

Measurement Data:

	Observation	Limit
Maximum transmission time	5 hours 44 minutes	8 hours

Start to transmission time and Cease of transmission time:

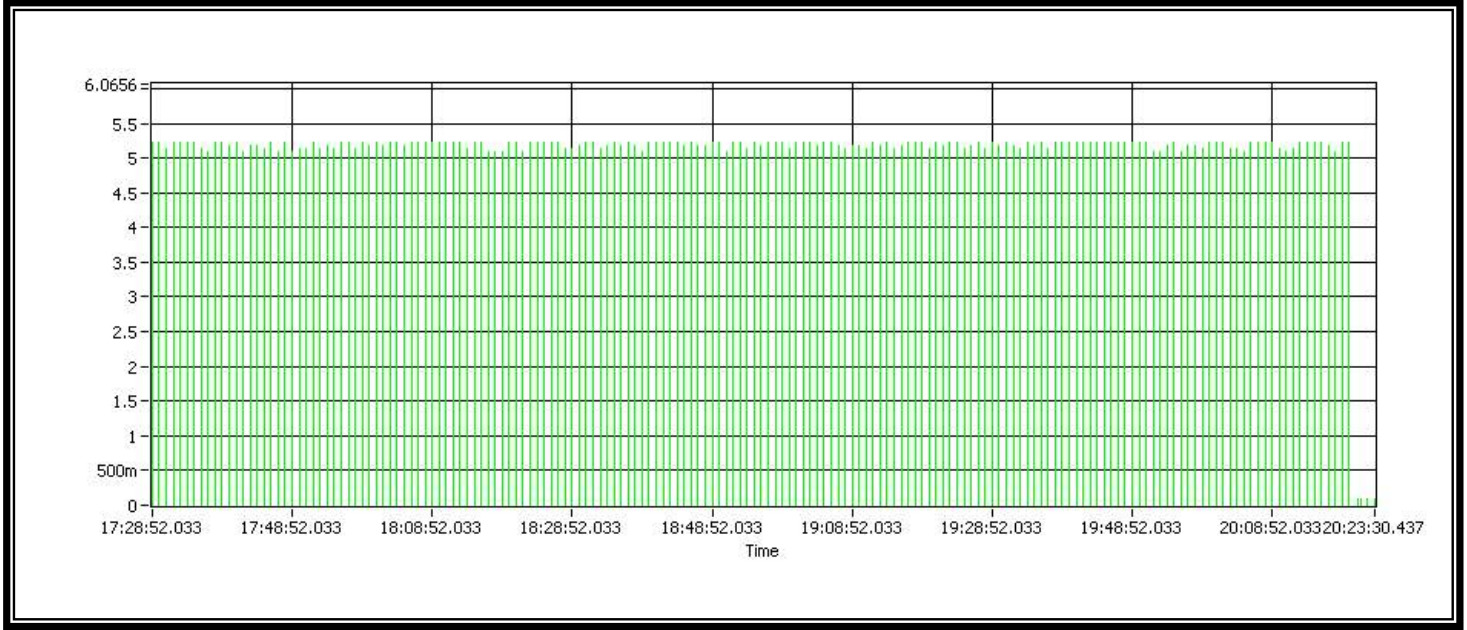

6.4 System Acknowledgement

6.4.1 Standard Applicable: FCC 15.323(c)(4), RSS-213_4.3.4(b)(4)

Once access to specific combined time and spectrum windows is obtained an acknowledgement from a system participant must be received by the initiating transmitter within one second or transmission must cease. Periodic acknowledgements must be received at least every 30 seconds or transmission must cease. Channels used exclusively for control and signaling information may transmit continuously for 30 seconds without receiving an acknowledgement, at which time the access criteria must be repeated.

6.4.2 Measurement procedure

Measurement method according to ANSI C63.17 2006 paragraph 8

6.4.3 Results: Complies

Measurement Data

Unacknowledged transmission:

Limit:

Requirement	Value
Change of access criteria for control information	30 s
Pause length	> 10 ms
Change of access channel	mandatory

Result:

Requirement	Time	Verdict
Change of access criteria for control information	----	n.a.
Pause length	----	n.a.
Change of access channel	----	n.a.

Connection acknowledgement:

Limit:

Requirement	Value
Connection acknowledgement	1 s
Termination of transmission	30 s

Result:

Requirement	Time observed	Verdict
Connection acknowledgement	5 ms	Pass
Termination of transmission	5.02 s	Pass

Comment: Connection acknowledgement

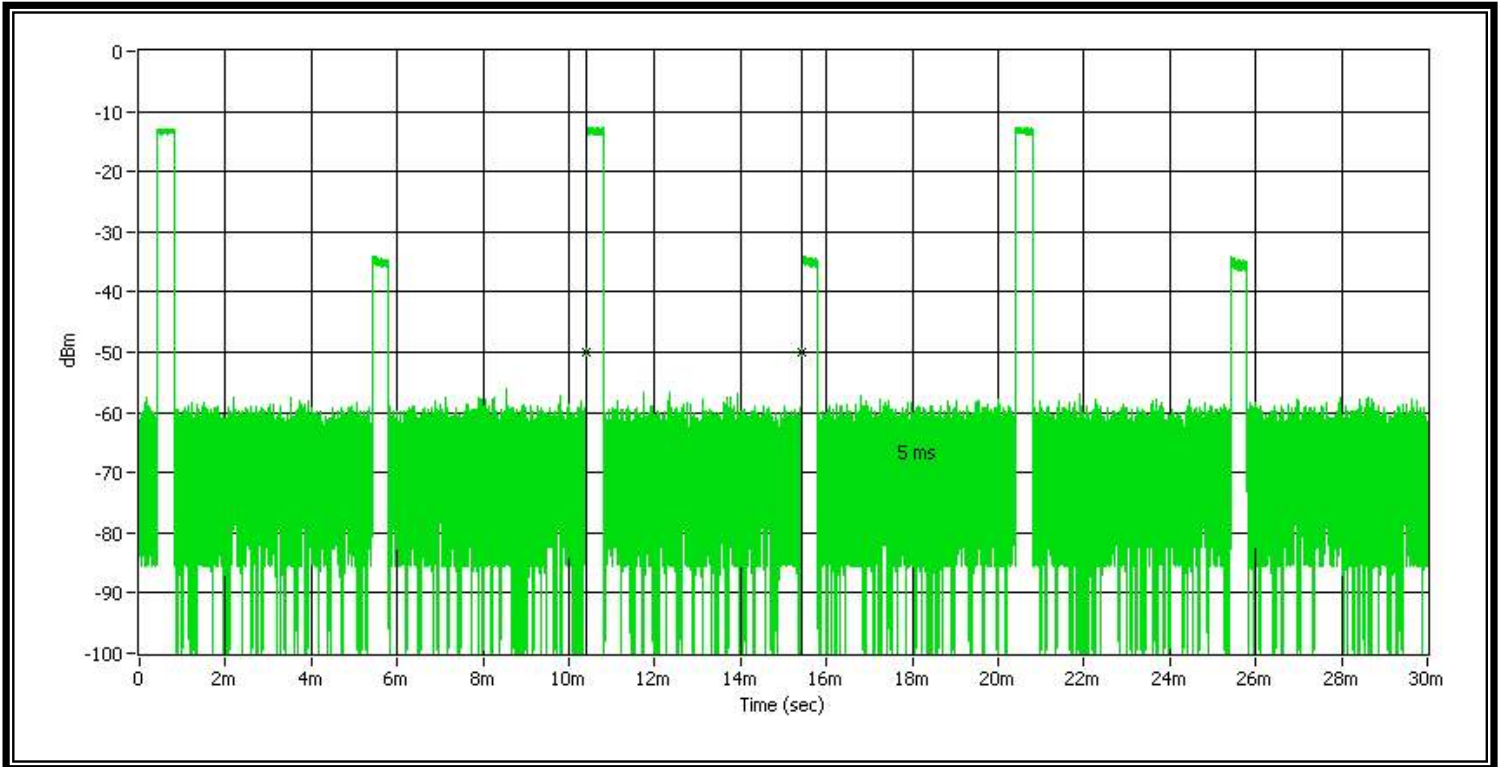

Comment: Connection acknowledgement

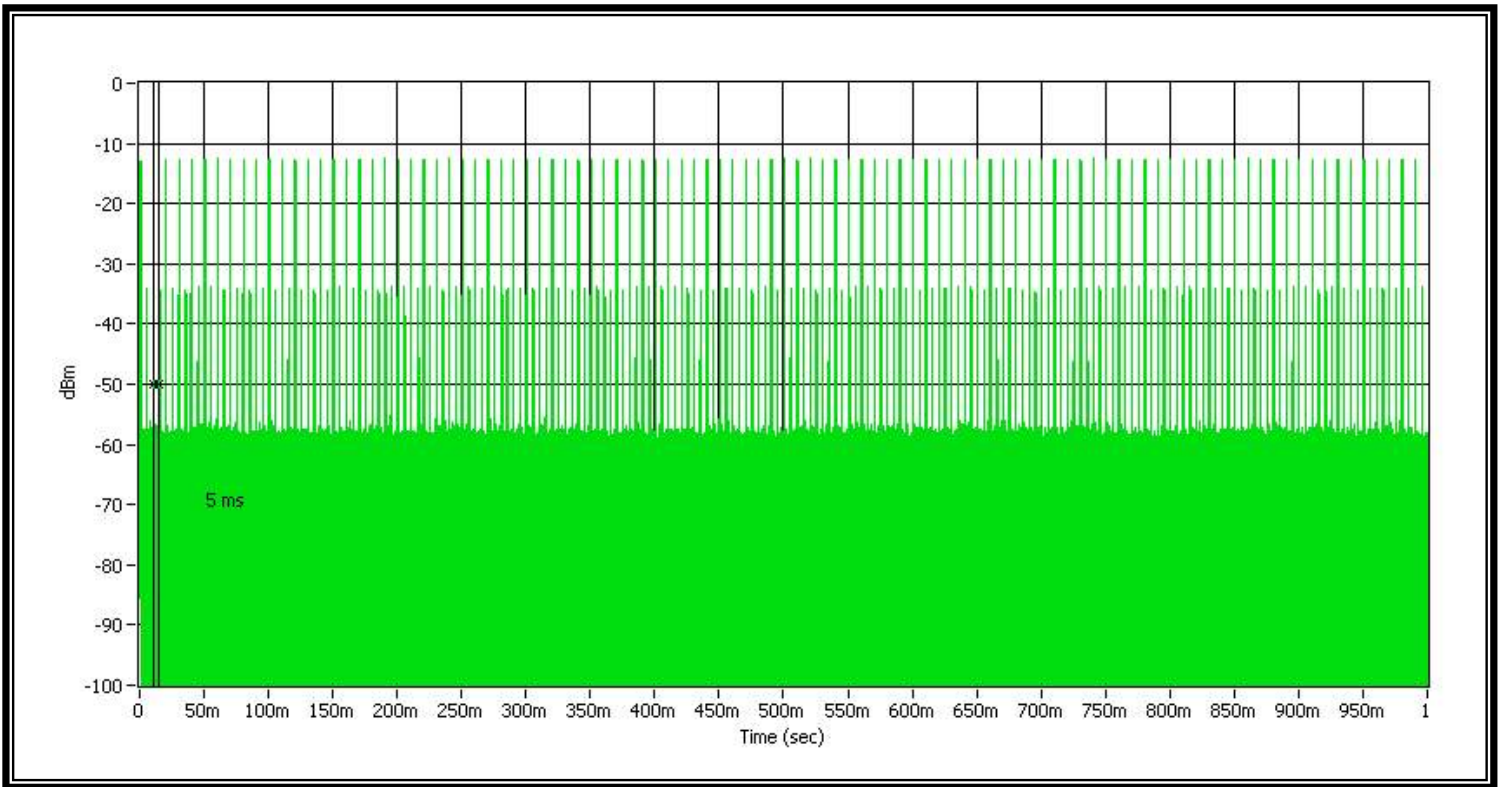

Comment: Termination of transmission

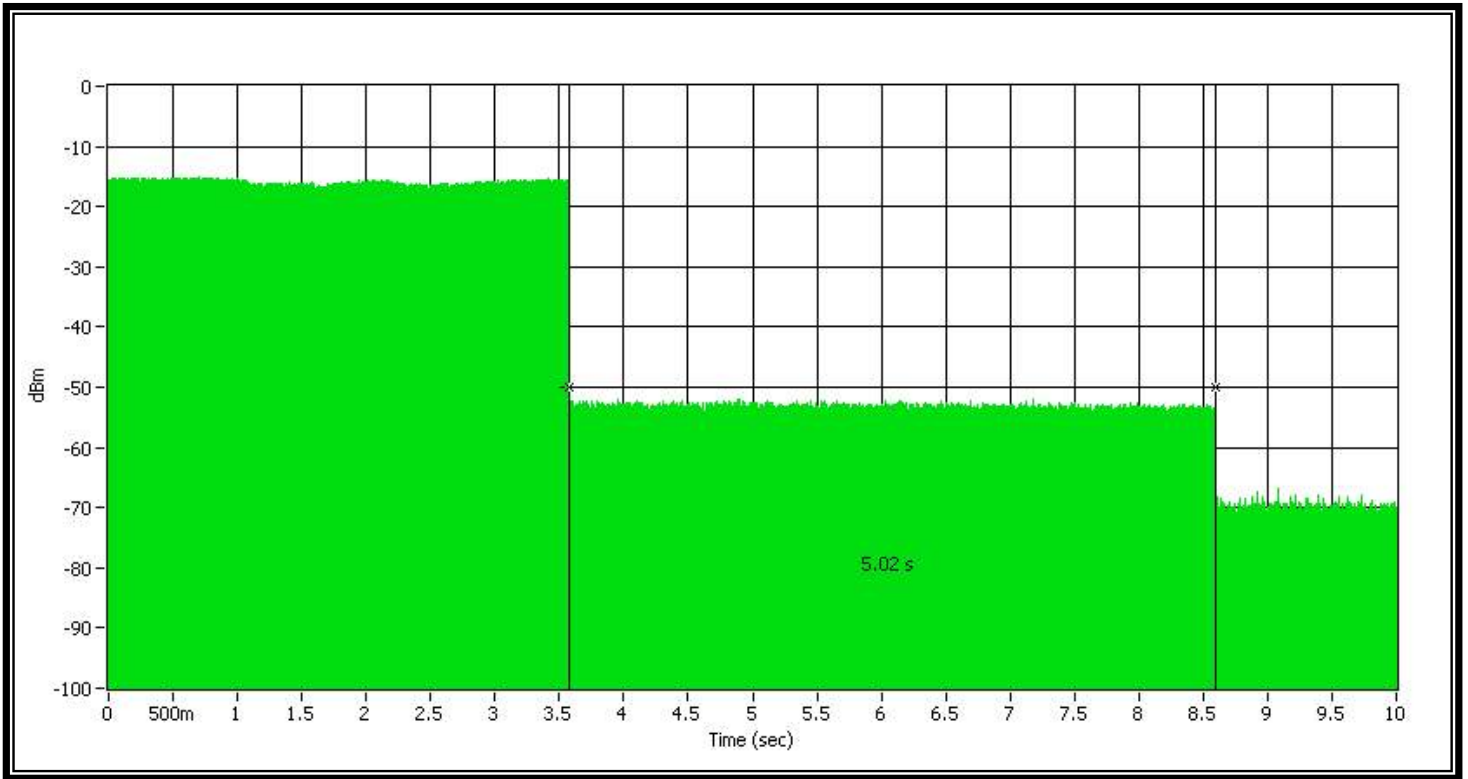

6.5 Least Interfered Channel, LIC

6.5.1 Standard Applicable: FCC 15.323(c)(5), RSS-213_4.3.4(b)(5)

If a minimum of 40 duplex system access channels are defined, the system must have monitored all access channels defined for its system within the last 10 seconds and must verify, within the 20 milliseconds (40 milliseconds for devices designed to use a 20 milliseconds frame period) immediately preceding actual channel access that the detected power of the selected time and spectrum windows is no higher than the previously detected value. The power measurement resolution for this comparison must be accurate within 6 dB. No device or group of co-operating devices located within 1 meter of each other shall during any frame period occupy more than 6 MHz of aggregate band width, or alternatively, more than one third of the time and spectrum windows defined by the system.

6.5.2 Measurement procedure

Measurement method according to ANSI C63.17 2006 paragraph 7.3.2, 7.3.3, 7.3.4

6.5.3 Results: Complies

Measurement Data

Calculation of monitoring threshold limits:

Lower threshold: $T_L = 15 \log_{10} B - 184 + 30 - P$ (dBm)

Upper threshold: $T_U = 15 \log_{10} B - 184 + 50 - P$ (dBm)

B = emission bandwidth (Hz)

P = peak transmit power (dBm)

Calculated thresholds:

TL: Lower threshold (dBm)	-79.0
Tu: Upper threshold (dBm)	-59.0

Limit:

Used results	Emission bandwidth (MHz)	1.43
	Peak transmit power (dBm)	17.37
Limits	$T_{LR} \leq T_L + U_M = -79.0 + 6 = -73.0$ (dBm)	
	$T_{UR} \leq T_U + U_M = -59.0 + 6 = -53.0$ (dBm)	

Result:

Least interfered channel	Pass
TLR: Lower threshold (dBm)	n.a.
TUR: Upper threshold (dBm)	-72.0

Note 1: The upper threshold is applicable for systems which have defined a minimum of 40 duplex system access channels.

Note 2: f1=1921.536 MHz, f2=1928.448 MHz

Comment: 7.3.2, initial setup

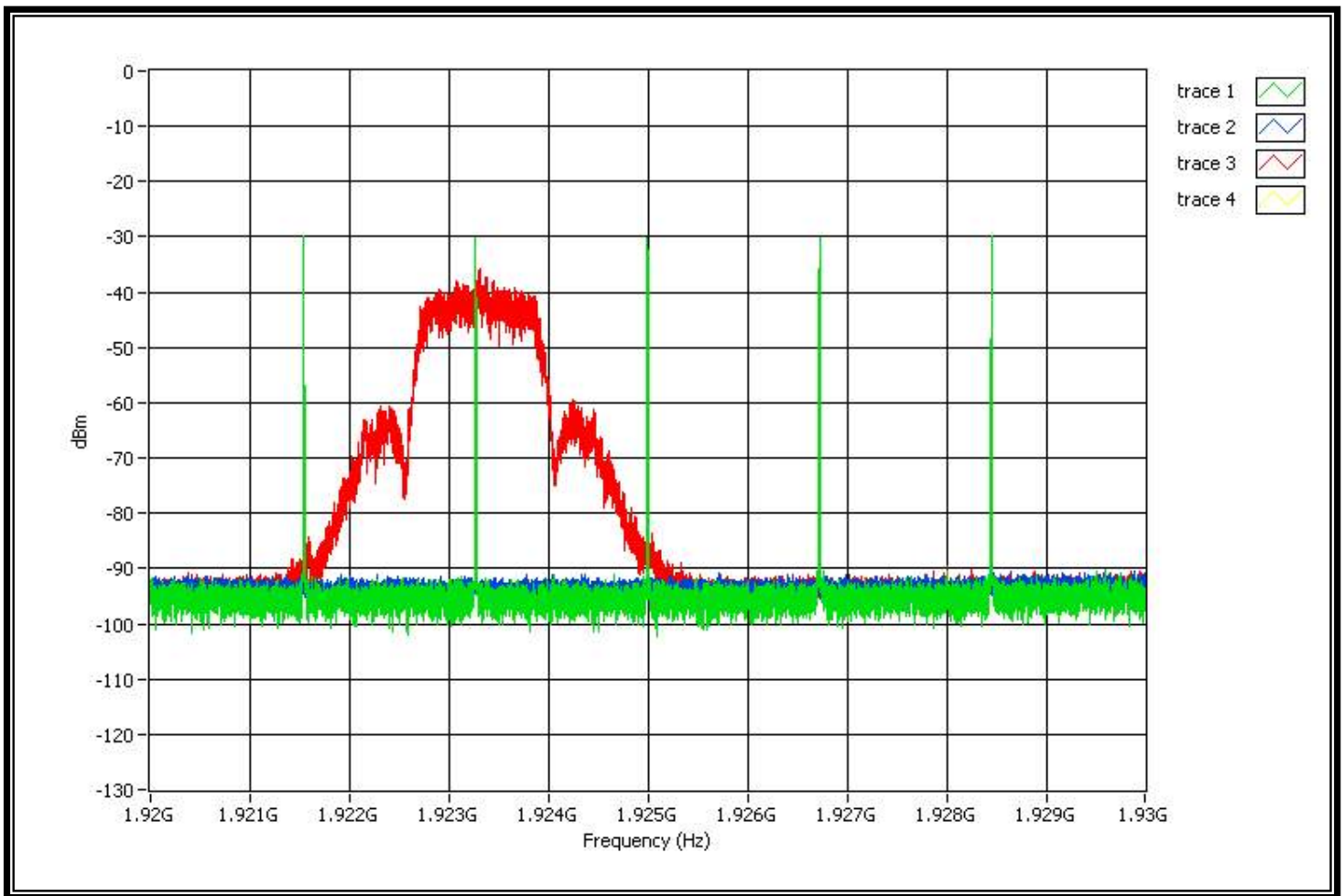

Note1: Trace1 (green) is the interference on all 5 carriers. The level is $T_U+U_M+10\text{dB}$.

Note2: Trace2 (blue) is interference on all 5 carriers. The level is T_{UR} .

Note3: Trace3 (Red) is the EUT begins to transmit the beacon when interference is T_{UR} .

Note: 7.3.2 (zoom in)

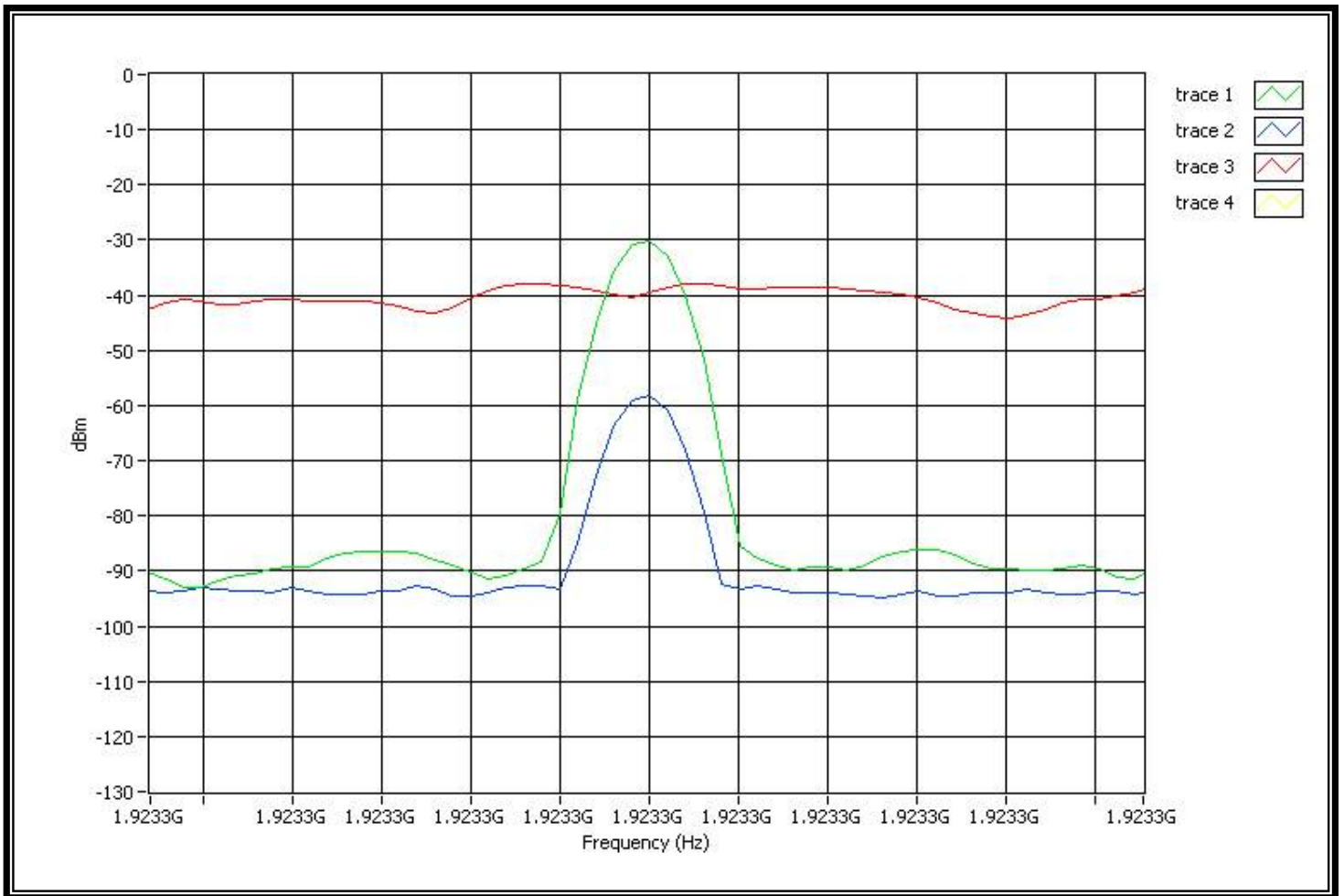

Note1: Trace1 (green) is the interference on all 5 carriers. The level is $T_U + U_M + 10\text{dB}$.

Note2: Trace2 (blue) is interference on all 5 carriers. The level is T_{UR} .

Note3: Trace3 (Red) is the EUT begins to transmit the beacon when interference level is T_{UR} .

Note: 7.3.3b

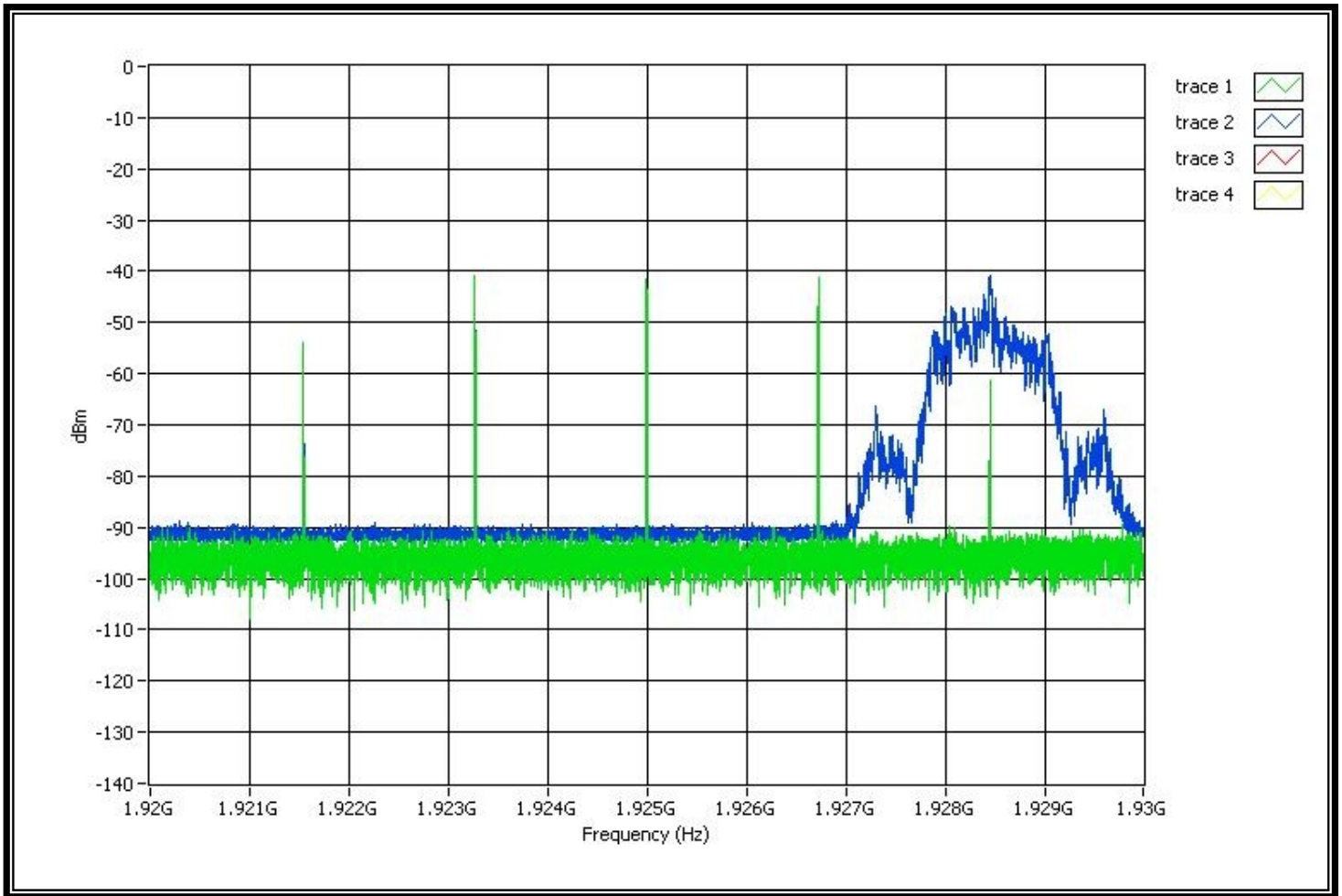

Note1: Trace1 (green) shows the interference profile.

Note2: Trace2 (blue) shows the EUT transmissions are occurring.

Note3: The EUT always transmits on f2 (the carrier with the lower interference level) and so meets the requirement.

Note: 7.3.3c

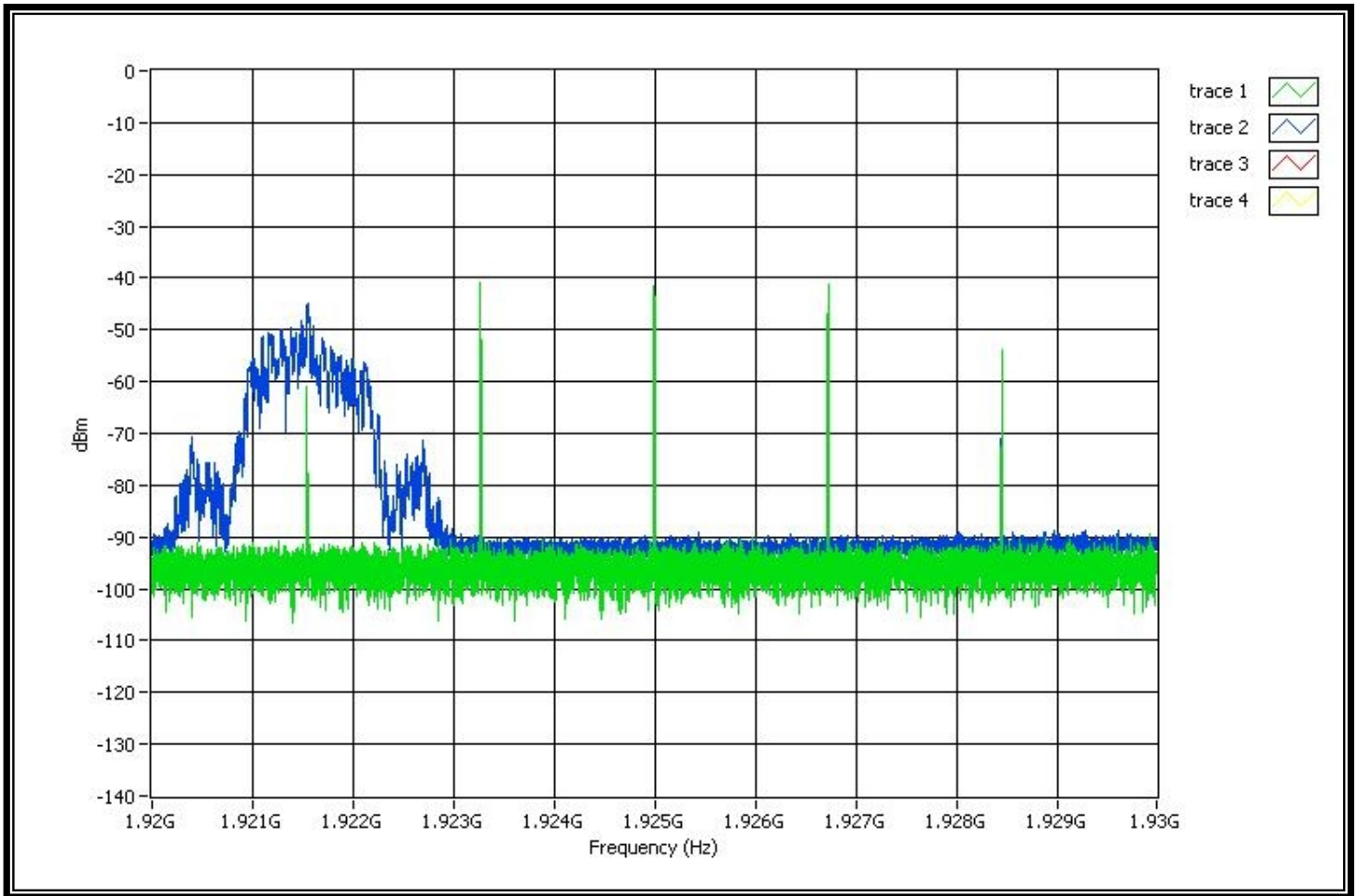

Note1: Trace1 (green) shows the interference profile.

Note2: Trace2 (blue) shows the EUT transmissions are occurring.

Note3: The EUT always transmits on f1 (the carrier with the lower interference level) and so meets the requirement.

Note: 7.3.3d

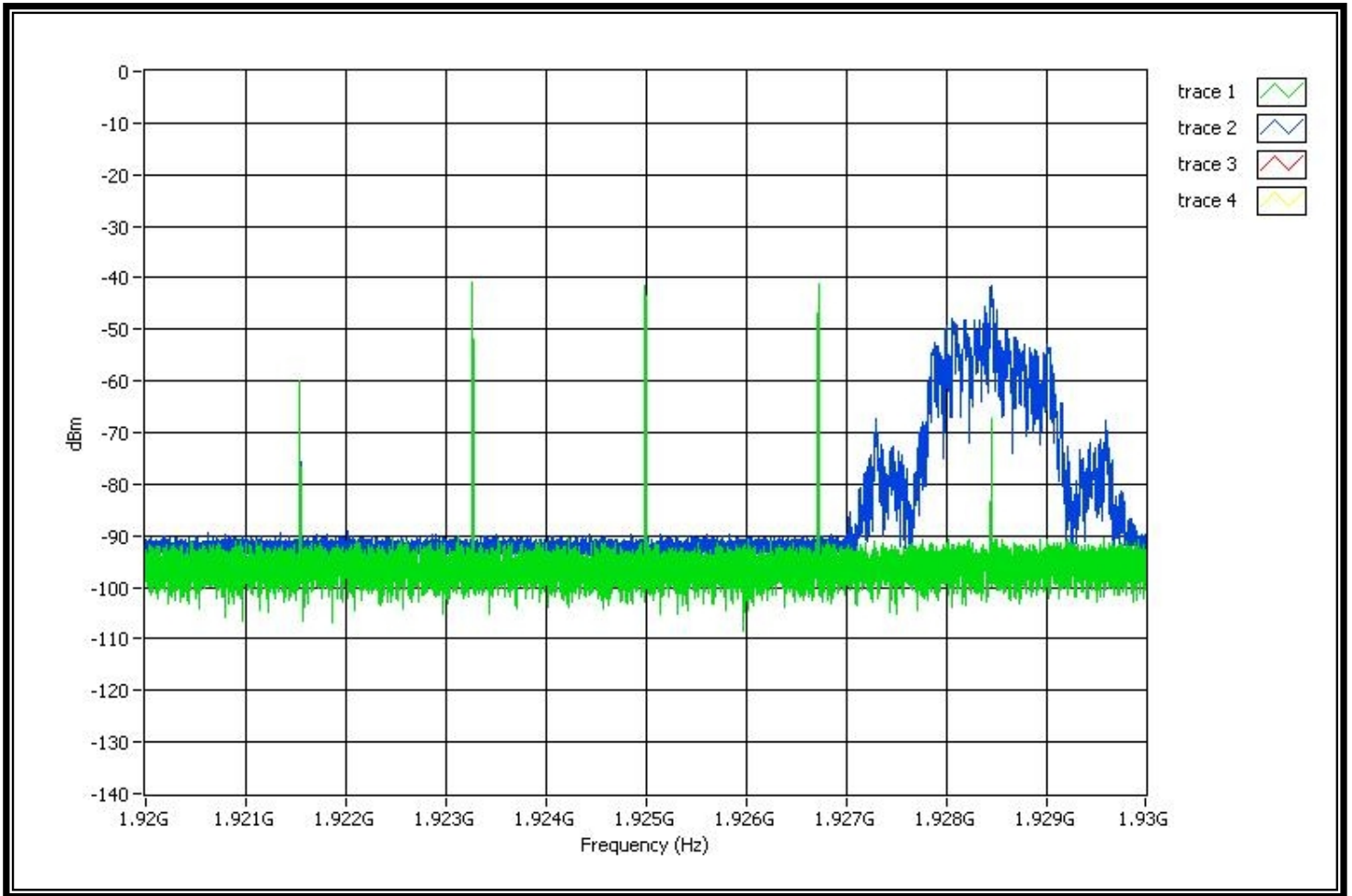

Note1: Trace1 (green) shows the interference profile.

Note2: Trace2 (blue) shows the EUT transmissions are occurring.

Note3: The EUT always transmits on f2 (the carrier with the lower interference level) and so meets the requirement.

Note: 7.3.3e

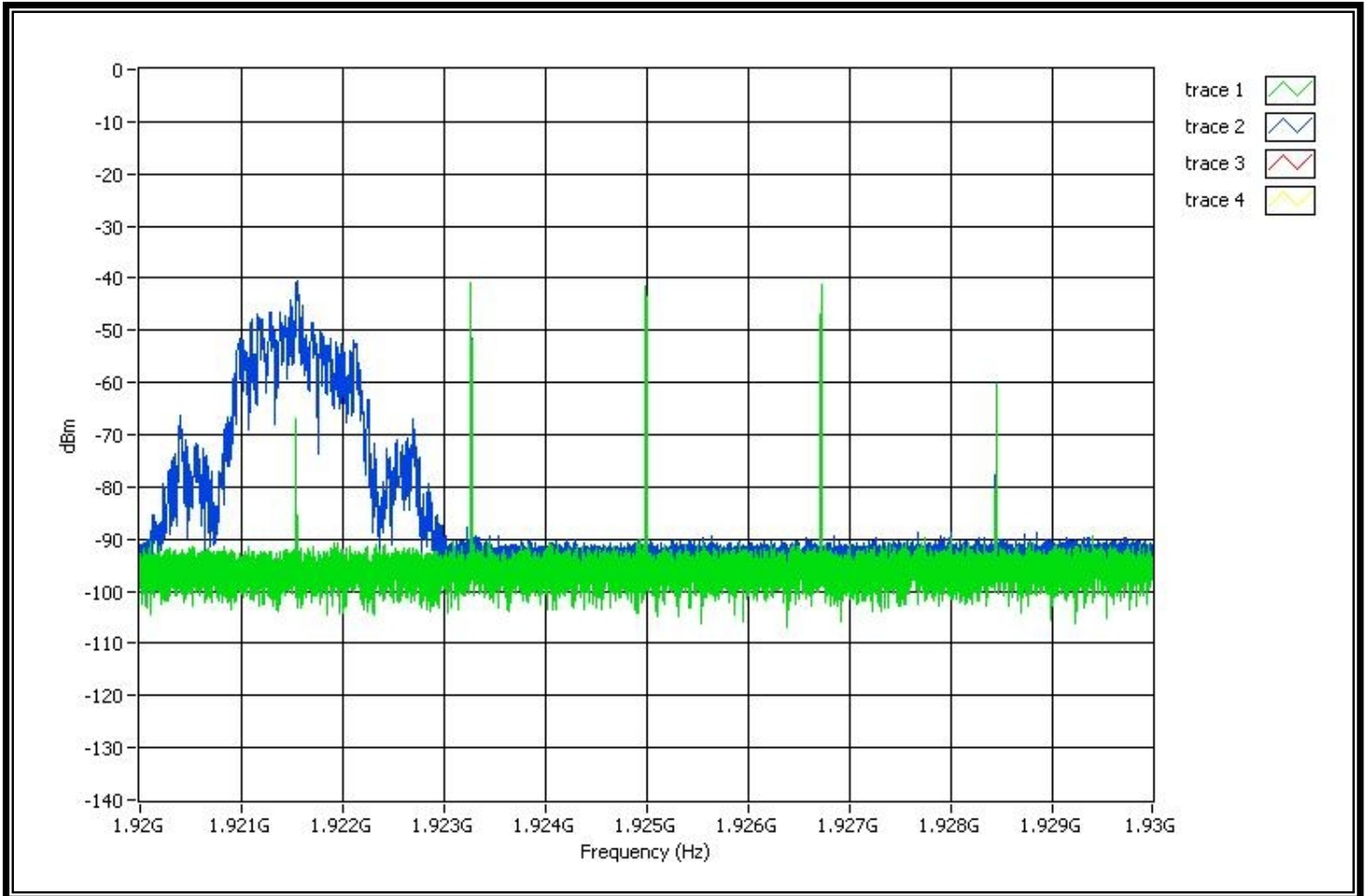

Note1: Trace1 (green) shows the interference profile.

Note2: Trace2 (blue) shows the EUT transmissions are occurring.

Note3: The EUT always transmits on f1 (the carrier with the lower interference level) and so meets the requirement.

Note: 7.3.4

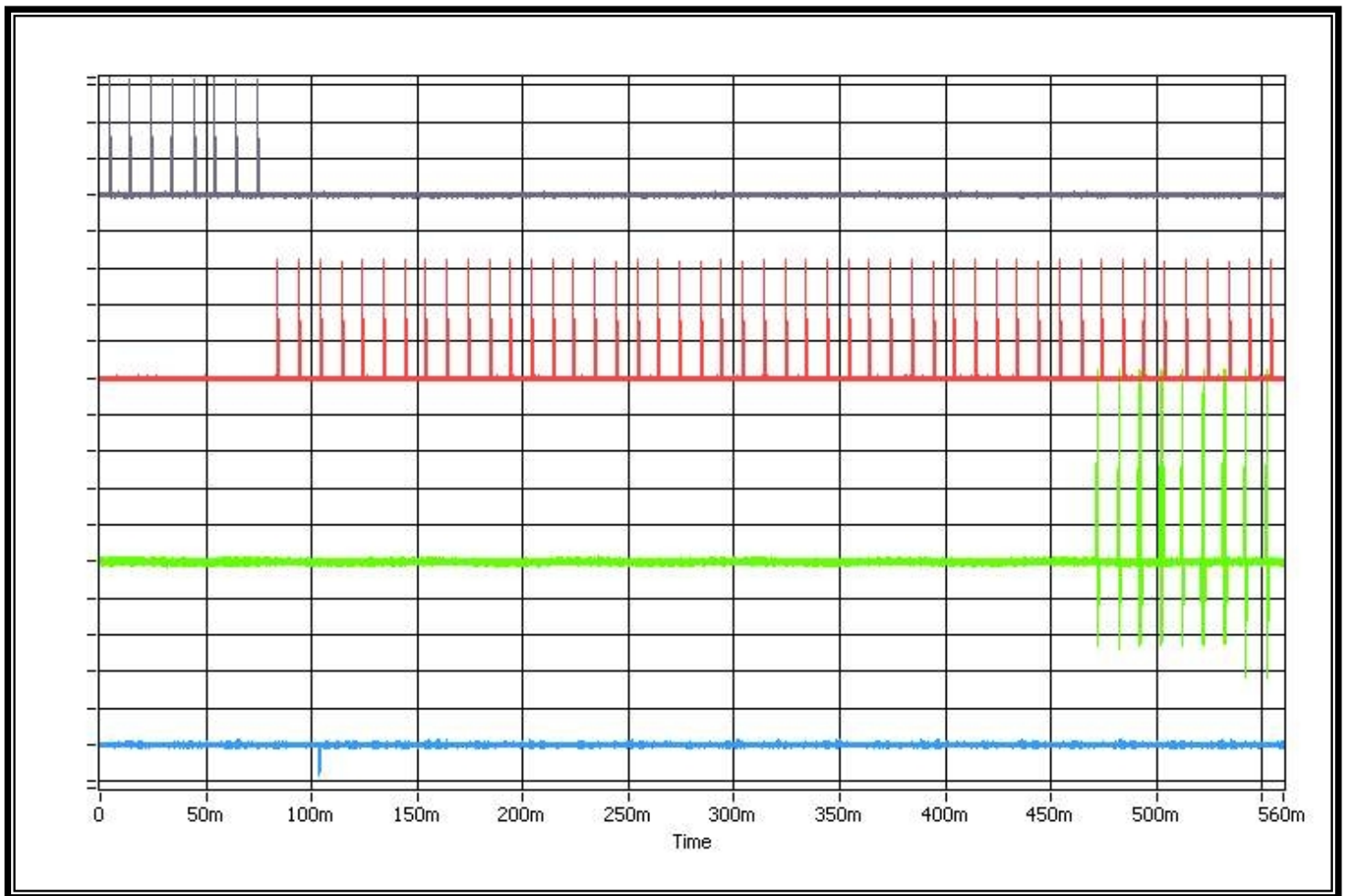

Note1: Trace1 (deep blue, top) shows interference on f1.

Note2: Trace2 (red, 2nd from top) shows the interference on f2.

Note3: Trace3 (green, 3rd from top) shows EUT transmissions on f1.

Note4: Trace4 (light blue, 4th from top) shows the signal to the handset to trigger the transmissions.

Note5: Set interference on all system carriers except f2, at a level of T_U+U_M , in-band per carrier.

Note6: Apply interference on f2 at a level of T_U+U_M , in-band, and immediately remove all interference from f1 and immediately (but not sooner than 20 ms after the interference on f2 is applied) cause the EUT to attempt transmission.

Note7: The EUT transmits on f1 and so meets the requirement.

Note: 7.3.4 (Zoom in)

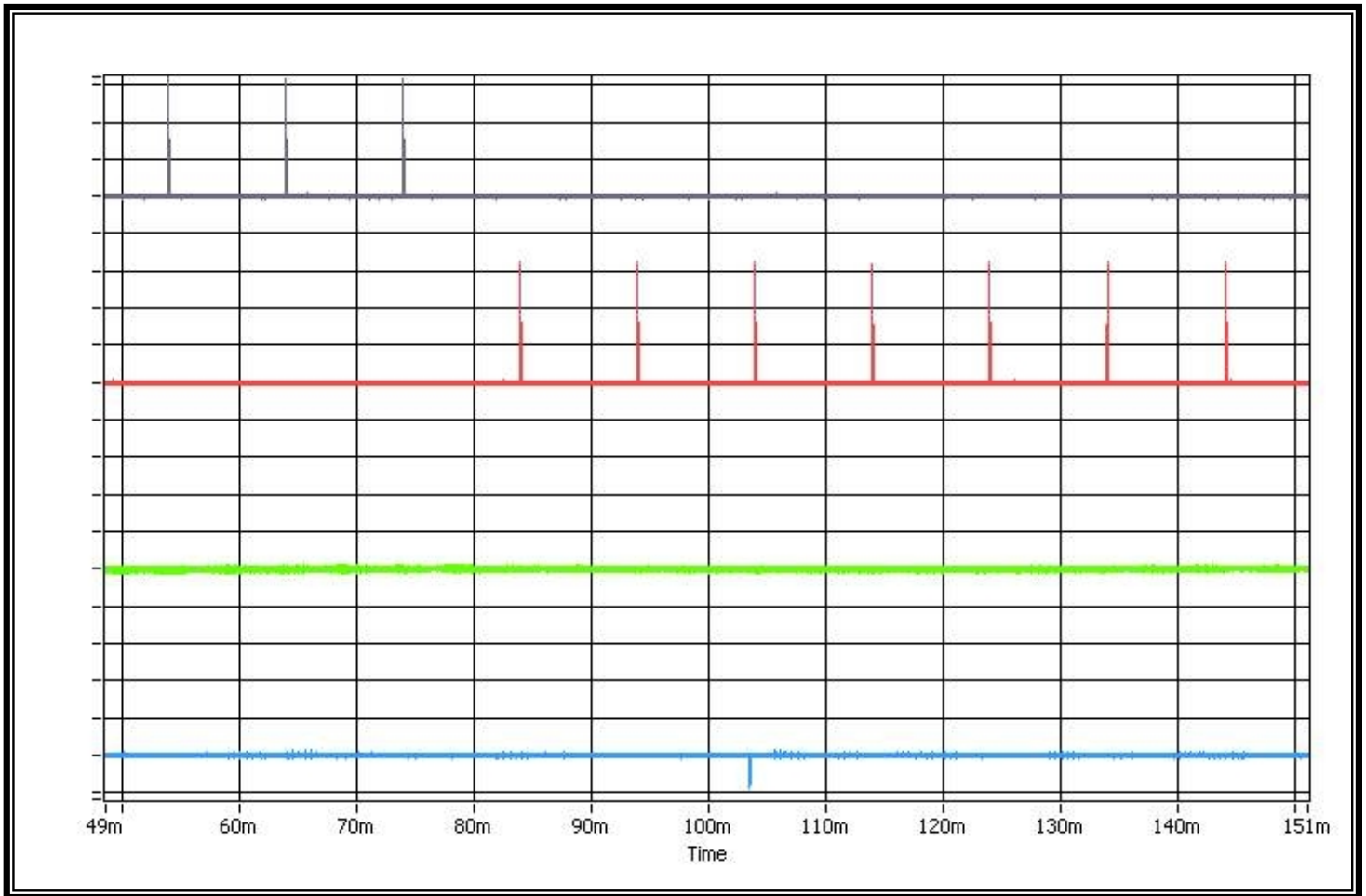

Note1: Trace1 (deep blue, top) shows interference on f1.

Note2: Trace2 (red, 2nd from top) shows the interference on f2.

Note3: Trace3 (green, 3rd from top) shows EUT transmissions on f1.

Note4: Trace4 (light blue, 4th from top) shows the signal to the handset to trigger the transmissions.

The signal is not sooner than 20 ms after the interference on f2 is applied.

6.6 Random waiting

6.6.1 Standard Applicable: FCC 15.323(c)(6), RSS-213_4.3.4(b)(6)

If the selected combined time and spectrum windows are unavailable, the device may either monitor and select different windows or seek to use the same window after waiting an amount of time, randomly chosen from a uniform random distribution between 10 and 150 milliseconds, commencing when the channel becomes available.

6.6.2 Measurement procedure

Measurement method according to ANSI C63.17 2006 paragraph 8.1.3

6.6.3 Results:

The manufacturer declares that this provision is not utilized by the EUT.

6.7 Monitoring bandwidth and reaction time

6.7.1 Standard Applicable: FCC 15.323(c)(7), RSS-213_4.3.4(b)(7)

The monitoring system band width must be equal to or greater than the emission band width of the intended transmission and have a maximum reaction time less than $50 \times \text{SQRT}(1.25/\text{emission band width in MHz})$ microseconds for signals at the applicable threshold level but shall not be required to be less than 50 microsecond. If a signal is detected that is 6 dB or more above the applicable threshold level, the maximum reaction time shall be $35 \times \text{SQRT}(1.25/\text{emission band width in MHz})$ microseconds but shall not be required to be less than 35 microseconds.

6.7.2 Measurement procedure

Measurement method according to ANSI C63.17 2006 paragraph 7.5

6.7.3 Results: Meets the requirement

Measurement Data

Calculation of applied pulse width and maximum reaction time:

For emission bandwidth > 1.25MHz, the pulse width is always 35us and 50us.

Used results	Emission bandwidth B (MHz)	1.43 MHz
Maximum reaction time and pulse width	$50\sqrt{1.25/B}$ (μs)	46.7 μs
	$35\sqrt{1.25/B}$ (μs)	32.7 μs

Result:

Pulse width	Connection
50 μs or $50\sqrt{1.25/B}$ μs	no
35 μs or $35\sqrt{1.25/B}$ μs	no

Note: 50us

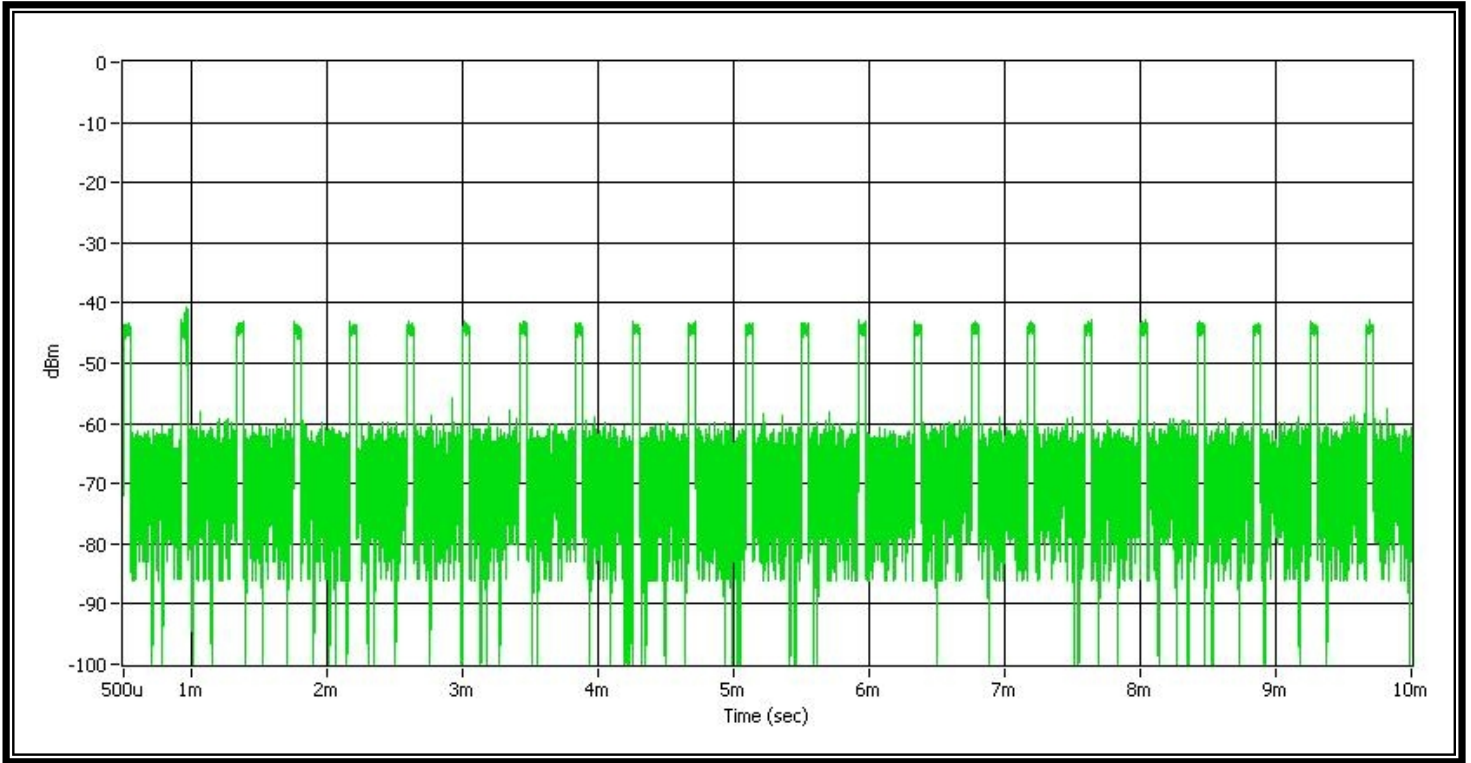

Note: 50us (Zoom in)

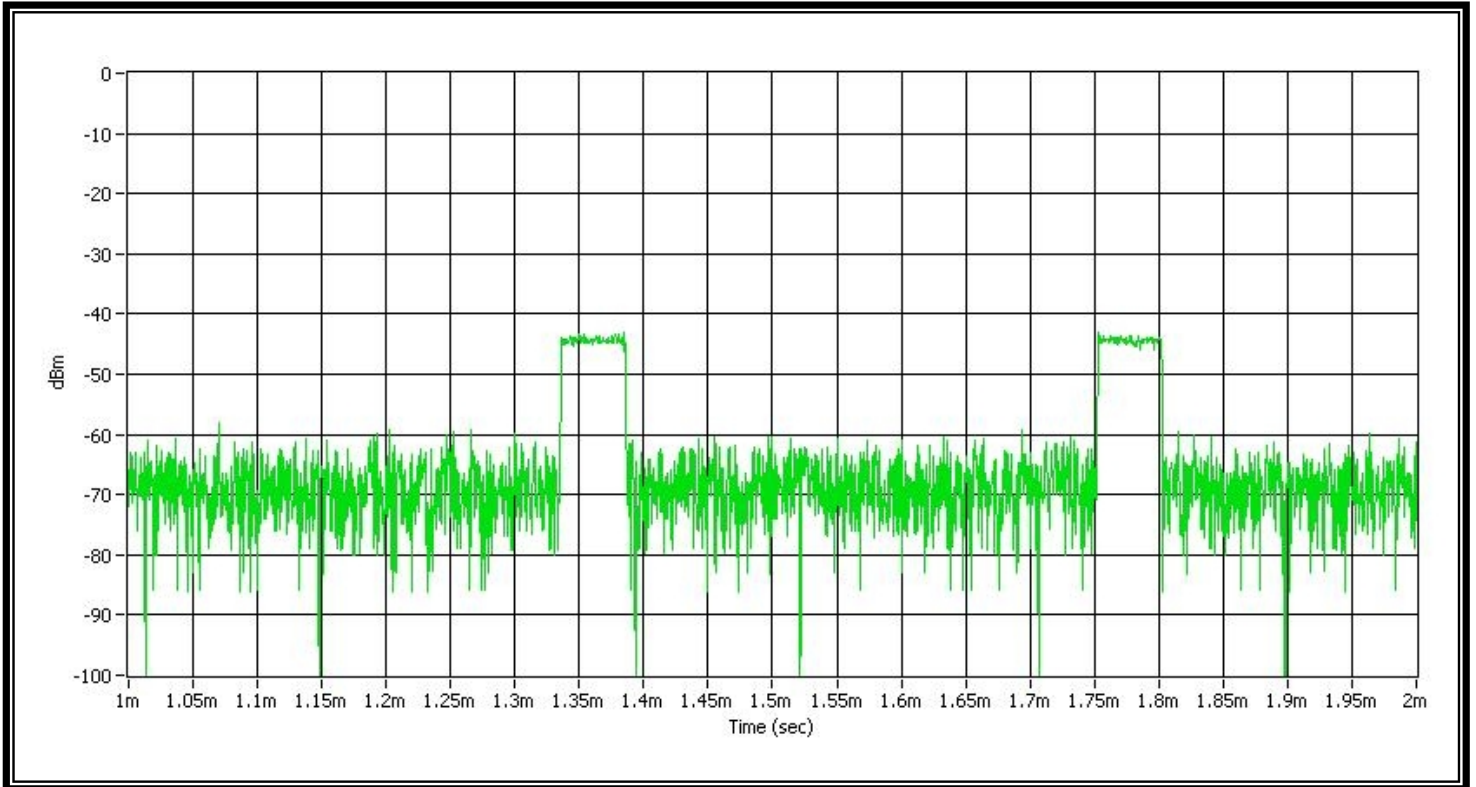

Note: 50us (5 carriers)

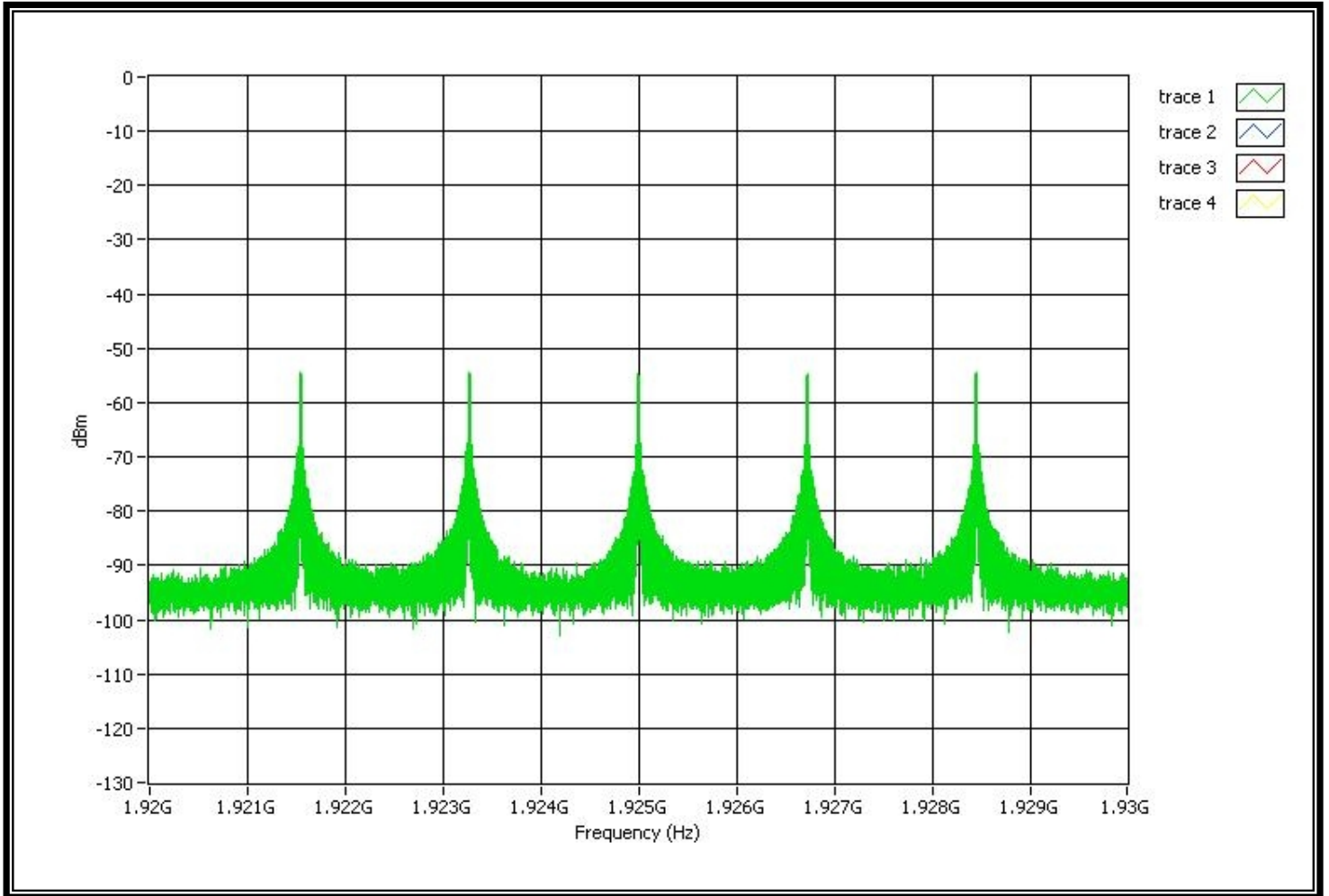

Note: 35us

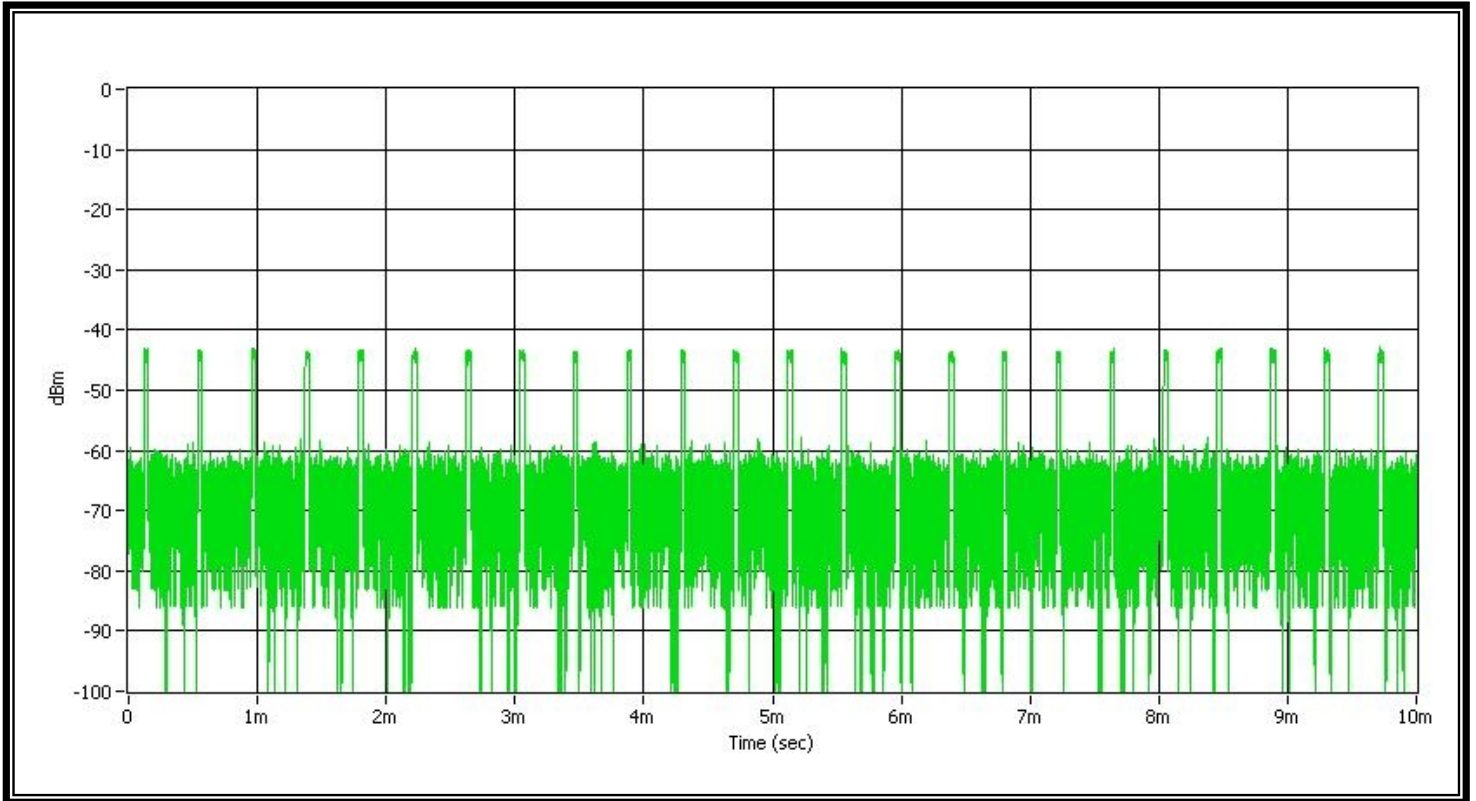

Note: 35us (Zoom in)

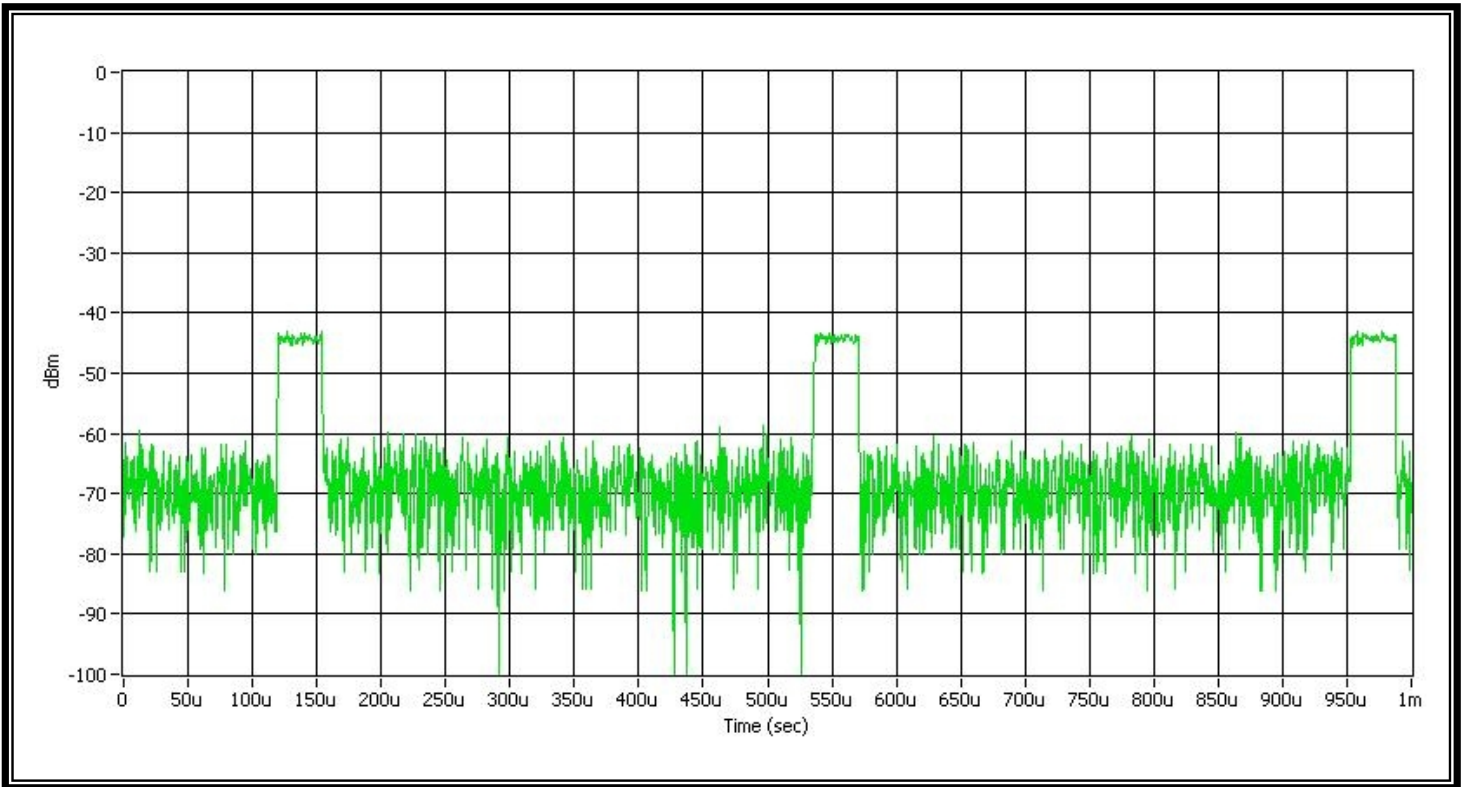

Note: 35us (5 carriers)

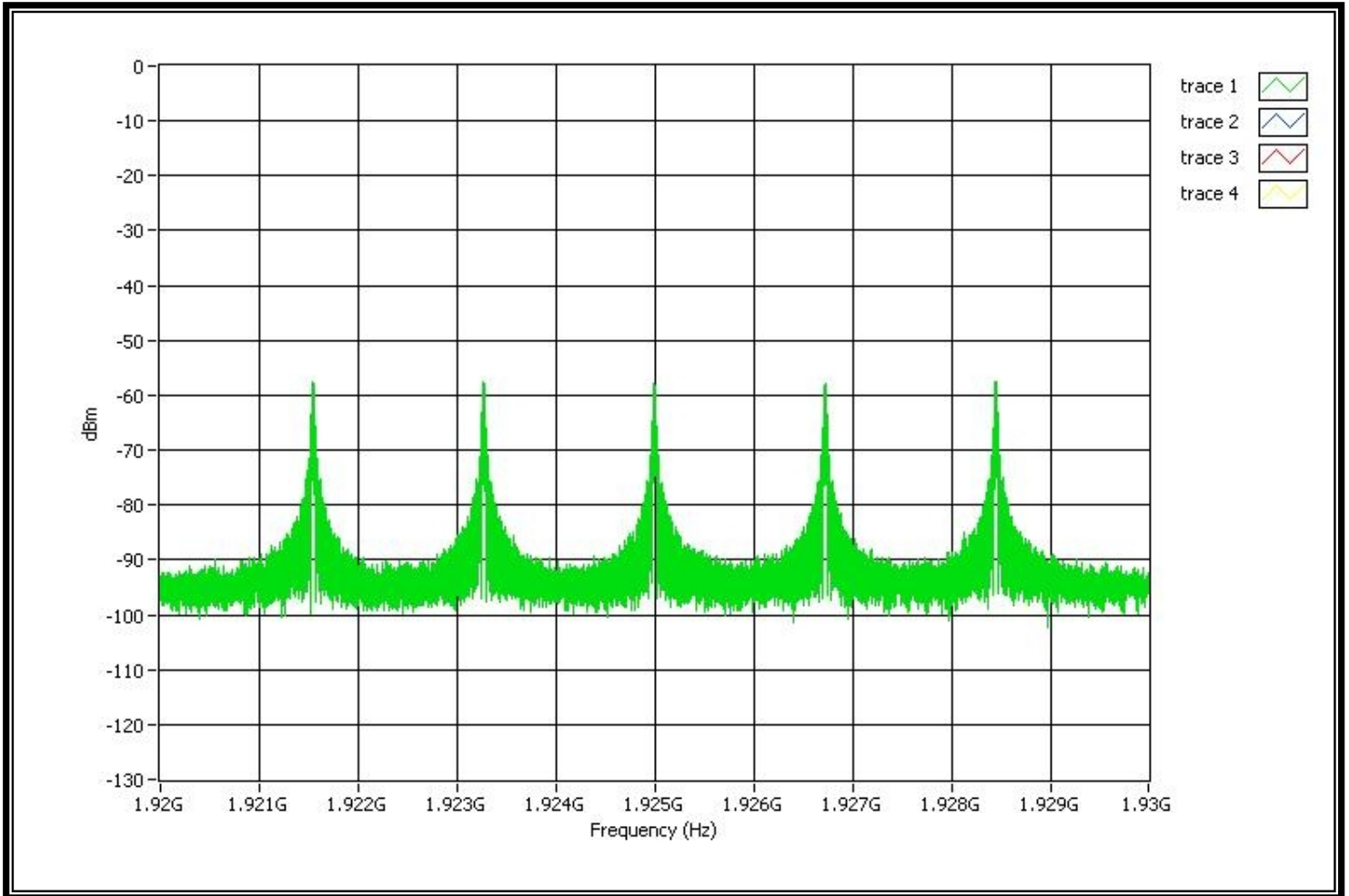

6.8 Monitoring antenna

6.8.1 Standard Applicable: FCC 15.323(c)(8), RSS-213_4.3.4(b)(8)

The monitoring system shall use the same antenna used for transmission, or an antenna that yields equivalent reception at that location.

6.8.2 Measurement procedure

Measurement method according to ANSI C63.17 2006 paragraph 4

6.8.3 Results: Complies

The EUT uses the same antennas for transmission and reception as for monitoring.

6.9 Monitoring threshold relaxation

6.9.1 Standard Applicable: FCC 15.323(c)(9), RSS-213_4.3.4(b)(9)

Devices that have a power output lower than the maximum permitted under the rules can increase their monitoring detection threshold by one decibel for each one decibel that the transmitter power is below the maximum permitted.

6.9.2 Measurement procedure

Measurement method according to ANSI C63.17 2006 paragraph 4

6.9.3 Results: Complies

Measurement Data:

This requirement is covered by results of Least Interfered Channel (LIC) test according to FCC 15.323(c) (5)	<input checked="" type="checkbox"/>
--	-------------------------------------

6.10 Duplex system LBT

6.10.1 Standard Applicable: FCC 15.323(c)(10), RSS-213_4.3.4(b)(10)

An initiating device may attempt to establish a duplex connection by monitoring both its intended transmit and receive time and spectrum windows. If both the intended transmit and receive time and spectrum windows meet the access criteria, then the initiating device can initiate a transmission in the intended transmit time and spectrum window. If the power detected by the responding device can be decoded as a duplex connection signal from the initiating device, then the responding device may immediately begin transmitting on the receive time and spectrum window monitored by the initiating device.

6.10.2 Measurement procedure

Measurement method according to ANSI C63.17, clause 8.3

This test is required for equipment that uses the access criteria in FCC 15.323(c)(10).

6.10.3 Test Results:

The manufacturer declares that this provision is not utilized by the EUT.

6.11 Co-located device LBT

6.11.1 Standard Applicable: FCC 15.323(c)(11), RSS-213_4.3.4(b)(11)

An initiating device that is prevented from monitoring during its intended transmit window due to monitoring system blocking from the transmissions of a co-located (within one meter) transmitter of the same system, may monitor the portions of the time and spectrum windows in which they intend to receive over a period of at least 10 milliseconds. The monitored time and spectrum window must total at least 50 percent of the 10 millisecond frame interval and the monitored spectrum must be within 1.25 MHz of the center frequency of channel(s) already occupied by that device or co-located co-operating device. If the access criteria is met for the intended receive time and spectrum window under the above conditions, then transmission in the intended transmit window by the initiating device may commence.

6.11.2 Measurement procedure

Measurement method according to ANSI C63.17 2006 paragraph 8.4

6.11.3 Results:

The manufacturer declares that this provision is not utilized by the EUT.

6.12 Fair Access

6.12.1 Standard Applicable: FCC 15.323(c)(12), RSS-213_4.3.4(b)(12)

The provisions of (c) (10) or (c) (11) shall not be used to extend the range of spectrum occupied over space or time for the purpose of denying fair access to spectrum for other devices.

6.12.2 Results:

The manufacturer declares that EUT does not work in a mode which denies fair access to spectrum for other devices.

Appendix1 Manufacturer Declaration



FCC Part 15D - APPLICATION FORM & SELF-DECLARATION

Applicant Name :	CCT Marketing, Ltd		
Address :	18/F, CCT Telecom Building, 11 Wo Shing Street, Fo Tan, Shatin, N.T., Hong Kong		
Contact person :	Brian Lai		
E-mail address:	brianlai@cct.com.hk		
Phone No. :	00852-2600 5246	Fax No. :	00852-2694 6165
Manufacturer Name :	Huiyang CCT Telecommunications Products Co. Ltd.		
Address :	CCT Technology Park, San He Economic Developmental Zone, Huiyang District, Huizhou City, Guangdong Province, PRC		

	PP	FP	
Model name :	30529	30522,30521	
FCC ID :	XYT30529	XYT30522	
			Remarks
Does a system built with the EUT that implement the provisions of 47CFR 15.323(c)(5) enabling the use of the upper threshold for deferral?	<input checked="" type="checkbox"/> Yes <input type="checkbox"/> No		
According to 47CFR15.323(c)(5).4, does your model not use bandwidth in further cooperation with other devices at any range?	<input checked="" type="checkbox"/> Yes <input type="checkbox"/> No		
Does a system built using the EUT that operate under the provisions of 47CFR 15.323(c)(6) incorporating provisions for waiting for a channel to go clear?	<input type="checkbox"/> Yes <input checked="" type="checkbox"/> No		
According to 47CFR15.323(c)(8), does EUT use the same antennas for transmission and reception as for monitoring?	<input checked="" type="checkbox"/> Yes <input type="checkbox"/> No		
Does a system built with the EUT that operate under the provisions of 47CFR 15.323(c)(10) to test for deferral only in conjunction with a companion device?	<input type="checkbox"/> Yes <input checked="" type="checkbox"/> No		
Does a system built using the EUT that operate under the provisions of 47CFR 15.323(c)(11) enabling the access criteria check on the receive channel while in the presence of collocated interferers?	<input type="checkbox"/> Yes <input checked="" type="checkbox"/> No		
According to 47CFR15.323(c)(12), does EUT not work in a mode with denies fair access to spectrum for other devices.	<input checked="" type="checkbox"/> Yes <input type="checkbox"/> No		

Signed by: Brian Lai

Signature:

Date: 17 Feb,2011