

# VIZIO

## USER MANUAL

VIZIO 20" 2.1 Channel Sound Bar with Wireless Subwoofer and Bluetooth

Model : SB2021n-J6

Please read this guide before using the product.

# IMPORTANT SAFETY INSTRUCTIONS



Your Unit is designed and manufactured to operate within defined design limits, and misuse may result in electric shock or fire. To prevent your Unit from being damaged, the following rules should be observed for its installation, use, and maintenance. Please read the following safety instructions before operating your Unit. Keep these instructions in a safe place for future reference.

- Read these instructions.
- Keep these instructions.
- Heed all warnings.
- Follow all instructions.
- Do not use this apparatus near water.
- Clean only with a dry cloth.
- Do not block any ventilation openings. Install in accordance with the manufacturer's instructions.
- Do not install near any heat sources such as radiators, heat registers, stoves, or other apparatus (including amplifiers) that produce heat.
- Do not defeat the safety purpose of the polarized or grounding-type plug. A polarized plug has two blades with one wider than the other. A grounding type plug has two blades and a third grounding prong. The wide blade or the third prong are provided for your safety. If the provided plug does not fit into your outlet, consult an electrician for replacement of the obsolete outlet.
- Protect the power cord from being walked on or pinched, particularly at plugs, convenience receptacles, and the point where they exit from the apparatus.
- Only use attachments/accessories specified by the manufacturer.
- Use only with the cart, stand, tripod, bracket, or table specified by the manufacturer, or sold with the apparatus. When a cart is used, use caution when moving the cart/apparatus combination to avoid injury from tip-over.
- Unplug this apparatus during lightning storms or when unused for long periods of time.
- Refer all servicing to qualified service personnel. Servicing is required when the apparatus has been damaged in any way, such as when the power supply cord or plug is damaged, liquid has been spilled or objects have fallen into the apparatus, the apparatus has been exposed to rain or moisture, does not operate normally, or has been dropped.
- To reduce the risk of electric shock or component damage, switch off the power before connecting other components to your Unit.
- Unplug the power cord before cleaning your Unit. A damp cloth is sufficient for cleaning. Do not use a liquid or a spray cleaner on your Unit. Do not use abrasive cleaners.
- Always use the accessories recommended by the manufacturer to insure compatibility.
- When moving your Unit from an area of low temperature to an area of high temperature, condensation may form in the housing. Wait before turning on your Unit to avoid causing fire, electric shock, or component damage.
- Slots and openings in the back and bottom of the cabinet are provided for ventilation. To ensure reliable operation of your Unit and to protect it from overheating, be sure these openings are not blocked or covered. Do not place your Unit in a bookcase or cabinet unless proper ventilation is provided.
- Never push any object into the slots and openings on your Unit enclosure. Do not place any objects on the top of your Unit. Doing so could short circuit parts causing a fire or electric shock. Never spill liquids on your Unit.
- **WARNING:** Exposure to loud sounds can damage your hearing causing hearing loss and tinnitus (ringing or buzzing in the ears). With continued exposure to loud noises, ears may become accustomed to the sound level, which may result in permanent damage to hearing without any noticeable discomfort.
- When connected to a power outlet, power is always flowing into your Unit. To totally disconnect power, unplug the power cord.
- Do not overload power strips and extension cords. Overloading can result in fire or electric shock.

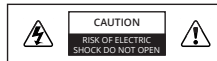

- The wall socket should be located near your Unit and be easily accessible
- Keep your Unit away from moisture. Do not expose your Unit to rain or moisture. If water penetrates into your Unit, unplug the power cord and contact your dealer. Continuous use in this case may result in fire or electric shock.
- Do not use your Unit if any abnormality occurs. If any smoke or odor becomes apparent, unplug the power cord and contact your dealer immediately. Do not try to repair your unit yourself.
- Avoid using dropped or damaged appliances. If your Unit is dropped and the housing is damaged, the internal components may function abnormally. Unplug the power cord immediately and contact your dealer for repair. Continued use of your Unit may cause fire or electric shock.
- Do not install your Unit in an area with heavy dust or high humidity. Operating your Unit in environments with heavy dust or high humidity may cause fire or electric shock.
- Ensure that the power cord and any other cables are unplugged before moving your Unit.
- When unplugging your Unit, hold the power plug, not the cord. Pulling on the power cord may damage the wires inside the cord and cause fire or electric shock. When your Unit will not be used for an extended period of time, unplug the power cord.
- To reduce risk of electric shock, do not touch the connector with wet hands.
- Insert the remote control batteries in accordance with instructions. Incorrect polarity may cause the battery to leak which can damage the remote control or injure the operator.
- See the important note and rating located on the back of the unit.
- **WARNING** - This equipment is not waterproof. To prevent a fire or shock hazard, do not place any container filled with liquid near the equipment (such as a vase or flower pot) or expose it to dripping, splashing, rain, or moisture.
- **CAUTION** - Danger of explosion or fire if batteries are mistreated. Replace only with the same or specified type.
- Do not leave the batteries exposed to direct sunlight for a long period of time with doors and windows closed. Do not disassemble the batteries or dispose of it in fire.
- Where the MAINS plug or appliance coupler is used as the disconnect device, the disconnect device shall remain readily operable
- No naked flame sources, such as lighted candles, should be placed on the apparatus.
- The ventilation should not be impeded by covering the ventilation openings with items, such as newspapers, table-cloths, curtains, etc.;
- The equipment shall be used at maximum 35 degree C ambient temperature.

**WARNING:** To reduce the risk of fire or electric shock, do not expose this apparatus to rain or moisture.

The lightning flash with arrowhead symbol within an equilateral triangle is intended to alert the user to the presence of not isolated dangerous voltage within the product that may be sufficient magnitude to constitute a risk of shock to persons.



The exclamation point within an equilateral triangle is intended to alert the user to the presence of important operating and servicing instructions in the literature accompanying the appliance.



Warning: This equipment is a Class II or double insulated electrical appliance. It has been designed in such a way that it does not require a safety connection to electrical earth.

# TABLE OF CONTENTS

|                                  |    |
|----------------------------------|----|
| Package Contents .....           | 5  |
| Controls & Connections .....     | 6  |
| First-Time Setup.....            | 9  |
| Using the Remote .....           | 13 |
| LED Indicators.....              | 15 |
| Programming the Sound Bar .....  | 17 |
| Using Button Combinations .....  | 18 |
| Bluetooth Pairing.....           | 19 |
| Using Bluetooth mode.....        | 20 |
| Advanced Setup.....              | 21 |
| Reconnecting the Subwoofer ..... | 22 |
| Help & Troubleshooting.....      | 25 |
| Limited Warranty.....            | 26 |
| Specifications.....              | 28 |
| Legal & Compliance.....          | 29 |

# PACKAGE CONTENTS



Sound Bar

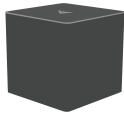

Wireless Subwoofer



Remote Control  
with 2x AAA Batteries



2 x Power Cables

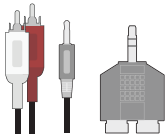

Stereo RCA to  
3.5mm Audio Cable  
with Adapter



Digital Optical  
Cable



Coaxial Audio  
Cable



User Manual

# CONTROLS & CONNECTIONS

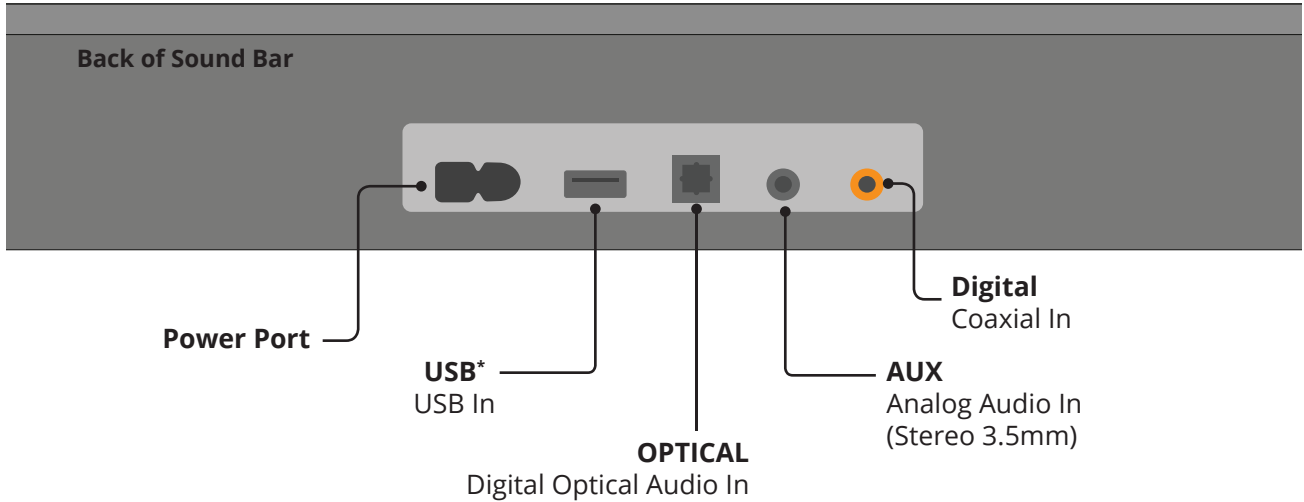

\*Supports .WAV and .MP3 file format playback only.

## Top of Sound Bar

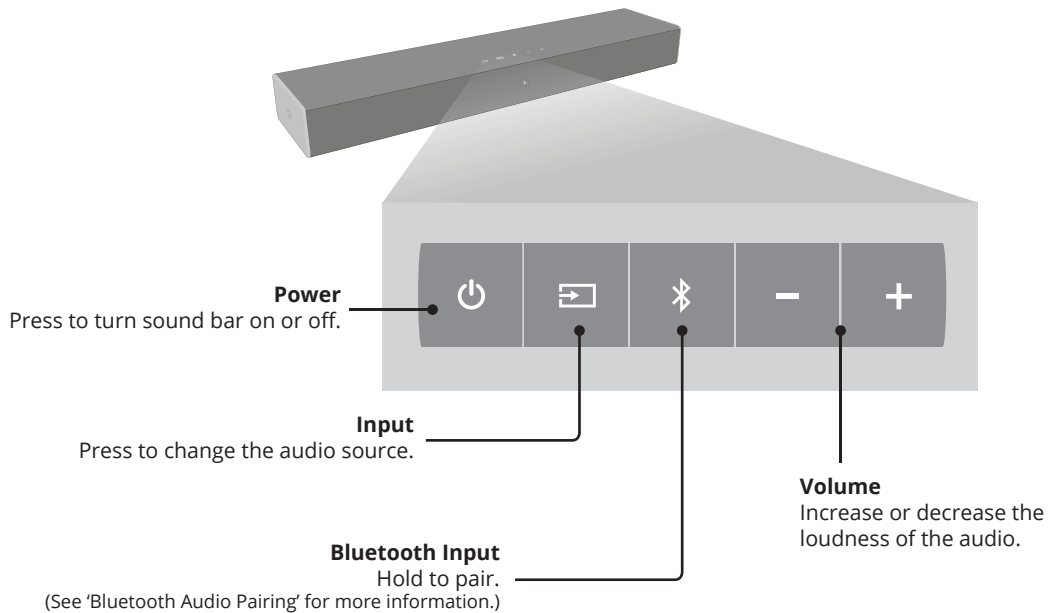

## Back of Subwoofer

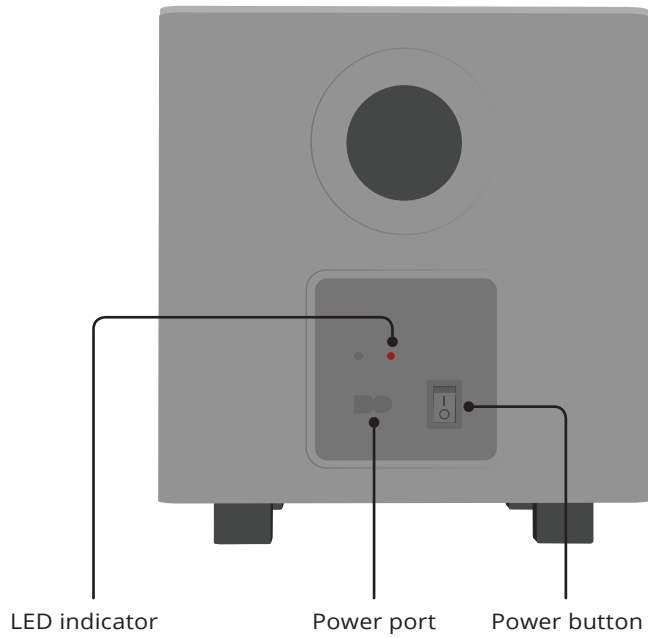



# FIRST-TIME SETUP



## 1 CHOOSE ONE CABLE\* AND CONNECT IT TO YOUR TV

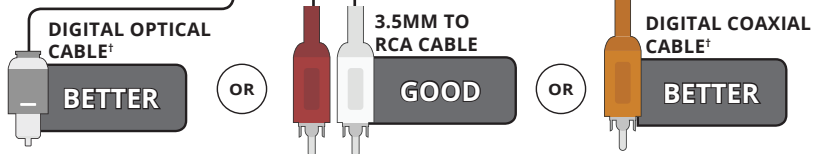

\* Not all TVs have the audio outputs shown above. To connect the sound bar directly to your other devices (Blu-ray player, game system, etc.) see your device's user manual.

† When using the optical or digital input, if there is no audio:  
(A) try setting the TV output to PCM  
-or-  
(B) connect directly to your Blu-ray/other source; some TVs do not pass through digital audio.

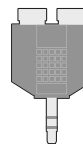
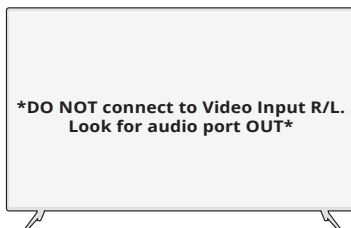

**Optional:** Use the included RCA adapter to connect to your TV if needed.

- 2** Connect the power cable to the sound bar **AC IN** as shown.  
Plug the power cable into an electrical outlet.

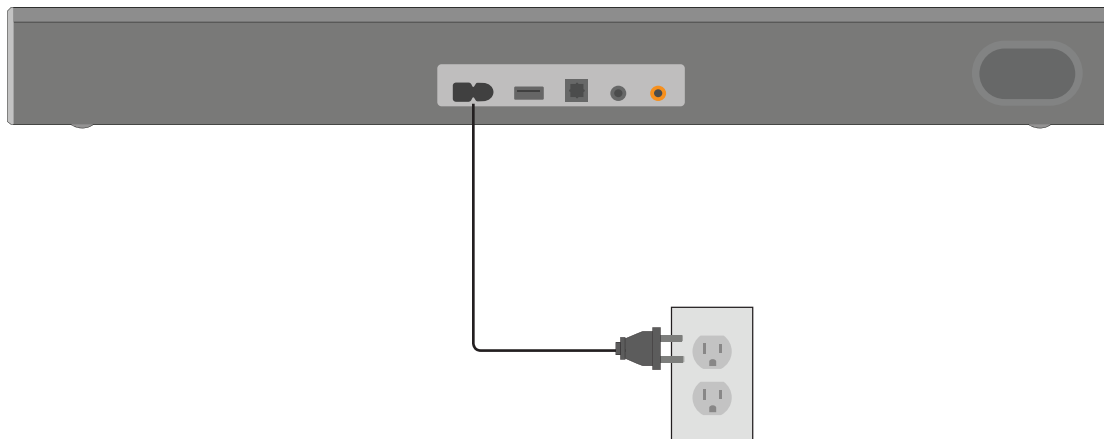

### Back of Subwoofer

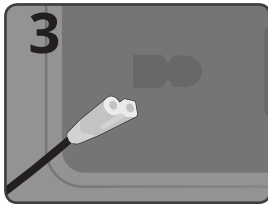
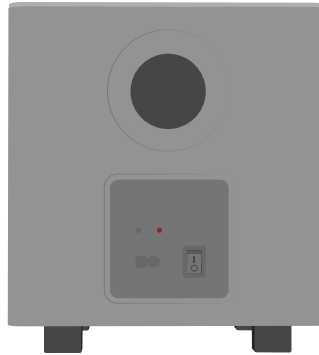

Connect the power cable to the subwoofer AC IN as shown.

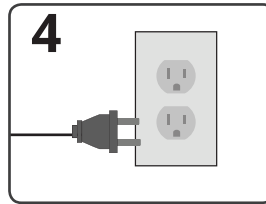

Plug the power cable into an electrical outlet.



Flip the power switch into the **ON** position.

6

Top



Remove the battery cover by gently sliding it away from the remote.

7

Top



Insert the included batteries and gently slide the battery cover back into place.

When needed, VIZIO recommends replacing the batteries that came with this remote with two, new Duracell 'AAA' alkaline batteries.



8

Turn on your TV and sound bar. The sound bar will announce "Searching" and automatically begin searching for an active input.\*

The LED indicator on the front of the sound bar will begin cycling through inputs until an audio source is detected. Once an active input has been found, the input name will be announced.\*\*



**Tip:** Pressing the **INPUT** button will stop the auto detect function.

You can press the **INPUT** button to switch between audio sources. For example, if you connected your TV to AUX, set the sound bar to AUX.

\*Occurs only during first-time set up.

\*\*Auto detect function only occurs once when the sound bar is first powered on. To enable this feature again, you must do a Factory Reset (see the Using Button Combinations section for more information) or press and hold the INPUT button for 3 seconds.



# USING THE REMOTE

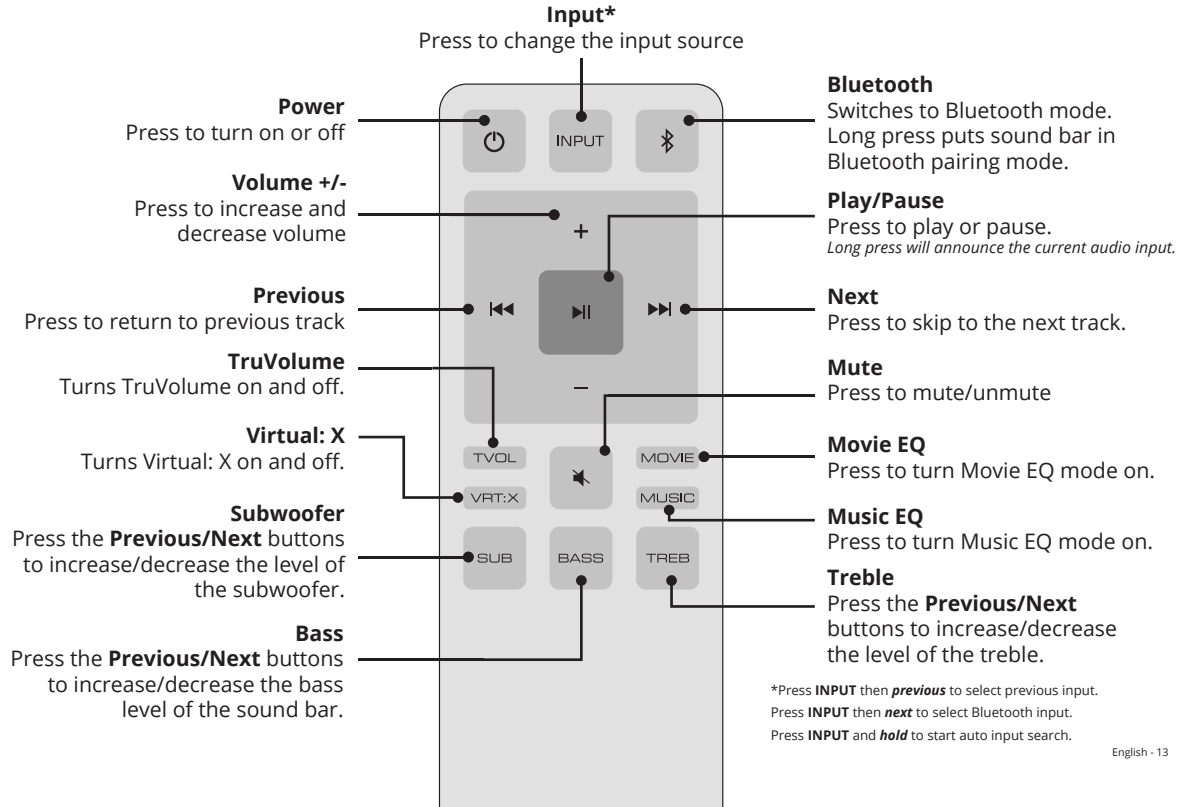

For the best surround sound experience, position the sound as shown.  
The sound bar should be close to ear level (approx. 2-3 feet off the floor).

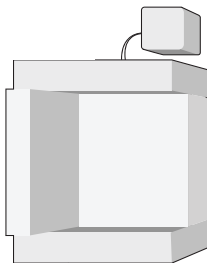

Sound bar is centered  
below the TV.

(If your TV permits it, you  
can also slide the sound bar  
underneath the TV.)

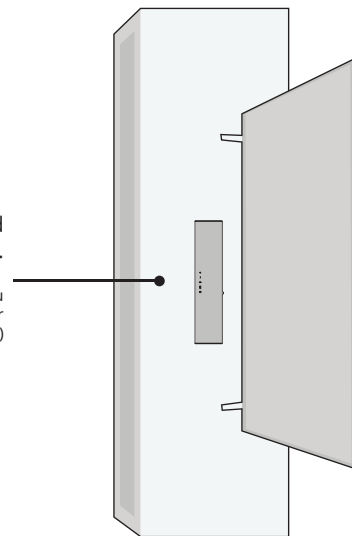







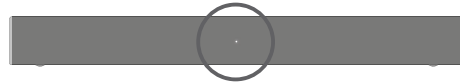

# LED INDICATOR

The LED and speakers will react differently for each function.

LED Indicator is located here.





| Function                 | LED/Speaker Behavior  | Description  |
|--------------------------|---|--|
| <b>Input</b>             |  <p>The LED will blink a different color for each input:<br/> <b>Red:</b> Optical<br/> <b>Green:</b> AUX<br/> <b>Amber:</b> Digital<br/> <b>Blue:</b> Bluetooth<br/> <b>Magenta:</b> USB</p> | <p>Press the <b>INPUT</b> button on the remote to cycle through the available inputs:</p> <ul style="list-style-type: none"> <li>• Analog Audio In - AUX Stereo 3.5mm</li> <li>• Digital Coaxial Audio in - Digital</li> <li>• Digital Optical Audio In - Optical</li> <li>• Bluetooth</li> <li>• USB In - USB</li> </ul> <p><b>Press and hold</b> the <b>INPUT</b> button on the remote control for 3 seconds to enable the auto input detect function.</p> |
| <b>Bluetooth Pairing</b> |  <p>The LED will blink blue when searching and turn solid once a device is paired successfully.</p>  | <p>Press and hold the  button on the remote. The sound bar will announce that it "searching." It will be discoverable for 15 minutes. You can now search for the sound bar (VIZIO SB2021n) using your Bluetooth device. The sound bar will power down if no device is found.</p> <p><b>Note:</b> Set your Bluetooth device into pairing mode prior to the sound bar.</p>    |
| <b>DTS TruVolume</b>     |  <p>A high tone double beep indicates <b>On</b>, while a low tone double beep indicates <b>Off</b>.</p>  | <p>Press the <b>TVOL</b> button to enable/disable TruVolume.</p> <p>When enabled (On), TruVolume provides a consistent and comfortable volume level for a more enjoyable listening experience.</p>   |
| <b>DTS Virtual:X</b>     |  <p>A high tone double beep indicates <b>On</b>, while a low tone double beep indicates <b>Off</b>.</p>  | <p>Press the <b>VRT:X</b> button to enable/disable Virtual:X. When enabled (<b>On</b>), all inputs will produce a virtual sound technology that simulates the effect of having overhead sound. When disabled (<b>Off</b>), all sources will playback in stereo.</p>  |

| Function                | LED/Speaker Behavior  | Description  |
|-------------------------|---|--|
| <b>Movie/Music Mode</b> |  <p>A high tone double beep indicates <b>Movie mode</b>, while a low tone double beep indicates <b>Music mode</b>.</p>                         | <p>Press either the <b>MOVIE</b> or <b>MUSIC</b> remote button to turn on each equalizer setting.</p> <p><b>Note:</b> Movie mode is on by default.</p>   |
| <b>Subwoofer Levels</b> |  <p><b>High tone double beep:</b> Max level<br/> <b>Medium tone single beep:</b> Mid level<br/> <b>Low tone double beep:</b> Minimum level</p> | <p>Press the <b>SUB</b> button then press the <b>Next/Previous</b> button to increase/decrease the subwoofer level. When set to the minimum level, the subwoofer will be muted.</p> <p><b>Note:</b> Mid level is the default setting.</p>                                    |
| <b>Bass Levels</b>      |  <p><b>High tone double beep:</b> Max level<br/> <b>Medium tone single beep:</b> Mid level<br/> <b>Low tone double beep:</b> Minimum level</p> | <p>Press the <b>BASS</b> button then press the <b>Next/Previous</b> button to increase/decrease the bass level.</p> <p><b>Note:</b> Mid level is the default setting.</p> <p>If a subwoofer is connected, adjusting the bass level will also adjust the subwoofer level.</p> |
| <b>Treble Levels</b>    |  <p><b>High tone double beep:</b> Max level<br/> <b>Medium tone single beep:</b> Mid level<br/> <b>Low tone double beep:</b> Minimum level</p> | <p>Press the <b>TREBLE</b> button then press the <b>Next/Previous</b> button to increase/decrease the treble level.</p> <p><b>Note:</b> Mid level is the default setting.</p>  |



# PROGRAMMING THE SOUND BAR

You can program the sound bar to accept TV remote IR commands.

| Function                 | LED Behavior  | Description  |
|--------------------------|---|--|
| <b>Learn Volume Down</b> | <br>The LED indicator will flash yellow when learning and will turn solid once it has successfully recognized the TV remote. | Press the <b>Play + Volume Down</b> buttons on the remote to put the sound bar into learning mode. While the sound bar is in learning mode, press the <b>Volume Down</b> button on the TV remote control while pointing the remote at the sound bar. |
| <b>Learn Volume Up</b>   | <br>The LED indicator will flash amber when learning and will turn solid once it has successfully recognized the TV remote.  | Press the <b>Play + Volume Up</b> buttons on the remote to put the sound bar into learning mode. While the sound bar is in learning mode, press the <b>Volume Up</b> button on the TV remote control while pointing the remote at the sound bar.     |
| <b>Learn Mute</b>        | <br>The LED indicator will flash white when learning and will turn solid once it has successfully recognized the TV remote.  | Press the <b>Play + Mute</b> buttons on the remote to put the sound bar into learning mode. While the sound bar is in learning mode, press the <b>Mute</b> button on the TV remote control while pointing the remote at the sound bar.               |



Turn off your TV speakers when programming your sound bar.





Point both the sound bar and TV remotes towards the front of the sound bar when programming.

# USING BUTTON COMBINATIONS

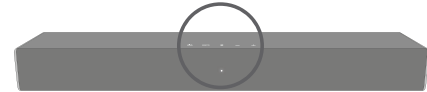
Buttons are located here.



There are functions that are triggered by different button combinations on the sound bar.

| Function                       | LED Behavior   | Description   |
|--------------------------------|--|---|
| <b>Factory Reset</b>           | <br>LED will flash 3 times.   | Reset the sound bar to the factory default settings. To perform a Factory Reset, <b>Press and Hold</b> the <b>Bluetooth</b> (📶) and <b>Volume Down</b> (—) buttons for 5 seconds.<br><br><b>Note:</b> This will erase all settings and preferences that you have set.   |
| <b>VIZIO TV Remote Control</b> | <br>A high tone double beep indicates <b>On</b> , while a low tone double beep indicates <b>Off</b> . | Enable/disable the use of a VIZIO TV remote control to power on and adjust the volume of the sound bar. To enable/disable this function, <b>Press and Hold</b> the <b>Power</b> (⏻) and <b>Volume Up</b> (+) buttons for 5 seconds.<br><br><b>Note:</b> This function is enabled by default.  |
| <b>Eco Power Mode</b>          | <br>A high tone double beep indicates <b>On</b> , while a low tone double beep indicates <b>Off</b> . | When the Eco Power setting is enabled, the sound bar will automatically power down after a period of inactivity. When disabled, the sound bar will remain powered on until you turn it off. To enable/disable this function, <b>Press and Hold</b> the <b>Power</b> (⏻) and <b>Volume Down</b> (—) buttons for 5 seconds.<br><br><b>Note:</b> Eco Power Mode setting is enabled by default. |
| <b>Speaker Test</b>            | —  | <b>Press and Hold</b> the <b>Bluetooth</b> (📶) and <b>Volume Up</b> (+) buttons for 5 seconds. A voice will begin calling out each speaker beginning with left front. (Left Front, Right Front, and subwoofer-white noise). If any of these are missing, check the connection and run the speaker test function again.  |

# BLUETOOTH PAIRING

To pair the sound bar with a Bluetooth device:

1. Press and hold the **Bluetooth** button  on the sound bar for five (5) seconds or select the Bluetooth button on the remote. When the sound bar is in Bluetooth Pairing Mode, the LED Indicator on the front display panel will turn blue and start blinking.

Once the device is paired, the LED Indicators will stop blinking.

2. You can now search for the sound bar (VIZIO SB2021n) using your Bluetooth device. For more information, refer to the user documentation that came with the device.
3. Play audio from your Bluetooth device. Volume can be controlled on your source device and the sound bar.

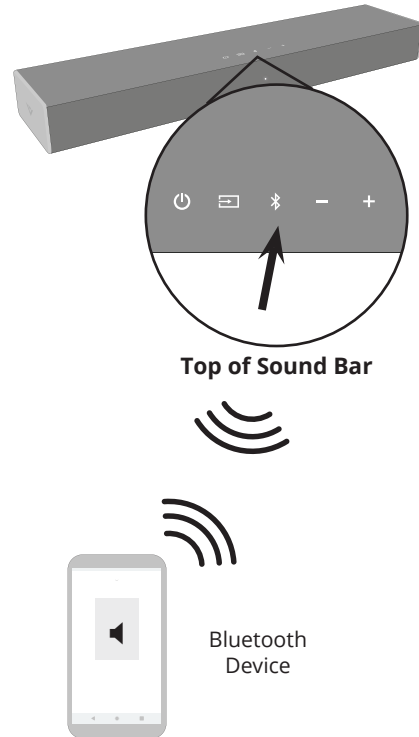

## USING BLUETOOTH MODE

Your sound bar supports music streaming from smartphones, tablets, and computers with Bluetooth capability. Device compatibility will vary, see your device's documentation for more information.

- Once you have paired your source device to the sound bar, as long as you stay within range of the sound bar, your device should remain paired.
- If the input is changed, the Bluetooth device will disconnect.
- If the source is changed back to Bluetooth, any paired Bluetooth device will reconnect automatically.



Your sound bar is not equipped with a microphone, so it cannot operate as a hands-free device for a smartphone.

### Maximizing Signal

A Bluetooth signal has a range of up to 30 feet. Keep in mind that Bluetooth is a compressed audio format, so streamed music may lose some integrity when compared to a wired connection.

Try the following if your sound quality is less than optimal:

- If you hear any break-up or disconnect while streaming music from your device, move the source device closer to the sound bar.
- Be sure that there are no solid obstructions in the line-of-sight between the sound bar and the source device.
- Other wireless devices can affect Bluetooth range, including wireless security cameras, wireless video baby monitors, cordless phones, and microwave ovens. Turning off or moving these devices may improve Bluetooth range.



Reduce the volume levels on your device and on the sound bar before pressing Play. High volume levels can damage your hearing.

# ADVANCED SETUP

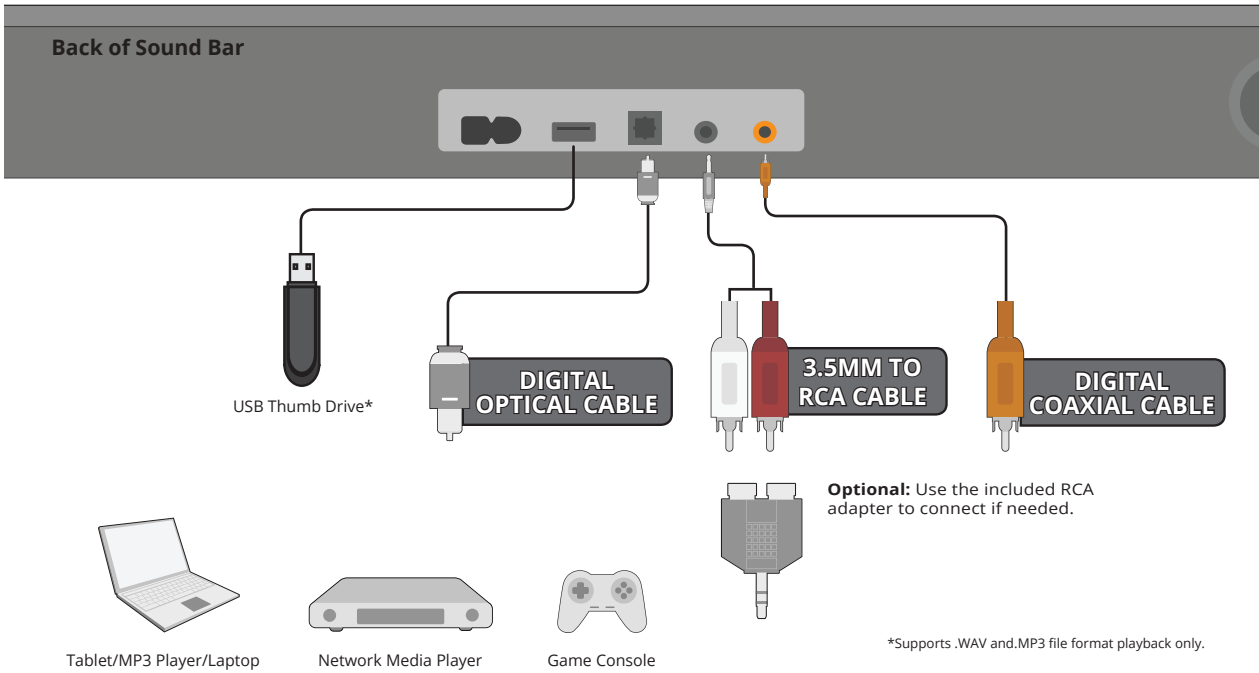

# Reconnecting the Subwoofer

The subwoofer has already been paired with the sound bar by VIZIO. However, the subwoofer may need to be re-linked to the sound bar if there is no sound coming from the subwoofer.



**What does pairing mean?**  
Pairing means to wirelessly connect.

1

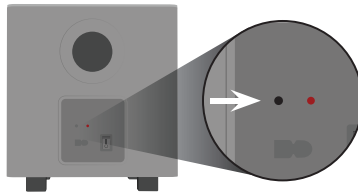

Back of Subwoofer

First confirm that the power switch is in the **ON** position. **Press and hold** the **pairing** button on the back of the subwoofer for 5 seconds. The LED on the back of the subwoofer will begin to blink.

2

Buttons are located on top of the sound bar.

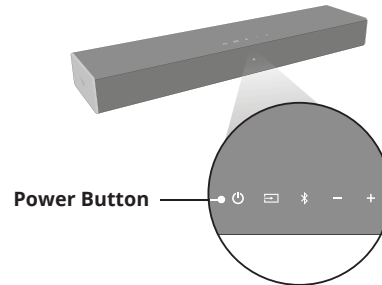

Power Button

**Press and hold** the **power** button on the top of the sound bar for 5 seconds. The LED indicator on the front will flash 3 times. The subwoofer is now linked with the sound bar.

Take a moment to register your product



# VIZIO.COM/PRODUCT-REGISTRATION

## Why register?



### **Customized Support**

Get assistance quickly with your information on hand.



### **News and Offers**

Take advantage of the latest news and special offers from VIZIO.



### **Safety and Satisfaction**

Stay up-to-date with important product updates and notifications.

Award-Winning Customer Care At Your Convenience.



# NEED HELP?

Go to: [support.vizio.com](https://support.vizio.com)

## Find help with:

- New product setup
- Connecting your devices
- Technical problems
- Product updates and more



Live chat  
support available

You can also contact our support team at:

**Phone: (877) 698-4946**

**Text Message: (205) 301-3729**

Note: This number accepts SMS/MMS messages only. No voice calls are accepted.  
Message and data rates may apply. (U.S. only).

Se habla Español • Nous parlons Français



# HELP & TROUBLESHOOTING

There is no power.

- Press the **POWER** button on the remote control or on the top of your sound bar.
- Ensure the power cord is securely connected.
- Plug a different device into the electrical outlet to verify that the outlet is working correctly.

There is no sound.

- Increase the volume. Press **Volume Up** on the remote control or on the top of your sound bar.
- Press **MUTE** on the remote to ensure the sound bar is not muted.
- Press **INPUT** on the remote or on the top of your sound bar to select a different input source.
- Confirm that the sound bar is connected to an **audio OUTPUT port** on the TV. **DO NOT** connect to Video Input R/L.
- When using the optical or digital input, if there is no audio: (A) Try setting the TV output to PCM or (B) Connect directly to your Blu-ray/other source, some TVs do not pass through digital audio.
- On the optical input, the input LEDs will flash rapidly and vocally announce "*Format Not Supported*" if an unsupported format is present. Set the source to output PCM.
- Your TV may be set to variable audio output. Confirm that the audio output setting is set to **FIXED** or **STANDARD**, not **VARIABLE**. Consult your TV's user manual for more detailed information.
- If using Bluetooth, ensure that the volume on your source device is turned up and that the device is not muted.

I hear buzzing or humming.

- Ensure all cables and wires are securely connected.
- Connect a different source device (TV, Blu-ray player, etc) to see if the buzzing persists. If it does not, the problem may be with the original device.
- Connect your device to a different input on the sound bar.

The remote isn't working.

- Replace the remote batteries with new ones.
- Point the remote directly at the center of the Sound Bar when pressing a button.
- If using a Bluetooth connection, some of the buttons on the remote may not be supported by the streaming application. (e.g., Pandora doesn't support the Back button.)

# LIMITED WARRANTY

## United States and Canada

BY USING YOUR VIZIO PRODUCT YOU AGREE TO BE BOUND BY ALL THE TERMS OF THIS WARRANTY. BEFORE USING YOUR VIZIO PRODUCT, PLEASE READ THIS WARRANTY CAREFULLY. IF YOU DO NOT AGREE TO THE TERMS OF THIS WARRANTY, DO NOT USE THE VIZIO PRODUCT AND, WITHIN THIRTY (30) DAYS OF THE DATE OF PURCHASE, RETURN IT FOR A REFUND TO THE AUTHORIZED RETAILER WHERE YOU PURCHASED IT.

**This warranty contains a binding arbitration agreement and a class action waiver for United States residents. If you live in the United States, the binding arbitration agreement and class action waiver affect your rights under this warranty. Please read the text under the section titled "Binding Arbitration Agreement; Class Action Waiver (U.S. Residents Only)" carefully.**

## How Long This Warranty Lasts

For non-commercial use, VIZIO warrants the product on the terms set forth below for one (1) year from the date of original purchase. For commercial use, VIZIO warrants this product on the terms set forth below for ninety (90) days from the date of original purchase.

## What This Warranty Covers

VIZIO warrants the product against defects in materials and workmanship when the product is used normally in accordance with VIZIO's user guides and manuals. Except where restricted by law, this warranty applies only to the original purchaser of a new product. The purchase must have been made from an authorized retailer in the United States (including Puerto Rico) or Canada. The product must also be located in the country where it was purchased at the time of warranty service.

## Zero Bright Pixel Defect Guarantee (Displays Only)

Your product may qualify for a warranty against "zero bright pixel" defects for the duration of the warranty on select new product purchases. To determine if this guarantee applies to your product, refer to the model's product information page at [www.vizio.com](http://www.vizio.com), look for the "zero bright pixel" guarantee on the box, or contact VIZIO Technical Support at the email address or telephone number below.

## How to Get Service

Before obtaining warranty service, you may visit [www.vizio.com](http://www.vizio.com) for additional help and troubleshooting. To obtain warranty service, contact VIZIO Technical Support via email at [TechSupport@VIZIO.com](mailto:TechSupport@VIZIO.com) or via phone at 877 MY VIZIO (877-698-4946).

## Your Obligations Before Service

You must obtain pre-authorization before sending your product to a VIZIO service center. You may be required to supply a purchase receipt (or copy) to show that the product is within the warranty period.

When you return a product to a VIZIO service center, you must ship the product in its original packaging or in packaging that affords an equal degree of protection. VIZIO Technical Support will provide instructions for packing and shipping the product to the VIZIO service center.

ALL USER DATA AND DOWNLOADED APPLICATIONS STORED ON A PRODUCT WILL BE DELETED IN THE COURSE OF SOME IN-HOME AND ALL SHIP-IN WARRANTY SERVICE. If this occurs, your product will be restored to its original state. You will be responsible for restoring all applicable user data and downloaded applications. Recovery and reinstallation of user data and downloaded applications is not covered under this warranty. In order to protect your personal information, VIZIO recommends that you always clear all personal information from the product before it is serviced, regardless of the servicer.

## VIZIO's Responsibilities

If VIZIO determines that a product is covered by this warranty, VIZIO will (at its option) repair or replace it, or refund the purchase price to you. There will be no charge for parts or labor during the warranty period. Replacement parts may be new or recertified at VIZIO's option and sole discretion. Replacement parts and VIZIO's labor are warranted for the remaining portion of the original warranty or for ninety (90) days from warranty service, whichever is longer.

## Types of Service

Displays that are 30 inches or larger will usually be repaired in-home. If in-home repair is not available, VIZIO will provide other service options. Displays that are 40 inches or larger may be eligible for in-home replacement if in-home repair is not available.

Both in-home repair and in-home replacement require complete and easy access to the product and neither includes de-installation or re-installation of the product. In-home repair and in-home replacement are subject to availability.

All other VIZIO products must be sent to a VIZIO service center to obtain warranty service. VIZIO is not responsible for transportation costs to the service center, but VIZIO will cover return shipping to the customer.

## What This Warranty Does Not Cover

This warranty does not cover: (a) cosmetic damage; (b) normal wear and tear; (c) improper operation; (d) improper voltage supply or power surges; (e) signal issues; (f) damage from shipping; (g) acts of God; (h) customer misuse, modifications or adjustments; (i) installation, set-up, or repairs attempted by anyone other than by a VIZIO authorized service center; (j) products with unreadable or removed serial

numbers; (k) products requiring routine maintenance; or (l) products sold "AS IS", "CLEARANCE", "FACTORY RECERTIFIED", or by a non-authorized reseller.

#### **What to Do If You Are Not Satisfied With Service**

If you feel VIZIO has not met its obligations under this warranty, you may attempt to resolve the issue informally with VIZIO. If you are unable to resolve the issue informally and wish to file a formal claim against VIZIO, and if you are a resident of the United States, you must submit your claim to binding arbitration according to the procedures described below, unless an exception applies. Submitting a claim to binding arbitration means that you do not have the right to have your claim heard by a judge or jury. Instead your claim will be heard by a neutral arbitrator.

#### **Binding Arbitration Agreement; Class Action Waiver (U.S. Residents Only)**

UNLESS YOU HAVE BROUGHT AN ELIGIBLE CLAIM IN SMALL CLAIMS COURT OR HAVE OPTED OUT AS DESCRIBED BELOW, ANY CONTROVERSY OR CLAIM RELATING IN ANY WAY TO YOUR VIZIO PRODUCT, INCLUDING ANY CONTROVERSY OR CLAIM ARISING OUT OF OR RELATING TO THIS WARRANTY, A BREACH OF THIS WARRANTY, OR THE VIZIO PRODUCT'S SALE, CONDITION OR PERFORMANCE, WILL BE SETTLED BY BINDING ARBITRATION ADMINISTERED BY THE AMERICAN ARBITRATION ASSOCIATION AND CONDUCTED BY A SINGLE ARBITRATOR APPOINTED BY THE AMERICAN ARBITRATION ASSOCIATION, IN ACCORDANCE WITH ITS COMMERCIAL ARBITRATION RULES AND ITS SUPPLEMENTARY PROCEDURES FOR CONSUMER-RELATED DISPUTES. You may learn more about the American Arbitration Association and its rules for arbitration by visiting [www.adr.org](http://www.adr.org) or by calling 800-778-7879. Since this warranty concerns a transaction in interstate or international commerce, the Federal Arbitration Act will apply.

The filing fees to begin and carry out arbitration will be shared between you and VIZIO, but in no event will your fees ever exceed the amount allowable by the American Arbitration Association, at which point VIZIO will cover all additional administrative fees and expenses. VIZIO waives its right to recover attorneys' fees in connection with any arbitration under this warranty. If you are the prevailing party in an arbitration to which the Supplementary Procedures for Consumer-Related Disputes applies, then you are entitled to recover attorneys' fees as the arbitrator may determine.

The dispute will be governed by the laws of the state or territory in which you resided at the time of your purchase (if in the United States). The place of arbitration will be Irvine, California, or your county of residence (if in the United States). The arbitrator will have no authority to award punitive or other damages not measured by the prevailing party's actual damages, except as may be required by statute. The arbitrator will not award consequential damages, and any award will be limited to monetary damages and will include no equitable relief, injunction, or direction to any party other than the direction to pay a monetary amount. Judgment on the award rendered by the arbitrator will be binding and final, except for any right of

appeal provided by the Federal Arbitration Act, and may be entered in any court having jurisdiction. Except as may be required by law, neither you nor VIZIO nor an arbitrator may disclose the existence, content, or results of any arbitration under this warranty without the prior written consent of you and VIZIO.

ANY DISPUTE, WHETHER IN ARBITRATION, IN COURT, OR OTHERWISE, WILL BE CONDUCTED SOLELY ON AN INDIVIDUAL BASIS. VIZIO AND YOU AGREE THAT NO PARTY WILL HAVE THE RIGHT OR AUTHORITY FOR ANY DISPUTE TO BE ARBITRATED AS A CLASS ACTION, A PRIVATE ATTORNEY GENERAL ACTION, OR IN ANY OTHER PROCEEDING IN WHICH EITHER PARTY ACTS OR PROPOSES TO ACT IN A REPRESENTATIVE CAPACITY.

NO ARBITRATION OR PROCEEDING WILL BE JOINED, CONSOLIDATED, OR COMBINED WITH ANOTHER ARBITRATION OR PROCEEDING WITHOUT THE PRIOR WRITTEN CONSENT OF ALL PARTIES TO ANY SUCH ARBITRATION OR PROCEEDING.

#### **Exceptions to Binding Arbitration Agreement and Class Action Waiver IF YOU DO NOT WISH TO BE BOUND BY THE BINDING ARBITRATION AGREEMENT AND CLASS ACTION WAIVER, THEN:**

(1) you must notify VIZIO in writing within sixty (60) days of the date that you purchased the product; (2) your written notification must be mailed to VIZIO at 39 Tesla, Irvine, CA 92618, Attn: Legal Department; and (3) your written notification must include (a) your name, (b) your address, (c) the date you purchased the product, and (d) a clear statement that you wish to opt out of the binding arbitration agreement and class action waiver. In addition, you may pursue a claim in small claims court in your county of residence (if in the United States) or in Orange County, California. In such case the provisions of the section titled "Binding Arbitration Agreement; Class Action Waiver (U.S. Residents)" will not apply.

#### **Exclusions and Limitations**

TO THE GREATEST EXTENT PERMITTED BY APPLICABLE LAW, THERE ARE NO EXPRESS WARRANTIES OTHER THAN THOSE DESCRIBED ABOVE. ANY IMPLIED WARRANTIES, INCLUDING ANY IMPLIED WARRANTY OF MERCHANTABILITY AND FITNESS FOR A PARTICULAR PURPOSE, WILL BE LIMITED IN DURATION TO THE WARRANTY PERIOD SET FORTH ABOVE. SOME STATES AND PROVINCES DO NOT ALLOW LIMITATIONS ON HOW LONG AN IMPLIED WARRANTY LASTS, SO THE ABOVE LIMITATION MAY NOT APPLY TO YOU.

VIZIO WILL NOT BE RESPONSIBLE FOR LOSS OF USE, LOSS OF INFORMATION OR DATA, COMMERCIAL LOSS, LOST REVENUE OR LOST PROFITS, OR OTHER INDIRECT, SPECIAL, INCIDENTAL OR CONSEQUENTIAL DAMAGES, EVEN IF VIZIO HAS BEEN ADVISED OF THE POSSIBILITY OF SUCH DAMAGES, AND EVEN IF THE REMEDY FAILS OF ITS ESSENTIAL PURPOSE. SOME STATES AND PROVINCES DO NOT ALLOW THE EXCLUSION OR LIMITATION OF INCIDENTAL OR CONSEQUENTIAL DAMAGES, SO THE ABOVE LIMITATION OR EXCLUSION MAY NOT APPLY TO YOU. IN LIEU OF ANY OTHER REMEDY FOR ANY AND ALL LOSSES AND DAMAGES

RESULTING FROM ANY CAUSE WHATSOEVER (INCLUDING VIZIO'S NEGLIGENCE, ALLEGED DAMAGE, OR DEFECTIVE GOODS, NO MATTER WHETHER SUCH DEFECTS ARE DISCOVERABLE OR LATENT), VIZIO MAY, AT ITS SOLE AND EXCLUSIVE OPTION AND IN ITS DISCRETION, REPAIR OR REPLACE YOUR PRODUCT, OR REFUND ITS PURCHASE PRICE. AS NOTED, SOME STATES AND PROVINCES DO NOT ALLOW THE EXCLUSION OR LIMITATION OF INCIDENTAL OR CONSEQUENTIAL DAMAGES, SO THE ABOVE LIMITATION OR EXCLUSION MAY NOT APPLY TO YOU.

#### How the Law Applies

This warranty gives you specific legal rights, and you may also have other rights, which vary from state to state and province to province. This warranty applies to the greatest extent permitted by applicable law.

#### General

No employee or agent of VIZIO may modify this warranty. If any term of this warranty, other than the class action waiver, is found to be unenforceable, that term will be severed from this warranty and all other terms will remain in effect. If the class action waiver is found to be unenforceable, then the entire section titled "Binding Arbitration Agreement; Class Action Waiver (U.S. Residents Only)" will not apply. This warranty applies to the maximum extent not prohibited by law.

#### Changes to Warranty

This warranty may change without notice, but any change will not affect your original warranty. Check [www.vizio.com](http://www.vizio.com) for the most current version.

## Specifications

**Sound Bar:** One 1.61" x 2.24" Full Range Driver for each channel (1 for left, 1 for right)

**Subwoofer:** One 4.5" Driver

**Inputs:** One 3.5mm Stereo Audio  
One Optical (Toslink)  
One Digital Coaxial Audio  
Bluetooth (Wireless)  
One USB

**Sound Pressure Level (System):** 95 dB

**Frequency Response (System):** 50 Hz - 20 KHz

**Voltage:** 120 VAC, 60 Hz

**Compliances:** UL60065 ,FCC Class B, ICES-003 , Energy star

# LEGAL & COMPLIANCE

## **FCC Class B Radio Interference Statement**

NOTE: This equipment has been tested and found to comply with the limits for a Class B digital device, pursuant to Part 15 of the FCC Rules. These limits are designed to provide reasonable protection against harmful interference in a residential installation. This equipment generates, uses and can radiate radio frequency energy, and if not installed and used in accordance with the instructions, may cause harmful interference to radio communications. However, there is no guarantee that interference will not occur in a particular installation. If this equipment does cause harmful interference to radio or television reception, which can be determined by turning the equipment off and on, the user is encouraged to try to correct the interference by one or more of the following measures:

1. Reorient or relocate the receiving antenna.
2. Increase the separation between the equipment and receiver.
3. Connect the equipment into an outlet on a circuit different from that to which the receiver is connected.
4. Consult the dealer or an experienced radio/TV technician for help.

This device complies with Part 15 of the FCC Rules. Operation is subject to the following two conditions: (1) this device may not cause harmful interference, and (2) this device must accept any interference received, including interference that may cause undesired operation.

## **Notice:**

1. Any Changes or modifications not expressly approved by the party responsible for compliance could void the user's authority to operate the equipment.
2. Shielded interface cables and AC power cord, if any, must be used in order to comply with the emission limits.
3. The manufacturer is not responsible for any radio or TV interference caused by unauthorized modification to this equipment. It is the responsibilities of the user to correct such interference.

## **FCC RF Radiation Exposure Statement**

1. This transmitter must not be collocated or operating in conjunction with any other antenna or transmitter.
2. This equipment complies with FCC radiation exposure limits set forth for an uncontrolled environment. This equipment should be installed and operated with minimum distance 20cm between the radiator & your body.

## **IC Statement**

1. This device contains licence-exempt transmitter(s)/receiver(s) that comply with Innovation, Science and Economic Development Canada's licence-exempt RSS(s).
  - (1) this device may not cause interference, and
  - (2) this device must accept any interference, including interference that may cause undesired operation of the device.
2. Changes or modifications not expressly approved by the party responsible for compliance could void the user's authority to operate the equipment.

**IC Radiation Exposure Statement**

This equipment complies with IC RSS-102 radiation exposure limits set forth for an uncontrolled environment. This equipment should be installed and operated with minimum distance 20cm between the radiator & your body.

**Battery Disposal and Recycling**

You must dispose of this product properly, according to local laws and regulations. Because this product contains electronic components and/or a battery, it must be disposed of separately from household waste. Contact local authorities to learn about disposal and recycling options. For more information, visit [www.vizio.com/environment](http://www.vizio.com/environment).

**Software Licenses**

All software is provided subject to software license agreements and you agree that you will be bound by such license agreements in addition to other applicable terms of use. By using the VIZIO products, you agree to the VIZIO Terms of Service and Privacy Policy, as well as Google's Terms of Service and Privacy Policy. The VIZIO Terms of Use and Privacy Policy may be updated from time to time and are available to view at <http://www.vizio.com/terms> and <http://www.vizio.com/privacy>, respectively.

**Export Regulations**

Customer acknowledges that the VIZIO products, which include technology and software, are subject to customs and export control laws in the United States ("US"). The products may also be subject to the customs and export control laws and regulations of the country in which the products are manufactured and/or received.

The applications and content of the applications pictured herein or described in accompanying documentation may only be available in certain countries or languages, may require additional fees or subscription charges, and may be subject to future updates, modifications or discontinuation without notice. VIZIO has no control over third party applications or content and assumes no responsibility for the availability or interruption of such applications or content. Additional third party terms, conditions and restrictions apply. A Google account is required to download applications from the Google Play store. A MyVIZIO account is required to access certain features of the VIZIO SmartCast app. Information in this User Manual is subject to change without notice. To review the most updated version of this User Manual and the associated Quick Start Guide, go to <http://www.vizio.com>.

© 2019 VIZIO, Inc. All Right Reserved.

Image(s) used under license from Shutterstock.com

This User Manual may not be copied in whole or in part without the written permission of VIZIO, Inc. VIZIO, Inc. has made reasonable efforts to ensure the accuracy of the information provided herein. If product specifications, functionality, features, configurations, performance, design and other product information described herein are subject to change without notice. VIZIO, Inc. is not responsible for typographical, technical, or descriptive errors.

VIZIO, the VIZIO logo, the V logo, and other terms and phrases are trademarks or registered trademarks of VIZIO, Inc.

Sound pressure level measured using pink noise at 1 meter, c-weighted.



Manufactured under license from Dolby Laboratories. Dolby, Dolby Audio and the double-D symbol are trademarks of Dolby Laboratories.



The Bluetooth® word mark and Logos are registered trademark owned by Bluetooth SIG, Inc. and any use of such marks by VIZIO, Inc. is under license. Other trademarks and trade names are those of their respective owners.



For DTS patents, see <http://patents.dts.com>. Manufactured under license from DTS, Inc. DTS, the Symbol, DTS and the Symbol together, and TruVolume are registered trademarks or trademarks of DTS, Inc. in the United States and/or other countries. ©DTS, Inc. All Rights Reserved.



For DTS patents, see <http://patents.dts.com>. Manufactured under license from DTS, Inc. DTS, the Symbol, DTS and the Symbol together, Virtual:X, and the DTS Virtual:X logo are registered trademarks or trademarks of DTS, Inc. in the United States and/or other countries. ©DTS, Inc. All Rights Reserved.



This product qualifies for ENERGY STAR in the “factory default” setting and this is the setting in which power savings will be achieved. Changing the factory default settings or enabling other features will increase power consumption that could exceed the limits necessary to qualify for ENERGY STAR rating. We want to help you save energy.



**© 2019 VIZIO INC. ALL RIGHTS RESERVED.  
191021SL**