

FCC Radio Test Report

FCC ID: XMF-MID1008

FCC Class II Permissive Change

Report No. : TB-FCC145089
Applicant : Lightcomm Technology Co., Ltd.
Equipment Under Test (EUT)
EUT Name : MID
Model No. : MID1008-L
Series Model No. : DL1010Q, DL1008M
Brand Name : N/A
Receipt Date : 2015-08-12
Test Date : 2015-08-12 to 2015-08-17
Issue Date : 2015-08-18
Standards : FCC Part 15: 2014, Subpart C(15.247)
Test Method : ANSI C63.10:2013
Conclusions : **PASS**

In the configuration tested, the EUT complied with the standards specified above,
The EUT technically complies with the FCC and IC requirements

Test/Witness Engineer :

Ivan Su

Approved & Authorized :

Ray Lai



This report details the results of the testing carried out on one sample. The results contained in this test report do not relate to other samples of the same product. The manufacturer should ensure that all products in series production are in conformity with the product sample detailed in the report.

Contents

CONTENTS	2
1. GENERAL INFORMATION ABOUT EUT	3
1.1 Client Information.....	3
1.2 General Description of EUT (Equipment Under Test)	3
1.3 Block Diagram Showing the Configuration of System Tested.....	4
1.4 Description of Support Units	4
1.5 Description of Test Mode.....	5
1.6 Description of Test Software Setting	5
1.7 Measurement Uncertainty	6
1.8 Test Facility.....	6
2. TEST SUMMARY	7
3. TEST EQUIPMENT	8
4. CONDUCTED EMISSION TEST	9
4.1 Test Standard and Limit.....	9
4.2 Test Setup.....	9
4.3 Test Procedure.....	9
4.4 EUT Operating Mode	10
4.5 Test Data.....	10
5. RADIATED EMISSION TEST	15
5.1 Test Standard and Limit.....	15
5.2 Test Setup.....	16
5.3 Test Procedure.....	17
5.4 EUT Operating Condition	17
5.5 Test Data.....	18
6. RESTRICTED BANDS REQUIREMENT	27
6.1 Test Standard and Limit.....	27
6.2 Test Setup.....	27
6.3 Test Procedure.....	27
6.4 EUT Operating Condition	28
6.5 Test Data.....	28
7. ANTENNA REQUIREMENT	33
7.1 Standard Requirement.....	33
7.2 Antenna Connected Construction	33

1. General Information about EUT

1.1 Client Information

Applicant : Lightcomm Technology Co., Ltd.
Address : RM 1708-10, 17/F, PROSPERITY CENTRE, 25 CHONG YIP STREET, KWUN TONG, KOWLOON, HONG KONG
Manufacturer : Huizhou Hengdu Electronics Co., Ltd.
Address : DIP South Area, Huiao Highway, Huizhou, Guangdong, China

1.2 General Description of EUT (Equipment Under Test)

EUT Name	:	MID
Models No.	:	MID1008-L, DL1010Q, DL1008M
Model Difference	:	All the other models are identical in the same PCB layout, interior structure and electrical circuits, The only difference is model name for commercial purpose.
Product Description	:	Operation Frequency: 2402MHz~2480MHz
	:	Number of Channel: Bluetooth 4.0 (BLE): 40 channels see note(3)
	:	RF Output Power: -4.171 dBm Conducted Power
	:	Antenna Gain: 0 dBi FPC Antenna
	:	Modulation Type: GFSK
	:	Bit Rate of Transmitter: 1Mbps(GFSK)
Power Supply	:	DC power supplied by AC/DC Adapter DC Voltage supplied from Li-Polymer battery.
Power Rating	:	USB DC 5V form PC. AC/DC Adapter(TEKA012-0502000UK): Input: AC 100~240V 50/60Hz 0.35A Max. Output: DC 5V 2.0A DC 3.7V 5000mAh from Li-Polymer battery
Connecting I/O Port(S)	:	The equipent have USB port for link with PC, so the equipment is considered as a Computing Device Peripheral. Please refer to the User's Manual

Note:

- (1) This Test Report is FCC Part 15.247 for Bluetooth BLE, the test procedure follows the FCC KDB 558074 D01 DTS Meas Guidance v03r03.
- (2) For a more detailed features description, please refer to the manufacturer's specifications or the User's Manual.
- (3) Antenna information provided by the applicant.
- (4) Channel List:

Channel	Frequency (MHz)	Channel	Frequency (MHz)	Channel	Frequency (MHz)
00	2402	14	2430	28	2458
01	2404	15	2432	29	2460
02	2406	16	2434	30	2462
03	2408	17	2436	31	2464
04	2410	18	2438	32	2466
05	2412	19	2440	33	2468
06	2414	20	2442	34	2470
07	2416	21	2444	35	2472
08	2418	22	2446	36	2474
09	2420	23	2448	37	2476
10	2422	24	2450	38	2478
11	2424	25	2452	39	2480
12	2426	26	2454		
13	2428	27	2456		

1.3 Block Diagram Showing the Configuration of System Tested

TX Mode

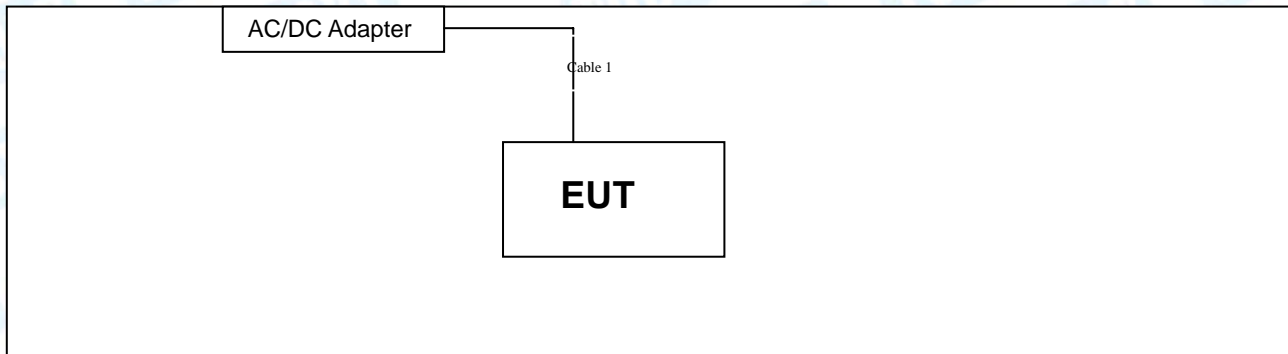

1.4 Description of Support Units

Equipment Information				
Name	Model	S/N	Manufacturer	Used “√”
Cable Information				
Number	Shielded Type	Ferrite Core	Length	Note
Cable 1	NO	NO	1.0M	Accessories

1.5 Description of Test Mode

To investigate the maximum EMI emission characteristics generates from EUT, the test system was pre-scanning tested base on the consideration of following EUT operation mode or test configuration mode which possible have effect on EMI emission level. Each of these EUT operation mode(s) or test configuration mode(s) mentioned follow was evaluated respectively.

For Conducted Test	
Final Test Mode	Description
Mode 1	AC Charging with TX Mode

For Radiated Test	
Final Test Mode	Description
Mode 2	AC Charging with TX Mode
Mode 3	AC Charging with TX Mode (Channel 01/20/39)

Note:

- (1) For all test, we have verified the construction and function in typical operation. And all the test modes were carried out with the EUT in transmitting operation in maximum power with all kinds of data rate.
According to ANSI C63.10 standards, the measurements are performed at the highest, middle, lowest available channels, and the worst case data rate as follows:
Bluetooth BLE Mode: GFSK Modulation Transmitting mode.
- (2) During the testing procedure, the continuously transmitting with the maximum power mode was programmed by the customer.
- (3) The EUT is considered a mobile unit; in normal use it was positioned on X-plane. The worst case was found positioned on X-plane. Therefore only the test data of this X-plane was used for radiated emission measurement test.

1.6 Description of Test Software Setting

During testing channel& Power controlling software provided by the customer was used to control the operating channel as well as the output power level. The RF output power selection is for the setting of RF output power expected by the customer and is going to be fixed on the firmware of the final end product power parameters of RF setting.

Test Software Version	Test Program: MTK Engineer Mode Open. apk		
Channel	CH 01	CH 20	CH 39
BLE Mode	DEF	DEF	DEF

1.7 Measurement Uncertainty

The reported uncertainty of measurement $y \pm U$, where expanded uncertainty U is based on a standard uncertainty multiplied by a coverage factor of $k=2$, providing a level of confidence of approximately 95 %.

Test Item	Parameters	Expanded Uncertainty (U_{Lab})
Conducted Emission	Level Accuracy: 9kHz~150kHz	± 3.42 dB
	150kHz to 30MHz	± 3.42 dB
Radiated Emission	Level Accuracy: 9kHz to 30 MHz	± 4.60 dB
Radiated Emission	Level Accuracy: 30MHz to 1000 MHz	± 4.40 dB
Radiated Emission	Level Accuracy: Above 1000MHz	± 4.20 dB

1.8 Test Facility

The testing report were performed by the Shenzhen Toby Technology Co., Ltd., in their facilities located at 1A/F., Bldg.6, Yusheng Industrial Zone, The National Road No.107 Xixiang Section 467, Xixiang, Bao'an, Shenzhen, Guangdong, China. At the time of testing, the following bodies accredited the Laboratory:

CNAS (L5813)

The Laboratory has been accredited by CNAS to ISO/IEC 17025: 2005 General Requirements for the Competence of Testing and Calibration Laboratories for the competence in the field of testing. And the Registration No.: CNAS L5813.

FCC List No.: (811562)

The Laboratory is listed in the United States of American Federal Communications Commission (FCC), and the registration number is 811562.

IC Registration No.: (11950A-1)

The Laboratory has been registered by Certification and Engineering Bureau of Industry Canada for radio equipment testing. The site registration: Site# 11950A-1.

May 22, 2014 certificated by TUV Rheinland(China) Co., Ltd. with TUV certificate No.: UA 50282953 0001 and report No.: 17026822 002. The certificate is valid until the next scheduled audit or up to 18 months, at the discretion of TUV Rhineland.

2. Test Summary

FCC Part 15 Subpart C(15.247)/ RSS 247 Issue 1				
Standard Section		Test Item	Judgment	Remark
FCC	IC			
15.203	/	Antenna Requirement	PASS	N/A
15.207	RSS-GEN 7.2.4	Conducted Emission	PASS	N/A Note(3)
15.205	RSS-GEN 7.2.2	Restricted Bands	PASS	N/A
15.247(a)(2)	RSS 247 5.2 (1)	6dB Bandwidth	PASS	N/A Note(3)
15.247(b)	RSS 247 5.4 (4)	Peak Output Power	PASS	N/A Note(3)
15.247(e)	RSS 247 5.2 (2)	Power Spectral Density	PASS	N/A Note(3)
15.247(d)	RSS 247 5.5	Transmitter Radiated Spurious Emission	PASS	N/A

Note (1): "/" for no requirement for this test item.
 (2): N/A is an abbreviation for Not Applicable.
 (3): This report is Class II change report for the original equipment have changed, the transmitter module itself has not changed. More information about the test data please refer to the original test report.

3. Test Equipment

Conducted Emission Test					
Equipment	Manufacturer	Model No.	Serial No.	Last Cal.	Cal. Due Date
EMI Test Receiver	Rohde & Schwarz	ESCI	100321	Aug. 07, 2015	Aug. 06, 2016
RF Switching Unit	Compliance Direction Systems Inc	RSU-A4	34403	Aug. 07, 2015	Aug. 06, 2016
AMN	SCHWARZBECK	NNBL 8226-2	8226-2/164	Aug. 07, 2015	Aug. 06, 2016
LISN	Rohde & Schwarz	ENV216	101131	Aug. 07, 2015	Aug. 06, 2016
Radiation Emission Test					
Equipment	Manufacturer	Model No.	Serial No.	Last Cal.	Cal. Due Date
Spectrum Analyzer	Agilent	E4407B	MY45106456	Sep. 01, 2014	Aug. 31, 2015
EMI Test Receiver	Rohde & Schwarz	ESCI	100010/007	Aug. 07, 2015	Aug. 06, 2016
Bilog Antenna	ETS-LINDGREN	3142E	00117537	Mar. 28, 2015	Mar. 27, 2016
Bilog Antenna	ETS-LINDGREN	3142E	00117542	Mar. 28, 2015	Mar. 27, 2016
Horn Antenna	ETS-LINDGREN	3117	00143207	Mar. 28, 2015	Mar. 27, 2016
Horn Antenna	ETS-LINDGREN	3117	00143209	Mar. 28, 2015	Mar. 27, 2016
Pre-amplifier	Sonoma	310N	185903	Mar. 28, 2015	Mar. 27, 2016
Pre-amplifier	HP	8447B	3008A00849	Mar. 28, 2015	Mar. 27, 2016
Cable	HUBER+SUHNER	100	SUCOFLEX	Mar. 28, 2015	Mar. 27, 2016
Positioning Controller	ETS-LINDGREN	2090	N/A	N/A	N/A

4. Conducted Emission Test

4.1 Test Standard and Limit

4.1.1 Test Standard

FCC Part 15.207

4.1.2 Test Limit

Conducted Emission Test Limit

Frequency	Maximum RF Line Voltage (dB μ V)	
	Quasi-peak Level	Average Level
150kHz~500kHz	66 ~ 56 *	56 ~ 46 *
500kHz~5MHz	56	46
5MHz~30MHz	60	50

Notes:

(1) *Decreasing linearly with logarithm of the frequency.

(2) The lower limit shall apply at the transition frequencies.

(3) The limit decrease in line with the logarithm of the frequency in the range of 0.15 to 0.50MHz.

4.2 Test Setup

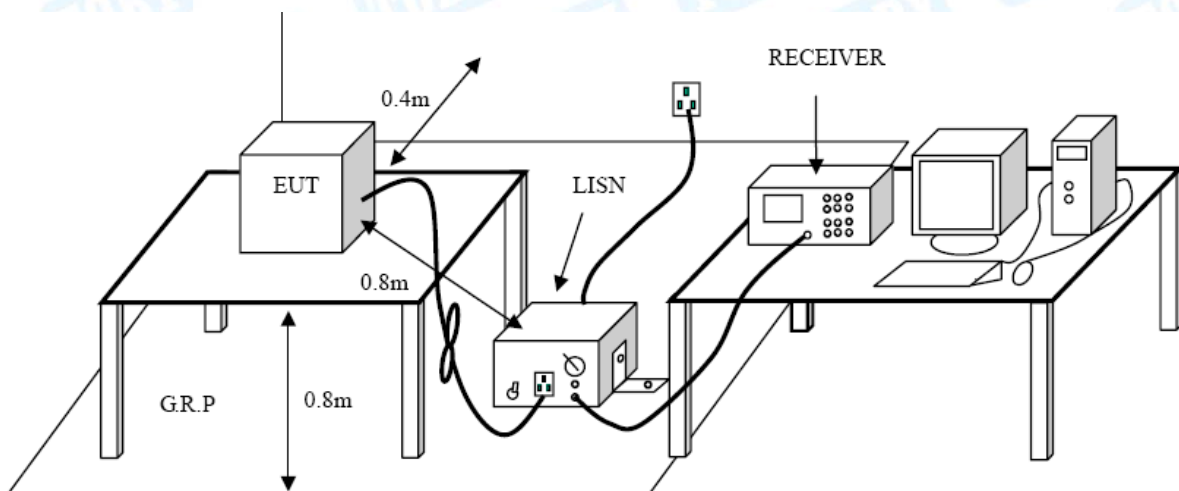

4.3 Test Procedure

The EUT was placed 0.8 meters from the horizontal ground plane with EUT being connected to the power mains through a line impedance stabilization network (LISN). All other support equipments powered from additional LISN(s). The LISN provide 50 Ohm/ 50uH of coupling impedance for the measuring instrument.

Interconnecting cables that hang closer than 40 cm to the ground plane shall be folded back and forth in the center forming a bundle 30 to 40 cm long.

I/O cables that are not connected to a peripheral shall be bundled in the center. The end of the cable may be terminated, if required, using the correct terminating impedance. The overall length shall not exceed 1 m.

LISN at least 80 cm from nearest part of EUT chassis.

The bandwidth of EMI test receiver is set at 9kHz, and the test frequency band is from 0.15MHz to 30MHz.

4.4 EUT Operating Mode

Please refer to the description of test mode.

4.5 Test Data

Please see the next page.

EUT:	MID	Model:	MID1008-L
Temperature:	25 °C	Relative Humidity:	55%
Test Voltage:	AC 240V/60 Hz		
Terminal:	Line		
Test Mode:	AC Charging with BLE TX 2402 MHz		
Remark:	Only worse case is reported		

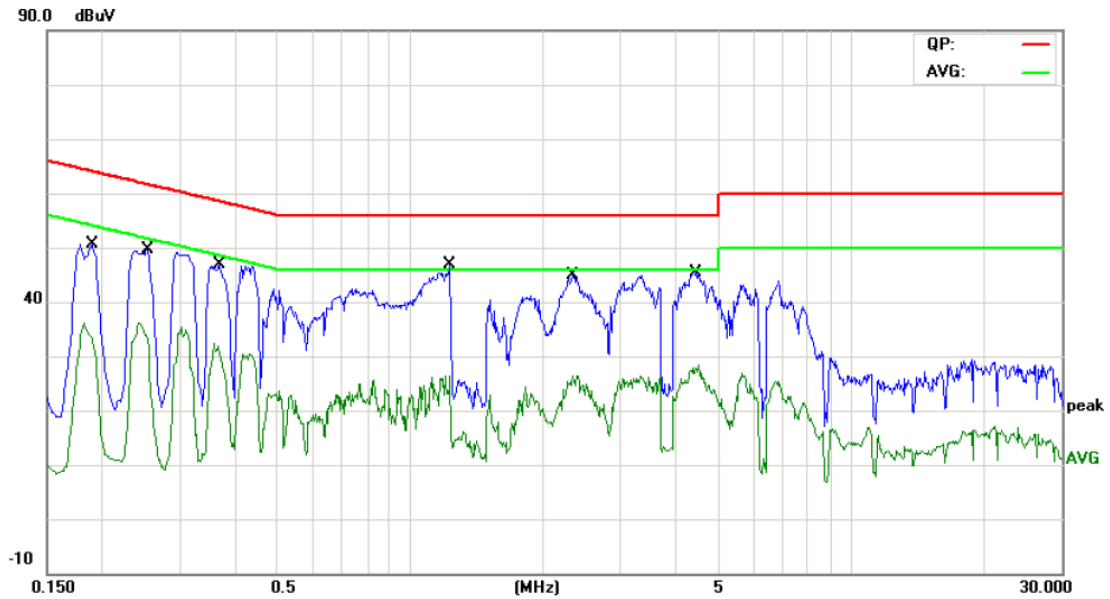

No.	Mk.	Freq. MHz	Reading Level dBuV	Correct Factor dB	Measure- ment dBuV	Limit dBuV	Over dB	Detector
1		0.1900	40.61	10.12	50.73	64.03	-13.30	QP
2		0.1900	22.79	10.12	32.91	54.03	-21.12	AVG
3		0.2540	39.58	10.10	49.68	61.62	-11.94	QP
4		0.2540	23.18	10.10	33.28	51.62	-18.34	AVG
5		0.3699	36.73	10.06	46.79	58.50	-11.71	QP
6		0.3699	20.64	10.06	30.70	48.50	-17.80	AVG
7	*	1.2338	36.73	10.14	46.87	56.00	-9.13	QP
8		1.2338	16.11	10.14	26.25	46.00	-19.75	AVG
9		2.3420	34.72	10.06	44.78	56.00	-11.22	QP
10		2.3420	16.29	10.06	26.35	46.00	-19.65	AVG
11		4.4499	35.42	10.06	45.48	56.00	-10.52	QP
12		4.4499	17.83	10.06	27.89	46.00	-18.11	AVG

*:Maximum data x:Over limit !:over margin

Emission Level= Read Level+ Correct Factor

EUT:	MID	Model:	MID1008-L
Temperature:	25 °C	Relative Humidity:	55%
Test Voltage:	AC 240V/60 Hz		
Terminal:	Neutral		
Test Mode:	AC Charging with BLE TX 2402 MHz		
Remark:	Only worse case is reported		

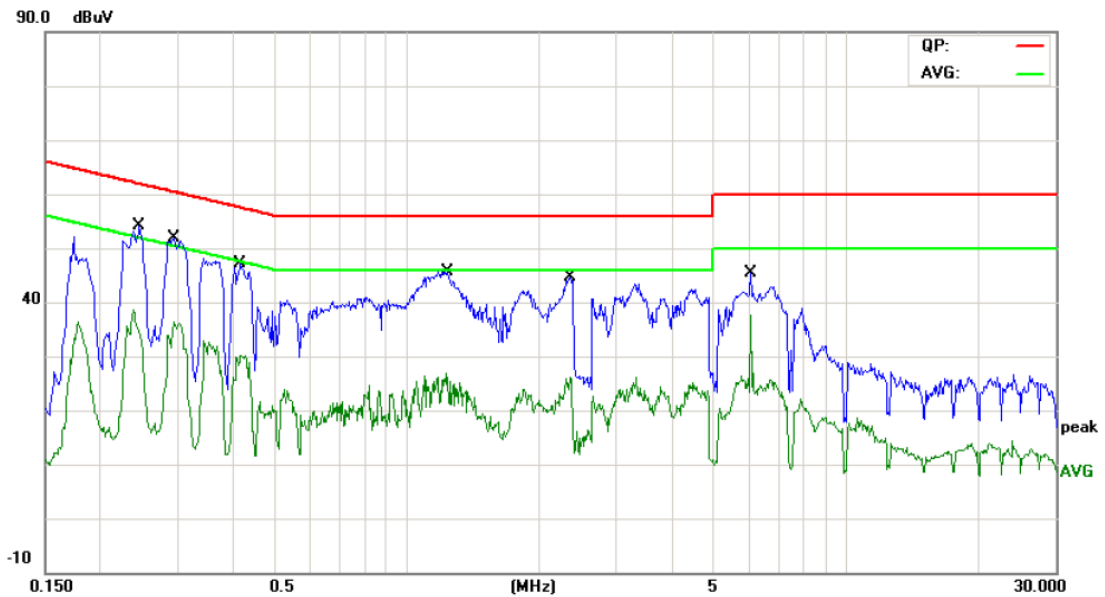

No.	Mk.	Freq. MHz	Reading Level dBuV	Correct Factor dB	Measure- ment dBuV	Limit dBuV	Over dB	Detector
1	*	0.2459	44.03	10.02	54.05	61.89	-7.84	QP
2		0.2459	24.64	10.02	34.66	51.89	-17.23	AVG
3		0.2938	41.89	10.02	51.91	60.41	-8.50	QP
4		0.2938	26.26	10.02	36.28	50.41	-14.13	AVG
5		0.4178	37.08	10.02	47.10	57.49	-10.39	QP
6		0.4178	20.07	10.02	30.09	47.49	-17.40	AVG
7		1.2419	35.56	10.06	45.62	56.00	-10.38	QP
8		1.2419	15.61	10.06	25.67	46.00	-20.33	AVG
9		2.3580	34.68	10.05	44.73	56.00	-11.27	QP
10		2.3580	16.18	10.05	26.23	46.00	-19.77	AVG
11		6.0658	35.25	10.01	45.26	60.00	-14.74	QP
12		6.0658	27.72	10.01	37.73	50.00	-12.27	AVG

*:Maximum data x:Over limit !:over margin

Emission Level= Read Level+ Correct Factor

EUT:	MID	Model:	MID1008-L
Temperature:	25 °C	Relative Humidity:	55%
Test Voltage:	AC 120V/60 Hz		
Terminal:	Line		
Test Mode:	AC Charging with BLE TX 2402 MHz		
Remark:	Only worse case is reported		

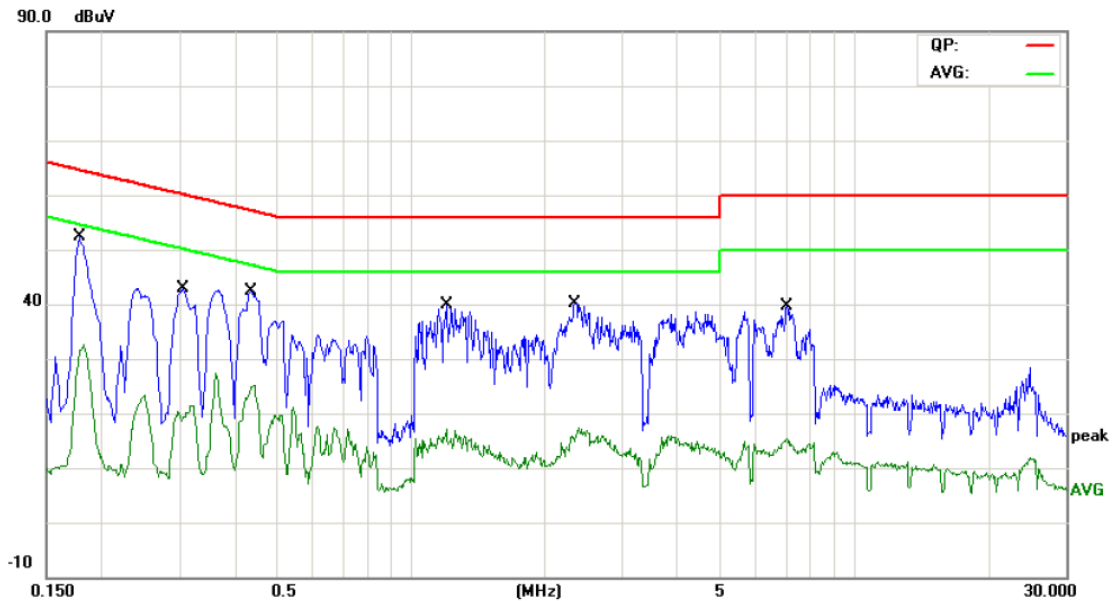

No.	Mk.	Freq. MHz	Reading Level dBuV	Correct Factor dB	Measure- ment dBuV	Limit dBuV	Over dB	Detector
1	*	0.1796	41.30	9.98	51.28	64.50	-13.22	QP
2		0.1796	21.65	9.98	31.63	54.50	-22.87	AVG
3		0.3060	32.96	10.02	42.98	60.08	-17.10	QP
4		0.3060	9.35	10.02	19.37	50.08	-30.71	AVG
5		0.4340	32.47	10.02	42.49	57.18	-14.69	QP
6		0.4340	14.81	10.02	24.83	47.18	-22.35	AVG
7		1.2020	29.80	10.06	39.86	56.00	-16.14	QP
8		1.2059	5.36	10.06	15.42	46.00	-30.58	AVG
9		2.3340	30.20	10.05	40.25	56.00	-15.75	QP
10		2.3340	4.79	10.05	14.84	46.00	-31.16	AVG
11		7.0259	29.60	10.06	39.66	60.00	-20.34	QP
12		7.0259	5.21	10.06	15.27	50.00	-34.73	AVG

*:Maximum data x:Over limit !:over margin

Emission Level= Read Level+ Correct Factor

EUT:	MID	Model:	MID1008-L
Temperature:	25 °C	Relative Humidity:	55%
Test Voltage:	AC 120V/60 Hz		
Terminal:	Neutral		
Test Mode:	AC Charging with BLE TX 2402 MHz		
Remark:	Only worse case is reported		

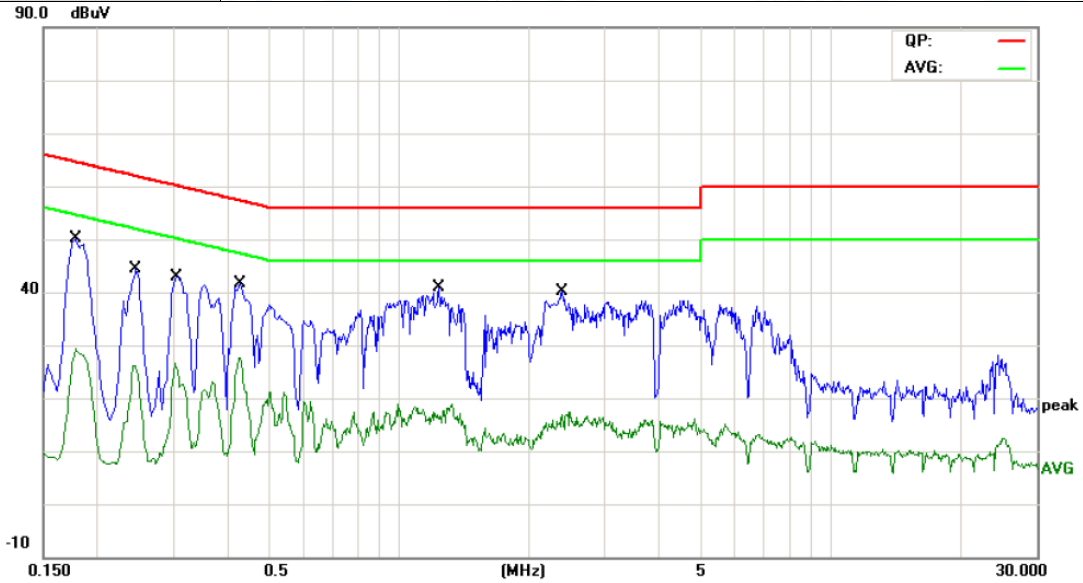

No.	Mk.	Freq. MHz	Reading Level dBuV	Correct Factor dB	Measure- ment dBuV	Limit dBuV	Over dB	Detector
1	*	0.1780	40.22	9.98	50.20	64.57	-14.37	QP
2		0.1780	19.14	9.98	29.12	54.57	-25.45	AVG
3		0.2460	34.29	10.02	44.31	61.89	-17.58	QP
4		0.2460	15.96	10.02	25.98	51.89	-25.91	AVG
5		0.3060	32.85	10.02	42.87	60.08	-17.21	QP
6		0.3060	15.86	10.02	25.88	50.08	-24.20	AVG
7		0.4300	31.66	10.02	41.68	57.25	-15.57	QP
8		0.4300	17.51	10.02	27.53	47.25	-19.72	AVG
9		1.2380	30.84	10.06	40.90	56.00	-15.10	QP
10		1.2380	5.98	10.06	16.04	46.00	-29.96	AVG
11		2.3860	30.15	10.05	40.20	56.00	-15.80	QP
12		2.3860	6.73	10.05	16.78	46.00	-29.22	AVG

*:Maximum data x:Over limit !:over margin

Emission Level= Read Level+ Correct Factor

5. Radiated Emission Test

5.1 Test Standard and Limit

5.1.1 Test Standard

FCC Part 15.209

5.1.2 Test Limit

Radiated Emission Limits (9kHz~1000MHz)

Frequency (MHz)	Field Strength (microvolt/meter)	Measurement Distance (meters)
0.009~0.490	2400/F(KHz)	300
0.490~1.705	24000/F(KHz)	30
1.705~30.0	30	30
30~88	100	3
88~216	150	3
216~960	200	3
Above 960	500	3

Radiated Emission Limit (Above 1000MHz)

Frequency (MHz)	Class A (dBuV/m)(at 3 M)		Class B (dBuV/m)(at 3 M)	
	Peak	Average	Peak	Average
Above 1000	80	60	74	54

Note:

- (1) The tighter limit applies at the band edges.
- (2) Emission Level(dBuV/m)=20log Emission Level(uV/m)

4.2 Test Setup

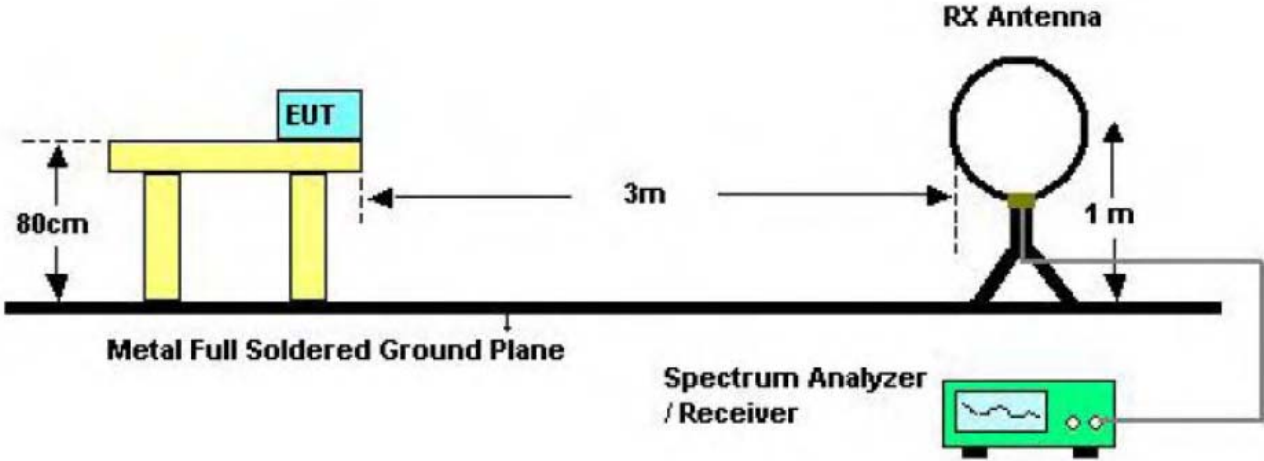

Below 30MHz Test Setup

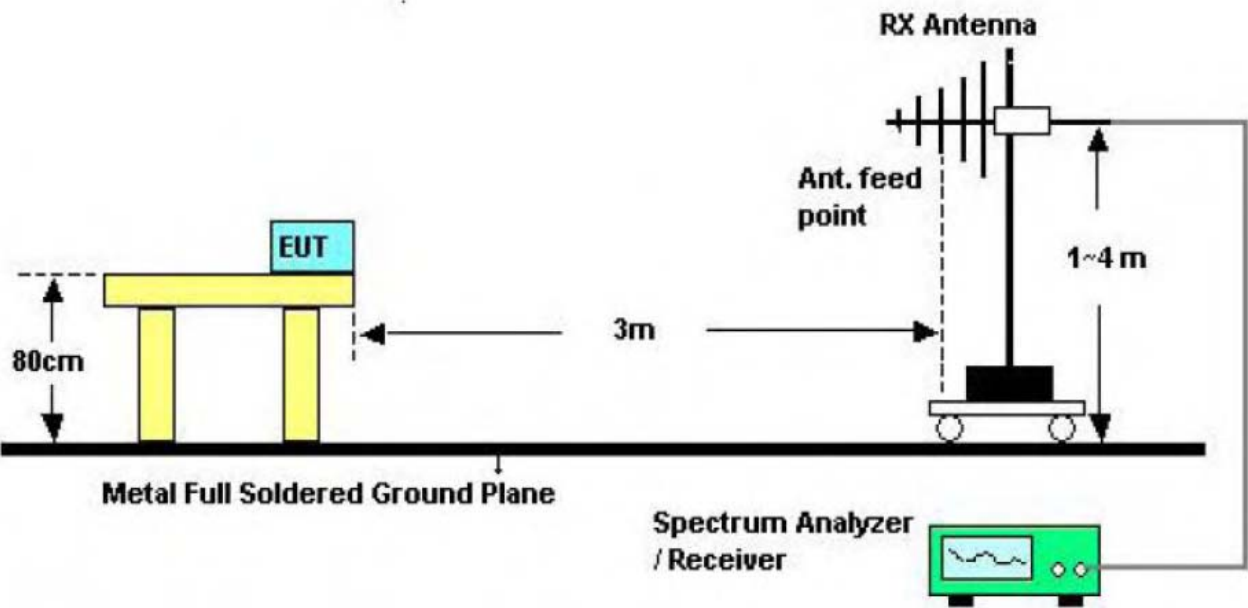

Below 1000MHz Test Setup

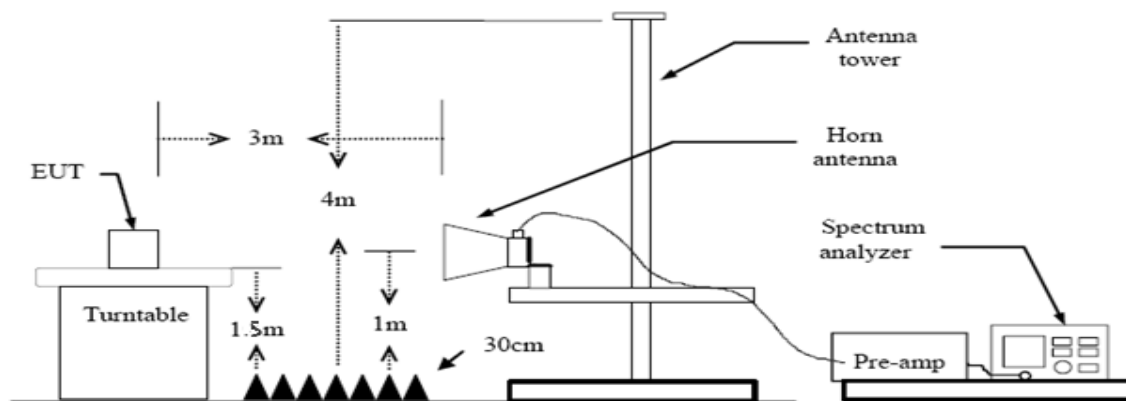

Above 1GHz Test Setup

5.3 Test Procedure

- (1) The measuring distance of 3m shall be used for measurements at frequency up to 1GHz. The EUT was placed on a rotating 0.8m high above the ground, the table was rotated 360 degrees to determine the position of the highest radiation.
- (2) Measurements at frequency above 1GHz. The EUT was placed on a rotating 1.5m high above the ground. RF absorbers covered the ground plane with a minimum area of 3.0m by 3.0m between the EUT and measurement receiver antenna. The RF absorber shall not exceed 30cm in high above the conducting floor. The table was rotated 360 degrees to determine the position of the highest radiation.
- (3) The Test antenna shall vary between 1m and 4m, Both Horizontal and Vertical antenna are set to make measurement.
- (4) The initial step in collecting conducted emission data is a spectrum analyzer peak detector mode pre-scanning the measurement frequency range. Significant peaks are then marked and then Quasi Peak detector mode re-measured.
- (5) If the Peak Mode measured value compliance with and lower than Quasi Peak Mode Limit Bellow 1 GHz, the EUT shall be deemed to meet QP Limits and then no additional QP Mode measurement performed. But the Peak Value and average value both need to comply with applicable limit above 1 GHz.
- (6) Testing frequency range below 1GHz the measuring instrument use VBW=120 kHz with Quasi-peak detection.
- (7) Testing frequency range above 1GHz the measuring instrument use RBW=1 MHz and VBW=3 MHz with Peak Detector for Peak Values, and use RBW=1 MHz and VBW=10 Hz with Peak Detector for Average Values.
- (8) For the actual test configuration, please see the test setup photo.

5.4 EUT Operating Condition

The Equipment Under Test was set to Continual Transmitting in maximum power.

5.5 Test Data

Remark: During testing above 1GHz the measuring instrument use RBW=1 MHz and VBW=3 MHz with Peak Detector for Peak Values, and use RBW=1 MHz and VBW=1 kHz with Peak Detector for Average Values.

Test data please refer the following pages.

EUT:	MID	Model:	MID1008-L
Temperature:	25 °C	Relative Humidity:	55%
Test Voltage:	AC 120V/60 Hz		
Ant. Pol.	Horizontal		
Test Mode:	BLE TX 2402 Mode		
Remark:	Only worse case is reported		

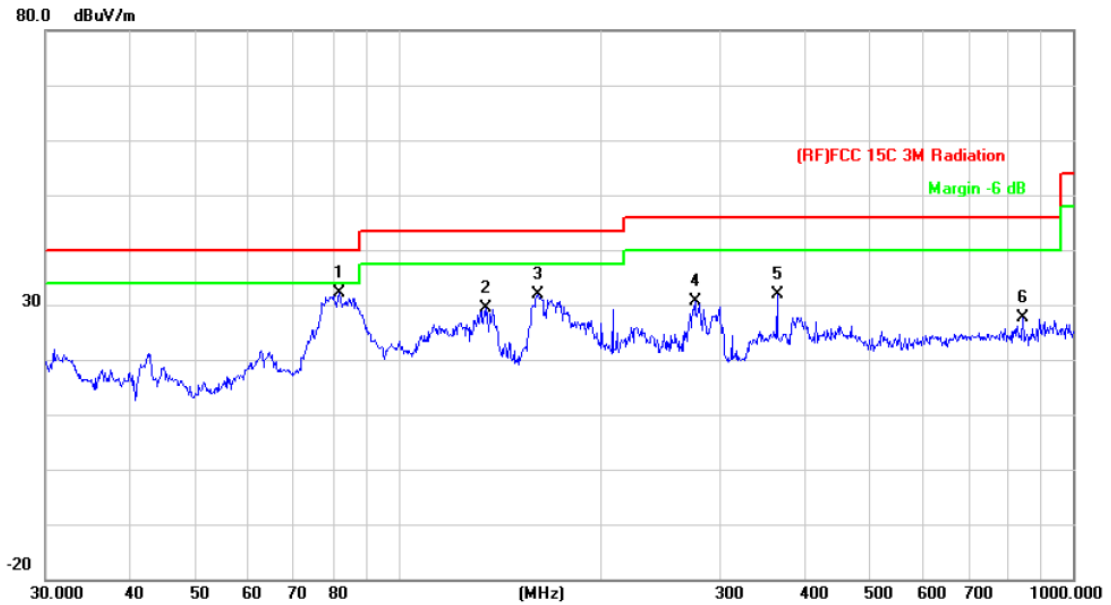

No.	Mk.	Freq. MHz	Reading Level dBuV	Correct Factor dB/m	Measure- ment dBuV/m	Limit dBuV/m	Over dB	Detector
1	*	81.7831	55.19	-23.18	32.01	40.00	-7.99	peak
2		135.0319	51.41	-22.08	29.33	43.50	-14.17	peak
3		160.9088	52.46	-20.57	31.89	43.50	-11.61	peak
4		275.1569	48.08	-17.57	30.51	46.00	-15.49	peak
5		364.2595	46.41	-14.52	31.89	46.00	-14.11	peak
6		842.1295	34.18	-6.56	27.62	46.00	-18.38	peak

*:Maximum data x:Over limit !:over margin

Emission Level= Read Level+ Correct Factor

EUT:	MID	Model:	MID1008-L
Temperature:	25 °C	Relative Humidity:	55%
Test Voltage:	AC 120V/60 Hz		
Ant. Pol.	Vertical		
Test Mode:	BLE TX 2402 Mode		
Remark:	Only worse case is reported		

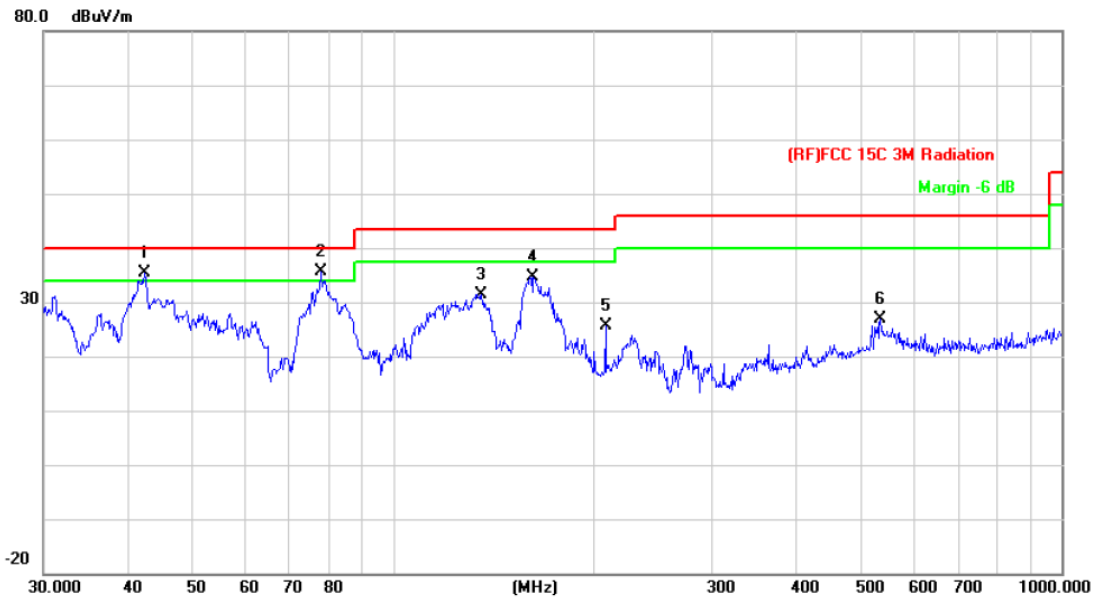

No.	Mk.	Freq. MHz	Reading Level dBuV	Correct Factor dB/m	Measurement dBuV/m	Limit dBuV/m	Over dB	Detector
1	!	42.4508	56.67	-21.19	35.48	40.00	-4.52	peak
2	*	77.8653	59.01	-23.35	35.66	40.00	-4.34	peak
3		135.5062	53.49	-22.07	31.42	43.50	-12.08	peak
4		162.0414	55.19	-20.65	34.54	43.50	-8.96	peak
5		207.8497	45.57	-20.05	25.52	43.50	-17.98	peak
6		535.7073	37.04	-10.13	26.91	46.00	-19.09	peak

*:Maximum data x:Over limit !:over margin

Emission Level= Read Level+ Correct Factor

EUT:	MID	Model:	MID1008-L
Temperature:	25 °C	Relative Humidity:	55%
Test Voltage:	AC 120V/60 Hz		
Ant. Pol.	Horizontal		
Test Mode:	BLE Mode TX 2402 MHz		
Remark:	No report for the emission which more than 10 dB below the prescribed limit.		

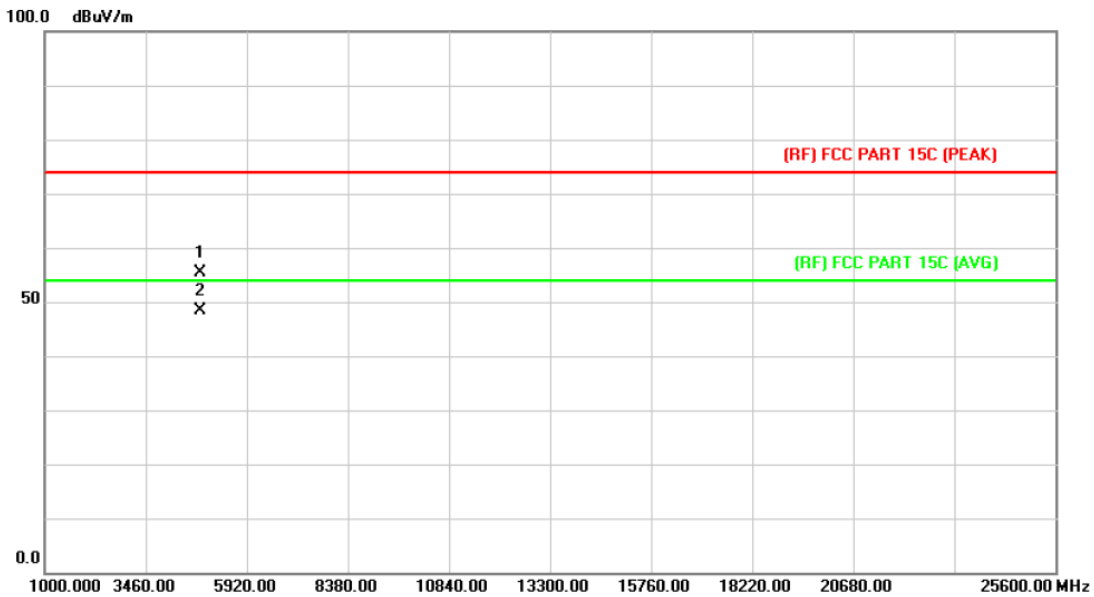

No.	Mk.	Freq. MHz	Reading Level dBuV	Correct Factor dB/m	Measure- ment dBuV/m	Limit dBuV/m	Over dB	Detector
1		4804.312	42.00	13.44	55.44	74.00	-18.56	peak
2	*	4804.326	34.93	13.44	48.37	54.00	-5.63	AVG

Emission Level= Read Level+ Correct Factor

EUT:	MID	Model:	MID1008-L
Temperature:	25 °C	Relative Humidity:	55%
Test Voltage:	AC 120V/60 Hz		
Ant. Pol.	Vertical		
Test Mode:	BLE Mode TX 2402 MHz		
Remark:	No report for the emission which more than 10 dB below the prescribed limit.		

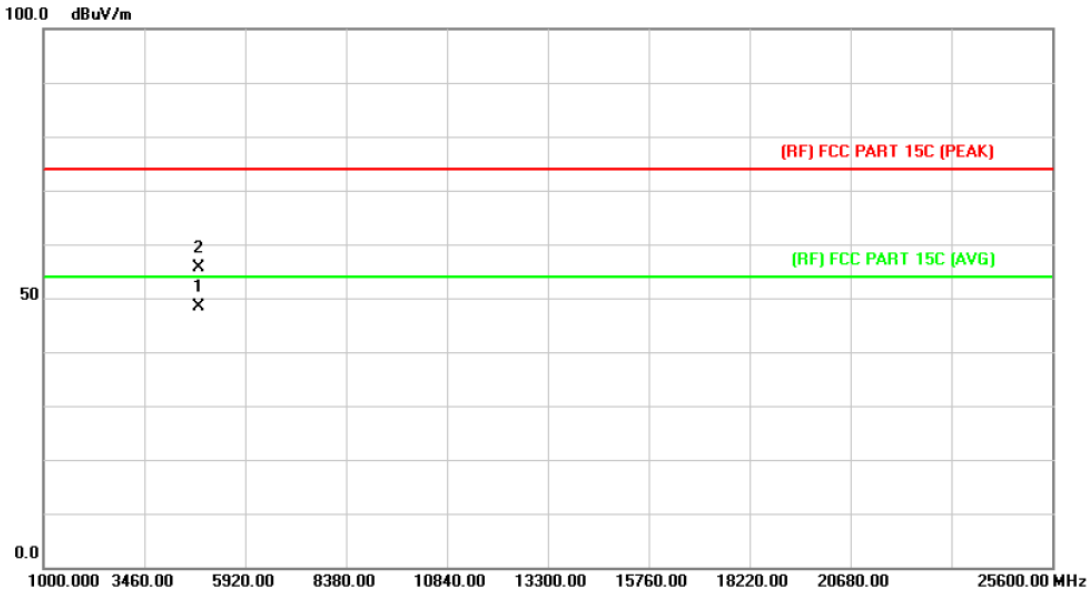

No.	Mk.	Freq.	Reading Level	Correct Factor	Measurement	Limit	Over	Detector
		MHz	dBuV	dB/m	dBuV/m	dBuV/m	dB	
1	*	4804.210	34.91	13.44	48.35	54.00	-5.65	AVG
2		4804.240	42.17	13.44	55.61	74.00	-18.39	peak

Emission Level= Read Level+ Correct Factor

EUT:	MID	Model:	MID1008-L
Temperature:	25 °C	Relative Humidity:	55%
Test Voltage:	AC 120V/60 Hz		
Ant. Pol.	Horizontal		
Test Mode:	BLE Mode TX 2442 MHz		
Remark:	No report for the emission which more than 10 dB below the prescribed limit.		

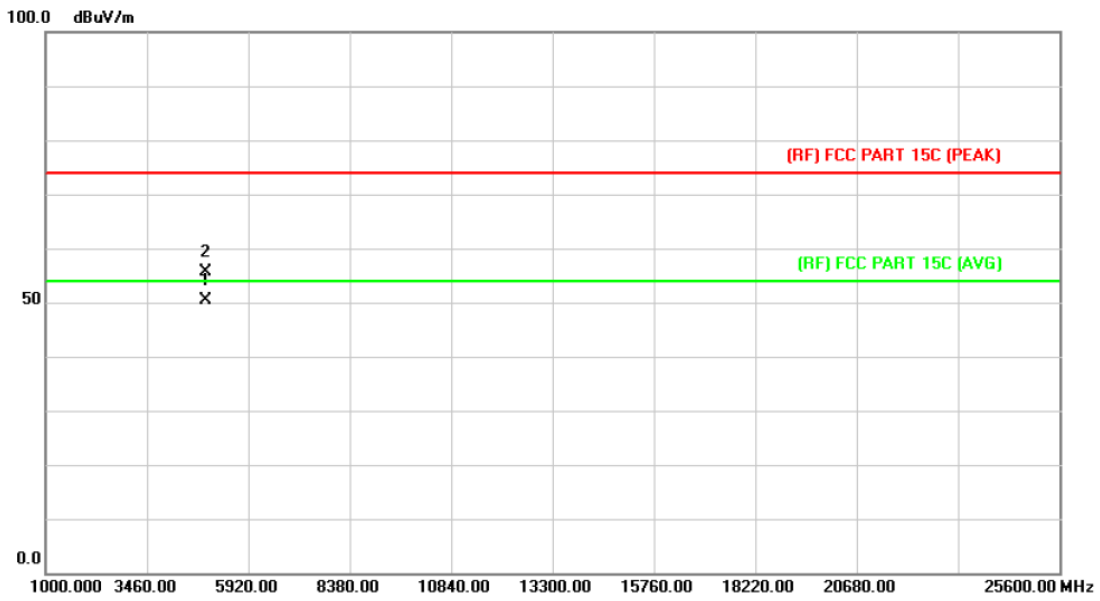

No.	Mk.	Freq.	Reading Level	Correct Factor	Measurement	Limit	Over	Detector
		MHz	dBuV	dB/m	dBuV/m	dBuV/m	dB	
1	*	4882.685	36.44	13.90	50.34	54.00	-3.66	AVG
2		4882.764	41.78	13.90	55.68	74.00	-18.32	peak

Emission Level= Read Level+ Correct Factor

EUT:	MID	Model:	MID1008-L
Temperature:	25 °C	Relative Humidity:	55%
Test Voltage:	AC 120V/60 HZ		
Ant. Pol.	Vertical		
Test Mode:	BLE Mode TX 2442 MHz		
Remark:	No report for the emission which more than 10 dB below the prescribed limit.		

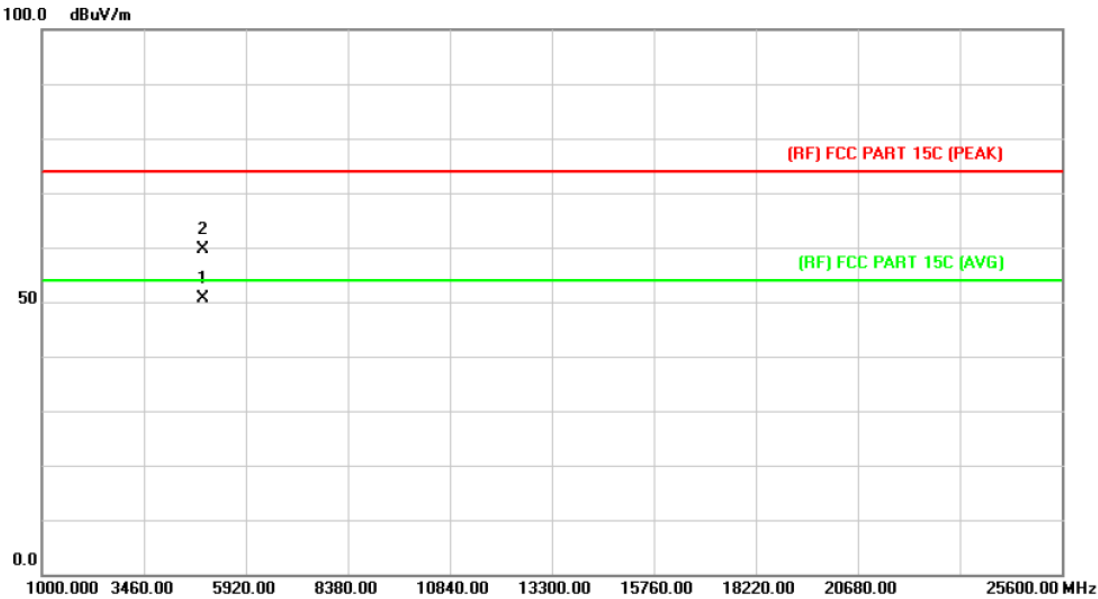

No.	Mk.	Freq. MHz	Reading Level dBuV	Correct Factor dB/m	Measure- ment dBuV/m	Limit dBuV/m	Over dB	Detector
1	*	4882.364	36.78	13.90	50.68	54.00	-3.32	AVG
2		4882.657	45.74	13.90	59.64	74.00	-14.36	peak

Emission Level= Read Level+ Correct Factor

EUT:	MID	Model:	MID1008-L
Temperature:	25 °C	Relative Humidity:	55%
Test Voltage:	AC 120V/60 HZ		
Ant. Pol.	Horizontal		
Test Mode:	BLE Mode TX 2480 MHz		
Remark:	No report for the emission which more than 10 dB below the prescribed limit.		

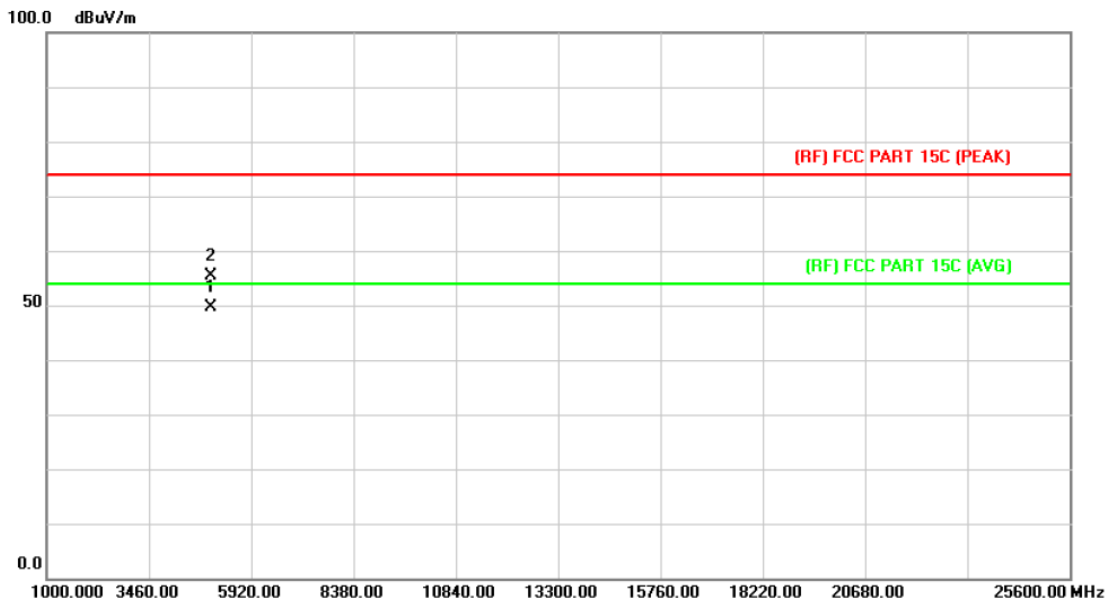

No.	Mk.	Freq. MHz	Reading Level dBuV	Correct Factor dB/m	Measure- ment dBuV/m	Limit dBuV/m	Over dB	Detector
1	*	4960.857	35.32	14.36	49.68	54.00	-4.32	AVG
2		4960.987	40.96	14.36	55.32	74.00	-18.68	peak

Emission Level= Read Level+ Correct Factor

EUT:	MID	Model:	MID1008-L
Temperature:	25 °C	Relative Humidity:	55%
Test Voltage:	AC 120V/60 HZ		
Ant. Pol.	Vertical		
Test Mode:	BLE Mode TX 2480 MHz		
Remark:	No report for the emission which more than 10 dB below the prescribed limit.		

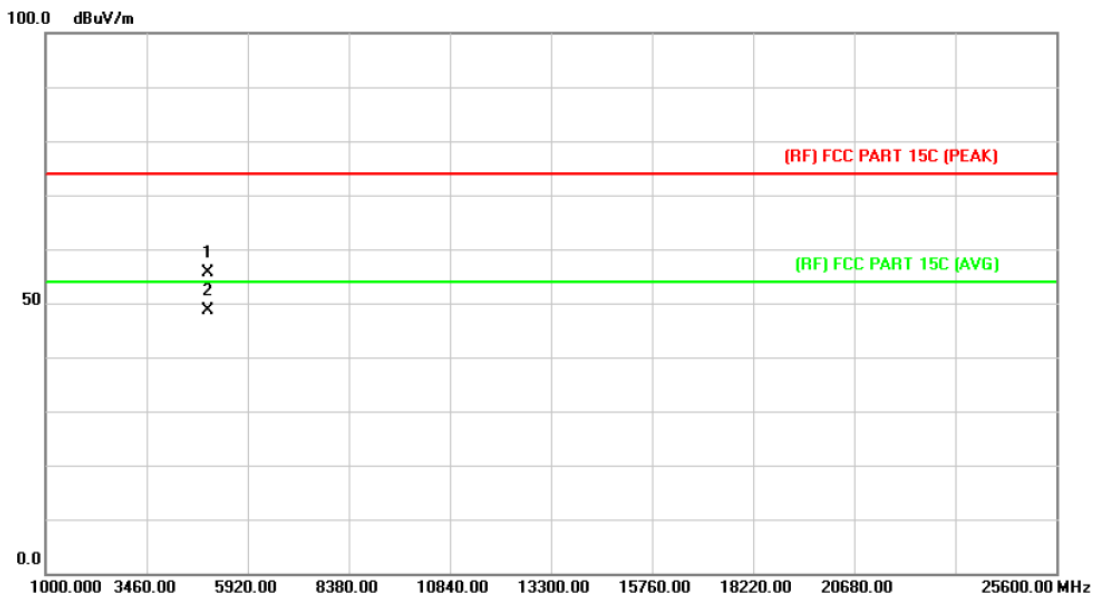

No.	Mk.	Freq. MHz	Reading Level dBuV	Correct Factor dB/m	Measure- ment dBuV/m	Limit dBuV/m	Over dB	Detector
1		4960.325	41.32	14.36	55.68	74.00	-18.32	peak
2	*	4960.542	34.31	14.36	48.67	54.00	-5.33	AVG

Emission Level= Read Level+ Correct Factor

6. Restricted Bands Requirement

6.1 Test Standard and Limit

6.1.1 Test Standard

FCC Part 15.209 FCC Part 15.205

6.1.2 Test Limit

Restricted Frequency Band (MHz)	Class B (dBuV/m)(at 3 M)	
	Peak	Average
2310 ~2390	74	54
2483.5 ~2500	74	54

6.2 Test Setup

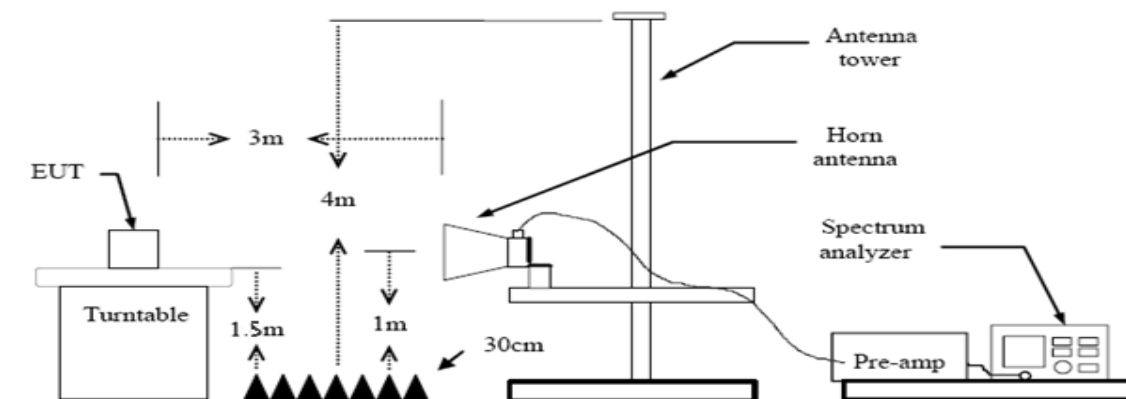

6.3 Test Procedure

- (1) The measuring distance of 3m shall be used for measurements at frequency up to 1GHz. The EUT was placed on a rotating 0.8m high above the ground, the table was rotated 360 degrees to determine the position of the highest radiation.
- (2) Measurements at frequency above 1GHz. The EUT was placed on a rotating 1.5m high above the ground. RF absorbers covered the ground plane with a minimum area of 3.0m by 3.0m between the EUT and measurement receiver antenna. The RF absorber shall not exceed 30cm in high above the conducting floor. The table was rotated 360 degrees to determine the position of the highest radiation.
- (3) The Test antenna shall vary between 1m and 4m, Both Horizontal and Vertical antenna are set to make measurement.
- (4) The initial step in collecting conducted emission data is a spectrum analyzer peak detector mode pre-scanning the measurement frequency range. Significant peaks are then marked and then Quasi Peak detector mode re-measured.
- (5) If the Peak Mode measured value compliance with and lower than Quasi Peak Mode Limit

Bellow 1 GHz, the EUT shall be deemed to meet QP Limits and then no additional QP Mode measurement performed. But the Peak Value and average value both need to comply with applicable limit above 1 GHz.

- (6) Testing frequency range below 1GHz the measuring instrument use VBW=120 kHz with Quasi-peak detection.
- (7) Testing frequency range above 1GHz the measuring instrument use RBW=1 MHz and VBW=3 MHz with Peak Detector for Peak Values, and use RBW=1 MHz and VBW=10 Hz with Peak Detector for Average Values.
- (8) For the actual test configuration, please see the test setup photo.

6.4 EUT Operating Condition

The Equipment Under Test was set to Continual Transmitting in maximum power.

6.5 Test Data

Remark: During testing above 1GHz the measuring instrument use RBW=1 MHz and VBW=3 MHz with Peak Detector for Peak Values, and use RBW=1 MHz and VBW=1 kHz with Peak Detector for Average Values.

Test data please refer the following pages.

(1) Radiation Test

EUT:	MID	Model:	MID1008-L
Temperature:	25 °C	Relative Humidity:	55%
Test Voltage:	AC 120V/60 HZ		
Ant. Pol.	Horizontal		
Test Mode:	BLE Mode TX 2402 MHz		
Remark:	N/A		

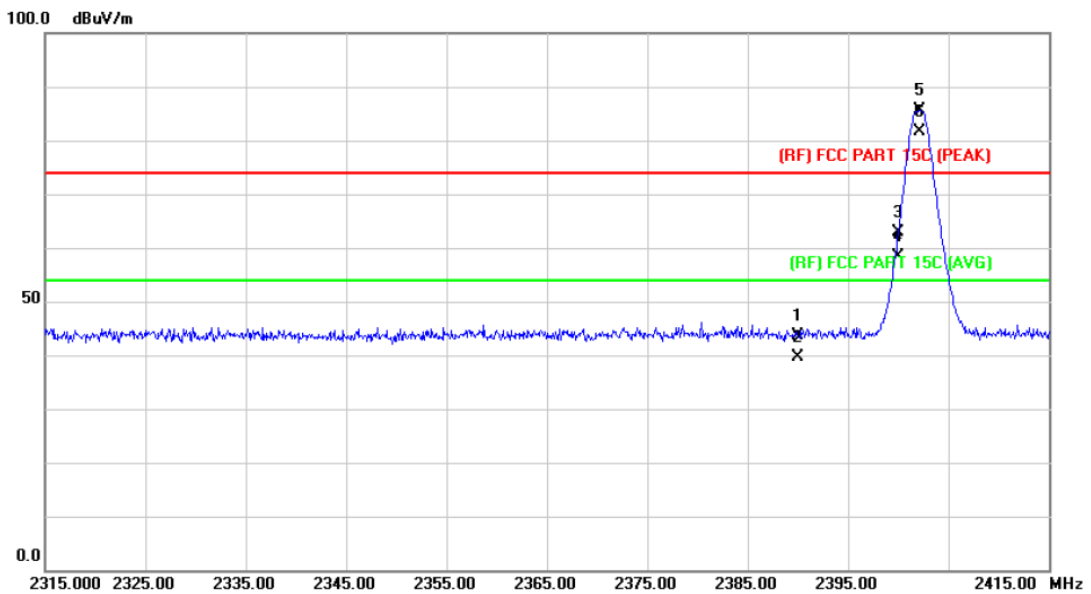

No.	Mk.	Freq. MHz	Reading Level dBuV	Correct Factor dB/m	Measure- ment dBuV/m	Limit dBuV/m	Over dB	Detector
1		2390.000	42.75	0.77	43.52	74.00	-30.48	peak
2		2390.000	38.87	0.77	39.64	54.00	-14.36	AVG
3		2400.000	62.03	0.81	62.84	Fundamental Frequency		peak
4	X	2400.000	57.53	0.81	58.34	Fundamental Frequency		AVG
5	X	2402.200	84.72	0.82	85.54	74.00	11.54	peak
6	*	2402.200	80.82	0.82	81.64	54.00	27.64	AVG

Emission Level= Read Level+ Correct Factor

EUT:	MID	Model:	MID1008-L
Temperature:	25 °C	Relative Humidity:	55%
Test Voltage:	AC 120V/60 HZ		
Ant. Pol.	Vertical		
Test Mode:	BLE Mode TX 2480 MHz		
Remark:	N/A		

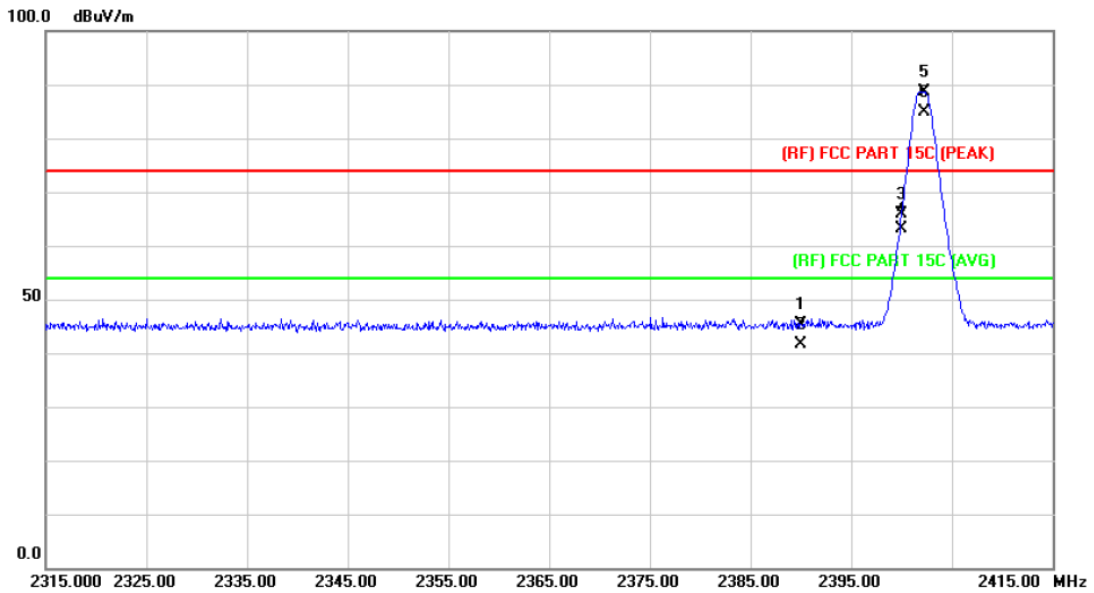

No.	Mk.	Freq. MHz	Reading Level dBuV	Correct Factor dB/m	Measure- ment dBuV/m	Limit dBuV/m	Over dB	Detector
1		2390.000	44.62	0.77	45.39	74.00	-28.61	peak
2		2390.000	40.74	0.77	41.51	54.00	-12.49	AVG
3		2400.000	64.97	0.81	65.78	Fundamental Frequency		peak
4	X	2400.000	62.23	0.81	63.04	Fundamental Frequency		AVG
5	X	2402.300	87.89	0.82	88.71	74.00	14.71	peak
6	*	2402.300	84.01	0.82	84.83	54.00	30.83	AVG

Emission Level= Read Level+ Correct Factor

EUT:	MID	Model:	MID1008-L
Temperature:	25 °C	Relative Humidity:	55%
Test Voltage:	AC 120V/60 HZ		
Ant. Pol.	Horizontal		
Test Mode:	BLE Mode TX 2480 MHz		
Remark:	N/A		

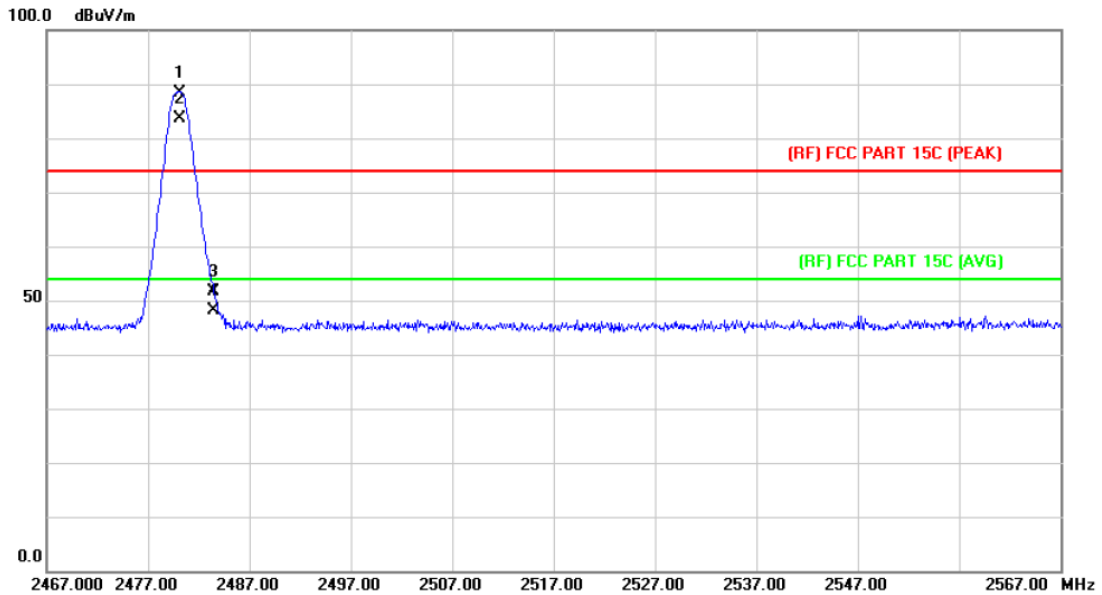

No.	Mk.	Freq.	Reading Level	Correct Factor	Measurement	Limit	Over	
		MHz	dBuV	dB/m	dBuV/m	dBuV/m	dB	Detector
1	X	2480.200	87.34	1.15	88.49	Fundamental Frequency		peak
2	*	2480.200	82.49	1.15	83.64	Fundamental Frequency		AVG
3		2483.500	50.51	1.17	51.68	74.00	-22.32	peak
4		2483.500	46.95	1.17	48.12	54.00	-5.88	AVG

Emission Level= Read Level+ Correct Factor

EUT:	MID	Model:	MID1008-L
Temperature:	25 °C	Relative Humidity:	55%
Test Voltage:	AC 120V/60 HZ		
Ant. Pol.	Vertical		
Test Mode:	BLE Mode TX 2480 MHz		
Remark:	N/A		

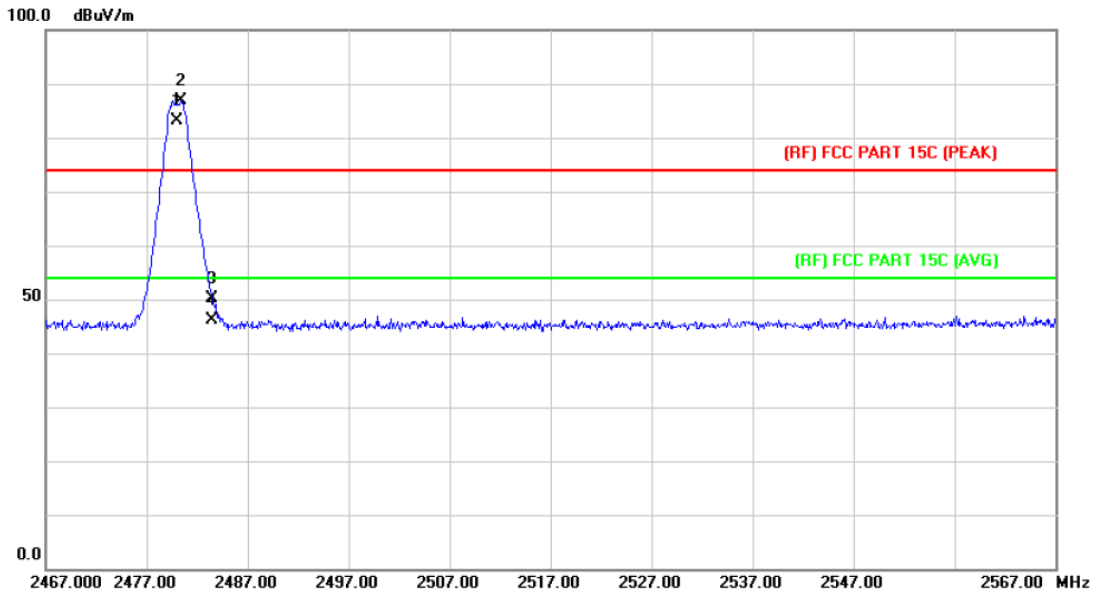

No.	Mk.	Freq. MHz	Reading Level dBuV	Correct Factor dB/m	Measure- ment dBuV/m	Limit dBuV/m	Over dB	Detector
1	*	2480.000	82.00	1.15	83.15	Fundamental Frequency		AVG
2	X	2480.400	85.81	1.15	86.96	Fundamental Frequency		peak
3		2483.500	49.06	1.17	50.23	74.00	-23.77	peak
4		2483.500	45.04	1.17	46.21	54.00	-7.79	AVG

Emission Level= Read Level+ Correct Factor

7. Antenna Requirement

7.1 Standard Requirement

7.1.1 Standard

FCC Part 15.203

7.1.2 Requirement

An intentional radiator shall be designed to ensure that no antenna other than that furnished by the responsible party shall be used with the device. The use of a permanently attached antenna or of an antenna that uses a unique coupling to the intentional radiator shall be considered sufficient to comply with the provisions of this Section. The manufacturer may design the unit so that a broken antenna can be replaced by the user, but the use of a standard antenna jack or electrical connector is prohibited.

7.2 Antenna Connected Construction

The directional gains of the antenna used for transmitting is 0 dBi, and the antenna de-signed with permanent attachment and no consideration of replacement. Please see the EUT photo for details.

The EUT antenna is a FPC Antenna. It complies with the standard requirement.

Antenna Type
<input checked="" type="checkbox"/> Permanent attached antenna
<input type="checkbox"/> Unique connector antenna
<input type="checkbox"/> Professional installation antenna