



FCC PART 15C TEST REPORT FOR CERTIFICATION

On Behalf of

Activision Publishing, Inc.

Portal of Power for Xbox360

Model No.: 84392790

Trade Name: Activision

FCC ID: XLU84392790

Prepared for : Activision Publishing, Inc.
3100 Ocean Park Boulevard, Santa Monica, CA90405,
USA

Prepared By : Audix Technology (Shenzhen) Co., Ltd.
No. 6, Ke Feng Rd., 52 Block,
Shenzhen Science & Industrial Park,
Nantou, Shenzhen, Guangdong, China

Tel: (0755) 26639496

Report Number : ACS-F12146
Date of Test : Jul.04~08, 2012
Date of Report : Jul.12, 2012

TABLE OF CONTENTS

Description	Page
1. SUMMARY OF STANDARDS AND RESULTS.....	1-1
1.1. Description of Standards and Results	1-1
2. GENERAL INFORMATION	2-1
2.1. Description of Device (EUT)	2-1
2.2. Tested Supporting System Details	2-2
2.3. Block Diagram of connection between EUT and simulators	2-2
2.4. Test Facility	2-3
2.5. Measurement Uncertainty (95% confidence levels, k=2)	2-3
3. POWER LINE CONDUCTED EMISSION TEST	3-1
3.1. Test Equipment	3-1
3.2. Block Diagram of Test Setup	3-1
3.3. Power Line Conducted Disturbance at Mains Terminals Limit.....	3-1
3.4. EUT Configuration on Test.....	3-2
3.5. Operating Condition of EUT.....	3-2
3.6. Test Procedure.....	3-2
3.7. Power Line Conducted Emission Test Results	3-2
4. RADIATED EMISSION TEST	4-1
4.1. Test Equipment	4-1
4.2. Block Diagram of Test Setup.....	4-2
4.3. Radiated Emission Limit.....	4-3
4.4. 15.205 Restricted bands of operation.....	4-3
4.5. EUT Configuration on Test.....	4-3
4.6. Operating Condition of EUT.....	4-4
4.7. Test Procedure.....	4-4
4.8. Radiated Emission Test Results	4-4
5. FREQUENCY STABILITY TEST	5-8
5.1. Test Equipment	5-8
5.2. Limits	5-8
5.3. Test Procedure.....	5-8
5.4. Test result.....	5-9
6. 20 DB BANDWIDTH TEST	6-18
6.1. Test Equipment	6-18
6.2. Limit.....	6-18
6.3. Test Results	6-18
7. DEVIATION TO TEST SPECIFICATIONS.....	7-1
8. PHOTOGRAPH OF TEST	8-1
8.1. Photos of Power Line Conducted Emission Test	8-1
8.2. Photos of Radiated Emission Test.....	8-2
9. PHOTOS OF THE EUT	9-1

FCC ID: XLU84392790

TEST REPORT CERTIFICATION

Applicant : Activision Publishing, Inc.
Manufacturer : Sunlight Technology Electronic Manufacturing Co; Ltd.
EUT Description : Portal of Power for Xbox360
FCC ID : XLU84392790
(A) MODEL NO. : 84392790
(B) Trade Name : Activision
(C) SERIAL NO. : N/A
(D) Power Supply : DC 5V From Xbox360 Input AC 120V/60Hz
(E) TEST VOLTAGE : DC 5V From Xbox360 Input AC 120V/60Hz

Tested for comply with:
FCC Rules and Regulations Part 15 Subpart C: 2008

Test procedure used:
ANSI C63.10:2009

The device described above is tested by AUDIX TECHNOLOGY (SHENZHEN) CO., LTD. to confirm comply with all the FCC Part 15 Subpart C requirements.

The test results are contained in this test report and AUDIX TECHNOLOGY (SHENZHEN) CO., LTD. is assumed full responsibility for the accuracy and completeness of these tests. This report contains data that are not covered by the NVLAP accreditation. Also, this report shows that the Equipment Under Test (EUT) is to be technically compliant with the FCC and IC requirements.

This Report is made under FCC Part 2.1075. No modifications were required during testing to bring this product into compliance.

This report applies to above tested sample only. This report shall not be reproduced in part without written approval of AUDIX TECHNOLOGY (SHENZHEN) CO., LTD.

The report must not be used by the client to claim product certification, approval, or endorsement by NVLAP, NIST, or any agency of the federal government.

Date of Test : Jul.04~ 08, 2012 Report of date: Jul.12, 2012

Prepared by : Selina Liu Reviewed by : Sunny Lu
Selina Liu / Assistant Sunny Lu / Supervisor

信華科技(深圳)有限公司
Audix Technology (Shenzhen) Co., Ltd.
EMC 部門報告專用章
Stamp only for EMC Dept. Report
Signature: Ken Lu 7/3/12

Approved & Authorized Signer : Ken Lu
Ken Lu / Manager

1. SUMMARY OF STANDARDS AND RESULTS

1.1. Description of Standards and Results

The EUT have been tested according to the applicable standards as referenced below.

EMISSION		
Description of Test Item	Standard	Results
Conducted Emission Test	FCC Part 15: 15.207 ANSI C63.10: 2009	PASS
Radiated Emission Test	FCC Part 15: 15.205, 15.209 FCC Part 15: 15.225(a)(b)(c)(d) ANSI C63.10: 2009	PASS
Frequency Stability Test	FCC Part 15: 15.225(e)	PASS
20dB Bandwidth Test	FCC Part 15: 15.215	PASS

2. GENERAL INFORMATION

2.1. Description of Device (EUT)

Product Name	:	Portal of Power for Xbox360
Model Number	:	84392790
Trade Name	:	Activision
FCC ID	:	XLU84392790
Operation frequency	:	RF ID: 13.56MHz
Modulation	:	ASK
Applicant	:	Activision Publishing, Inc. 3100 Ocean Park Boulevard, Santa Monica, CA90405, USA
Manufacturer	:	Sunlight Technology Electronic Manufacturing Co; Ltd. New Asia Industrial City, Lin Village, Tangxia Town, Dongguan City, China
Date of Test	:	Jul.04~08, 2012
Date of Receipt	:	Jul.03, 2012
Sample Type	:	Prototype production

FCC ID: XLU84392790

2.2. Tested Supporting System Details

No.	Description	ACS No.	Manufacturer	Model	Serial Number	Approved type
1.	Monitor	ACS-EMC-LM06R	DELL	2407WFPb	CN-0YY528-46633 -764-1Y8S	<input checked="" type="checkbox"/> FCC DoC <input checked="" type="checkbox"/> BSMI ID: R43002
		Power Cord: Unshielded, Detachable, 1.8m VGA Cable: Shielded, Detachable, 2.0m (with two cores) DVI Cable: Shielded, Detachable, 2.0m (with two cores)				
2.	X-Box360	ACS-EMC-X01	Microsoft	WA 98052-6399	N/A	<input checked="" type="checkbox"/> FCC DoC <input type="checkbox"/> BSMI ID
		Data Cable: Unshielded, Undetachabled , 1.8m Power Cord: Unshielded, Undetachabled , 2.0m				

2.3. Block Diagram of connection between EUT and simulators

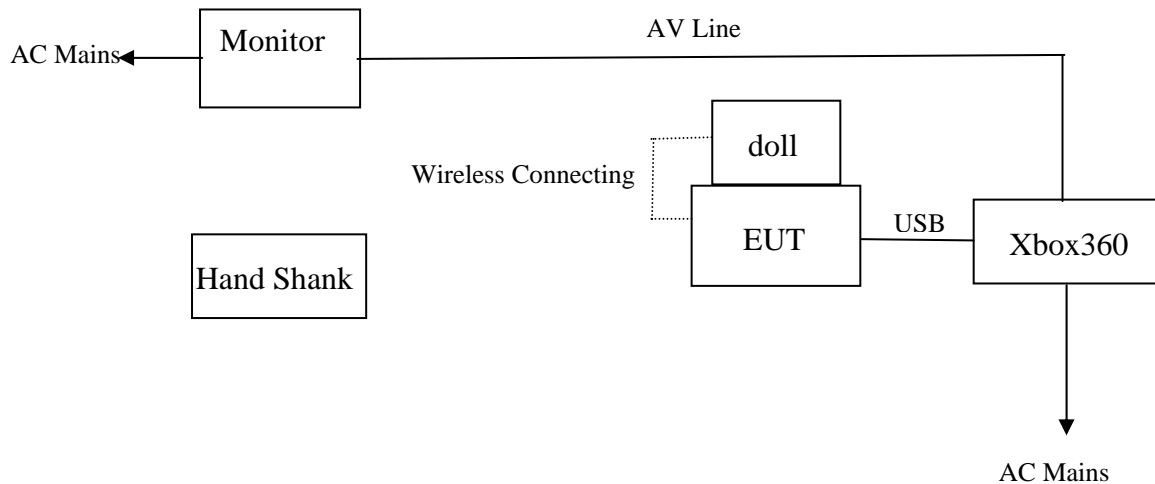

(EUT: Portal of Power for Xbox360)

2.4. Test Facility

Site Description

Name of Firm : Audix Technology (Shenzhen) Co., Ltd.
No. 6, Ke Feng Rd., 52 Block, Shenzhen
Science & Industrial Park, Nantou,
Shenzhen, Guangdong, China

3m Anechoic Chamber : Certificated by FCC, USA
Registration Number: 90454
Valid Date: Feb.22, 2015

3m & 10m Anechoic Chamber : Certificated by FCC, USA
Registration Number: 794232
Valid Date: Dec.30, 2012

EMC Lab. : Certificated by Industry Canada
Registration Number: IC 5183A-1
Valid Date: Jun.13, 2014

: Certificated by DAkkS, Germany
Registration No: D-PL-12151-01-01
Valid Date: Feb.01, 2014

Accredited by NVLAP, USA
NVLAP Code: 200372-0
Valid Date: Mar.31, 2013

2.5. Measurement Uncertainty (95% confidence levels, k=2)

Test Item	Uncertainty
Uncertainty for Radiation Emission test in 10m chamber	3.6dB (30~200MHz, Polarize: H)
	3.8dB (30~200MHz, Polarize: V)
	3.8dB (200M~1GHz, Polarize: H)
	3.8dB (200M~1GHz, Polarize: V)
Uncertainty for Frequency range test	7×10^{-8}
Uncertainty for Bandwidth test	83kHz
Uncertainty for DC power test	0.038 %
Uncertainty for test site temperature and humidity	0.6°C
	3%

3. POWER LINE CONDUCTED EMISSION TEST

3.1. Test Equipment

Item	Equipment	Manufacturer	Model No.	Serial No.	Last Cal.	Cal. Interval
1.	Test Receiver	Rohde & Schwarz	ESHS10	838693/001	Oct.31, 11	1 Year
2.	L.I.S.N.#1	Rohde & Schwarz	ESH2-Z5	834066/011	Oct.31, 11	1 Year
3.	L.I.S.N.#3	Kyoritsu	KNW-242C	8-1920-1	May.08, 12	1 Year
4.	Terminator	Hubersuhner	50Ω	No. 1	May.08, 12	1 Year
5.	Terminator	Hubersuhner	50Ω	No. 2	May.08, 12	1 Year
6.	RF Cable	Fujikura	3D-2W	No.1	May.08, 12	1Year
7.	Coaxial Switch	Anritsu	MP59B	M50564	May.08, 12	1 Year
8.	Pulse Limiter	Rohde & Schwarz	ESH3-Z2	100341	May.08, 12	1 Year

3.2. Block Diagram of Test Setup

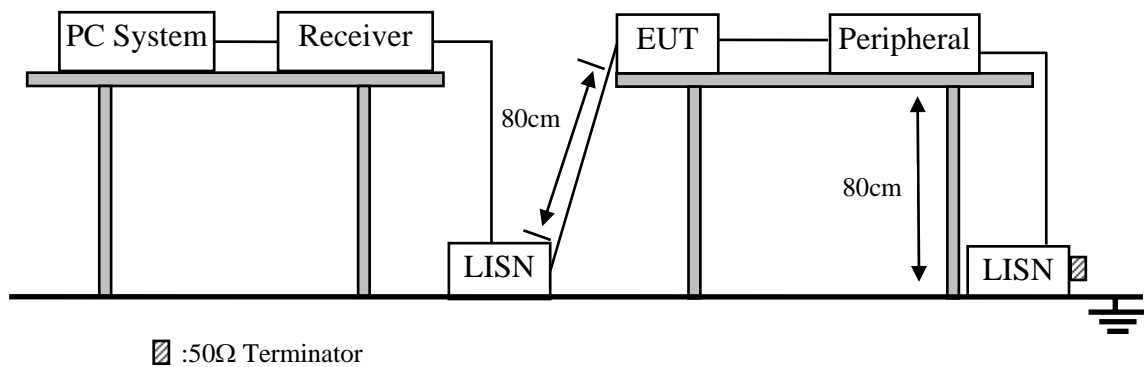

3.3. Power Line Conducted Disturbance at Mains Terminals Limit

Frequency	Maximum RF Line Voltage	
	Quasi-Peak Level dB(μV)	Average Level dB(μV)
150kHz ~ 500kHz	66 ~ 56*	56 ~ 46*
500kHz ~ 5MHz	56	46
5MHz ~ 30MHz	60	50

- Notes: 1. * Decreasing linearly with logarithm of frequency.
 2. The lower limit shall apply at the transition frequencies.

3.4.EUT Configuration on Test

The following equipments are installed on Conducted Emission Test to meet EN 55022 requirement and operating in a manner which tends to maximize its emission characteristics in a normal application.

3.4.1.Portals of Power for Xbox360 (EUT)

Model Number : 84392790
Serial Number : N/A

3.5.Operating Condition of EUT

3.5.1.Setup the EUT and simulator as shown as Section 3.2.

3.5.2.Turned on the power of all equipment.

3.5.3.Let the EUT worked in test mode (Tx Mode) and tested it.

3.6.Test Procedure

The EUT was placed on a non-metallic table, 80cm above the ground plane. The EUT Power connected to the power mains through a line impedance stabilization network (L.I.S.N. 1#). This provided a 50-ohm coupling impedance for the EUT (Please refer to the block diagram of the test setup and photographs). The other peripheral devices power cord connected to the power mains through a line impedance stabilization network (L.I.S.N.#3). Both sides of power line were checked for maximum conducted interference. In order to find the maximum emission, the relative positions of equipments and all of the interface cables were changed according to ANSI C63.10 on conducted Disturbance test.

The bandwidth of test receiver (R & S ESHS10) is set at 10kHz.

The frequency range from 150kHz to 30MHz is checked. The test result is reported on Section 3.8.

3.7.Power Line Conducted Emission Test Results

PASS. (All emissions not reported below are too low against the prescribed limits.)

FCC ID: XLU84392790

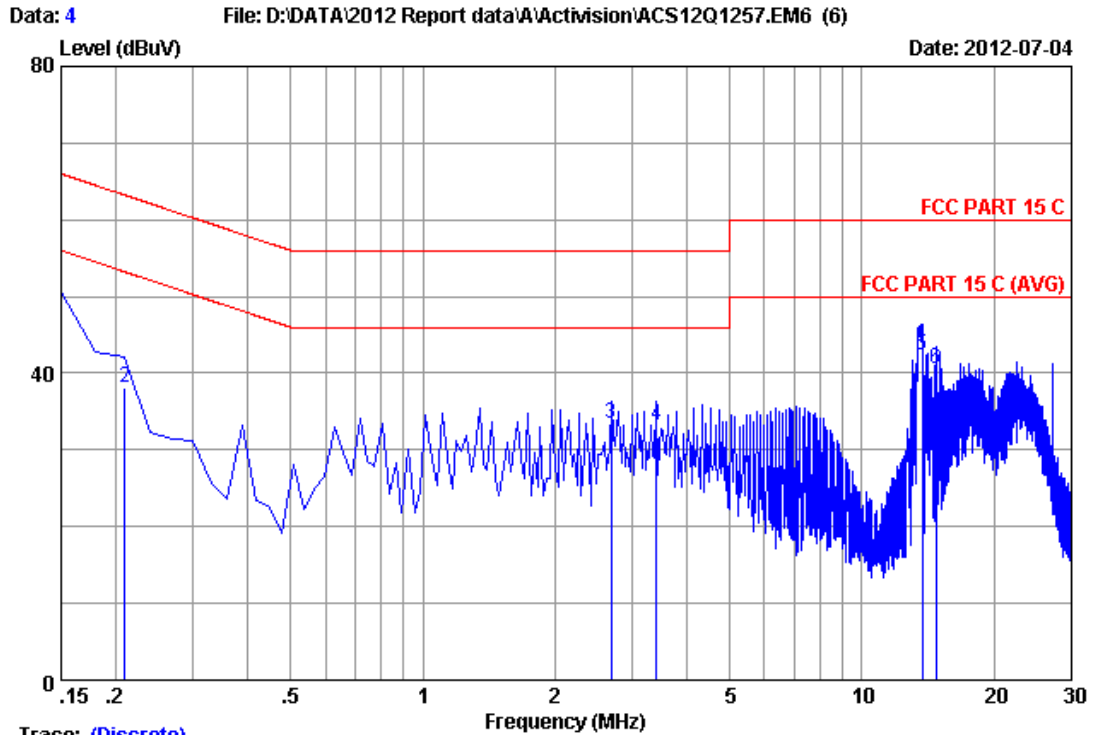

Trace: (Discrete)

Site no :1#conduction Data No :4
 Dis./Ant. :** 2012 ESH2-25 LINE
 Limit :FCC PART 15 C
 Env./Ins. :29.5*C/55% Engineer :Leo_Li
 EUT :Portal of Power for Xbox360
 Power Rating :DC 5V From Xbox360 Input AC 120V/60Hz
 Test Mode :Tx Mode
 M/N:84392790

No	Freq (MHz)	LISN Factor (dB)	Cable Loss (dB)	Reading (dBUV)	Emission Level (dBUV)	Limits (dBUV)	Margin (dB)	Remark
1	0.15000	0.17	9.94	28.43	38.54	66.00	27.46	QP
2	0.20970	0.15	9.95	28.02	38.12	63.22	25.10	QP
3	2.687	0.22	9.94	23.26	33.42	56.00	22.58	QP
4	3.404	0.23	9.94	23.14	33.31	56.00	22.69	QP
5	13.702	0.38	9.98	31.98	42.34	60.00	17.66	QP
6	14.747	0.40	9.99	30.12	40.51	60.00	19.49	QP

Remarks: 1. Emission Level=LISN Factor+Cable Loss(Include 10dB pulse limit)+Reading.
 2. If the average limit is met when using a quasi-peak detector, the EUT shall be deemed to meet both limits and measurement with average detector is unnecessary.

FCC ID: XLU84392790

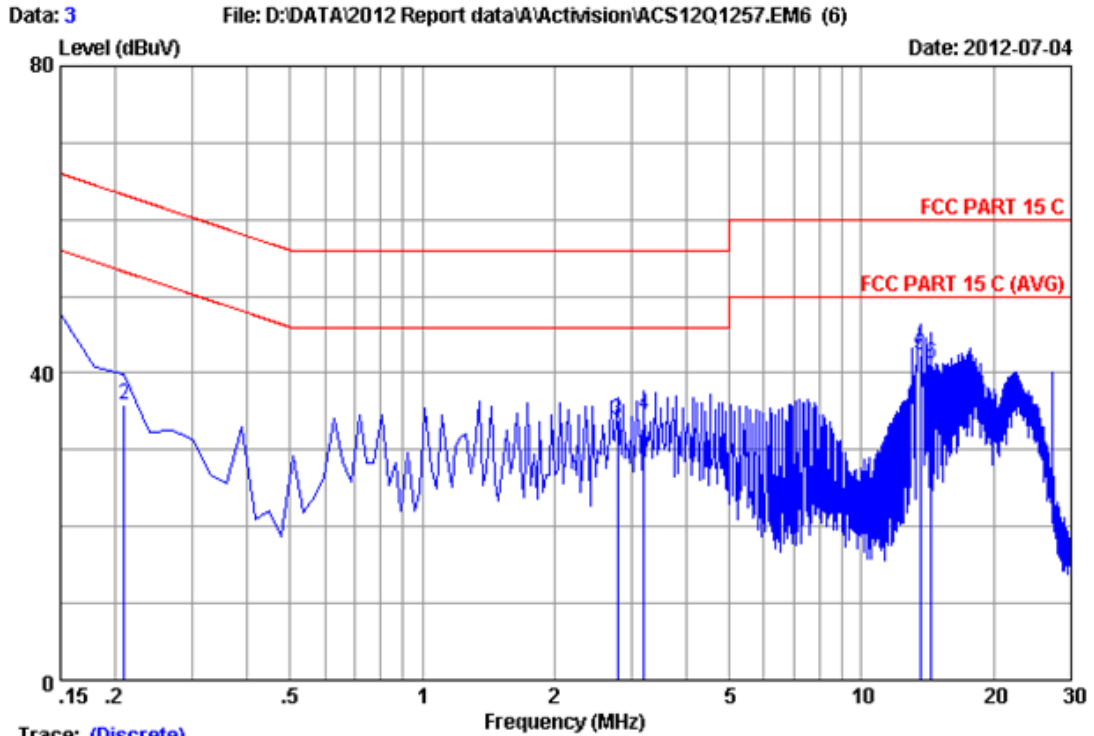

Trace: (Discrete)
 Site no :1#conduction Data No :3
 Dis./Ant. **: 2012 ESH2-25 NEUTRAL
 Limit :FCC PART 15 C
 Env./Ins. :29.5°C/55% Engineer :Leo_Li
 EUT :Portal of Power for Xbox360
 Power Rating :DC 5V From Xbox360 Input AC 120V/60Hz
 Test Mode :Tx Mode
 M/N:84392790

No	Freq (MHz)	LISN Factor (dB)	Cable Loss (dB)	Reading (dBuV)	Emission Level (dBuV)	Limits (dBuV)	Margin (dB)	Remark
1	0.15000	0.14	9.94	30.55	40.63	66.00	25.37	QP
2	0.20970	0.14	9.95	25.71	35.80	63.22	27.42	QP
3	2.777	0.22	9.94	23.69	33.85	56.00	22.15	QP
4	3.195	0.23	9.94	24.41	34.58	56.00	21.42	QP
5	13.612	0.31	9.98	32.11	42.40	60.00	17.60	QP
6	14.388	0.32	9.99	30.96	41.27	60.00	18.73	QP

Remarks: 1. Emission Level=LISN Factor+Cable Loss(Include 10dB pulse limit)+Reading.
 2. If the average limit is met when using a quasi-peak detector, the EUT shall be deemed to meet both limits and measurement with average detector is unnecessary.

4. RADIATED EMISSION TEST

4.1. Test Equipment

Frequency Range: 30-1000MHz

Item	Equipment	Manufacturer	Model No.	Serial No.	Last Cal.	Cal. Interval
1	10m Chamber	AUDIX	N/A	N/A	Nov.28,11	1 Year
2	EMC Analyzer	Agilent	E7405A	MY42000131	Oct.31, 11	1 Year
3	EMC Analyzer	Agilent	E7405A	MY45116588	Oct.31, 11	1 Year
4	Test Receiver	Rohde & Schwarz	ESCI	100842	May.08, 12	1 Year
5	Amplifier	Agilent	8447D	2944A10684	May.08, 12	1Year
6	Amplifier	Agilent	8447D	2944A11140	May.08, 12	1 Year
7	Bilog Antenna	Schaffner	CBL6112D	25238	June.30, 11	1 Year
8	Bilog Antenna	Schaffner	CBL6112D	25237	Aug.28, 11	1 Year
9	RF Cable	MIYAZAKI	CFD400-NL	10m Chamber No.1	May.08, 12	1 Year
10	RF Cable	MIYAZAKI	CFD400-NL	10m Chamber No.2	May.08, 12	1 Year
11	Coaxial Switch	Anritsu	MP59B	M73989	May.08, 12	1 Year
12	Coaxial Switch	Anritsu	MP59B	6200766905	May.08, 12	1 Year
13	Coaxial Switch	Anritsu	MP59B	6200313662	May.08, 12	1 Year

Frequency Range: 1.705-30MHz

Item	Equipment	Manufacturer	Model No.	Serial No.	Last Cal.	Cal. Interval
1	10m Chamber	AUDIX	N/A	N/A	Dec.05, 11	1 Year
2	EMC Analyzer	Agilent	E7405A	MY42000131	May.08, 12	1 Year
3	EMC Analyzer	Agilent	E7405A	MY45116588	May.08, 12	1 Year
4	Test Receiver	Rohde & Schwarz	ESCI	100842	May.08, 12	1 Year
5	Amplifier	Agilent	8447D	2944A10684	May.08, 12	1Year
6	Amplifier	Agilent	8447D	2944A11140	May.08, 12	1 Year
7	Loop Antenna	Chase	HLA6120	1062	May.08, 12	1 Year
8	RF Cable	MIYAZAKI	8D-FB	10m Chamber No.1	May.08, 12	1 Year
9	RF Cable	MIYAZAKI	8D-FB	10m Chamber No.2	May.08, 12	1 Year
10	Coaxial Switch	Anritsu	MP59B	6200766906	May.08, 12	1 Year
11	Coaxial Switch	Anritsu	MP59B	6200766905	May.08, 12	1 Year
12	Coaxial Switch	Anritsu	MP59B	6200313662	May.08, 12	1 Year

FCC ID: XLU84392790

4.2. Block Diagram of Test Setup

Frequency Range: 30-1000MHz

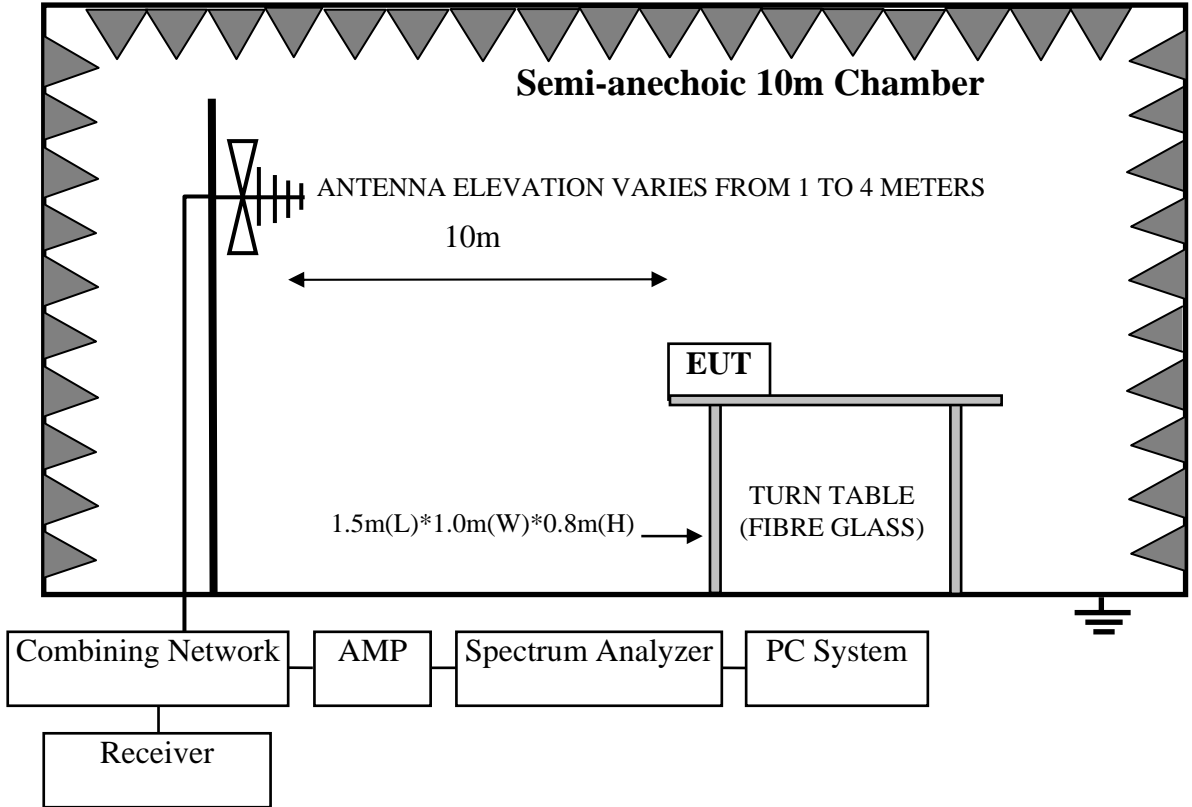

Frequency Range: 1.705-30MHz

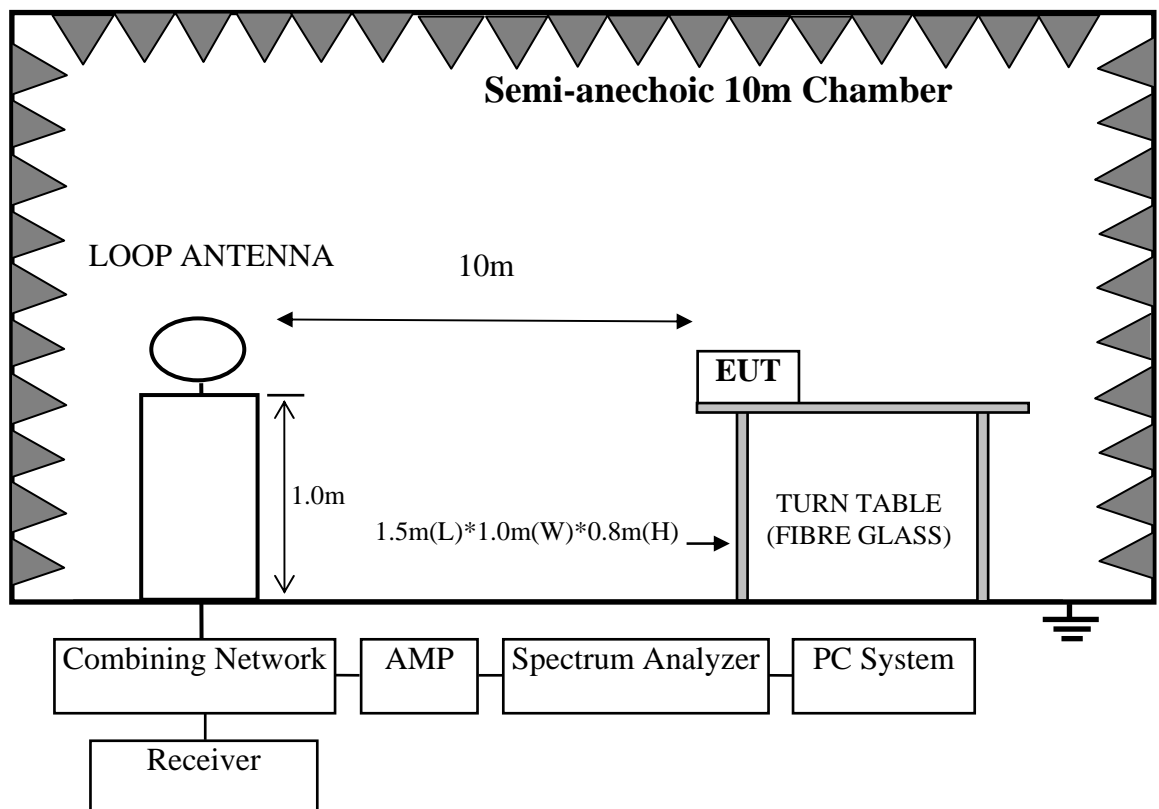

4.3. Radiated Emission Limit

- (a) The field strength of any emissions within the band 13.553-13.567 MHz shall not exceed 15,848 microvolts/meter at 30 meters.
- (b) Within the bands 13.410-13.553 MHz and 13.567-13.710 MHz, the field strength of any emissions shall not exceed 334 microvolts/meter at 30 meters.
- (c) Within the bands 13.110-13.410 MHz and 13.710-14.010 MHz the field strength of any emissions shall not exceed 106 microvolts/meter at 30 meters.
- (d) The field strength of any emissions appearing outside of the 13.110-14.010 MHz band shall not exceed the general radiated emission limits in § 15.209.

- Remark :
- (1) Emission level dB μ V = 20 log Emission level μ V/m
 - (2) The smaller limit shall apply at the cross point between two frequency bands.
 - (3) Distance is the distance in meters between the measuring instrument, antenna and the closest point of any part of the device or system.

4.4. 15.205 Restricted bands of operation

MHz	MHz	MHz	GHz
0.090 - 0.110	16.42 - 16.423	399.9 - 410	4.5 - 5.15
¹ 0.495 - 0.505	16.69475 - 16.69525	608 - 614	5.35 - 5.46
2.1735 - 2.1905	16.80425 - 16.80475	960 - 1240	7.25 - 7.75
4.125 - 4.128	25.5 - 25.67	1300 - 1427	8.025 - 8.5
4.17725 - 4.17775	37.5 - 38.25	1435 - 1626.5	9.0 - 9.2
4.20725 - 4.20775	73 - 74.6	1645.5 - 1646.5	9.3 - 9.5
6.215 - 6.218	74.8 - 75.2	1660 - 1710	10.6 - 12.7
6.26775 - 6.26825	108 - 121.94	1718.8 - 1722.2	13.25 - 13.4
6.31175 - 6.31225	123 - 138	2200 - 2300	14.47 - 14.5
8.291 - 8.294	149.9 - 150.05	2310 - 2390	15.35 - 16.2
8.362 - 8.366	156.52475 - 156.52525	2483.5 - 2500	17.7 - 21.4
8.37625 - 8.38675	156.7 - 156.9	2690 - 2900	22.01 - 23.12
8.41425 - 8.41475	162.0125 - 167.17	3260 - 3267	23.6 - 24.0
12.29 - 12.293	167.72 - 173.2	3332 - 3339	31.2 - 31.8
12.51975 - 12.52025	240 - 285	3345.8 - 3358	36.43 - 36.5
12.57675 - 12.57725	322 - 335.4	3600 - 4400	(²)

All the emissions appearing within 15.205 restricted frequency bands shall not exceed the limits shown in 15.209, all the other emissions shall be at least 20dB below the fundamental emissions, or comply with 15.209 limits.

4.5. EUT Configuration on Test

The following equipment are installed on Radiated Emission Test to meet the commission requirements and operating regulations in a manner which tends to maximize its emission characteristics in normal application.

4.6. Operating Condition of EUT

4.6.1. Setup the EUT as shown in Section 4.2.

4.6.2. Turned on the power of all equipment.

4.6.3. Let the EUT work in test mode (Tx Mode) and tested it.

4.7. Test Procedure

EUT and its simulators are placed on a turn table, which is 0.8 meter high above ground. The turn table can rotate 360 degrees to determine the position of the maximum emission level. Power on the EUT and let it work in test mode, then test it. EUT is set 10 meters away from the receiving antenna, which is mounted on an antenna tower. The antenna can be moved up and down between 1 meter and 4 meters to find out the maximum emission level. Broadband antenna (calibrated bilog antenna) is used as receiving antenna. Both horizontal and vertical polarization of the antenna are set on test.

For frequency range below 30MHz the Loop antenna was used at 10m measurement distance with antenna heights of 1m and antenna loop front and side faced to the EUT. The axis of the antenna was rotated to maximize the emission. A CISPR quasi-peak detector is used for measurements below 30MHz and RBW/VBW is 9kHz/30kHz.

The limit 1.705MHz to 30MHz in clause 4.3 are specified at 30 meters, and measurements were made at 10 meters, the limit is translated to 10 meters by using a formula as follows:
$$\text{Limit}_{10\text{m}} = \text{Limit}_{30\text{m}} + 40\log(30\text{m}/10)$$

4.8. Radiated Emission Test Results

PASS.

The frequency range from 30MHz to 1000MHz and 1.705MHz to 30MHz is investigated. Please see the following pages.

Note: According to exploratory test, 9kHz to 1.705MHz no obvious signal can be detected.
Remark: According to exploratory test with the loop antenna on the Horizontal and Vertical polarity find the Vertical polarity has the worst case emission, so Reported the test result on Vertical polarity which has the Worst case result in this Report.

FCC ID:XLU84392790

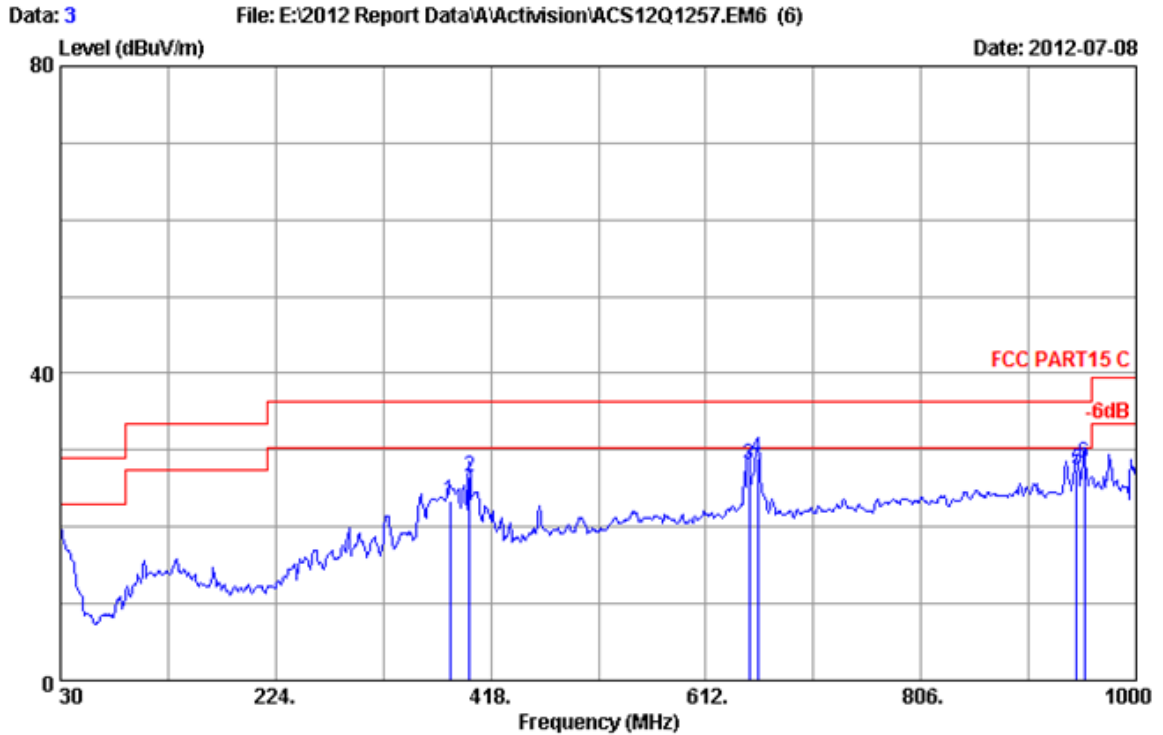

Site no. : 10m Chamber Data no. : 3
 Dis. / Ant. : 10m 11 CBL6112D 25237 Ant. pol. : HORIZONTAL
 Limit : FCC PART15 C
 Env. / Ins. : 24°C/56% Engineer : Leo-Li
 EUT : Potal of Power for Xbox360
 Power rating : DC 5V From Xbox360 Input AC 120V/60Hz
 Test Mode : Tx Mode
 M/N:84392790

No.	Freq. (MHz)	Ant. Factor (dB/m)	Cable Loss (dB)	Reading (dBuV)	Emission Level (dBuV/m)	Limits (dBuV/m)	Margin (dB)	Remark
1	381.14	15.16	1.73	6.50	23.39	36.40	13.01	QP
2	398.60	16.04	1.80	8.65	26.49	36.40	9.91	QP
3	650.80	19.40	2.51	6.23	28.14	36.40	8.26	QP
4	658.56	19.32	2.53	7.05	28.90	36.40	7.50	QP
5	946.65	21.44	3.20	2.74	27.38	36.40	9.02	QP
6	953.44	21.57	3.21	3.50	28.28	36.40	8.12	QP

Remarks: 1. Emission Level= Antenna Factor + Cable Loss + Reading.
 2. The emission levels that are 20dB below the official limit are not reported.

FCC ID: XLU84392790

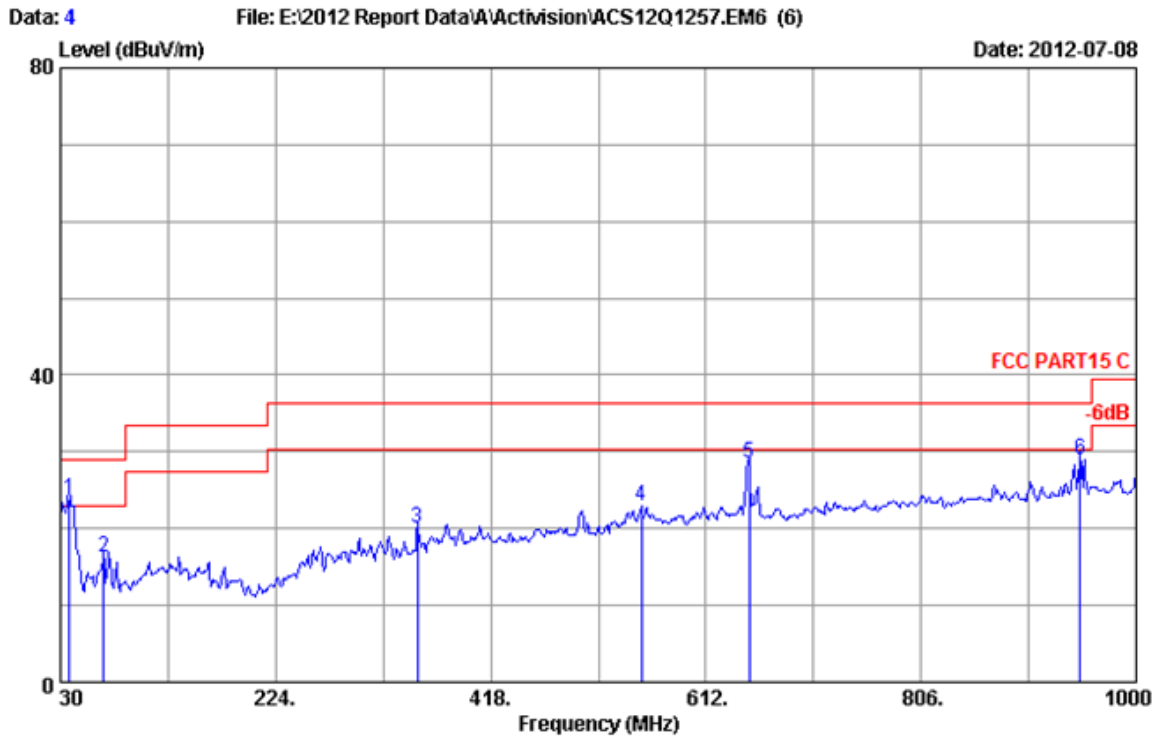

Site no. : 10m Chamber Data no. : 4
 Dis. / Ant. : 10m 11 CBL6112D 25237 Ant. pol. : VERTICAL
 Limit : FCC PART15 C
 Env. / Ins. : 24°C/56% Engineer : Leo-Li
 EUT : Potal of Power for Xbox360
 Power rating : DC 5V From Xbox360 Input AC 120V/60Hz
 Test Mode : Tx Mode
 M/N:84392790

No.	Freq. (MHz)	Ant. Factor (dB/m)	Cable Loss (dB)	Reading (dBuV)	Emission Level (dBuV/m)	Limits (dBuV/m)	Margin (dB)	Remark
1	37.76	14.90	0.57	8.43	23.90	29.00	5.10	QP
2	68.80	7.65	0.75	7.85	16.25	29.00	12.75	QP
3	352.04	14.44	1.64	3.88	19.96	36.40	16.44	QP
4	553.80	19.10	2.27	1.50	22.87	36.40	13.53	QP
5	650.80	19.40	2.51	6.57	28.48	36.40	7.92	QP
6	949.56	21.50	3.20	4.38	29.08	36.40	7.32	QP

Remarks: 1. Emission Level= Antenna Factor + Cable Loss + Reading.
 2. The emission levels that are 20dB below the official limit are not reported.

FCC ID:XLU84392790

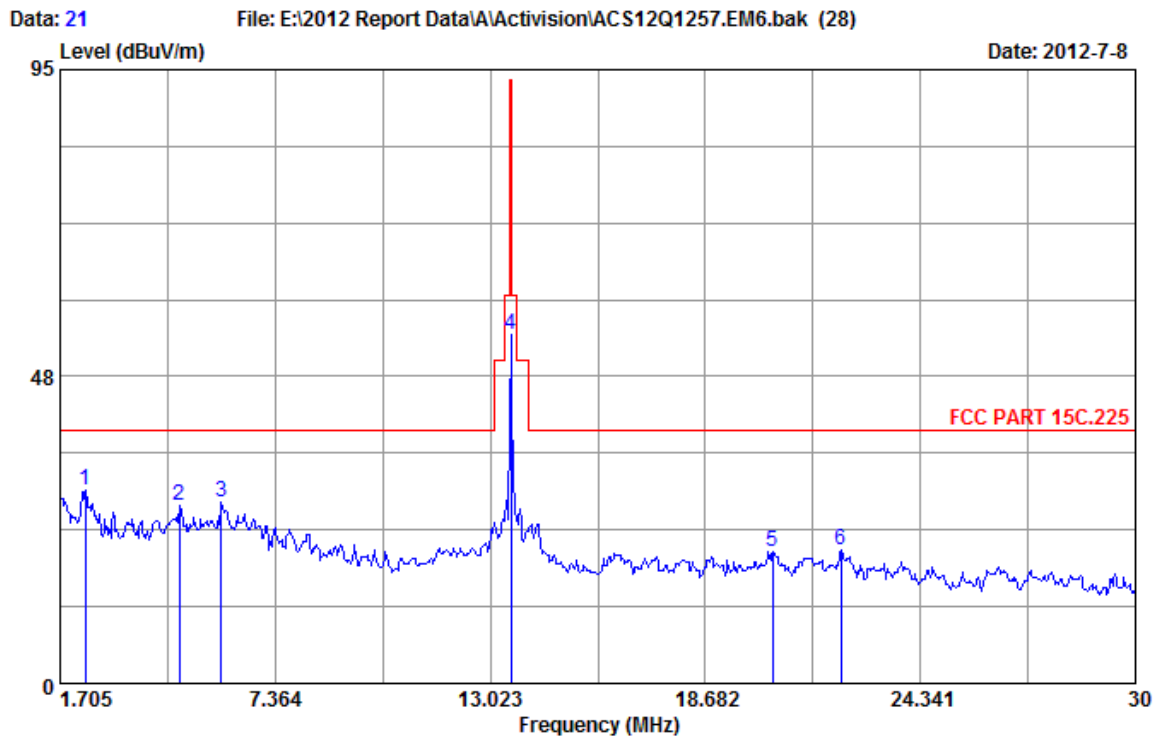

Site no. : 10m Chamber Data no. : 21
 Dis. / Ant. : 10m 2011 LOOP ANTENNA Ant. pol. :
 Limit : FCC PART 15C.225
 Env. / Ins. : 24°C/56% Engineer : Leo-Li
 EUT : Potal of Power for Xbox360
 Power rating : DC 5V From Xbox360 Input AC 120V/60Hz
 Test Mode : Tx Mode
 M/N:84392790

No.	Freq. (MHz)	Ant. Factor (dB/m)	Cable Loss (dB)	Reading (dBuV)	Emission Level (dBuV/m)	Limits (dBuV/m)	Margin (dB)	Remark
1	2.378	19.60	0.34	9.88	29.82	39.08	9.26	QP
2	4.838	21.04	0.39	6.17	27.60	39.08	11.48	QP
3	5.947	20.99	0.41	6.69	28.09	39.08	10.99	QP
4	13.560	21.43	0.52	32.02	53.97	93.53	39.56	QP
5	20.463	22.08	0.53	-2.11	20.50	39.08	18.58	QP
6	22.262	22.01	0.53	-1.87	20.67	39.08	18.41	QP

Remarks: 1. Emission Level= Antenna Factor + Cable Loss + Reading.
 2. The emission levels that are 20dB below the official limit are not reported.

5. FREQUENCY STABILITY TEST

5.1. Test Equipment

Item	Equipment	Manufacturer	Model No.	Serial No.	Last Cal.	Cal. Interval
1.	Spectrum Analyzer	Agilent	E4446A	US44300459	May.08,12	1 Year
2.	RF Cable	Hubersuhner	SUCOFLEX102	28618/2	May.08,12	1Year

5.2. Limits

The frequency tolerance of the carrier signal shall be maintained within +/- 0.01% of the operating frequency over a temperature variation of -20 degrees to +50 degrees C at normal supply voltage, and for a variation in the primary supply voltage from 85% to 115% of the rated supply voltage at a temperature of 20 degrees C. For battery operated equipment, the equipment tests shall be performed using a new battery.

5.3. Test Procedure

The EUT was placed in an environmental test chamber and powered such that control element received normal voltage and the transmitter provided maximum RF output.

FCC ID: XLU84392790

5.4. Test result

EUT: Portal of Power for Xbox360				
M/N: 84392790				
Power: DC 5V From Xbox360 Input AC 120V/60Hz				
Test Date: 2012-07-08	Test site: RF Chamber		Tested by: Leo-Li	
Ambient Temperature: 24.3°C	Relative Humidity: 53.7%		Pressure: 101.2 kpa	
Test Frequency: 13.56MHz				
Frequency stability VS Voltage (Temperature: 20°C)				
Supply Voltage (V)	Test result (MHz)	Deviation (ppm)	Limit (ppm)	Conclusion
102	13.560080	25.07	100	PASS
108	13.560250	12.54	100	
114	13.560500	5.90	100	
120	13.560420	0	100	
126	13.560580	11.80	100	
132	13.560670	18.44	100	
138	13.560830	30.24	100	
Frequency stability VS Temperature (supply voltage 4.5V)				
Temperature (°C)	Test result (MHz)	Deviation (ppm)	Limit (ppm)	Conclusion
-20	13.560000	24.34	100	PASS
-10	13.560080	18.44	100	
0	13.560420	6.64	100	
10	13.560250	5.90	100	
20	13.560330	0	100	
30	13.560080	18.44	100	
40	13.560170	11.80	100	
50	13.560750	30.97	100	

FCC ID: XLU84392790

Frequency stability VS Temperature:

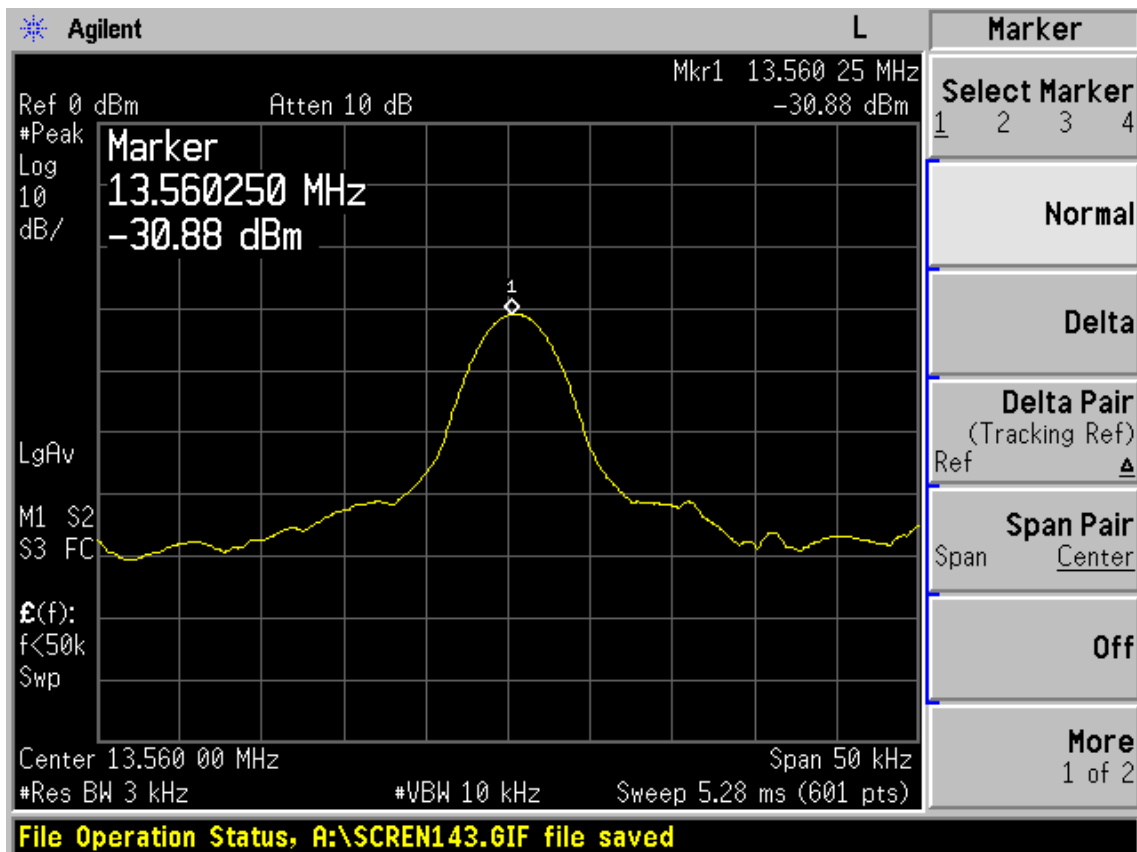
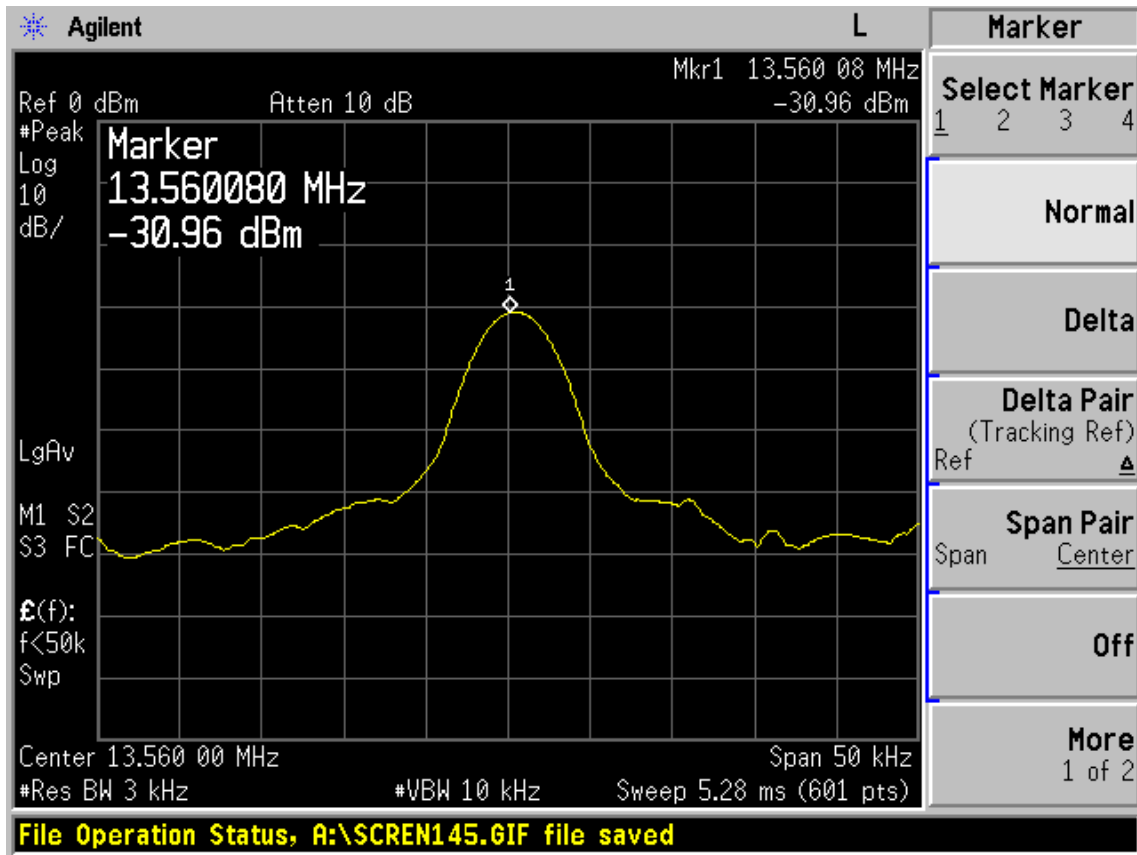

FCC ID: XLU84392790

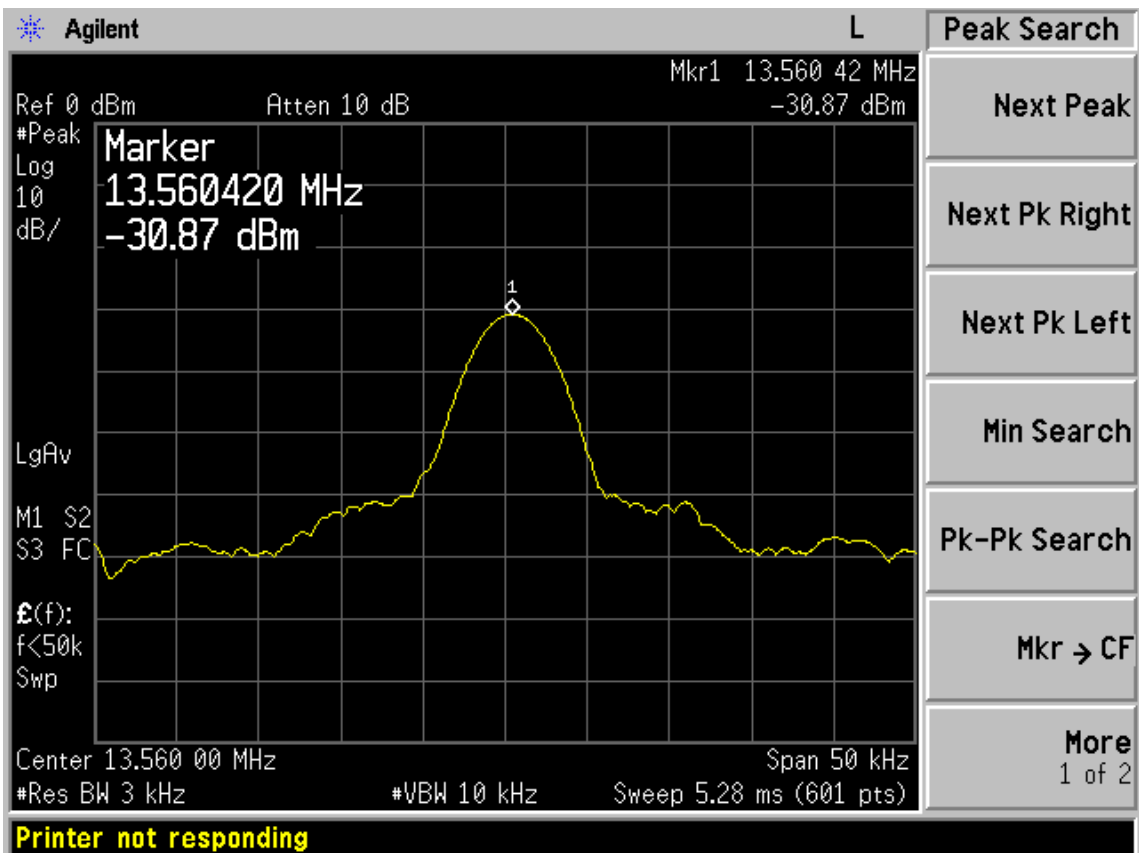
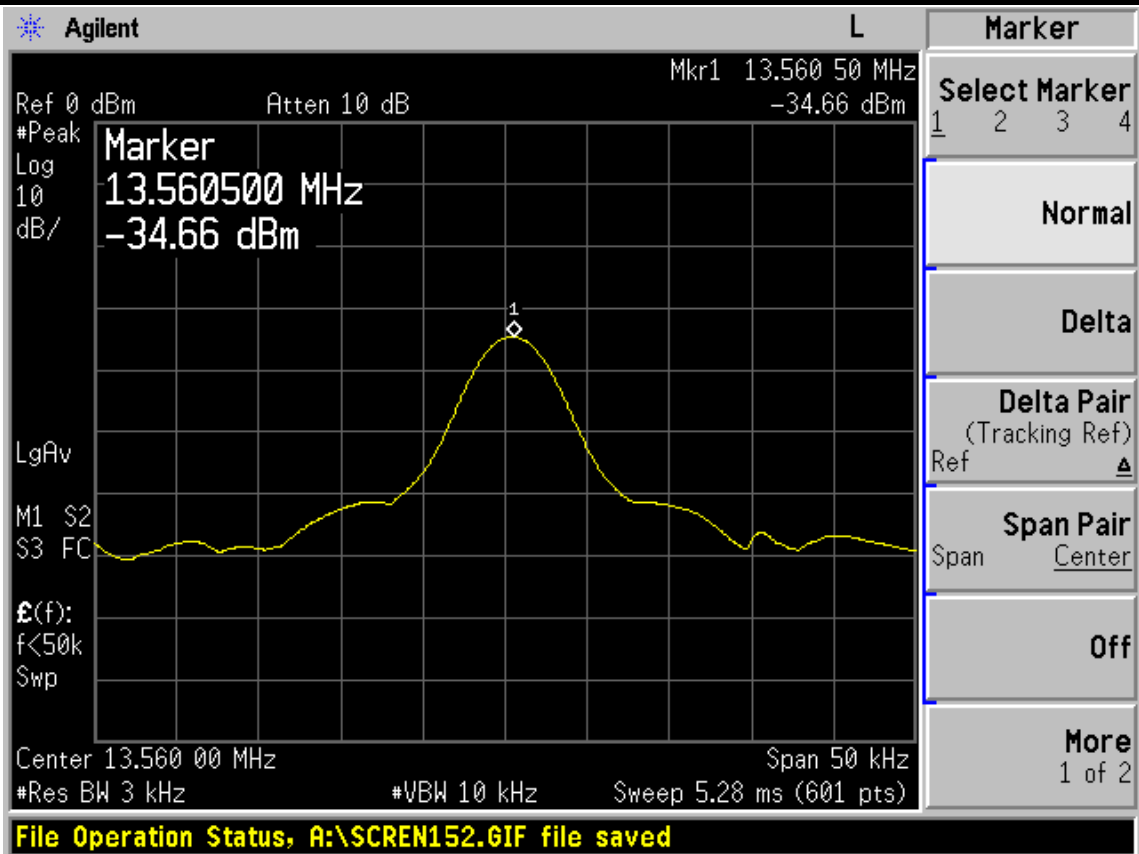

FCC ID: XLU84392790

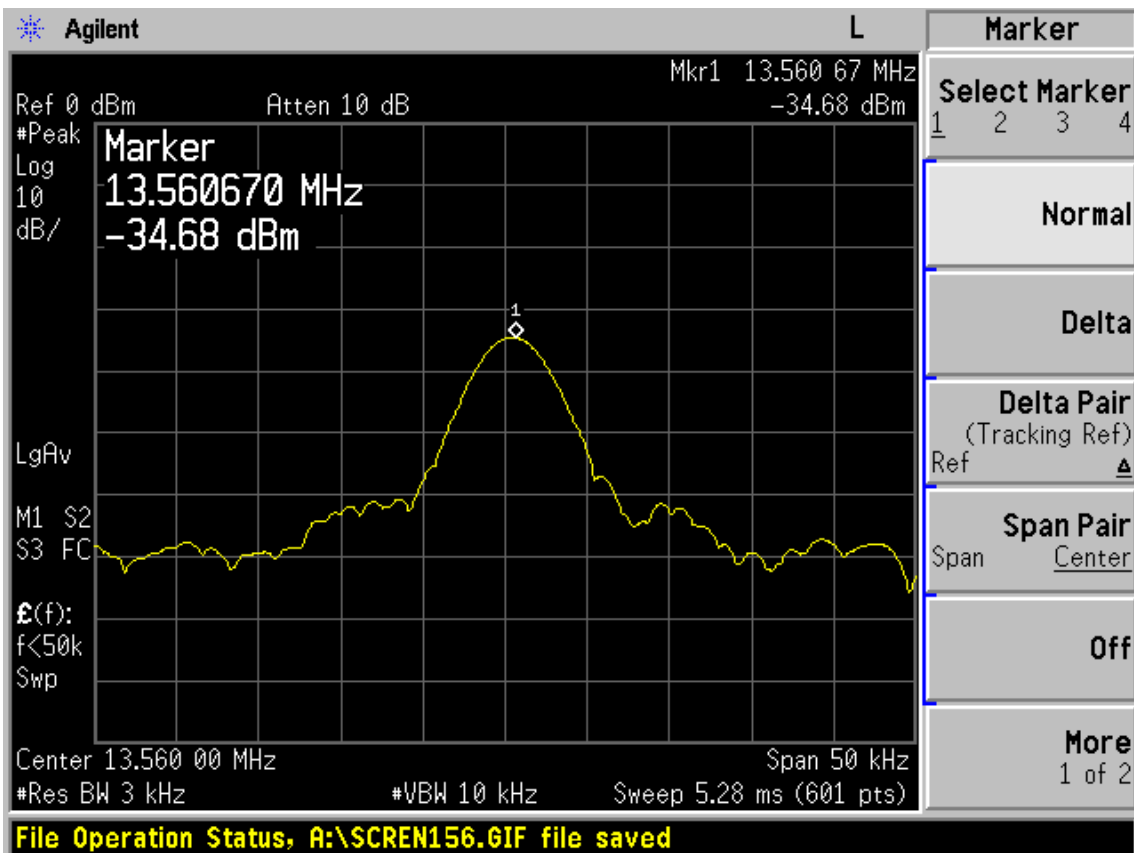
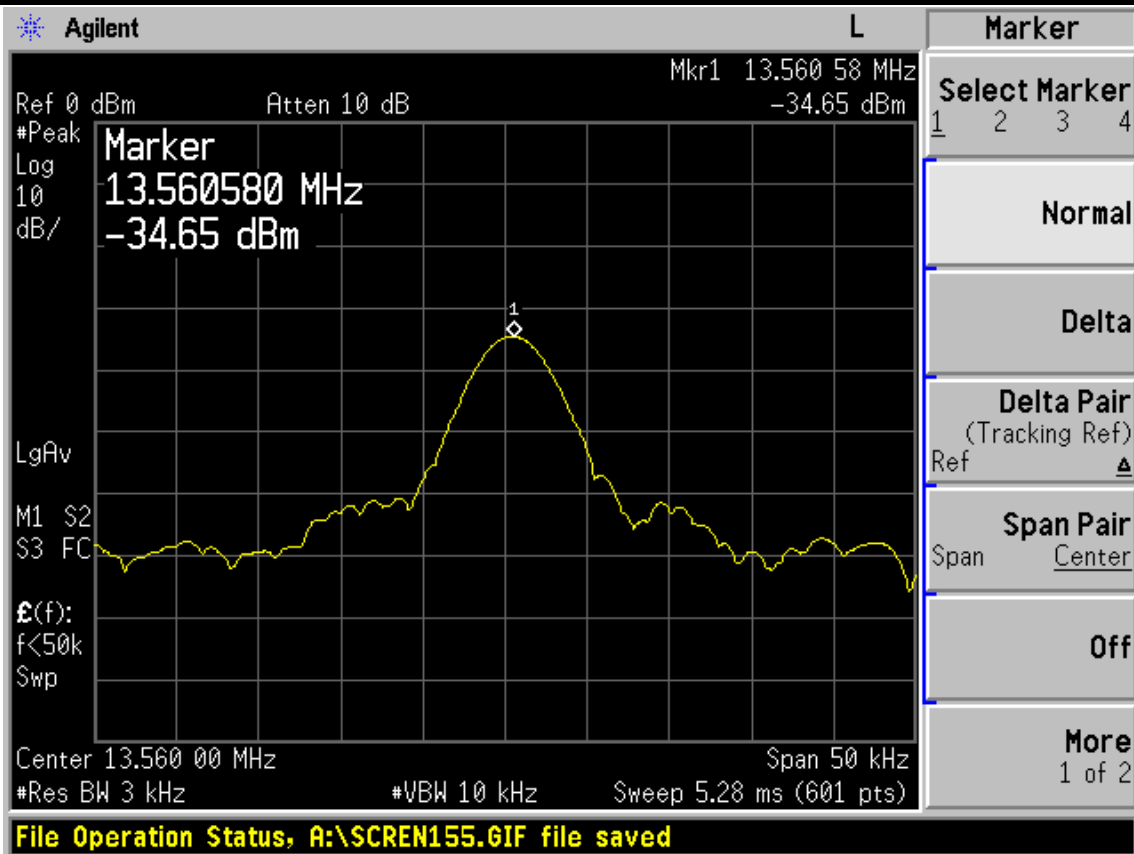

FCC ID: XLU84392790

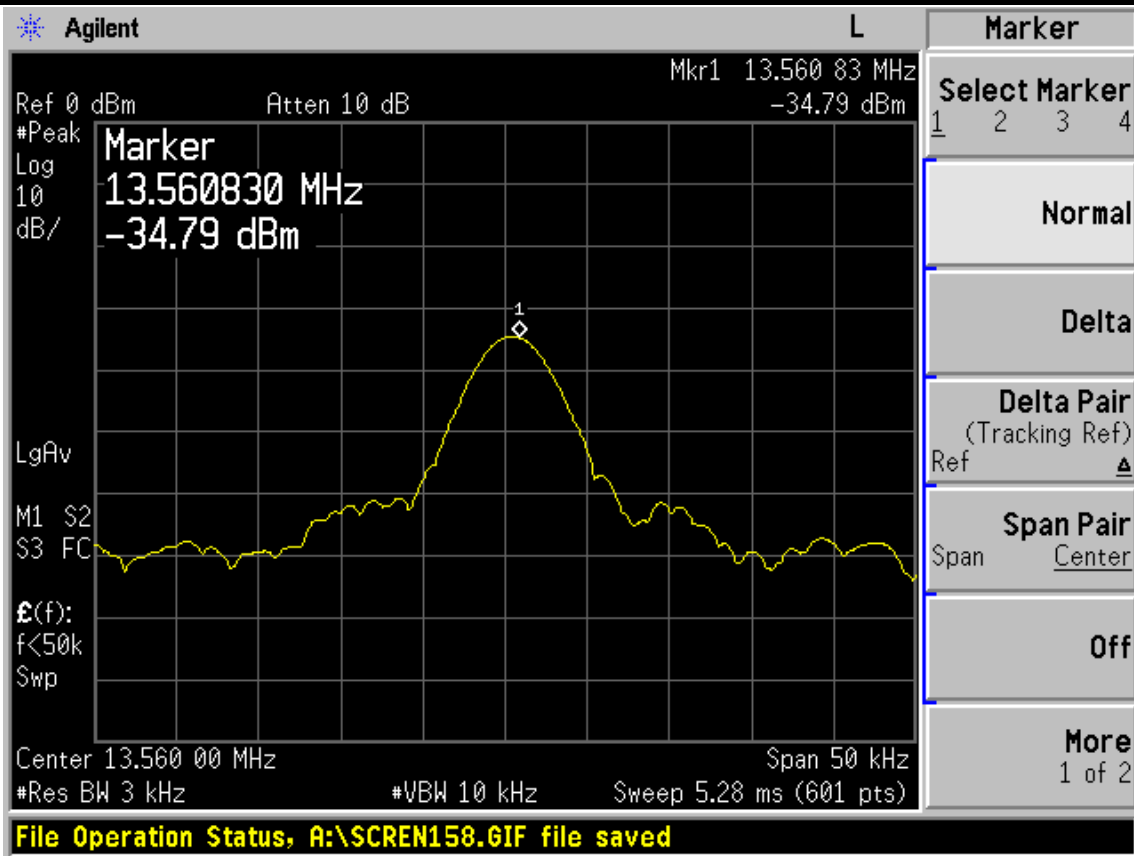

Frequency stability VS Voltage:

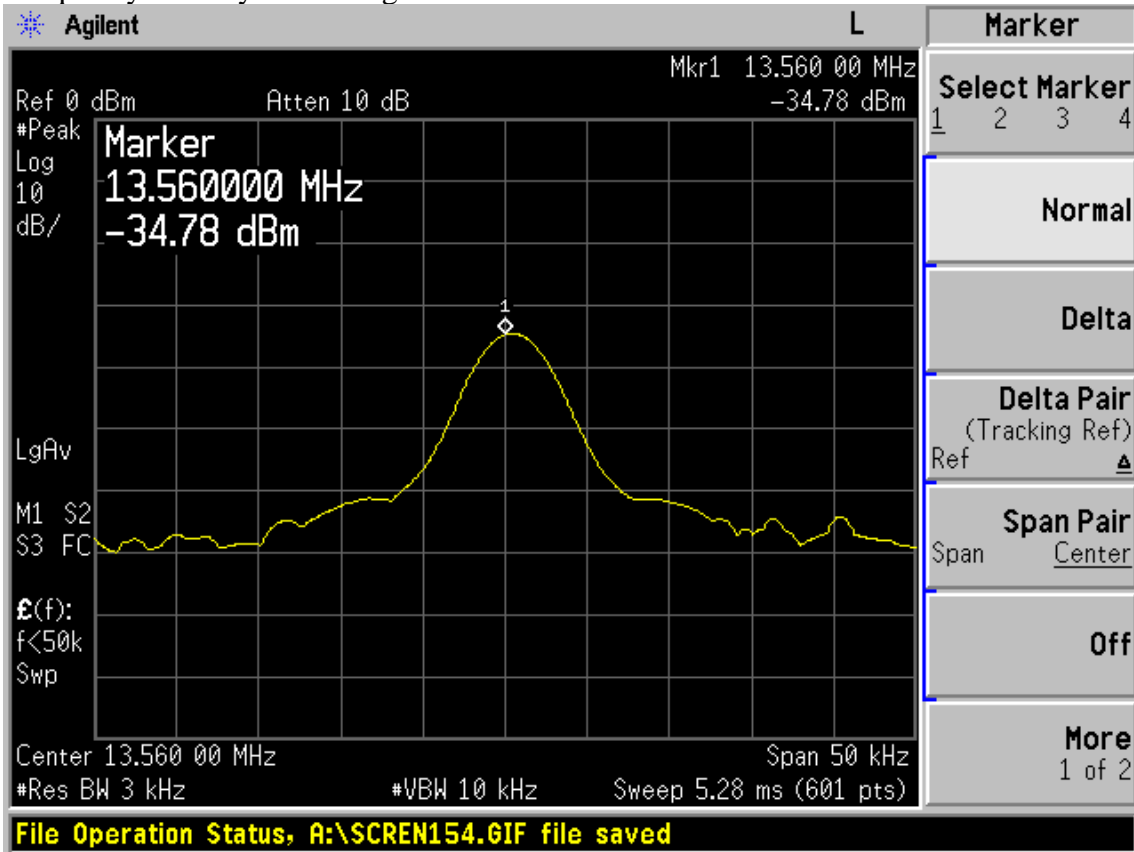

FCC ID: XLU84392790

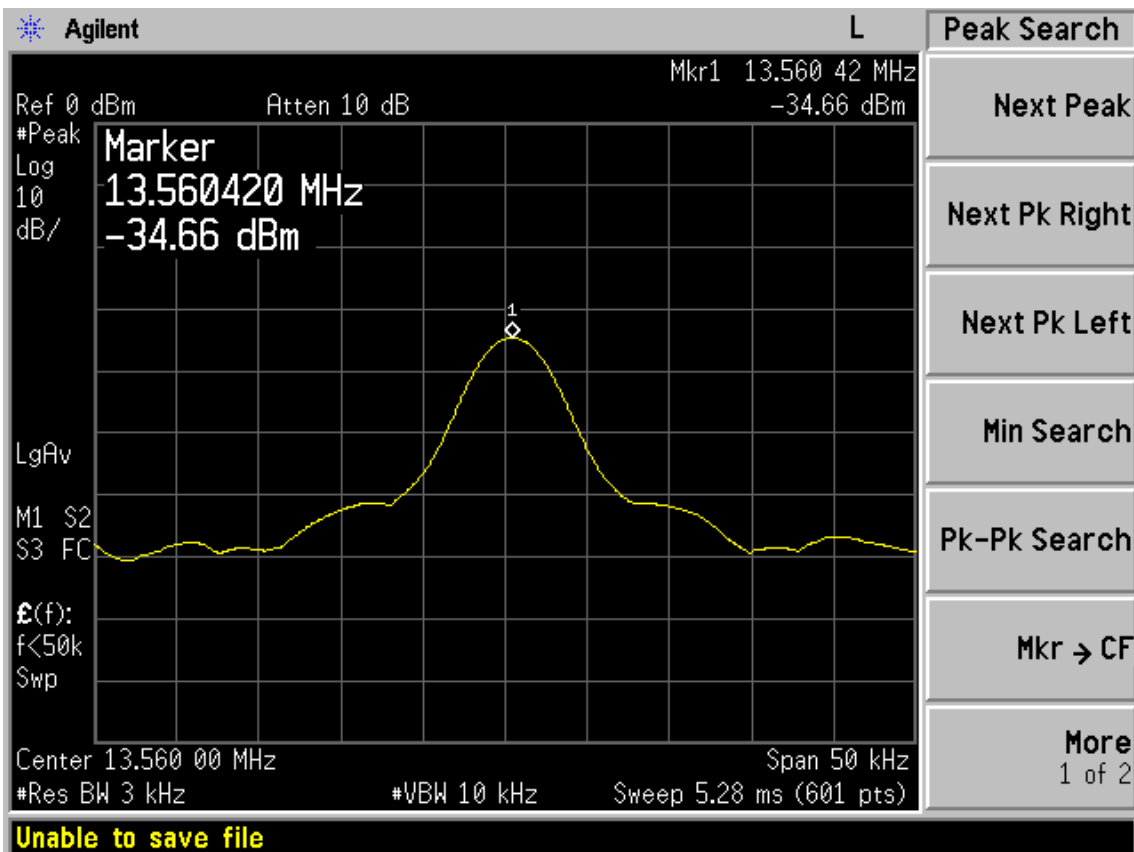
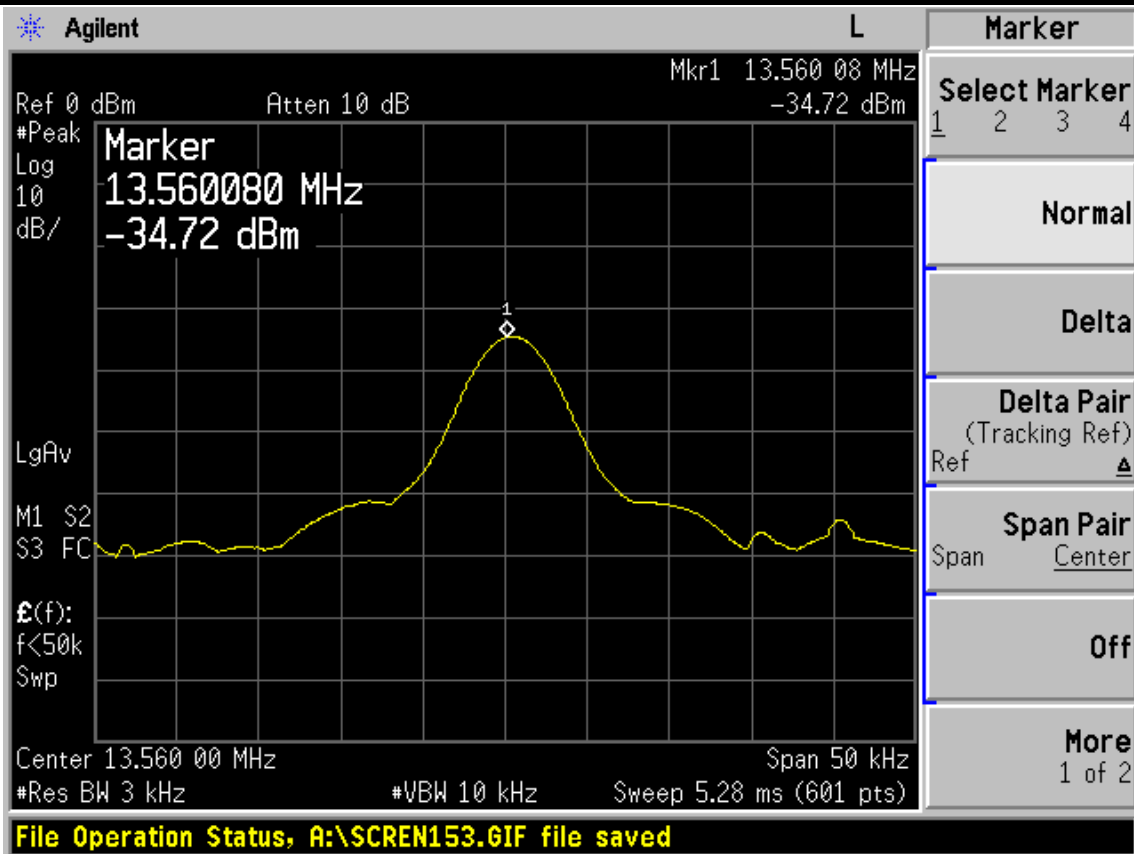

FCC ID: XLU84392790

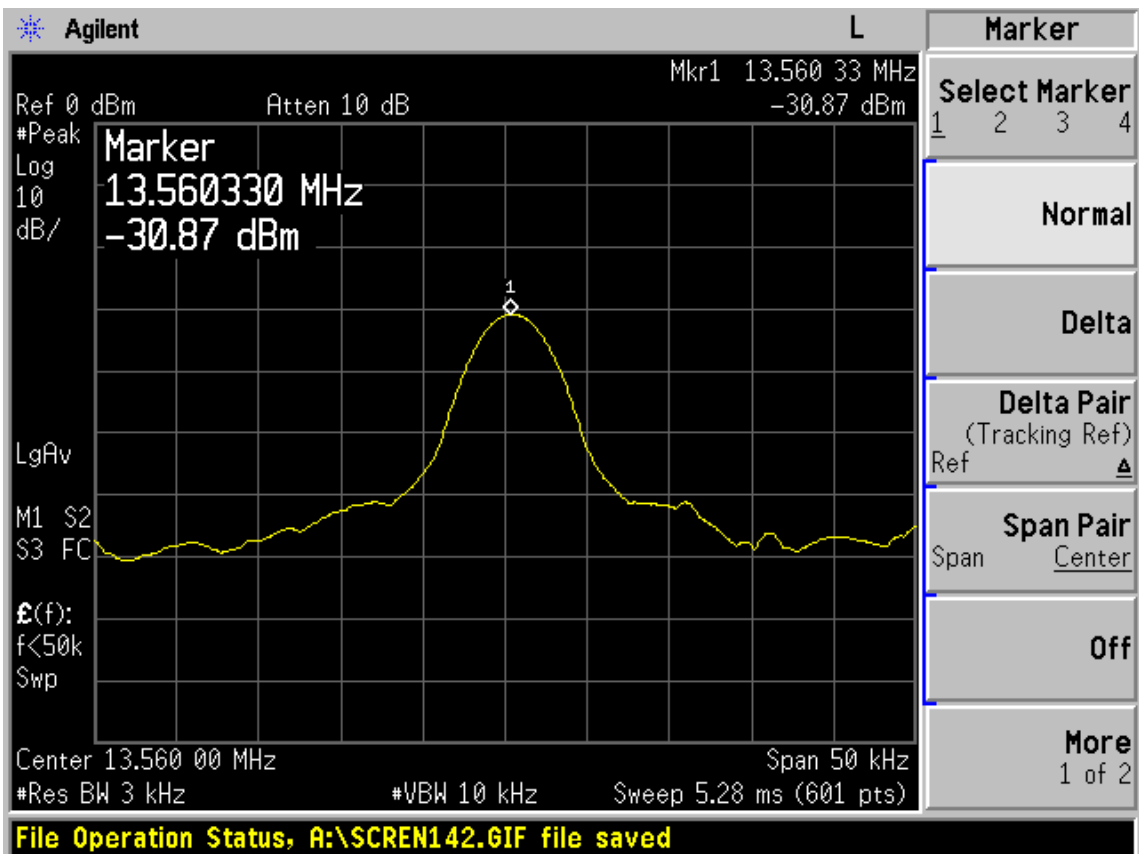
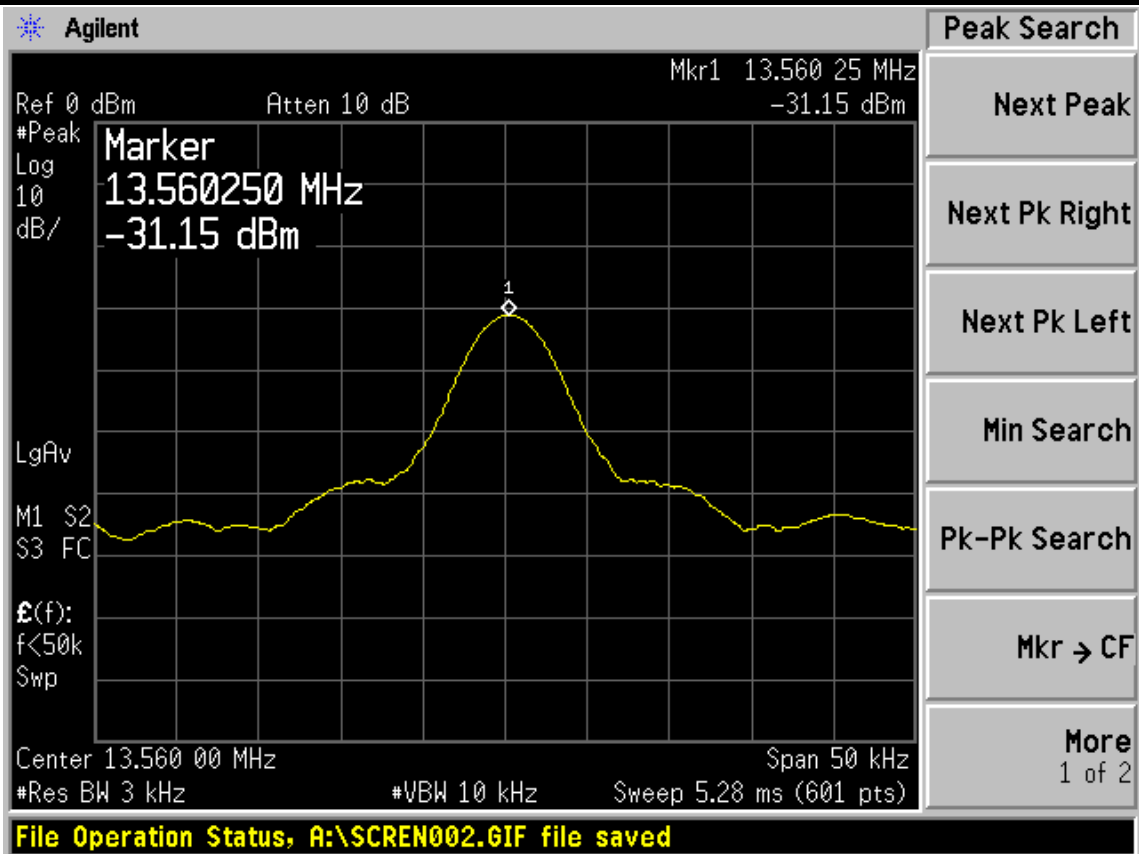

FCC ID: XLU84392790

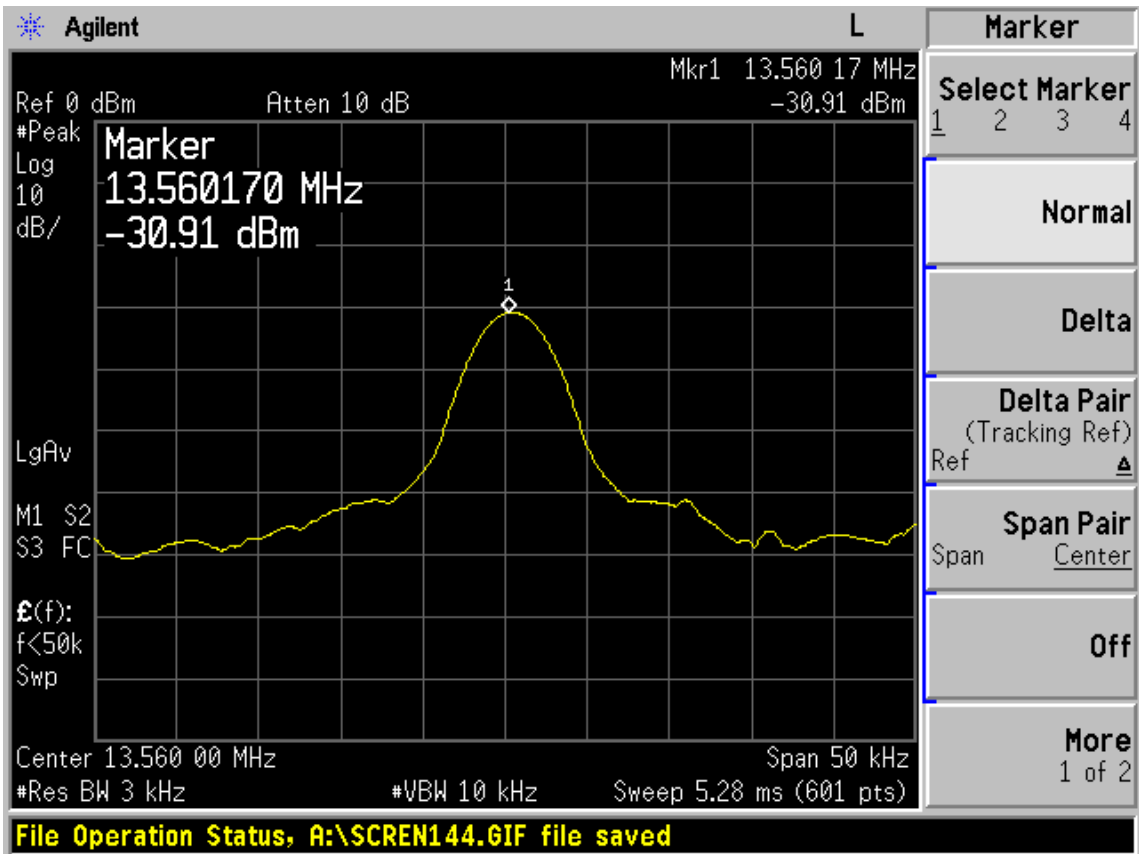
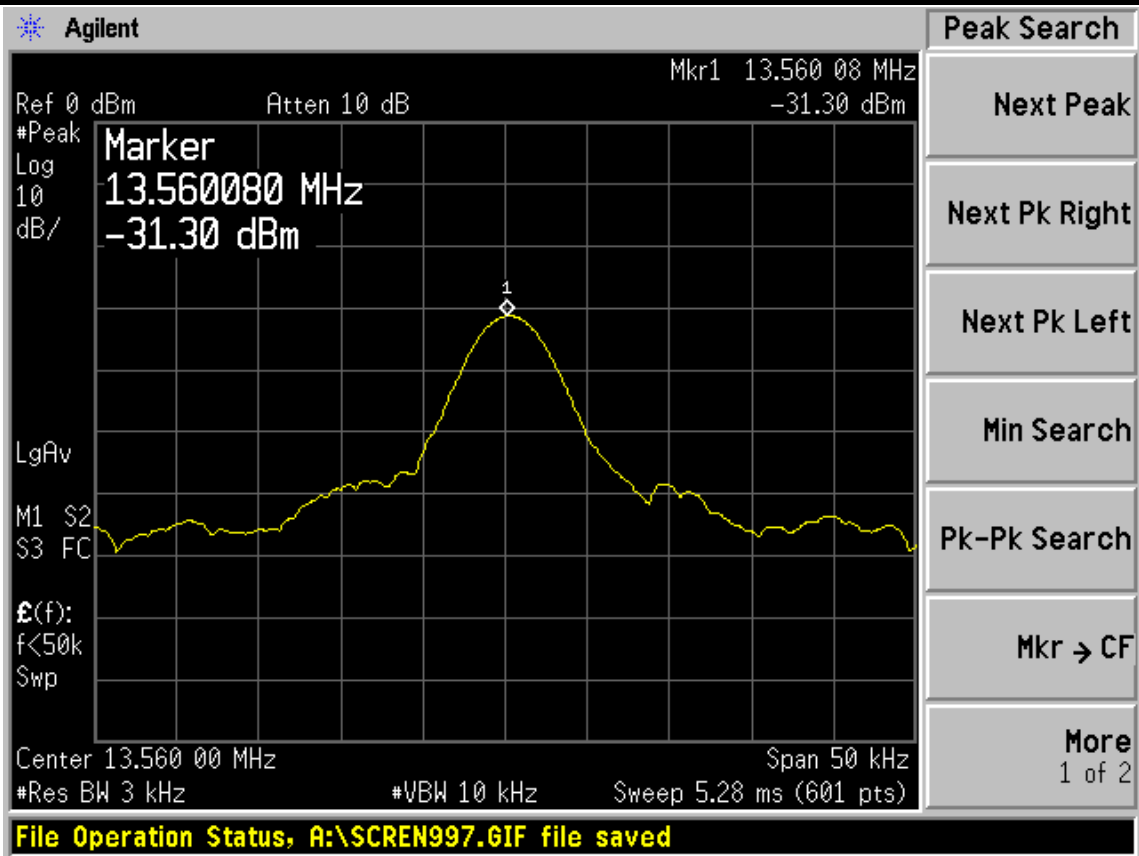

FCC ID: XLU84392790

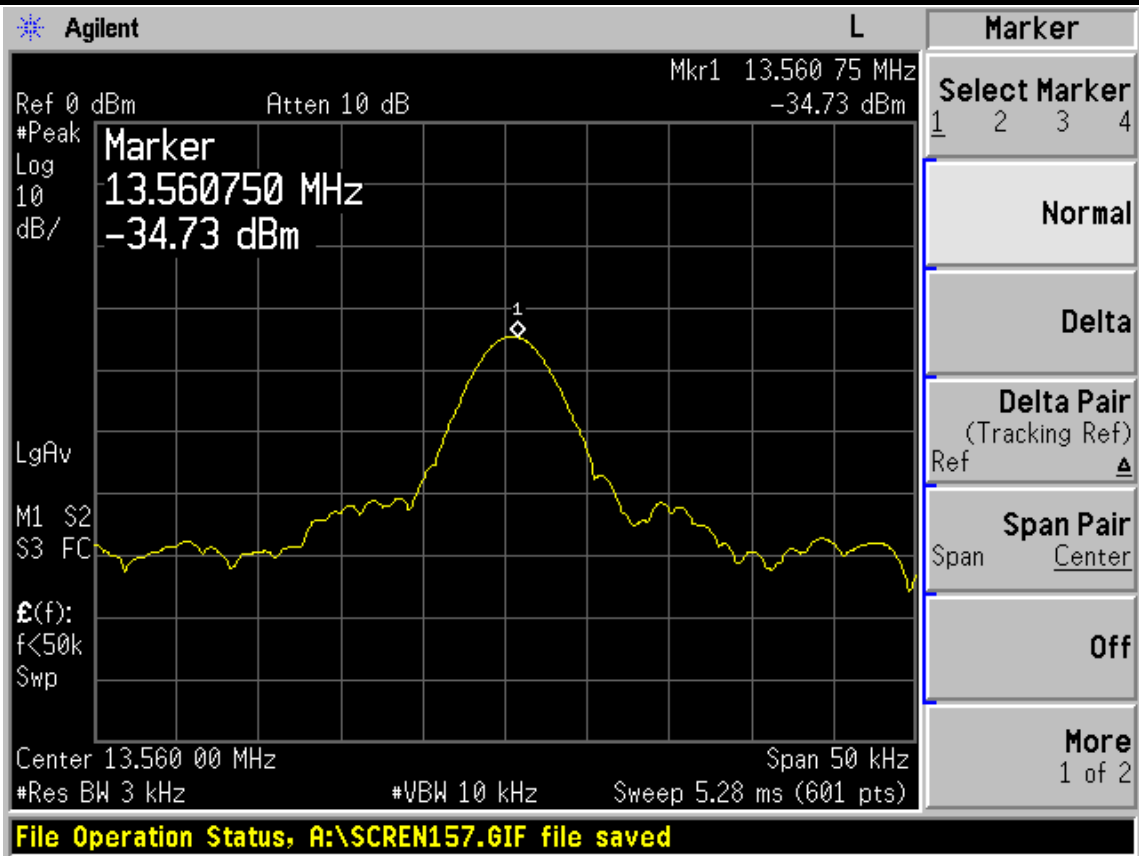

6. 20 DB BANDWIDTH TEST

6.1. Test Equipment

Item	Equipment	Manufacturer	Model No.	Serial No.	Last Cal.	Cal. Interval
1.	Spectrum Analyzer	Agilent	E4446A	US44300459	May.08,12	1 Year
2.	RF Cable	Hubersuhner	SUCOFLEX102	28618/2	May.08,12	1Year

6.2.Limit

Intentional radiators operating under the alternative provisions to the general emission limits, as contained in §§ 15.217 through 15.257 and in Subpart E of this part, must be designed to ensure that the 20 dB bandwidth of the emission, or whatever bandwidth may otherwise be specified in the specific rule section under which the equipment operates, is contained within the frequency band designated in the rule section under which the equipment is operated.

6.3. Test Results

EUT: Portal of Power for Xbox 360		
M/N: 84392790		
Test date:2012-07-04	Pressure:101.1kpa	Humidity:53.9%
Tested by:Leo-Li	Test site: RF site	Temperature : 24.3°C

Frequency	20dB bandwidth (KHz)	Limit (KHz)
13.56MHz	435.140	N/A
Conclusion : PASS		

FCC ID: XLU84392790

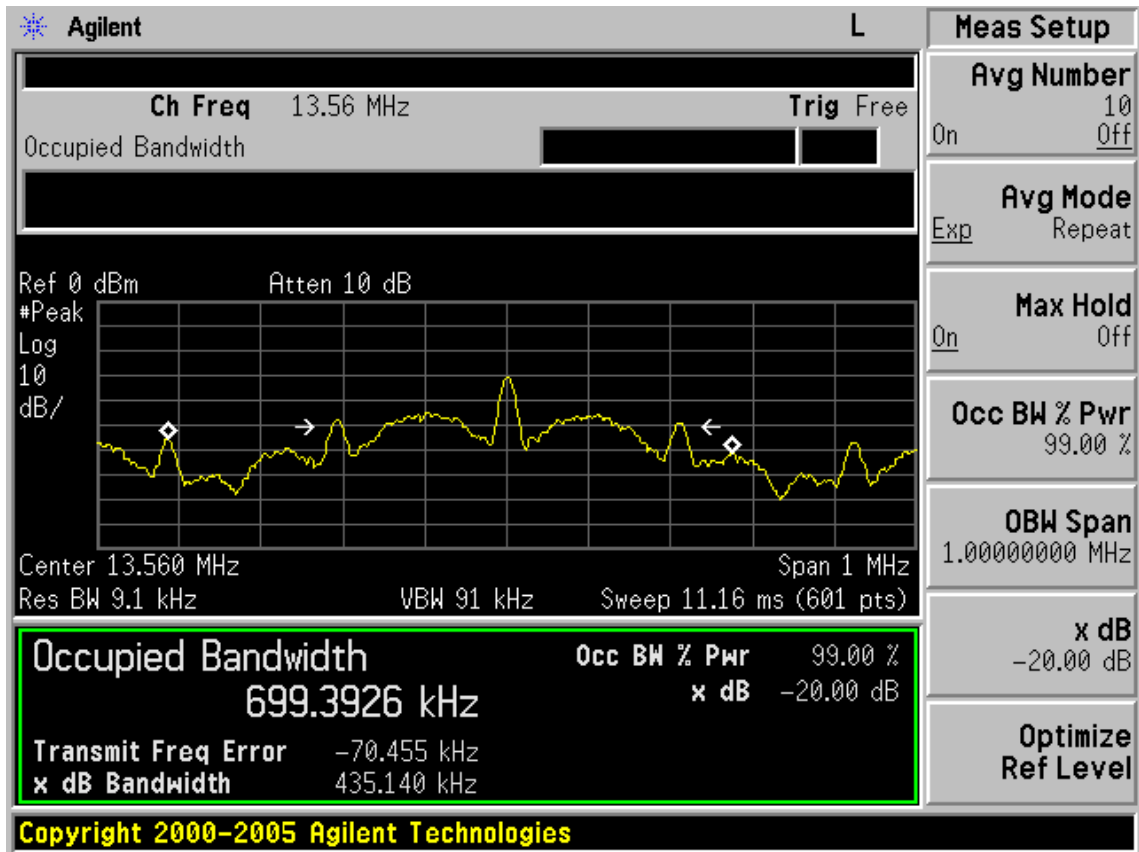

7. DEVIATION TO TEST SPECIFICATIONS

[NONE]