

# FCC RADIO TEST REPORT

**FCC ID: XJ6-MT600**

**Product :** 6CH 2.4GHz FHSS RADIO SYSTEM

**Trade Name :** MERITRC

**Model Number :** MT-600

**Serial Model :** N/A

**Report No. :** NTEK-2012NT0307279F

## Prepared for

SHANGHAI MERIT TECHNOLOGY CORP.

No. 1058 TAOGAN ROAD, SHESHAN, SONGJIANG, SHANGHAI, CHINA

## Prepared by

NTEK Testing Technology Co., Ltd.

1/F, Building E, Fenda Science Park, Sanwei Community, Xixiang Street  
Bao'an District, Shenzhen P.R. China

Tel.: +86-0755-61156588 Fax.: +86-0755-61156599

Website: [www.ntek.org.cn](http://www.ntek.org.cn)

## TEST RESULT CERTIFICATION

**Applicant's name** ..... : SHANGHAI MERIT TECHNOLOGY CORP.  
Address ..... : No. 1058 TAOGAN ROAD, SHESHAN, SONGJIANG, SHANGHAI, CHINA

**Manufacturer's Name** ..... : SHANGHAI MERIT TECHNOLOGY CORP.  
Address ..... : No. 1058 TAOGAN ROAD, SHESHAN, SONGJIANG, SHANGHAI, CHINA

### Product description

Product name ..... : 6CH 2.4GHz FHSS RADIO SYSTEM

Model and/or type reference : MT-600

Serial Model : N/A

Rating(s) ..... : DC 6V(1.5V\*4cell "AA" alkaline battery)

**Standards** ..... : FCC Part15.249

Test procedure ..... ANSI C63.4-2003

This device described above has been tested by NTEK, and the test results show that the equipment under test (EUT) is in compliance with the FCC requirements. And it is applicable only to the tested sample identified in the report.

This report shall not be reproduced except in full, without the written approval of NTEK, this document may be altered or revised by NTEK, personal only, and shall be noted in the revision of the document.

**Date of Test** .....

Date (s) of performance of tests ..... : 04 Mar. 2012 ~08 Mar. 2012

Date of Issue ..... : 10 Mar. 2012

Test Result ..... : **Pass**

Testing Engineer : Apple Huang  
(Apple Huang)

Technical Manager : Tom Zhang  
(Tom Zhang)

Authorized Signatory : Bovey Yang  
(Bovey Yang)

<b>Table of Contents</b>	<b>Page</b>
<b>1 . SUMMARY OF TEST RESULTS</b>	<b>4</b>
1.1 TEST FACILITY	5
1.2 MEASUREMENT UNCERTAINTY	5
<b>2 . GENERAL INFORMATION</b>	<b>6</b>
2.1 GENERAL DESCRIPTION OF EUT	6
2.2 DESCRIPTION OF TEST MODES	8
2.3 BLOCK DIGRAM SHOWING THE CONFIGURATION OF SYSTEM TESTED	9
2.4 DESCRIPTION OF SUPPORT UNITS(CONDUCTED MODE)	10
<b>3 . TEST RESULT</b>	<b>12</b>
3.1 ANTENNA REQUIREMENT	12
3.1.1 STANDARD REQUIREMENT	12
3.1.2 EUT ANTENNA	12
3.2 CONDUCTED EMISSION MEASUREMENT	13
3.2.1 POWER LINE CONDUCTED EMISSION LIMITS	13
3.2.2 TEST PROCEDURE	14
3.2.3 DEVIATION FROM TEST STANDARD	14
3.2.4 TEST SETUP	14
3.2.5 TEST RESULT	15
3.3 RADIATED EMISSION MEASUREMENT	17
3.3.1 RADIATED EMISSION LIMITS	17
3.3.2 TEST PROCEDURE	18
3.3.3 DEVIATION FROM TEST STANDARD	18
3.3.4 TEST SETUP	19
3.3.5 TEST RESULTS (BLOW 30MHZ)	21
3.3.6 TEST RESULTS (BETWEEN 30 – 1000 MHZ)	22
3.3.7 TEST RESULTS (ABOVE 1000 MHZ)	24
<b>4 . BANDWIDTH TEST</b>	<b>34</b>
4.1 TEST PROCEDURE	34
4.2 DEVIATION FROM STANDARD	34
4.3 TEST SETUP	34
4.4 TEST RESULTS	35
<b>5 . EUT TEST PHOTO</b>	<b>38</b>
<b>APPENDIX-PHOTOGRAPHS OF EUT CONSTRUCTIONAL DETAILS</b>	

## 1. SUMMARY OF TEST RESULTS

Test procedures according to the technical standards:

FCC Part15, Subpart C (15.249)			
Standard Section	Test Item	Judgment	Remark
15.207	Conducted Emission	Pass	
15.203	Antenna Requirement	Pass	
15.249	Radiated Spurious Emission	Pass	
15.249	Occupied Bandwidth	Pass	

**1.1 TEST FACILITY**

NTEK Testing Technology Co., Ltd

Add. : 1/F, Building E, Fenda Science Park, Sanwei Community, Xixiang Street, Bao'an District, Shenzhen P.R. China.

FCC FRN Registration Nombre:238937; IC Registration Nombre:9270A-1

**1.2 MEASUREMENT UNCERTAINTY**

The reported uncertainty of measurement  $y \pm U$ , where expanded uncertainty  $U$  is based on a standard uncertainty multiplied by a coverage factor of  $k=2$ , providing a level of confidence of approximately **95 %**.

No.	Item	Uncertainty
1	Conducted Emission Test	$\pm 1.38\text{dB}$
2	RF power,conducted	$\pm 0.16\text{dB}$
3	Spurious emissions,conducted	$\pm 0.21\text{dB}$
4	All emissions,radiated(<1G)	$\pm 4.68\text{dB}$
5	All emissions,radiated(>1G)	$\pm 4.89\text{dB}$
6	Temperature	$\pm 0.5^{\circ}\text{C}$
7	Humidity	$\pm 2\%$

## 2. GENERAL INFORMATION

### 2.1 GENERAL DESCRIPTION OF EUT

Equipment	6CH 2.4GHz FHSS RADIO SYSTEM	
Trade Name	MERITRC	
Model Name	MT-600	
Serial Model	N/A	
Model Difference	N/A	
Product Description	The EUT is a 6CH 2.4GHz FHSS RADIO SYSTEM	
	Operation Frequency:	2405~2455 MHz
	Modulation Type:	FHSS
	Antenna Designation:	Built-in Antenna
	Antenna Gain(Peak)	2.0 dBi
	EIRP	99.51dbuv/m@3m
	Based on the application, features, or specification exhibited in User's Manual, the EUT is considered as an ITE/Computing Device. More details of EUT technical specification, please refer to the User's Manual.	
Channel List	Please refer to the Note 2.	
Adapter	AC Power Input: 100-240V~, 50/60Hz, 0.6A Output: 5V  0.5A	
Battery	1.5V*4cell "AA" alkaline battery	

**Note:**

1. For a more detailed features description, please refer to the manufacturer's specifications or the User's Manual.

2.

Channel	Frequency (MHz)
01	2405
02	2406
.....	.....
26	2430
27	2431
.....	.....
50	2454
51	2455

3.

Table for Filed Antenna

Ant	Brand	Model Name	Antenna Type	Connector	Gain (dBi)	NOTE
1	N/A	N/A	Built-in Antenna	NA	2.0	Antenna

## 2.2 DESCRIPTION OF TEST MODES

To investigate the maximum EMI emission characteristics generates from EUT, the test system was pre-scanning tested base on the consideration of following EUT operation mode or test configuration mode which possible have effect on EMI emission level. Each of these EUT operation mode(s) or test configuration mode(s) mentioned above was evaluated respectively.

Pretest Mode	Description
Mode 1	CH1
Mode 2	CH26
Mode 3	CH51
Mode 4	Charge Mode

For Conducted Emission	
Final Test Mode	Description
Mode 4	Charge Mode

For Radiated Emission	
Final Test Mode	Description
Mode 1	CH1
Mode 2	CH26
Mode 3	CH51

Note:

- (1) The measurements are performed at the highest, middle, lowest available channels.
- (2) The EUT use new battery.



### 2.3 BLOCK DIGRAM SHOWING THE CONFIGURATION OF SYSTEM TESTED

Conducted Emission Test

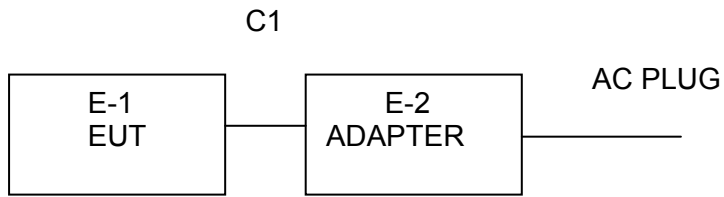

Radiated Spurious Emission Test

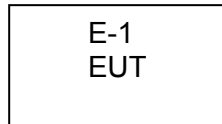

**2.4 DESCRIPTION OF SUPPORT UNITS(CONDUCTED MODE)**

The EUT has been tested as an independent unit together with other necessary accessories or support units. The following support units or accessories were used to form a representative test configuration during the tests.

Item	Equipment	Mfr/Brand	Model/Type No.	Series No.	Note
E-1	6CH 2.4GHz FHSS RADIO SYSTEM	MERITRC	MT-600	N/A	EUT
E-2	Adapter	N/A	SSER2	N/A	

Item	Shielded Type	Ferrite Core	Length	Note
C-1	NO	NO	1.2m	

Note:

- (1) The support equipment was authorized by Declaration of Confirmation.
- (2) For detachable type I/O cable should be specified the length in cm in 『Length』 column.

**2.5 EQUIPMENTS LIST FOR ALL TEST ITEMS**

**Radiation Test equipment**

Item	Kind of Equipment	Manufacturer	Type No.	Serial No.	Calibrated until
1	Spectrum Analyzer	Agilent	E4407B	160400005	Jul. 06. 2012
2	Test Receiver	R&S	ESPI	101318	Jul. 06. 2012
3	Bilog Antenna	TESEQ	CBL6111D	31216	Jul. 06. 2012
4	50Ω Coaxial Switch	Anritsu	MP59B	6200264416	Jul. 06. 2012
5	Spectrum Analyzer	ADVANTEST	R3132	150900201	Jul. 06. 2012
6	Horn Antenna	EM	EM-AH-10180	2011071402	Jul. 06. 2012
7	Horn Ant	Schwarzbeck	BBHA 9170	9170-181	Jul. 06. 2012
8	Amplifier	EM	EM-30180	060538	Jul. 06. 2012
9	Loop Antenna	ARA	PLA-1030/B	1029	Jul. 06. 2012
10	Power Meter	R&S	NRVS	100696	Jul. 06. 2012

**Conduction Test equipment**

Item	Kind of Equipment	Manufacturer	Type No.	Serial No.	Calibrated until
1	Test Receiver	R&S	ESCI	101160	Jul. 06. 2012
2	LISN	R&S	ENV216	101313	Jul. 06. 2012
3	LISN	EMCO	3816/2	00042990	Jul. 06. 2012
4	50Ω Coaxial Switch	Anritsu	MP59B	6200264417	Jul. 06. 2012
5	Passive Voltage Probe	R&S	ESH2-Z3	100196	Jul. 06. 2012
6	Absorbing clamp	R&S	MOS-21	100423	Jul. 06. 2012

### **3. TEST RESULT**

#### **3.1 ANTENNA REQUIREMENT**

##### **3.1.1 STANDARD REQUIREMENT**

15.203 requirement: For intentional device, according to 15.203: an intentional radiator shall be designed to ensure that no antenna other than that furnished by the responsible party shall be used with the device.

##### **3.1.2 EUT ANTENNA**

The EUT antenna is integral Antenna. It comply with the standard requirement.

### 3.2 CONDUCTED EMISSION MEASUREMENT

#### 3.2.1 POWER LINE CONDUCTED EMISSION Limits (Frequency Range 150KHz-30MHz)

FREQUENCY (MHz)	Class A (dBuV)		Class B (dBuV)		Standard
	Quasi-peak	Average	Quasi-peak	Average	
0.15 -0.5			66 - 56 *	56 - 46 *	CISPR
0.50 -5.0			56.00	46.00	CISPR
5.0 -30.0			60.00	50.00	CISPR

0.15 -0.5			66 - 56 *	56 - 46 *	LP002.
0.50 -5.0			56.00	46.00	LP002.
5.0 -30.0			60.00	50.00	LP002.

Note:

- (1) The tighter limit applies at the band edges.
- (2) The limit of " \* " marked band means the limitation decreases linearly with the logarithm of the frequency in the range.

The following table is the setting of the receiver

Receiver Parameters	Setting
Attenuation	10 dB
Start Frequency	0.15 MHz
Stop Frequency	30 MHz
IF Bandwidth	9 kHz

**3.2.2 TEST PROCEDURE**

- a. The EUT was placed 0.4 meters from the horizontal ground plane with EUT being connected to the power mains through a line impedance stabilization network (LISN). All other support equipments powered from additional LISN(s). The LISN provide 50 Ohm/ 50uH of coupling impedance for the measuring instrument.
- b. Interconnecting cables that hang closer than 40 cm to the ground plane shall be folded back and forth in the center forming a bundle 30 to 40 cm long.
- c. I/O cables that are not connected to a peripheral shall be bundled in the center. The end of the cable may be terminated, if required, using the correct terminating impedance. The overall length shall not exceed 1 m.
- d. LISN at least 80 cm from nearest part of EUT chassis.
- e. For the actual test configuration, please refer to the related Item –EUT Test Photos.

**3.2.3 DEVIATION FROM TEST STANDARD**

No deviation

**3.2.4 TEST SETUP**

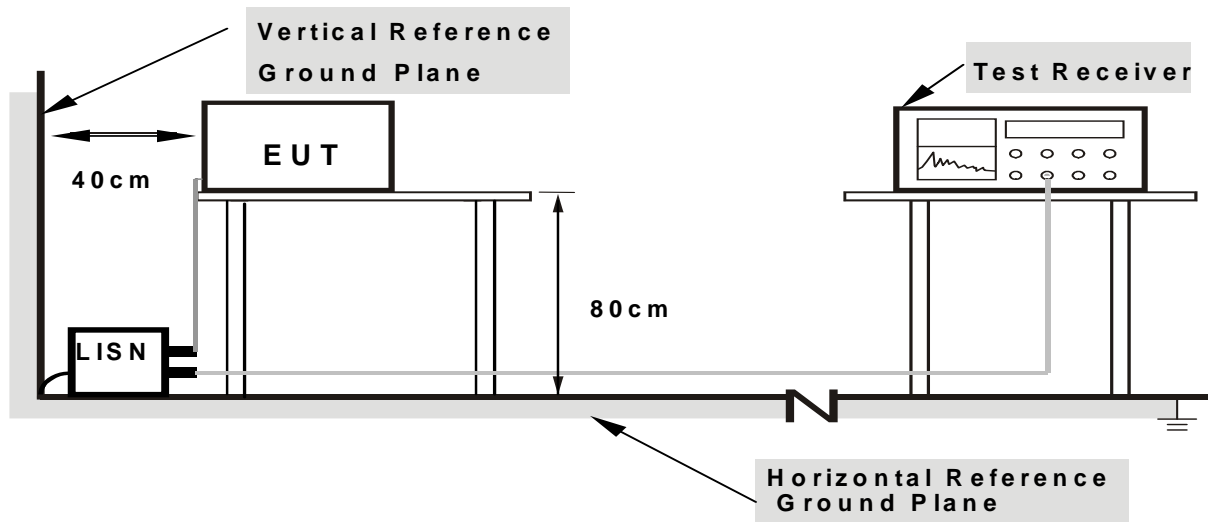

- Note:**
- 1. Support units were connected to second LISN.
  - 2. Both of LISNs (AMN) are 80 cm from EUT and at least 80 from other units and other metal planes

### 3.2.5 TEST RESULT

EUT :	6CH 2.4GHz FHSS RADIO SYSTEM	Model Name. :	MT-600
Temperature :	26 °C	Relative Humidity :	54%
Pressure :	1010hPa	Phase :	L
Test Voltage :	DC 5.0V from adapter AC 120V/60Hz	Test Mode :	Mode 4

Frequency (MHz)	Reading Level (dBμV)	Correct Factor (dB)	Measure-ment (dBμV)	Limits (dBμV)	Margin (dB)	Detector Type
0.202	33.1	10.44	43.54	63.52	-19.98	QP
0.202	31.03	10.44	41.47	53.52	-12.05	AVG
3.698	27.24	10.62	37.86	46	-8.14	AVG
4.1019	29.13	10.62	39.75	56	-16.25	QP
11.7099	32.83	10.69	43.52	60	-16.48	QP
12.0819	21.05	10.69	31.74	50	-18.26	AVG

Remark:

1. All readings are Quasi-Peak and Average values.
2. Factor = Insertion Loss + Cable Loss.

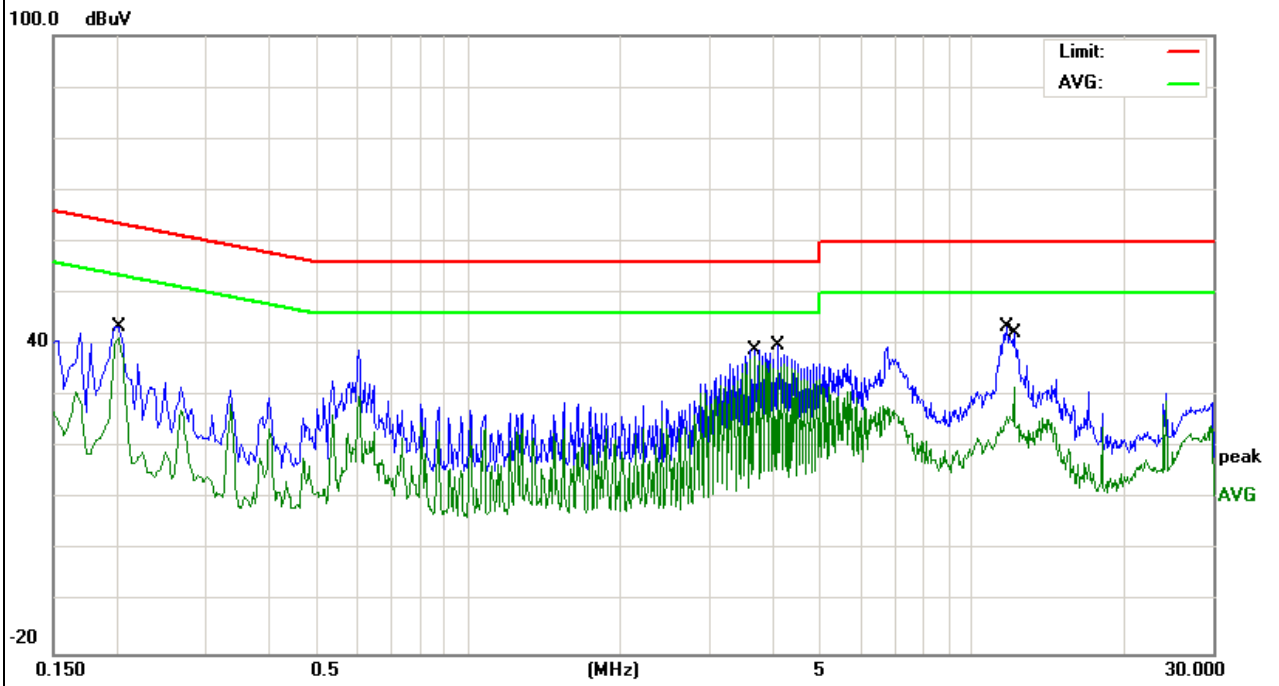

EUT :	6CH 2.4GHz FHSS RADIO SYSTEM	Model Name. :	MT-600
Temperature :	26 °C	Relative Humidity :	54%
Pressure :	1010hPa	Phase :	N
Test Voltage :	DC 5.0V from adapter AC 120V/60Hz	Test Mode :	Mode 4

Frequency (MHz)	Reading Level (dBμV)	Correct Factor (dB)	Measure-ment (dBμV)	Limits (dBμV)	Margin (dB)	Detector Type
0.202	31.07	10.43	41.5	63.52	-22.02	QP
0.202	29.13	10.43	39.56	53.52	-13.96	AVG
3.6979	27.93	10.65	38.58	46	-7.42	AVG
3.898	29.17	10.66	39.83	56	-16.17	QP
11.8899	30.47	10.71	41.18	60	-18.82	QP
12.0818	21.36	10.71	32.07	50	-17.93	AVG

Remark:

1. All readings are Quasi-Peak and Average values.
2. Factor = Insertion Loss + Cable Loss.

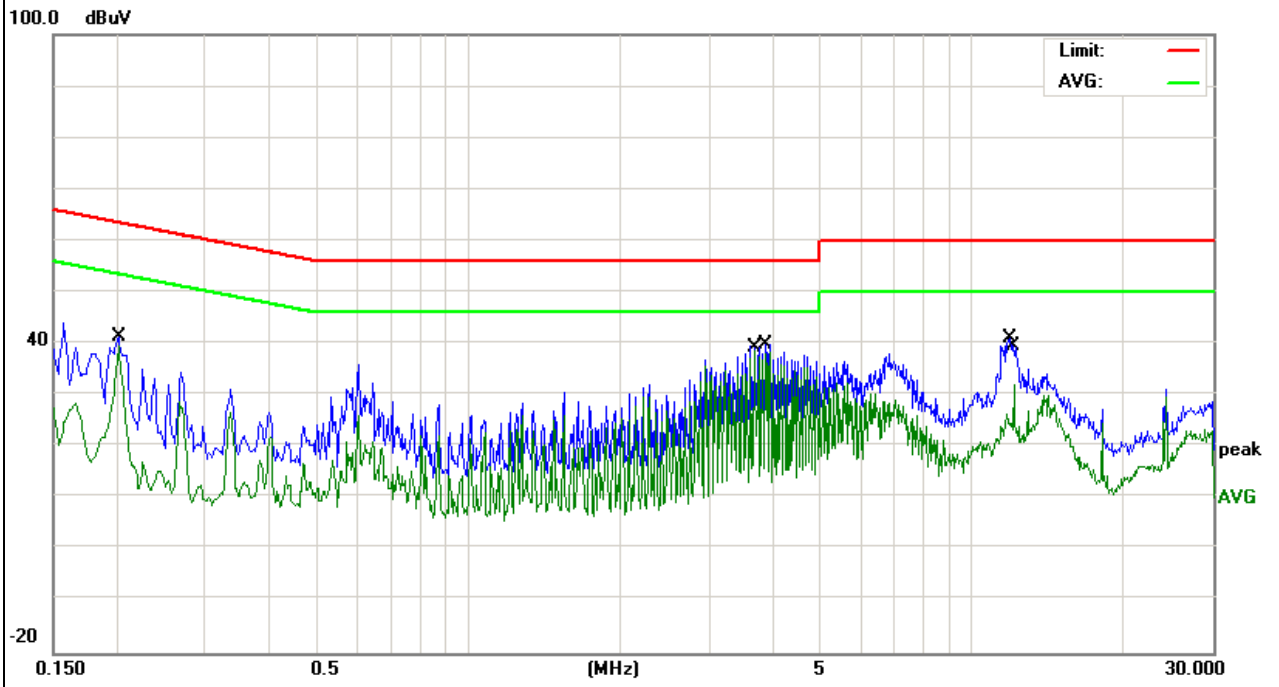



### 3.3 RADIATED EMISSION MEASUREMENT

#### 3.3.1 Radiated Emission Limits ( FCC 15.209 )

Frequencies (MHz)	Field Strength (micorvolts/meter)	Measurement Distance (meters)
0.009~0.490	2400/F(KHz)	300
0.490~1.705	24000/F(KHz)	30
1.705~30.0	30	30
30~88	100	3
88~216	150	3
216~960	200	3
Above 960	500	3

Note:

- (1) The tighter limit applies at the band edges.
- (2) Emission level (dBuV/m)=20log Emission level (uV/m).

#### LIMITS OF RADIATED EMISSION MEASUREMENT ( FCC 15.249)

Frequency of Emission (MHz)	Field Strength of fundamental ((millivolts /meter)	Field Strength of Harmonics (microvolts/meter)
2400 - 2483.5	50	500

Notes:

- (1) Emissions radiated outside of the specified frequency bands, except for harmonics, shall be attenuated by at least 50 dB below the level of the fundamental or to the general radiated emission limits in Section 15.209, whichever is the lesser attenuation.

Spectrum Parameter	Setting
Attenuation	Auto
Start Frequency	1000 MHz
Stop Frequency	10th carrier harmonic
RB / VB (emission in restricted band)	1MHz / 1MHz for Peak

Receiver Parameter	Setting
Attenuation	Auto
Start ~ Stop Frequency	9kHz~150kHz / RB 200Hz for QP
Start ~ Stop Frequency	150kHz~30MHz / RB 9kHz for QP
Start ~ Stop Frequency	30MHz~1000MHz / RB 120kHz for QP

**3.3.2 TEST PROCEDURE**

- a. The measuring distance of at 3 m shall be used for measurements at frequency up to 1GHz. For frequencies above 1GHz, any suitable measuring distance may be used.
- b. The EUT was placed on the top of a rotating table 0.8 meters above the ground at a 3m meter open area test site. The table was rotated 360 degrees to determine the position of the highest radiation.
- c. The height of the equipment or of the substitution antenna shall be 0.8 m; the height of the test antenna shall vary between 1 m to 4 m.
- d. The initial step in collecting conducted emission data is a spectrum analyzer peak detector mode pre-scanning the measurement frequency range. Significant peaks are then marked and then Quasi Peak detector mode re-measured.
- e. If the Peak Mode measured value compliance with and lower than Quasi Peak Mode Limit, the EUT shall be deemed to meet QP Limits and then no additional QP Mode measurement performed.
- f. For the actual test configuration, please refer to the related Item –EUT Test Photos.

Note:

Both horizontal and vertical antenna polarities were tested and performed pretest to three orthogonal axis. The worst case emissions were reported

**3.3.3 DEVIATION FROM TEST STANDARD**

No deviation

### 3.3.4 TEST SETUP

(A) Radiated Emission Test-Up Frequency Below 30MHz

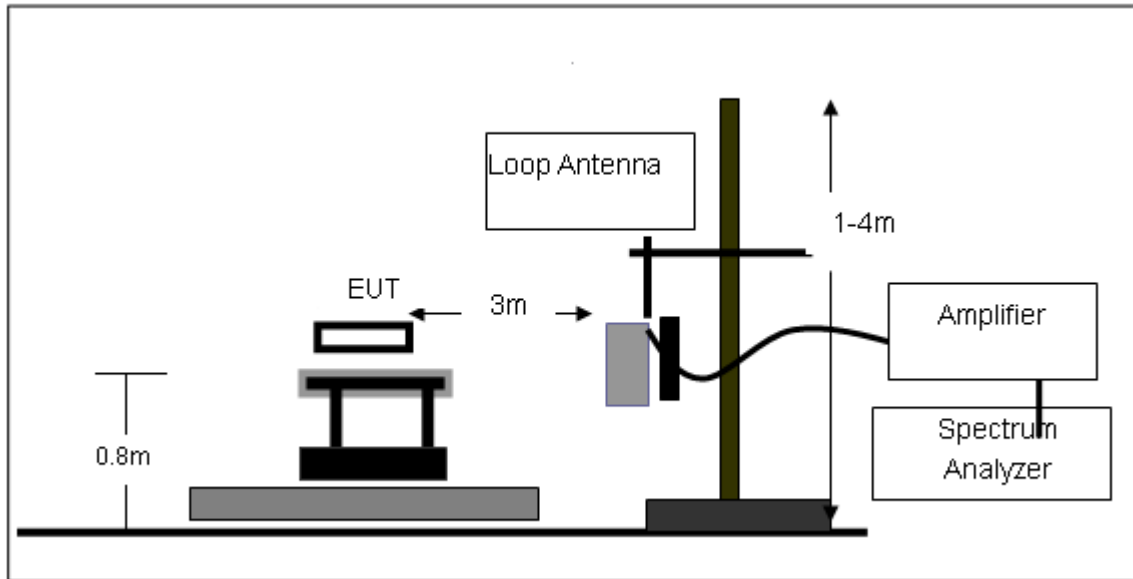

(B) Radiated Emission Test-Up Frequency 30MHz~1GHz

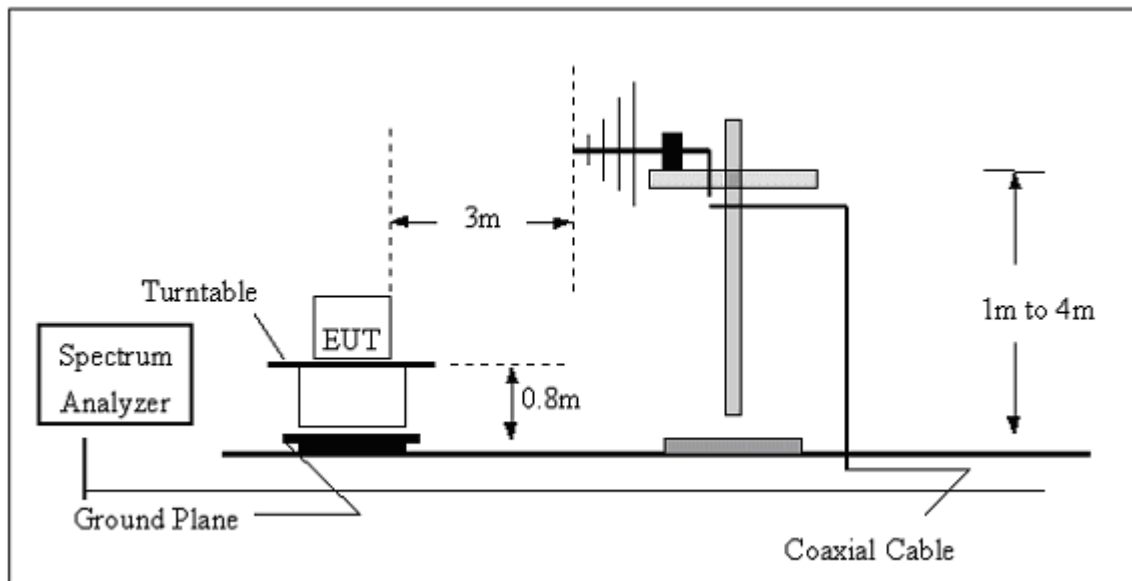

(C) Radiated Emission Test-Up Frequency Above 1GHz

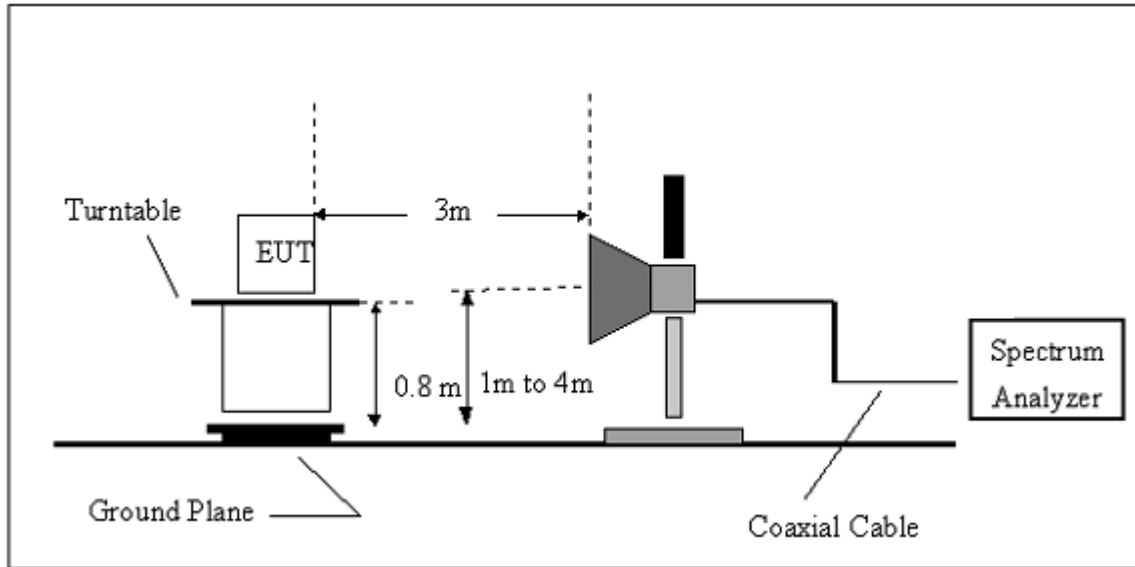

### 3.3.5 TEST RESULTS (BLOW 30MHz)

EUT :	6CH 2.4GHz FHSS RADIO SYSTEM	Model Name. :	MT-600
Temperature :	20 °C	Relative Humidity :	48%
Pressure :	1010 hPa	Test Voltage :	DC6.0V
Test Mode :	TX	Polarization :	--

Freq.	Reading	Limit	Margin	State
(MHz)	(dBuV/m)	(dBuV/m)	(dB)	P/F
--	--	--	--	PASS
--	--	--	--	PASS

**NOTE:**

The amplitude of spurious emissions which are attenuated by more than 20dB below the permissible value has no need to be reported.

Distance extrapolation factor =  $20 \log(\text{specific distance}/\text{test distance})$ (dB);

Limit line = specific limits(dBuv) + distance extrapolation factor.

### 3.3.6 TEST RESULTS (BETWEEN 30 – 1000 MHZ)

EUT :	6CH 2.4GHz FHSS RADIO SYSTEM	Model Name :	MT-600
Temperature :	20 °C	Relative Humidity :	48%
Pressure :	1010 hPa	Test Voltage :	DC 6.0V
Test Mode :	TX	Polarization :	Vertical

Frequency (MHz)	Meter Reading (dBμV)	Factor (dB)	Emission Level (dBμV/m)	Limits (dBμV/m)	Margin (dB)	Detector Type
42.3021	20.54	11.65	32.19	40	-7.81	Quasi-Peak
51.843	23.81	6.87	30.68	40	-9.32	Quasi-Peak
130.8369	16.64	11.27	27.91	43.5	-15.59	Quasi-Peak

Remark:

- Factor = Antenna Factor + Cable Loss – Pre-amplifier.

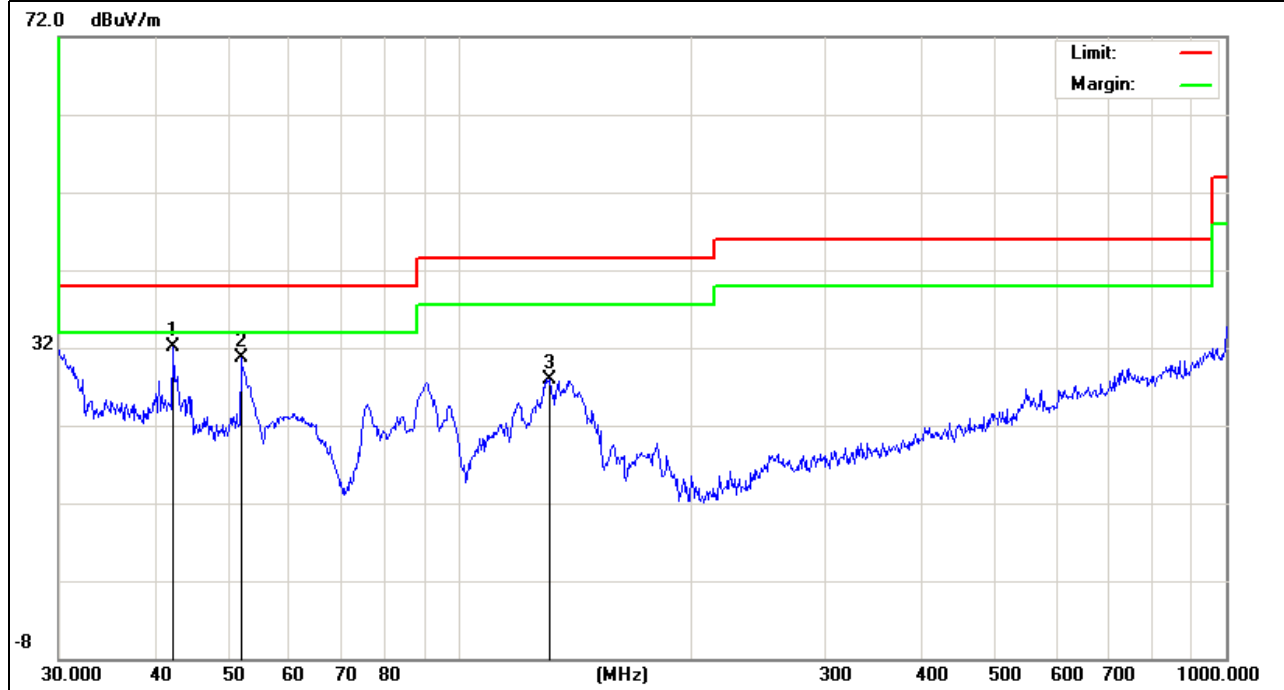

EUT :	6CH 2.4GHz FHSS RADIO SYSTEM	Model Name :	MT-600
Temperature :	20 °C	Relative Humidity :	48%
Pressure :	1010 hPa	Test Voltage :	DC 6.0V
Test Mode :	TX	Polarization :	Horizontal

Frequency (MHz)	Meter Reading (dBµV)	Factor (dB)	Emission Level (dBµV/m)	Limits (dBµV/m)	Margin (dB)	Detector Type
44.5868	17.42	10.48	27.9	40	-12.1	Quasi-Peak
90.8554	14.6	8.83	23.43	43.5	-20.07	Quasi-Peak
153.2004	13.95	10.53	24.48	43.5	-19.02	Quasi-Peak

Remark:

- Factor = Antenna Factor + Cable Loss – Pre-amplifier.

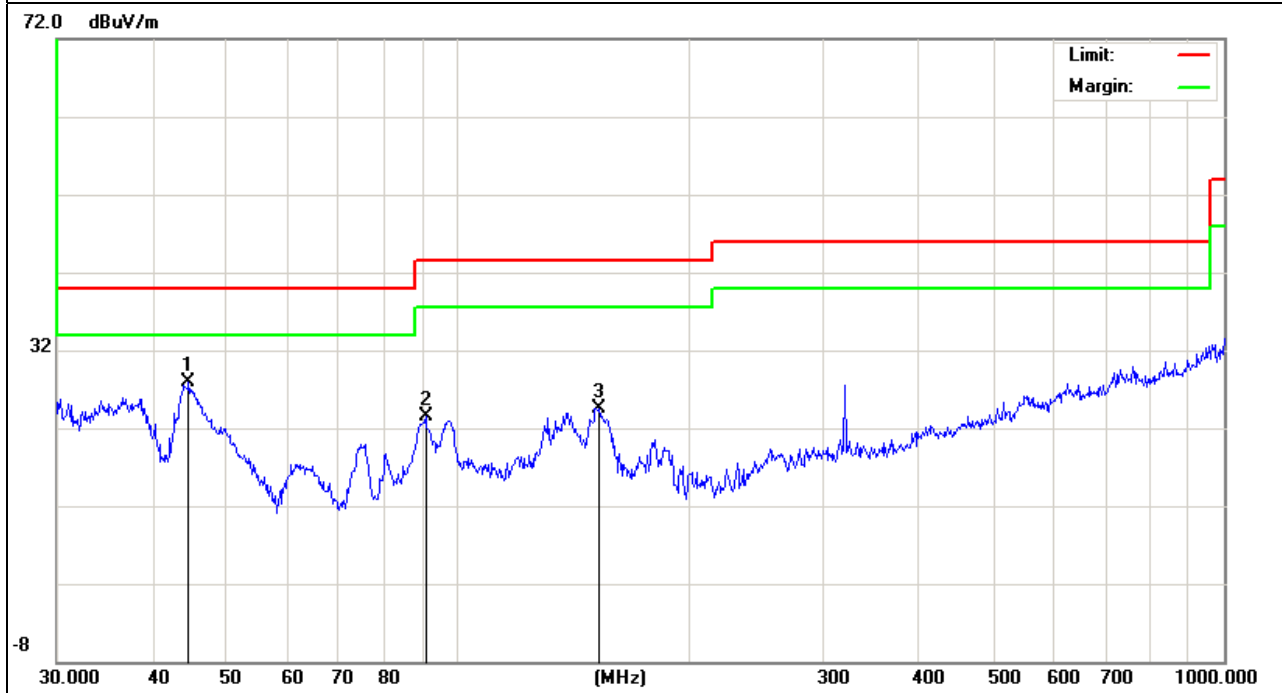

### 3.3.7 TEST RESULTS (ABOVE 1000 MHZ)

EUT :	6CH 2.4GHz FHSS RADIO SYSTEM	Model Name :	MT-600
Temperature :	20 °C	Relative Humidity :	48%
Pressure :	1010 hPa	Test Voltage :	DC 6.0V
Test Mode :	TX /2405MHz	Polarization :	Horizontal

Frequency (MHz)	Meter Reading (dBμV)	Factor (dB)	Emission Level (dBμV/m)	Limits (dBμV/m)	Margin (dB)	Detector Type
2405	109.97	-17.46	99.51	114	-14.49	peak
2405	84.91	-17.46	67.45	94	-26.55	AVG
4810	64.76	-8.16	56.6	74	-17.4	peak
4810	56.41	-8.16	48.25	54	-5.75	AVG

Remark:  
Factor = Antenna Factor + Cable Loss – Pre-amplifier.

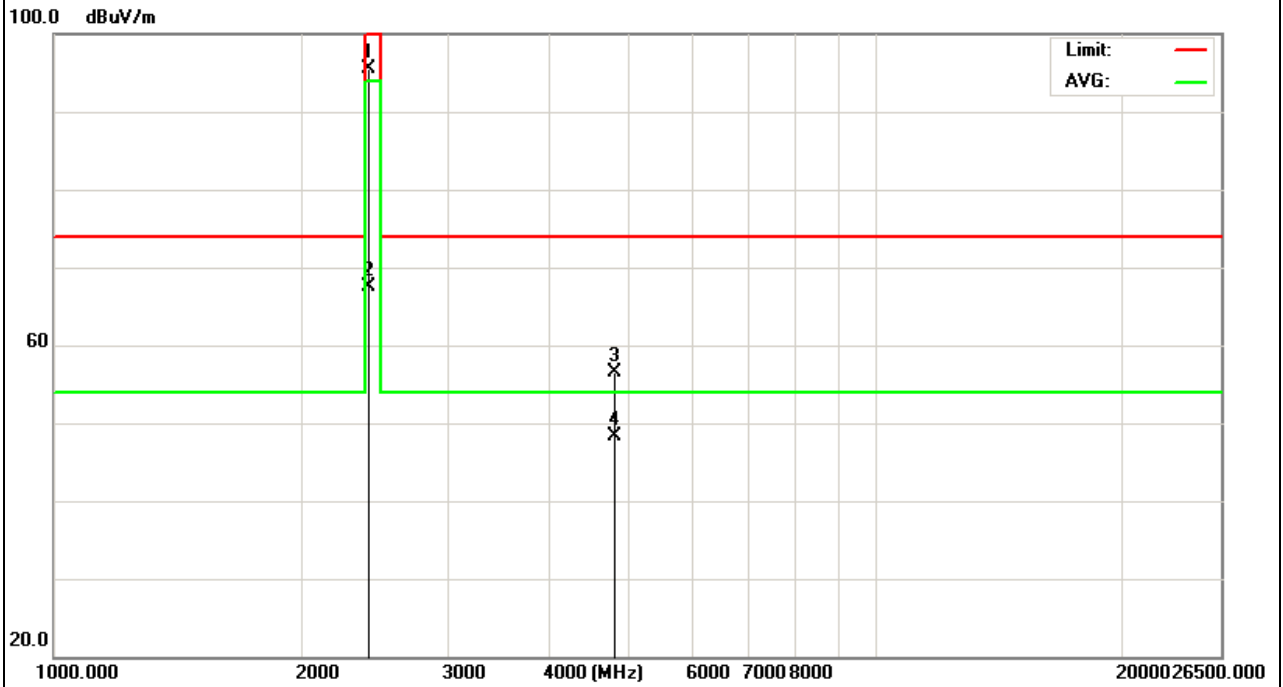



EUT :	6CH 2.4GHz FHSS RADIO SYSTEM	Model Name :	MT-600
Temperature :	20 °C	Relative Humidity :	48%
Pressure :	1010 hPa	Test Voltage :	DC 6.0V
Test Mode :	TX /2405MHz	Polarization :	Vertical

Frequency (MHz)	Meter Reading (dBμV)	Factor (dB)	Emission Level (dBμV/m)	Limits (dBμV/m)	Margin (dB)	Detector Type
2405	111.91	-17.46	94.45	114.0 0	-19.55	peak
2405	83.12	-17.46	65.66	94	-28.34	AVG
4810	64.19	-8.16	56.03	74	-17.97	peak
4810	55.23	-8.16	47.07	54	-6.93	AVG

Remark:  
Factor = Antenna Factor + Cable Loss – Pre-amplifier.

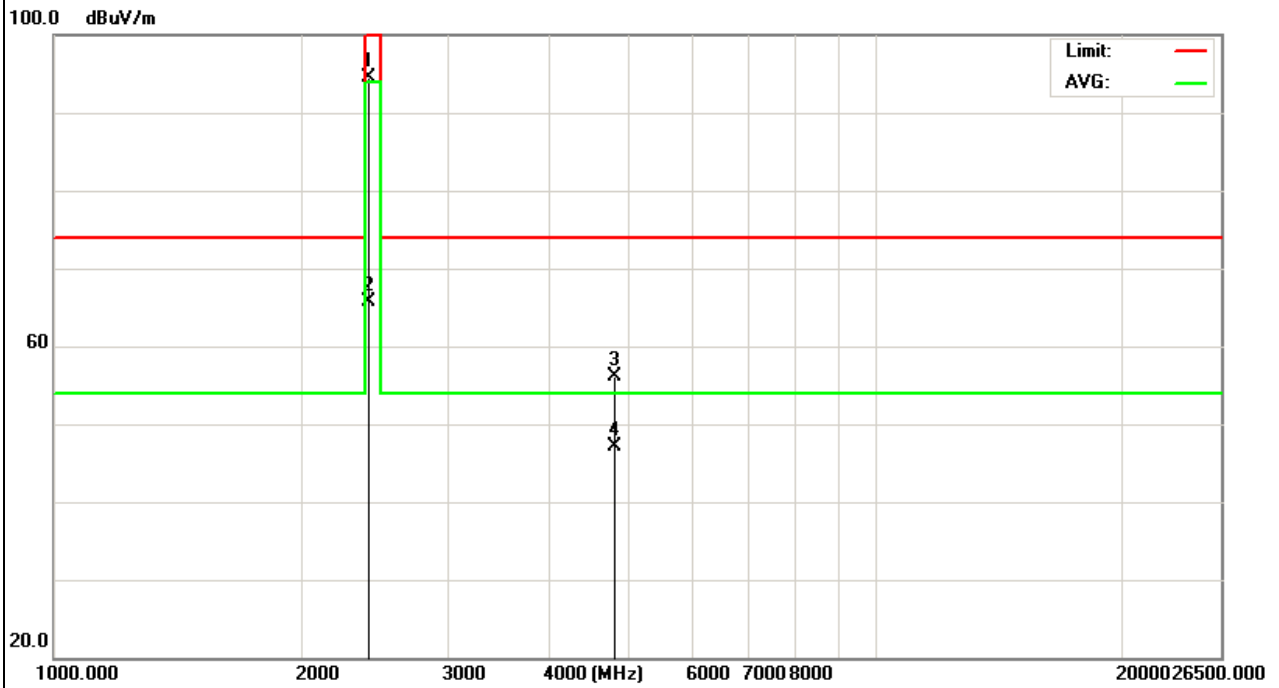

EUT :	6CH 2.4GHz FHSS RADIO SYSTEM	Model Name :	MT-600
Temperature :	20 °C	Relative Humidity :	48%
Pressure :	1010 hPa	Test Voltage :	DC 6.0V
Test Mode :	TX /2430MHz	Polarization :	Horizontal

Frequency (MHz)	Meter Reading (dBμV)	Factor (dB)	Emission Level (dBμV/m)	Limits (dBμV/m)	Margin (dB)	Detector Type
2430	106.12	-17.45	96.67	114.0 0	-17.33	peak
2430	86.21	-17.45	68.76	94	-25.24	AVG
4860	67.21	-8.2	59.01	74	-14.99	peak
4860	56.41	-8.2	48.21	54	-5.79	AVG

Remark:  
Factor = Antenna Factor + Cable Loss – Pre-amplifier.

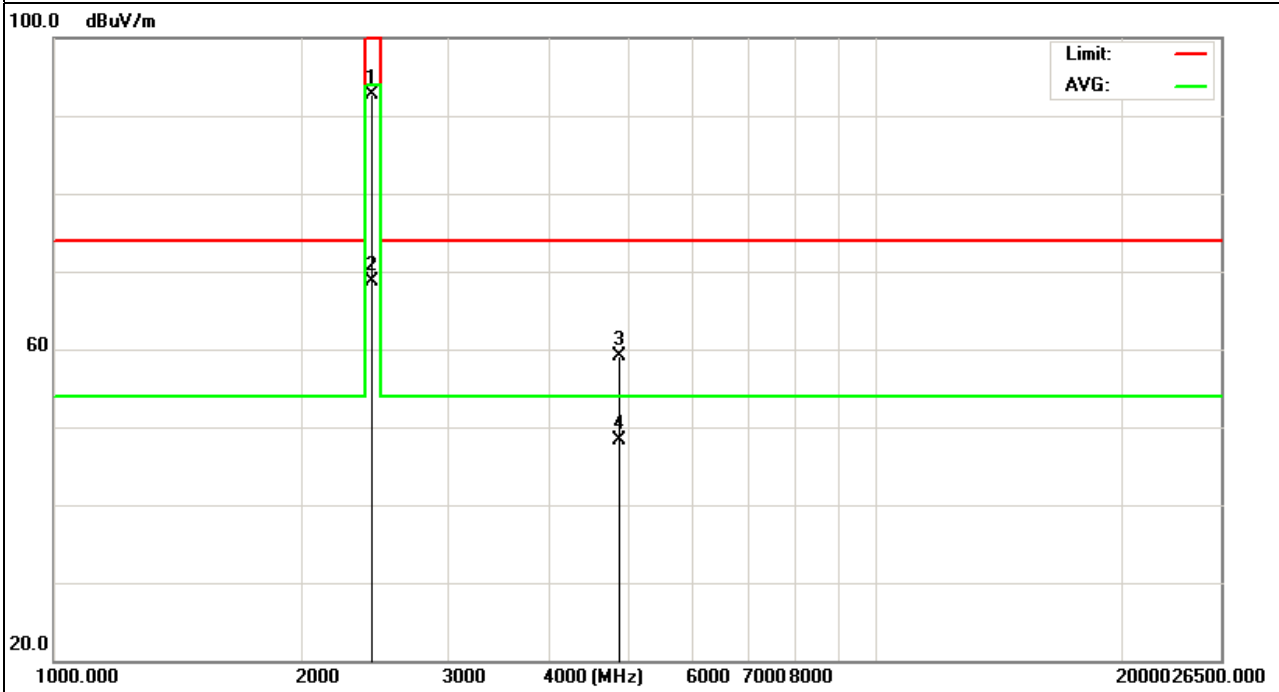

EUT :	6CH 2.4GHz FHSS RADIO SYSTEM	Model Name :	MT-600
Temperature :	20 °C	Relative Humidity :	48%
Pressure :	1010 hPa	Test Voltage :	DC 6.0V
Test Mode :	TX /2430MHz	Polarization :	Vertical

Frequency (MHz)	Meter Reading (dBµV)	Factor (dB)	Emission Level (dBµV/m)	Limits (dBµV/m)	Margin (dB)	Detector Type
2430	110.21	-17.45	92.76	114.0 0	-21.24	peak
2430	86.9	-17.45	69.45	94	-24.55	AVG
4860	67.33	-8.2	59.13	74	-14.87	peak
4860	51.23	-8.2	43.03	54	-10.97	AVG

Remark:  
Factor = Antenna Factor + Cable Loss – Pre-amplifier.

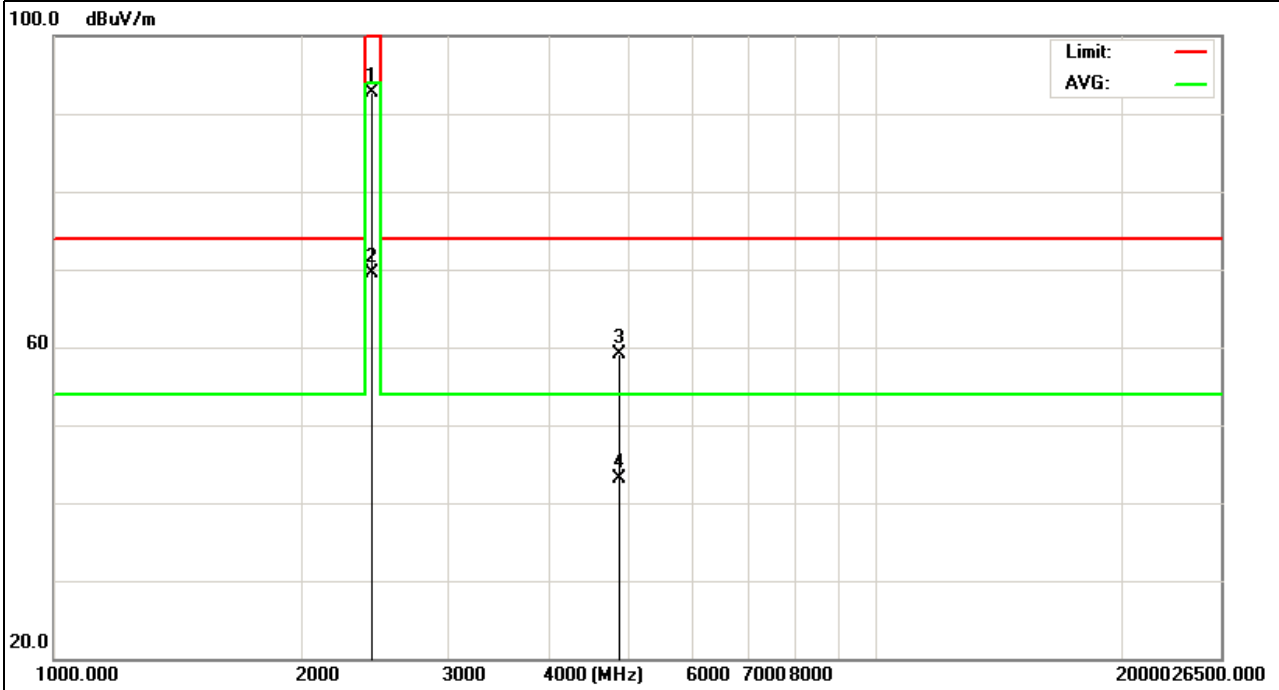

EUT :	6CH 2.4GHz FHSS RADIO SYSTEM	Model Name :	MT-600
Temperature :	20 °C	Relative Humidity :	48%
Pressure :	1010 hPa	Test Voltage :	DC 6.0V
Test Mode :	TX /2455MHz	Polarization :	Horizontal

Frequency (MHz)	Meter Reading (dBµV)	Factor (dB)	Emission Level (dBµV/m)	Limits (dBµV/m)	Margin (dB)	Detector Type
2455	107.09	-17.36	97.73	114	-16.27	peak
2455	84.23	-17.36	66.87	94	-27.13	AVG
4911	69.24	-8.13	61.11	74	-12.89	peak
4911	57.67	-8.13	49.54	54	-4.46	AVG

Remark:  
Factor = Antenna Factor + Cable Loss – Pre-amplifier.

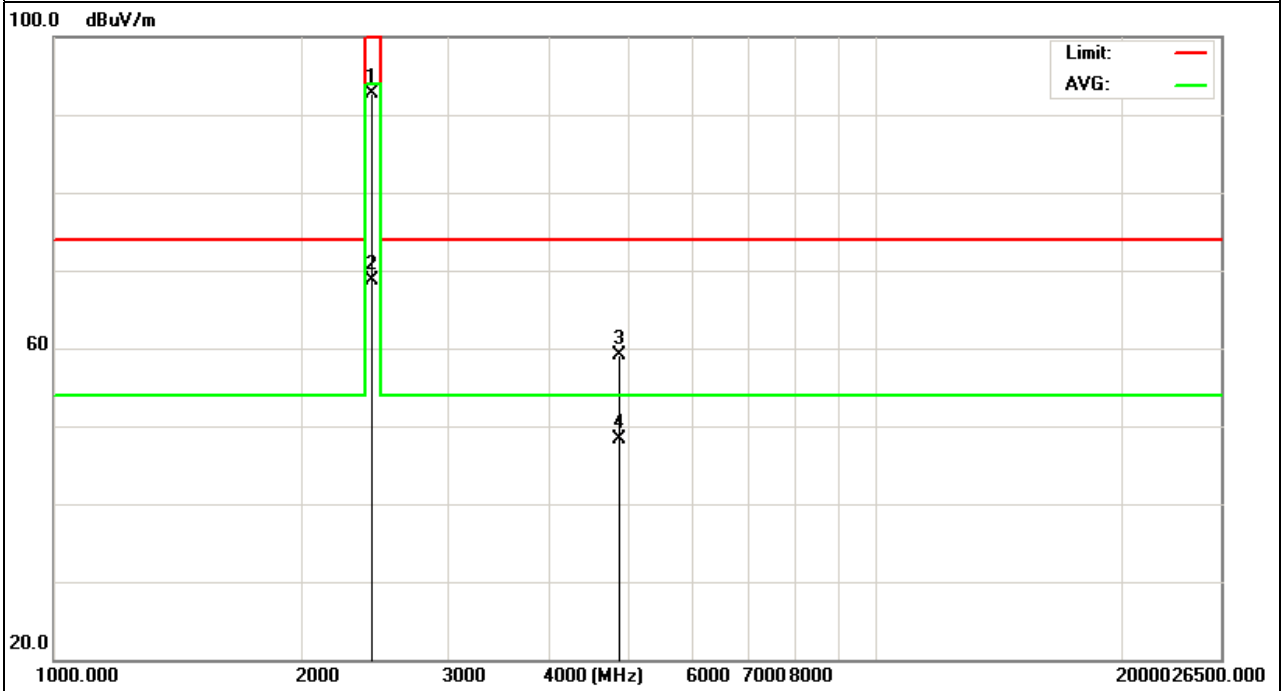

EUT :	6CH 2.4GHz FHSS RADIO SYSTEM	Model Name :	MT-600
Temperature :	20 °C	Relative Humidity :	48%
Pressure :	1010 hPa	Test Voltage :	DC 6.0V
Test Mode :	TX /2455MHz	Polarization :	Vertical

Frequency (MHz)	Meter Reading (dBμV)	Factor (dB)	Emission Level (dBμV/m)	Limits (dBμV/m)	Margin (dB)	Detector Type
2455	112.08	-17.36	94.72	114.0 0	-19.28	peak
2455	87.12	-17.36	69.76	94	-24.24	AVG
4911	69.45	-8.13	61.32	74	-12.68	peak
4911	52.21	-8.13	44.08	54	-9.92	AVG

Remark:  
Factor = Antenna Factor + Cable Loss – Pre-amplifier.

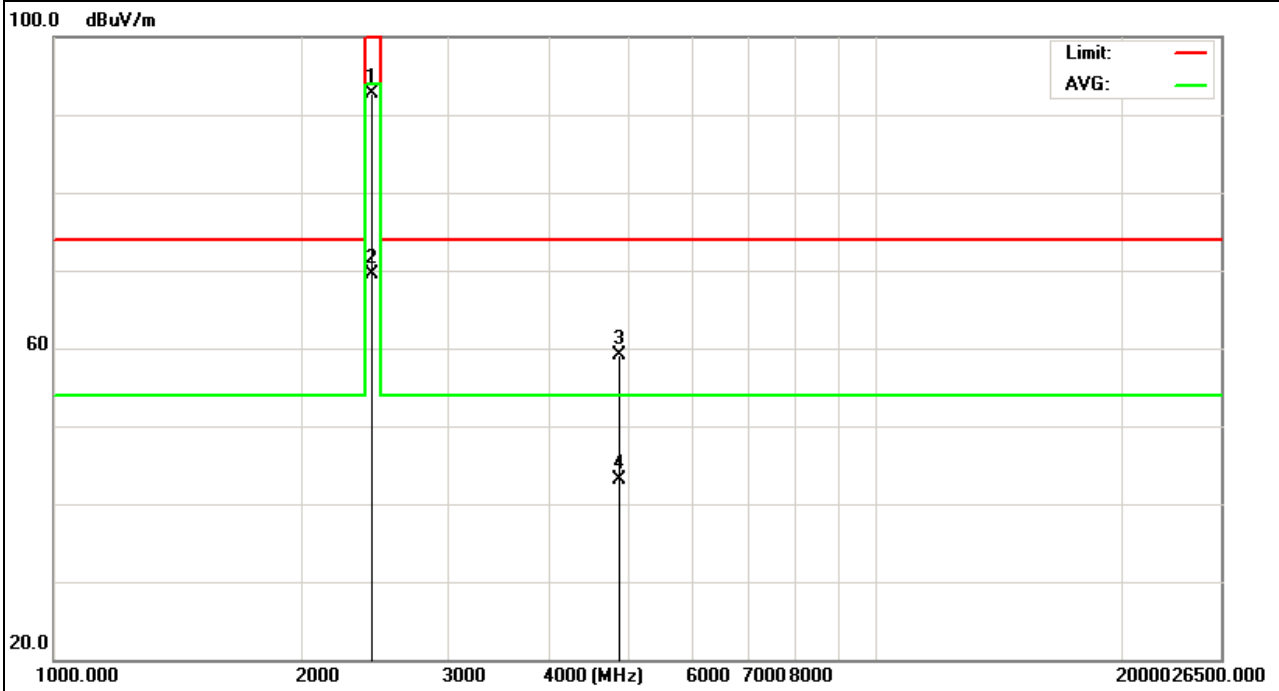

**Band Edge Emission:**

EUT :	6CH 2.4GHz FHSS RADIO SYSTEM	Model Name :	MT-600
Temperature :	20 °C	Relative Humidity :	48%
Pressure :	1010 hPa	Test Voltage :	DC 6.0V
Test Mode :	TX /2405MHz	Polarization :	Vertical

Frequency (MHz)	Meter Reading (dBμV)	Factor (dB)	Emission Level (dBμV/m)	Limits (dBμV/m)	Margin (dB)	Detector Type
2400	66.77	-12.99	53.78	74	-20.22	peak
2400	53.76	-12.99	40.77	54	-13.23	AVG

Remark:

Factor = Antenna Factor + Cable Loss – Pre-amplifier.

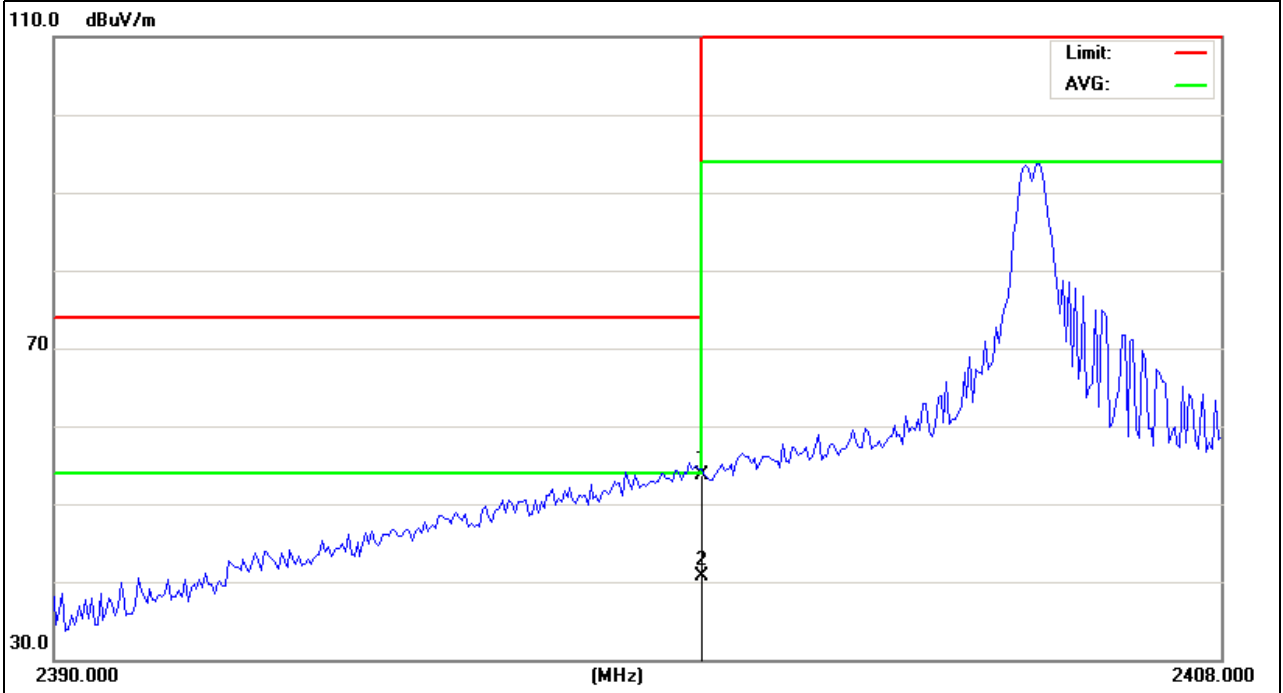

EUT :	6CH 2.4GHz FHSS RADIO SYSTEM	Model Name :	MT-600
Temperature :	20 °C	Relative Humidity :	48%
Pressure :	1010 hPa	Test Voltage :	DC 6.0V
Test Mode :	TX /2405MHz	Polarization :	Horizontal

Frequency (MHz)	Meter Reading (dBμV)	Factor (dB)	Emission Level (dBμV/m)	Limits (dBμV/m)	Margin (dB)	Detector Type
2400	68.6	-12.99	55.61	74	-18.39	peak
2400	54.96	-12.99	41.97	54	-12.03	AVG

Remark:  
 Factor = Antenna Factor + Cable Loss – Pre-amplifier.

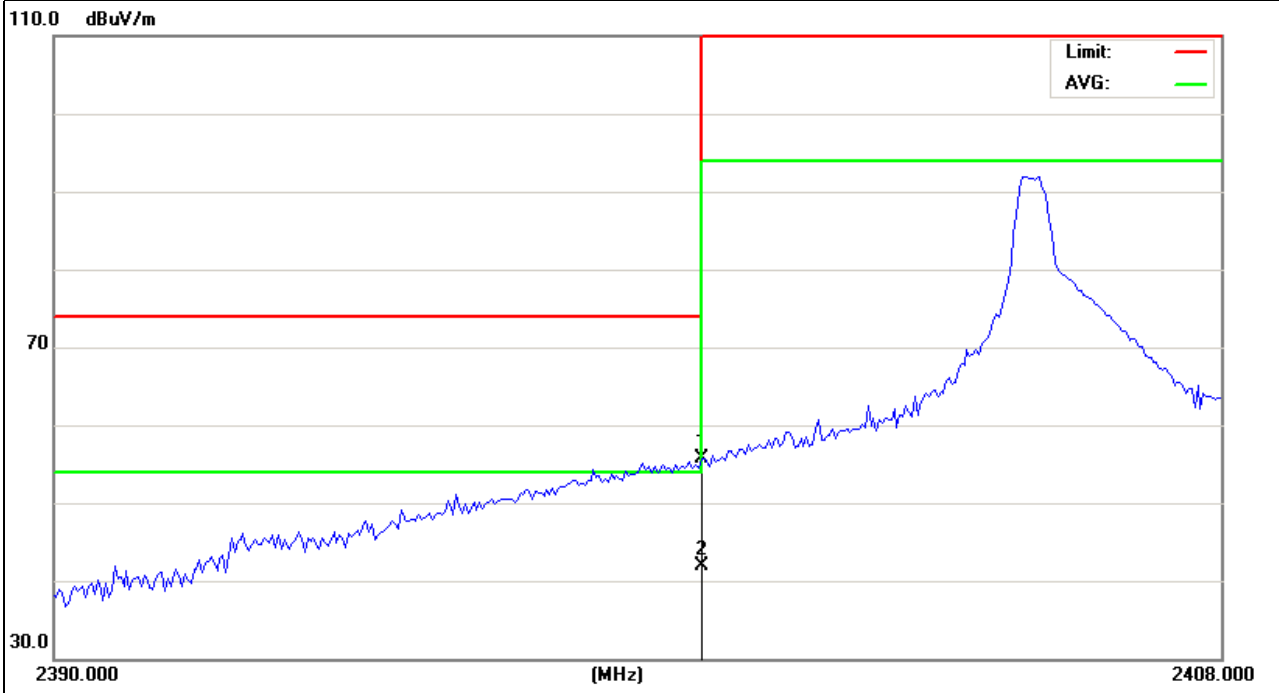

EUT :	6CH 2.4GHz FHSS RADIO SYSTEM	Model Name :	MT-600
Temperature :	20 °C	Relative Humidity :	48%
Pressure :	1010 hPa	Test Voltage :	DC 6.0V
Test Mode :	TX /2455MHz	Polarization :	Vertical

Frequency (MHz)	Meter Reading (dBμV)	Factor (dB)	Emission Level (dBμV/m)	Limits (dBμV/m)	Margin (dB)	Detector Type
2483.5	47.69	-12.78	34.91	74	-39.09	peak

Remark:  
Factor = Antenna Factor + Cable Loss – Pre-amplifier.

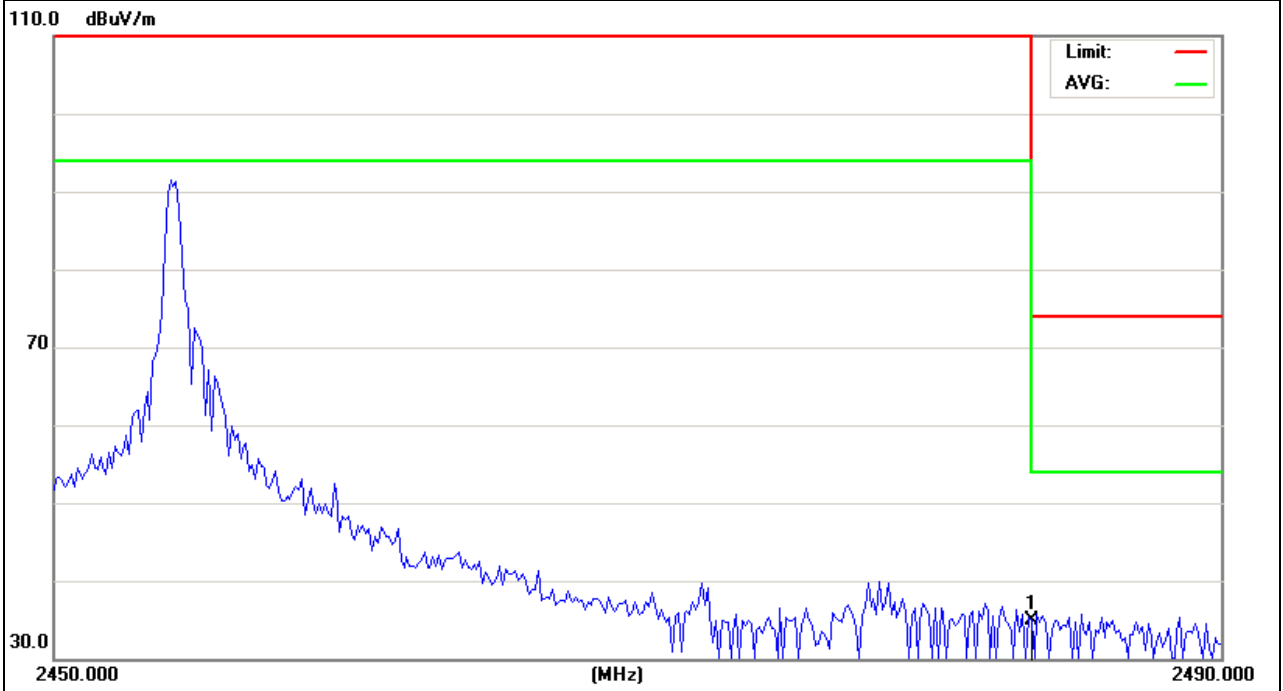



EUT :	6CH 2.4GHz FHSS RADIO SYSTEM	Model Name :	MT-600
Temperature :	20 °C	Relative Humidity :	48%
Pressure :	1010 hPa	Test Voltage :	DC 6.0V
Test Mode :	TX /2455MHz	Polarization :	Horizontal

Frequency (MHz)	Meter Reading (dBμV)	Factor (dB)	Emission Level (dBμV/m)	Limits (dBμV/m)	Margin (dB)	Detector Type
2483.5	48.18	-12.78	35.4	74	-38.6	peak

Remark:  
Factor = Antenna Factor + Cable Loss – Pre-amplifier.

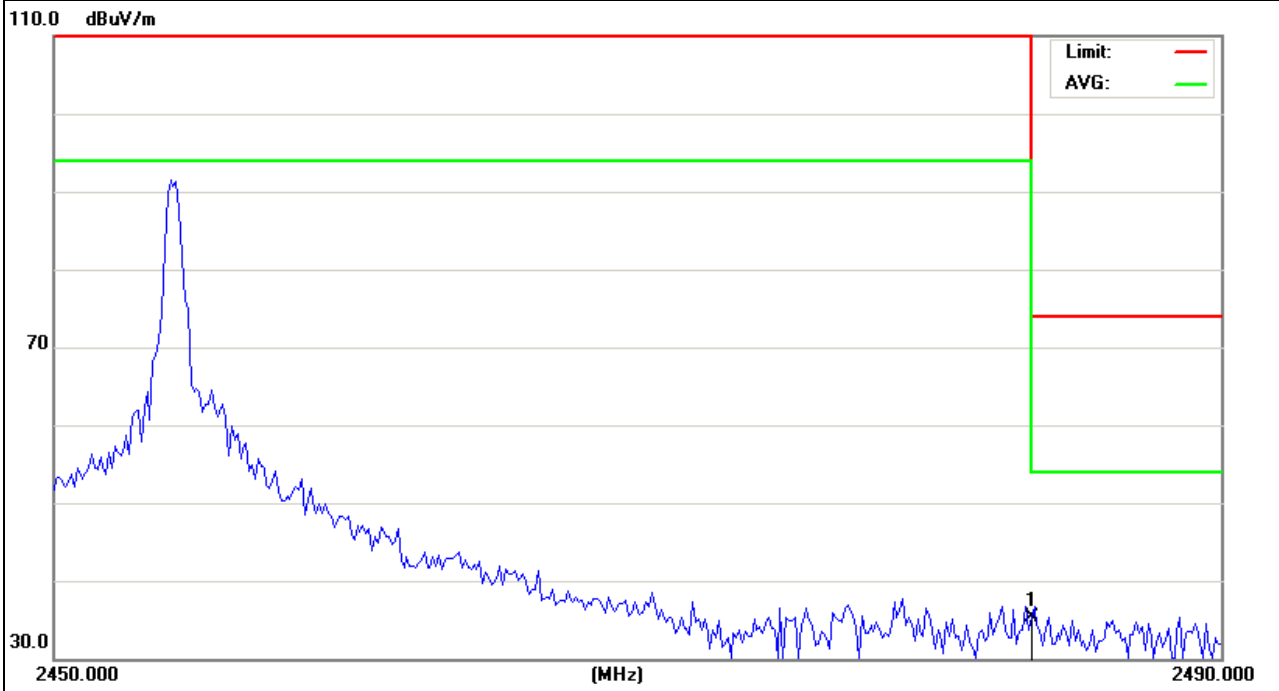

#### 4. BANDWIDTH TEST

##### 4.1 TEST PROCEDURE

- a. The EUT was directly connected to the spectrum analyzer and antenna output port as show in the block diagram below,
- b. Spectrum Setting : RBW= 100KHz, VBW $\geq$ RBW, Sweep time = Auto.

##### 4.2 DEVIATION FROM STANDARD

No deviation.

##### 4.3 TEST SETUP



#### 4.4 TEST RESULTS

EUT :	MERITRC	Model Name :	MT-600
Temperature :	26 °C	Relative Humidity :	53%
Pressure :	1020 hPa	Test Power :	DC 6.0V
Test Mode :	TX CH 1/26/51		

Test Channel	Frequency (MHz)	20 dBc Bandwidth (MHz)	99% Bandwidth (MHz)
CH01	2405	0.629	0.563
CH08	2430	0.630	0.559
CH16	2455	0.712	0.613

### The Lowest Channel: 2405MHz

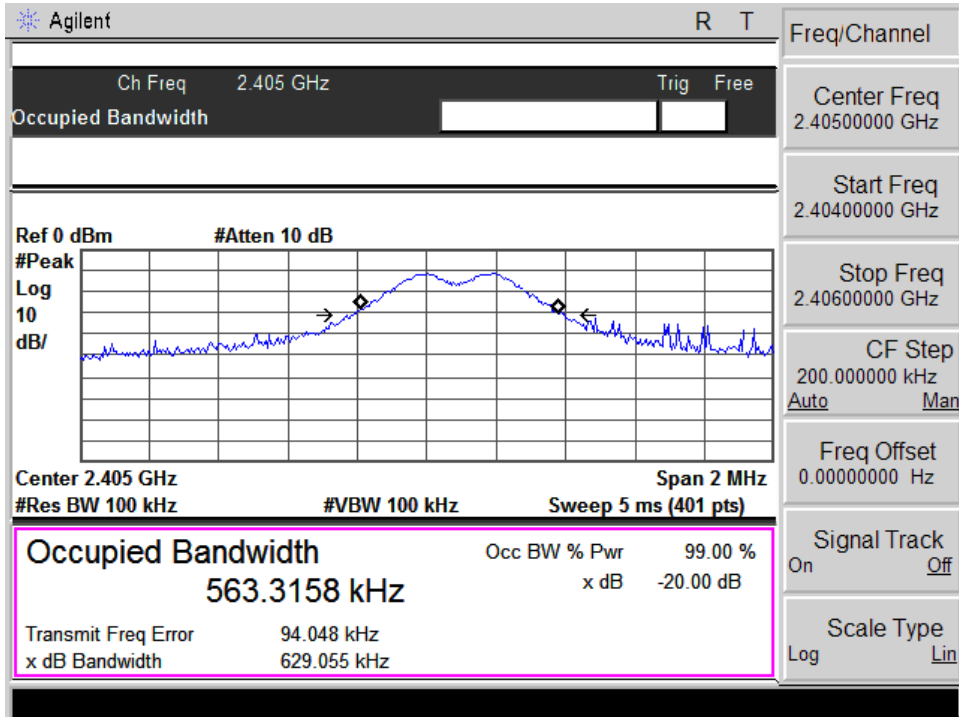

### The Middle Channel: 2430GHz

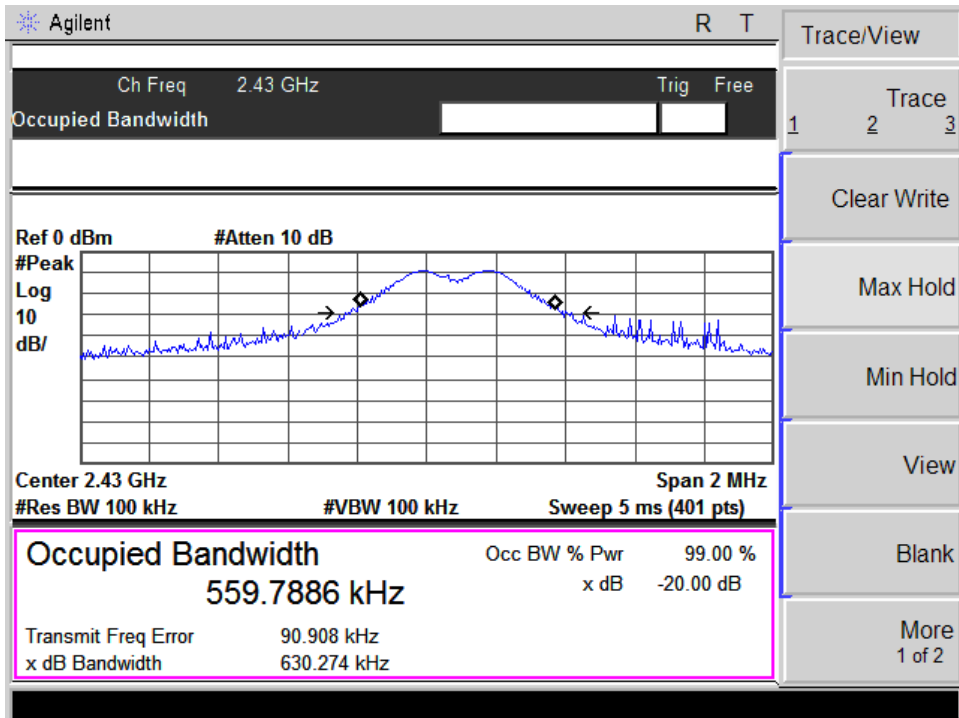

### The High Channel:2455MHz

Agilent
R T

---

Ch Freq 2.455 GHz
Trig Free

Occupied Bandwidth

---

Ref 0 dBm
#Atten 10 dB

#Peak
Log

10
dB/

Center 2.455 GHz
Span 2 MHz

#Res BW 100 kHz
#VBW 100 kHz
Sweep 5 ms (401 pts)

<b>Occupied Bandwidth</b>	Occ BW % Pwr	99.00 %
613.3682 kHz	x dB	-20.00 dB
Transmit Freq Error	96.613 kHz	
x dB Bandwidth	712.827 kHz	

Span

Span  
2.00000000 MHz

Span Zoom

Full Span

Zero Span

Last Span

Zone ▶

### 5. EUT TEST PHOTO

**Radiated Measurement Photos**

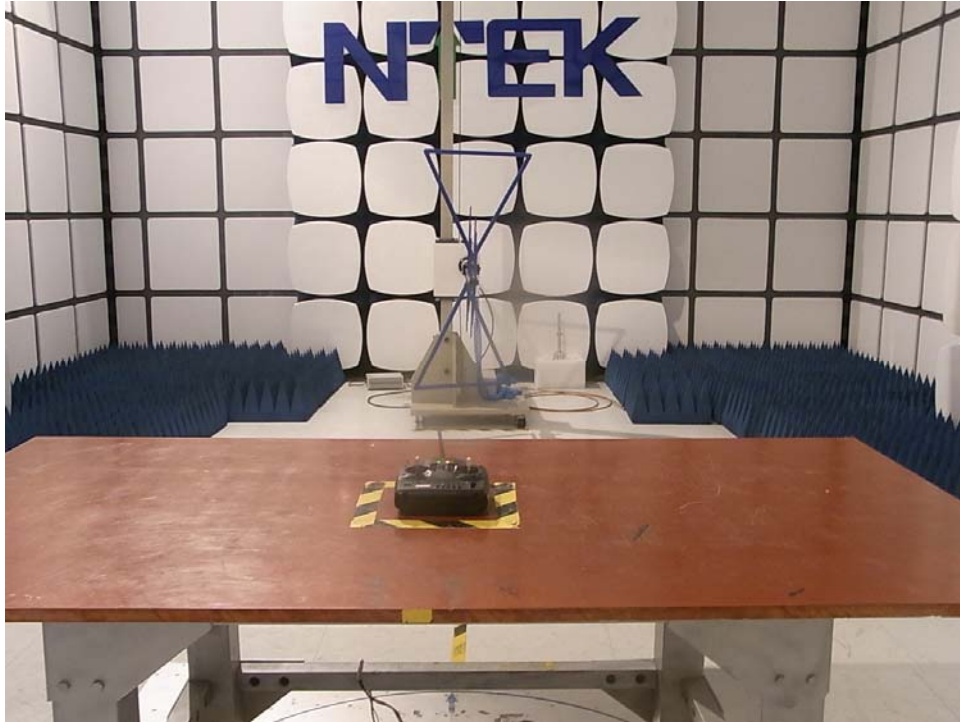

**Conducted Measurement Photos**

