

User Guide

Smart Installation Tool (CTL-2000)



Doc No. UG01467

Important notice

This device, like any wireless device, operates using radio signals which cannot guarantee the transmission and reception of data in all conditions. While the delay or loss of signal is rare, you should not rely solely on any wireless device for emergency communications or otherwise use the device in situations where the interruption of data connectivity could lead to death, personal injury, property damage, data loss, or other loss. Casa Systems accepts no responsibility for any loss or damage resulting from errors or delays in transmission or reception, or the failure of the Casa Systems CTL-2000 Smart Installation tool to transmit or receive such data.

Safety and hazards



Warning –

Do not connect or disconnect cables or devices to or from the Ethernet cable port or the terminals of the battery in hazardous locations such as those in which flammable gases or vapours may be present, but normally are confined within closed systems; are prevented from accumulating by adequate ventilation; or the location is adjacent to a location from which ignitable concentrations might occasionally be communicated.

Copyright

Copyright© 2023 Casa Systems. All rights reserved.

The information contained herein is proprietary to Casa Systems. No part of this document may be translated, transcribed, reproduced, in any form, or by any means without prior written consent of Casa Systems.

Trademarks and registered trademarks are the property of Casa Systems or their respective owners. Specifications are subject to change without notice. Images shown may vary slightly from the actual product.



Note – This document is subject to change without notice.

Document history

This document relates to the following product:

Casa Systems Smart Installation Tool (CTL-2000)

Ver.	Document description	Date
v1.00	Initial document release	29 September 2023
v1.01	Updated RSRP value in LED table. Improved information about disconnecting the tool from the ODU Ethernet port. Improved instructions for powering the tool on and off.	7 November 2023

Table i. – Document revision history

Contents

1	Overview.....	5
1.1	Document introduction	5
1.2	Target audience.....	5
1.3	Prerequisites	5
1.4	Notation.....	5
2	Product introduction.....	6
3	Package contents.....	7
4	Device overview	8
5	Inserting, removing, and charging the battery.....	9
5.1	Inserting the battery	9
5.2	Removing the battery	9
5.3	Charging the battery.....	9
6	Powering the Smart Installation Tool on and off	10
7	LED indicators	11
7.1	Battery level	11
7.2	Calibration status	11
7.3	Signal strength	12
7.3.1	Signal strength	12
7.3.2	Service type and tool status.....	13
8	Calibration.....	14
9	Using the Smart Installation Tool to align an Outdoor CPE.....	15
10	Firmware management and updates	17
11	Using the Pole Mounted Tool Rail	20
12	Using the Smart Installation Tool to power an Outdoor CPE with the Ethernet Passthrough Adapter.....	22
13	Aligning an Outdoor CPE without the Aurora Pro app	24
14	Maintenance and Storage.....	25
14.1	Replacing the Ethernet cable.....	25
14.2	Tool operation and storage	27
14.2.1	Cold temperatures.....	27
14.2.2	Direct sunlight and high temperatures	27
14.3	Updating the firmware of the Smart Installation Tool	28

15	Battery information	30
15.1	Battery temperature	30
15.2	Battery storage	30
15.3	Replacing the batteries	30
16	Safety and regulatory information	31
16.1	FCC (USA).....	31
16.1.1	RF Exposure	31
16.1.2	FCC compliance	31
16.1.3	FCC regulations.....	31
16.1.4	Company details	32
16.1.5	Product Details.....	32
16.2	Canada (IC).....	32
16.2.1	RF Radiation Exposure Statement:.....	32
16.2.2	ISED Emissions compliance statement	33
16.3	CE Regulation	33
16.3.1	RF Exposure Information (MPE).....	33
16.3.2	RF General Information.....	33
16.3.3	Maximum RF Power Table.....	34
16.3.4	WEEE Regulation.....	34
16.3.5	Simplified EU Doc.....	34
16.4	Australia ACMA.....	34

1 Overview

1.1 Document introduction

This document provides you all the information you need to set up, configure and use the Casa Systems CTL-2000 Smart Installation Tool. It provides an overview of the device, the included components, LED indicators, and details the process that is required to perform an Outdoor CPE installation using the Smart Installation Tool.

1.2 Target audience

This document is intended for system integrators or experienced hardware installers who understand telecommunications terminology and concepts.

1.3 Prerequisites

Before using the Casa Systems CTL-2000 Smart Installation Tool, you are required to download the AuroraPRO app, available on the Google Play Store.

1.4 Notation

The following symbols may be used in this document:



Note – This note contains useful information.



Important – This is important information that may require your attention.



Warning – This is a warning that may require immediate action in order to avoid damage or injury.

2 Product introduction

The CTL-2000 Smart Installation Tool is designed to assist technicians in providing a more accurate Outdoor CPE installation process. Attached through the RJ45 Power Over Ethernet port on the Outdoor CPE, the Smart Installation Tool delivers power via its replaceable rechargeable battery, providing the requisite portability for an efficient site survey. The Smart Installation Tool includes an integrated electronic compass allowing capture of device bearing and elevation to an accuracy of 10 degrees.



3 Package contents

Your Smart Installation Tool package includes the following items:



1 x Smart Installation Tool



2 x Battery packs



1 x AC battery charger



1 x Ethernet passthrough adapter



1 x Carabiner strap



1 x Carry case



1 x US charging cable



1 x EU charging cable



1 x AU charging cable



1 x UK charging cable



1 x Welcome card



1 x Safety/compliance leaflet

4 Device overview



Figure 1 - Smart Installation Tool Interfaces

No.	Interface	Description
1	Ethernet cable with weather seals	Connects to the Ethernet port on the back of a Fixed Wireless Outdoor CPE to power it up and allow alignment.
2	Removable battery pack	The battery pack slides into the Smart Installation Tool in only one orientation.
3	LED indicators	Display various statuses. Refer to the LED Indicators section for details.
4	Carabiner hook	Attach a carabiner here to free up your hands when climbing a ladder or when the device is not in use.
5	Power button	Turns the Smart Installation Tool on or off.
6	Mounting rail clip	Slides on to the rail on the Outdoor CPE via this clip. Can only slide on to the rail in one direction.

5 Inserting, removing, and charging the battery

The Smart Installation Tool is equipped with a removable lithium-ion rechargeable battery.



Figure 2 - Smart Installation Tool battery insertion

5.1 Inserting the battery

Insert the battery into the Smart Installation tool by gripping the larger end of the battery and sliding it into the battery slot, ensuring the orientation is correct. A click sound can be heard once the battery locks into place.

5.2 Removing the battery

Remove the battery by gripping the device in one hand and the bottom of the battery in the other, then push in the two locking tabs and pull.

5.3 Charging the battery

Connect the included battery charger to a wall outlet, and ensure it is switched on. Insert the battery into battery charger, ensuring the orientation is correct. The light on the battery charger blinks green to indicate charging. The battery takes approximately two hours to charge, from completely flat to fully charged. The light turns solid green once the battery is charged.



Important – Do not leave the battery charging for extended periods. Once the light is solid green disconnect the charger from the outlet and remove the battery.

6 Powering the Smart Installation Tool on and off

To turn the Smart Installation Tool **ON** either:

- Insert the battery. The tool powers on automatically.
- Press and hold the power button for two seconds, then release.

The tool is powered on when any LED indicators begin to show.

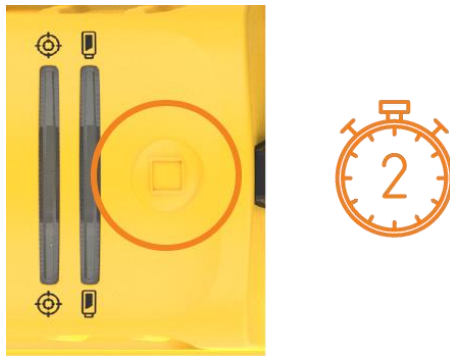

To turn the Smart Installation Tool **OFF** either:

- Remove the battery. The tool powers off.
- Press and hold the power button for longer than five seconds, then release. All LED indicators turn off to indicate the power is off.

 **Note** – The recommended way to power off the tool is to remove the battery. Powering off the device using the power button puts the device in a stand-by state, which will eventually discharge the battery.

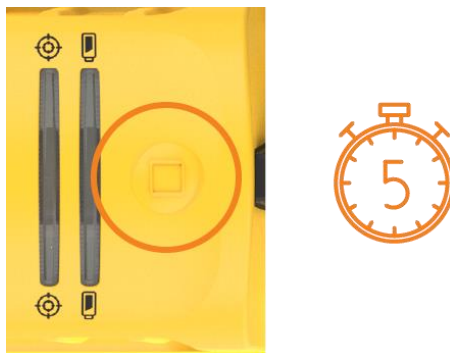

7 LED indicators

The LED Indicators display information to assist with the positioning of the antenna the device is attached to, and to indicate information about the tool itself, such as battery levels. Four indicator types are available, **Battery Level**, **Compass calibration status**, **Signal strength**, and **Information**. The information LED is not currently used.







Warning –

The LED indicators are designed to be bright so that they are visible outdoors. Do not view the LED indicators from close proximity or for long periods.

7.1 Battery level





The battery level is indicated by the battery level LED.

LED		Colour / Status		Description
	Battery level	Solid green		Battery 50% - 100%
		Solid yellow		Battery 20% - 50%
		Blinking red		Battery less than 20%

7.2 Calibration status

The Calibration LED indicates how accurate the calibration is, and if the tool requires calibration. The Calibration LED blinks red when the device needs to be calibrated. Refer to the calibration steps in the [Calibration section](#) to calibrate the device.

If you are using the electronic compass function to assist with installation, then the Smart Installation Tool requires calibration each time it is powered on. If you are not using the compass feature, the Calibration LED can be ignored.











LED		Colour / Status		Description
	Compass calibration status	Solid green		Calibrated
		Solid orange		Calibrated – Medium accuracy
		Solid red		Calibrated – Low accuracy
		Blinking red		Uncalibrated

7.3 Signal strength

The signal strength indicators are used to show both the signal strength and the type of service the Smart Installation Tool is receiving.









7.3.1 Signal strength

The number of signal strength LEDs that are lit indicates the signal strength.

LED	Status	Description
	All signal LEDs off – No Signal	 No cellular network is available.
	One signal LED - Weak	 LTE or 5G Sub6 SA RSRP -115 ≥ RSRP > -120
		 mmWave RSRP 90 ≥ RSRP > -110
	Two signal LEDs - Fair	 LTE or 5G Sub6 SA RSRP 100 ≥ RSRP > -115
		 mmWave RSRP 80 ≥ RSRP > -90
	Three signal LEDs - Good	 LTE or 5G Sub6 SA RSRP -90 ≥ RSRP > -90
		 mmWave RSRP 70 ≥ RSRP > -80
	Four signal LEDs - Excellent	 LTE or 5G Sub6 SA RSRP > -90
		 mmWave RSRP > -70

7.3.2 Service type and tool status

The colour of the signal strength LEDs indicates the service type and tool status.

LED	Colour / Status	Description
 Signal strength	Solid white	 Connected to a network that supports LTE only.
	Solid green	 Connected to a network using LTE, but 5G is available on the network.
	Solid blue	 Connected to a 5G Sub-6 network.
	Solid orange	 Connected to a mmWave network. The following types of mmWave networks are represented by orange LEDs: <ul style="list-style-type: none"> • mmWave only • LTE + mmWave • Sub6 + mmWave (SA)
	Off	 No cellular network is available.
	Blinking yellow	 Tool is providing power to the Outdoor CPE, but no data connection between the tool and the Outdoor CPE is active.
	Blinking blue	 A data connection between the tool and the Outdoor CPE has been established.
	Blinking red	 SIM error has been detected on the Outdoor CPE, such as: <ul style="list-style-type: none"> • SIM PIN locked • SIM PUK locked • SIM not detected

8 Calibration

The Smart Installation tool may require calibration if the compass function is in use. If the compass function is in use, the device will require calibration every time it is switched on. The Calibration LED blinks red when the device needs to be calibrated.

To calibrate the device, hold the device with two hands and isolate it from any magnetic field or metal structures (for example, vehicles, the antenna pole, power lines, etc). Slowly and steadily rotate the unit fully through all three axes. See the diagram below:



Figure 3 - Smart Installation Tool calibration technique



Note –

Ensure the rotation of the device is done at a slow pace, with each movement taking three to five seconds. Moving too quickly will cause the calibration to take longer.

The calibration LED indicates how well the device is calibrated. Refer to 6.2 Calibration status for the different LED statuses. If the calibration LED is solid red or solid orange, consider performing the calibration again to improve the calibration accuracy.

9 Using the Smart Installation Tool to align an Outdoor CPE

To align an Outdoor CPE:

- 1 Prepare the Outdoor CPE as per the AuroraPRO Installation Guide.
- 2 Power on the Smart Installation Tool using the power button. The device is ready to use as soon as the LEDs are visible on the device.
- 3 If the Calibration LED is blinking red, calibrate the device using the calibration instructions in the [Calibration section](#).
- 4 Locate the mounting rail on the Outdoor CPE, then slide the Smart Installation Tool onto the rail. The Smart Installation Tool can only be slid onto the rail in one direction. If the Outdoor CPE is not fitted with a mounting rail, the tool can be attached using the Pole Mounted Tool Rail accessory. Refer to [Using the Pole Mounted Tool Rail](#) section.



Figure 4 - Smart Installation Tool mounted on Outdoor CPE



Warning –

When the Smart Installation Tool is connected to the Outdoor CPE, do not point the front panel of the Outdoor CPE directly at other people or yourself. Always maintain a separation distance greater than the recommended exposure distance of the connected Outdoor CPE between any part of your body and the front of the Outdoor CPE. We recommend that you disconnect the PoE cable when working in front of the CPE.

- 5 Connect the Ethernet cable of the Smart Installation Tool to the Power over Ethernet (PoE) port of the Outdoor CPE. The protruding yellow tab can be used to identify the top of the Ethernet cable for alignment. A click sound is heard when the plug is inserted correctly and the signal LEDs blink yellow as soon as power is being supplied to the Outdoor CPE.



Figure 5 - Smart Installation Tool connected to PoE port of the Outdoor CPE

- 6 Wait at least five minutes for the Outdoor CPE to complete its boot process, then on your smartphone, open the AuroraPro app, and follow the instructions to complete the Outdoor CPE installation.



Note –

If the Outdoor CPE is not discovered in the app, ensure that you have waited long enough for the antenna to have completed its boot up process. If the antenna has been powered on for more than 15 minutes, it will no longer be discoverable. In this case, power cycle the antenna by disconnecting then reconnecting the Ethernet cable and try again.

- 7 When you have completed the installation using the smartphone, disconnect the Ethernet cable of the Smart Installation Tool from the PoE port. To disconnect the plug, grasp it in one hand and then use your thumb to **push and apply pressure to the yellow tab**. Whilst continuing to apply pressure, **pull the plug from the port**.

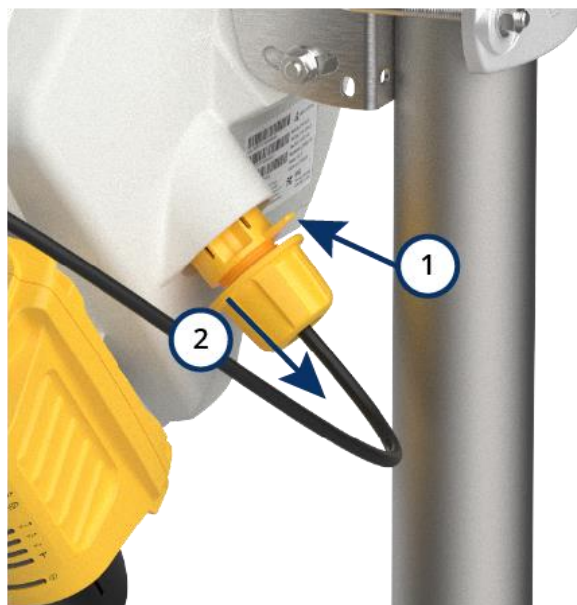

- 8 Remove the Smart Installation Tool from the Outdoor CPE by holding the Outdoor CPE in one hand and sliding the Smart Installation tool off the rail with the other.

10 Firmware management and updates

The Smart Installation Tool can be used to update firmware and configuration on Outdoor CPEs. Firmware upgrade and configuration update files can be stored directly on the tool for use on multiple Outdoor CPEs, allowing for a faster installation as the Outdoor CPE and Smart Installation Tool are connected via Ethernet.

The following sections detail how to manage the files that are stored on the Smart Installation Tool. For general information on how to complete a firmware upgrade using the AuroraPro app, refer to the AuroraPro User Manual.



Note –

The software of the Smart Installation Tool has not been finalised, and the below stages may not be complete, or may change depending on the final version of the software.

To manage firmware updates on the tool:

- 1 Ensure the Outdoor CPE and tool are powered on and the Outdoor CPE is connected to the AuroraPro app.
- 2 Select either **Upgrade Firmware** or **Load New Configuration** depending on which type of file you would like to manage, then select the Continue button.

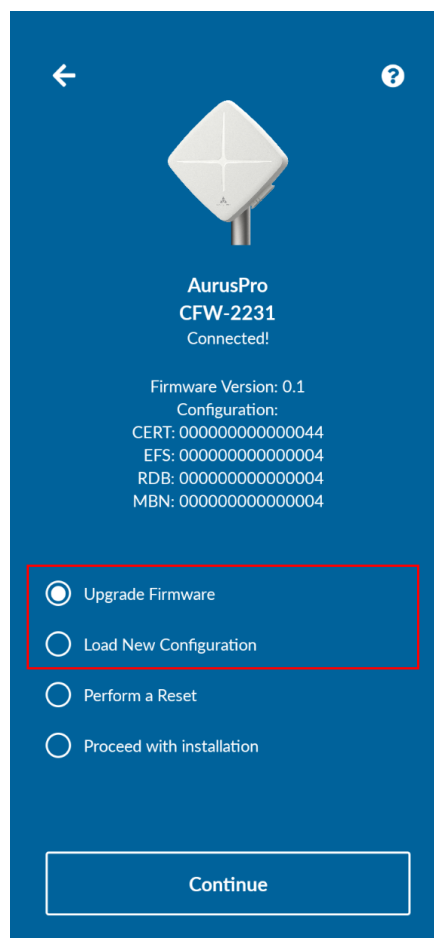

Figure 6 – Dashboard of Aurora Pro app when connected to the Outdoor CPE

- 3 Follow the prompts to connect to the Smart Installation Tool. The **Source Selection** page or **File browser** page is shown.
- 4 To upload a file to the Smart Installation Tool you must first perform a firmware upgrade or configuration update on an Outdoor CPE. This will push and store the file on the Smart Installation Tool, so that future installations can be completed without having to upload the file from your smartphone. To perform the firmware upgrade or configuration update:
 - a Select either **Phone** on the source selection screen or open the **Phone** tab. Use the file browser to locate the firmware or configuration file.

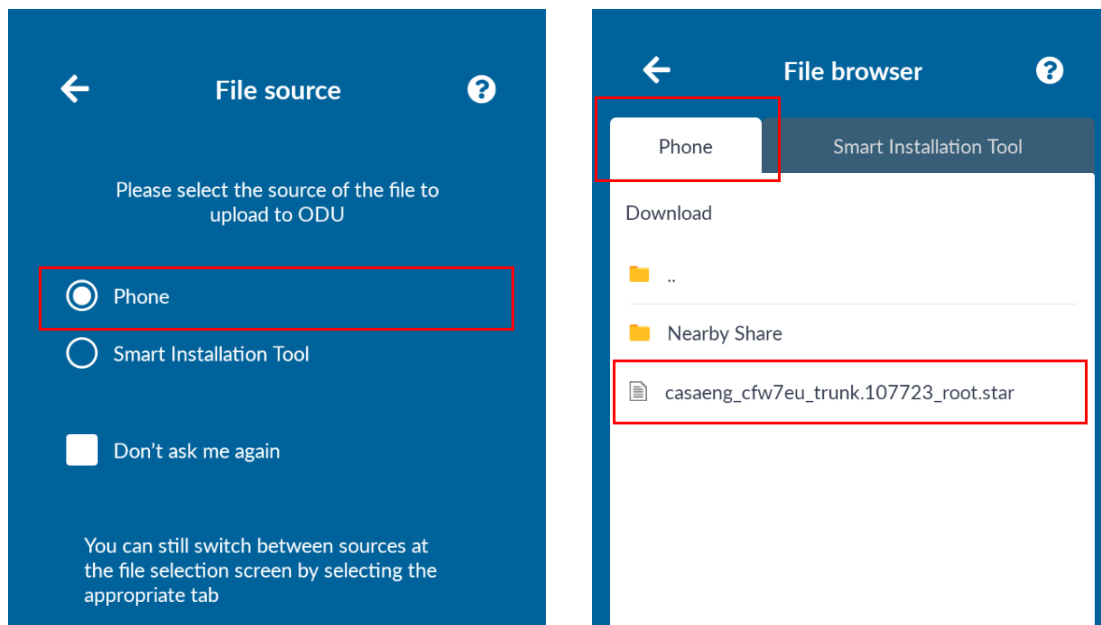

Figure 7 – File source and file browser screens

- b Select the file and follow the prompts to install the file. This may take some time for the first upload. Refer to the AuroraPro app documentation for specifics on completing a firmware update or configuration update. The installation is complete when the **Firmware upgrade completed** dialog is shown.

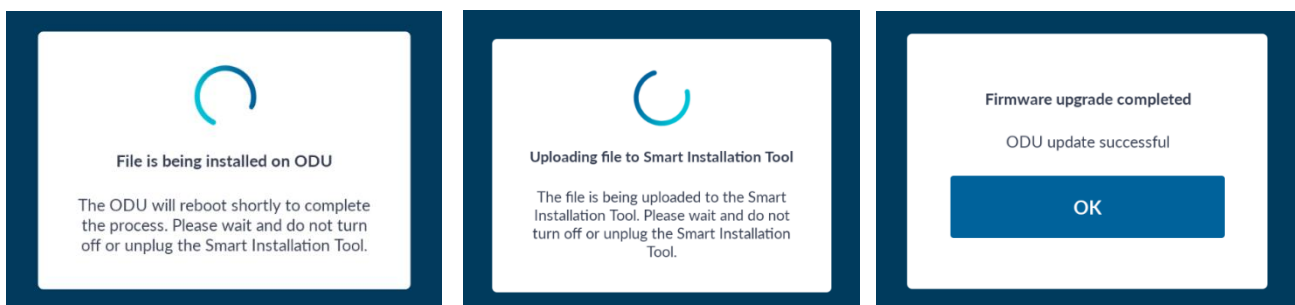

Figure 8 – Installation in progress information

- c After the installation is complete the file is available by selecting the **Update Firmware** or **Load Configuration** pages, and then selecting the **Smart Installation Tool** tab. Select the file from this tab, instead of the phone file browser, to complete the installation of the file directly from the Smart Installation Tool.

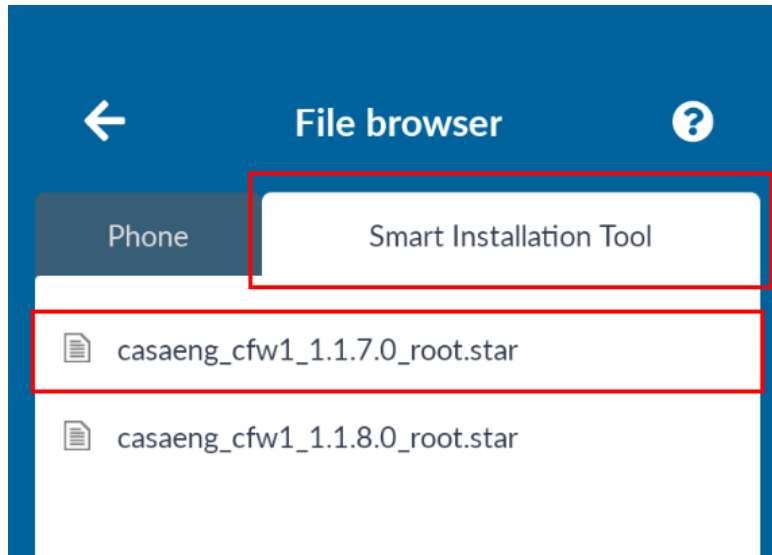

Figure 9 – Location of uploaded files on the Smart Installation Tool

- 5 To delete an existing file from the Smart Installation Tool:
- Select the **Smart Installation Tool** tab.
 - Select the firmware file to be deleted.
 - Select the 'Delete' button.

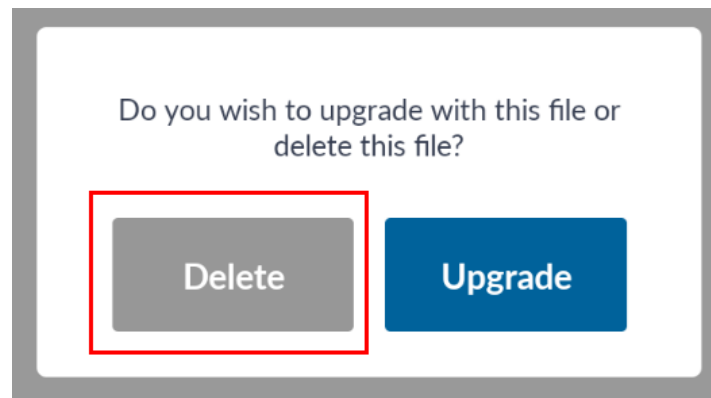

Figure 10 – Delete dialog box

- d The file is deleted from the Smart Installation Tool.

11 Using the Pole Mounted Tool Rail

Previous models of the Outdoor CPEs were not fitted with a rail for the Smart Installation Tool. These Outdoor CPEs are still compatible with the Smart Installation Tool, however they require the use of the Pole Mounted Tool Rail accessory to safely mount the tool.

To use the Pole Mounted Tool Rail:

- 1 Insert the two straps through the slots on the Pole Mounted Tool Rail.

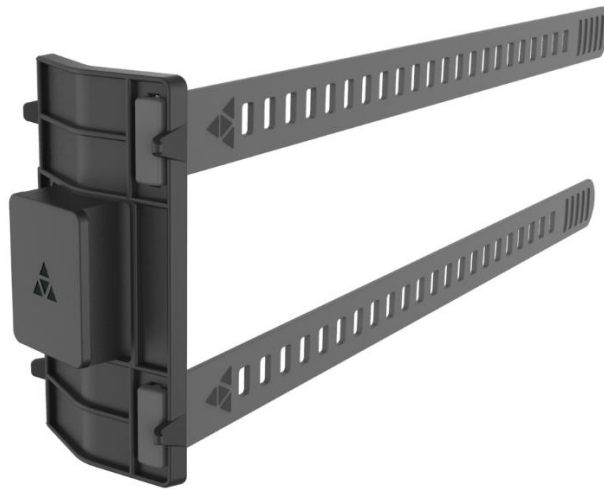

Figure 11 – Pole Mounted Tool Rail with straps inserted

- 2 Wrap the straps around the pole, pulling them taut over the four hooks. The straps may be gently stretched to ensure a secure fit. Any excess strap length can be looped around the pole a second time and secured in place by pushing the end of the strap into the holes.

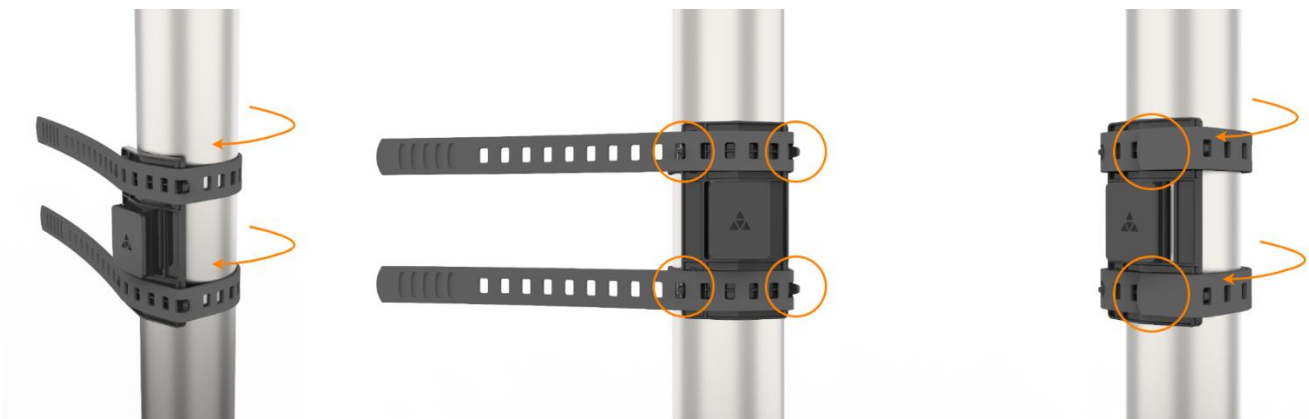

Figure 12 – Pole Mounted Tool Rail attachment

- 3 Power on the Smart Installation Tool using the power button. The device is ready to use as soon as the LEDs are visible on the device.

- Slide the Smart Installation Tool onto the Pole Mounted Tool Rail as shown below. Attach the Smart Installation Tool with the battery facing towards the ground.



Figure 13 – Pole Mounted Tool Rail with Smart Installation Tool attached

12 Using the Smart Installation Tool to power an Outdoor CPE with the Ethernet Passthrough Adapter

In circumstances where the web interface of an Outdoor CPE needs to be accessed using Ethernet, the Smart Installation Tool can be used with the included Ethernet Passthrough Adapter to provide power to the Outdoor CPE. Using the Ethernet Passthrough Adapter requires the weather sealed Ethernet cable to be removed from the Smart Installation Tool.



Note –

When the Outdoor CPE is used in Ethernet passthrough mode, the Smart Installation Tool will only provide power to the Outdoor CPE. The Smart Installation Tool will not connect with the AuroraPRO app or display signal information on the indicator LEDs.

To use the Ethernet Passthrough Adapter:

- 1 On the black end of the Ethernet cable:
 - a Unscrew the clamp surrounding the Ethernet cable on the Smart Antenna tool in a counterclockwise direction.
 - b Pull back the cable seal surrounding the Ethernet cable, then disconnect the Ethernet cable from the Smart Antenna tool.
- 2 Using a cat5e Ethernet cable, connect one end of the cable to the port on the Ethernet Passthrough Adapter labelled Installation Tool and the other end to the Smart Installation tool.

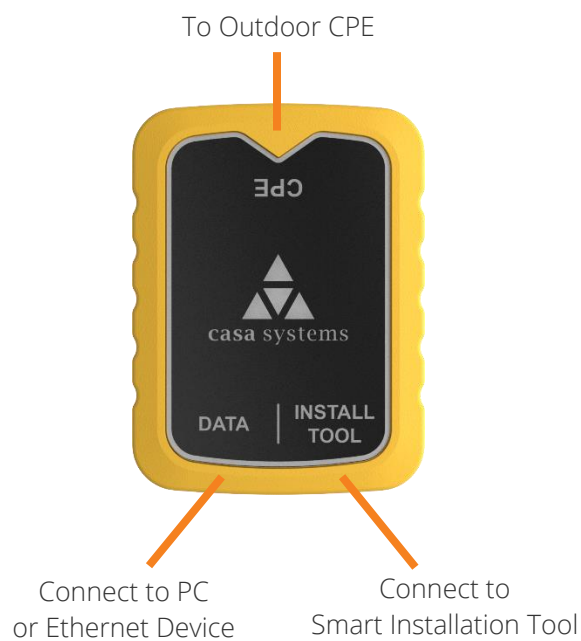

- 3 Locate the mounting rail on the Outdoor CPE, then slide the Smart Installation Tool onto the rail. The Smart Installation Tool can only be slid onto the rail in one direction.
- 4 Using a cat5e Ethernet cable, connect one end of the cable to the port on the Ethernet Passthrough Adapter labelled CPE and the other end to the Outdoor CPE.
- 5 Using a cat5e Ethernet cable, connect one end of the cable to the port on the Ethernet Passthrough Adapter labelled data, and connect the other end to your laptop or PC.
- 6 Wait for the Outdoor CPE to fully power on, which may take up to five minutes.
- 7 Access the web interface of the Outdoor CPE by opening a web browser and navigating to <https://192.168.1.1>.
- 8 For further configuration information of the Outdoor CPE, refer to the Aurus Pro Outdoor Receiver User Guide.

13 Aligning an Outdoor CPE without the Aurora Pro app

We recommend that you always use the Aurora Pro app when performing an Outdoor CPE installation, as this will provide in depth data to ensure the best location. However, in certain cases you may not wish to use the Aurora Pro app to perform an installation. The Smart Installation Tool can be used to help you position a compatible Outdoor CPE without the app. Performing an installation without the app is only supported on some Outdoor CPEs. Speak to your Casa Representative for more information.

To perform an installation without the app:

- 1 Set up the Outdoor CPE and connect the Smart Installation Tool, as shown in steps 1 – 5 of [Using the Smart Installation Tool to align an Outdoor CPE](#) section.
- 2 Using the Signal LEDs, view the signal strength and service type that the Outdoor CPE is receiving. Refer to the [LED Indicators](#) section or LED table on the rear of the Welcome Card.
- 3 Move the antenna to a different position, then wait ten seconds for the LED status to update. Again, using the signal LEDs, view the signal strength and service type that the Outdoor CPE is receiving.
- 4 Repeat the process until you have found a location with the strongest signal and preferred signal type.
- 5 When you have completed the installation using the smartphone, disconnect the Ethernet cable of the Smart Installation Tool from the PoE port by pushing forward on the yellow tab and then pulling the plug.
- 6 Remove the Smart Installation Tool from the Outdoor CPE by holding the Outdoor CPE in one hand and sliding the Smart Installation tool off of the rail with the other.

14 Maintenance and Storage

14.1 Replacing the Ethernet cable

The Ethernet cable on the Smart Installation Tool is user replaceable.

The black fitting connected to the Smart Antenna tool contains the following components:

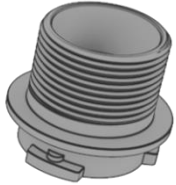

Body



Sealing washer



Cable seal



Collar



Clamp

The yellow fitting that connects to the Outdoor Unit contains the following components:



Body



Cable seal



Collar



Clamp

To replace the ethernet cable:

- 1 Obtain or prepare a replacement Ethernet cable. The recommended replacement is a 50cm straight through Cat5e Ethernet cable.
- 2 On the black end of the Ethernet cable:
 - a Unscrew the clamp surrounding the Ethernet cable on the Smart Antenna tool in a counterclockwise direction.
 - b Pull back the cable seal surrounding the Ethernet cable, then disconnect the Ethernet cable from the Smart Antenna tool.
 - c Remove the body, cable seal, sealing washer, collar, and clamp.
- 3 On the yellow end of the cable:
 - a Whilst gripping the clip section in one hand, unscrew the clamp surrounding the Ethernet cable in a counterclockwise direction.

- b Pull the yellow clip housing off the Ethernet cable, removing the Ethernet clip through the larger hole at the rear of the housing.
 - c Pull back the clip and cable seal surrounding the Ethernet cable.
- 4 On the black end of the cable, reinstall the cable seal on the replacement Ethernet cable, installing as shown below:

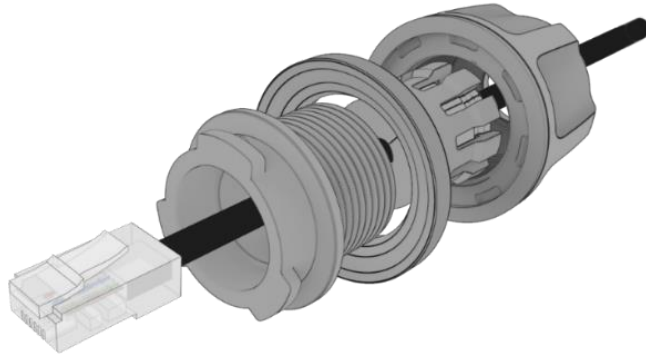

Figure 14 - Smart Installation Tool cable seal replacement (black end)

- 5 On the yellow end of the cable, reinstall the cable seal and yellow clip housing, installing as shown in the diagram below. Ensure the Ethernet cable is installed through the clip body correctly.



Figure 15 - Smart Installation Tool cable seal replacement (yellow end)

- 6 Reconnect the black end of the Ethernet cable to the Smart Antenna tool Ethernet port, ensuring the Ethernet connector is aligned with the port on the Smart Antenna tool, then twist and click the black housing into place.

14.2 Tool operation and storage

The Smart Installation Tool and associated components should be stored in the carry case when not in use. The case should be stored in a cool, dry environment. When charging the batteries, ensure they are removed from the charger once they are fully charged, do not leave the batteries on the charger when they are in storage.

14.2.1 Cold temperatures

When stored the Smart Installation Tool should be protected from low temperature. The Smart Installation Tool should not be stored overnight in the rear of vans and trucks where the temperature is likely to drop lower than 0°C (32°F).

When operating the Smart Installation Tool, you should minimise the amount of time that the device is exposed to low temperatures. If the temperature is lower than 0°C (32°F), the device should be removed from the storage case and powered on immediately for use with the Outdoor CPE. Return it to the storage case as soon as the Outdoor CPE installation is complete.

14.2.2 Direct sunlight and high temperatures

The Smart Installation Tool should not be kept in direct sunlight for extended periods of time. Return the Smart Installation to the storage case as soon as the Outdoor CPE installation is complete. When stored, the Smart Installation Tool should be protected from excessively hot temperatures.

The tool should not be operated where the ambient temperature is higher than +40°C (104°F). Similarly, the batteries should not be charged where the ambient temperature is higher than +40°C (104°F).

14.3 Updating the firmware of the Smart Installation Tool

From time-to-time Casa Systems may release a new firmware for the Smart Installation Tool. A laptop or PC which has a Wi-Fi network card and internet browser is required to update the Smart Installation Tool.

To install updated firmware for the Smart Installation Tool:

- 1 Insert the battery into the Smart Installation Tool and power it on.
- 2 On your PC, connect to the Wi-Fi network of the Smart Installation Tool. The network SSID and password can be found on the label of the Smart Installation Tool. For example, to connect to the Wi-Fi network on Windows:
 - a Select the Networks panel from the Quick Launch toolbar, then locate the SSID of the Smart Installation Tool.
 - b Enter the password from the device label.
 - c Select Next to connect.

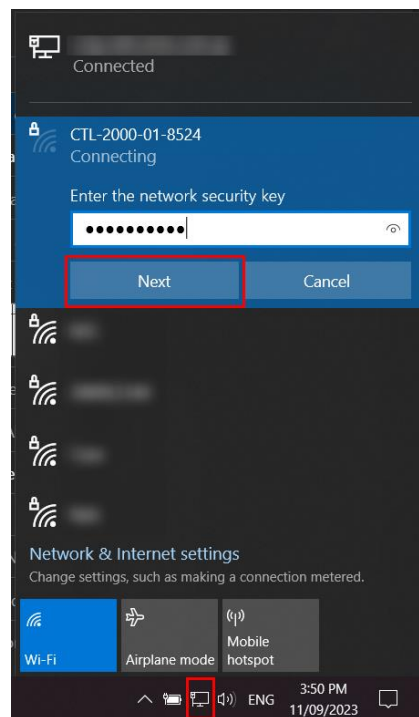

- 3 Open a web browser and navigate to <http://192.168.4.1>. The **System information** page is displayed.

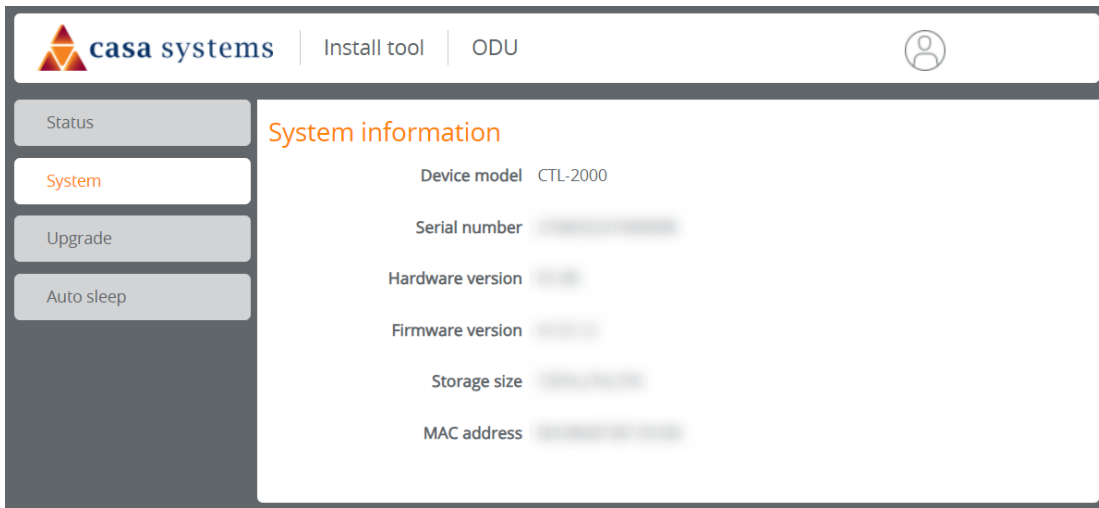

- 4 From the left-hand navigation bar, select **Upgrade**. If required, enter the username and password for the device.
- 5 Select the **Choose a file** button, then locate the firmware upgrade file on your PC.
- 6 Wait for the firmware to upload, then select **Upgrade**. Wait for the installation to complete.
- 7 After the installation is complete, the Smart Installation Tool reboots. Connect to the Wi-Fi network, then navigate to the System Information page. Verify that the Firmware version on the Smart Installation Tool is as expected.

15 Battery information

15.1 Battery temperature

The temperature of the battery can influence both its performance and life span. To get the best performance out of your battery, ensure that it is used within the following temperature ranges:

Operating temperature range: -15°C to +40°C (5°F to 104°F) (ambient)

Battery charging temperature range: 0°C to +40°C (32°F to 104°F) (ambient)



Warning – Do not operate the Smart Installation Tool in direct sunlight for longer than 45 minutes.

15.2 Battery storage

Batteries should be stored in the case when not in use to ensure they remain undamaged and in good condition. Do not store the Smart Installation Tool in the rear of vans and trucks where the temperature is likely to drop lower than 0°C (32°F).



Important – Batteries should not be stored in excessive heat or cold. Ensure that the case is not stored where there may be extreme temperature fluctuations, such as the rear of vans and trucks.

15.3 Replacing the batteries

Batteries degrade over time and may require replacement. The batteries in the Smart Installation Tool can be replaced and is compatible with 48-11-2430 and 48-11-2460 batteries available from local online resellers.



Important – Warranty is only applicable whilst using the Casa Systems supplied batteries or certified 48-11-2430 and 48-11-2460 branded replacement batteries. The use of generic compatible batteries from other vendors is at the user's risk.

16 Safety and regulatory information

16.1 FCC (USA)

16.1.1 RF Exposure

The CTL-2000 contains a transmitter and a receiver. When it is on, it receives and transmits RF energy. When you communicate with your device, the system handling your connection controls the power level at which your device transmits. The CTL-2000 meets the government's requirements for exposure to radio waves. It is designed and manufactured not to exceed the emission limits for exposure to radio frequency (RF) energy set by the Federal Communications Commission of the U.S. Government.

When the CTL-2000 is connected to the Outdoor CPE during the installation process, this equipment should be operated with a minimum distance greater than the recommended exposure distance of the connected Outdoor CPE between the radiator and your body.

The exposure standard for wireless transmitter employs a unit of measurement known as the Specific Absorption Rate, or SAR. The SAR limit set by the government FCC is 1.6 W/kg when averaged over 1g of tissue.

The highest SAR value for the EUT as reported to the FCC when averaged over 1g of tissue is 0.34W/kg and when worn on the body. This device has been tested and meets the FCC RF exposure guidelines for use when positioned a minimum of 0 mm (0 inches) from the body.

16.1.2 FCC compliance

Federal Communications Commission Notice (United States): Before a wireless device model is available for sale to the public, it must be tested and certified to the FCC that it does not exceed the limit established by the government-adopted requirement for safe exposure.

16.1.3 FCC regulations

This device complies with part 15 of the FCC Rules. Operation is subject to the following two conditions: (1) This device must not cause harmful interference, and (2) this device must accept any interference received, including interference that will cause undesired operation.

This device has been tested and found to comply with the limits for a Class B digital device, pursuant to Part 15 of the FCC Rules. These limits are designed to provide reasonable protection against harmful interference in a residential installation. This equipment generates, uses and can radiate radio frequency energy and, if not installed and used in accordance with the instructions, may cause harmful interference to radio communications. However, there is no guarantee that interference will not occur in a particular installation. If this equipment does cause harmful interference to radio or television reception, which can be determined by turning the equipment off and on, the user is encouraged to try to correct the interference by one or more of the following measures:

- Reorient or relocate the receiving antenna.
- Increase the separation between the equipment and receiver.
- Connect the equipment into an outlet on a circuit different from that to which the receiver is connected.
- Consult the dealer or an experienced radio/TV technician for help.

Changes or modifications not expressly approved by the party responsible for compliance could void the user's authority to operate the equipment.

16.1.4 Company details

Casa Systems, Inc. 100 Old River Road, Andover, Massachusetts 01810 USA
<https://www.casa-systems.com/contact-us/>

16.1.5 Product Details

Product: Smart Installation Tool; Model No: CTL-2000

16.2 Canada (IC)

This device contains licence-exempt transmitter(s)/receiver(s) that comply with Innovation, Science and Economic Development Canada's licence-exempt RSS standard(s). Operation is subject to the following two conditions: 1. This device may not cause interference, and 2. This device must accept any interference, including interference that may cause undesired operation of the device.

Cet appareil est conforme à la norme RSS d'Industrie Canada. Son fonctionnement est sujet aux deux conditions suivantes:

(1) le dispositif ne doit pas produire de brouillage préjudiciable, et

(2) ce dispositif doit accepter tout brouillage reçu, y compris un brouillage susceptible de provoquer un fonctionnement indésirable.

16.2.1 RF Radiation Exposure Statement:

This device has been tested and meets applicable limits for Radio Frequency (RF) exposure.

The exposure standard for wireless transmitter employs a unit of measurement known as the Specific Absorption Rate, or SAR. The SAR limit set by the government ISED is 1.6 W/kg when averaged over 1g of tissue.

The highest SAR value for the EUT as reported to the ISED when averaged over 1g of tissue is 0.34W/kg and when worn on the body. This device has been tested and meets the ISED RF exposure guidelines for use when positioned a minimum of 0 mm (0 inches) from the body.

Cet appareil a été testé et respecte les limites applicables pour l'exposition aux radio fréquences (RF).

La norme d'exposition pour les émetteurs sans fil utilise une unité de mesure connue sous le nom de taux d'absorption spécifique ou SAR. La limite SAR fixée par le gouvernement ISED est de 1,6 W/kg en moyenne sur 1 g de tissu.

La valeur SAR la plus élevée pour l'EUT telle que rapportée à l'ISED lorsqu'elle est calculée en moyenne sur 1 g de tissu est de 0,34 W/kg et lorsqu'elle est portée sur le corps. Cet appareil a été testé et répond aux directives d'exposition RF ISED pour une utilisation lorsqu'il est positionné à au moins 0 mm (0 pouce) du corps.

16.2.2 ISED Emissions compliance statement

This Class B digital apparatus complies with Canadian ICES-003.

Avis de Conformité à la Réglementation d'Industrie Canada. Cet appareil numérique de la classe B est conforme à la norme NMB-003 du Canada.

16.3 CE Regulation

16.3.1 RF Exposure Information (MPE)

This device meets the EU requirements and the International Commission on NonIonizing Radiation Protection (ICNIRP) on the limitation of exposure of the general public to electromagnetic fields by way of health protection.

The exposure standard for a wireless transmitter employs a unit of measurement known as the Specific Absorption Rate, or SAR. In the EU, the SAR limit is 2.0 W/kg when averaged over 10g of tissue.

The highest SAR value for the EUT measured when averaged over 10g of tissue is 0.23W/kg when worn on the body. This device has been tested and meets the EU RF exposure guidelines for use when positioned a minimum of 0 mm from the body.

16.3.2 RF General Information

Evaluation Mode	Frequency Range (MHZ)	Modulation Type
b	2412 - 2472	DSSS
g		OFDM
n_HT20		
n_HT40	2402 - 2480	GFSK
Bluetooth Low Energy		

16.3.3 Maximum RF Power Table

Wi-Fi 802.11	Maximum Average Output Power (DBM)
b	19.84
g	19.77
n_HT20	19.84
n_HT40	19.72

Bluetooth Low Energy	Maximum Average Output Power (DBM)
BLE	11.53

16.3.4 WEEE Regulation



Waste Electrical and Electronic Equipment (WEEE)

This symbol means that according to local laws and regulations your product and/or its battery shall be disposed of separately from household waste. When this product reaches its end of life, take it to a collection point designated by local authorities. Proper recycling of your product will protect human health and the environment.

16.3.5 Simplified EU Doc

Hereby, Casa Systems, Inc. declares that the radio equipment type CTL-2000 is in compliance with Directive 2014/53/EU. The full text of the EU declaration of conformity is available at the following internet address: <http://support.casa-systems.com/doc>

16.4 Australia ACMA

The device contains a transmitter and a receiver. When it is on, it receives and transmits RF energy. The exposure standard for a wireless transmitter employs a unit of measurement known as the Specific Absorption Rate, or SAR. The SAR limit is 2.0 W/kg when averaged over 10g of tissue.

The highest SAR value for the EUT measured when averaged over 10g of tissue is 0.23W/kg when worn on the body. The device conforms with the radio frequency (RF) exposure limits adopted by the Australian Communications and Media Authority, for use when positioned a minimum of 0 mm from the body.