

EMC Test Report
FCCID: XEC-5X00
5.8 GHz WiMax CPE
EION Inc.

Testing body: Tranzeo Wireless
19473 Fraser Way,
Pitt Meadows,
BC, Canada
V3Y 2V4

Client: EION
320 March Road,
Suite 500, Ottawa
ON, Canada
K2K 2E3

The test results indicated in this report refer exclusively to the equipment under test specified below. It is not permitted to transfer the results to other systems or configurations.

Order number: 88

Type of test: Testing of electromagnetic disturbances characteristics

Date the EUT was received: October 5th, 2009

Date of test: October 6th, 2009 to October 22nd, 2009

Report No.: 102609.1

Pitt Meadows, 26 October, 2009



EMC Manager: Andrew Marles

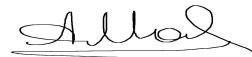

EMC Engineer: Andrei Moldavanov

Revision History

Table of Contents

1.0	GENERAL INFORMATION.....	6
1.1	<i>EUT Description.....</i>	6
1.2	<i>Operational Description.....</i>	7
1.3	<i>Standards Applied.....</i>	7
1.4	<i>EUT Testing Configuration.....</i>	7
1.5	<i>Auxillary Equipment.....</i>	8
1.6	<i>EUT Modifications.....</i>	8
1.7	<i>Test Facilities.....</i>	9
1.8	<i>Test Equipment.....</i>	9
1.9	<i>Test Results.....</i>	9
2.0	CONDUCTED EMISSIONS.....	10
2.1	<i>Test Standard.....</i>	10
2.2	<i>Test Limits.....</i>	10
2.3	<i>Method of measurements.....</i>	10
2.4	<i>Test Setup.....</i>	10
2.4.1	<i>Test Setup Block Diagram.....</i>	11
2.5	<i>Test Results.....</i>	11
2.5.1	<i>Test Data Peak Detector.....</i>	12
2.5.2	<i>Test Data Average Detector.....</i>	12
3.0	PEAK POWER OUTPUT.....	13
3.1	<i>Test Standard.....</i>	13
3.2	<i>Test Limits.....</i>	14
3.3	<i>Method of measurement.....</i>	14
3.4	<i>Test Setup.....</i>	14
3.4.1	<i>Test Setup Block Diagram.....</i>	14
3.5	<i>Test Results.....</i>	15
4.0	RADIATED EMISSIONS, GENERAL REQUIREMENTS.....	17
4.1	<i>Test Standard.....</i>	17
4.2	<i>Test Limits.....</i>	18
4.3	<i>Method of measurements.....</i>	18
4.4	<i>Test Setup.....</i>	18
4.4.1	<i>Test Setup Block Diagram.....</i>	19
4.5	<i>Test Results.....</i>	19
4.5.1	<i>32 dBi Dish antenna.....</i>	19
4.5.2	<i>26 dBi Grid antenna.....</i>	20
4.5.3	<i>24 dBi Integrated antenna.....</i>	20
5.0	HARMONIC AND SPURIOUS EMISSIONS.....	21
5.1	<i>Test Standard.....</i>	21
5.2	<i>Test Limits.....</i>	21
5.3	<i>Method of measurements.....</i>	21
5.4	<i>Test Setup – Spurious Emissions.....</i>	21
5.4.1	<i>Test Setup Block Diagram – Conducted Measurements (Harmonics).....</i>	22
5.4.2	<i>Test Setup Block Diagram – Radiated Measurements (Spurious).....</i>	23
5.5	<i>Test Results.....</i>	24
5.5.1	<i>Test Results 15.247–Harmonics -30 dBc.....</i>	24
5.5.2	<i>Test Results 15.247– Restricted Bands (Spurious Emissions).....</i>	27

6.0	BAND EDGE	28
6.1	<i>Test Standard</i>	28
6.2	<i>Test Limits.....</i>	28
6.3	<i>Method of measurements.....</i>	28
6.4	<i>Test Setup.....</i>	28
6.4.1	<i>Test Setup Block Diagram – Conducted Measurements)</i>	29
6.4.2	<i>Test Setup Block Diagram – Radiated Measurements</i>	29
6.5	<i>Test Results, 5725-5850 MHz, Conducted Measurements</i>	30
7.0	OCCUPIED BANDWIDTH	33
7.1	<i>Test Standard</i>	33
7.2	<i>Test Limits.....</i>	33
7.3	<i>Method of measurements.....</i>	33
7.4	<i>Test Setup.....</i>	33
7.4.1	<i>Test Setup Block Diagram.....</i>	34
7.5	<i>Test Results, 6 dB Occupied Bandwidth.....</i>	34
7.5.4	<i>Data Table – Occupied Bandwidth.....</i>	40
8.0	POWER SPECTRAL DENSITY	41
8.1	<i>Test Standard</i>	41
8.2	<i>Test Limits.....</i>	41
8.3	<i>Method of measurements.....</i>	41
8.4	<i>Test Setup.....</i>	41
8.4.1	<i>Test Setup Block Diagram.....</i>	42
8.5	<i>Test Results, Power Spectral Density.....</i>	42
8.6	<i>Results, Data Tables</i>	44
9.0	RF EXPOSURE EVALUATION	45
9.1	<i>EUT Operating Condition.....</i>	45
9.2	<i>Method of measurements.....</i>	45
9.3	<i>RF exposure evaluation distance calculation.....</i>	45
10.0	TEST PHOTOS	46
10.1	<i>Grid antenna (26 dBi).....</i>	47
10.2	<i>Integrated 24dBi antenna.....</i>	48
10.3	<i>Conducted Emissions Setup.....</i>	49

1.0 General Information

1.1 EUT Description

Product Name	WiMax CPE
Company Name	EION Inc.
FCC ID	XEC-5X00
Model No.	Libra MAX-SS 5X00e; Libra MAX-SS 5X00i16; Libra MAX-SS 5X00i20; Libra MAX-SS 5X00i24
Frequency Range	5725-5850 MHz
Channel Separation	3.5/5/7 MHz in dependence on bandwidth used
Transmit Rate	25.9 Mbps maximum bit rate specification
Type of Modulation	OFDM
Antenna Type	Integral/external
Antenna Gain	5725-5850 32 dBi MAX
Product Software Revision	TR6-WMX-0.2.5.bin
Test Software	Bandwidth test software
Operator Channel Selection	By software
Power Adapter	SP48-181000
	Input: AC 120V 60Hz, 25.9 W
	Output: DC 18 V, 1000 mA
	Serial: 0504

Product samples tested:

Manufacturer	Model No.	Serial No.
EION Inc.	Libra MAX-SS 5X00i16	Libra MAX-SS 5X00i16-Eng1
EION Inc.	Libra MAX-SS 5X00i20	Libra MAX-SS 5X00i20-Eng1
EION Inc.	Libra MAX-SS 5X00i24	Libra MAX-SS 5X00i24-Eng1
EION Inc.	Libra MAX-SS 5X00e	Libra MAX-SS 5X00e-Eng1

As an IEEE 802.16 compliant wireless system, this device includes a 5.8 GHz receive function as well as 5.8 GHz digital modulation transmit function. There are no user serviceable parts inside the unit. It is factory sealed in a one-time use manner and inaccessible to the end user.

The products, Libra MAX-SS 5X00e, Libra MAX-SS 5X00i16, Libra MAX-SS 5X00i20, and Libra MAX-SS 5X00i24 are a product family. These products operate at 5.8 GHz. They use the same internal components, including radio and are identical with the following exceptions:

- Libra MAX-SS 5X00e does not contain an integrated antenna and is fitted with a standard Type N connector for external antenna.
- The Libra MAX-SS 5X00i16, Libra MAX-SS 5X00i20, and Libra MAX-SS 5X00i24 are fitted with an integrated 5.8 GHz 16, 20, and 24 dBi patch antenna, respectively.

1.2 Operational Description

The device is a WiMax CPE designed specifically for wireless networks. The device has an IEEE 802.16 radio and uses integrated antennae with the gain of 16, 20, and 24 dBi, as well as external antennae. The transceiver operates in the frequency band 5725-5850 MHz. The device transmits digital network data and is mounted in fixed point-to-point installations. There are no user serviceable parts inside the unit.

The type of RF modulation is OFDM used at 5.8 GHz band. The device can transmit data at a bit rate of 25.9 Mbps or a real-world data rate of approximately 20.88 Mbps. The device's standard compliance ensures that it can communicate with a corresponding WiMax Base Station.

The firmware used with the device prevents the use of channels outside the specified frequency bands.

The product is used exclusively in a professionally installed, fixed point-to-point environment.

1.3 Standards Applied

According to the specifications of the manufacturer, the EUT must comply with the requirements of the following standards:

FCC Part 15, Subparts B and C
Industry Canada RSS-210 Issue 7
Industry Canada RSS-Gen Issue 2

All tests have been performed in accordance with the above test standards.

1.4 EUT Testing Configuration

The tests were performed on production sample models to demonstrate compliance with FCC Part 15, Subpart B, and Subpart C, as well as Industry Canada RSS-210 Issue 7 for digitally modulated devices.

All the models Libra MAX-SS 5X00e, Libra MAX-SS 5X00i16, Libra MAX-SS 5X00i20, and Libra MAX-SS 5X00i24 were tested. The device fitted with a standard Type N connector was tested with the highest gain antenna of each type. Data is presented for the worst case configuration only.

All emissions testing was performed in a semi-anechoic chamber. This device is tested as a tabletop device. The EUT is mounted to a custom non-metallic stand to best represent a typical user installation. The EUT is connected to a Base Station Emulator (BSE) to simulate a real world situation. The CPE does not transmit any signals unless

it can identify a base station. Both the BSE and the EUT are connected to a host PC so that they can be cycled through the various test modes and channels.

The EUT was tested in the following modes:

Standby/Receive mode: In this mode the EUT searches for a base station and transmits information back and forth to the base station.

Data transfer mode: In this mode the EUT is exercised with commercially available bandwidth test software. A link is established between two PCs through the unit and the base station and data is transmitted at the highest possible rate.

This product has a channel spacing of 3.5, 5 and 7MHz. Data is presented for the worst case configuration across each frequency band/bandwidth.

1.5 Auxillary Equipment

The following auxiliary equipment and cables were used for performing the tests:

Manufacturer	Model	Description	S/N	FCC DoC
Soyo	PW-930S	Laptop PC	6188	Yes
Powertron	SP48-181000	Power Adapter	0504	Yes
Dell	CU036	Optical mouse	N/A	Yes

The TR-WMX-58-N unit was tested with the antennas listed.

5 GHz Antennas model	Description
TR-5.8-32DB-ANT	32 dBi Dish Antenna
TR-GD58-26	26 dBi Grid Antenna

1.6 EUT Modifications

No modifications were necessary for this unit to comply with FCC Part 15, Industry Canada RSS-210 Issue 7, and Industry Canada RSS-Gen Issue 2.

1.7 Test Facilities

Tranzeo EMC Labs
 19473 Fraser Way
 Pitt Meadows, BC V3Y 2V4
 Canada

Phone: (604) 460-6002
 Fax: (604) 460-6005

FCC registration number: 960532
 Industry Canada Number: 5238A

1.8 Test Equipment

Manufacturer	Model	Description	Serial Number	Cal Due Date
Rohde & Schwarz	ESU 40	EMI Test Receiver	10011	12-Jun-10
Rohde & Schwarz	SMJ 100A	Vector Signal Generator	100645	N/R
ETS-Lindgren	2165	Turndtable	00043883	N/R
ETS-Lindgren	2175	Mast Motor	00077487	N/R
Sunol Sciences	JB3	Antenna	A042004	23-Oct-10
Sunol Sciences	DRH-118	Antenna	A052804	07-Feb-10
Com-Power	LI-115	LISN	241037	30-Jan-10
Chase	EMCell	RF Immunity Cell	1016	N/R
Agilent	8648C	Signal Generator	3623A03622	14-Aug-10
Instruments for Industry	Power Amplifier	Power Amplifier	5580-20	N/R
ETS Lindgren	HI-6005	Isotropic Field Probe	00034277	N/R
ETS Lindgren	2090	Multi-Device Controller	00058942	07-Nov-10
FCC	F-120-9A	Bulk Current Injection Probe	399	N/R

1.9 Test Results

The EUT complies with FCC Part 15, Subparts B and C, as well as Industry Canada RSS-210 Issue 7 and Industry Canada RSS-Gen Issue 2.

2.0 Conducted Emissions

2.1 Test Standard

Test Requirement: ANSI C63.4-2003 Clause 7.1; FCC Part 15, Subpart C, 15.207a; IC RSS-Gen Issue 2, Section 7.2

Test Method: ANSI C63.4-2003 Clause 7.2

a) Except as shown in Paragraphs (b) and (c) of this section, for an intentional radiator that is designed to be connected to the public utility (AC) power line, the radio frequency voltage that is conducted back onto the AC power line on any frequency or frequencies within the band 150 kHz to 30 MHz shall not exceed the limits in the following table, as measured using a 50 μ H/50 ohms line impedance stabilization network (LISN). Compliance with the provisions of this paragraph shall be based on the measurement of the radio frequency voltage between each power line and ground at the power terminal. The lower limit applies at the boundary between the frequency ranges.

2.2 Test Limits

Frequency (MHz)	Maximum Level (dBuV) Quasi-Peak	Maximum Level (dBuV) Average
0.15-0.50	66-56 (Log Delta)	56-46 (Log Delta)
0.50-5.00	56	46
5.00-30.0	60	50

2.3 Method of measurements

All test conditions and measurement procedures were performed in accordance with ANSI 63.4-2003 “AC powerline conducted emission measurements”; FCC Part 15, Subpart C, 15.207a

2.4 Test Setup

The EUT was exercised using bandwidth test software at the highest possible data rate. The test is performed at low (5727, 5730, and 5732 MHz), middle (5787.5 MHz) and high channels (5848, 5845, and 5843 MHz) in 3.5, 5, and 7 MHz bandwidths, correspondingly for the 5.8 GHz frequency band. All emission bandwidths were tested. Only worst case data is shown below.

Note: For testing purposes only, to ensure worst case performance in all testing configurations, the radio is configured to transmit at the maximum possible RF power.

2.4.1

Test Setup Block Diagram

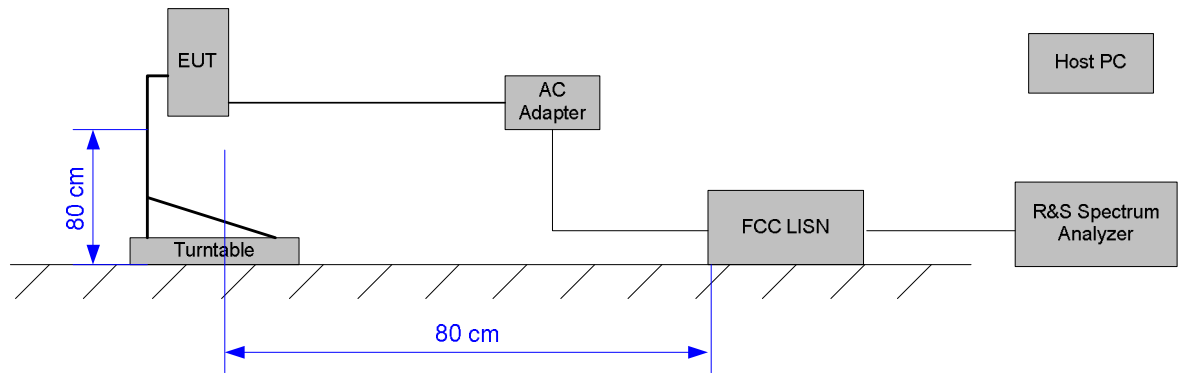

Note: The unused LISN terminal is terminated with a 50 ohms terminator.

2.5 Test Results

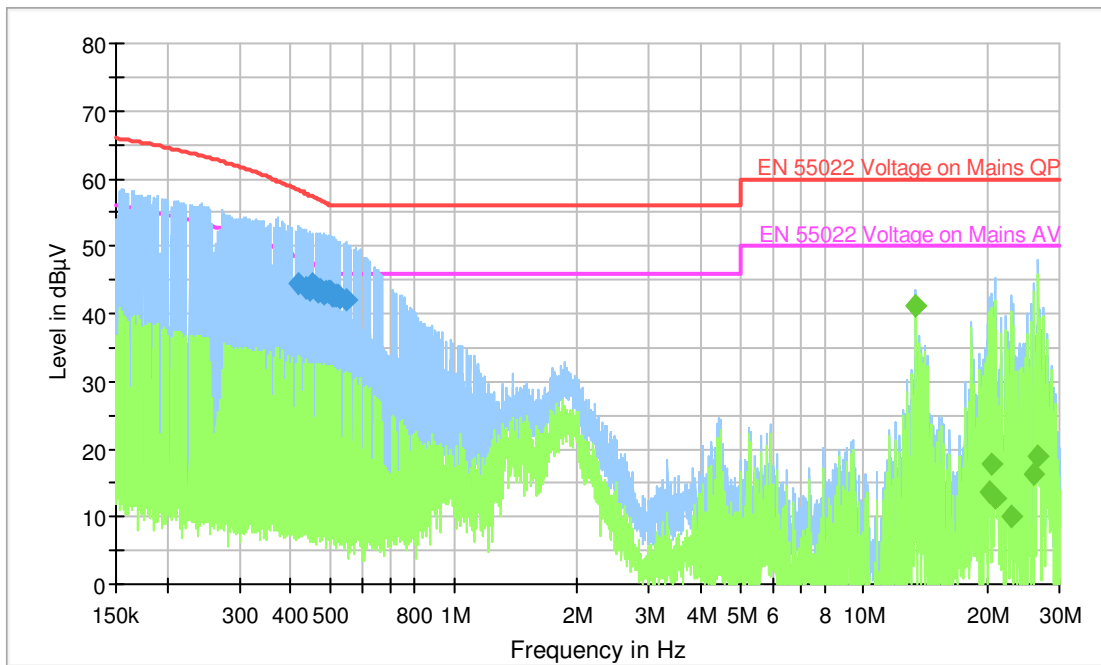

2.5.1 Test Data Peak Detector

Frequency (MHz)	QuasiPeak (dB μ V)	Bandwidth (kHz)	Filter	Line	Corr. (dB)	Margin (dB)	Limit (dB μ V)
0.416599	44.5	9.000	On	L1	0.0	13.9	58.4
0.437073	43.7	9.000	On	N	-0.1	14.1	57.8
0.449029	43.4	9.000	On	L1	0.0	14.1	57.5
0.453539	44.4	9.000	On	L1	0.0	12.9	57.3
0.460851	43.5	9.000	On	L1	0.0	13.6	57.1
0.464550	44.0	9.000	On	N	-0.1	13.0	57.0
0.469686	43.2	9.000	On	N	-0.1	13.7	56.9
0.473457	43.7	9.000	On	L1	0.0	13.1	56.8
0.478691	43.2	9.000	On	L1	0.0	13.4	56.6
0.482534	43.1	9.000	On	N	-0.1	13.4	56.5
0.487868	43.3	9.000	On	L1	0.0	13.0	56.3
0.491785	43.3	9.000	On	N	-0.1	12.9	56.2
0.497222	43.2	9.000	On	L1	0.0	12.9	56.1
0.501214	43.3	9.000	On	L1	0.0	12.7	56.0
0.506755	42.6	9.000	On	N	-0.1	13.4	56.0
0.511334	42.6	9.000	On	L1	0.0	13.4	56.0
0.515439	42.7	9.000	On	N	-0.1	13.3	56.0
0.524272	42.6	9.000	On	N	-0.1	13.4	56.0
0.529009	42.5	9.000	On	N	-0.1	13.5	56.0
0.544023	42.1	9.000	On	N	-0.1	13.9	56.0

Note: All data points are corrected for insertion loss.

2.5.2 Test Data Average Detector

Frequency (MHz)	Average (dB μ V)	Bandwidth (kHz)	Filter	Line	Corr. (dB)	Margin (dB)	Limit (dB μ V)
13.418489	41.3	9.000	On	L1	0.0	8.7	50.0
20.215076	13.7	9.000	On	L1	0.0	36.3	50.0
20.397741	17.9	9.000	On	L1	0.0	32.1	50.0
20.830404	12.7	9.000	On	L1	0.0	37.3	50.0
22.905251	10.1	9.000	On	L1	0.0	39.9	50.0
25.901600	16.4	9.000	On	L1	0.0	33.6	50.0
26.636721	19.0	9.000	On	L1	0.0	31.0	50.0

Note: All data points are corrected for insertion loss.

3.0 Peak Power Output

3.1 Test Standard

Test Requirement: FCC CFR47, Part 15, Subpart B 15.247(b); IC RSS-210 Issue 7, Section A8.4

Test Method: FCC CFR47, Part 15, Subpart B 15.247(b); "Measurement of Digital Transmission Systems Operating under Section 15.247 (March 23, 2005) KDB publication number #558074

1 (b) The maximum peak conducted output power of the intentional radiator shall not exceed the following:

(3) For systems using digital modulation in the 902-928 MHz, 2400-2483.5 MHz, and 5725-5850 MHz bands: 1 watt. As an alternative to a peak power measurement, compliance with the 1 watt limit can be based on a measurement of the maximum conducted output power. Maximum Conducted Output Power is defined as the total transmit power delivered to all antennas and antenna elements averaged across all symbols in the signaling alphabet when the transmitter is operating at its maximum power control level. Power must be summed across all antennas and antenna elements. The average must not include any time intervals during which the transmitter is off or is transmitting at a reduced power level. If multiple modes of operation are possible (e.g., alternative modulation methods), the maximum conducted output power is the highest total transmit power occurring in any mode.

(4) The conducted output power limit specified in Paragraph (b) of this section is based on the use of antennas with directional gains that do not exceed 6 dBi. Except as shown in Paragraph (c) of this section, if transmitting antennas of directional gain greater than 6 dBi are used, the conducted output power from the intentional radiator shall be reduced below the stated values in Paragraphs (b)(1), (b)(2), and (b)(3) of this section, as appropriate, by the amount in dB that the directional gain of the antenna exceeds 6 dBi.

(c) Operation with directional antenna gains greater than 6 dBi.

(1) Fixed point-to-point operation:

(ii) Systems operating in the 5725–5850 MHz band that are used exclusively for fixed, point-to-point operations may employ transmitting antennas with directional gain greater than 6 dBi without any corresponding reduction in transmitter conducted output power.

(iii) Fixed, point-to-point operation, as used in Paragraphs (c)(4)(i) and (c)(4)(ii) of this section, excludes the use of point-to-multipoint systems, omnidirectional applications, and multiple co-located intentional radiators transmitting the same information. The operator of the spread spectrum or digitally modulated intentional

radiator or, if the equipment is professionally installed, the installer is responsible for ensuring that the system is used exclusively for fixed, point-to-point operations. The instruction manual furnished with the intentional radiator shall contain language in the installation instructions informing the operator and the installer of this responsibility. |

3.2 Test Limits

When used exclusively for fixed, point-to-point operations in the 5.725-5.850 MHz band, the intentional radiator may employ transmitting antennas with directional gain greater than 6 dBi without any corresponding reduction in transmitter conducted output power. Therefore, the maximum peak power output of the intentional radiator shall be less than 1 watt (30 dBm).

3.3 Method of measurement

All test conditions and measurement procedures were performed in accordance with FCC CFR47, Part 15, Subpart B 15.247(b)(3) and Measurement of Digital Transmission Systems Operating under Section 15.247 (March 23, 2005) KDB publication number #558074

3.4 Test Setup

This test is performed conducted. The measurement equipment is connected directly to the antenna port of the EUT.

The test is performed at low (5727, 5730, and 5732 MHz), middle (5787.5 MHz) and high channels (5848, 5845, and 5843 MHz) in 3.5, 5, and 7 MHz bandwidths, correspondingly for the 5.8 GHz frequency band. Power is measured using the channel power measurement feature of the spectrum analyzer. Only worst case data for each bandwidth is shown below

3.4.1 Test Setup Block Diagram



3.5 Test Results

3.5MHz
Bandwidth

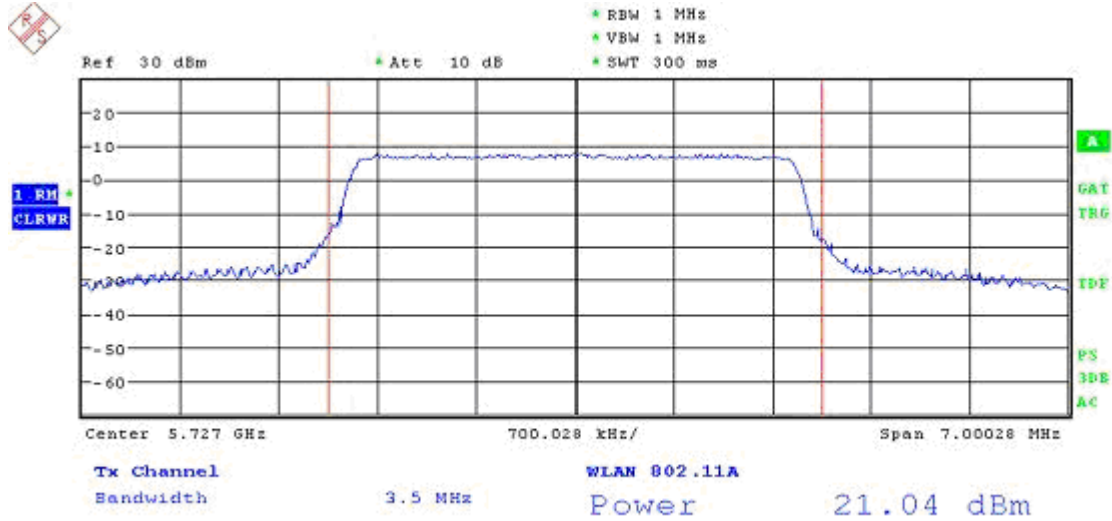

5MHz Bandwidth

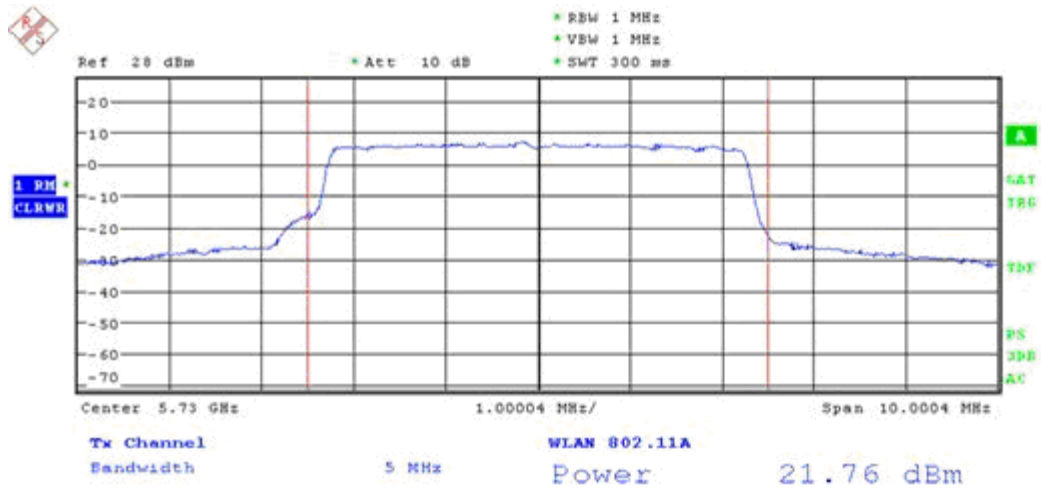

7MHz Bandwidth

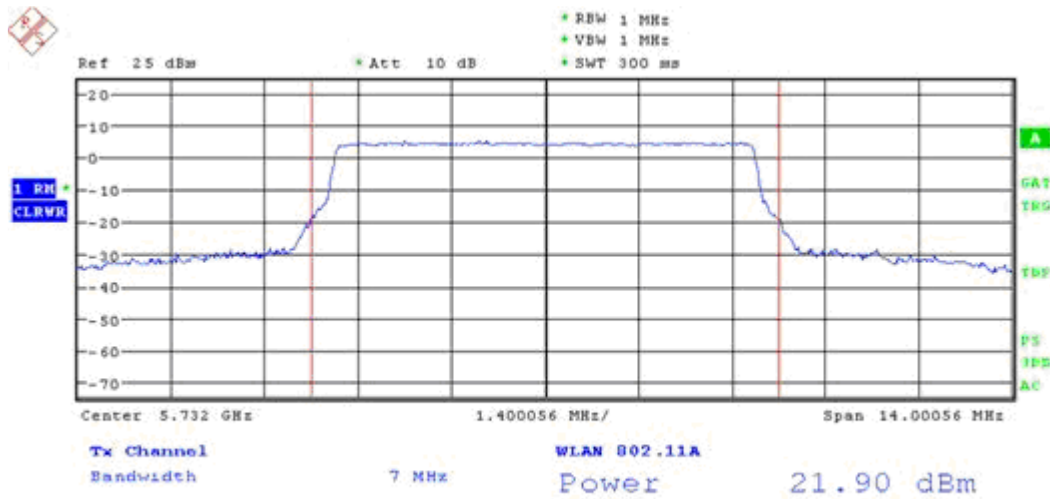

Mode OFDM/ Channel BW = 3.5MHz			
Frequency(MHz)	Measurement(dBm)	Limit	Result
5727	21.04	30	PASS
5787.5	20.69	30	PASS
5848	20.70	30	PASS

Mode OFDM/ Channel BW = 5MHz			
Frequency(MHz)	Measurement(dBm)	Limit	Result
5730	21.76	30	PASS
5787.5	21.45	30	PASS
5845	21.19	30	PASS

Mode OFDM/ Channel BW = 7MHz			
Frequency(MHz)	Measurement(dBm)	Limit	Result
5732	21.90	30	PASS
5787.5	21.66	30	PASS
5843	21.22	30	PASS

4.0 Radiated Emissions, General Requirements

4.1 Test Standard

Test Requirement: ANSI C63.4-2003 Clause 8.1; FCC CFR47, Part 15, Subpart C, 15.209 “Radiated Emission Limits, General Requirements”; IC RSS-210 Issue 7, Section 2.7

Test Method: ANSI C63.4-2003 Clause 8.3; CFR47, Part 15, Subpart C 15.247(b); “Measurement of Digital Transmission Systems Operating under Section 15.247 (March 23, 2005) KDB publication number #558074

l (a) Except as provided elsewhere in this subpart, the emissions from an intentional radiator shall not exceed the field strength levels specified in the following table:

<i>Frequency (MHz)</i>	<i>Field Strength (Microvolts/Meter)</i>	<i>Measurement Distance (Meters)</i>
0.009 - 0.490	2400/F(kHz)	300
0.490 - 1.705	24000/F(kHz)	30
1.705 - 30.0	30	30
30 - 88	100 **	3
88 - 216	150 **	3
216 - 960	200 **	3
Above 960	500	3

*** Except as provided in Paragraph (g), fundamental emissions from intentional radiators operating under this section shall not be located in the frequency bands 54-72 MHz, 76-88 MHz, 174-216 MHz or 470-806 MHz. However, operation within these frequency bands is permitted under other sections of this part, e.g., Sections 15.231 and 15.241.*

(b) In the emission table above, the tighter limit applies at the band edges.

(c) The level of any unwanted emissions from an intentional radiator operating under these general provisions shall not exceed the level of the fundamental emission. For intentional radiators which operate under the provisions of other sections within this part and which are required to reduce their unwanted emissions to the limits specified in this table, the limits in this table are based on the frequency of the unwanted emission and not the fundamental frequency. However, the level of any unwanted emissions shall not exceed the level of the fundamental frequency.

(d) The emission limits shown in the above table are based on measurements employing a CISPR quasi-peak detector except for the frequency bands 9-90 kHz,

110-490 kHz and above 1000 MHz. Radiated emission limits in these three bands are based on measurements employing an average detector. †

4.2 Test Limits

Frequency (MHz)	Maximum Field Strength (uV/m @ 3m)	Maximum Field Strength (dBuV/m @ 3m)
30-88	100	40.0
88-216	150	43.5
216-960	200	46.0
960-1000	500	54.0

4.3 Method of measurements

All test conditions and measurement procedures were performed in accordance with ANSI C63.4-2003 Clause 8.3; FCC CFR47, Part 15, Subpart C, 15.209.

4.4 Test Setup

All sample units were tested. The Libra MAX-SS 5X00e was tested with Dish and Grid antennae. The EUT was exercised using beaconing mode at the highest possible transmit rate. The test is performed at low (5727, 5730, and 5732 MHz), middle (5787.5 MHz) and high channels (5848, 5845, and 5843 MHz) in 3.5, 5, and 7 MHz bandwidths, correspondingly for the 5.8 GHz frequency band. The MAX-SS 5X00e is connected to the external antenna via 1m of coaxial shielded cable. Only worst case data is shown below.

Note: For testing purposes and to ensure worst case performance in all testing configurations, the radio is configured to transmit at the maximum possible RF power.

4.4.1 Test Setup Block Diagram

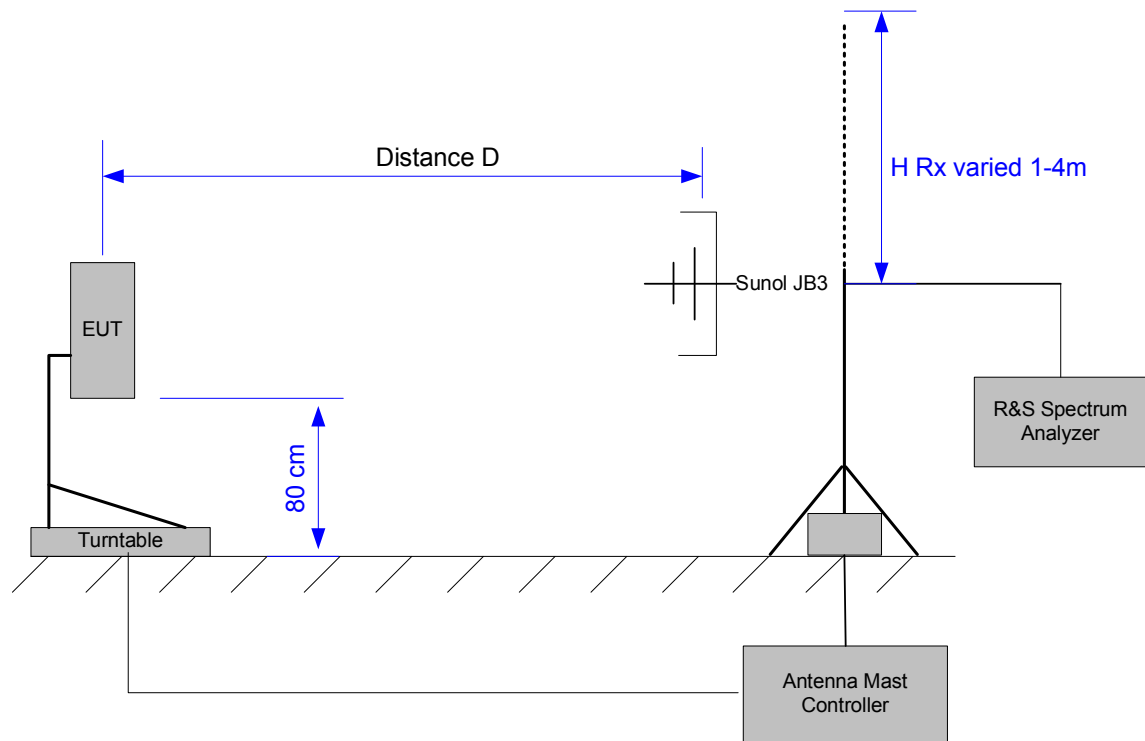

Note: Measurements below 1 GHz were performed with the Sunol JB3 antenna with a measurement distance of 3 m. Compliance above 1 GHz is covered in Section 5.0.

4.5 Test Results

4.5.1 32 dBi Dish antenna

Frequency (MHz)	QuasiPeak (dB μ V/m)	Bandwidth (kHz)	Antenna height (cm)	Polarity	Turntable position (deg)	Corr. (dB)	Margin (dB)	Limit (dB μ V/m)
77.200000	37.8	120.000	105.0	V	192.0	8.9	2.2	40.0
880.00000	38.5	120.000	105.0	V	271.0	24.3	7.5	46.0
770.00000	37.7	120.000	105.0	H	90.0	23.8	8.3	46.0
92.400000	35.2	120.000	148.0	V	180.0	10.5	8.3	43.5
594.00000	35.8	120.000	162.0	H	102.0	21.2	10.2	46.0
660.00000	35.2	120.000	105.0	H	12.0	22.2	10.8	46.0
550.00000	35.1	120.000	112.0	H	102.0	20.6	10.9	46.0
220.00000	35.0	120.000	155.0	V	192.0	12.9	11.0	46.0
450.00000	35.0	120.000	155.0	H	270.0	18.8	11.0	46.0
825.20000	31.8	120.000	112.0	H	102.0	24.4	14.2	46.0

Note: All data points are corrected for insertion loss.

4.5.2 26 dBi Grid antenna

Frequency (MHz)	QuasiPeak (dB μ V/m)	Bandwidth (kHz)	Antenna height (cm)	Polarity	Turntable position (deg)	Corr. (dB)	Margin (dB)	Limit (dB μ V/m)
77.2000	36.5	120.000	100.0	V	105.0	8.9	4.0	40.5
92.4000	34.1	120.000	165.0	V	195.0	10.5	6.4	40.5
98.4800	33.2	120.000	115.0	V	-13.0	12.1	7.3	40.5
198.000	32.7	120.000	100.0	V	-13.0	13.6	7.8	40.5
220.000	30.8	120.000	100.0	V	-12.0	12.9	9.7	40.5
475.000	34.1	120.000	100.0	V	-12.0	19.4	13.4	47.5
605.000	39.9	120.000	145.0	H	78.0	21.3	7.6	47.5
627.000	40.4	120.000	145.0	H	105.0	22.0	7.1	47.5
935.000	41.8	120.000	215.0	H	168.0	25.4	5.7	47.5
990.000	40.9	120.000	195.0	H	166.0	26.3	6.6	47.5

Note: All data points are corrected for insertion loss.

4.5.3 24 dBi Integrated antenna

Frequency (MHz)	QuasiPeak (dB μ V/m)	Bandwidth (kHz)	Antenna height (cm)	Polarity	Turntable position (deg)	Corr. (dB)	Margin (dB)	Limit (dB μ V/m)
77.20000	36.1	120.000	115.0	V	256.0	9.0	4.4	40.5
605.0000	42.7	120.000	100.0	V	181.0	21.0	4.8	47.5
85.48000	34.8	120.000	115.0	V	195.0	9.9	5.7	40.5
989.9600	41.6	120.000	100.0	V	181.0	25.6	5.9	47.5
98.48000	34.3	120.000	115.0	V	167.0	12.3	6.2	40.5
880.0000	40.1	120.000	195.0	H	180.0	24.7	7.4	47.5
627.0000	39.9	120.000	100.0	V	181.0	21.6	7.6	47.5
715.0000	37.4	120.000	115.0	H	105.0	22.7	10.1	47.5
825.0000	37.2	120.000	105.0	H	256.0	24.4	10.3	47.5
220.0000	29.6	120.000	100.0	V	15.0	13.0	10.9	40.5

Note: All data points are corrected for insertion loss.

The data above is for 3.5 MHz bandwidth at channel 5727 MHz which is the worst case configuration.

5.0 Harmonic and Spurious Emissions

5.1 Test Standard

Test Requirement: ANSI C63.4-2003 Clause 8.1; FCC CFR 47, Part 15, Subpart B 15.247d; IC RSS-210 Issue 7, A8.5

Test Method: ANSI C63.4-2003 Clause 8.3; FCC CFR 47, Part 15, Subpart C Section 15.247(d)

l (d) In any 100 kHz bandwidth outside the frequency band in which the spread spectrum or digitally modulated intentional radiator is operating, the radio frequency power that is produced by the intentional radiator shall be at least 20 dB below that in the 100 kHz bandwidth within the band that contains the highest level of the desired power, based on either an RF conducted or a radiated measurement, provided the transmitter demonstrates compliance with the peak conducted power limits. If the transmitter complies with the conducted power limits based on the use of RMS averaging over a time interval, as permitted under Paragraph (b)(3) of this section, the attenuation required under this paragraph shall be 30 dB instead of 20 dB. Attenuation below the general limits specified in Section 15.209(a) is not required. In addition, radiated emissions which fall in the restricted bands, as defined in Section 15.205(a), must also comply with the radiated emission limits specified in Section 15.209(a) (see Section 15.205(c)). l

5.2 Test Limits

5725-5850 MHz limits:

Fundamental Limit = 30 dBm

Harmonics and Spurious Emissions = 30 dBc

Restricted Band Emissions = AVG 54 dBuV, PK 74dBuV

5.3 Method of measurements

All test conditions and measurement procedures were performed in accordance with ANSI C63.4-2003 Clause 8.3; FCC CFR47, Part 15, Subpart B 15.247d.

5.4 Test Setup – Spurious Emissions

Both radiated and conducted measurements are made on the EUT to ensure compliance with the required emission levels. Conducted scans are used to determine compliance with the 30 dBc limit for emissions outside of the operational frequency band.

In addition to conducted measurements, extensive radiated testing above 1 GHz is performed. The measurement antenna is scanned around all sides of the EUT to identify signals of interest. Additional measurements at an appropriate measurement distance are performed to ensure that emissions were at maximum.

All units were tested. The MAX-SS 5X00e was tested with Grid and Dish antennae. The EUT was exercised using beaconing mode at the highest possible transmit rate. The test is performed at low (5727, 5730, and 5732 MHz), middle (5787.5 MHz) and high channels (5848, 5845, and 5843 MHz) in 3.5, 5, and 7 MHz bandwidths, correspondingly for the 5.8 GHz frequency band. Only worst case data is shown below.

The antenna is connected to the EUT equipped with a Type N connector via 1 m of coaxial shielded cable.

Note: For testing purposes only, to ensure worst case performance in all configurations, the radio is configured to transmit at the maximum possible RF power.

5.4.1 Test Setup Block Diagram – Conducted Measurements (Harmonics)

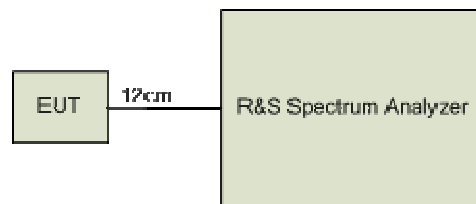

5.4.2 Test Setup Block Diagram – Radiated Measurements (Spurious)

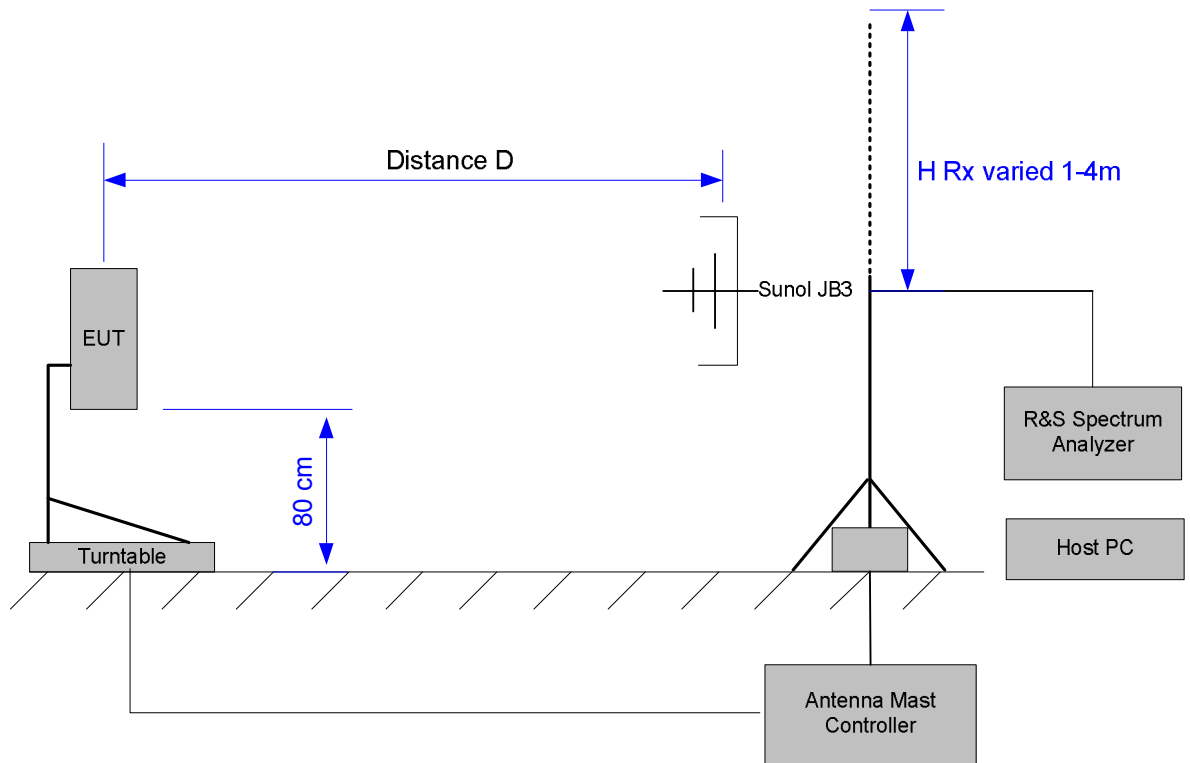

5.5 Test Results

5.5.1 Test Results 15.247-Harmonics -30 dBc

3.5MHz Bandwidth

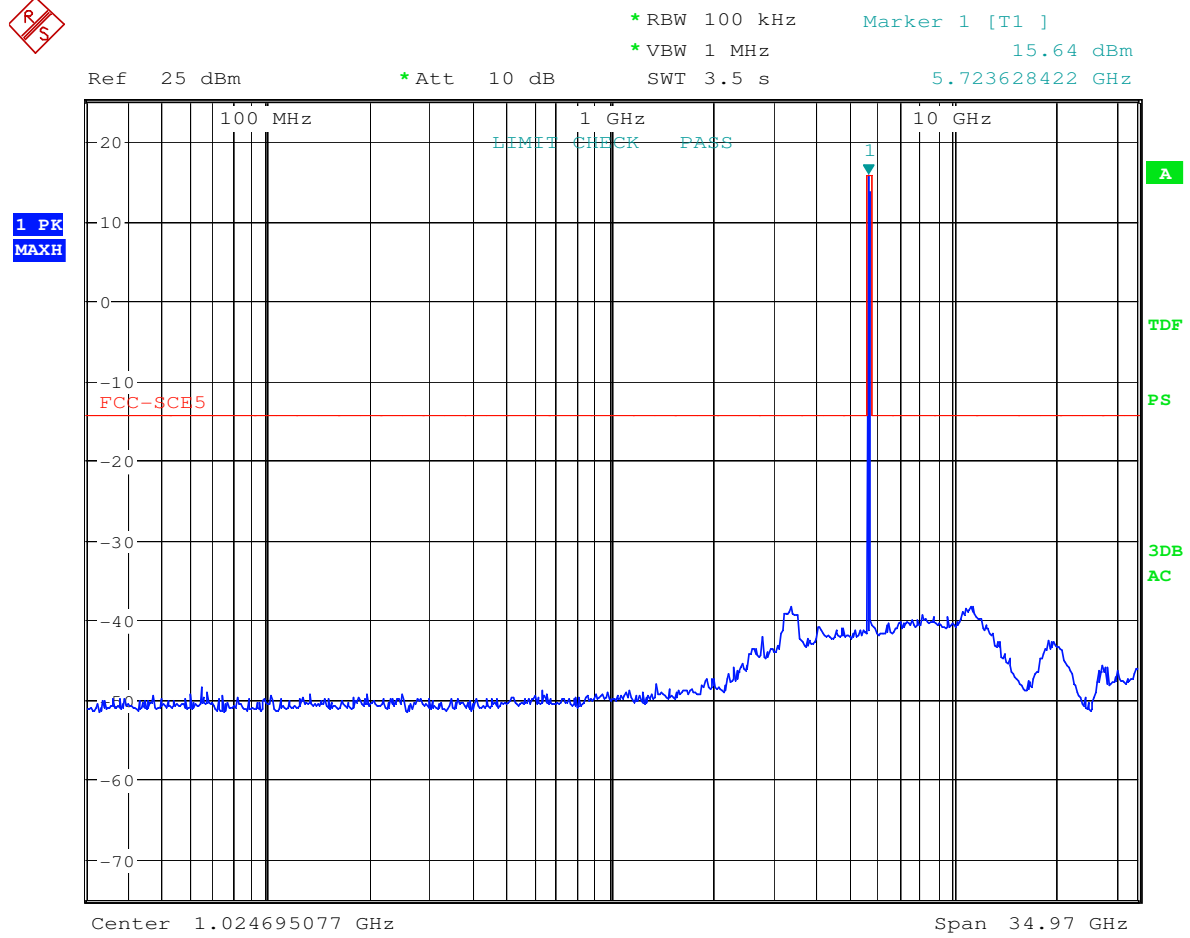

Date: 17.MAR.2008 12:12:46

5MHz Bandwidth

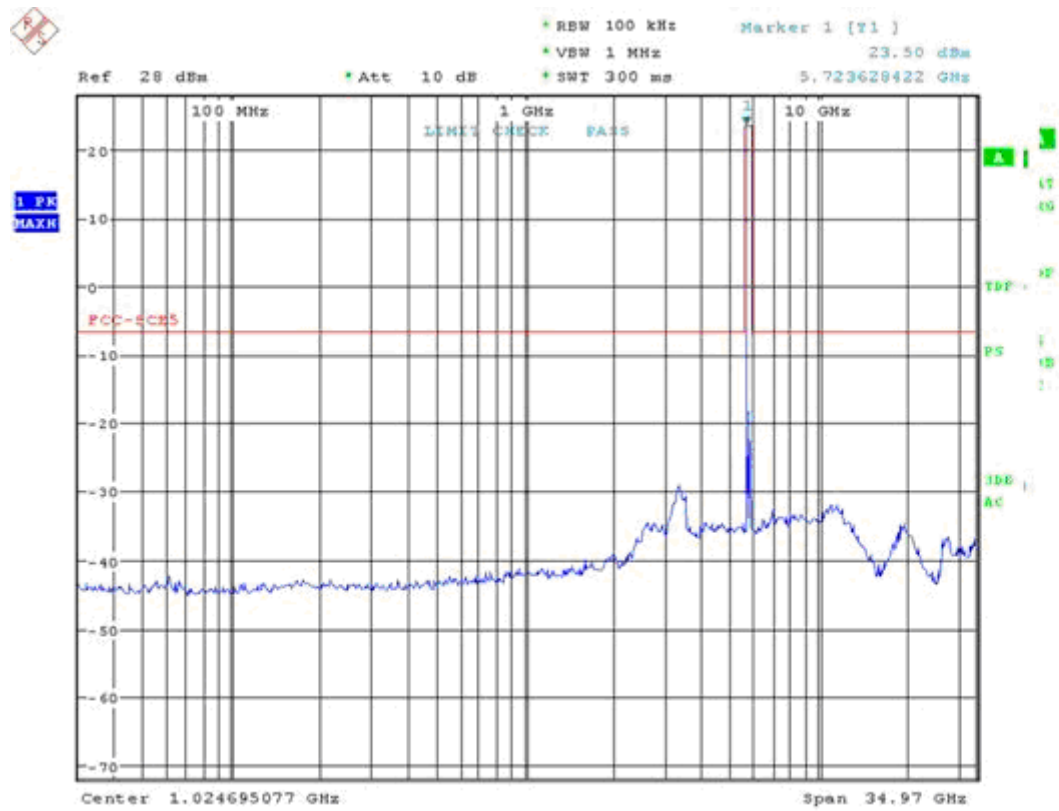

7MHz Bandwidth

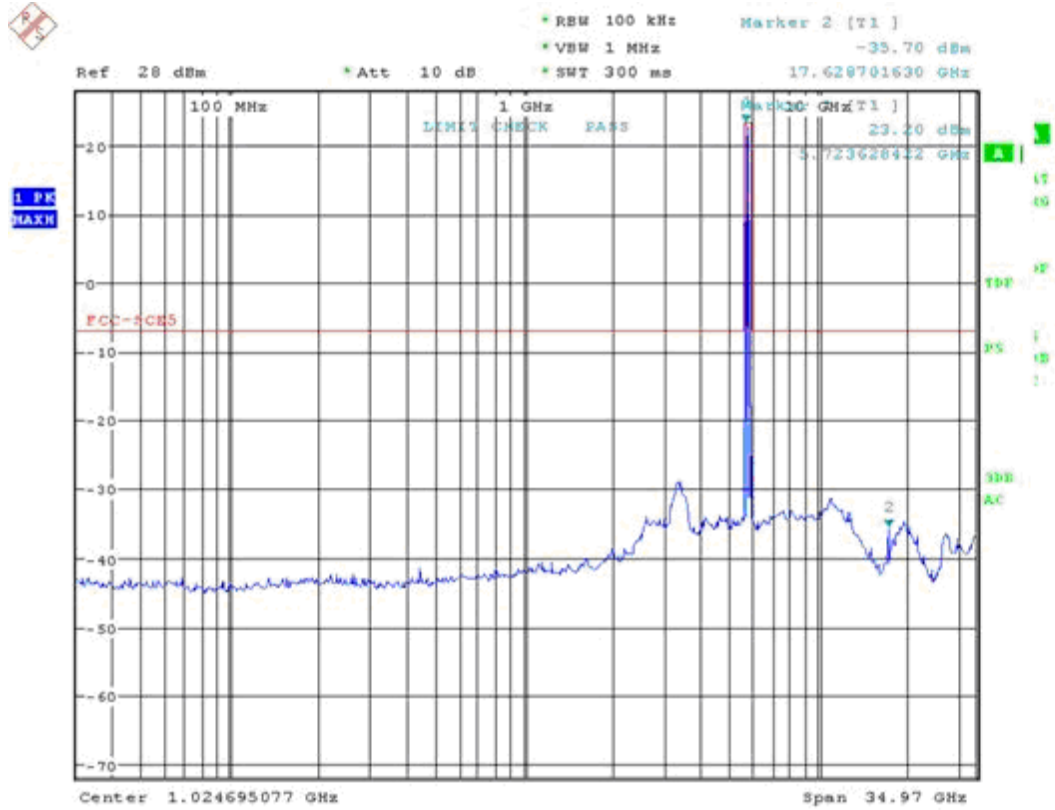

The above plot shows the worst case conducted output of the transmitter. It should be noted that the EUT is not transmitting on two channels simultaneously. All conducted harmonics are at least 30 dBc.

5.5.2 Test Results 15.247– Restricted Bands (Spurious Emissions)

The following data was measured at a distance of 3 m. Data is presented for the worst case antenna configuration.

External 32 dBi 5.8 GHz Dish Antenna					
Frequency (MHz)	Reading Type	Reading (dBuV/m@3m)	Limit (dBuV/m)	Margin (dB)	Result
11575.6	Peak	71.9	74.0	2.10	Pass
11576.0	Average	53.0	54.0	1.00	Pass

External 26 dBi 5.8 GHz Grid Antenna					
Frequency (MHz)	Reading Type	Reading (dBuV/m@3m)	Limit (dBuV/m)	Margin (dB)	Result
11575.6	Peak	73.2	74.0	0.80	Pass
11576.0	Average	53.5	54.0	0.50	Pass

External 24 dBi 5.8 GHz Integrated antenna					
Frequency (MHz)	Reading Type	Reading (dBuV/m@3m)	Limit (dBuV/m)	Margin (dB)	Result
11443.2	Peak	70.5	74.0	3.50	Pass
14443.8	Average	42.1	54.0	11.9	Pass

No other emissions were detected within 30 dB of the limit.

6.0 Band Edge

6.1 Test Standard

Test Requirement: FCC CFR 47, Part 15, Subpart B 15.247d; IC RSS-210 Issue 7, A8.5

Test Method: FCC CFR 47, Part 15, Subpart C 15.209a; “Measurement of Digital Transmission Systems Operating under Section 15.247 (March 23, 2005) KDB publication number #558074

l (d) In any 100 kHz bandwidth outside the frequency band in which the spread spectrum or digitally modulated intentional radiator is operating, the radio frequency power that is produced by the intentional radiator shall be at least 20 dB below that in the 100 kHz bandwidth within the band that contains the highest level of the desired power, based on either an RF conducted or a radiated measurement, provided the transmitter demonstrates compliance with the peak conducted power limits. If the transmitter complies with the conducted power limits based on the use of RMS averaging over a time interval, as permitted under Paragraph (b)(3) of this section, the attenuation required under this paragraph shall be 30 dB instead of 20 dB. Attenuation below the general limits specified in Section 15.209(a) is not required. In addition, radiated emissions which fall in the restricted bands, as defined in Section 15.205(a), must also comply with the radiated emission limits specified in Section 15.209(a) (see Section 15.205(c)). l

6.2 Test Limits

In any 100 kHz bandwidth outside the frequency band in which the spread spectrum intentional radiator is operating, the radio frequency power that is produced by the intentional radiator shall be at least 30 dB below that in the 100 kHz bandwidth within the band that contains the highest level of the desired power, based on either an RF conducted or a radiated measurement. Attenuation below the general limits specified in Section 15.209(a) is not required. In addition, radiated emissions which fall in the restricted bands, as defined in Section 15.205(a), must also comply with the radiated emission limits specified in Section 15.209(a). (See Section 15.205(c).)

6.3 Method of measurements

All test conditions and measurement procedures were performed in accordance with FCC CFR 47, Part 15, Subpart B 15.247d; “Measurement of Digital Transmission Systems Operating under Section 15.247 (March 23, 2005) KDB publication number #558074

6.4 Test Setup

Conducted measurements are made on the EUT to ensure compliance with the required emission levels.

The test is performed at low and high channels in 3.5, 5, and 7 MHz bandwidth. Compliance in the 5725-5850 MHz band is established through conducted measurements. Please note that in the following plots the EUT is not transmitting on two channels simultaneously.

6.4.1 Test Setup Block Diagram – Conducted Measurements)

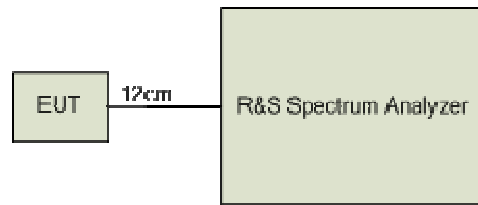

6.4.2 Test Setup Block Diagram – Radiated Measurements

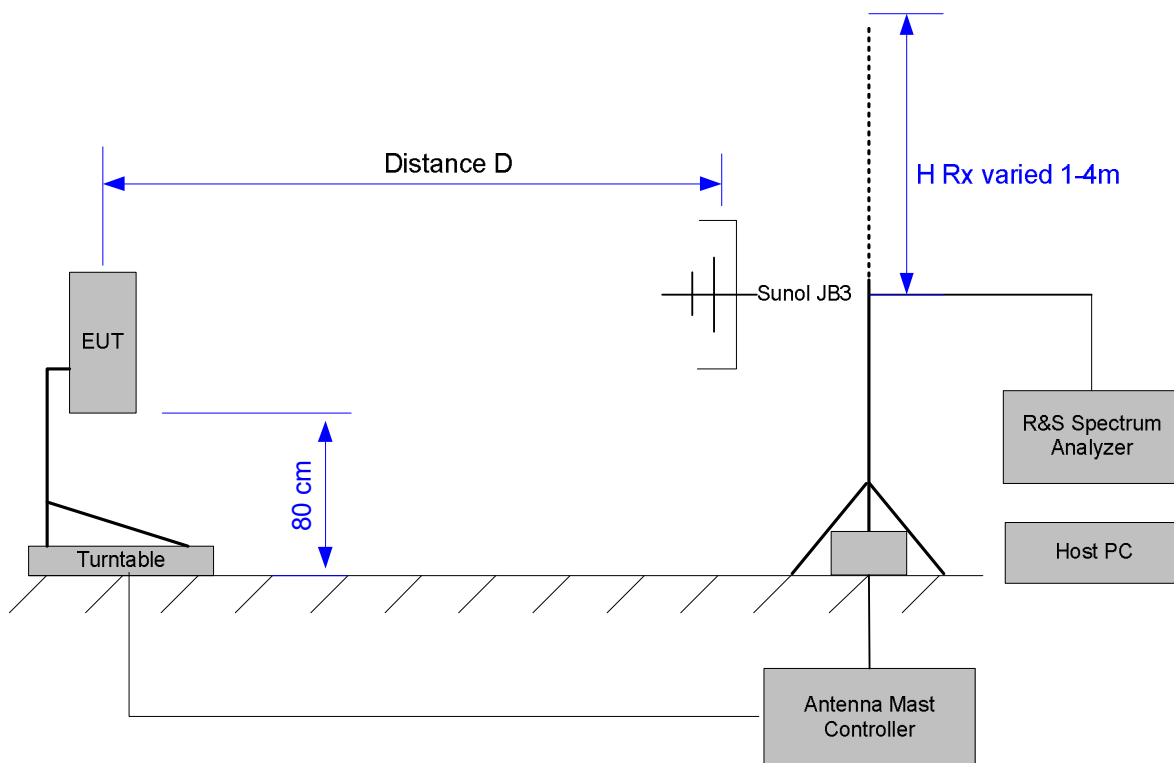

6.5 Test Results, 5725-5850 MHz, Conducted Measurements

3.5MHz Bandwidth

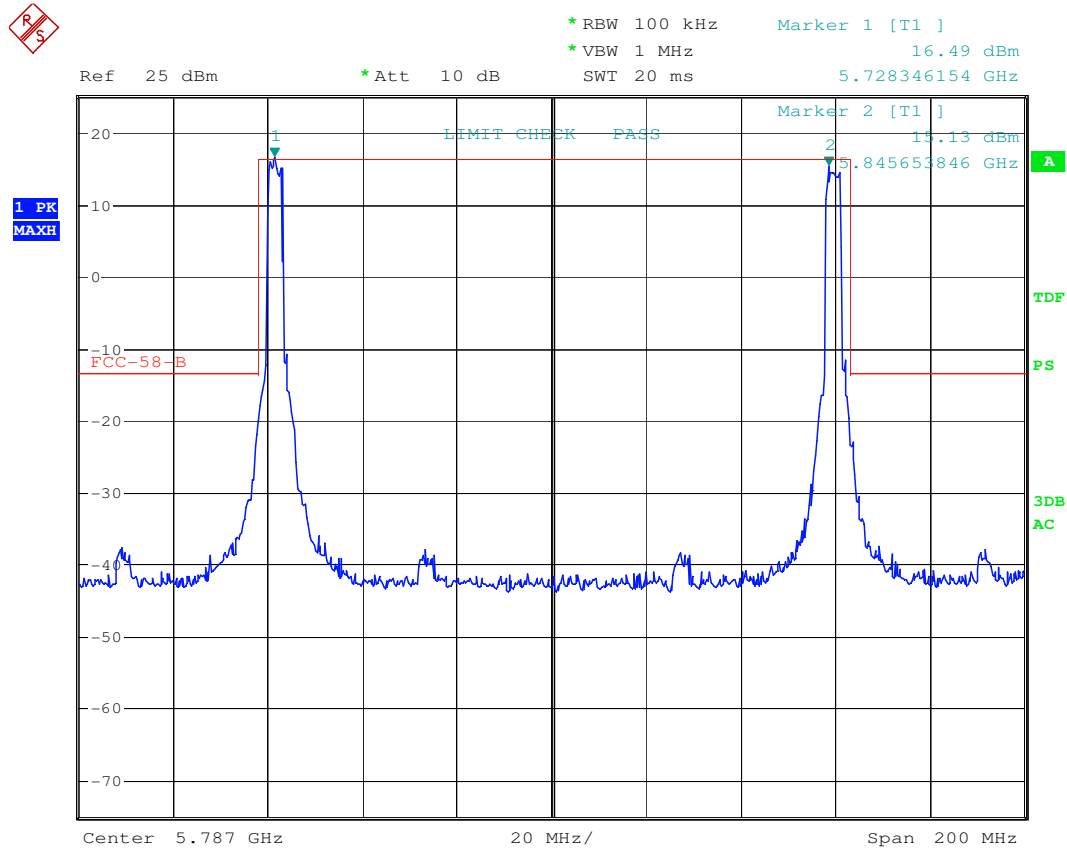

Date: 17.MAR.2008 12:26:32

5MHz Bandwidth

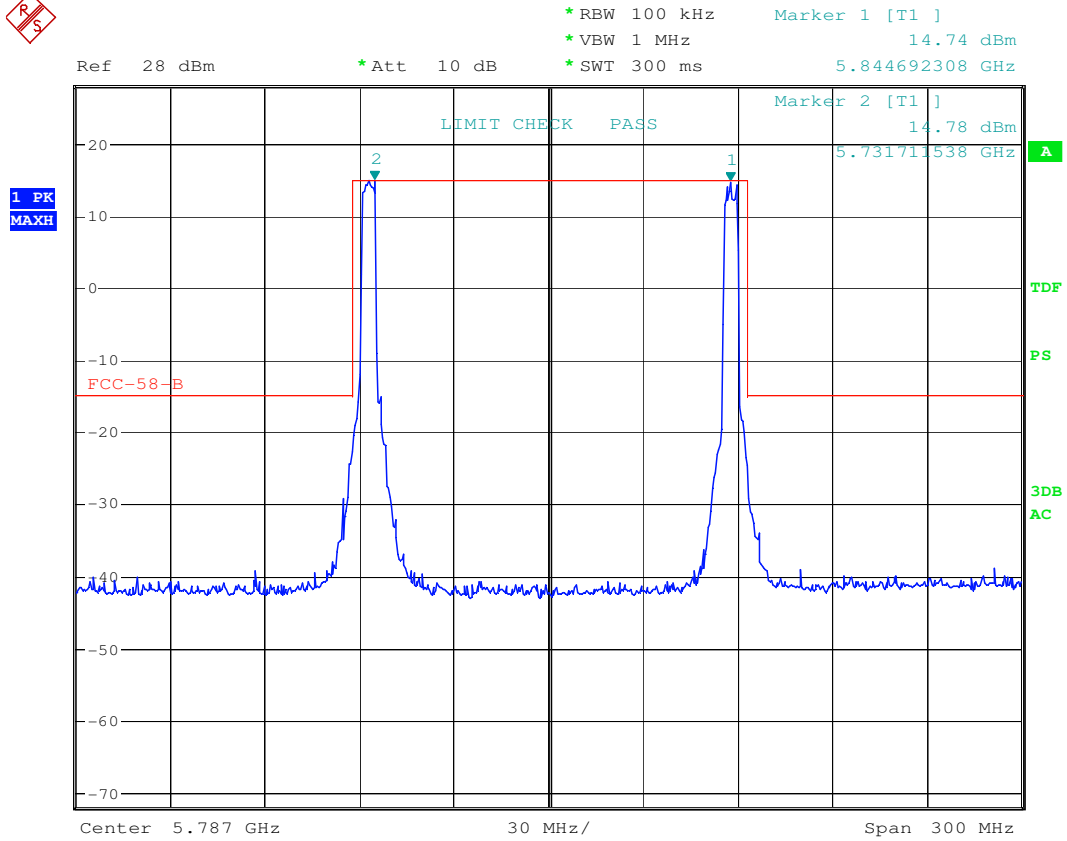

Date: 17.MAR.2008 13:44:09

7MHz Bandwidth

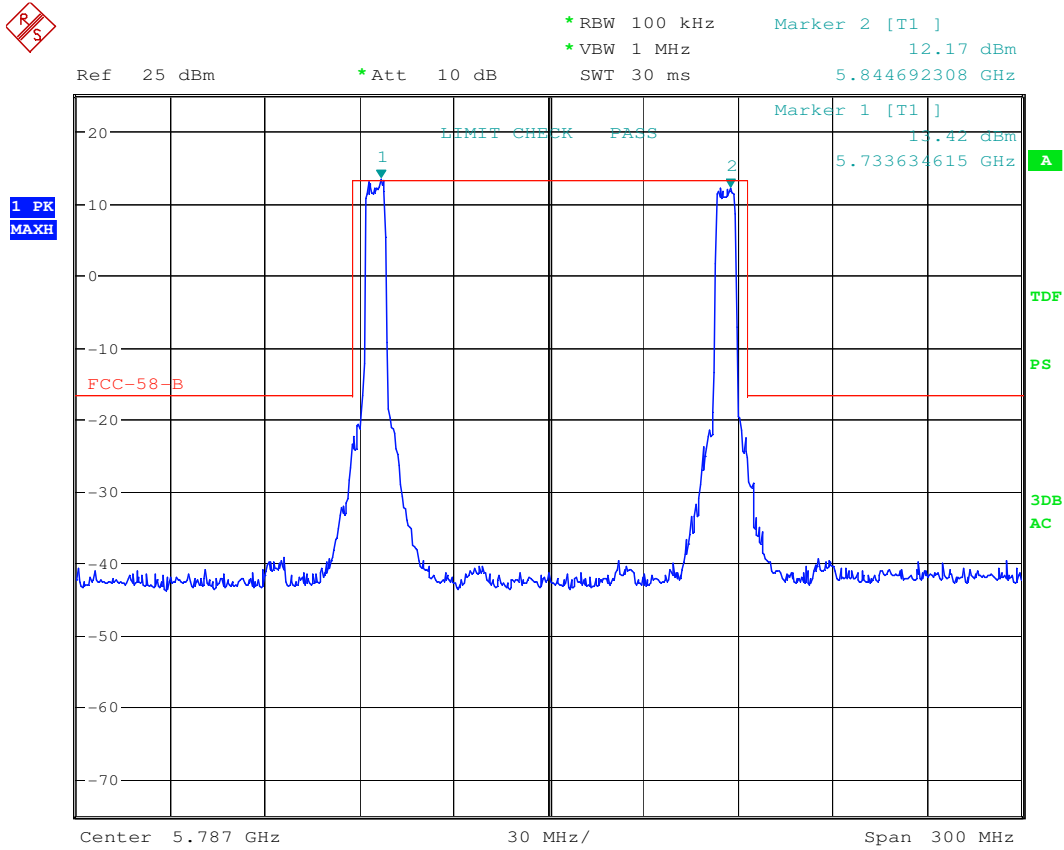

Date: 17.MAR.2008 12:54:54

All emissions outside of the 5725-5850 MHz frequency band are attenuated by at least 30 dB.

7.0 Occupied Bandwidth

7.1 Test Standard

Test Requirement: FCC CFR47, Part 15, Subpart B 15.247a; IC RSS-210 Issue 7, Section A8.2

Test Method: FCC CFR47, Part 15, Subpart B 15.247a; "Measurement of Digital Transmission Systems Operating under Section 15.247 (March 23, 2005) KDB publication number #558074

1 (a) Operation under the provisions of this section is limited to frequency hopping and digitally modulated intentional radiators that comply with the following provisions:

(2) Systems using digital modulation techniques may operate in the 902 - 928 MHz, 2400 - 2483.5 MHz, and 5725 - 5850 MHz bands. The minimum 6 dB bandwidth shall be at least 500 kHz. 1

7.2 Test Limits

The minimum 6 dB bandwidth shall be at least 500 kHz.

7.3 Method of measurements

All test conditions and measurement procedures were performed in accordance with. FCC CFR47, Part 15, Subpart B 15.247a; "Measurement of Digital Transmission Systems Operating under Section 15.247 (March 23, 2005) KDB publication number #558074.

7.4 Test Setup

This test is performed conducted. The measurement equipment is connected directly to the antenna port of the EUT.

The test is performed at low (5727, 5730, and 5732 MHz), middle (5787.5 MHz) and high channels (5848, 5845, and 5843 MHz) in 3.5, 5, and 7 MHz bandwidths, correspondingly for the 5.8 GHz frequency band.

7.4.1 Test Setup Block Diagram

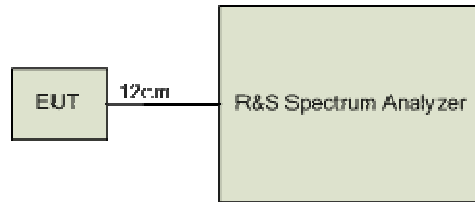

7.5 Test Results, 6 dB Occupied Bandwidth

3.5MHz Bandwidth

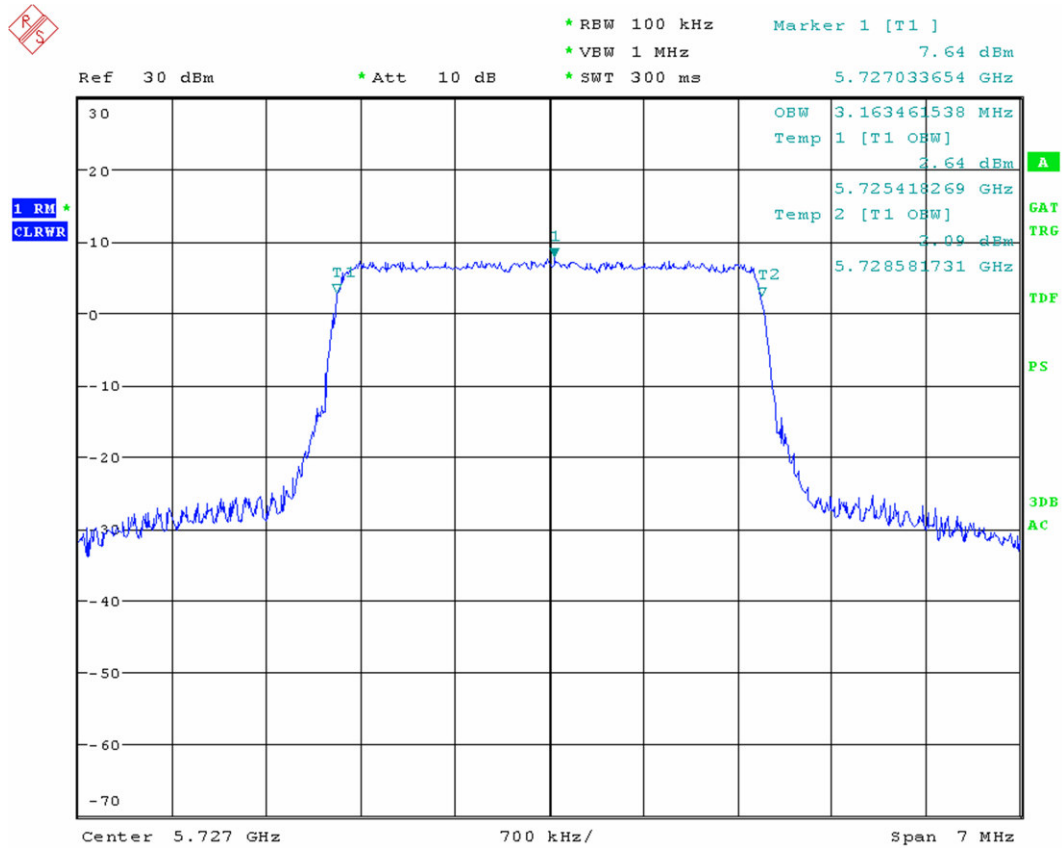

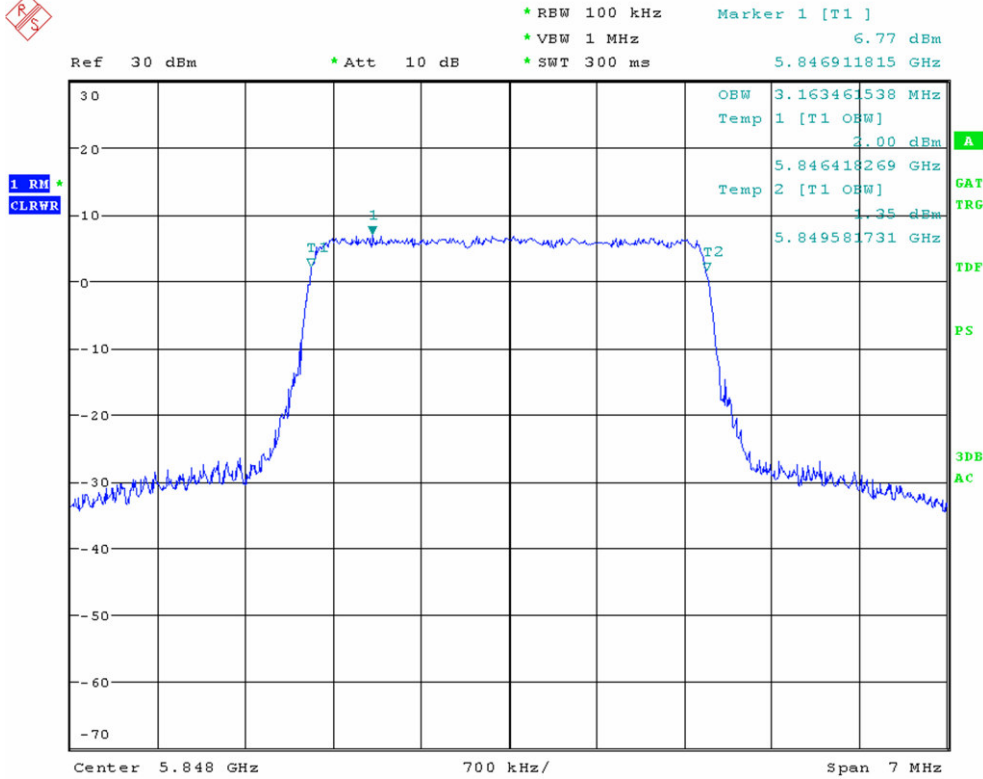
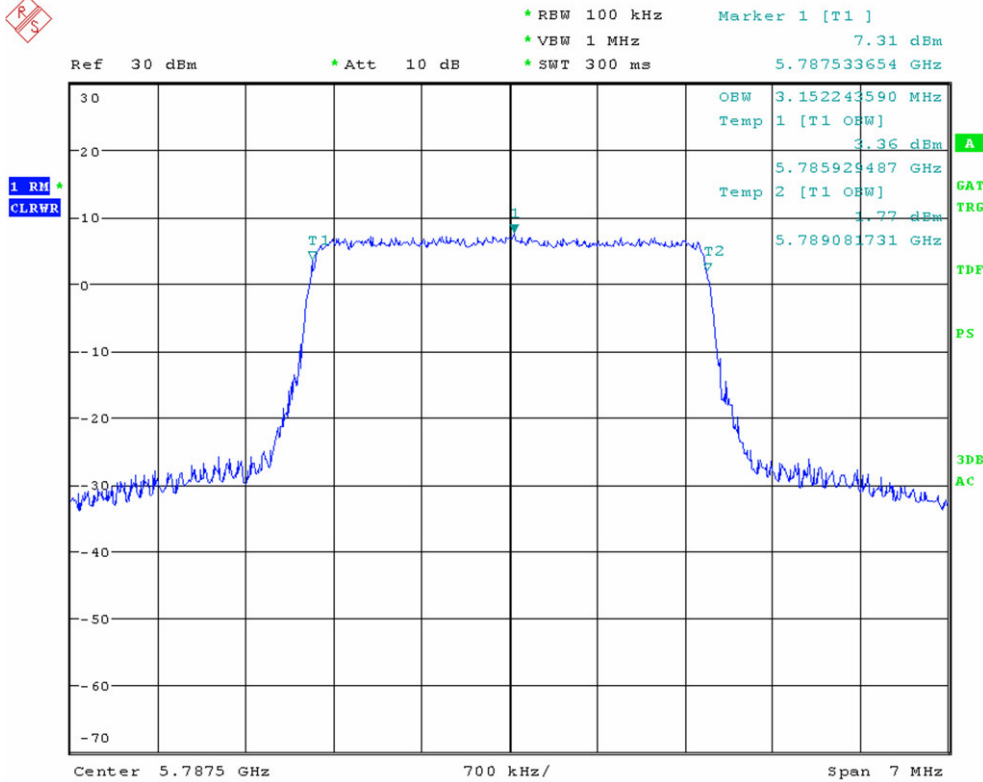

5MHz Bandwidth

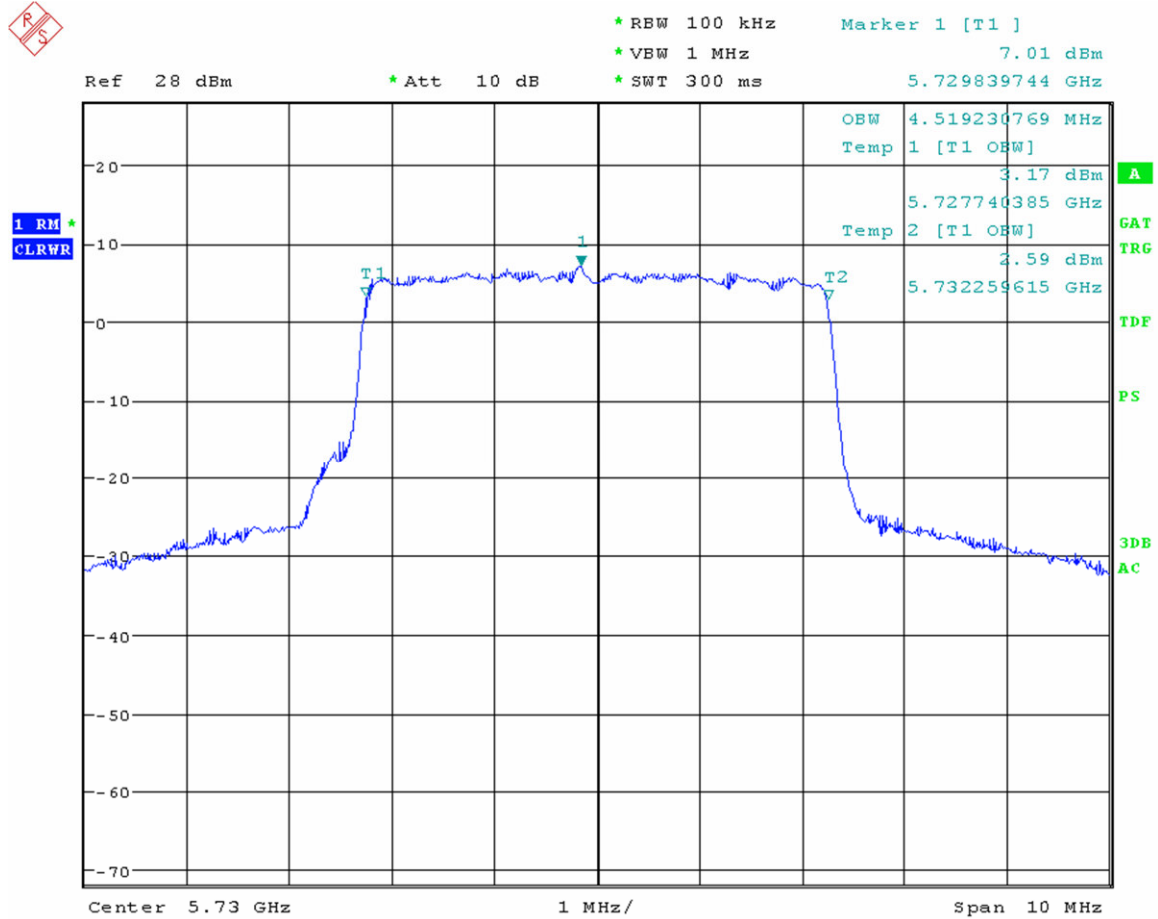



* RBW 100 kHz Marker 1 [T1]
* VBW 1 MHz 7.03 dBm
* SWT 300 ms 5.787323718 GHz

Ref 28 dBm

* Att 10 dB

1 RM *
CLRWR

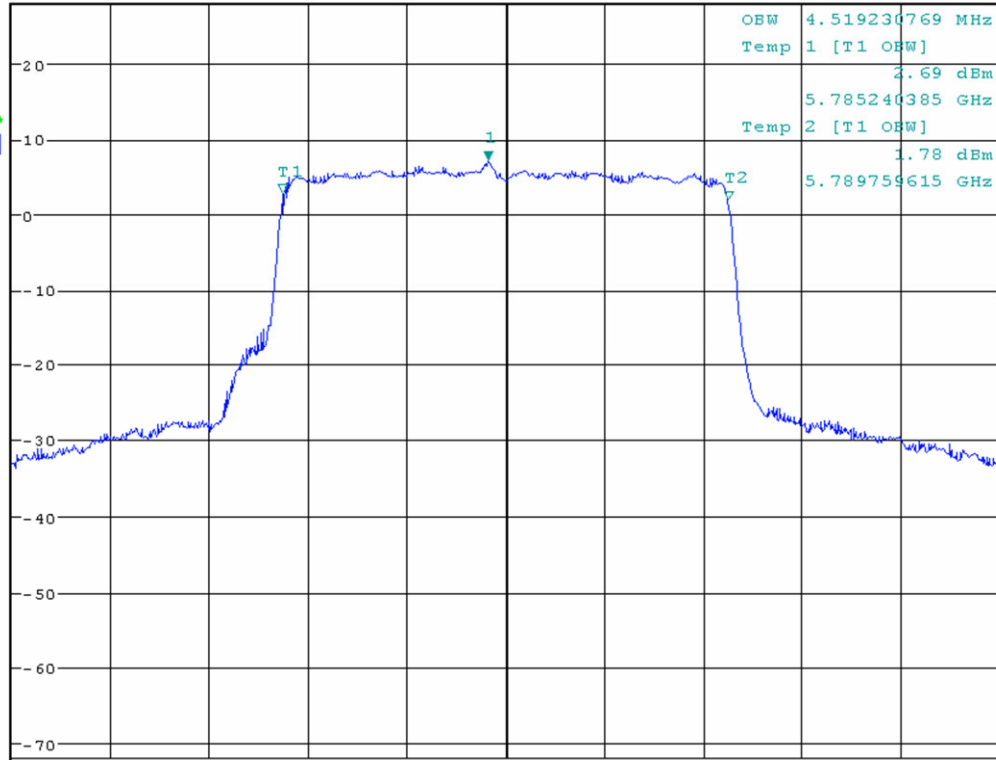

Center 5.7875 GHz

1 MHz/

Span 10 MHz

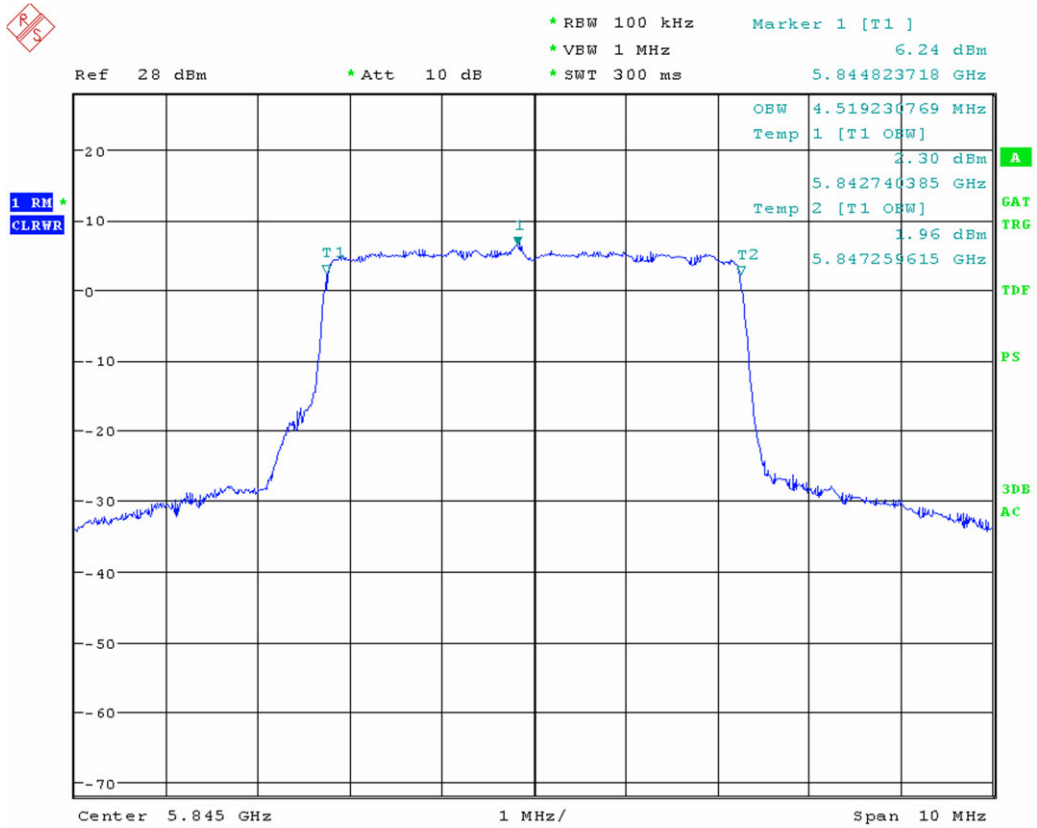

7MHz Bandwidth

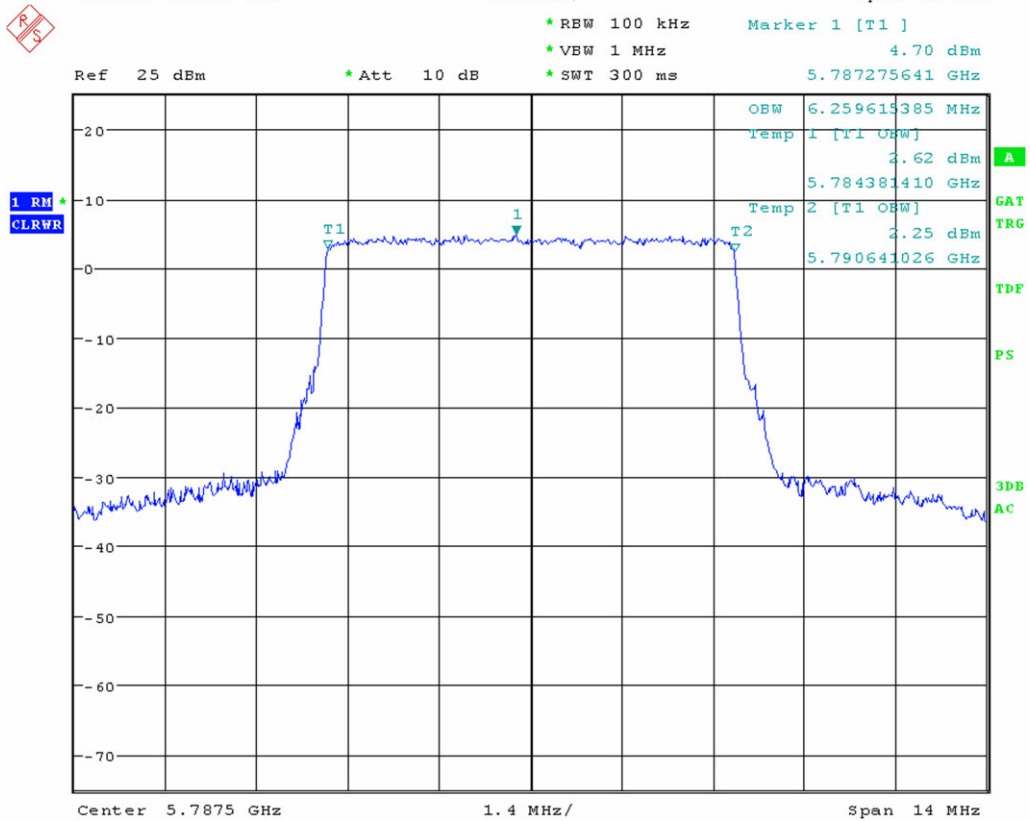
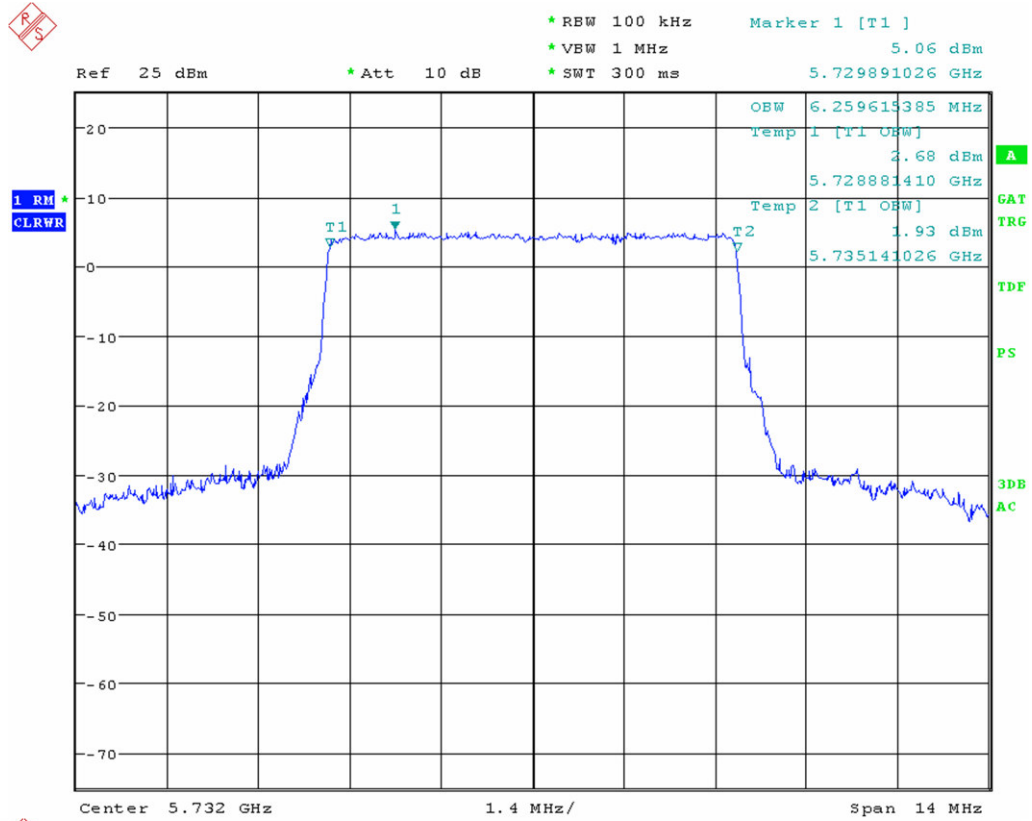

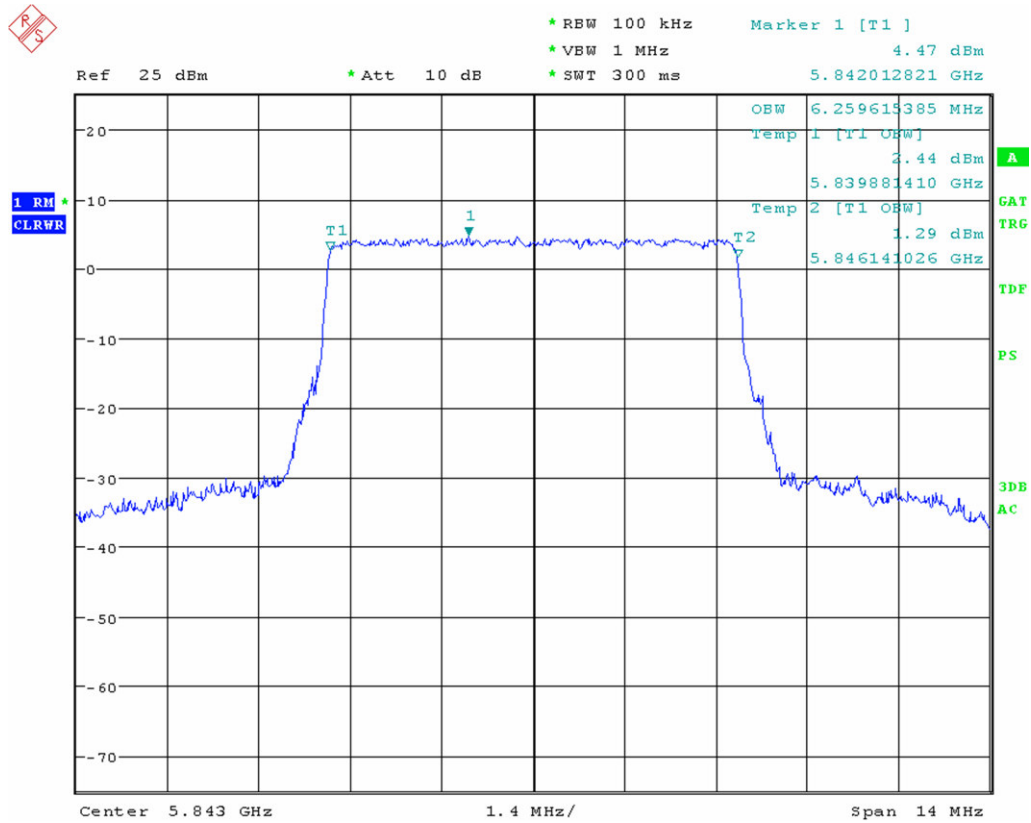

7.5.4 Data Table – Occupied Bandwidth

Mode OFDM/ Channel BW = 7MHz			
Frequency(MHz)	Occupied Bandwidth(MHz)	Limit	Result
5732	6.26	0.5	PASS
5787.5	6.26	0.5	PASS
5843	6.26	0.5	PASS

Mode OFDM/ Channel BW = 5MHz			
Frequency(MHz)	Occupied Bandwidth(MHz)	Limit	Result
5730	4.52	0.5	PASS
5787.5	4.52	0.5	PASS
5845	4.52	0.5	PASS

Mode OFDM Channel BW = 3.5MHz			
Frequency(MHz)	Occupied Bandwidth(MHz)	Limit	Result
5727	3.16	0.5	PASS
5787.5	3.16	0.5	PASS
5848	3.16	0.5	PASS

8.0 Power Spectral Density

8.1 Test Standard

Test Requirement: FCC CFR 47, Part 15, Subpart B 15.247e; IC RSS-210 Issue 7, Section A8.2

Test Method: FCC CFR47, Part 15, Subpart C 15.247d; "Measurement of Digital Transmission Systems Operating under Section 15.247 (March 23, 2005) KDB publication number #558074

FCC CFR 47, Part 15, Subpart B 15.247e \ IC RSS-210 Issue 7, Section A8.2

(e) For digitally modulated systems, the power spectral density conducted from the intentional radiator to the antenna shall not be greater than 8 dBm in any 3 kHz band during any time interval of continuous transmission. This power spectral density shall be determined in accordance with the provisions of Paragraph (b) of this section. The same method of determining the conducted output power shall be used to determine the power spectral density. |

8.2 Test Limits

The transmitted power density shall not be greater than 8 dBm in any 3 kHz band during any time interval of continuous transmission.

8.3 Method of measurements

All test conditions and measurement procedures were performed in accordance with. FCC CFR47, Part 15, Subpart B 15.247e ; "Measurement of Digital Transmission Systems Operating under Section 15.247 (March 23, 2005) KDB publication number #558074.

8.4 Test Setup

This test is performed conducted. The measurement equipment is connected directly to the antenna port of the EUT.

The test is performed at low (5727, 5730, and 5732 MHz), middle (5787.5 MHz) and high channels (5848, 5845, and 5843 MHz) in 3.5, 5, and 7 MHz bandwidths, correspondingly for the 5.8 GHz frequency band. Only worst case data in each bandwidth is shown below.

8.4.1 Test Setup Block Diagram

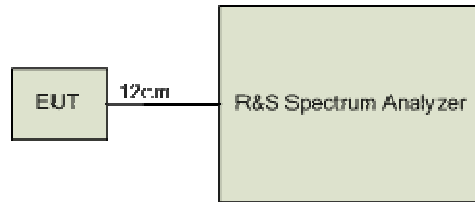

8.5 Test Results, Power Spectral Density

3.5MHz Bandwidth

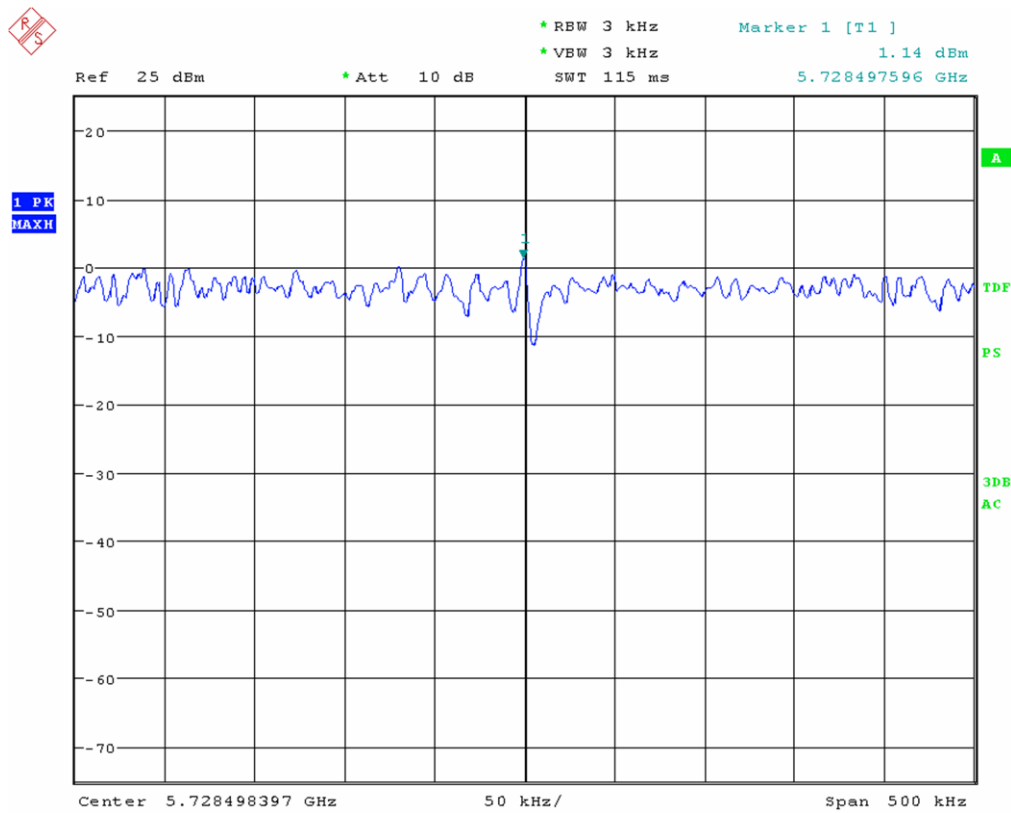

5MHz Bandwidth

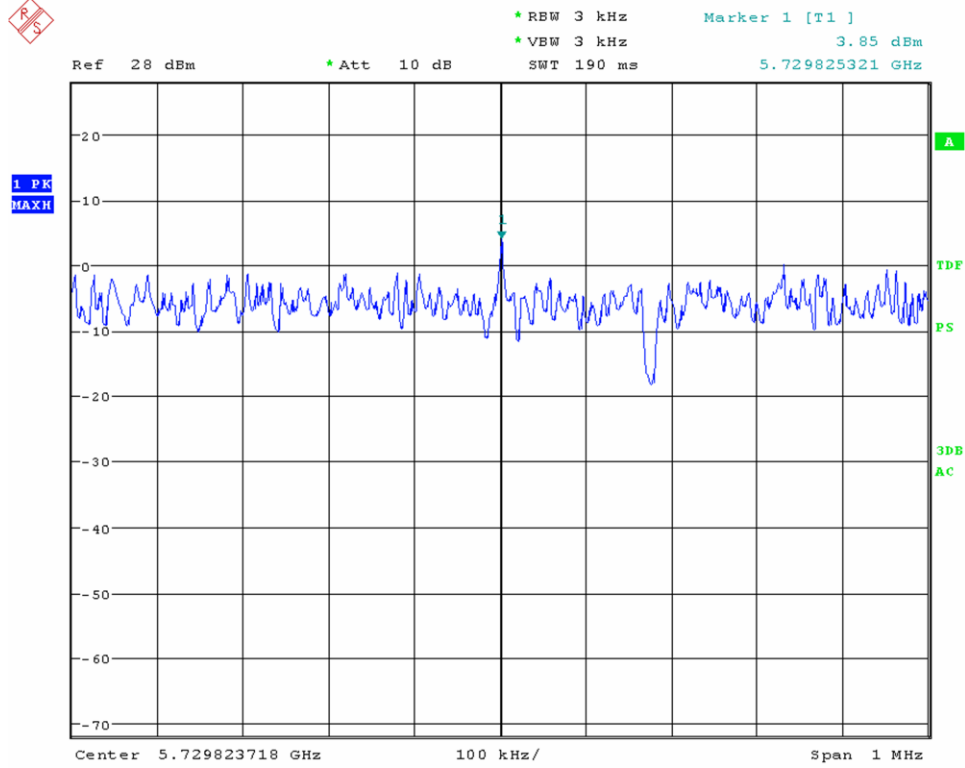

7Mhz Bandwidth

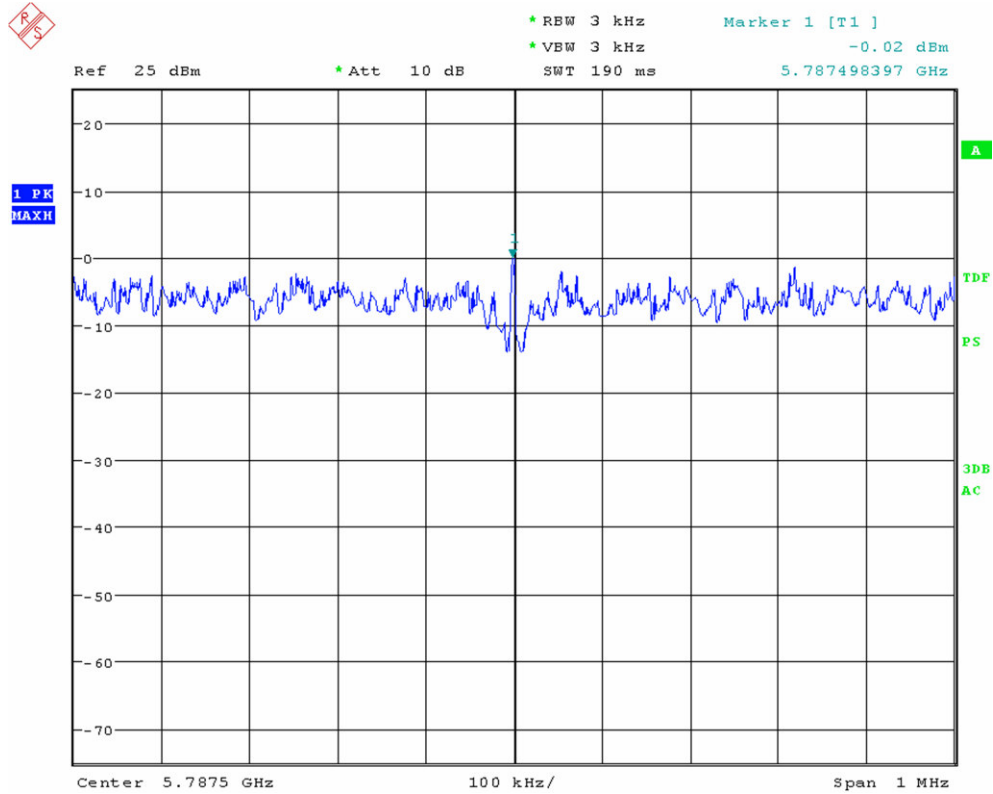

8.6 Results, Data Tables

Mode OFDM// Channel BW = 3.5MHz			
Frequency(MHz)	PSD in 3 KHz (dBm)	Limit	Result
5728.50	1.14	8	PASS
5787.50	1.85	8	PASS
5846.50	0.33	8	PASS

Mode OFDM/ Channel BW = 5MHz			
Frequency(MHz)	PSD in 3 KHz (dBm)	Limit	Result
5729.83	3.85	8	PASS
5787.32	3.56	8	PASS
5844.82	3.54	8	PASS

Mode OFDM/ Channel BW = 7MHz			
Frequency(MHz)	PSD in 3 KHz (dBm)	Limit	Result
5732.00	-0.12	8	PASS
5787.50	-0.02	8	PASS
5843.00	-0.82	8	PASS

9.0 RF Exposure Evaluation

Test Requirement: FCC 1.1310; IC RSS-102 Issue 2, Section 4

FCC 1.1310 states the criteria listed in the table below shall be used to evaluate the environmental impact of human exposure to radiofrequency (RF) radiation as specified in Section 1.1307(b), except in the case of portable devices which shall be evaluated according to the provisions of Section 2.1093 of this chapter. Further information on evaluating compliance with these limits can be found in the FCC's OST/OET Bulletin Number 65, "Evaluating Compliance with FCC-Specified Guidelines for Human Exposure to Radiofrequency Radiation".

Frequency Range (MHZ)	Electric Field Strength (V/m)	Magnetic Field Strength (A/M)	Power Density (mW/cm ²)	Average Time
(A) Limits for Occupational/Control Exposures				
300-1500	--	--	F/300	6
1500-100,000	--	--	5	6
(B) Limits for General Population/Uncontrolled Exposures				
300-1500	--	--	F/1500	6
1500-100,000	--	--	1	30

9.1 EUT Operating Condition

The maximum antenna gain is 32 dBi at 5.8 GHz.

9.2 Method of measurements

All test conditions and measurement procedures were performed in accordance with FCC 1.1310.

9.3 RF exposure evaluation distance calculation

EUT with 32 dBi antenna

Mode OFDM/ Channel BW = 7MHz			
Freq (MHz)	Output Power to Antenna (dBm)	Antenna Gain (dBi)	r (cm)
5732	21.90	32	139
5787.5	21.66	32	136
5843	21.32	32	131

As shown above, the minimum distance where the MPE limit is reached is 139 cm for the EUT.

10.0 Test Photos

Dish antenna (32 dBi)



10.1 Grid antenna (26 dBi)



10.2 Integrated 24dBi antenna

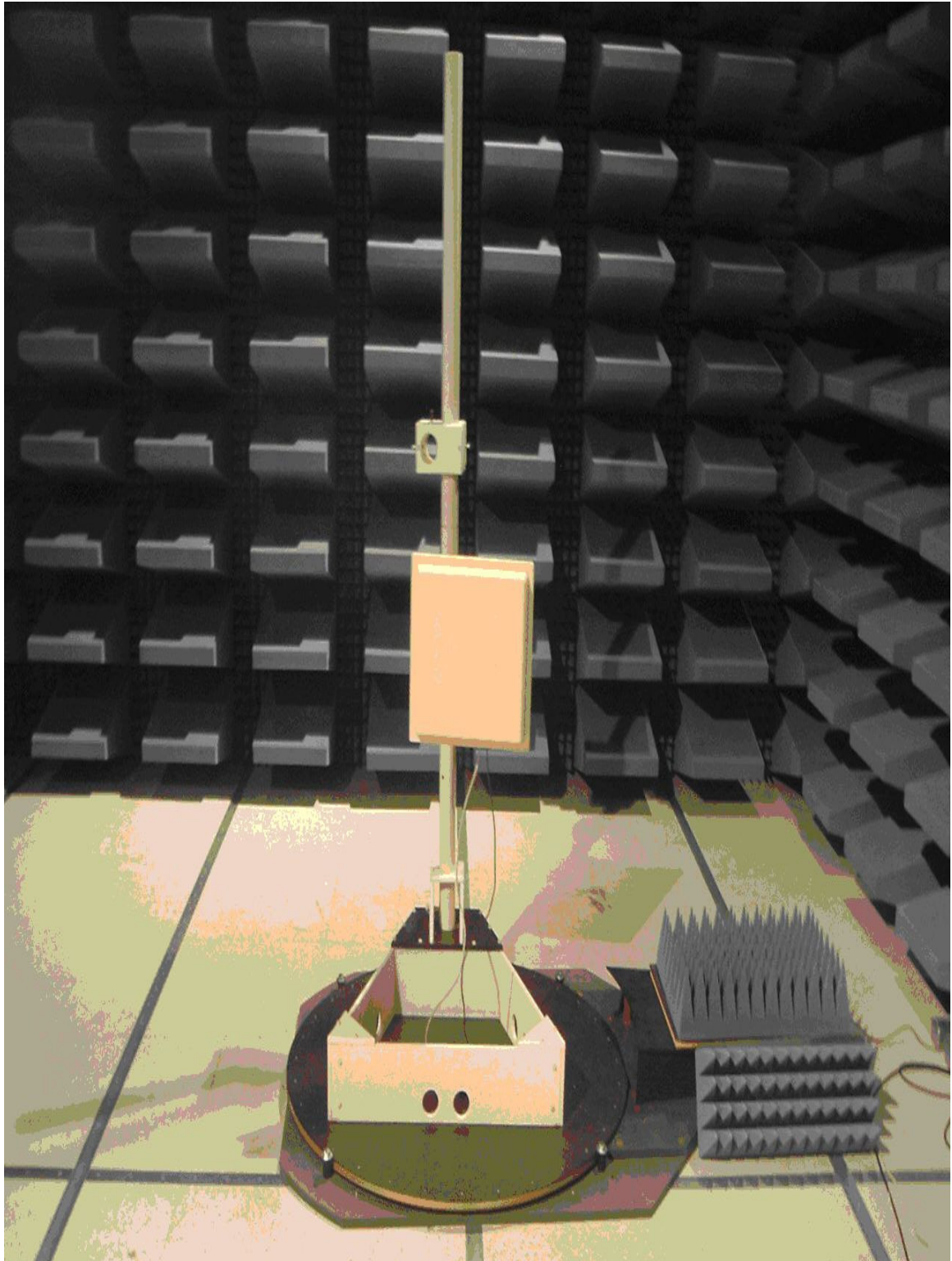

10.3 Conducted Emissions Setup

