

FCC Test Report

APPLICANT : Brightstar Corporation
EQUIPMENT : Mobile Phone
BRAND NAME : Avvio
MODEL NAME : Avvio 765S/Avvio 765
FCC ID : WVBA765X
STANDARD : FCC 47 CFR FCC Part 15 Subpart B
CLASSIFICATION : Certification

The product was received on Aug. 16, 2013 and testing was completed on Sep. 04, 2013. We, SPORTON INTERNATIONAL (SHENZHEN) INC., would like to declare that the tested sample has been evaluated in accordance with the procedures given in ANSI C63.4-2003 and shown to be compliant with the applicable technical standards.

The test results in this report apply exclusively to the tested model / sample. Without written approval of SPORTON INTERNATIONAL (SHENZHEN) INC., the test report shall not be reproduced except in full.

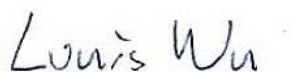

Reviewed by: Louis Wu / Manager

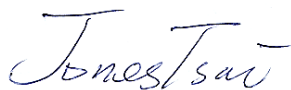

Approved by: Jones Tsai / Manager



SPORTON INTERNATIONAL (SHENZHEN) INC.

**No. 3 Building, the third floor of south, Shahe River west, Fengzeyuan warehouse, Nanshan District,
Shenzhen, Guangdong, P.R.C.**



TABLE OF CONTENTS

REVISION HISTORY..... 3

SUMMARY OF TEST RESULT 4

1. GENERAL DESCRIPTION 5

 1.1. Applicant..... 5

 1.2. Manufacturer 5

 1.3. Feature of Equipment Under Test..... 5

 1.4. Product Specification of Equipment Under Test 6

 1.5. Modification of EUT 6

 1.6. Test Site 7

 1.7. Applied Standards 7

2. TEST CONFIGURATION OF EQUIPMENT UNDER TEST 8

 2.1. Test Mode 8

 2.2. Connection Diagram of Test System 10

 2.3. Support Unit used in test configuration and system..... 11

 2.4. EUT Operation Test Setup..... 12

3. TEST RESULT..... 13

 3.1. Test of AC Conducted Emission Measurement 13

 3.2. Test of Radiated Emission Measurement 20

4. LIST OF MEASURING EQUIPMENT 24

5. UNCERTAINTY OF EVALUATION 25

APPENDIX A. SETUP PHOTOGRAPHS



REVISION HISTORY

REPORT NO.	VERSION	DESCRIPTION	ISSUED DATE
FC381603	Rev. 01	Initial issue of report	Sep. 12, 2013
FC381603	Rev. 02	Remove the Model Name: MEU AN351	Sep. 13, 2013

SUMMARY OF TEST RESULT

Report Section	FCC Rule	Description	Limit	Result	Remark
3.1	15.107	AC Conducted Emission	< 15.107 limits	PASS	Under limit 8.77 dB at 0.170 MHz
3.2	15.109	Radiated Emission	< 15.109 limits	PASS	Under limit 13.96 dB at 99.840 MHz

1. General Description

1.1. Applicant

Brightstar Corporation

9725 NW 117th Ave., Miami, Florida, FL 33178, United States

1.2. Manufacturer

Tinno Mobile Technology Corp.

4/F., H-3 Building, OCT Eastern Industrial Park. No.1 XiangShan East Road., Nan Shan District, Shenzhen, P.R.China

1.3. Feature of Equipment Under Test

Product Feature	
Equipment	Mobile Phone
Brand Name	Avvio
Model Name	Avvio 765S/Avvio 765
FCC ID	WVBA765X
EUT supports Radios application	GSM/GPRS/EDGE/WCDMA/HSPA/HSPA+(Downlink Only)/ WLAN 2.4GHz 802.11bgn/Bluetooth v3.0 + EDR/Bluetooth v4.0
HW Version	V1.0
SW Version	MEU_AN351_Brazil_V1.04
EUT Stage	Production Unit

Remark:

1. The above EUT's information was declared by manufacturer. Please refer to the specifications or user's manual for more detailed description.
2. There are two different types of EUT. They are single SIM card mobile (Model Name: Avvio 765) and dual SIM card mobile (Model Name: Avvio 765S). The others are the same including circuit design, PCB board, structure and all components. It is special to declare. After pre-scan two types of EUT, we found test result of the sample that dual SIM (Model Name: Avvio 765S) was the worst, so we choose dual SIM card mobile to perform all test.
3. There are two SIM cards for dual SIM card mobile. SIM1 supports GSM and WCDMA functions, and SIM2 only supports GSM function.

1.4. Product Specification of Equipment Under Test

Product Specification subjective to this standard	
Tx Frequency	GSM850 : 824.2 MHz ~ 848.8 MHz GSM1900 : 1850.2 MHz ~ 1909.8MHz WCDMA Band V : 826.4 MHz ~ 846.6 MHz WCDMA Band II : 1852.4 MHz ~ 1907.6 MHz 802.11b/g/n: 2412 MHz ~ 2462 MHz Bluetooth: 2402 MHz ~ 2480 MHz
Rx Frequency	GSM850 : 869.2 MHz ~ 893.8 MHz GSM1900 : 1930.2 MHz ~ 1989.8 MHz WCDMA Band V : 871.4 MHz ~ 891.6 MHz WCDMA Band II : 1932.4 MHz ~ 1987.6 MHz 802.11b/g/n: 2412 MHz ~ 2462 MHz Bluetooth: 2402 MHz ~ 2480 MHz GPS : 1.57542 GHz
Antenna Type	WWAN : Dipole Antenna WLAN : PIFA Antenna Bluetooth : PIFA Antenna
Type of Modulation	GSM: GMSK GPRS: GMSK EDGE(MCS 0-4): GMSK / (MCS 5-9): 8PSK WCDMA: QPSK (Uplink) HSDPA: QPSK (Uplink) HSUPA: QPSK (Uplink) HSPA+: 16QAM (Downlink Only) 802.11b : DSSS (DBPSK / DQPSK / CCK) 802.11g/n : OFDM (BPSK / QPSK / 16QAM / 64QAM) Bluetooth 4.0 - LE : GFSK Bluetooth v3.0 + EDR : GFSK, $\pi/4$ -DQPSK, 8-DPSK GPS : BPSK

1.5. Modification of EUT

No modifications are made to the EUT during all test items.

1.6. Test Site

Test Site	SPORTON INTERNATIONAL (SHENZHEN) INC.		
Test Site Location	No. 3 Building, the third floor of south, Shahe River west, Fengzeyuan warehouse, Nanshan District, Shenzhen, Guangdong, P.R.C. TEL: +86-755- 3320-2398		
Test Site No.	Sporton Site No.		FCC Registration No.
	CO01-SZ	03CH01-SZ	831040

1.7. Applied Standards

According to the specifications of the manufacturer, the EUT must comply with the requirements of the following standards:

- ♦ FCC 47 CFR FCC Part 15 Subpart B
- ♦ ANSI C63.4-2003

Remark: All test items were verified and recorded according to the standards and without any deviation during the test.

2. Test Configuration of Equipment Under Test

2.1. Test Mode

The EUT has been associated with peripherals pursuant to ANSI C63.4-2003 and configuration operated in a manner tended to maximize its emission characteristics in a typical application.

Frequency range investigated: conduction (150 kHz to 30 MHz), radiation (30MHz to the 5th harmonic of the highest fundamental frequency or to 40 GHz, whichever is lower).

The following tables are showing the test modes as the worst cases and recorded in this report.

Item	EUT Configuration	Test Condition		
		EMI AC	EMI RE<1G	EMI RE≥1G
1.	Charging Mode (EUT with adapter)	☒	☒	Note 1
2.	Data application transferred mode (EUT with notebook)	☒	☒	☒

Abbreviations:

- EMI AC: AC conducted emissions
- EMI RE ≥ 1G: EUT radiated emissions ≥ 1GHz
- EMI RE < 1G: EUT radiated emissions < 1GHz

Note 1: Testing for this mode is not required or not the worst case.

Remark: For signal above 1GHz, the worst case was test item 2.

Test Items	EUT Configure Mode	Function Type
AC Conducted Emission	1/2	Mode 1: GSM850 Idle + Bluetooth Idle + WLAN Idle + USB Cable (Charging from Adapter) + Earphone + Camera + SIM 1<Fig. 1> Mode 2: WCDMA Band II Idle + Bluetooth Idle + WLAN Idle + USB Cable (Data Link with Notebook) + Earphone + GPS Rx + SIM 1<Fig. 2>
Radiated Emissions < 1GHz	1/2	Mode 1: GSM850 Idle + Bluetooth Idle + WLAN Idle + USB Cable (Charging from Adapter) + Earphone + Camera + SIM 1<Fig. 1> Mode 2: WCDMA Band II Idle + Bluetooth Idle + WLAN Idle + USB Cable (Data Link with Notebook) + Earphone + GPS Rx + SIM 1<Fig. 2>
Radiated Emissions ≥ 1GHz	2	Mode 1: WCDMA Band II Idle + Bluetooth Idle + WLAN Idle + USB Cable (Data Link with Notebook) + Earphone + GPS Rx + SIM 1<Fig. 2>

Remark:

1. The worst case of AC conducted emission is mode 1; the test data of this mode is reported.
2. The USB link mode of AC Conducted Emission is mode 2; the test data of this mode is reported.
3. The worst case of Radiated Emissions is mode 2; only the test data of this mode is reported.
4. Data Link with Notebook means data application transferred mode between EUT and Notebook.

2.2. Connection Diagram of Test System

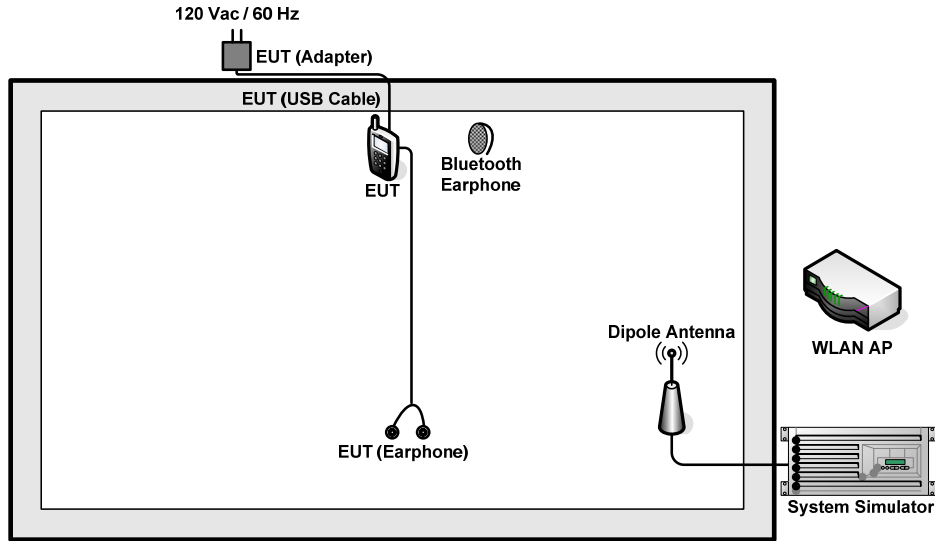

<Fig. 1>

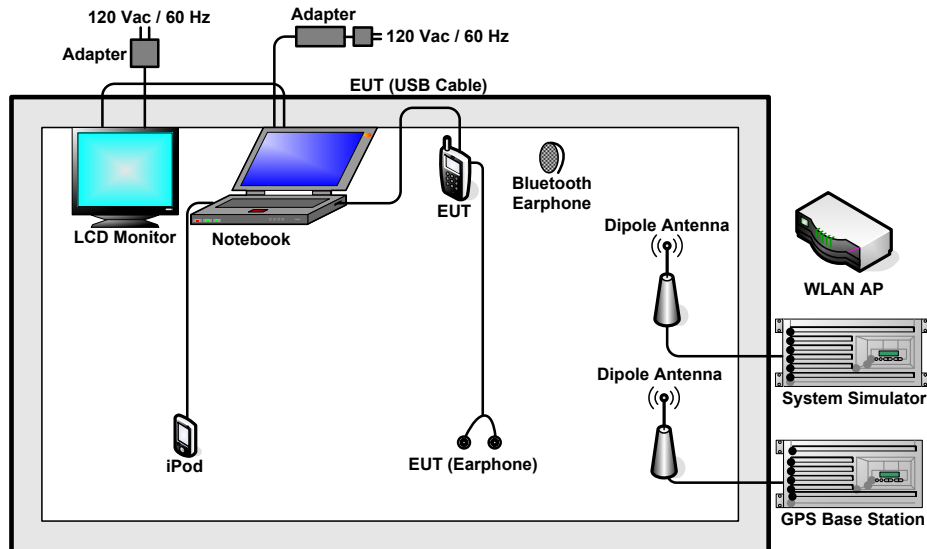

<Fig. 2>

2.3. Support Unit used in test configuration and system

Item	Equipment	Trade Name	Model Name	FCC ID	Data Cable	Power Cord
1.	GPS Base Station	T&E	GS-50	N/A	N/A	Unshielded, 1.8 m
2.	System Simulator	Agilent	E5515C	N/A	N/A	Unshielded, 1.8 m
3.	WLAN AP	D-link	DIR-612	FCC DoC	N/A	Unshielded, 1.8 m
4.	WLAN AP	D-link	DIR-615	FCC DoC	N/A	Unshielded, 1.8 m
5.	Bluetooth Earphone	Nokia	BH-108	FCC DoC	N/A	N/A
6.	Notebook	DELL	P08S	FCC DoC	N/A	AC I/P: Unshielded, 1.8 m DC O/P: Shielded, 1.8 m
7.	Monitor	Dell	1707FPt	FCC DoC	shielded, 1.2 m	Unshielded, 1.8 m
8.	Monitor	Dell	IN1940MWB	FCC DoC	shielded, 1.2 m	Unshielded, 1.8 m
9.	iPod	Apple	MC525 ZP/A	FCC DoC	Shielded, 1.0 m	N/A



2.4. EUT Operation Test Setup

The EUT was in GSM or WCDMA idle mode during the testing. The EUT was synchronized to the BCCH, and was in continuous receiving mode by setting system simulator's paging reorganization.

At the same time, the EUT was attached to the Bluetooth earphone or WLAN AP, and the following programs installed in the EUT were programmed during the test.

1. Execute the program, "Winthrax" under WIN7 installed in notebook for files transfer with EUT via USB cable.
2. Turn on GPS function to make the EUT receive continuous signals from GPS station.
3. Turn on camera to capture images.
4. Execute "H Pattern" to show H Pattern via VGA Cable on the Monitor.

3. Test Result

3.1. Test of AC Conducted Emission Measurement

3.1.1 Limits of AC Conducted Emission

For equipment that is designed to be connected to the public utility (AC) power line, the radio frequency voltage that is conducted back onto the AC power line on any frequency or frequencies within the band 150 kHz to 30 MHz shall not exceed the limits in the following table.

Frequency of emission (MHz)	Conducted limit (dBuV)	
	Quasi-peak	Average
0.15-0.5	66 to 56*	56 to 46*
0.5-5	56	46
5-30	60	50

*Decreases with the logarithm of the frequency.

3.1.2 Measuring Instruments

See list of measuring instruments of this test report.

3.1.3 Test Procedure

1. The EUT was placed 0.4 meter from the conducting wall of the shielding room was kept at least 80 centimeters from any other grounded conducting surface.
2. Connect EUT to the power mains through a line impedance stabilization network (LISN).
3. All the support units are connecting to the other LISN.
4. The LISN provides 50 ohm coupling impedance for the measuring instrument.
5. The FCC states that a 50 ohm, 50 microhenry LISN should be used.
6. Both sides of AC line were checked for maximum conducted interference.
7. The frequency range from 150 kHz to 30 MHz was searched.
8. Set the test-receiver system to Peak Detect Function and specified bandwidth with Maximum Hold Mode.

3.1.4 Test Setup





3.1.5 Test Result of AC Conducted Emission

Test Mode :	Mode 1	Temperature :	23~24°C
Test Engineer :	Henry Chen	Relative Humidity :	48~49%
Test Voltage :	120Vac / 60Hz	Phase :	Line
Function Type :	GSM850 Idle + Bluetooth Idle + WLAN Idle + USB Cable (Charging from Adapter) + Earphone + Camera + SIM 1		

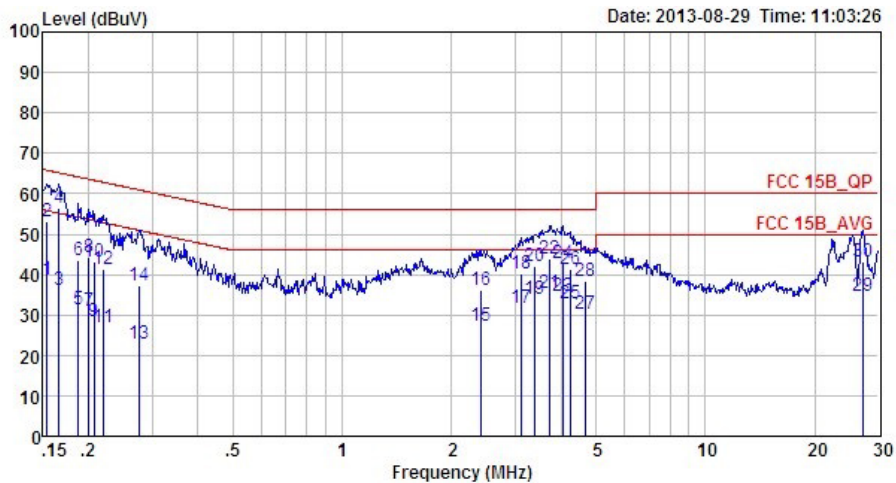

Site : CO01-SZ
 Condition: FCC 15B_QP LISN_L_20130328 LINE

Mode : Mode 1

	Freq	Level	Over Limit	Limit Line	Read Level	LISN Factor	Cable Loss	Remark
	MHz	dBuV	dB	dBuV	dBuV	dB	dB	
1	0.15	38.91	-16.87	55.78	28.50	0.06	10.35	Average
2	0.15	53.21	-12.57	65.78	42.80	0.06	10.35	QP
3	0.17	36.19	-18.97	55.16	25.80	0.06	10.33	Average
4 *	0.17	56.39	-8.77	65.16	46.00	0.06	10.33	QP
5	0.19	31.46	-22.69	54.15	21.10	0.07	10.29	Average
6	0.19	43.56	-20.59	64.15	33.20	0.07	10.29	QP
7	0.20	30.84	-22.74	53.58	20.50	0.07	10.27	Average
8	0.20	44.14	-19.44	63.58	33.80	0.07	10.27	QP
9	0.21	28.53	-24.79	53.32	18.20	0.07	10.26	Average
10	0.21	43.03	-20.29	63.32	32.70	0.07	10.26	QP
11	0.22	27.03	-25.80	52.83	16.70	0.08	10.25	Average
12	0.22	41.33	-21.50	62.83	31.00	0.08	10.25	QP
13	0.28	23.00	-27.94	50.94	12.70	0.09	10.21	Average
14	0.28	37.10	-23.84	60.94	26.80	0.09	10.21	QP
15	2.42	27.24	-18.76	46.00	16.80	0.25	10.19	Average
16	2.42	36.14	-19.86	56.00	25.70	0.25	10.19	QP
17	3.11	31.58	-14.42	46.00	21.10	0.27	10.21	Average
18	3.11	40.28	-15.72	56.00	29.80	0.27	10.21	QP
19	3.38	33.79	-12.21	46.00	23.30	0.28	10.21	Average
20	3.38	42.19	-13.81	56.00	31.70	0.28	10.21	QP
21	3.74	35.50	-10.50	46.00	25.00	0.28	10.22	Average
22	3.74	43.90	-12.10	56.00	33.40	0.28	10.22	QP



Test Mode :	Mode 1	Temperature :	23~24°C
Test Engineer :	Henry Chen	Relative Humidity :	48~49%
Test Voltage :	120Vac / 60Hz	Phase :	Line
Function Type :	GSM850 Idle + Bluetooth Idle + WLAN Idle + USB Cable (Charging from Adapter) + Earphone + Camera + SIM 1		

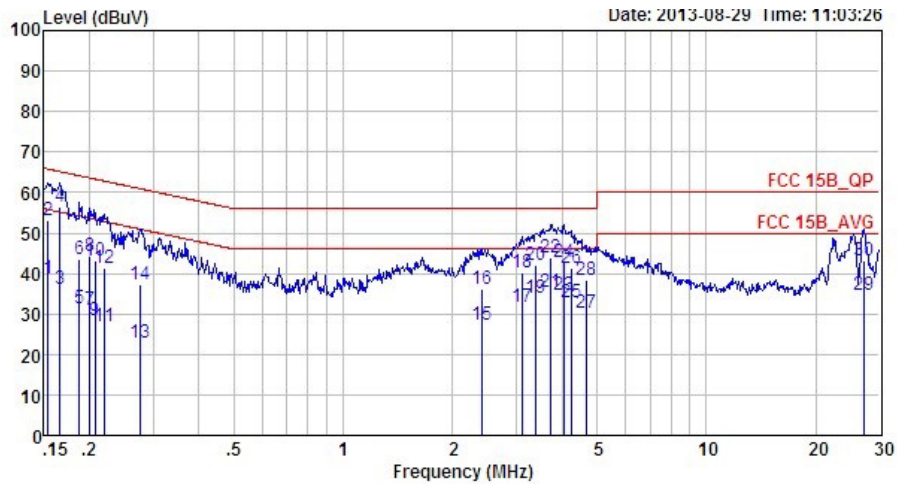

Site : CO01-SZ
 Condition: FCC 15B_QP LISN_L_20130328 LINE
 Mode : Mode 1

	Freq	Level	Over Limit	Limit Line	Read Level	LISN Factor	Cable Loss	Remark
	MHz	dBuV	dB	dBuV	dBuV	dB	dB	
23	4.05	34.51	-11.49	46.00	24.00	0.29	10.22	Average
24	4.05	42.81	-13.19	56.00	32.30	0.29	10.22	QP
25	4.25	32.92	-13.08	46.00	22.39	0.30	10.23	Average
26	4.25	41.22	-14.78	56.00	30.69	0.30	10.23	QP
27	4.67	30.24	-15.76	46.00	19.71	0.30	10.23	Average
28	4.67	38.54	-17.46	56.00	28.01	0.30	10.23	QP
29	27.13	34.62	-15.38	50.00	22.21	1.85	10.56	Average
30	27.13	43.12	-16.88	60.00	30.71	1.85	10.56	QP



Test Mode :	Mode 1	Temperature :	23~24°C
Test Engineer :	Henry Chen	Relative Humidity :	48~49%
Test Voltage :	120Vac / 60Hz	Phase :	Neutral
Function Type :	GSM850 Idle + Bluetooth Idle + WLAN Idle + USB Cable (Charging from Adapter) + Earphone + Camera + SIM 1		

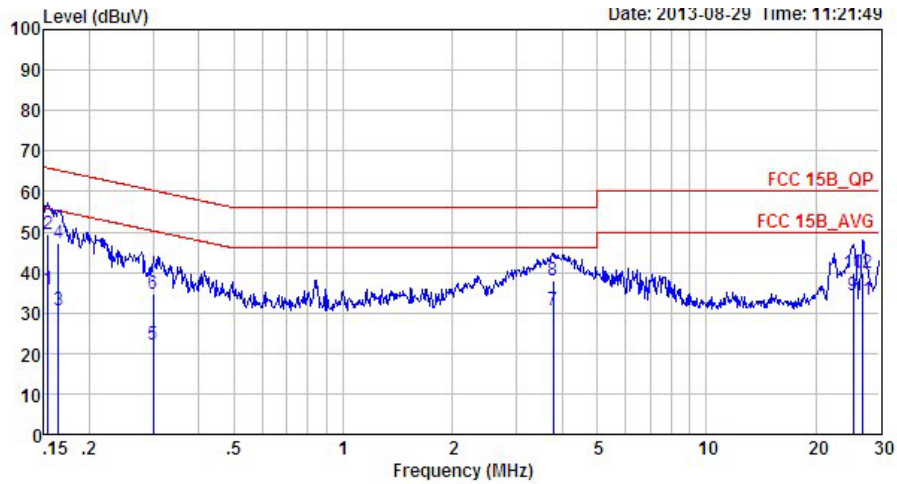

Site : CO01-SZ
 Condition: FCC 15B_QP LISN_N_20130328 NEUTRAL
 Mode : Mode 1

	Freq	Level	Over Limit	Limit Line	Read Level	LISN Factor	Cable Loss	Remark
	MHz	dBuV	dB	dBuV	dBuV	dB	dB	
1	0.15	35.89	-19.89	55.78	25.50	0.04	10.35	Average
2	0.15	49.39	-16.39	65.78	39.00	0.04	10.35	QP
3	0.16	30.77	-24.48	55.25	20.40	0.04	10.33	Average
4	0.16	47.37	-17.88	65.25	37.00	0.04	10.33	QP
5	0.30	22.24	-28.00	50.24	12.00	0.04	10.20	Average
6	0.30	34.74	-25.50	60.24	24.50	0.04	10.20	QP
7 *	3.78	30.71	-15.29	46.00	20.40	0.09	10.22	Average
8	3.78	37.91	-18.09	56.00	27.60	0.09	10.22	QP
9	25.32	34.22	-15.78	50.00	22.61	1.06	10.55	Average
10	25.32	39.82	-20.18	60.00	28.21	1.06	10.55	QP
11	26.98	33.05	-16.95	50.00	21.31	1.18	10.56	Average
12	26.98	39.95	-20.05	60.00	28.21	1.18	10.56	QP



Test Mode :	Mode 2	Temperature :	23~24°C
Test Engineer :	Henry Chen	Relative Humidity :	48~49%
Test Voltage :	120Vac / 60Hz	Phase :	Line
Function Type :	WCDMA Band II Idle + Bluetooth Idle + WLAN Idle + USB Cable (Data Link with Notebook) + Earphone + GPS Rx + SIM 1		

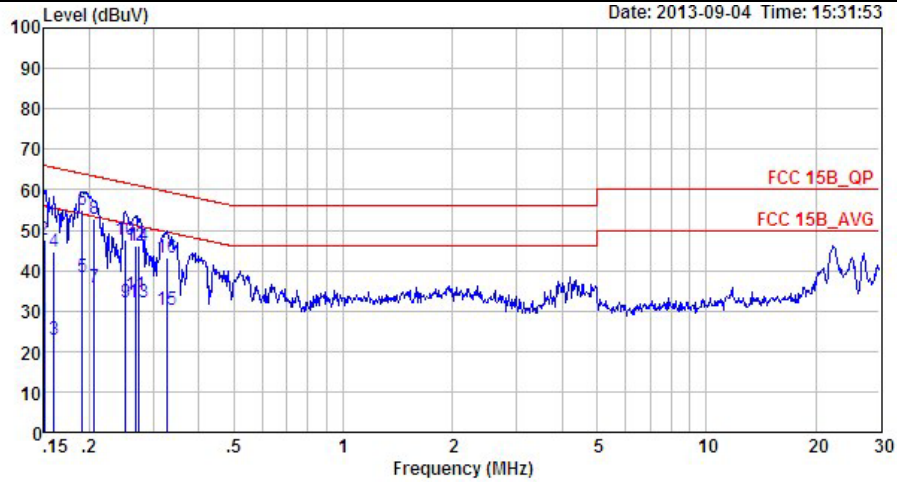

Site : CO01-SZ
 Condition: FCC 15B_QP LISN_L_20130328 LINE
 Mode : Mode 2

	Freq	Level	Over Limit	Limit Line	Read Level	LISN Factor	Cable Loss	Remark
	MHz	dBuV	dB	dBuV	dBuV	dB	dB	
1	0.15	27.82	-28.18	56.00	17.40	0.06	10.36	Average
2	0.15	47.42	-18.58	66.00	37.00	0.06	10.36	QP
3	0.16	22.90	-32.57	55.47	12.50	0.06	10.34	Average
4	0.16	44.50	-20.97	65.47	34.10	0.06	10.34	QP
5	0.19	38.35	-15.63	53.98	28.00	0.07	10.28	Average
6 *	0.19	54.85	-9.13	63.98	44.50	0.07	10.28	QP
7	0.21	35.84	-17.52	53.36	25.51	0.07	10.26	Average
8	0.21	52.74	-10.62	63.36	42.41	0.07	10.26	QP
9	0.25	32.11	-19.58	51.69	21.80	0.09	10.22	Average
10	0.25	47.51	-14.18	61.69	37.20	0.09	10.22	QP
11	0.27	34.10	-17.10	51.20	23.80	0.09	10.21	Average
12	0.27	46.30	-14.90	61.20	36.00	0.09	10.21	QP
13	0.27	32.10	-18.88	50.98	21.80	0.09	10.21	Average
14	0.27	46.30	-14.68	60.98	36.00	0.09	10.21	QP
15	0.33	30.10	-19.43	49.53	19.80	0.11	10.19	Average
16	0.33	43.10	-16.43	59.53	32.80	0.11	10.19	QP



Test Mode :	Mode 2	Temperature :	23~24°C
Test Engineer :	Henry Chen	Relative Humidity :	48~49%
Test Voltage :	120Vac / 60Hz	Phase :	Neutral
Function Type :	WCDMA Band II Idle + Bluetooth Idle + WLAN Idle + USB Cable (Data Link with Notebook) + Earphone + GPS Rx + SIM 1		

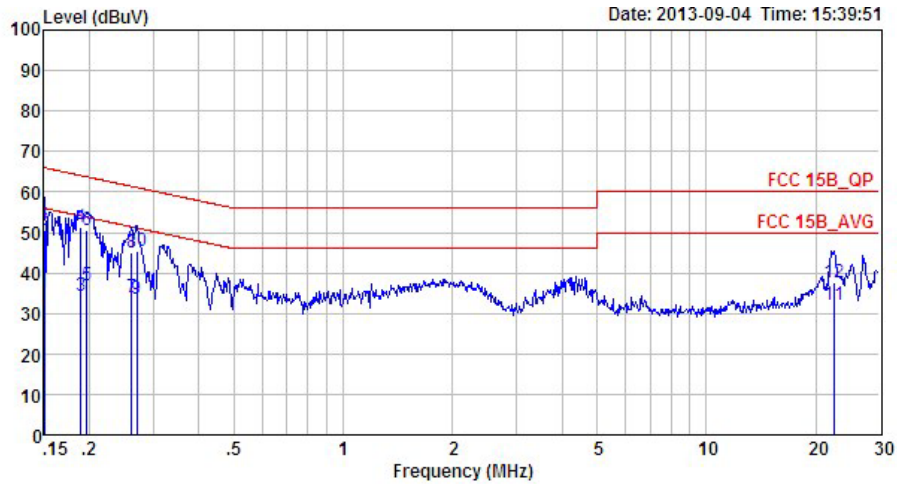

Site : CO01-SZ
 Condition: FCC 15B_QP LISN_N_20130328 NEUTRAL
 Mode : Mode 2

	Freq	Level	Over Limit	Limit Line	Read Level	LISN Factor	Cable Loss	Remark
	MHz	dBuV	dB	dBuV	dBuV	dB	dB	
1	0.15	35.10	-20.90	56.00	24.70	0.04	10.36	Average
2	0.15	50.40	-15.60	66.00	40.00	0.04	10.36	QP
3	0.19	34.43	-19.63	54.06	24.10	0.04	10.29	Average
4 *	0.19	51.33	-12.73	64.06	41.00	0.04	10.29	QP
5	0.20	37.01	-16.75	53.76	26.69	0.04	10.28	Average
6	0.20	50.42	-13.34	63.76	40.10	0.04	10.28	QP
7	0.26	33.95	-17.43	51.38	23.70	0.04	10.21	Average
8	0.26	44.85	-16.53	61.38	34.60	0.04	10.21	QP
9	0.27	33.55	-17.57	51.12	23.30	0.04	10.21	Average
10	0.27	45.25	-15.87	61.12	35.00	0.04	10.21	QP
11	22.54	32.13	-17.87	50.00	20.60	0.96	10.57	Average
12	22.54	37.53	-22.47	60.00	26.00	0.96	10.57	QP

3.2. Test of Radiated Emission Measurement

3.2.1. Limit of Radiated Emission

The emissions from an unintentional radiator shall not exceed the field strength levels specified in the following table:

Frequency (MHz)	Field Strength (microvolts/meter)	Measurement Distance (meters)
30 – 88	100	3
88 – 216	150	3
216 - 960	200	3
Above 960	500	3

3.2.2. Measuring Instruments

See list of measuring instruments of this test report.

3.2.3. Test Procedures

1. The EUT was placed on a turntable with 0.8 meter above ground.
2. The EUT was set 3 meters from the interference receiving antenna, which was mounted on the top of a variable height antenna tower.
3. The table was rotated 360 degrees to determine the position of the highest radiation.
4. The antenna is a Bi-Log antenna and its height is adjusted between one to four meters above ground to find the maximum value of the field strength for both horizontal polarization and vertical polarization of the antenna.
5. For each suspected emission, the EUT was arranged to its worst case and then tune the antenna tower (from 1 m to 4 m) and turntable (from 0 degree to 360 degrees) to find the maximum reading.
6. Set the test-receiver system to Peak Detect Function and specified bandwidth with Maximum Hold Mode.
7. If the emission level of the EUT in peak mode was 3 dB lower than the limit specified, peak values of EUT will be reported. Otherwise, the emission will be repeated by using the quasi-peak method and reported.
8. Emission level (dB μ V/m) = 20 log Emission level (μ V/m)
9. Corrected Reading: Antenna Factor + Cable Loss + Read Level - Preamp Factor = Level

3.2.4. Test Setup of Radiated Emission

For radiated emissions from 30MHz to 1GHz

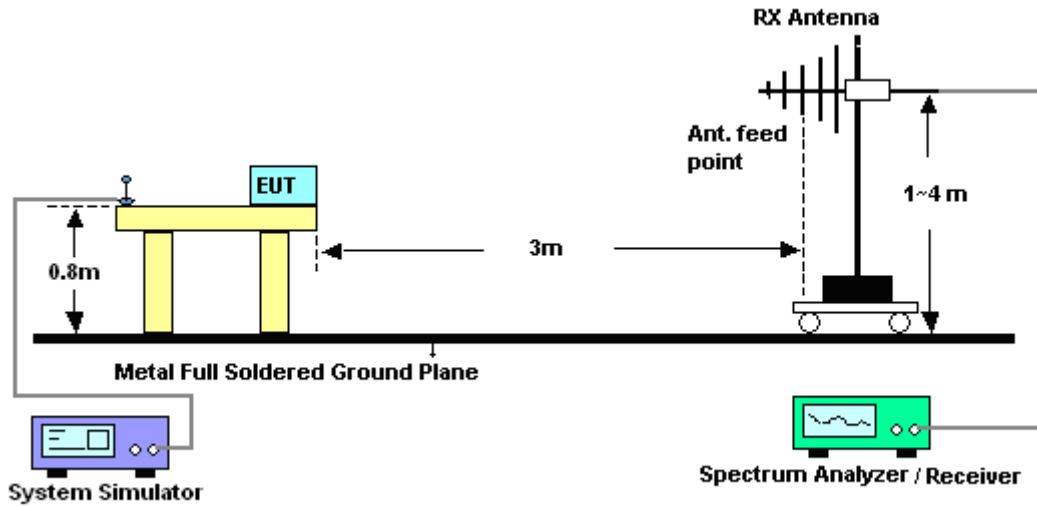

For radiated emissions above 1GHz

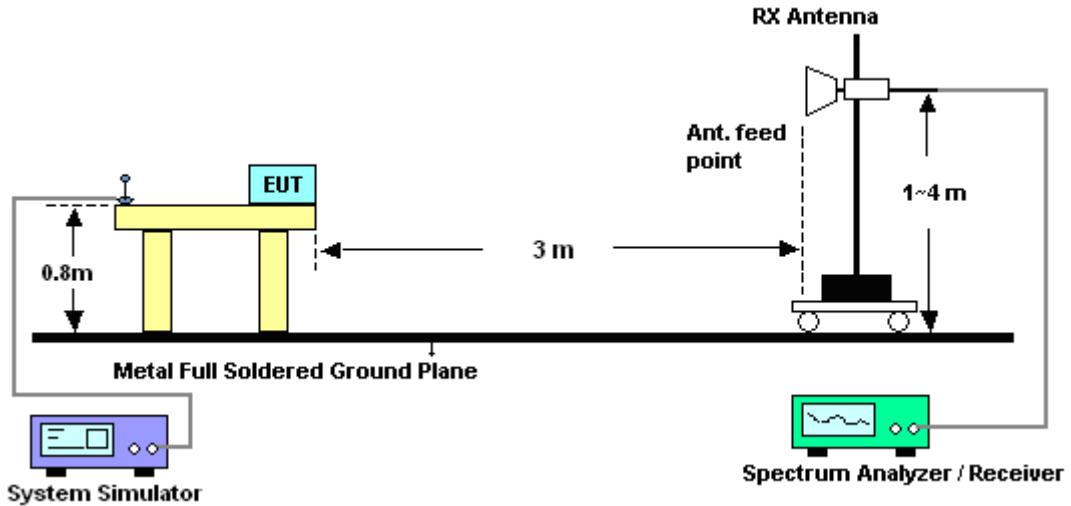



3.2.5. Test Result of Radiated Emission

Test Mode :	Mode 2	Temperature :	23~25°C
Test Engineer :	Gavin Zhang	Relative Humidity :	49~52%
Test Distance :	3m	Polarization :	Horizontal
Function Type :	WCDMA Band II Idle + Bluetooth Idle + WLAN Idle + USB Cable (Data Link with Notebook) + Earphone + GPS Rx + SIM 1		

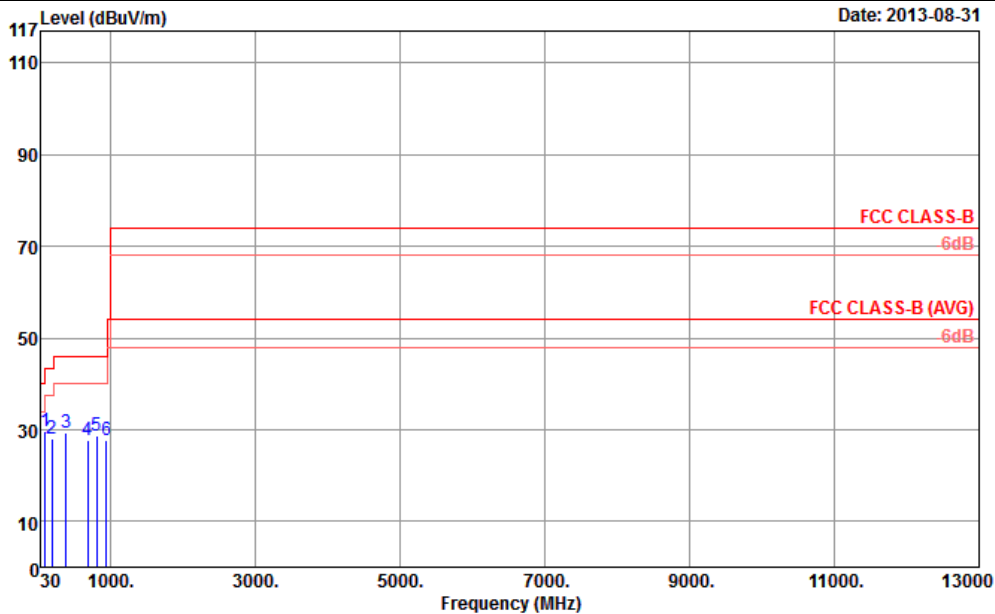

Site : 03CH01-SZ
 Condition : FCC CLASS-B 3m LF_ANT_121103 HORIZONTAL
 Project : (FC)381603
 Mode : Mode 2

	Freq	Level	Over	Limit	ReadAntenna	Cable	Preamp	A/Pos	T/Pos	Remark	
	MHz	dBuV/m	dB	dBuV/m	dBuV	dB/m	dB	dB	cm	deg	
1 P	99.84	29.54	-13.96	43.50	48.02	10.93	1.26	30.67	148	236 Peak	
2	190.05	28.03	-15.47	43.50	46.85	9.90	1.65	30.37	---	---	Peak
3	382.11	29.35	-16.65	46.00	40.80	16.04	2.24	29.73	---	---	Peak
4	687.66	27.80	-18.20	46.00	34.69	19.24	2.95	29.08	---	---	Peak
5	809.88	28.83	-17.17	46.00	33.46	21.10	3.19	28.92	---	---	Peak
6	937.92	27.63	-18.37	46.00	30.90	22.04	3.44	28.75	---	---	Peak



Test Mode :	Mode 2	Temperature :	23~25°C
Test Engineer :	Gavin Zhang	Relative Humidity :	49~52%
Test Distance :	3m	Polarization :	Vertical
Function Type :	WCDMA Band II Idle + Bluetooth Idle + WLAN Idle + USB Cable (Data Link with Notebook) + Earphone + GPS Rx + SIM 1		

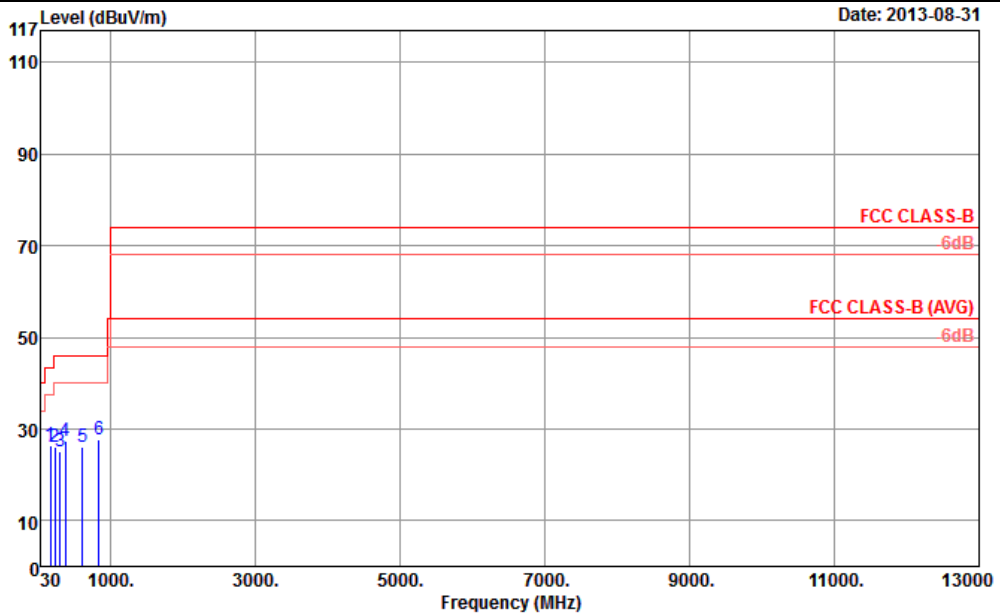

Site : 03CH01-SZ
 Condition : FCC CLASS-B 3m LF_ANT_121103 VERTICAL
 Project : (FC)381603
 Mode : Mode 2

	Freq	Level	Over	Limit	ReadAntenna	Cable	Preamp	A/Pos	T/Pos	Remark
	MHz	dBuV/m	dB	dBuV/m	dBuV	dB/m	dB	dB	cm	deg
1 P	164.83	26.36	-17.14	43.50	45.35	9.90	1.56	30.45	158	125 Peak
2	228.85	26.18	-19.82	46.00	44.03	10.60	1.79	30.24	---	---
3	305.48	25.07	-20.93	46.00	39.95	13.06	2.04	29.98	---	---
4	380.17	27.31	-18.69	46.00	38.80	16.00	2.24	29.73	---	---
5	609.09	26.13	-19.87	46.00	33.34	19.20	2.78	29.19	---	---
6	837.04	27.59	-18.41	46.00	32.23	21.00	3.24	28.88	---	---

4. List of Measuring Equipment

Instrument	Manufacturer	Model No.	Serial No.	Characteristics	Calibration Date	Test Date	Due Date	Remark
AC LISN	ETS-LINDGREN	3816/2SH	00103912	0.1MHz~108MHz	Feb. 28, 2011	Aug. 29, 2013~ Sep. 04, 2013	Feb. 27, 2014	Conduction (CO01-SZ)
AC LISN (for auxiliary equipment)	ETS-LINDGREN	3816/2SH	00103892	0.1MHz~108MHz	Feb. 28, 2011	Aug. 29, 2013~ Sep. 04, 2013	Feb. 27, 2014	Conduction (CO01-SZ)
ESCIO TEST Receiver	R&S	1142.8007.0 3	100724	9K-3GHz	Mar. 08, 2011	Aug. 29, 2013~ Sep. 04, 2013	Mar. 07, 2014	Conduction (CO01-SZ)
AC Power Source	Chroma	61602	616020000 891N/A	N/A	Oct. 12, 2011	Aug. 29, 2013~ Sep. 04, 2013	Oct. 11, 2013	Conduction (CO01-SZ)
Spectrum Analyzer	Agilent Technologies	N9038A	MY52260 185	20Hz~26.5GHz	Apr. 04, 2013	Aug. 31, 2013	Apr. 03, 2014	Radiation (03CH01-SZ)
Double Ridge Horn Antenna	ETS Lindgren	3117	00119436	1GHz~18GHz	Oct. 12, 2012	Aug. 31, 2013	Oct. 11, 2013	Radiation (03CH01-SZ)
Bilog Antenna	SCHAFFNER	CBL6112B	2614	30Mhz~2Ghz	Nov. 03, 2012	Aug. 31, 2013	Nov. 02, 2013	Radiation (03CH01-SZ)
Amplifier	ADVANTEST	BB525C	E9007003	9K-3000MHz GAIN 30db	Mar. 28, 2013	Aug. 31, 2013	Mar. 27, 2014	Radiation (03CH01-SZ)
Amplifier	Yiai	AV3860B	04030	2GHz~26.5GHz	Mar. 28, 2013	Aug. 31, 2013	Mar. 27, 2014	Radiation (03CH01-SZ)
Turn Table	EM Electronic	EM 1000	N/A	0 ~ 360 degree	N/A	Aug. 31, 2013	N/A	Radiation (03CH01-SZ)
Antenna Mast	EM electronic	EM 1000	N/A	1 m - 4 m	N/A	Aug. 31, 2013	N/A	Radiation (03CH01-SZ)

5. Uncertainty of Evaluation

Uncertainty of Conducted Emission Measurement (150 kHz ~ 30 MHz)

Measuring Uncertainty for a Level of Confidence of 95% ($U = 2Uc(y)$)	2.26
---	------

Uncertainty of Radiated Emission Measurement (30 MHz ~ 1000 MHz)

Measuring Uncertainty for a Level of Confidence of 95% ($U = 2Uc(y)$)	2.54
---	------

Uncertainty of Radiated Emission Measurement (1 GHz ~ 40 GHz)

Measuring Uncertainty for a Level of Confidence of 95% ($U = 2Uc(y)$)	4.72
---	------