



**FCC PART 15
TEST REPORT
No. I19N02247-DFS**

For

Doro AB

LTE phone

Model Name: DSB-0230

With

Hardware Version: 1031

Software Version:

MAGIC01A-S10A_DSB0230_123_USERDEBUG_190925

FCC ID: WS5DSB0230

Issued Date: 2019-11-19

Designation Number: CN1210

Note:

The test results in this test report relate only to the devices specified in this report. This report shall not be reproduced except in full without the written approval of SAICT.

Test Laboratory:

Shenzhen Academy of Information and Communications Technology
Building G, Shenzhen International Innovation Center, No.1006 Shennan Road, Futian District, Shenzhen,
Guangdong, P. R. China 518026.

Tel: +86(0)755-33322000, Fax: +86(0)755-33322001

Email: yewu@caict.ac.cn, website: www.cszit.com

REPORT HISTORY

Report Number	Revision	Description	Issue Date
I19N02247-DFS	Rev.0	1st edition	2019-11-19

CONTENTS

1.	TEST LATORATORY	4
1.1.	TESTING LOCATION	4
1.2.	TESTING ENVIRONMENT	4
1.3.	PROJECT DATA	4
1.4.	SIGNATURE	4
2.	CLIENT INFORMATION	5
2.1.	APPLICANT INFORMATION	5
2.2.	MANUFACTURER INFORMATION	5
3.	EQUIPMENT UNDER TEST (EUT) AND ANCILLARY EQUIPMENT(AE)	6
3.1.	ABOUT EUT	6
3.2.	INTERNAL IDENTIFICATION OF EUT	6
3.3.	INTERNAL IDENTIFICATION OF AE	6
3.4.	GENERAL DESCRIPTION	6
4.	REFERENCE DOCUMENTS	7
4.1.	DOCUMENTS SUPPLIED BY APPLICANT	7
4.2.	REFERENCE DOCUMENTS FOR TESTING	7
4.3.	LABORATORY ENVIRONMENT	7
5.	SUMMARY OF TEST RESULTS	8
5.1.	SUMMARY OF TEST RESULTS	8
5.2.	STATEMENTS	8
5.3.	TERMS USED IN THE RESULT TABLE	8
6.	TEST EQUIPMENTS UTILIZED	9
	ANNEX A: MEASUREMENT RESULTS	10
A.1.	MEASUREMENT METHOD	10
A.2.	CHANNEL MOVE TIME AND CHANNEL CLOSING TRANSMISSION TIME	12
A.3.	NON-OCCUPANCY PERIOD	15
	ANNEX B: PHOTOGRAPHS OF THE TEST SET-UP	17

1. TEST LATORATORY

1.1. Testing Location

Location: Shenzhen Academy of Information and Communications Technology
Address: Building G, Shenzhen International Innovation Center, No.1006
Shennan Road, Futian District, Shenzhen, Guangdong Province, China
Postal Code: 518026
Telephone: +86(0)755-33322000
Fax: +86(0)755-33322001

1.2. Testing Environment

Normal Temperature: 15-35℃
Relative Humidity: 20-75%

1.3. Project data

Testing Start Date: 2019-10-08
Testing End Date: 2019-10-25

1.4. Signature

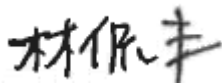

Lin Kanfeng
(Prepared this test report)



Tang Weisheng
(Reviewed this test report)



Zhang Bojun
(Approved this test report)

2. CLIENT INFORMATION

2.1. Applicant Information

Company Name: Doro AB
Address: Jörgen Kocksgatan 1B SE-211 20 Malmö Sweden
Contact: Per Carlenhag
Email: per.carlenhag@doro.com
Telephone: +46 46 280 5000
Fax: +46 46 280 5001

2.2. Manufacturer Information

Company Name: CK TELECOM LTD.
Address: Technology Road. High-Tech Development Zone. Heyuan,
Guangdong, P.R.China
Contact: mourong xie
Email: mourong.xie@ck-telecom.com
Telephone: 0755-26739100 ext.8514
Fax: 0755-26739600

3. Equipment Under Test (EUT) and Ancillary Equipment(AE)

3.1. About EUT

Description	LTE phone
Model Name	DSB-0230
Brand Name	Doro
FCC ID	WS5DSB0230
RLAN Frequency Range	ISM Bands: 5250MHz~5350MHz 5470MHz~5725MHz
RLAN Protocol	IEEE 802.11a, 802.11n-HT20/40
Type of Modulation	OFDM
Antenna	Integrated
Antenna Gain	-0.5dBi
Power Supply	3.85V DC by Battery
Device Type (DFS)	Client without radar detection (only support client mode)
Condition of EUT as received	No abnormality in appearance

Note: Components list, please refer to documents of the manufacturer

3.2. Internal Identification of EUT

EUT ID*	IMEI	HW Version	SW Version	Receive Date
EUT1	358707100008323	1031	MAGIC01A-S10A_DSB0230_1 23_USERDEBUG_190925	2019-10-08

*EUT ID: is used to identify the test sample in the lab internally.

3.3. Internal Identification of AE

AE ID*	Description	Mode	Manufacturer
AE1	Battery	DBV 3000A	Dongguang HongDe Battery Co.,Ltd
AE2	Charger	UT-133E-5100BY	Shenzhen BaiJunDa Electronic Co., LTD
AE3	Charger	A806A-050100U-UK1	Dongguan Aohai Power Technology Co., LTD

*AE ID: is used to identify the test sample in the lab internally.

3.4. General Description

The Equipment under Test (EUT) is a model of LTE phone with integrated antenna and battery. It consists of normal options: travel charger, USB cable and Phone. Manual and specifications of the EUT were provided to fulfil the test. Samples undergoing test were selected by the client.

4. REFERENCE DOCUMENTS

4.1. Documents supplied by applicant

EUT feature information is supplied by the applicant or manufacturer, which is the basis of testing.

4.2. Reference Documents for testing

The following documents listed in this section are referred for testing.

Reference	Title	Version
FCC Part15	Title 47 of the Code of Federal Regulations; Chapter I Part 15 - Radio frequency devices Subpart E – UNII Devices	2018
FCC 06-96	Revision of Parts 2 and 15 of the Commission’s Rules to Permit Unlicensed National Information Infrastructure (U-NII) devices in the 5 GHz band	2006

Note: This report is only for DFS.

4.3. Laboratory Environment

Shielded room

Temperature	Min. = 15 °C, Max. = 35 °C
Relative humidity	Min. = 20 %, Max. = 75 %
Shielding effectiveness	0.014 MHz - 1 MHz, > 60 dB; 1 MHz - 1000 MHz, > 90 dB.
Electrical insulation	> 2 MΩ
Ground system resistance	< 4 Ω

5. SUMMARY OF TEST RESULTS

5.1. Summary of Test Results

No	Test cases	Sub-clause of Part15E	Verdict
1	Channel move time and channel closing transmission time	15.407 (h)(2)(iii)	P
2	Non-Occupancy Period	15.407 (h)(2)(iv)	P

Please refer to **ANNEX A** for detail.

Terms used in Verdict column

P	Pass, The EUT complies with the essential requirements in the standard
NM	Not measured, The test was not measured by SAICT
NA	Not Applicable, The test was not applicable
F	Fail, The EUT does not comply with the essential requirements in the standard

5.2. Statements

SAICT has evaluated the test cases requested by the applicant/manufacturer as listed in section 5.1 of this report, for the EUT specified in section 3, according to the standards or reference documents listed in section 4.2.

This report only deal with the UNII DFS functions among the features described in section 3, and The EUT met all requirements of the reference documents.

The end user is not available to get and modify the parameters of the detected Radar Waveforms in this product.

5.3. Terms used in the result table

Test Conditions

T nom	Normal Temperature
T min	Low Temperature
T max	High Temperature
V nom	Normal Voltage
V min	Low Voltage
V max	High Voltage
H nom	Norm Humidity
A nom	Norm Air Pressure

For this report, all the test case listed above is tested under Normal Temperature and Normal Voltage, and also under norm humidity, the specific conditions as following:

Temperature	T nom	25°C
Voltage	V nom	3.85V(By battery)
Humidity	H nom	60%
Air Pressure	A nom	1010hPa

6. TEST EQUIPMENTS UTILIZED

Conducted test system

No.	Equipment	Model	Serial Number	Manufacturer	Calibration Due date	Calibration Period
1	Vector Signal Analyzer	FSV40	100903	Rohde & Schwarz	2020-01-02	1 year
2	Vector Signal General	SMU200A	104096	Rohde & Schwarz	2020-01-02	1 year
3	Shielding Room	S81	/	ETS-Lindgren	2019-11-13	3 year
No.	Equipment	Model	FCC ID	Manufacturer	Calibration Due date	Calibration Period
4	Master AP	BCM94709R	QDS-BR CM1091	BROADCOM	/	/

ANNEX A: MEASUREMENT RESULTS

A.1. Measurement Method

A.1.1. Conducted Measurements

The below figure shows the DFS setup, where the EUT is a RLAN device operating in slave mode, without Radar Interference Detection function. This setup also contains a device operating in master mode. The radar test signals are injected into the master device. The EUT (slave device) is associated with the master device. WLAN traffic is generated by streaming the mpeg file from the master to the slave in full monitor video mode using the media player.

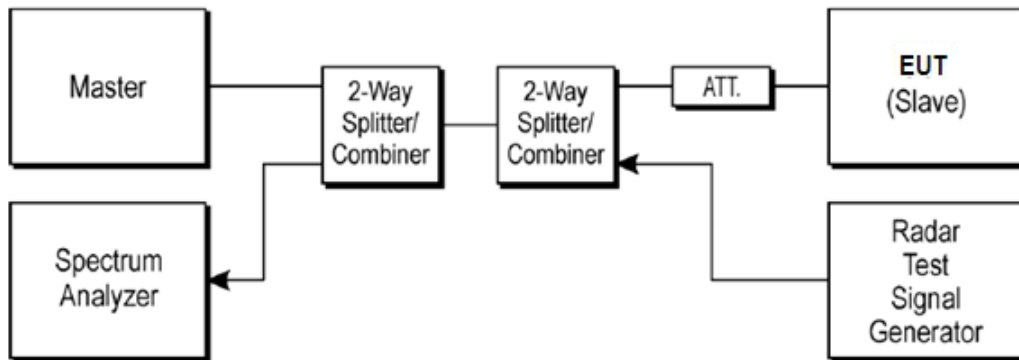

A.1.2. Parameters of DFS test signal

1). Interference threshold values, master or client incorporation in service monitoring. For device Power less than 23dBm (E.I.R.P.), the threshold level is -62 dBm at the antenna port after Correction for antenna gain and procedural adjustments.

Because of conducted measurement performed, the calibration power from radar signal generator to antenna port of DFS test equipment is -62 dBm.

Maximum Transmit Power	Value
> 200 mW	-64 dBm
< 200 mW	-62 dBm

2). DFS requirement values

The required values are as the following table.

Parameter	Value
Non-occupancy	> 1800 s
Channel Availability Check Time	60 s
Channel Move Time	10 s
Channel Closing Transmission Time	200 ms + 60 ms
U-NII Detection Bandwidth	Minimum 80% of the 99% transmission power bandwidth

As the EUT is IP based system, the MPEG video file from NTIA website is used to steam to EUT via the Master device.

3). Parameters of the reference DFS test signal

Pulse width W (μ s)	Pulse repetition frequency PRF (PPS)	Pulses per burst (PPB)
1	700	18

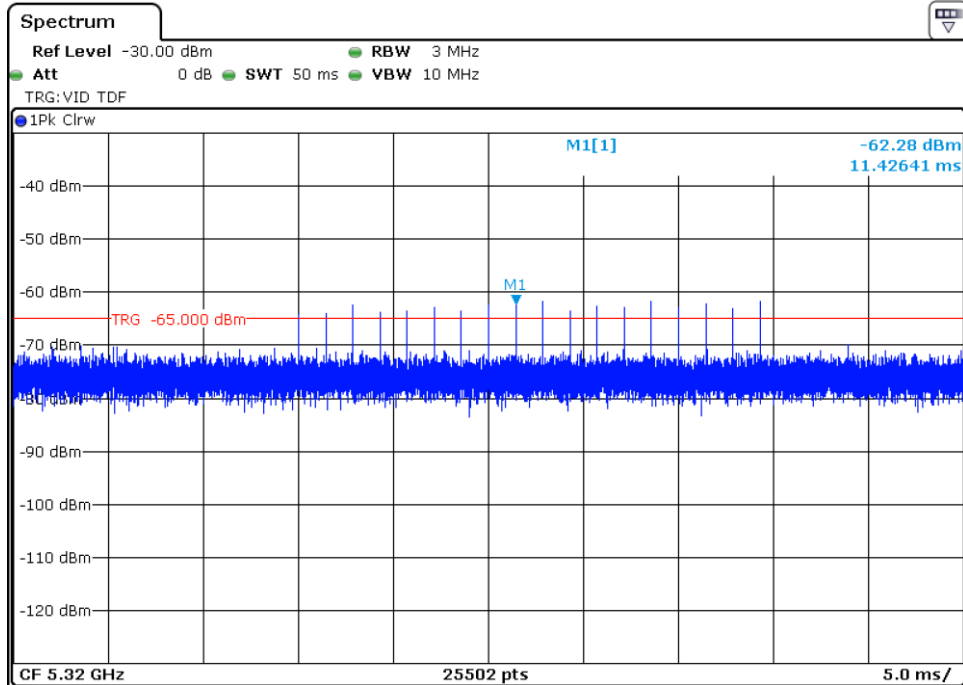

Radar Signal (Type 0)

A.2. Channel move time and channel closing transmission time

Measurement Limit:

Test Items	Limit
channel closing transmission time	< 200 ms + 60 ms
Channel move time	< 10 s

Measurement Results:

HT20 Frequency Band: 5250MHz ~ 5350MHz

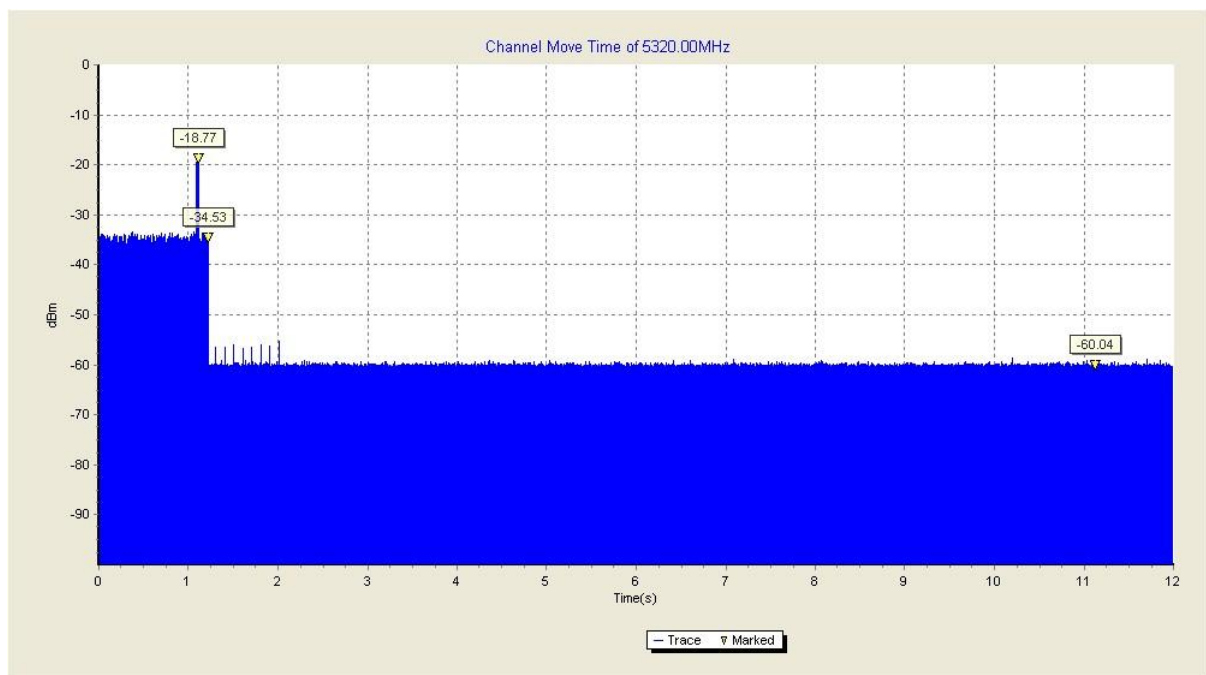

Fig.1 channel move time (HT20 Frequency Band: 5250MHz ~ 5350MHz)

The channel move time is as the figure. It shows the time of the radar and the client pulses. The figure shows that the client stops transmission within 10 seconds, and no transmissions occur after 10 seconds later of the radar burst signal.

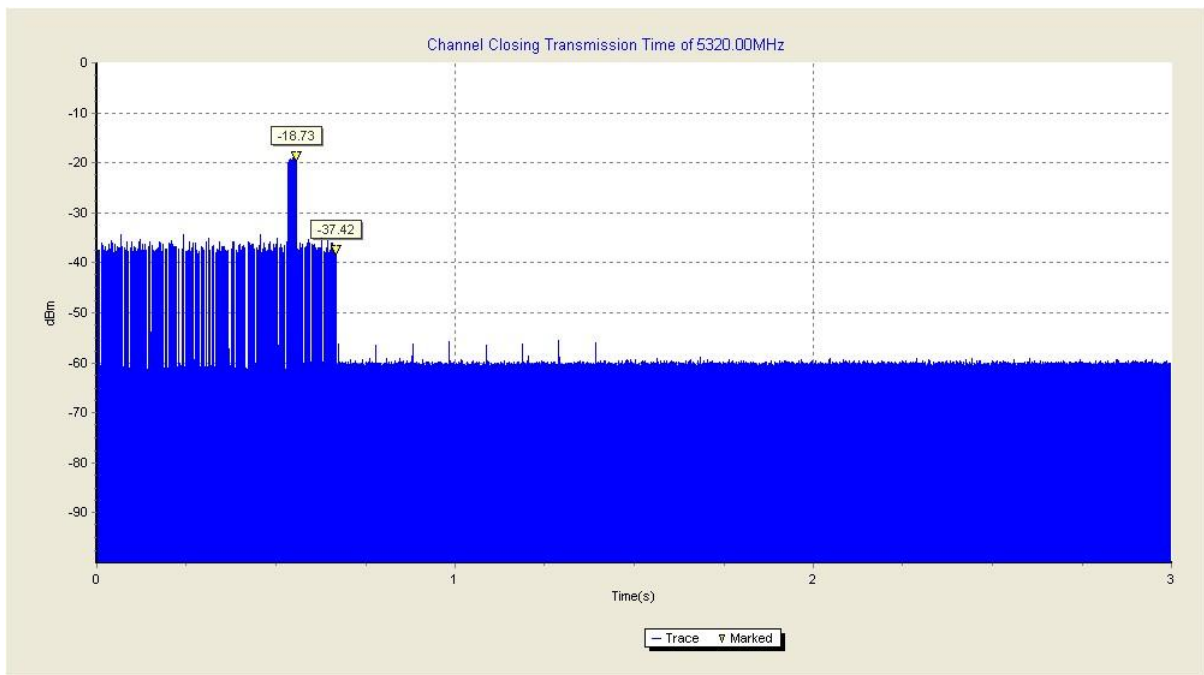

Fig.2 channel closing transmission time (HT20 Frequency Band: 5250MHz ~ 5350MHz)

The closing transmission time is as the figure, and the result is 111ms.

HT40 Frequency Band: 5470MHz ~ 5725MHz

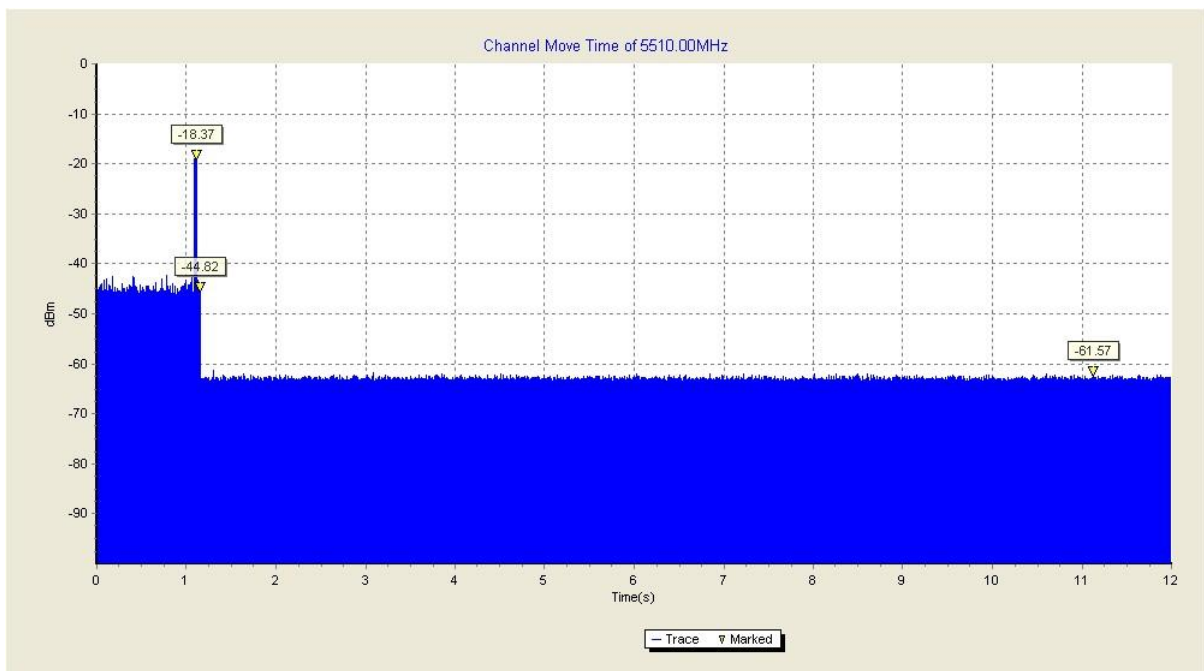

Fig.3 channel move time (HT40 Frequency Band: 5470MHz ~ 5725MHz)

The channel move time is as the figure. It shows the time of the radar and the client pulses. The figure shows that the client stops transmission within 10 seconds, and no transmissions occur after 10 seconds later of the radar burst signal.

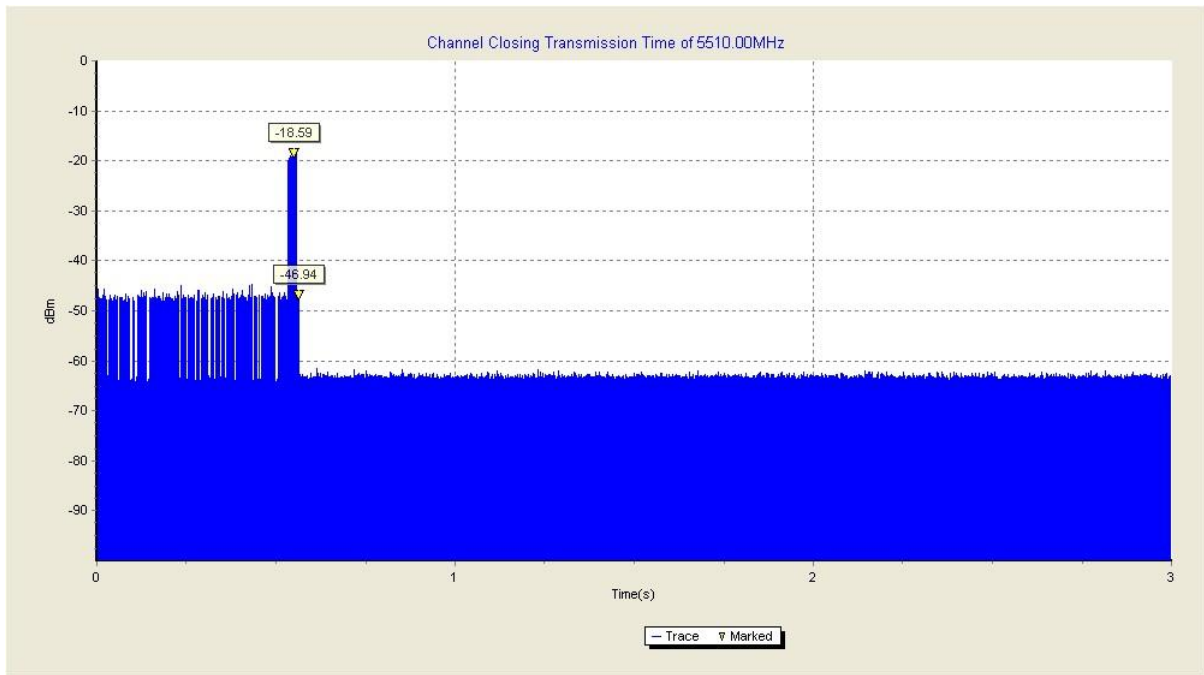

Fig.4 channel closing transmission time (HT40 Frequency Band: 5470MHz ~ 5725MHz)

The closing transmission time is as the figure, and the result is 15ms.

Conclusion: PASS

A.3. Non-Occupancy Period

Measurement Limit:

Test Items	Limit
Non-Occupancy Period	> 1800 s

Associated test

Associate the master and client, transmit specified stream between the master and client; monitor the analyzer on the operating frequency to make sure no beacons have been transmitted for 1800 seconds.

HT20 Frequency Band: 5250MHz ~ 5350MHz

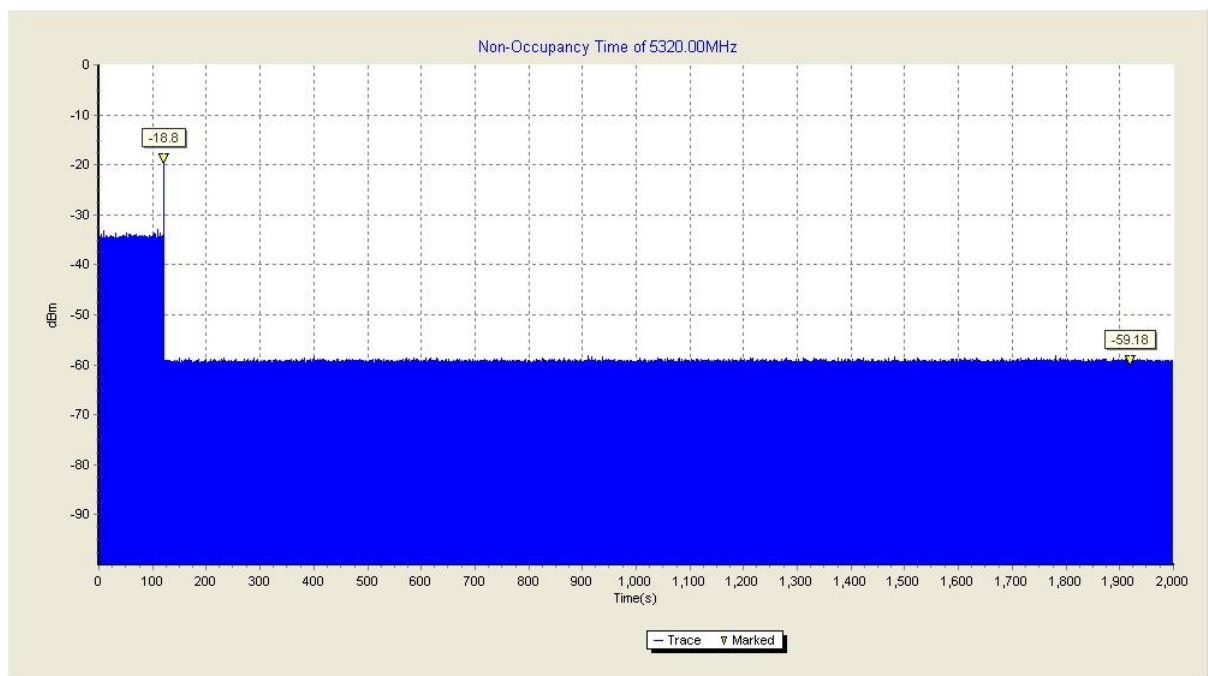

Fig.5 Non-Occupancy Period (HT20 Frequency Band: 5250MHz ~ 5350MHz)

The figure above shows that the client does not transmit any emission within 1800 seconds after getting the order of “stop transmits” from the DFS master (access point).

HT40 Frequency Band: 5470MHz ~ 5725MHz

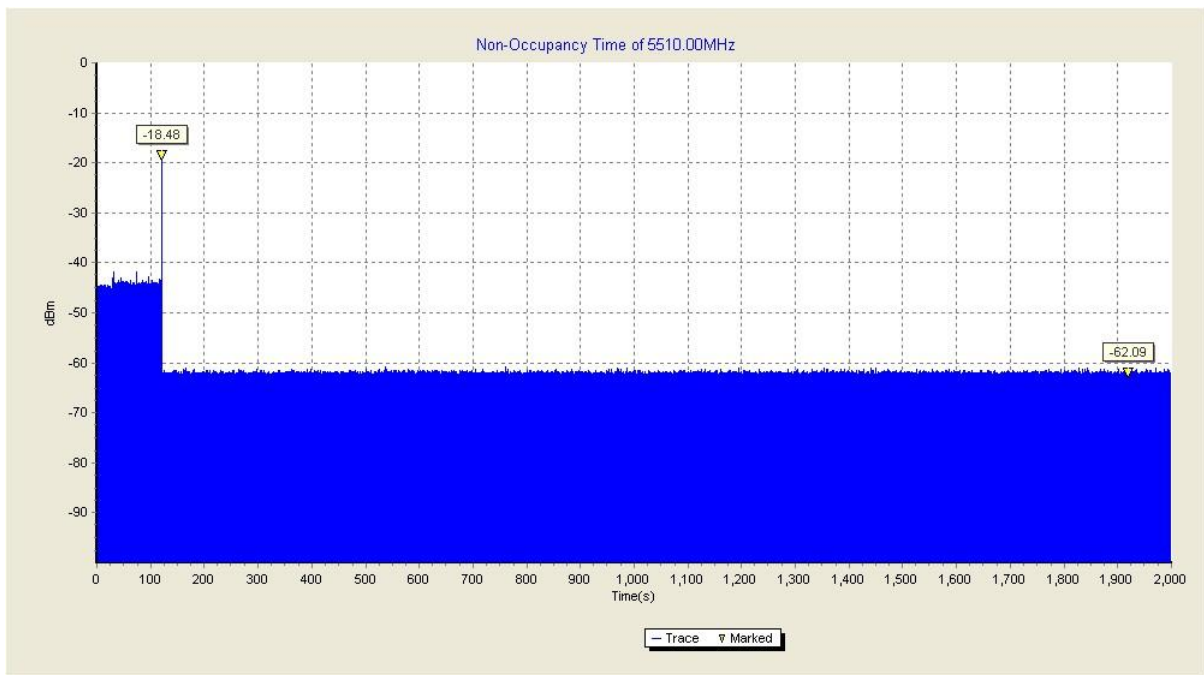

Fig.6 Non-Occupancy Period (HT40 Frequency Band: 5470MHz ~ 5725MHz)

The figure above shows that the client does not transmit any emission within 1800 seconds after getting the order of "stop transmits" from the DFS master (access point).

Conclusion: PASS

ANNEX B: PHOTOGRAPHS OF THE TEST SET-UP

Layout of Conducted Test



*** END OF REPORT BODY ***