



# TEST REPORT

No.I19N02247-SAR

For

**Doro AB**

**LTE phone**

**Model Name: DSB-0230**

With

**Hardware Version: 1031**

**Software Version:**

**MAGIC01A-S10A\_DSB0230\_123\_USERDEBUG\_190925**

**FCC ID: WS5DSB0230**

**Issued Date: 2019-11-20**

**Designation Number: CN1210**

**Note:**

The test results in this test report relate only to the devices specified in this report. This report shall not be reproduced except in full without the written approval of SAICT.

**Test Laboratory:**

Shenzhen Academy of Information and Communications Technology

Building G, Shenzhen International Innovation Center, No.1006 Shennan Road, Futian District, Shenzhen,

Guangdong, P. R. China 518026.

Tel: +86(0)755-33322000, Fax: +86(0)755-33322001

Email: [yewu@caict.ac.cn](mailto:yewu@caict.ac.cn), website: [www.cszit.com](http://www.cszit.com)

## **REPORT HISTORY**

<b>Report Number</b>	<b>Revision</b>	<b>Issue Date</b>	<b>Description</b>
I19N02247-SAR	Rev.0	2019-11-20	Initial creation of test report

## TABLE OF CONTENT

<b>1 SUMMARY OF TEST REPORT .....</b>	<b>5</b>
1.1 TEST ITEMS .....	5
1.2 TEST STANDARDS .....	5
1.3 TEST RESULT .....	5
1.4 TESTING LOCATION .....	5
1.5 PROJECT DATA .....	5
1.6 SIGNATURE.....	5
<b>2 STATEMENT OF COMPLIANCE .....</b>	<b>6</b>
<b>3 CLIENT INFORMATION .....</b>	<b>8</b>
3.1 APPLICANT INFORMATION .....	8
3.2 MANUFACTURER INFORMATION .....	8
<b>4 EQUIPMENT UNDER TEST (EUT) AND ANCILLARY EQUIPMENT (AE) .....</b>	<b>9</b>
4.1 ABOUT EUT .....	9
4.2 INTERNAL IDENTIFICATION OF EUT USED DURING THE TEST .....	9
4.3 INTERNAL IDENTIFICATION OF AE USED DURING THE TEST .....	10
<b>5 TEST METHODOLOGY .....</b>	<b>10</b>
5.1 APPLICABLE LIMIT REGULATIONS .....	10
5.2 APPLICABLE MEASUREMENT STANDARDS.....	10
<b>6 SPECIFIC ABSORPTION RATE (SAR).....</b>	<b>11</b>
6.1 INTRODUCTION.....	11
6.2 SAR DEFINITION.....	11
<b>7 TISSUE SIMULATING LIQUIDS .....</b>	<b>12</b>
7.1 TARGETS FOR TISSUE SIMULATING LIQUID .....	12
7.2 DIELECTRIC PERFORMANCE .....	12
<b>8 SYSTEM VERIFICATION .....</b>	<b>16</b>
8.1 SYSTEM SETUP.....	16
8.2 SYSTEM VERIFICATION.....	17
<b>9 MEASUREMENT PROCEDURES .....</b>	<b>18</b>
9.1 TESTS TO BE PERFORMED .....	18
9.2 GENERAL MEASUREMENT PROCEDURE.....	20
9.3 GSM MEASUREMENT PROCEDURES FOR SAR .....	21
9.4 WCDMA MEASUREMENT PROCEDURES FOR SAR .....	21
9.5 BLUETOOTH & WI-FI MEASUREMENT PROCEDURES FOR SAR.....	22
9.6 SAR MEASUREMENT FOR LTE.....	22
9.7 POWER DRIFT.....	23
9.8 PROXIMITY SENSOR CONSIDERATIONS .....	23
<b>10 CONDUCTED OUTPUT POWER.....</b>	<b>24</b>
10.1 GSM MEASUREMENT RESULT .....	24
10.2 WCDMA MEASUREMENT RESULT .....	26
10.3 LTE MEASUREMENT RESULT .....	28

10.4 WI-FI AND BT MEASUREMENT RESULT .....	32
<b>11 SIMULTANEOUS TX SAR CONSIDERATIONS .....</b>	<b>34</b>
11.1 INTRODUCTION.....	34
11.2 TRANSMIT ANTENNA SEPARATION DISTANCES .....	34
11.3 SAR MEASUREMENT POSITIONS .....	35
11.4 STANDALONE SAR TEST EXCLUSION CONSIDERATIONS .....	35
<b>12 EVALUATION OF SIMULTANEOUS.....</b>	<b>36</b>
<b>13 SUMMARY OF TEST RESULTS.....</b>	<b>38</b>
13.1 SAR RESULTS.....	39
13.2 WLAN EVALUATION FOR 2.4G .....	45
13.3 WLAN EVALUATION FOR 5G .....	47
<b>14 SAR MEASUREMENT VARIABILITY.....</b>	<b>49</b>
<b>15 MEASUREMENT UNCERTAINTY .....</b>	<b>50</b>
15.1 MEASUREMENT UNCERTAINTY FOR NORMAL SAR TESTS (300MHZ~3GHZ) .....	50
15.2 MEASUREMENT UNCERTAINTY FOR NORMAL SAR TESTS (3GHZ~6GHZ).....	51
<b>16 MAIN TEST INSTRUMENTS.....</b>	<b>52</b>
<b>ANNEX A GRAPH RESULTS.....</b>	<b>53</b>
<b>ANNEX B SYSTEMVERIFICATION RESULTS .....</b>	<b>68</b>
<b>ANNEX C SAR MEASUREMENT SETUP.....</b>	<b>75</b>
C.1 MEASUREMENT SET-UP .....	75
C.2 DASY5 E-FIELD PROBE SYSTEM.....	76
C.3 E-FIELD PROBE CALIBRATION .....	76
C.4 OTHER TEST EQUIPMENT.....	77
<b>ANNEX D POSITION OF THE WIRELESS DEVICE IN RELATION TO THE PHANTOM .....</b>	<b>81</b>
D.1 GENERAL CONSIDERATIONS .....	81
D.2 BODY-WORN DEVICE .....	82
D.3 DESKTOP DEVICE.....	82
D.4 DUT SETUP PHOTOS.....	83
<b>ANNEX E EQUIVALENT MEDIA RECIPES.....</b>	<b>84</b>
<b>ANNEX F SYSTEM VALIDATION.....</b>	<b>85</b>
<b>ANNEX G DAE CALIBRATION CERTIFICATE.....</b>	<b>86</b>
<b>ANNEX H PROBE CALIBRATION CERTIFICATE.....</b>	<b>89</b>
<b>ANNEX I DIPOLE CALIBRATION CERTIFICATE.....</b>	<b>100</b>
<b>ANNEX J SENSOR TRIGGERING DATA SUMMARY .....</b>	<b>146</b>
<b>ANNEX K EXTENDED CALIBRATION SAR DIPOLE .....</b>	<b>148</b>

## 1 Summary of Test Report

### 1.1 Test Items

Description: LTE phone  
Model Name: DSB-0230  
Applicant's name: Doro AB  
Manufacturer's Name: CK TELECOM LTD.

### 1.2 Test Standards

Please refer to "5. Test Methodology"

### 1.3 Test Result

Please refer to "14. Summary of Test Results"

### 1.4 Testing Location

Address: Building G, Shenzhen International Innovation Center, No.1006 Shennan Road,  
Futian District, Shenzhen, Guangdong, P. R. China

### 1.5 Project Data

Testing Start Date: October 18, 2019  
Testing End Date: November 14, 2019

### 1.6 Signature

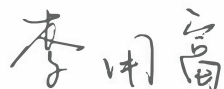

---

Li yongfu  
(Prepared this test report)



---

Zhang Yunzhan  
(Reviewed this test report)



---

Cao Junfei  
Deputy Director of the laboratory  
(Approved this test report)

## 2 Statement of Compliance

The maximum results of Specific Absorption Rate (SAR) found during testing for Doro AB LTE phone DSB-0230 are as follows:

**Table 2.1: Highest Reported SAR for Head (1g)**

Exposure Configuration	Technology Band	Highest Reported SAR 1g(W/Kg)	Equipment Class
Head (Separation Distance 0mm)	GSM850	0.16	PCE
	PCS1900	0.27	
	UMTS FDD 5	0.19	
	UMTS FDD 2	0.50	
	LTE Band 7	0.79	
	BT 2.4GHz	0.08	DSS
	WLAN 2.4GHz	0.87	DTS
	WLAN 5GHz	0.94	NII

**Table 2.2: Highest Reported SAR for Hotspot / Body Worn (1g)**

Exposure Configuration	Technology Band	Highest Reported SAR 1g(W/Kg)	Equipment Class
Hotspot / Body Worn (Separation Distance 10 mm)	GSM850	0.20	PCE
	PCS1900	0.68	
	UMTS FDD 5	0.25	
	UMTS FDD 2	1.02	
	LTE Band 7	<b>1.15</b>	
	WLAN 2.4GHz	0.22	DTS
	WLAN 5GHz	0.22	NII

The SAR values found for the Mobile Phone are below the maximum recommended levels of 1.6 W/Kg as averaged over any 1g tissue according to the ANSI C95.1-1992.

The EUT battery must be fully charged and checked periodically during the test to ascertain uniform power output.

The measurement together with the test system set-up is described in annex C of this test report. A detailed description of the equipment under test can be found in chapter 4 of this test report.

The highest reported SAR value is obtained at the case of **(Table 2.1 & 2.2)**, and the value is: **1.15W/kg (1g)**.

**Table2.3: The sum of reported SAR values for main antenna and Wi-Fi**

/	Position	Main antenna	Wi-Fi	Sum	SPLSR
Highest reported SAR value for Head	Left Cheek	0.79	0.87	1.66	Yes
Highest reported SAR value for Body	Front	1.15	0.14	1.29	/

According to the KDB 447498 D01, when the sum of SAR is larger than the limit, SAR test exclusion is determined by the SAR to peak location separation ratio. The ratio is determined by  $(SAR1 + SAR2)^{1.5}/R_i$ , rounded to two decimal digits, and must be  $\leq 0.04$  for all antenna pairs in the configuration to qualify for 1-g SAR test exclusion.

**Table2.4: The sum of reported SAR values for main antenna and BT**

/	Position	Main antenna	BT*	Sum
Highest reported SAR value for Head	Left Touch	0.79	0.08	0.87
Highest reported SAR value for Body	Front	1.15	0.33	1.48

BT\*-Estimated SAR for Bluetooth (seethetable12.3)

According to the above tables, the highest sum of reported SAR values is **1.66 W/kg (1g)**.

The detail for simultaneous transmission consideration is described in chapter 12.

### 3 Client Information

#### 3.1 Applicant Information

Company Name:	Doro AB
Address /Post:	Jörgen Kocksgatan 1B SE-211 20 Malmö Sweden
Contact:	Per Carlenhag
Email:	per.carlenhag@doro.com
Telephone:	+46 46 280 5000
Fax:	+46 46 280 5001

#### 3.2 Manufacturer Information

Company Name:	CK TELECOM LTD
Address /Post:	Technology Road. High-Tech Development Zone. Heyuan, Guangdong, P.R. China
Contact:	mourong xie
Email:	mourong.xie@ck-telecom.com
Telephone:	+86 0755-26739100 ext.8514
Fax:	+86 0755-26739600



## 4 Equipment under Test (EUT) and Ancillary Equipment (AE)

### 4.1 About EUT

Description:	LTE phone
Model Name:	DSB-0230
Brand Name	Doro
Condition of EUT as received	No obvious damage in appearance
Operating mode(s):	GSM 850/1900, WCDMA 850/1900, LTE Band 7, Bluetooth, Wi-Fi 2.4G/5G
Tested Tx Frequency:	824.2 – 848.8MHz (GSM 850)
	1850.2 – 1910MHz (GSM 1900)
	826.4 – 846.6MHz (WCDMA850 Band V)
	1852.4 – 1907.6MHz (WCDMA1900 Band II)
	2502.5 – 2567.5MHz (LTE_FDD Band 7)
	2402 – 2480MHz (Bluetooth 2.4G)
	2412 – 2462MHz (Wi-Fi 2.4G)
5180 – 5825MHz (Wi-Fi 5G)	
GPRS / EGPRS Multislot Class:	33
GPRS capability Class:	B
Test device Production information:	Production unit
Device type:	Portable device
Antenna type:	Integrated antenna
Hotspot mode:	Support
Product Dimensions:	Long 152.9mm ;Wide 70.6mm ; Overall Diagonal 157mm
Display Diagonal:	140mm
<b>Remark:</b>	
1. This device does not support DTM operation.	
2. This device has two cellular antennas, and the DIV antenna has only signal receiving function	

### 4.2 Internal Identification of EUT used during the test

EUT ID*	IMEI	HW Version	SW Version
EUT1	358707100008109	1031	MAGIC01A-S10A_DSB0230_123_USERDEBUG_190925
EUT2	358707100005436	1031	MAGIC01A-S10A_DSB0230_123_USERDEBUG_190925
EUT3	358707100004025	1031	MAGIC01A-S10A_DSB0230_123_USERDEBUG_190925

\*EUT ID: is used to identify the test sample in the lab internally.

**Note:** It is performed to test SAR with the EUT 1 & 2, and conducted power with the EUT 3.

### 4.3 Internal Identification of AE used during the test

AE ID*	Description	Model	Manufacturer
AE1	Battery	DBV 3000A	Dongguang HongDe Battery Co.,Ltd
AE4	Headset	150C-333E-3.5MM-2 8A V3	BOLUO COUNTY QUANCHENG ELECTRONIC CO.,LTD

\*AE ID: is used to identify the test sample in the lab internally.

## 5 Test Methodology

### 5.1 Applicable Limit Regulations

**ANSI C95.1–1992:** IEEE Standard for Safety Levels with Respect to Human Exposure to Radio Frequency Electromagnetic Fields, 3 kHz to 300 GHz.

It specifies the maximum exposure limit of **1.6 W/kg** as averaged over any 1 gram of tissue for portable devices being used within 20 cm of the user in the uncontrolled environment.

### 5.2 Applicable Measurement Standards

**IEEE 1528–2013:** Recommended Practice for Determining the Peak Spatial-Average Specific Absorption Rate (SAR) in the Human Head from Wireless Communications Devices: Experimental Techniques.

**KDB 447498 D01 General RF Exposure Guidance v06:** Mobile and Portable Devices RF Exposure Procedures and Equipment Authorization Policies.

**KDB 648474 D04 Handset SAR v01r03:** SAR Evaluation Considerations for Wireless Handsets.

**KDB 941225 D01 SAR test for 3G devices v03r01:** SAR Measurement Procedures for 3G Devices

**KDB 941225 D05 SAR for LTE Devices v02r05:** SAR Evaluation Considerations for LTE Devices

**KDB 941225 D06 Hot Spot SAR v02r01:** SAR Evaluation Procedures for Portable Devices with Wireless Router Capabilities

**KDB 248227 D01 802.11 Wi-Fi SAR v02r02:** SAR Guidance for IEEE 802.11 (Wi-Fi) Transmitters.

**KDB 865664 D01 SAR measurement 100 MHz to 6 GHz v01r04:** SAR Measurement Requirements for 100 MHz to 6 GHz.

**KDB 865664 D02 RF Exposure Reporting v01r02:** RF Exposure Compliance Reporting and Documentation Considerations

**TCB workshop April 2019; RF Exposure Procedures (Tissue Simulating Liquids)**

## 6 Specific Absorption Rate (SAR)

### 6.1 Introduction

SAR is related to the rate at which energy is absorbed per unit mass in an object exposed to a radio field. The SAR distribution in a biological body is complicated and is usually carried out by experimental techniques or numerical modeling. The standard recommends limits for two tiers of groups, occupational/controlled and general population/uncontrolled, based on a person's awareness and ability to exercise control over his or her exposure. In general, occupational/controlled exposure limits are higher than the limits for general population/uncontrolled.

### 6.2 SAR Definition

The SAR definition is the time derivative (rate) of the incremental energy ( $dW$ ) absorbed by (dissipated in) an incremental mass ( $dm$ ) contained in a volume element ( $dv$ ) of a given density ( $\rho$ ). The equation description is as below:

$$SAR = \frac{d}{dt} \left( \frac{dW}{dm} \right) = \frac{d}{dt} \left( \frac{dW}{\rho dv} \right)$$

SAR is expressed in units of Watts per kilogram (W/kg)

SAR measurement can be either related to the temperature elevation in tissue by

$$SAR = c \left( \frac{\delta T}{\delta t} \right)$$

Where:  $C$  is the specific heat capacity,  $\delta T$  is the temperature rise and  $\delta t$  is the exposure duration, or related to the electrical field in the tissue by

$$SAR = \frac{\sigma |E|^2}{\rho}$$

Where:  $\sigma$  is the conductivity of the tissue,  $\rho$  is the mass density of tissue and  $E$  is the RMS electrical field strength.

However for evaluating SAR of low power transmitter, electrical field measurement is typically applied.

## 7 Tissue Simulating Liquids

### 7.1 Targets for tissue simulating liquid

**Table 7.1: Targets for tissue simulating liquid**

Frequency (MHz)	Liquid Type	Conductivity ( $\sigma$ )	$\pm 5\%$ Range	Permittivity ( $\epsilon$ )	$\pm 5\%$ Range
835	Head	0.90	0.86~0.95	41.5	39.4~43.6
1900	Head	1.40	1.33~1.47	40.0	38.0~42.0
2450	Head	1.80	1.71~1.89	39.2	37.2~41.2
2550	Head	1.91	1.81~2.01	39.1	37.1~41.0
5250	Head	4.71	4.47~4.95	35.9	34.1~37.7
5600	Head	5.07	4.82~5.32	35.5	33.8~37.3
5750	Head	5.22	4.96~5.48	35.4	33.6~37.1

### 7.2 Dielectric Performance

**Table 7.2: Dielectric Performance of Tissue Simulating Liquid**

Measurement Date (yyyy-mm-dd)	Type	Frequency	Conductivity $\sigma$ (S/m)	Drift (%)	Permittivity $\epsilon$	Drift (%)
2019-10-18	Head	835	0.913	1.44	40.78	-1.73
2019-10-20	Head	1900	1.393	-0.50	38.64	-3.40
2019-11-14	Head	2450	1.825	1.39	38.53	-1.71
2019-10-21	Head	2550	1.946	1.88	38.16	-2.40
2019-10-24	Head	5250	4.768	1.23	34.77	-3.15
2019-10-24	Head	5600	4.954	-2.29	35.92	1.18
2019-10-24	Head	5800	5.136	-1.61	36.28	2.49

Note: The liquid temperature is 22.0°C.

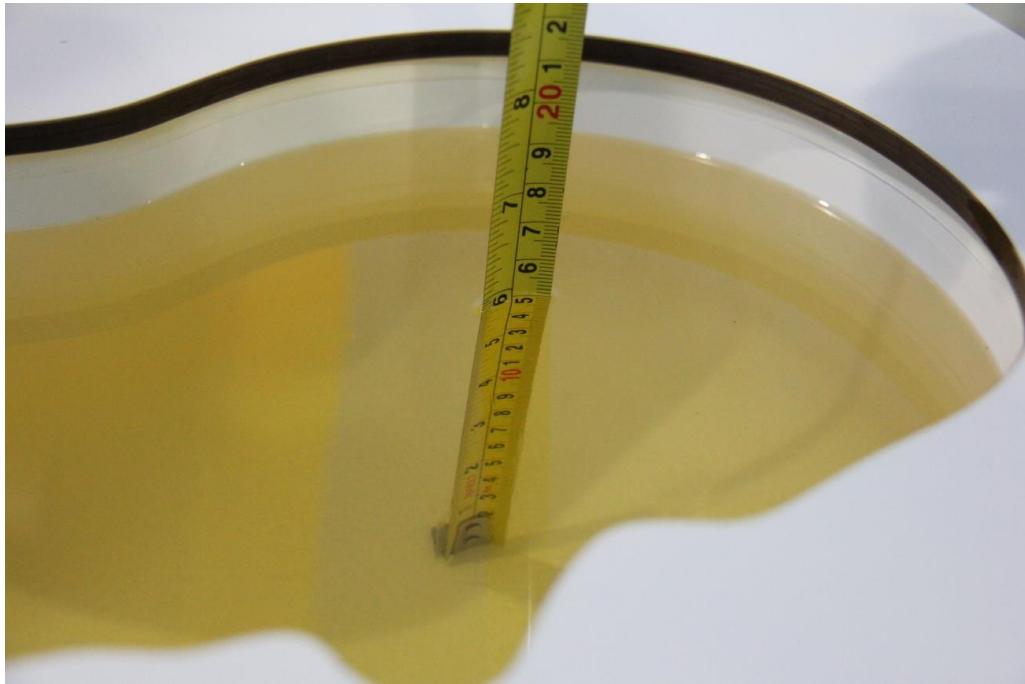

**Picture 7-1: Liquid depth in the Head Phantom (835MHz)**



**Picture 7-2: Liquid depth in the Head Phantom (1900MHz)**

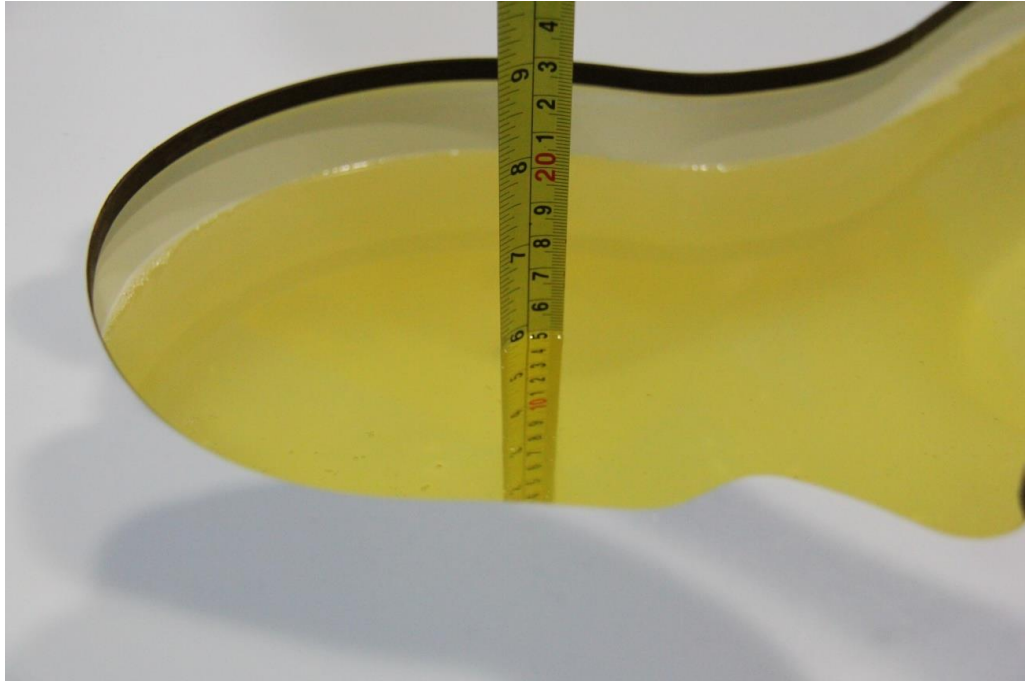

**Picture 7-3: Liquid depth in the Head Phantom (2450MHz)**

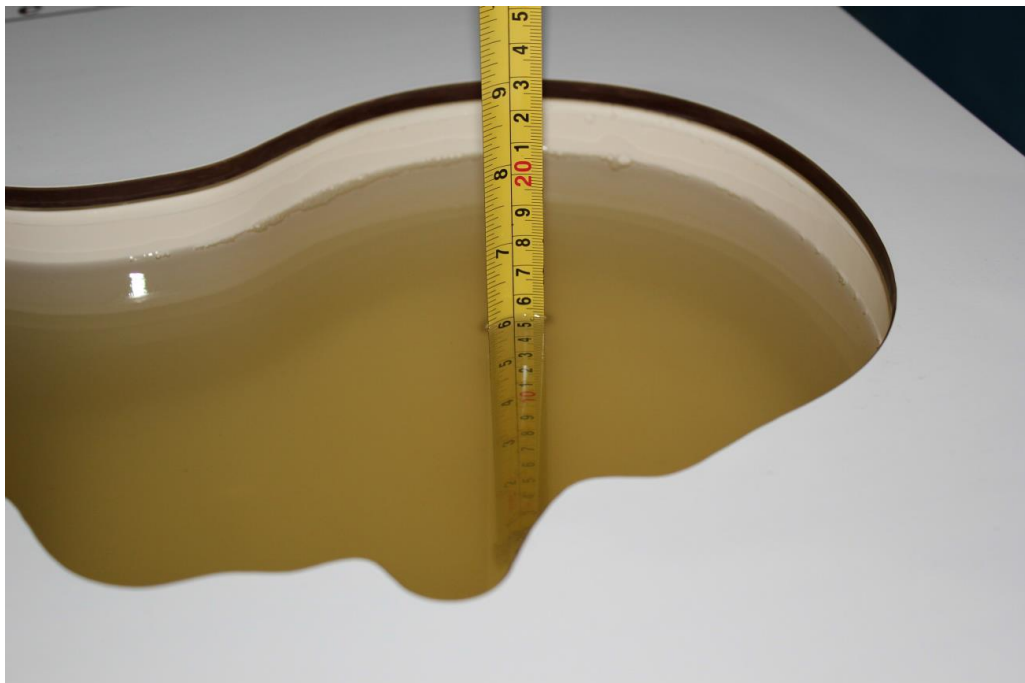

**Picture 7-4: Liquid depth in the Head Phantom (2550MHz)**

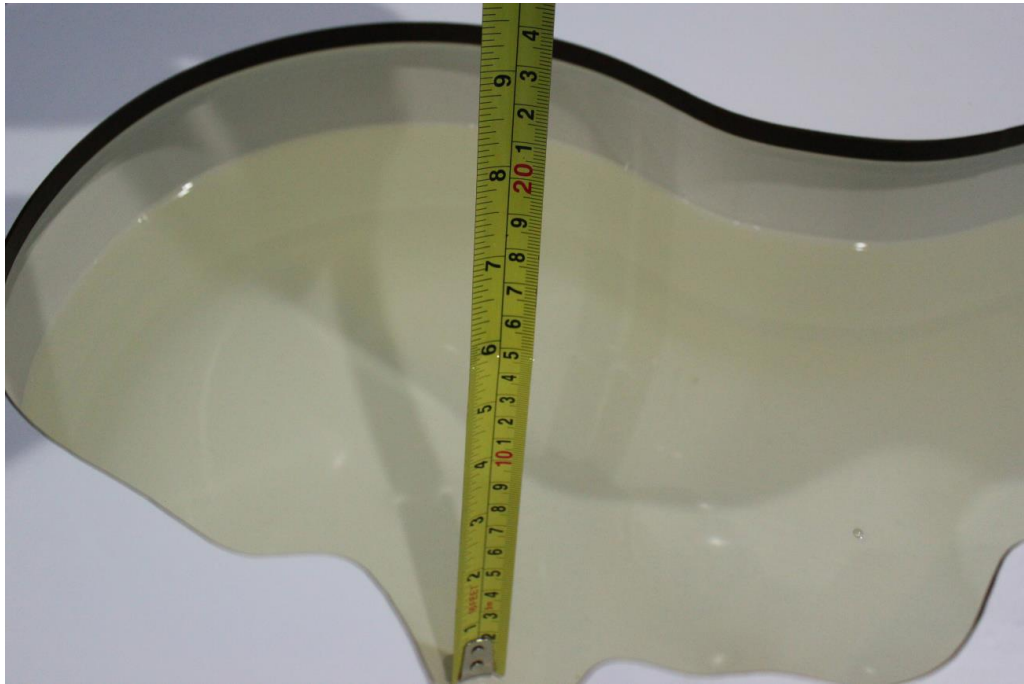

**Picture 7-5: Liquid depth in the Head Phantom (5GHz)**

## 8 System verification

### 8.1 System Setup

In the simplified setup for system evaluation, the DUT is replaced by a calibrated dipole and the power source is replaced by a continuous wave that comes from a signal generator. The calibrated dipole must be placed beneath the flat phantom section of the SAM twin phantom with the correct distance holder. The distance holder should touch the phantom surface with a light pressure at the reference marking and be oriented parallel to the long side of the phantom. The equipment setup is shown below:

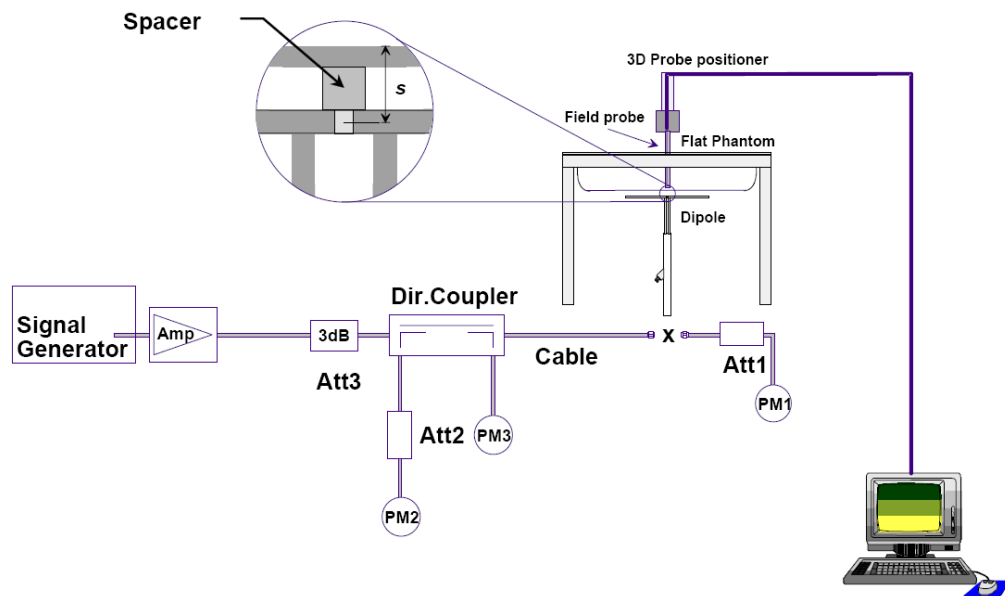

Picture 8.1 System Setup for System Evaluation



Picture 8.2 Photo of Dipole Setup



## 8.2 System Verification

SAR system verification is required to confirm measurement accuracy, according to the tissue dielectric media, probe calibration points and other system operating parameters required for measuring the SAR of a test device. The system verification must be performed for each frequency band and within the valid range of each probe calibration point required for testing the device.

**Table 8.1: System Verification of Head**

Measurement Date (yyyy-mm-dd)	Frequency	Target value (W/kg)		Measured value (W/kg)		Deviation (%)	
		10 g Average	1 g Average	10 g Average	1 g Average	10 g Average	1 g Average
2019-10-18	835 MHz	6.29	9.62	6.44	10.04	2.38	4.37
2019-10-20	1900 MHz	21.0	40.5	20.52	38.68	-2.29	-4.49
2019-11-14	2450 MHz	24.1	52.0	24.60	54.00	2.07	3.85
2019-10-21	2550 MHz	26.5	57.8	27.28	60.40	2.94	4.50
2019-10-24	5250 MHz	22.3	78.0	22.80	80.60	2.24	3.33
2019-10-24	5600 MHz	22.7	79.5	22.30	76.90	-1.76	-3.27
2019-10-24	5750 MHz	22.2	78.4	21.70	75.70	-2.25	-3.44

## 9 Measurement Procedures

### 9.1 Tests to be performed

In order to determine the highest value of the peak spatial-average SAR of a handset, all device positions, configurations and operational modes shall be tested for each frequency band according to steps 1 to 3 below. A flowchart of the test process is shown in picture 9.1.

**Step 1:** The tests described in 9.2 shall be performed at the channel that is closest to the center of the transmit frequency band ( $f_c$ ) for:

- a) all device positions (cheek and tilt, for both left and right sides of the SAM phantom, as described in annex D),
- b) all configurations for each device position in a), e.g., antenna extended and retracted, and
- c) all operational modes, e.g., analogue and digital, for each device position in a) and configuration in b) in each frequency band.

If more than three frequencies need to be tested according to 11.1 (i.e.,  $N_c > 3$ ), then all frequencies, configurations and modes shall be tested for all of the above test conditions.

**Step 2:** For the condition providing highest peak spatial-average SAR determined in Step 1, perform all tests described in 9.2 at all other test frequencies, i.e., lowest and highest frequencies. In addition, for all other conditions (device position, configuration and operational mode) where the peak spatial-average SAR value determined in Step 1 is within 3 dB of the applicable SAR limit, it is recommended that all other test frequencies shall be tested as well.

**Step 3:** Examine all data to determine the highest value of the peak spatial-average SAR found in Steps 1 to 2.

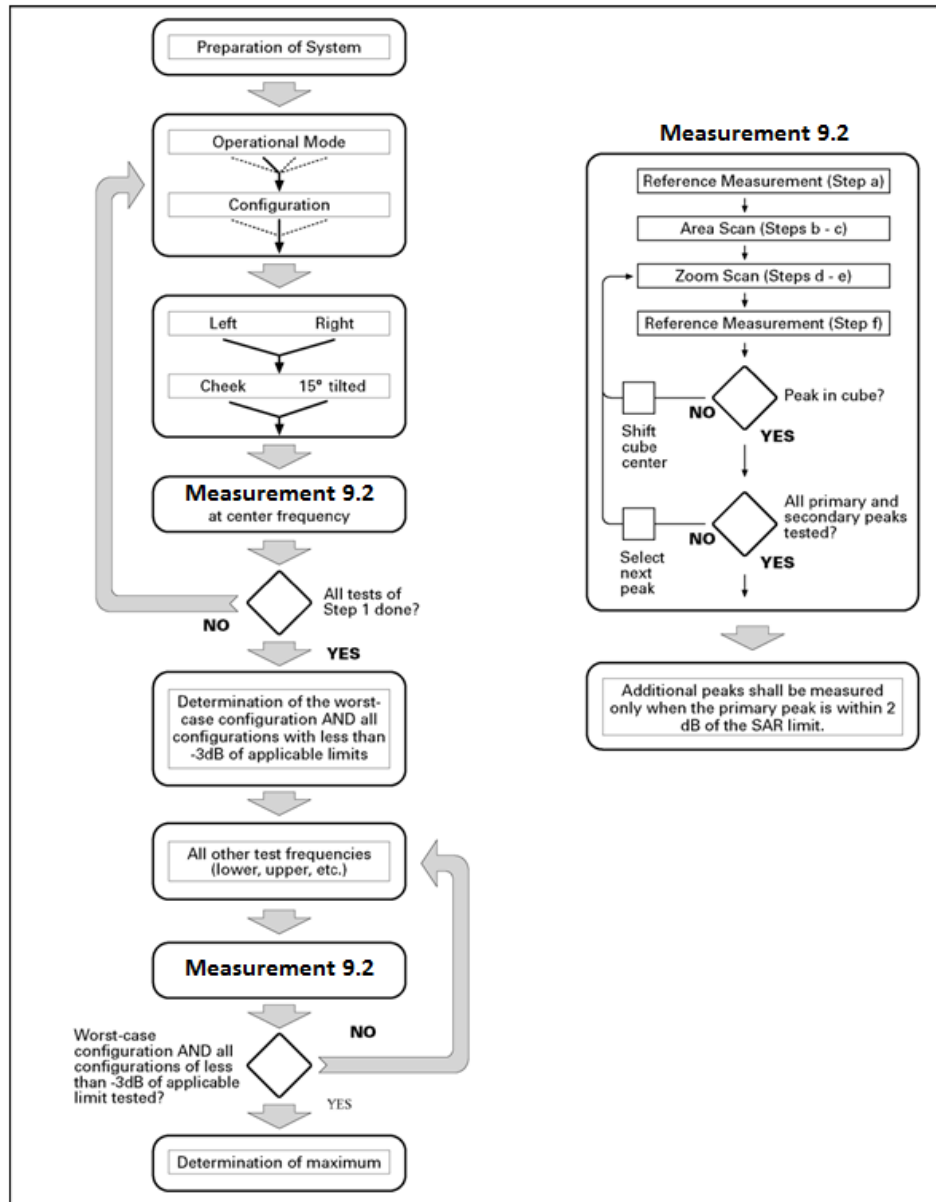

Picture 9.1 Block diagram of the tests to be performed

## 9.2 General Measurement Procedure

The area and zoom scan resolutions specified in the table below must be applied to the SAR measurements and fully documented in SAR reports to qualify for TCB approval. Probe boundary effect error compensation is required for measurements with the probe tip closer than half a probe tip diameter to the phantom surface. Both the probe tip diameter and sensor offset distance must satisfy measurement protocols; to ensure probe boundary effect errors are minimized and the higher fields closest to the phantom surface can be correctly measured and extrapolated to the phantom surface for computing 1-g SAR. Tolerances of the post-processing algorithms must be verified by the test laboratory for the scan resolutions used in the SAR measurements, according to the reference distribution functions specified in IEEE Std 1528-2013. The results should be documented as part of the system validation records and may be requested to support test results when all the measurement parameters in the following table are not satisfied.

		$\leq 3$ GHz	$> 3$ GHz	
Maximum distance from closest measurement point (geometric center of probe sensors) to phantom surface		$5 \pm 1$ mm	$\frac{1}{2} \cdot \delta \cdot \ln(2) \pm 0.5$ mm	
Maximum probe angle from probe axis to phantom surface normal at the measurement location		$30^\circ \pm 1^\circ$	$20^\circ \pm 1^\circ$	
Maximum area scan spatial resolution: $\Delta x_{Area}, \Delta y_{Area}$		$\leq 2$ GHz: $\leq 15$ mm 2 – 3 GHz: $\leq 12$ mm	3 – 4 GHz: $\leq 12$ mm 4 – 6 GHz: $\leq 10$ mm	
		When the x or y dimension of the test device, in the measurement plane orientation, is smaller than the above, the measurement resolution must be $\leq$ the corresponding x or y dimension of the test device with at least one measurement point on the test device.		
Maximum zoom scan spatial resolution: $\Delta x_{Zoom}, \Delta y_{Zoom}$		$\leq 2$ GHz: $\leq 8$ mm 2 – 3 GHz: $\leq 5$ mm*	3 – 4 GHz: $\leq 5$ mm* 4 – 6 GHz: $\leq 4$ mm*	
Maximum zoom scan spatial resolution, normal to phantom surface	uniform grid: $\Delta z_{Zoom}(n)$	$\leq 5$ mm	3 – 4 GHz: $\leq 4$ mm 4 – 5 GHz: $\leq 3$ mm 5 – 6 GHz: $\leq 2$ mm	
	graded grid	$\Delta z_{Zoom}(1)$ : between 1 <sup>st</sup> two points closest to phantom surface	$\leq 4$ mm	3 – 4 GHz: $\leq 3$ mm 4 – 5 GHz: $\leq 2.5$ mm 5 – 6 GHz: $\leq 2$ mm
		$\Delta z_{Zoom}(n>1)$ : between subsequent points	$\leq 1.5 \cdot \Delta z_{Zoom}(n-1)$	
Minimum zoom scan volume	x, y, z	$\geq 30$ mm	3 – 4 GHz: $\geq 28$ mm 4 – 5 GHz: $\geq 25$ mm 5 – 6 GHz: $\geq 22$ mm	
<p>Note: <math>\delta</math> is the penetration depth of a plane-wave at normal incidence to the tissue medium; see draft standard IEEE P1528-2011 for details.</p> <p>* When zoom scan is required and the reported SAR from the area scan based 1-g SAR estimation procedures of KDB 447498 is <math>\leq 1.4</math> W/kg, <math>\leq 8</math> mm, <math>\leq 7</math> mm and <math>\leq 5</math> mm zoom scan resolution may be applied, respectively, for 2 GHz to 3 GHz, 3 GHz to 4 GHz and 4 GHz to 6 GHz.</p>				

### 9.3 GSM Measurement Procedures for SAR

The following procedures may be considered for each frequency band to determine SAR test reduction for devices operating in GSM/GPRS/EDGE modes to demonstrate RF exposure compliance. GSM voice mode transmits with 1 time slot. GPRS and EDGE may transmit up to 4 time slots in the 8 time-slot frame according to the multislot class implemented in a device.

SAR test reduction for GPRS and EDGE modes is determined by the source-based time-averaged output power specified for production units, including tune-up tolerance. The data mode with highest specified time-averaged output power should be tested for SAR compliance in the applicable exposure conditions. For modes with the same specified maximum output power and tolerance, the higher number time-slot configuration should be tested. GSM voice and GPRS data use GMSK, which is a constant amplitude modulation with minimal peak to average power difference within the time-slot burst. For EDGE, GMSK is used for MCS 1 – MCS 4 and 8-PSK is used for MCS 5 – MCS 9; where 8-PSK has an inherently higher peak-to-average power ratio. The GMSK and 8-PSK EDGE configurations are considered separately for SAR compliance. The GMSK EDGE configurations are grouped with GPRS and considered with respect to time-averaged maximum output power to determine compliance. The 3G SAR test reduction procedure is applied to 8-PSK EDGE with GMSK GPRS/EDGE as the primary mode.

### 9.4 WCDMA Measurement Procedures for SAR

The following procedures are applicable to WCDMA handsets operating under 3GPP Release99, Release 5 and Release 6. The default test configuration is to measure SAR with an established radio link between the DUT and a communication test set using a 12.2kbps RMC (reference measurement channel) configured in Test Loop Mode 1. SAR is selectively confirmed for other physical channel configurations (DPCCH & DPDCH<sub>n</sub>), HSDPA and HSPA (HSUPA/HSDPA) modes according to output power, exposure conditions and device operating capabilities. Both uplink and downlink should be configured with the same RMC or AMR, when required. SAR for Release 5 HSDPA and Release 6 HSPA are measured using the applicable FRC (fixed reference channel) and E-DCH reference channel configurations. Maximum output power is verified according to applicable versions of 3GPP TS 34.121 and SAR must be measured according to these maximum output conditions. When Maximum Power Reduction (MPR) is not implemented according to Cubic Metric (CM) requirements for Release 6 HSPA, the following procedures do not apply.

#### For Release 5 HSDPA Data Devices:

Sub-test	$\beta_c$	$\beta_d$	$\beta_d$ (SF)	$\beta_c / \beta_d$	$\beta_{hs}$	CM/dB
1	2/15	15/15	64	2/15	4/15	0.0
2	12/15	15/15	64	12/15	24/25	1.0
3	15/15	8/15	64	15/8	30/15	1.5
4	15/15	4/15	64	15/4	30/15	1.5

### For Release 6 HSPA Data Devices

Sub-test	$\beta_c$	$\beta_d$	$\beta_d$ (SF)	$\beta_c / \beta_d$	$\beta_{hs}$	$\beta_{ec}$	$\beta_{ed}$	$\beta_{ed}$ (SF)	$\beta_{ed}$ (codes)	CM (dB)	MPR (dB)	AG Index	E-TFCI
1	11/15	15/15	64	11/15	22/15	209/225	1039/225	4	1	1.0	0.0	20	75
2	6/15	15/15	64	6/15	12/15	12/15	12/15	4	1	3.0	2.0	12	67
3	15/15	9/15	64	15/9	30/15	30/15	$\beta_{ed1}:47/15$ $\beta_{ed2}:47/15$	4	2	2.0	1.0	15	92
4	2/15	15/15	64	2/15	4/15	4/15	56/75	4	1	3.0	2.0	17	71
5	15/15	15/15	64	15/15	24/15	30/15	134/15	4	1	1.0	0.0	21	81

### 9.5 Bluetooth & WI-FI Measurement Procedures for SAR

Normal network operating configurations are not suitable for measuring the SAR of 802.11 transmitters in general. Unpredictable fluctuations in network traffic and antenna diversity conditions can introduce undesirable variations in SAR results. The SAR for these devices should be measured using chipset based test mode software to ensure that the results are consistent and reliable.

Chipset based test mode software is hardware dependent and generally varies among manufacturers. The device operating parameters established in a test mode for SAR measurements must be identical to those programmed in production units, including output power levels, amplifier gain settings and other RF performance tuning parameters. The test frequencies should correspond to actual channel frequencies defined for domestic use. SAR for devices with switched diversity should be measured with only one antenna transmitting at a time during each SAR measurement, according to a fixed modulation and data rate. The same data pattern should be used for all measurements.

### 9.6 SAR Measurement for LTE

SAR tests for LTE are performed with a base station simulator, Anristu MT8820C. Closed loop power control was used so the UE transmits with maximum output power during SAR testing. All powers were measured with the Anristu MT8820C. It is performed for conducted power and SAR based on the KDB941225 D05.

SAR is evaluated separately according to the following procedures for the different test positions in each exposure condition – head, body, body-worn accessories and other use conditions. The procedures in the following subsections are applied separately to test each LTE frequency band.

#### 1) QPSK with 1 RB allocation

Start with the largest channel bandwidth and measure SAR for QPSK with 1 RB allocation, using the RB offset and required test channel combination with the highest maximum output power among RB offsets at the upper edge, middle and lower edge of each required test channel. When the reported SAR is  $\leq 0.8$  W/kg, testing of the remaining RB offset configurations and required test channels is not required for 1 RB allocation; otherwise, SAR

is required for the remaining required test channels and only for the RB offset configuration with the highest output power for that channel. When the reported SAR of a required test channel is  $> 1.45$  W/kg, SAR is required for all three RB offset configurations for that required test channel.

2) QPSK with 50% RB allocation

The procedures required for 1 RB allocation in 1) are applied to measure the SAR for QPSK with 50% RB allocation.

3) QPSK with 100% RB allocation

For QPSK with 100% RB allocation, SAR is not required when the highest maximum output power for 100 % RB allocation is less than the highest maximum output power in 50% and 1 RB allocations and the highest reported SAR for 1 RB and 50% RB allocation in 1) and 2) are  $\leq 0.8$  W/kg. Otherwise, SAR is measured for the highest output power channel; and if the reported SAR is  $> 1.45$  W/kg, the remaining required test channels must also be tested.

## 9.7 Power Drift

To control the output power stability during the SAR test, DASY5 system calculates the power drift by measuring the E-field at the same location at the beginning and at the end of the measurement for each test position. These drift values can be found in Section 14 labeled as: (Power Drift [dB]). This ensures that the power drift during one measurement is within 5%.

## 9.8 Proximity Sensor Considerations

This device uses a proximity sensor that share the same metallic electrode as the transmitting antenna to facilitate triggering in typical user interactivity with the device. Due to the operating configurations and exposure conditions required by the device, the proximity sensor is used to indicate when the Mobile Phone is held close to a user's body exposure condition. It utilizes the proximity sensor to reduce the output power in specific wireless and operating modes to ensure SAR compliance for the following scenarios: To reduce the output power of main antennas during body operating configurations. . It is also set an output power leveled to the lowest one to make sure that in any case of SAR sensor hardware failure the SAR requirements can still be satisfied.

Sensor triggering distance summary data is included in Appendix J.

## 10 Conducted Output Power

### 10.1 GSM Measurement result

During the process of testing, the EUT was controlled via Agilent Digital Radio Communication tester (E5515C) to ensure the maximum power transmission and proper modulation. This result contains conducted output power for the EUT. In all cases, the measured peak output power should be greater and within 5% than EMI measurement.

**Table 10.1: The conducted power measurement results for GSM**

GSM 850MHz	Tune up 34.5	Conducted Power (dBm)		
		Channel 251(848.8MHz)	Channel 190(836.6MHz)	Channel 128(824.2MHz)
		32.95	33.24	33.20
GSM 1900MHz	Tune up 31	Conducted Power(dBm)		
		Channel 810(1909.8MHz)	Channel 661(1880MHz)	Channel 512(1850.2MHz)
		29.41	29.60	29.72



**Table 10.2: The conducted power measurement results for GPRS and EGPRS**

GPRS850 / EGPRS850	Tune up	Measured Power (dBm)			calculation	Average Power (dBm)		
		251	190	128		251	190	128
1Tx-slots	<b>34.5</b>	32.79	33.04	33.05	<b>-9.03dB</b>	23.76	24.01	24.02
2Tx-slots	<b>31</b>	<b>29.90</b>	<b>30.05</b>	<b>30.20</b>	<b>-6.02dB</b>	<b>23.88</b>	<b>24.03</b>	<b>24.18</b>
3Tx-slots	<b>29</b>	27.96	27.89	28.27	<b>-4.26dB</b>	23.70	23.63	24.01
4Tx-slots	<b>27.5</b>	26.57	26.54	26.71	<b>-3.01dB</b>	23.56	23.53	23.70
EGPRS 850 (8PSK)	Tune up	Measured Power (dBm)			calculation	Measured Power (dBm)		
		251	190	128		251	190	128
1Tx-slots	<b>27.5</b>	26.54	26.72	27.01	<b>-9.03dB</b>	17.51	17.69	17.98
2Tx-slots	<b>26</b>	24.83	25.01	25.58	<b>-6.02dB</b>	18.81	18.99	19.56
3Tx-slots	<b>24</b>	22.86	22.88	23.34	<b>-4.26dB</b>	18.6	18.62	19.08
4Tx-slots	<b>22.5</b>	21.27	21.06	21.43	<b>-3.01dB</b>	18.26	18.05	18.42
GPRS1900 / EGPRS1900	Tune up	Measured Power (dBm)			calculation	Average Power (dBm)		
		810	661	512		810	661	512
1Tx-slots	<b>30.5</b>	29.27	29.44	29.62	<b>-9.03dB</b>	20.24	20.41	20.59
2Tx-slots	<b>28</b>	<b>26.67</b>	<b>26.83</b>	<b>27.13</b>	<b>-6.02dB</b>	<b>20.65</b>	<b>20.81</b>	<b>21.11</b>
3Tx-slots	<b>26</b>	24.42	24.65	24.86	<b>-4.26dB</b>	20.16	20.39	20.60
4Tx-slots	<b>24.5</b>	23.15	23.41	23.60	<b>-3.01dB</b>	20.14	20.40	20.59
EGPRS 1900 (8PSK)	Tune up	Measured Power (dBm)			calculation	Measured Power (dBm)		
		810	661	512		810	661	512
1Tx-slots	<b>26.5</b>	25.30	25.49	25.74	<b>-9.03dB</b>	16.27	16.46	16.71
2Tx-slots	<b>25</b>	23.78	24.01	24.37	<b>-6.02dB</b>	17.76	17.99	18.35
3Tx-slots	<b>23</b>	21.64	21.80	22.13	<b>-4.26dB</b>	17.38	17.54	17.87
4Tx-slots	<b>21</b>	19.73	19.78	20.08	<b>-3.01dB</b>	16.72	16.77	17.07

## NOTES:

## 1) Division Factors

To average the power, the division factor is as follows:

1TX-slot = 1 transmit time slot out of 8 time slots=> conducted power divided by (8/1) => -9.03dB

2TX-slots = 2 transmit time slots out of 8 time slots=> conducted power divided by (8/2) => -6.02dB

3TX-slots = 3 transmit time slots out of 8 time slots=> conducted power divided by (8/3) => -4.26dB

4TX-slots = 4 transmit time slots out of 8 time slots=> conducted power divided by (8/4) => -3.01dB

**According to the conducted power as above, the body measurements are performed with 2Txslots for 850MHz and 1900MHz.**

## 10.2 WCDMA Measurement result

Table 10.3: The conducted Power for WCDMA

**Full Power**

Item	band	FDD Band 2 result			
	ARFCN	Tune up	9538 (1907.6MHz)	9400 (1880MHz)	9262 (1852.4MHz)
WCDMA	\	<b>24</b>	23.1	23.2	23.4
HSUPA	1	<b>22.5</b>	21.5	21.6	21.6
	2	<b>22</b>	21.1	21.3	20.8
	3	<b>21.5</b>	20.7	20.8	20.8
	4	<b>22.5</b>	21.6	21.1	21.6
	5	<b>23</b>	22.1	22.2	22.4
HSDPA	1	<b>23</b>	22.1	22.1	22.4
	2	<b>23</b>	22.2	22.4	22.3
	3	<b>23</b>	21.6	21.8	21.8
	4	<b>23</b>	21.6	21.6	21.8
DC-HSDPA	1	<b>23</b>	22.0	22.1	22.2
	2	<b>23</b>	22.2	22.2	22.1
	3	<b>23</b>	21.5	21.6	21.7
	4	<b>23</b>	21.6	21.7	21.6
Item	band	FDD Band 5 result			
	ARFCN	Tune up	4233 (846.6MHz)	4182 (836.4MHz)	4132 (826.4MHz)
WCDMA	\	<b>24</b>	23.2	23.4	23.3
HSUPA	1	<b>23</b>	21.6	21.9	22.0
	2	<b>22</b>	20.9	21.5	20.9
	3	<b>22</b>	21.2	21.3	21.2
	4	<b>22.5</b>	21.8	21.9	21.9
	5	<b>23.5</b>	22.3	22.6	22.4
HSDPA	1	<b>23</b>	22.4	22.5	22.4
	2	<b>23</b>	22.4	22.6	22.4
	3	<b>23</b>	21.6	21.9	21.8
	4	<b>23</b>	21.9	21.9	21.8
DC-HSDPA	1	<b>23</b>	22.4	22.4	22.3
	2	<b>23</b>	22.4	22.5	22.3
	3	<b>23</b>	21.5	21.7	21.6
	4	<b>23</b>	21.8	21.8	21.6

**Sensor ON**

Item	band	FDD Band 2 result			
	ARFCN	Tune up	9538 (1907.6MHz)	9400 (1880MHz)	9262 (1852.4MHz)
<b>WCDMA</b>	\	<b>21.5</b>	21.3	20.5	20.4
<b>HSUPA</b>	<b>1</b>	<b>18</b>	16.4	17.5	16.9
	<b>2</b>	<b>18</b>	16.6	16.9	17.2
	<b>3</b>	<b>17</b>	15.7	15.8	16.3
	<b>4</b>	<b>17.5</b>	16.7	16.2	16.5
	<b>5</b>	<b>18.5</b>	17.1	17.3	17.6
<b>HSDPA</b>	<b>1</b>	<b>19.7</b>	18.3	17.8	19.7
	<b>2</b>	<b>19.7</b>	17.7	17.9	19.6
	<b>3</b>	<b>19</b>	17.0	17.9	18.8
	<b>4</b>	<b>19</b>	17.0	17.2	17.4
<b>DC-HSDPA</b>	<b>1</b>	<b>19.7</b>	18.2	17.9	19.5
	<b>2</b>	<b>19.7</b>	17.8	18.0	19.4
	<b>3</b>	<b>19</b>	17.2	17.9	18.6
	<b>4</b>	<b>19</b>	17.1	17.2	17.3

### 10.3 LTE Measurement result

**Table 10.4: The conducted Power for LTE**
**Full Power**

LTE-FDD Band 7				Actual output Power (dBm)			Tune up
Band-width	RB allocation	RB offset	Modulation	High	Middle	Low	
5 MHz				2567.4MHz	2535MHz	2502.5MHz	
	1RB	High	QPSK	21.97	22.20	22.08	<b>23</b>
			16QAM	20.82	20.74	20.78	<b>22</b>
		Middle	QPSK	22.12	22.23	22.09	<b>23</b>
			16QAM	20.86	21.03	21.39	<b>22</b>
		Low	QPSK	22.03	22.10	22.02	<b>23</b>
			16QAM	20.66	20.53	20.86	<b>22</b>
	12RB	High	QPSK	21.09	21.28	21.30	<b>22</b>
			16QAM	19.97	20.15	20.32	<b>21</b>
		Middle	QPSK	21.09	21.24	21.15	<b>22</b>
			16QAM	20.01	20.31	20.18	<b>21</b>
		Low	QPSK	21.11	21.22	21.17	<b>22</b>
			16QAM	20.03	20.36	20.23	<b>21</b>
	25RB	/	QPSK	21.10	21.26	21.28	<b>22</b>
16QAM			20.24	20.31	20.33	<b>21</b>	
10 MHz				2565MHz	2535MHz	2505MHz	/
	1RB	High	QPSK	22.05	22.47	22.15	<b>23</b>
			16QAM	20.87	21.21	20.84	<b>22</b>
		Middle	QPSK	22.14	22.23	22.19	<b>23</b>
			16QAM	21.08	21.15	21.00	<b>22</b>
		Low	QPSK	22.16	22.13	22.11	<b>23</b>
			16QAM	21.08	20.94	20.79	<b>22</b>
	25RB	High	QPSK	21.16	21.27	21.13	<b>22</b>
			16QAM	20.24	20.39	20.18	<b>21</b>
		Middle	QPSK	21.20	21.24	21.26	<b>22</b>
			16QAM	20.29	20.40	20.34	<b>21</b>
		Low	QPSK	21.16	21.37	21.17	<b>22</b>
			16QAM	20.26	20.43	20.18	<b>21</b>
	50RB	/	QPSK	21.10	21.39	21.21	<b>22</b>
16QAM			20.16	20.42	20.27	<b>21</b>	

**Full Power**

LTE-FDD Band 7				Actual output Power (dBm)			Tune up
Band-width	RB allocation	RB offset	Modulation	High	Middle	Low	
15 MHz				2562.5MHz	2535MHz	2507.5MHz	
	1RB	High	QPSK	21.99	22.39	22.38	<b>23</b>
			16QAM	20.35	20.97	21.28	<b>22</b>
		Middle	QPSK	22.43	22.05	22.32	<b>23</b>
			16QAM	20.74	20.89	21.33	<b>22</b>
		Low	QPSK	21.97	22.18	22.16	<b>23</b>
			16QAM	20.79	21.11	21.04	<b>22</b>
	36RB	High	QPSK	21.23	21.42	21.18	<b>22</b>
			16QAM	20.20	20.40	20.22	<b>21</b>
		Middle	QPSK	21.20	21.22	21.29	<b>22</b>
			16QAM	20.25	20.28	20.33	<b>21</b>
		Low	QPSK	21.17	21.24	21.32	<b>22</b>
			16QAM	20.23	20.29	20.28	<b>21</b>
	75RB	/	QPSK	21.16	21.40	21.32	<b>22</b>
16QAM			20.21	20.46	20.36	<b>21</b>	
20 MHz				2560MHz	2535MHz	2510MHz	/
	1RB	High	QPSK	22.21	22.42	22.28	<b>23</b>
			16QAM	20.78	20.88	21.58	<b>22</b>
		Middle	QPSK	22.10	<b>22.50</b>	22.41	<b>23</b>
			16QAM	20.96	20.65	20.96	<b>22</b>
		Low	QPSK	22.19	22.25	22.01	<b>23</b>
			16QAM	20.70	20.39	20.34	<b>22</b>
	50RB	High	QPSK	21.26	21.37	<b>21.41</b>	<b>22</b>
			16QAM	20.32	20.49	20.46	<b>21</b>
		Middle	QPSK	21.24	21.37	21.27	<b>22</b>
			16QAM	20.31	20.47	20.33	<b>21</b>
		Low	QPSK	21.14	21.31	21.18	<b>22</b>
			16QAM	20.20	20.39	20.35	<b>21</b>
	100RB	/	QPSK	21.15	21.33	21.26	<b>22</b>
16QAM			20.14	20.40	20.30	<b>21</b>	

**Sensor ON**

LTE-FDD Band 7				Actual output Power (dBm)			Tune up
Band-width	RB allocation	RB offset	Modulation	High	Middle	Low	
5 MHz				2567.4MHz	2535MHz	2502.5MHz	
	1RB	High	QPSK	20.93	21.27	21.10	<b>21.5</b>
			16QAM	21.02	20.62	20.71	<b>21.5</b>
		Middle	QPSK	21.02	21.12	21.07	<b>21.5</b>
			16QAM	20.81	20.87	21.13	<b>21.5</b>
		Low	QPSK	20.84	21.11	20.87	<b>21.5</b>
			16QAM	20.67	20.65	20.76	<b>21.5</b>
	12RB	High	QPSK	20.95	21.13	21.19	<b>21.5</b>
			16QAM	20.13	20.17	20.26	<b>21.5</b>
		Middle	QPSK	21.04	21.16	21.08	<b>21.5</b>
			16QAM	20.04	20.14	20.09	<b>21.5</b>
		Low	QPSK	21.04	21.04	21.00	<b>21.5</b>
			16QAM	20.25	20.06	19.99	<b>21.5</b>
	25RB	/	QPSK	21.03	21.18	21.10	<b>21.5</b>
16QAM			19.98	20.23	20.09	<b>21.5</b>	
10 MHz				2565MHz	2535MHz	2505MHz	/
	1RB	High	QPSK	21.00	21.27	21.14	<b>21.5</b>
			16QAM	20.79	20.93	20.85	<b>21.5</b>
		Middle	QPSK	20.99	21.27	21.20	<b>21.5</b>
			16QAM	21.02	21.15	21.48	<b>21.5</b>
		Low	QPSK	20.94	21.03	21.01	<b>21.5</b>
			16QAM	20.91	20.84	20.96	<b>21.5</b>
	25RB	High	QPSK	21.11	21.18	21.03	<b>21.5</b>
			16QAM	20.08	20.21	20.13	<b>21.5</b>
		Middle	QPSK	21.11	21.18	21.18	<b>21.5</b>
			16QAM	20.20	20.32	20.32	<b>21.5</b>
		Low	QPSK	21.17	21.23	21.09	<b>21.5</b>
			16QAM	20.17	20.39	20.13	<b>21.5</b>
	50RB	/	QPSK	21.08	21.29	21.13	<b>21.5</b>
16QAM			20.03	20.34	20.18	<b>21.5</b>	

**Sensor ON**

LTE-FDD Band 7				Actual output Power (dBm)			Tune up
Band-width	RB allocation	RB offset	Modulation	High	Middle	Low	
15 MHz				2562.5MHz	2535MHz	2507.5MHz	
	1RB	High	QPSK	20.95	21.40	21.26	<b>21.5</b>
			16QAM	21.12	20.97	20.80	<b>21.5</b>
		Middle	QPSK	21.15	21.21	21.27	<b>21.5</b>
			16QAM	20.87	20.95	20.73	<b>21.5</b>
		Low	QPSK	21.19	21.20	21.09	<b>21.5</b>
			16QAM	20.68	20.85	20.94	<b>21.5</b>
	36RB	High	QPSK	21.07	21.30	21.09	<b>21.5</b>
			16QAM	20.21	20.39	20.10	<b>21.5</b>
		Middle	QPSK	21.16	21.10	21.12	<b>21.5</b>
			16QAM	20.23	20.22	20.24	<b>21.5</b>
		Low	QPSK	21.18	21.23	21.16	<b>21.5</b>
			16QAM	20.14	20.25	20.18	<b>21.5</b>
	75RB	/	QPSK	21.00	21.35	21.23	<b>21.5</b>
16QAM			20.08	20.37	20.14	<b>21.5</b>	
20 MHz				2560MHz	2535MHz	2510MHz	/
	1RB	High	QPSK	21.05	21.17	20.99	<b>21.5</b>
			16QAM	20.72	20.97	21.27	<b>21.5</b>
		Middle	QPSK	<b>21.09</b>	<b>21.29</b>	<b>21.07</b>	<b>21.5</b>
			16QAM	21.09	20.90	20.91	<b>21.5</b>
		Low	QPSK	20.84	20.80	20.94	<b>21.5</b>
			16QAM	20.92	20.74	20.81	<b>21.5</b>
	50RB	High	QPSK	21.09	21.23	<b>21.24</b>	<b>21.5</b>
			16QAM	20.29	20.36	20.25	<b>21.5</b>
		Middle	QPSK	<b>21.11</b>	<b>21.25</b>	21.14	<b>21.5</b>
			16QAM	20.32	20.28	20.16	<b>21.5</b>
		Low	QPSK	21.09	21.18	21.07	<b>21.5</b>
			16QAM	20.29	20.30	20.10	<b>21.5</b>
	100RB	/	QPSK	21.14	<b>21.25</b>	21.11	<b>21.5</b>
16QAM			20.23	20.23	20.12	<b>21.5</b>	

## 10.4 Wi-Fi and BT Measurement result

**Table 10.5: The conducted Power measurement results for BT**

BT	Tune up	Averaged Power (dBm)		
Mode		Ch.0 (2402 MHz)	Ch39 (2441 MHz)	Ch78 (2480 MHz)
GFSK	<b>12</b>	11.37	10.49	10.74
EDR2M-4_DQPSK	<b>12</b>	11.44	10.52	10.82
EDR3M-8DPSK	<b>12</b>	<b>11.69</b>	10.69	11.11
/	<b>Tune up</b>	Ch0 (2402MHz)	Ch19 (2440MHz)	Ch39 (2480MHz)
BLE	<b>2</b>	1.79	1.30	1.02

**Table 10.6: The conducted Power measurement results for 2.4G WIFI**

WiFi 2.4GHz	Tune up	Averaged Power (dBm) Duty Cycle: <b>100%</b>		
Mode		Ch.1(2412 MHz)	Ch.6(2437Mhz)	Ch.11(2462MHz)
802.11b	<b>16.5</b>	<b>15.99</b>	15.67	15.56
802.11g	<b>15.5</b>	14.51	14.18	14.03
802.11n(20MHz)	<b>15.5</b>	14.55	14.27	14.07



**Table 10.7: The conducted Power measurement results for 5G WIFI**

Averaged Power (dBm) Duty Cycle: <b>100%</b>				
Mode	802.11a	802.11n -20MHz	Mode	802.11n -40MHz
Channel	6Mbps	MCS0	Channel	MCS0
<b>&lt;U-NII-1&gt;</b>				
<b>Tune up</b>	<b>14</b>	<b>14</b>	/	<b>13.5</b>
36(5180MHz)	13.50	13.29	38(5190MHz)	12.30
40(5200MHz)	13.44	13.16	46(5230MHz)	12.35
44(5220MHz)	13.42	13.24	/	/
44(5240MHz)	13.41	13.22	/	/
<b>&lt;U-NII-2A&gt;</b>				
<b>Tune up</b>	<b>14</b>	<b>14</b>	/	<b>13.5</b>
52(5260MHz)	<b>13.44</b>	13.32	54(5270MHz)	12.28
56(5280MHz)	13.33	13.24	62(5310MHz)	12.14
60(5300MHz)	13.29	13.21	/	/
64(5320MHz)	13.25	13.15	/	/
<b>&lt;U-NII-2C&gt;</b>				
<b>Tune up</b>	<b>14</b>	<b>14</b>	/	<b>13.5</b>
100(5500MHz)	13.45	13.37	102(5510MHz)	12.21
116(5580MHz)	13.60	13.47	110(5550MHz)	12.23
124(5620MHz)	13.63	13.45	126(5630MHz)	12.26
132(5660MHz)	13.69	13.57	134(5670MHz)	12.25
140(5700MHz)	13.66	13.53	142(5710MHz)	12.34
144(5720MHz)	<b>13.70</b>	13.58	/	/
<b>&lt;U-NII-3&gt;</b>				
<b>Tune up</b>	<b>14.5</b>	<b>14.5</b>	/	<b>13.5</b>
149(5745MHz)	13.83	13.76	151(5755MHz)	12.78
157(5785MHz)	14.03	13.97	159(5795MHz)	12.83
165(5825MHz)	<b>14.15</b>	14.11	/	/

## 11 Simultaneous TX SAR Considerations

### 11.1 Introduction

The following procedures adopted from “FCC SAR Considerations for Cell Phones with Multiple Transmitters” are applicable to handsets with built-in unlicensed transmitters such as 802.11 a/b/g and Bluetooth devices which may simultaneously transmit with the licensed transmitter. For this device, the BT and Wi-Fi can transmit simultaneous with other transmitters.

### 11.2 Transmit Antenna Separation Distances

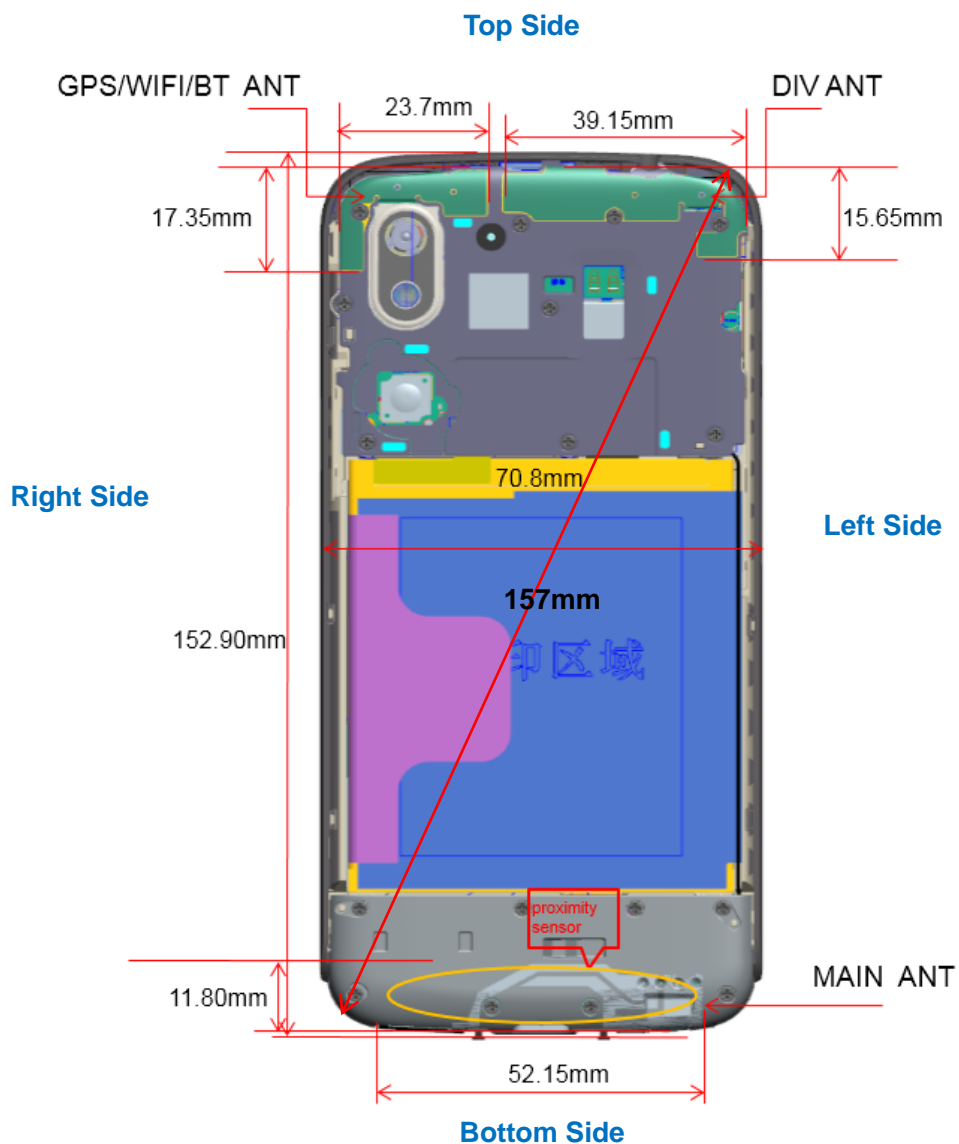

Picture 11.1 Antenna Locations (Back View)

### 11.3 SAR Measurement Positions

According to the KDB941225 D06 Hot Spot SAR, the edges with less than 25mm distance to the antennas need to be tested for SAR.

SAR measurement positions						
Mode	Front	Rear	Left edge	Right edge	Top edge	Bottom edge
Main antenna	Yes	Yes	Yes	Yes	No	Yes
WIFI antenna	Yes	Yes	No	Yes	Yes	No

### 11.4 Standalone SAR Test Exclusion Considerations

Standalone 1-g head or body SAR evaluation by measurement or numerical simulation is not required when the corresponding SAR Exclusion Threshold condition, listed below, is satisfied. The 1-g SAR test exclusion threshold for 100 MHz to 6 GHz at test separation distances  $\leq 50$  mm are determined by:

$[(\text{max. power of channel, including tune-up tolerance, mW}) / (\text{min. test separation distance, mm})] \cdot [\sqrt{f(\text{GHz})}] \leq 3.0$  for 1-g SAR, where

- $f(\text{GHz})$  is the RF channel transmit frequency in GHz
- Power and distance are rounded to the nearest mW and mm before calculation
- The result is rounded to one decimal place for comparison

**Table 11.1: Standalone SAR test exclusion considerations**

Band/Mode	f(GHz)	Position	SAR test exclusion threshold (mW)	RF output power		SAR test exclusion
				dBm	mW	
Bluetooth	2.441	Head	9.60	12	15.85	No
		Body	19.20	12	15.85	Yes
2.4GHz WLAN	2.45	Head	9.58	16.5	44.67	No
		Body	19.17	16.5	44.67	No
5GHz WLAN	5.2	Head	6.58	14	25.12	No
		Body	13.16	14	25.12	No
	5.3	Head	6.52	14	25.12	No
		Body	13.03	14	25.12	No
	5.6	Head	6.34	14	25.12	No
		Body	12.68	14	25.12	No
	5.8	Head	6.23	14.5	28.18	No
		Body	12.46	14.5	28.18	No

## 12 Evaluation of Simultaneous

**Table 12.1: The sum of reported SAR values for main antenna and Wi-Fi**

/	Position	Main antenna	Wi-Fi	Sum	SPLSR
Highest reported SAR value for Head	Left Cheek	0.79	0.87	1.66	Yes
Highest reported SAR value for Body	Front	1.15	0.14	1.29	/

According to the KDB 447498 D01, when the sum of SAR is larger than the limit, SAR test exclusion is determined by the SAR to peak location separation ratio. The ratio is determined by  $(SAR1 + SAR2)^{1.5}/R_i$ , rounded to two decimal digits, and must be  $\leq 0.04$  for all antenna pairs in the configuration to qualify for 1-g SAR test exclusion.

Band	Position	SAR (W/kg)	Gap (cm)	SAR peak location (m)			3D distance (mm)	Pair SAR sum (W/kg)	SPLSR	Simultaneous SAR
				X	Y	Z				
LTE Band 7	Left Cheek	1.11	0	0.0638	0.245	-0.173	84.9	2.36	0.04	Not required
WLAN 2.4G		1.25	0	0.0355	0.325	-0.174				

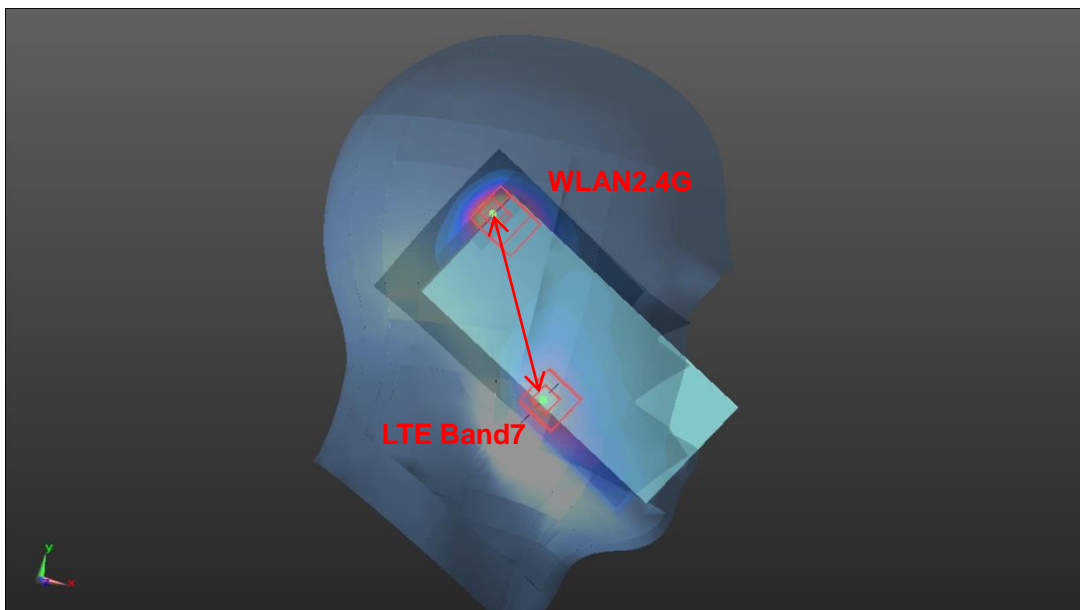

**Table 12.2: The sum of reported SAR values for main antenna and Bluetooth**

/	Position	Main antenna	BT*	Sum
Highest reported SAR value for Head	Left Touch	0.79	0.08	0.87
Highest reported SAR value for Body	Front	1.15	0.33	1.48

BT\* - Estimated SAR for Bluetooth (see the table 13.3)

**Table 12.3: Estimated SAR for Bluetooth**

Position	f (GHz)	Distance (mm)	Upper limit of power *		Estimated <sub>1g</sub> (W/kg)
			dBm	mW	
Body	2.441	10	12	15.85	0.33

\* - Maximum possible output power declared by manufacturer

When standalone SAR test exclusion applies to an antenna that transmits simultaneously with other antennas, the standalone SAR must be estimated according to following to determine simultaneous transmission SAR test exclusion:

(max. power of channel, including tune-up tolerance, mW) / (min. test separation distance, mm) · [ $\sqrt{f(\text{GHz})/x}$ ] W/kg for test separation distances  $\leq 50$  mm;

Where  $x = 7.5$  for 1-g SAR.

When the minimum test separation distance is  $< 5$  mm, a distance of 5 mm is applied to determine SAR test exclusion

**Conclusion:**

According to the above tables, the sum of reported SAR values is 1.66 W/kg and the SPLSR  $\leq 0.04$ .

### 13 Summary of Test Results

According to the client's decision rule in the test registration form, which is "based on the measurement results as the basis of the conformity statement", the test conclusion of this report meets the limit requirements.

The calculated SAR is obtained by the following formula:

$$\text{Reported SAR} = \text{Measured SAR} \times 10^{(P_{\text{Target}} - P_{\text{Measured}})/10}$$

Where  $P_{\text{Target}}$  is the power of manufacturing upper limit;

$P_{\text{Measured}}$  is the measured power in chapter 10.

#### Duty Cycle

Mode	Duty Cycle
Speech for GSM850/1900	1:8.3
GPRS for GSM850/1900	1:4
WCDMA850/1900	1:1
LTE Band 7	1:1

#### Testing Environment

Temperature:	18°C~25°C
Relative humidity:	30%~70%
Ground system resistance:	<4Ω
Ambient noise & Reflection:	< 0.012 W/kg

### 13.1 SAR results

**Table 13.1: SAR Values (GSM 850 - Head)**

Frequency		Test Mode	Test Position	Figure No.	Ambient Temperature: 22.5°C		Liquid Temperature: 22.0°C		Power Drift(dB)
MHz	Ch.				Conducted Power (dBm)	Max. tune-up Power (dBm)	Measured SAR(1g) (W/kg)	Reported SAR(1g) (W/kg)	
836.6	190	Speech	Left Touch	<b>1</b>	33.24	34.5	<b>0.120</b>	<b>0.16</b>	0.04
836.6	190	Speech	Left Tilt	/	33.24	34.5	0.080	0.11	0.01
836.6	190	Speech	Right Touch	/	33.24	34.5	0.112	0.15	0.08
836.6	190	Speech	Right Tilt	/	33.24	34.5	0.059	0.08	0.01

**Table 13.2: SAR Values (GSM 850 -Body)**

Frequency		Test Mode	Test Position	Figure No.	Ambient Temperature: 22.5°C		Liquid Temperature: 22.0°C		Power Drift(dB)
MHz	Ch.				Conducted Power (dBm)	Max. tune-up Power (dBm)	Measured SAR(1g) (W/kg)	Reported SAR(1g) (W/kg)	
<b>Hotspot / Body Worn Test Data (10mm)</b>									
836.6	190	GPRS	Front	/	30.05	31	0.094	0.12	0.08
836.6	190	GPRS	Rear	<b>2</b>	30.05	31	<b>0.158</b>	<b>0.20</b>	0.01
836.6	190	GPRS	Left	/	30.05	31	0.033	0.04	0.06
836.6	190	GPRS	Right	/	30.05	31	0.058	0.07	0.04
836.6	190	GPRS	Bottom	/	30.05	31	0.021	0.03	0.03

**Table 13.3: SAR Values (GSM 1900 - Head)**

Frequency		Test Mode	Test Position	Figure No.	Conducted Power (dBm)	Max. tune-up Power (dBm)	Measured SAR(1g) (W/kg)	Reported SAR(1g) (W/kg)	Power Drift(dB)
MHz	Ch.								
Ambient Temperature: 22.7°C      Liquid Temperature: 22.2°C									
1880	661	Speech	Left Touch	<b>3</b>	29.60	31	<b>0.195</b>	<b>0.27</b>	0.06
1880	661	Speech	Left Tilt	/	29.60	31	0.124	0.17	0.12
1880	661	Speech	Right Touch	/	29.60	31	0.140	0.19	0.06
1880	661	Speech	Right Tilt	/	29.60	31	0.098	0.13	0.01

**Table 13.4: SAR Values (GSM 1900 - Body)**

Frequency		Test Mode	Test Position	Figure No.	Conducted Power (dBm)	Max. tune-up Power (dBm)	Measured SAR(1g) (W/kg)	Reported SAR(1g) (W/kg)	Power Drift(dB)
MHz	Ch.								
Ambient Temperature: 22.4°C      Liquid Temperature: 22.0°C									
<b>Hotspot / Body Worn Test Data (10mm)</b>									
1880	661	GPRS	Front	/	26.83	28	0.463	0.61	0.03
1880	661	GPRS	Rear	<b>4</b>	26.83	28	<b>0.520</b>	<b>0.68</b>	0.02
1880	661	GPRS	Left	/	26.83	28	0.251	0.33	0.01
1880	661	GPRS	Right	/	26.83	28	0.163	0.21	0.03
1880	661	GPRS	Bottom	/	26.83	28	0.204	0.27	0.08



**Table 13.5: SAR Values (WCDMA 850 - Head)**

Frequency		Test Mode	Test Position	Figure No.	Conducted Power (dBm)	Max. tune-up Power (dBm)	Measured SAR(1g) (W/kg)	Reported SAR(1g) (W/kg)	Power Drift(dB)
MHz	Ch.								
		Ambient Temperature: 22.5°C		Liquid Temperature: 22.0°C					
836.4	4182	RMC	Left Touch	/	23.40	24	0.150	0.17	0.01
836.4	4182	RMC	Left Tilt	/	23.40	24	0.107	0.12	0.02
836.4	4182	RMC	Right Touch	<b>5</b>	23.40	24	<b>0.162</b>	<b>0.19</b>	-0.12
836.4	4182	RMC	Right Tilt	/	23.40	24	0.157	0.18	-0.10

**Table 13.6: SAR Values (WCDMA 850 -Body)**

Frequency		Test Mode	Test Position	Figure No.	Conducted Power (dBm)	Max. tune-up Power (dBm)	Measured SAR(1g) (W/kg)	Reported SAR(1g) (W/kg)	Power Drift(dB)
MHz	Ch.								
		Ambient Temperature: 22.8°C		Liquid Temperature: 22.2°C					
<b>Hotspot / Body Worn Test Data (10mm)</b>									
836.4	4182	RMC	Front	/	23.40	24	0.119	0.14	0.05
836.4	4182	RMC	Rear	<b>6</b>	23.40	24	<b>0.219</b>	<b>0.25</b>	0.03
836.4	4182	RMC	Left	/	23.40	24	0.063	0.07	0.09
836.4	4182	RMC	Right	/	23.40	24	0.156	0.18	0.05
836.4	4182	RMC	Bottom	/	23.40	24	0.034	0.04	0.10

**Table 13.7: SAR Values (WCDMA1900 - Head)**

Frequency		Test Mode	Test Position	Figure No.	Conducted Power (dBm)	Max. tune-up Power (dBm)	Measured SAR(1g) (W/kg)	Reported SAR(1g) (W/kg)	Power Drift(dB)
MHz	Ch.								
Ambient Temperature: 22.7°C      Liquid Temperature: 22.2°C									
1880	9400	RMC	Left Touch	<b>7</b>	23.20	24	<b>0.415</b>	<b>0.50</b>	-0.05
1880	9400	RMC	Left Tilt	/	23.20	24	0.223	0.27	0.11
1880	9400	RMC	Right Touch	/	23.20	24	0.304	0.37	-0.04
1880	9400	RMC	Right Tilt	/	23.20	24	0.200	0.24	0.07

**Table 13.8: SAR Values (WCDMA1900 - Body)**

Frequency		Test Mode	Test Position	Figure No.	Conducted Power (dBm)	Max. tune-up Power (dBm)	Measured SAR(1g) (W/kg)	Reported SAR(1g) (W/kg)	Power Drift(dB)
MHz	Ch.								
Ambient Temperature: 22.4°C      Liquid Temperature: 22.0°C									
<b>Hotspot / Body Worn Test Data (10mm)</b>									
1880	9400	RMC	Front	/	20.50	21.5	0.606	0.76	0.09
1880	9400	RMC	Rear	<b>8</b>	20.50	21.5	<b>0.812</b>	<b>1.02</b>	0.01
1880	9400	RMC	Left	/	23.20	24	0.429	0.52	0.15
1880	9400	RMC	Right	/	23.20	24	0.263	0.32	0.04
1880	9400	RMC	Bottom	/	20.50	21.5	0.400	0.50	0.09
1907.6	9538	RMC	Rear	/	21.30	21.5	0.804	0.84	0.06
1852.4	9262	RMC	Rear	/	20.40	21.5	0.651	0.84	0.06
1880	9400	RMC	Front-17mm	/	23.20	24	0.326	0.39	-0.07
1880	9400	RMC	Rear-25mm	/	23.20	24	0.210	0.25	0.07
1880	9400	RMC	Bottom-27mm	/	23.20	24	0.128	0.15	-0.04

**Table 13.9: SAR Values (LTE Band 7 - Head)**

Frequency		Ambient Temperature: 22.2°C				Liquid Temperature: 21.7°C			
MHz	Ch.	Test Mode	Test Position	Figure No.	Conducted Power (dBm)	Max. tune-up Power (dBm)	Measured SAR(1g) (W/kg)	Reported SAR(1g) (W/kg)	Power Drift(dB)
2535	21100	1RB_Mid	Left Touch	<b>9</b>	22.50	23	<b>0.708</b>	<b>0.79</b>	-0.05
2510	20850	50RB_High	Left Touch	/	21.41	22	0.561	0.64	0.07
2535	21100	1RB_Mid	Left Tilt	/	22.50	23	0.241	0.27	-0.04
2510	20850	50RB_High	Left Tilt	/	21.41	22	0.205	0.23	0.07
2535	21100	1RB_Mid	Right Touch	/	22.50	23	0.362	0.41	0.03
2510	20850	50RB_High	Right Touch	/	21.41	22	0.269	0.31	0.03
2535	21100	1RB_Mid	Right Tilt	/	22.50	23	0.274	0.31	0.05
2510	20850	50RB_High	Right Tilt	/	21.41	22	0.230	0.26	0.08

**Table 13.10: SAR Values (LTE Band 7 - Body)**

Frequency		Test Mode	Test Position	Figure No. / Note	Ambient Temperature: 22.2°C		Liquid Temperature: 21.7°C		
MHz	Ch.				Conducted Power (dBm)	Max. tune-up Power (dBm)	Measured SAR(1g) (W/kg)	Reported SAR(1g) (W/kg)	Power Drift(dB)
<b>Hotspot / Body Worn Test Data (10mm)</b>									
2535	21100	1RB_Mid	Front	/	21.29	21.5	0.979	1.03	-0.11
2535	21100	50RB_Mid	Front	/	21.25	21.5	1.030	1.09	0.06
2535	21100	1RB_Mid	Rear	/	21.29	21.5	0.642	0.67	0.03
2535	21100	50RB_Mid	Rear	/	21.25	21.5	0.636	0.67	0.08
2535	21100	1RB_Mid	Left	/	22.50	23	0.588	0.66	-0.15
2535	21100	50RB_Mid	Left	/	21.41	22	0.464	0.53	0.14
2535	21100	1RB_Mid	Right	/	22.50	23	0.032	0.04	0.04
2535	21100	50RB_Mid	Right	/	21.41	22	0.030	0.03	0.09
2535	21100	1RB_Mid	Bottom	/	21.29	21.5	0.641	0.67	-0.07
2535	21100	50RB_Mid	Bottom	/	21.25	21.5	0.429	0.45	0.05
2560	21350	1RB_Mid	Front	/	21.09	21.5	0.968	1.06	-0.05
2510	20850	1RB_Mid	Front	<b>10</b>	21.07	21.5	<b>1.040</b>	<b>1.15</b>	-0.02
2560	21350	50RB_Mid	Front	/	21.11	21.5	0.992	1.09	0.06
2510	20850	50RB_High	Front	/	21.24	21.5	1.010	1.07	0.04
2535	21100	100RB	Front	/	21.25	21.5	1.010	1.07	0.11
2535	21100	1RB_Mid	Front-17mm	/	22.50	23	0.498	0.56	0.03
2510	20850	50RB_High	Front-17mm	/	21.41	22	0.397	0.45	0.08
2535	21100	1RB_Mid	Rear-25mm	/	22.50	23	0.123	0.14	0.08
2510	20850	50RB_High	Rear-25mm	/	21.41	22	0.094	0.11	0.07
2535	21100	1RB_Mid	Bottom-27mm	/	22.50	23	0.109	0.12	0.09
2510	20850	50RB_High	Bottom-27mm	/	21.41	22	0.084	0.10	0.15

**Table 13.11: SAR Values (BT - Head)**

Frequency		Test Mode	Test Position	Figure No.	Ambient Temperature: 22.2°C		Liquid Temperature: 21.7°C		
MHz	Ch.				Conducted Power (dBm)	Max. tune-up Power (dBm)	Measured SAR(1g) (W/kg)	Reported SAR(1g) (W/kg)	Power Drift(dB)
2402	0	8DPSK	Left Touch	<b>11</b>	11.69	12	<b>0.070</b>	<b>0.08</b>	-0.08
2402	0	8DPSK	Left Tilt	/	11.69	12	0.026	0.03	0.06
2402	0	8DPSK	Right Touch	/	11.69	12	<0.01	<0.01	0.06
2402	0	8DPSK	Right Tilt	/	11.69	12	<0.01	<0.01	0.00

### 13.2 WLAN Evaluation for 2.4G

According to the KDB248227 D01, SAR is measured for 2.4GHz 802.11b DSSS using the initial test position procedure.

**Table 13.12: SAR Values (WLAN 2.4G - Head)**

Frequency		Test Mode	Test Position	Figure No.	Conducted Power (dBm)	Max. tune-up Power (dBm)	Measured SAR(1g) (W/kg)	Reported SAR(1g) (W/kg)	Power Drift(dB)
MHz	Ch.								
		Ambient Temperature: 22.6°C			Liquid Temperature: 22.0°C				
2412	1	802.11 b	Left Touch	<b>12</b>	15.99	16.5	<b>0.751</b>	0.84	0.01
2412	1	802.11 b	Left Tilt	/	15.99	16.5	0.628	0.71	0.09
2412	1	802.11 b	Right Touch	/	15.99	16.5	0.343	0.39	-0.04
2412	1	802.11 b	Right Tilt	/	15.99	16.5	0.239	0.27	0.02
2437	6	802.11 b	Left Touch	/	15.67	16.5	0.715	<b>0.87</b>	0.11

Note1: For all positions/configurations tested using the initial test position and subsequent test positions, when the reported SAR is > 0.8 W/kg, SAR is measured for these test positions/configurations on the subsequent next highest measured output power channel until the reported SAR is ≤ 1.2 W/kg or all required channels are tested.

According to the KDB248227 D01, The reported SAR must be scaled to 100% transmission duty factor to determine compliance at the maximum tune-up tolerance limit.

**Table 13.13: SAR Values (WLAN 2.4G - Head) – Scaled Reported SAR**

Frequency		Test Position	Actual duty factor	maximum duty factor	Reported SAR (1g)(W/kg)	Scaled reported SAR (1g)(W/kg)
MHz	Ch.					
2437	6	Left Touch	100%	100%	0.87	<b>0.87</b>

SAR is not required for OFDM because the 802.11b adjusted SAR ≤ 1.2 W/kg.

**Table 13.14: SAR Values (WLAN 2.4G - Body)**

Frequency		Test Mode	Test Position	Figure No.	Conducted Power (dBm)	Max. tune-up Power (dBm)	Measured SAR(1g) (W/kg)	Reported SAR(1g) (W/kg)	Power Drift(dB)
MHz	Ch.								
Ambient Temperature: 22.6°C      Liquid Temperature: 22.0°C									
<b>Test Data (10mm)</b>									
2412	1	802.11 b	Front	/	15.99	16.5	0.125	0.14	0.04
2412	1	802.11 b	Rear	<b>13</b>	15.99	16.5	<b>0.198</b>	<b>0.22</b>	-0.14
2412	1	802.11 b	Right	/	15.99	16.5	0.133	0.15	0.04
2412	1	802.11 b	Top	/	15.99	16.5	0.082	0.09	0.05

Note1: For all positions/configurations tested using the initial test position and subsequent test positions, when the reported SAR is > 0.8 W/kg, SAR is measured for these test positions/configurations on the subsequent next highest measured output power channel until the reported SAR is ≤ 1.2 W/kg or all required channels are tested.

According to the KDB248227 D01, The reported SAR must be scaled to 100% transmission duty factor to determine compliance at the maximum tune-up tolerance limit.

**Table 13.15: SAR Values (WLAN 2.4G - Body) – Scaled Reported SAR**

Frequency		Test Position	Actual duty factor	maximum duty factor	Reported SAR (1g)(W/kg)	Scaled reported SAR (1g)(W/kg)
MHz	Ch.					
Ambient Temperature: 22.6°C      Liquid Temperature: 22.0°C						
2412	1	Rear	100%	100%	0.22	<b>0.22</b>

SAR is not required for OFDM because the 802.11b adjusted SAR ≤ 1.2 W/kg.

### 13.3 WLAN Evaluation for 5G

**Table 13.16: SAR Values (WLAN 5G - Head)**

Frequency		Test Mode	Test Position	Figure No.	Conducte d Power (dBm)	Max. tune-up Power (dBm)	Measured SAR(1g) (W/kg)	Reported SAR(1g) (W/kg)	Power Drift(dB)
MHz	Ch.								
Ambient Temperature: 22.6°C      Liquid Temperature: 22.0°C									
<b>U-NII-2A</b>									
5260	52	802.11 a	Left Touch	/	13.44	14	0.571	0.65	0.08
5260	52	802.11 a	Left Tilt	/	13.44	14	0.510	0.58	0.06
5260	52	802.11 a	Right Touch	/	13.44	14	0.543	0.62	-0.12
5260	52	802.11 a	Right Tilt	<b>14</b>	13.44	14	<b>0.829</b>	<b>0.94</b>	-0.13
5280	56	802.11 a	Right Tilt	/	13.33	14	0.551	0.64	-0.13
<b>U-NII-2C</b>									
5720	144	802.11 a	Left Touch	/	13.70	14	0.351	0.38	0.07
5720	144	802.11 a	Left Tilt	/	13.70	14	0.321	0.34	0.08
5720	144	802.11 a	Right Touch	/	13.70	14	<b>0.425</b>	0.46	0.49
5720	144	802.11 a	Right Tilt	/	13.70	14	0.342	0.37	0.01
<b>U-NII-3</b>									
5825	165	802.11 a	Left Touch	/	14.15	14.5	0.288	0.31	0.07
5825	165	802.11 a	Left Tilt	/	14.15	14.5	0.261	0.28	0.04
5825	165	802.11 a	Right Touch	/	14.15	14.5	<b>0.293</b>	0.32	0.09
5825	165	802.11 a	Right Tilt	/	14.15	14.5	0.231	0.25	0.07

**Note1:** U-NII-1 and U-NII-2A bands have the same specified maximum output and tolerance; SAR is measured for U-NII-2A band first. Adjusted SAR of U-NII-2A band is  $\leq 1.2$ W/kg, SAR is not required for U-NII-1 band.

**Note2:** For all positions/configurations tested using the initial test position and subsequent test positions, when the reported SAR is  $> 0.8$  W/kg, SAR is measured for these test positions/configurations on the subsequent next highest measured output power channel until the reported SAR is  $\leq 1.2$  W/kg or all required channels are tested.

According to the KDB248227 D01, The reported SAR must be scaled to 100% transmission duty factor to determine compliance at the maximum tune-up tolerance limit.

**Table 13.17: SAR Values (WLAN 5G - Head) – Scaled Reported SAR**

Frequency		Test Position	Actual duty factor	maximum duty factor	Reported SAR (1g)(W/kg)	Scaled reported SAR (1g)(W/kg)
MHz	Ch.					
5260	52	Right Tilt	100%	100%	0.94	<b>0.94</b>

**Table 13.18: SAR Values (WLAN 5G - Body)**

Frequency		Test Mode	Test Position	Figure No.	Ambient Temperature: 22.6°C		Liquid Temperature: 22.0°C		
MHz	Ch.				Conducted Power (dBm)	Max. tune-up Power (dBm)	Measured SAR(1g) (W/kg)	Reported SAR(1g) (W/kg)	Power Drift(dB)
<b>Test Data (10mm)</b>									
<b>U-NII-2A</b>									
5260	52	802.11 a	Front	/	13.44	14	0.118	0.13	0.09
5260	52	802.11 a	Rear	/	13.44	14	0.173	0.20	0.05
5260	52	802.11 a	Right	/	13.44	14	0.031	0.04	0.03
5260	52	802.11 a	Top	<b>15</b>	13.44	14	<b>0.192</b>	<b>0.22</b>	0.05
<b>U-NII-2C</b>									
5720	144	802.11 a	Front	/	13.70	14	0.085	0.09	0.01
5720	144	802.11 a	Rear	/	13.70	14	<b>0.097</b>	0.10	0.05
5720	144	802.11 a	Right	/	13.70	14	<0.01	<0.01	0.00
5720	144	802.11 a	Top	/	13.70	14	0.078	0.08	0.06
<b>U-NII-3</b>									
5825	165	802.11 a	Front	/	14.15	14.5	0.027	0.03	0.01
5825	165	802.11 a	Rear	/	14.15	14.5	<b>0.075</b>	0.08	0.09
5825	165	802.11 a	Right	/	14.15	14.5	<0.01	<0.01	0.00
5825	165	802.11 a	Top	/	14.15	14.5	0.074	0.08	0.03

**Note1:** U-NII-1 and U-NII-2A bands have the same specified maximum output and tolerance; SAR is measured for U-NII-2A band first. Adjusted SAR of U-NII-2A band is  $\leq 1.2$ W/kg, SAR is not required for U-NII-1 band.

**Note2:** For all positions/configurations tested using the initial test position and subsequent test positions, when the reported SAR is  $> 0.8$  W/kg, SAR is measured for these test positions/configurations on the subsequent next highest measured output power channel until the reported SAR is  $\leq 1.2$  W/kg or all required channels are tested.

According to the KDB248227 D01, The reported SAR must be scaled to 100% transmission duty factor to determine compliance at the maximum tune-up tolerance limit.

**Table 13.19: SAR Values (WLAN 5G - Body) –Scaled Reported SAR**

Frequency		Test Position	Ambient Temperature: 22.6°C		Liquid Temperature: 22.0°C	
MHz	Ch.		Actual duty factor	maximum duty factor	Reported SAR (1g)(W/kg)	Scaled reported SAR (1g)(W/kg)
5260	52	Top	100%	100%	0.22	<b>0.22</b>

SAR is not required for OFDM because the 802.11b adjusted SAR  $\leq 1.2$  W/kg.



## 14 SAR Measurement Variability

SAR measurement variability must be assessed for each frequency band, which is determined by the SAR probe calibration point and tissue-equivalent medium used for the device measurements. When both head and body tissue-equivalent media are required for SAR measurements in a frequency band, the variability measurement procedures should be applied to the tissue medium with the highest measured SAR, using the highest measured SAR configuration for that tissue-equivalent medium.

The following procedures are applied to determine if repeated measurements are required.

- 1) Repeated measurement is not required when the original highest measured SAR is < 0.80 W/kg; steps 2) through 4) do not apply.
- 2) When the original highest measured SAR is  $\geq 0.80$  W/kg, repeat that measurement once.
- 3) Perform a second repeated measurement only if the ratio of largest to smallest SAR for the original and first repeated measurements is > 1.20 or when the original or repeated measurement is  $\geq 1.45$  W/kg (~ 10% from the 1-g SAR limit).
- 4) Perform a third repeated measurement only if the original, first or second repeated measurement is  $\geq 1.5$  W/kg and the ratio of largest to smallest SAR for the original, first and second repeated measurements is > 1.20.

**Table 14.1: SAR Measurement Variability for Body – WCDMA1900**

Frequency		Test Position	Original	1 <sup>st</sup> Repeated	Ratio	2 <sup>nd</sup> Repeated
MHz	Ch.		SAR (W/kg)	SAR (W/kg)		SAR (W/kg)
1880	9400	Rear	0.812	0.805	1.01	/

**Table 14.2: SAR Measurement Variability for Body – LTE Band 7**

Frequency		Test Position	Original	1 <sup>st</sup> Repeated	Ratio	2 <sup>nd</sup> Repeated
MHz	Ch.		SAR (W/kg)	SAR (W/kg)		SAR (W/kg)
2510	20850	Front	1.04	0.997	1.04	/

**Table 14.3: SAR Measurement Variability for Head – WIFI 5G**

Frequency		Test Position	Original	1 <sup>st</sup> Repeated	Ratio	2 <sup>nd</sup> Repeated
MHz	Ch.		SAR (W/kg)	SAR (W/kg)		SAR (W/kg)
5260	52	Left Cheek	0.829	0.816	1.02	/

## 15 Measurement Uncertainty

### 15.1 Measurement Uncertainty for Normal SAR Tests (300MHz~3GHz)

No.	Error Description	Type	Uncertainty value	Probably Distribution	Div.	(Ci) 1g	(Ci) 10g	Std. Unc. (1g)	Std. Unc. (10g)	Degree of freedom
<b>Measurement system</b>										
1	Probe calibration	B	12	N	2	1	1	6.0	6.0	∞
2	Axial isotropy	B	4.7	R	$\sqrt{3}$	$\sqrt{0.5}$	$\sqrt{0.5}$	4.3	4.3	∞
3	Hemispherical isotropy	B	9.6	R	$\sqrt{3}$	1	1	4.8	4.8	∞
4	Boundary effect	B	1.1	R	$\sqrt{3}$	1	1	0.6	0.6	∞
5	Linearity	B	4.7	R	$\sqrt{3}$	1	1	2.7	2.7	∞
6	Detection limit	B	1.0	R	$\sqrt{3}$	1	1	0.6	0.6	∞
7	Modulation response	B	4.0	R	$\sqrt{3}$	1	1	2.3	2.3	∞
8	Readout electronics	B	1.0	N	1	1	1	1.0	1.0	∞
9	Response time	B	0.8	R	$\sqrt{3}$	1	1	0.5	0.5	∞
10	Integration time	B	1.7	R	$\sqrt{3}$	1	1	1.0	1.0	∞
11	RF ambient conditions-noise	B	3.0	R	$\sqrt{3}$	1	1	1.7	1.7	∞
12	RF ambient conditions-reflection	B	3.0	R	$\sqrt{3}$	1	1	1.7	1.7	∞
13	Probe positioned mech. restrictions	B	0.35	R	$\sqrt{3}$	1	1	0.2	0.2	∞
14	Probe positioning with respect to phantom shell	B	2.9	R	$\sqrt{3}$	1	1	1.7	1.7	∞
15	Post-processing	B	1.0	R	$\sqrt{3}$	1	1	0.6	0.6	∞
<b>Test sample related</b>										
16	Test sample positioning	A	3.3	N	1	1	1	3.3	3.3	5
17	Device holder uncertainty	A	3.4	N	1	1	1	3.4	3.4	5
18	Drift of output power	B	5.0	R	$\sqrt{3}$	1	1	2.9	2.9	∞
<b>Phantom and set-up</b>										
19	Phantom uncertainty	B	1.0	R	$\sqrt{3}$	1	1	0.6	0.6	∞
20	Liquid conductivity (target)	B	5.0	R	$\sqrt{3}$	0.64	0.43	1.8	1.2	∞
21	Liquid conductivity (meas.)	A	1.3	N	1	0.64	0.43	0.83	0.56	9
22	Liquid permittivity (target)	B	5.0	R	$\sqrt{3}$	0.6	0.49	1.7	1.4	∞
23	Liquid permittivity (meas.)	A	1.6	N	1	0.6	0.49	0.96	0.78	9
Combined standard uncertainty		$u_c = \sqrt{\sum_{i=1}^{23} c_i^2 u_i^2}$						11.3	11.2	95.5
Expanded uncertainty (Confidence interval of 95 %)		$u_e = 2u_c$						22.6	22.4	

**15.2 Measurement Uncertainty for Normal SAR Tests (3GHz~6GHz)**

No.	Error Description	Type	Uncertainty value	Probably Distribution	Div.	(Ci) 1g	(Ci) 10g	Std. Unc. (1g)	Std. Unc. (10g)	Degree of freedom
<b>Measurement system</b>										
1	Probe calibration	B	13	N	2	1	1	6.5	6.5	∞
2	Axial isotropy	B	4.7	R	$\sqrt{3}$	$\sqrt{0.5}$	$\sqrt{0.5}$	4.3	4.3	∞
3	Hemispherical isotropy	B	9.6	R	$\sqrt{3}$	1	1	4.8	4.8	∞
4	Boundary effect	B	2.3	R	$\sqrt{3}$	1	1	1.3	1.3	∞
5	Linearity	B	4.7	R	$\sqrt{3}$	1	1	2.7	2.7	∞
6	Detection limit	B	1.0	R	$\sqrt{3}$	1	1	0.6	0.6	∞
7	Modulation response	B	4.0	R	$\sqrt{3}$	1	1	2.3	2.3	∞
8	Readout electronics	B	1.0	N	1	1	1	1.0	1.0	∞
9	Response time	B	0.8	R	$\sqrt{3}$	1	1	0.5	0.5	∞
10	Integration time	B	1.7	R	$\sqrt{3}$	1	1	1.0	1.0	∞
11	RF ambient conditions-noise	B	3.0	R	$\sqrt{3}$	1	1	1.7	1.7	∞
12	RF ambient conditions-reflection	B	3.0	R	$\sqrt{3}$	1	1	1.7	1.7	∞
13	Probe positioned mech. restrictions	B	0.71	R	$\sqrt{3}$	1	1	0.4	0.4	∞
14	Probe positioning with respect to phantom shell	B	5.7	R	$\sqrt{3}$	1	1	3.3	3.3	∞
15	Post-processing	B	4.0	R	$\sqrt{3}$	1	1	2.3	2.3	∞
<b>Test sample related</b>										
16	Test sample positioning	A	3.3	N	1	1	1	3.3	3.3	5
17	Device holder uncertainty	A	3.4	N	1	1	1	3.4	3.4	5
18	Drift of output power	B	5.0	R	$\sqrt{3}$	1	1	2.9	2.9	∞
<b>Phantom and set-up</b>										
19	Phantom uncertainty	B	1.0	R	$\sqrt{3}$	1	1	0.6	0.6	∞
20	Liquid conductivity (target)	B	5.0	R	$\sqrt{3}$	0.64	0.43	1.8	1.2	∞
21	Liquid conductivity (meas.)	A	1.3	N	1	0.64	0.43	0.83	0.56	9
22	Liquid permittivity (target)	B	5.0	R	$\sqrt{3}$	0.6	0.49	1.7	1.4	∞
23	Liquid permittivity (meas.)	A	1.6	N	1	0.6	0.49	0.96	0.78	9
Combined standard uncertainty		$u_c = \sqrt{\sum_{i=1}^{23} c_i^2 u_i^2}$						12.2	12.1	95.5
Expanded uncertainty (Confidence interval of 95 %)		$u_e = 2u_c$						24.4	24.2	

## 16 Main Test Instruments

**Table 17.1: List of Main Instruments**

No.	Name	Type	Serial Number	Calibration Date	Valid Period
01	Network analyzer	Agilent E5071C	MY46103759	2018-11-16	One year
02	Dielectric probe	85070E	MY44300317	/	/
03	Power meter	E4418B	MY50000366	2018-12-14	One year
04	Power sensor	E9304A	MY50000188		
05	Power meter	NRP	101460	2019-02-04	One year
06	Power sensor	NRP-Z91	100553		
07	Signal Generator	E8257D	MY47461211	2019-06-03	One year
08	Amplifier	VTL5400	0404	/	/
09	E-field Probe	SPEAG EX3DV4	3633	2019-02-26	One year
10	DAE	SPEAG DAE4	786	2019-01-11	One year
11	Dipole Validation Kit	SPEAG D835V2	4d057	2018-10-09	Three year
12	Dipole Validation Kit	SPEAG D1900V2	5d088	2018-10-24	Three year
13	Dipole Validation Kit	SPEAG D2450V2	873	2018-10-26	Three year
14	Dipole Validation Kit	SPEAG D2550V2	1010	2018-08-24	Three year
15	Dipole Validation Kit	SPEAG D5GHzV2	1238	2019-08-29	Three year
16	BTS	E5515C	GB46110722	2019-01-05	One year
17	Radio Communication Analyzer	Anristu MT8820C	6201341853	2019-03-07	One year
18	Thermometer	FLUKE 51-II	99250045	2019-07-17	One year
19	Thermometer	Anymetre JR900	31#	2019-07-18	One year

\*\*\*END OF REPORT BODY\*\*\*

## ANNEX A Graph Results

### GSM850 Head

Date: 2019-10-18

Electronics: DAE4 Sn786

Medium: Head 835 MHz

Medium parameters used (interpolated):  $f = 836.6$  MHz;  $\sigma = 0.914$  S/m;  $\epsilon_r = 40.757$ ;  $\rho = 1000$  kg/m<sup>3</sup>

Ambient Temperature: 22.0°C      Liquid Temperature: 21.5°C

Communication System: UID 0, GSM (0) Frequency: 836.6 MHz Duty Cycle: 1:8.3

Probe: EX3DV4 - SN3633 ConvF (9.51, 9.51, 9.51)

**Left Cheek Middle/Area Scan (61x111x1):** Interpolated grid: dx=1.500 mm, dy=1.500 mm

Maximum value of SAR (interpolated) = 0.132 W/kg

**Left Cheek Middle/Zoom Scan (5x5x7)/Cube 0:** Measurement grid: dx=8mm, dy=8mm, dz=5mm

Reference Value = 2.260 V/m; Power Drift = 0.04 dB

Peak SAR (extrapolated) = 0.159 W/kg

**SAR(1 g) = 0.120 W/kg; SAR(10 g) = 0.089 W/kg**

Maximum value of SAR (measured) = 0.141 W/kg

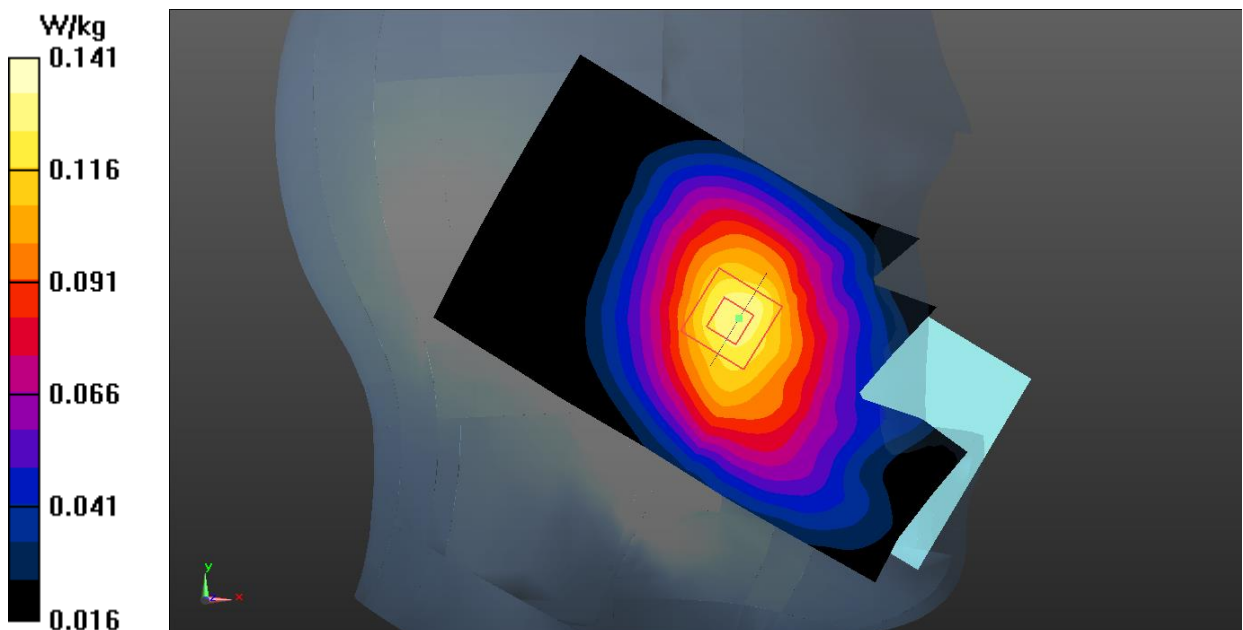

Fig.1 GSM850 Head

**GSM850 Body**

Date: 2019-10-18

Electronics: DAE4 Sn786

Medium: Head 835 MHz

Medium parameters used (interpolated):  $f = 836.6$  MHz;  $\sigma = 0.914$  S/m;  $\epsilon_r = 40.757$ ;  $\rho = 1000$  kg/m<sup>3</sup>

Ambient Temperature: 22.0°C      Liquid Temperature: 21.5°C

Communication System: UID 0, GPRS 2Txslot (0) Frequency: 836.6 MHz Duty Cycle: 1:4

Probe: EX3DV4 - SN3633 ConvF (9.51, 9.51, 9.51)

**Rear Side Middle/Area Scan (61x111x1):** Interpolated grid: dx=1.500 mm, dy=1.500 mm

Maximum value of SAR (interpolated) = 0.178 W/kg

**Rear Side Middle/Zoom Scan (5x5x7)/Cube 0:** Measurement grid: dx=8mm, dy=8mm, dz=5mm

Reference Value = 12.71 V/m; Power Drift = 0.01 dB

Peak SAR (extrapolated) = 0.215 W/kg

**SAR(1 g) = 0.158 W/kg; SAR(10 g) = 0.114 W/kg**

Maximum value of SAR (measured) = 0.176 W/kg

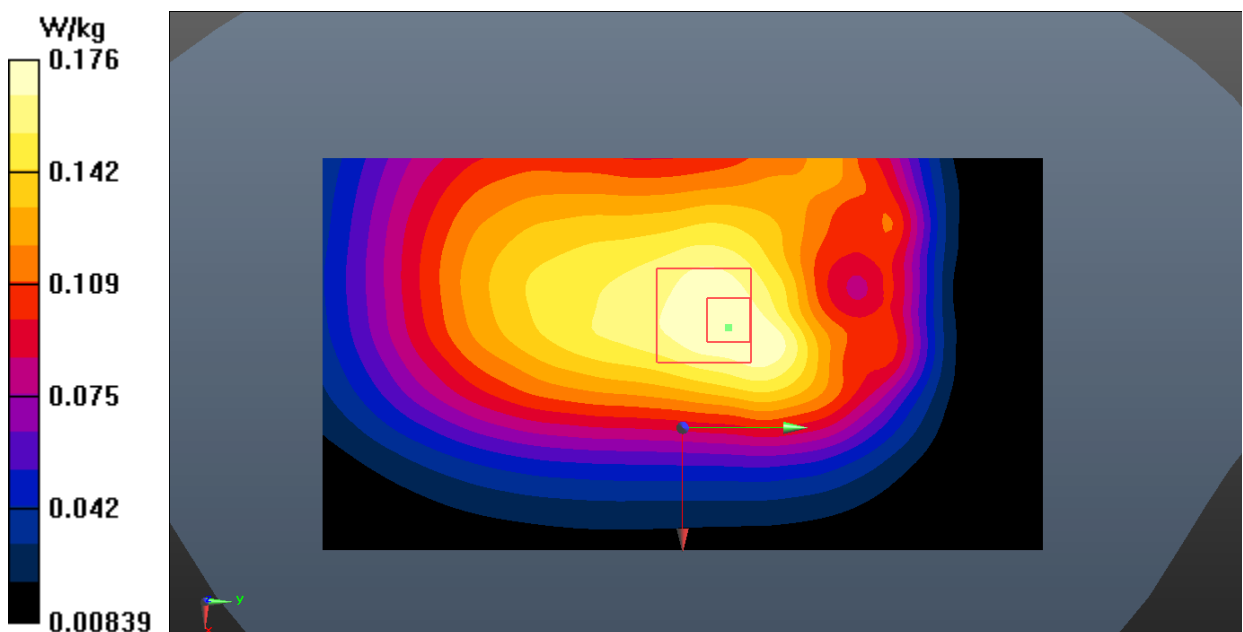

**Fig.2 GSM850 Body**

**GSM1900 Head**

Date: 2019-10-20

Electronics: DAE4 Sn786

Medium: Head 1900 MHz

Medium parameters used:  $f = 1880$  MHz;  $\sigma = 1.375$  S/m;  $\epsilon_r = 38.722$ ;  $\rho = 1000$  kg/m<sup>3</sup>

Ambient Temperature: 22.0°C      Liquid Temperature: 21.5°C

Communication System: UID 0, GSM (0) Frequency: 1880 MHz Duty Cycle: 1:8.3

Probe: EX3DV4 - SN3633 ConvF (7.63, 7.63, 7.63)

**Left Cheek Middle/Area Scan (61x61x1):** Interpolated grid: dx=1.500 mm, dy=1.500 mm

Maximum value of SAR (interpolated) = 0.212 W/kg

**Left Cheek Middle/Zoom Scan (5x5x7)/Cube 0:** Measurement grid: dx=8mm, dy=8mm, dz=5mm

Reference Value = 3.951 V/m; Power Drift = 0.06 dB

Peak SAR (extrapolated) = 0.308 W/kg

**SAR(1 g) = 0.195 W/kg; SAR(10 g) = 0.120 W/kg**

Maximum value of SAR (measured) = 0.253 W/kg

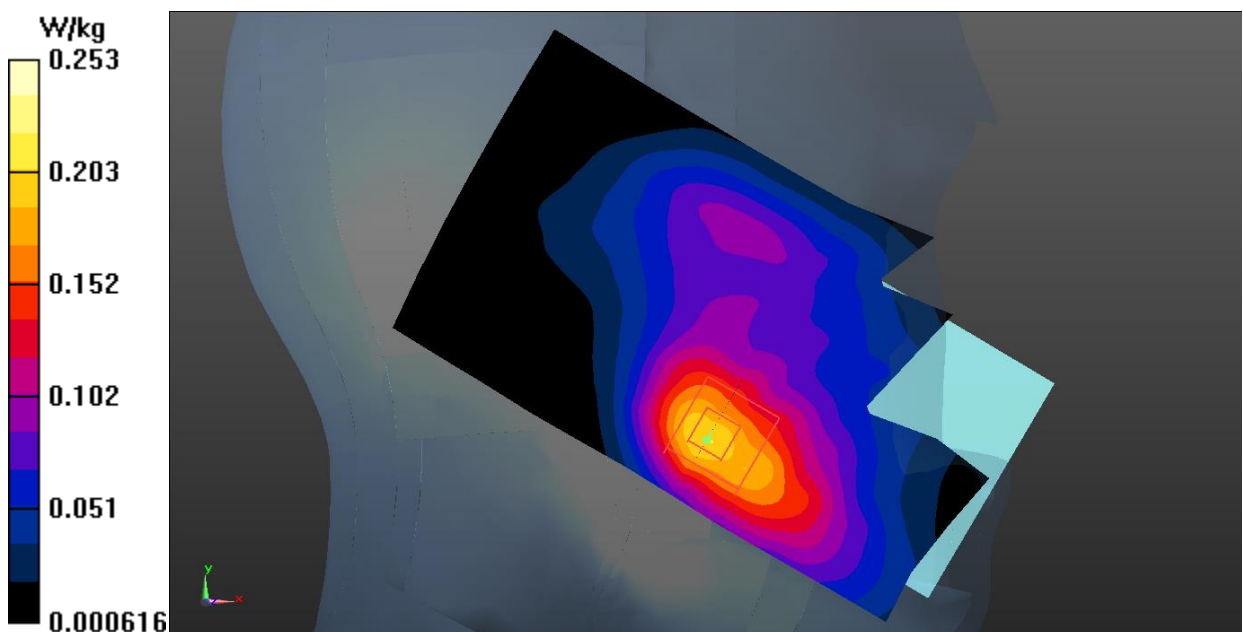

**Fig.3 GSM1900 Head**

**GSM1900 Body**

Date: 2019-10-20

Electronics: DAE4 Sn786

Medium: Head 1900 MHz

Medium parameters used:  $f = 1880 \text{ MHz}$ ;  $\sigma = 1.375 \text{ S/m}$ ;  $\epsilon_r = 38.722$ ;  $\rho = 1000 \text{ kg/m}^3$

Ambient Temperature:  $22.0^\circ\text{C}$       Liquid Temperature:  $21.5^\circ\text{C}$

Communication System: UID 0, GPRS 2Txslot (0) Frequency: 1880 MHz Duty Cycle: 1:4

Probe: EX3DV4 - SN3633 ConvF (7.63, 7.63, 7.63)

**Rear Side Middle/Area Scan (61x111x1):** Interpolated grid:  $dx=1.500 \text{ mm}$ ,  $dy=1.500 \text{ mm}$

Maximum value of SAR (interpolated) =  $0.666 \text{ W/kg}$

**Rear Side Middle /Zoom Scan (5x5x7)/Cube 0:** Measurement grid:  $dx=8\text{mm}$ ,  $dy=8\text{mm}$ ,  $dz=5\text{mm}$

Reference Value =  $11.95 \text{ V/m}$ ; Power Drift =  $0.02 \text{ dB}$

Peak SAR (extrapolated) =  $0.943 \text{ W/kg}$

**SAR(1 g) =  $0.520 \text{ W/kg}$ ; SAR(10 g) =  $0.295 \text{ W/kg}$**

Maximum value of SAR (measured) =  $0.634 \text{ W/kg}$

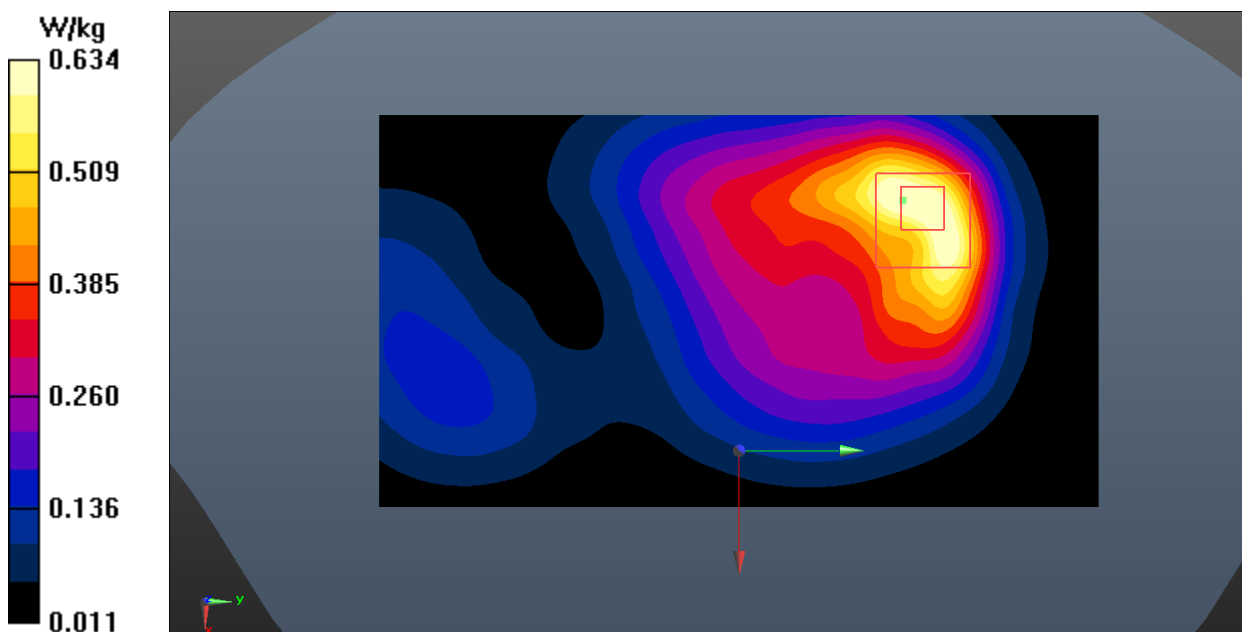

**Fig.4 GSM1900 Body**



**WCDMA 850 Head**

Date: 2019-10-18

Electronics: DAE4 Sn786

Medium: Head 835 MHz

Medium parameters used (interpolated):  $f = 836.4$  MHz;  $\sigma = 0.914$  S/m;  $\epsilon_r = 40.759$ ;  $\rho = 1000$  kg/m<sup>3</sup>

Ambient Temperature: 22.0°C      Liquid Temperature: 21.5°C

Communication System: UID 0, WCDMA (0) Frequency: 836.4 MHz Duty Cycle: 1:1

Probe: EX3DV4 - SN3633 ConvF (9.51, 9.51, 9.51)

**Right Cheek Middle/Area Scan (61x111x1):** Interpolated grid:  $dx=1.500$  mm,  $dy=1.500$  mm

Maximum value of SAR (interpolated) = 0.169 W/kg

**Right Cheek Middle/Zoom Scan (5x5x7)/Cube 0:** Measurement grid:  $dx=8$ mm,  $dy=8$ mm,  $dz=5$ mm

Reference Value = 3.845 V/m; Power Drift = -0.12 dB

Peak SAR (extrapolated) = 0.212 W/kg

**SAR(1 g) = 0.162 W/kg; SAR(10 g) = 0.118 W/kg**

Maximum value of SAR (measured) = 0.188 W/kg

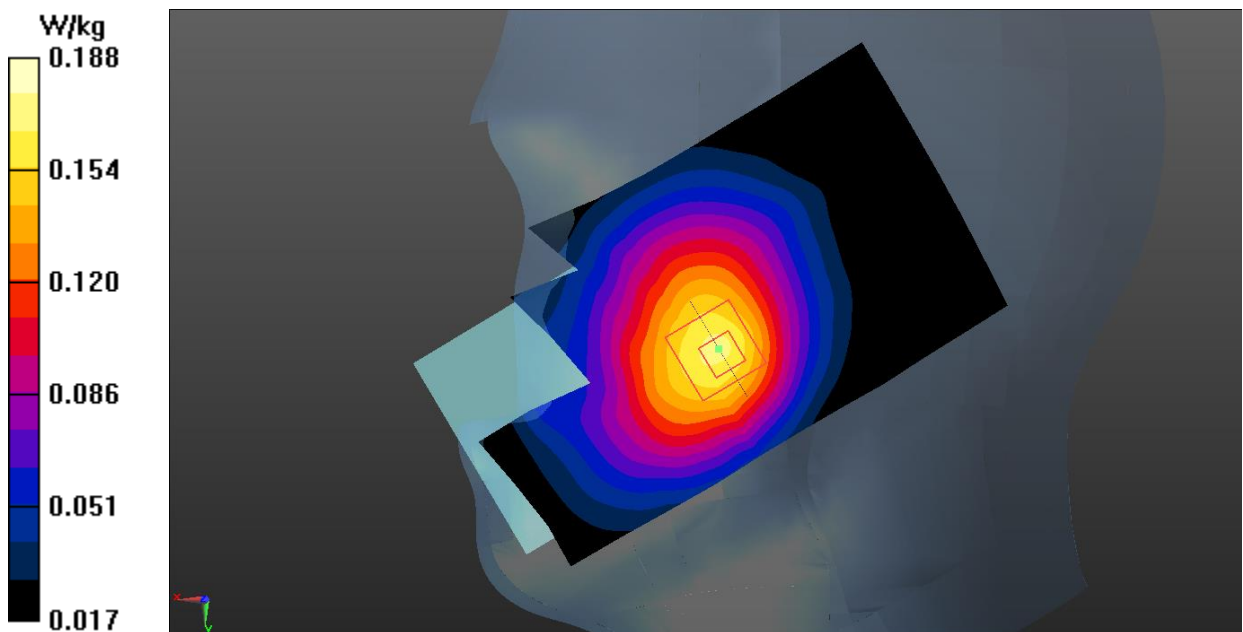

**Fig.5 WCDMA850 Head**

**WCDMA 850 Body**

Date: 2019-10-18

Electronics: DAE4 Sn786

Medium: Head 835 MHz

Medium parameters used (interpolated):  $f = 836.4$  MHz;  $\sigma = 0.914$  S/m;  $\epsilon_r = 40.759$ ;  $\rho = 1000$  kg/m<sup>3</sup>

Ambient Temperature: 22.0°C      Liquid Temperature: 21.5°C

Communication System: UID 0, WCDMA (0) Frequency: 836.4 MHz Duty Cycle: 1:1

Probe: EX3DV4 - SN3633 ConvF (9.51, 9.51, 9.51)

**Rear Side Middle/Area Scan (61x111x1):** Interpolated grid: dx=1.500 mm, dy=1.500 mm

Maximum value of SAR (interpolated) = 0.263 W/kg

**Rear Side Middle/Zoom Scan (5x5x7)/Cube 0:** Measurement grid: dx=8mm, dy=8mm, dz=5mm

Reference Value = 13.89 V/m; Power Drift = 0.03 dB

Peak SAR (extrapolated) = 0.313 W/kg

**SAR(1 g) = 0.219 W/kg; SAR(10 g) = 0.157 W/kg**

Maximum value of SAR (measured) = 0.265 W/kg

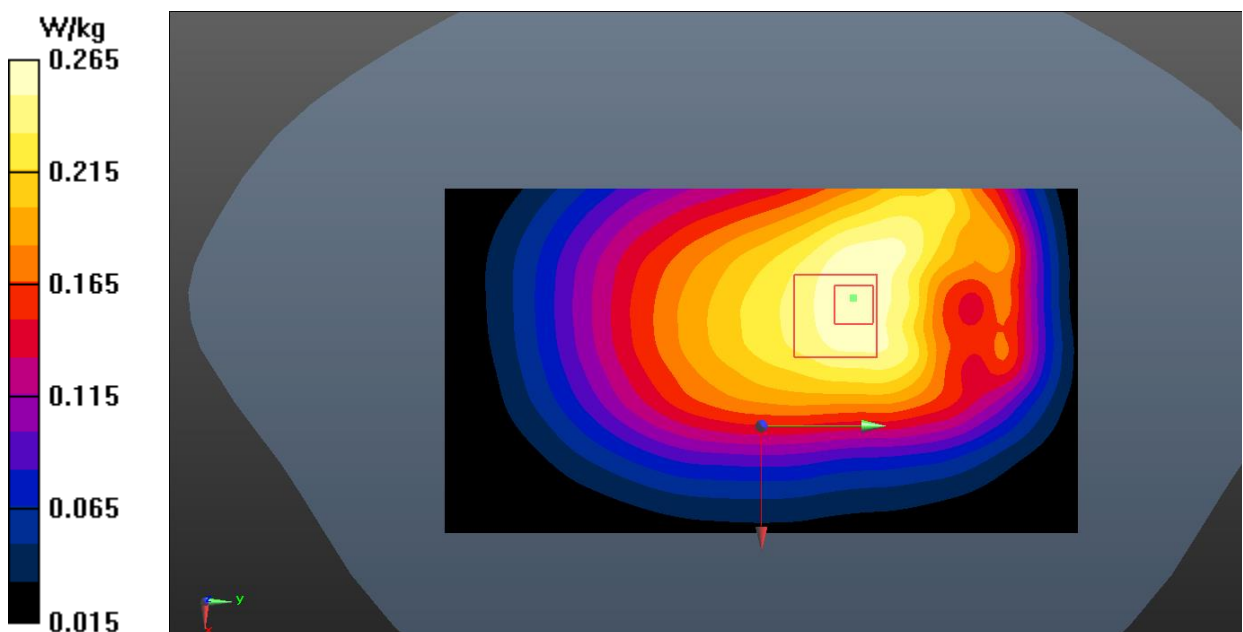

**Fig.6 WCDMA850 Body**

**WCDMA 1900 Head**

Date: 2019-10-20

Electronics: DAE4 Sn786

Medium: Head 1900 MHz

Medium parameters used:  $f = 1880$  MHz;  $\sigma = 1.375$  S/m;  $\epsilon_r = 38.722$ ;  $\rho = 1000$  kg/m<sup>3</sup>

Ambient Temperature: 22.0°C      Liquid Temperature: 21.5°C

Communication System: UID 0, WCDMA (0) Frequency: 1880 MHz Duty Cycle: 1:1

Probe: EX3DV4 - SN3633 ConvF (7.63, 7.63, 7.63)

**Left Cheek Middle/Area Scan (61x61x1):** Interpolated grid: dx=1.500 mm, dy=1.500 mm

Maximum value of SAR (interpolated) = 0.442 W/kg

**Left Cheek Middle/Zoom Scan (5x5x7)/Cube 0:** Measurement grid: dx=8mm, dy=8mm, dz=5mm

Reference Value = 5.373 V/m; Power Drift = -0.05 dB

Peak SAR (extrapolated) = 1.04 W/kg

**SAR(1 g) = 0.415 W/kg; SAR(10 g) = 0.120 W/kg**

Maximum value of SAR (measured) = 0.441 W/kg

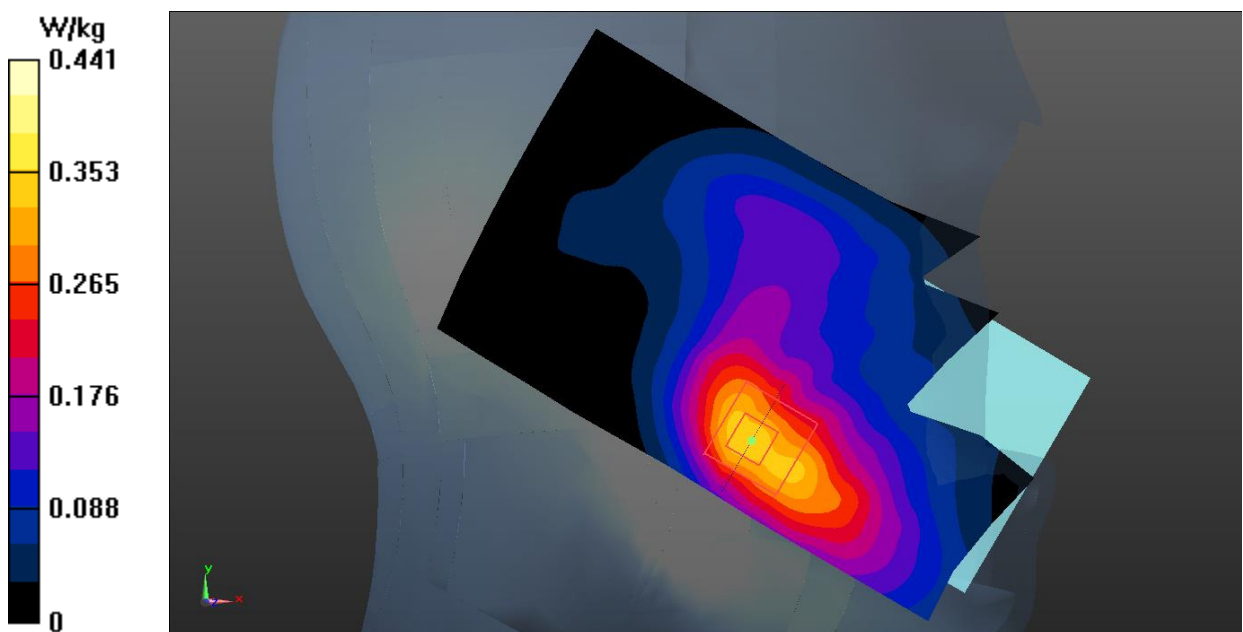

**Fig.7 WCDMA1900 Head**

**WCDMA 1900 Body**

Date: 2019-10-20

Electronics: DAE4 Sn786

Medium: Head 1900 MHz

Medium parameters used:  $f = 1880$  MHz;  $\sigma = 1.375$  S/m;  $\epsilon_r = 38.722$ ;  $\rho = 1000$  kg/m<sup>3</sup>

Ambient Temperature: 22.0°C      Liquid Temperature: 21.5°C

Communication System: UID 0, WCDMA (0) Frequency: 1880 MHz Duty Cycle: 1:1

Probe: EX3DV4 - SN3633 ConvF (7.63, 7.63, 7.63)

**Rear Side Middle/Area Scan (61x111x1):** Interpolated grid: dx=1.500 mm, dy=1.500 mm

Maximum value of SAR (interpolated) = 1.24 W/kg

**Rear Side Middle/Zoom Scan (5x5x7)/Cube 0:** Measurement grid: dx=8mm, dy=8mm, dz=5mm

Reference Value = 13.55 V/m; Power Drift = 0.01 dB

Peak SAR (extrapolated) = 1.48 W/kg

**SAR(1 g) = 0.812 W/kg; SAR(10 g) = 0.452 W/kg**

Maximum value of SAR (measured) = 1.15 W/kg

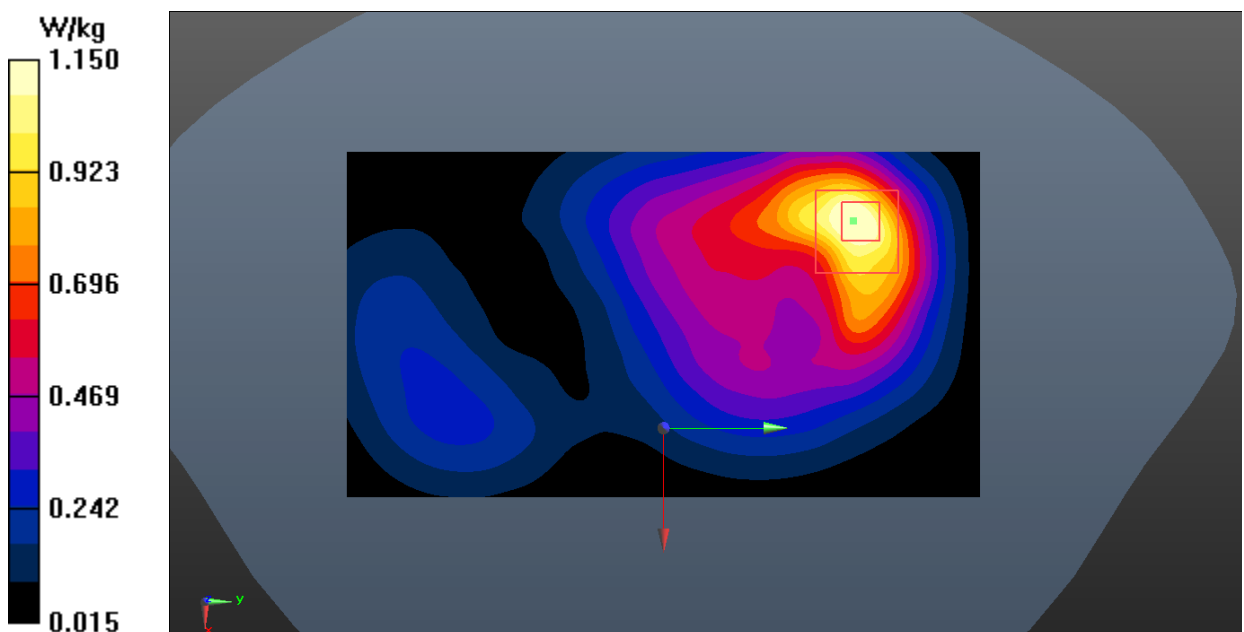

**Fig.8 WCDMA1900 Body**

**LTE Band 7 Head**

Date: 2019-10-21

Electronics: DAE4 Sn786

Medium: Head 2550 MHz

Medium parameters used:  $f = 2535$  MHz;  $\sigma = 1.928$  S/m;  $\epsilon_r = 38.211$ ;  $\rho = 1000$  kg/m<sup>3</sup>

Ambient Temperature: 22.0°C      Liquid Temperature: 21.5°C

Communication System: UID 0, LTE\_FDD (0) Frequency: 2535 MHz Duty Cycle: 1:1

Probe: EX3DV4 - SN3633 ConvF (7.12, 7.12, 7.12)

**Left Cheek Middle 1RB\_Mid/Area Scan (81x161x1):** Interpolated grid: dx=1.000 mm, dy=1.000 mm

Maximum value of SAR (interpolated) = 0.830 W/kg

**Left Cheek Middle 1RB\_Mid/Zoom Scan (7x7x7)/Cube 0:** Measurement grid: dx=5mm, dy=5mm, dz=5mm

Reference Value = 4.048 V/m; Power Drift = -0.05 dB

Peak SAR (extrapolated) = 1.26 W/kg

**SAR(1 g) = 0.708 W/kg; SAR(10 g) = 0.388 W/kg**

Maximum value of SAR (measured) = 0.993 W/kg

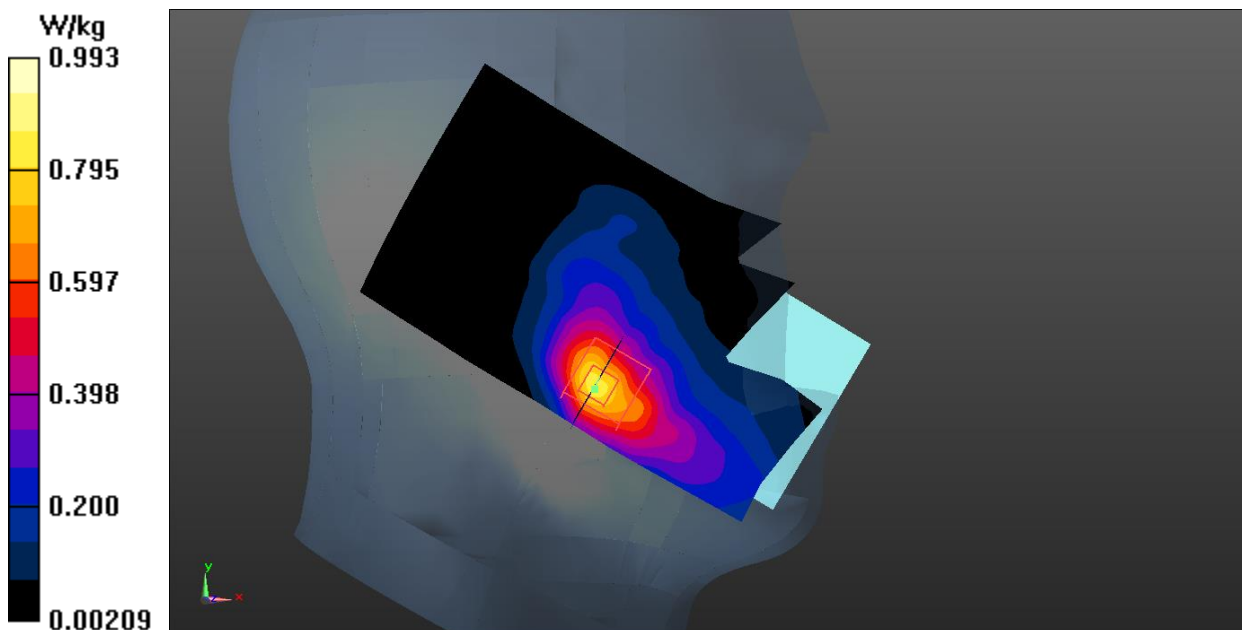

**Fig.9 LTE Band 7 Head**

**LTE Band 7 Body**

Date: 2019-10-21

Electronics: DAE4 Sn786

Medium: Head 2550 MHz

Medium parameters used:  $f = 2510$  MHz;  $\sigma = 1.899$  S/m;  $\epsilon_r = 38.292$ ;  $\rho = 1000$  kg/m<sup>3</sup>

Ambient Temperature: 22.0°C      Liquid Temperature: 21.5°C

Communication System: UID 0, 4G\_LTE\_FDD (0) Frequency: 2510 MHz Duty Cycle: 1:1

Probe: EX3DV4 - SN3633 ConvF (7.33, 7.33, 7.33)

**Front Side Low 1RB\_Mid/Area Scan (81x161x1):** Interpolated grid: dx=1.000 mm, dy=1.000 mm

Maximum value of SAR (interpolated) = 1.58 W/kg

**Front Side Low 1RB\_Mid /Zoom Scan (7x7x7)/Cube 0:** Measurement grid: dx=5mm, dy=5mm, dz=5mm

Reference Value = 10.36 V/m; Power Drift = -0.02 dB

Peak SAR (extrapolated) = 2.06 W/kg

**SAR(1 g) = 1.04 W/kg; SAR(10 g) = 0.528 W/kg**

Maximum value of SAR (measured) = 1.51 W/kg

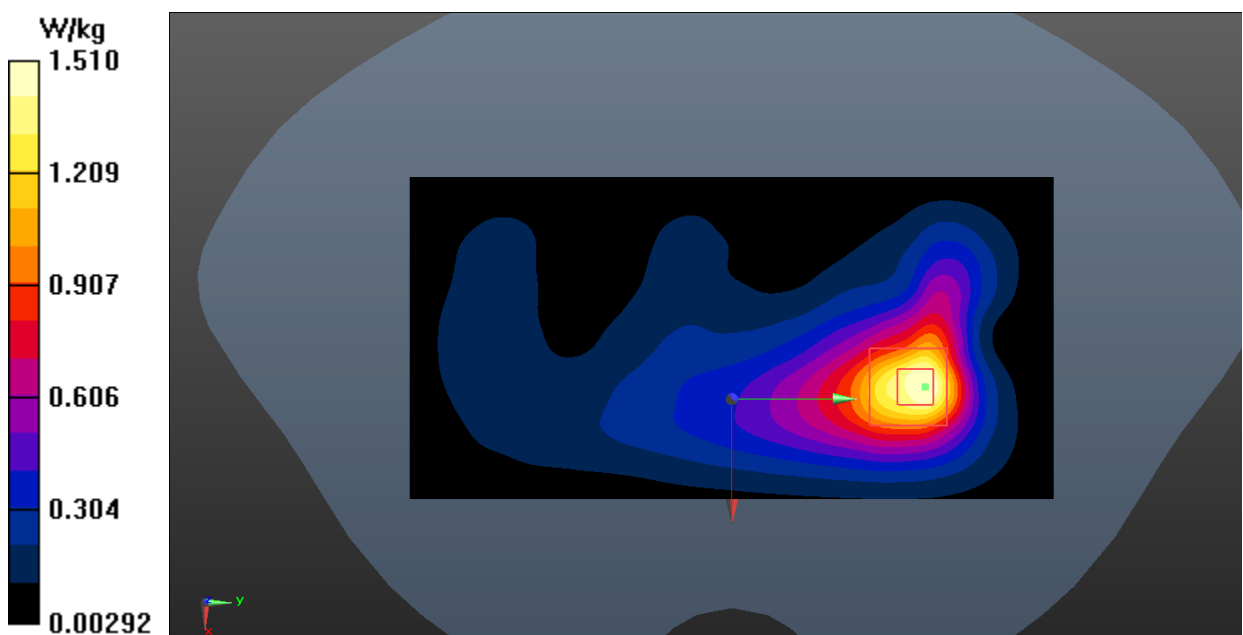

**Fig.10 LTE Band 7 Body**

**Bluetooth 2.4G Head**

Date: 2019-11-14

Electronics: DAE4 Sn786

Medium: Head 2450 MHz

Medium parameters used (interpolated):  $f = 2402$  MHz;  $\sigma = 1.768$  S/m;  $\epsilon_r = 38.687$ ;  $\rho = 1000$  kg/m<sup>3</sup>

Ambient Temperature: 22.0°C      Liquid Temperature: 21.5°C

Communication System: UID 0, BT (0) Frequency: 2402 MHz Duty Cycle: 1:1

Probe: EX3DV4 – SN3633 ConvF (7.33, 7.33, 7.33);

**Left Cheek Low/Area Scan (81x161x1):** Interpolated grid: dx=1.000 mm, dy=1.000 mm

Maximum value of SAR (interpolated) = 0.171 W/kg

**Left Cheek Low/Zoom Scan (7x7x7)/Cube 0:** Measurement grid: dx=5mm, dy=5mm, dz=5mm

Reference Value = 3.485 V/m; Power Drift = -0.08 dB

Peak SAR (extrapolated) = 0.149 W/kg

**SAR(1 g) = 0.070 W/kg; SAR(10 g) = 0.035 W/kg**

Maximum value of SAR (measured) = 0.100 W/kg

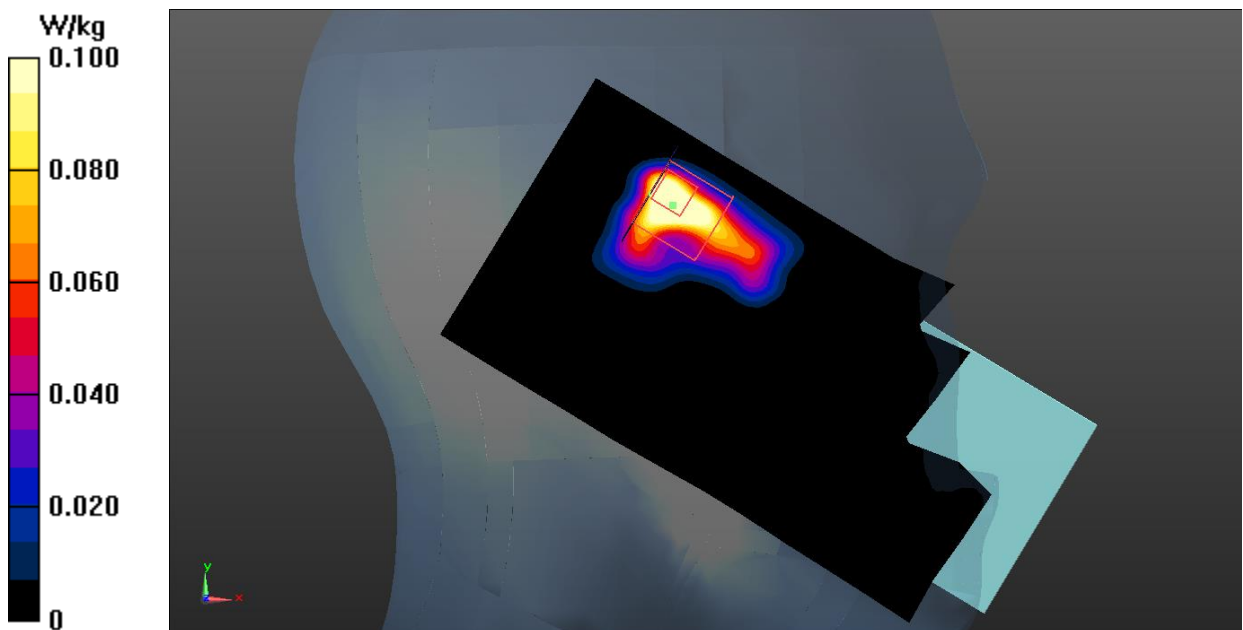

**Fig.11 Bluetooth 2.4G Head**

**Wi-Fi 2.4G Head**

Date: 2019-11-14

Electronics: DAE4 Sn786

Medium: Head 2450 MHz

Medium parameters used:  $f = 2412$  MHz;  $\sigma = 1.78$  S/m;  $\epsilon_r = 38.654$ ;  $\rho = 1000$  kg/m<sup>3</sup>

Ambient Temperature: 22.0°C      Liquid Temperature: 21.5°C

Communication System: UID 0, WiFi (0) Frequency: 2412 MHz Duty Cycle: 1:1

Probe: EX3DV4 – SN3633 ConvF (7.33, 7.33, 7.33);

**Left Cheek Low /Area Scan (81x161x1):** Interpolated grid: dx=1.000 mm, dy=1.000 mm

Maximum value of SAR (interpolated) = 1.42 W/kg

**Left Cheek Low /Zoom Scan (7x7x7)/Cube 0:** Measurement grid: dx=5mm, dy=5mm, dz=5mm

Reference Value = 11.99 V/m; Power Drift = 0.01 dB

Peak SAR (extrapolated) = 1.57 W/kg

**SAR(1 g) = 0.751 W/kg; SAR(10 g) = 0.387 W/kg**

Maximum value of SAR (measured) = 1.06 W/kg

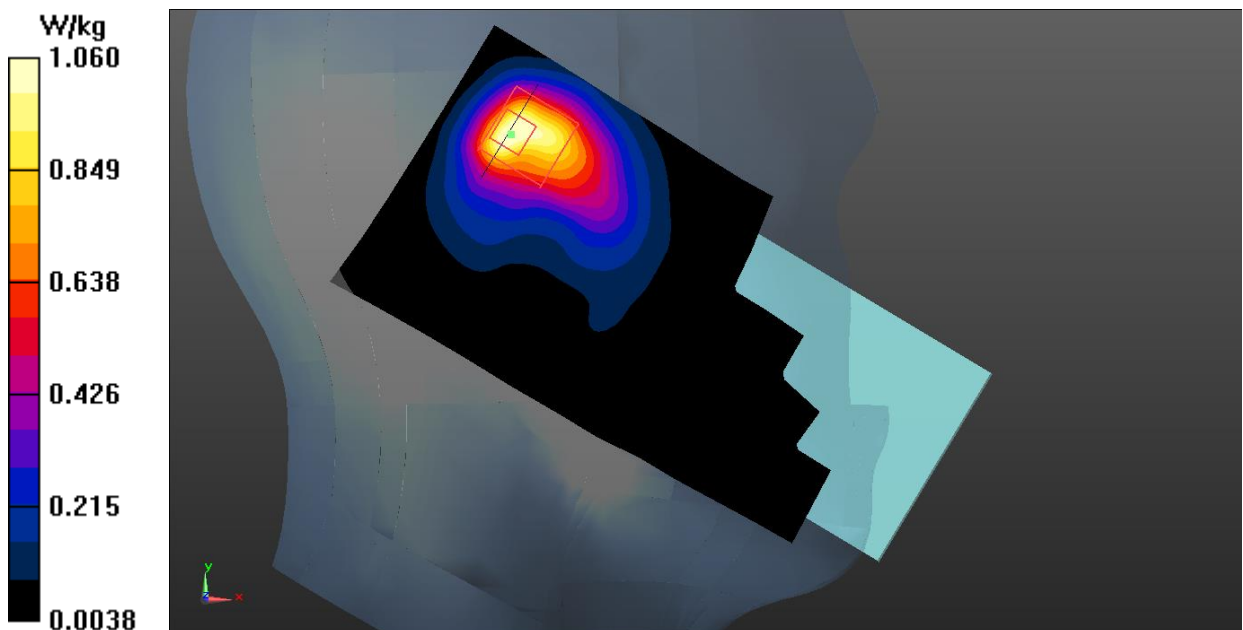

**Fig.12 Wi-Fi 2.4G Head**



**Wi-Fi 2.4G Body**

Date: 2019-11-14

Electronics: DAE4 Sn786

Medium: Head 2450 MHz

Medium parameters used:  $f = 2412$  MHz;  $\sigma = 1.78$  S/m;  $\epsilon_r = 38.654$ ;  $\rho = 1000$  kg/m<sup>3</sup>

Ambient Temperature: 22.0°C      Liquid Temperature: 21.5°C

Communication System: UID 0, WiFi (0) Frequency: 2412 MHz Duty Cycle: 1:1

Probe: EX3DV4 – SN3633 ConvF (7.33, 7.33, 7.33);

**Rear Side Low/Area Scan (81x161x1):** Interpolated grid: dx=1.000 mm, dy=1.000 mm

Maximum value of SAR (interpolated) = 0.299 W/kg

**Rear Side Low/Zoom Scan (7x7x7)/Cube 0:** Measurement grid: dx=5mm, dy=5mm, dz=5mm

Reference Value = 3.445 V/m; Power Drift = -0.14 dB

Peak SAR (extrapolated) = 0.418 W/kg

**SAR(1 g) = 0.198 W/kg; SAR(10 g) = 0.100 W/kg**

Maximum value of SAR (measured) = 0.296 W/kg

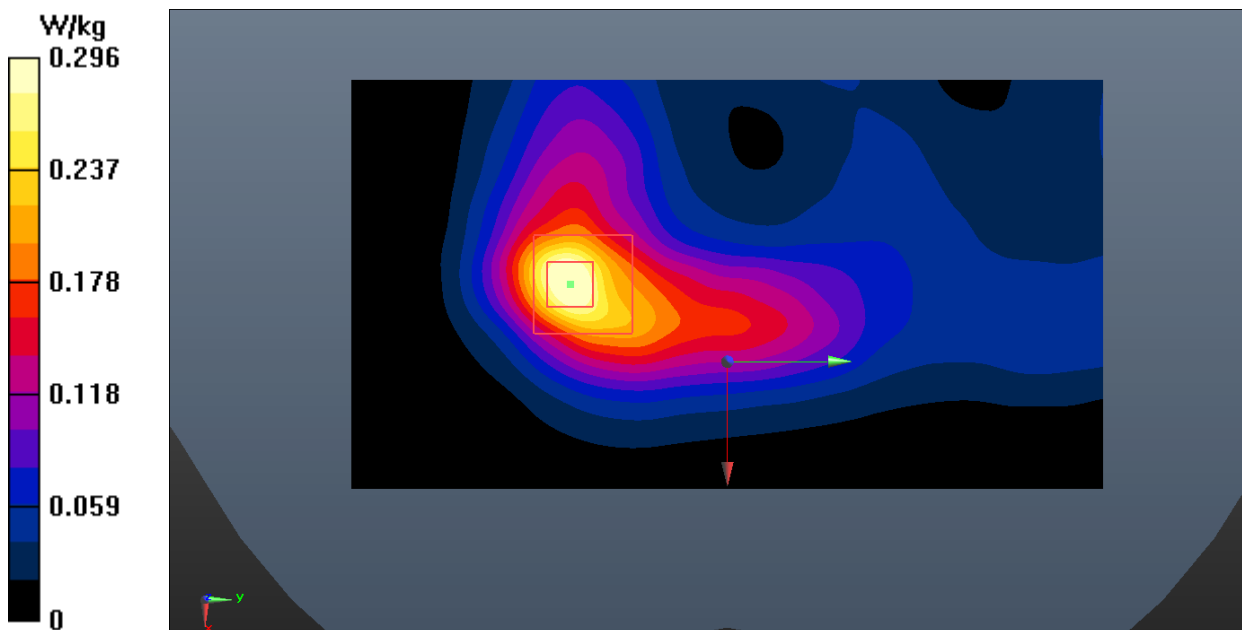

**Fig.13 Wi-Fi 2.4G Body**

**Wi-Fi 5.2G Head**

Date: 2019-10-24

Electronics: DAE4 Sn786

Medium: Head 5250 MHz

Medium parameters used:  $f = 5260$  MHz;  $\sigma = 4.801$  S/m;  $\epsilon_r = 34.75$ ;  $\rho = 1000$  kg/m<sup>3</sup>

Ambient Temperature: 22.0°C      Liquid Temperature: 21.5°C

Communication System: UID 0, LTE\_TDD (0) Frequency: 5260 MHz Duty Cycle: 1:1.58

Probe: EX3DV4 - SN3633 ConvF (5.42, 5.42, 5.42)

**Right Tilt CH52/Area Scan (81x161x1):** Interpolated grid: dx=1.000 mm, dy=1.000 mm

Maximum value of SAR (interpolated) = 0.902 W/kg

**Right Tilt CH52/Zoom Scan (7x7x11)/Cube 0:** Measurement grid: dx=4mm, dy=4mm, dz=2mm

Reference Value = 14.01 V/m; Power Drift = -0.13 dB

Peak SAR (extrapolated) = 1.82 W/kg

**SAR(1 g) = 0.829 W/kg; SAR(10 g) = 0.456 W/kg**

Maximum value of SAR (measured) = 1.20 W/kg

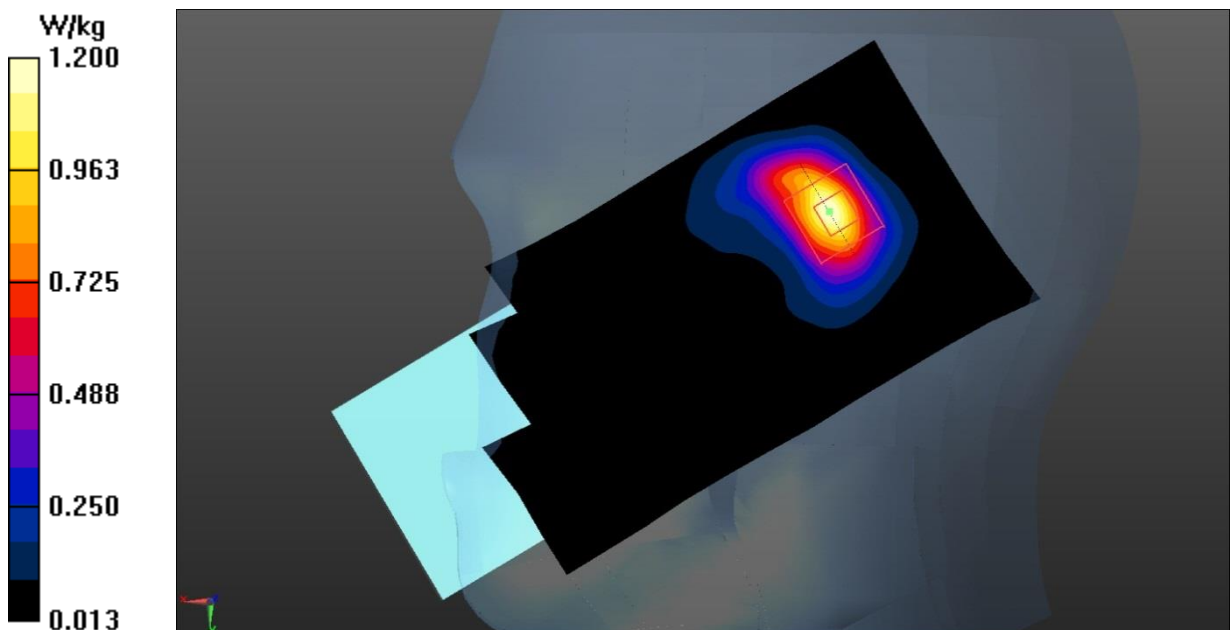

**Fig.14 Wi-Fi 5G Head**

**Wi-Fi 5.2G Body**

Date: 2019-10-24

Electronics: DAE4 Sn786

Medium: Head 5250 MHz

Medium parameters used:  $f = 5260$  MHz;  $\sigma = 4.801$  S/m;  $\epsilon_r = 34.75$ ;  $\rho = 1000$  kg/m<sup>3</sup>

Ambient Temperature: 22.0°C      Liquid Temperature: 21.5°C

Communication System: UID 0, LTE\_TDD (0) Frequency: 5260 MHz Duty Cycle: 1:1.58

Probe: EX3DV4 - SN3633 ConvF (5.42, 5.42, 5.42)

**Top Side CH52/Area Scan (71x91x1):** Interpolated grid: dx=1.000 mm, dy=1.000 mm

Maximum value of SAR (interpolated) = 0.407 W/kg

**op Side CH52/Zoom Scan (7x7x11)/Cube 0:** Measurement grid: dx=4mm, dy=4mm, dz=2mm

Reference Value = 4.634 V/m; Power Drift = 0.05 dB

Peak SAR (extrapolated) = 0.627 W/kg

**SAR(1 g) = 0.192 W/kg; SAR(10 g) = 0.076 W/kg**

Maximum value of SAR (measured) = 0.358 W/kg

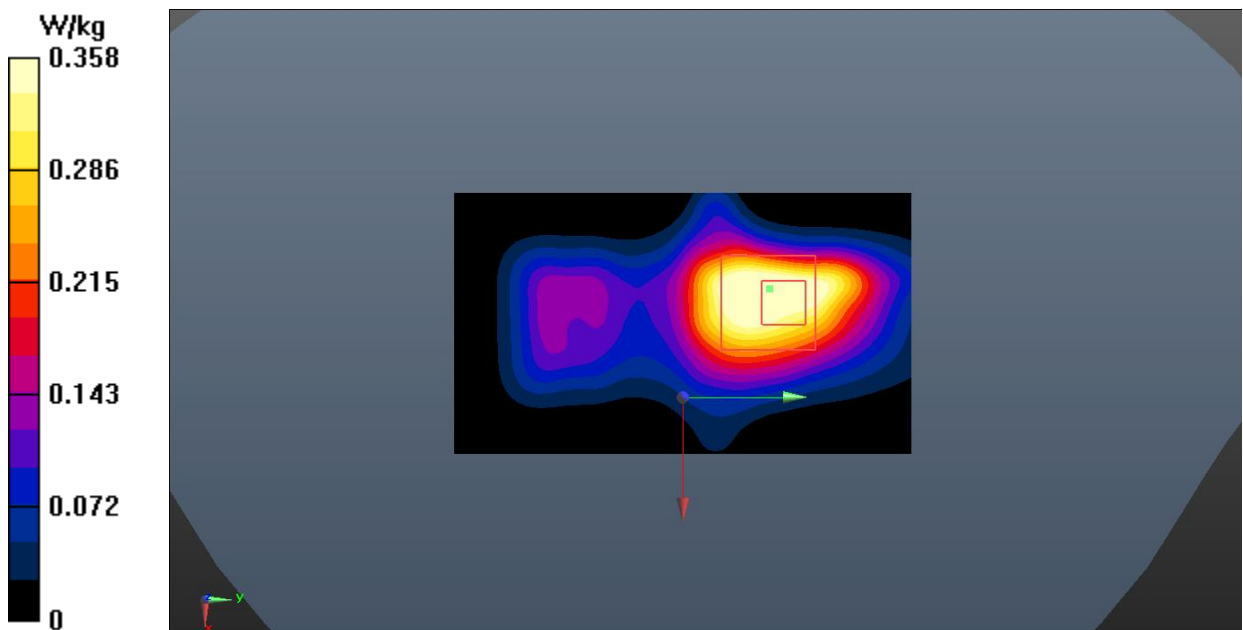

**Fig.15 Wi-Fi 5G Body**

## ANNEX B System Verification Results

### 835MHz

Date: 2019-10-18

Electronics: DAE4 Sn786

Medium: Head 835 MHz

Medium parameters used:  $f = 835 \text{ MHz}$ ;  $\sigma = 0.913 \text{ S/m}$ ;  $\epsilon_r = 40.776$ ;  $\rho = 1000 \text{ kg/m}^3$

Ambient Temperature:  $22.9^\circ\text{C}$       Liquid Temperature:  $22.5^\circ\text{C}$

Communication System: CW Frequency: 835 MHz Duty Cycle: 1:1

Probe: EX3DV4 - SN3633 ConvF (9.51, 9.51, 9.51)

**System Validation /Area Scan (81x161x1):** Interpolated grid:  $dx=1.000 \text{ mm}$ ,  $dy=1.000 \text{ mm}$

Reference Value =  $61.464 \text{ V/m}$ ; Power Drift =  $0.08 \text{ dB}$

**SAR(1 g) =  $2.48 \text{ W/kg}$ ; SAR(10 g) =  $1.59 \text{ W/kg}$**

Maximum value of SAR (interpolated) =  $2.66 \text{ W/kg}$

**System Validation /Zoom Scan (7x7x7)/Cube 0:** Measurement grid:  $dx=5\text{mm}$ ,  $dy=5\text{mm}$ ,  $dz=5\text{mm}$

Reference Value =  $61.464 \text{ V/m}$ ; Power Drift =  $0.08 \text{ dB}$

Peak SAR (extrapolated) =  $3.43 \text{ W/kg}$

**SAR(1 g) =  $2.51 \text{ W/kg}$ ; SAR(10 g) =  $1.61 \text{ W/kg}$**

Maximum value of SAR (measured) =  $2.68 \text{ W/kg}$

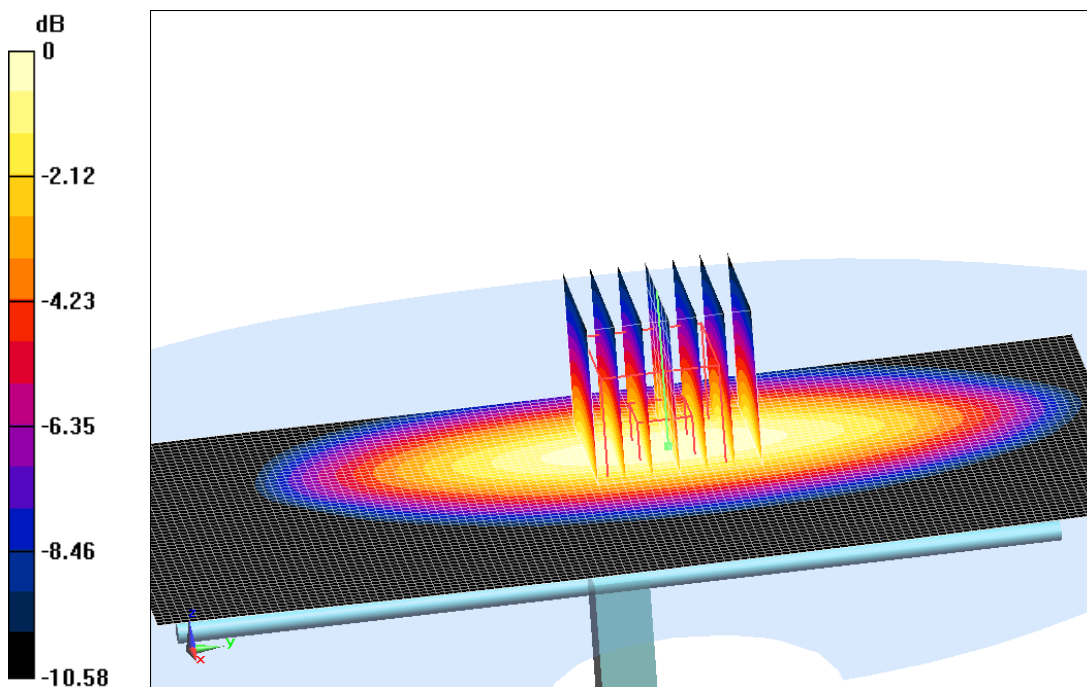

$0 \text{ dB} = 2.68 \text{ W/kg} = 4.28 \text{ dB W/kg}$

**Fig.B.1. Validation 835MHz 250mW**

**1900MHz**

Date: 2019-10-20

Electronics: DAE4 Sn786

Medium: Head 1900MHz

Medium parameters used:  $f = 1900 \text{ MHz}$ ;  $\sigma = 1.393 \text{ S/m}$ ;  $\epsilon_r = 38.644$ ;  $\rho = 1000 \text{ kg/m}^3$

Ambient Temperature:  $22.5^\circ\text{C}$       Liquid Temperature:  $22.0^\circ\text{C}$

Communication System: CW\_TMC Frequency: 1900 MHz Duty Cycle: 1:1

Probe: EX3DV4 – SN3633 ConvF (7.63, 7.63, 7.63);

**System Validation/Area Scan (61x121x1):** Interpolated grid:  $dx=1.000 \text{ mm}$ ,  $dy=1.000 \text{ mm}$

Reference Value =  $80.259 \text{ V/m}$ ; Power Drift =  $-0.04 \text{ dB}$

**SAR(1 g) = 9.78 W/kg; SAR(10 g) = 5.18 W/kg**

Maximum value of SAR (interpolated) =  $10.4 \text{ W/kg}$

**System Validation/Zoom Scan (7x7x7)/Cube0:** Measurement grid:  $dx=5\text{mm}$ ,  $dy=5\text{mm}$ ,  $dz=5\text{mm}$

Reference Value =  $80.259 \text{ V/m}$ ; Power Drift =  $-0.04 \text{ dB}$

Peak SAR (extrapolated) =  $20.9 \text{ W/kg}$

**SAR(1 g) = 9.67 W/kg; SAR(10 g) = 5.13 W/kg**

Maximum value of SAR (measured) =  $10.3 \text{ W/kg}$

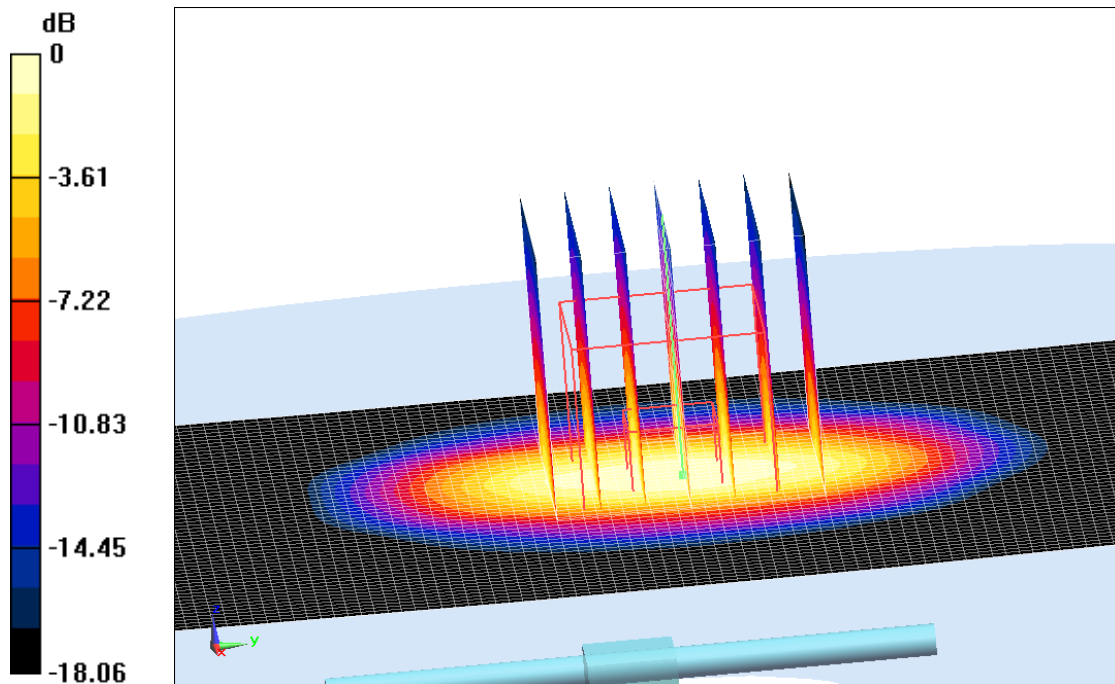

0 dB =  $10.3 \text{ W/kg}$  =  $10.13 \text{ dB W/kg}$

**Fig.B.2. validation 1900MHz 250Mw**

**2450MHz**

Date: 2019-11-14

Electronics: DAE4 Sn786

Medium: Head 2450MHz

Medium parameters used:  $f = 2450 \text{ MHz}$ ;  $\sigma = 1.825 \text{ S/m}$ ;  $\epsilon_r = 38.529$ ;  $\rho = 1000 \text{ kg/m}^3$

Ambient Temperature:  $22.3^\circ\text{C}$       Liquid Temperature:  $21.8^\circ\text{C}$

Communication System: CW\_TMC Frequency: 2450 MHz Duty Cycle: 1:1

Probe: EX3DV4 – SN3633 ConvF (7.33, 7.33, 7.33);

**System Validation /Area Scan (31x91x1):** Interpolated grid:  $dx=1.000 \text{ mm}$ ,  $dy=1.000 \text{ mm}$

Reference Value = 86.363 V/m; Power Drift = 0.08 dB

**SAR(1 g) = 13.3 W/kg; SAR(10 g) = 6.10 W/kg**

Maximum value of SAR (interpolated) = 14.4 W/kg

**System Validation/Zoom Scan (7x7x7)/Cube0:** Measurement grid:  $dx=5\text{mm}$ ,  $dy=5\text{mm}$ ,  $dz=5\text{mm}$

Reference Value = 86.363 V/m; Power Drift = 0.08 dB

Peak SAR (extrapolated) = 27.4 W/kg

**SAR(1 g) = 13.5 W/kg; SAR(10 g) = 6.15 W/kg**

Maximum value of SAR (measured) = 14.6 W/kg

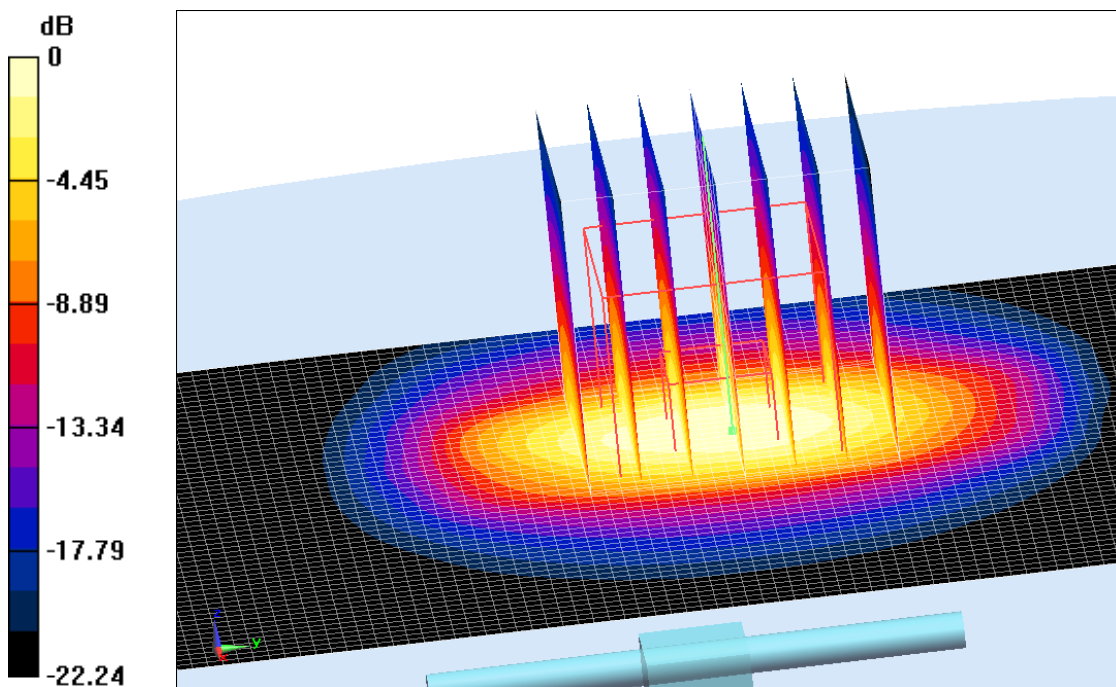

0 dB = 14.6 W/kg = 11.64 dB W/kg

**Fig.B.3. validation 2450MHz 250mW**

**2550MHz**

Date: 2019-10-21

Electronics: DAE4 Sn786

Medium: Head 2550MHz

Medium parameters used:  $f = 2550 \text{ MHz}$ ;  $\sigma = 1.946 \text{ S/m}$ ;  $\epsilon_r = 38.16$ ;  $\rho = 1000 \text{ kg/m}^3$

Ambient Temperature:  $22.5^\circ\text{C}$       Liquid Temperature:  $22.0^\circ\text{C}$

Communication System: CW\_TMC Frequency: 2550 MHz Duty Cycle: 1:1

Probe: EX3DV4 – SN3633 ConvF (7.12, 7.12, 7.12);

**System Validation/Area Scan (61x121x1):** Interpolated grid:  $dx=1.000 \text{ mm}$ ,  $dy=1.000 \text{ mm}$

Reference Value =  $90.713 \text{ V/m}$ ; Power Drift =  $0.11 \text{ dB}$

**SAR(1 g) = 14.9 W/kg; SAR(10 g) = 6.67 W/kg**

Maximum value of SAR (interpolated) =  $16.3 \text{ W/kg}$

**System Validation/Zoom Scan (7x7x7)/Cube0:** Measurement grid:  $dx=5\text{mm}$ ,  $dy=5\text{mm}$ ,  $dz=5\text{mm}$

Reference Value =  $90.713 \text{ V/m}$ ; Power Drift =  $0.11 \text{ dB}$

Peak SAR (extrapolated) =  $31.8 \text{ W/kg}$

**SAR(1 g) = 15.1 W/kg; SAR(10 g) = 6.82 W/kg**

Maximum value of SAR (measured) =  $16.5 \text{ W/kg}$

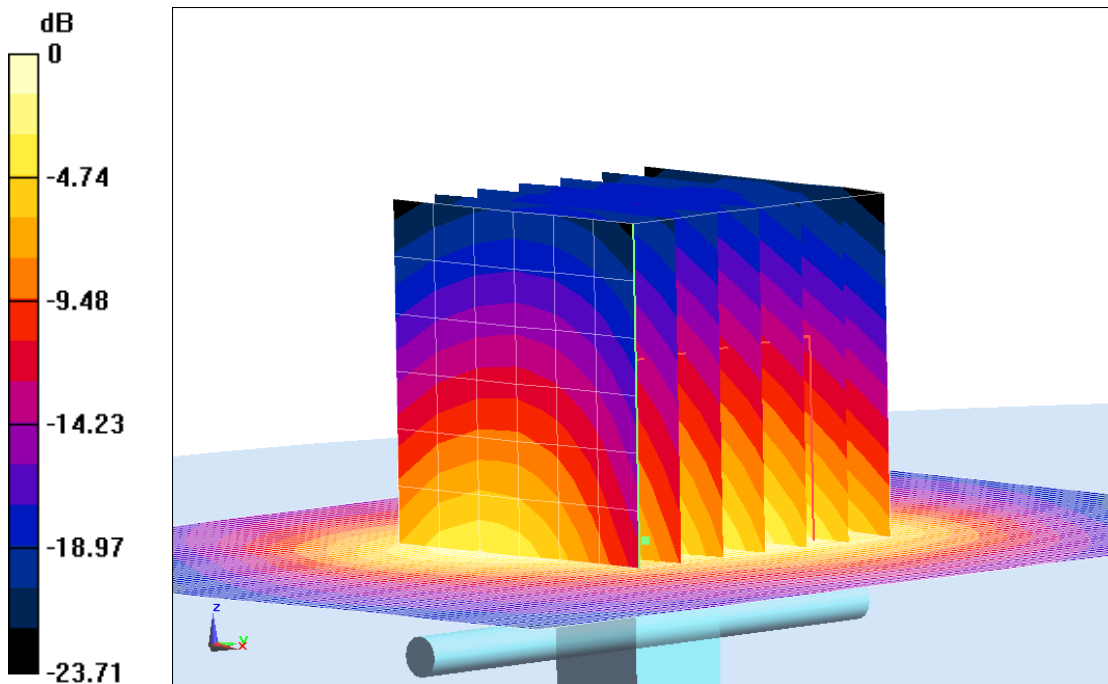

0 dB =  $16.5 \text{ W/kg} = 12.17 \text{ dB W/kg}$

**Fig.B.4. validation 2550MHz 250mW**

**5250MHz**

Date: 2019-10-24

Electronics: DAE4 Sn786

Medium: Head 5300MHz

Medium parameters used:  $f = 5250 \text{ MHz}$ ;  $\sigma = 4.768 \text{ S/m}$ ;  $\epsilon_r = 34.772$ ;  $\rho = 1000 \text{ kg/m}^3$

Ambient Temperature:  $23.0^\circ\text{C}$       Liquid Temperature:  $22.5^\circ\text{C}$

Communication System: CW Frequency: 5250 MHz Duty Cycle: 1:1

Probe: EX3DV4 – SN3633 ConvF (5.42, 5.42, 5.42);

**System Validation /Area Scan (91x91x1):** Interpolated grid:  $dx=1.000 \text{ mm}$ ,  $dy=1.000 \text{ mm}$

Reference Value = 64.148 V/m; Power Drift = 0.06 dB

**SAR(1 g) = 7.94 W/kg; SAR(10 g) = 2.26 W/kg**

Maximum value of SAR (interpolated) = 9.47 W/kg

**System Validation/Zoom Scan (8x8x8)/Cube0:** Measurement grid:  $dx=4\text{mm}$ ,  $dy=4\text{mm}$ ,  $dz=4\text{mm}$

Reference Value = 64.148 V/m; Power Drift = 0.06 dB

Peak SAR (extrapolated) = 25.4 W/kg

**SAR(1 g) = 8.06 W/kg; SAR(10 g) = 2.28 W/kg**

Maximum value of SAR (measured) = 9.51 W/kg

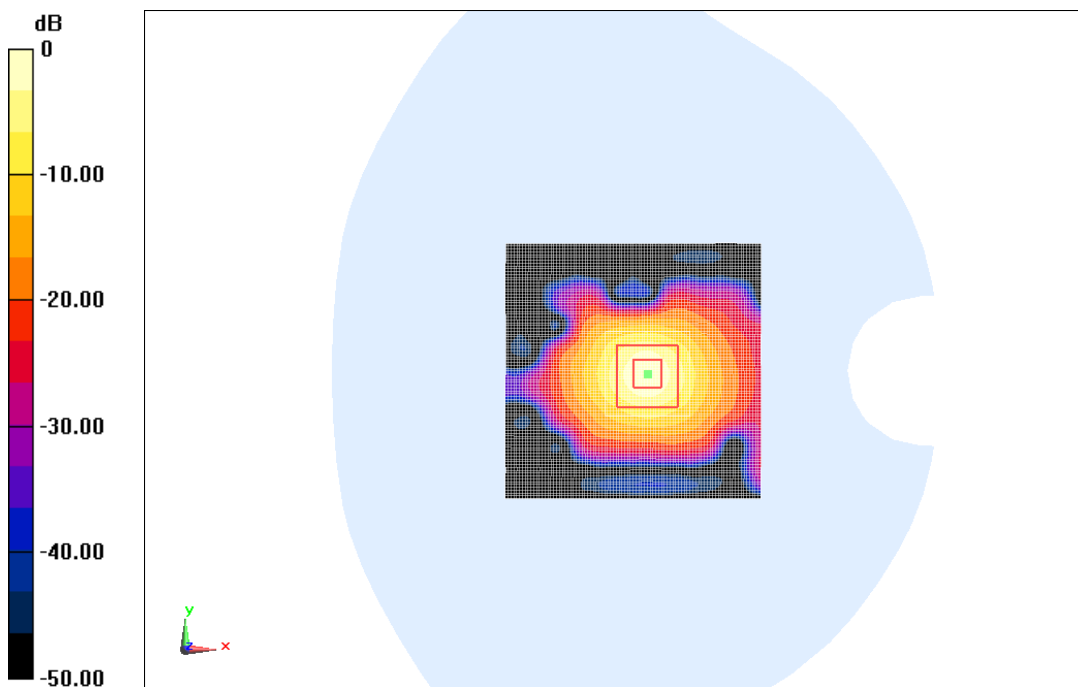

0 dB = 9.51 W/kg = 9.78 dB W/kg

**Fig.B.5. validation 5250MHz 100mW**



**5600MHz**

Date: 2019-10-24

Electronics: DAE4 Sn786

Medium: Head 5600MHz

Medium parameters used:  $f = 5600$  MHz;  $\sigma = 4.954$  S/m;  $\epsilon_r = 35.917$ ;  $\rho = 1000$  kg/m<sup>3</sup>

Ambient Temperature: 23.0°C      Liquid Temperature: 22.5°C

Communication System: CW Frequency: 5600 MHz Duty Cycle: 1:1

Probe: EX3DV4 – SN3633 ConvF (4.72, 4.72, 4.72);

**System Validation/Area Scan (91x91x1):** Interpolated grid: dx=1.000 mm, dy=1.000 mm

Reference Value = 62.772 V/m; Power Drift = -0.03 dB

**SAR(1 g) = 7.85 W/kg; SAR(10 g) = 2.26 W/kg**

Maximum value of SAR (interpolated) = 9.41 W/kg

**System Validation/Zoom Scan (8x8x8)/Cube0:** Measurement grid: dx=4mm, dy=4mm, dz=4mm

Reference Value = 62.772 V/m; Power Drift = -0.03 dB

Peak SAR (extrapolated) = 23.9 W/kg

**SAR(1 g) = 7.69 W/kg; SAR(10 g) = 2.23 W/kg**

Maximum value of SAR (measured) = 9.38 W/kg

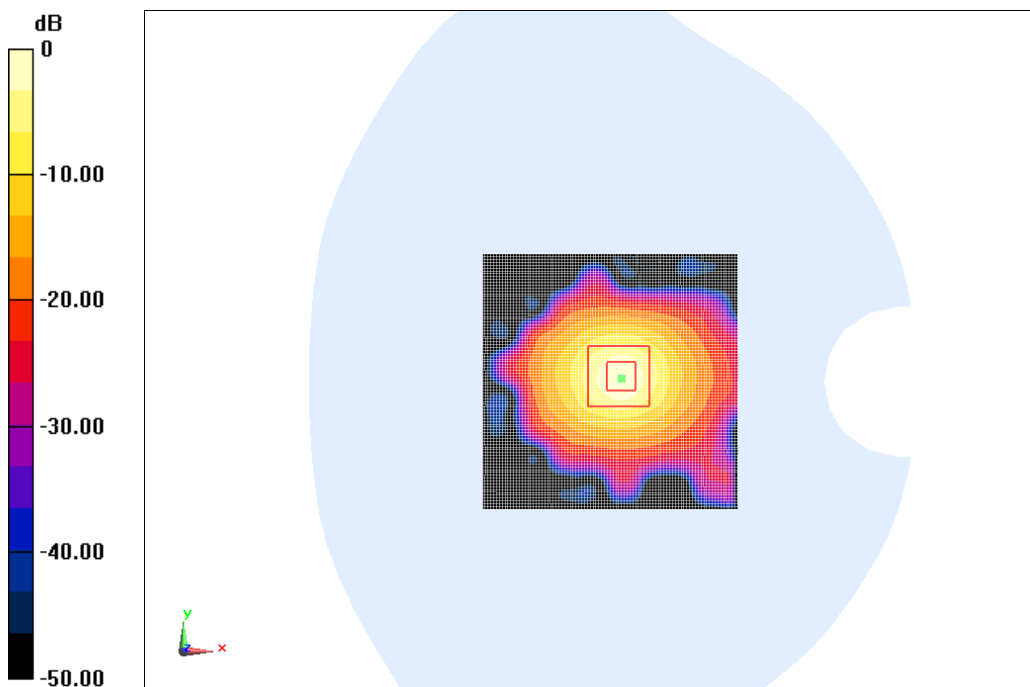

0 dB = 9.38 W/kg = 9.72 dB W/kg

**Fig.B.8. validation 5600MHz 100mW**

**5750MHz**

Date: 2019-10-24

Electronics: DAE4 Sn786

Medium: Head 5800 MHz

Medium parameters used:  $f = 5750 \text{ MHz}$ ;  $\sigma = 5.136 \text{ S/m}$ ;  $\epsilon_r = 36.284$ ;  $\rho = 1000 \text{ kg/m}^3$

Ambient Temperature:  $23.0^\circ\text{C}$       Liquid Temperature:  $22.5^\circ\text{C}$

Communication System: CW Frequency: 5750 MHz Duty Cycle: 1:1

Probe: EX3DV4 – SN3633 ConvF (4.73, 4.73, 4.73);

**System Validation/Area Scan (91x91x1):** Interpolated grid:  $dx=1.000 \text{ mm}$ ,  $dy=1.000 \text{ mm}$

Reference Value = 61.809 V/m; Power Drift = -0.08 dB

**SAR(1 g) = 7.74 W/kg; SAR(10 g) = 2.20 W/kg**

Maximum value of SAR (interpolated) = 9.35 W/kg

**System Validation/Zoom Scan (8x8x8)/Cube0:** Measurement grid:  $dx=4\text{mm}$ ,  $dy=4\text{mm}$ ,  $dz=4\text{mm}$

Reference Value = 61.809 V/m; Power Drift = -0.08 dB

Peak SAR (extrapolated) = 23.2 W/kg

**SAR(1 g) = 7.57 W/kg; SAR(10 g) = 2.17 W/kg**

Maximum value of SAR (measured) = 9.31 W/kg

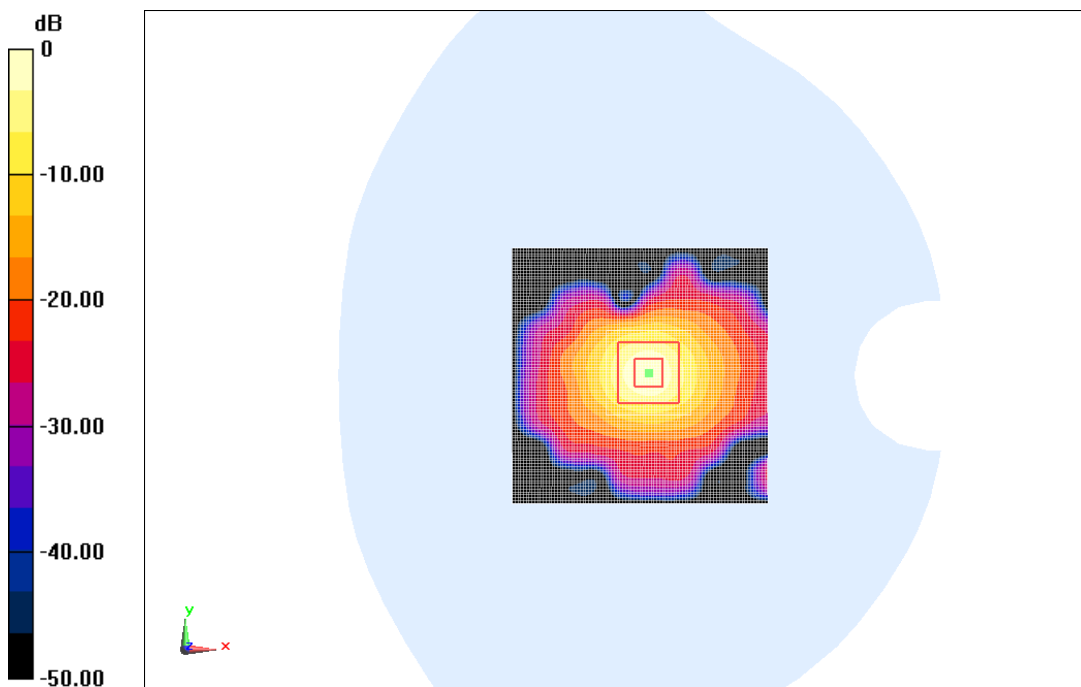

0 dB = 9.31 W/kg = 9.69 dB W/kg

**Fig.B.9. validation 5750MHz 100mW**



## C.2 DASY5 E-field Probe System

The SAR measurements were conducted with the dosimetric probe designed in the classical triangular configuration and optimized for dosimetric evaluation. The probe is constructed using the thick film technique; with printed resistive lines on ceramic substrates. The probe is equipped with an optical multifiber line ending at the front of the probe tip. It is connected to the EOC box on the robot arm and provides an automatic detection of the phantom surface. Half of the fibers are connected to a pulsed infrared transmitter, the other half to a synchronized receiver. As the probe approaches the surface, the reflection from the surface produces a coupling from the transmitting to the receiving fibers. This reflection increases first during the approach, reaches maximum and then decreases. If the probe is flatly touching the surface, the coupling is zero. The distance of the coupling maximum to the surface is independent of the surface reflectivity and largely independent of the surface to probe angle. The DASY5 software reads the reflection during a software approach and looks for the maximum using 2<sup>nd</sup> order curve fitting. The approach is stopped at reaching the maximum.

### Probe Specifications:

<b>Model:</b>	<b>ES3DV3, EX3DV4</b>
<b>Frequency</b>	<b>10MHz — 6.0GHz(EX3DV4)</b>
<b>Range:</b>	<b>10MHz — 4GHz(ES3DV3)</b>
<b>Calibration:</b>	<b>In head and body simulating tissue at Frequencies from 835 up to 5800MHz</b>
<b>Linearity:</b>	<b>± 0.2 dB(30 MHz to 6 GHz) for EX3DV4 ± 0.2 dB(30 MHz to 4 GHz) for ES3DV3</b>
<b>Dynamic Range:</b>	<b>10 mW/kg — 100W/kg</b>
<b>Probe Length:</b>	<b>330 mm</b>
<b>Probe Tip</b>	
<b>Length:</b>	<b>20 mm</b>
<b>Body Diameter:</b>	<b>12 mm</b>
<b>Tip Diameter:</b>	<b>2.5 mm (3.9 mm for ES3DV3)</b>
<b>Tip-Center:</b>	<b>1 mm (2.0mm for ES3DV3)</b>
<b>Application:</b>	<b>SAR Dosimetry Testing Compliance tests of mobile phones Dosimetry in strong gradient fields</b>



Picture C.2 Near-field Probe



Picture C.3 E-field Probe

## C.3 E-field Probe Calibration

Each E-Probe/Probe Amplifier combination has unique calibration parameters. A TEM cell calibration procedure is conducted to determine the proper amplifier settings to enter in the probe parameters. The amplifier settings are determined for a given frequency by subjecting the probe to a known E-field density ( $1 \text{ mW/cm}^2$ ) using an RF Signal generator, TEM cell, and RF Power Meter.

The free space E-field from amplified probe outputs is determined in a test chamber. This calibration can be performed in a TEM cell if the frequency is below 1 GHz and in a waveguide or other methodologies above 1 GHz for free space. For the free space calibration, the probe is placed

in the volumetric center of the cavity and at the proper orientation with the field. The probe is then rotated 360 degrees until the three channels show the maximum reading. The power density readings equates to 1 mW/ cm<sup>2</sup>:

E-field temperature correlation calibration is performed in a flat phantom filled with the appropriate simulated brain tissue. The E-field in the medium correlates with the temperature rise in the dielectric medium. For temperature correlation calibration a RF transparent thermistor-based temperature probe is used in conjunction with the E-field probe.

$$SAR = C \frac{\Delta T}{\Delta t}$$

Where:

$\Delta t$  = Exposure time (30 seconds),

C = Heat capacity of tissue (brain or muscle),

$\Delta T$  = Temperature increase due to RF exposure.

$$SAR = \frac{|E|^2 \cdot \sigma}{\rho}$$

Where:

$\sigma$  = Simulated tissue conductivity,

$\rho$  = Tissue density (kg/m<sup>3</sup>).

## C.4 Other Test Equipment

### C.4.1 Data Acquisition Electronics (DAE)

The data acquisition electronics consist of a highly sensitive electrometer-grade preamplifier with auto-zeroing, a channel and gain-switching multiplexer, a fast 16 bit AD-converter and a command decoder with a control logic unit. Transmission to the measurement server is accomplished through an optical downlink for data and status information, as well as an optical uplink for commands and the clock.

The mechanical probe mounting device includes two different sensor systems for frontal and sideways probe contacts. They are used for mechanical surface detection and probe collision detection.

The input impedance of the DAE is 200 MOhm; the inputs are symmetrical and floating. Common mode rejection is above 80 dB.

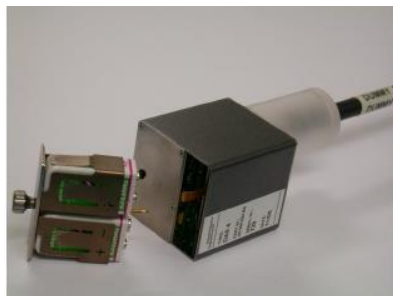

**PictureC.4: DAE**

### C.4.2 Robot

The SPEAG DASY system uses the high precision robots (DASY5: RX160L) type from Stäubli SA (France). For the 6-axis controller system, the robot controller version from Stäubli is used. The Stäubli robot series have many features that are important for our application:

- High precision (repeatability 0.02mm)
- High reliability (industrial design)
- Low maintenance costs (virtually maintenance free due to direct drive gears; no belt drives)
- Jerk-free straight movements (brushless synchron motors; no stepper motors)
- Low ELF interference (motor control fields shielded via the closed metallic construction shields)



**Picture C.5 DASY 5**

### C.4.3 Measurement Server

The Measurement server is based on a PC/104 CPU board with CPU (DASY5: 400 MHz, Intel Celeron), chipdisk (DASY5:128MB), RAM (DASY5:128MB). The necessary circuits for communication with the DAE electronic box, as well as the 16 bit AD converter system for optical detection and digital I/O interface are contained on the DASY I/O board, which is directly connected to the PC/104 bus of the CPU board.

The measurement server performs all real-time data evaluation of field measurements and surface detection, controls robot movements and handles safety operation. The PC operating system cannot interfere with these time critical processes. All connections are supervised by a watchdog, and disconnection of any of the cables to the measurement server will automatically disarm the robot and disable all program-controlled robot movements. Furthermore, the measurement server is equipped with an expansion port which is reserved for future applications. Please note that this expansion port does not have a standardized pinout, and therefore only devices provided by SPEAG can be connected. Devices from any other supplier could seriously damage the measurement server.



**Picture C.6 Server for DASY 5**

#### C.4.4 Device Holder for Phantom

The SAR in the phantom is approximately inversely proportional to the square of the distance between the source and the liquid surface. For a source at 5mm distance, a positioning uncertainty of  $\pm 0.5\text{mm}$  would produce a SAR uncertainty of  $\pm 20\%$ . Accurate device positioning is therefore crucial for accurate and repeatable measurements. The positions in which the devices must be measured are defined by the standards.

The DASY device holder is designed to cope with the different positions given in the standard. It has two scales for device rotation (with respect to the body axis) and device inclination (with respect to the line between the ear reference points). The rotation centers for both scales is the ear reference point (ERP). Thus the device needs no repositioning when changing the angles.

The DASY device holder is constructed of low-loss POM material having the following dielectric

parameters: relative permittivity  $\varepsilon = 3$  and loss tangent  $\delta = 0.02$ . The amount of dielectric material has been reduced in the closest vicinity of the device, since measurements have suggested that the influence of the clamp on the test results could thus be lowered.

<Laptop Extension Kit>

The extension is lightweight and made of POM, acrylic glass and foam. It fits easily on the upper part of the Mounting Device in place of the phone positioner. The extension is fully compatible with the Twin-SAM and ELI phantoms.



Picture C.7-1: Device Holder

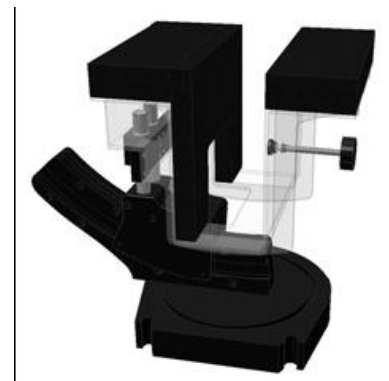

Picture C.7-2: Laptop Extension Kit

#### C.4.5 Phantom

The SAM Twin Phantom V4.0 is constructed of a fiberglass shell integrated in a table. The shape of the shell is based on data from an anatomical study designed to

Represent the 90<sup>th</sup> percentile of the population. The phantom enables the dissymmetric evaluation of SAR for both left and right handed handset usage, as well as body-worn usage using the flat phantom region. Reference markings on the Phantom allow the complete setup of all predefined phantom positions and measurement grids by manually teaching three points in the robot. The shell phantom has a 2mm shell thickness (except the ear region where shell thickness increases to 6 mm).

Shell Thickness:  $2 \pm 0.2$  mm  
Filling Volume: Approx. 25 liters  
Dimensions: 810 x 1000 x 500 mm (H x L x W)  
Available: Special



**Picture C.8: SAM Twin Phantom**



## ANNEX D Position of the wireless device in relation to the phantom

### D.1 General Considerations

This standard specifies two handset test positions against the head phantom – the “cheek” position and the “tilt” position.

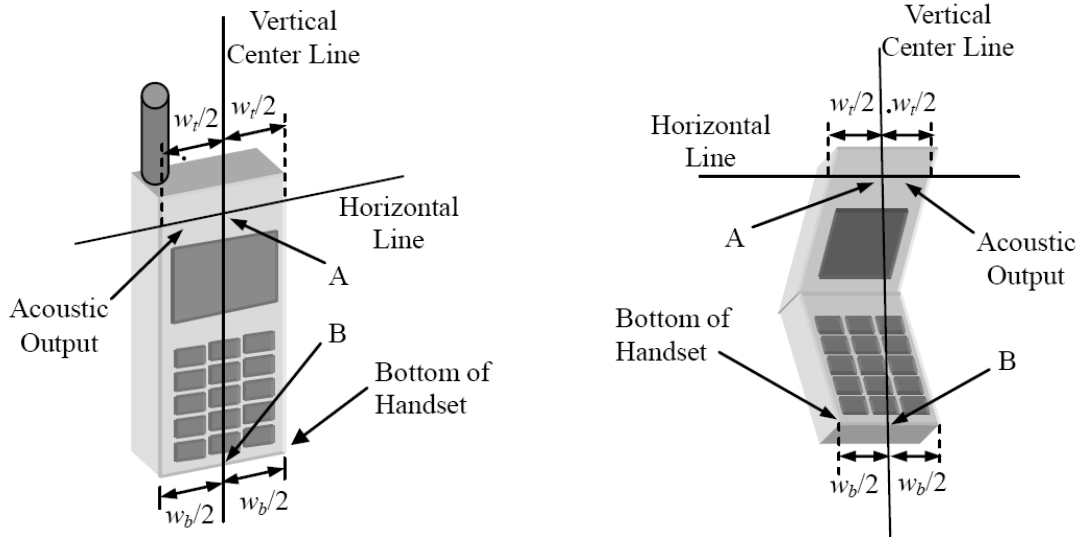

- $w_t$  Width of the handset at the level of the acoustic
- $w_b$  Width of the bottom of the handset
- A Midpoint of the width  $w_t$  of the handset at the level of the acoustic output
- B Midpoint of the width  $w_b$  of the bottom of the handset

Picture D.1-a Typical “fixed” case handset      Picture D.1-b Typical “clam-shell” case handset

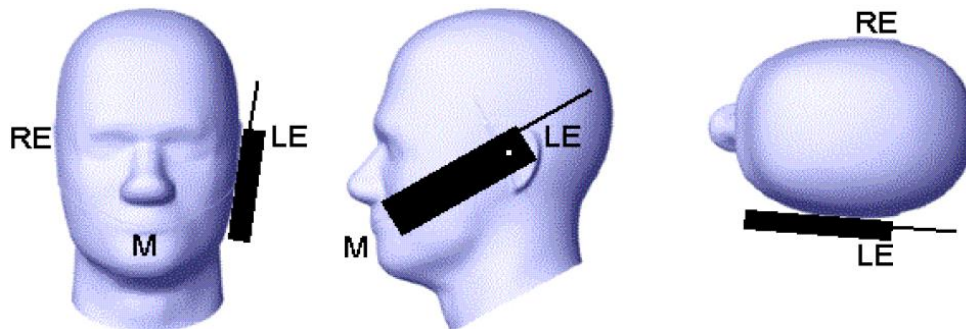

Picture D.2 Cheek position of the wireless device on the left side of SAM