



UL LLC
333 Pfingsten Rd.
Northbrook, IL 60062

www.ul.com/emc
(847) 272-8800

Job Number: 1001541562
Project Number: 12CA51812A
File Number: E332959
Date: November 20, 2012
Model: ITCS-A202

Electromagnetic Compatibility Test Report

For

RF Controls LLC

Copyright © 2012 UL LLC

UL LLC authorizes the above-named company to reproduce this Report provided it is reproduced in its entirety.

Test Report Details

Tests Performed By: **UL LLC**
333 Pfingsten Rd.
Northbrook, IL 60062

Tests Performed For: **RF Controls LLC**
1141 S. 7th St.
St. Louis, MO 63104

Applicant Contact: **Matt Narzinski**
Phone: **(314) 571-6202**
E-mail: **mnarzinski@rf-controls.com**

Test Report Date: **November 20, 2012**

Product Type: **Wireless Device**

Product standards: **FCC Part 15, Subpart C – Required tests for C2PC**

Model Number: **ITCS-A202**

EUT Category: **Frequency Hopping Spread Spectrum Transmitter**

Testing Start Date: **September 14, 2012**

Date Testing Complete: **September 21, 2012**

Overall Results: **Compliant**

UL LLC reports apply only to the specific samples tested under stated test conditions. All samples tested were in good operating condition throughout the entire test program. It is the manufacturer's responsibility to assure that additional production units of this model are manufactured with identical electrical and mechanical components. UL LLC shall have no liability for any deductions, inferences or generalizations drawn by the client or others from UL LLC issued reports. This report must not be used by the client to claim product certification, approval, or endorsement by NVLAP, NIST, any agency of the Federal Government, or any agency of any government.

This report may contain test results that are not covered by the NVLAP or A2LA accreditation. The scope of accreditation is limited to the specific tests that are listed on the NVLAP and/or A2LA websites referenced at the end of this report.

Report Directory

1.0	G E N E R A L - Product Description	4
1.1	Equipment Description	4
1.2	Device Configuration During Test	4
1.2.1	Equipment Used During Test:	4
1.2.2	Input/Output Ports:	4
1.2.3	EUT Internal Operating Frequencies:	5
1.2.4	Power Interface:	5
1.3	Block Diagram:	5
1.4	EUT Configurations	6
1.5	EUT Operation Modes	6
1.6	Rational for EUT Configuration	6
2.0	Summary	7
2.1	Deviations from standard test methods	7
2.2	Device Modifications Necessary for Compliance	7
2.3	Reference Standards	8
2.4	Results Summary	8
3.0	Calibration of Equipment Used for Measurement	9
4.0	EMISSIONS TEST RESULTS	9
4.1	Test Conditions and Results – OUTPUT POWER	10
4.2	Test Conditions and Results – SPURIOUS EMISSIONS (Radiated)	15
4.3	Test Conditions and Results – MAINS TERMINAL – CONDUCTED EMISSIONS	25
4.4	Test Conditions and Results – RADIATED EMISSIONS	30
Appendix A		35
Test Setup Photos		35
Appendix B		36
Antenna Gain Information		36
Appendix C		37
Accreditations and Authorizations		37

Report Revision History

Revision Date	Description	Revised By	Revision Reviewed By
None			

1.0 GENERAL - Product Description

1.1 Equipment Description

The Equipment under test is a long range RF ID tag reader. It uses radio model IN610, certified under FCC ID: WFQIN610. This report is for class II permissive change – addition of antenna.

1.2 Device Configuration During Test

1.2.1 Equipment Used During Test:

Use	Product Type	Manufacturer	Model	Comments
EUT	RF ID Reader	RF Controls LLC	ITCS-A202	None
AE	Laptop	Generic	-	Used to put the EUT in various test modes.

Note: **EUT** - Equipment Under Test, **AE** - Auxiliary/Associated Equipment, or **SIM** - Simulator (Not Subjected to Test)

1.2.2 Input/Output Ports:

Port #	Name	Type*	Cable Max. >3m (Y/N)	Cable Shielded (Y/N)	Comments
0	Enclosure	N/E	—	—	None
1	Mains	AC	Y	N	None
2	Ethernet	I/O	Y	Y	None
3	USB	I/O	N	Y	Only Used for factory and filed install programming.

Note:
 AC = AC Power Port DC = DC Power Port N/E = Non-Electrical
 I/O = Signal Input or Output Port (Not Involved in Process Control)
 TP = Telecommunication Ports

1.2.3 EUT Internal Operating Frequencies:

Frequency (MHz)	Description
24	U4, USB Microcontroller
12	U3, 32 bit Microcontroller
0.032768	U3, 32 bit Microcontroller

1.2.4 Power Interface:

Mode # /Rated	Voltage (V)	Current (A)	Power (W)	Frequency (DC/AC-Hz)	Phases (#)	Comments
1	120Vac	-	-	60Hz	1	None

1.3 Block Diagram:

The diagram below illustrates the configuration of the equipment above.

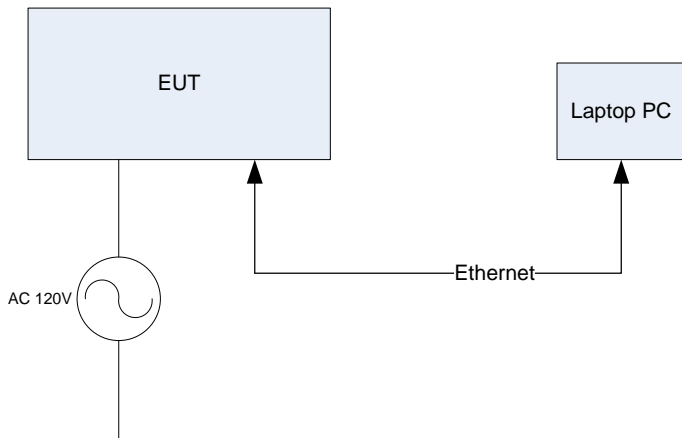

1.4 EUT Configurations

Mode #	Description
1	EUT was setup on 80cm support and connected via Ethernet to laptop.

1.5 EUT Operation Modes

Mode #	Description
1	EUT transmitting with power level software setting of 2840, transmitting hopping on all channels.
2	EUT transmitting with power level software setting of 2840, transmitting on low, middle, and high channels individually.
3	EUT set to “digital mode only”, transmitter active, but internal output attenuators set to maximum thus no tx is possible.

1.6 Rational for EUT Configuration

Mode #	Description
1	The selected EUT configuration was chosen to maximize emissions

2.0 **Summary**

The tests listed in the Summary of Testing section of this report have been performed and the results recorded by UL LLC in accordance with the procedures stated in each test requirement and specification. The applicant determined the list of tests performed were applicable to the Equipment Under Test. As a result, the subject product has been verified to comply or not comply as noted in the Summary of Testing with each test specification. The test results relate only to the items tested.

2.1 **Deviations from standard test methods**

None

2.2 **Device Modifications Necessary for Compliance**

Multiple ferrites and internal I/O lines shield was attached to ground. Manufacturer will document all changes in detail in technical documentation.
--

2.3 Reference Standards

Standard Number	Standard Name	Standard Date
FCC Part 15, Subpart C	Digital Devices	2012

2.4 Results Summary

This product is considered Class B

Requirement – Test	Result (Compliant / Non-Compliant)*
Output Power	* N/A
Spurious Emissions (Radiated)	Compliant
Mains Terminal - Conducted Emissions	Compliant
Radiated Emissions - Digital	Compliant
* Power measurements were conducted to establish a reference table that will be used to adjust power on assembly line in final product.	

Test Engineer:



Bartlomiej Mucha (Ext.41216)
 Staff Engineer
 International EMC Services
 Conformity Assessment Services

Reviewer:



Michael Ferrer(Ext.41312)
 Senior Project Engineer
 International EMC Services
 Conformity Assessment Services

Any information and documentation involving UL Mark services are provided on behalf of UL LLC (UL) or any authorized licensee of UL.

3.0 Calibration of Equipment Used for Measurement

All test equipment and test accessories are calibrated on a regular basis. The maximum time between calibrations is one year or the manufacturers' recommendation, whichever is less.

All test equipment calibrations are traceable to the National Institute of Standards and Technology (NIST); therefore, all test data recorded in this report is traceable to NIST.

4.0 EMISSIONS TEST RESULTS

The emissions tests were performed according to following regulations:

----- United States -----

Code of Federal Regulations Title 47	Part 15, Subpart B and C, Radio Frequency Devices
--------------------------------------	---

Unless specified otherwise in the individual Methods, the tests shall be conducted under the following ambient conditions. Confirmation of these conditions shall be verified at the time the test is conducted.

Ambient Temperature, °C	22.5 ± 2.5	Relative Humidity, %	45 ± 15	Barometric Pressure, mBar	950 ± 150
-------------------------	------------	----------------------	---------	---------------------------	-----------

Measurement Uncertainty

Test	Uncertainty k=2
Conducted Emissions	0.9dB
Radiated Emissions	3.1dB

Sample Calculations

Radiated Field Strength and Conducted Emissions data contained within this report is calculated on the following basis:

- Field Strength (dBuV/m) = Meter Reading (dBuV) + AF (dB/m) - Gain (dB) + Cable Loss (dB)
- Conducted Voltage (dBuV) = Meter Reading (dBuV) + Cable Loss (dB) + LISN IL (dB)
- Conducted Current (dBuA) = Meter Reading (dBuV) + Cable Loss (dB) - Transducer Factor (dBohms)

4.1 Test Conditions and Results – OUTPUT POWER

Test Description	For frequency hopping systems operating in the 902-928 MHz band: 1 watt for systems employing at least 50 hopping channels; and, 0.25 watts for systems employing less than 50 hopping channels, but at least 25 hopping channels, as permitted under paragraph (a)(1)(i) of this section.	
Basic Standard	47 CFR Part 15.247(b)(2) RSS-210, A8.4(2)	
	Frequency range	Measurement Point
Fully configured sample scanned over the following frequency range	902MHz – 928MHz	Antenna Conducted
Limits		
Frequency (MHz)	Limit mW	
	Peak	
902 - 928	1000 (30dBm – gain of Antenna over 6dBi)	
Supplementary information: Per user manual specification power level on the device is adjustable. For power measurements a power table was created showing the software value and actual power measured. In the end product the power will be adjusted on assembly line based on power level setting used for radiated spurious emissions.		

Table 1 Maximum Peak Output Power EUT Configuration Settings

Power Interface Mode #	EUT Configurations Mode #	EUT Operation Mode #
1	1	2
Supplementary information: None		

Table 2 Maximum Peak Output Power Test Equipment

Description	Manufacturer	Model	Identifier	Cal. Date	Cal. Due Date
EMI Test Receiver	Rohde & Schwarz	ESU	EMC4323	20111228	20121231
Attenuator with Cable	-	-	-	*	*
* Device characterized prior to use.					

Model Number: ITCS-A202

Client Name: RF Controls LLC

Table Peak Output Power Results vs software setting

	Software Value setting	Peak Power Reading dBm	Peak Power Reading mW
Low CH Power Setting 1	2250	23.03	200.91
Low CH Power Setting 2	2550	26.02	399.94
Low CH Power Setting 3	2850	29.05	803.53
Middle CH Power Setting 1	2250	23.00	199.53
Middle CH Power Setting 2	2550	25.99	397.19
Middle CH Power Setting 3	2850	29.03	799.83
High CH Power Setting 1	2250	22.93	196.34
High CH Power Setting 2	2550	25.95	393.55
High CH Power Setting 3	2850	28.99	792.50

Figure 1 Peak Output Power Graphs

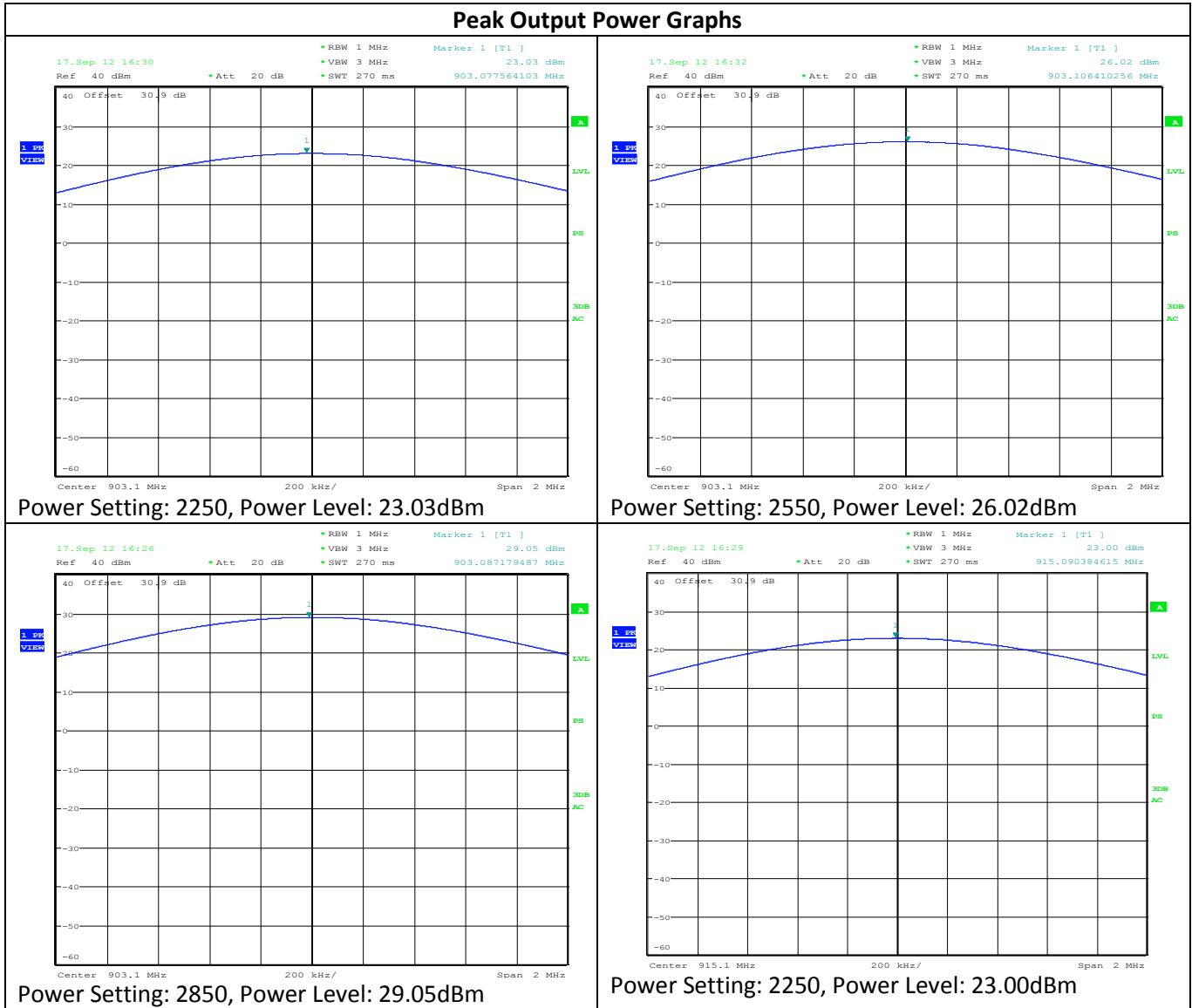

Peak Output Power Graphs

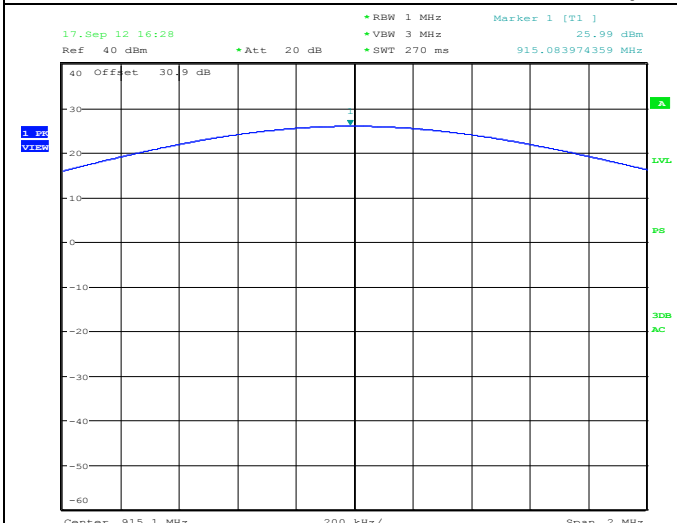

Power Setting: 2550, Power Level: 25.99dBm

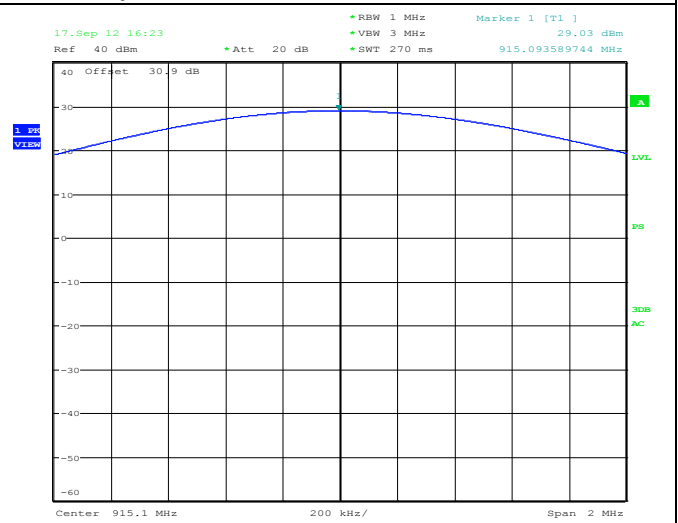

Power Setting: 2850, Power Level: 29.03dBm

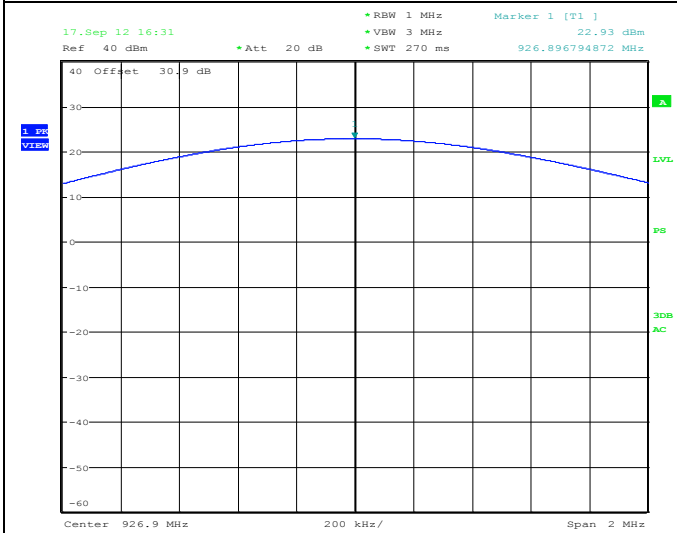

Power Setting: 2250, Power Level: 22.93dBm

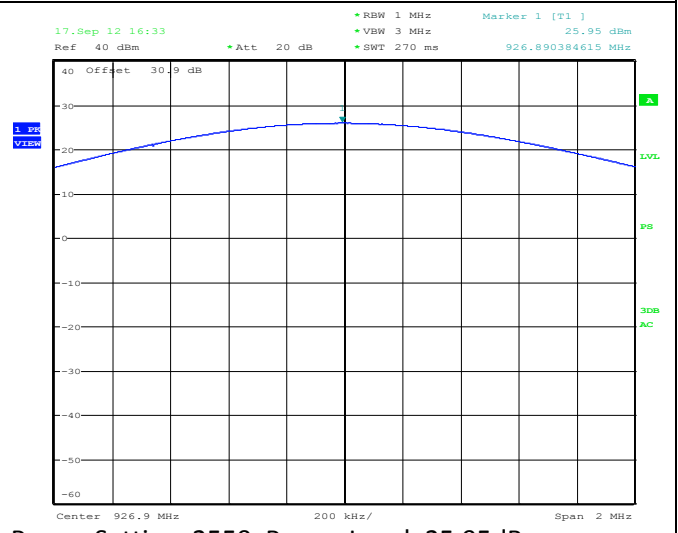

Power Setting: 2550, Power Level: 25.95dBm

Model Number: ITCS-A202

Client Name: RF Controls LLC

Peak Output Power Graphs

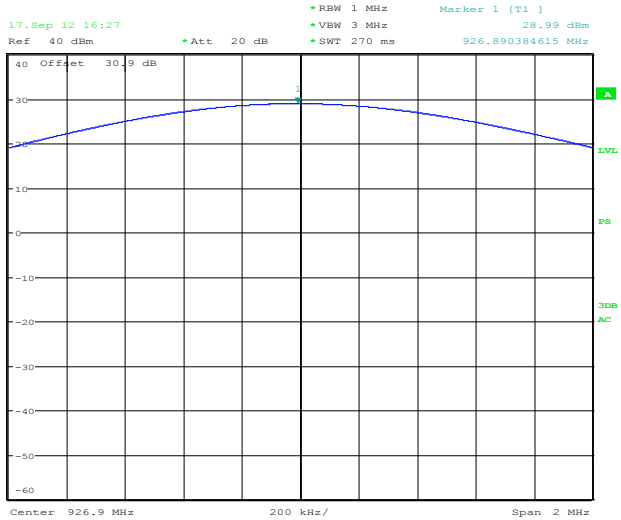

Power Setting: 2850, Power Level: 28.99dBm

4.2 Test Conditions and Results – SPURIOUS EMISSIONS (Radiated)

Test Description	In any 100 kHz bandwidth outside the frequency band in which the spread spectrum or digitally modulated intentional radiator is operating, the radio frequency power that is produced by the intentional radiator shall be at least 20 dB below that in the 100 kHz bandwidth within the band that contains the highest level of the desired power, based on either an RF conducted or a radiated measurement, provided the transmitter demonstrates compliance with the peak conducted power limits. If the transmitter complies with the conducted power limits based on the use of RMS averaging over a time interval, as permitted under paragraph (b)(3) of this section, the attenuation required under this paragraph shall be 30 dB instead of 20 dB. Attenuation below the general limits specified in Section 15.209(a) is not required. In addition, radiated emissions which fall in the restricted bands, as defined in Section 15.205(a), must also comply with the radiated emission limits specified in Section 15.209(a) (see Section 15.205(c)).		
Basic Standard	47 CFR Part 15.247(d) RSS-210, A8.5 RSS-Gen 7.2.1 and 7.2.3		
	Frequency range	Measurement Point	
Fully configured sample scanned over the following frequency range	30MHz – 1GHz	3 meter distance and / or antenna port	
Fully configured sample scanned over the following frequency range	1GHz – 10GHz	3 meter distance and / or antenna port	
Limits (Antenna Conducted)			
All emissions must be 20dB below the level of the fundamental frequency.			
Limits (Radiated – Restricted Bands Only)			
Frequency (MHz)	Limit (dB μ V/m)		
	Quasi-Peak	Average	
	General Emissions	Fundamental	Spurious
30 – 88	29.54	-	-
88 – 216	33.06	-	-
216-960	35.56	-	-
960-1000	43.52	-	-
1,000-25,000	-	-	54
Supplementary information: Below 1GHz, spectrum was checked. All emissions related to the transmitter below 1GHz are not in the restricted band therefore only antenna conducted limits apply (20dB below the peak level of the fundamental).			

Table 3 SPURIOUS EMISSIONS EUT Configuration Settings

Power Interface Mode #	EUT Configurations Mode #	EUT Operation Mode #
1	1	1 and 2
Supplementary information: None		

Table 4 SPURIOUS RADIATED EMISSIONS Test Equipment

Description	Manufacturer	Model	Identifier	Cal. Date	Cal. Due Date
EMI Test Receiver	Rohde & Schwarz	ESU	EMC4323	20111228	20121231
Bicon Antenna	Chase	VBA6106A	EMC4078	20120117	20130131
Log-P Antenna	Chase	UPA6109	EMC4258	20110927	20120928
Spectrum Analyzer	Rhode & Schwarz	FSEK	EMC4182	20111227	20121231
Antenna Array	UL	BOMS	EMC4276	20111227	20121231
Band Notch Filter	-	-	-	*	*

* Characterized prior to use

Figure 2 Radiated Spurious Emissions below 1GHz, Hopping with BRF

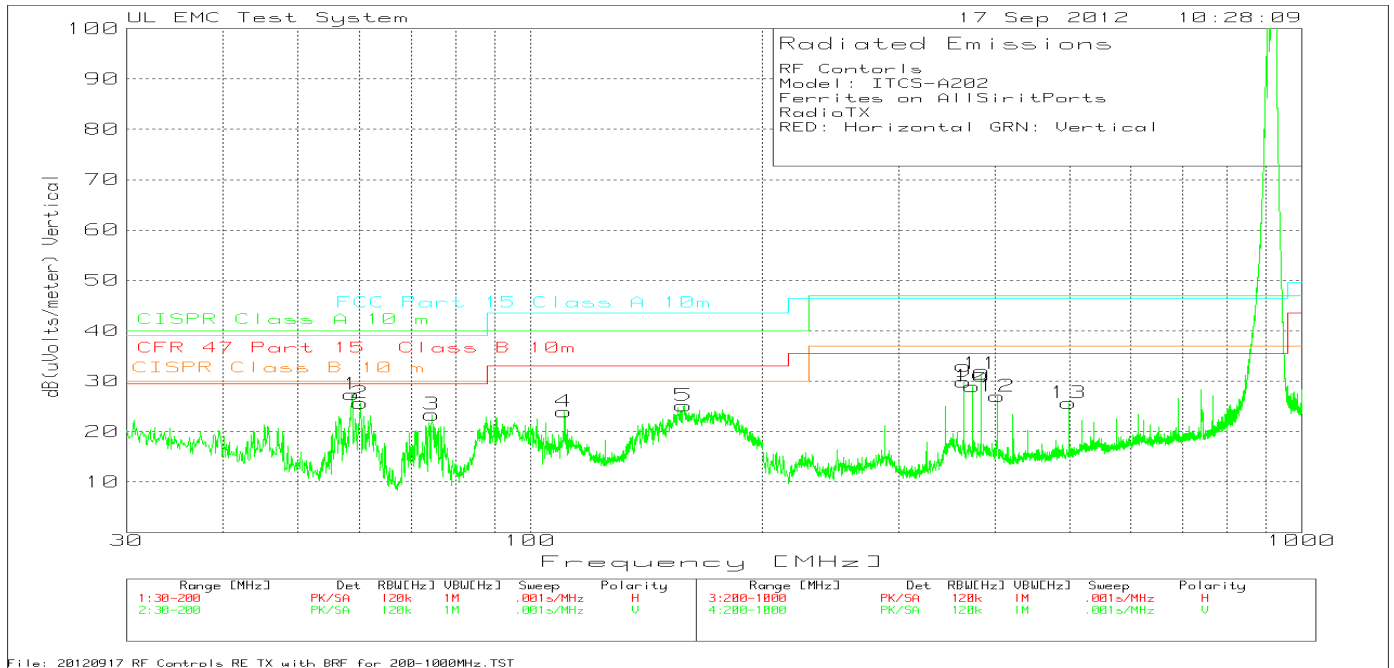
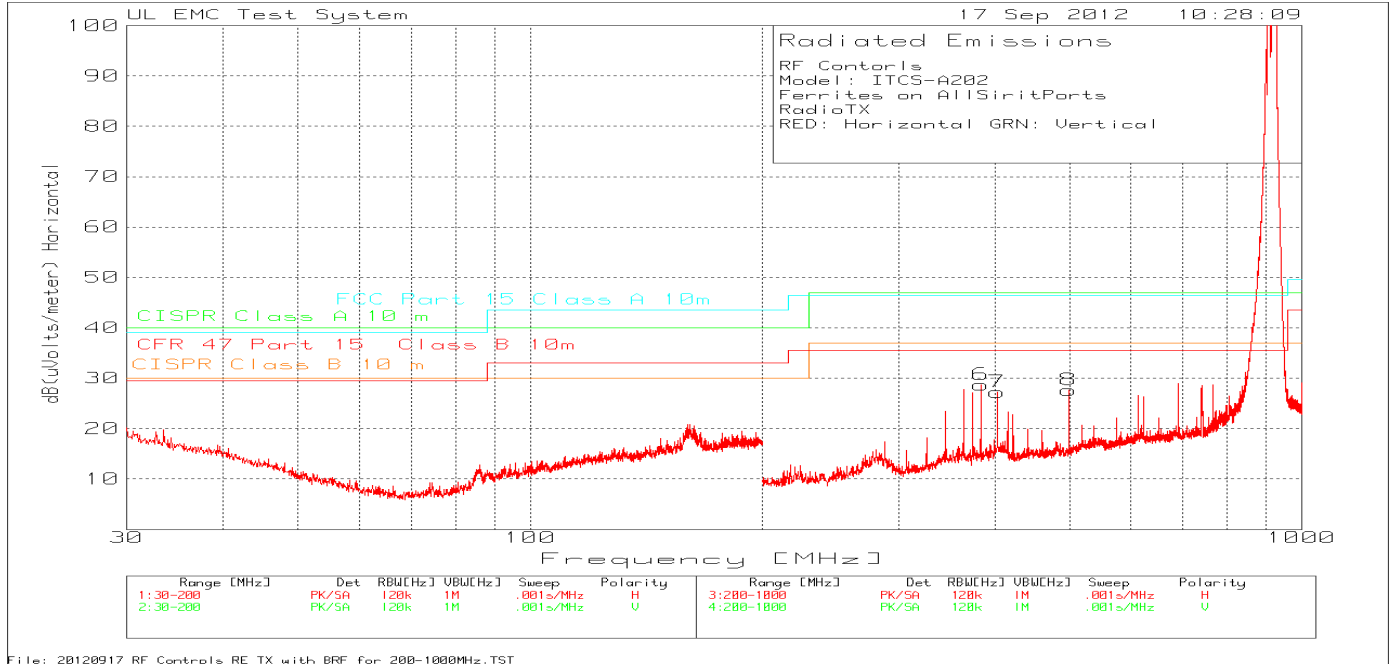

Area of the plot between 850MHz to 950MHz is a result of BRF factors inserted as losses in the path correction factors. All other emissions are product of the digital part of the device.

Model Number: ITCS-A202

Client Name: RF Controls LLC

Table 5 Radiated Spurious Emissions below 1GHz, Hopping with BRF

RF Controls Model: ITCS-A202 Ferrites on AllSirtPorts RadioTX RED: Horizontal GRN: Vertical											
Marker No.	Test Frequency MHz	Meter Reading	Detector	Antenna Factor dB	Path Loss/Gain dB	BRF Factor dB	Level dBuV/m	CFR 47 Part 15 Class B 10m	Margin dB	Height [cm]	Polarity
1	58.7156	49.62	PK	7.1	-29.3	N/A	27.42	29.6	-2.18	250	Vert
2	60.2449	48.29	PK	6.8	-29.4	N/A	25.69	29.6	-3.91	250	Vert
3	74.5177	46.38	PK	6.4	-29.4	N/A	23.38	29.6	-6.22	250	Vert
4	110.7096	41.21	PK	12.1	-29.4	N/A	23.91	33.1	-9.19	99	Vert
5	158.1159	39.37	PK	15.1	-29.3	N/A	25.17	33.1	-7.93	99	Vert
6	383.8774	45.61	PK	15.2	-32.3	0.2	28.71	35.6	-6.89	199	Horz
7	403.0646	43.5	PK	15.7	-32.1	0.2	27.3	35.6	-8.3	199	Horz
8	499.2672	42.09	PK	17.2	-31.8	0.2	27.69	35.6	-7.91	99	Horz
9	364.6902	47.24	PK	14.8	-32.4	0.2	29.84	35.6	-5.76	399	Vert
10	374.2838	46.21	PK	15	-32.4	0.2	29.01	35.6	-6.59	399	Vert
11	383.8774	48.39	PK	15.2	-32.3	0.2	31.49	35.6	-4.11	399	Vert
12	403.0646	43.21	PK	15.7	-32.1	0.2	27.01	35.6	-8.59	399	Vert
13	499.2672	40.09	PK	17.2	-31.8	0.2	25.69	35.6	-9.91	299	Vert

PK - Peak detector

Figure 3 Radiated Spurious Emissions above 1GHz, Low Channel

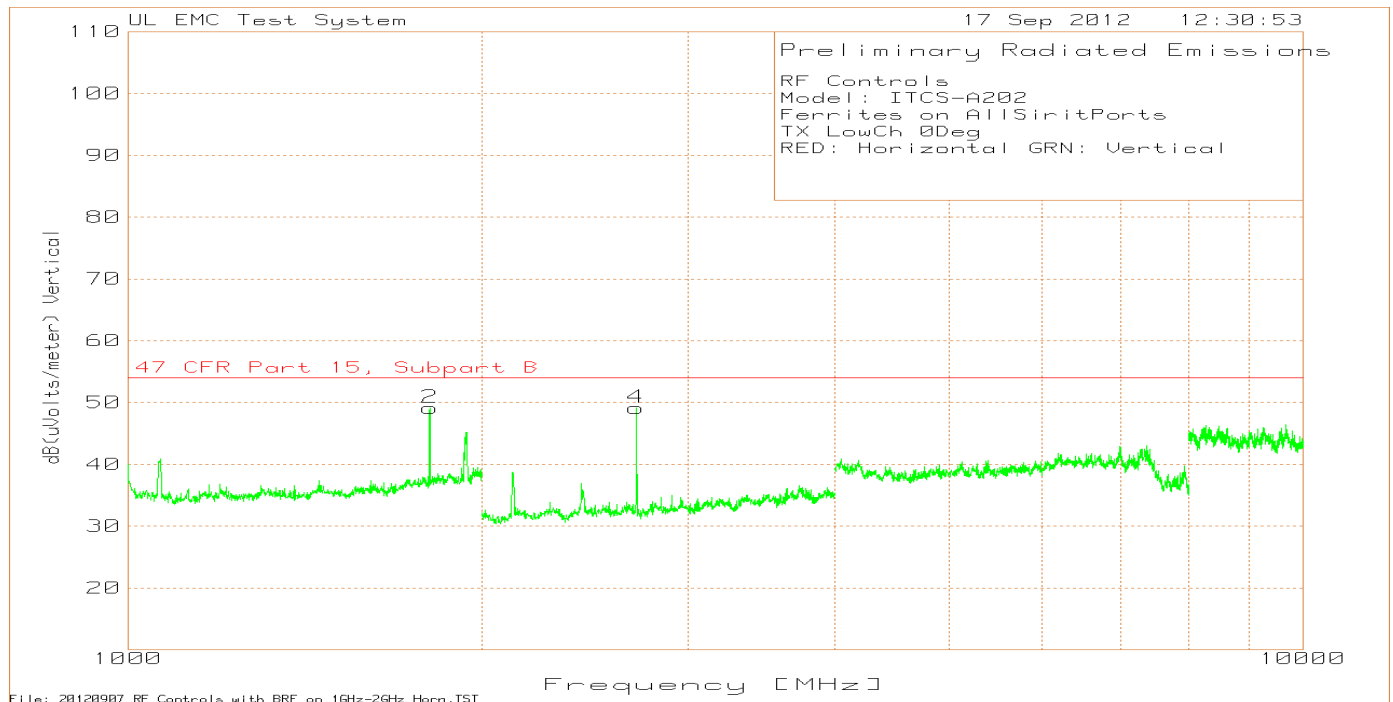
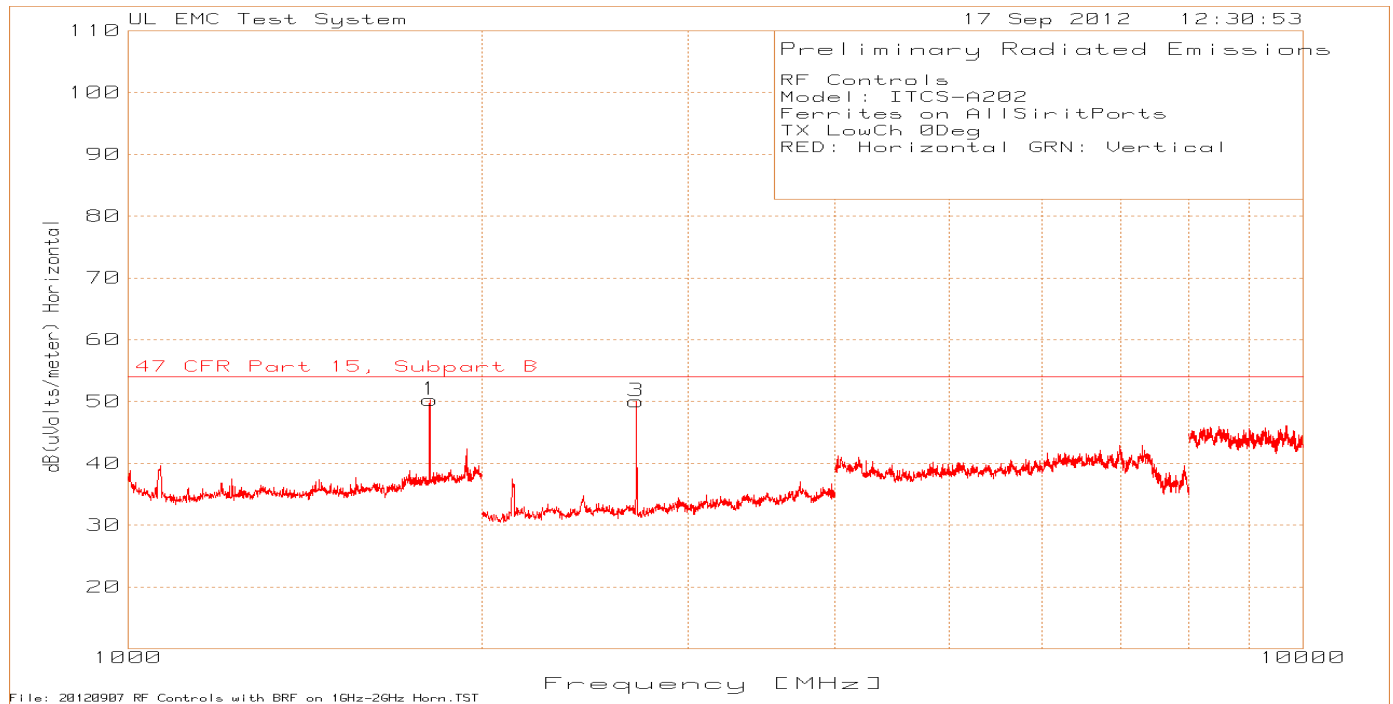

Model Number: ITCS-A202

Client Name: RF Controls LLC

Table 6 Radiated Spurious Emissions above 1GHz, Low Channel

RF Controls Model: ITCS-A202 Ferrites on AllSiriPorts TX LowCh 0Deg RED: Horizontal GRN: Vertical											
Marker No.	Test Frequency MHz	Meter Reading dBuV	Detector	Antenna Factor dB	BRF Factor dB	Path Loss/Gain Factor dB	Level dBuV/m	47 CFR Part 15, Subpart B	Margin dB	Height [cm]	Polarity
1	1806.807	78.12	PK	27	0.4	-55.2	50.32	54	-3.68	150	Horz
3	2708.709	79.88	PK	22.1	N/A	-51.91	50.07	54	-3.93	100	Horz
2	1806.807	76.99	PK	27	0.4	-55.2	49.19	54	-4.81	150	Vert
4	2708.709	78.96	PK	22.1	N/A	-51.91	49.15	54	-4.85	150	Vert
Test Frequency MHz	Meter Reading	Detector	Antenna Factor dB	BRF Factor dB	Path Loss/Gain Factor dB	Level dBuV/m	47 CFR Part 15, Subpart B	Margin dB	Azimuth [Degs]	Height [cm]	Polarity
1806.1373	80	PK	27	0.4	-55.19	52.21	54	-1.79	132	144	Horz
1806.2275	74.48	LnAv	27	0.4	-55.19	46.69	54	-7.31	132	144	Horz
1806.0651	77.75	PK	27	0.4	-55.19	49.96	54	-4.04	275	162	Vert
1806.2515	72.33	LnAv	27	0.4	-55.19	44.54	54	-9.46	275	162	Vert
2709.4098	79.68	PK	22.1	N/A	-51.91	49.87	54	-4.13	140	173	Horz
2709.3497	73.7	LnAv	22.1	N/A	-51.91	43.89	54	-10.11	140	173	Horz
2709.3437	79.53	PK	22.1	N/A	-51.91	49.72	54	-4.28	208	142	Vert
2709.3257	73.73	LnAv	22.1	N/A	-51.91	43.92	54	-10.08	208	142	Vert

PK - Peak detector
LnAv - Linear Average detector

Figure 4 Radiated Spurious Emissions above 1GHz, Middle Channel

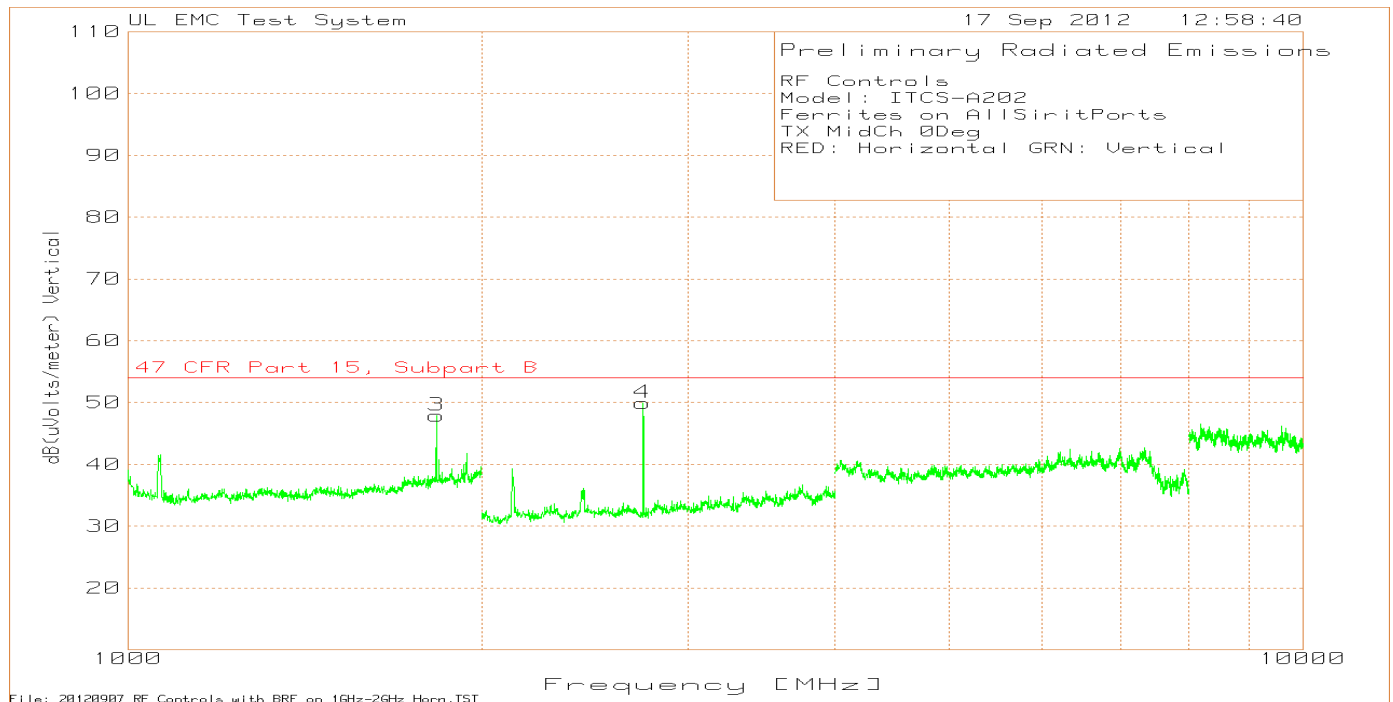
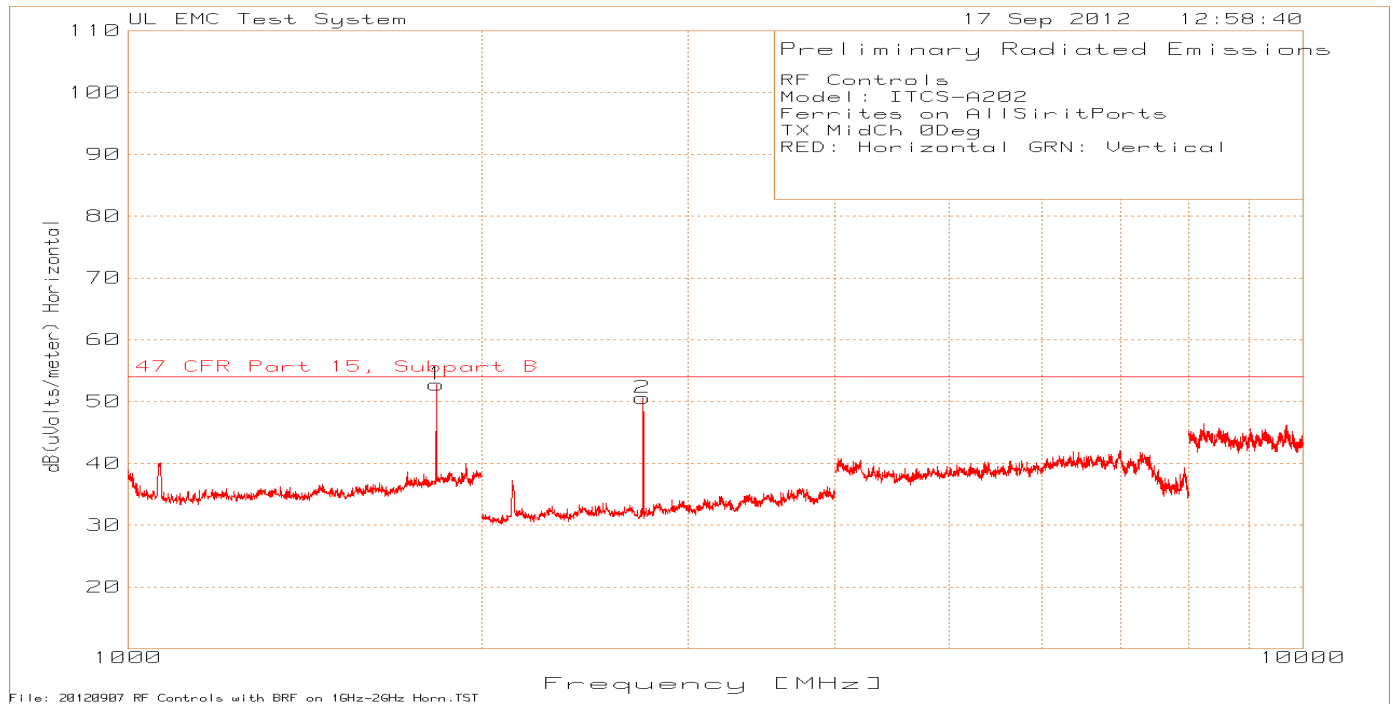

Model Number: ITCS-A202

Client Name: RF Controls LLC

Table 7 Radiated Spurious Emissions above 1GHz, Middle Channel

RF Controls Model: ITCS-A202 Ferrites on AllSirtPorts TX MidCh 0Deg RED: Horizontal GRN: Vertical											
Marker No.	Test Frequency MHz	Meter Reading dBuV	Detector	Antenna Factor dB	BRF Factor dB	Path Loss/Gain Factor dB	Level dBuV/m	47 CFR Part 15, Subpart B	Margin dB	Height [cm]	Polarity
1	1830.831	80.25	PK	27.1	0.4	-54.98	52.77	54	-1.23	100	Horz
2	2744.745	80.55	PK	22.1	N/A	-52.09	50.56	54	-3.44	100	Horz
3	1830.831	75.33	PK	27.1	0.4	-54.98	47.85	54	-6.15	150	Vert
4	2744.745	79.94	PK	22.1	N/A	-52.09	49.95	54	-4.05	150	Vert
Test Frequency MHz	Meter Reading	Detector	Antenna Factor dB	BRF Factor dB	Path Loss/Gain Factor dB	Level dBuV/m	47 CFR Part 15, Subpart B	Margin dB	Azimuth [Degs]	Height [cm]	Polarity
1830.3246	79.48	PK	27.1	0.4	-55	51.98	54	-2.02	134	140	Horz
1830.2285	74.34	LnAv	27.1	0.4	-55	46.84	54	-7.16	134	140	Horz
1830.2946	78.68	PK	27.1	0.4	-55	51.18	54	-2.82	181	135	Vert
1830.2345	73.41	LnAv	27.1	0.4	-55	45.91	54	-8.09	181	135	Vert
2745.3016	82.13	PK	22.1	N/A	-52.1	52.13	54	-1.87	120	108	Horz
2745.3497	76.82	LnAv	22.1	N/A	-52.11	46.81	54	-7.19	120	108	Horz
2745.3257	81.95	PK	22.1	N/A	-52.1	51.95	54	-2.05	177	213	Vert
2745.3317	76.57	LnAv	22.1	N/A	-52.1	46.57	54	-7.43	177	213	Vert
PK - Peak detector LnAv - Linear Average detector											

Figure 5 Radiated Spurious Emissions above 1GHz, High Channel

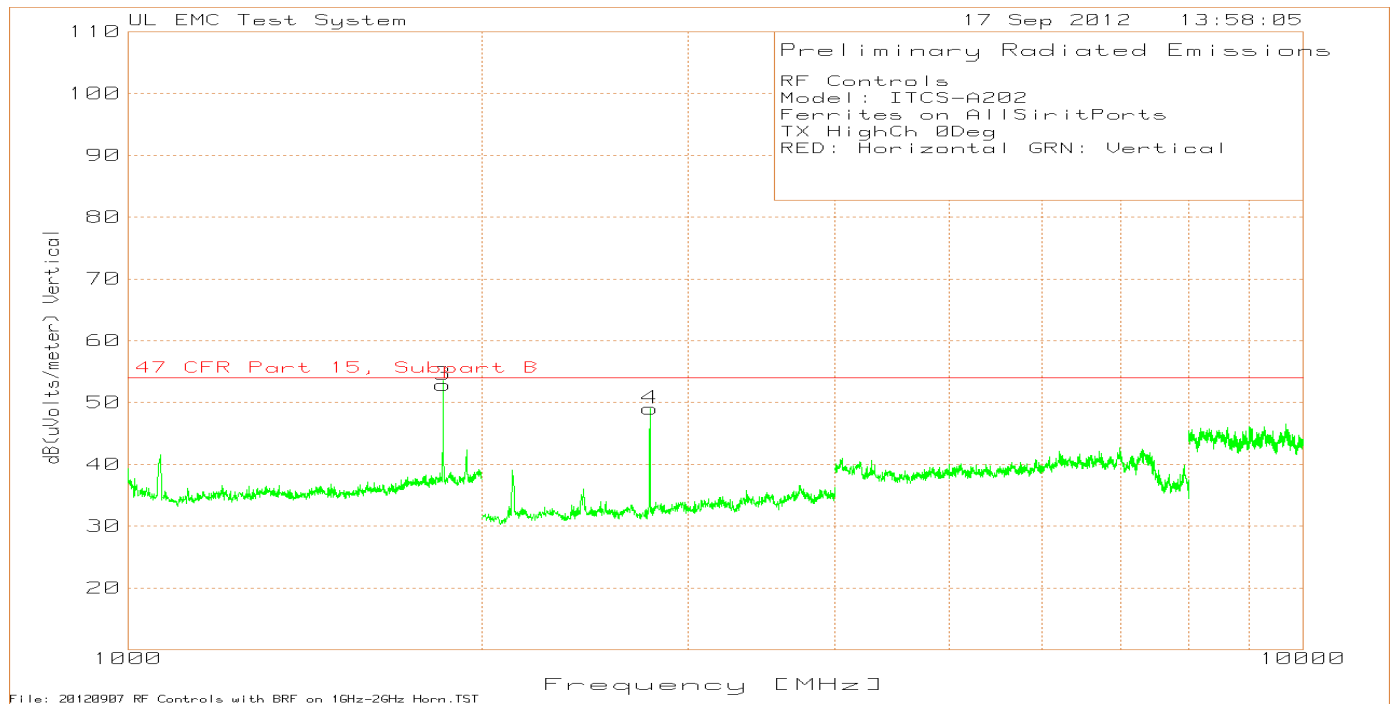
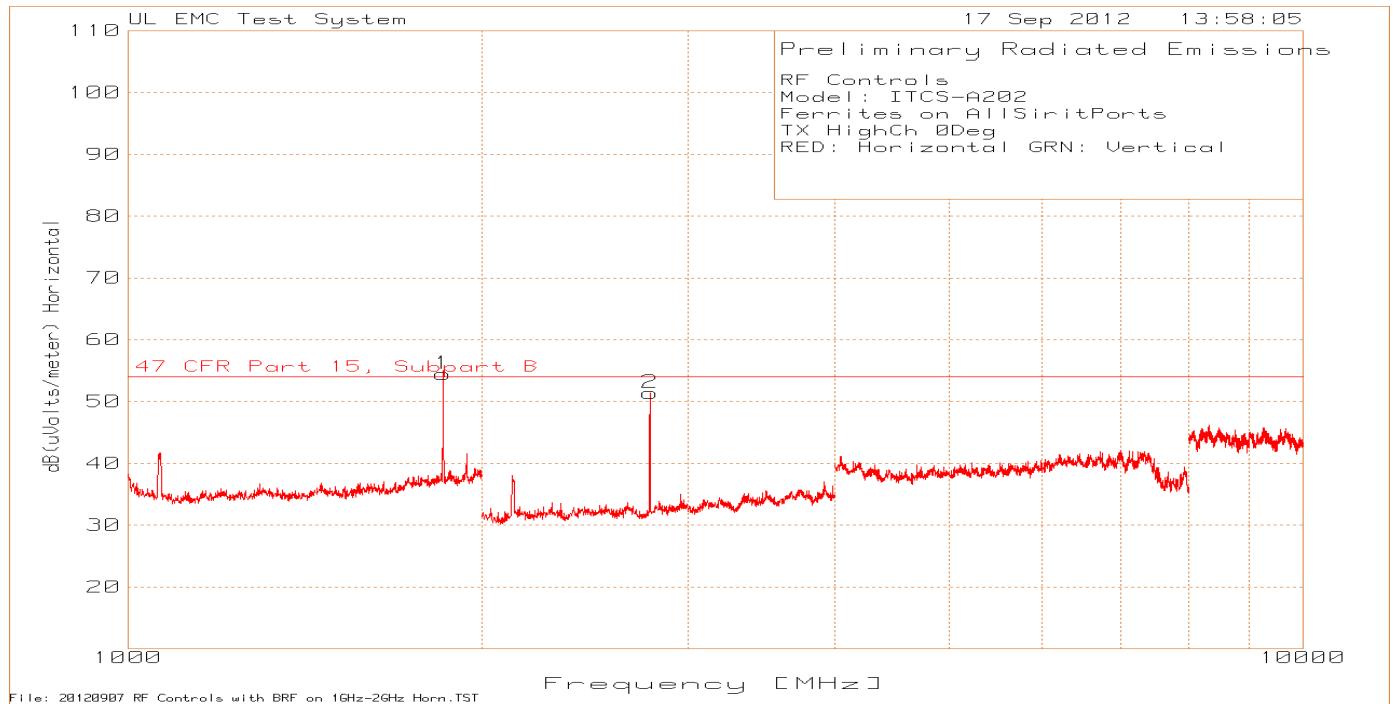

Model Number: ITCS-A202

Client Name: RF Controls LLC

Table 8 Radiated Spurious Emissions above 1GHz, High Channel

RF Controls Model: ITCS-A202 Ferrites on AllSirtPorts TX HighCh 0Deg RED: Horizontal GRN: Vertical											
Marker No.	Test Frequency MHz	Meter Reading dBuV	Detector	Antenna Factor dB	BRF Factor dB	Path Loss/Gain Factor dB	Level dBuV/m	47 CFR Part 15, Subpart B	Margin dB	Height [cm]	Polarity
1	1854.855	81.16	PK	27.2	0.4	-54.34	54.42	54	0.42	100	Horz
2	2780.781	80.97	PK	22.2	N/A	-51.72	51.45	54	-2.55	100	Horz
3	1854.855	79.64	PK	27.2	0.4	-54.34	52.9	54	-1.1	200	Vert
4	2780.781	78.6	PK	22.2	N/A	-51.72	49.08	54	-4.92	150	Vert
Test Frequency MHz	Meter Reading	Detector	Antenna Factor dB	BRF Factor dB	Path Loss/Gain Factor dB	Level dBuV/m	47 CFR Part 15, Subpart B	Margin dB	Azimuth [Degs]	Height [cm]	Polarity
1853.8267	83.84	PK	27.2	0.4	-54.32	57.12	54	3.12	230	125	Horz
1853.8357	79.37	LnAv	27.2	0.4	-54.32	52.65	54	-1.35	230	125	Horz
1853.8116	80.65	PK	27.2	0.4	-54.32	53.93	54	-0.07	159	196	Vert
1853.8597	75.88	LnAv	27.2	0.4	-54.32	49.16	54	-4.84	159	196	Vert
2780.7465	80.66	PK	22.2	N/A	-51.73	51.13	54	-2.87	142	100	Horz
2780.7164	75.15	LnAv	22.2	N/A	-51.73	45.62	54	-8.38	142	100	Horz
2780.6112	81.82	PK	22.2	N/A	-51.73	52.29	54	-1.71	175	209	Vert
2780.7615	76.52	LnAv	22.2	N/A	-51.73	46.99	54	-7.01	175	209	Vert
PK - Peak detector LnAv - Linear Average detector											

4.3 Test Conditions and Results – MAINS TERMINAL – CONDUCTED EMISSIONS

Test Description	Measurements were made on a ground plane. All power was connected to the system through Artificial Mains Network (AMN). Conducted voltage measurements on mains lines were made at the output of the AMN.	
Basic Standard	FCC Part 15, Subpart C, 15.209	
UL LPG	80-EM-S0026	
	Frequency range on each side of line	Measurement Point
Fully configured sample scanned over the following frequency range	150kHz to 30MHz	Mains
Limits - Class A		
Frequency (MHz)	Limit (dB μ V)	
	Quasi-Peak	Average
0.15-0.5	79	66
0.5-30	73	60
Limits - Class B		
Frequency (MHz)	Limit (dB μ V)	
	Quasi-Peak	Average
0.15-0.5	66 to 56	56 to 46
0.5-5	56	46
5-30	60	50
Supplementary information: None		

Table 9 Conducted Emissions EUT Configuration Settings

Power Interface Mode #	EUT Configurations Mode #	EUT Operation Mode #
1	1	1
Supplementary information: None		

Model Number: ITCS-A202

Client Name: RF Controls LLC

Table 10 Conducted Emissions Test Equipment

Description	Manufacturer	Model	Identifier	Cal. Date	Cal. Due Date
EMI Test Receiver	Rohde & Schwarz	ESCI	EMC4328	Dec 28 2011	Dec 31 2012
Transient Limiter	Electro-Metrics	EM7600-2	EMC4224	N/A	N/A
HighPass Filter	Solar Electronics	2803-150	885551	N/A	N/A
Attenuator	HP	8494B	2831A00 838	N/A	N/A
LISN - L1	Solar	8602-50-TS-50-N	EMC4052	Jan 6 2012	Jan 6 2013
LISN - L2	Solar	8602-50-TS-50-N	EMC4064	Jan 6 2012	Jan 6 2013
*LISN - L3	Solar	8602-50-TS-50-N	EMC4067	Jan 6 2012	Jan 6 2013
*LISN - L4	Solar	8602-50-TS-50-N	EMC4065	Jan 6 2012	Jan 6 2013
* used to power AE equipment					

Figure 6 Conducted Emissions Graph

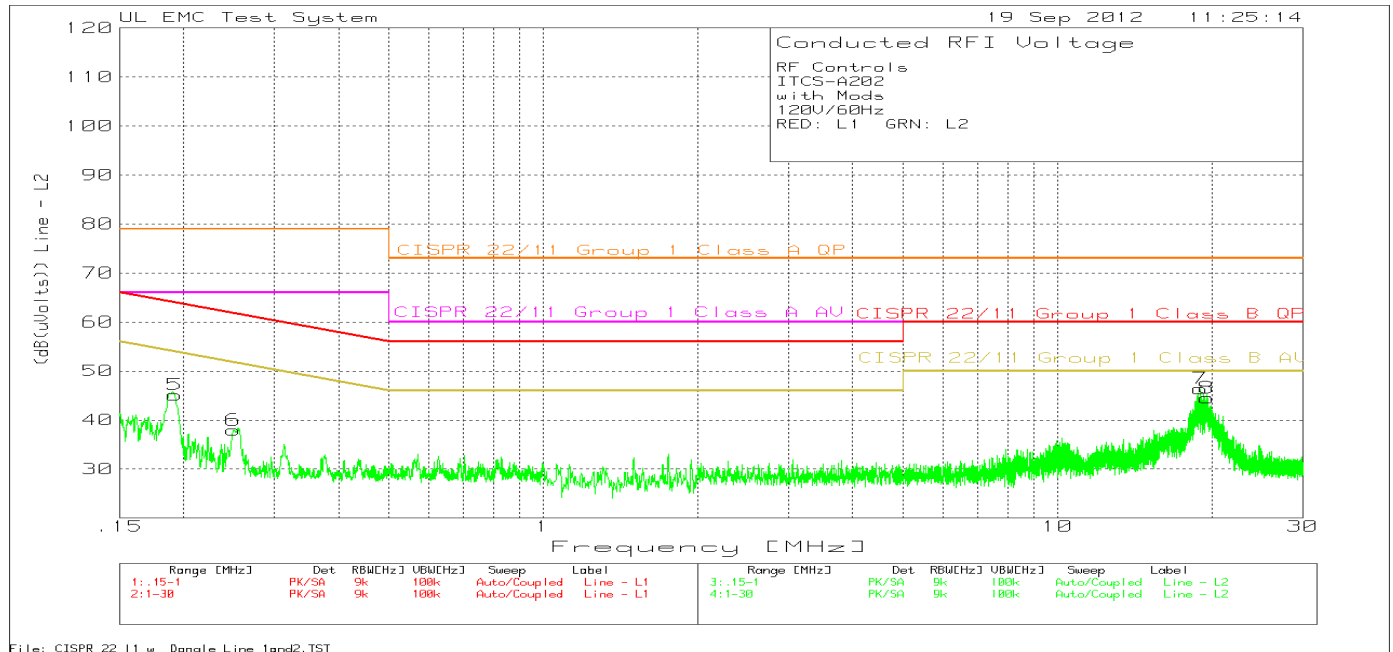
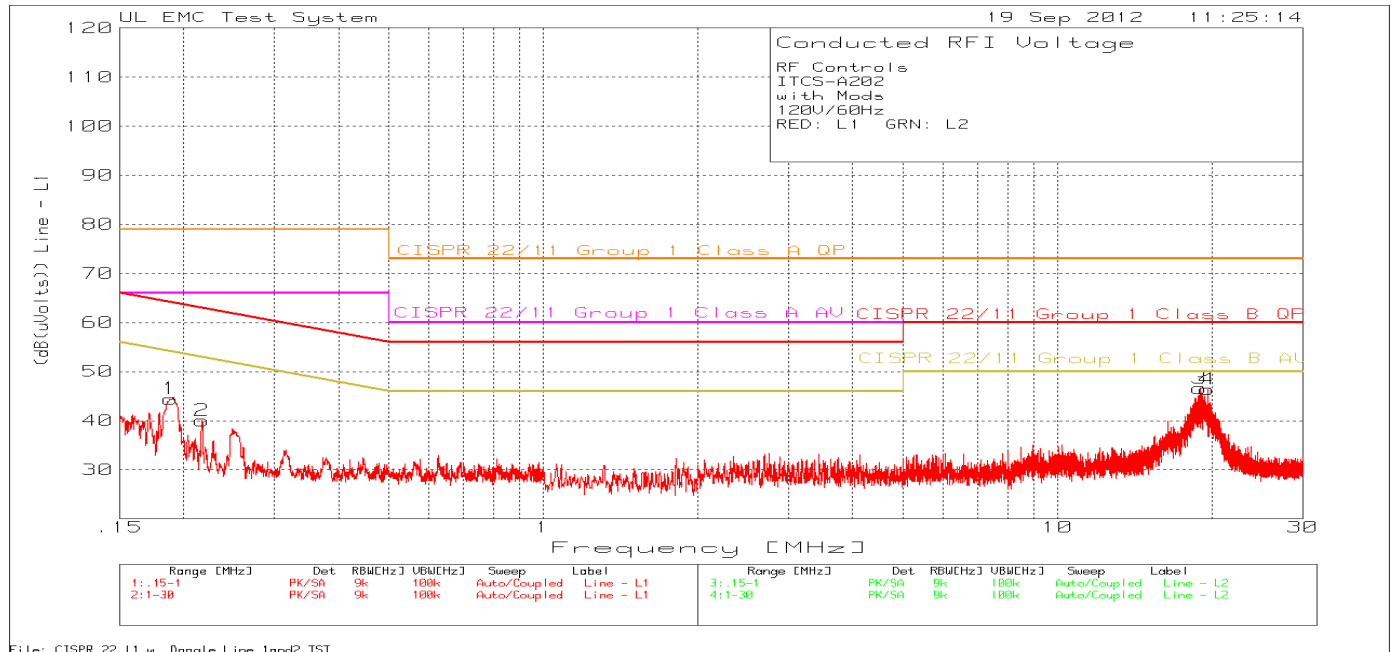

Table 11 Conducted Emissions Data Points

RF Controls
 ITCS-A202
 with Mods
 120V/60Hz
 RED: L1 GRN: L2

No.	Test Frequency [MHz]	Meter Reading (dBUV)	Transducer Factor [dB]	Gain/Loss Factor [dB]	Level (dB(uVolts))	Limit:1	2	3	4	5	6
=====											
Line - L1											
1	.18843	32.63 PK	.1	11.7	44.43	79	66	64.1	54.1	-	-
				Margin [dB]		-34.57	-21.57	-19.67	-9.67	-	-
2	.2171	28.55 PK	.1	11.4	40.05	79	66	62.9	52.9	-	-
				Margin [dB]		-38.95	-25.95	-22.85	-12.85	-	-
3	18.92444	35.23 PK	0	11.4	46.63	73	60	60	50	-	-
				Margin [dB]		-26.37	-13.37	-13.37	-3.37	-	-
4	19.57275	35.01 PK	0	11.4	46.41	73	60	60	50	-	-
				Margin [dB]		-26.59	-13.59	-13.59	-3.59	-	-
Line - L2											
5	.19204	33.42 PK	.1	11.6	45.12	79	66	63.9	53.9	-	-
				Margin [dB]		-33.88	-20.88	-18.78	-8.78	-	-
6	.2498	26.54 PK	.1	11.3	37.94	79	66	61.8	51.8	-	-
				Margin [dB]		-41.06	-28.06	-23.86	-13.86	-	-
7	18.94617	34.89 PK	.1	11.4	46.39	73	60	60	50	-	-
				Margin [dB]		-26.61	-13.61	-13.61	-3.61	-	-
8	19.57637	33 PK	.1	11.4	44.5	73	60	60	50	-	-
				Margin [dB]		-28.5	-15.5	-15.5	-5.5	-	-

LIMIT 1: CISPR 22/11 Group 1 Class A QP
 LIMIT 2: CISPR 22/11 Group 1 Class A AV
 LIMIT 3: CISPR 22/11 Group 1 Class B QP
 LIMIT 4: CISPR 22/11 Group 1 Class B AV

RF Controls
 ITCS-A202
 with Mods
 120V/60Hz
 RED: L1 GRN: L2

Test Frequency [MHz]	Meter Reading (dBuV)	Transducer Factor [dB]	Gain/Loss Factor [dB]	Level (dB(uVolts))	Limit:1	2	3	4	5	6
Line - L1										
.18741	30.69	QP	.1	11.8	42.59	79	66	64.15	54.15	-
				Margin [dB]:		-36.41	-23.41	-21.56	-11.56	-
.21605	13.79	QP	.1	11.4	25.29	79	66	62.97	52.97	-
				Margin [dB]:		-53.71	-40.71	-37.68	-27.68	-
18.9316	29.23	QP	0	11.4	40.63	73	60	60	50	-
				Margin [dB]:		-32.37	-19.37	-19.37	-9.37	-
19.56813	26.73	QP	0	11.4	38.13	73	60	60	50	-
				Margin [dB]:		-34.87	-21.87	-21.87	-11.87	-
Line - L2										
.1903	32.28	QP	.1	11.7	44.08	79	66	64.02	54.02	-
				Margin [dB]:		-34.92	-21.92	-19.94	-9.94	-
.25028	22.75	QP	.1	11.3	34.15	79	66	61.75	51.75	-
				Margin [dB]:		-44.85	-31.85	-27.6	-17.6	-
18.94733	28.31	QP	.1	11.4	39.81	73	60	60	50	-
				Margin [dB]:		-33.19	-20.19	-20.19	-10.19	-
19.5802	26.57	QP	.1	11.4	38.07	73	60	60	50	-
				Margin [dB]:		-34.93	-21.93	-21.93	-11.93	-

Test Frequency [MHz]	Meter Reading (dBuV)	Transducer Factor [dB]	Gain/Loss Factor [dB]	Level (dB(uVolts))	Limit:1	2	3	4	5	6
Line - L1 .15 - 1MHz										
.18741	21.72	Av	.1	11.8	33.62	79	66	64.15	54.15	-
				Margin [dB]:		-45.38	-32.38	-30.53	-20.53	-
.21605	-8.85	Av	.1	11.4	2.65	79	66	62.97	52.97	-
				Margin [dB]:		-76.35	-63.35	-60.32	-50.32	-
Line - L1 1 - 30MHz										
18.9316	19.43	Av	0	11.4	30.83	73	60	60	50	-
				Margin [dB]:		-42.17	-29.17	-29.17	-19.17	-
19.56813	15.27	Av	0	11.4	26.67	73	60	60	50	-
				Margin [dB]:		-46.33	-33.33	-33.33	-23.33	-
Line - L2 .15 - 1MHz										
.1903	20.29	Av	.1	11.7	32.09	79	66	64.02	54.02	-
				Margin [dB]:		-46.91	-33.91	-31.93	-21.93	-
.25028	12.06	Av	.1	11.3	23.46	79	66	61.75	51.75	-
				Margin [dB]:		-55.54	-42.54	-38.29	-28.29	-
Line - L2 1 - 30MHz										
18.94733	15.72	Av	.1	11.4	27.22	73	60	60	50	-
				Margin [dB]:		-45.78	-32.78	-32.78	-22.78	-
19.5802	14.57	Av	.1	11.4	26.07	73	60	60	50	-
				Margin [dB]:		-46.93	-33.93	-33.93	-23.93	-

NOTE: "+" - Indicates an emission level in excess of the applicable limit (s).

PK - Peak detector
 QP - Quasi-Peak detector
 Av - average detection

LIMIT 1: CISPR 22/11 Group 1 Class A QP
 LIMIT 2: CISPR 22/11 Group 1 Class A AV
 LIMIT 3: CISPR 22/11 Group 1 Class B QP
 LIMIT 4: CISPR 22/11 Group 1 Class B AV

4.4 Test Conditions and Results – RADIATED EMISSIONS

Test Description	Measurements were made in a 10-meter semi-anechoic chamber that complies to CISPR 16/ANSI C63.4:2003. Preliminary (peak) measurements were performed at an antenna to EUT separation distance of 10-meter. The EUT was rotated 360° about its azimuth with the receive antenna located at various heights in both horizontal and vertical polarities. Final measurements (quasi-peak or average as noted) were then performed by rotating the EUT 360° and adjusting the receive antenna height from 1 to 4-meters. All frequencies were investigated in both horizontal and vertical antenna polarity, where applicable.	
Basic Standard	47 CFR Part 15, Subpart B	
UL LPG	80-EM-S0029	
	Frequency range	Measurement Point
Fully configured sample scanned over the following frequency range	30MHz – 1GHz	(10 meter distance)
	1GHz – 5GHz	(3 meter distance)
Limits - Class B		
Frequency (MHz)	Limit (dBµV/m)	
	Quasi-Peak @ 10m	Average @ 3m
30 to 88	29.54	NA
88 to 216	33.06	NA
216 to 960	35.56	NA
960 to 1000	43.52	NA
1000 to 5000	N/A	54
Supplementary information: None		

Table 12 Radiated Emissions EUT Configuration Settings

Power Interface Mode #	EUT Configurations Mode #	EUT Operation Mode #
1	1	3
Supplementary information: None		

Table 13 Radiated Emissions Test Equipment

Description	Manufacturer	Model	Identifier	Cal. Date	Cal. Due Date
EMI Test Receiver	Rohde & Schwarz	ESU	EMC4323	20111228	20121231
Bicon Antenna	Chase	VBA6106A	EMC4078	20120117	20130131
Log-P Antenna	Chase	UPA6109	EMC4258	20110927	20120928
Antenna Array	UL	BOMS	EMC4276	20111227	20121231

Figure 7 Radiated Emissions Graph below 1GHz

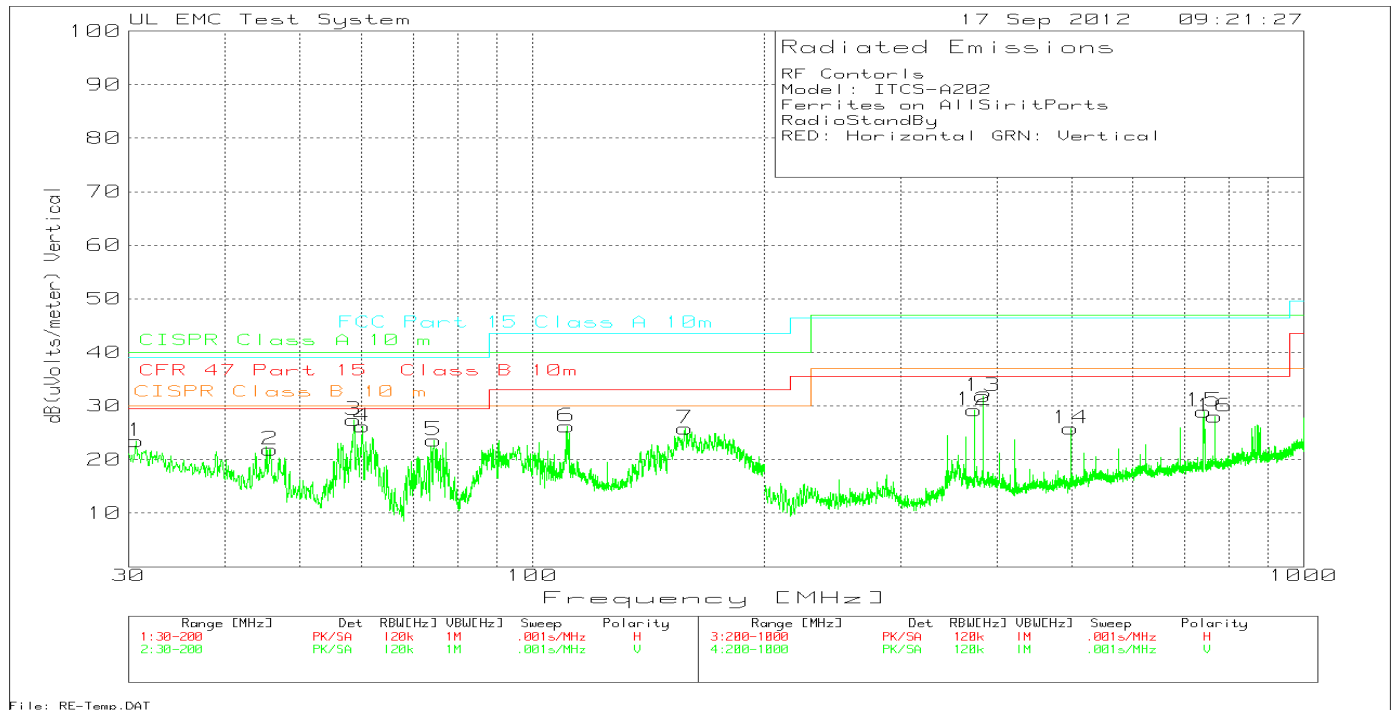
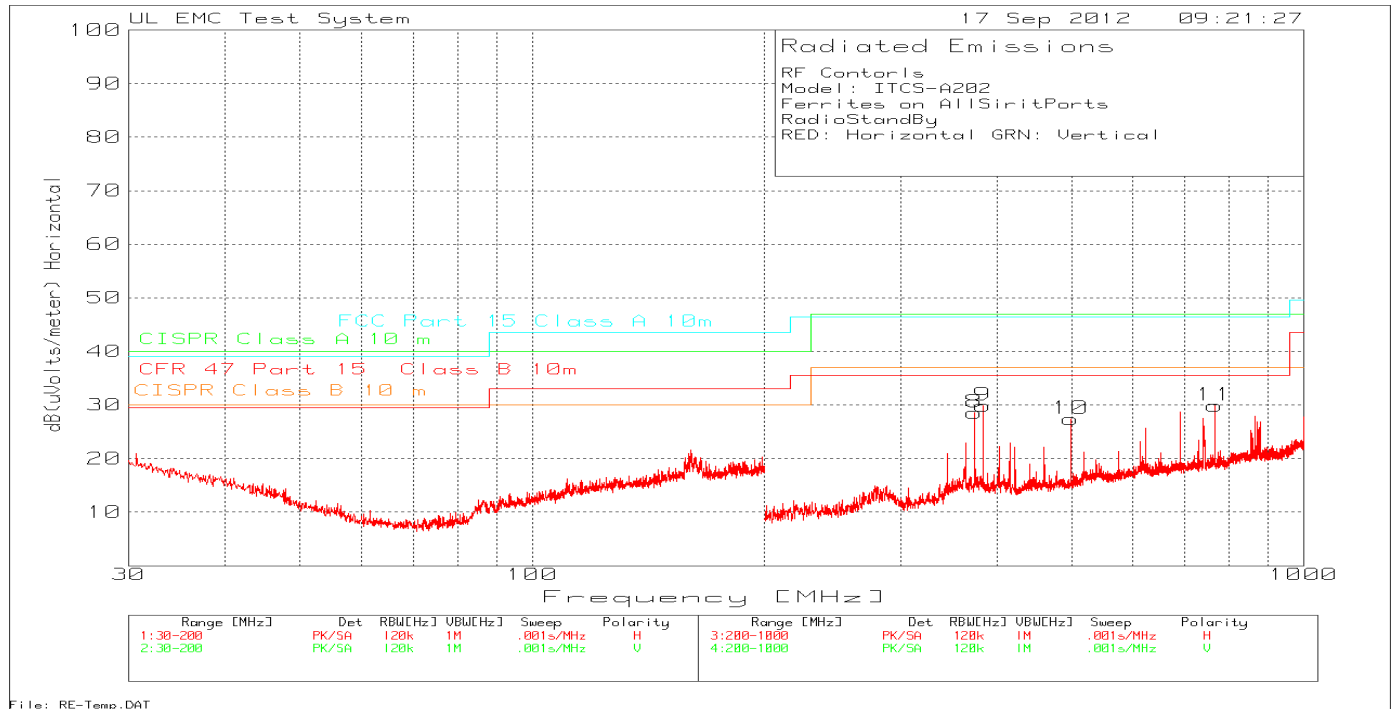
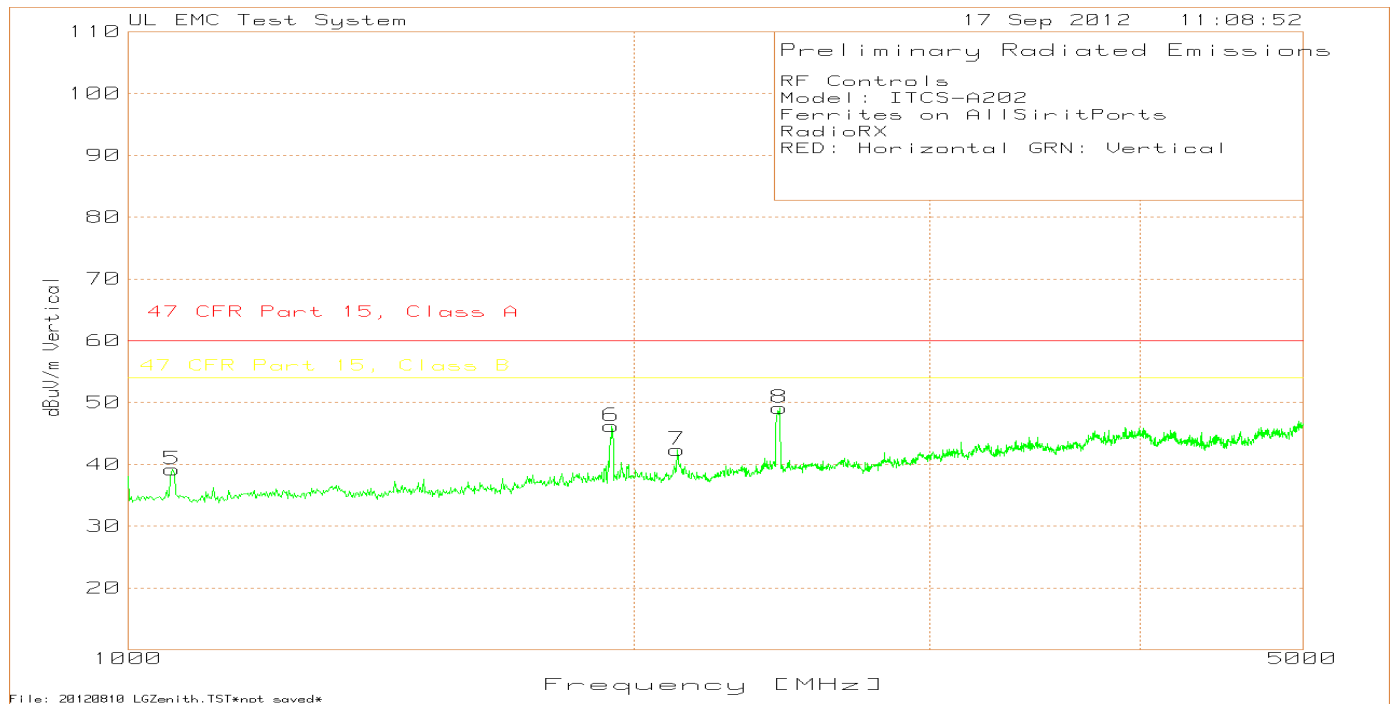
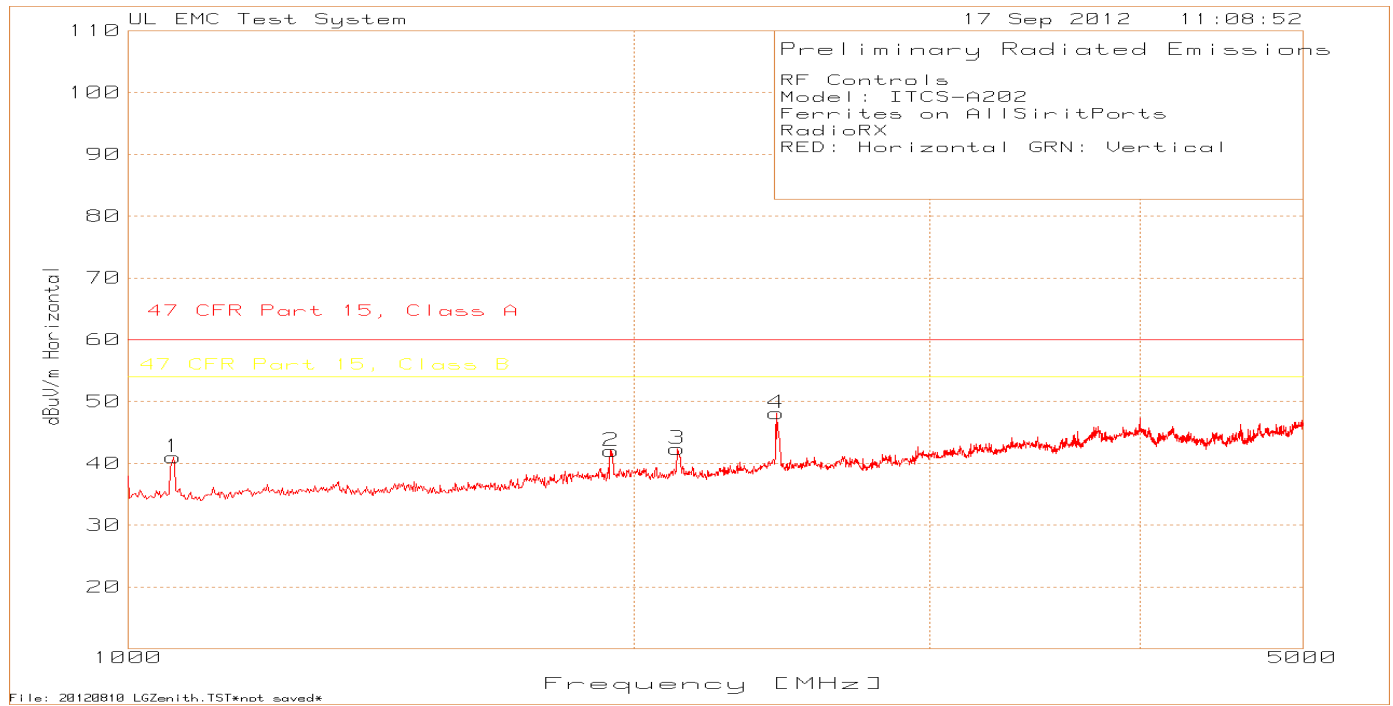

Table 14 Radiated Emissions Data Points below 1GHz

RF Controls Model: ITCS-A202 Ferrites on AllSiriPorts RadioStandBy RED: Horizontal GRN: Vertical												
Marker No.	Test Frequency MHz	Meter Reading dBuV	Detector	Antenna Factor dB	Path Factor dB	Level dBuV/m	CISPR Class B 10 m	Margin dB	CFR 47 Part 15 Class B 10m	Margin dB	Height [cm]	Polarity
1	30.5947	35.06	PK	17.7	-29.3	23.46	30	-6.54	29.6	-6.14	99	Vert
2	45.7171	39.42	PK	11.8	-29.3	21.92	30	-8.08	29.6	-7.68	99	Vert
3	58.7156	49.6	PK	7.1	-29.3	27.4	30	-2.6	29.6	-2.2	250	Vert
4	60.2449	48.84	PK	6.8	-29.4	26.24	30	-3.76	29.6	-3.36	250	Vert
5	74.6027	46.63	PK	6.4	-29.4	23.63	30	-6.37	29.6	-5.97	399	Vert
6	110.7946	43.43	PK	12.2	-29.4	26.23	30	-3.77	33.1	-6.87	99	Vert
7	157.7761	40.01	PK	15.1	-29.3	25.81	30	-4.19	33.1	-7.29	99	Vert
8	374.2838	46	PK	15	-32.4	28.6	37	-8.4	35.6	-7	199	Horz
9	383.8774	46.95	PK	15.2	-32.3	29.85	37	-7.15	35.6	-5.75	199	Horz
10	499.2672	41.97	PK	17.2	-31.8	27.37	37	-9.63	35.6	-8.23	99	Horz
11	768.1546	39.77	PK	21.4	-31.3	29.87	37	-7.13	35.6	-5.73	99	Horz
12	374.2838	46.63	PK	15	-32.4	29.23	37	-7.77	35.6	-6.37	399	Vert
13	383.8774	48.94	PK	15.2	-32.3	31.84	37	-5.16	35.6	-3.76	399	Vert
14	499.2672	40.36	PK	17.2	-31.8	25.76	37	-11.24	35.6	-9.84	299	Vert
15	743.3711	39.82	PK	20.5	-31.3	29.02	37	-7.98	35.6	-6.58	199	Vert
16	768.1546	37.95	PK	21.4	-31.3	28.05	37	-8.95	35.6	-7.55	399	Vert
Test Frequency MHz	Meter Reading dBuV	Detector	Antenna Factor dB	Path Factor dB	Level dBuV/m	CISPR Class B 10 m	Margin dB	CFR 47 Part 15 Class B 10m	Margin dB	Azimuth [Degs]	Height [cm]	Polarity
58.730833	47.72	QP	7.1	-29.3	25.52	30	-4.48	29.6	-4.08	124	321	Vert
60.208013	49.05	QP	6.8	-29.4	26.45	30	-3.55	29.6	-3.15	52	343	Vert
74.563141	45.89	QP	6.4	-29.4	22.89	30	-7.11	29.6	-6.71	341	372	Vert
110.7625	36.98	QP	12.2	-29.4	19.78	30	-10.22	33.1	-13.32	232	100	Vert
157.7	31.44	QP	15.1	-29.3	17.24	30	-12.76	33.1	-15.86	198	100	Vert
384	46.49	QP	15.2	-32.3	29.39	37	-7.61	35.6	-6.21	358	198	Horz
768	38.18	QP	21.4	-31.3	28.28	37	-8.72	35.6	-7.32	48	100	Horz
384	49.21	QP	15.2	-32.3	32.11	37	-4.89	35.6	-3.49	35	396	Vert

PK - Peak detector
 QP - Quasi-Peak detector

Figure 8 Radiated Emissions Graph above 1GHz



Model Number: ITCS-A202

Client Name: RF Controls LLC

Table 15 Radiated Emissions Data Points above 1GHz

RF Controls Model: ITCS-A202 Ferrites on AllSiriPorts RadioRX RED: Horizontal GRN: Vertical										
Marker No.	Test Frequency MHz	Meter Reading dBuV	Detector	Antenna Factor dB	Path Factor dB	Level dBuV/m	47 CFR Part 15, Class B	Margin dB	Height [cm]	Polarity
1	1064.032	73.43	PK	24.2	-56.63	41	54	-13	150	Horz
2	1940.47	69.18	PK	27.4	-54.54	42.04	54	-11.96	100	Horz
3	2122.561	68.18	PK	27.5	-53.28	42.4	54	-11.6	150	Horz
4	2430.715	71.41	PK	28.7	-51.98	48.13	54	-5.87	100	Horz
5	1062.031	71.63	PK	24.2	-56.64	39.19	54	-14.81	99	Vert
6	1940.47	73.38	PK	27.4	-54.54	46.24	54	-7.76	99	Vert
7	2122.561	68.15	PK	27.5	-53.28	42.37	54	-11.63	150	Vert
8	2440.72	72.5	PK	28.8	-52.12	49.18	54	-4.82	99	Vert

PK - Peak detector

Appendix A

Test Setup Photos

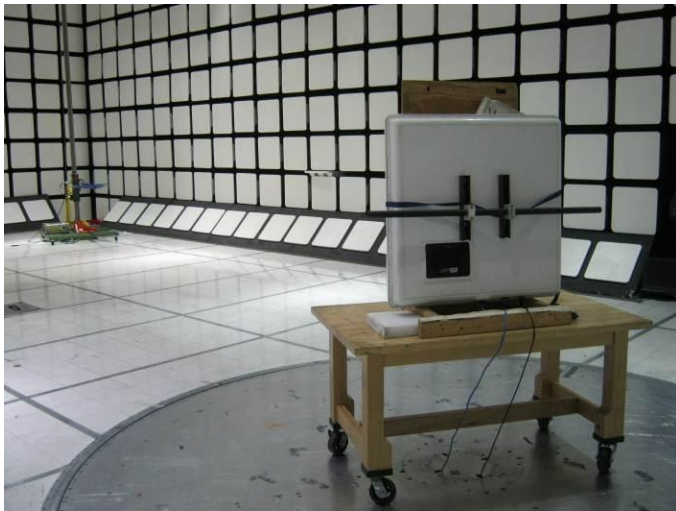

Radiated Emissions – Digital Below 1GHz

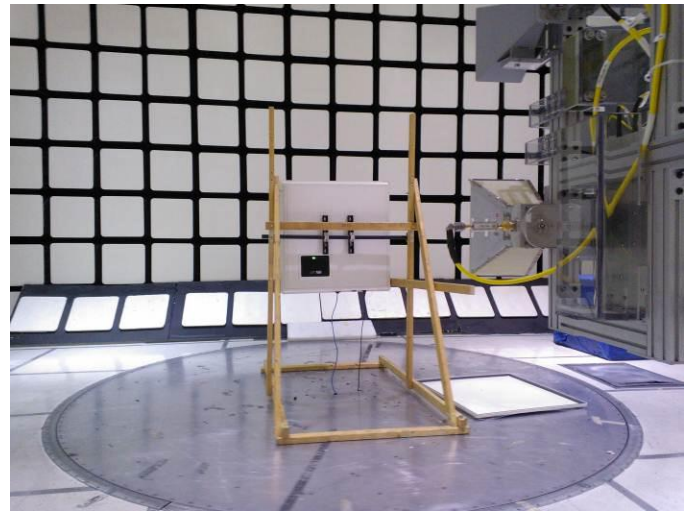

Radiated Emissions – Above 1GHz



Mains – Line Conducted Emissions

Appendix B

Antenna Gain Information

Antenna gain was measured using substitution power measurements with absorber on the floor between the EUT and receive antenna and between the substitution antenna and receive antenna.

Polarization	Freq MHz	SG Drive dBm	Level at Ant dBm	TX Ant Factor dBi	Substitution EIRP Level	Substitution FS dBuV/m	Software Radio Power Setting	EUT FS dBuV/m @ 3m	FS Delta EUT-Subs dB	EUT EIRP Level dBm	EUT EIRP Level mW	EUT Peak Power Measured dBm	Antenna Gain Level dBi
Horz	903.1	2.7	0.0	5.95	5.95	102.70	2840	131.58	28.88	34.83	3040.89	28.9	5.93
Vert	903.1	2.7	0.0	5.75	5.75	101.71	2840	132.23	30.52	36.27	4236.43	28.9	7.37
Horz	915.1	2.7	0.0	5.90	5.90	102.30	2840	131.77	29.47	35.37	3443.50	28.9	6.47
Vert	915.1	2.7	0.0	5.70	5.70	101.47	2840	131.53	30.06	35.76	3767.04	28.9	6.86
Horz	926.9	2.7	-0.1	5.90	5.80	102.15	2840	131.20	29.05	34.85	3054.92	28.9	5.95
Vert	926.9	2.7	-0.1	5.70	5.60	101.18	2840	131.87	30.69	36.29	4255.98	28.9	7.39

Based on above table maximum antenna gain is: 7.39dBi (1.39dB above 6dBi)

Power output used for antenna gain determination: 28.9dBm

Maximum allowed power output 1W (30dBm) – antenna gain over 6dBi (1.39dB) is 726.11mW (28.6dBm)

Maximum radio setting allowed per above (assuming linear power change – see section 4.1): **2810**

Appendix C

Accreditations and Authorizations



NVLAP Lab code: 100414-0

NVLAP: The National Institute of Standards and Technology (NIST) administers the National Voluntary Laboratory Accreditation Program (NVLAP). NVLAP is comprised of laboratory accreditation programs (LAPs) which are established on the basis of requests and demonstrated need. Each LAP includes specific calibration and/or test standards and related methods and protocols assembled to satisfy the unique needs for accreditation in a field of testing or calibration. NVLAP accredits public and private laboratories based on evaluation of their technical qualifications and competence to carry out specific calibrations or tests. Accreditation criteria are established in accordance with the U.S. Code of Federal Regulations (CFR, Title 15, Part 285), NVLAP Procedures and General Requirements, and encompass the requirements of ISO/IEC 17025. For a full scope listing see <http://ts.nist.gov/standards/scopes/1004140.htm>



FCC: Details of the measurement facilities used for these tests have been filed with the Federal Communications Commission's Laboratory in Columbia, Maryland (Ref. No. 91044).



Industry Canada Industrie Canada

Industry of Canada: Accredited by Industry Canada for performance of radiated measurements. Our test site complies with RSP 100, Issue 7, Section 3.3. File #: IC 2180A



VCCI: Accepted as an Associate Member to the VCCI. The measurement facilities detailed in this test report have been registered in accordance with Regulations for Voluntary Control Measures, Article 8. Registration Nos.: Radiated Emissions R-621 and G-344, Conducted Emissions C-642.



ICASA: ICASA (Independent Communications Authority of South Africa) has appointed UL as a Designated Test Laboratory to test Telecommunications equipment for type approval in compliance with CISPR 22 to assist in fulfilling its mandate under section 54(1) of the Telecommunications Act, 1996 (Act 103 of 1996).



NIST/CAB: Validated by the European Commission as a U.S. Conformity Assessment Body (CAB) of the U.S.-EU Mutual Recognition Agreement (MRA) for the Electromagnetic Compatibility - Council Directive 2004/108/EC, Annex III (2-3). Also validated for the Telecommunication Equipment-Council Directive 99/5/EC, Annex III and IV, Identification Number: 0983.

NIST/CAB: Provisioned to act as a U.S. Conformity Assessment Body (CAB) under Appendix B, Phase I Procedures, of the Asia Pacific Economic Cooperation (APEC) MRA between the American Institute in Taiwan (AIT) and the United States. Our laboratory is considered qualified to test equipment subject to the applicable EMC regulations of the Chinese Taipei Bureau of Standards, Metrology and Inspection (BSMI) which require testing to CNS 13438 (CISPR 22).

NIST/CAB: Recognized by the Infocomm Development Authority of Singapore (IDA) under the Asia Pacific Economic Cooperation Mutual Recognition Agreement (APEC MRA). Our laboratory is provisionally designated to act as a Conformity Assessment Body (CAB) under Appendix B, Phase I Procedures, of the APEC MRA. Our scope of designation includes IDA TS EMC (CISPR 22), IEC 61000-4-2, -4-3, -4-4, -4-5, and -4-6

