

# MX-725 Quick User Guide

## Catalog

Getting Started.....	2
Getting To Know Your Device.....	2
Installing and Removing Carrier 4G Card.....	3
Installing and Removing Memory Card.....	4
Connection Scenarios.....	4
Using the Power Adapter to charge MX-725.....	6
Restore Factory Setting.....	7
Setting Up a Wi-Fi Connection.....	7
FAQ.....	8
FCC statements.....	10
RF Exposure.....	10

## Getting Started

Thank you for choosing MX-725 works in Carrier LTE network. MX-725 allows you to access a wireless network at high speed.

**Note:**

This guide briefly describes the appearance of the MX-725 and the procedures for using the MX-725. For details about how to set the management parameters, see help information on the WEB management.

## Getting To Know Your Device

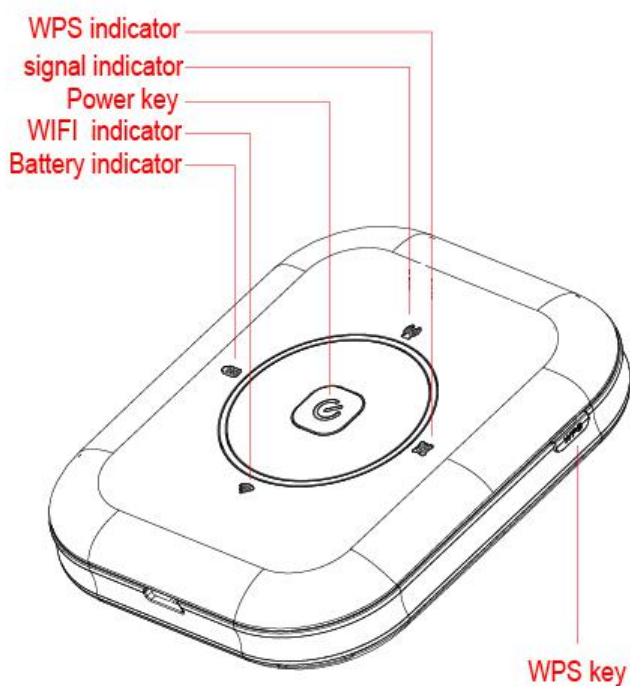

Indicator	Light Status	Function State
LTE light	Red fast blinking	No SIM card
	Red	No service/signal (RSRP< -125dbm)
	Green	Weak Signal (-125dbm =< RSRP < -105dbm)
	Blue	Good signal ( RSRP > = -105dbm)
Battery light	Red fast blinking	0%~5% battery
	Red	5%-19% battery
	Green	20%-59% battery
	Blue	60%-100% battery

	Red,Green,Blue	Charging
	Red,Green,Blue slow blinking (Based on battery status)	Device On no charging (Standby)
WIFI light	Blue	WIFI on
	Off	WIFI off
WPS light	Blue	WPS on
	Off	WPS off

## Installing and Removing Carrier 4G Card

1. Power off MX-725.
2. Remove the back cover of MX-725.
3. Insert Carrier 4G Card into card slot in the correct position.
4. Install back cover of MX-725.
5. Power off MX-725 Before you take out the Carrier 4G Card.

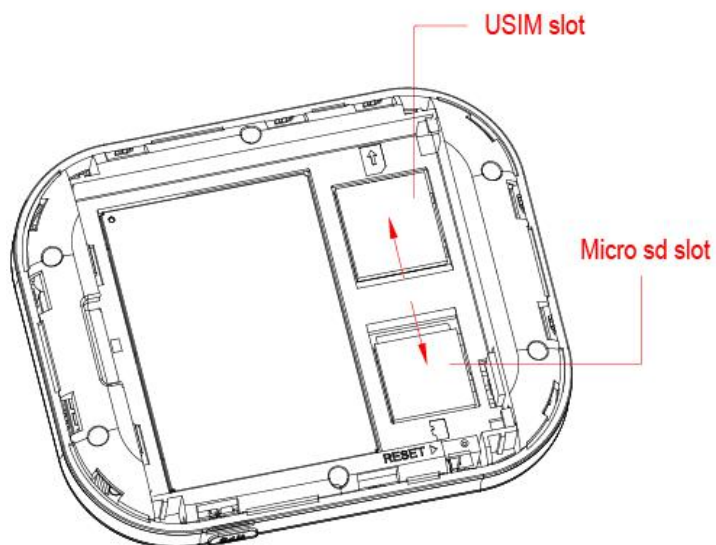

**Note:** Do not remove the Carrier 4G Card when MX-725 power on. Otherwise, the card and MX-725 may be damaged.

## Installing and Removing Memory Card

1. Power off MX-725.
2. Remove the back cover of MX-725.
3. Insert Micro SD card into card slot in the correct position.
4. Install back cover of MX-725.
5. Power off MX-725 Before you take out the Micro SD card.

### Note:

- The Micro SD card is an optional accessory. Not included the product package, please purchase separately.
- When installing a Micro SD card, ensure that the Micro SD card notch aligns with the Micro SD card holder.
- Micro SD card support up to 32GB.
- Do not remove the Micro SD card when MX725 power on. Otherwise, the card and MX-725 may be damaged and the data stored on the card may be corrupted.

## Connection Scenarios

**Scenario 1:** Multi-device Internet access using Wi-Fi (MX-725 power on)

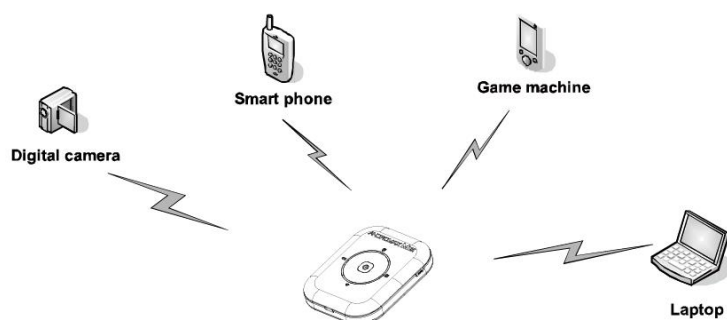

**Scenario 2:** One-device Internet access using computer

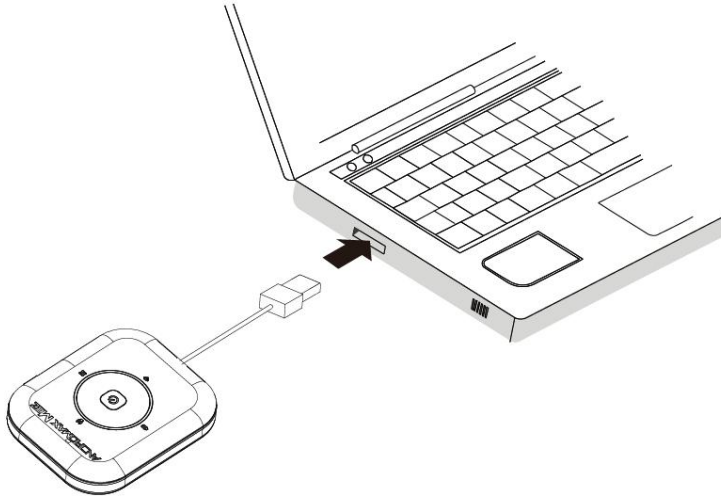

**Scenario 3:** Multi-device Internet access using Wi-Fi (connected to a computer)

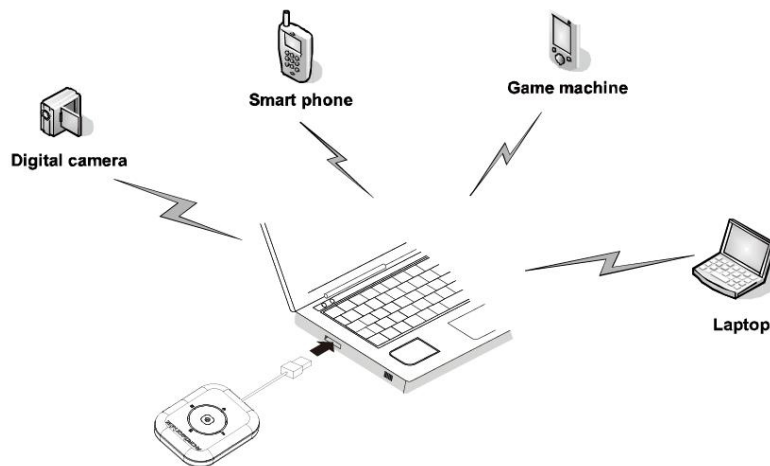

**Scenario 4:** Multi-device Internet access using Wi-Fi (connected to the power adapter)

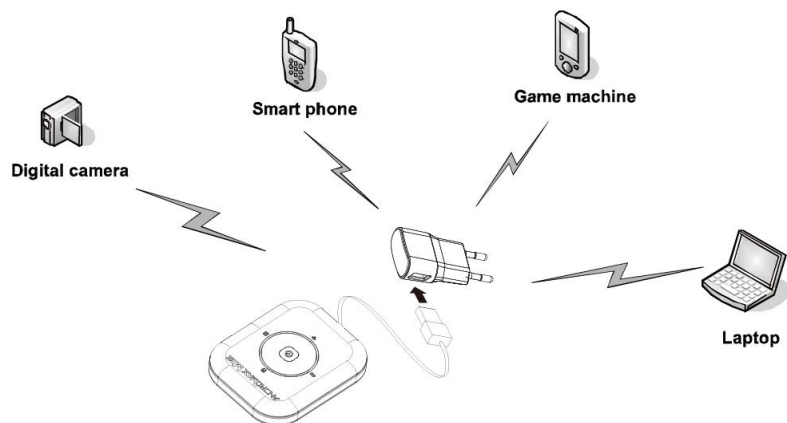

## Using the Power Adapter to charge MX-725

Connect the MX-725 to the power adapter's USB port, and connect the power adapter to a power outlet.

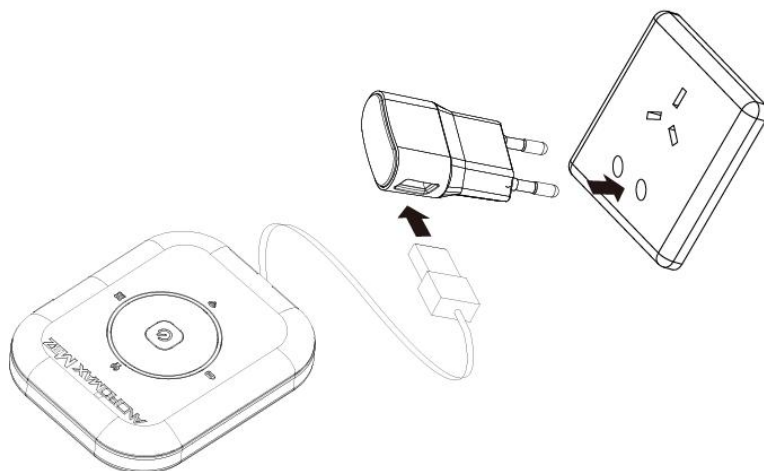

### Note :

Charger not included in package bundling, please use the charge head follow below specification.

### Charge Head

Technical Parameters	Charge Head
Input	100-240V~50/60Hz 300mA
Output	5.0V/1.0A
Maximum Output Current	1000mA



### Note:

- Do not store the charge in an area of dampness or high temperature. Don't use the charge under high-temperature, high-humidity or lightning environment.

If you want to charge MX-725 with Car charge, please note Car charge must be accord as follow specification

Technical Parameters	Car Charge
Input	DC 12~24V
Output	DC 5.0V/1.0A
Maximum Output Current	1000mA

## Restore Factory Setting

If you are uncertain of which Wi-Fi settings you have configured or changed, you can restore the factory defaults that come with MX-725, and reconfigure the device Wi-Fi setting.

- Power on MX-725, Press and hold the Reset button for 3 seconds to restore Wi-Fi to factory default settings.
- Power on MX-725, and connect to it. Login in to the management page <http://192.168.1.1> or <http://mobile.router>, Go to Setting > System Setting, click "Factory Default Setting" button to restore Admin Setting and Wi-Fi Setting to factory default settings.

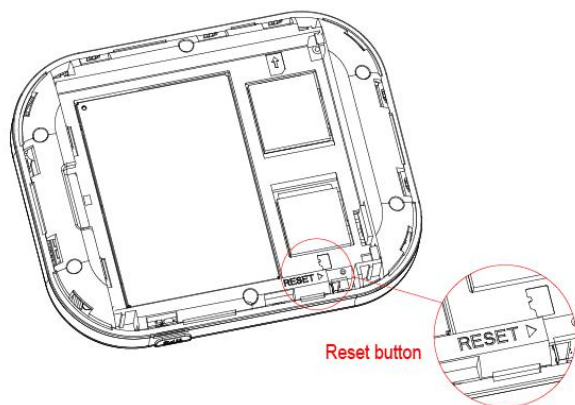

### Note:

Reset button on device will deletes all the device' s user-defined Wi-Fi settings and restore Admin Setting and Wi-Fi Setting to factory defaults.

## Setting Up a Wi-Fi Connection

1. Ensure that the MX-725 's Wi-Fi function is available.
2. To setup a computer with MX-725, choose "Start > Control Panel > Network Connection > Wireless Network

Connection” .

**Note:**

To set up a Wi-Fi connection, your computer must have a wireless network adapter installed. If Wireless Network Connection is displayed, means a wireless network adapter is available. Otherwise, check to make sure you have a wireless network adapter installed.

3. Click View available wireless networks to view the wireless network connection.
4. Select the wireless network connection which service set identification (SSID) is the same as that of the MX-725, and click Connect.

**Note:**

- Default SSID will be mentioned on the device.
- Wait until a wireless network connection icon is displayed in the lower right corner of the computer screen. A wireless network connection is set up.

**FAQ**

1. Q: What' s the range of the Wi-Fi supported?  
A: It can support around 40-50 meters in non-obstruction outdoor condition.
2. Q: How many users can access simultaneously?  
A: It can support 32 user (31 Wi-Fi users and 1 usb user) simultaneously.
3. Q: What to be done when forget the WIFI Key?  
A: Long press Reset button in power on condition for 3 seconds and Wi-Fi settings will be restored to factory defaults.
4. Q: Can modem and Wi-Fi work simultaneously?  
A: Yes modem and Wi-Fi can work simultaneously.
5. Q: What if MX-725 WEB page is not opening?  
A: Disconnect any of his existing internet connection first so that MX-725 browser can be opened.
6. Q: What to be done if Multi-Network IP Address Conflict?  
A: Disable other network devices or disconnect other Internet connections from the client, and then restart MX-725.
7. Q: What to do if cannot login Web management Page?



A: Try the following steps:

1. Disconnect other network connections, such as an Ethernet or Wireless Fidelity (Wi-Fi) connection.
  2. Clear the cookies and caches of IE browsers.
  3. Close all IE browsers and Open again.
  4. Check the name and password of administrator is correct.
  5. Remove and then insert the MX-725, or restart the computer.
8. Q: What to do if the file display 0 B after finish uploading on some Android device?
- A: If you find the file name change to follow format with % 20 automatically, and the file size is 0 B on some Android device.

**Solution:** Please change the file name without the space, and try to upload again.

More details about the device can be checked using User manual inside device help.

### **FCC statements**

This device complies with part 15 of the FCC rules. Operation is subject to the following two conditions: (1) this device may not cause harmful interference, and (2) this device must accept any interference received, including interference that may cause undesired operation.

NOTE: The manufacturer is not responsible for any radio or TV interference caused by unauthorized modifications or changes to this equipment. Such modifications or changes could void the user' s authority to operate the equipment.

Note: This equipment has been tested and found to comply with the limits for a Class B digital device, pursuant to part 15 of the FCC Rules. These limits are designed to provide reasonable protection against harmful interference in a residential installation. This equipment generates uses and can radiate radio frequency energy and, if not installed and used in accordance with the instructions, may cause harmful interference to radio communications. However, there is no guarantee that interference will not occur in a particular installation. If this equipment does cause harmful interference to radio or television reception, which can be determined by turning the equipment off and on, the user is encouraged to try to correct the interference by one or more of the following measures:

- Reorient or relocate the receiving antenna.
- Increase the separation between the equipment and receiver.
- Connect the equipment into an outlet on a circuit different from that to which the receiver is connected.
- Consult the dealer or an experienced radio/TV technician for help.

### **RF Exposure**

The highest SAR value reported under this standard during product certification for use when properly worn on the body is 0.694 W/Kg. Simultaneous RF exposure is 1.539 W/Kg.

This device was tested for typical body-worn operations with the back of the handset kept 5mm from the body. Accessory designated by Manufacture must be used to meet body worn RF exposure compliance.