

---

# FCC Test Report

---

Report No.: AGC11991012SZ01F1

**FCC ID** : W8D-F2  
**PRODUCT DESIGNATION** : FM transmitter  
**BRAND NAME** : N/A  
**TEST MODEL** : F2  
**CLIENT** : Shenzhen Onuoda Electronics Technology Co., Ltd  
**DATE OF ISSUE** : Dec.09, 2010  
**STANDARD(S)** : FCC Part 15 Rules

**Attestation of Global Compliance Co., Ltd.**

CAUTION: This report shall not be reproduced except in full without the written permission of the test laboratory and shall not be quoted out of context.

## TABLE OF CONTENTS

<b>1. VERIFICATION OF COMPLIANCE</b>	<b>3</b>
<b>2. GENERAL INFORMATION</b>	<b>4</b>
2.1.PRODUCT DESCRIPTION FOR EQUIPMENT UNDER TEST (EUT)	4
2.2. TEST STANDARDS	4
2.3. RELATED SUBMITTAL(S)/GRANT(S)	4
2.4. TEST METHODOLOGY	4
2.5. TEST FACILITY	5
2.6. EUT EXERCISE SOFTWARE	5
2.7. ACCESSORIES EQUIPMENT LIST AND DETAILS	5
2.8. EUT PORT&CABLE LIST AND DETAILS	5
<b>3. SUMMARY OF TEST RESULTS</b>	<b>6</b>
<b>4.§15.203 - ANTENNA REQUIREMENT</b>	<b>7</b>
4.1. STANDARD APPLICABLE	7
4.2. TEST RESULT	7
<b>5.§15.209, §15.239 (b)(c)- RADIATED EMISSION</b>	<b>8</b>
5.1. MEASUREMENT UNCERTAINTY	8
5.2. STANDARD APPLICABLE	8
5.3. TEST EQUIPMENT LIST AND DETAILS	8
5.4. TEST PROCEDURE	8
5.5. TEST SET-UP (BLOCK DIAGRAM OF CONFIGURATION)	9
5.6. LIMITS AND TEST RESULTS/PLOTS	11
<b>6. §15.239(a) EMISSION BANDWIDTH TESTING</b>	<b>19</b>
6.1. STANDARD APPLICABLE	19
6.2. TEST EQUIPMENT LIST AND DETAILS	19

6.3. TEST PROCEDURE .....	19
6.4. SUMMARY OF TEST RESULTS/PLOTS .....	19
<b>7.§15.249(b) OUT OF BAND EMISSIONS .....</b>	<b>22</b>
7.1. STANDARD APPLICABLE .....	22
7.2. TEST EQUIPMENT LIST AND DETAILS .....	22
7.3. TEST PROCEDURE .....	22
7.4. SUMMARY OF TEST RESULTS/PLOTS .....	22
<b>APPENDIX 1 .....</b>	<b>25</b>
<b>PHOTOGRAPHS OF TEST SETUP.....</b>	<b>25</b>
<b>APPENDIX 2.....</b>	<b>26</b>
<b>PHOTOGRAPHS OF EUT .....</b>	<b>26</b>

## 1. VERIFICATION OF COMPLIANCE

Applicant:	Shenzhen Onuoda Electronics Technology Co.,Ltd
Applicant Address:	3F D Building jingfu industry zone Airway(west) Gushu village xixiang town Bao`an district Shenzhen city Guangdong China
Manufacturer:	Shenzhen Onuoda Electronics Technology Co.,Ltd
Manufacturer Address:	3F D Building jingfu industry zone Airway(west) Gushu village xixiang town Bao`an district Shenzhen city Guangdong Chin
Product Description:	FM transmitter
Brand Name:	N/A
Model Name:	F2
FCC ID:	W8D-F2
Report Number:	AGC11991012SZ01F1
Date of Test:	Dec.06 ~ Dec.09, 2010

### WE HEREBY CERTIFY THAT:

The above equipment was tested by Attestation of Global Compliance Co., Ltd. for compliance with the requirements set forth in the FCC Rules and Regulations Part 15, the measurement procedure according to ANSI C63.4:2003. This said equipment in the configuration described in this report shows the maximum emission levels emanating from equipment are within the compliance requirements.

The test results of this report relate only to the tested sample identified in this report.

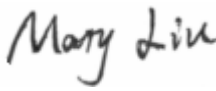
Checked By:   
Mary Liu                      Dec.09, 2010

Authorized By 

---

King Zhang      Dec.09, 2010

## 2. GENERAL INFORMATION

### 2.1. PRODUCT DESCRIPTION FOR EQUIPMENT UNDER TEST (EUT)

EUT Designation:	FM transmitter
Brand Name:	N/A
Model Name:	F2
Rated Voltage:	DC 3V by Battery or DC 12V by Vehicle Charger
Frequency Range:	88.1-107.9MHz
Channel Separation:	0.2MHz
Modulation Type:	FM
Type of Antenna:	Integrated Antenna
EUT Size:	7.5cm(Length) x 4.5cm(Width) x 2.4cm(Height)
<b>**Note:</b> For more information refer to the circuit diagram form and the user's manual.	

### 2.2. TEST STANDARDS

The following report of is prepared on behalf of the Attestation of Global Compliance Co., Ltd. in accordance with FCC Part 15, Subpart C, and section 15.239, 15.203 and 15.209 of the Federal Communication Commission rules.

The objective is to determine compliance with FCC Part 15, Subpart C, and section 15.239, 15.203 and 15.209 of the Federal Communication Commission rules.

Maintenance of compliance is the responsibility of the manufacturer. Any modification of the product, which result in lowering the emission/immunity, should be checked to ensure compliance has been maintained.

### 2.3. RELATED SUBMITTAL(S)/GRANT(S)

This submittal(s) (test report) is intended for FCC ID: filing to comply with Section 15.239 of the FCC Part 15, Subpart C Rules.

### 2.4. TEST METHODOLOGY

All measurements contained in this report were conducted with ANSI C63.4-2003, American National Standard

for Methods of Measurement of Radio-Noise Emissions from Low-Voltage Electrical and Electronic Equipment in the range of 9 kHz to 40 GHz.

The equipment under test (EUT) was configured to measure its highest possible emission level. The test modes were adapted accordingly in reference to the Operating Instructions. The EUT was tested in all three orthogonal planes and the worse case was showed.

## 2.5. TEST FACILITY

All measurement facilities used to collect the measurement data are located at

### **Attestation of Global Compliance Co., Ltd.**

(1&2F, No.2 Building, Huafeng No.1 Technical, Industrial Park, Sanwei, Xixiang, Baoan District, Shenzhen, China)

The test site is constructed and calibrated to meet the FCC requirements in documents ANSI C63.4: 2003. FCC register No.: 259865

## 2.6. EUT EXERCISE SOFTWARE

The EUT exercise program used during the testing was designed to exercise the system components. The test software is started while the EUT system is on.

## 2.7. ACCESSORIES EQUIPMENT LIST AND DETAILS

Device Type	Manufacturer	Model Name	Serial No.	Data Cable	Power Cable
Mac Book Pro	Apple. Inc	MC374CH/A	W89259FA66D	N/A	N/A

## 2.8. EUT PORT&CABLE LIST AND DETAILS

I/O Port Type	Q'TY	Cable	Tested with
(DC) Power Supply Port	1	N/A	1
USB I/O Port	1	N/A	1
Signal Port	1	One Cable, 0.15m Non-shielded	1

### 3. SUMMARY OF TEST RESULTS

Description of Test	Result
§15.203 Antenna Requirement	Compliant
§15.209 General Requirement	Compliant
§15.239 (a) Emission Bandwidth Testing	Compliant
§15.239 (b) Radiated Emission	Compliant
§15.239 (c) Out of band emission Testing	Compliant

## **4. § 15.203 - ANTENNA REQUIREMENT**

### **4.1. STANDARD APPLICABLE**

According to FCC 15.203, An intentional radiator shall be designed to ensure that no antenna other than that furnished by the responsible party shall be used with the device. The use of a permanently attached antenna or of an antenna that uses a unique coupling to the intentional radiator shall be considered sufficient to comply with the provisions of this Section. The manufacturer may design the unit so that a broken antenna can be replaced by the user, but the use of a standard antenna jack or electrical connector is prohibited. This requirement does not apply to carrier current devices or to devices operated under the provisions of Sections 15.211, 15.213, 15.217, 15.219, or 15.221. Further, this requirement does not apply to intentional radiators that must be professionally installed, such as perimeter protection systems and some field disturbance sensors, or to other intentional radiators which, in accordance with Section 15.31(d), must be measured at the installation site. However, the installer shall be responsible for ensuring that the proper antenna is employed so that the limits in this Part are not exceeded.

### **4.2. TEST RESULT**

This product has a permanent antenna, fulfill the requirement of this section.



## 5.§15.209, §15.239 (b)(c)- RADIATED EMISSION

### 5.1. MEASUREMENT UNCERTAINTY

Based on NIS 81, The Treatment of Uncertainty in EMC Measurements, the best estimate of the uncertainty of a radiation emissions measurement is +3.0 dB.

### 5.2. STANDARD APPLICABLE

According to §15.239(b), The field strength of any emissions within the permitted 200 kHz band shall not exceed 250 microvolts/meter at 3 meters. The emission limit in this paragraph is based on measurement instrumentation employing an average detector. The provisions in §15.35 for limiting peak emissions apply.

According to §15.239(c), The field strength of any emissions radiated on any frequency outside of the specified 200 kHz band shall not exceed the general radiated emission limits in §15.209.

### 5.3. TEST EQUIPMENT LIST AND DETAILS

Equipment	Manufacturer	Model	S/N	Cal. Date	Cal. Due
PSA SERIES SPECTRUM ANALYZER	AGILENT	E4440A	US41421290	06/29/2010	06/28/2011
BICONICAL ANTENNA	A.H.	SAS-521-4	128	06/29/2010	06/28/2011
LOOP ANTENNA	R&S	HM525	N/A	06/29/2010	06/28/2011
HORN ANTENNA	EM	EM-AH-10180	N/A	06/29/2010	06/28/2011
AMPLIFIER	EM	EM30180	0607030	06/29/2010	06/28/2011
COAXIAL CABLE	SCHWARZBECK	AK9513	9513-10	06/29/2010	06/28/2011
POSITIONING CONTROLLER	MF	MF-7802	MF780208147	06/29/2010	06/28/2011

### 5.4. TEST PROCEDURE

The setup of EUT is according with per ANSI C63.4-2003 measurement procedure. The specification used was with the FCC Part 15.239(b) and FCC Part 15.209 Limit.

### 5.5. TEST SET-UP (BLOCK DIAGRAM OF CONFIGURATION)

**BELOW 30MHz:**

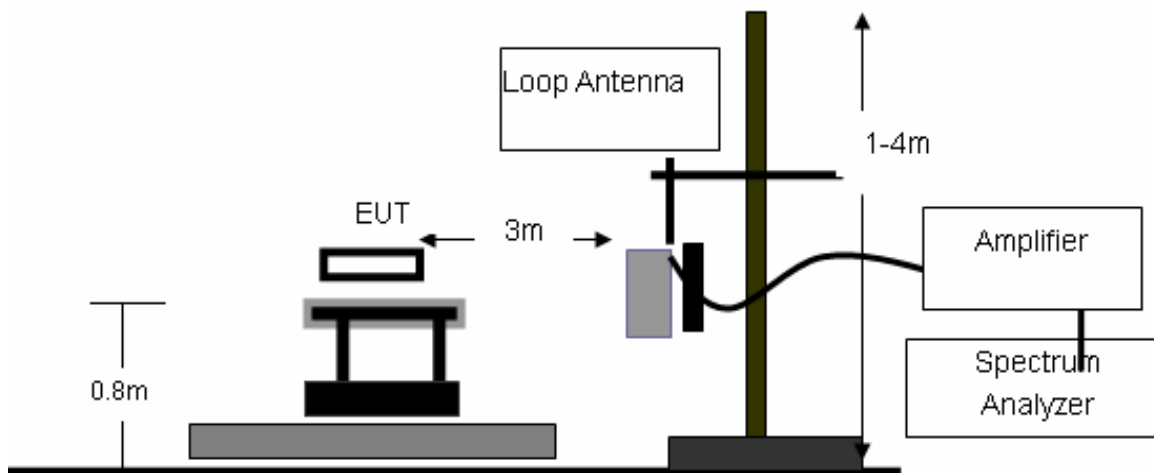

**30MHz-1000MHz:**

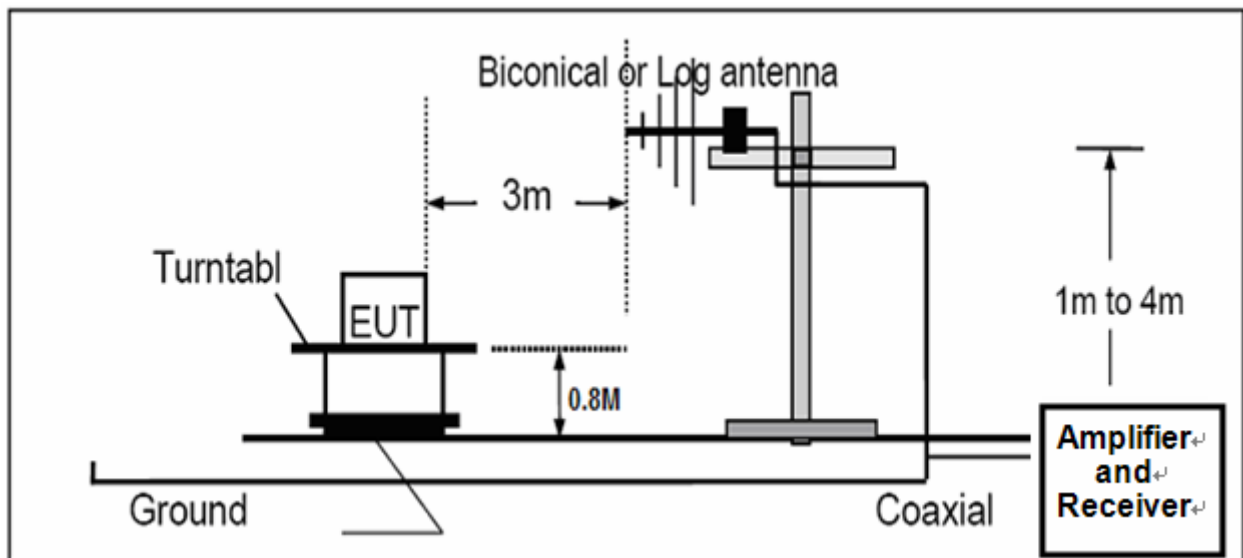

**ABOVE 1000MHz:**

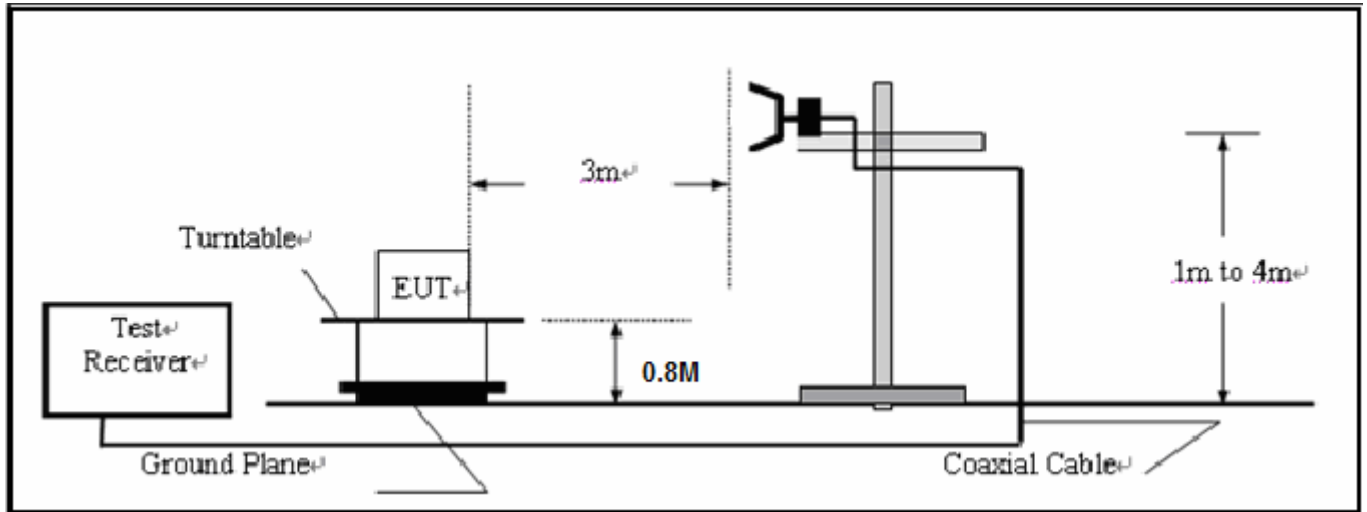



**TEST RESULT OF RADIATED EMISSION TEST (30MHZ-1GHZ)**

Refer to the attached plots.

**Low Channel (88.1MHz) :**

Horizontal:

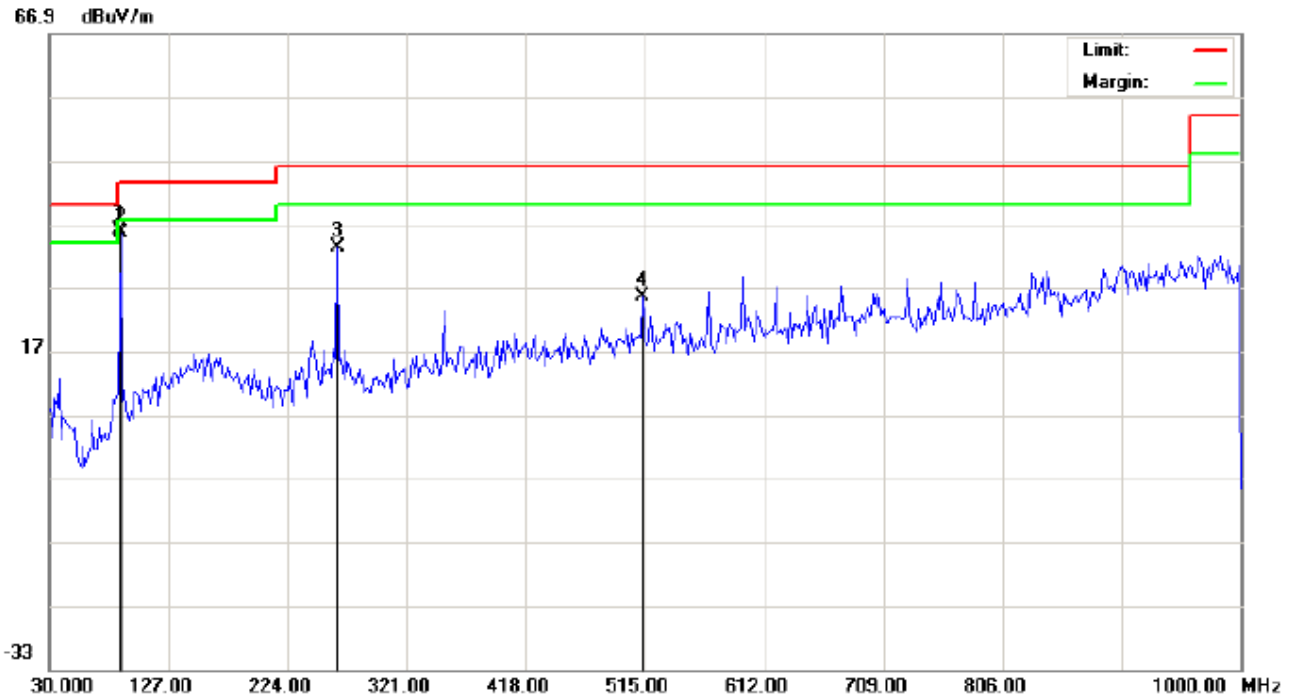

Site: site #1	Polarization: <i>Horizontal</i>	Temperature: 26
Limit: FCC Class B 3M Radiation	Power:	Humidity: 60 %
EUT: FM transmitter	Distance: 3m	
M/N: F2		
Mode:		
Note:		

No.	Mk	Freq.	Reading	Factor	Measurement	Limit	Over	Detector	Antenna Height	Table Degree	Comment
		MHz	dBuV	dB/m	dBuV/m	dBuV/m	dB		cm	degree	
1	*	88.1052	26.59	11.93	38.42	68.00	-29.58	peak			
2		88.1052	26.59	11.93	35.54	48.00	-12.46	AVG			
3		264.4166	16.26	16.94	33.20	46.00	-12.80	peak			
4		513.3832	2.46	23.18	25.64	46.00	-20.36	peak			

Vertical:

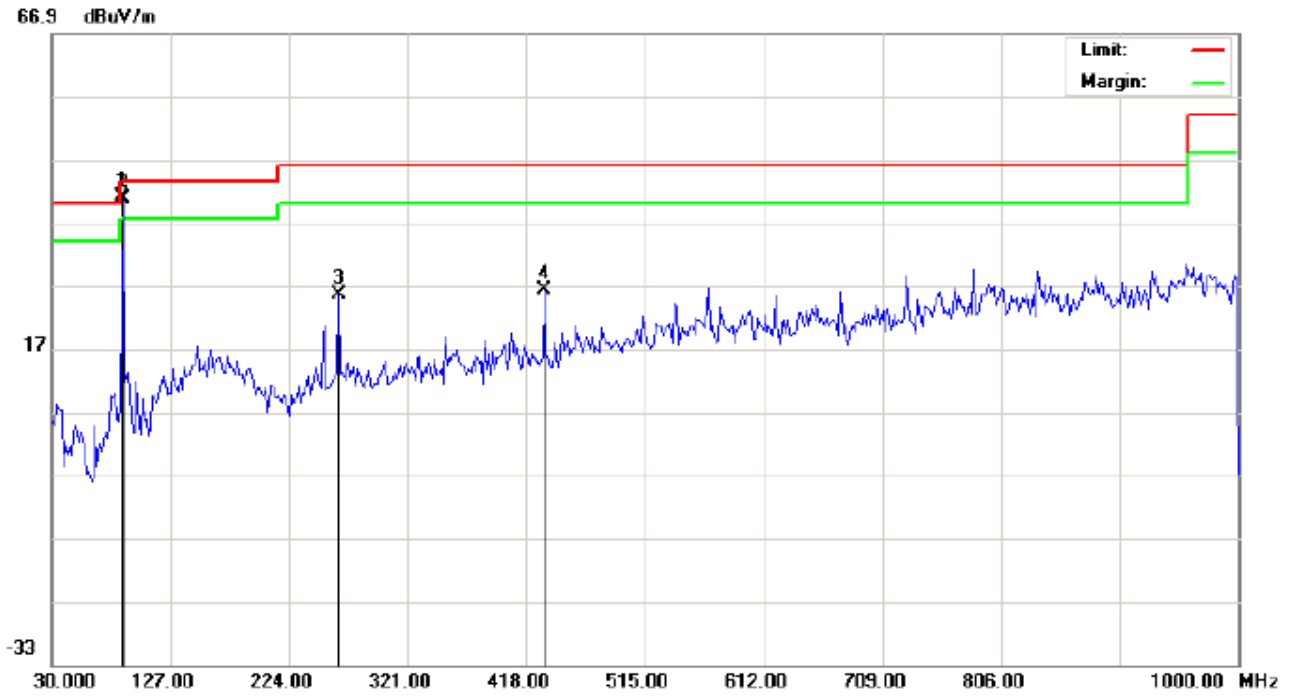

Site: site #1  
Limit: FCC Class B 3M Radiation  
EUT: FM stransmitter  
M/N: F2  
Mode:  
Note:

Polarization: *Vertical*  
Power:  
Distance: 3m

Temperature: 26  
Humidity: 60 %

No.	Mk	Freq.	Reading	Factor	Measurement	Limit	Over	Detector	Antenna	Table	Comment
		MHz	dBuV	dB/m	dBuV/m	dBuV/m	dB		Height	Degree	
									cm	degree	
1	*	88.1124	32.49	9.94	42.43	68.00	-25.57	peak			
2		88.1124	30.81	9.94	40.75	48.00	-7.25	AVG			
3		264.4166	8.26	17.23	25.49	46.00	-20.51	peak			
4		432.5500	4.90	21.47	26.37	46.00	-19.63	peak			

**Middle Channel (98.1MHz) :**

Horizontal:

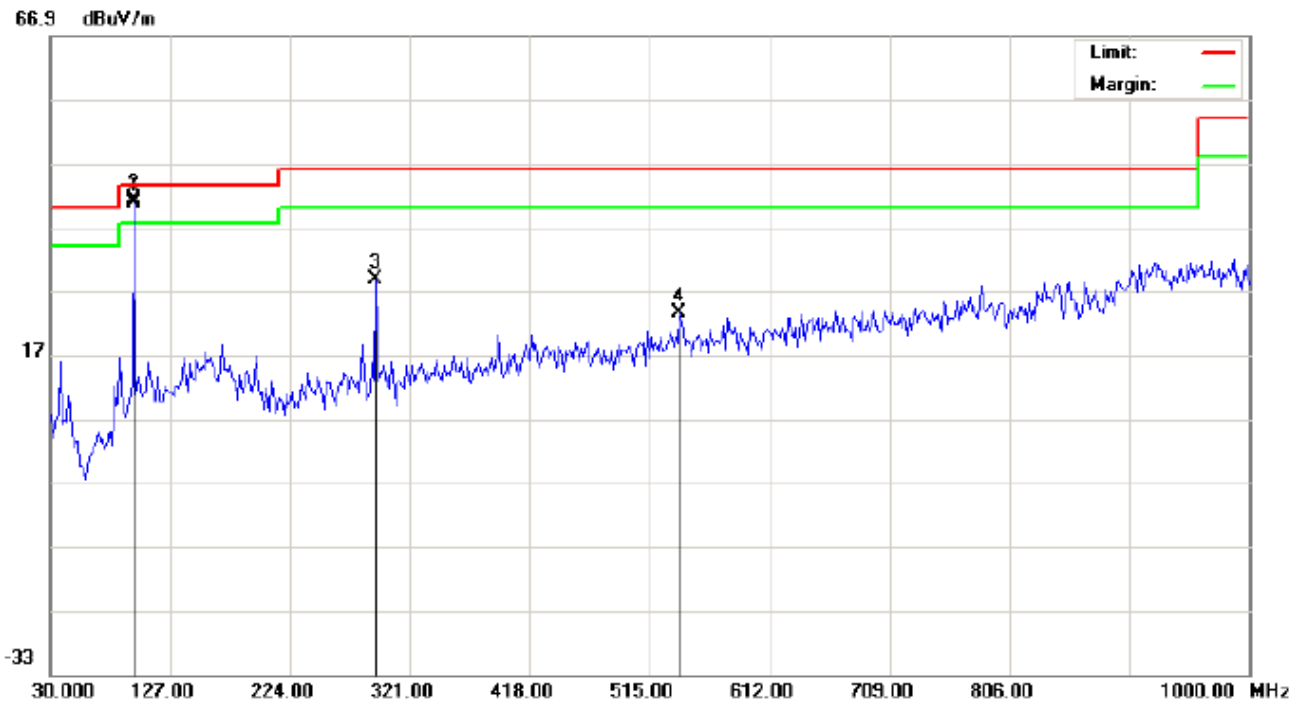

Site: site #1	Polarization: <i>Horizontal</i>	Temperature: 26
Limit: FCC Class B 3M Radiation	Power:	Humidity: 60 %
EUT: FM stransmitter	Distance: 3m	
M/N: F2		
Mode:		
Note:		

No.	Mk	Freq.	Reading	Factor	Measurement	Limit	Over	Detector	Antenna Height	Table Degree	Comment
		MHz	dBuV	dB/m	dBuV/m	dBuV/m	dB		cm	degree	
1	*	98.1002	28.83	13.89	42.72	68.00	-25.28	peak			
2		98.1002	27.30	13.89	41.19	48.00	-6.81	AVG			
3		293.5167	11.78	17.06	28.84	46.00	-17.16	peak			
4		539.2500	0.12	23.43	23.55	46.00	-22.45	peak			

Vertical:

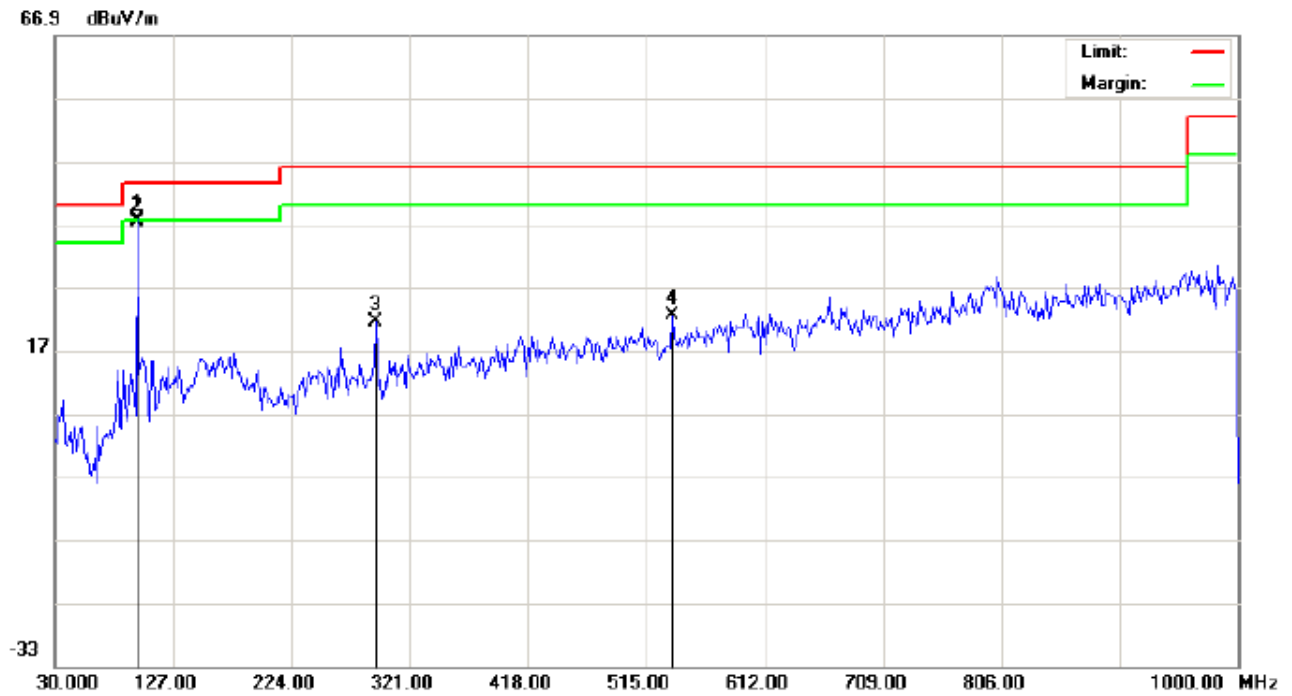

Site: site #1	Polarization: <i>Vertical</i>	Temperature: 26
Limit: FCC Class B 3M Radiation	Power:	Humidity: 60 %
EUT: FM transmitter	Distance: 3m	
M/N: F2		
Mode:		
Note:		

No.	Mk	Freq.	Reading	Factor	Measurement	Limit	Over	Detector	Antenna Height	Table Degree	Comment
		MHz	dBuV	dB/m	dBuV/m	dBuV/m	dB		cm	degree	
1	*	98.1083	28.54	10.15	38.69	68.00	-29.31	peak			
2		98.1083	27.02	10.15	37.17	48.00	-10.83	AVG			
3		293.5167	4.48	17.06	21.54	46.00	-24.46	peak			
4		536.0167	-0.98	23.41	22.43	46.00	-23.57	peak			



**High Channel (107.9MHz) :**

Horizontal:

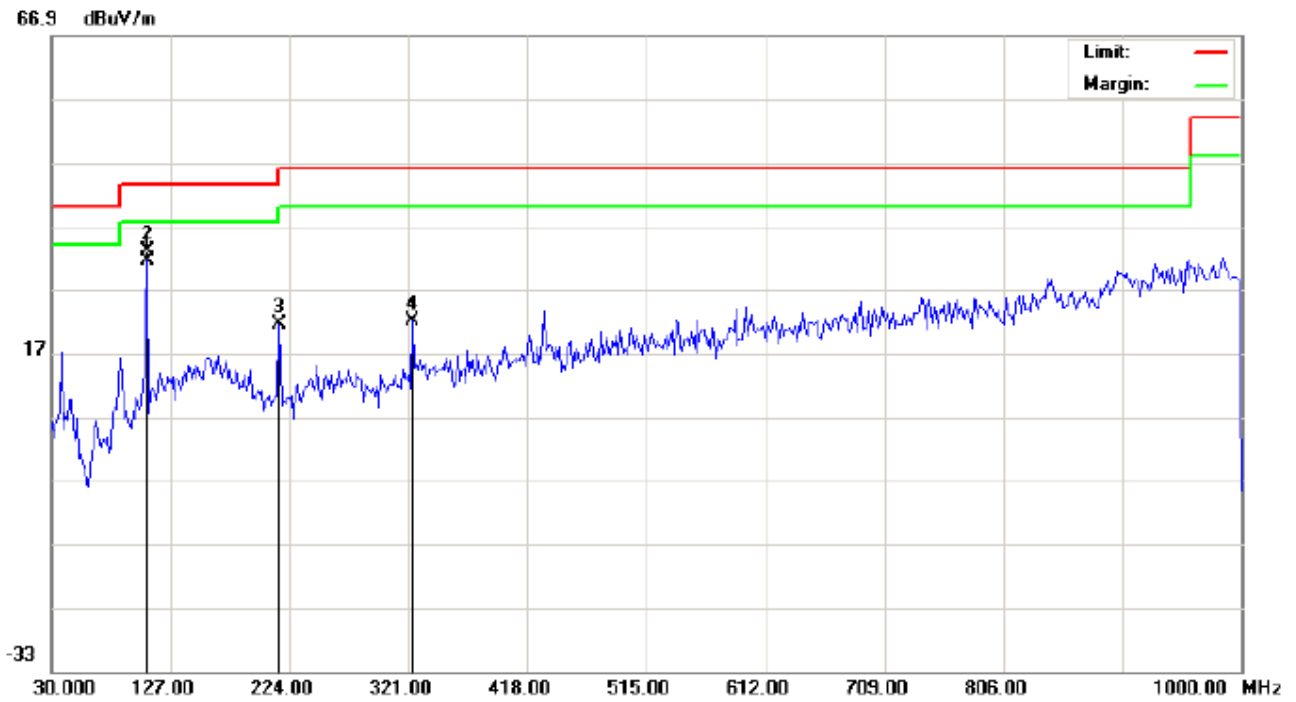

Site: site #1	Polarization: <i>Horizontal</i>	Temperature: 26
Limit: FCC Class B 3M Radiation	Power:	Humidity: 60 %
EUT: FM transmitter	Distance: 3m	
M/N: F2		
Mode:		
Note:		

No.	Mk	Freq.	Reading	Factor	Measurement	Limit	Over	Detector	Antenna Height	Table Degree	Comment
		MHz	dBuV	dB/m	dBuV/m	dBuV/m	dB		cm	degree	
1	*	107.9066	18.50	16.02	34.52	68.00	-33.48	peak			
2		107.9066	17.04	16.02	33.06	48.00	-14.94	AVG			
3		215.9166	6.93	14.56	21.49	43.50	-22.01	peak			
4		324.2332	3.53	18.45	21.98	46.00	-24.02	peak			

Vertical:

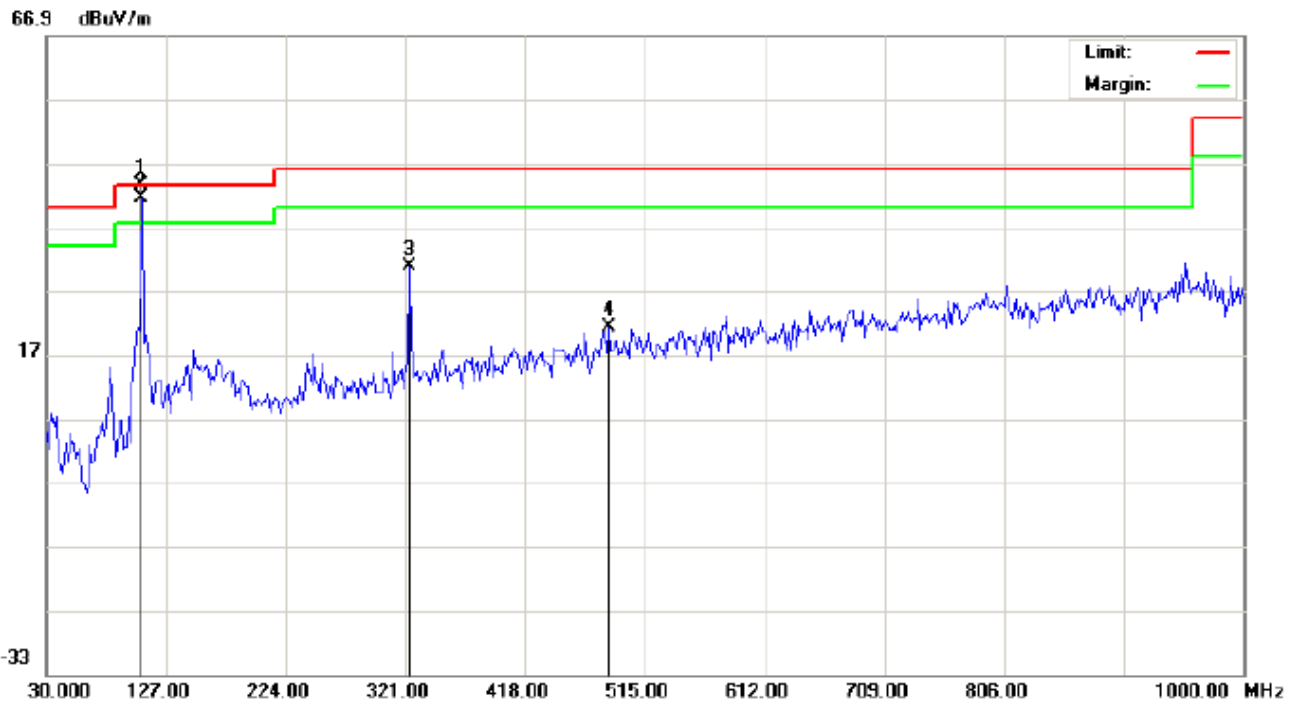

Site: site #1  
Limit: FCC Class B 3M Radiation  
EUT: FM stransmitter  
M/N: F2  
Mode:  
Note:

Polarization: *Vertical*  
Power:  
Distance: 3m

Temperature: 26  
Humidity: 60 %

No.	Mk	Freq.	Reading	Factor	Measurement	Limit	Over	Detector	Antenna Height	Table Degree	Comment
		MHz	dBuV	dB/m	dBuV/m	dBuV/m	dB		cm	degree	
1	*	107.9012	32.43	11.39	43.72	68.00	-24.28	peak			
2		107.9012	30.03	11.39	41.42	48.00	-6.58	AVG			
3		324.2332	12.39	18.45	30.84	46.00	-15.16	peak			
4		485.8999	-0.85	22.05	21.20	46.00	-24.80	peak			

**TEST RESULT OF RADIATED EMISSION TEST (ABOVE 1000MHZ)**

Freq. (MHz)	Level (dB uV)	Over Limit (dB)	Limit Line (dB uV)	Remark
--	--	--	--	Seen to Note

**\*\*Note:**

*The amplitude of spurious emissions which are attenuated by more than 20dB below the permissible value has no need to be report.*



Low Channel :

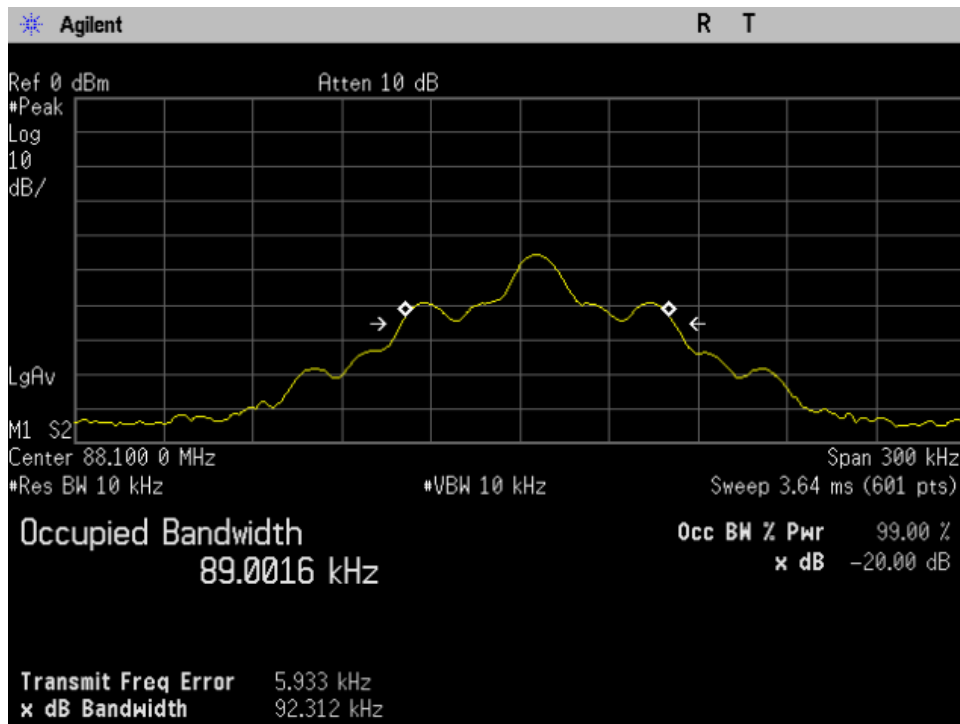

Middle Channel :

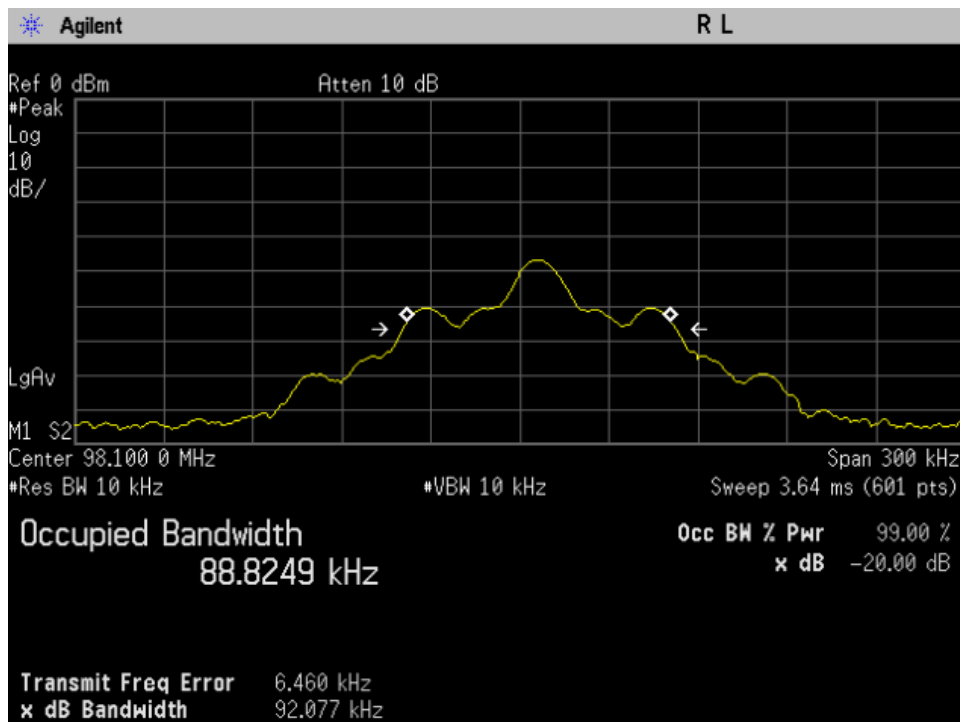

High Channel :

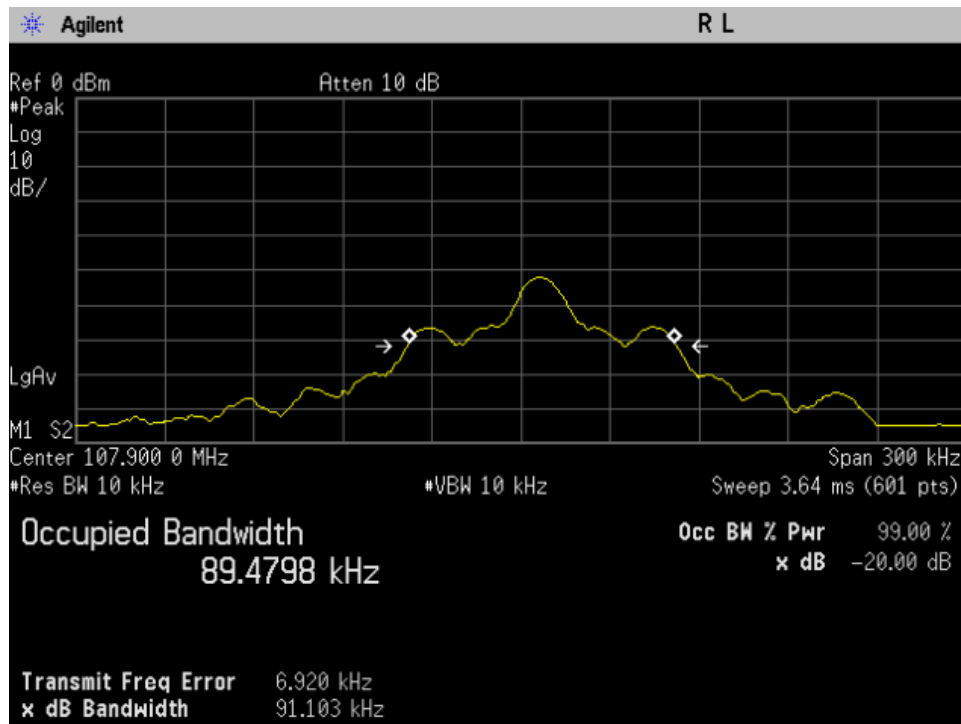



**Lower Band Edge:**

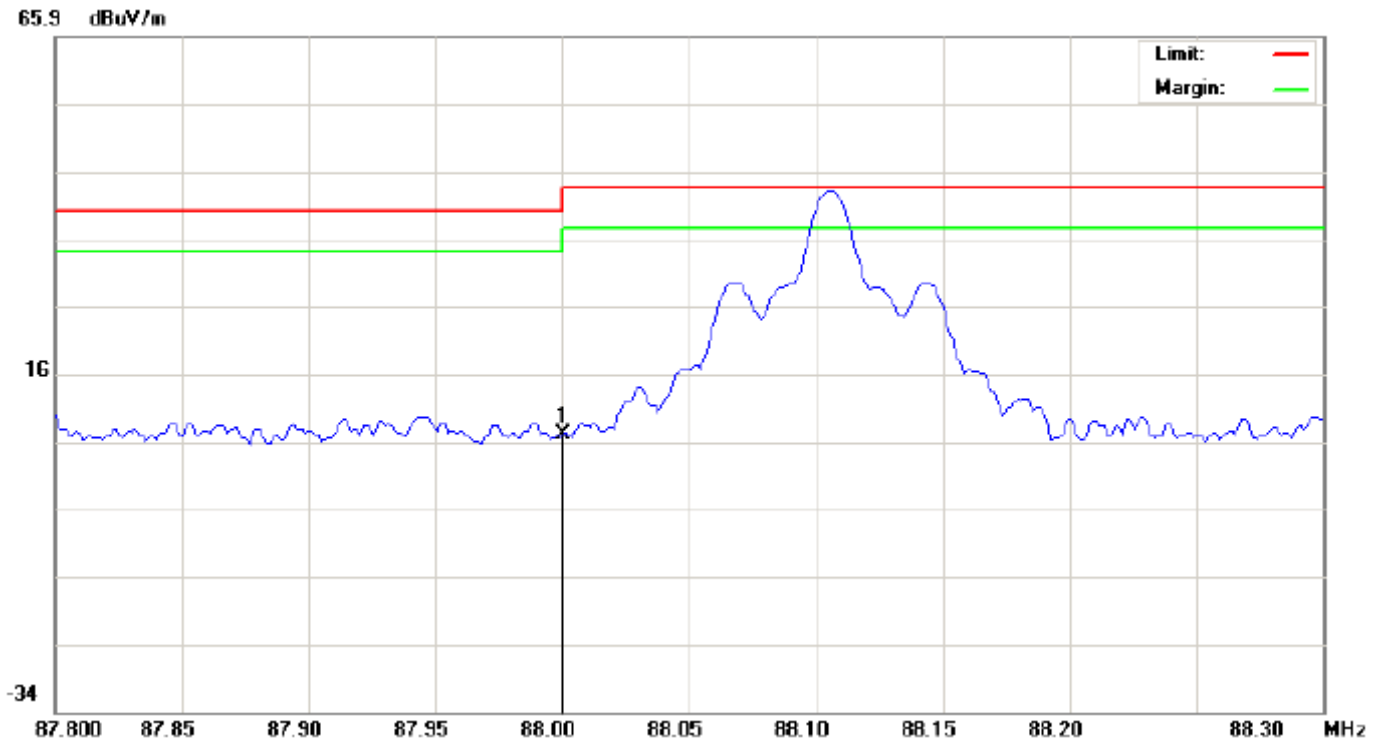

No.	Mk	Freq.	Reading	Factor	Measurement	Limit	Over	Detector	Antenna Height	Table Degree	Comment
		MHz	dBuV	dB/m	dBuV/m	dBuV/m	dB		cm	degree	
1	*	88.0000	-4.79	11.90	7.11	40.00	-32.89	peak			



Upper Band Edge:

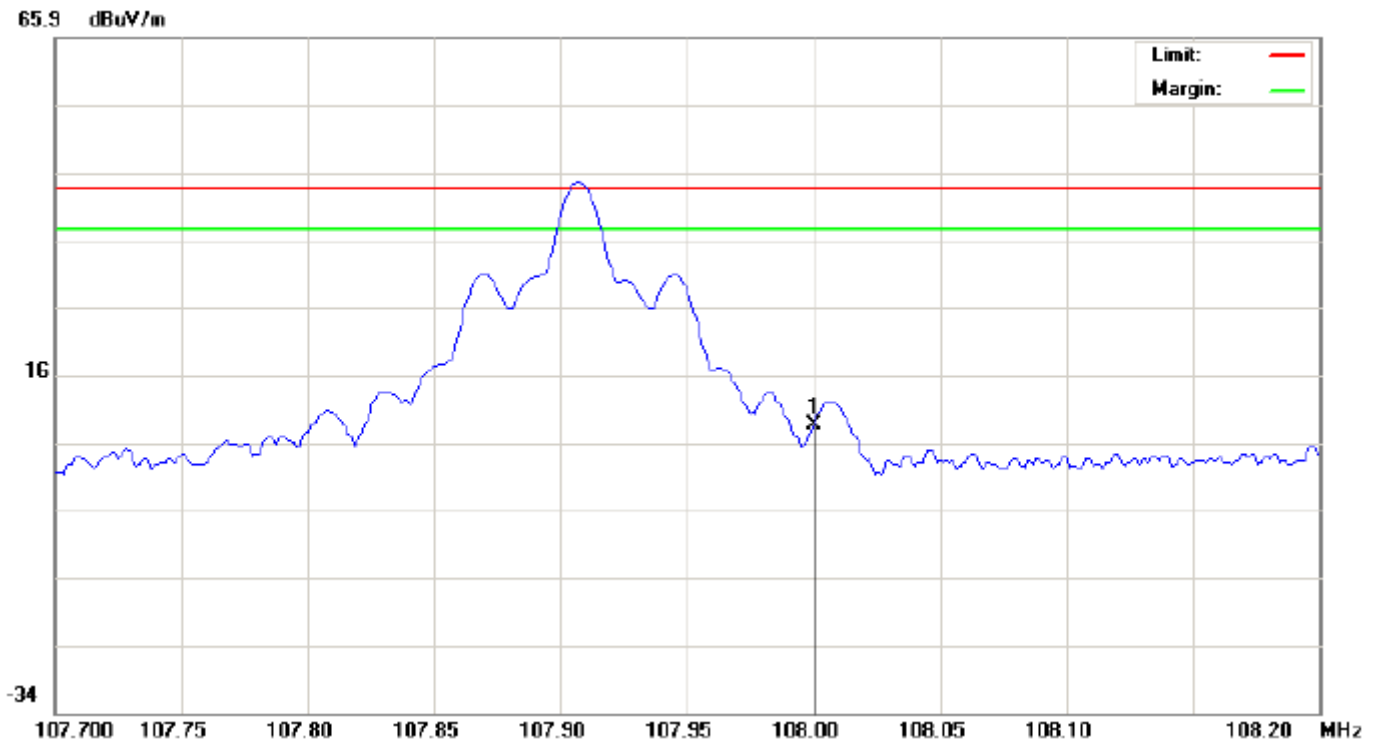

No.	Mk	Freq.	Reading	Factor	Measurement	Limit	Over	Detector	Antenna Height	Table Degree	Comment
		MHz	dBuV	dB/m	dBuV/m	dBuV/m	dB		cm	degree	
1	*	108.0000	-7.42	16.03	8.61	43.50	-34.89	peak			

## APPENDIX 1 PHOTOGRAPHS OF TEST SETUP

Radiated Emission Test Setup (Below 30MHz)

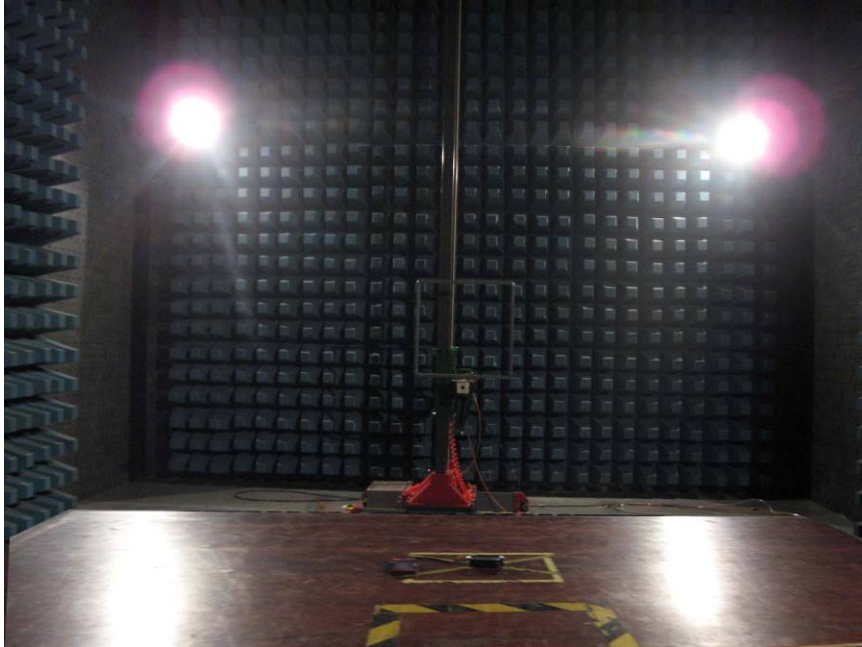

Radiated Emission Test Setup (30MHz-1000MHz)

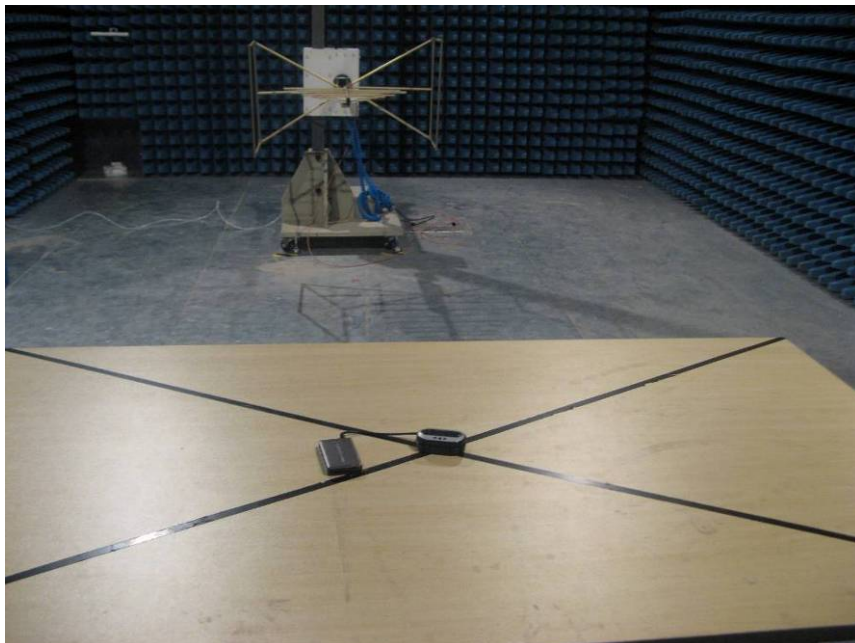

**APPENDIX 2**  
**PHOTOGRAPHS OF EUT**  
FRONT VIEW OF EUT



BACK VIEW OF EUT





LEFT VIEW OF EUT



RIGHT VIEW OF EUT



TOP VIEW OF EUT



BOTTOM VIEW OF EUT





VIEW OF PCB-1

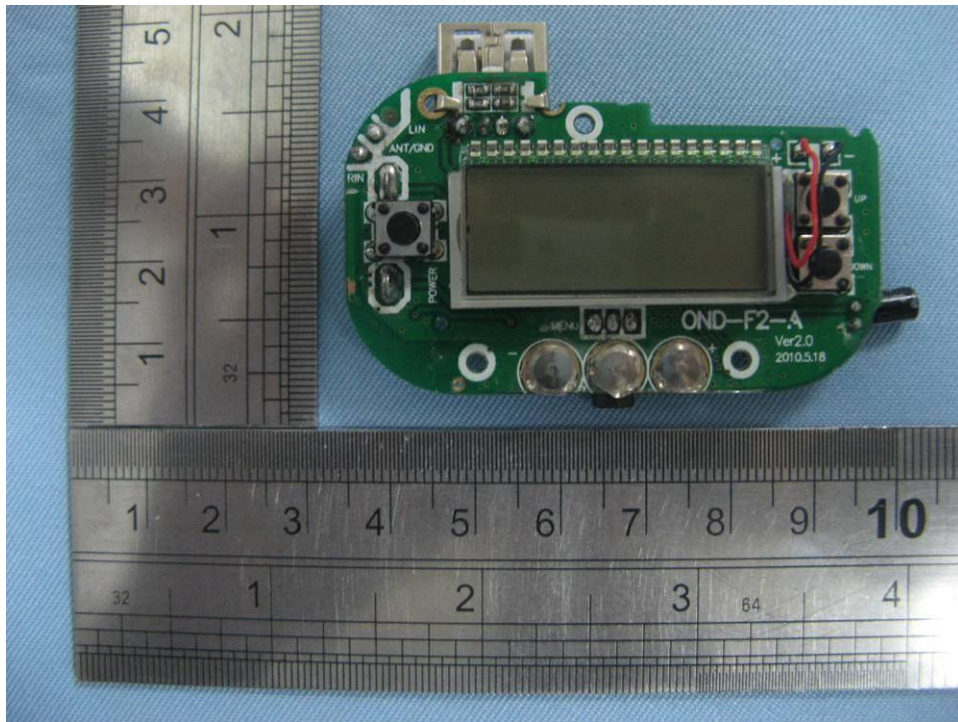

VIEW OF PCB-2

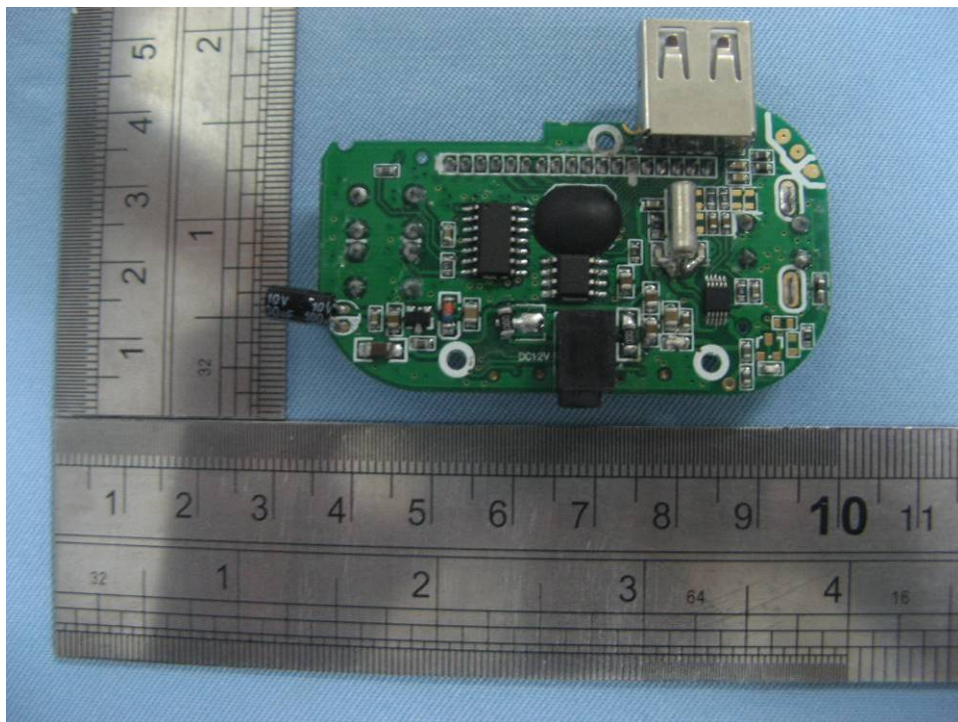

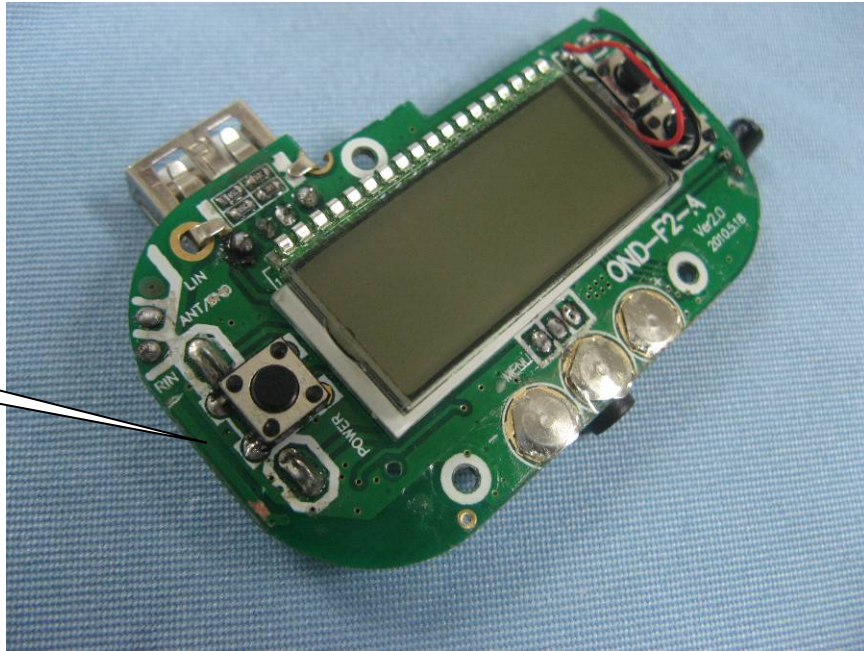

-----END OF REPORT-----